



ANIMAL HEALTH

GENERAL & SPECIALTY SURGICAL INSTRUMENTS

Sterile Procedure Trays • Instrument Care & Cleaning • Dental Instrumentation



800.221.2166 | www.sklarcorp.com



SKLAR SOAK™

INSTRUMENT PRE-SOAK & DECONTAMINANT



SKLAR SOAK is an effective pre-cleaner that breaks down bio-burden, lifting blood and other organic debris from the surface, while penetrating box locks and crevices. The rust inhibitor protects the delicate chromium oxide layer of the instrument, thus defending against rust and corrosion. Using SKLAR SOAK™ as a pre-cleaner is the first line of defense against rust, prolonging the life of the instrument and therefore protecting your investment!

SKLAR SOAK is ideal for use on all stainless steel instruments:

- PH balanced, designed specifically for stainless steel instruments.
- Intermediate level disinfectant with broad spectrum of efficacy.
- Rust resistant.
- Non-caustic.
- Ready to use.
- No special handling or disposal.
- Fragrant, no offensive odors.
- Non-glutaraldehyde.



PRODUCT NUMBER	FEATURES	QUANTITIES
10-1603	1 Gallon Bottles	4/case
10-1609	1 Gallon Bottle	1 bottle

VISIT OUR WEBSITE WWW.SKLARCORP.COM FOR MORE INFORMATION



TABLE OF CONTENTS

Care & Cleaning	3-18	Dental	273-311
Scissors	19-52	Rodent	312-315
Forceps	53-88	Syringes	316
Needle Holders	89-102	Post Mortem	317-318
Retractors	103-116	Surgi-OR™	319-326
Hooks	117-120	Merit™	327-337
Rasps	121-124	Econo™ Sterile	338-347
Dilators	125-128	Instrument Sets	348-350
Trocars	129	Blades & Scalpels	351-354
Ear Instruments	130-135	Diagnostics	355-358
Microsurgery	136-145	Stethoscopes	359-364
Ophthalmic	146-158	Sterile Trays	365-370
Suction & Aspiration	159-163	Wound Care	371-374
Grooming Shears	164-165	Protective Apparel	375
Nail & Hoof	166-168	Disposables	376-387
Orthopedic	169-191	Stainless Steelware	388-406
Teat Instruments	192-193	Plasticware	407-409
Gynecology & Obstetrics	194-197	Plastic Instruments	410-412
Spay, Neuter & Castration	198	Instrument ID & Protectors	413-414
Electrosurgery	199-214	Brushes	415-420
Laparoscopic	215-244	Care & Cleaning	421-435
Care & Cleaning	245-259	Equipment	436-440
Suturing	260-268	Index	441-488
Sutures	269-272		



© Copyright 2012.
 Sklar Corporation, West Chester, PA. All rights reserved. No portion of this catalog may be reproduced without written permission of Sklar.

**DISCLAIMERS:**

Sklar offers a full line of quality surgical products and services to meet your needs.

Product information within this catalog is intended to provide general information about Sklar, its products and services and makes no representation either expressed or implied to the contrary. It is not meant to provide specialist advice or instructions concerning the products available from Sklar. For additional information and special inquiries concerning our products and services, please contact Sklar directly.

In an effort to continually improve our product line, Sklar reserves the right to change patterns without notice. Contact your sales representative to verify availability.

In no event is Sklar liable for any incidental, special or exemplary damages or loss of profits in connection with the use of a Sklar Instrument or Product.

Convenience Kits (FDA recognized term) illustrated in this catalog are representative of Sklar's assembly capability. The final design and approval of the kit is the responsibility of the customer and will be managed in accordance with the Sklar Design and Development process.

Sklar Corporation
889 S. Matlack Street
West Chester, PA 19382

Phone: 800.221.2166
Fax: 610.696.9007
Email: Surgi@sklarcorp.com

ORDERS

- Sklar's full line of Instrument Products are available through any authorized Sklar Distributor. Contact our Customer Service Department at 800.221.2166 to locate a Sales Representative in your area.
- Customers with established accounts and in good standing are subject to Net 30 days from date of invoice. Poor credit conditions can result in denial, delay or cancellation of orders.

SHIPMENTS

- Pricing is FOB West Chester PA unless otherwise noted and may be subject to change. Shipping schedules are approximate and subject to change without notice. Same day shipping is available. Standard orders will be shipped via the carrier of Sklar's choice. Special shipping requests will be accepted but additional handling charges are applicable.
- All Sklar instruments and product are carefully inspected prior to shipment. Customers shall inspect all items upon receipt and file a claim within (10) days of receipt of shipment.

WARRANTY

- Instruments and Products are recommended for their intended use only, and require continuous and proper care. Misuse can damage instruments and products and void the warranty.
- All Sklar instruments are guaranteed to be free from defect in material and workmanship. Defective instruments may be returned for repair or replacement at no charge. Repair or replacement is at the discretion of Sklar. Warranty is void on any instrument serviced by any company other than Sklar Instrument Repair Services.
- Sklar offers a variety of supplementary surgical products. These products are held to high standards for material and craftsmanship and some are subject to a limited warranty (vary by product).
- Standard sterile kits may be returned within 30 days, provided sterility of the inner packs have not been compromised, package is unopened and resalable.
- Most cleaning products are non-returnable.

RETURNS

- A Returned Goods Authorization (RGA) number must be obtained prior to returning products to Sklar. Contact our Customer Service Department at 800.221.2166 for authorization and complete return instructions. Following an investigation, any credit, repair or replacement will be issued at Sklar's discretion.





Sklar is pleased to offer a full line of Care & Cleaning agents to disinfect, decontaminate, sterilize, lubricate and protect your stainless steel surgical instruments and equipment. For expert care of your surgical instruments at every stage of the cleaning process, trust Sklar to deliver the right cleaning agent for you.



3 EASY STEPS FOR THE CARE AND CLEANING OF YOUR INSTRUMENTS

1 DECONTAMINATION

Sklar Disinfectants are a pre-cleaner and disinfectant for the safe decontamination of soiled surgical instruments, medical and surgical equipment and inanimate surfaces including plastics, stainless steel, chrome, glass, Plexiglas and baked on painted surfaces. Disinfectants are effective against a broad range of pathogens in as little as 2 minutes.



2 CLEANING

Sklar carries a complete line of effective detergents and enzymatics for cleaning, not only for your surgical instruments, but also metals, glassware, plastic and rubber. Available in your choice of powder, liquid concentrate or spray foams.



3 LUBRICATION

To guarantee extended life and performance of your surgical instruments, choose one of Sklar's lubricants or sprays as the final step in your instrument processing regimen. Specifically designed to protect against corrosion, rust and staining, Sklar offers several different types of lubricants to protect your investments.





SKLAR-CIDE™

HIGH LEVEL DISINFECTING/STERILIZING SOLUTION

Sporicidal • Bactericidal • Virucidal • Fungicidal

SKLAR-CIDE provides a safe and efficient means for the high-level disinfection or sterilization of medical, ophthalmic, dental and surgical devices including endoscopes and lensed instruments. It may be used as a standard soak solution or in automatic reprocessing units set at room temperature. Unlike other solutions, there is no need to increase the solution temperature to provide high-level disinfection in 25 minutes.

SKLAR-CIDE is a surfactant-free, activated glutaraldehyde liquid chemical sterilant and high-level disinfectant. Its active ingredient is glutaraldehyde in a nominal concentration of 3%. When the powdered activator is added, the solution turns green in color to indicate its readiness for use. In addition to the active ingredient, this ready-to-use solution contains buffers, wetting agents, and a rust and corrosion inhibitor and it has a pleasant fragrance.

SKLAR-CIDE produces high-level disinfection at room temperature in as little time as 25 minutes, and complete sterilization in 10 hours at room temperature.

- Reusable for 28 days instead of 14, safer and saves time and money.
- Surfactant free - Will not damage scope surfaces or cloud lenses.
- Can be used safely on all devices, including instruments and endoscopes. No need to stock several products.



PRODUCT NUMBER	FEATURES	QUANTITIES
10-1623	28 HLD 1 Gallon Bottles	4/case
10-1624	28 HLD 1 Gallon Bottle	1 bottle

GLUTARALDEHYDE STRIPS

PRODUCT NUMBER	FEATURES	QUANTITIES
96-4105	2.1% MEC 60 Strips / Bottle	2 bottles/ case





SKLAR DISINFECTANT

READY-TO-USE SPRAY SURFACE DISINFECTANT

2 MINUTE KILL TIME!

- Ready to use, non-toxic formula.
- Specially formulated for the control of cross contamination.
- Effective against H1N1, MRSA, Salmonella, Parvo, Feline Leukemia, Herpes Simplex, Distemper, Ringworm, Strangles.
- Safe for all areas of the facility.
- Satisfies OSHA's Bloodborne Pathogen Standards.
- Non-irritating formula.
- EPA registered.

PRODUCT NUMBER	FEATURES	QUANTITIES
10-1643	24 oz. Spray Bottles	6/case
10-1642	24 oz. Spray Bottle	1 bottle
10-1653	1 Gallon Bottles	4/case
10-1654	1 Gallon Bottle	1 bottle
10-1644	2.5 Gallon Bottles	2/case





SKLAR DISINFECTANT SURFACE WIPES

READY-TO-USE, PRE-MOISTENED TOWELETTES

2 MINUTE KILL TIME!

**SAME EFFECTIVE FORMULA AS
SKLAR DISINFECTANT!**

- Ready to use, non-toxic formula.
- Specially formulated for the control of cross contamination.
- Effective against H1N1, MRSA, Salmonella, Parvo, Feline Leukemia, Herpes Simplex, Distemper, Ringworm, Strangles.
- Safe for all areas of the facility.
- Satisfies OSHA's Bloodborne Pathogen Standards.
- Destroys odor-causing bacteria.
- 7" x 10" non-woven, tear resistant towelette.
- Clean scent.
- EPA registered.



KILLS MRSA AND H1N1 VIRUS

PRODUCT NUMBER	FEATURES	QUANTITIES
10-1616	100 Towelettes / Canister	6/case
10-1617	100 Towelettes / Canister	12/case



SKLAR SPRAY-ZYME™

SURGICAL INSTRUMENT PRE-CLEANER

Multi-Enzyme Based Instrument Presoak & Cleaner Foam Spray Cleaner

The newest product from Sklar for expert care of your surgical instruments. This multi-enzymatic spray creates a heavy foam which lasts for hours, keeping soiled instruments moist to avoid encrustation while also pre-cleaning prior to processing.

- Prevents Organic Encrustation - enzyme foam stops blood and bodily fluids from drying onto surgical instruments.
- No More Spills - messy spills between the operating room and central cleaning /processing department are eliminated.
- Neutral pH - safe and effective for stainless steel, tungsten carbide, aluminum and brass instruments.
- Bacteriostatic - microbiological control agents inhibit bacterial growth in the ready-to-use foam solution.
- Long Lasting Foam - saves time, foam lasts many hours after application.
- Multi-Enzymatic - contains a synergistic blend of lipase and protease enzymes.

PRODUCT NUMBER	FEATURES	QUANTITIES
10-2722	22 oz. Refillable Spray Bottles	12/case
10-2724	1 Gallon Bottles	4/case

SKLAR-ZYME™ POUCHES

CONVENIENT VALUE

Each pouch of SKLAR-ZYME produces one gallon of enzymatic detergent. This convenient, easy to use product guarantees very little waste and is ideal for the office or smaller surgical setting.

PRODUCT NUMBER	FEATURES	QUANTITIES
10-2774	½ oz. Pouches	32/box





SKLAR SOAK™

INSTRUMENT PRE-SOAK & DECONTAMINANT RUST RESISTANT!

Immersing soiled instruments in SKLAR SOAK effectively pre-cleans and decontaminates, without fear of rusting! SKLAR SOAK is an effective pre-cleaner that breaks down bio-burden, lifting blood and other organic debris from the surface, while penetrating box locks and crevices. The rust inhibitor protects the delicate chromium oxide layer of the instrument, thus defending against rust and corrosion. Using SKLAR SOAK™ as a pre-cleaner is the first line of defense against rust, prolonging the life of the instrument and therefore protecting your investment!

Soaking for only two minutes thoroughly decontaminates instruments, reducing the risk of exposure to pathogens such as N1H1, MRSA, Salmonella, Parvo, Feline Leukemia, Herpes Simplex, Distemper, Ringworm, Strangles. However, because SKLAR SOAK™ contains a rust inhibitor, instruments may soak for several hours without fear of rusting! Employees are protected from cross contamination, and at the same time can enjoy the freedom to reprocess instruments when it's convenient!

SKLAR SOAK is ideal for use on all stainless steel instruments:

- PH balanced, designed specifically for stainless steel instruments.
- Intermediate level disinfectant with broad spectrum of efficacy.
- Rust resistant.
- Non-caustic.
- Ready to use.
- No special handling or disposal.
- Fragrant, no offensive odors.
- Non-glutaraldehyde.



PRODUCT NUMBER	FEATURES	QUANTITIES
10-1603	1 Gallon Bottles	4/case
10-1609	1 Gallon Bottle	1 bottle



SKLAR INSTRU-GUARD™ ONE STEP

**A “ONE STEP” INSTRUMENT
CLEANER AND LUBRICANT**

EXTENDS INSTRUMENT LIFE!

SKLAR INSTRU-GUARD ONE STEP contains a penetrating lubricant that protects and helps extend the life of surgical instruments. The detergents and emulsifiers quickly break up and remove organic soils from box locks and other hard to reach places.

SKLAR INSTRU-GUARD ONE STEP contains four rust inhibitors to control corrosion and eliminate scaling and spotting. It does not contain phosphates and can reduce the time and cost involved in processing your instruments by cleaning and lubricating in one easy step.

PRODUCT NUMBER	FEATURES	QUANTITIES
10-2800	1 Gallon Bottles	4/case
10-2801	1 Gallon Bottle	1 bottle





SKLAR INSTRU-GUARD™ LUBE

SURGICAL INSTRUMENT LUBRICANT / RUST INHIBITOR

- Extends the Life of Instruments.
- Protects all Surgical Instruments.

SKLAR INSTRU-GUARD LUBE is an easy-to-use, water soluble, lubricant and rust inhibitor. When used daily as a rinse after every cleaning it keeps moving parts operating smoothly and remains effective after autoclaving, but without leaving an oily residue.

Regular lubrication is essential no matter which cleaning method is employed (including ultrasonic). SKLAR INSTRU-GUARD LUBE is ideal for maintaining instrument quality and performance.

PRODUCT NUMBER	FEATURES	QUANTITIES
10-1635	1 Gallon Containers Concentrated	4/case
10-1634	1 Gallon Container Concentrated	1 container
10-1636	8 oz. Spray Bottles	12/case
10-1637	8 oz. Spray Bottle	1 bottle





SKLAR KLEEN™

LOW FOAM, LIQUID DETERGENT AND POWDERED FORMULA

Regular Formula for Manual and Ultrasonic Cleaning

SKLAR KLEEN is non-corrosive, non aggressive, phosphate free and biodegradable. We have specifically developed SKLAR KLEEN for manual and ultrasonic cleaning. It is moderately alkaline, affording optimum cleaning without etching glassware or attacking instrument metal.

Low Foam Formula for Automatic Cleaning

The SKLAR KLEEN Low Foam Liquid is concentrated in order to provide a very cost-effective solution. It is especially formulated to maintain low foam, ensuring effective and trouble-free action in washer/sterilizers and tunnel washers. Dispersing quickly, the SKLAR KLEEN Low Foam formula is also well suited for automatic injection systems.

PRODUCT NUMBER	FEATURES	QUANTITIES
10-2701	Low Foam 1 Gallon Bottles	4/case
10-1608	Powdered 5 lb. Containers	4/case
10-1607	Powdered 5 lb. Container	1 container
10-1630	Powdered 3.5 lb. Pitchers	6/case
10-2765	Powdered 3.5 lb. Pitcher	1 pitcher
10-1612	Liquid 8 oz. Bottles	6/case
10-1614	Liquid 8 oz. Bottle	1 bottle
10-1613	Liquid 1 Gallon Bottles	4/case
10-1627	Liquid 1 Gallon Bottle	1 bottle





SKLAR-SHEEN™

AUTOCLAVE AND INSTRUMENT CLEANER AND CONDITIONER

With an efficacious phosphoric acid cleaning agent, Sklar Sheen is a robust spot, stain and rust remover. Ideal for dissolving hard water deposits, use in autoclaves to quickly cut through steam sterilizer scale and deposits.

Verstile and effective, SKLAR SHEEN couples powerful stain and rust removers with corrosion inhibitors, making it tough on stains but gentle on instruments. Recondition instruments to restore them to nearly brand new working condition.

Use to clean and recondition any stainless steel surface to its original luster, including carts, trays and basins.

- Conditions for lasting protection.
- Dissolves hard water deposits.
- Frees up frozen box locks.
- Restores and extends surgical instrument life.

PRODUCT NUMBER	FEATURES	QUANTITIES
10-2730	Stain & Rust Remover	1 gallon bottle
10-2732	Stain & Rust Remover	4/case
10-2736	Spray Foam Autoclave Cleaner & Conditioner	22oz. bottle
10-2738	Spray Foam Autoclave Cleaner & Conditioner	12/case





SKLAR ENZYMATIC™ DETERGENT

MULTI-ENZYME DETERGENT CONCENTRATE

100% Biodegradable

SKLAR ENZYMATIC Detergent is a low-foaming, fast acting detergent specifically designed for use when instruments and/or cloth materials become soiled with organic debris.

SKLAR ENZYMATIC Detergent may be used as a manual instrument cleaner as well as a pre-soak for blood-contaminated linens, clothing and instruments. It is also used in ultrasonic units and in washer/sterilizer/decontaminators. When used as directed, the enzymatic pH neutral formula is safe for use on rubber, plastic, stainless steel instruments, and surgical equipment as well as cloth.

PRODUCT NUMBER	FEATURES	QUANTITIES
10-2777	1 Gallon Bottles	4/case
10-2775	1 Gallon Bottles	2/case
10-2776	1 Gallon Bottle	1 bottle





SKLAR STAT™

INSTANT FOAM HAND SANITIZER

KILLS 99% OF GERMS IN LESS THAN 15 SECONDS!

SKLAR-STAT Instant Foam Hand Sanitizer, based on the active ingredient Benzalkonium Chloride, is a unique formulation featuring exceptional skin feel, conditioning and moisturizing properties. The efficacy of this product has been confirmed to reduce *S. Aureus* 99.999% and *S. Aureus* MRSA 99.9% in as little as 15 seconds. SKLAR-STAT Instant Foaming Hand Sanitizer produces a fast drying, non-sticky foam that contains unique conditioning and moisturizing ingredients, leaving the skin with a soft, silky after-feel.

PRODUCT NUMBER	FEATURES	QUANTITIES
10-2850	50 ml Pump Dispensers	24/case
10-2852	550 ml Pump Dispensers	12/case

SKLAR STAT™

AUTOMATIC FOAM DISPENSER

Motion activated, battery powered and wall-mounted, Sklar's AUTOMATIC FOAM DISPENSER allows for easy access and reduced risk of cross contamination. Ideal for use in hospitals, medical centers, offices, schools and any high-traffic public area with multiple users.



PRODUCT NUMBER	FEATURES	QUANTITIES
10-2856	Wall Mount Dispenser	1 Each
10-2854	1000ml Refill Bottles	6/case
10-2858	(2) Cases 1000ml Refill Bottles plus Free Wall Mount Dispenser	1 Set

- Alcohol-Free
- Non-Sticky
- Moisturizes and Conditions Hands

1. Pump a small amount into palm of hand.
2. Rub thoroughly over both surfaces of both hands.
3. Rub hands together briskly until dry.





SKLAR FRESH™

LIQUID SPRAY ODOR ABSORBER

SKLAR FRESH is an environmentally friendly blend of pure biodegradable organic essential oils and trace elements. It is a non-allergenic liquid spray that neutralizes odors at their source. Simply spray SKLAR FRESH directly in the air or on the source (i.e. bathrooms, refuse, soiled items from vomitus, incontinence odors, etc.)

PRODUCT NUMBER	FEATURES	QUANTITIES
10-2842	22 oz. Spray Bottles	12/case

SKLAR POLISH™

INSTRUMENT STAIN REMOVER

Non-Abrasive

SKLAR POLISH is an effective stain remover for use on all your metal surgical instruments, including stainless steel, chrome and brass. It will brighten instrument trays, basins and racks and may also be used on porcelain and tile surfaces.



PRODUCT NUMBER	FEATURES	QUANTITIES
10-1626	8 oz. Jars	12/case
10-1629	8 oz. Jars	6/case
10-1927	8 oz. Jar	1 jar





SKLAR INSTRUMENT CARE KIT

A Trio of Sklar's Care and Cleaning products to keep instruments in tiptop shape.

PRODUCT NUMBER	FEATURES	QUANTITIES
10-1625		
	Sklar Lube™ 8 oz. Spray Bottle	1 each
	Sklar Kleen™ Liquid 8 oz. Bottle	1 each
	Sklar Polish™ 8 oz. Jar	1 each
	Stainless Steel Bristle Cleaning Brush	1 each
	Nylon Bristle Cleaning Brush	1 each



TROUBLE SHOOTING

NO STEEL IS TRULY “STAINLESS”

It's a fact that so-called stainless steel is subject to both water-spotting and staining. However what many people identify as a “rust” problem usually turns out to be something else.

Most often the problem is actually a stain caused by a surface deposit. These deposits appear in a variety of colors depending upon the type of deposit involved. Once the cause is found and eliminated, most of the time the problem quickly diminishes or disappears completely.

As you probably know, stainless steel is ideally suited for the surgical suite because it is rust resistant, it can be honed to an extremely sharp edge or fine point,

and it can be hardened to maintain the delicate, yet precise, requirements of the surgeon. But it is this hardenable quality – the amount of carbon used during the manufacturing process – coupled with harsh chemicals and improper care that renders stainless steel susceptible to corrosion.

To protect your instrument investment, Sklar cleaning agents have been specifically formulated to provide cost effective instrument care solutions that help maintain the life and performance of your valuable stainless steel instruments.



TROUBLE SHOOTING

CORROSION

- Problem:** Debris and residue in box locks, serrations and ratchets.
- Solution:** Serrations, box locks and ratchets should be carefully cleaned and rinsed. A soft bristle brush is effective in these difficult areas.
- Problem:** Moisture remaining on the instruments within the sterile wrapped packs; excessive moisture in autoclave during sterilization and termination of cycle.
- Solution:** Preheat autoclave, drying time cannot be accelerated, open autoclave door slightly. Routinely inspect valves. Malfunctioning valves can precipitate corrosion.
- Problem:** Some local water supplies contain excessive quantities of alkali. This can manifest itself by depositing corrosive matter on the instruments.
- Solution:** It is generally accepted that cold distilled or demineralized water be used during sterilization. An alternative is to use the local water supply, while instituting a program of preventive maintenance. Carefully clean surfaces with SKLAR KLEEN™, using SKLAR POLISH™ to remove difficult stains and SKLAR LUBE™ for proper lubrication.

PITTING

- Problem:** Instruments are inevitably exposed to chemical compounds that initiate pitting. The most common are saline solutions and blood.
- Solution:** It is essential that instruments be rinsed with distilled or demineralized water and then cleaned routinely.
- Problem:** Some Non-Sklar detergents contain a chloride or have an acid base. If rinsing is not thorough, the residual detergent can precipitate pitting. Hydrochloric acid can be formed by the combination of chloride in the cleaner and steam, causing the instrument to pit.
- Solution:** Evaluate detergents without a chloride base. SKLAR KLEEN™ is recommended.
- Problem:** Instruments may be pitted when the detergent used has an excessively high pH. If instruments are not rinsed thoroughly and then autoclaved, the heat increases the effect of the solution on the instruments.
- Solution:** Use only detergents specifically developed for instrument cleaning. SKLAR KLEEN™ products are pH balanced.

BROWNISH STAIN

- Problem:** This stain is more obvious on dull finish instruments. Most likely, it is a deposit of chromium oxide. The thin hard layer protects stainless steel from corrosion precipitated by the atmosphere. The brownish film (sometimes dull blue) occurs naturally when stainless is heated. Occasionally this stain can be traced to the sterilizer. Improper cleaning compounds could contain poly phosphates that cause the copper components in the sterilizer to be deposited by electrolytic action on the stainless steel instruments.
- Solution:** Water supply to autoclave should be cold and demineralized. Use the correct amount of SKLAR KLEEN™ as recommended for best results.

BLUISH GRAY STAINS

- Problem:** Cold sterilizing solutions.
- Solution:** In the preparation of the solution make certain the manufacturer's directions are followed accurately. To minimize discoloration use distilled water and add a rust inhibitor. Using the solution beyond recommended time limitations will cause the solution to become corrosive.

RUST DEPOSIT

- Problem:** Sterilizing instruments of different metals in the same cycle will cause rusting. An electrolytic action carries the carbon particles from the exposed metal and deposits them on the stainless steel instruments. The rapid oxidation of molecules results in a surface film of rust.
- Solution:** The ideal technique would be to sterilize the two types of instruments separately. It is recommended that chrome plated instruments that indicate signs of peeling or flaking be replaced with stainless steel instruments.
- Problem:** The rust film on the surface of stainless steel instruments can be caused by chemicals in the detergent. Excess amounts of iron or other minerals from the local water supply may cause the rust deposits.
- Solution:** It is recommended that instruments be rinsed with distilled or demineralized water. Surface rust can be removed by light buffing or an application of SKLAR POLISH™.

LIGHT AND DARK COLORED SPOTS

- Problem:** Spotting caused by slow evaporation of water drops identified with the mineral content of the water.
- Solution:** Eliminate water droplets by adhering to autoclave manufacturer's operating instructions. Autoclave door should not be opened until steam has been completely vented.



100% COTTON WEAVE OR TOWELS

SKLAR COTTON OR TOWELS

- 100% Pure Cotton, Natural Feel
- Less Abrasive to Wounds
- More Absorbent
- Requires Less Storage Space
- Biodegradable & Environmentally Friendly

COTTON OR TOWELS		
Sterile		Case / 50
Product Number	96-1940	2/pk
Sterile		Case / 20
Product Number	96-1942	4/pk
Sterile		Case / 12
Product Number	96-1944	6/pk
Sterile		Case / 10
Product Number	96-1946	8/pk
COTTON OR TOWELS, BULK		
Non-Sterile		
Product Number	96-1949	420 Towels



Scissors

Sklar Edge™ Tungsten Carbide

Sklar Edge scissors are manufactured using a Sklar Exclusive edging process that permanently bonds tungsten carbide to the scissor blades. Tungsten carbide is an extremely hard alloy that provides an exceptionally strong and sharper edge while maintaining a Sklar 5-year guarantee of durability. These perfectly balanced scissors are readily identified by the dual gold finger rings.

Supercut Sklar Edge™ Tungsten Carbide SklarHone™

Supercut Sklar Edge Tungsten Carbide SklarHone Scissors combine all the advantages of tungsten carbide with the precision performance of Supercut SklarHone blades, featuring the razor sharp cutting edge of a knife on one blade and micro-serrations on the other. Easily identified with one gold handle and one black handle.

Premium

Sklar is proud to offer a full line of Premium instruments that have been modified to meet the needs of clinicians for specific procedures. Choose from a wide variety of the most popular patterns.

Supercut SklarHone™

SklarHone scissors feature a razor-like edge of a surgical knife on the upper blade designed to cut through tissue effortlessly. Combine with a micro-serrated (Supercut) lower blade to hold tissue and prevent slippage or a smooth, standard edge lower blade for a smooth, clean cutting action. SklarHone scissors are distinctively identified by their dual black handles.

SklarCut™

SklarCut improves the design and function of your most frequently used surgical instruments with the addition of ultra-fine serrations on one blade. This premium feature provides additional surgical control by holding the tissue while cutting more cleanly and with greater precision. SklarCut scissors are easily identified by the gold finger ring on the serrated blade handle.

SklarLite™ / SklarLite XD™

SklarLite premium scissors provide the clinician a lighter pattern, minimizing fatigue during prolonged procedures. A comfortable instrument that withstands the rigors of frequent use while retaining its structural integrity. SklarLite XD extra delicate scissors provide the most sensitive surgical tool as well as our lightest pattern with surprising strength. SklarLite and SklarLite XD are fully guaranteed for a lifetime of dependable use.

General Surgery Instruments

Our very best operating room, high quality instruments incorporating optimum grades of German grade surgical steel, finely detailed craftsmanship and exacting standards of manufacturing. Choose from a full line of the most popular patterns.

Surgi-OR™ Instruments

A Mid-Grade line of high-quality OR instruments, hand-crafted and forged from Japanese surgical grade stainless steel. This cost-effective line of instruments offers significant value to the Operating Room as well as other important surgical settings.

Econo™ Sterile Instruments

Econo Sterile instruments are suitable in a number of surgical venues where economical choice with reliable performance is most important. Convenient, ready-to-use sterile instruments provide the very best value with the greatest utility of any surgical instrument.





SKLAR EDGE™ TC OPERATING SCISSORS

STRAIGHT

16-1055	5½"	Sharp/Sharp
16-1056	5½"	Sharp/Blunt
16-1057	5½"	Blunt/Blunt



SKLAR EDGE™ TC OPERATING SCISSORS

CURVED

16-1155	5½"	Sharp/Sharp
16-1156	5½"	Sharp/Blunt
16-1157	5½"	Blunt/Blunt



SKLAR EDGE™ TC IRIS SCISSORS

SHARP/SHARP

16-2405	4½"	Straight
16-2505	4½"	Curved



SKLAR EDGE™ TC MAYO DISSECTING SCISSORS

BLUNT/BLUNT

16-1505	5½"	Straight
16-1605	5½"	Curved
16-1510	6¾"	Straight
16-1610	6¾"	Curved
16-1515	9"	Straight
16-1615	9"	Curved

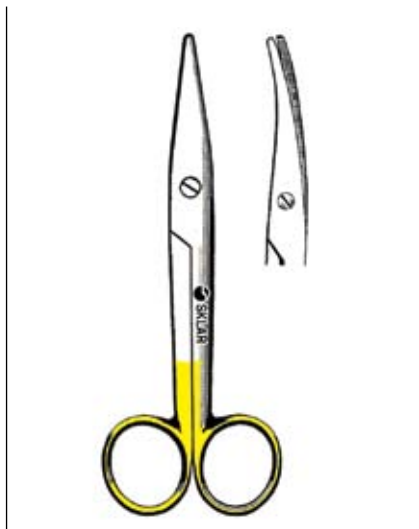

SKLAR EDGE™ TC MAYO-STILLE DISSECTING SCISSORS

16-3552	5½"	Straight
16-3562	5½"	Curved
16-3557	6¾"	Straight
16-3567	6¾"	Curved



SKLAR EDGE™ TC METZENBAUM (LAHEY) SCISSORS

BLUNT/BLUNT

16-1810	5¾"	Straight	
16-1910	5¾"	Curved	
16-1805	5¾"	Straight	Delicate
16-1905	5¾"	Curved	Delicate

SHARP/SHARP

16-1815	5¾"	Straight	Delicate
16-1915	5¾"	Curved	Delicate

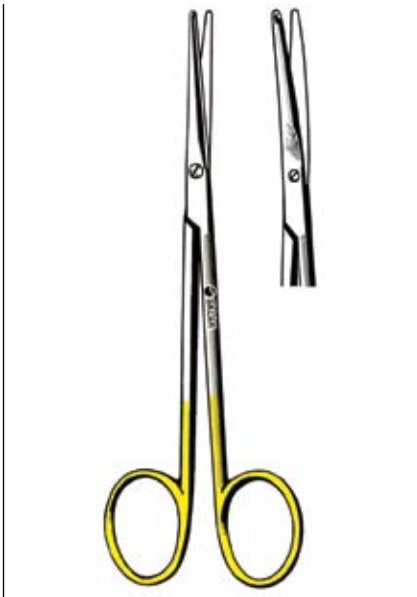

SKLAR EDGE™ TC METZENBAUM SCISSORS

STRAIGHT, BLUNT/BLUNT

- 16-2010 7"
- 16-2005 7" Delicate
- 16-2210 9"
- 16-2205 9" Delicate

STRAIGHT, SHARP/SHARP

- 16-2015 7" Delicate

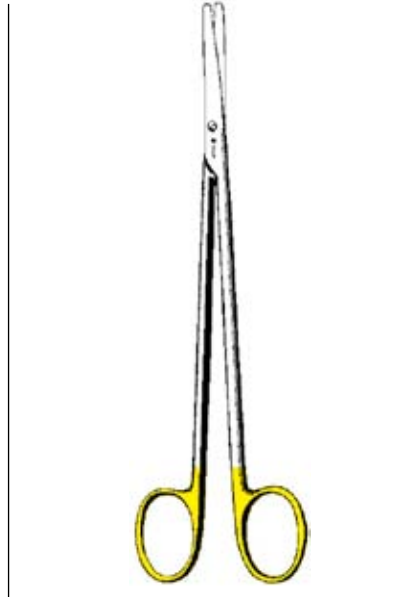

SKLAR EDGE™ TC METZENBAUM SCISSORS

CURVED, BLUNT/BLUNT

- 16-2110 7"
- 16-2105 7" Delicate
- 16-2215 8"
- 16-2310 9"
- 16-2305 9" Delicate
- 16-2211 10"
- 16-2311 11"
- 16-2312 12"

CURVED, SHARP/SHARP

- 16-2115 7" Delicate



SKLAR EDGE™ TC STRABISMUS SCISSORS

- 16-2605 4½" Straight
- 16-2705 4½" Curved

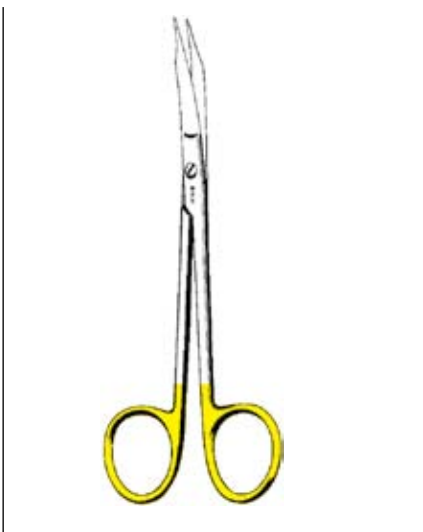

SKLAR EDGE™ TC GOLDMAN-FOX SCISSORS

- 16-3614 5" Straight Blunt
- 16-3615 5" Curved Blunt



SKLAR EDGE™ TC DISSECTING SCISSOR

- 16-2610 5" Curved

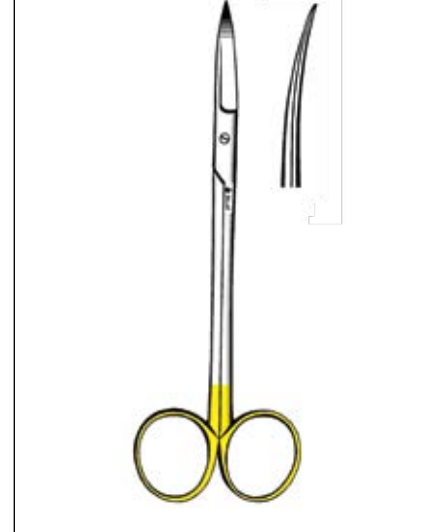

SKLAR EDGE™ TC KAYE RHYTIDECTOMY & DISSECTING SCISSOR

- 16-3620 5¾" Curved



SKLAR EDGE™ TC WIRE CUTTING SCISSOR

16-2800 4¾" Serrated Angled



SKLAR EDGE™ TC KAYE BLEPHAROPLASTY & DISSECTING SCISSOR

47-1148 4½" Curved

Z-TYPE SCISSORS

Sklar's Z-Type Hysterectomy/Parametrium Scissors are specifically designed to ideally meet the surgeon's needs during abdominal procedures. Manufactured from German grade stainless steel and under the highest quality standards, these specialized instruments provide uncompromised balance, feel and performance. With solid Tungsten Carbide inserts, Z-Type Scissors have extremely sharp, strong and precise cutting edges with lasting durability, and are specifically formed to cut tissue laterally.

PRODUCT NUMBER		DESCRIPTION
16-4000	9"	Z-Type Parametrium Scissors, Slight Curve
16-4001	9"	Z-Type Parametrium Scissors, Curved
16-4002	9"	Z-Type Parametrium Scissors, Full Curve
16-4004	10½"	Z-Type Parametrium Scissors, Slight Curve
16-4005	10½"	Z-Type Parametrium Scissors, Curved
16-4006	10½"	Z-Type Parametrium Scissors, Full Curve
16-4008	12"	Z-Type Parametrium Scissors, Slight Curve
16-4009	12"	Z-Type Parametrium Scissors, Curved
16-4010	12"	Z-Type Parametrium Scissors, Full Curve
16-4012	14"	Z-Type Parametrium Scissors, Slight Curve
16-4013	14"	Z-Type Parametrium Scissors, Curved
16-4014	14"	Z-Type Parametrium Scissors, Full Curve





SUPERCUT SKLAR EDGE™ TUNGSTEN CARBIDE SKLARHONE™ scissors combine all the advantages of durable tungsten carbide with the precision performance of Supercut SklarHone™ blades, featuring the razor sharp cutting edge of a knife on one blade and micro-serrations on the other. Easily identified with one gold handle and one black handle.



SUPERCUT TC SKLARHONE™ IRIS SCISSORS

- 16-3545 4½" Straight
- 16-3546 4½" Curved



SUPERCUT TC SKLARHONE™ MAYO SCISSORS

- 16-3530 5½" Straight
- 16-3531 5½" Curved
- 16-3532 6¾" Straight
- 16-3533 6¾" Curved

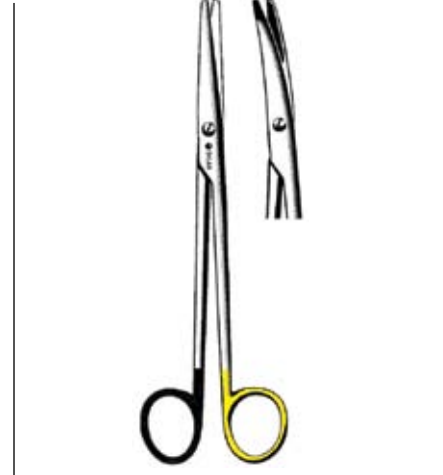

SUPERCUT TC SKLARHONE™ MAYO-STILLÉ SCISSORS

- 16-3572 6" Straight
- 16-3582 6" Curved
- 16-3577 6¾" Straight
- 16-3587 6¾" Curved



SUPERCUT TC SKLARHONE™ METZENBAUM SCISSORS

STRAIGHT, BLUNT/BLUNT TIPS

- 16-3503 5¾"
- 16-3513 5¾" Delicate
- 16-3504 7"
- 16-3514 7" Delicate
- 16-3505 8"
- 16-3515 8" Delicate



SUPERCUT TC SKLARHONE™ METZENBAUM SCISSORS

CURVED, BLUNT/BLUNT TIPS

- 16-3506 5¾"
- 16-3526 5¾" Delicate
- 16-3507 7"
- 16-3527 7" Delicate
- 16-3508 8"
- 16-3528 8" Delicate
- 16-3509 9"
- 16-3510 10"
- 16-3511 11"

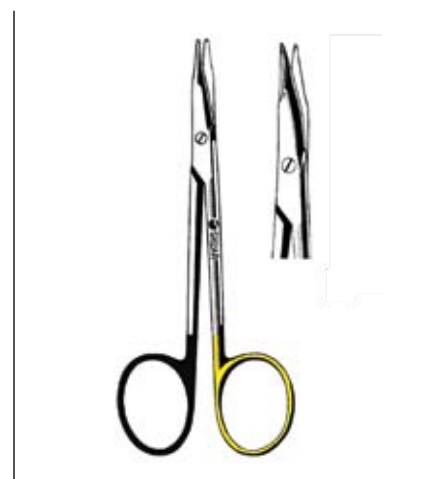

SUPERCUT TC SKLARHONE™ STEVENS TENOTOMY SCISSORS

POINTED

- 16-3540 4½" Straight
- 16-3541 4½" Curved

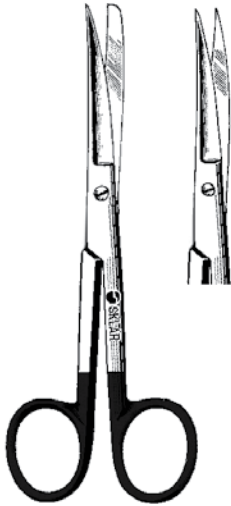

SKLARHONE™
SKLARHONE™
OPERATING SCISSORS

STRAIGHT, SMOOTH
 15-3343 5½" Sharp/Blunt
 15-3342 5½" Sharp/Sharp

SUPER-CUT
 SKLARHONE™
SUPERCUT SKLARHONE™
OPERATING SCISSORS

STRAIGHT, SERRATED
 15-3443 5½" Sharp/Blunt
 15-3442 5½" Sharp/Sharp

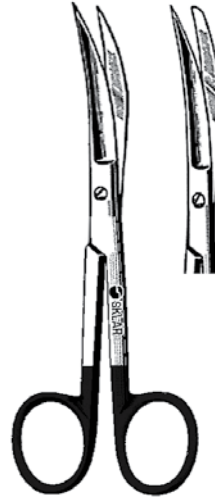

SKLARHONE™
SKLARHONE™
OPERATING SCISSORS

CURVED, SMOOTH
 15-3349 5½" Sharp/Blunt
 15-3348 5½" Sharp/Sharp

SUPER-CUT
 SKLARHONE™
SUPERCUT SKLARHONE™
OPERATING SCISSORS

CURVED, SERRATED
 15-3449 5½" Sharp/Blunt
 15-3448 5½" Sharp/Sharp



SKLARHONE™
SKLARHONE™
IRIS SCISSORS

SMOOTH
 15-3352 4½" Straight
 15-3357 4½" Curved

SUPER-CUT
 SKLARHONE™
SUPERCUT SKLARHONE™
IRIS SCISSORS

SERRATED
 15-3452 4½" Straight
 15-3457 4½" Curved



SKLARHONE™
SKLARHONE™
MAYO SCISSORS

SMOOTH
 15-3325 5½" Straight
 15-3330 5½" Curved
 15-3326 6¾" Straight
 15-3331 6¾" Curved

SUPER-CUT
 SKLARHONE™
SUPERCUT SKLARHONE™
MAYO SCISSORS

SERRATED
 15-3429 5½" Straight
 15-3430 5½" Curved
 15-3426 6¾" Straight
 15-3427 6¾" Curved
 15-3434 9" Straight
 15-3435 9" Curved



SKLARHONE™
SKLARHONE™ METZENBAUM (LAHEY) SCISSORS

SMOOTH

15-3305	5¾"	Straight
15-3306	5¾"	Curved
15-3507	7"	Straight
15-3310	7"	Curved
15-3508	8"	Straight
15-3311	8"	Curved
15-3509	9"	Straight
15-3315	9"	Curved

SUPER-CUT
 SKLARHONE™
SUPERCUT SKLARHONE™ METZENBAUM (LAHEY) SCISSORS

SERRATED

15-3405	5¾"	Straight
15-3406	5¾"	Curved
15-3407	7"	Straight
15-3410	7"	Curved
15-3408	8"	Straight
15-3411	8"	Curved
15-3409	9"	Straight
15-3412	9"	Curved



SKLARHONE™
SKLARHONE™ SKLARLITE™ METZENBAUM SCISSORS

SMOOTH

15-9107	7"	Straight
15-9117	7"	Curved
15-9108	8"	Straight
15-9118	8"	Curved
15-9109	9"	Straight
15-9119	9"	Curved

SKLARLITE
 THE LIGHT TOUCH

SUPER-CUT
 SKLARHONE™
SUPERCUT SKLARHONE™ SKLARLITE™ METZENBAUM SCISSORS

SERRATED

15-3307	7"	Straight
15-3317	7"	Curved
15-3308	8"	Straight
15-3318	8"	Curved
15-3309	9"	Straight
15-3319	9"	Curved

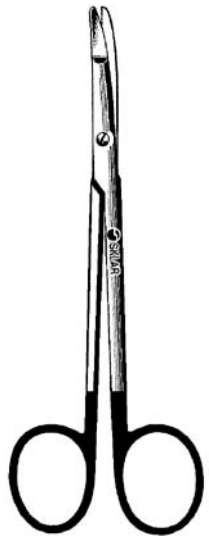

SKLARHONE™
SKLARHONE™ RAGNELL SCISSOR

SMOOTH

15-3336	5"	Curved
---------	----	--------

SUPER-CUT
 SKLARHONE™
SUPERCUT SKLARHONE™ RAGNELL SCISSORS

SERRATED

15-3335	5"	Curved
---------	----	--------

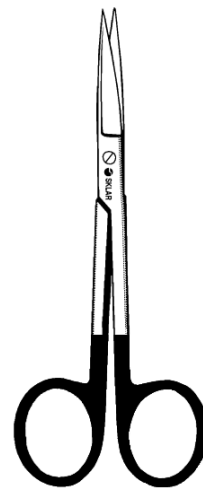

SKLARHONE™
SKLARHONE™ PLASTIC SURGERY SCISSORS

SMOOTH

15-3460	4¾"	Straight
15-3461	4¾"	Curved

SUPER-CUT
 SKLARHONE™
SUPERCUT SKLARHONE™ PLASTIC SURGERY SCISSORS

SERRATED

15-3360	4¾"	Straight
15-3361	4¾"	Curved

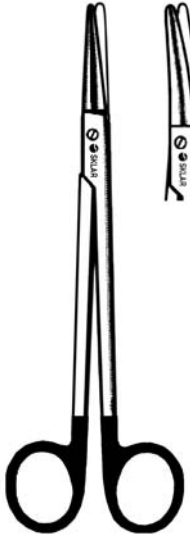

SUPER-CUT
SKLARHONE™

**SUPERCUT SKLARHONE™
GORNEY PLASTIC SURGERY
SCISSORS**

SERRATED

15-3450	7¼"	Straight
15-3451	7¼"	Curved



SUPER-CUT
SKLARHONE™

**SUPERCUT SKLARHONE™
GOLDMAN-FOX SCISSOR**

SERRATED

15-3340	5"	Curved
---------	----	--------

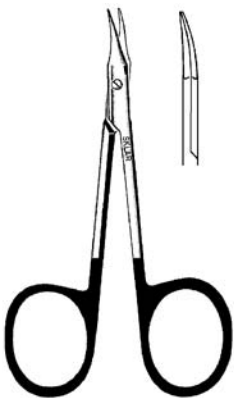

SUPER-CUT
SKLARHONE™

**SUPERCUT SKLARHONE™
GRADLE SCISSOR**

SERRATED

15-3444	3¾"	Slight Curve
---------	-----	--------------

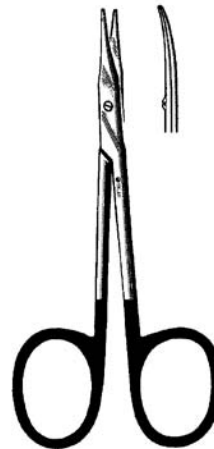

SUPER-CUT
SKLARHONE™

**SUPERCUT SKLARHONE™
STEVENS TENOTOMY
SCISSORS**

SERRATED

15-1242	4½"	Straight	Blunt
15-1243	4½"	Straight	Sharp
15-1342	4½"	Curved	Blunt
15-1343	4½"	Curved	Sharp



SUPER-CUT
SKLARHONE™

**SUPERCUT SKLARHONE™
JAMESON SCISSOR**

SERRATED
15-7032 7" Curved

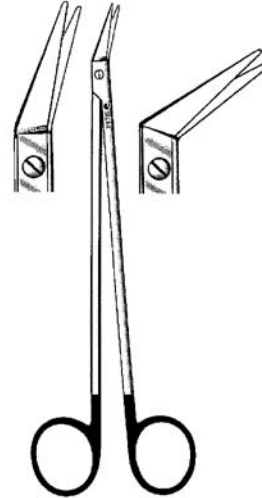

SKLARHONE™

**SKLARHONE™
POTTS-SMITH SCISSORS**

SMOOTH
15-3464 7" 25° Angle
15-3466 7" 45° Angle
15-3468 7" 60° Angle

SUPER-CUT
SKLARHONE™

**SUPERCUT SKLARHONE™
POTTS-SMITH SCISSORS**

SERRATED
15-3364 7" 25° Angle
15-3366 7" 45° Angle
15-3368 7" 60° Angle



SUPER-CUT
SKLARHONE™

**SUPERCUT SKLARHONE™
HI-LEVEL
BANDAGE SCISSOR**

SERRATED
15-3354 5½"



SUPER-CUT
SKLARHONE™

**SUPERCUT SKLARHONE™
LISTER SCISSORS**

SERRATED
15-3355 5½"
15-3356 7¼"
15-3358 8"



SKLARCUT™ OPERATING SCISSORS

15-3505	5½"	Straight	Sharp/Blunt
15-3500	5½"	Straight	Sharp/Sharp
15-3515	5½"	Curved	Sharp/Blunt
15-3510	5½"	Curved	Sharp/Sharp



SKLARLITE™ SKLARCUT™ OPERATING SCISSORS

23-1262	5½"	Straight	Sharp/Blunt
23-1260	5½"	Straight	Sharp/Sharp
23-1266	5½"	Curved	Sharp/Blunt
23-1264	5½"	Curved	Sharp/Sharp



SKLARCUT™ IRIS SCISSORS

15-3585	4½"	Straight
15-3590	4½"	Curved



SKLARLITE™ SKLARCUT™ IRIS SCISSORS

23-1268	4½"	Straight
23-1270	4½"	Curved

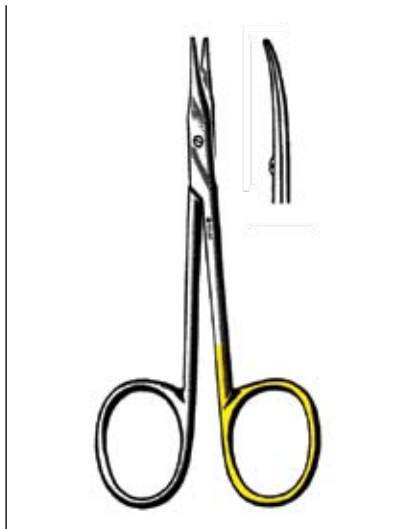

SKLARCUT™ STEVENS TENOTOMY SCISSORS

15-3372	4½"	Straight	Blunt/Blunt
15-3370	4½"	Curved	Blunt/Blunt

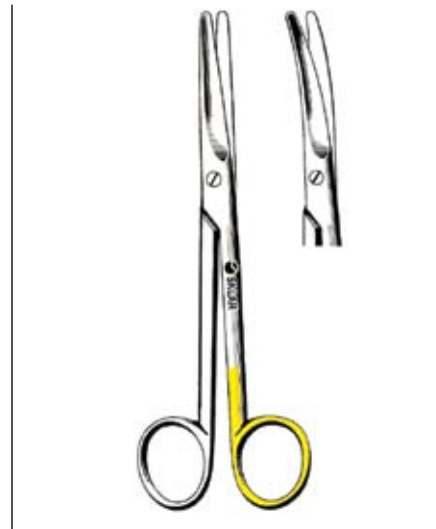

SKLARCUT™ MAYO SCISSORS

15-3550	5½"	Straight
15-3560	5½"	Curved
15-3555	6¾"	Straight
15-3565	6¾"	Curved
15-3566	9"	Straight
15-3568	9"	Curved

SKLARCUT
SERRATED BLADE



SKLARLITE™ SKLARCUT™ MAYO SCISSORS

23-1274 6¾" Straight
23-1278 6¾" Curved

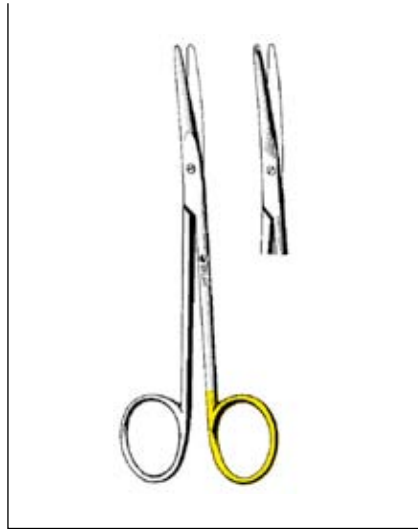

SKLARCUT™ METZENBAUM (LAHEY) SCISSORS

15-3569 4½" Straight
15-3571 4½" Curved
15-3567 5¾" Straight
15-3570 5¾" Curved

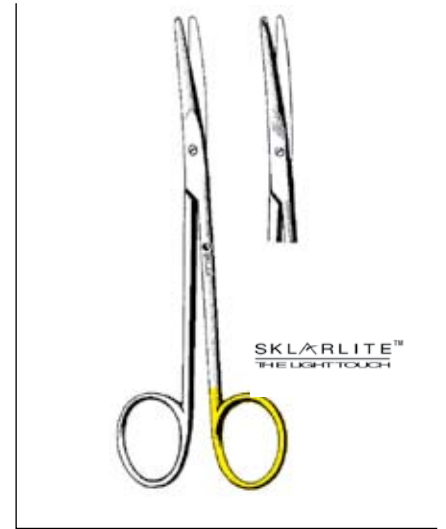

SKLARLITE™ SKLARCUT™ METZENBAUM (LAHEY) SCISSOR

23-1280 5¾" Curved
23-1267 7" Curved



SKLARCUT™ METZENBAUM SCISSOR

15-3575 7" Curved Blunt/Blunt
15-3574 9" Curved Blunt/Blunt

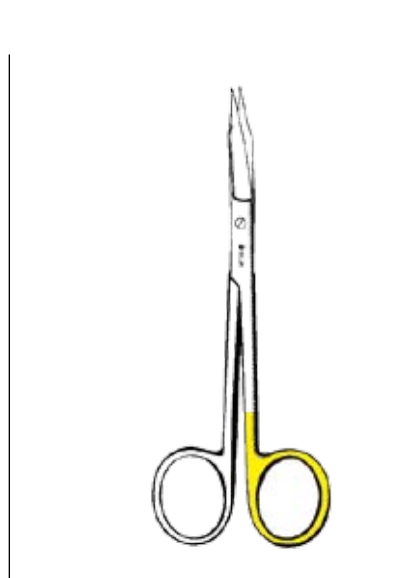

SKLARCUT™ GOLDMAN-FOX SCISSOR

15-3536 5" Delicate

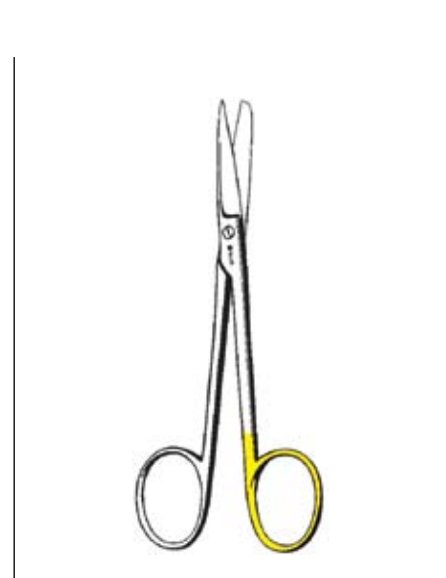

SKLARCUT™ WAGNER SCISSOR

15-3542 4½" Straight Sharp/Blunt

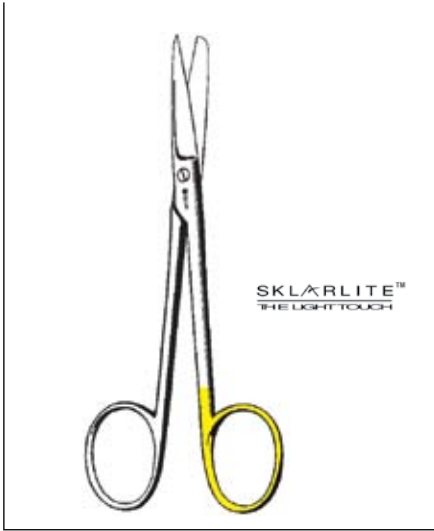

SKLARLITE™ SKLARCUT™ WAGNER SCISSOR

23-1254 4½" Straight Sharp/Blunt

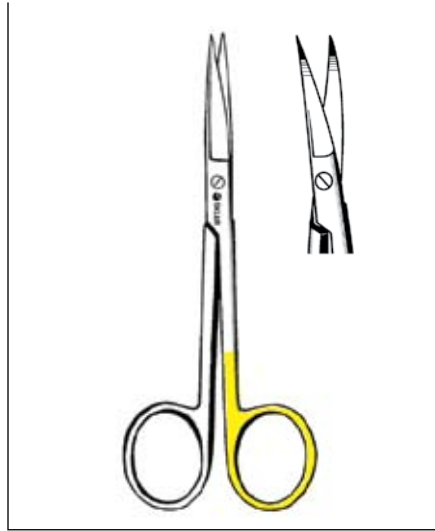

SKLARCUT™ PLASTIC SURGERY SCISSORS

15-3520 4½" Straight
15-3525 4½" Curved
15-3535 4½" Curved, Delicate

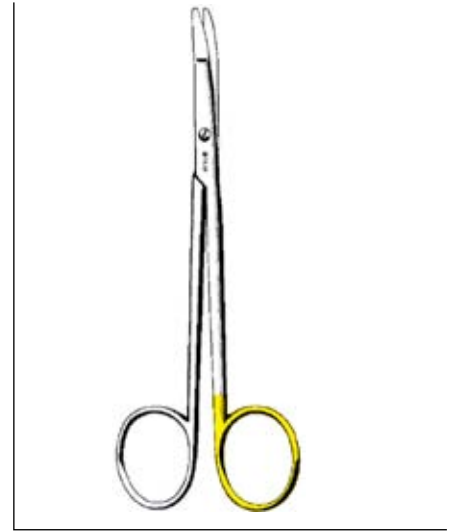

SKLARCUT™ RAGNELL SCISSOR

15-3320 5" Curved



SKLARLITE™ SKLARCUT™ RAGNELL SCISSOR

23-1250 5" Curved



SKLARCUT™ GRADLE SCISSOR

15-3244 3¾" Curved

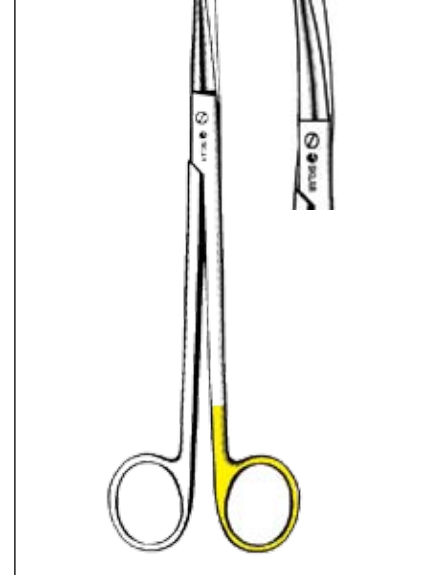

SKLARCUT™ GORNEY PLASTIC SURGERY SCISSORS

15-3577 7¼" Straight
15-3578 7¼" Curved

SKLARCUT
SERRATED BLADE

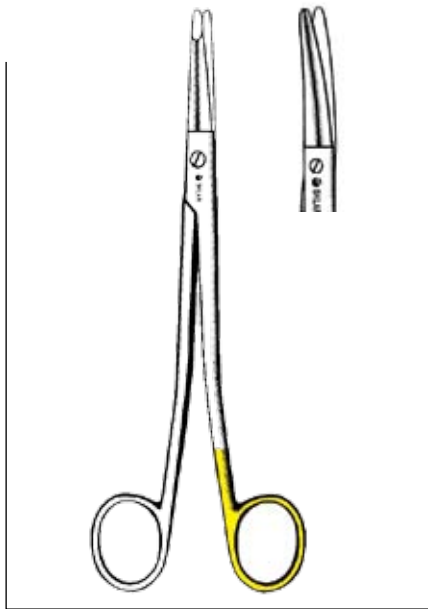

**SKLARCUT™ GORNEY
FACE LIFT SCISSORS**

15-3583 7½" Straight
15-3584 7½" Curved

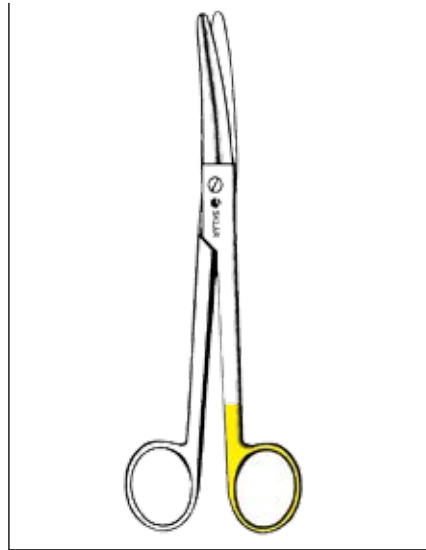

**SKLARCUT™ KAYE FACE
LIFT SCISSORS**

15-3579 6" Curved
15-3580 7½" Curved

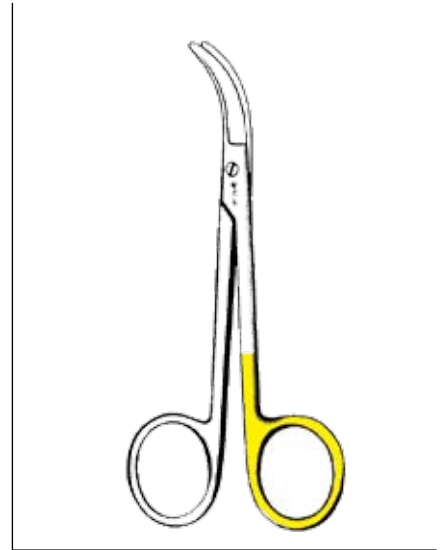

**SKLARCUT™ FOMON LATERAL
SCISSOR**

15-3548 5" Curved

**KILLS 99% OF GERMS
IN LESS THAN 15 SECONDS!**

SKLAR STAT™

Instant Foam Hand Sanitizer

SKLAR-STAT Instant Foam Hand Sanitizer, based on the active ingredient Benzalkonium Chloride, is a unique formulation featuring exceptional skin feel, conditioning and moisturizing properties. The efficacy of this product has been confirmed to reduce *S. Aureus* 99.999% and *S. Aureus* MRSA 99.9% in as little as 15 seconds.

Automatic Foam Dispenser

Motion activated battery powered and wall-mounted, Sklar's Automatic Foam Dispenser allows for easy access and reduced risk of cross contamination.

PRODUCT NUMBER	FEATURES	QUANTITIES
10-2856	Wall Mount Dispenser	1 Each
10-2854	1000ml Refill Bottles	6/case
10-2858	(2) Cases 1000ml Refill Bottles plus Free Wall Mount Dispenser	1 Set



SKLARLITE
THE LIGHT TOUCH

**SKLARLITE™ OPERATING
SCISSORS**

STRAIGHT

23-1104	4½"	Sharp/Blunt
23-1100	4½"	Sharp/Sharp
23-1105	5"	Sharp/Blunt
23-1101	5"	Sharp/Sharp
23-1106	5½"	Sharp/Blunt
23-1102	5½"	Sharp/Sharp

SKLARLITE XD
EXTRA DELICATE

**SKLARLITE XD™ OPERATING
SCISSORS**

STRAIGHT

23-1116	4½"	Sharp/Blunt
23-1112	4½"	Sharp/Sharp
23-1117	5"	Sharp/Blunt
23-1113	5"	Sharp/Sharp
23-1118	5½"	Sharp/Blunt
23-1114	5½"	Sharp/Sharp

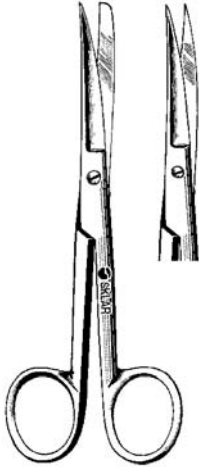

SKLARLITE
THE LIGHT TOUCH

**SKLARLITE™ OPERATING
SCISSORS**

CURVED

23-1128	4½"	Sharp/Blunt
23-1124	4½"	Sharp/Sharp
23-1130	5½"	Sharp/Blunt
23-1126	5½"	Sharp/Sharp

SKLARLITE XD
EXTRA DELICATE

**SKLARLITE XD™ OPERATING
SCISSORS**

CURVED

23-1140	4½"	Sharp/Blunt
23-1136	4½"	Sharp/Sharp
23-1142	5½"	Sharp/Blunt
23-1138	5½"	Sharp/Sharp

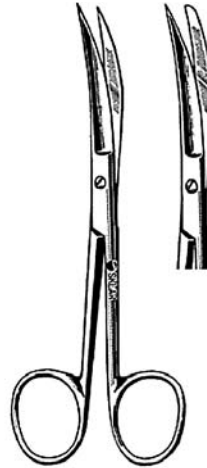

SKLARLITE
THE LIGHT TOUCH

**SKLARLITE™ MAYO
DISSECTING SCISSORS**

23-1164	5½"	Straight
23-1166	5½"	Curved
23-1165	6¾"	Straight
23-1167	6¾"	Curved

SKLARLITE XD
EXTRA DELICATE

**SKLARLITE XD™ MAYO
DISSECTING SCISSORS**

23-1168	5½"	Straight
23-1170	5½"	Curved
23-1169	6¾"	Straight
23-1171	6¾"	Curved



SKLARLITE
THE LIGHT TOUCH

**SKLARLITE™ METZENBAUM
(LAHEY) SCISSORS**

23-1172	4½"	Straight
23-1174	4½"	Curved
23-1173	5¾"	Straight
23-1175	5¾"	Curved

SKLARLITE XD
EXTRA DELICATE

**SKLARLITE XD™ METZENBAUM
(LAHEY) SCISSORS**

23-1176	4½"	Straight
23-1178	4½"	Curved
23-1177	5¾"	Straight
23-1179	5¾"	Curved

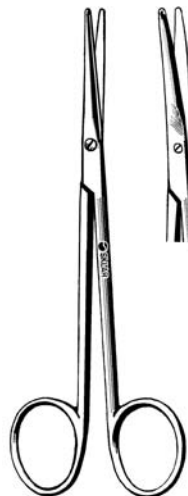



SKLARLITE
THE LIGHT TOUCH

**SKLARLITE™ METZENBAUM
SCISSORS**

23-1180	7"	Straight
23-1182	7"	Curved



SKLARLITE XD
EXTRA DELICATE

**SKLARLITE XD™ METZENBAUM
SCISSORS**

23-1184	7"	Straight
23-1186	7"	Curved

SKLARLITE
THE LIGHT TOUCH

SKLARLITE™ IRIS SCISSORS

SHARP/SHARP

23-1148	3½"	Straight
23-1149	4½"	Straight
23-1150	3½"	Curved
23-1151	4½"	Curved



SKLARLITE XD
EXTRA DELICATE

SKLARLITE XD™ IRIS SCISSORS

SHARP/SHARP

23-1152	3½"	Straight
23-1153	4½"	Straight
23-1154	3½"	Curved
23-1155	4½"	Curved

SKLARLITE
THE LIGHT TOUCH

**SKLARLITE™ STEVENS
SCISSORS**

23-1156	4½"	Straight	Blunt/Blunt
23-1157	4½"	Curved	Blunt/Blunt

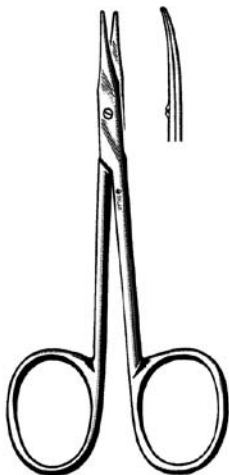

SKLARLITE XD
EXTRA DELICATE

**SKLARLITE XD™ STEVENS
SCISSORS**

23-1160	4½"	Straight	Blunt/Blunt
23-1161	4½"	Curved	Blunt/Blunt

SKLARLITE
THE LIGHT TOUCH

**SKLARLITE™ STRABISMUS
SCISSORS**

23-1158	4½"	Straight
23-1159	4½"	Curved



SKLARLITE XD
EXTRA DELICATE

**SKLARLITE XD™ STRABISMUS
SCISSORS**

23-1162	4½"	Straight
23-1163	4½"	Curved



SKLARLITE
THE LIGHT TOUCH

SKLARLITE™ STITCH SCISSORS

- 23-1188 3½" Spencer
- 23-1189 4½" Spencer
- 23-1190 5½" Littauer



SKLARLITE XD
EXTRA DELICATE

SKLARLITE XD™ STITCH SCISSORS

- 23-1193 3½" Spencer
- 23-1194 4½" Spencer
- 23-1195 5½" Littauer

SKLARLITE
THE LIGHT TOUCH

SKLARLITE™ SHORTBENT SUTURE SCISSORS

- 23-1191 3½"



SKLARLITE XD
EXTRA DELICATE

SKLARLITE XD™ SHORTBENT SUTURE SCISSORS

- 23-1196 3½"

SKLARLITE™
THE LIGHT TOUCH

SKLARLITE™ PRECISION SUTURE SCISSORS

- 23-1290 3½" Straight
- 23-1292 3½" Curved
- 23-1294 4½" Straight
- 23-1296 4½" Curved



SKLARLITE XD™
EXTRA DELICATE

SKLARLITE XD™ PRECISION SUTURE SCISSORS

- 23-1300 3½" Straight
- 23-1302 3½" Curved
- 23-1304 4½" Straight
- 23-1306 4½" Curved

SKLARLITE
THE LIGHT TOUCH

SKLARLITE™ LISTER BANDAGE SCISSORS

- 23-1199 5½"
- 23-1200 7¼"



SKLARLITE XD
EXTRA DELICATE

SKLARLITE XD™ LISTER BANDAGE SCISSORS

- 23-1202 5½"
- 23-1203 7¼"

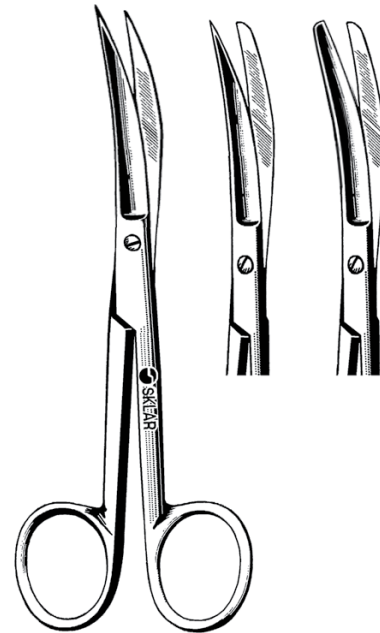
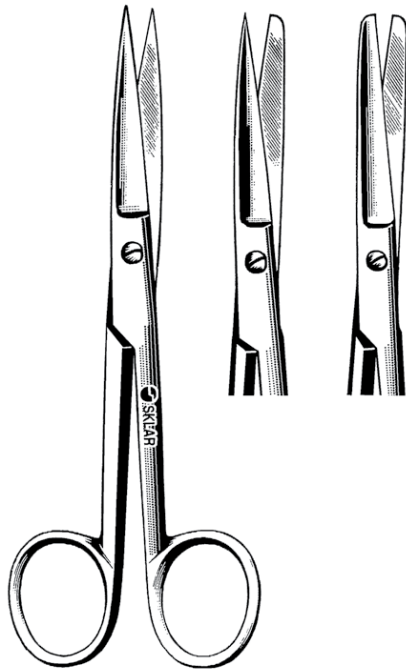

OPERATING SCISSORS

STRAIGHT

13-1045	4½"	Sharp/Sharp
14-1045	4½"	Sharp/Blunt
15-1045	4½"	Blunt/Blunt
13-1050	5"	Sharp/Sharp
14-1050	5"	Sharp/Blunt
15-1050	5"	Blunt/Blunt
13-1055	5½"	Sharp/Sharp
14-1055	5½"	Sharp/Blunt
15-1055	5½"	Blunt/Blunt
13-1060	6"	Sharp/Sharp
14-1060	6"	Sharp/Blunt
15-1060	6"	Blunt/Blunt
13-1065	6½"	Sharp/Sharp
14-1065	6½"	Sharp/Blunt
15-1065	6½"	Blunt/Blunt
13-1072	7¼"	Sharp/Sharp
14-1072	7¼"	Sharp/Blunt

DELICATE

22-1145	4½"	Sharp/Sharp
22-1245	4½"	Sharp/Blunt
22-1345	4½"	Blunt/Blunt
22-1150	5"	Sharp/Sharp
22-1250	5"	Sharp/Blunt
22-1350	5"	Blunt/Blunt
22-1155	5½"	Sharp/Sharp
22-1255	5½"	Sharp/Blunt
22-1355	5½"	Blunt/Blunt

OPERATING SCISSORS

CURVED

13-2045	4½"	Sharp/Sharp
14-2045	4½"	Sharp/Blunt
15-2045	4½"	Blunt/Blunt
13-2050	5"	Sharp/Sharp
14-2050	5"	Sharp/Blunt
15-2050	5"	Blunt/Blunt
13-2055	5½"	Sharp/Sharp
14-2055	5½"	Sharp/Blunt
15-2055	5½"	Blunt/Blunt
13-2060	6"	Sharp/Sharp
14-2060	6"	Sharp/Blunt
15-2060	6"	Blunt/Blunt
13-2065	6½"	Sharp/Sharp
14-2065	6½"	Sharp/Blunt
15-2065	6½"	Blunt/Blunt
13-2072	7¼"	Sharp/Sharp
14-2072	7¼"	Sharp/Blunt

DELICATE

22-1445	4½"	Sharp/Sharp
22-1545	4½"	Sharp/Blunt
22-1645	4½"	Blunt/Blunt
22-1450	5"	Sharp/Sharp
22-1550	5"	Sharp/Blunt
22-1650	5"	Blunt/Blunt
22-1455	5½"	Sharp/Sharp
22-1555	5½"	Sharp/Blunt
22-1655	5½"	Blunt/Blunt

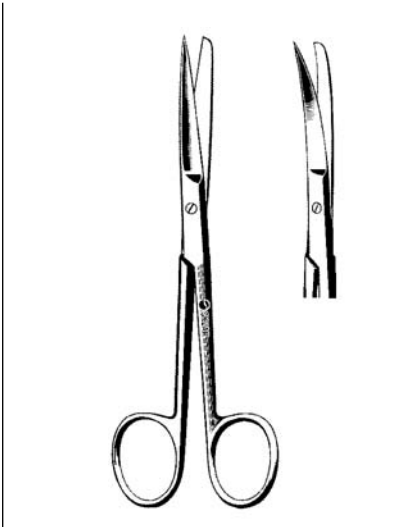
DEAVER SCISSORS
DELICATE

15-1155	5½"	Straight	Blunt/Blunt
14-1155	5½"	Straight	Sharp/Blunt
14-2155	5½"	Curved	Sharp/Blunt
13-1155	5½"	Straight	Sharp/Sharp
13-2155	5½"	Curved	Sharp/Sharp

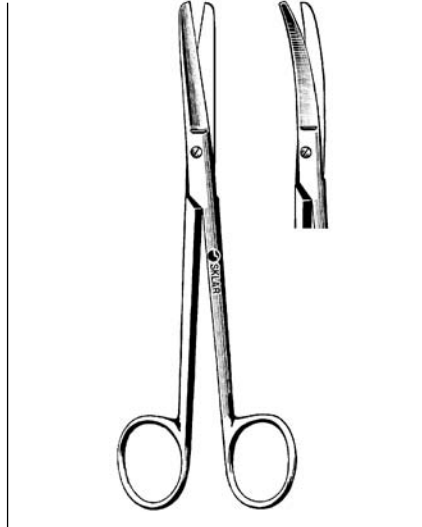
MIXTER SCISSORS

15-1360	6¼"	Straight
15-1361	6¼"	Curved

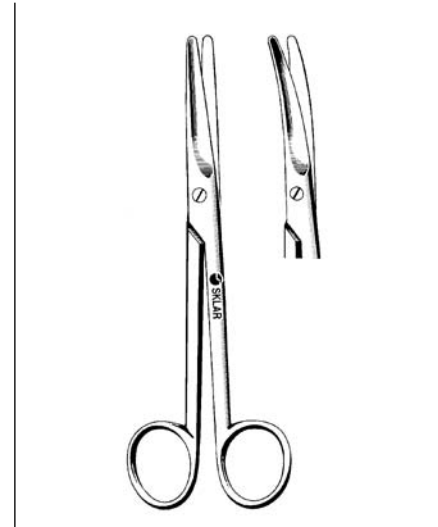
MAYO DISSECTING SCISSORS

15-1555	5½"	Straight	
15-2555	5½"	Curved	
15-1567	6¾"	Straight	
15-2567	6¾"	Curved	
90-1590	9"	Straight	
90-1690	9"	Curved	
55-8711	11"	Straight	Harrington
55-8611	11"	Curved	Harrington

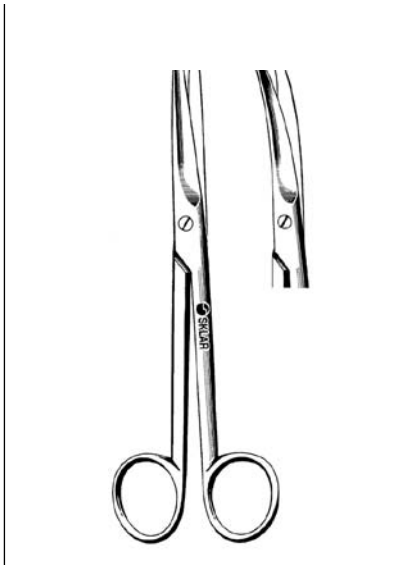
MAYO DISSECTING SCISSORS
DELICATE

22-1556	5½"	Straight
22-2555	5½"	Curved
22-1567	6¾"	Straight
22-2567	6¾"	Curved

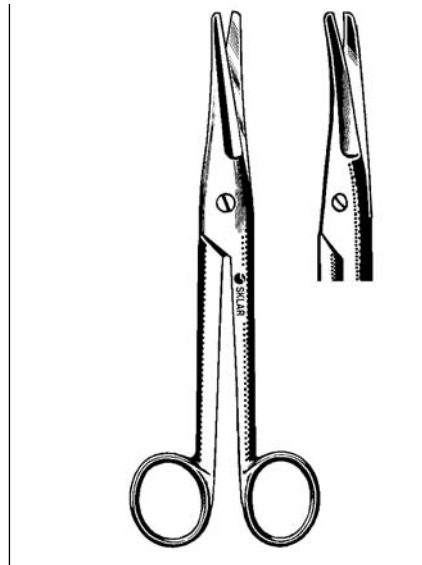
MAYO NOBLE DISSECTING SCISSORS

15-1762	6½"	Straight
15-2762	6½"	Curved

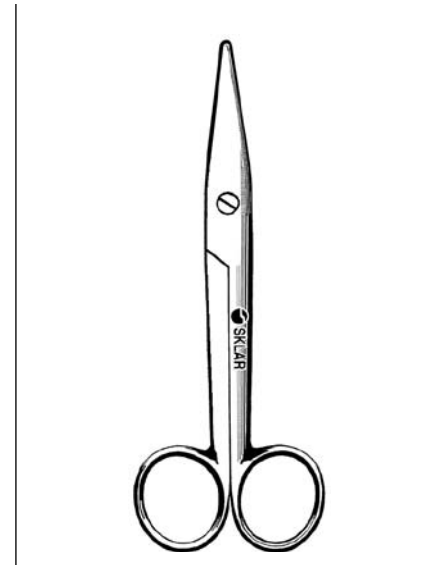
MAYO-NOBLE STILLE DISSECTING SCISSORS

15-1862	6"	Straight
15-2862	6"	Curved

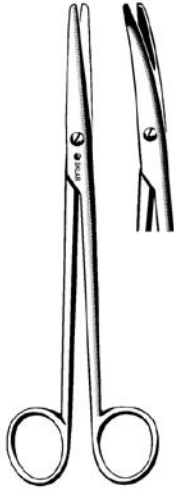

MAYO-STILLE DISSECTING SCISSORS

15-1655	5½"	Straight
15-2655	5½"	Curved
15-1667	6¾"	Straight
15-2667	6¾"	Curved



METZENBAUM (LAHEY) SCISSORS

22-2550	4½"	Straight
22-2545	4½"	Curved
75-5460	5¾"	Straight
47-1360	5¾"	Curved



METZENBAUM (LAHEY) SCISSORS

DELICATE

22-2450	4½"	Straight
22-2460	5¾"	Straight
22-1057	5¾"	Curved



METZENBAUM SCISSORS

STRAIGHT

75-5570	7"	
55-9180	8"	Nelson
55-9190	9"	Nelson
55-9310	10"	Nelson
55-9311	11"	Nelson
55-9314	14½"	Nelson



METZENBAUM SCISSORS

CURVED

75-5670	7"	
55-9080	8"	Nelson
55-9090	9"	Nelson
55-9210	10"	Nelson
55-9411	11"	Nelson
55-9612	12"	Nelson
55-9614	14"	Nelson



METZENBAUM SCISSORS

DELICATE

22-1071	7"	Straight
22-1070	7"	Curved
55-9184	8"	Straight Nelson
55-9084	8"	Curved Nelson
55-9194	9"	Straight Nelson
55-9094	9"	Curved Nelson
55-9414	11"	Curved Nelson

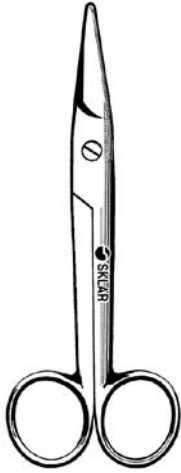

SISTRUNK DISSECTING SCISSORS

- 15-2445 5¾" Straight
- 15-2455 5¾" Curved

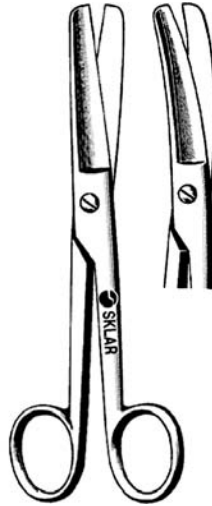

DOYEN SCISSORS

- 15-1307 7" Straight Smooth
- 15-1308 7" Straight Serrated
- 15-2307 7" Curved Smooth
- 15-2308 7" Curved Serrated



REYNOLDS SCISSORS

NARROW TIP

- 22-2758 6" Straight
- 22-2759 6" Straight, Serrated
- 22-2760 6" Curved
- 22-2762 6" Curved Serrated
- 22-2772 7" Straight
- 22-2768 7" Straight, Serrated
- 22-2770 7" Curved
- 22-2722 7" Curved, Serrated

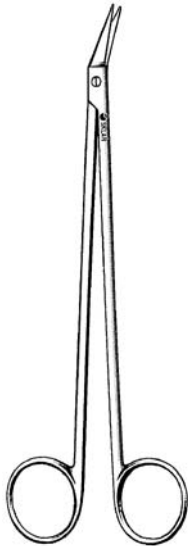

POTTS-SMITH SCISSORS

- 52-2825 7¼" 25° Angle
- 52-2845 7¼" 45° Angle
- 52-2860 7¼" 60° Angle

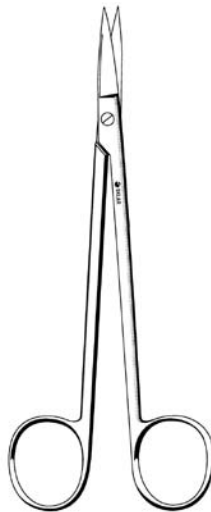

KELLY-ADSON SCISSORS

STRAIGHT

- 50-4562 6¼" Smooth
- 50-4563 6¼" Serrated



KELLY-ADSON SCISSOR

- 50-4662 6¼" Curved Smooth

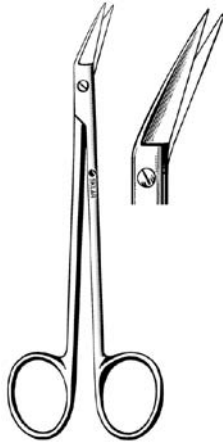

KELLY-ADSON SCISSOR

50-4462 6¼" Angled Smooth



BOETTCHER TONSIL SCISSOR

75-5070 7" Curved

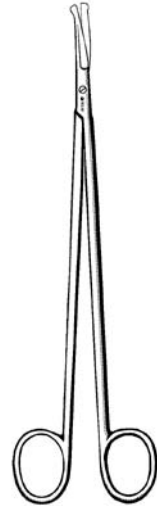

STRULLY NEURO SCISSOR

42-2787 8¾" Curved

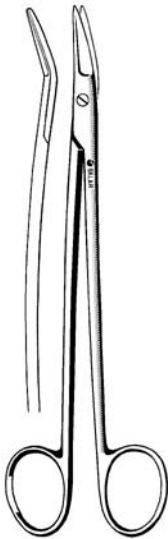

DEAN TONSIL SCISSOR

75-5267 6¾" Angled Serrated



KAHN DISSECTING SCISSORS

SABER BLADE

- 41-1132 5½" Straight
- 41-1134 5½" Curved
- 41-1136 7" Straight
- 41-1138 7" Curved

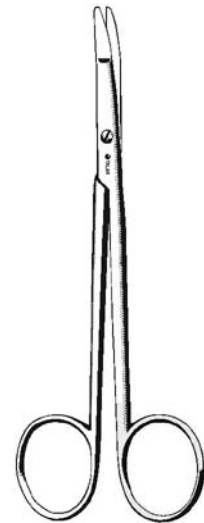

RAGNELL DISSECTING SCISSORS

- 22-2652 5" Curved (Flat Tip)
- 22-2657 7" Curved (Flat Tip)



WAGNER SCISSORS

STRAIGHT

47-1070	4½"	Blunt/Blunt	Smooth
47-1048	4½"	Sharp/Blunt	Smooth
47-1047	4½"	Sharp/Sharp	Smooth
47-1071	4½"	Blunt/Blunt	Serrated
47-1060	4½"	Sharp/Blunt	Serrated
47-1049	4½"	Sharp/Sharp	Serrated

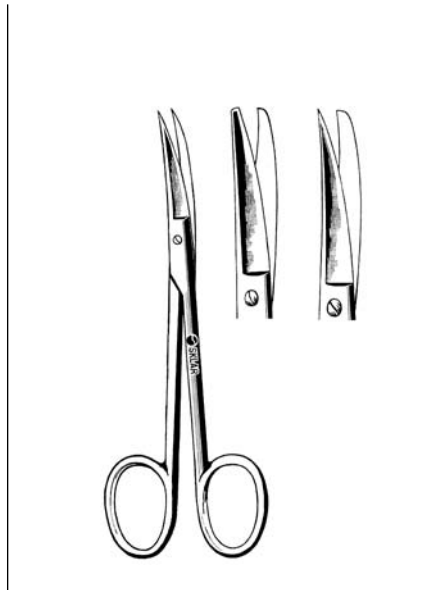

WAGNER SCISSORS

CURVED

47-1075	4½"	Blunt/Blunt	Smooth
47-1068	4½"	Sharp/Blunt	Smooth
47-1058	4½"	Sharp/Sharp	Smooth
47-1072	4½"	Blunt/Blunt	Serrated
47-1069	4½"	Sharp/Blunt	Serrated
47-1059	4½"	Sharp/Sharp	Serrated

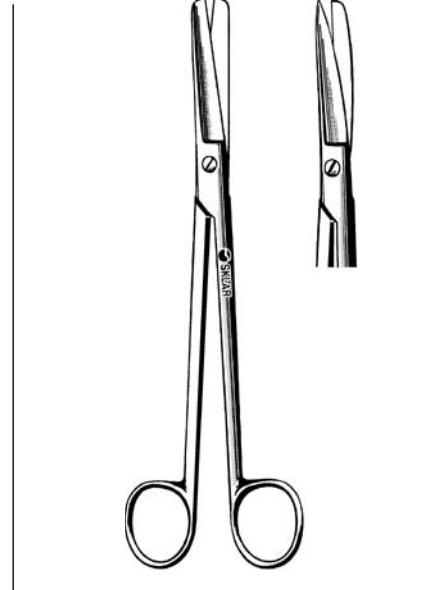

SIMS SCISSORS

90-1080	8"	Straight	Blunt/Blunt
90-1180	8"	Straight	Sharp/Blunt
90-1280	8"	Straight	Sharp/Sharp
90-1380	8"	Curved	Blunt/Blunt
90-1480	8"	Curved	Sharp/Blunt
90-1580	8"	Curved	Sharp/Sharp

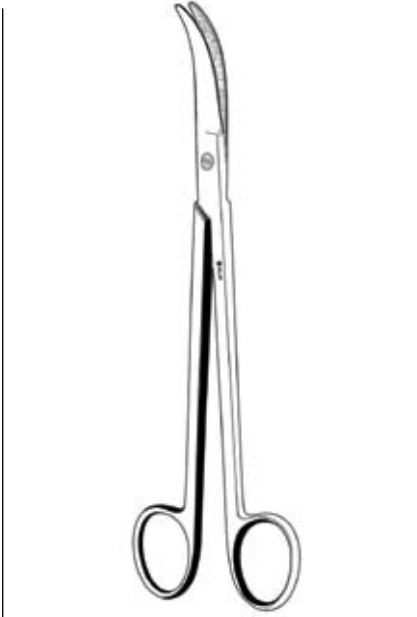

JORGENSON SCISSOR

52-2970	9"	Strong Curve
---------	----	--------------

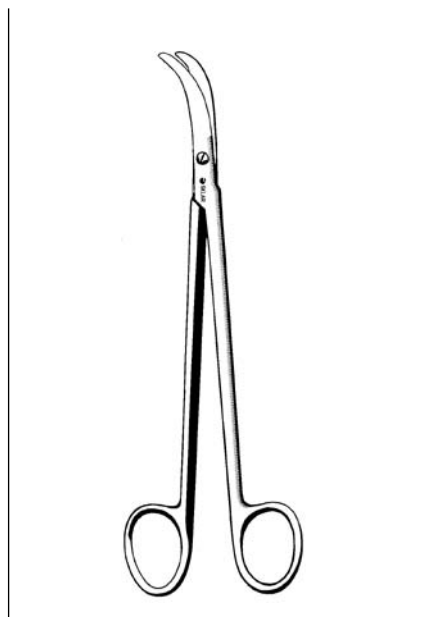

THOREK SCISSORS

15-3172	7¼"	Full Curve
15-3210	10"	Full Curve

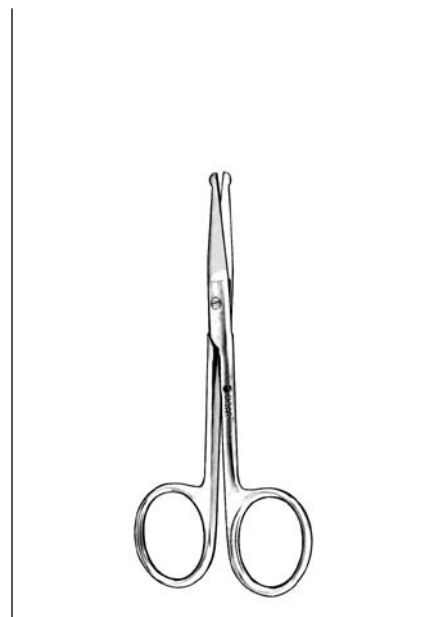

IRIS SCISSORS

2 PROBE POINTS		
64-2046	4"	Straight
64-2048	4"	Curved

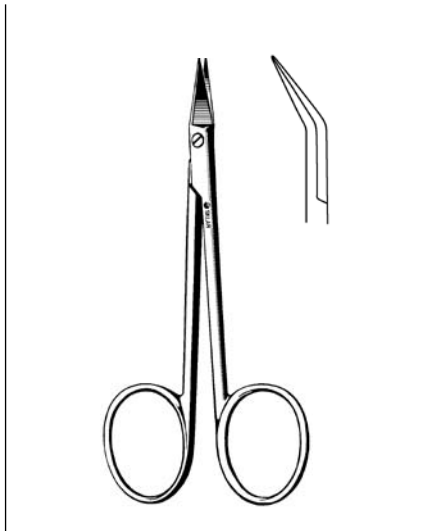

WILMER SCISSOR

64-1735 4" Angled on Flat



RIBBON STRABISMUS SCISSORS

64-1240 4" Straight
64-1340 4" Curved

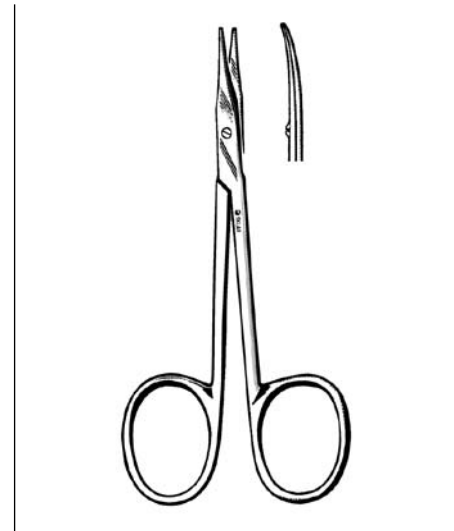

STEVENS TENOTOMY SCISSORS

64-1242 4½" Straight Blunt/Blunt
64-1342 4½" Curved Blunt/Blunt
64-1243 4½" Straight Sharp/Sharp
64-1343 4½" Curved Sharp/Sharp

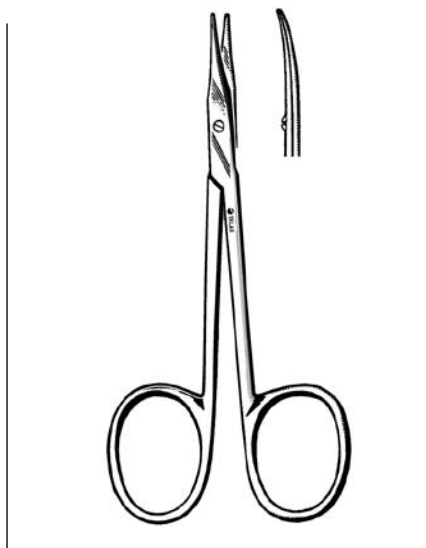

STEVENS TENOTOMY SCISSORS

DELICATE

22-1242 4½" Straight Blunt/Blunt
22-1342 4½" Curved Blunt/Blunt
22-1240 4½" Straight Sharp/Sharp
22-1241 4½" Curved Sharp/Sharp

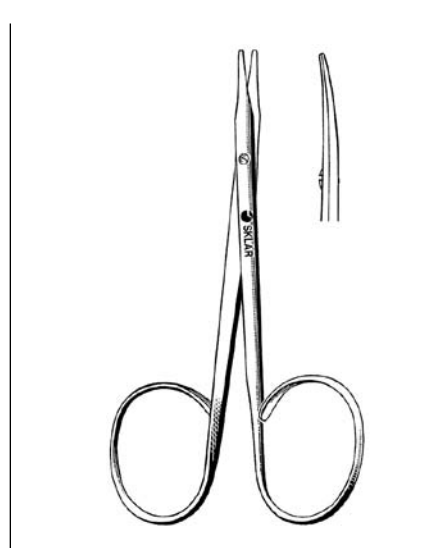

RIBBON STEVENS TENOTOMY SCISSORS

64-1241 4" Straight
64-1341 4" Curved



GOLDMAN-FOX SCISSOR

22-2520 5" Curved, Serrated

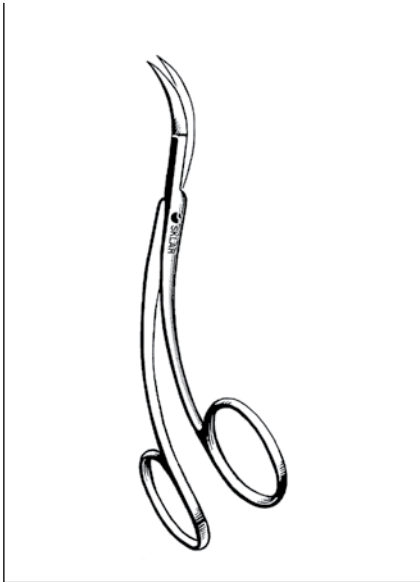

LA GRANGE SCISSOR

22-2745 4½" Sharp/Sharp S-Shape

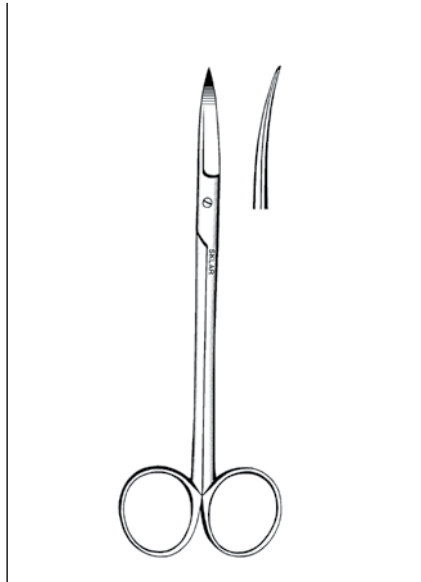

RHYTIDECTOMY SCISSORS

DOUBLE EDGE

41-1100 6½" Straight
41-1105 6½" Curved

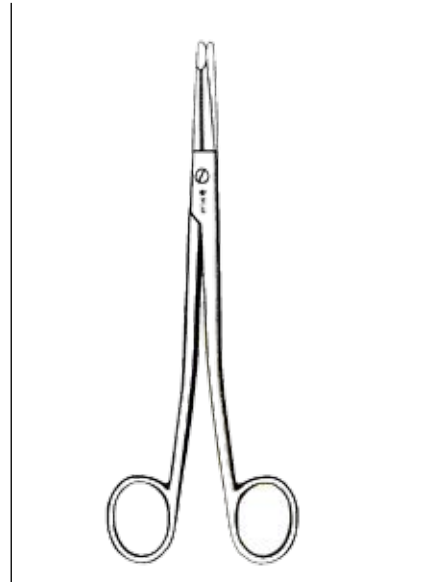

GORNEY FACE LIFT SCISSORS

47-1089 7½" Curved
47-1091 9" Straight

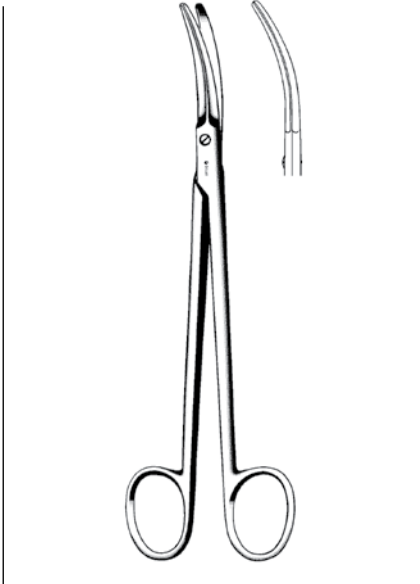

LILLY DISSECTING SCISSOR

41-1147 7½" Strong Curve

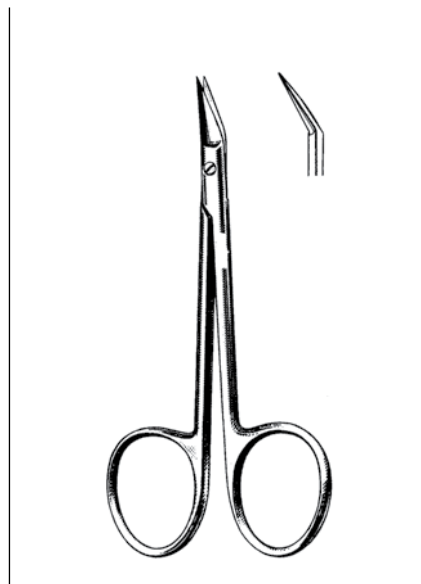

BIRO DERMAL NAEVUS SCISSOR

64-1740 4" Delicate

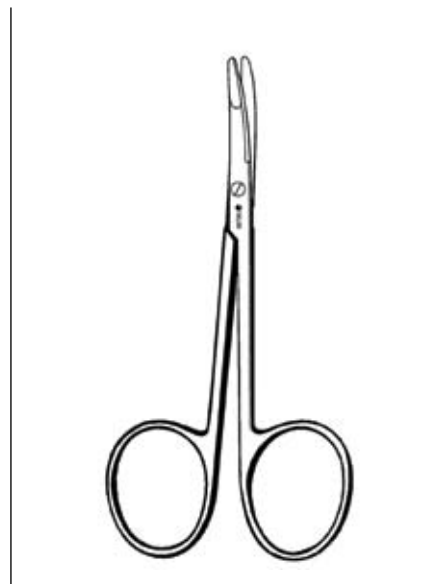

BLEPHAROPLASTY SCISSOR

47-1147 4¾" Curved Serrated

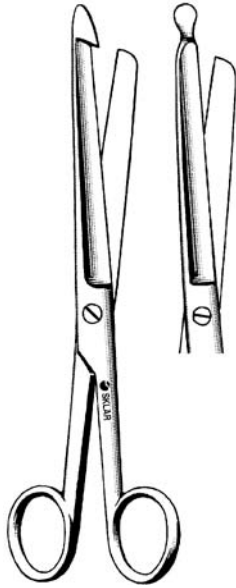

ENTEROTOME SCISSORS

15-1282 8¼" Hook Point
 15-1285 8¼" Probe Point

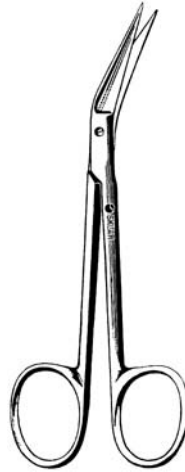

SKLAR ANGULAR SCISSORS

SHARP/SHARP
 47-1080 4¾" Smooth
 47-1081 4¾" Serrated

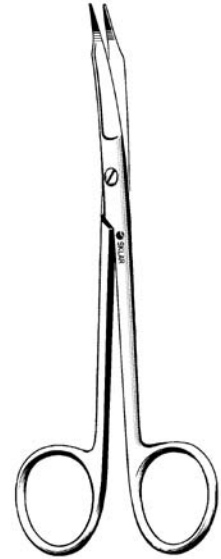

MARTIN SCISSOR

41-1120 8" Curved Heavy Serrations

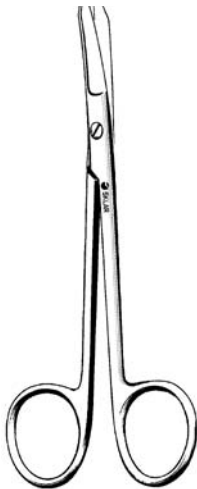

MILLER DISSECTING SCISSOR

41-1125 5" Serrated

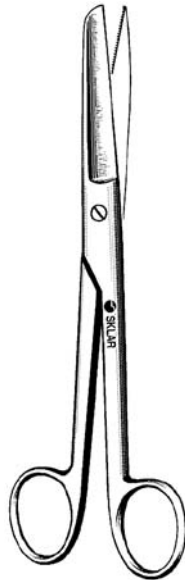

MOLESKIN SCISSORS

SERRATED
 97-1350 7½" Straight
 97-1351 7½" Curved

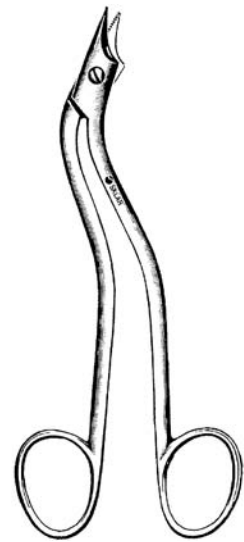

HEATH SCISSOR

24-1962 6¼" Serrated

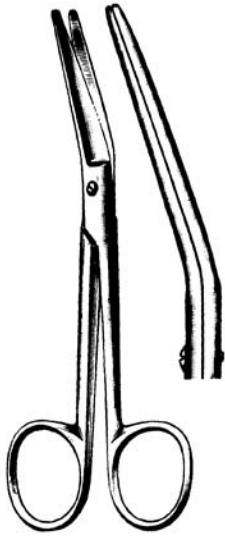

NEW'S SUTURE SCISSOR

41-1163 5½" Angled Flat

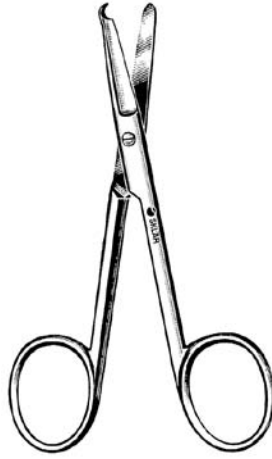

STITCH SCISSORS

22-2835 3½" Spencer
 22-2845 4½" Spencer
 15-1355 5½" Littauer

DELICATE

22-2834 3½" Spencer
 22-2844 4½" Spencer
 22-1354 5½" Littauer



SUTURE SCISSORS

22-2935 3½" Shortbent
 22-2934 3½" Shortbent Delicate
 22-2947 4¾" Northbent

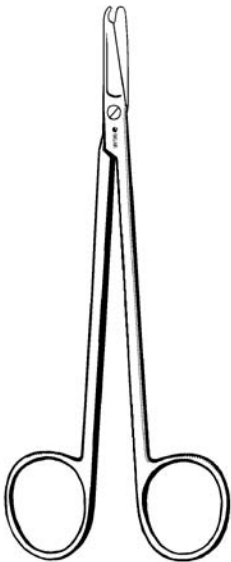

LONG STITCH SCISSOR

15-1358 6¼"



SKLAR STITCH SCISSORS

15-3150 4½" Angled
 22-2950 5" Curved Sideways

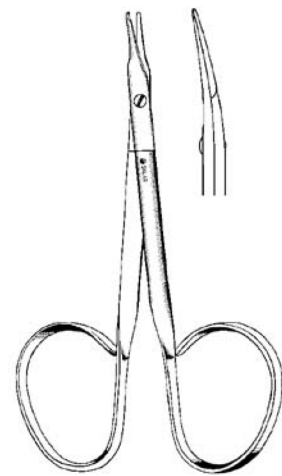

REEH RIB STITCH SCISSOR

64-1348 3¾"

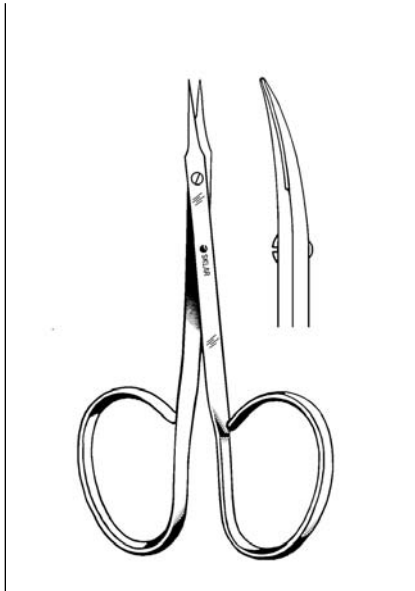

RIBBON STITCH SCISSORS

64-1345 4" Straight
64-1445 4" Curved

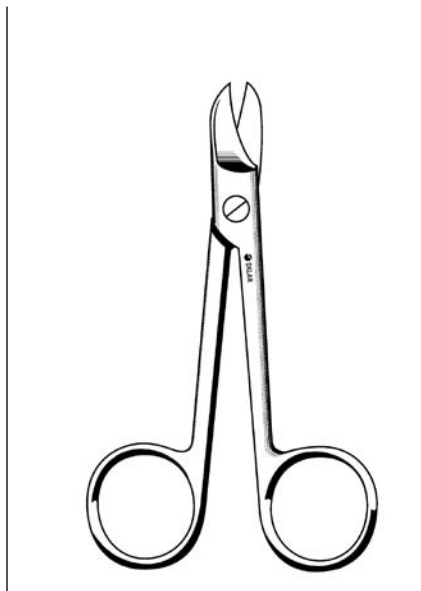

CROWN SCISSORS

24-2345 4" Straight Smooth
24-2340 4" Straight Serrated
24-2346 4" Curved Smooth
24-2341 4" Curved Serrated

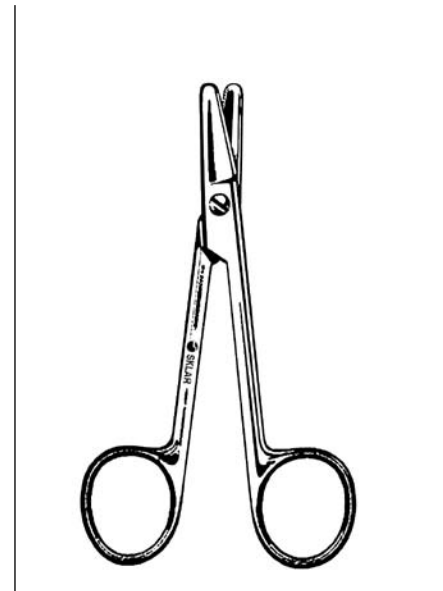

SUTURE SCISSOR

HEAVY
24-2347 4¾" Straight Serrated

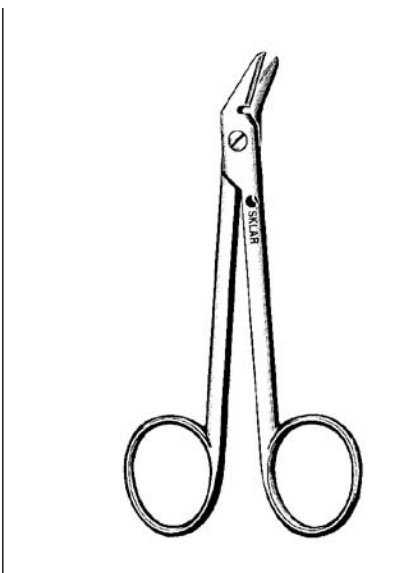

SUTURE WIRE CUTTING SCISSOR

24-2342 4¾" Angled Serrated

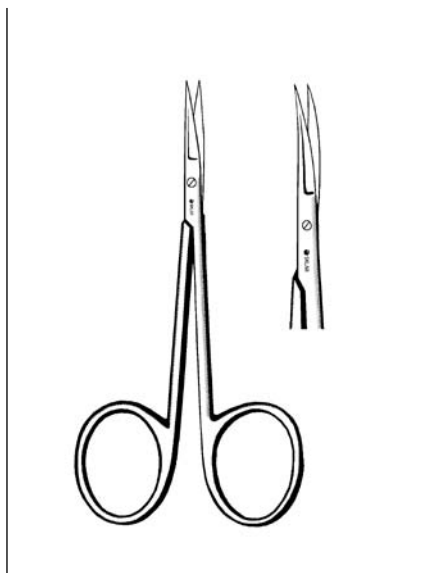

BONN MINI IRIS SCISSORS

64-2035 3½" Straight
64-2036 3½" Curved



IRIS SCISSORS

STRAIGHT

47-1135 3½" Sharp/Sharp
47-1140 3½" Blunt/Blunt
47-1143 4" Sharp/Sharp
47-1441 4" Sharp/Sharp, Heavy
47-1145 4½" Sharp/Sharp
47-1144 4½" Blunt/Blunt

CURVED

47-1235 3½" Sharp/Sharp
47-1240 3½" Blunt/Blunt
47-1243 4" Sharp/Sharp
47-1442 4" Sharp/Sharp, Heavy
47-1245 4½" Sharp/Sharp
47-1244 4½" Blunt/Blunt

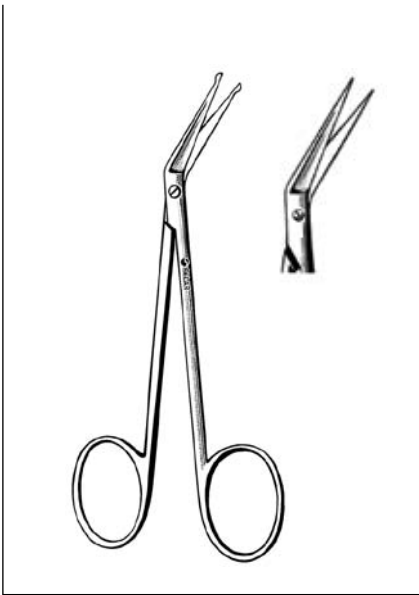

IRIS SCISSORS

- 64-2142 4½" Angled
- 64-2143 4½" Curved Sideways
- 64-2042 4¼" Angled, Probe Point



IRIS SCISSORS

- DELICATE, SHARP/SHARP**
- 22-1135 3½" Straight
 - 22-1235 3½" Curved
 - 47-1440 4" Straight
 - 47-1246 4½" Straight
 - 47-1248 4½" Curved

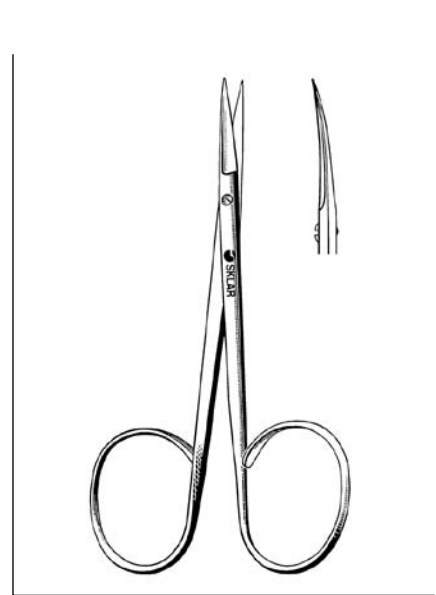

RIBBON IRIS SCISSORS

- 47-1250 4" Straight
- 47-1255 4" Curved

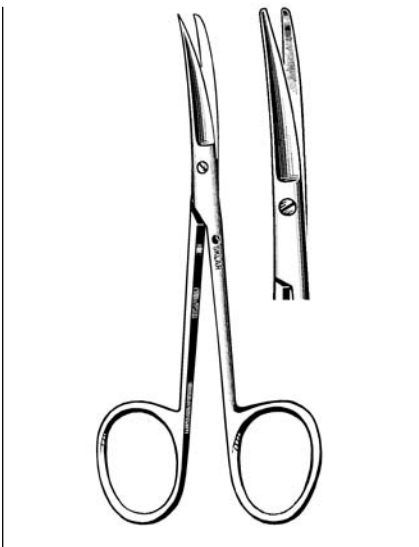

KNAPP IRIS SCISSORS

- 64-3435 4" Straight Blunt/Blunt
- 64-3235 4" Curved Blunt/Blunt
- 64-3430 4" Straight Sharp/Blunt
- 64-3230 4" Curved Sharp/Blunt

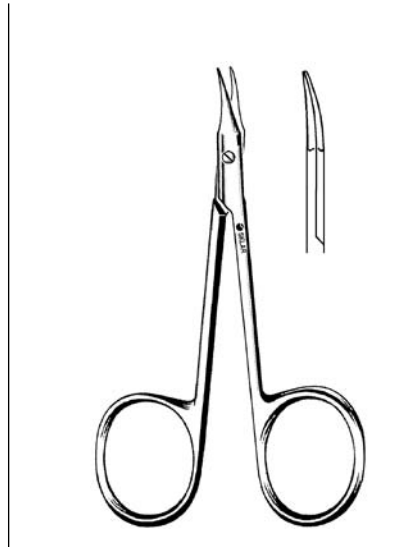

GRADLE SCISSOR

- 64-3280 3¾" Slight Curve, Sharp

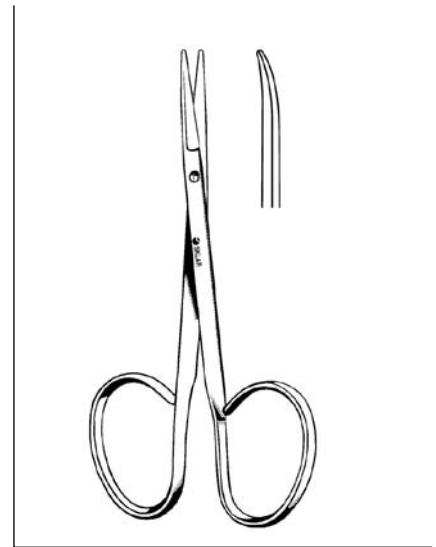

UTILITY RIBBON SCISSORS

- 47-1146 4" Straight Blunt/Blunt
- 47-1247 4" Curved Blunt/Blunt

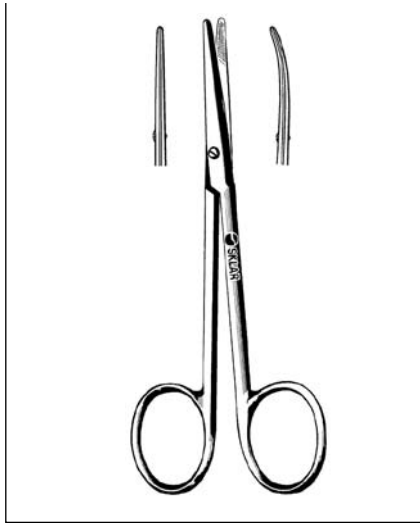

STRABISMUS SCISSORS

64-1442 4½" Straight
 64-1542 4½" Curved

DELICATE

22-1442 4½" Straight
 22-1542 4½" Curved

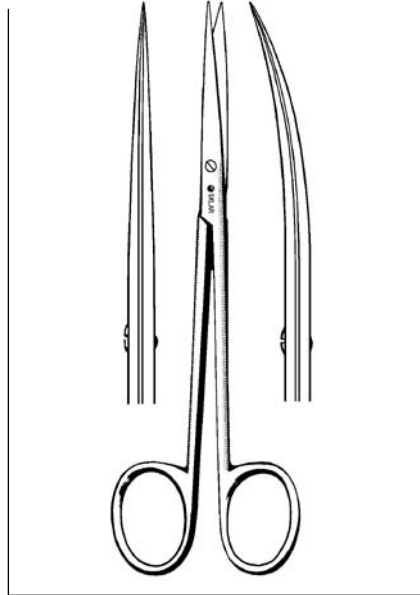

BROPHY SCISSORS

SMOOTH

64-1160 5¾" Straight
 64-1161 5¾" Curved

SERRATED, SULLIVAN

22-2855 5¾" Straight
 22-2755 5¾" Curved

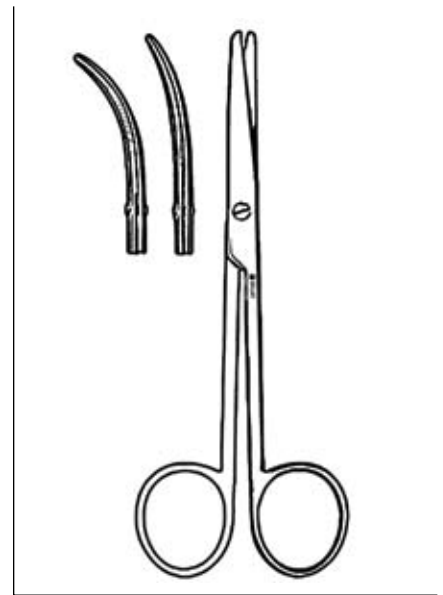

ENUCLEATION SCISSORS

64-1150 5" Light Curve
 64-1151 5" Medium Curve
 64-1152 5" Full Curve

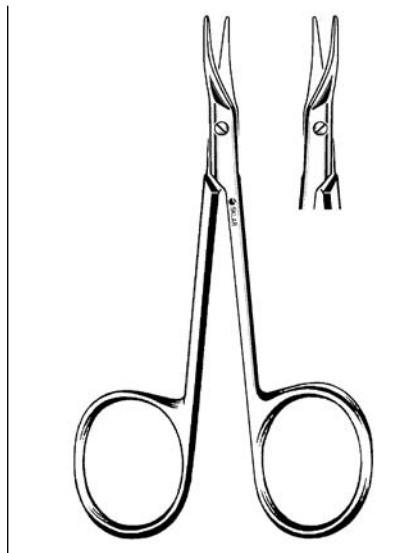

MCGUIRE CORNEAL SCISSORS

64-3297 4¼" Right
 64-3298 4¼" Left



AEBLI CORNEAL SCISSOR

64-3270 4" Straight

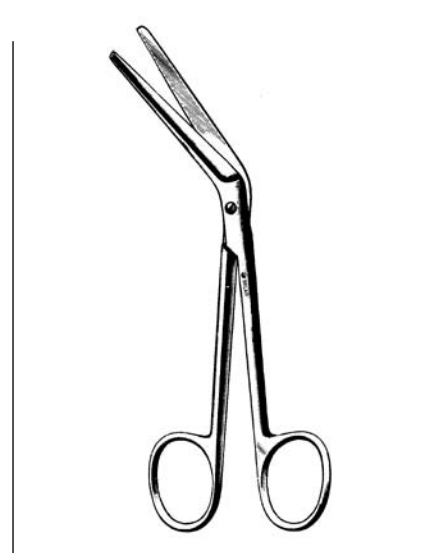

SEILER TURBINATE SCISSOR

41-1165 6¼" Angled Sideways

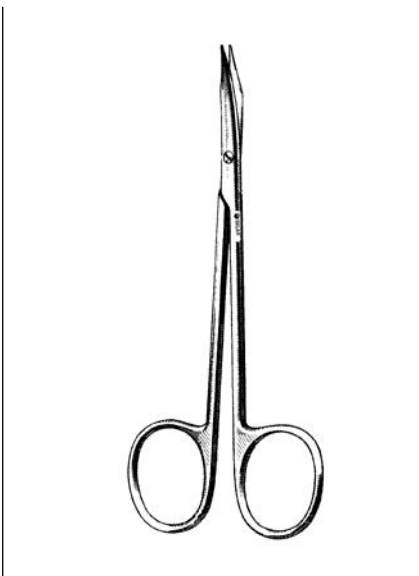

KLEINERT-KUTZ TENOTOMY SCISSOR

64-1250 5" Curved

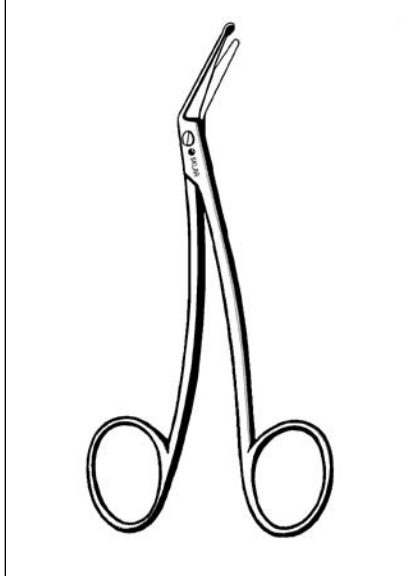

TAYLOR DURAL SCISSOR

50-4655 6½" Probe tip

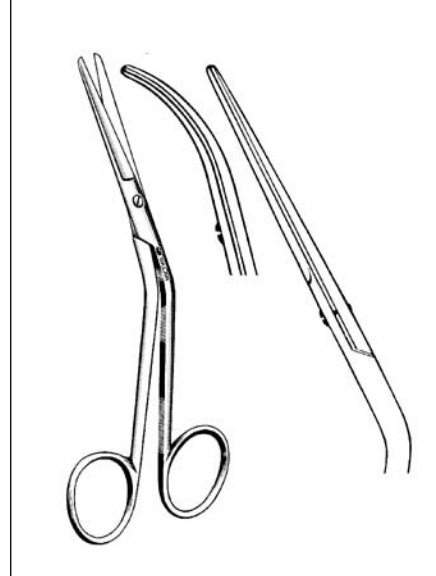

FOMON SCISSORS

DELICATE

- 70-4352 5¼" Curved
- 41-1076 5½" Curved, Saber Back
- 70-4350 5¾" Angled

SKLAR INSTRU-GUARD™ LUBE

Sklar Instru-Guard Lube is an easy-to-use, water soluble, lubricant and rust inhibitor. When used daily as a rinse after every cleaning it keeps moving parts operating smoothly and remains effective after autoclaving, but without leaving an oily residue.

Regular lubrication is essential no matter which cleaning method is employed (including ultrasonic). Sklar Instru-Guard Lube is ideal for maintaining instrument quality and performance.

10-1635	1 Gallon Containers Concentrated	4/case
10-1634	1 Gallon Container Concentrated	1 container
10-1636	8 oz. Spray Bottles	12/case
10-1637	8 oz. Spray Bottle	1 bottle

SURGICAL INSTRUMENT LUBRICANT / RUST INHIBITOR

- Extends the Life of Instruments
- Protects all Surgical Instruments

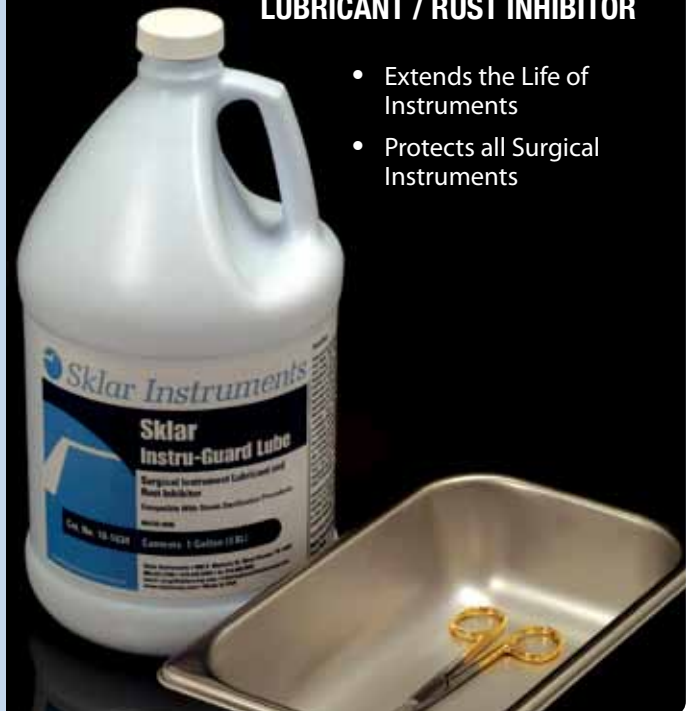

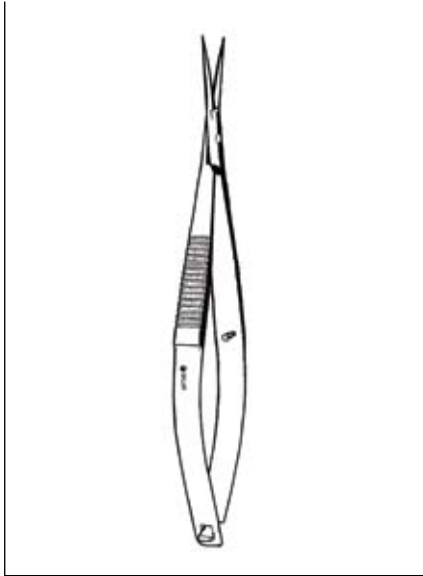

NOYES IRIS SCISSORS

64-3210	4½"	Straight	Blunt/Blunt
64-3211	4½"	Straight	Sharp/Blunt
64-3212	4½"	Straight	Sharp/Sharp
64-3215	4½"	Curved	Sharp/Sharp

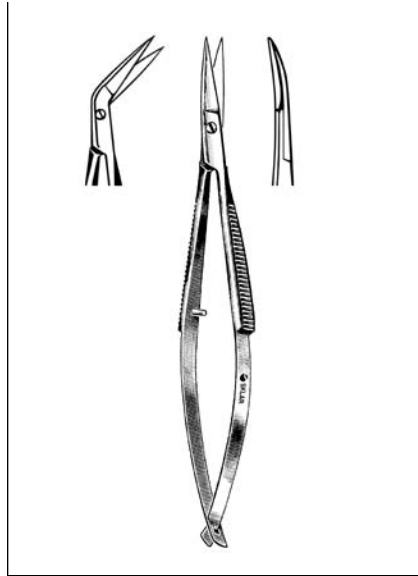

McCLURE IRIS SCISSORS

64-1842	4¼"	Straight
64-1942	4¼"	Curved
64-1742	4¼"	Angled

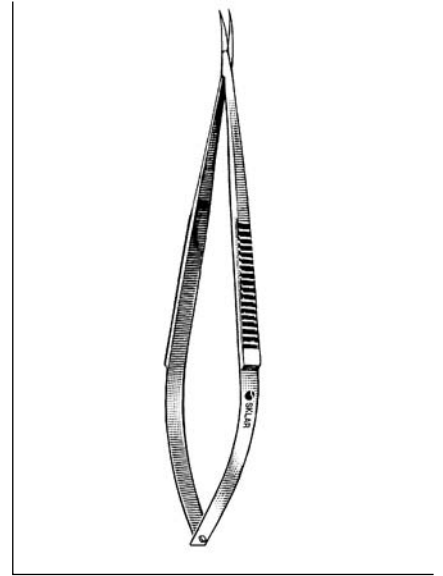

JACOBSON SCISSORS

98-1052	5¼"	Curved
98-1055	6¼"	Straight
98-1067	6¼"	Curved

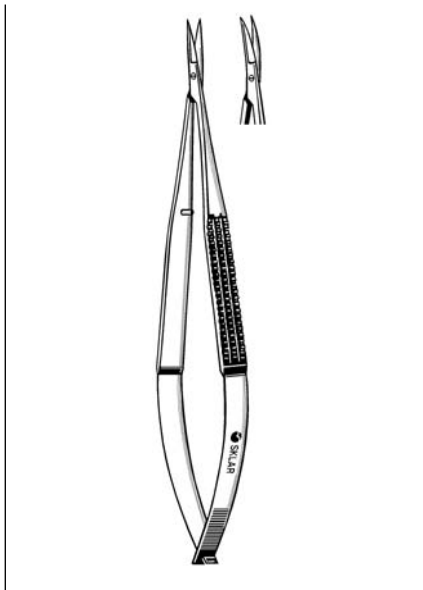

**MICRO SURGICAL SCISSORS
ROUND HANDLE, SHARP**

98-7814	6"	Straight
98-7815	6"	Curved
98-7816	7⅞"	Straight
98-7817	7⅞"	Curved

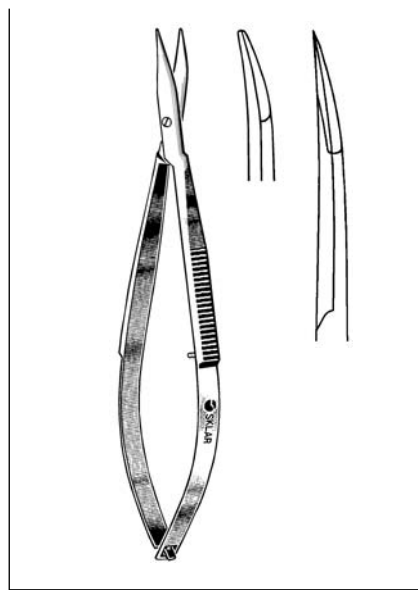

**WESTCOTT TENOTOMY
SCISSORS**

SPRING HANDLE			
64-3146	4¼"	Straight	Blunt
64-3145	4¼"	Straight	Sharp
64-3142	5"	Curved Right	Blunt
64-3144	5"	Curved Left	Blunt

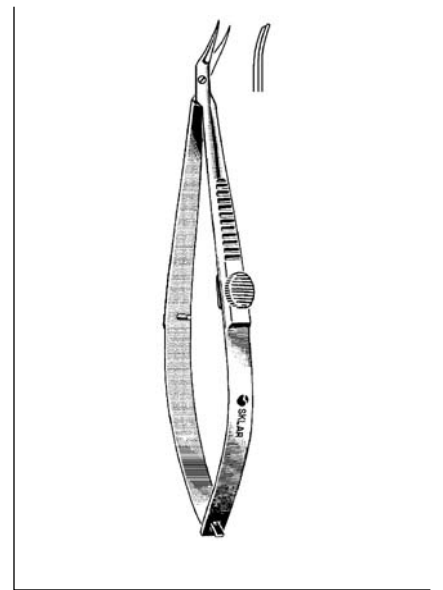

**CASTROVIEJO CORNEAL
SCISSORS**

INNER BLADE LONGER THAN OUTER BLADE

64-3294	4"	Right
64-3296	4"	Left

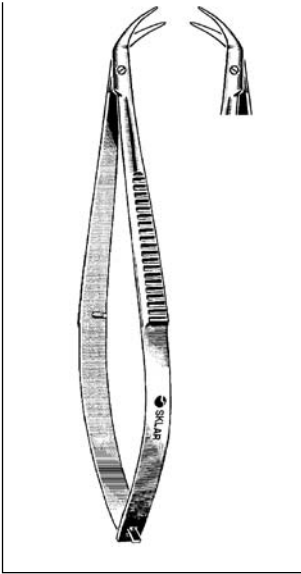

CASTROVIEJO CORNEAL SCISSORS

INNER BLADE .5MM LONGER THAN OUTER BLADE

- 64-2242 4 1/4" Curved Right
- 64-2342 4 1/4" Curved Left

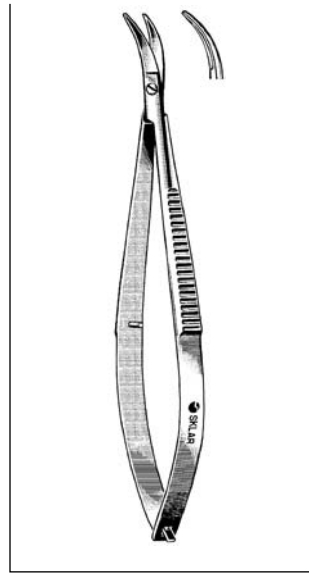

CASTROVIEJO CORNEAL SCISSOR

64-2442 4" Curved Blunt

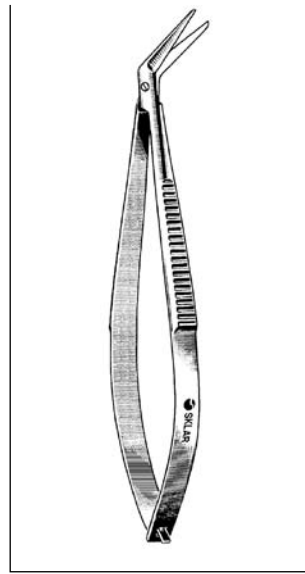

CASTROVIEJO CORNEAL SCISSORS

64-2535 4" Angled Blunt

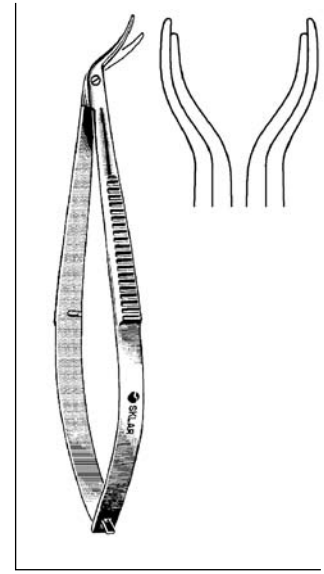

CASTROVIEJO CATARACT SCISSORS

OUTER BLADE LONGER THAN INNER BLADE

- 64-3290 4" Right Angled and Curved
- 64-3292 4" Left Angled and Curved

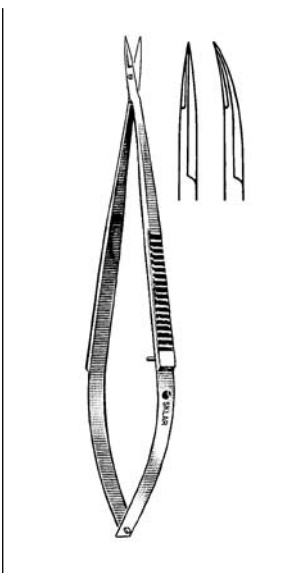

IRIS MICRO-MINI SCISSORS

EXTRA DELICATE

- 64-3050 4" Straight
- 64-3052 4" Curved

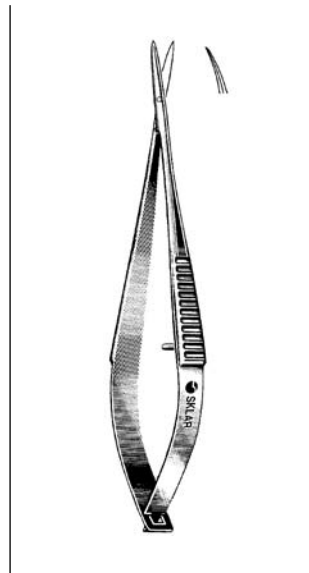

McPHERSON VANNAS SCISSORS

- 64-1960 3" Straight
- 64-1961 3" Curved

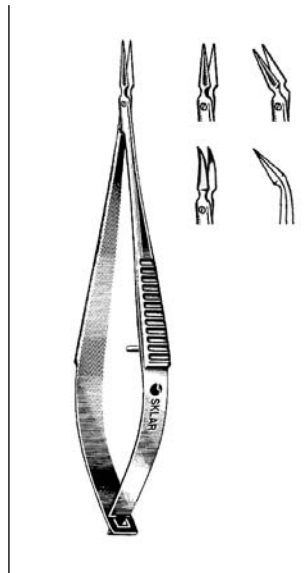

VANNAS SCISSORS

DELICATE, 8MM

- 64-1950 3" Straight
- 64-1951 3" Curved
- 64-1952 3" Angled
- 64-1955 3" Angled on Flat

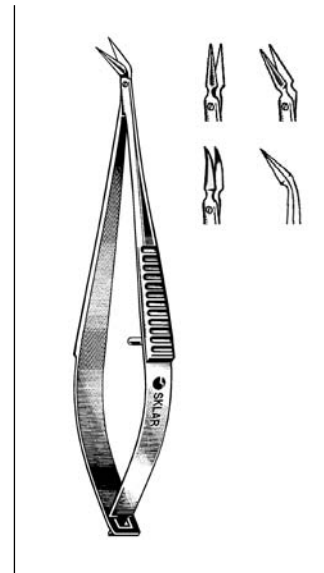

MICRO VANNAS SCISSORS

ULTRA FINE BLADES, 5MM

- 64-1850 3" Straight
- 64-1851 3" Curved
- 64-1852 3" Angled
- 64-1853 3" Angled on Flat

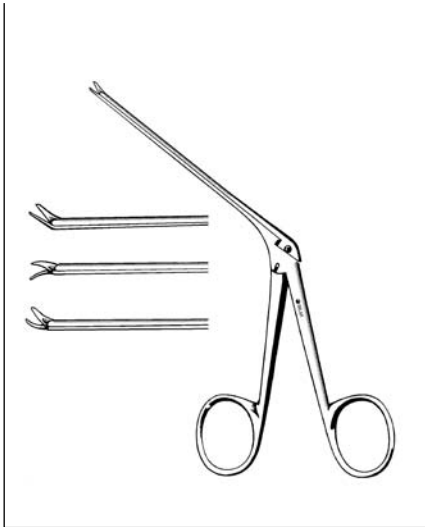

**MICRO BELLUCCI
EAR SCISSORS**

67-8187	3"	4mm	Straight
67-8188	3"	4mm	Straight, Ebony
67-8189	3"	4mm	Curved Right
67-8191	3"	4mm	Curved Left
67-8193	3"	4mm	Curved Upward

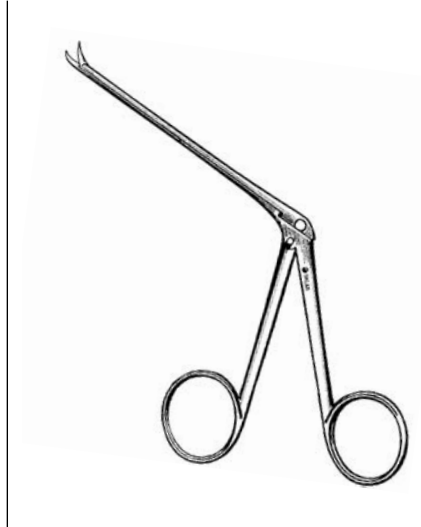

ALLIGATOR EAR SCISSORS

DELICATE			
67-8014	3¼"	Straight	
67-8020	3¼"	Curved Right	
67-8018	3¼"	Curved Left	
67-8016	3¼"	Angled	

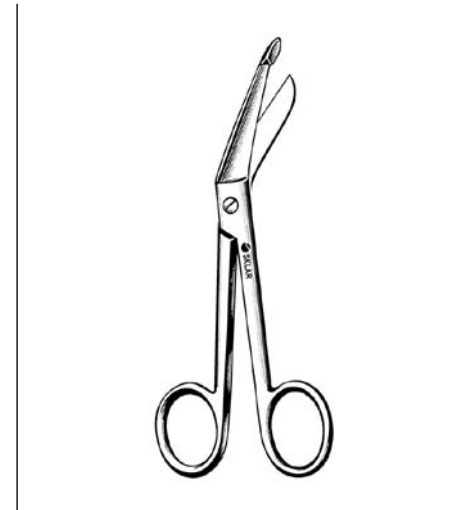

LISTER BANDAGE SCISSORS

11-1035	3½"	
11-1045	4½"	
11-1055	5½"	
22-1054	5½"	Delicate
11-1072	7¼"	
22-1072	7¼"	Delicate
11-1080	8"	
11-1060	8"	Large Ring

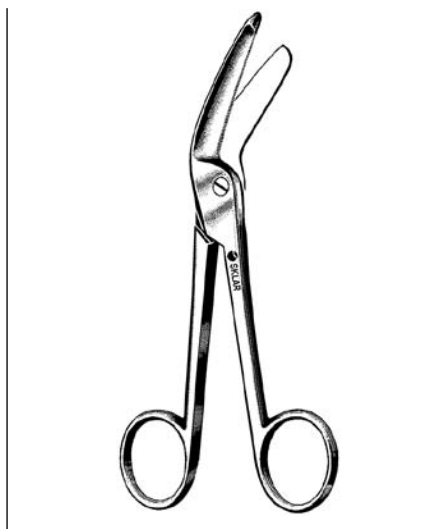

HERCULES UTILITY SCISSOR

11-1297	7½"	Serrated
---------	-----	----------

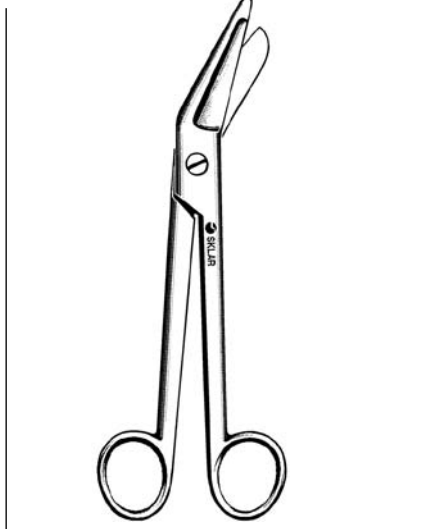

**ESMARCH HEAVY PLASTER
SHEARS**

11-1380	8"
11-1390	9"

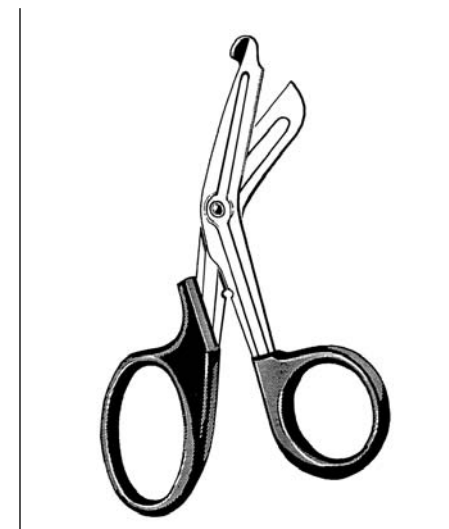

UTILITY SCISSORS

SERRATED		
11-1278	6"	Blue
11-1280	7½"	Blue
11-1281	7½"	Black
11-1282	7½"	Green
11-1283	7½"	Red
11-1284	7½"	White
11-1285	7½"	Purple
11-1286	7½"	Orange
11-1287	7½"	Yellow

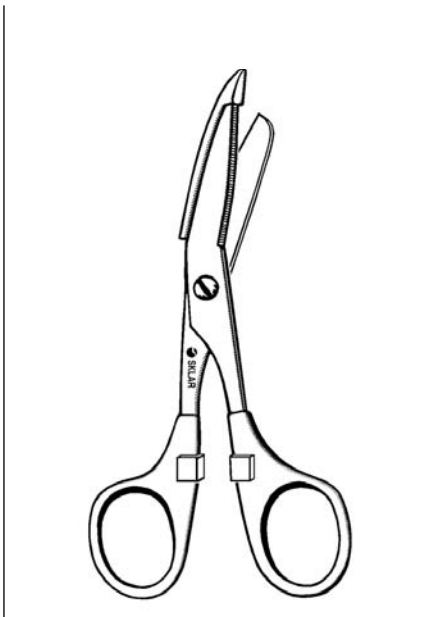

NURSES BANDAGE SCISSORS

11-1495 5½" Pink
11-1496 5½" Blue

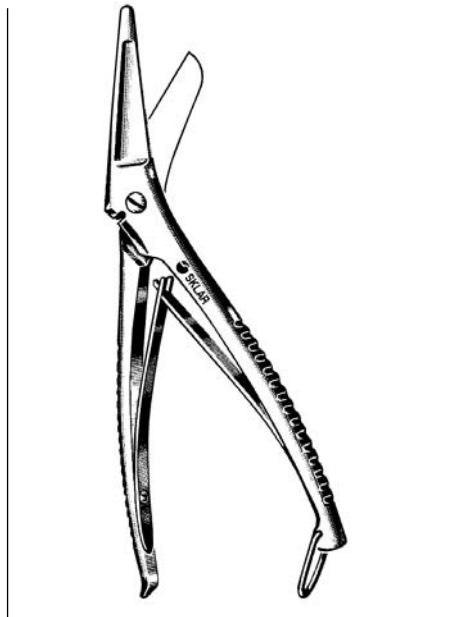

COMMANDER UTILITY SHEAR

11-1298 8½" Serrated

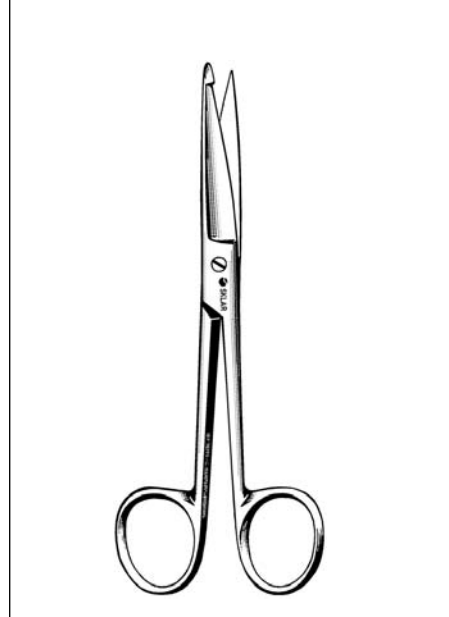

KNOWLES BANDAGE SCISSOR

11-1255 5½"

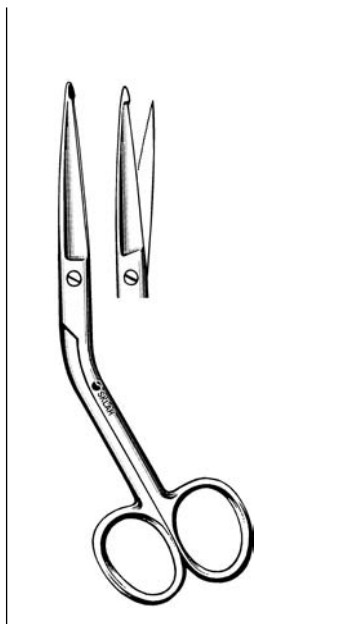

SKLAR HI LEVEL BANDAGE SCISSOR

11-1252 5½" Serrated

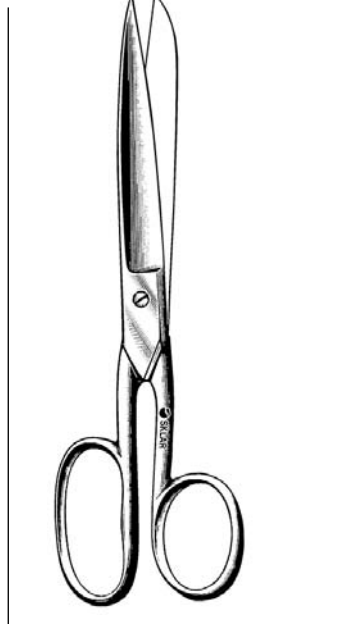

USA GAUZE SCISSOR

11-1180 8"

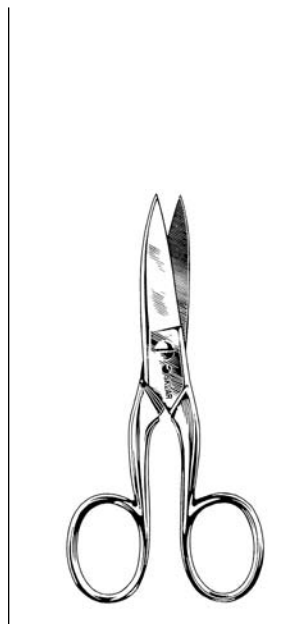

SKLAR NAIL SCISSORS

97-1235 3½" Straight
97-1245 4½" Curved

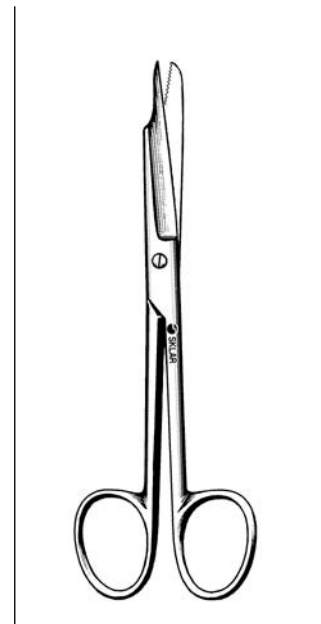

NAIL SPLITTING SCISSOR

97-0555 6" Serrated



Forceps



Tungsten Carbide

Sklar TC Forceps utilize solid tungsten carbide insert jaws for long-lasting, positive holding power beyond that of any standard instrument. Sklar TC Forceps use this special non-slip tissue gripping profile to enable the user to apply exact pressure for proper tissue handling and suture tying, with exceptional control that reduces trauma. These precisely ground forceps are readily identified by the gold handles.

Premium

Sklarlite™

Premium Forceps have been reduced in their overall pattern weight while maintaining the strength and durability of a standard pattern. The result is a noticeably lighter, extremely sensitive instrument that can withstand the daily rigors of surgery.

Sklarlite XD™

Extra Delicate Forceps mill scant microns off the delicate pattern to produce one of the lightest general surgery forceps on the market today, without compromising instrument integrity and reliability. Sklarlite and Sklarlite XD are covered under the same warranty that guarantees all Sklar instruments for a lifetime of dependable use.

Sklar LiteGrip™

Forceps offer fenestrated handles to allow for a firm secure grip in a lighter pattern.

General Surgery Instruments

Our very best operating room, high quality instruments incorporating optimum grades of German grade surgical steel, finely detailed craftsmanship and exacting standards of manufacturing. Choose from a full line of the most popular patterns.

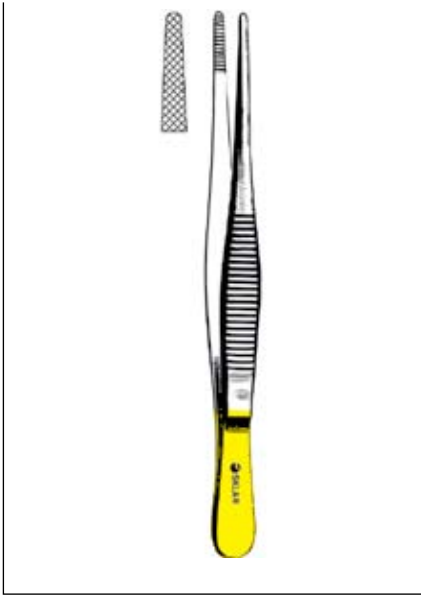

TC DRESSING FORCEPS

SERRATED

- 51-3460 6"
- 51-3480 8"



TC ADSON DRESSING FORCEPS

SERRATED

- 51-3447 4¾"
- 51-3448 6"



TC ADSON TISSUE FORCEPS

1X2 TEETH, WITH TYING PLATFORM

- 51-3049 4¾" Serrated
- 51-3050 4¾" Smooth, Gorney-Adson
- 51-3051 6" Serrated

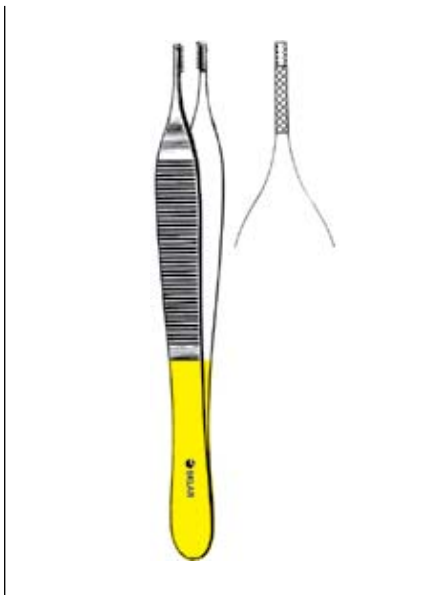

TC ADSON-BROWN FORCEPS

SIDE GRASPING

- 51-1446 4¾" 4x4 Teeth
- 51-1447 4¾" 7x7 Teeth

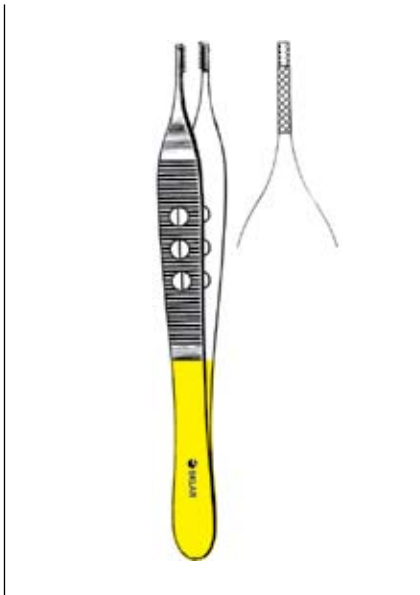

TC LITEGRIP™ ADSON-BROWN FORCEP

SIDE GRASPING

- 51-1448 4¾" 7x7 Teeth

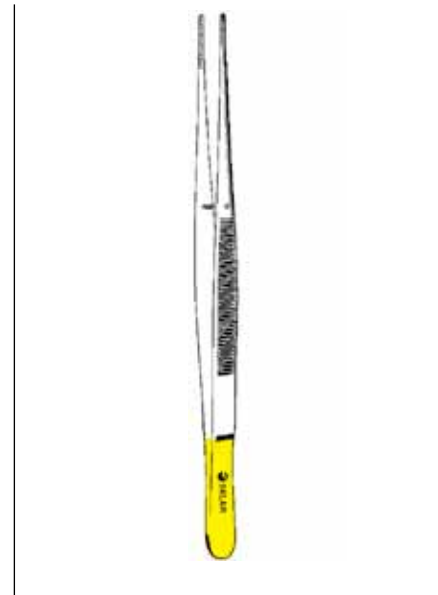

TC POTTS-SMITH DRESSING FORCEPS

SERRATED

- 51-4360 6"
- 51-4370 7"
- 51-4382 8¼"
- 51-4395 9½"

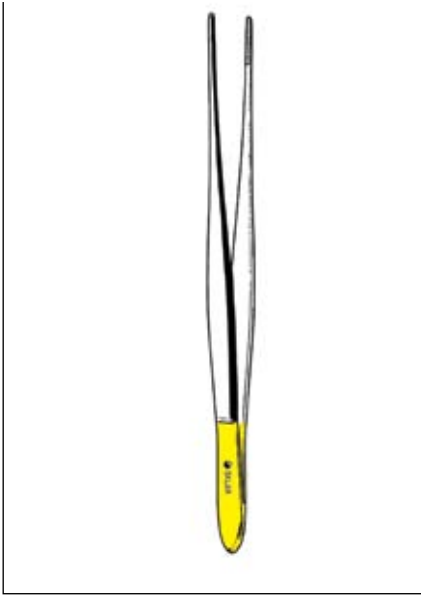

TC CUSHING DRESSING FORCEP

GUTCH HANDLE

51-4398 7" Serrated

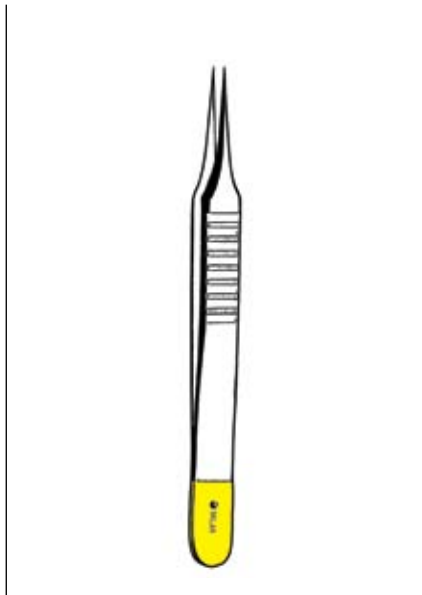

TC JEWELER'S FORCEPS

DIAMOND DUST TIPS

51-4450 4" #4
51-4451 4¼" #5A

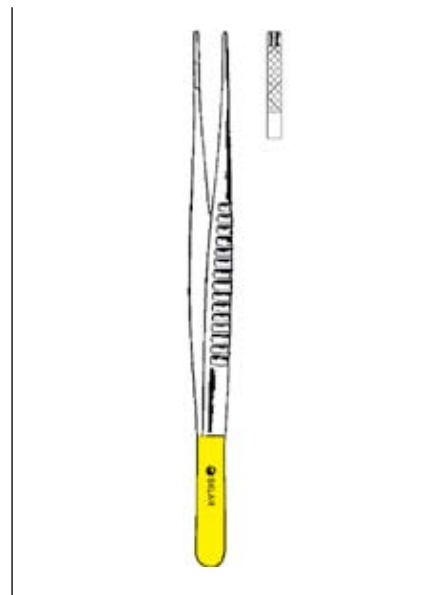

TC DEBAKEY ATRAUMATIC FORCEPS

97-1530 6" 2mm
97-1531 6" 2.7mm
97-1540 8" 2mm
97-1541 8" 2.7mm



TC ALLIS TISSUE FORCEPS

ATRAUMATIC

97-1555 6"
97-1560 7½"



TC BABCOCK FORCEPS

ATRAUMATIC

97-1565 6¼"
97-1570 8"



SKLARLITE
THE LIGHT TOUCH

SKLARLITE XD™
EXTRA DELICATE

**SKLARLITE™ AND SKLARLITE XD™
PROVIDES LIGHTNESS
AND DURABILITY**

Sklar has developed a new line of premium operating room instruments that offers the surgeon maximum control and precision. Our research determined a need for instruments that were lighter patterns while maintaining the strength and durability of a standard pattern.

Sklar has recognized the need for a manufacturing technique that mills scant microns off our standard pattern while maintaining the structural integrity of the original instrument. The result is a noticeably lighter, extremely sensitive instrument that can withstand the daily rigors of surgery.

SKLARLITE™ and SKLARLITE XD™ instruments carry the same day-in and day-out reliability that you have come to expect from all Sklar instruments. Sklar has applied its more than 100 years of experience in developing this superior instrument.

SKLARLITE
THE LIGHT TOUCH

**SKLARLITE™ DRESSING
FORCEPS**

SERRATED

23-2824	4½"
23-2826	5"
23-2828	5½"
23-2830	6"

SKLARLITE XD™
EXTRA DELICATE

**SKLARLITE XD™
DRESSING FORCEPS**

SERRATED

23-2834	4½"
23-2836	5"
23-2838	5½"



SKLARLITE
THE LIGHT TOUCH

**SKLARLITE™ TISSUE
FORCEP**

23-2811 5½" 1x2 Teeth

SKLARLITE XD™
EXTRA DELICATE

**SKLARLITE XD™
TISSUE FORCEP**

23-2819 5½" 1x2 Teeth

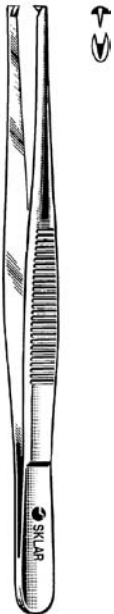

SKLARLITE
THE LIGHT TOUCH

**SKLARLITE™ ADSON
FORCEPS**

DRESSING

23-2600 4¾" Serrated

TISSUE

23-2602 4¾" 1x2 Teeth

ADSON-BROWN

23-2603 4¾" Side Grasping

SKLARLITE XD™
EXTRA DELICATE

**SKLARLITE XD™
ADSON FORCEPS**

DRESSING

23-2604 4¾" Serrated

TISSUE

23-2606 4¾" 1x2 Teeth

ADSON-BROWN

23-2608 4¾" Side Grasping

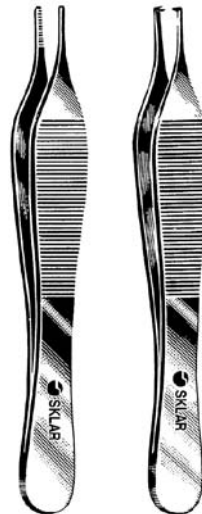



SKLARLITE
THE LIGHT TOUCH

**SKLARLITE™ HARTMANN
MOSQUITO FORCEPS**

SERRATED

23-2100	3½"	Straight
23-2101	3½"	Curved

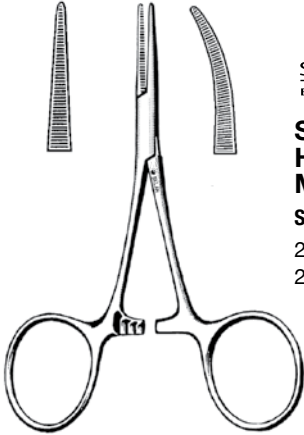

SKLARLITE XD™
EXTRA DELICATE

**SKLARLITE XD™
HARTMANN
MOSQUITO FORCEPS**

SERRATED

23-2500	3½"	Straight
23-2501	3½"	Curved

SKLARLITE
THE LIGHT TOUCH

**SKLARLITE™ HALSTED
MOSQUITO FORCEPS**

23-2105	5"	Straight
23-2106	5"	Curved

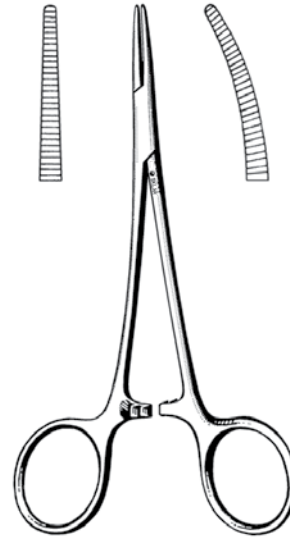

SKLARLITE XD™
EXTRA DELICATE

**SKLARLITE XD™
HALSTED MOSQUITO
FORCEPS**

23-2505	5"	Straight
23-2506	5"	Curved

SKLARLITE
THE LIGHT TOUCH

**SKLARLITE™ KELLY
HEMOSTATIC FORCEPS**

23-2107	5½"	Straight
23-2108	5½"	Curved

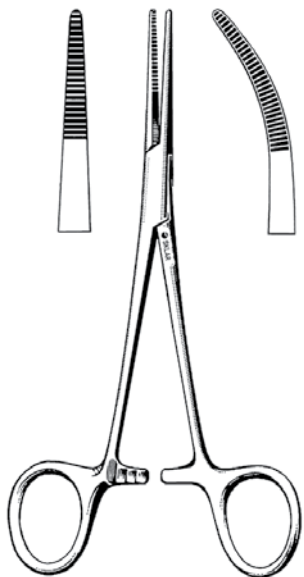

SKLARLITE XD™
EXTRA DELICATE

**SKLARLITE XD™ KELLY
HEMOSTATIC FORCEPS**

23-2507	5½"	Straight
23-2508	5½"	Curved

SKLARLITE
THE LIGHT TOUCH

**SKLARLITE™ CRILE
HEMOSTATIC FORCEPS**

23-2110	5½"	Straight
23-2113	5½"	Curved

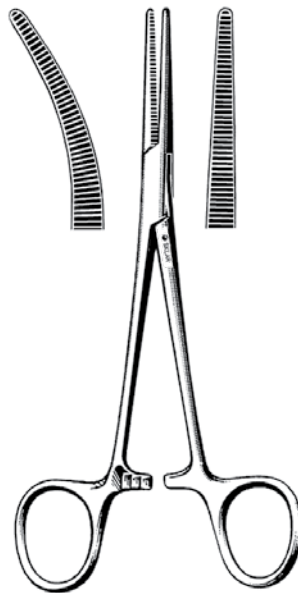

SKLARLITE XD™
EXTRA DELICATE

**SKLARLITE XD™
CRILE HEMOSTATIC
FORCEPS**

23-2510	5½"	Straight
23-2513	5½"	Curved

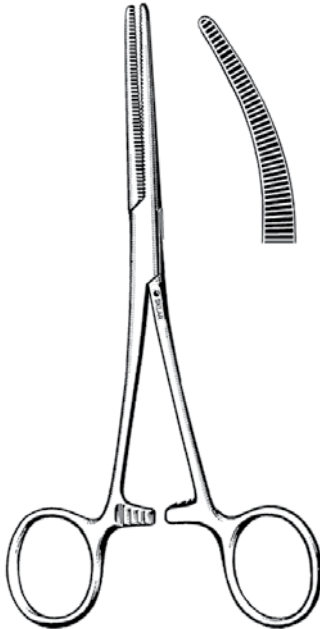

SKLARLITE
THE LIGHT TOUCH

SKLARLITE™ ROCHESTER-PEAN FORCEPS

23-2532	6¼"	Straight
23-2538	6¼"	Curved
23-2534	7¼"	Straight
23-2542	7¼"	Curved

SKLARLITE XD™
EXTRA DELICATE

SKLARLITE XD™ ROCHESTER-PEAN FORCEPS

23-2552	6¼"	Straight
23-2561	6¼"	Curved
23-2554	7¼"	Straight
23-2563	7¼"	Curved

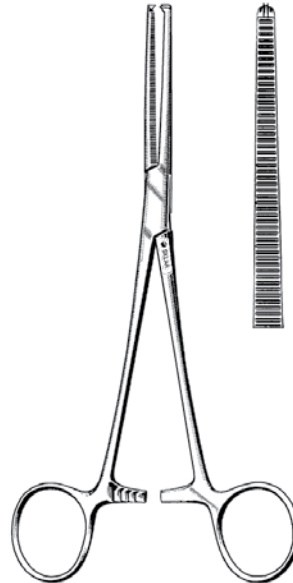

SKLARLITE
THE LIGHT TOUCH

SKLARLITE™ ROCHESTER-OCHSNER FORCEPS

1X2 TEETH

23-2560	6¼"	Straight
23-2568	6¼"	Curved

SKLARLITE XD™
EXTRA DELICATE

SKLARLITE XD™ ROCHESTER-OCHSNER FORCEPS

1X2 TEETH

23-2577	6¼"	Straight
23-2585	6¼"	Curved



SKLARLITE
THE LIGHT TOUCH

SKLARLITE™ MIXTER FORCEPS

RIGHT ANGLE

23-2516	5½"
23-2520	7¼"

SKLARLITE XD™
EXTRA DELICATE

SKLARLITE XD™ MIXTER FORCEPS

RIGHT ANGLE

23-2521	5½"
23-2525	7¼"



SKLARLITE
THE LIGHT TOUCH

SKLARLITE™ ALLIS TISSUE FORCEPS

23-2851	6"	4x5 Teeth
23-2852	6"	5x6 Teeth

SKLARLITE XD™
EXTRA DELICATE

SKLARLITE XD™ ALLIS TISSUE FORCEPS

23-2861	5"	4x5 Teeth
23-2862	5½"	4x5 Teeth
23-2864	6"	4x5 Teeth
23-2865	6"	5x6 Teeth

DRESSING FORCEPS
SERRATED

19-1040	4"	19-1070	7"
19-1045	4½"	19-1080	8"
19-1050	5"	19-1110	10"
19-1055	5½"	19-1112	12"
19-1060	6"		

SERRATED, DELICATE

22-1161	4½"
22-1162	5"
22-1163	5½"
22-1164	6"

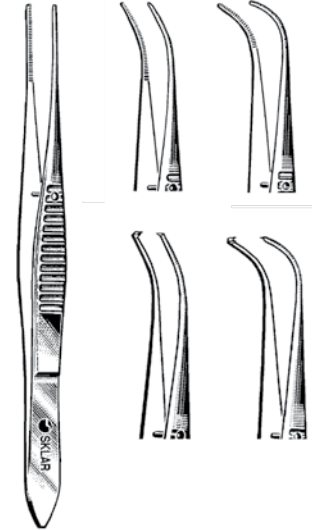
EYE DRESSING FORCEPS
4", SERRATED

66-2734	Straight	0.5mm Delicate
66-2736	Half Curve	0.5mm Delicate
66-2738	Full Curve	0.5mm Delicate
66-2740	Straight	0.8mm
66-2840	Straight	0.8mm Non-Magnetic
66-2940	Half Curve	0.8mm
66-3140	Full Curve	0.8mm

TISSUE FORCEPS
1X2 TEETH

19-1245	4½"
19-1250	5"
19-1255	5½"
19-1260	6"
19-1270	7"
19-1280	8"
19-1310	10"
19-1312	12"

1X2 TEETH, DELICATE

22-1061	4½"
22-1062	5"
22-1063	5½"
22-1064	6"

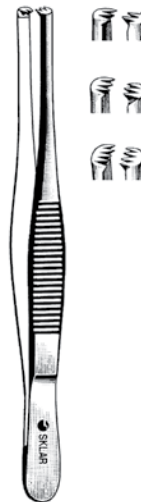
TISSUE FORCEPS
2X3 TEETH

19-1445	4½"
19-1450	5"
19-1455	5½"
19-1460	6"
19-1480	8"
19-1510	10"
19-1512	12"

3X4 TEETH

19-1650	5"
19-1655	5½"
19-1660	6"

4X5 TEETH

19-1850	5"
19-1855	5½"
19-1905	6"
19-1910	10"

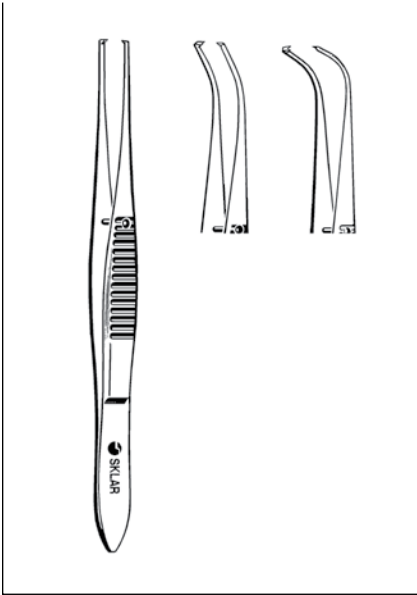
EYE TISSUE FORCEPS
1X2 TEETH, 4"

- | | | |
|---------|------------|------------------------|
| 66-3340 | Straight | 0.8mm |
| 66-3240 | Straight | 0.8mm,
Non-Magnetic |
| 66-3540 | Half Curve | 0.8mm |
| 66-3740 | Full Curve | 0.8mm |

1X2 TEETH, EXTRA DELICATE, 4"

- | | | |
|---------|------------|-------|
| 66-3341 | Straight | 0.5mm |
| 66-3541 | Half Curve | 0.5mm |
| 66-3741 | Full Curve | 0.5mm |

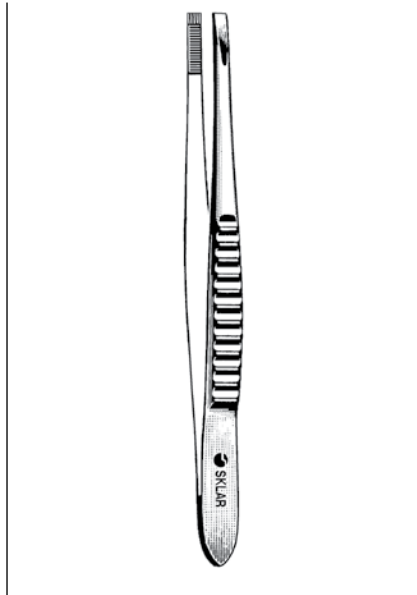
STILLE PATTERN TISSUE FORCEP

- | | | |
|---------|----|-----------|
| 19-2050 | 5" | 4x5 Teeth |
|---------|----|-----------|

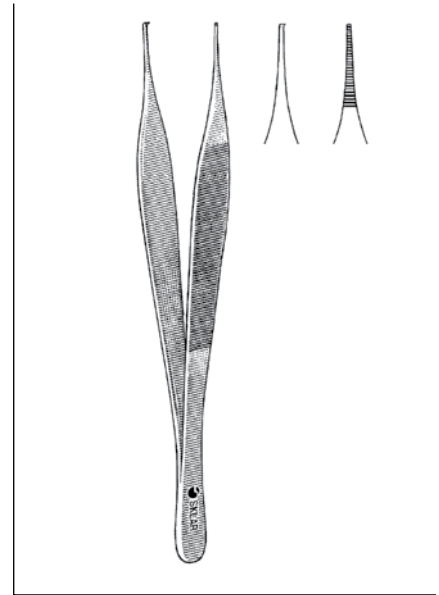
MICRO ADSON FORCEPS

- | | | |
|---------|--------|-----------|
| 98-2048 | 4 3/4" | Serrated |
| 98-2047 | 4 3/4" | 1x2 Teeth |

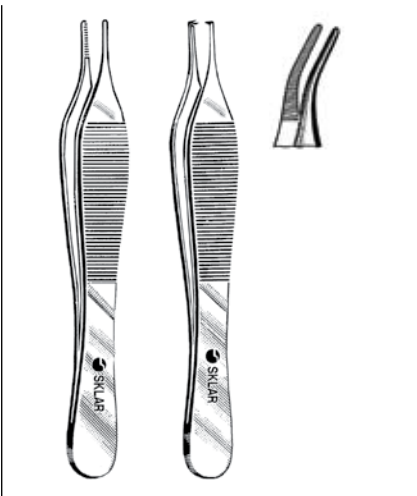
ADSON FORCEPS
DRESSING, SERRATED

- | | | |
|---------|--------|----------|
| 50-3147 | 4 3/4" | |
| 47-2147 | 4 3/4" | Delicate |
| 47-2148 | 4 3/4" | Angled |

TISSUE

- | | | |
|---------|--------|---------------------|
| 50-3047 | 4 3/4" | 1x2 Teeth |
| 47-2047 | 4 3/4" | 1x2 Teeth, Delicate |
| 50-3046 | 4 3/4" | 1x2 Teeth, Angled |
| 47-2049 | 4 3/4" | 2x3 Teeth, Delicate |

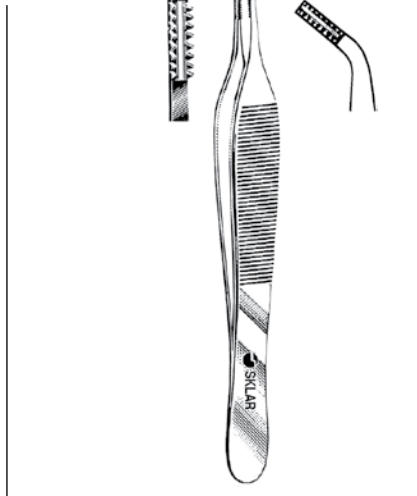
ADSON BROWN FORCEPS
7X7 TEETH, SIDE GRASPING

- | | | |
|---------|--------|------------------|
| 47-1447 | 4 3/4" | |
| 47-2447 | 4 3/4" | Delicate |
| 47-1450 | 4 3/4" | Delicate, Angled |

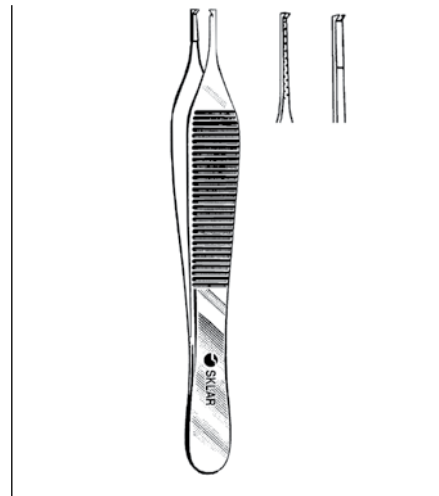
ADSON FORCEPS
1X2 TEETH

- | | | |
|---------|--------|---------------------|
| 50-3048 | 4 3/4" | Serrated |
| 50-3049 | 4 3/4" | With Tying Platform |

**ADSON LITEGRIP™
DRESSING FORCEPS**
FENESTRATED HANDLES, 4¾"

- 50-3148 Serrated
- 50-3050 1x2 Teeth
- 50-3052 1x2 Teeth With Tying Platform
- 47-1448 7x7 Teeth, Side Grasping

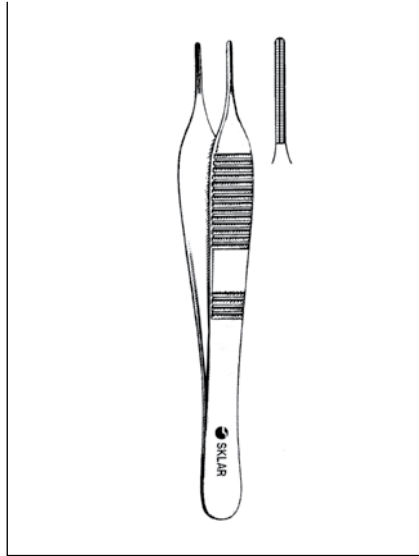
**ADSON-DEBAKEY
DRESSING FORCEP**
ATRAUMATIC TIPS

- 52-5362 4¾" 1.5mm

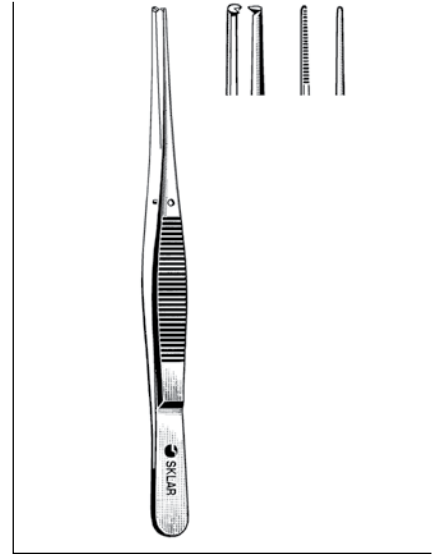
SEMKIN FORCEPS
DRESSING, SERRATED

- 22-4150 5" Straight
- 22-4152 5" Curved
- 22-4154 6" Straight
- 22-4156 6" Curved

TISSUE

- 22-4350 1x2 Teeth 5" Straight
- 22-4352 1x2 Teeth 5" Curved
- 22-4354 1x2 Teeth 6" Straight
- 22-4356 1x2 Teeth 6" Curved
- 22-4550 2x3 Teeth 5" Straight

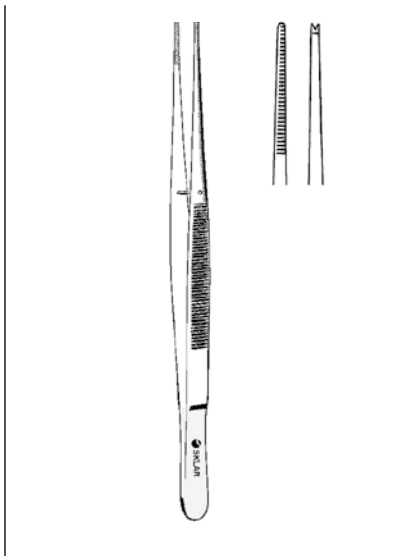
POTTS-SMITH FORCEPS
DRESSING, SERRATED
TISSUE, 1X2 TEETH

- 52-3270 7" 52-3370 7"
- 52-3282 8¼" 52-3382 8¼"
- 52-3310 10" 52-3410 10"
- 52-3312 12" 52-3412 12"

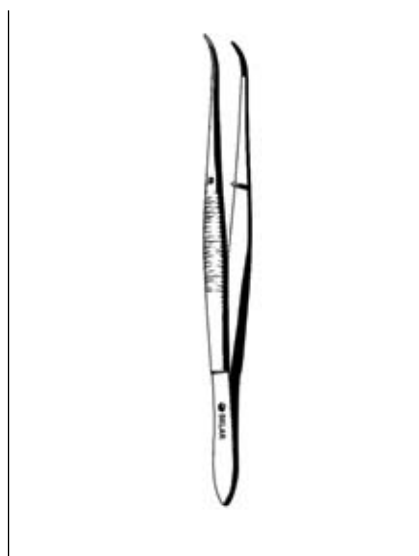
DRESSING FORCEP
SERRATED

- 22-4050 5" Curved, Narrow

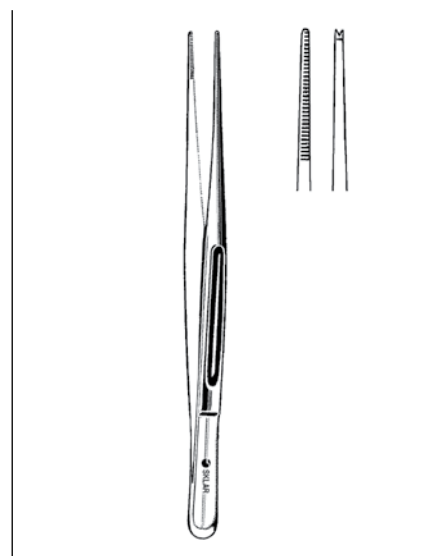

CUSHING FORCEPS
GUTCH HANDLE, SCRAPER END

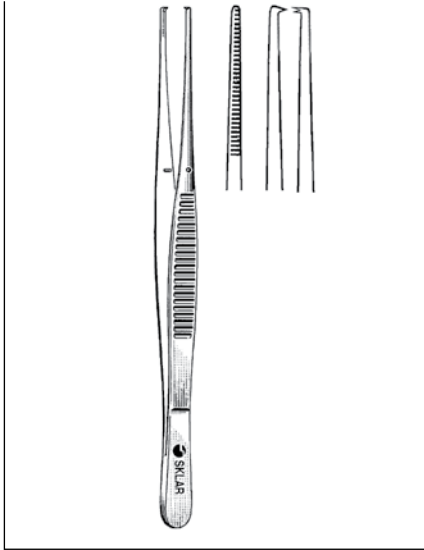
- 50-2670 7" Serrated
- 50-2870 7" 1x2 Teeth

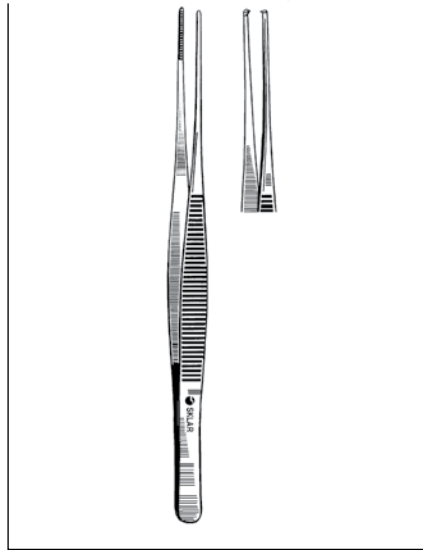

CUSHING FORCEPS

22-6770 7" Serrated
22-6870 7" 1x2 Teeth



CUSHING BRAIN FORCEPS

DELICATE, SERRATED HANDLE

50-2770 7" Serrated
50-2970 7" 1x2 Teeth

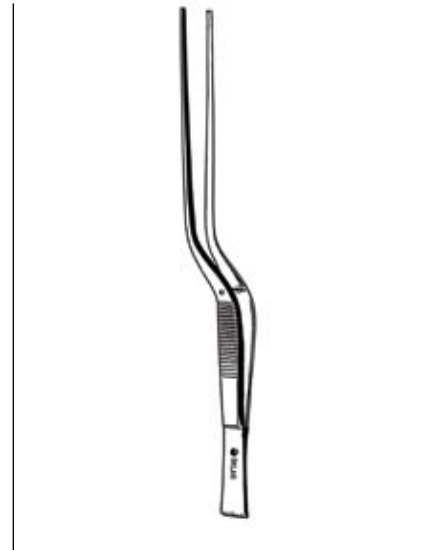

CUSHING FORCEPS

SCRAPER END, BAYONET

22-6970 7¼" Serrated
22-6670 7¼" 1x2 Teeth

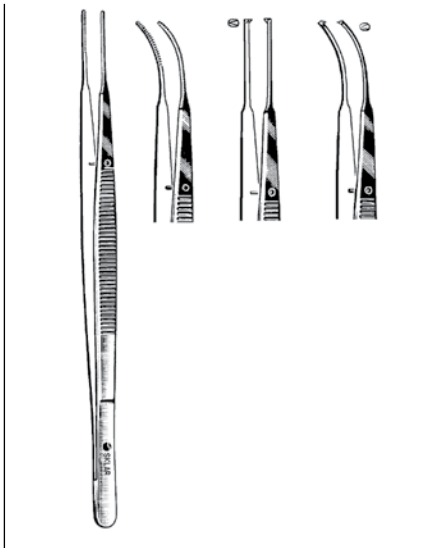

GERALD FORCEPS

DRESSING, SERRATED

47-1180 7" Straight
47-1175 7" Curved

TISSUE, 1X2 TEETH

47-1173 7" Straight
47-1186 7" Curved

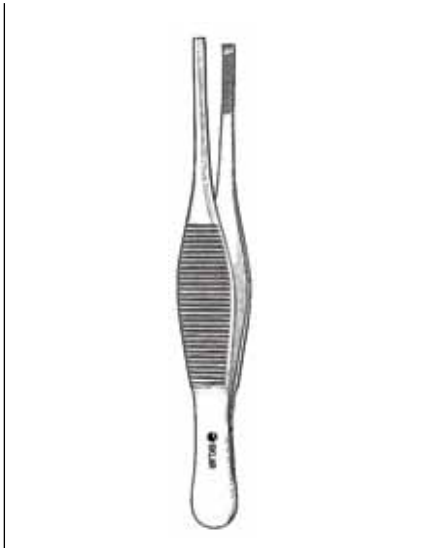

HEANEY TISSUE FORCEP

19-2200 5½" 2x3 Teeth, Serrated

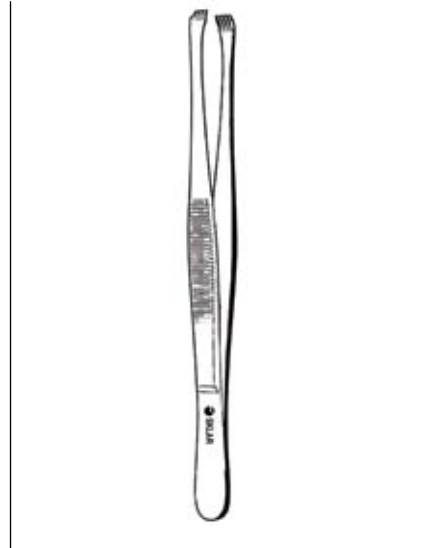

STONE TISSUE FORCEP

19-2160 6" 4x5 Teeth Extra Heavy

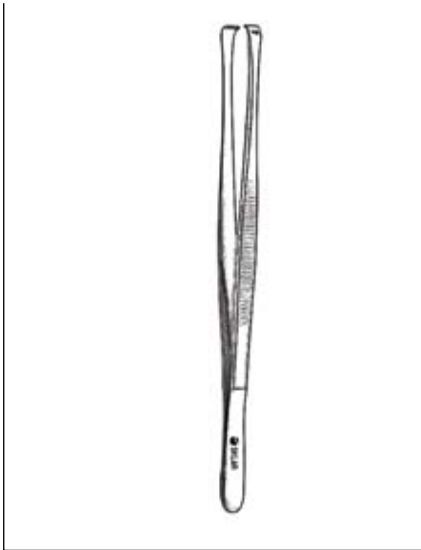

MARTIN TISSUE FORCEPS

7X8 TEETH

19-2166	6"
19-2167	7½"
19-2168	9"

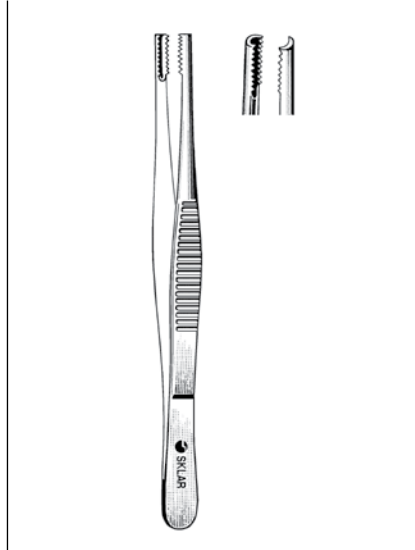

BROWN TISSUE FORCEPS

SIDE GRASPING, 8X8 TEETH

19-2860	6"
19-2880	8"
19-2910	10"



RUSSIAN TISSUE FORCEPS

19-2260	6"
19-2280	8"
19-2320	9"
19-2310	10"

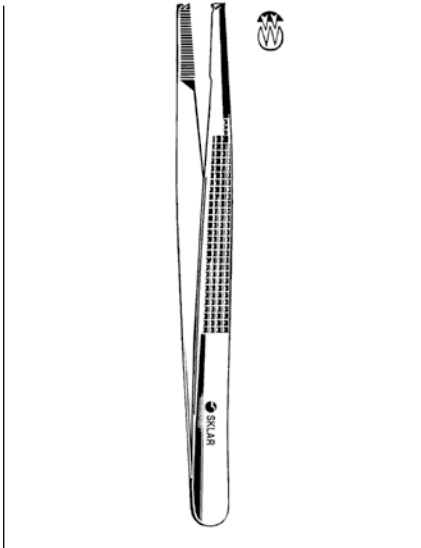

BONNEY TISSUE FORCEPS

SERRATED

19-2170	7"	1x2 Teeth
19-2172	7"	2x3 Teeth

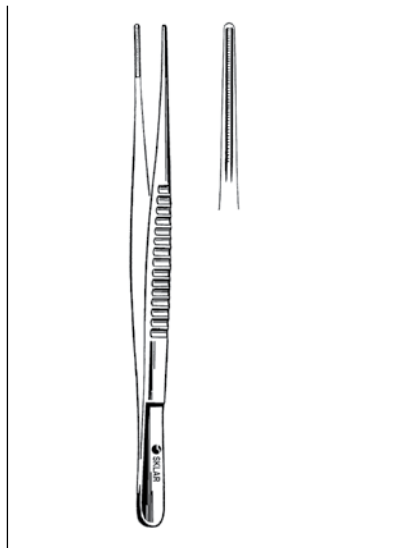

DEBAKEY FORCEPS

3.5MM JAWS, ATRAUMATIC

52-5262	6¼"
52-5277	7¾"
52-5295	9½"

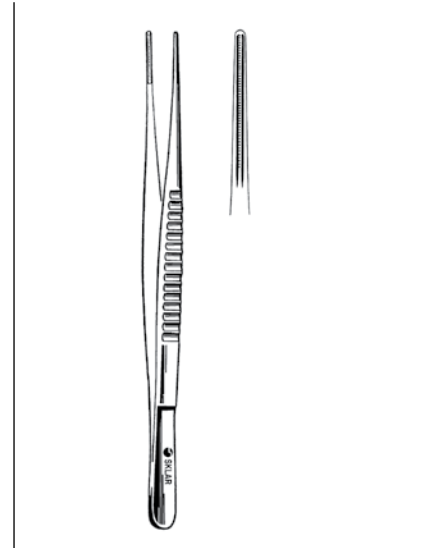

DEBAKEY FORCEPS

2MM JAWS, ATRAUMATIC

52-5162	6¼"
52-5177	7¾"
52-5195	9½"
52-5198	12"

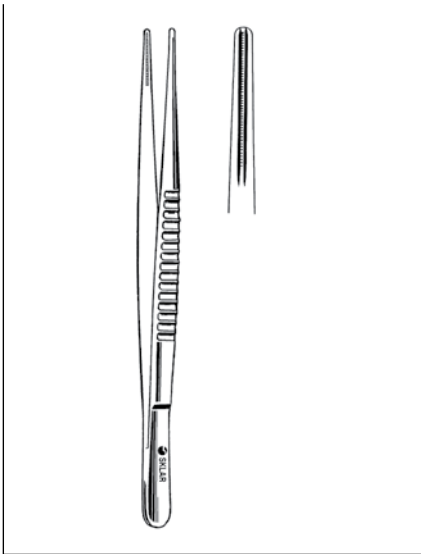

DEBAKEY FORCEPS

1.5MM JAWS, ATRAUMATIC

52-5062	6¼"
52-5077	7¾"
52-5095	9½"

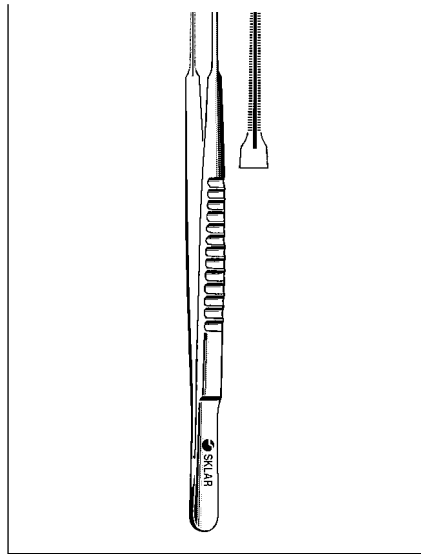

COOLEY VASCULAR FORCEPS

52-6690	6"
52-6694	8"
52-6696	9½"

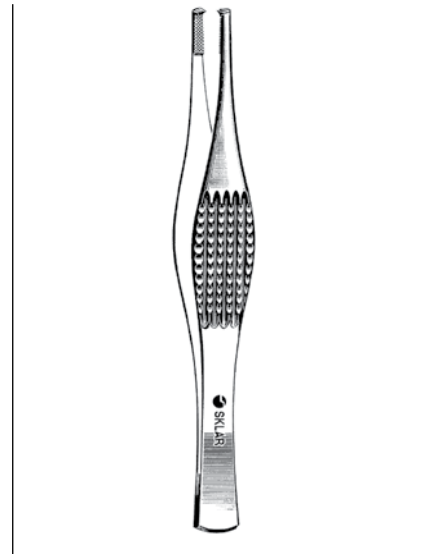

FERRIS-SMITH TISSUE FORCEPS

SERRATED, PLATFORM TIPS

47-1470	7"	1x2 Teeth
52-3970	7"	2x3 Teeth

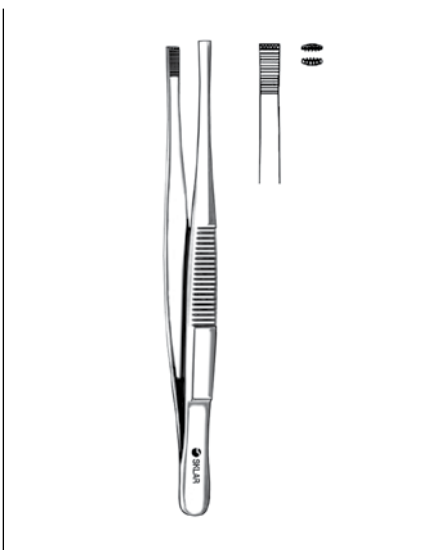

DEPILATORY FORCEP

FLAT SQUARE TIPS WITH DEEP SERRATIONS

52-3975	5½"
---------	-----

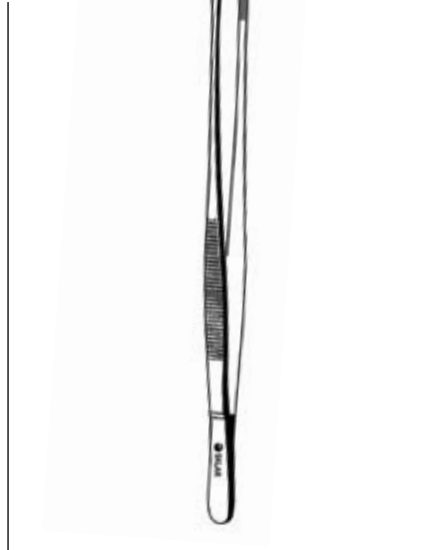

WANGENSTEEN FORCEP

ROUNDED JAWS WITH FINE CROSS SERRATIONS

36-1310	9"
---------	----

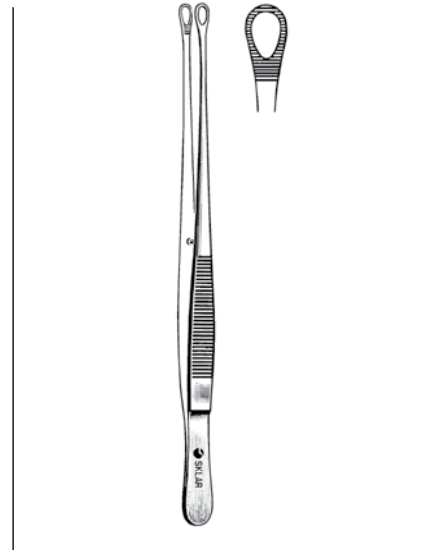

TUTTLE/SINGLEY FORCEPS

22-7470	7"	Tuttle
36-1290	9"	Singley

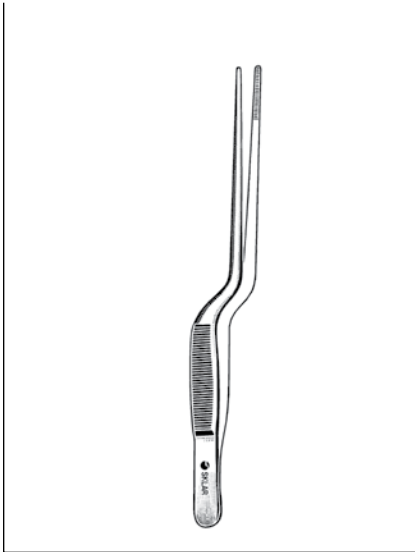
LUCAE EAR FORCEP
BAYONET, SERRATED

67-1455 5½"

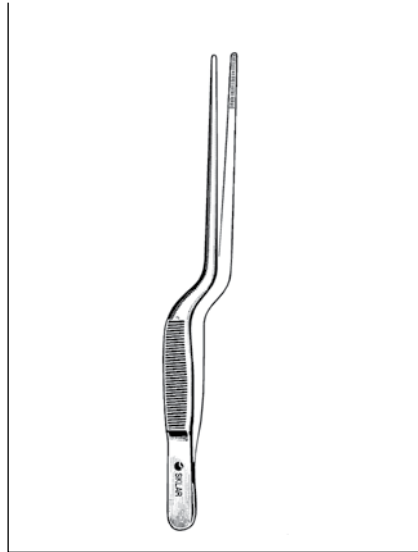
JANSEN NASAL FORCEPS
BAYONET SERRATED

67-1465 6½"

70-4375 7½"

70-4385 8½"

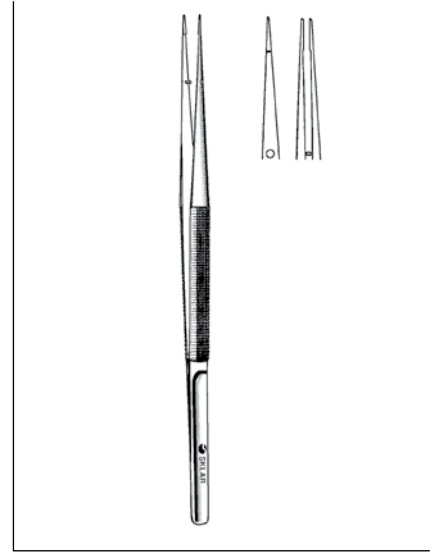

RHOTON MICRO SUTURE FORCEPS
STRAIGHT

98-3056 7" 0.3mm

98-3055 7" 0.7mm With Tying Platform

KIRBY IRIS FORCEPS
1X2 TEETH

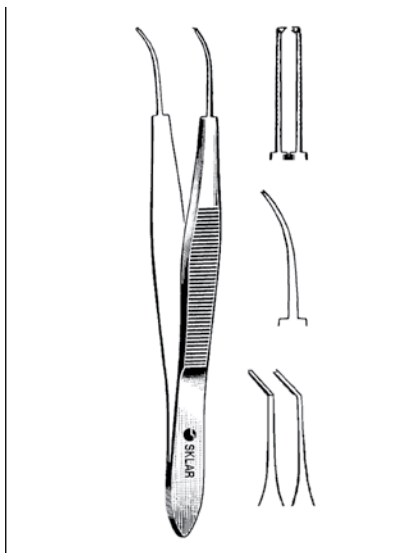
66-2750	4"	Straight
66-2755	4"	Curved
66-2760	4"	Angled

STEVENS IRIS FORCEPS
WITHOUT CATCH

66-4947	Serrated	Straight
66-4948	Serrated	Curved
66-4949	Serrated	Angled
66-4950	1x2 Teeth	Straight
66-4951	1x2 Teeth	Curved
66-4955	1x2 Teeth	Angled

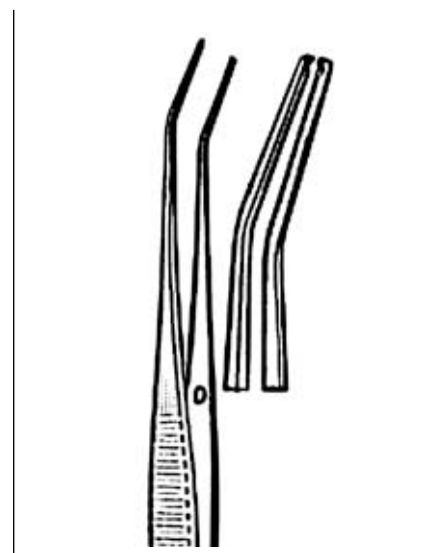
O'CONNOR IRIS FORCEP
1X2 TEETH, ANGLED

66-4956 3¾" 0.5mm x 9mm

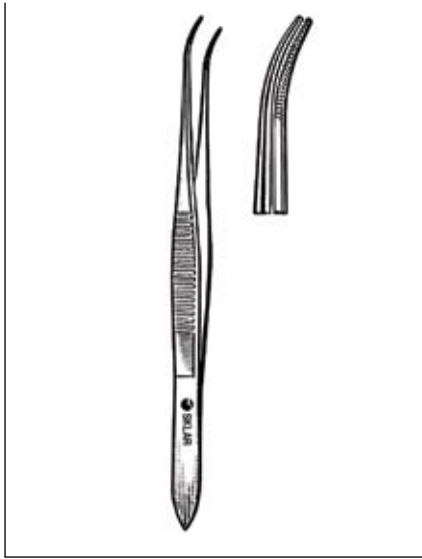

BRACKEN IRIS FORCEP
FINE CROSS SERRATED TIPS

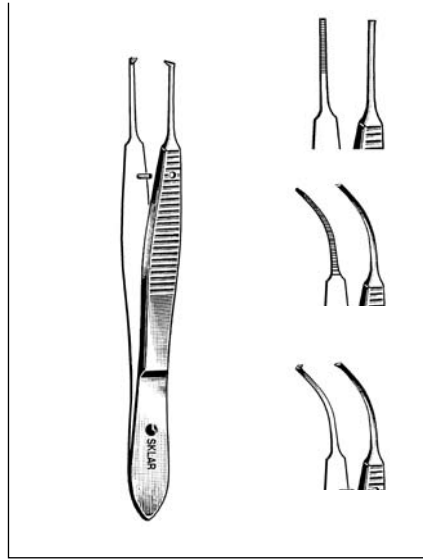
66-4958 4" Curved

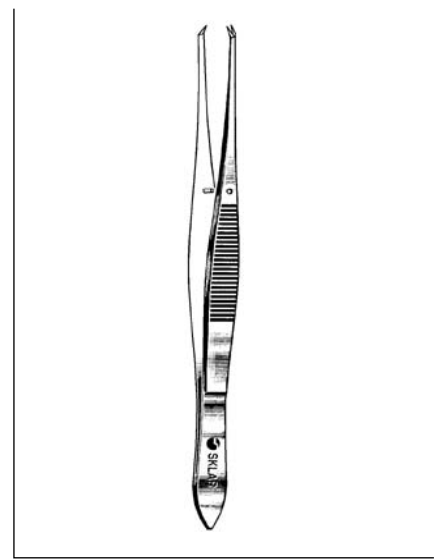

GRAEFE IRIS FORCEPS
STRAIGHT

 66-4526 2¾" Serrated
 66-4525 2¾" 1x2 Teeth

CURVED

 66-4626 2¾" Serrated
 66-4625 2¾" 1x2 Teeth

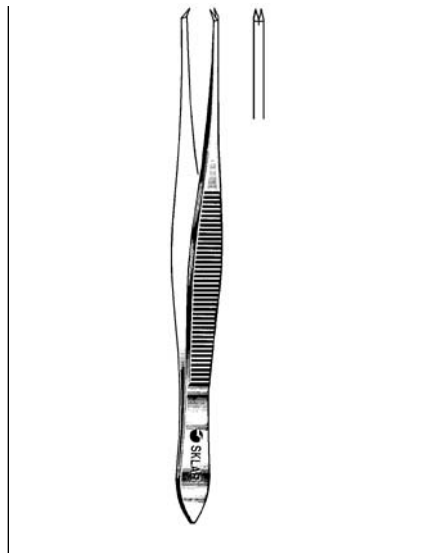
O'BRIEN FIXATION FORCEP
1X2 TEETH, ANGLED FORWARD

66-2440 4" 0.9mm, Delicate

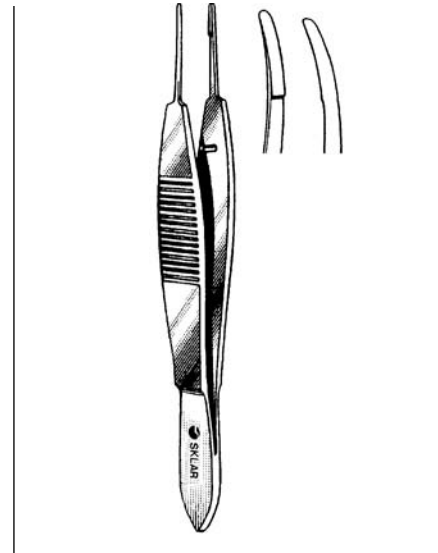

ELSCHMIG FIXATION FORCEPS
ANGLED UPWARD

 66-2350 4¼" 1x2 Teeth
 66-2351 4¼" 2x3 Teeth
 66-2352 4¼" 3x4 Teeth

LESTER FIXATION FORCEPS
DELICATE

 66-4237 3½" 1x2 Teeth
 66-4238 3½" 2x3 Teeth
 66-4235 4" 1x2 Teeth, Non-Magnetic

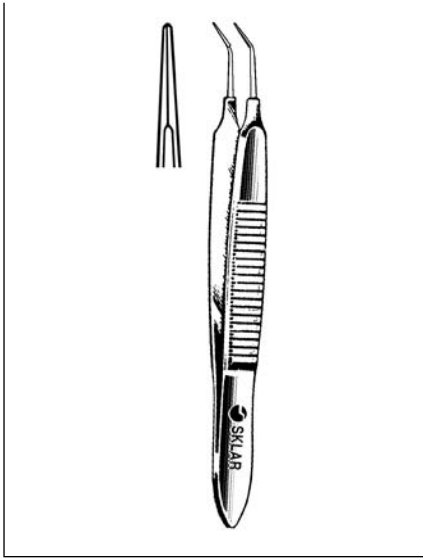
HARMS SUTURING FORCEPS
WITH TYING PLATFORM

 66-6140 4" 0.5mm, Straight
 66-6142 4" 0.5mm, Curved



McPHERSON MICRO IRIS SUTURING FORCEPS

SMOOTH PLATFORM, 0.3MM X 5MM

66-6164	3½"	Straight
66-6166	3½"	Angled

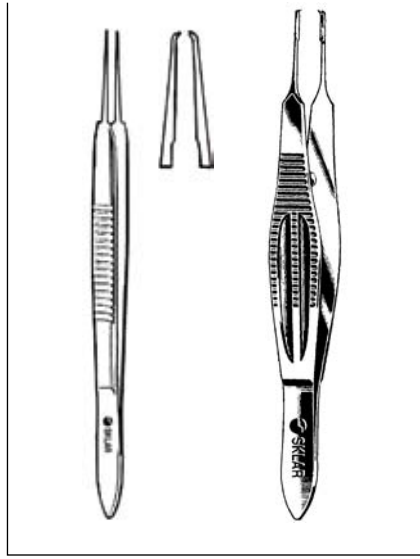

CASTROVIEJO SUTURING FORCEPS

1X2 TEETH WITH TYING PLATFORM

66-6119	4"	0.12mm
66-6103	4"	0.3mm
66-6105	4"	0.5mm
66-6109	4"	0.9mm
66-6115	4¼"	0.5mm, Wide Handle
66-6118	4¼"	1.5mm, Wide Handle

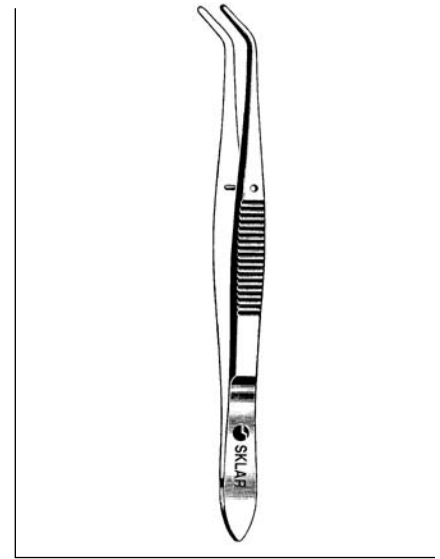

NUGENT UTILITY FORCEPS

1.2MM WIDE, ANGLED

66-6240	4¼"	Smooth
66-6242	4¼"	Cross Serrations

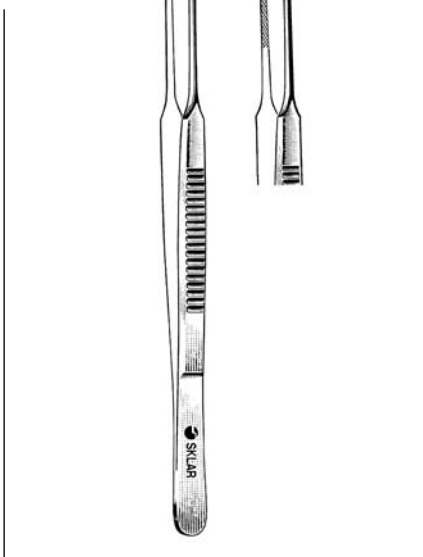

MCCULLOUGH UTILITY FORCEPS

66-6112	4"	1.2mm, Smooth
66-6110	4"	1.5mm, Serrated
66-6114	4"	1.5mm, Serrated, 1x2 Teeth

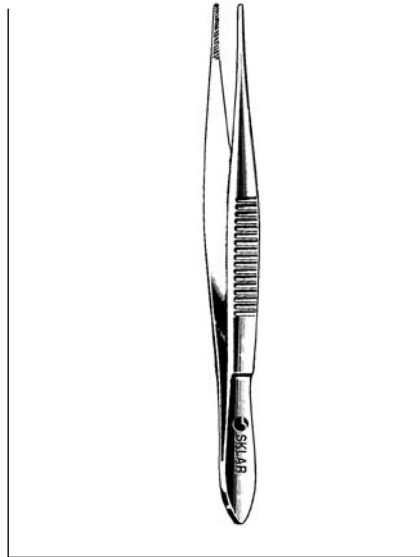

WILLS HOSPITAL UTILITY FORCEP

WITH TYING PLATFORM

66-6268	4"	1.2mm Wide, Serrated
---------	----	----------------------

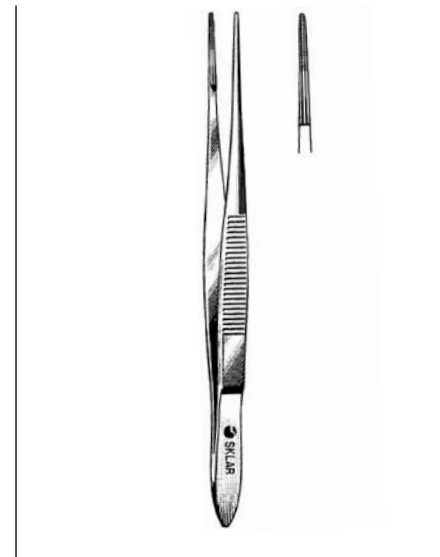

BONACCOLTO UTILITY FORCEPS

LONGITUDINAL SERRATIONS WITH CROSS SERRATIONS ON TIP

66-6340	4"	1.2mm, Tapered Tip
66-6338	4"	1.7mm, Tapered Tip

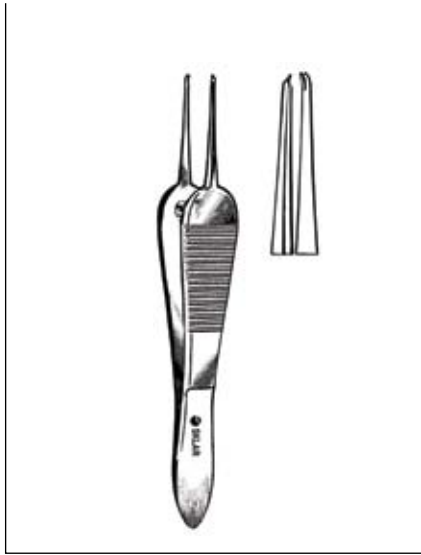

SAUER SUTURING FORCEP

1X2 CURVED TEETH, OVERLAPPING

66-6330 3½" 0.6mm

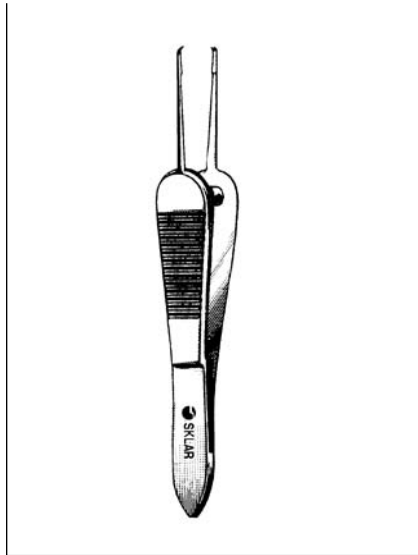

MANHATTAN EYE & EAR SUTURING FORCEP

1X2 SMOOTH PLATFORM, OVERLAPPING TEETH

66-6168 3½" 0.7mm

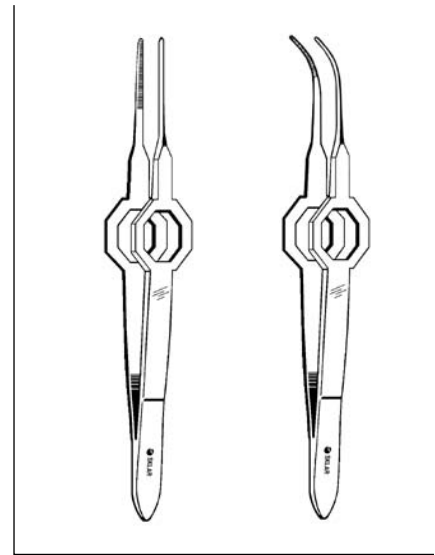

FOERSTER EYE DRESSING FORCEPS

OCTAGONAL GRIP, 0.5MM

- 66-6036 3¾" Straight, Serrated
- 66-6038 3¾" Straight, 1x2 Teeth
- 66-6037 3¾" Full Curve, Serrated
- 66-6039 3¾" Full Curve, 1x2 Teeth

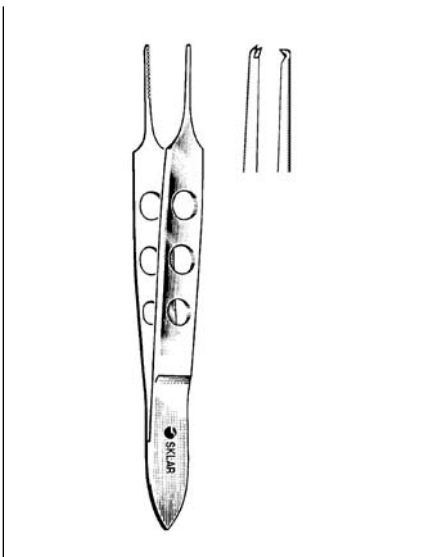

BISHOP-HARMON IRIS FORCEPS

- 66-4032 3½" Serrated
- 66-4132 3½" 1x2 Teeth
- 66-4232 3½" 1x2 Teeth, Delicate
- 66-4133 3½" 1x2 Teeth, Extra Delicate

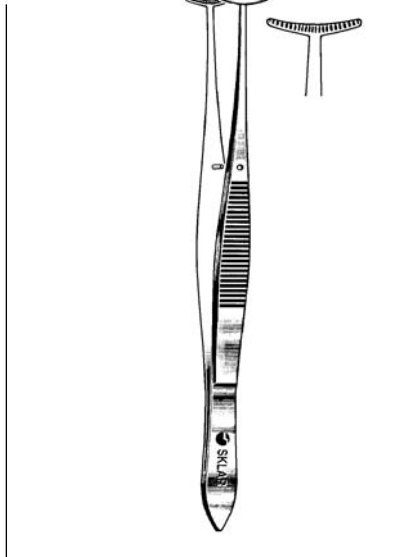

GREEN FIXATION FORCEPS

- 66-2005 4" 5mm
- 66-2009 4" 9mm
- 66-2012 4" 12.5mm

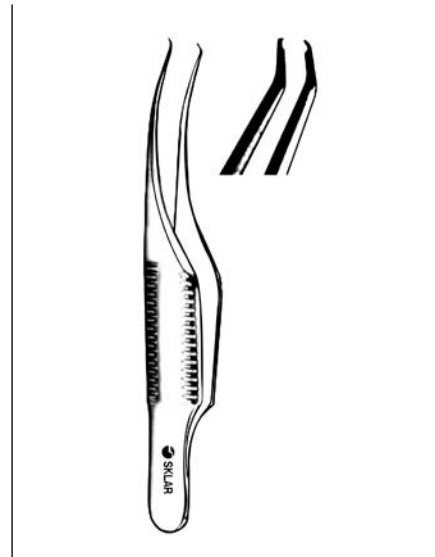

PIERSE CORNEAL FORCEPS

COLIBRI TYPE

- 66-7234 3¼" 0.12mm
- 66-7236 3¼" 0.3mm

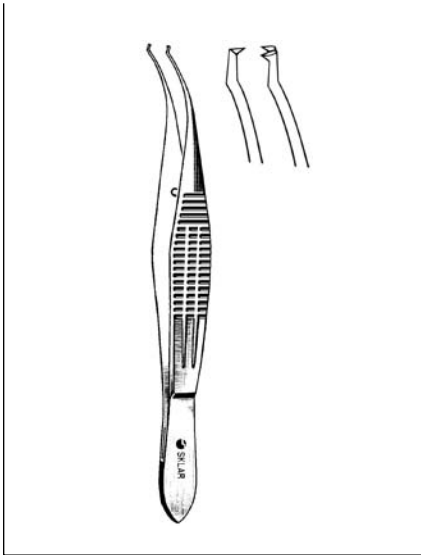

CASTROVIEJO CORNEAL FORCEP
COLIBRI TYPE, EXTRA DELICATE
 66-3450 4" 1x2 Teeth With Tying Platform

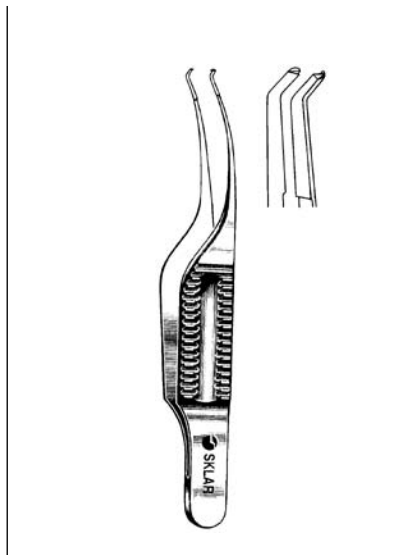

TROUTMAN-BARRAQUER CORNEAL UTILITY FORCEP
COLIBRI TYPE, TYING PLATFORM, 45° ANGLE
 66-7250 3" 1x2 Teeth, 0.4mm

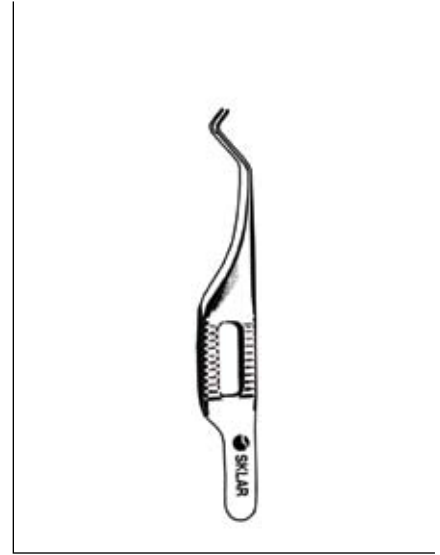

BOTVIN IRIS FORCEP
FINE CROSS SERRATED TIPS
 66-7258 2 7/8" 0.5mm

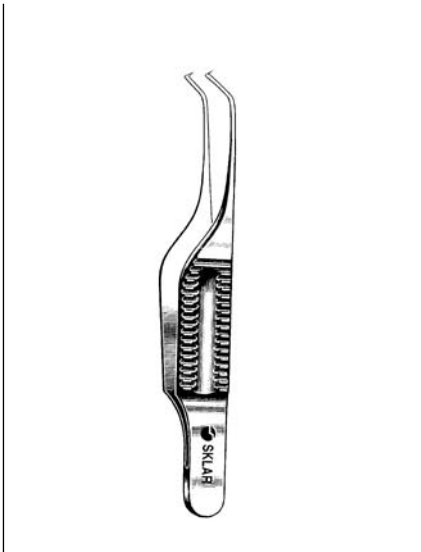

GILL HESS IRIS FORCEPS
0.5MM
 66-7240 2 3/4" 1x2 Teeth, Downward
 66-7238 2 3/4" 1x2 Teeth, Forward

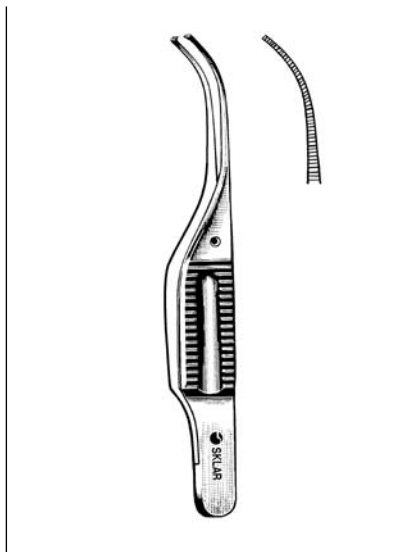

GILL IRIS FORCEPS
0.6MM
 66-7246 3" 1x2 Teeth
 66-7244 3" Serrated

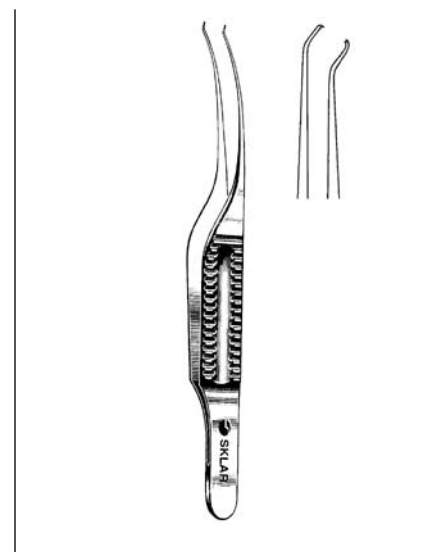

COLIBRI CORNEAL UTILITY FORCEPS
1X2 TEETH
 66-7259 3" 0.12mm
 66-7261 3" 0.4mm

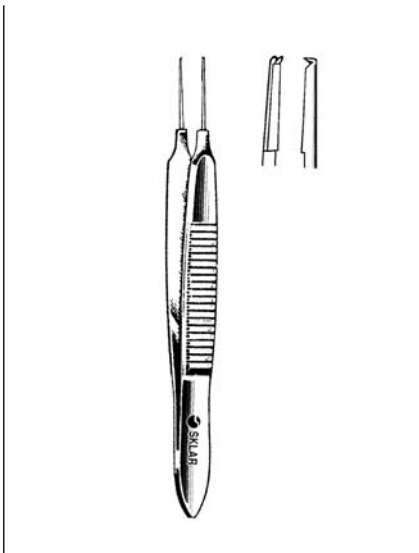

BONN MICRO SUTURE FORCEPS

WITH TYING PLATFORM

- 66-6125 2¾" 1x2 Teeth
- 66-6126 3¾" 1x2 Teeth
- 66-6160 4" Straight
- 66-6162 4" Curved

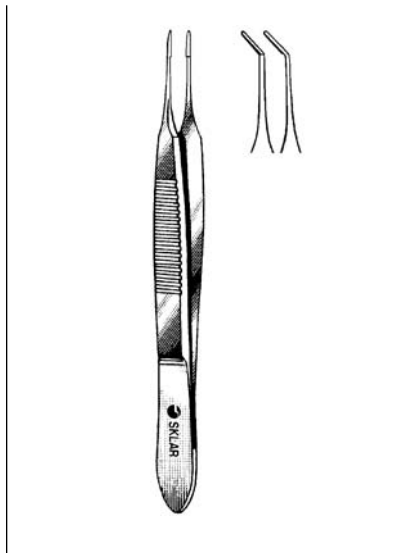

McPHERSON MICRO TYING FORCEPS

WITH TYING PLATFORM

- 66-6150 3¼" Straight
- 66-6152 4" Angled

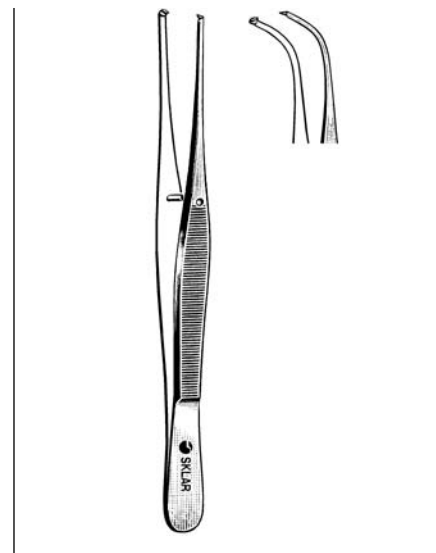

STRABISMUS TISSUE FORCEP

FINE CROSS SERRATED TIPS

- 66-4840 4" 1x2 Teeth, 1mm

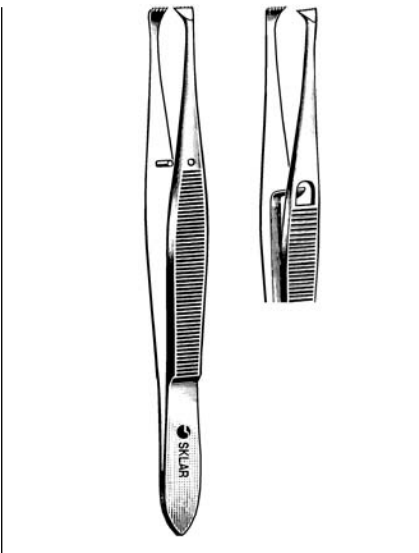

GRAEFE FIXATION FORCEPS

FINE STANDARD JAWS, 4MM

- 66-1940 4⅛" Without Catch
- 66-2140 4⅛" With Catch

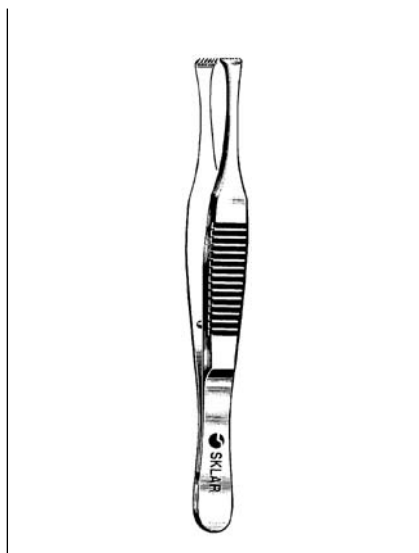

HARMON FIXATION FORCEP

DELICATE, 2.5MM

- 66-1930 3" 4x5 Teeth

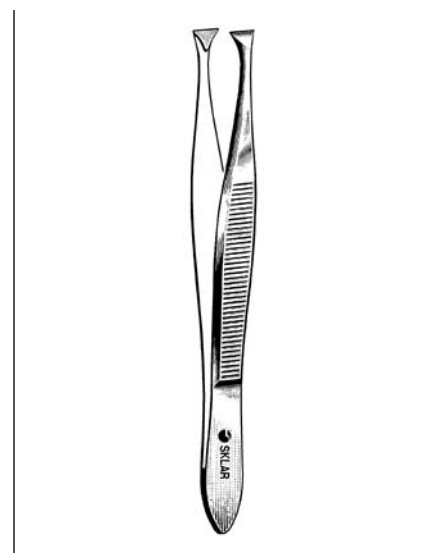

LITTAUER CILIA FORCEP

FINE HORIZONTAL SERRATIONS

- 66-1735 3½" 4mm



BEER CILIA FORCEP
66-1770 3½" 4mm, Smooth



ZIEGLER CILIA FORCEP
66-1535 3½" 2mm, Smooth



DOUGLASS CILIA FORCEP
FINE HORIZONTAL SERRATIONS
66-1830 3½" 2.5mm, Thin Tips



SWISS CILIA SUTURE FORCEP
DIAGONAL JAWS
66-1740 3¾" 3mm



BERGH CILIA FORCEP
HORIZONTAL SERRATIONS
66-1635 3½" 5mm



BARRAQUER CILIA FORCEP
66-1742 4¼" 5mm, Smooth

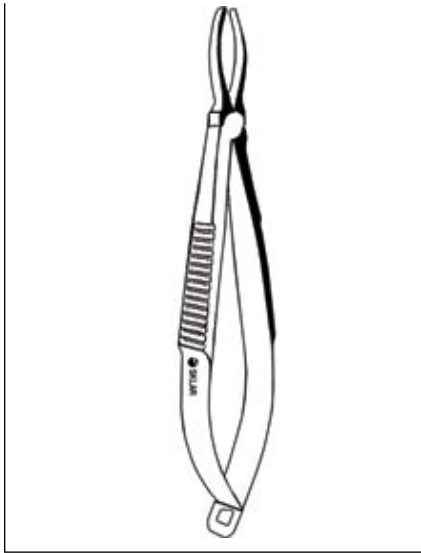

GRADLE CILIA FORCEP
PRECISION GROUND JAWS
66-1745 4"

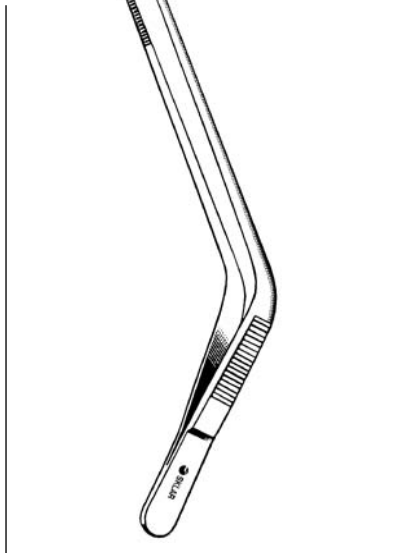

BLAKE EAR FORCEP
VERY DELICATE
67-1058 4½" Angular, Serrated

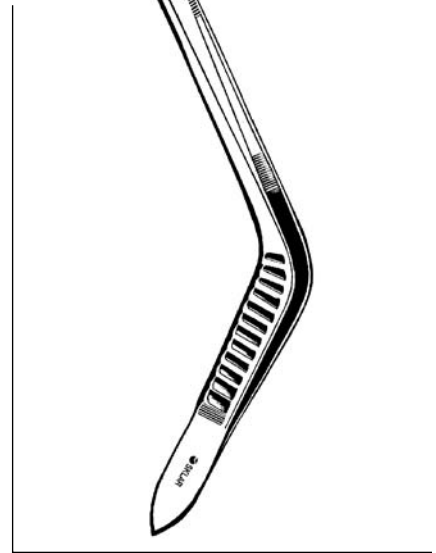

WILDE EAR FORCEPS
ANGULAR, SERRATED
67-1150 5"
70-4470 7"

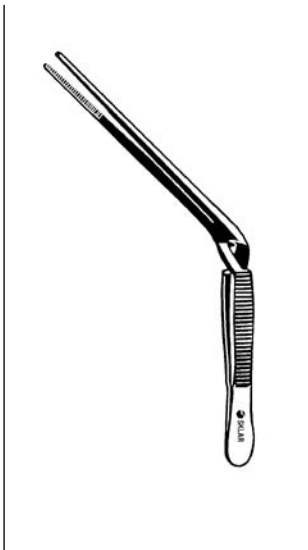

WILDE EAR FORCEPS
ANGULAR, CROSS ACTION
67-1350 5" Serrated
67-1450 5" 1x2 Teeth

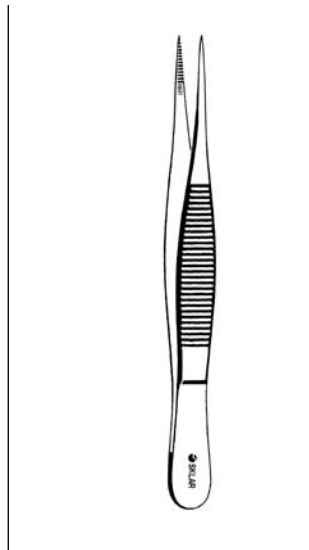

FINE POINT SPLINTER FORCEPS
STRAIGHT
19-3035 3½"
19-3040 4"
19-3045 4½"

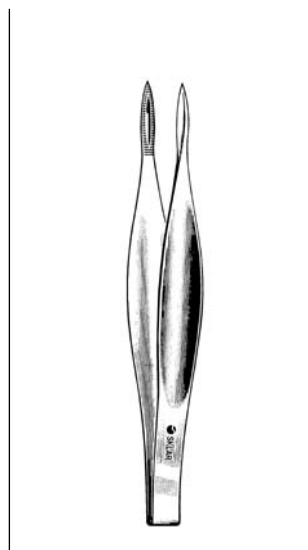

FEILCHENFELD SPLINTER FORCEPS
STRAIGHT
19-2930 3"
19-2945 4½"

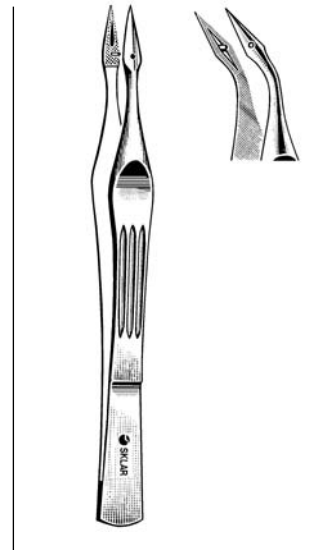

CARMALT SPLINTER FORCEPS
PRECISION GROUND JAWS
19-3240 4¼" Straight
19-3340 4¼" Curved

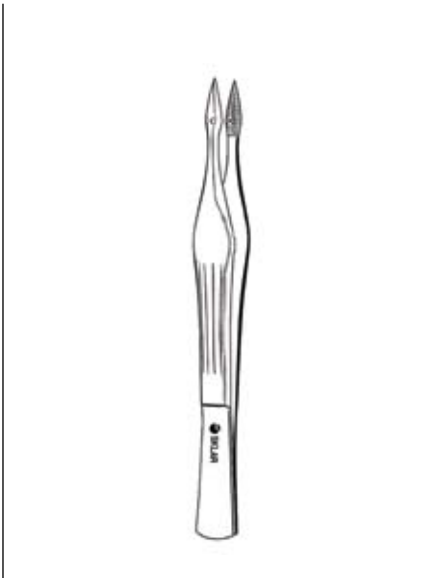

WALTER SPLINTER FORCEPS

19-3250 4¼" Straight
19-3252 4¼" Curved

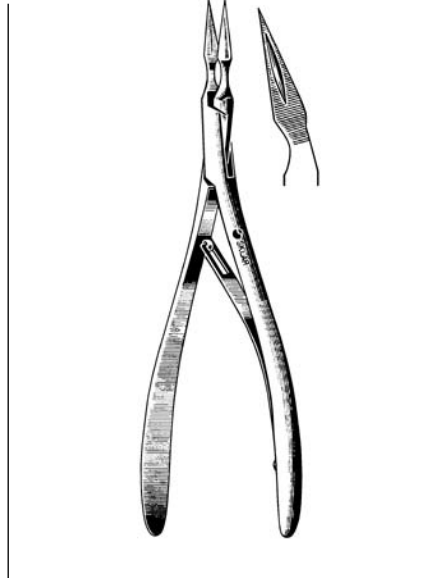

VIRTUS SPLINTER FORCEPS

19-3160 6" Straight
19-3162 6" 45° Angle

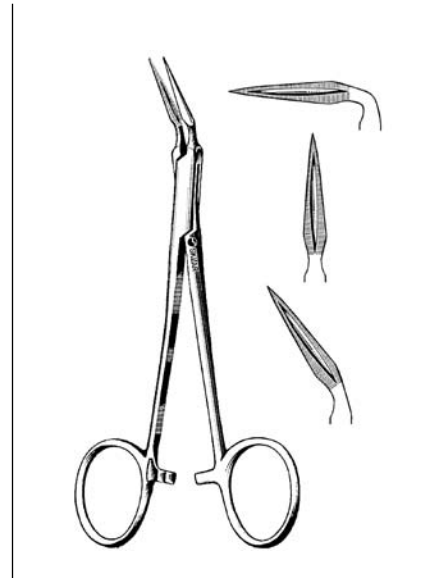

WILLIAMS SPLINTER FORCEPS

19-3056 4¾" Right Angle
19-3161 5½" Straight
19-3055 5½" 45° Angle

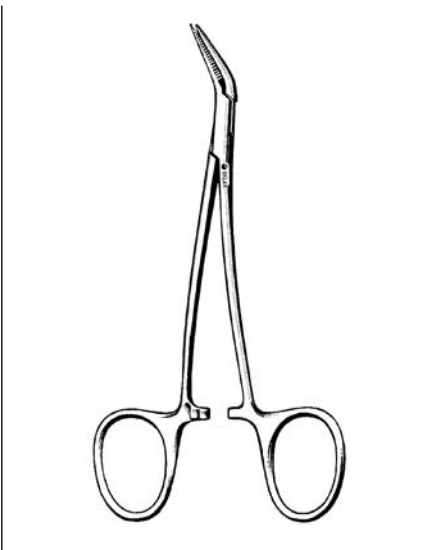

**PEET SPLINTER FORCEP
ANGLED**

19-3147 4¾" Double Curve

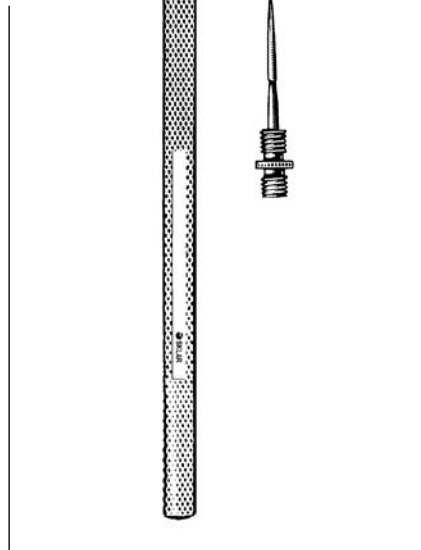

**VANGUARD SPLINTER
LIBERATOR
TROCAR POINT**

19-3350 5"



**PLAIN SPLINTER FORCEP
3" WITH MAGNIFIER, NON-AUTOCCLAVABLE**

19-3030 Non-Autoclavable
21-707 Floor Grade
21-708 Floor Grade, 12/box

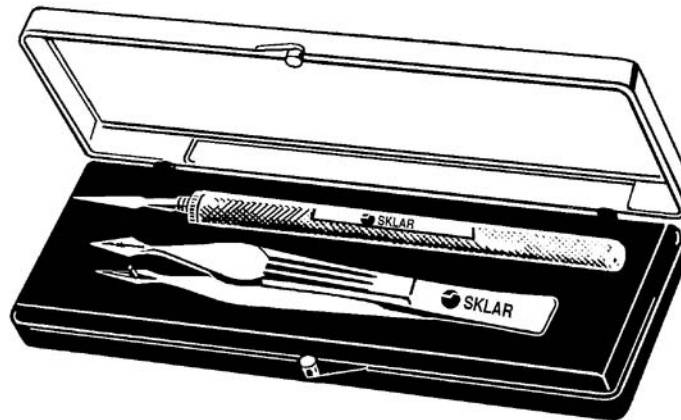

SKLAR SPLINTER REMOVAL KIT

19-3360 Contains one Forcep, 19-3240, and one Liberator, 19-3350, in a convenient storage case

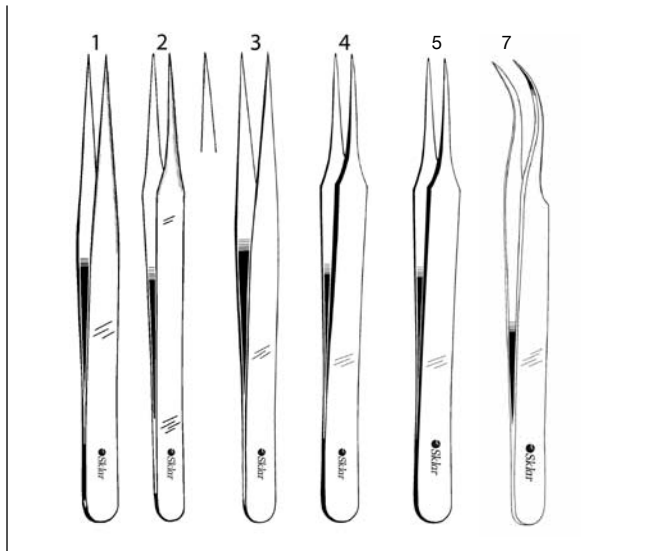

SWISS JEWELER STYLE FORCEPS

NON-MAGNETIC, STAINLESS STEEL

66-7438	4½"	#1	Fine
66-7440	4½"	#2	Fine
66-7447	4½"	#3	Straight
66-7442	4½"	#3C	Straight, Delicate
66-7443	4½"	#3	Micro-Fine
66-7542	4½"	#4	Straight, Delicate
66-7642	4½"	#5	Straight
66-7643	4½"	#5	Straight, Micro-Fine
66-7645	4½"	#5	Angled
66-7644	4½"	#7	Curved
66-7446	4½"	#7	Curved, Micro-Fine



THORPE CORNEOSCLERAL AND SPLINTER FORCEP

VERY SHARP POINTS

66-7347 4¾"

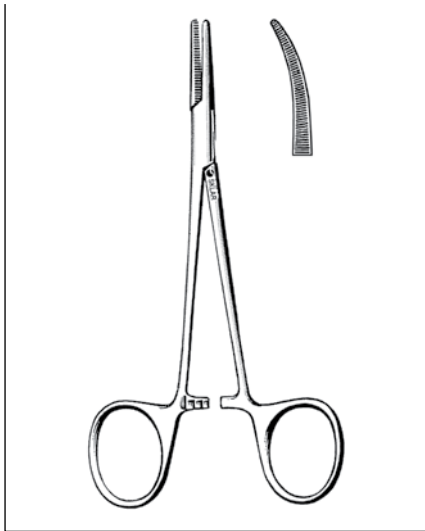
HALSTED MOSQUITO FORCEPS

17-1450 5" Straight
17-1550 5" Curved

NON-MAGNETIC

17-1455 5" Straight
17-1555 5" Curved
18-1050 5" Straight, Delicate
18-1150 5" Curved, Delicate

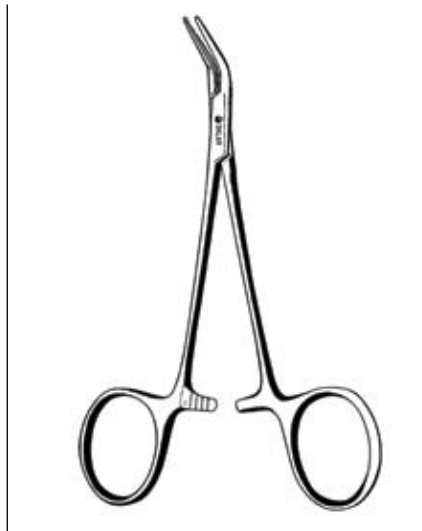
HALSTED MOSQUITO FORCEPS

SERRATED
17-1850 5" 45° Angled on Flat,
Extra Delicate

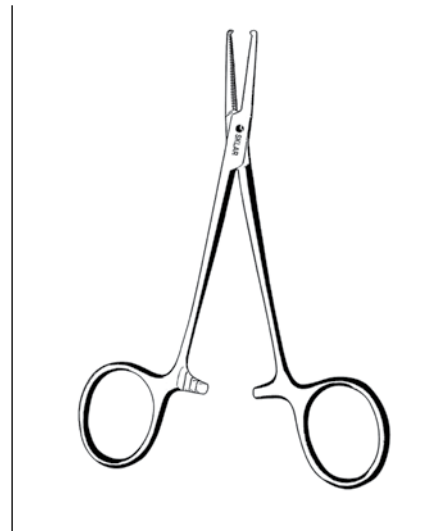
HALSTED MOSQUITO FORCEPS

1X2 TEETH
17-1650 5" Straight
17-1750 5" Curved

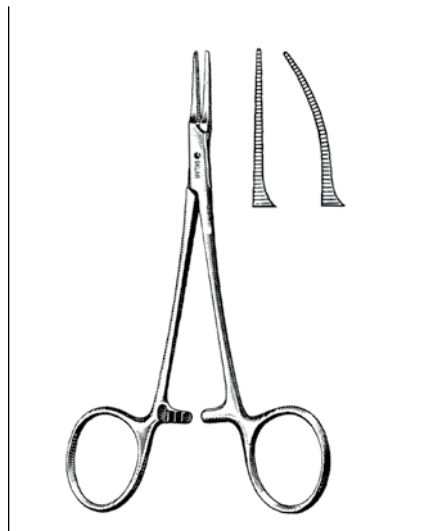
PACKER MOSQUITO FORCEPS
FLAT JAWS

98-2054 5" Straight
98-2056 5" Curved

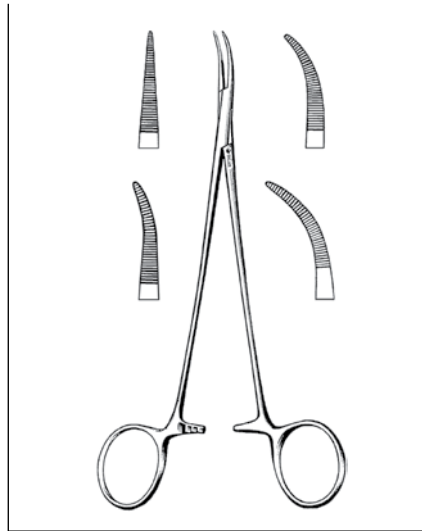
JACOBSON MICRO MOSQUITO FORCEPS

DELICATE
98-2050 5" Straight
98-2051 5" Curved
98-2070 7" Slight Curve
98-2071 7" Full Curve

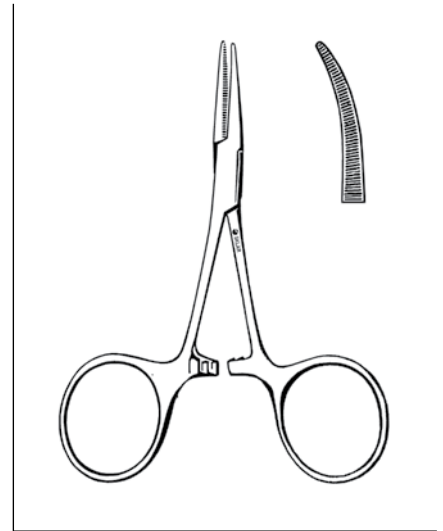
HARTMANN MOSQUITO FORCEPS

SERRATED
17-1235 3½" Straight
17-1230 3½" Straight, Delicate
17-1335 3½" Curved
17-1232 3½" Curved, Delicate

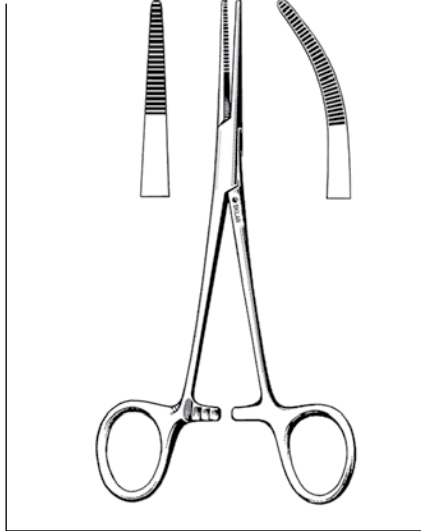

HARTMAN LEE MOSQUITO FORCEP
STRAIGHT JAWS, SHANKS ANGLED ON FLAT

17-1238 3½" Straight

KELLY HEMOSTATIC FORCEPS

 17-2055 5½" Straight
 17-2155 5½" Curved
 74-3260 7" Straight, Extra Heavy
 74-3270 7" Curved, Extra Heavy

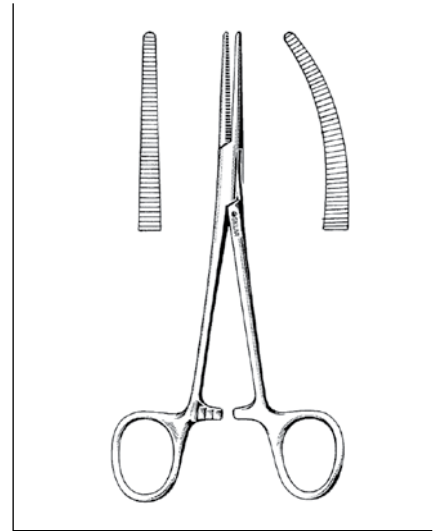
DELICATE

 18-1552 5½" Straight
 18-1652 5½" Curved

CRILE HEMOSTATIC FORCEPS

 17-3055 5½" Straight
 17-3155 5½" Curved
 17-3062 6¼" Straight
 17-3162 6¼" Curved
 17-3075 7½" Straight
 17-3175 7½" Curved

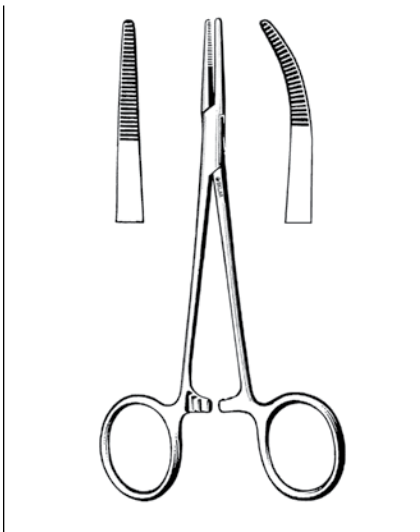
DELICATE

 18-1952 5½" Straight
 18-2052 5½" Curved

PROVIDENCE HOSPITAL FORCEPS

 17-1855 5½" Straight
 17-1955 5½" Curved

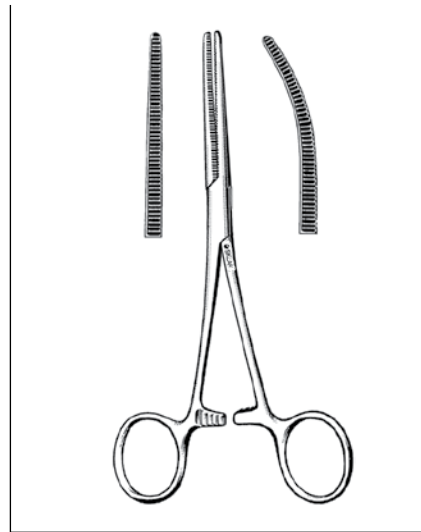
DELICATE

 18-1352 5½" Straight
 18-1452 5½" Curved

ROCHESTER-PEAN FORCEPS
STRAIGHT

 17-2455 5½"
 17-2462 6¼"
 17-2467 6¾" Heavy
 17-2472 7¼"
 17-2480 8"
 36-2690 9"
 36-2710 10¼"
 36-2712 12"

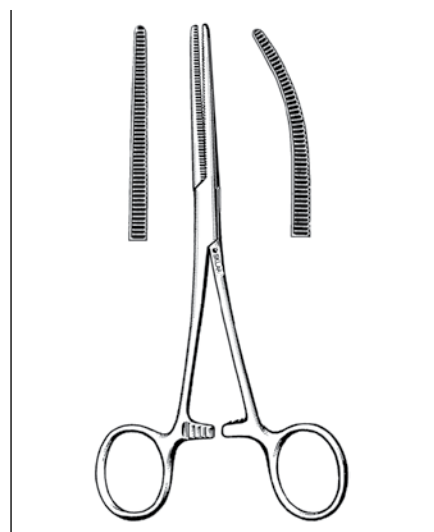
CURVED

 17-2255 5½"
 17-2262 6¼"
 17-2267 6¾" Heavy
 17-2272 7¼"
 17-2280 8"
 36-2790 9"
 36-2810 10¼"
 36-2812 12"

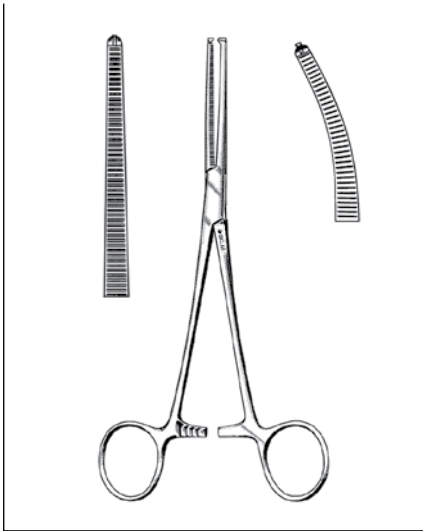
ROCHESTER-PEAN FORCEPS
DELICATE

 22-3555 5½" Straight
 22-3655 5½" Curved
 17-2362 6¼" Curved
 22-2272 7¼" Curved
 22-2280 8" Curved

**ROCHESTER-OGHSNER
FORCEPS**
1X2 TEETH

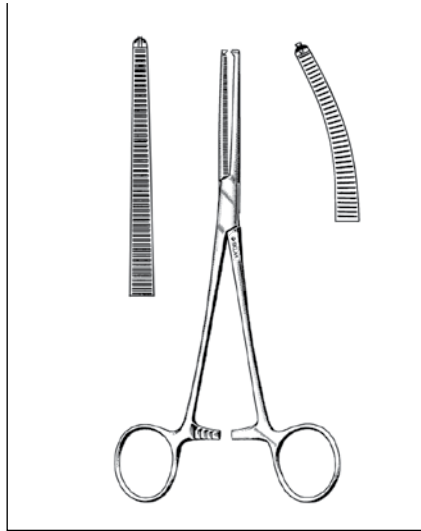
STRAIGHT		CURVED	
17-2855	5½"	17-2655	5½"
17-2862	6¼"	17-2662	6¼"
17-2872	7¼"	17-2672	7¼"
17-2880	8"	17-2680	8"
17-2885	9"	17-2685	9"
17-2890	10"	17-2690	10"

**ROCHESTER-OGHSNER
FORCEPS**
1X2 TEETH, DELICATE

STRAIGHT		CURVED	
18-1752	5¼"	18-1852	5¼"
22-3755	5½"	22-3855	5½"
17-2962	6¼"	17-2762	6¼"

**ROCHESTER-CARMALT
FORCEPS**
LONGITUDINAL SERRATIONS, CROSS TIP

STRAIGHT		CURVED	
17-1062	6¼"	17-1162	6¼"
17-1080	8"	17-1180	8"

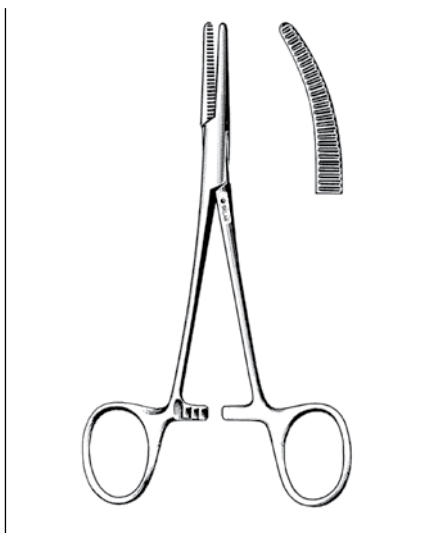
LAHEY FORCEPS

17-3255	5½"	Straight
17-3355	5½"	Curved

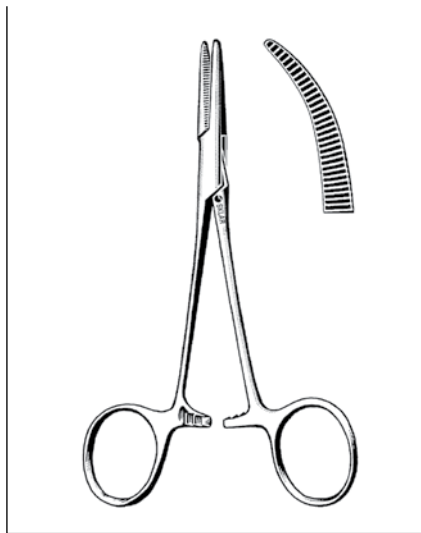
JONES FORCEPS

17-1255	5"	Straight
17-1355	5"	Curved

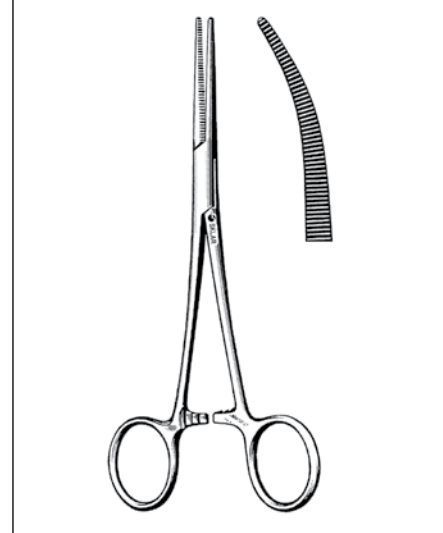
COLLER FORCEPS

STRAIGHT		CURVED	
17-3455	5½"	17-3555	5½"
17-3265	6¼"	17-3365	6¼"
17-3275	7½"	17-3375	7½"

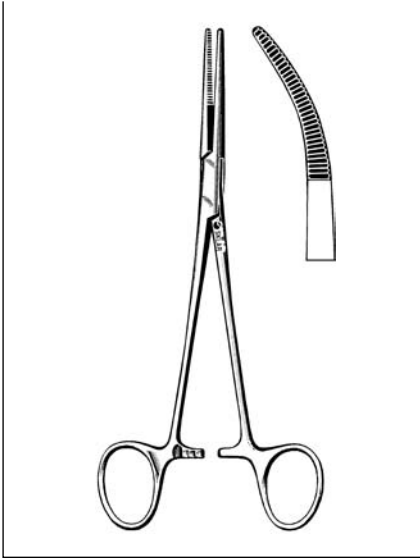
RANKIN KELLY FORCEPS

17-1262 6¼" Straight
17-1362 6¼" Curved

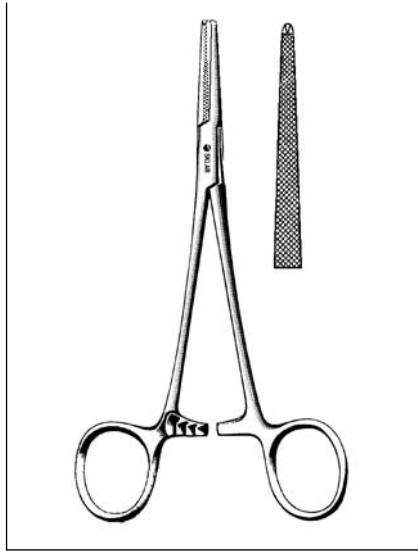
LOVELACE FORCEP

1x2 TEETH, CROSS SERRATIONS
17-3460 6¼" Straight

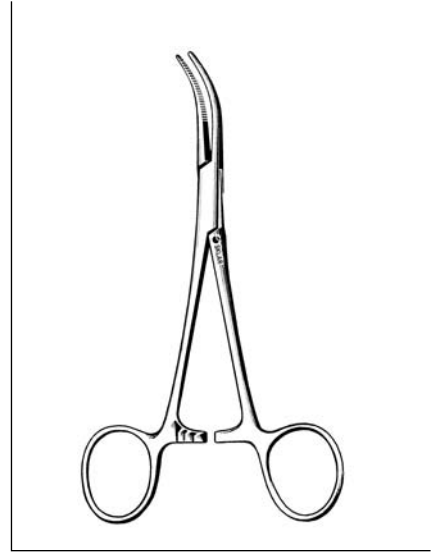
DANDY SCALP HEMOSTATIC FORCEPS

CURVED TO SIDE
50-1355 5½"
50-1357 5½" 1x2 Teeth

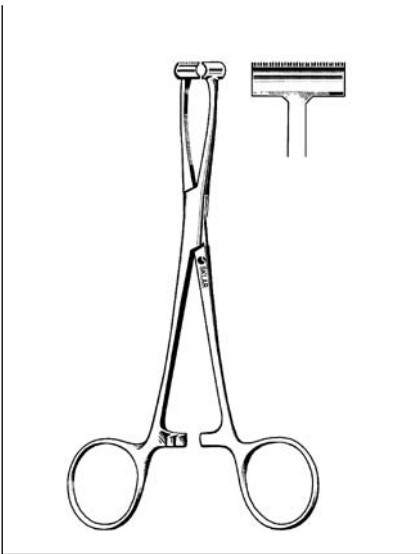
PRATT T-SHAPED CLAMP

17-1055 6"

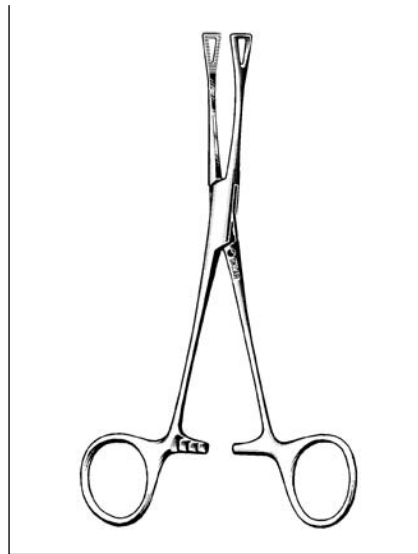
PENNINGTON TISSUE GRASPING FORCEPS

TRIANGLE TIP, STRAIGHT
17-2957 6¼" ½" Jaw
17-2958 8" ½" Jaw

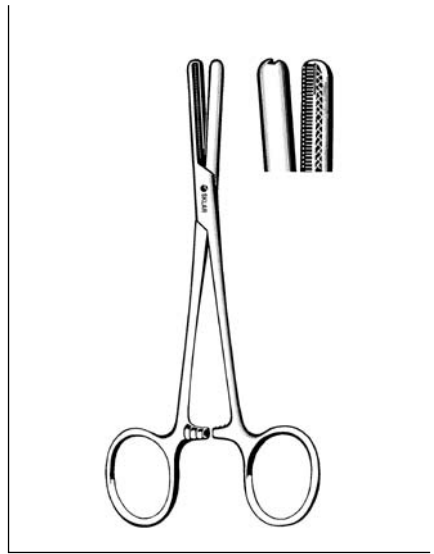
FERGUSON ANGIOTRIBE HEMOSTATIC FORCEPS

STRAIGHT	CURVED
17-1260 6"	17-1360 6"
17-1250 7½"	17-1350 7½"



ADSON FORCEPS

STRAIGHT

50-1372 7¼"

CURVED

50-1472 7¼"



BABY MIXTER FORCEP

CURVED, PARTIALLY SERRATED

22-3452 5½"



MIXTER FORCEPS

RIGHT ANGLE, FULLY SERRATED

22-3255 5½" Delicate

22-3270 7" Delicate

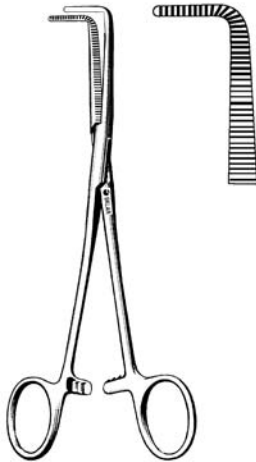

MIXTER FORCEPS

RIGHT ANGLE, FULLY SERRATED

18-1250 5½"

17-1762 6¼"

17-1772 7¼"

55-2892 9¼"



MIXTER FORCEP

DELICATE

22-3257 5¼" Curved, Angled Shank



LAHEY GALL DUCT FORCEPS

LONGITUDINAL SERRATIONS

32-1875 7½"

32-1890 9"

32-1990 9" Heavy

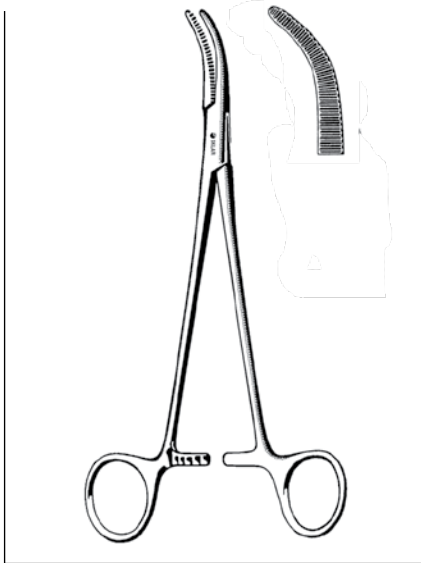

MOYNIHAN GALL DUCT FORCEP

32-1785 8½"

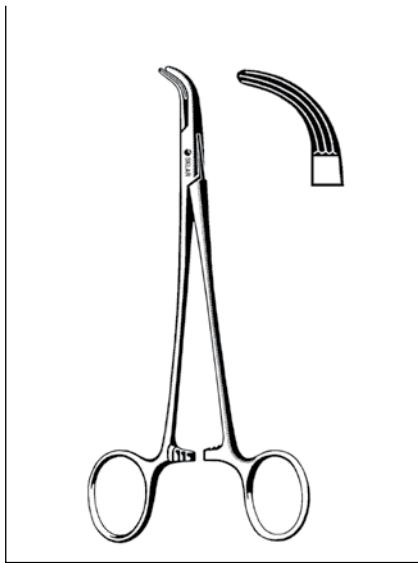

LOWER GALL DUCT FORCEP

32-1870 7"

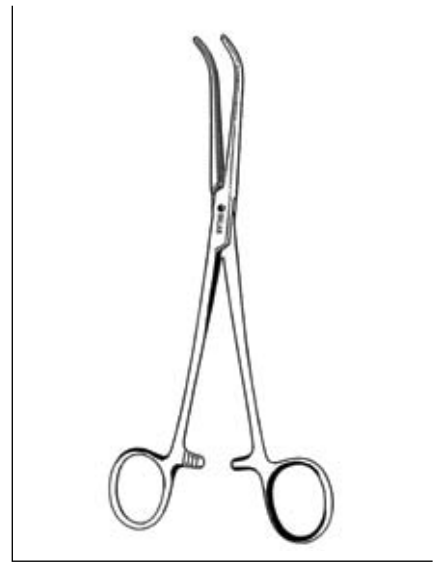

JOHNS HOPKINS GALL BLADDER FORCEP

32-1850 8"

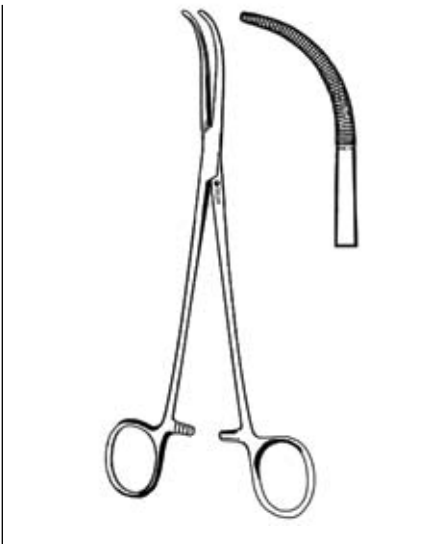

GREEN CYSTIC DUCT FORCEP

DELICATE

32-1860 8½"

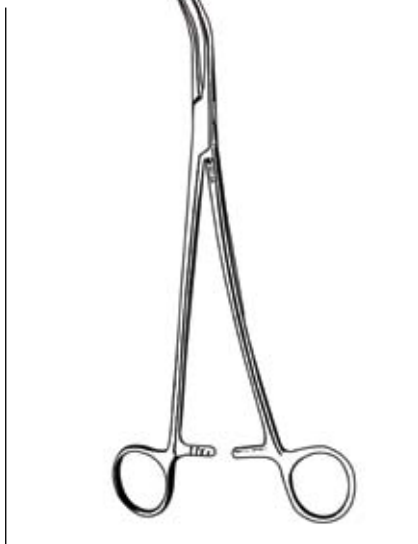

GRAY CYSTIC DUCT FORCEP

SET OF 2

32-2090 9" Serrated

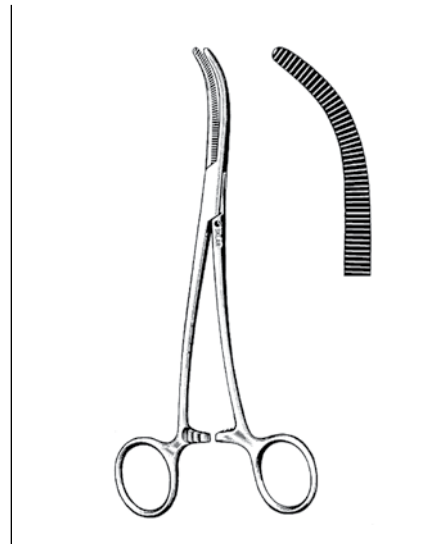

SHALLCROSS CYSTIC DUCT FORCEP

32-2070 7" Double Curve

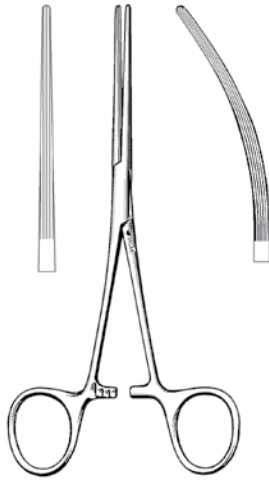
BAINBRIDGE FORCEPS
LONGITUDINAL SERRATIONS

STRAIGHT		CURVED	
17-3660	6"	17-3760	6"
17-3670	7"	17-3762	7"

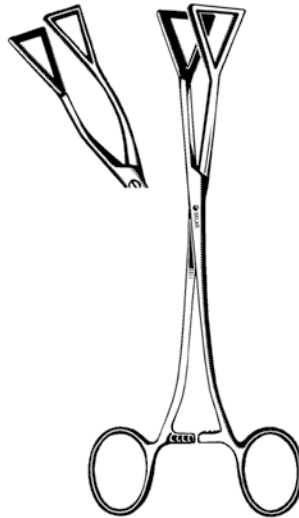
**LOVELACE GALL
BLADDER FORCEPS**

32-2470	7"	Angled
32-2477	8"	Straight

**PEAN GASTRO-INTESTINAL
FORCEPS**
LONGITUDINAL SERRATIONS

STRAIGHT		CURVED	
36-2890	9"	36-2962	6¼"
36-2895	9½"	36-2990	9"
		36-2995	9½"

DOYEN INTESTINAL FORCEPS
LONGITUDINAL SERRATIONS

36-3590	9"	Straight
36-3690	9"	Curved

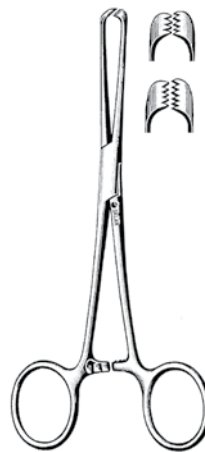
ALLIS TISSUE FORCEPS

36-2060	6"	3x4 Teeth
36-2160	6"	4x5 Teeth
36-2260	6"	5x6 Teeth
36-2275	7½"	5x6 Teeth

DELICATE

18-2140	4"	4x5 Teeth
18-2155	5"	4x5 Teeth
22-6157	5½"	4x5 Teeth
18-2162	6"	4x5 Teeth
18-2164	6"	5x6 Teeth
36-2295	9½"	5x6 Teeth

**BABCOCK INTESTINAL
FORCEPS**

22-6155	5½"	6mm	Delicate
36-1662	6¼"	9mm	
36-1677	8"	10mm	
36-1692	9½"	15mm	

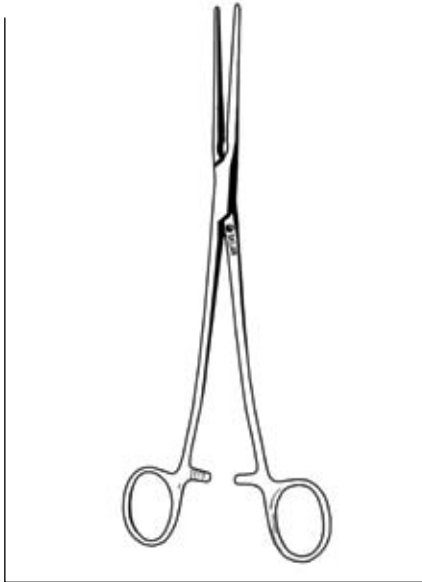

DENNIS ANASTOMOSIS CLAMP
LONGITUDINAL SERRATIONS
36-1602 9"



ALLEN INTESTINAL CLAMPS
1X2 TEETH, LONGITUDINAL SERRATIONS
22-6160 6"
36-3180 8"
36-3195 9½"

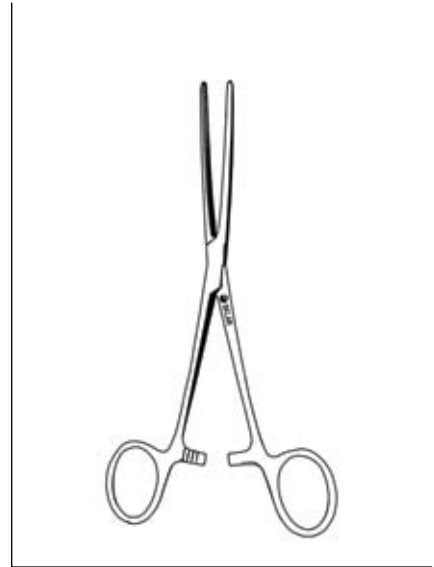

BABY DOYEN INTESTINAL FORCEPS
FLEXIBLE BLADES WITH LONGITUDINAL SERRATIONS
22-2154 6½" Straight
22-2155 6½" Curved

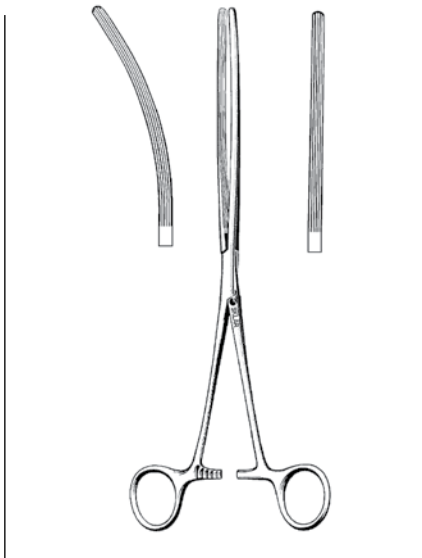

MAYO-ROBSON INTESTINAL FORCEPS
LONGITUDINAL SERRATIONS
36-3210 10" Straight
36-3310 10" Curved

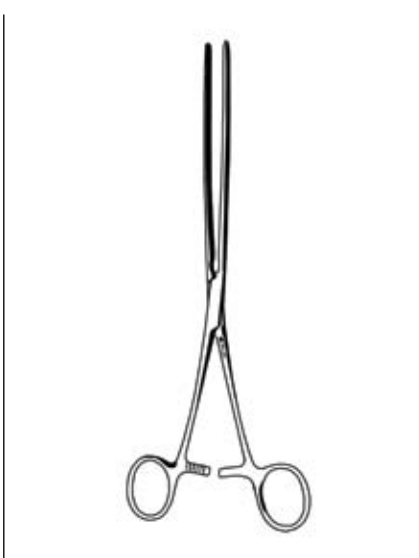

SCUDDER INTESTINAL FORCEPS
22-6260 6" Straight, Smooth
36-3510 9½" Straight, Smooth

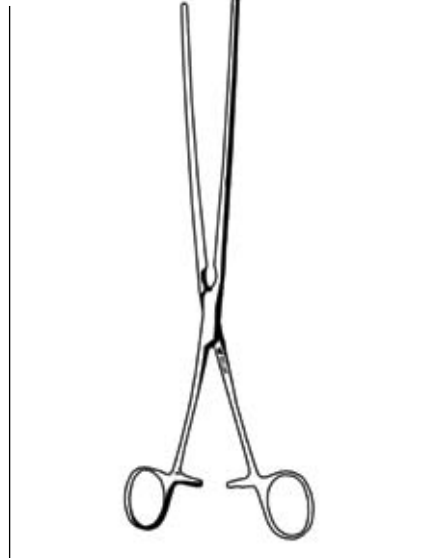

KOCHER INTESTINAL FORCEPS
LONGITUDINAL SERRATIONS
90-2574 10½" Straight
90-2576 10½" Curved

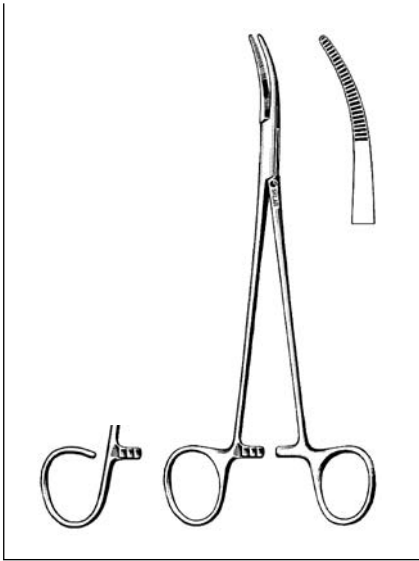

SCHNIDT TONSIL HEMOSTATIC FORCEPS

HALF CURVE

74-3073	7½"	One Open Ring
74-3075	7½"	Closed Rings

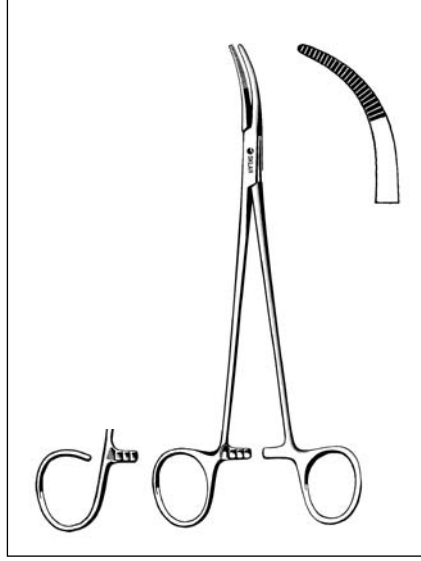

SAWTELL TONSIL HEMOSTATIC FORCEPS

FULL CURVE

74-3173	7½"	One Open Ring
74-3175	7½"	Closed Rings

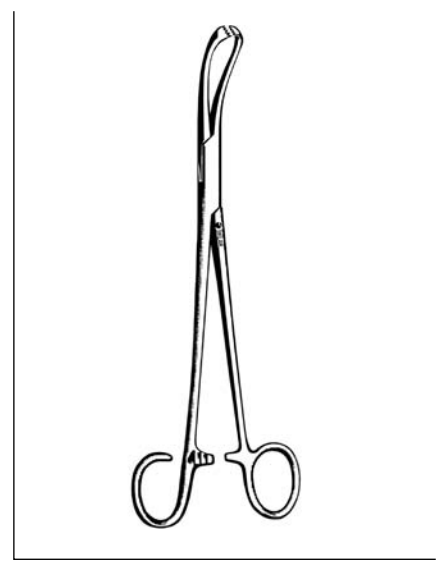

COLVER-COAKLEY TONSIL FORCEP

74-2475 7½" Curved

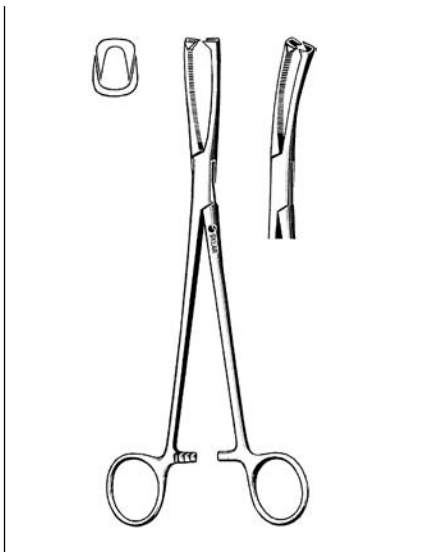

JACOBS UTERINE VULSELLUM FORCEPS

2X2 TEETH, SERRATED

91-2282	8¼"	Straight
91-2382	8¼"	Angled

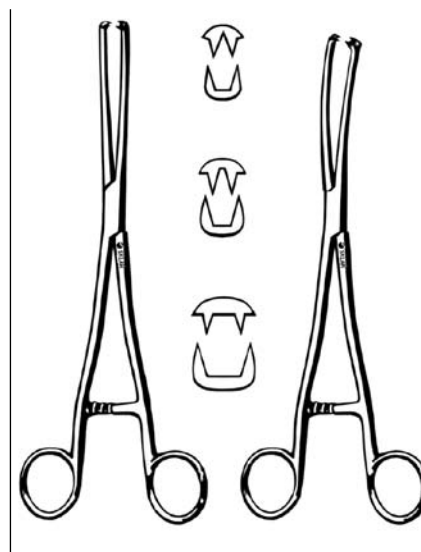

MUSEUX UTERINE VULSELLUM FORCEPS

2X2 TEETH, 9½"

STRAIGHT		CURVED
91-2906	6mm	91-3006 6mm
91-2908	8mm	91-3008 8mm
91-2910	10mm	91-3010 10mm



MIKULICZ PERITONEAL FORCEP

1X2 TEETH

90-2584 8" Slight Curve

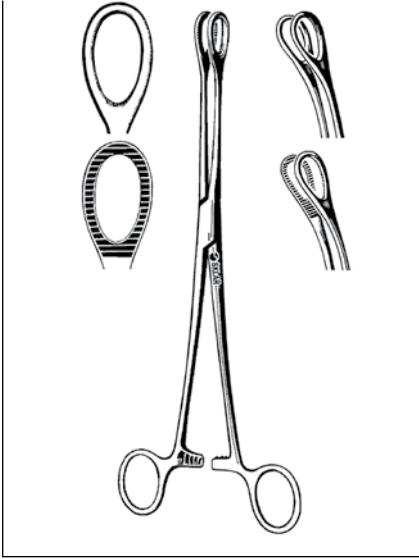
FOERSTER SPONGE FORCEPS
STRAIGHT

87-2095 9½" Smooth
87-2195 9½" Serrated

CURVED

87-2295 9½" Smooth
87-2395 9½" Serrated

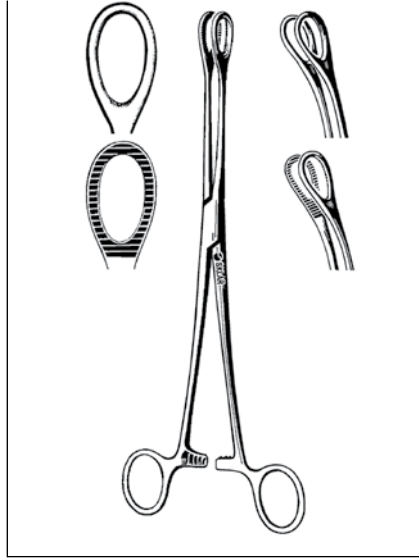
BALLENGER SPONGE FORCEPS
STRAIGHT

74-1370 7" Smooth
74-1470 7" Serrated

CURVED

74-1570 7" Smooth
74-1670 7" Serrated

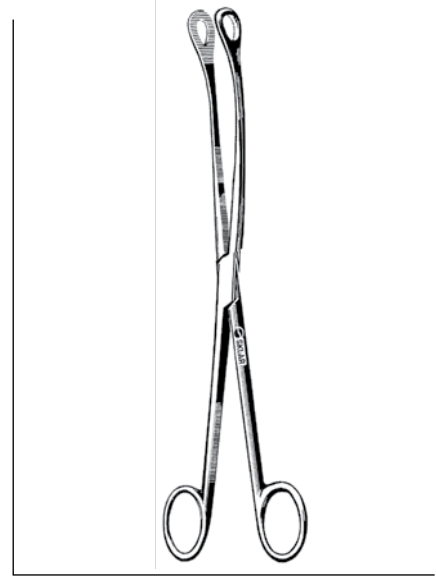
KELLY SPONGE OR PLACENTA FORCEP
SERRATED

92-5012 12" Slightly Curved

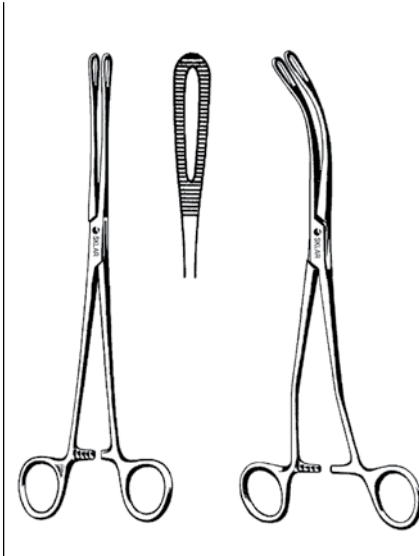
FLETCHER VAN DOREN SPONGE FORCEPS

93-1222 9½" Straight
93-1226 9½" Curved

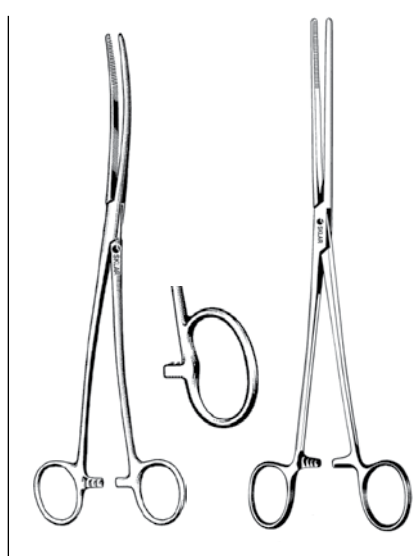
BOZEMAN SPONGE FORCEPS

80-1410 10¼" S-Curve
90-7710 10¼" S-Curve One Large Ring
90-7610 10½" Straight

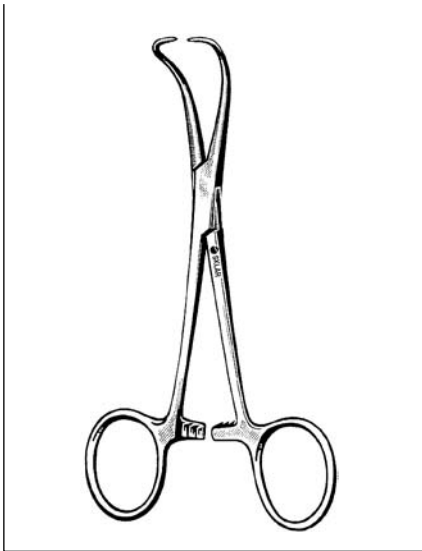

HOFF TOWEL CLAMPS

47-3040 4"
47-3057 6¼"

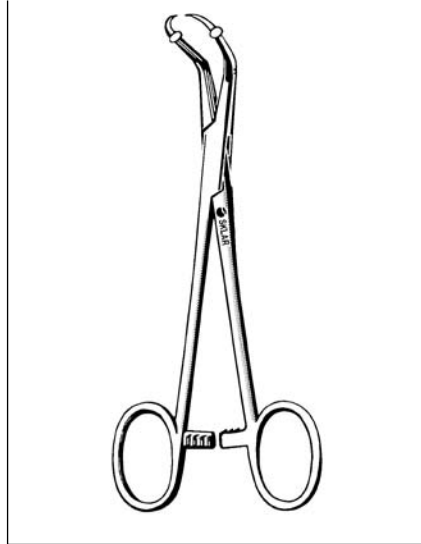

BACKHAUS TOWEL CLAMP

47-2935 3½"
47-2955 5¼"



**ROEDER TOWEL CLAMP
WITH BALL STOPS**

87-1052 5¼"



**LORNA-EDNA TOWEL CLAMPS
NON-PERFORATING**

47-2837 4"
47-2852 5¼"



JONES TOWEL CLAMPS

CROSS ACTION TIPS
47-2925 2¼" Delicate
47-2930 3½" Standard

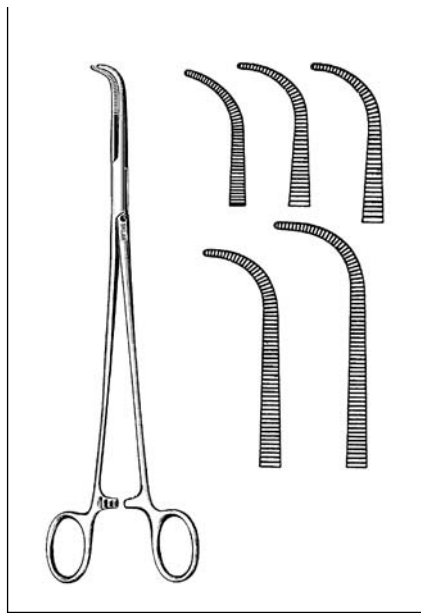

GEMINI HEMOSTATIC FORCEPS

DELICATE, FULL CURVE
55-2855 5"
55-2870 6¼"
55-2880 8"
55-2890 9"
55-2898 11"

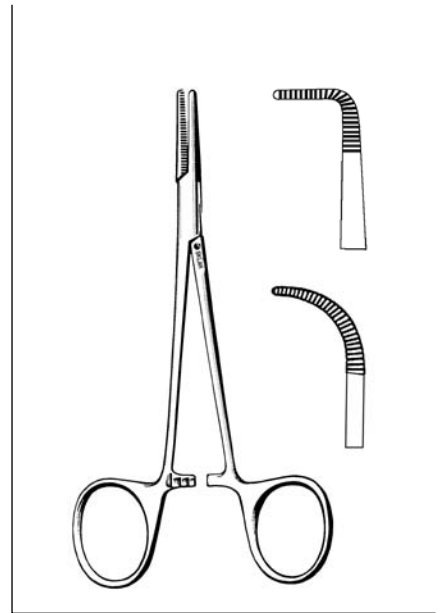

**MOSQUITO HEMOSTATIC
FORCEPS**

DELICATE, SERRATED
55-2021 7" Straight
55-2023 7" Straight 1x2 Teeth
55-2022 7" Curved
55-2024 7" Curved 1x2 Teeth
55-2028 7¾" Right Angle
55-2025 8¼" Straight
55-2026 8¼" Straight 1x2 Teeth
55-2027 8¼" Curved 1x2 Teeth

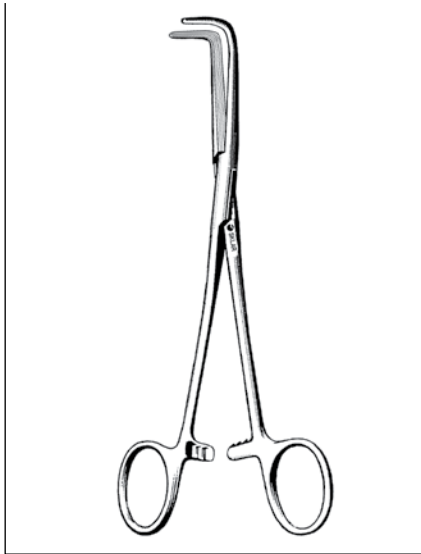

MIXTER FORCEPS
LONGITUDINAL SERRATIONS, RIGHT ANGLE
 55-2893 9"
 55-2894 10½"
 55-2912 12"
 55-3012 12"

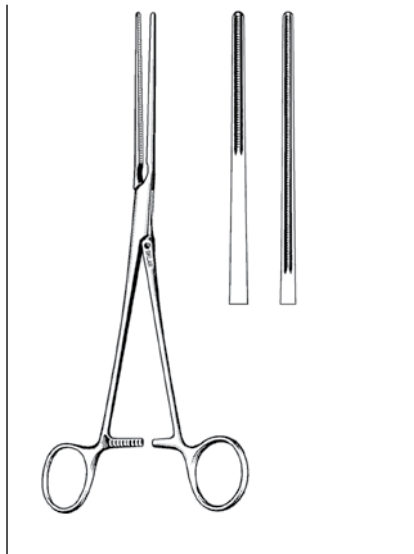

COARCTATION CLAMPS
 52-2082 8¾" Straight
 52-2080 8¾" Angled



PATENT DUCTUS CLAMPS
3CM
 52-1980 8¼" Straight
 52-1975 8¼" Angled

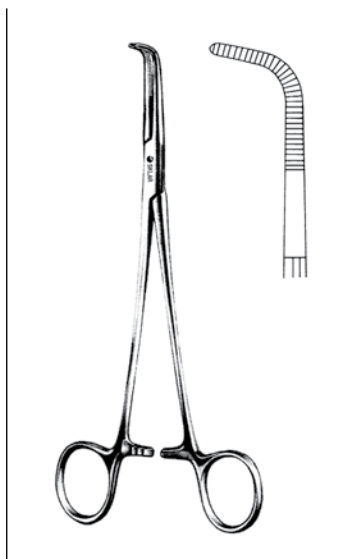

KANTROWITZ THORACIC FORCEPS
DELICATE, RIGHT ANGLE
 55-2775 7½"
 55-2795 9½"
 55-2810 10½"

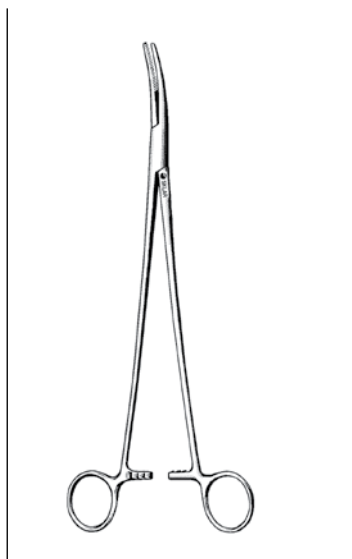

SKLAR THORACIC CLAMPS
CURVED
 55-3080 7"
 55-3110 10"

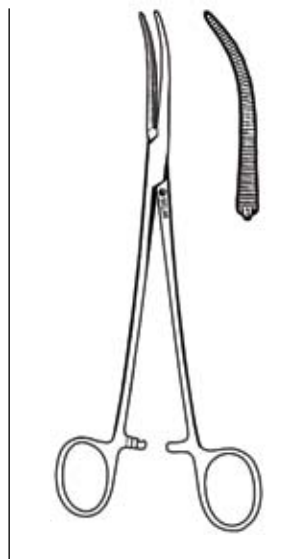

FINOCHIETTO THORACIC FORCEP
 55-3136 9" Slightly Curved



FINOCHIETTO THORACIC FORCEP
LONGITUDINAL SERRATIONS & SUTURE HOLES AT TIP
 55-3138 9½" 90° Jaws

BRIDGE DEEP SURGERY FORCEPS
VERY DELICATE

90-2640	11"	Straight
90-2641	11"	Curved

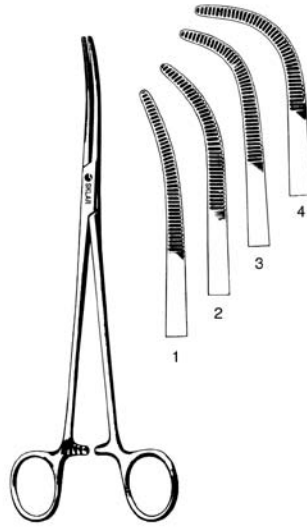
RUMEL THORACIC FORCEPS
2 3/8" JAW, 9"

55-3123	1	Slight Curve
55-3125	2	Medium Curve
55-3127	3	Full Curve
55-3129	4	Angled

SAROT INTRA-THORACIC ARTERY FORCEP
2 1/2" JAW

32-2066	9 1/2"
---------	--------

JOHNS HOPKINS BULLDOG CLAMPS

STRAIGHT		CURVED	
52-1416	1 1/2"	52-1415	1 1/2"
52-1421	2"	52-1420	2"
52-1426	2 1/2"	52-1425	2 1/2"
52-1431	3"	52-1430	3"
52-1436	3 1/2"	52-1435	3 1/2"

DIEFENBACH BULLDOG CLAMPS

SERRATED, FINE			
STRAIGHT		CURVED	
17-3815	1 1/2"	17-3915	1 1/2"
17-3817	2 1/4"	17-3917	2 1/4"

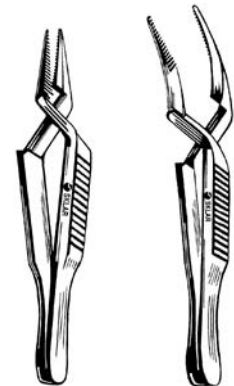
DIETRICH MICRO BULLDOG CLAMPS

2"	
STRAIGHT	ANGLED
98-4008 8mm	98-4108 8mm
98-4012 12mm	98-4112 12mm
98-4020 20mm	98-4120 20mm

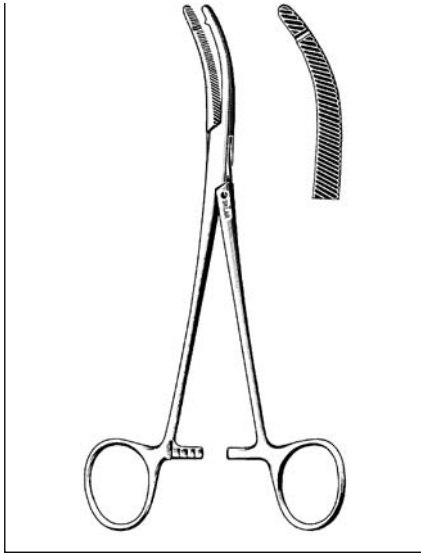
HEANEY FORCEPS

- | | | |
|---------|-----|---------------------|
| 90-1977 | 7¾" | Light, Single Tooth |
| 90-2177 | 8¼" | Heavy, Single Tooth |
| 90-2280 | 8" | Heavy, Double Tooth |
| 90-2387 | 8¾" | Heavy, Double Tooth |

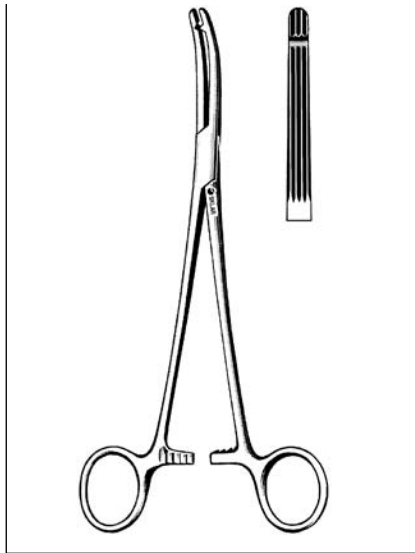
HEANEY BALLENTINE FORCEPS
LONGITUDINAL SERRATIONS

- | | | |
|---------|----|----------|
| 90-2580 | 8" | Curved |
| 90-2480 | 8" | Straight |

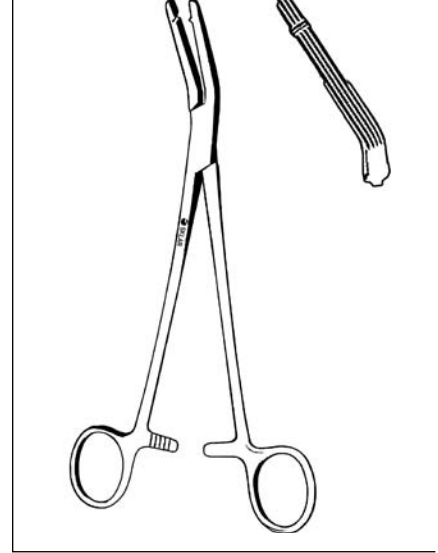
GARLAND HYSTERECTOMY FORCEP
LONGITUDINAL SERRATIONS, SINGLE TOOTH

- | | | |
|---------|-----|--------------------|
| 90-2695 | 8½" | Angled on the Flat |
|---------|-----|--------------------|

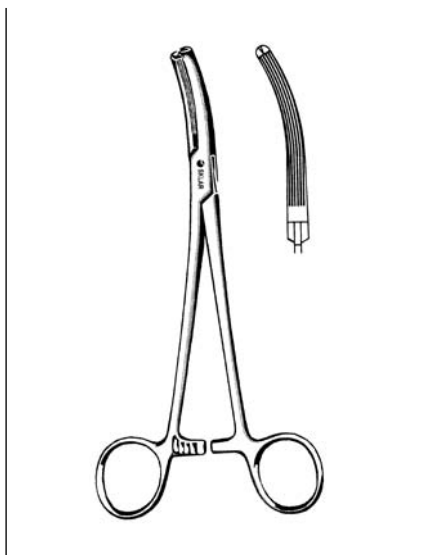
LONG HYSTERECTOMY FORCEP
LONGITUDINAL SERRATIONS, 1X2 TEETH

- | | | |
|---------|-----|--------|
| 90-2690 | 7½" | Curved |
|---------|-----|--------|

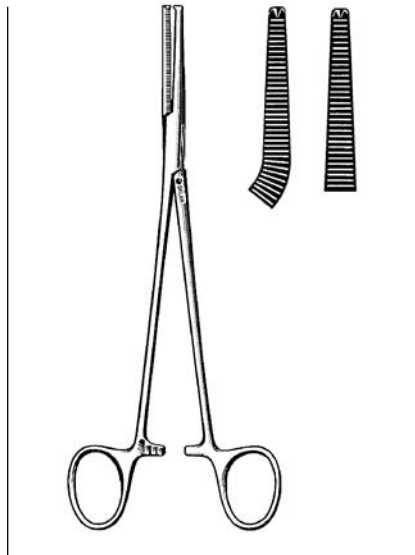
PHANEUF UTERINE ARTERY FORCEPS
HORIZONTAL SERRATIONS, 1X2 TEETH

- | | | |
|---------|-----|----------------|
| 90-2682 | 8¼" | Straight |
| 90-2680 | 8¼" | Angled on Flat |

WERTHIEM CULLEN PEDICLE CLAMPS

- | | | |
|---------|-----|-----------------|
| 33-1375 | 8½" | Right Angle, 2" |
| 33-1376 | 9¾" | Curved, 2" |



Needle Holders



Tungsten Carbide

TC Needle Holders utilize solid tungsten carbide insert jaws with a Sklar pyramid profile to hold suture needles far more securely than any standard instrument. All TC inserts are virtually indestructible with an extremely hard alloy that provides exceptional control, eliminating needle rotation and slippage. These precisely ground needle holders are readily identified by the dual gold finger rings.

Premium

SklarLite™ / SklarLite XD™

SklarLite Premium needle holders have been reduced in their overall pattern weight to produce a lighter instrument for improved comfort that minimizes fatigue to clinicians during prolonged procedures. SklarLite XD Extra Delicate needle holders provide the most sensitive surgical tool as well as our lightest possible pattern while retaining its needle grasping capability and strength. SklarLite and SklarLite XD are fully guaranteed for a lifetime of dependable use.

General Surgery Instruments

Our very best operating room, high quality needle holders are forged and finished from optimum grades of German surgical steel with finely detailed craftsmanship and exacting standards of manufacturing, including our exceptional line of Microsurgery instruments.

Microsurgery

Sklar offers a highly functional range of Micro Needle Holders designed to carry out the needs of the surgeon at the micro level. Perfectly designed pointed jaws provide a better grip on needles and are widely appreciated for minimizing hand fatigue.



**TC DERF
NEEDLE HOLDER**
21-8004 4¾" Serrated



**TC WEBSTER
NEEDLE HOLDERS**
21-8002 5¼" Smooth
21-8080 5¼" Serrated



**TC HALSEY
NEEDLE HOLDERS**
21-8000 5¼" Smooth
21-8001 5¼" Serrated

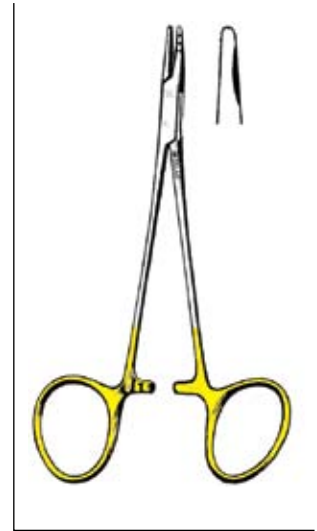

**TC NEIVERT
NEEDLE HOLDER**
SERRATED
21-8086 5" One Offset Ring

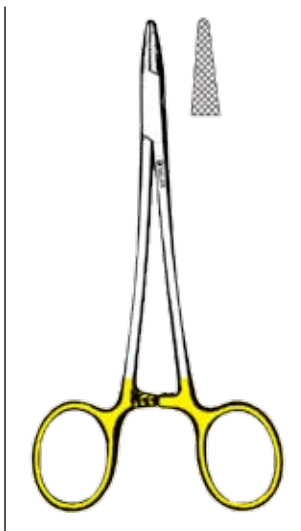

**TC BAUMGARTNER
NEEDLE HOLDER**
21-8005 5¼" Serrated



**TC PAR
NEEDLE HOLDERS**
DELICATE, SERRATED
21-7012 4½"
21-7013 5"



**TC CRILE-WOOD
NEEDLE HOLDERS**
21-8003 6" Smooth
21-8006 6" Serrated
21-8007 7" Serrated
21-8008 8" Serrated
21-8009 9" Serrated
21-8010 10½" Serrated
21-8011 12" Serrated

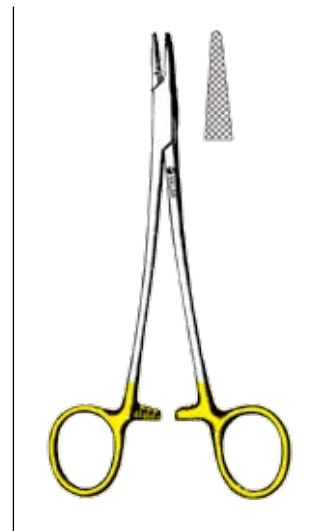

**TC CRILE-MURRAY
NEEDLE HOLDER**
21-8075 6" Serrated

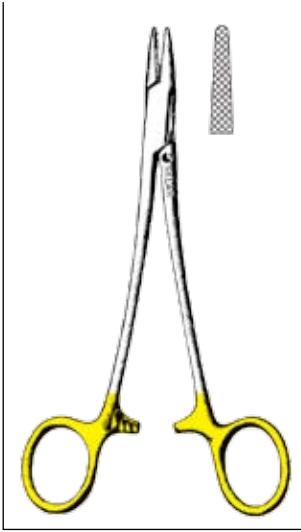

**TC MAYO-HEGAR
NEEDLE HOLDERS**

SERRATED

- 21-8030 5½"
- 21-8031 6"
- 21-8032 7"
- 21-8033 8"
- 21-8051 9½"
- 21-8034 10½"
- 21-8035 12"

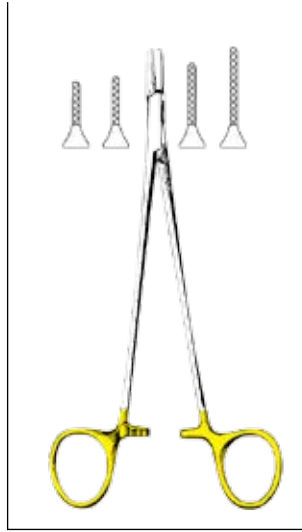

**TC RYDER
NEEDLE HOLDERS**

MICRO SERRATED

- 21-8012 5"
- 21-8013 6"
- 21-8014 7"
- 21-8016 9"



**TC RYDER
NEEDLE HOLDERS**

SERRATED

- 21-8019 5"
- 21-8020 6"
- 21-8021 7"
- 21-8022 8"
- 21-8023 9"
- 21-8024 10¼"

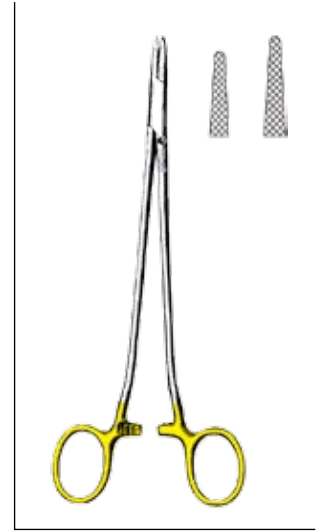

**TC SAROT
NEEDLE HOLDERS**

- 21-8036 7⅞" Serrated
- 21-8037 10½" Serrated



**TC NEW ORLEANS
NEEDLE HOLDER**

- 21-8082 7" Serrated



**TC OLSEN-HEGAR
NEEDLE HOLDERS**

- 21-8026 4¾" Smooth, Delicate
- 21-8025 4¾" Serrated, Delicate
- 21-8027 5½" Serrated
- 21-8028 6½" Serrated
- 21-8029 7½" Serrated



**TC GILLIES
NEEDLE HOLDER**

- 21-2662 6" Serrated

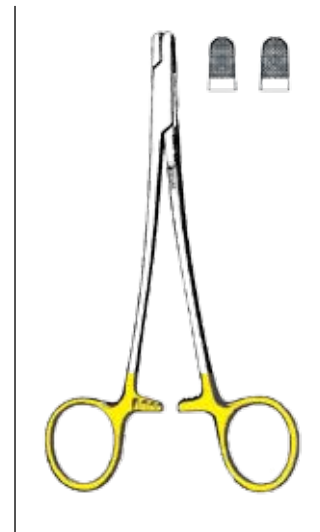

**TC STERNAL WIRE
TWISTERS**

- 21-9060 5"
- 21-9065 7"

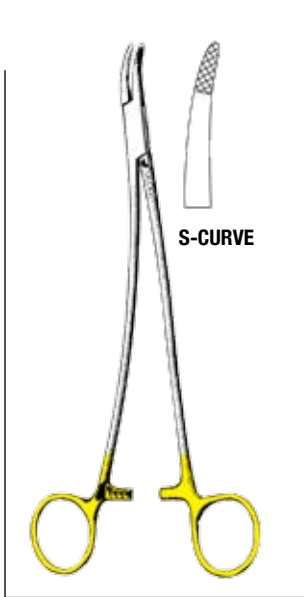

**TC STRATTE
NEEDLE HOLDER**
21-8065 9" Serrated,
S-Curve

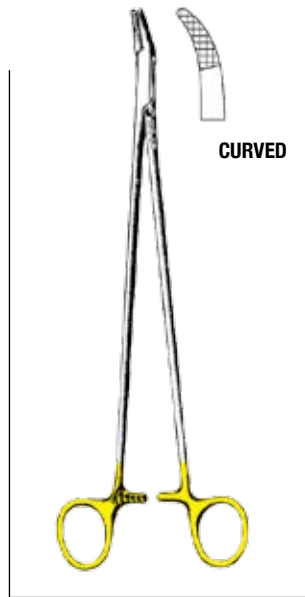

**TC HEANEY
NEEDLE HOLDERS**
21-8060 8¼" Serrated, Curved
21-8061 10" Serrated, Curved



**TC BIHRLE
NEEDLE HOLDER**
SMOOTH/ SERRATED TIPS
21-8079 11"



**TC WANGENSTEEN
NEEDLE HOLDER**
21-3510 10½" Serrated

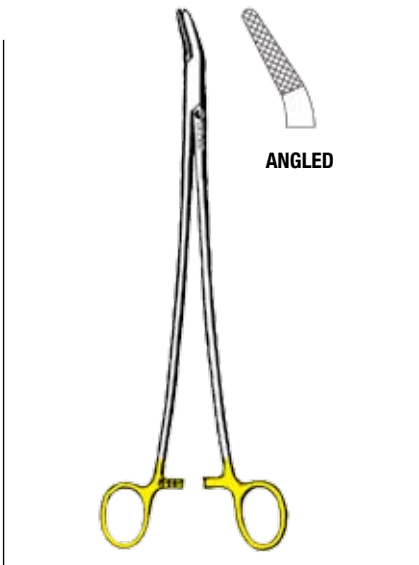

**TC FINOCHIETTO
NEEDLE HOLDER**
21-8039 10½" Serrated, Angled

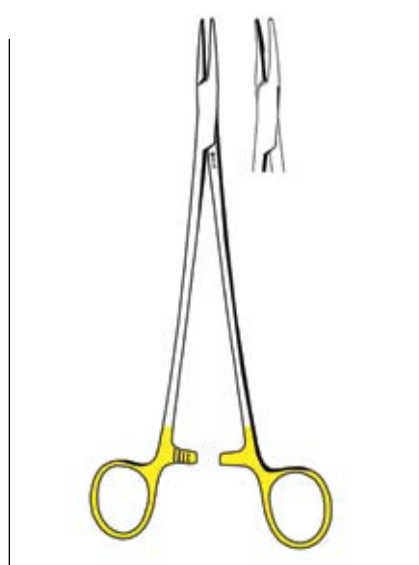

**TC JULIAN PATTERN
NEEDLE HOLDERS**
SERRATED
21-8095 8¼" Straight
21-8096 8¼" Curved

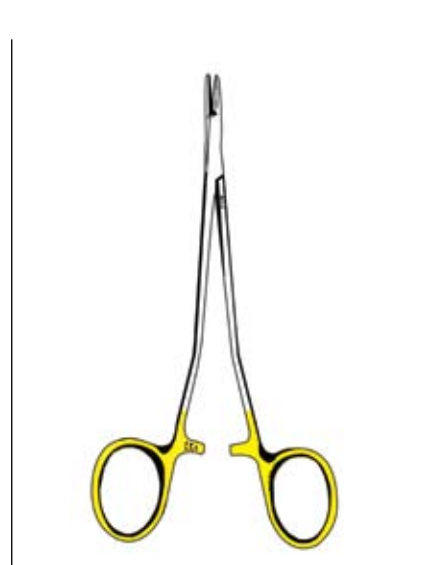

TC SWEDISH NEEDLE HOLDER
21-8097 6" Serrated



Sklar's Left-Handed Needle Holders

Now there's a ring-handled needle holder created for the needs of left-handed surgeons.

Sklar's left-handed needle holder features a unique ratchet design that makes it possible for surgeons to easily control the needle holder with their left hand. As a result surgeons experience less fatigue and hand strain than ever before.

Suitable for left hand use.



TC WEBSTER NEEDLE HOLDER

21-9012 5" Smooth



TC CRILE-WOOD NEEDLE HOLDERS

21-9030 6" Serrated
21-9035 7" Serrated



TC MAYO-HEGAR NEEDLE HOLDERS

21-9016 6" Serrated
21-9018 7" Serrated



TC RYDER NEEDLE HOLDER

21-9045 6" Serrated

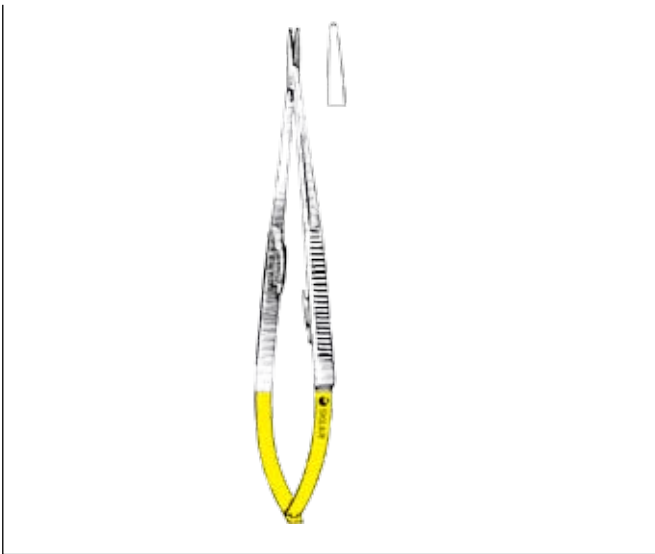

TC JACOBSON MICROVASCULAR NEEDLE HOLDERS

SMOOTH

WITH LOCK

- 21-8053 7" Straight
- 21-8253 7" Curved
- 21-8055 8½" Straight
- 21-8255 8½" Curved
- 21-8059 9" Straight
- 21-8257 9" Curved

WITHOUT LOCK

- 21-8054 7" Straight
- 21-8254 7" Curved
- 21-8058 8½" Straight
- 21-8258 8½" Curved
- 21-8057 9" Straight
- 21-8259 9" Curved

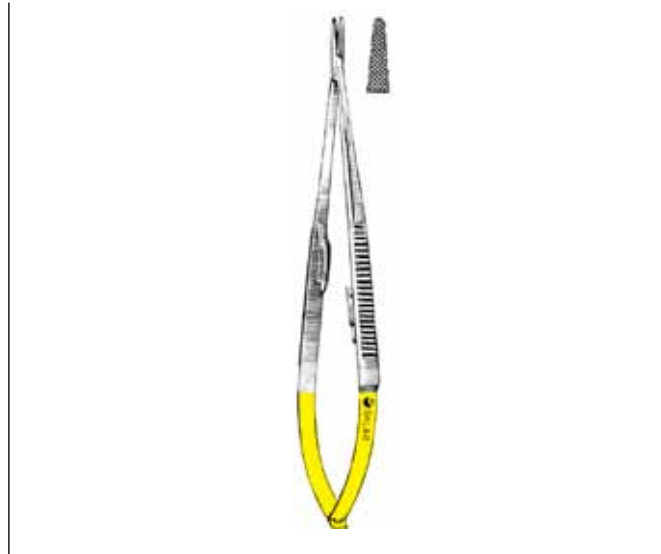

TC JACOBSON MICROVASCULAR NEEDLE HOLDERS

SERRATED

WITH LOCK

- 21-8250 7" Straight
- 21-8251 7" Curved
- 21-8052 8½" Straight
- 21-8056 8½" Curved
- 21-8157 9" Straight
- 21-8158 9" Curved

WITHOUT LOCK

- 21-8150 7" Straight
- 21-8151 7" Curved
- 21-8152 8½" Straight
- 21-8156 8½" Curved
- 21-8159 9" Straight
- 21-8160 9" Curved

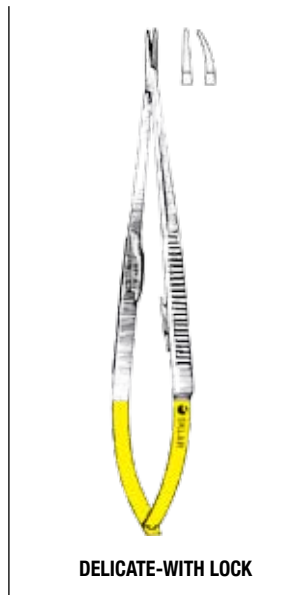

TC CASTROVIEJO NEEDLE HOLDERS

- 21-8040 5½" Smooth, Straight
- 21-8046 5½" Serrated, Straight
- 21-8047 5½" Serrated, Curved

TC CASTROVIEJO NEEDLE HOLDERS

- 21-8044 5½" Smooth, Straight
- 21-8045 5½" Smooth, Curved

TC CASTROVIEJO NEEDLE HOLDERS

- 21-8042 5½" Smooth, Straight
- 21-8043 5½" Smooth, Curved

TC MATHIEU NEEDLE HOLDERS

- 21-8070 5½"
- 21-8071 6¼" Narrow Jaw



SKLARLITE
THE LIGHT TOUCH

SKLARLITE XD™
EXTRA DELICATE

SKLARLITE™ AND SKLARLITE XD™
PROVIDES LIGHTNESS
AND DURABILITY

Sklar has developed a new line of premium operating room instruments that offers the surgeon maximum control and precision. Our research determined a need for instruments that were lighter patterns while maintaining the strength and durability of a standard pattern.

Sklar has recognized the need for a manufacturing technique that mills scant microns off our standard pattern while maintaining the structural integrity of the original instrument. The result is a noticeably lighter, extremely sensitive instrument that can withstand the daily rigors of surgery.

SKLARLITE™ and SKLARLITE XD™ instruments carry the same day-in and day-out reliability that you have come to expect from all Sklar instruments. Sklar has applied its more than 100 years of experience in developing this superior instrument.



SKLARLITE
THE LIGHT TOUCH

SKLARLITE™
DERF NEEDLE HOLDER
23-2124 4¾" Serrated

SKLARLITE XD™
EXTRA DELICATE

SKLARLITE XD™
DERF NEEDLE HOLDER
23-2224 4¾" Serrated

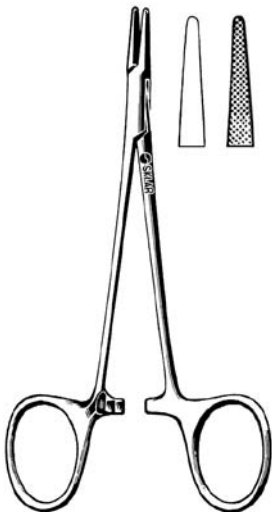

SKLARLITE
THE LIGHT TOUCH

SKLARLITE™
WEBSTER
NEEDLE HOLDERS
23-2125 5¼" Smooth
23-2120 5¼" Serrated

SKLARLITE XD™
EXTRA DELICATE

SKLARLITE XD™
WEBSTER
NEEDLE HOLDERS
23-2225 5¼" Smooth
23-2220 5¼" Serrated

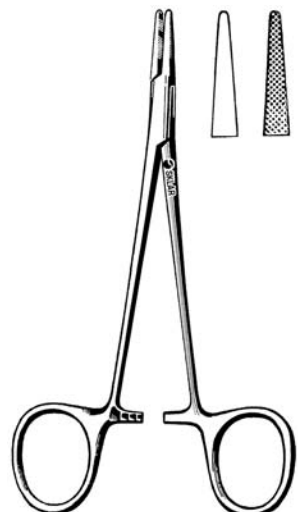

SKLARLITE
THE LIGHT TOUCH

SKLARLITE™
HALSEY
NEEDLE HOLDERS
23-2135 5¼" Smooth
23-2130 5¼" Serrated

SKLARLITE XD™
EXTRA DELICATE

SKLARLITE XD™
HALSEY
NEEDLE HOLDERS
23-2235 5¼" Smooth
23-2230 5¼" Serrated



SKLARLITE
THE LIGHT TOUCH

**SKLARLITE™
BAUMGARTNER
NEEDLE HOLDER**

23-2132 5¼" Serrated

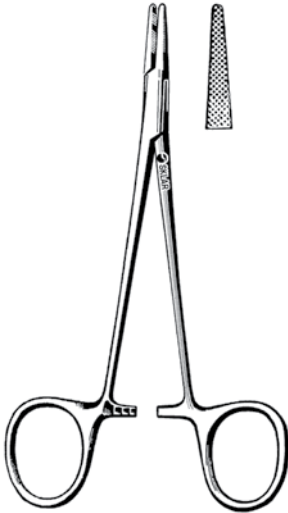

SKLARLITE XD™
EXTRA DELICATE

**SKLARLITE XD™
BAUMGARTNER
NEEDLE HOLDER**

23-2232 5¼" Serrated



SKLARLITE
THE LIGHT TOUCH

**SKLARLITE™
CRILE-WOOD
NEEDLE HOLDER**

23-2134 6" Serrated



SKLARLITE XD™
EXTRA DELICATE

**SKLARLITE XD™
CRILE-WOOD
NEEDLE HOLDER**

23-2234 6" Serrated



SKLARLITE
THE LIGHT TOUCH

**SKLARLITE™
MAYO-HEGAR
NEEDLE HOLDER**

23-2128 7" Serrated

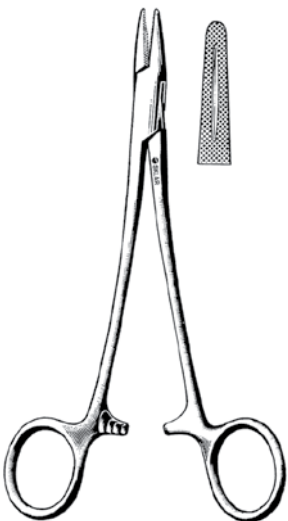

SKLARLITE XD™
EXTRA DELICATE

**SKLARLITE XD™
MAYO-HEGAR
NEEDLE HOLDER**

23-2228 7" Serrated



SKLARLITE
THE LIGHT TOUCH

**SKLARLITE™
OLSEN-HEGAR
NEEDLE HOLDER**

23-2136 5½" Serrated



SKLARLITE XD™
EXTRA DELICATE

**SKLARLITE XD™
OLSEN-HEGAR
NEEDLE HOLDER**

23-2236 5½" Serrated





DERF NEEDLE HOLDER
20-1547 4¾" Serrated

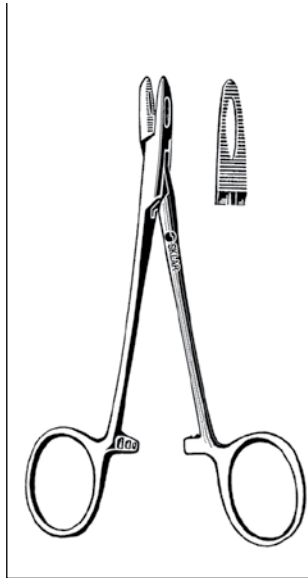

COLLIER NEEDLE HOLDER
65-6550 5¼" Serrated, Fenestrated

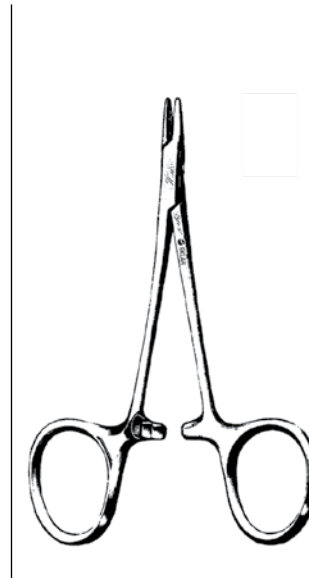

CONVERSE NEEDLE HOLDER
20-3350 5" Longitudinal Serrations

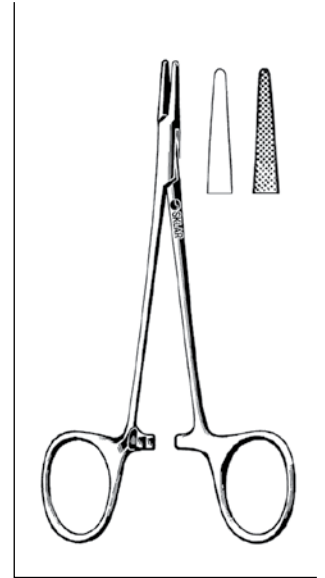

WEBSTER NEEDLE HOLDERS
20-1350 5¼" Smooth
20-1352 5¼" Serrated

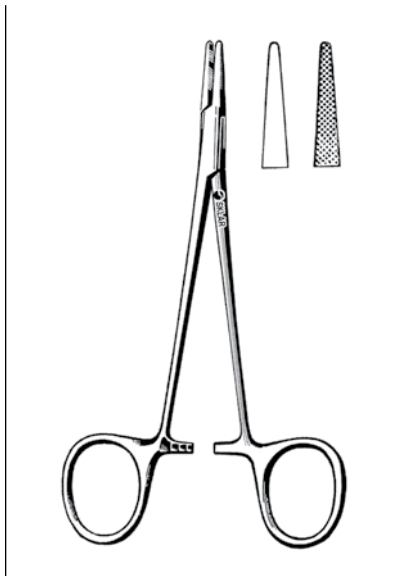

HALSEY NEEDLE HOLDERS
20-1750 5¼" Smooth
20-1751 5¼" Serrated

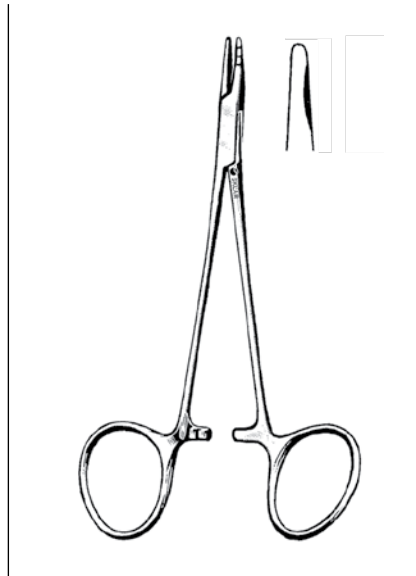

NEIVERT NEEDLE HOLDER
20-1760 5" One Offset Ring

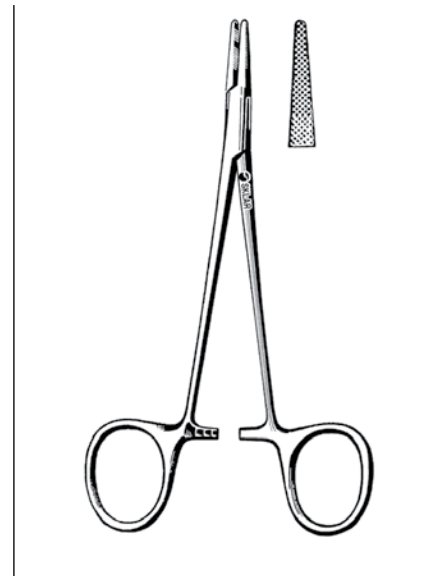

BAUMGARTNER NEEDLE HOLDER
20-1450 5¼" Serrated



CRILE-WOOD NEEDLE HOLDERS

SERRATED

- 20-1265 6" Narrow Jaws
- 20-1270 7"
- 20-1280 8"
- 20-1290 9"
- 20-1295 10½"

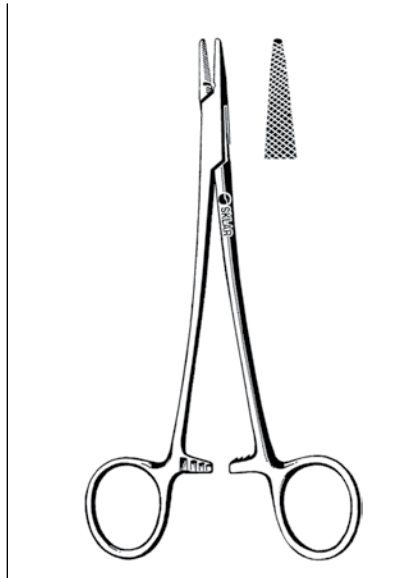

CRILE-MURRAY NEEDLE HOLDER

- 20-1260 6" Serrated

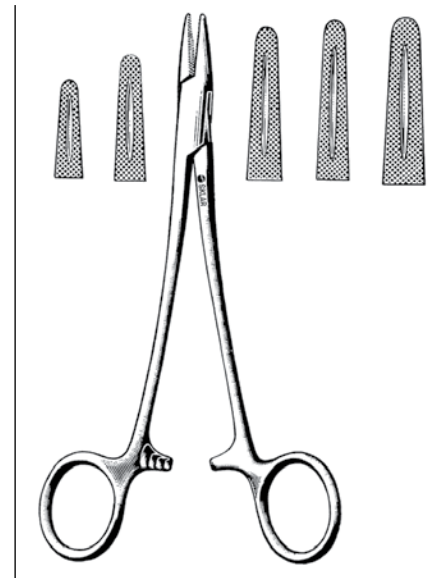

MAYO-HEGAR NEEDLE HOLDERS

SERRATED

- 20-2052 5¼"
- 20-2060 6"
- 20-2070 7"
- 20-2270 7" Broad Jaw
- 20-2480 8"
- 20-2490 9½"
- 20-2910 10½" Masson
- 20-2911 11½" Masson

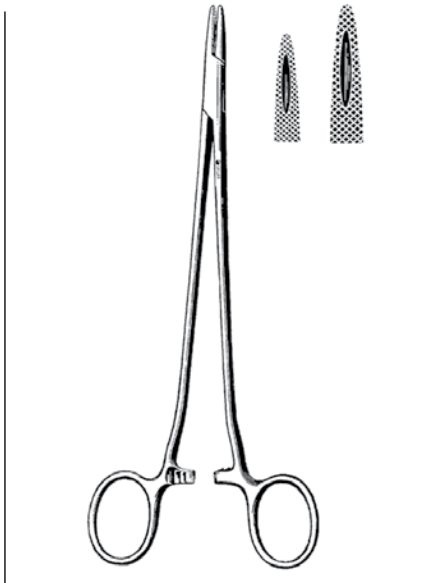

SAROT NEEDLE HOLDERS

- 22-5050 5" Serrated
- 20-4170 7½" Serrated
- 20-3910 10¼" Serrated

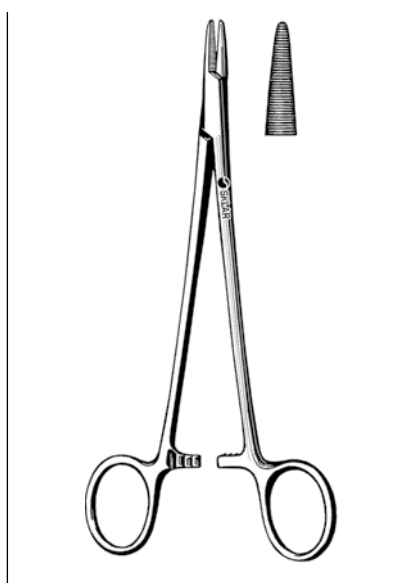

BROWN NEEDLE HOLDERS

- HORIZONTAL SERRATIONS**
- 20-4852 5¼" Rounded Jaws
 - 20-4867 6¾" Rounded Jaws

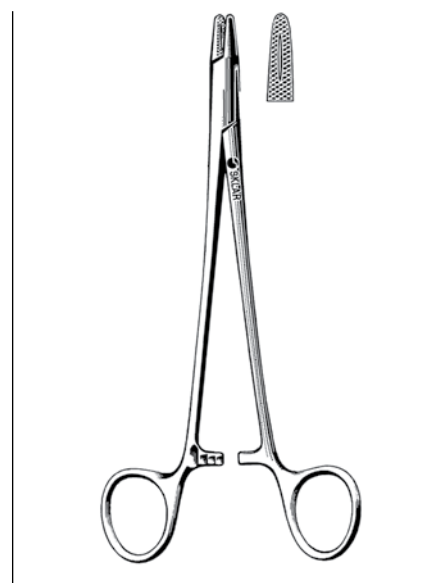

NEW ORLEANS NEEDLE HOLDER

- 20-1870 7" Serrated



M.G.H. NEEDLE HOLDER
20-2730 7"

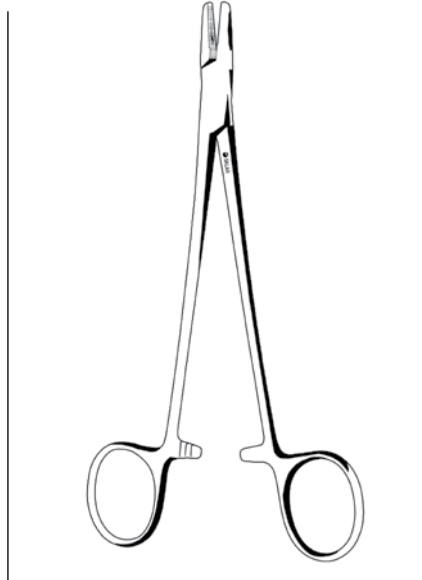

METZENBAUM NEEDLE HOLDERS

FENESTRATED
20-2733 7¼" Straight
20-2734 7¼" Curved

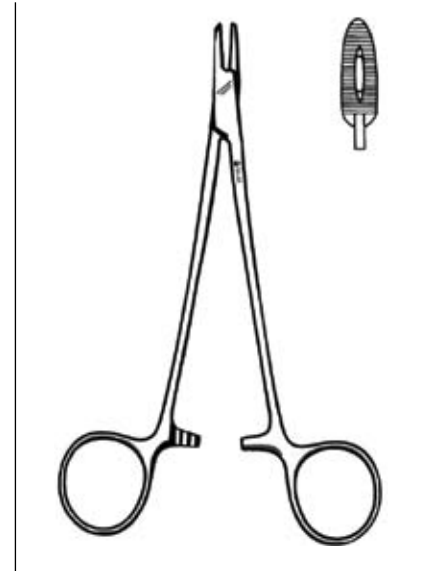

ADSON NEEDLE HOLDER
20-2740 7¼" Fenestrated



OLSEN-HEGAR NEEDLE HOLDERS

SCISSOR COMBINATION
20-2748 4¾" Smooth, Delicate
20-2747 4¾" Serrated, Delicate
20-2755 5½" Serrated
20-2765 6½" Serrated
20-2775 7" Serrated

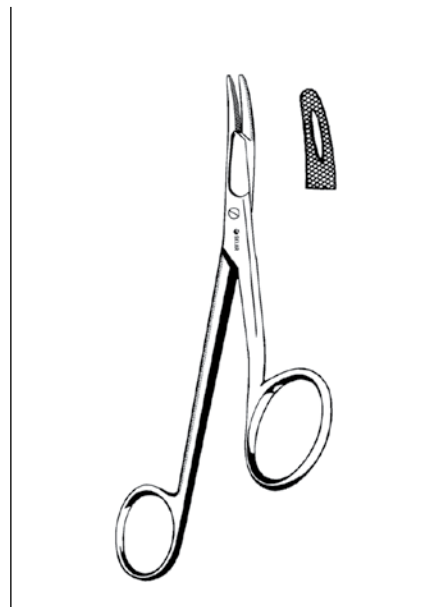

GILLIES NEEDLE HOLDER
ONE FENESTRATED JAW, ONE ANGLED FINGER RING
20-2662 6" Curved, Serrated

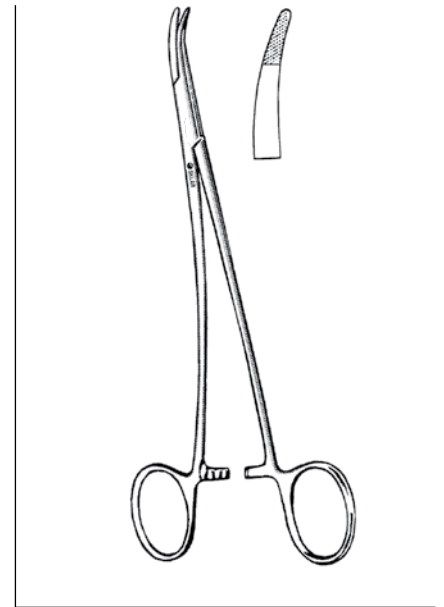

STRATTE NEEDLE HOLDER
20-4795 9" Serrated, S-Curve



HEANEY NEEDLE HOLDER
20-4682 8¼" Serrated, Curved



FINOCHIETTO NEEDLE HOLDER
20-4510 10¼" Serrated, Angular



WANGENSTEEN NEEDLE HOLDERS
20-2780 10½" Short Jaws
20-2781 10½" Long Jaws



CRILE NEEDLE HOLDER
20-1160 6" Serrated



MATHIEU NEEDLE HOLDERS
20-3055 5½" Serrated
20-3075 7½" Serrated



BOYNTON NEEDLE HOLDER
20-3080 5" Delicate



MICRO SURGERY NEEDLE HOLDERS

ROUND HANDLE, .6MM TIPS

WITHOUT LOCK

98-3182	6"	Straight
98-3183	6"	Curved
98-3186	7 ¹ / ₈ "	Straight
98-3188	7 ¹ / ₈ "	Curved

WITH LOCK

98-3184	6"	Straight
98-3185	6"	Curved
98-3190	7 ¹ / ₈ "	Straight
98-3192	7 ¹ / ₈ "	Curved



CASTROVIEJO NEEDLE HOLDERS

STANDARD WITH LOCK

65-6357	5 ¹ / ₂ "	Straight
65-6358	5 ¹ / ₂ "	Curved



CASTROVIEJO NEEDLE HOLDERS

DELICATE

65-6350	5 ¹ / ₂ "	Straight without Lock
65-6351	5 ¹ / ₂ "	Curved without Lock
65-6352	5 ¹ / ₂ "	Straight with Lock
65-6354	5 ¹ / ₂ "	Curved with Lock



CASTROVIEJO KALT NEEDLE HOLDER

65-6055	5 ¹ / ₂ "	Serrated
---------	---------------------------------	----------

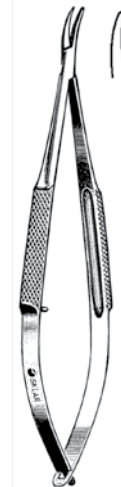

BARRAQUER NEEDLE HOLDERS

DELICATE, WITHOUT LOCK

65-6452	5 ¹ / ₄ "	Curved
65-6454	5 ¹ / ₂ "	Straight
65-6455	5 ¹ / ₂ "	Curved
65-6456	7 ¹ / ₂ "	Straight
65-6457	7 ¹ / ₂ "	Curved

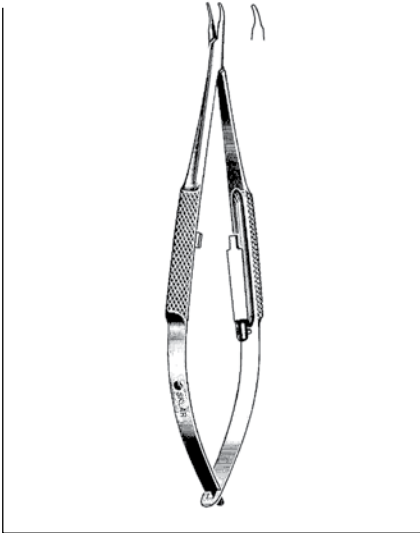

BARRAQUER NEEDLE HOLDERS

DELICATE, WITH LOCK

- 65-6448 5¼" Curved
- 65-6445 5½" Straight
- 65-6446 5½" Curved
- 65-6449 7½" Straight
- 65-6450 7½" Curved

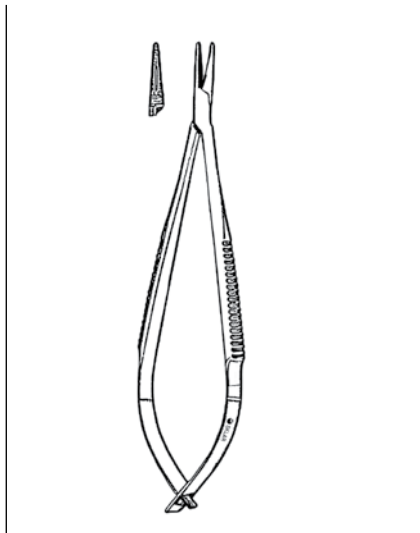

PATTON NEEDLE HOLDER

65-6360 4½" Straight without Lock

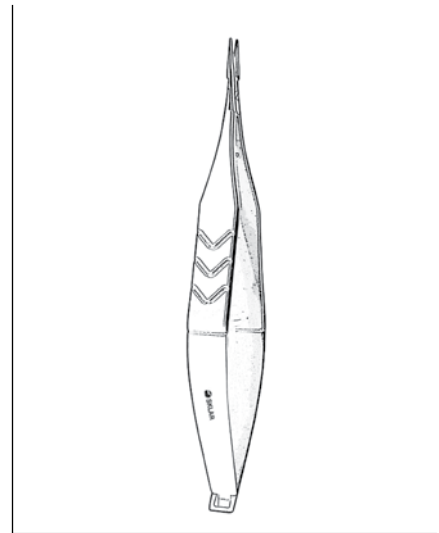

McPHERSON NEEDLE HOLDERS

DELICATE, WITHOUT LOCK

- 65-6365 4½" Straight
- 65-6366 4½" Curved

STETHOSCOPES

SKLAR OFFERS A COMPLETE LINE OF HIGH QUALITY STETHOSCOPES

For a complete listing of Sklar's extensive Stethoscope product line see pages 359-364. For more information contact your Sklar Account Manager or Distributor Sales Representative.



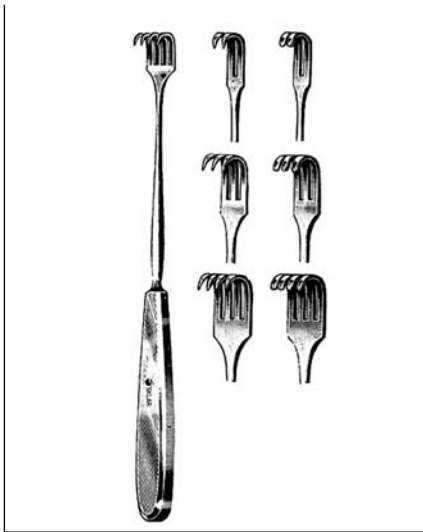

VOLKMAN RETRACTORS
HOLLOW HANDLE
BLUNT

60-5622	8½"	2 Prong
60-5623	8½"	3 Prong
60-5624	8½"	4 Prong

SHARP

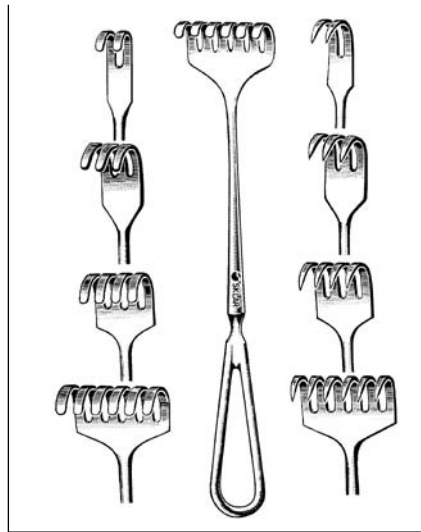
60-5612	8½"	2 Prong
60-5613	8½"	3 Prong
60-5614	8½"	4 Prong

VOLKMAN RETRACTORS
USA
BLUNT

60-5502	8½"	2 Prong
60-5503	8½"	3 Prong
60-5504	8½"	4 Prong
60-5506	8½"	6 Prong

SHARP

60-5602	8½"	2 Prong
60-5603	8½"	3 Prong
60-5604	8½"	4 Prong
60-5606	8½"	6 Prong

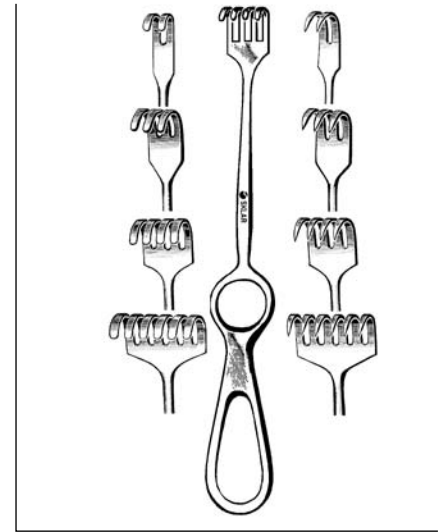
VOLKMAN RETRACTORS
RING HANDLE
BLUNT

60-5812	8½"	2 Prong
60-5813	8½"	3 Prong
60-5814	8½"	4 Prong
60-5816	8½"	6 Prong

SHARP

60-5822	8½"	2 Prong
60-5823	8½"	3 Prong
60-5824	8½"	4 Prong
60-5826	8½"	6 Prong

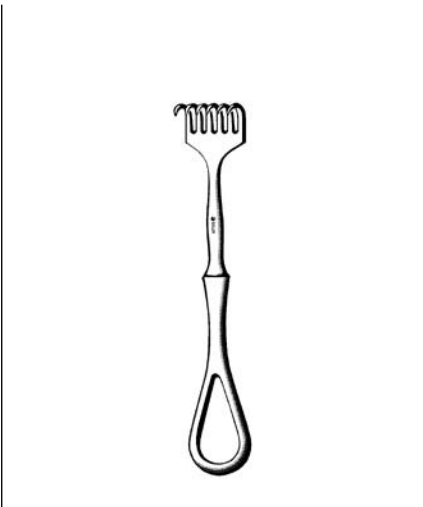
VOLKMAN RETRACTORS
BLUNT

60-4252	4½"	2 Prong
60-4253	4½"	3 Prong
60-4254	4½"	4 Prong
60-4256	4½"	6 Prong

SHARP

60-4242	4½"	2 Prong
60-4243	4½"	3 Prong
60-4244	4½"	4 Prong
60-4246	4½"	6 Prong

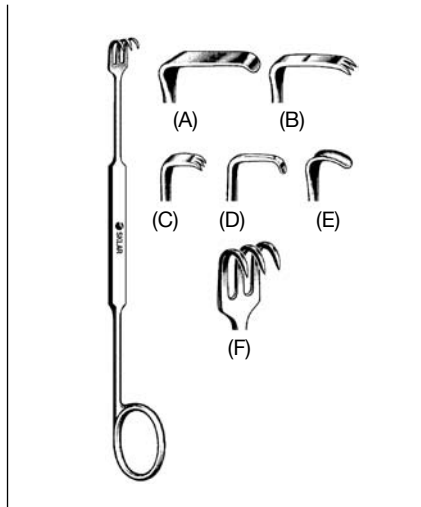
MEYERDING RETRACTORS
7"

22-8210	A	1½"	Deep
22-8211	B	5⁄8"	Deep
22-8212	C	¼"	Deep
22-8213	D	3⁄8"	Deep
22-8214	E	¼"	Deep
22-8215	F	3 Prong	Sharp

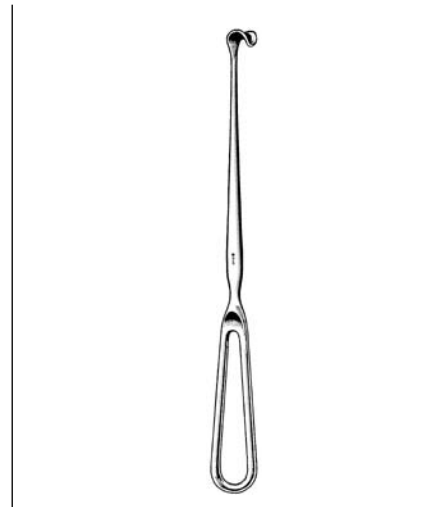
**CUSHING NERVE/VEIN
RETRACTOR**

50-1290 9"

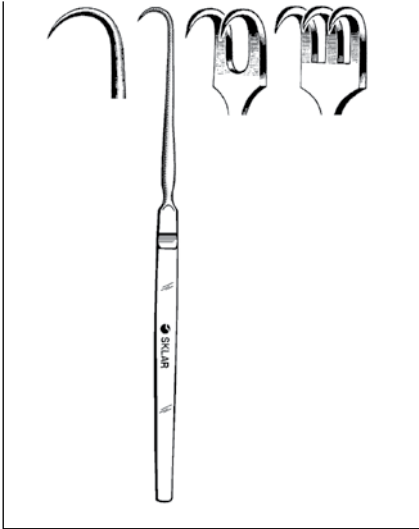
TRACHEAL RETRACTORS
BLUNT

78-1101	6½"	1 Prong
78-1102	6½"	2 Prong
78-1103	6½"	3 Prong

SHARP

78-1001	6½"	1 Prong
78-1002	6½"	2 Prong
78-1003	6½"	3 Prong

ISRAEL RETRACTORS
BLUNT

60-6100	10"	1¾" x 1⅝"	4 Prong
60-6101	10"	1¾" x 2"	5 Prong
60-6102	10"	2⅜" x 1¾"	6 Prong
60-6103	10"	2¾" x 2¾"	6 Prong

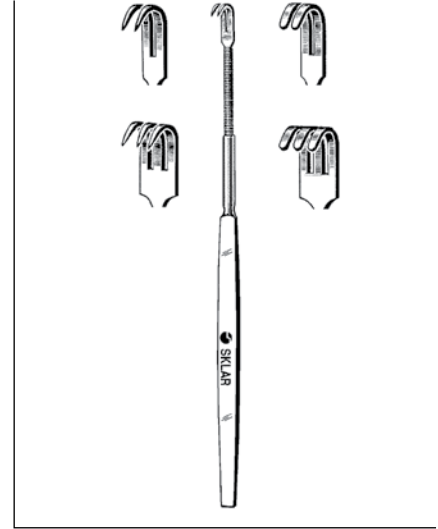
PLASTIC SURGERY RETRACTORS
FLEXIBLE NECK
BLUNT

22-9141	6"	1 Prong
22-9142	6"	2 Prong
22-9143	6"	3 Prong

SHARP

22-9144	6"	1 Prong
22-9132	6"	2 Prong
22-9133	6"	3 Prong

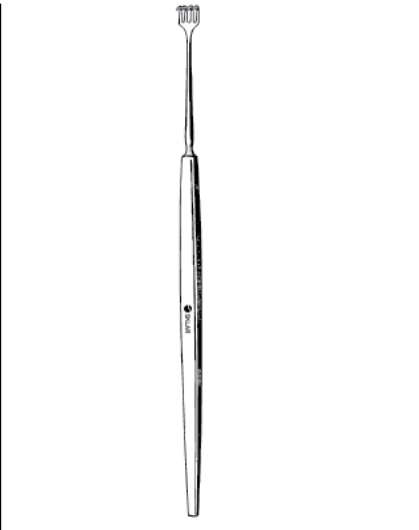
BLAIR-ROLLET RETRACTORS

47-2752	5½"	Blunt	4 Prong
47-2655	5½"	Sharp	4 Prong

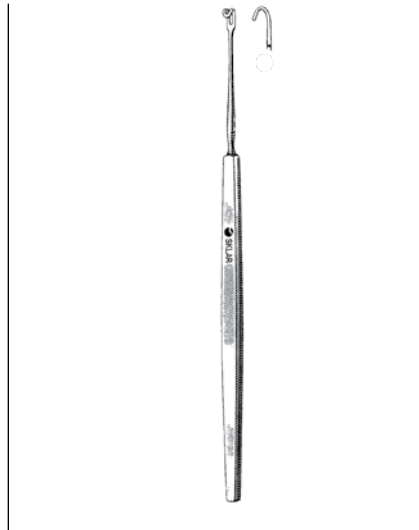
McGANNON IRIS RETRACTOR

65-3258	5¼"
---------	-----

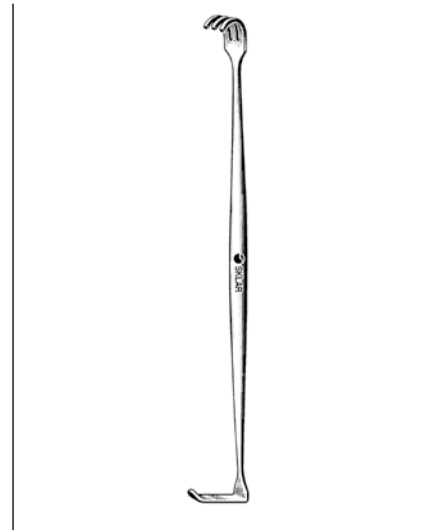
MATHIEU RETRACTORS
DOUBLE END

60-6062	6¼"	Blunt
60-6064	6¼"	Sharp

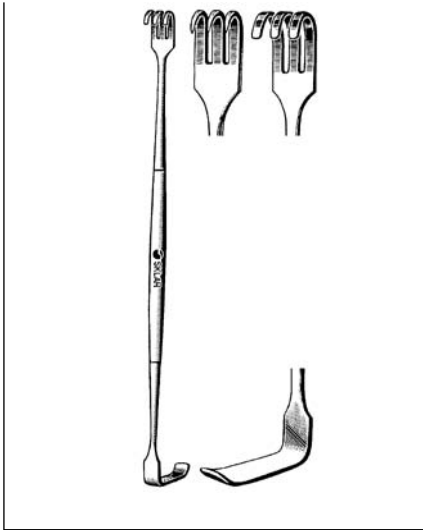

SENN RETRACTORS

DOUBLE END

60-6164 6¼" Blunt
60-6162 6¼" Sharp

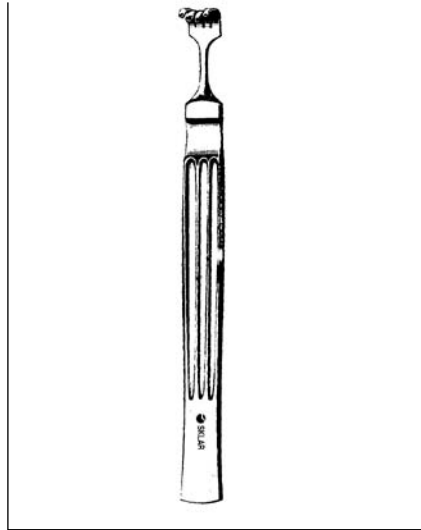

COTTLE RETRACTOR

41-1385 5½" 4 Prong, 2 Recessed



CRILE RETRACTOR

DOUBLE END

57-1445 4½"

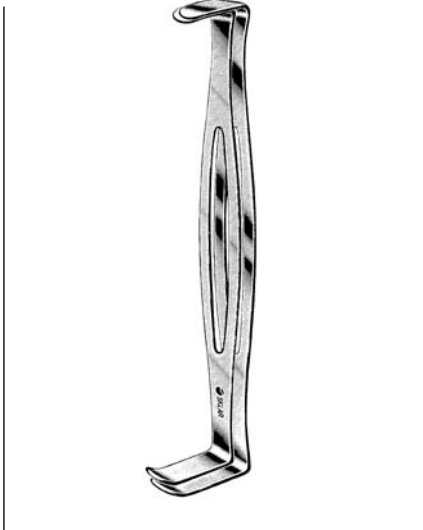

U.S. ARMY RETRACTOR

DOUBLE END

60-1085 8¼" Set of 2

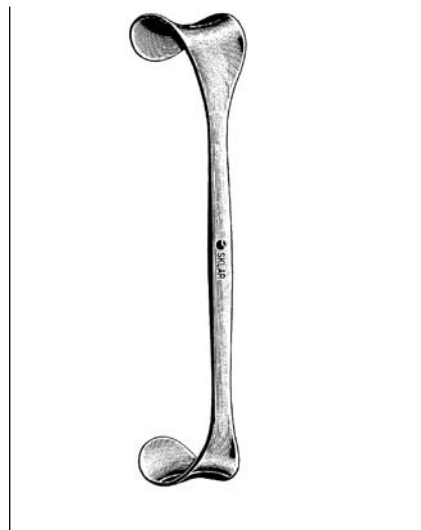

GOELET RETRACTOR

DOUBLE END

60-1075 7½" 1¼" x 1½"



RICHARDSON RETRACTORS

9½" WITH SKLAR GRIP HANDLE

60-1676 ¾" x 1"
60-1691 ¾" x 2"
60-1681 1" x 1¼"
60-1686 1½" x 1½"

FARABEUFR RETRACTOR
DOUBLE END

60-1460 6" Set of 2
1" x $\frac{3}{8}$ " and 1 $\frac{1}{4}$ " x $\frac{1}{2}$ "

BABY FARABEUFR RETRACTOR
DOUBLE END

60-1461 4 $\frac{3}{4}$ " Set of 2
1" x $\frac{3}{8}$ " and 1 $\frac{1}{4}$ " x $\frac{1}{2}$ "

PARKER RETRACTORS
DOUBLE END

60-1350 $\frac{5}{8}$ " x 5" Set of 2
60-1370 1" x 7" Set of 2

ROUX RETRACTORS
DOUBLE END

60-1101 5 $\frac{1}{2}$ " Small
60-1102 6" Medium
60-1103 6 $\frac{3}{4}$ " Large
60-1100 Set of 3

HIBBS RETRACTORS

55-7167 6 $\frac{3}{4}$ " 1 $\frac{1}{4}$ " x $\frac{1}{2}$ "
55-7175 9" 2" x $\frac{5}{8}$ "
55-7192 9 $\frac{1}{2}$ " 3" x 1"

ZALKIND RIBBON RETRACTORS

60-3594 7 $\frac{3}{4}$ " x $\frac{1}{4}$ " 60-3607 13" x $\frac{3}{4}$ "
60-3596 7 $\frac{3}{4}$ " x $\frac{1}{2}$ " 60-3610 13" x 1"
22-8067 7 $\frac{3}{4}$ " x $\frac{5}{8}$ " 60-3612 13" x 1 $\frac{1}{4}$ "
60-3598 7 $\frac{3}{4}$ " x $\frac{3}{4}$ " 60-3615 13" x 1 $\frac{1}{2}$ "
22-8075 7 $\frac{3}{4}$ " x 1" 60-3617 13" x 1 $\frac{3}{4}$ "
60-3620 13" x 2"
60-3625 13" x 2 $\frac{1}{2}$ "

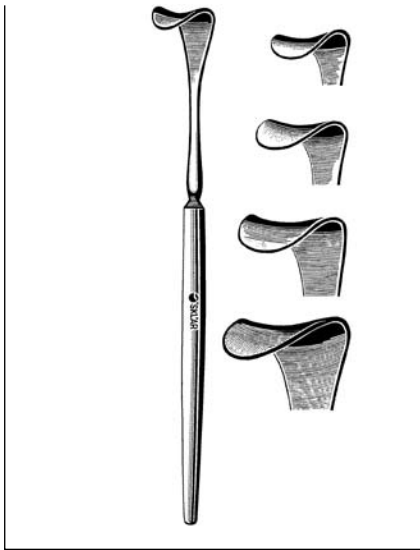
DESMARRES LID RETRACTORS

65-1841	12mm
65-1842	14mm
65-1843	16mm
65-1844	18mm

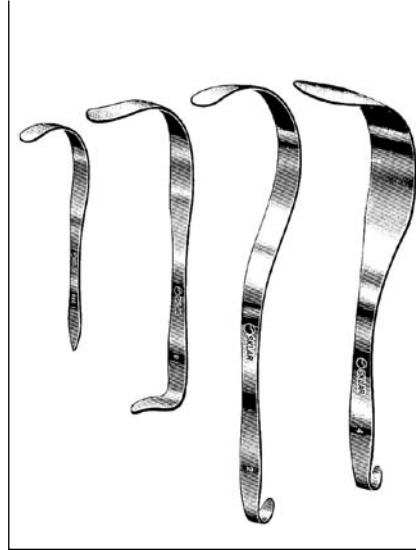
DEAVER RETRACTORS

60-3070	3/4" x 7"	#000
60-3085	7/8" x 8 1/2"	#00
60-3090	1" x 9"	#0
60-3112	1" x 12"	#1
60-3113	1" x 13"	#2
60-3114	1" x 14"	#2 1/2
60-3212	1 1/2" x 12"	#3
60-3312	2" x 12"	#4
60-3412	3" x 12"	#5

PETITE

22-8080	5/8" x 8"
22-8180	1" x 8"

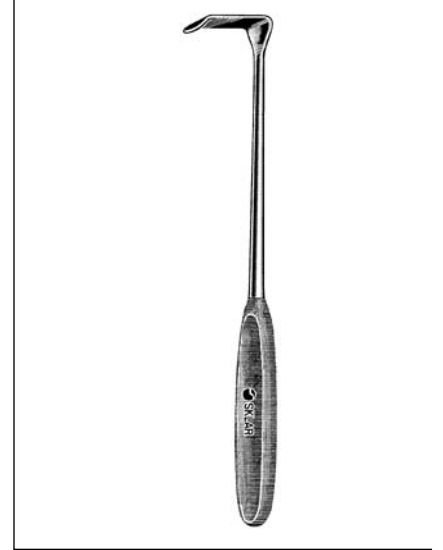
LANGENBECK RETRACTORS

60-1891	9"	1 1/8" x 3/8"
60-1892	9"	1 1/8" x 1/2"
60-1893	9"	1 1/8" x 5/8"
60-1894	9"	1 1/2" x 3/8"
60-1895	9"	2" x 3/8"

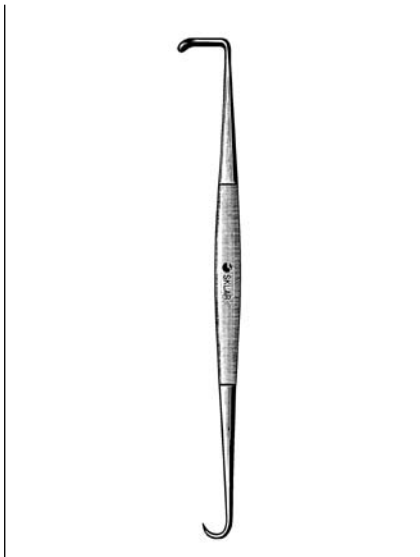
**MEYERDING SKIN HOOK
RETRACTOR**
DOUBLE END

47-2462	6 1/4"	1 1/4" x 1/2"
---------	--------	---------------

MEYERDING RETRACTORS

42-2085	7 3/4"	Small	2" x 5/8"
42-2092	8 3/4"	Medium	3" x 1"
42-2095	9 1/2"	Large	3 1/2" x 2"

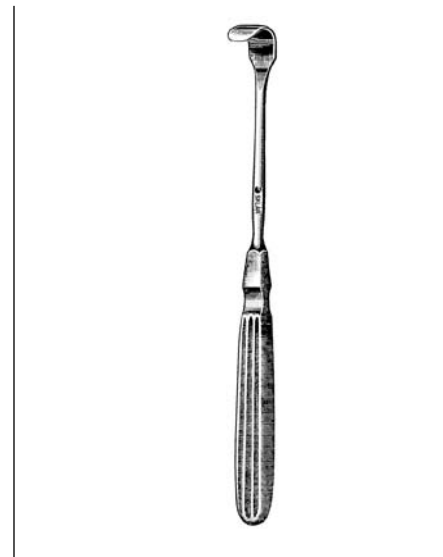
LITTLE RETRACTOR
THIN BLADE

60-5472	7 1/4" x 1/2"
---------	---------------

LITTLE RETRACTOR
THIN BLADE

22-8270 7" x 1/2" Ring Handle

**SMILLE MENISCUS HOOK
RETRACTOR**

40-2290 5 3/4" 3/4" x 1 3/8"

MINI HOHMANN ELEVATORS

40-7450	6 1/2"	6mm
40-7451	6 1/2"	8mm

HOHMANN BONE ELEVATORS

40-7447	8 1/2"	8mm
40-7448	9"	10mm
40-7452	9 1/2"	18mm
40-7453	9 1/2"	43mm
40-7455	10"	20mm
40-7454	10"	24mm
40-7458	10 1/2"	65mm
40-7456	11"	22mm

**HAYS HAND AND FINGER
RETRACTOR**

40-8265 6"

SAUER EYE SPECULUM

65-1012 1 1/4"

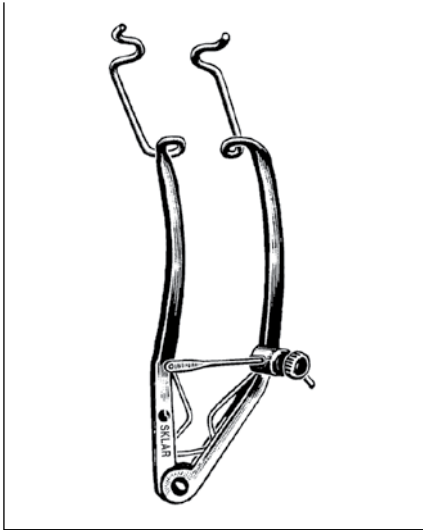

KNAPP EYE SPECULUM
65-1545 3¼" Non-Magnetic

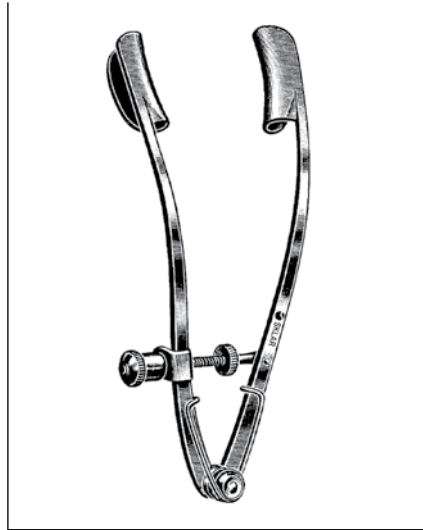

LANCASTER EYE SPECULUM
65-1532 3¼"



CASTROVIEJO SPECULUMS
65-1535 3½" 15mm x 5mm Blades
65-1536 4" 18mm x 5mm Blades

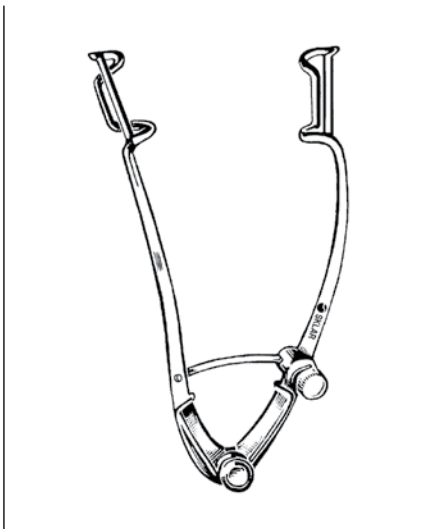

WILLIAMS SPECULUMS
65-1227 2¾"
65-1332 3¼"

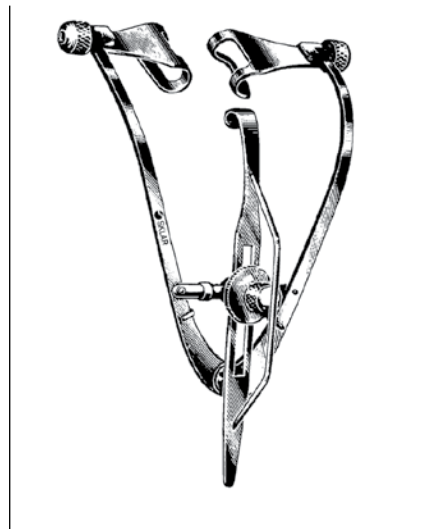

PARK-MAUMENEE EYE SPECULUM
WITH LOCK SCREWS
65-1528 3¼" 14mm Blades

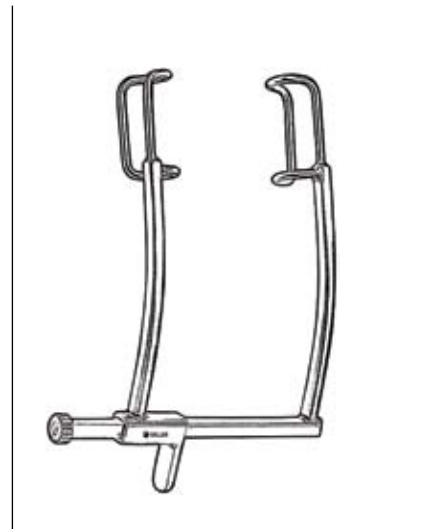

MURDOCK EYE SPECULUM
65-1540 2¼" 15mm Spread

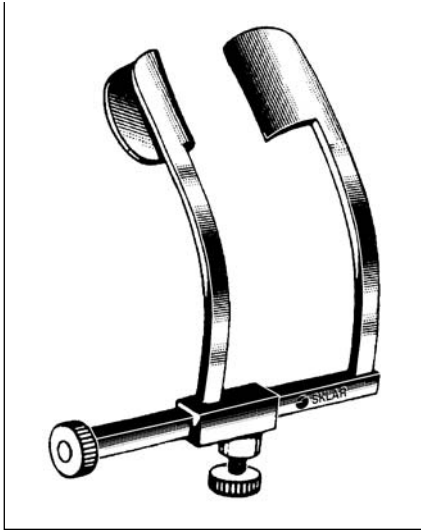
COOK EYE SPECULUMS
WITH LOCK

65-1765	9mm Blades	25mm Spread
65-1766	11mm Blades	27mm Spread

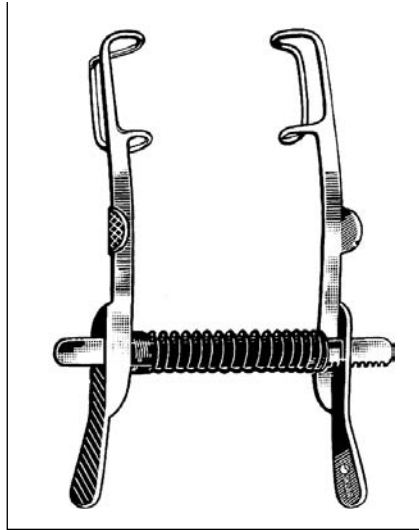
MELLINGER EYE SPECULUMS
15MM SPREAD

65-1426	2¾"	Solid
65-1427	2¾"	Fenestrated

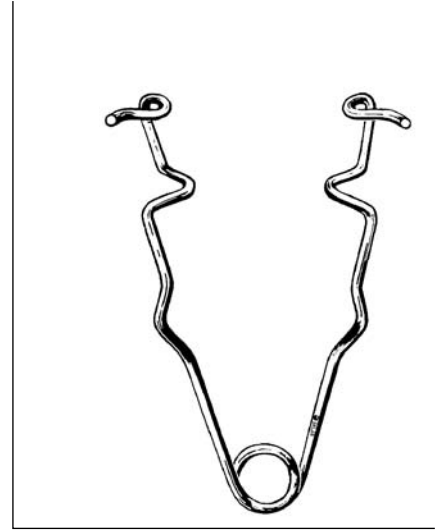
PLAIN WIRE SPECULUM

65-1127	2¾"	Large
---------	-----	-------

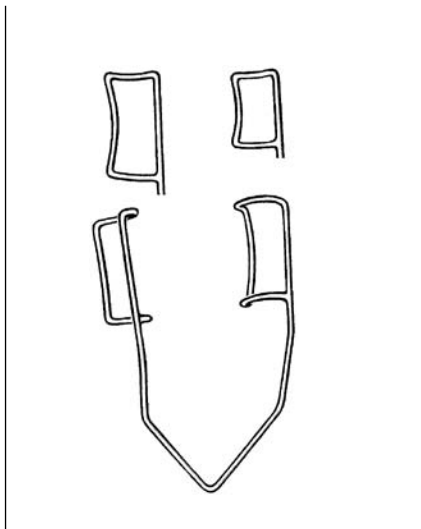
BARRAQUER WIRE SPECULUMS
FENESTRATED

65-1746	1½"	8mm	Small
65-1740	1½"	10mm	Medium
65-1742	1½"	15mm	Large
65-1744	1½"	15mm	Large Heavy

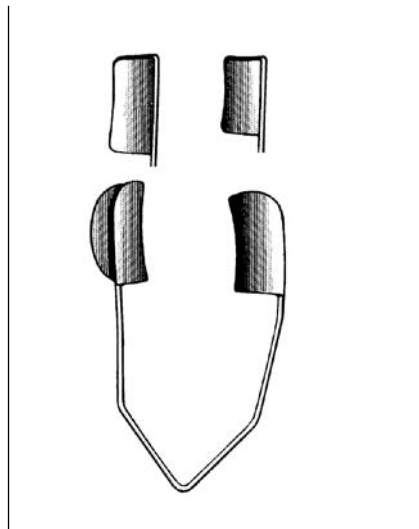
BARRAQUER WIRE SPECULUMS
SOLID

65-1756	1½"	10mm	Medium
65-1758	1½"	15mm	Large

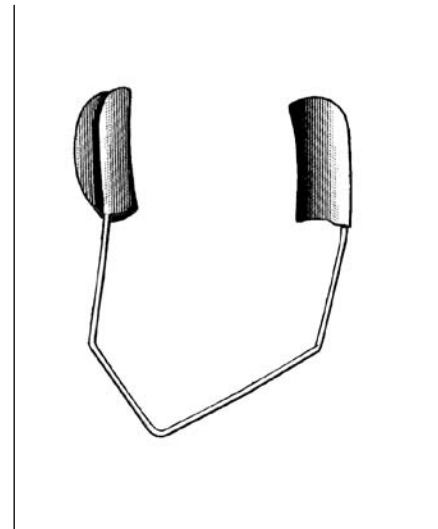
FEASTER WIRE SPECULUM

65-1760	1½"	XL Solid Blades
---------	-----	-----------------

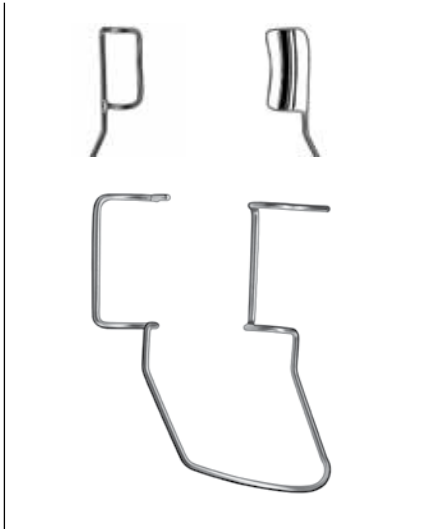
TEMPORAL APPROACH WIRE SPECULUMS
SPRING ON NASAL SIDE

22-8824	1½"	Solid Blades
22-8826	1½"	Closed Wire
22-8828	2"	Open Wire

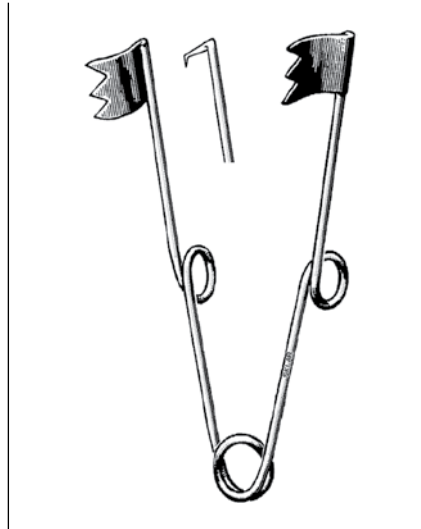
WIRE RETAINING RETRACTORS
SHARP

22-8832	¾"	3x3 Prongs
22-8834	¾"	1x1 Prongs

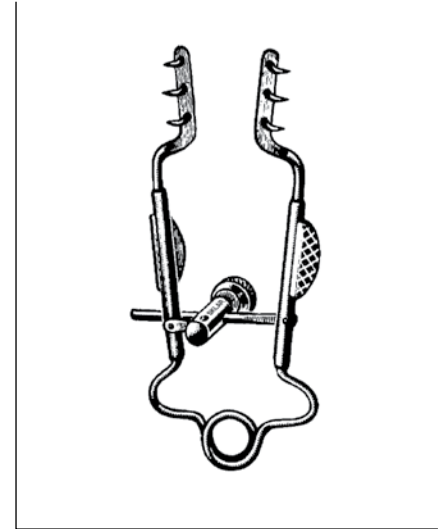
MELLER LACRIMAL SAC RETRACTORS
3X3 PRONGS

65-1815	1½"	Sharp	4mm Deep, Delicate
65-1830	3"	Blunt	3mm Deep

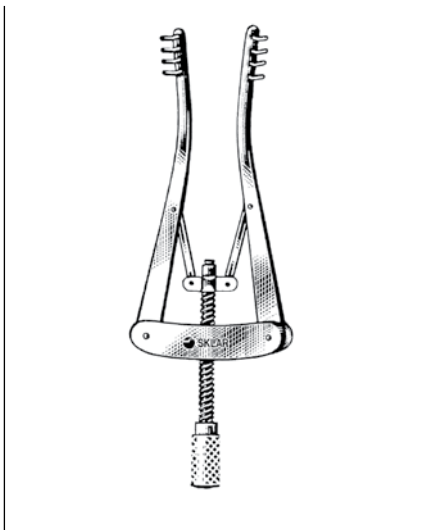
ALM SELF RETAINING RETRACTORS
4X4 PRONGS

BLUNT		SHARP	
22-9027	2¾"	22-9029	2¾"
60-6340	4"	60-6342	4"

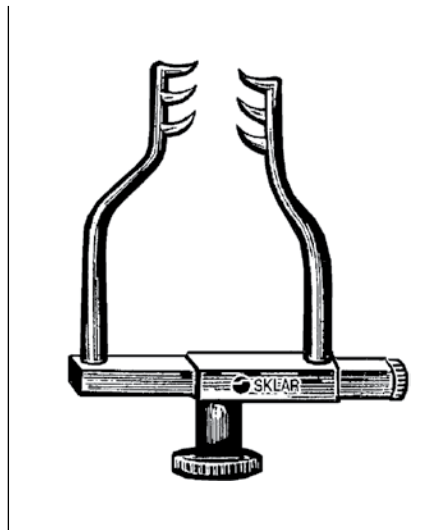
GOLDSTEIN RETRACTOR
3X3 PRONGS

SHARP	
47-2913	1½"

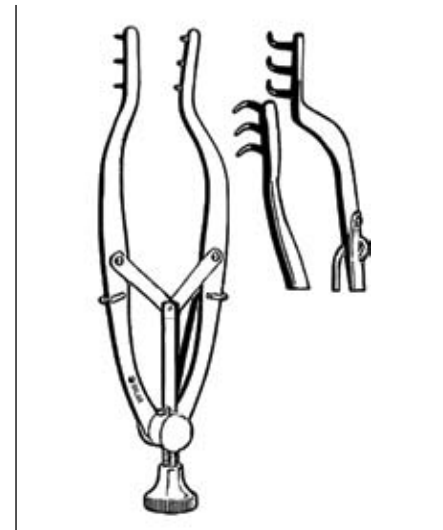
STEVENSON LACRIMAL SAC RETRACTOR
3X3 PRONGS

65-1831	¾"	3mm Deep
---------	----	----------

JANSEN RETRACTORS
3" SPREAD
BLUNT

 47-2832 4" 3x3 Prongs
 47-2836 4½" 4x4 Prongs

SHARP

 47-2834 4" 3x3 Prongs
 47-2838 4½" 4x4 Prongs

JANSEN WAGNER RETRACTOR
SELF-ADJUSTING
SHARP

47-2840 5" 5x5 Prongs

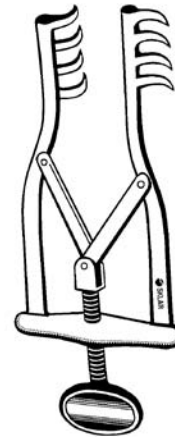

ALLPORT RETRACTOR
2½" SPREAD
SHARP

60-6320 4" 4x4 Prongs

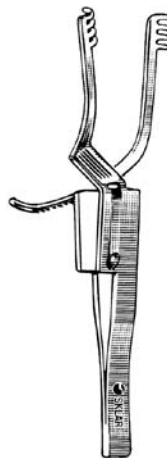

DAVIS RETRACTOR
BLUNT

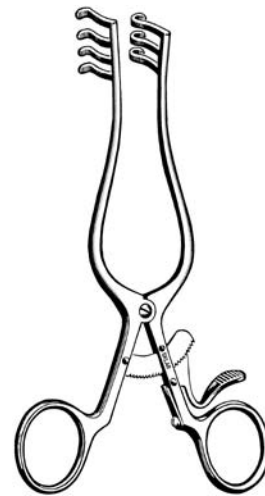
47-3833 4½" 3x3 Prongs

HOLZHEIMER RETRACTORS

 22-8920 4" 4x4 Prongs Sharp
 22-8940 4" 4x4 Prongs Blunt

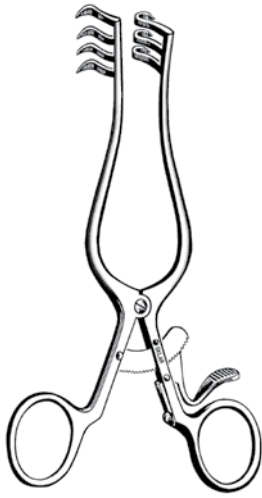
WEITLANER RETRACTORS
BLUNT

 22-8345 4½" 2x3 Prongs
 22-8355 5½" 3x4 Prongs
 42-1865 6½" 3x4 Prongs
 42-1875 8" 3x4 Prongs
 42-1895 9½" 3x4 Prongs

WEITLANER RETRACTORS
SHARP

22-8245	4½"	2x3 Prongs
22-8255	5½"	3x4 Prongs
42-1965	6½"	3x4 Prongs
42-1975	8"	3x4 Prongs
42-1995	9½"	3x4 Prongs

SOLID BLADES

22-8760	5½"
---------	-----

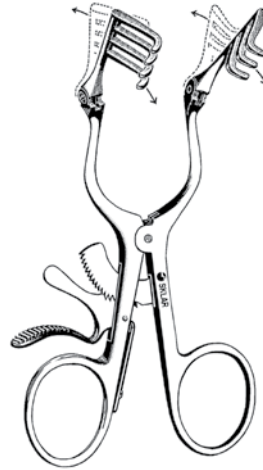
WEITLANER BECKMAN RETRACTORS
HINGED BLADES WITH 3X4 PRONGS

BLUNT		SHARP	
42-1654	5½"	42-1764	5½"
42-1655	6½"	42-1765	6½"
42-1656	9"	42-1766	9"
42-1657	10¼"	42-1767	10¼"

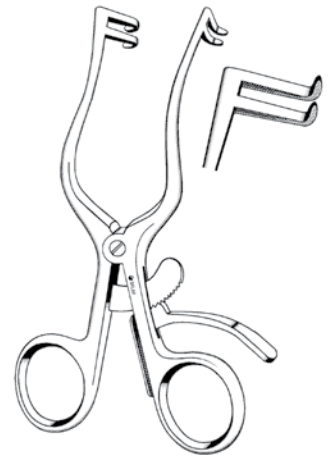
PAPARELLA-WEITLANER RETRACTOR
1¼" INSIDE SPREAD

42-1820	5"	2x2 Semi-Sharp Prongs
---------	----	-----------------------

MEYERDING RETRACTORS
SELF-RETAINING

42-2075	¾" x 2⅜"
42-2076	1" x 1¾"
42-2077	1" x 2⅞"
42-2078	1" x 2⅜"

GELPI RETRACTORS

22-8850	3½"	
22-8853	5½"	
22-8855	6¼"	
60-6570	7"	
60-6580	7½"	With Stops

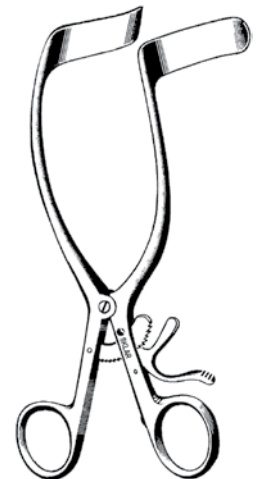
RIGBY RETRACTOR

60-6370	7"	Tru Grip
---------	----	----------



SCHINK METATARSAL SPREADER

97-5045 4½"



GOSSET RETRACTORS

FENESTRATED SIDE BLADES

60-6240 4" Spread 1" and 1½" Blades
55-7355 5½" Spread 1¼" and 2½" Blades

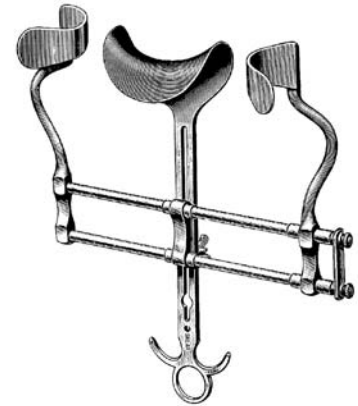

BALFOUR ABDOMINAL RETRACTOR

1¼" FENESTRATED SIDE BLADES

22-9030 3" Spread ¾" x ¾"
Center Blade

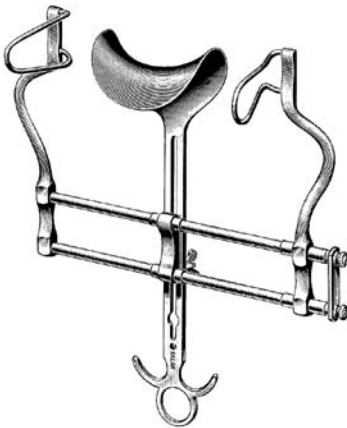

BALFOUR ABDOMINAL RETRACTORS

2½" FENESTRATED SIDE BLADES

60-6670 7" Spread 2" x 3"
Center Blade
60-6710 10" Spread 2¾" x 3¼"
Center Blade

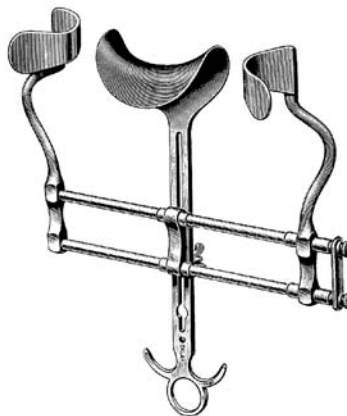

BALFOUR ABDOMINAL RETRACTOR

2½" SOLID SIDE BLADES

60-6870 7" Spread 2" x 3"
Center Blade

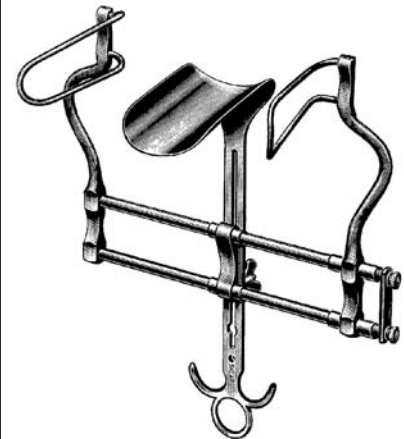

BALFOUR ABDOMINAL RETRACTORS

4" FENESTRATED SIDE BLADES

60-7070 7" Spread 2½" x 4"
Center Blade
60-7110 10" Spread 2½" x 4"
Center Blade

**BALFOUR ABDOMINAL
RETRACTOR**

INTERCHANGEABLE FENESTRADED SIDE BLADES
60-7112 7" Spread Includes Ratchet Bar,
Two Side Blades
(2¼" and 3") and One
Center Blade 1¼" x 3"

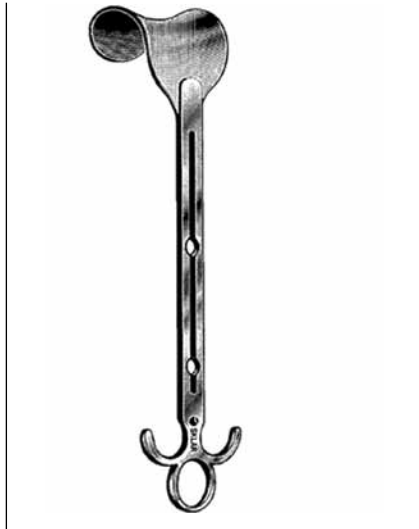
BALFOUR CENTER BLADE

60-7120	12"	1¼" x 3" Blade
60-7125	12"	2½" x 3" Blade
60-7115	12"	3¼" x 3½" Blade

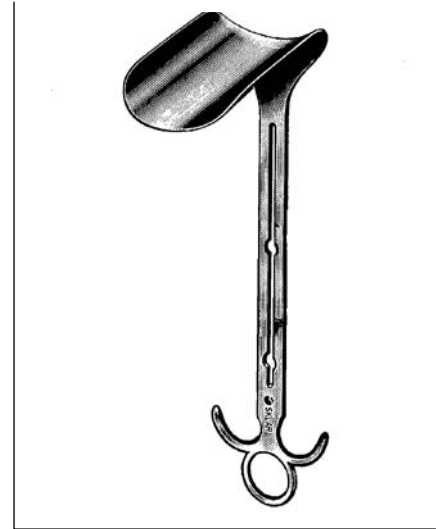
BALFOUR CENTER BLADE

60-7130	11"	2½" x 4" Blade
---------	-----	----------------

BALFOUR CENTER BLADE

60-7135	12"	2" x 5" Blade, Malleable
---------	-----	--------------------------

**BADGLEY RETRACTOR
4X4 PRONGS, BLUNT**

60-7140	6½" Spread	1¼" x 2" Blade
---------	------------	----------------

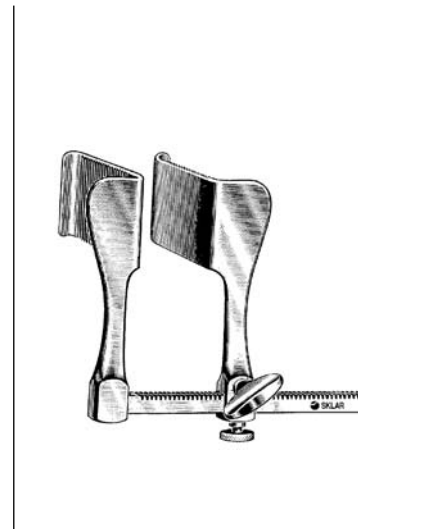
**TUFFIER RIB SPREADERS
GROOVED BLADE**

55-7445	4½"	Small
55-7465	6½"	Large



NON-WOVEN, 3 PLY WITH ELASTIC EAR LOOPS

SKLAR FACE MASKS

- **ELASTIC EAR LOOPS**
- **3-PLY COMPOSITION REDUCES THE SPREAD OF BACTERIA**
- **NON-WOVEN MATERIAL IS SOFT, LIGHT-WEIGHT AND BREATHABLE**
- **MOLDABLE NOSEPIECE ASSURES PROPER FIT**
- **UNIVERSAL, GENEROUS MASK SIZE**
- **BFE OF \geq 98%**
- **DISPOSABLE**
- **LATEX FREE**
- **NON-STERILE**

PRODUCT NUMBER	QUANTITIES
96-5557	50/bx
96-5557A	500/cs
96-5557BNS	2000/cs

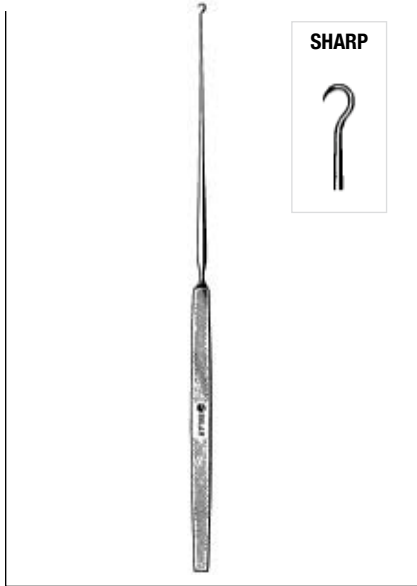

GILLIES SKIN HOOKS

47-2570 7" 3mm Sharp
 47-2572 7" 4mm Sharp

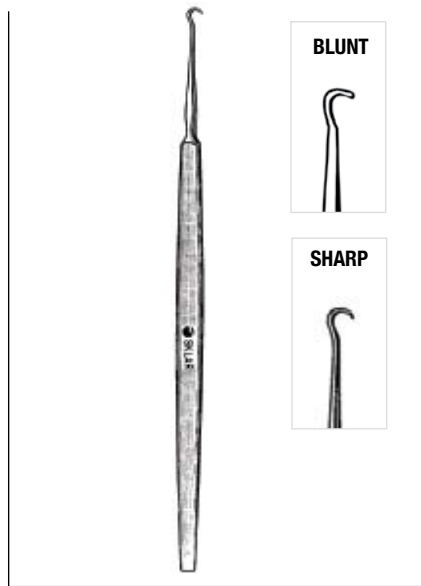

FRAZIER TISSUE HOOKS

47-2556 5" Blunt Extra Delicate
 47-2555 5" Sharp Extra Delicate

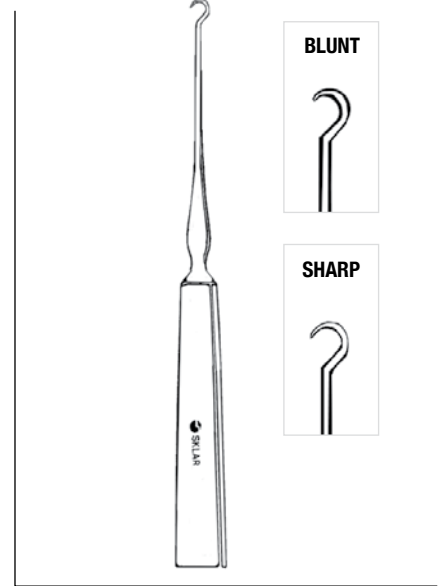

TYRELL IRIS HOOKS

65-3205 5" 3mm Blunt
 65-3206 5" 1mm Sharp

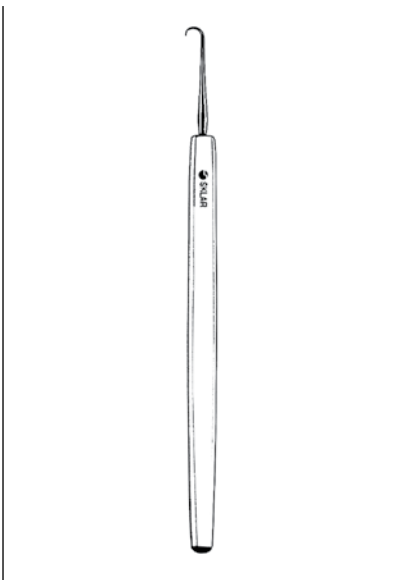

SKIN HOOK

SHARP
 47-2550 4¾" 2mm

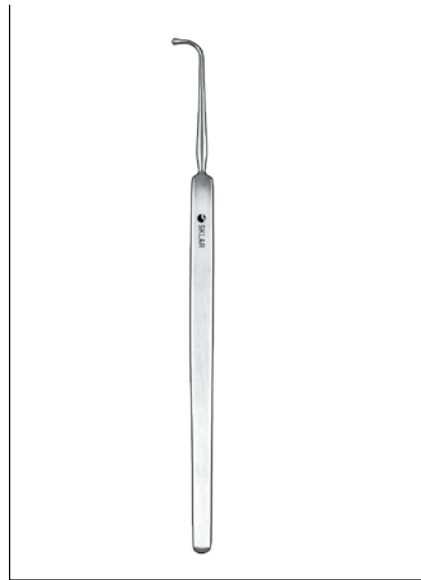

GRAEFE STRABISMUS HOOKS

65-3215 Small
 65-3216 Medium
 65-3217 Large



SKLAR SINGLE PRONG HOOK

60-6280 8" 20mm



HOOKS

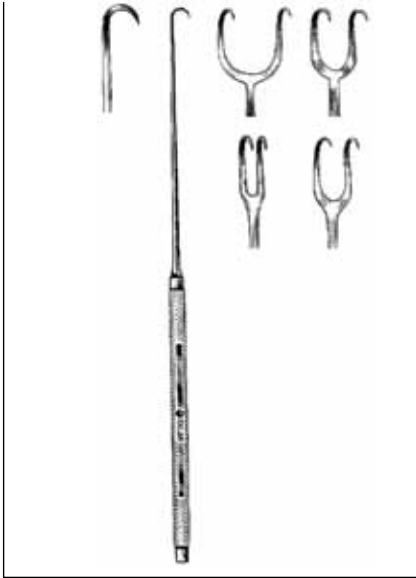

JOSEPH SKIN HOOKS

SHARP				
47-2500	6¼"	-		1 Prong
47-2502	6¼"	2mm		2 Prong
47-2505	6¼"	5mm		2 Prong
47-2507	6¼"	7mm		2 Prong
47-2510	6¼"	10mm		2 Prong

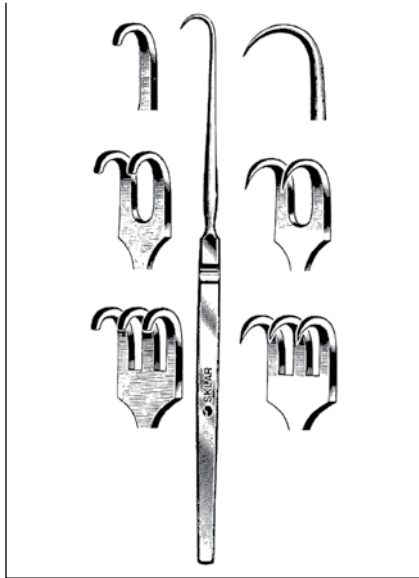

TRACHEAL RETRACTOR HOOKS

78-1101	6½"	Blunt		1 Prong
78-1001	6½"	Sharp		1 Prong
78-1102	6½"	Blunt		2 Prong
78-1002	6½"	Sharp		2 Prong
78-1103	6½"	Blunt		3 Prong
78-1003	6½"	Sharp		3 Prong

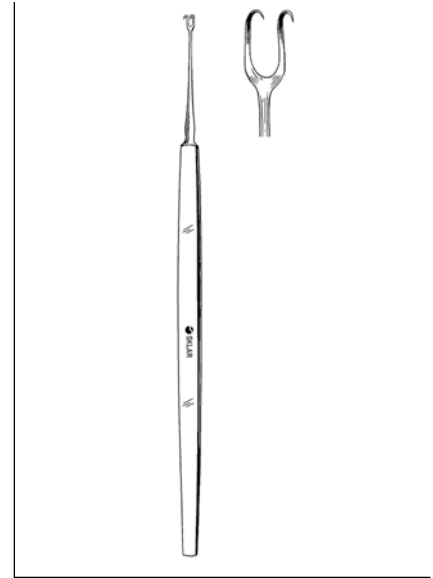

FREER SKIN HOOKS

47-2758	6"	2.5mm	Blunt	2 Prong
47-2760	6"	2.5mm	Sharp	2 Prong

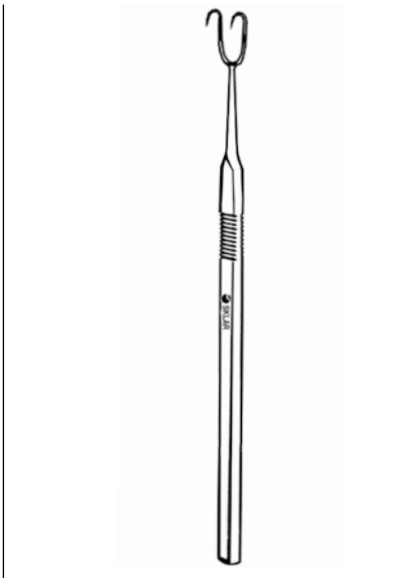

COTTLE HOOK

SHARP				
47-2646	5½"	12mm		2 Prong

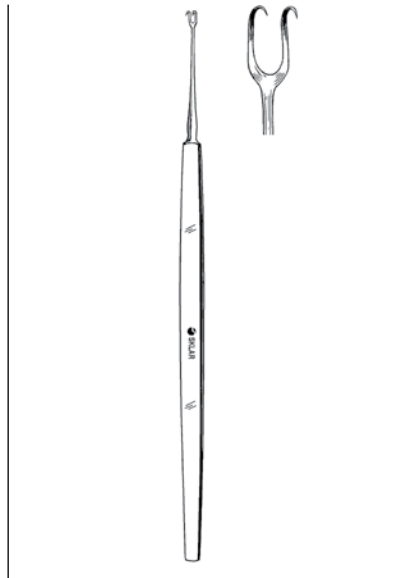

GUTHRIE DOUBLE HOOKS

SHARP				
47-2651	5"	5mm		2 Small Prong
47-2650	5"	5mm		2 Large Prong

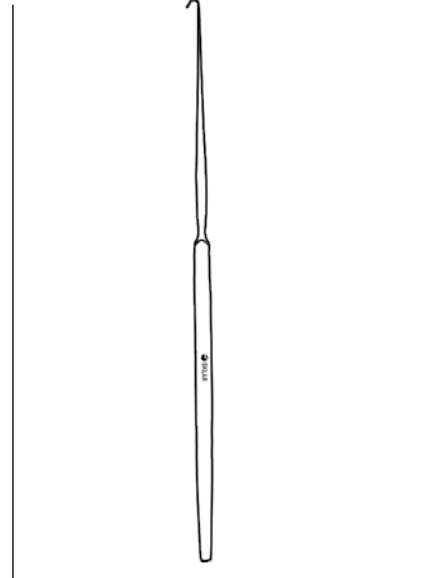

CUSHING DURA HOOK

BLUNT				
47-2656	6½"			

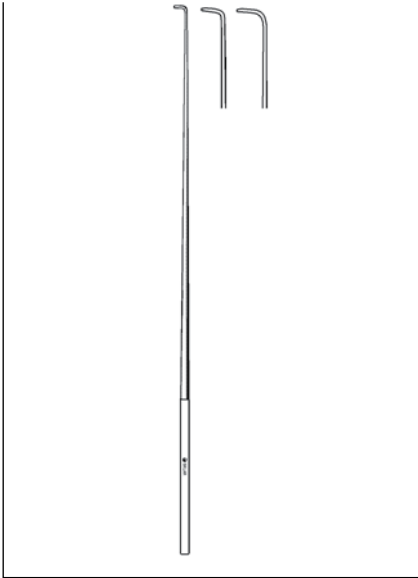

DAY EAR HOOKS

67-2550 6½" Small
67-2552 6½" Large

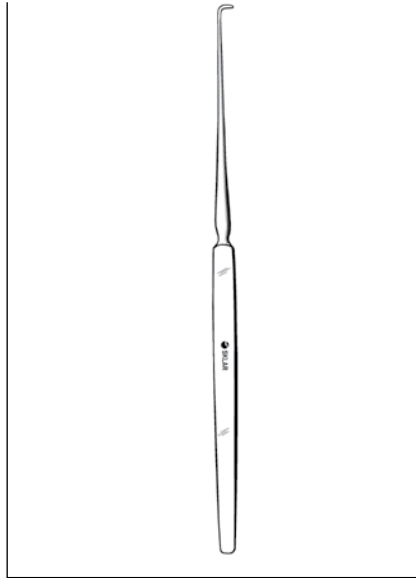

ADSON HOOKS

50-1585 8" Blunt
50-1685 8" Sharp

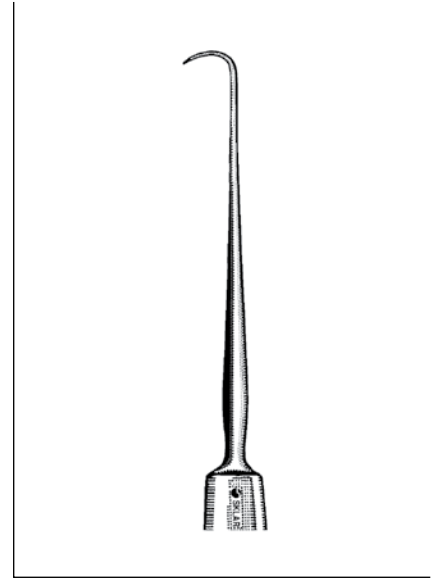

WIENER CORNEAL HOOKS

65-3248 5" Blunt
65-3250 5" Sharp 4mm

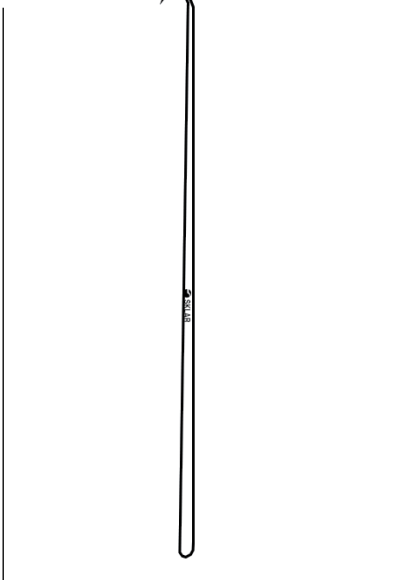

VOLKMAN HOOK

RING HANDLE
60-5810 8½" Sharp

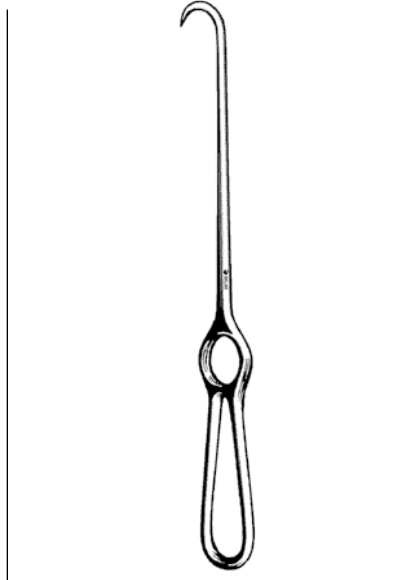

**VOLKMAN BONE HOOK
RETRACTORS**

RING HANDLE
60-5820 8" Sharp 20mm
60-5821 9" Blunt 15mm

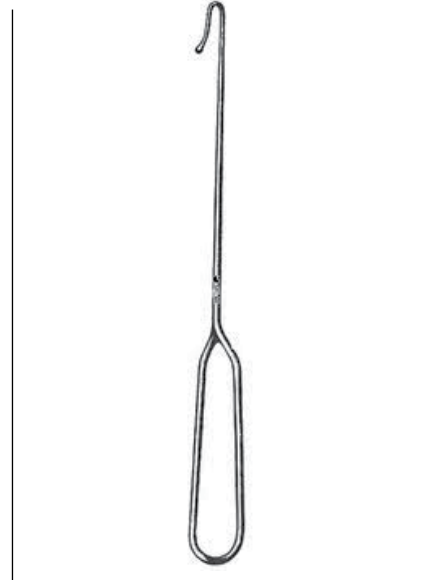

ROSSER CRYPT HOOK

RING HANDLE
60-5840 6¾" Blunt

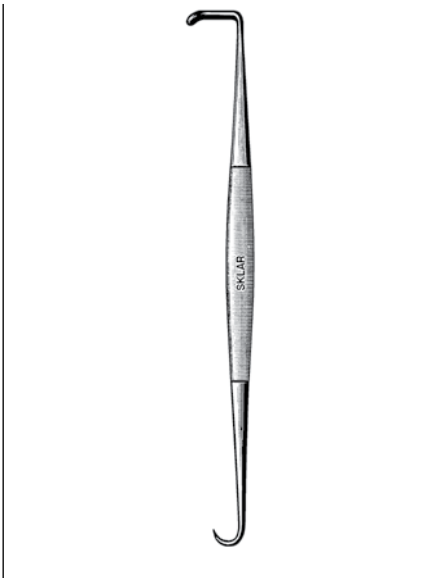

MEYERDING SKIN HOOK

DOUBLE ENDED
47-2462 6¼"

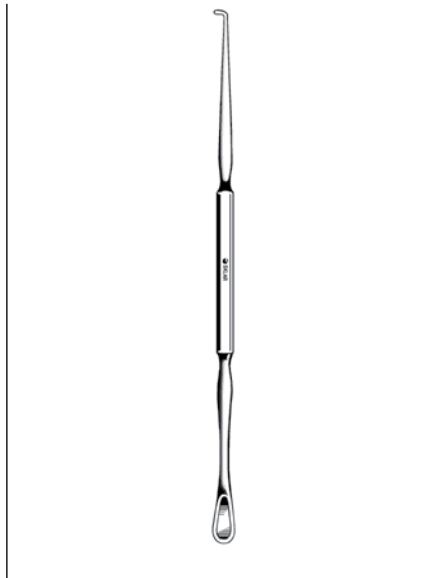

GROSS HOOK AND SPOON

DOUBLE ENDED
67-2540 5¼"

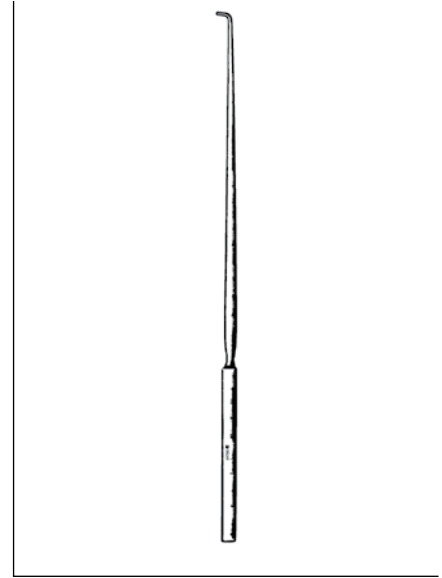

DANDY NERVE HOOK

50-1790 8" 5mm

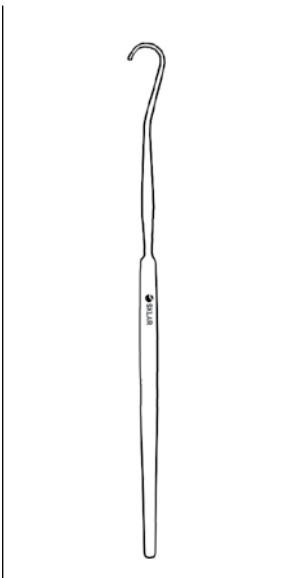

SMITHWICK NERVE HOOKS

BLUNT
47-2560 6¾" 10mm
47-2564 8¼" 10mm

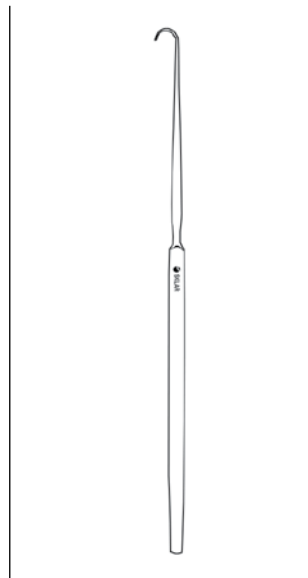

GRAHAM NERVE HOOK

BLUNT
47-2580 7" 6mm

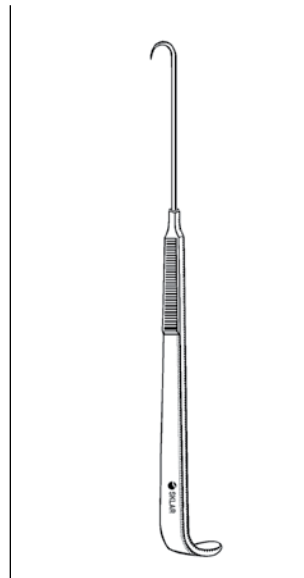

NEWS TRACHEAL HOOK

SHARP
78-3545 6" 7mm

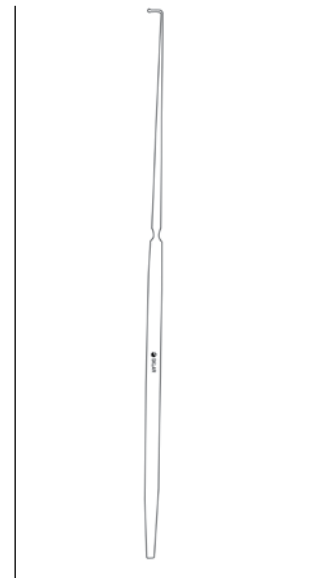

ALLPORT MASTOID SEARCHER

WITH BALL TIP
67-2560 6½"

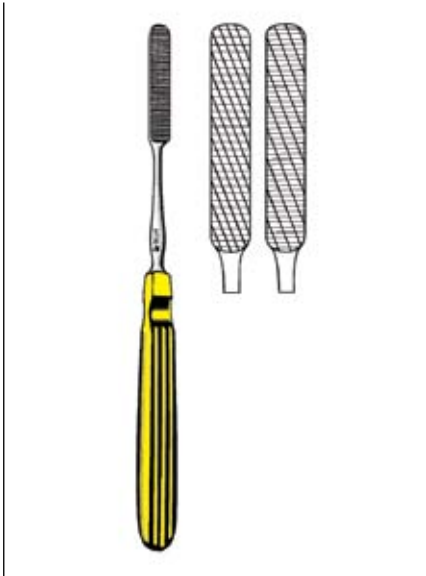

TC MALTZ RASPS

SINGLE END

- 97-1505 Fine
- 97-1506 Medium

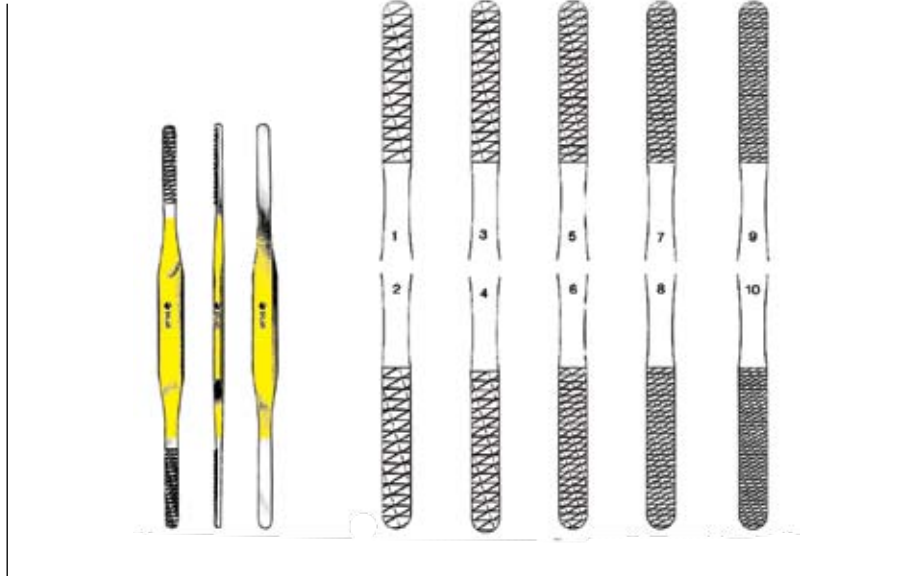

TC FOMON RASPS

DOUBLE ENDED, FLAT, BACKWARD CUTTING, 8"

- 97-1510 #1 and #2 Very Coarse/Coarse
- 97-1511 #3 and #4 Coarse/Coarse
- 97-1512 #5 and #6 Coarse/Fine
- 97-1513 #7 and #8 Fine/Fine
- 97-1514 #9 and #10 Fine/Very Fine



PEET (COTTLE) RASPS

DIAMOND COATED

- 97-1520 7½" Straight
- 97-1521 7½" Curved

COHESIVE BANDAGES

NON-STERILE / LATEX-FREE

PRODUCT NUMBER	FEATURES	QUANTITIES
96-1340	1" Dark Blue	30 rolls/cs
96-1341	1" White	30 rolls/cs
96-1342	1" Tan	30 rolls/cs
96-1343	1" Assorted	30 rolls/cs
96-1344	2" Dark Blue	36 rolls/cs
96-1345	2" White	36 rolls/cs
96-1346	2" Tan	36 rolls/cs
96-1347	2" Assorted	36 rolls/cs
96-1348	3" Dark Blue	24 rolls/cs
96-1349	3" White	24 rolls/cs
96-1350	3" Tan	24 rolls/cs
96-1351	3" Assorted	24 rolls/cs



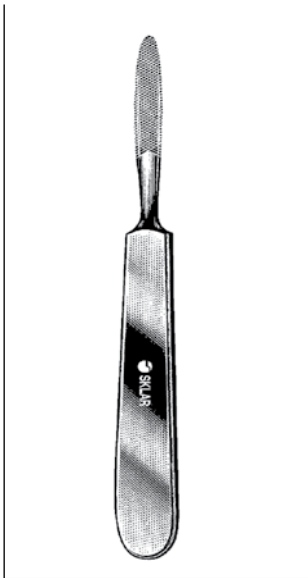

JOSEPH RASP
40-9825 6¼" Fine Cross
Serrations

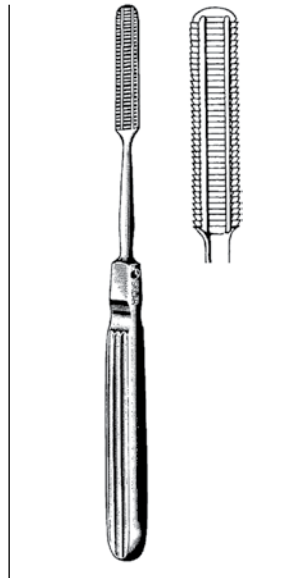

MALTZ RASP
BACKWARD CUTTING
40-9815 7"

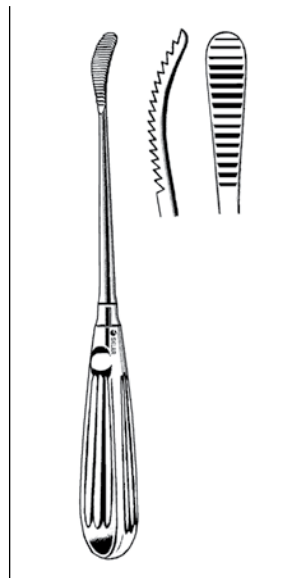

AUFRICHT GLABELLAR RASPS
40-9840 8" Forward
Cutting
40-9841 8" Backward
Cutting

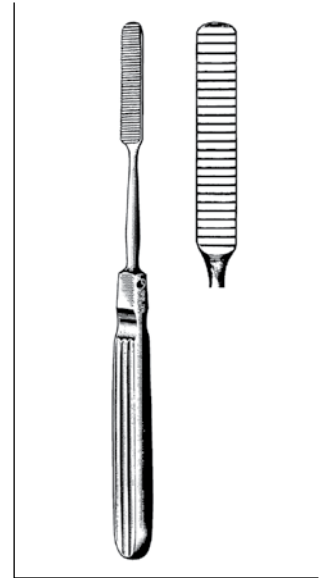

COTTLE RASP
40-9820 8" Backward
Cutting

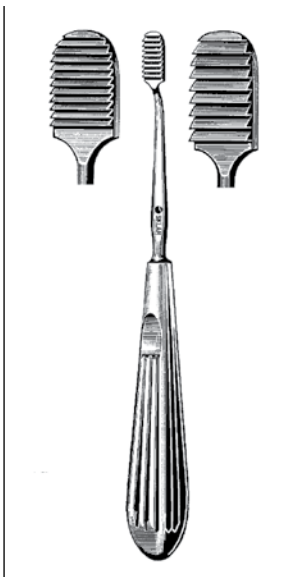

LEWIS NASAL RASPS
70-2292 7" Fine
70-2293 7" Coarse

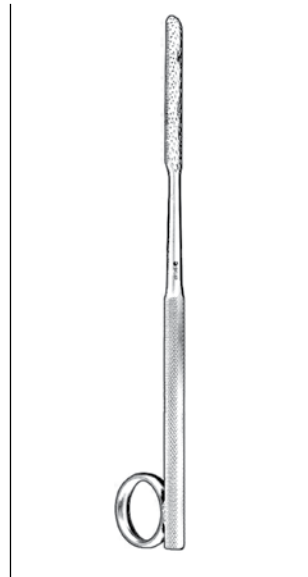

GALLAHER RASPS
COARSE
70-2295 6½" Straight
70-2296 6½" Curved Left
70-2297 6½" Curved Right

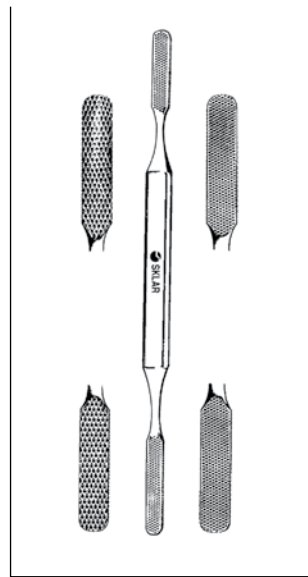

FOMON RASPS
DOUBLE ENDED, FLAT & CONVEX
40-9686 8¼" 2 Sided,
Coarse
40-9688 8½" 4 Sided,
Coarse & Fine



PUTTI BONE RASP
STRAIGHT & CURVED
40-9812 10¼"



PUTTI BONE RASP
FLAT & CONIC
 40-9712 12"

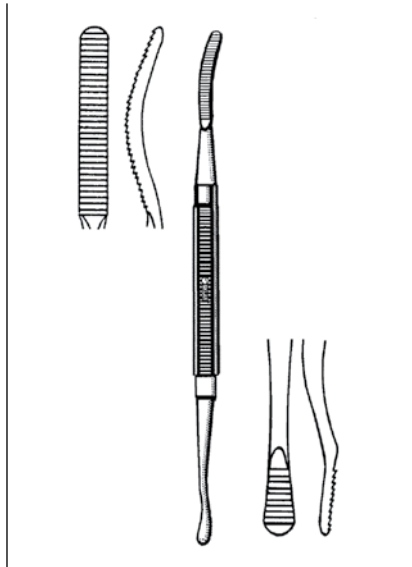

BONE FILE #10
DOUBLE END, PLAIN SERRATIONS
 97-1615 7½" One End Curved
 One End Flat

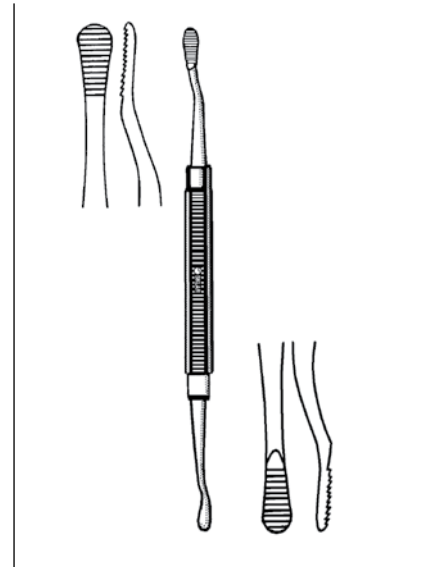

BONE FILE #12
DOUBLE END
 97-1620 7" Plain Serrations

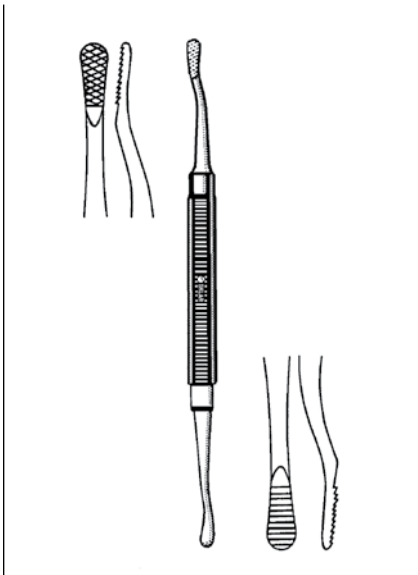

BONE FILE #12A
DOUBLE END
 97-1625 7" One End Plain
 Serrations
 One End Cross
 Serrations

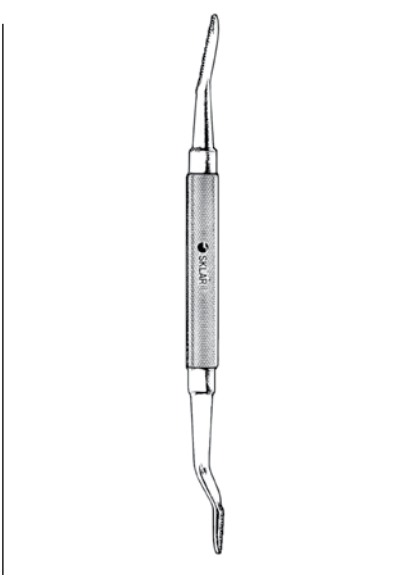

BONE FILE (MILLER) #33
DOUBLE END
 97-1533 7" Plain Serrations

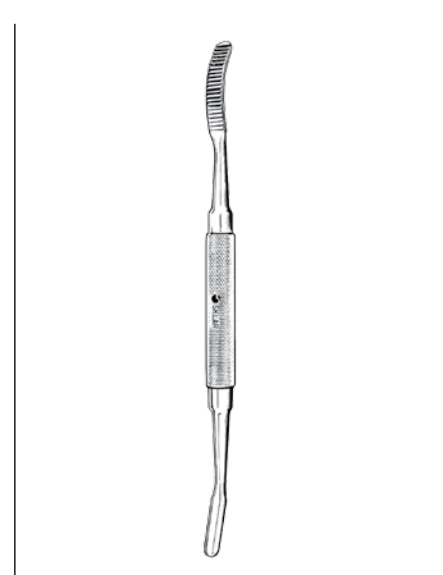

BONE FILE (MILLER) #45
DOUBLE END
 97-1545 7" Plain Serrations

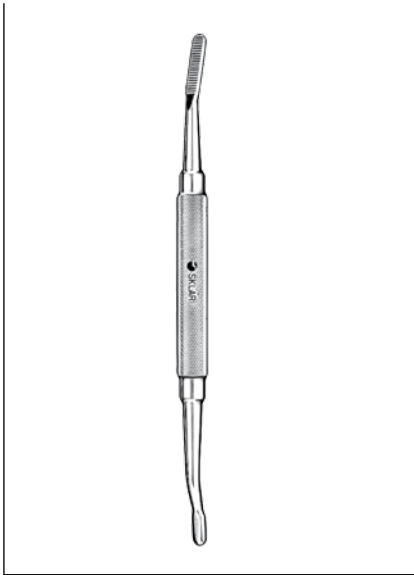

BONE FILE (MILLER) #64
DOUBLE END
 97-1564 7" Plain Serrations

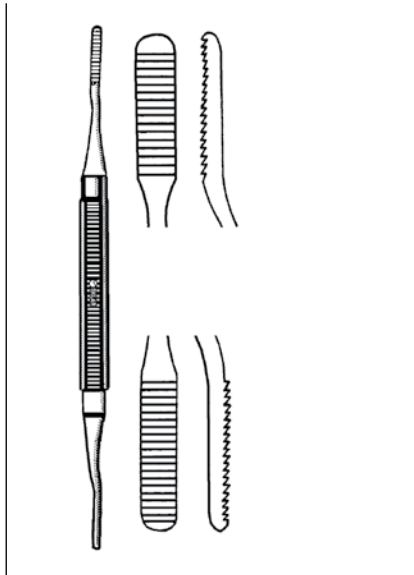

NAIL/BONE FILE
DOUBLE END
 97-1645 7½" 6mm

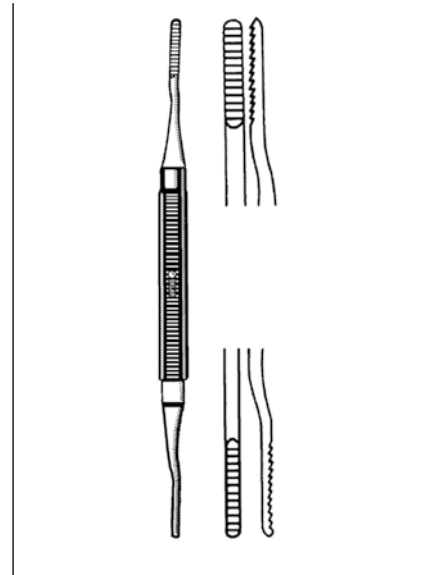

NAIL/BONE FILE
DOUBLE END
 97-1640 7" 3-4mm
 97-1635 8½" 5-6mm



POLOKOFF RASP
SINGLE END
 97-1642 6½" Medium Serrations



BONE FILE
BAYONET HANDLE
 40-9685 9"

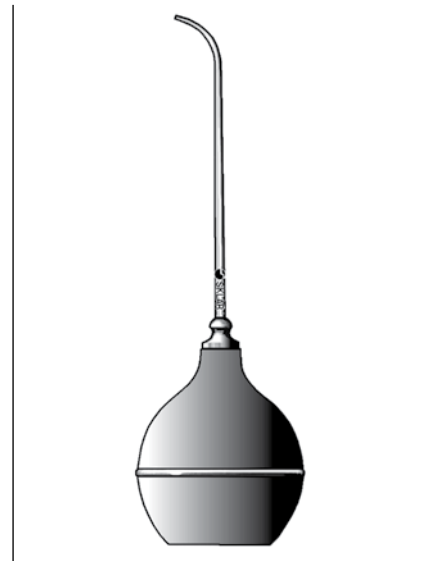

CHIP BLOWER
 97-1650 Complete
 97-1652 Tip Only
 97-1654 Bulb Only

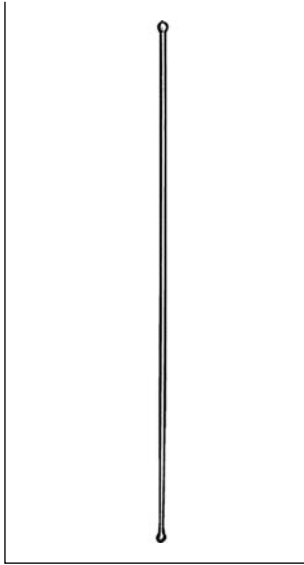
PROBES
DOUBLE END

30-1545	4½"
30-1550	5"
30-1555	5½"
30-1560	6"
30-1580	8"
30-1610	10"
30-1612	12"

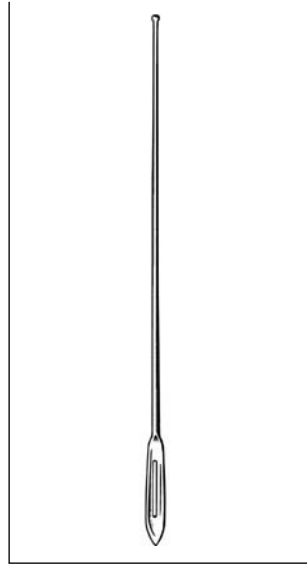
PROBES
WITH EYE

30-1945	4½"
30-1950	5"
30-1955	5½"
30-1960	6"
30-1970	7"
30-1980	8"
30-2010	10"
30-2012	12"

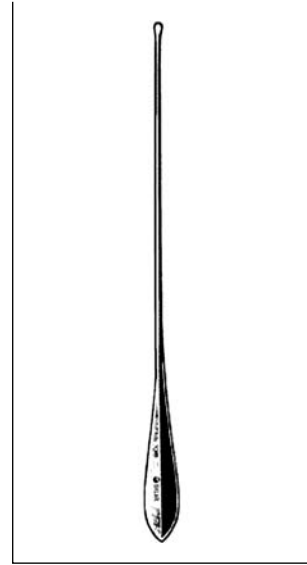
PROBE
WITH MYRTLE LEAF ENDS

30-1450	5"
---------	----

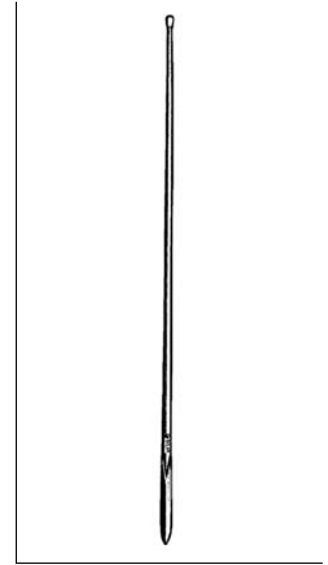
PROBES
WITH SPEAR

30-2145	4½"
30-2150	5"
30-2155	5½"
30-2160	6"

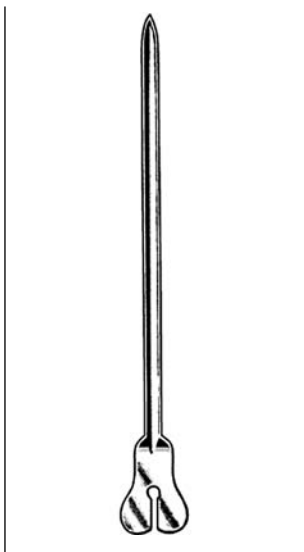
DIRECTOR & TONGUE TIES

30-1045	4½"
30-1050	5"
30-1055	5½"
30-1060	6"
30-1070	7"
30-1080	8"

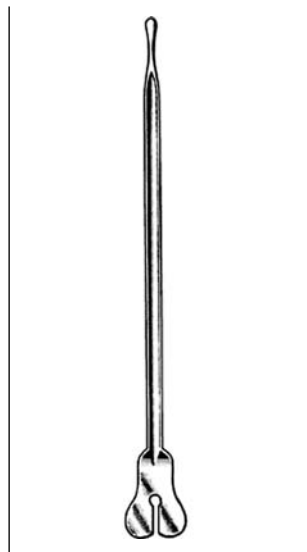
DIRECTOR & TONGUE TIES (PROBE)

30-1145	4½"
30-1150	5"
30-1155	5½"
30-1160	6"
30-1170	7"
30-1180	8"

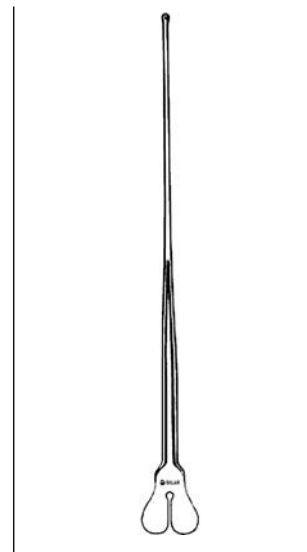
LARRY RECTAL PROBE

80-2870	7"
---------	----

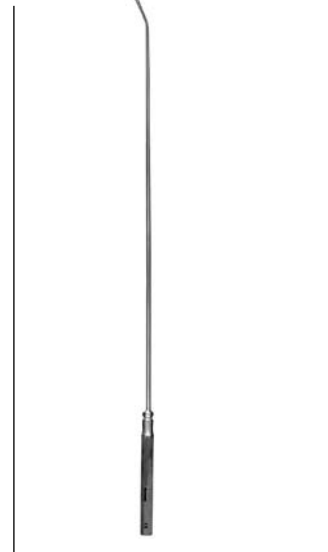
PRATT RECTAL PROBE
STERLING SILVER SHAFT

80-1260	10" With 7¾" Shaft
---------	--------------------

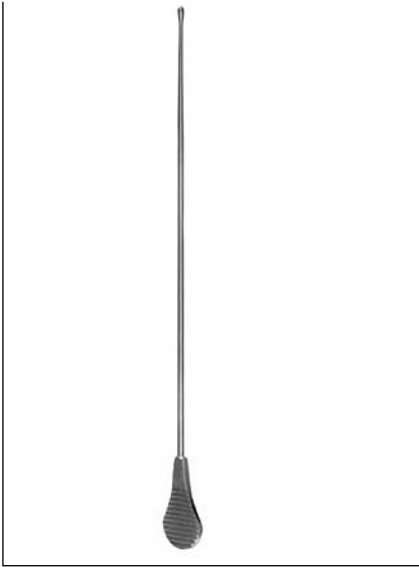

BUIE FISTULA PROBE

STERLING SILVER SHAFT

30-1250 6¾" With 5½" Shaft

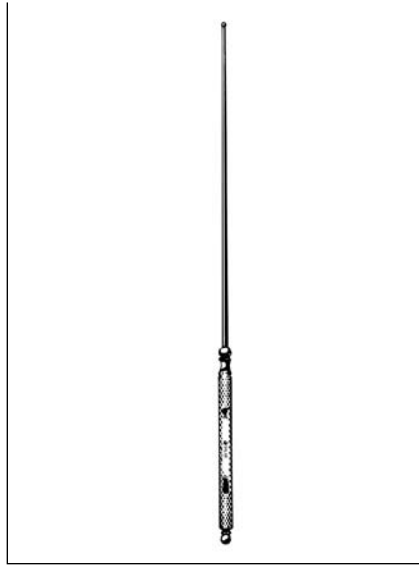

BUCK EAR PROBE

STERLING SILVER SHAFT

30-1030 5½"

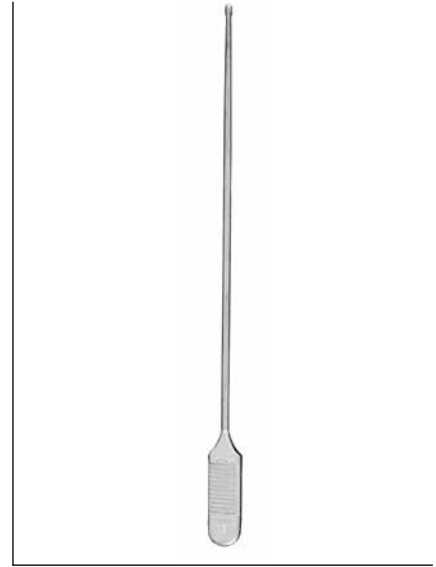

THEOBALD (FISH) SINUS PROBE

STERLING SILVER SHAFT

30-1240 6"

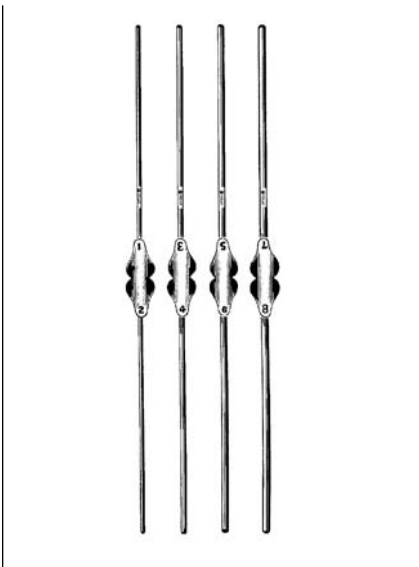

BOWMAN LACHRYMAL PROBES

65-4098 Size 0000/000
 65-4099 Size 00/0
 65-4101 Size 1/2
 65-4103 Size 3/4
 65-4105 Size 5/6
 65-4107 Size 7/8
 65-4100 Set of 4, Sizes 1-8

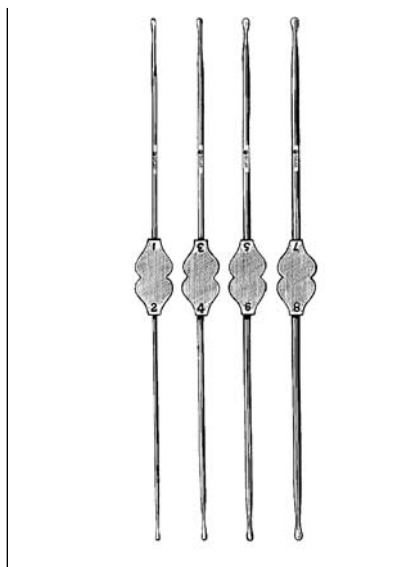

WILLIAMS LACHRYMAL PROBES

STERLING SILVER

65-4129 Size 0000/000
 65-4128 Size 00/0
 65-4121 Size 1/2
 65-4123 Size 3/4
 65-4125 Size 5/6
 65-4127 Size 7/8
 65-4120 Set of 4, Sizes 1-8

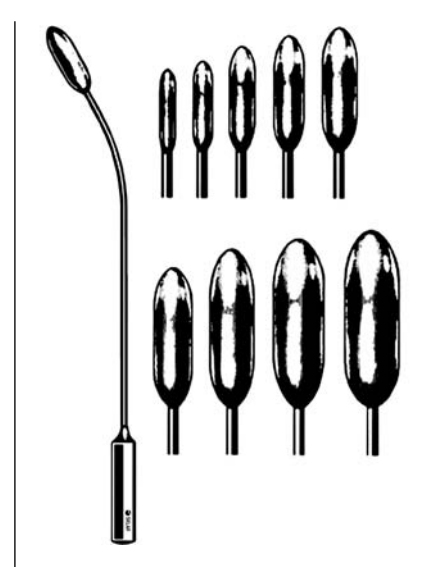

BAKES DILATORS

MALLEABLE

32-1533	3mm	32-1538	8mm
32-1534	4mm	32-1539	9mm
32-1535	5mm	32-1610	10mm
32-1536	6mm	32-1611	11mm
32-1537	7mm	32-1530	Set of 9



WALTHER DILATORS

CHROME

85-2012	12 FR	85-2022	22 FR	85-2032	32 FR
85-2014	14 FR	85-2024	24 FR	85-2034	34 FR
85-2016	16 FR	85-2026	26 FR	85-2036	36 FR
85-2018	18 FR	85-2028	28 FR	85-2038	38 FR
85-2020	20 FR	85-2030	30 FR	85-2010	Set of 14

FEMALE CATHETERS

CHROME

85-2210	10 FR
85-2212	12 FR
85-2214	14 FR
85-2216	16 FR
85-2218	18 FR
85-2220	20 FR



BENIQUE CATHETER GUIDE

85-2355 8 FR

GUYON CATHETER GUIDE

85-2360 8 FR

CATHETER GUIDE

STRAIGHT
85-2365 8 FR

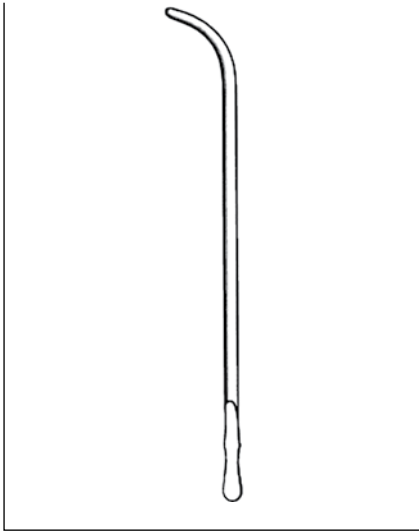
VAN BUREN SOUNDS

85-1008	8 FR	85-1026	26 FR
85-1010	10 FR	85-1028	28 FR
85-1012	12 FR	85-1030	30 FR
85-1014	14 FR	85-1032	32 FR
85-1016	16 FR	85-1034	34 FR
85-1018	18 FR	85-1036	36 FR
85-1020	20 FR	85-1038	38 FR
85-1022	22 FR	85-1040	40 FR
85-1024	24 FR		

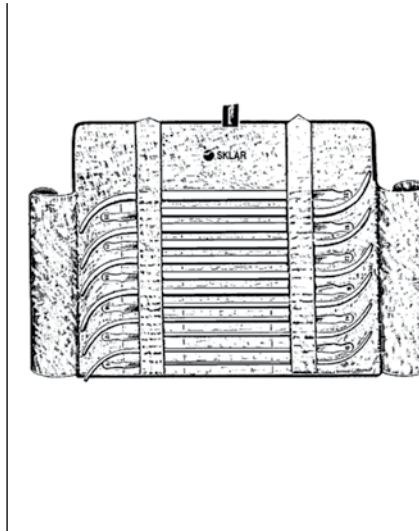
VAN BUREN SOUND SETS
SETS IN KHAKI ROLL

85-1065	Set of 17, Sizes 8-40 FR
85-1070	Set of 6, Sizes 14-24 FR
85-1075	Set of 12, Sizes 8-30 FR
85-1076	Khaki Roll Holds up to 12 Sounds.

McCREA URETHRAL SOUNDS
EXTRA SMALL

85-2408	7" 8 FR	85-2424	7" 24 FR
85-2410	7" 10 FR	85-2426	7" 26 FR
85-2412	7" 12 FR	85-2428	7" 28 FR
85-2414	7" 14 FR	85-2430	7" 30 FR
85-2416	7" 16 FR	85-2432	7" 32 FR
85-2418	7" 18 FR	85-2434	7" 34 FR
85-2420	7" 20 FR	85-2436	7" 36 FR
85-2422	7" 22 FR		

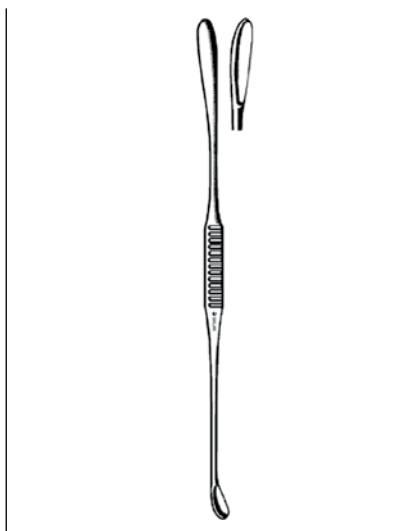
MAYO GALLSTONE SCOOP

32-1040	10 3/4"	Double End
---------	---------	------------

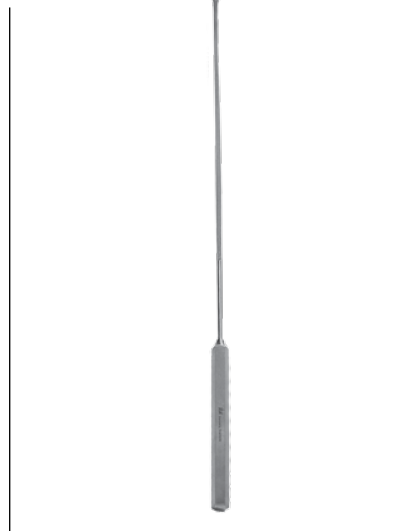
DESJARDIN SCOOPS

32-3092	17 FR
32-3094	21 FR
32-3096	24 FR
32-3098	27 FR

FERGUSON GALLSTONE SCOOPS
DOUBLE END, 9 1/2"

32-1035	Small	3/8" x 1" and 5/16" x 3/4"
32-1036	Medium	1/2" x 1 1/8" and 3/8" x 1"
32-1037	Large	1/2" x 1 1/4" and 7/16" x 1"



**TROCAR (SET OF FOUR)
NESTED IN FLAT HANDLE**

PRODUCT NUMBER	DESCRIPTION
34-1014	6, 9,13,17 French 5½"

**DUKE IMPROVED TROCAR
PERFORATED CANNULA**

PRODUCT NUMBER	DESCRIPTION
34-1017	17 French 4¼"

OCHSNER TROCAR

PRODUCT NUMBER	DESCRIPTION	FOR USE WITH
34-1410	10 French	6 Fr Catheter
34-1414	14 French	10 Fr Catheter
34-1417	16 French	12 Fr Catheter
34-1418	18 French	14 Fr Catheter
34-1420	20 French	16 Fr Catheter
34-1422	22 French	18 Fr Catheter
34-1424	24 French	20 Fr Catheter
34-1428	28 French	22 Fr Catheter

NELSON TROCAR

PRODUCT NUMBER	DESCRIPTION
34-2422	25 French #1 8¼"
34-2428	30 French #2 8¼"
34-2434	33 French #3 8¼"
34-2438	35 French #4 8¼"

HURWITZ TROCAR

PRODUCT NUMBER	DESCRIPTION
34-2522	22 French
34-2526	26 French
34-2536	36 French

TROCAR



**DUKE IMPROVED
TROCAR**

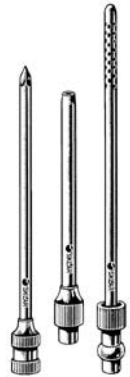

**OCHSNER
TROCAR**



**NELSON
TROCAR**

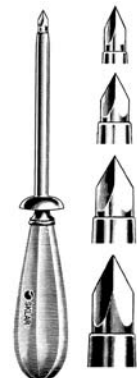

**HURWITZ
TROCAR**





**BELLUCCI MICRO
EAR SCISSORS**

67-8187	3"	4mm Straight
67-8188	3"	4mm Straight Ebony
67-8189	3"	4mm Curved Right
67-8191	3"	4mm Curved Left
67-8193	3"	4mm Curved Upward



ALLIGATOR EAR SCISSORS

DELICATE		
67-8014	3¼"	Straight
67-8020	3¼"	Curved Right
67-8018	3¼"	Curved Left
67-8016	3¼"	Angled

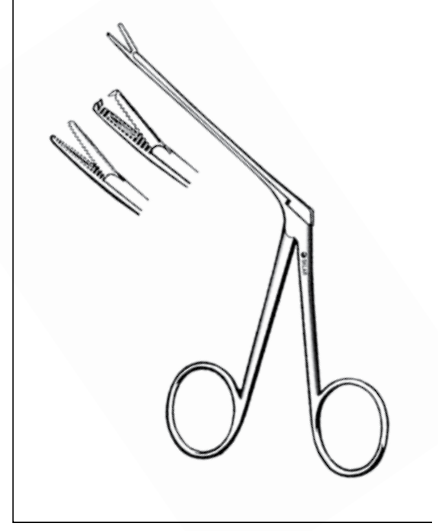

**HARTMANN ALLIGATOR EAR
FORCEPS**

67-1035	3½"	Serrated
67-1036	3½"	Serrated, Delicate
67-1040	3½"	1x2 Teeth
67-1038	5½"	Serrated
67-1039	6½"	Serrated



**HARTMANN ALLIGATOR EAR
FORCEPS**

67-1020	Spoon Jaws	
67-1021	Spoon Jaws	Delicate



HARTMANN EAR FORCEPS

67-1045	Regular Serrations
67-1050	Light Serrations

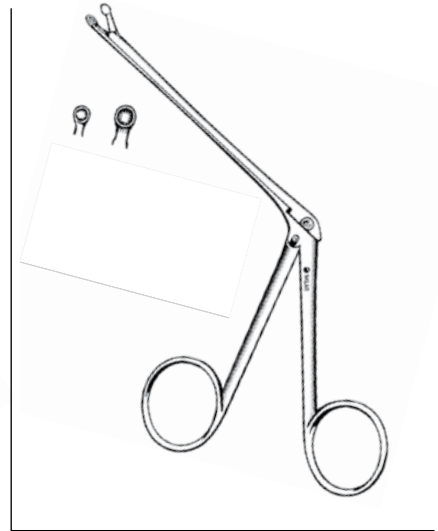

**HARTMANN HERZFELD
FORCEPS**

67-8150	3"	2mm Cup
67-8152	3"	3mm Cup



WEINGARTNER EAR FORCEP

67-8155 3" Serrated

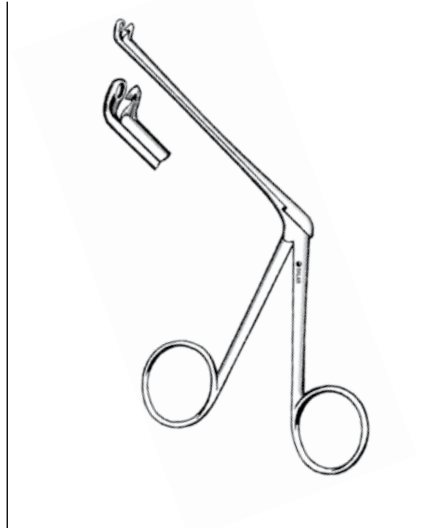

HARTMANN PUNCH

67-1030 Curved Up



LITTAUER EAR FORCEP

67-1052 3" Serrated

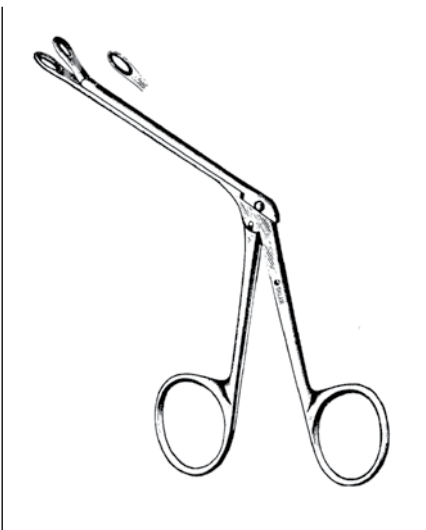

STRUEMPEL EAR FORCEP

67-1032 Oval Spoon Jaw

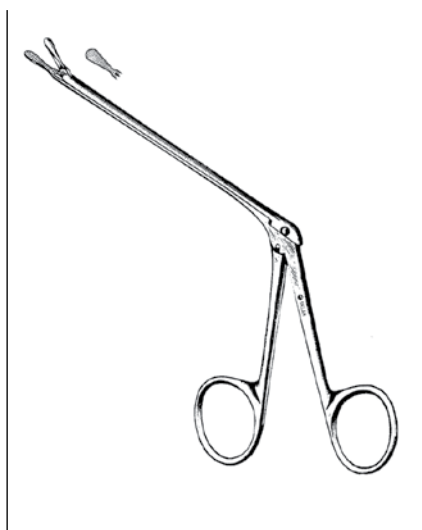

DUCKBILL EAR FORCEP

67-1033 Flat Serrated Jaw

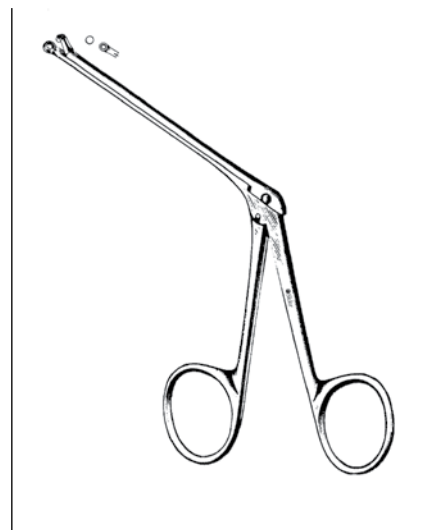

HOFFMAN EAR FORCEP

67-1034 Round Jaws Thru Cut

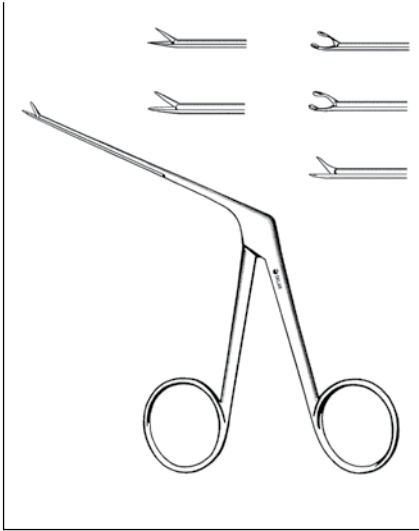

ALLIGATOR EAR FORCEPS

DELICATE, SERRATED

67-8006	3/4"	Straight	4mm
67-8000	3/4"	Straight	7mm
67-8008	3/4"	Curved Right	4mm
67-8010	3/4"	Curved Left	4mm

DELICATE, SMOOTH

67-8024	3/4"	Curved Down	
---------	------	-------------	--



GREVEN EAR FORCEP

67-8026 2 7/8" 5mm Serrated

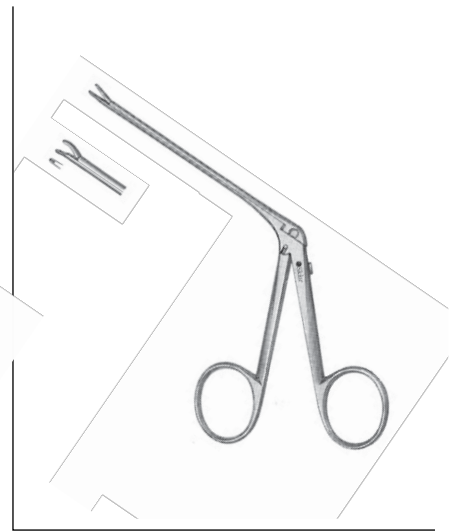

McGEE CRIMPER/WIRE CLOSURE FORCEP

67-8028 2 5/6" 3mm Jaws, Angled Slightly Downward



BELLUCCI EAR FORCEP

67-8030 3" 8mm Serrated

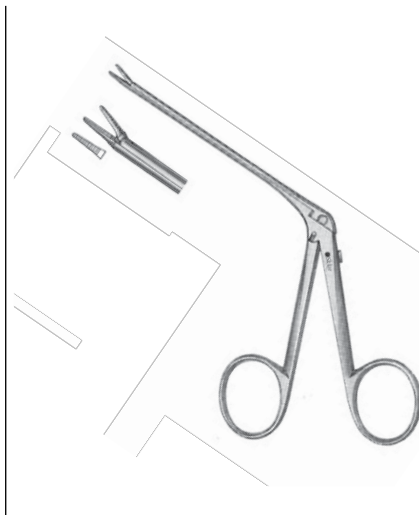

GOODHILL EAR FORCEP

67-8031 3" 5mm Serrated

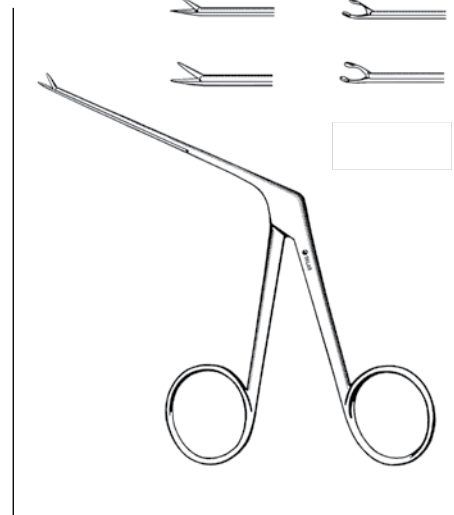

MICRO ALLIGATOR EAR FORCEPS

3/4"		
67-8173	.5mm	Oval
67-8177	.5mm	Oval Ebony
67-8170	.6mm	Serrated
67-8172	.6mm	Serrated Ebony
67-8178	.8mm	Oval
67-8180	.8mm	Oval Ebony
67-8175	.8mm	Smooth
67-8174	.8mm	Serrated
67-8176	.8mm	Serrated Ebony

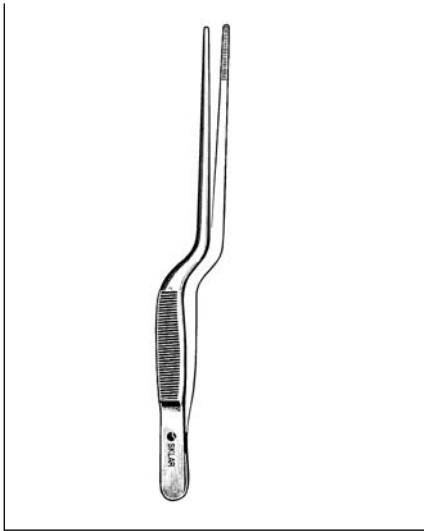

JANSEN NASAL FORCEPS

BAYONET SERRATED

- 67-1465 6½"
- 70-4375 7½"
- 70-4385 8½"



ADSON FORCEP

BAYONET

- 50-3371 7½" Delicate

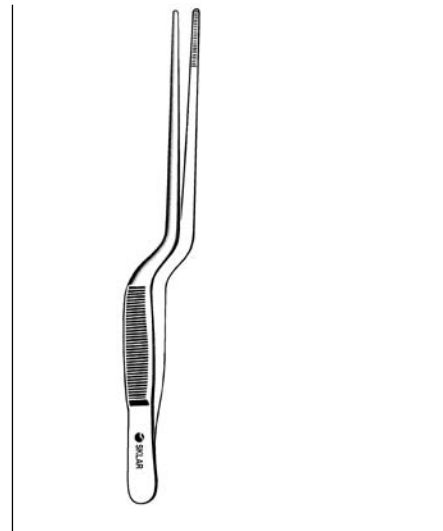

LUCAE BAYONET FORCEP

- 67-1455 5½" Serrated

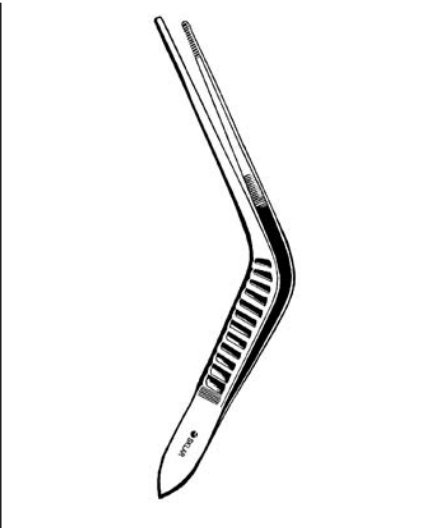

WILDE FORCEPS

- 67-1150 5" Angled, Serrated
- 70-4470 7" Angled, Serrated

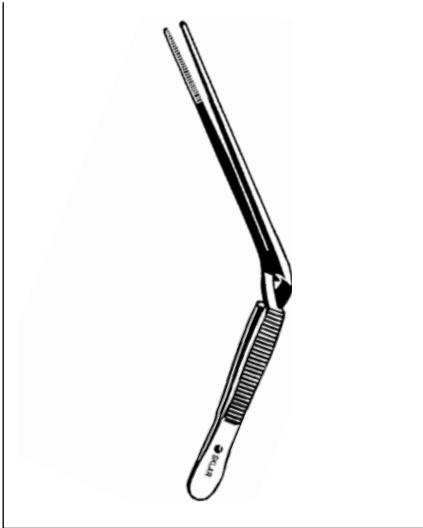

WILDE FORCEPS

CROSS ACTION

- 67-1350 5" Angled, Serrated
- 67-1450 5" Angled, 1x2 Teeth

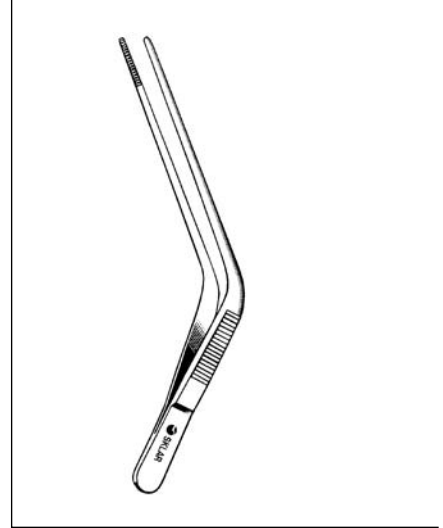

BLAKE EAR FORCEP

DELICATE

- 67-1058 4½" Angled, Serrated

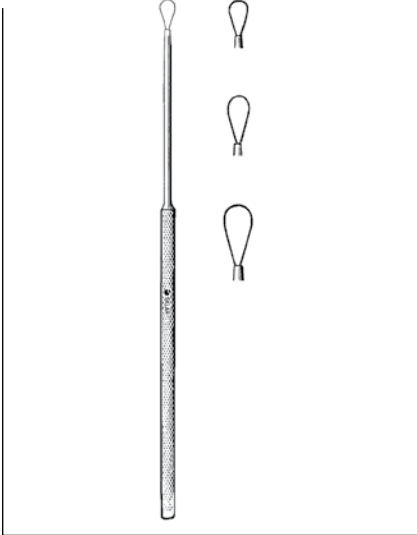
BILLEAU EAR LOOPS

- 67-2521 Small
- 67-2522 Medium
- 67-2523 Large

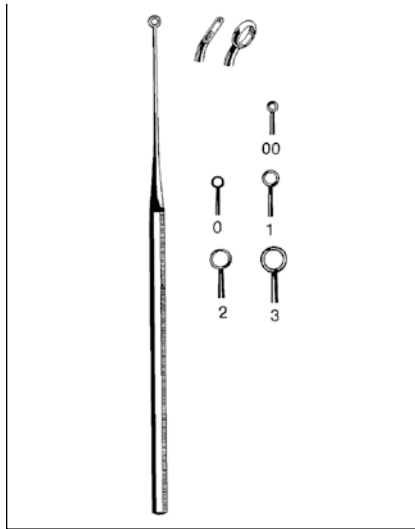
BUCK EAR CURETTES

- | SHARP, STRAIGHT | | SHARP, ANGLED | |
|-----------------|------|---------------|------|
| 67-2519 | #000 | 67-2498 | #000 |
| 67-2514 | #00 | 67-2499 | #00 |
| 67-2515 | #0 | 67-2500 | #0 |
| 67-2516 | #1 | 67-2501 | #1 |
| 67-2517 | #2 | 67-2502 | #2 |
| 67-2518 | #3 | 67-2503 | #3 |

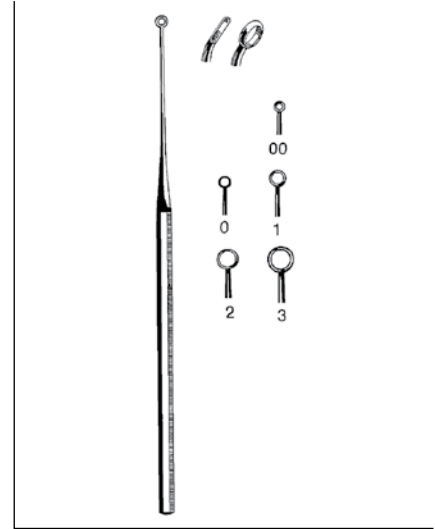
BUCK EAR CURETTES

- | BLUNT, STRAIGHT | | BLUNT, ANGLED | |
|-----------------|------|---------------|------|
| 67-2488 | #000 | 67-2508 | #000 |
| 67-2489 | #00 | 67-2509 | #00 |
| 67-2490 | #0 | 67-2510 | #0 |
| 67-2491 | #1 | 67-2511 | #1 |
| 67-2492 | #2 | 67-2512 | #2 |
| 67-2493 | #3 | 67-2513 | #3 |

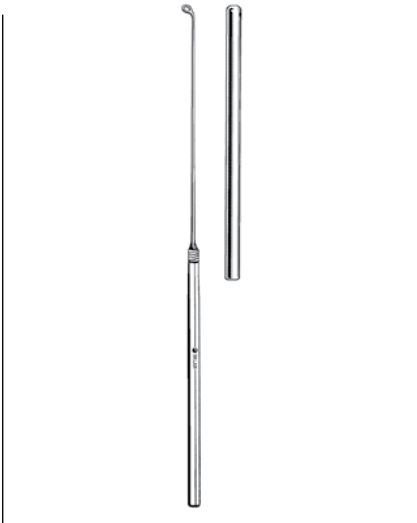
WEISMAN INFANT CURETTES

- BLUNT**
- 67-2480 Size 0
 - 67-2481 Size 1

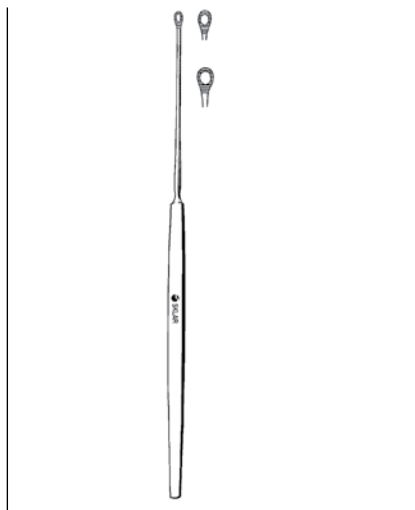
SHAPLEIGH EAR CURETTES

- 67-2525 Size 1 6¼" Small
- 67-2526 Size 2 6¼" Large

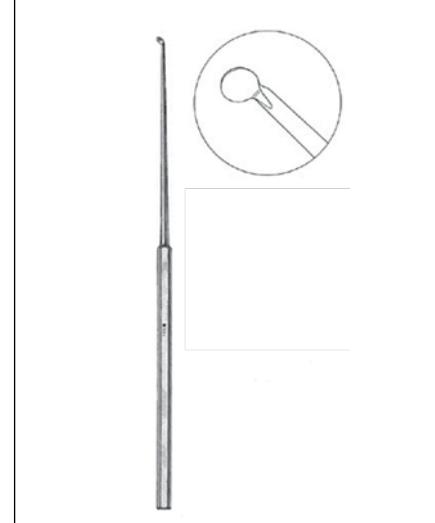
ROSEN KNIFE CURETTES

- 50° ANGLE**
- 65-3240 6¼" 1.0mm
 - 65-3241 6¼" 1.4mm
 - 65-3242 6¼" 1.6mm
 - 65-3221 6¼" 2.0mm
 - 65-3244 6¼" 2.6mm
 - 65-3245 6¼" 2.8mm
 - 65-3246 6¼" 3.0mm



ROSEN PICKS

CURVED

65-3223	6¼"	1.5mm
65-3222	6¼"	3mm



HOUSE HOOKS

90° ANGLE

66-7785	Left Angle
66-7786	Right Angle



DAY EAR HOOKS

67-2550	6½"	Small
67-2552	6½"	Large



GROSS HOOK AND SPOON

DOUBLE EDGED

67-2540	5¼"
---------	-----

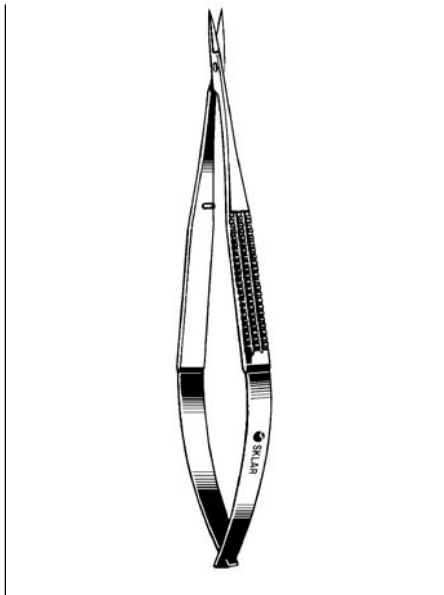

MICRO SURGERY SCISSORS

FLAT HANDLE, SHARP

- 98-7810 6" Straight
- 98-7812 6" Curved

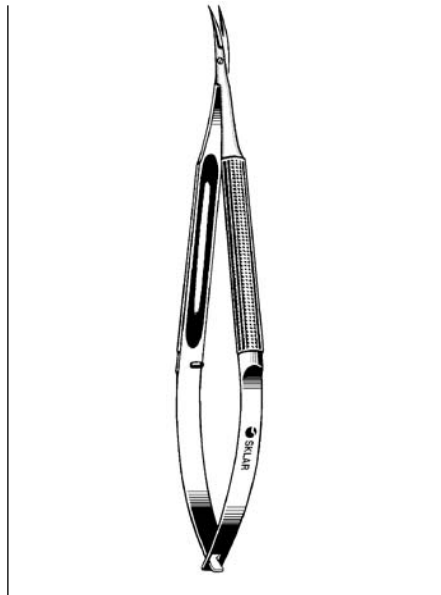

MICRO SURGERY SCISSORS

ROUND HANDLE, SHARP

- 98-7814 6" Straight
- 98-7815 6" Curved
- 98-7816 7 1/8" Straight
- 98-7817 7 1/8" Curved

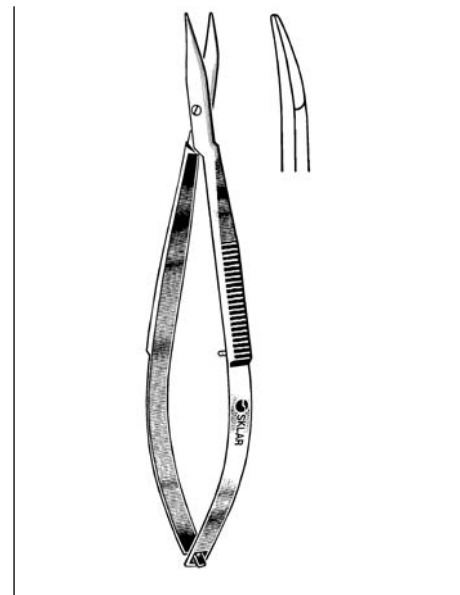

WESTCOTT TENOTOMY SCISSORS

SPRING HANDLE

- 64-3146 4 1/4" Curved Blunt
- 64-3145 4 1/4" Curved Sharp
- 64-3142 5" Right Blunt
- 64-3144 5" Left Blunt



SCHIEE-WESTCOTT CORNEAL SCISSORS

- 64-3138 5" Right
- 64-3140 5" Left

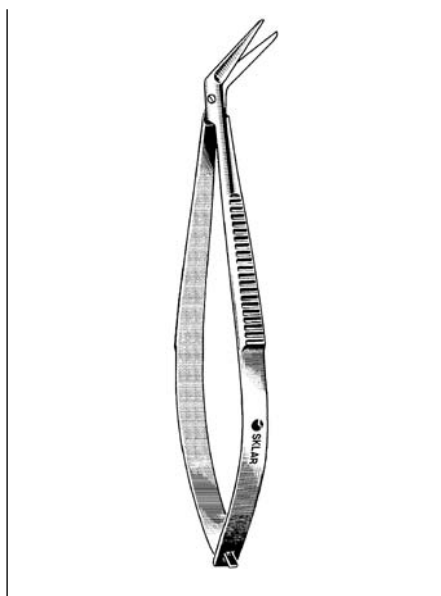

CASTROVIEJO CORNEAL SCISSOR

- 64-2535 4" Angled Blunt

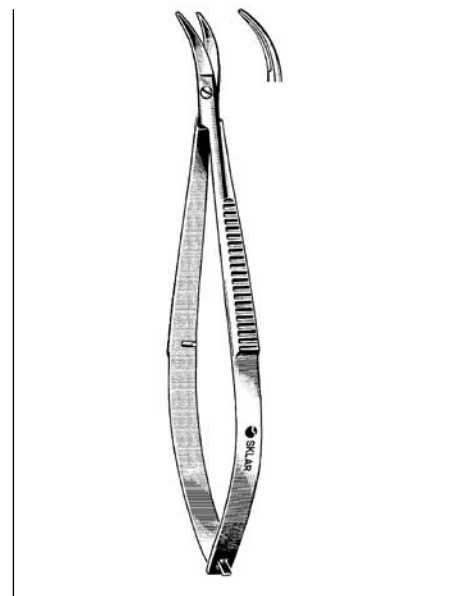

CASTROVIEJO CORNEAL SCISSOR

- 64-2442 4" Curved Blunt

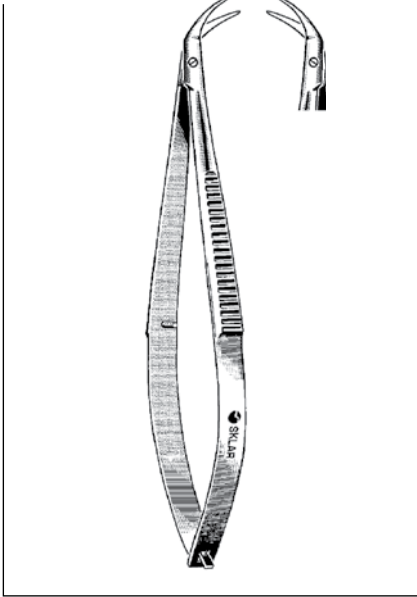

CASTROVIEJO CORNEAL SCISSORS

INNER BLADE .5MM LONGER THAN OUTER BLADE

- 64-2242 4 1/4" Curved Right
- 64-2342 4 1/4" Curved Left

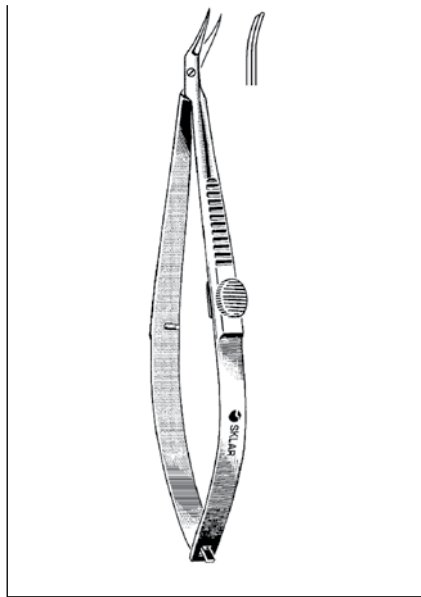

CASTROVIEJO CORNEAL SCISSORS

INNER BLADE LONGER THAN OUTER BLADE

- 64-3294 4" Right
- 64-3296 4" Left

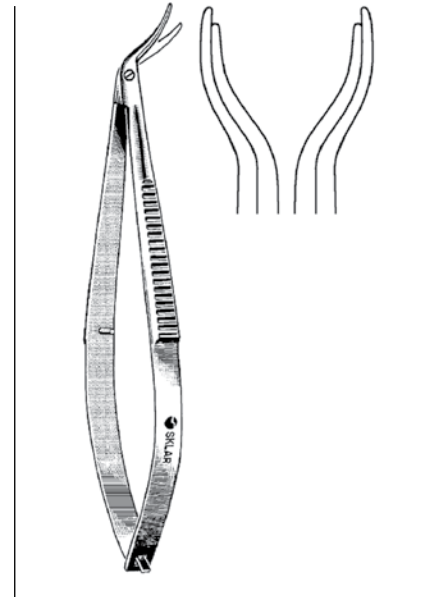

CASTROVIEJO CATARACT SCISSORS

OUTER BLADE LONGER THAN INNER BLADE

- 64-3290 4" Right Angled and Curved
- 64-3292 4" Left Angled and Curved

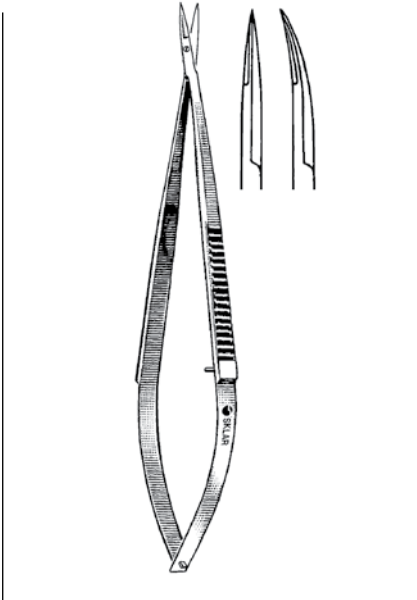

IRIS MICRO-MINI SCISSORS

EXTRA DELICATE

- 64-3050 4" Straight
- 64-3052 4" Curved

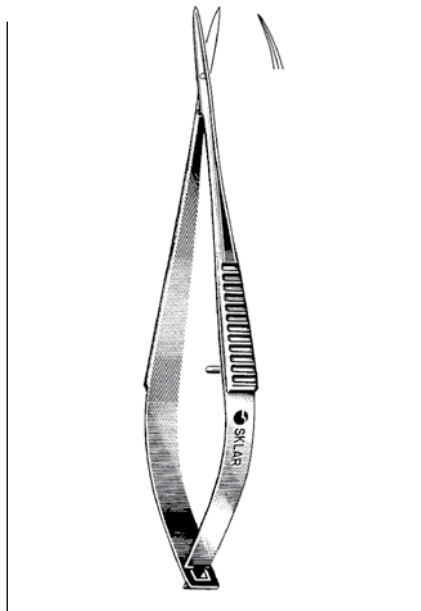

McPHERSON VANNAS SCISSORS

- 64-1960 3" Straight
- 64-1961 3" Curved

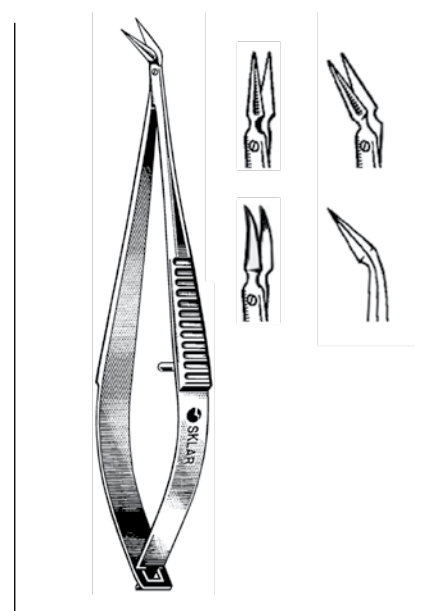

VANNAS SCISSORS

DELICATE

- 64-1950 3" Straight
- 64-1951 3" Curved
- 64-1952 3" Angled
- 64-1955 3" Angled on Flat

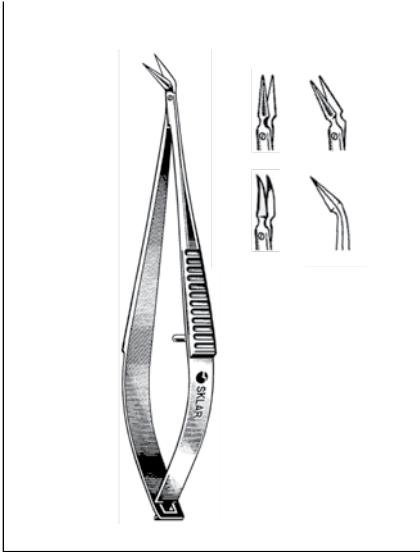

MICRO VANNAS SCISSORS

ULTRA FINE BLADES

64-1850	3"	Straight
64-1851	3"	Curved
64-1852	3"	Angled
64-1853	3"	Angled on Flat

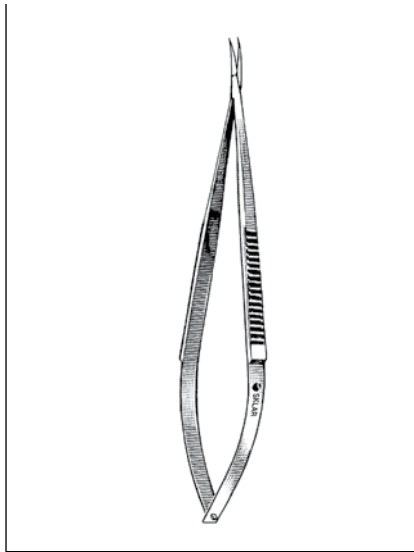

JACOBSON SCISSORS

98-1052	5 1/4"	Curved
98-1055	6 1/4"	Straight
98-1067	6 1/4"	Curved

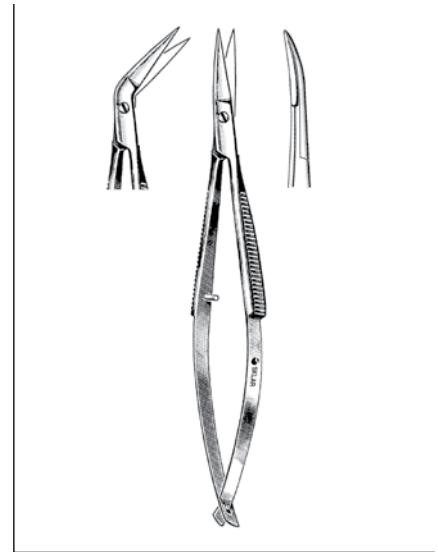

McCLURE IRIS SCISSORS

64-1842	4 1/4"	Straight
64-1942	4 1/4"	Curved
64-1742	4 1/4"	Angled

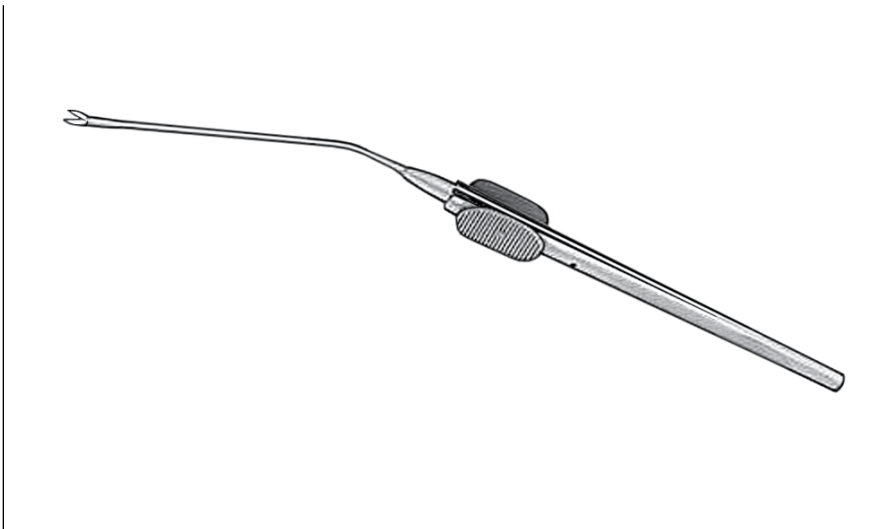

MICRO SCISSORS

PENCIL-TYPE, ANGLED

64-1945	7 1/4"	4mm
64-1946	7 1/4"	8mm

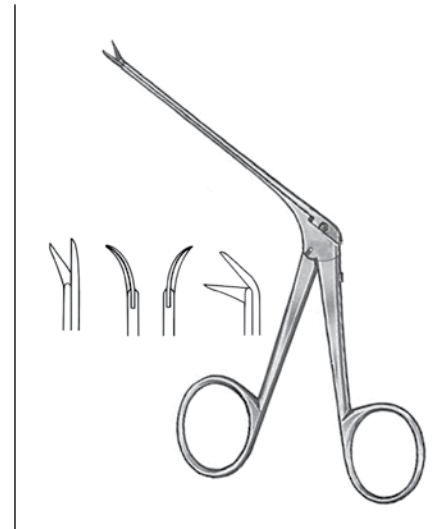

MICRO BELLUCCI EAR SCISSORS

67-8187	3"	4mm	Straight
67-8188	3"	4mm	Straight, Ebony
67-8189	3"	4mm	Curved Right
67-8191	3"	4mm	Curved Left
67-8193	3"	4mm	Curved Upward

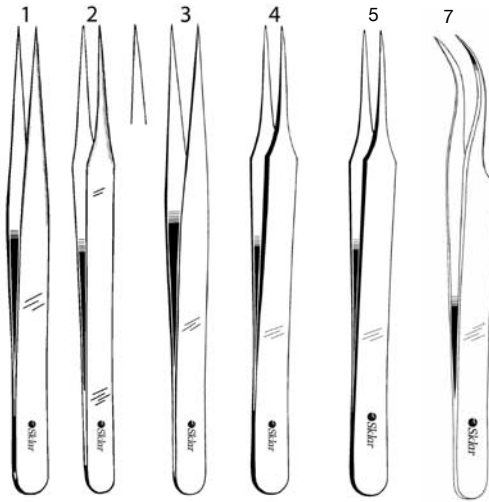

SWISS JEWELER STYLE FORCEPS

NON-MAGNETIC, STAINLESS STEEL

66-7438	4½"	#1	Fine	66-7642	4½"	#5	Straight
66-7440	4½"	#2	Fine	66-7643	4½"	#5	Straight, Micro-Fine
66-7447	4½"	#3	Straight	66-7645	4½"	#5	Angled
66-7442	4½"	#3C	Straight, Delicate	66-7644	4½"	#7	Curved
66-7443	4½"	#3	Micro-Fine	66-7446	4½"	#7	Curved, Micro-Fine
66-7542	4½"	#4	Straight, Delicate				



BONN TYING FORCEPS

WITH TYING PLATFORM

66-6160	4"	Straight
66-6162	4"	Curved

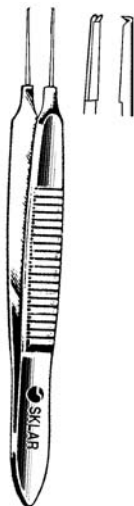

BONN MICRO SUTURE FORCEPS

WITH TYING PLATFORM

66-6125	2¾"	1x2 Teeth
66-6126	3¾"	1x2 Teeth

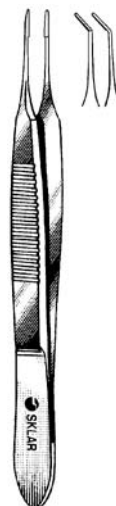

McPHERSON MICRO TYING FORCEPS

WITH TYING PLATFORM

66-6150	¾"	Straight
66-6152	4"	Angled



McPHERSON MICRO IRIS SUTURING FORCEPS

SMOOTH PLATFORM, 0.3MM X 5MM

66-6164	¾"	Straight
66-6166	¾"	Angled

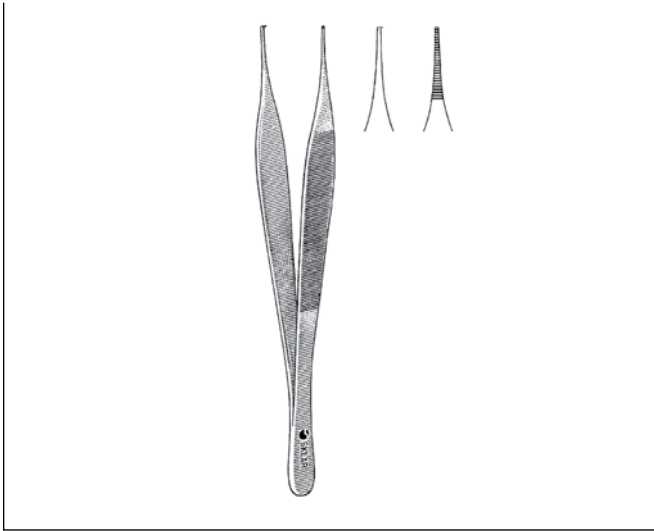

MICRO ADSON FORCEPS

- 98-2047 4¾" 1x2 Teeth
- 98-2048 4¾" Serrated



RHOTON MICRO SUTURE FORCEPS

- STRAIGHT**
- 98-3055 7" With Tying Platform
 - 98-3056 7" Without Tying Platform



JACOBSON MICRO MOSQUITO FORCEPS

- DELICATE**
- 98-2050 5" Straight
 - 98-2051 5" Curved
 - 98-2070 7" Slight Curve
 - 98-2071 7" Full Curve

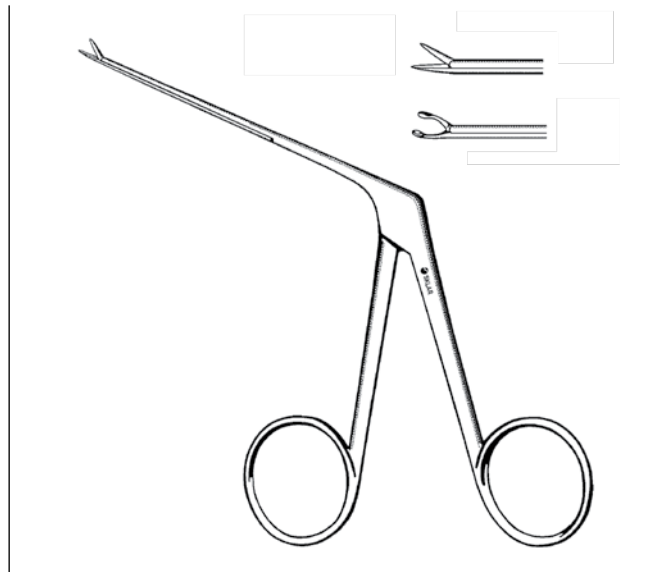

MICRO ALLIGATOR EAR FORCEPS

- ¾"**
- 67-8173 .5mm Oval
 - 67-8177 .5mm Oval Ebony
 - 67-8170 .6mm Serrated
 - 67-8172 .6mm Serrated Ebony
 - 67-8178 .8mm Oval
 - 67-8180 .8mm Oval Ebony
 - 67-8175 .8mm Smooth
 - 67-8174 .8mm Serrated
 - 67-8176 .8mm Serrated Ebony

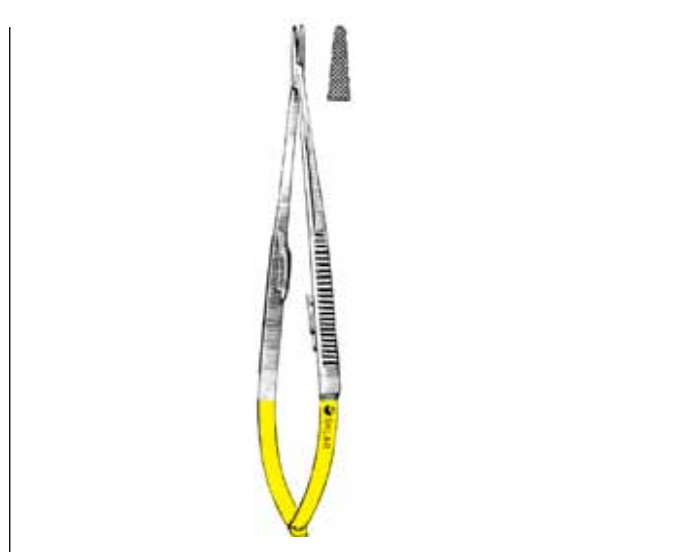
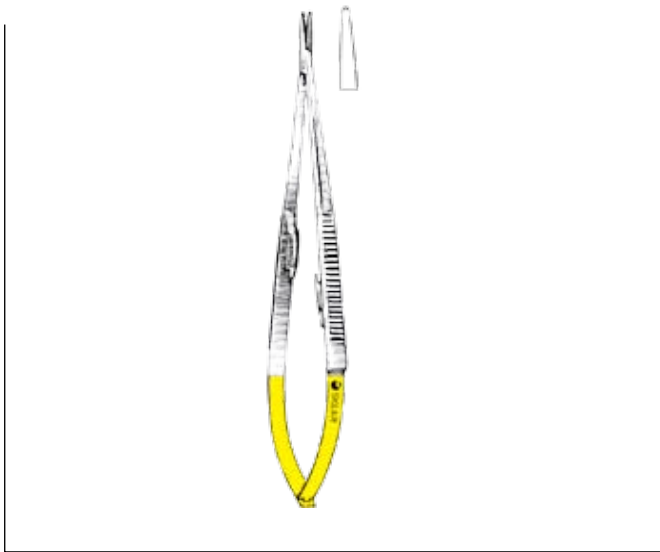

TC JACOBSON MICROVASCULAR NEEDLE HOLDERS

SMOOTH

WITH LOCK

21-8053	7"	Straight
21-8253	7"	Curved
21-8055	8½"	Straight
21-8255	8½"	Curved
21-8059	9"	Straight
21-8257	9"	Curved

WITHOUT LOCK

21-8054	7"	Straight
21-8254	7"	Curved
21-8058	8½"	Straight
21-8258	8½"	Curved
21-8057	9"	Straight
21-8259	9"	Curved

TC JACOBSON MICROVASCULAR NEEDLE HOLDERS

SERRATED

WITH LOCK

21-8250	7"	Straight
21-8251	7"	Curved
21-8052	8½"	Straight
21-8056	8½"	Curved
21-8157	9"	Straight
21-8158	9"	Curved

WITHOUT LOCK

21-8150	7"	Straight
21-8151	7"	Curved
21-8152	8½"	Straight
21-8156	8½"	Curved
21-8159	9"	Straight
21-8160	9"	Curved



TC DERF NEEDLE HOLDER

21-8004	4¾"	Serrated
---------	-----	----------

TC OLSEN-HEGAR NEEDLE HOLDERS

21-8026	4¾"	Smooth, Delicate
21-8025	4¾"	Serrated, Delicate
21-8027	5½"	Serrated
21-8028	6½"	Serrated
21-8029	7½"	Serrated

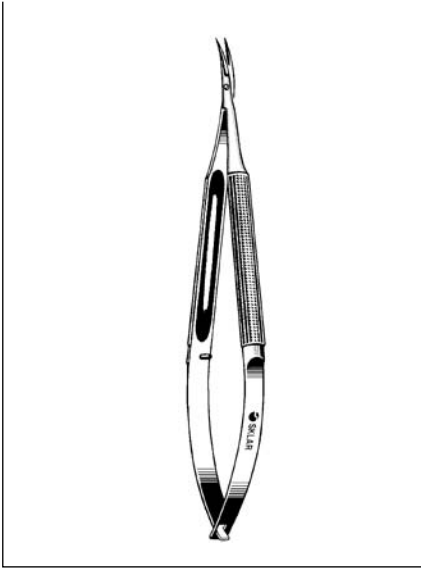

MICRO SURGERY NEEDLE HOLDERS

ROUND HANDLE, .6MM TIPS

WITHOUT LOCK

WITH LOCK

98-3182	6"	Straight	98-3184	6"	Straight
98-3183	6"	Curved	98-3185	6"	Curved
98-3186	7 ¹ / ₈ "	Straight	98-3190	7 ¹ / ₈ "	Straight
98-3188	7 ¹ / ₈ "	Curved	98-3192	7 ¹ / ₈ "	Curved

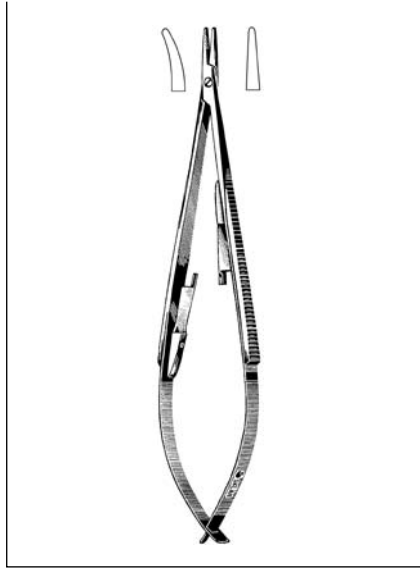

CASTROVIEJO NEEDLE HOLDERS

WITH LOCK

65-6352	5 ¹ / ₂ "	Straight, Delicate
65-6354	5 ¹ / ₂ "	Curved, Delicate
65-6357	5 ¹ / ₂ "	Straight
65-6358	5 ¹ / ₂ "	Curved

WITHOUT LOCK

65-6350	5 ¹ / ₂ "	Straight, Delicate
65-6351	5 ¹ / ₂ "	Curved, Delicate

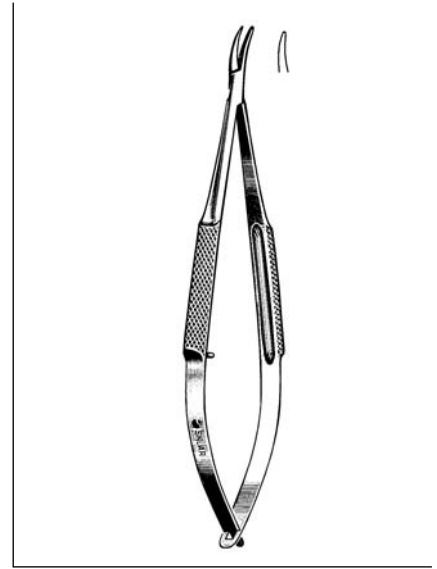

BARRAQUER NEEDLE HOLDERS

WITHOUT LOCK

WITH LOCK

65-6452	5 ¹ / ₄ "	Curved	65-6448	5 ¹ / ₄ "	Curved
65-6454	5 ¹ / ₂ "	Straight	65-6445	5 ¹ / ₂ "	Straight
65-6455	5 ¹ / ₂ "	Curved	65-6446	5 ¹ / ₂ "	Curved
65-6456	7 ¹ / ₂ "	Straight	65-6449	7 ¹ / ₂ "	Straight
65-6457	7 ¹ / ₂ "	Curved	65-6450	7 ¹ / ₂ "	Curved



COHAN NEEDLE HOLDERS

7MM, CURVED

65-6470	4"	Without Lock
65-6475	4"	With Lock

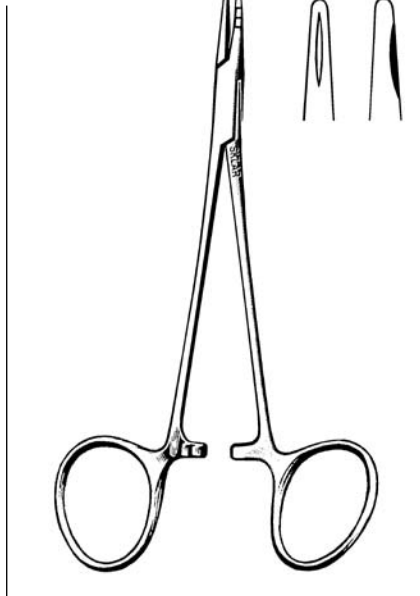

NEIVERT NEEDLE HOLDER

ONE OFF-SET RING

20-1760	5"
---------	----

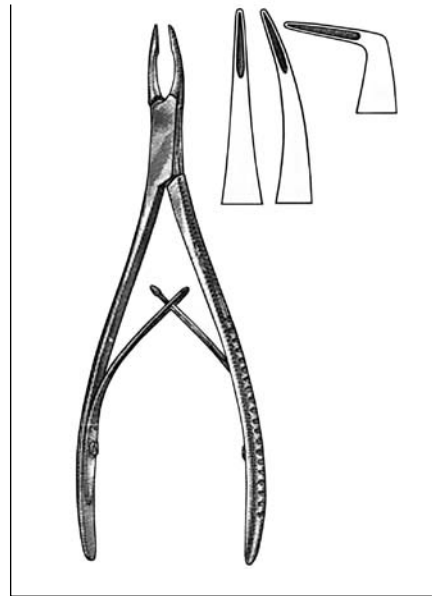

MICRO FRIEDMAN RONGEURS

1.3MM JAWS, VERY DELICATE

40-3186	5 ¹ / ₂ "	Straight
40-3189	5 ¹ / ₂ "	Curved
40-3191	5 ¹ / ₂ "	90° Angle



SAUER EYE SPECULUM
65-1012 1¼"

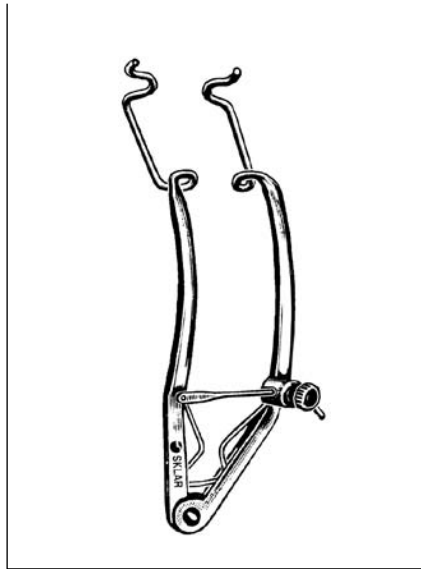

KNAPP EYE SPECULUM
65-1545 3¼" Non-Magnetic

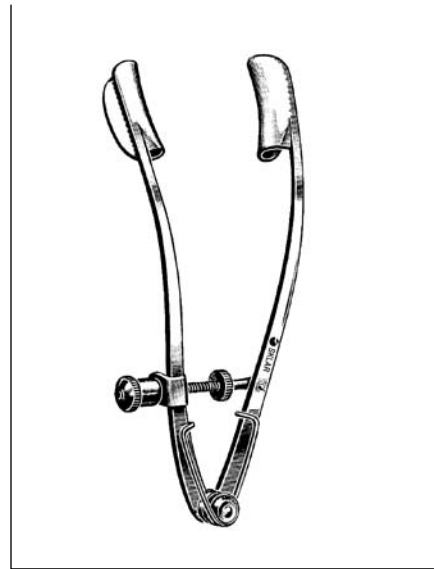

LANCASTER EYE SPECULUM
65-1532 3¼"

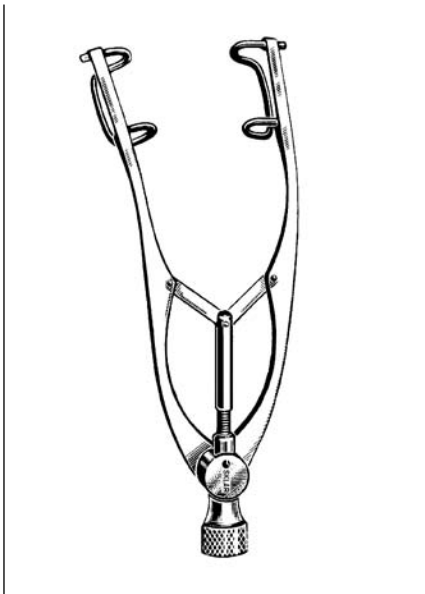

CASTROVIEJO SPECULUMS
65-1535 3½" 15mm x 5mm Blades
65-1536 4" 18mm x 5mm Blades

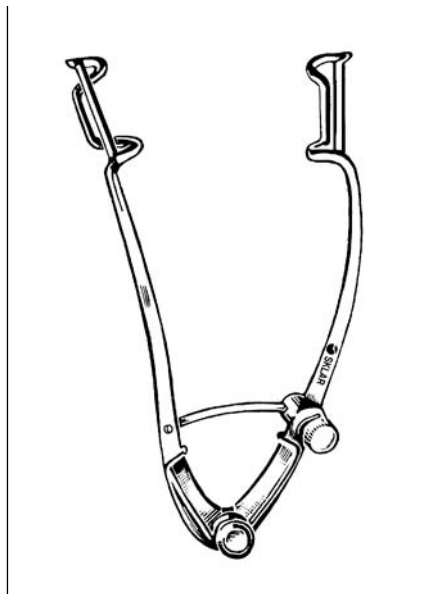

WILLIAMS SPECULUMS
65-1227 2¾"
65-1332 3¼"

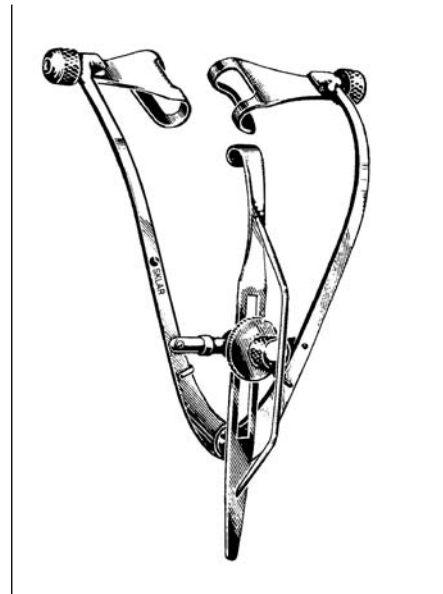

PARK-MAUMENEE EYE SPECULUM WITH LOCK SCREWS
65-1528 3¼" 14mm Blades



MURDOCK EYE SPECULUM
65-1540 2¼" 15mm Spread

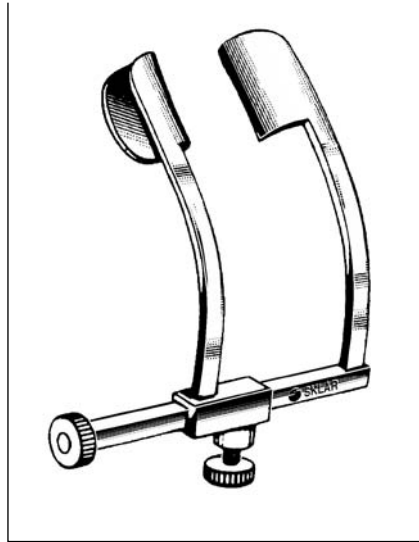

COOK EYE SPECULUMS WITH LOCK
65-1765 9mm Blades 25mm Spread
65-1766 11mm Blades 27mm Spread

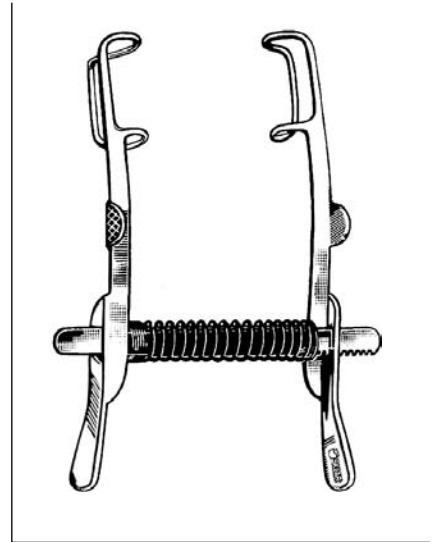

MELLINGER EYE SPECULUMS 15MM SPREAD
65-1426 2¾" Solid
65-1427 2¾" Fenestrated

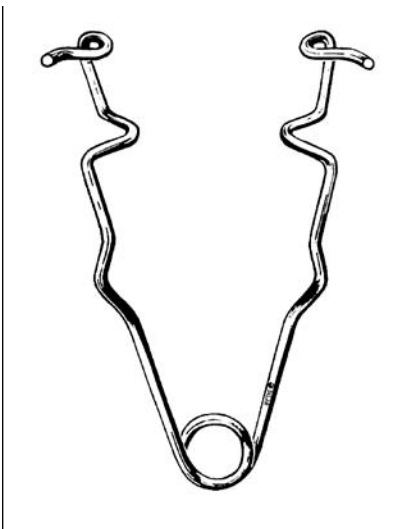

PLAIN WIRE SPECULUM
65-1127 2¾" Large

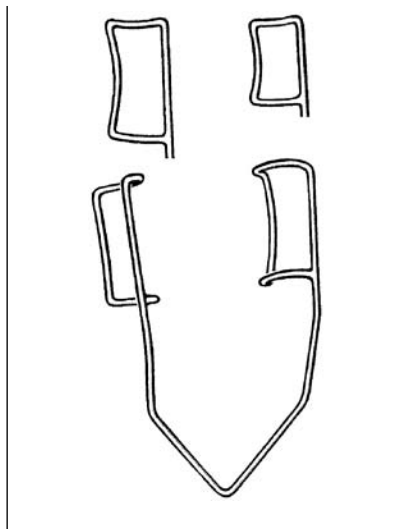

BARRAQUER WIRE SPECULUMS FENESTRATED
65-1746 1½" 8mm Small
65-1740 1½" 10mm Medium
65-1742 1½" 15mm Large
65-1744 1½" 15mm Large Heavy

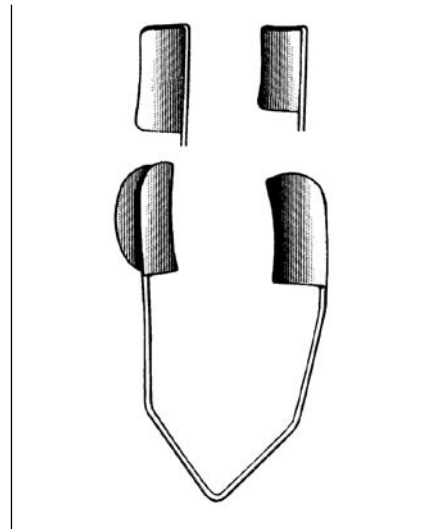

BARRAQUER WIRE SPECULUMS SOLID
65-1756 1½" 10mm Medium
65-1758 1½" 15mm Large

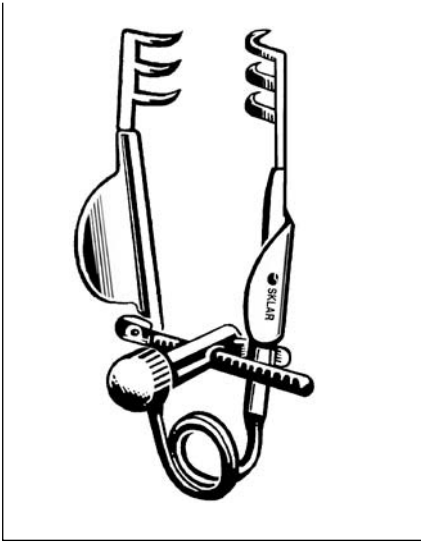

**MELLER LACHRYMAL SAC
RETRACTORS**

3X3 PRONGS

65-1815 1½" 4mm Deep Sharp, Delicate
65-1830 3" 3mm Deep Blunt

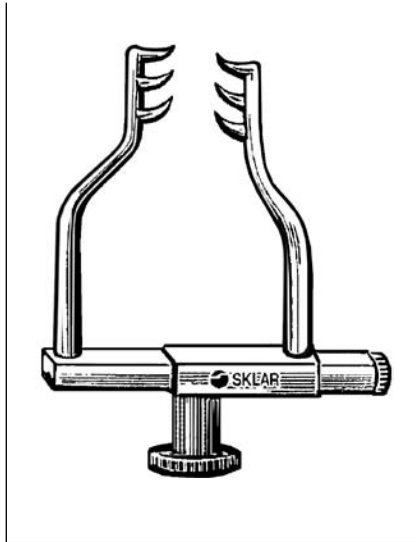

GOLDSTEIN RETRACTOR

3X3 PRONGS

47-2913 1½" Sharp

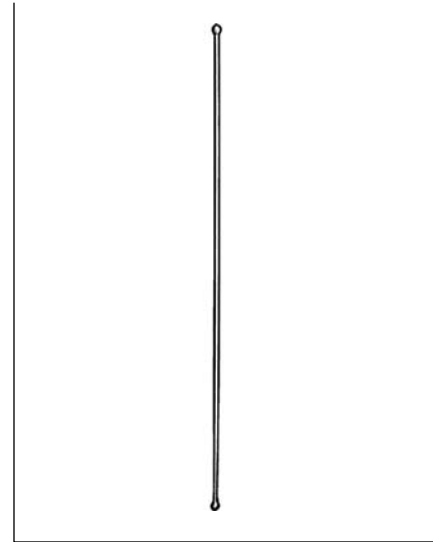

PROBE

DOUBLE END

30-1545 4½"

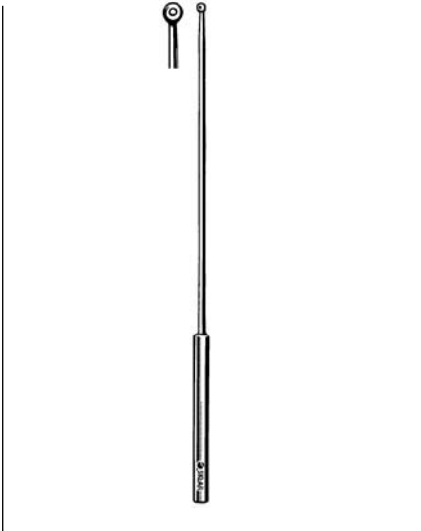

BARR FISTULA PROBE

80-2910 9" With Eye

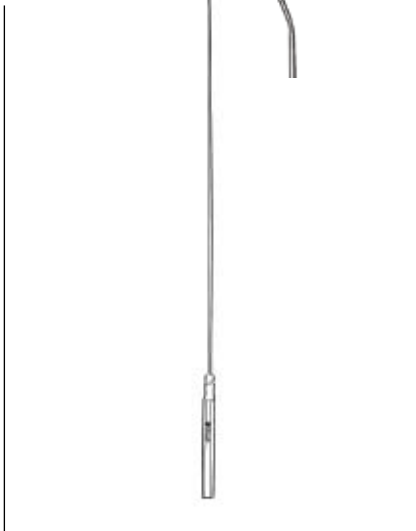

PRATT RECTAL PROBE

7¾" STERLING SHAFT

80-1260 10"



RUBBER DAM PUNCH

W TYPE

45-266

48-266 Office Grade



PROVIDES LIGHTNESS AND DURABILITY

Sklar premium operating room instruments offers the surgeon maximum control and precision. Our researchers recognized a need for instruments that were lighter patterns but maintained the strength and durability of a standard pattern.

Sklar developed a manufacturing technique that mills scant microns off our standard pattern while maintaining the structural integrity of the original instrument. The result is a noticeably lighter, extremely sensitive instrument that can withstand the daily rigors of surgery.

SKLARLITE™ and SKLARLITE XD™ instruments carry the same day-in and day-out reliability that you have come to expect from all Sklar instruments. Sklar has applied its more than 100 years of experience in developing this superior instrument.

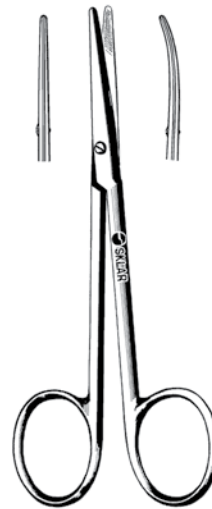

SKLARLITE
THE LIGHT TOUCH

SKLARLITE™ STRABISMUS SCISSORS

- 23-1158 4½" Straight
- 23-1159 4½" Curved

SKLARLITE XD
EXTRA DELICATE

SKLARLITE XD™ STRABISMUS SCISSORS

- 23-1162 4½" Straight
- 23-1163 4½" Curved



SKLARLITE
THE LIGHT TOUCH

SKLARLITE™ STITCH SCISSORS

- 23-1188 3½" Spencer
- 23-1189 4½" Spencer
- 23-1190 5½" Littauer

SKLARLITE XD
EXTRA DELICATE

SKLARLITE XD™ STITCH SCISSORS

- 23-1193 3½" Spencer
- 23-1194 4½" Spencer
- 23-1195 5½" Littauer



SKLARLITE
THE LIGHT TOUCH

**SKLARLITE™
SHORTBENT SUTURE
SCISSORS**

23-1191 3½"

SKLARLITE XD
EXTRA * DELICATE

**SKLARLITE XD™
SHORTBENT SUTURE
SCISSORS**

23-1196 3½"

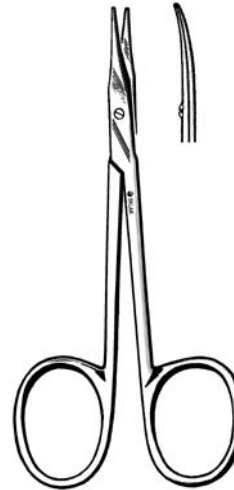

SKLARLITE
THE LIGHT TOUCH

**SKLARLITE™
STEVENS TENOTOMY
SCISSORS**

23-1156 4½" Straight Blunt/Blunt

23-1157 4½" Curved Blunt/Blunt

SKLARLITE XD
EXTRA * DELICATE

**SKLARLITE XD™
STEVENS TENOTOMY
SCISSORS**

23-1160 4½" Straight Blunt/Blunt

23-1161 4½" Curved Blunt/Blunt



SKLARLITE
THE LIGHT TOUCH

**SKLARLITE™
IRIS SCISSORS**

SHARP/SHARP

23-1148 3½" Straight

23-1150 3½" Curved

23-1149 4½" Straight

23-1151 4½" Curved

SKLARLITE XD
EXTRA * DELICATE

**SKLARLITE XD™
IRIS SCISSORS**

SHARP/SHARP

23-1152 3½" Straight

23-1154 3½" Curved

23-1153 4½" Straight

23-1155 4½" Curved



OPHTHALMIC | PREMIUM | FORCEPS

SKLARLITE
THE LIGHT TOUCH

**SKLARLITE™
HALSTED MOSQUITO
FORCEPS**

23-2105 5" Straight
23-2106 5" Curved

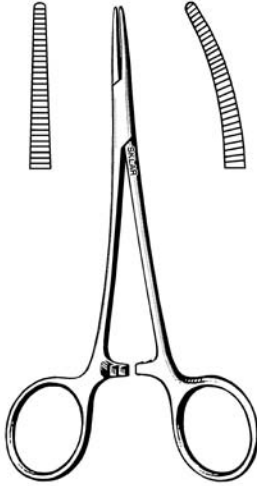

SKLARLITE XD
EXTRA DELICATE

**SKLARLITE XD™
HALSTED MOSQUITO
FORCEPS**

23-2505 5" Straight
23-2506 5" Curved

SKLARLITE
THE LIGHT TOUCH

**SKLARLITE™
HARTMANN MOSQUITO
FORCEPS**

23-2100 3½" Straight
23-2101 3½" Curved

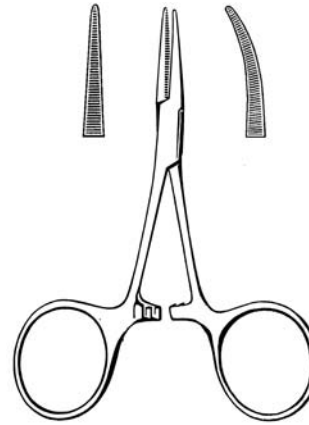

SKLARLITE XD
EXTRA DELICATE

**SKLARLITE XD™
HARTMANN MOSQUITO
FORCEPS**

23-2500 3½" Straight
23-2501 3½" Curved

SKLAR DISINFECTANT

READY-TO-USE SPRAY SURFACE DISINFECTANT

2 MINUTE KILL TIME!

- Ready to use, non-toxic formula.
- Specially formulated for the control of cross contamination.
- Effective against H1N1, MRSA, Salmonella, Parvo, Feline Leukemia, Herpes Simplex, Distemper, Ringworm, Strangles.
- Safe for all areas of the facility.
- Satisfies OSHA's Bloodborne Pathogen Standards.
- Non-irritating formula.
- EPA registered.

PRODUCT NUMBER	FEATURES	QUANTITIES
10-1643	24 oz. Spray Bottles	6/case
10-1642	24 oz. Spray Bottle	1 bottle
10-1653	1 Gallon Bottles	4/case
10-1654	1 Gallon Bottle	1 bottle
10-1644	2.5 Gallon Bottles	2/case



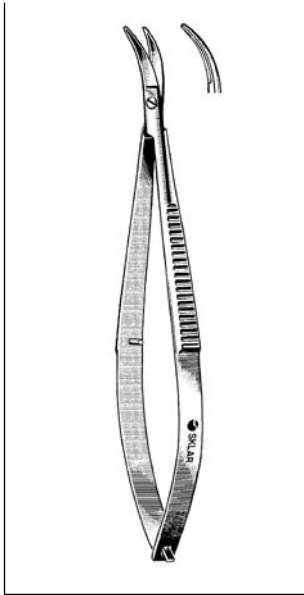

**CASTROVIEJO
CORNEAL SCISSOR**

BLUNT
64-2442 4" Curved

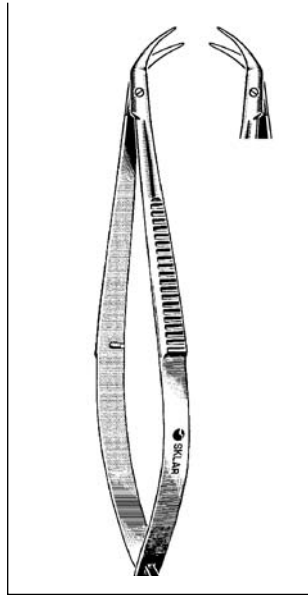

**CASTROVIEJO
CORNEAL SCISSORS**
INNER BLADE .5MM LONGER THAN
OUTER BLADE

64-2242 4¼" Curved Right
64-2342 4¼" Curved Left

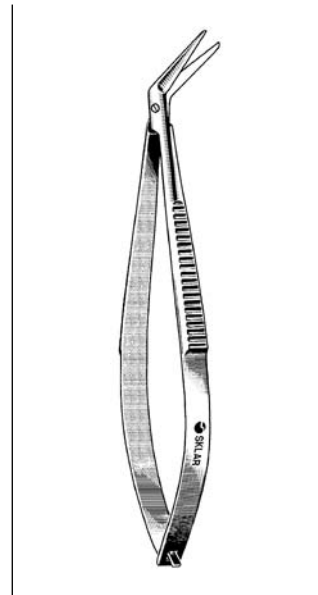

**CASTROVIEJO
CORNEAL SCISSOR**

64-2535 4" Angled, Blunt

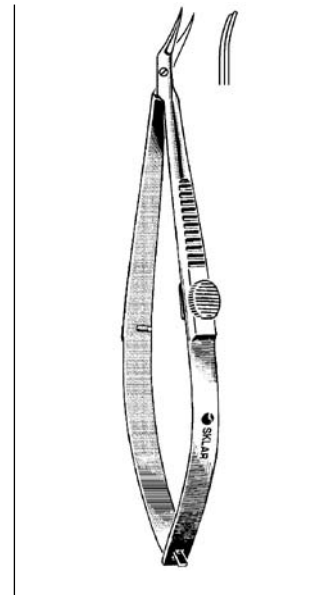

**CASTROVIEJO
CORNEAL SCISSORS**

INNER BLADE LONGER THAN OUTER
BLADE
64-3294 4" Right
64-3296 4" Left

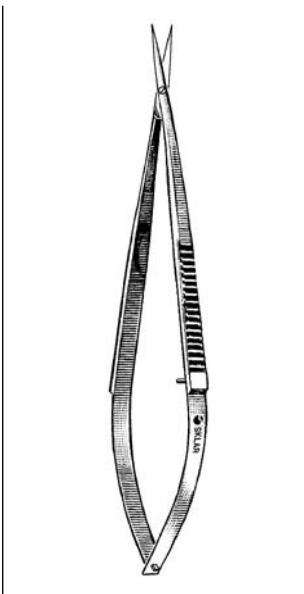

FINE STITCH SCISSOR

DELICATE, SHARP
64-3260 4¼"

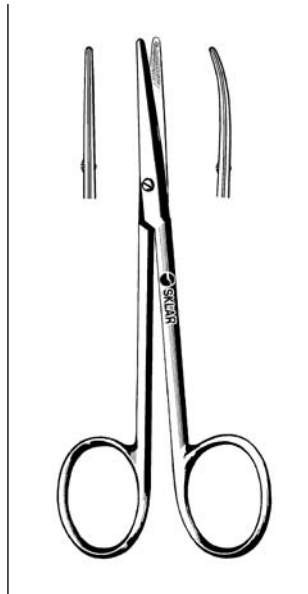

STRABISMUS SCISSORS

64-1442 4½" Straight
64-1542 4½" Curved
DELICATE
22-1442 4½" Straight
22-1542 4½" Curved

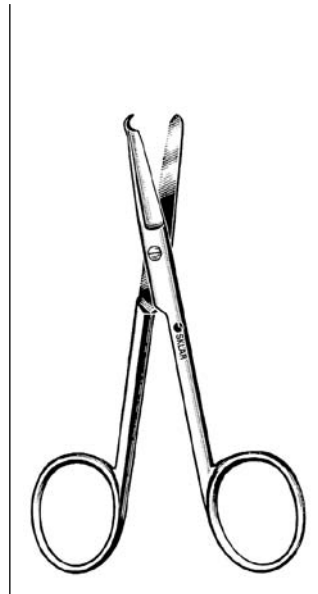

STITCH SCISSORS

22-2835 3½" Spencer
22-2845 4½" Spencer
15-1355 5½" Littauer
DELICATE
22-2834 3½" Spencer
22-2844 4½" Spencer
22-1354 5½" Littauer

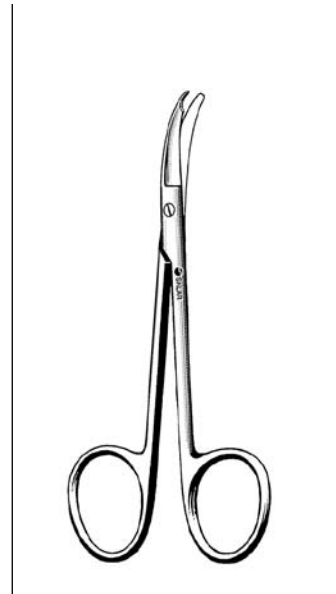

SUTURE SCISSORS

22-2935 3½" Shortbent
22-2934 3½" Shortbent
Delicate
22-2947 4¾" Northbent

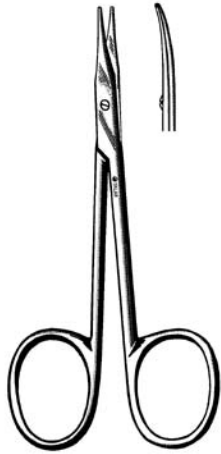
STEVENS TENOTOMY SCISSORS

64-1242	4½"	Straight	Blunt/Blunt
64-1243	4½"	Straight	Sharp/Sharp
64-1343	4½"	Curved	Sharp/Sharp
64-1342	4½"	Curved	Blunt/Blunt

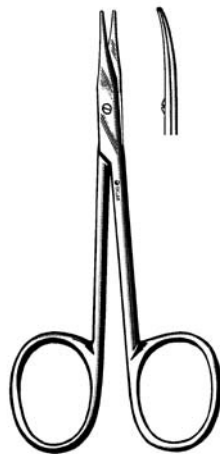
STEVENS TENOTOMY SCISSORS

DELICATE			
22-1242	4½"	Straight	Blunt/Blunt
22-1342	4½"	Curved	Blunt/Blunt
22-1240	4½"	Straight	Sharp/Sharp
22-1241	4½"	Curved	Sharp/Sharp

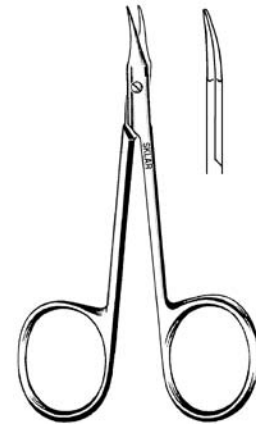
GRADLE SCISSOR

64-3280	3¾"	Slight Curve, Sharp
---------	-----	---------------------

IRIS SCISSORS
STRAIGHT

47-1135	3½"	Sharp/Sharp
47-1140	3½"	Blunt/Blunt
47-1143	4"	Sharp/Sharp
47-1441	4"	Sharp/Sharp, Heavy
47-1145	4½"	Sharp/Sharp
47-1144	4½"	Blunt/Blunt

CURVED

47-1235	3½"	Sharp/Sharp
47-1240	3½"	Blunt/Blunt
47-1243	4"	Sharp/Sharp
47-1442	4"	Sharp/Sharp, Heavy
47-1245	4½"	Sharp/Sharp
47-1244	4½"	Blunt/Blunt

IRIS SCISSORS
DELICATE

22-1135	3½"	Straight	Sharp/Sharp
22-1235	3½"	Curved	Sharp/Sharp
47-1440	4"	Straight	Sharp/Sharp
47-1246	4½"	Straight	Sharp/Sharp
47-1248	4½"	Curved	Sharp/Sharp

IRIS SCISSORS

64-2042	4¼"	Angled	Probe Point
64-2142	4½"	Angled	Sharp/Sharp
64-2143	4½"	Curved	Sideways

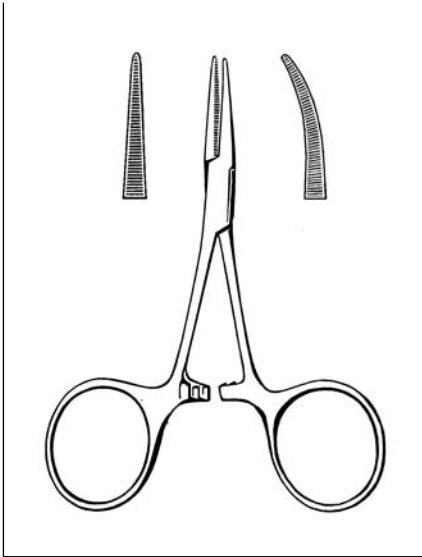

HARTMANN MOSQUITO FORCEPS

SERRATED

- 17-1235 3½" Straight
- 17-1335 3½" Curved

SERRATED, DELICATE

- 17-1230 3½" Straight
- 17-1232 3½" Curved

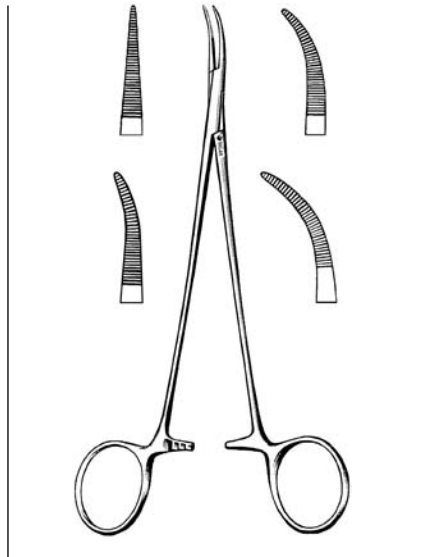

JACOBSON MICRO MOSQUITO FORCEPS

DELICATE

- 98-2050 5" Straight
- 98-2051 5" Curved
- 98-2070 7" Slight Curve
- 98-2071 7" Full Curve

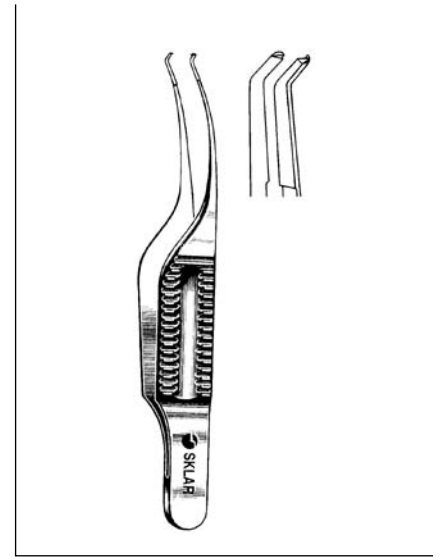

TROUTMAN BARRAQUER CORNEAL UTILITY FORCEP

COLIBRI TYPE, 45° ANGLE WITH TYING PLATFORM

- 66-7250 3" 1x2 Teeth .5mm

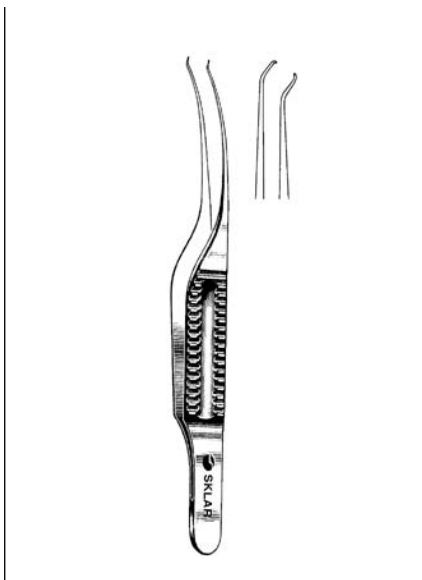

COLIBRI CORNEAL UTILITY FORCEPS

1X2 TEETH

- 66-7259 3" 0.12mm
- 66-7261 3" 0.4mm

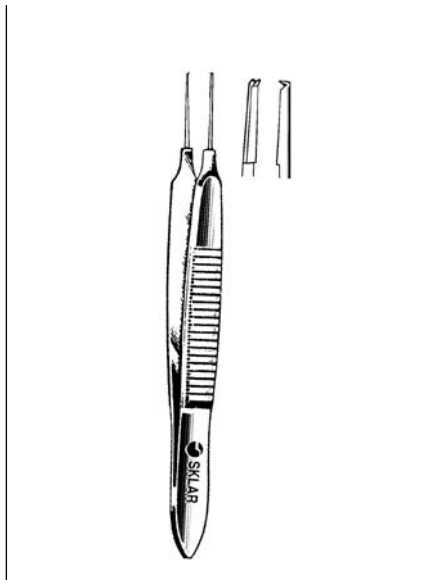

BONN MICRO SUTURE FORCEPS

WITH TYING PLATFORM

- 66-6125 2¾" 1x2 Teeth
- 66-6126 3¾" 1x2 Teeth
- 66-6160 4" Straight
- 66-6162 4" Curved

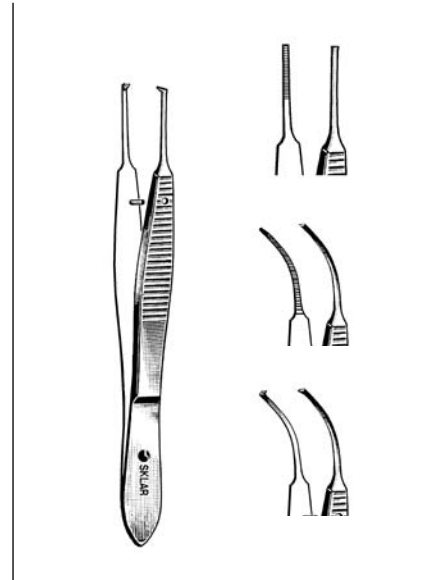

GRAEFE IRIS FORCEPS

STRAIGHT

- 66-4526 2¾" Serrated
- 66-4525 2¾" 1x2 Teeth

CURVED

- 66-4626 2¾" Serrated
- 66-4625 2¾" 1x2 Teeth

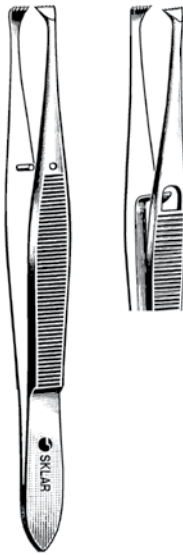

GRAEFE FIXATION FORCEPS

FINE STANDARD JAWS, 4MM

- 66-1940 4 1/8" Without Catch
- 66-2140 4 1/8" With Catch

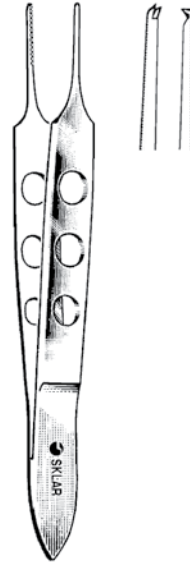

BISHOP-HARMON IRIS FORCEPS

- 66-4032 3 1/2" Serrated
- 66-4132 3 1/2" 1x2 Teeth
- 66-4232 3 1/2" 1x2 Teeth Delicate
- 66-4133 3 1/2" 1x2 Teeth Extra Delicate

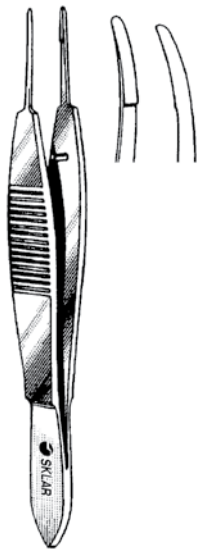

HARMS TYING FORCEPS

- 66-6140 4" Straight, .5mm
- 66-6142 4" Curved, .5mm

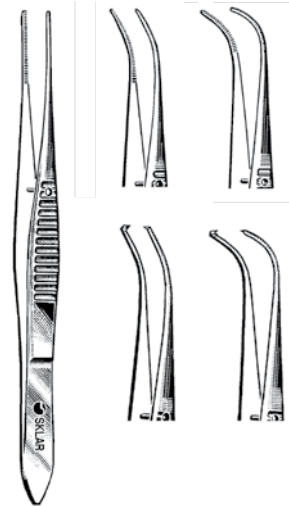

EYE FORCEPS

- 4", 0.8MM**
- DRESSING, SERRATED**
- 66-2740 Straight
- 66-2840 Straight, Non-Magnetic
- 66-2940 Half Curve
- 66-3140 Full Curve
- TISSUE, 1X2 TEETH**
- 66-3340 Straight
- 66-3240 Straight, Non-Magnetic
- 66-3540 Half Curve
- 66-3740 Full Curve

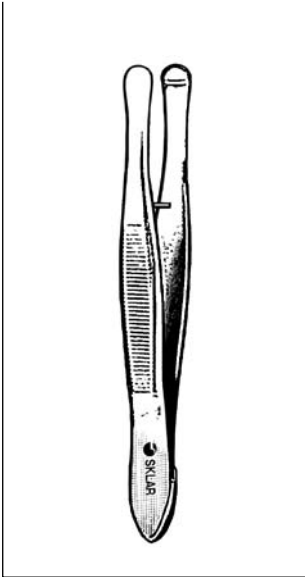

BEER CILIA FORCEP
66-1770 3½" 4mm Smooth

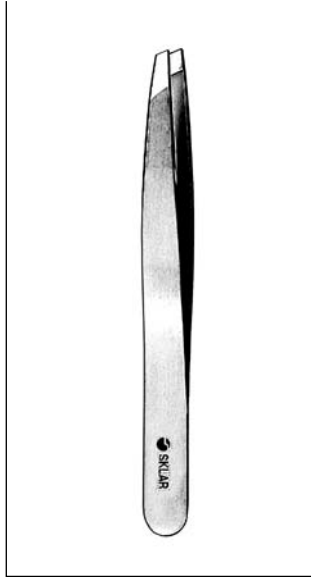

SWISS CILIA SUTURE FORCEP
66-1740 3¾"

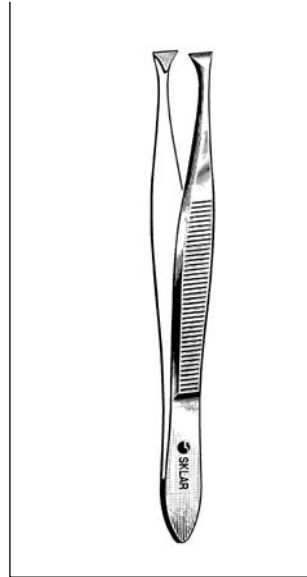

LITTAUER CILIA FORCEP
66-1735 3½"

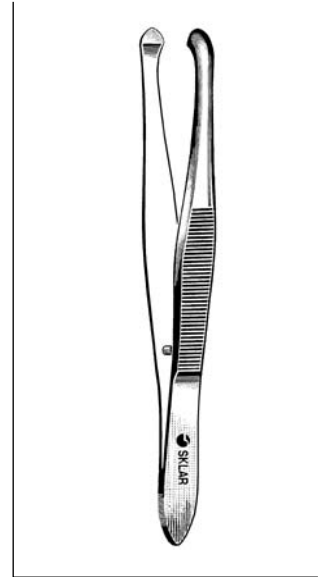

ZIEGLER CILIA FORCEP
66-1535 3½"

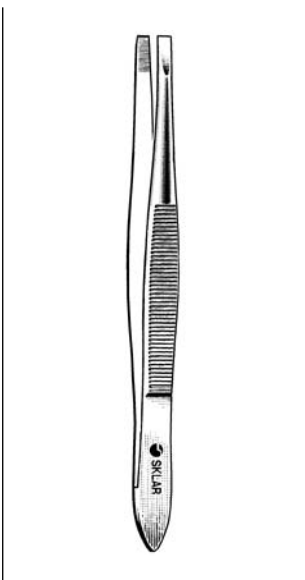

DOUGLASS CILIA FORCEP
66-1830 3½"

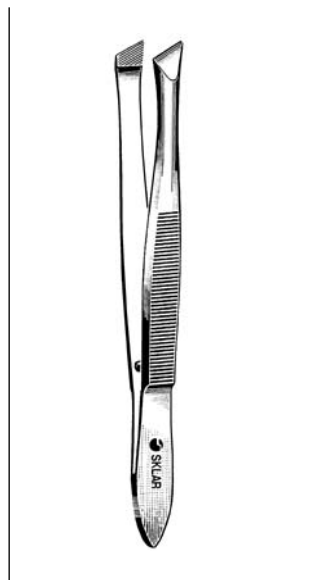

BERGH CILIA FORCEP
66-1635 3½"

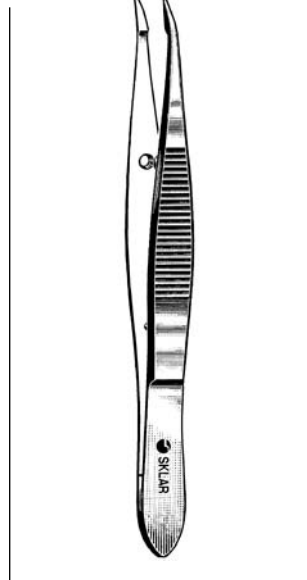

BARRAQUER CILIA FORCEP
66-1742 4¼"

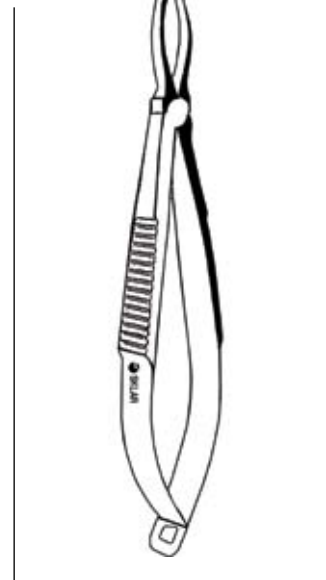

GRADLE CILIA FORCEP
66-1745 4"

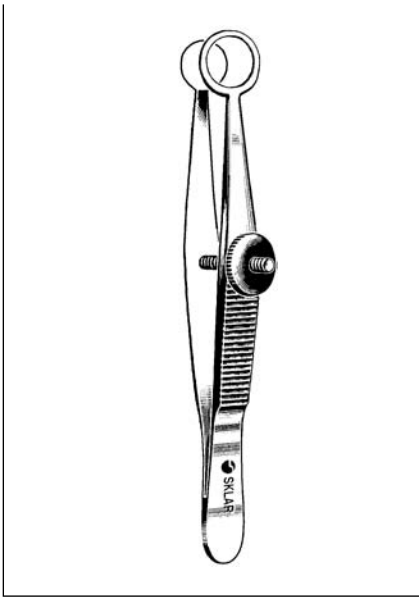

AYERS CHALAZION FORCEP

66-1435 3½"

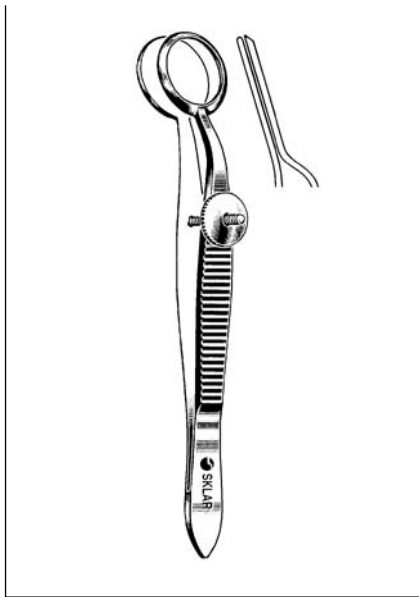

HEATH CHALAZION FORCEPS

66-1037 3½" 11mm
66-1137 3½" 16mm



DESMARRES CHALAZION FORCEPS

66-1038 3½" Small
66-1036 3½" Medium
66-1035 3½" Large



FRANCIS CHALAZION FORCEP

66-1255 3¾" 12x14mm



PRINCE TRACHOMA FORCEP

66-1275 3½"

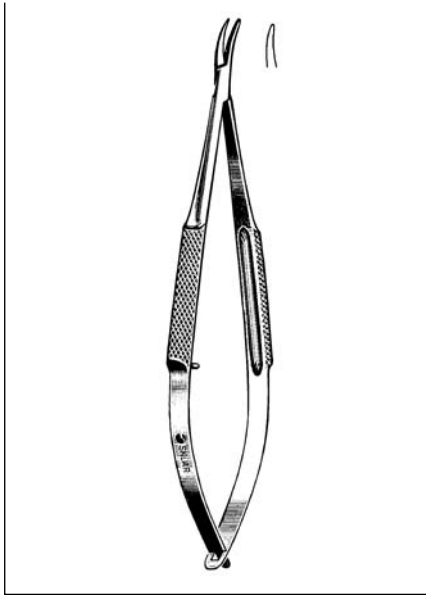

BARRAQUER NEEDLE HOLDERS

DELICATE WITHOUT LOCK

65-6452	5¼"	Curved
65-6454	5½"	Straight
65-6455	5½"	Curved
65-6456	7½"	Straight
65-6457	7½"	Curved

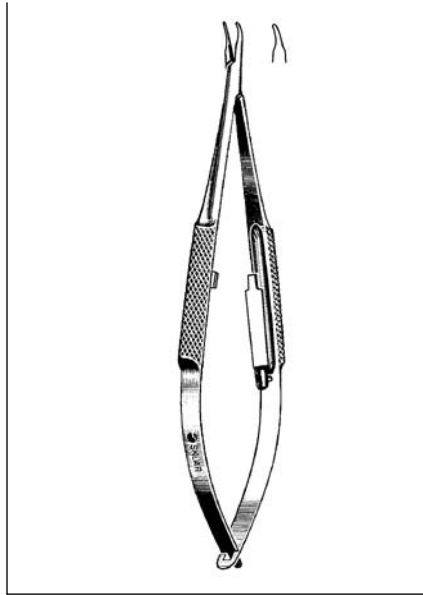

BARRAQUER NEEDLE HOLDERS

DELICATE, WITH LOCK

65-6448	5¼"	Curved
65-6445	5½"	Straight
65-6446	5½"	Curved
65-6449	7½"	Straight
65-6450	7½"	Curved

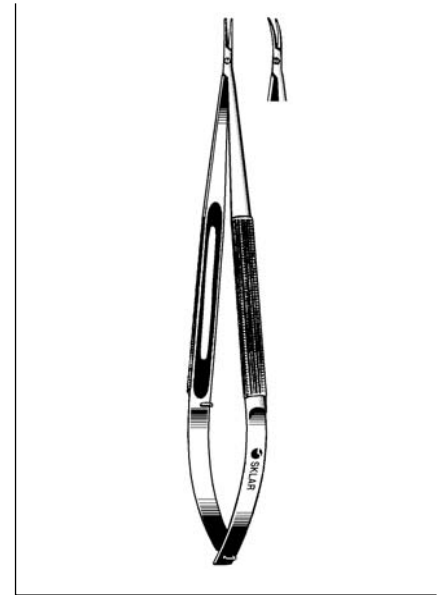

MICRO SURGERY NEEDLE HOLDERS

ROUND HANDLE, .6MM TIPS

WITHOUT LOCK

98-3182	6"	Straight
98-3183	6"	Curved
98-3186	7⅛"	Straight
98-3188	7⅛"	Curved

WITH LOCK

98-3184	6"	Straight
98-3185	6"	Curved
98-3190	7⅛"	Straight
98-3192	7⅛"	Curved

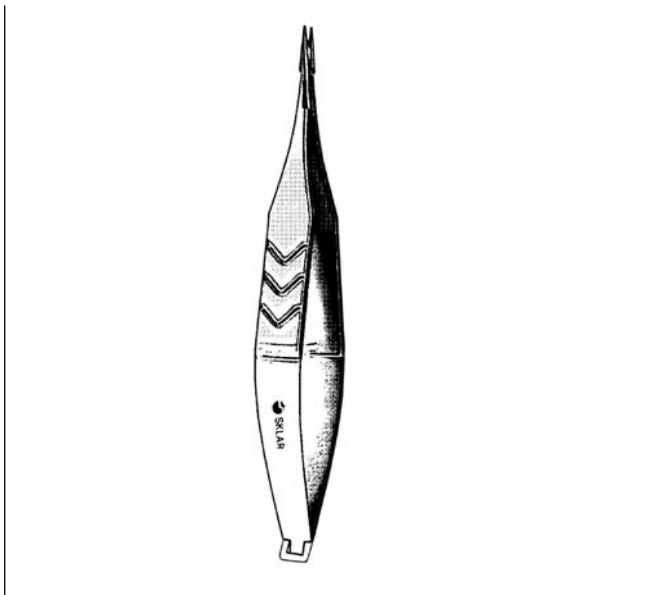

McPHERSON NEEDLE HOLDERS

VERY DELICATE, WITHOUT LOCK

65-6365	4½"	Straight
65-6366	4½"	Curved



BOYNTON NEEDLE HOLDER

DELICATE

20-3080	5"
---------	----

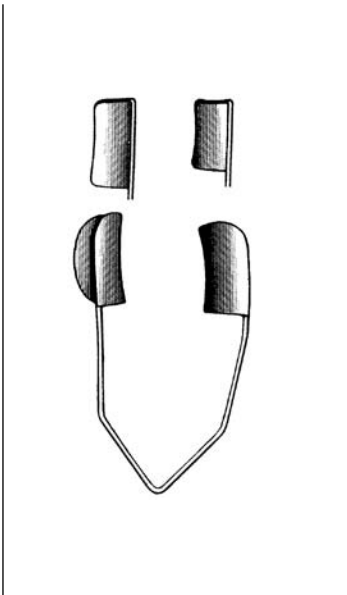

BARRAQUER WIRE SPECULUMS

SOLID, 1½"

- 65-1756 10mm Medium
- 65-1758 15mm Large

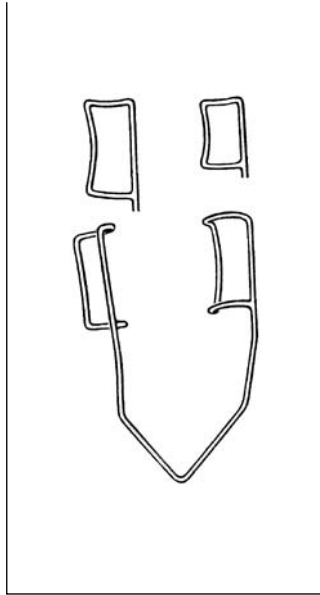

BARRAQUER WIRE SPECULUMS

FENESTRATED, 1½"

- 65-1746 8mm Small
- 65-1740 10mm Medium
- 65-1742 15mm Large
- 65-1744 15mm Large Heavy

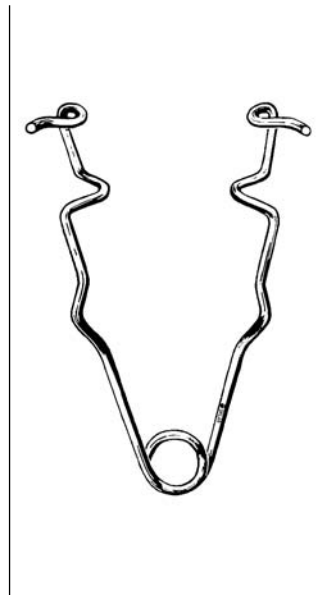

PLAIN WIRE SPECULUM

65-1127 2¾" Large

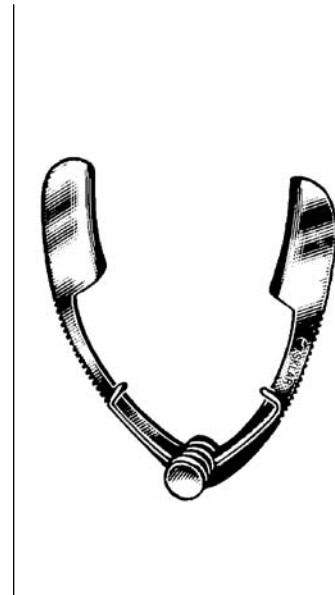

SAUER EYE SPECULUM

65-1012 1¼"

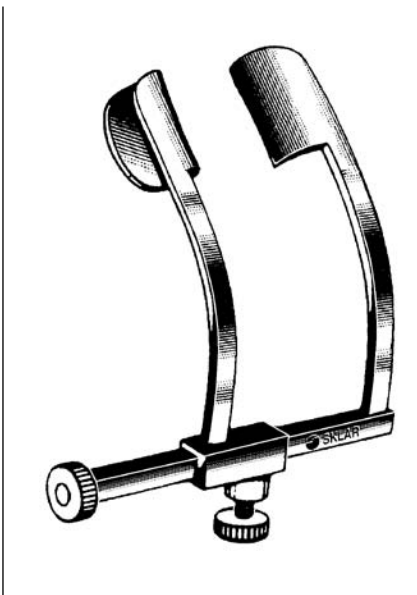

COOK EYE SPECULUMS

WITH LOCK

- 65-1765 9mm Blades 25mm Spread
- 65-1766 11mm Blades 27mm Spread

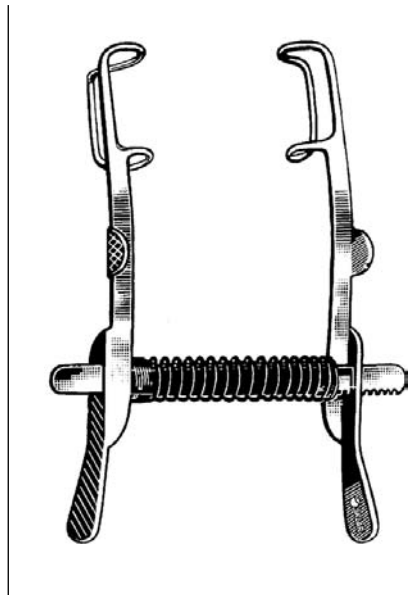

MELLINGER EYE SPECULUMS

15MM SPREAD

- 65-1426 2¾" Solid
- 65-1427 2¾" Fenestrated

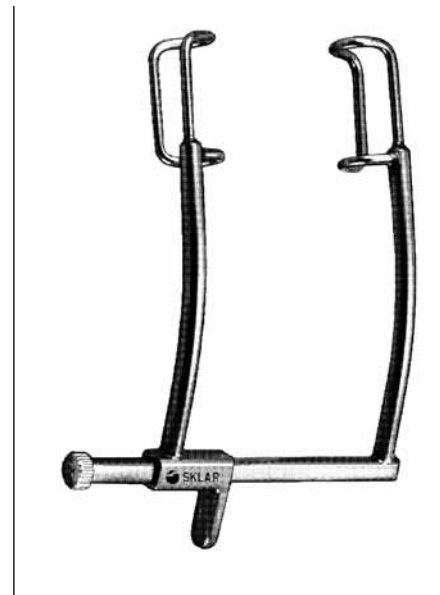

MURDOCK EYE SPECULUM

65-1540 2¼" 15mm Spread

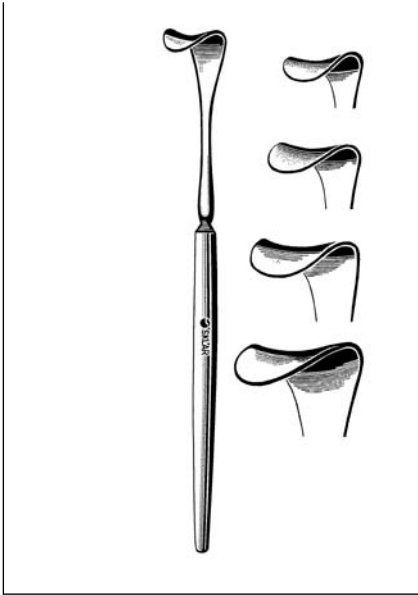

DESMARRES LID RETRACTORS

- 65-1841 6¼" 12mm Blade
- 65-1842 6¼" 14mm Blade
- 65-1843 6¼" 16mm Blade
- 65-1844 6¼" 18mm Blade

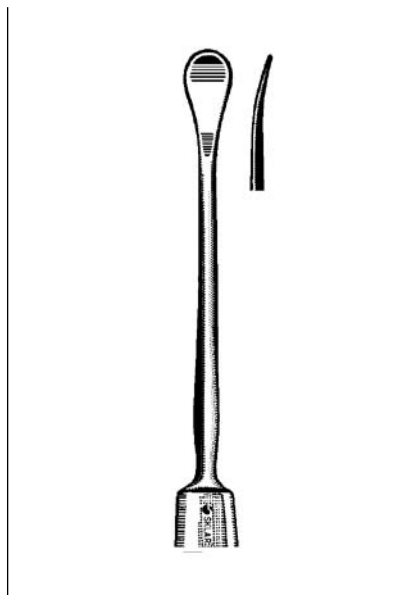

GILL CORNEAL KNIFE

- 65-3025 4¾"

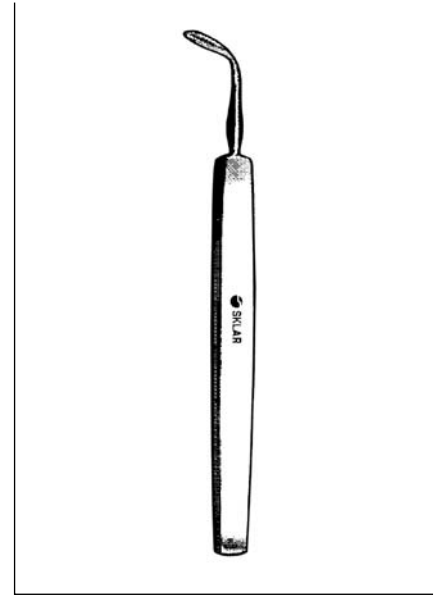

DESMARRES CORNEAL DISSECTOR

- 65-3015 4¾" 8mm Blade

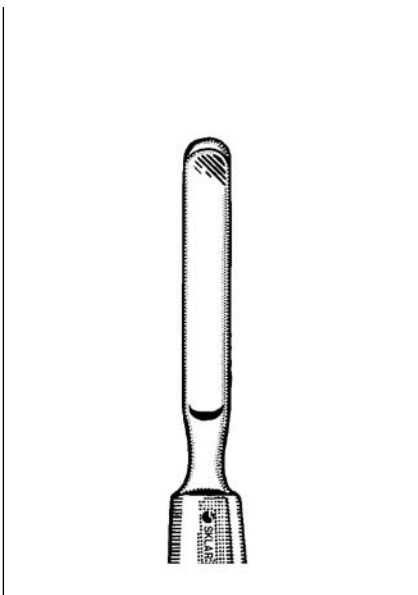

TOOKE CORNEAL KNIFE

- 65-3028 4½"

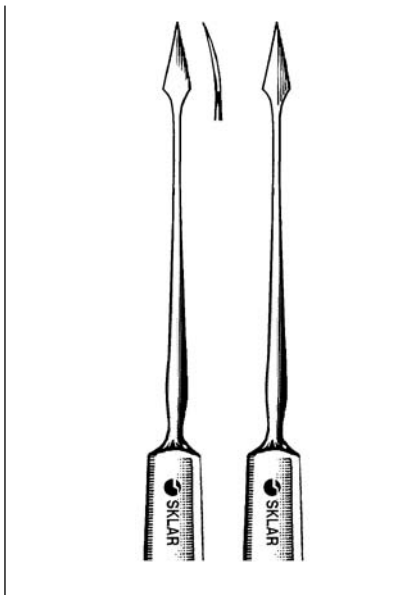

FOREIGN BODY NEEDLES

- 65-7270 Straight
- 65-7272 Curved

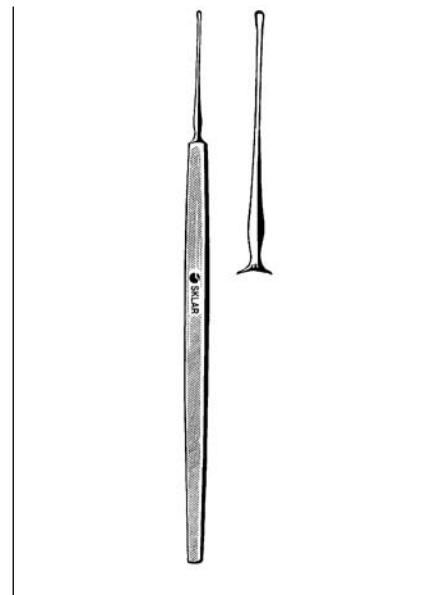

DAVIS FOREIGN BODY SPUD CHISEL

- 65-7260

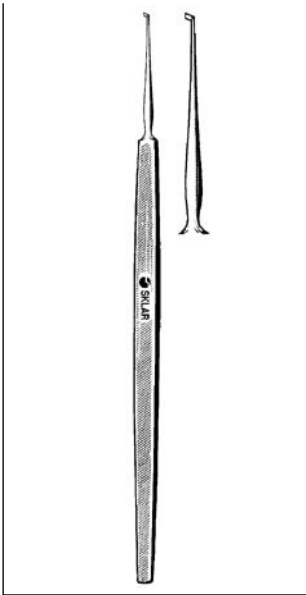

FRANCIS FOREIGN BODY SPUD
65-7257 Flag-Shape Blade

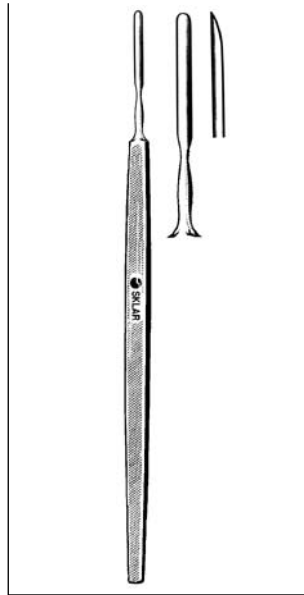

DIX FOREIGN BODY SPUD
65-7254 Beveled At Tip

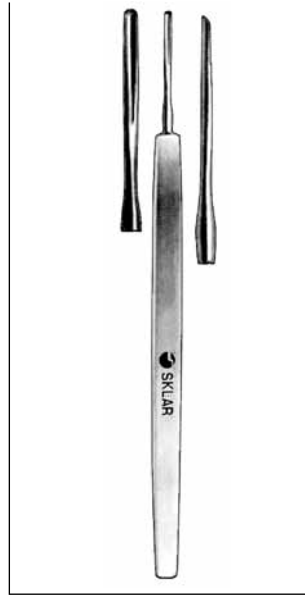

WALTON FOREIGN BODY GOUGE
65-7240 4½" Round End

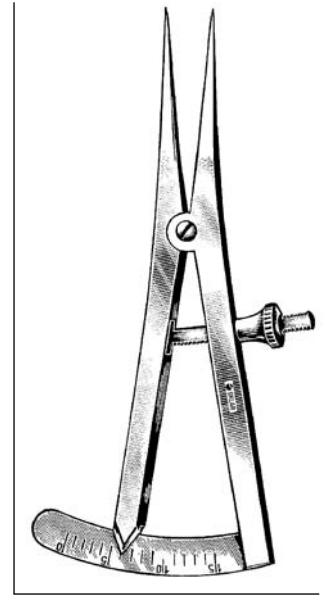

CASTROVIEJO CALIPER
GRADUATED MEASURE, 3¼"
65-6730 0-15mm Straight
65-6732 0-20mm Straight
65-6734 0-20mm Curved



SCHIOTZ ORIGINAL TONOMETER
65-7523 Contains:
Screw-on 5.5 gr. weight
2 additional weights = 7.5 and 10 gr.
Test Block, Plunger and Fitted Case



JAEGER LID RETRACTOR
STAINLESS STEEL
65-1835 4¼"

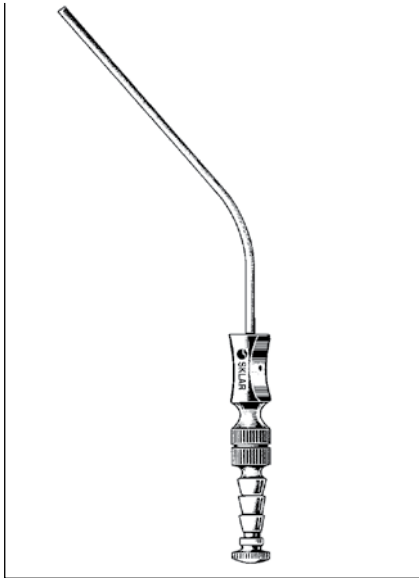

FRAZIER SUCTION TUBES

- 50-2006 6 French
- 50-2007 7 French
- 50-2008 8 French
- 50-2009 9 French
- 50-2010 10 French
- 50-2011 11 French
- 50-2012 12 French
- 50-2014 14 French



**FRAZIER SUCTION TUBES
90 DEGREE**

- 50-2206 6 French
- 50-2207 7 French
- 50-2208 8 French
- 50-2210 10 French
- 50-2212 12 French

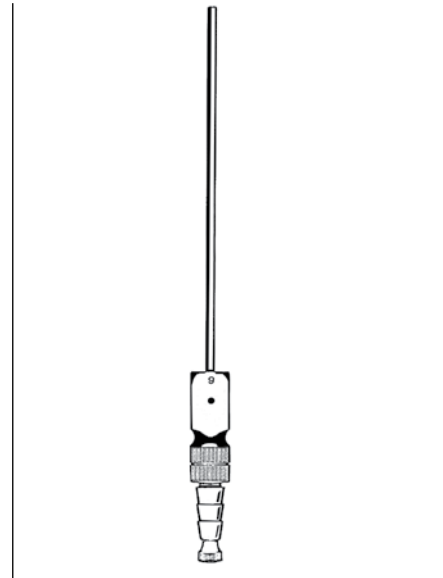

**FRAZIER FERGUSON
SUCTION TUBES**

STRAIGHT WITH THUMB CONTROL

- 50-2106 6 French
- 50-2108 8 French
- 50-2109 9 French
- 50-2110 10 French
- 50-2112 12 French

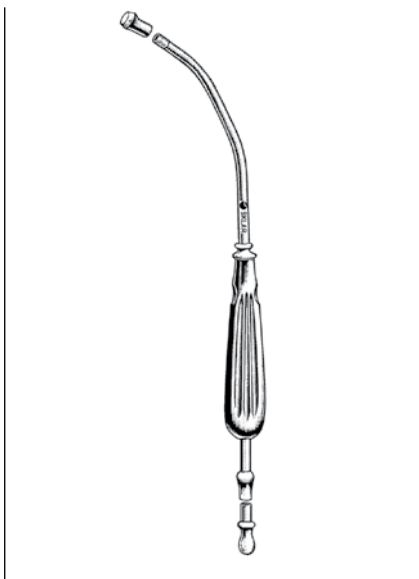

YANKAUER SUCTION TUBES

- 07-1801 11" Chrome Plated
- 07-1805 11" Stainless Steel
- 22-6585 8½" Stainless Steel, Pediatric
- 07-1802 Tip For use with 07-1801
- 07-1806 Tip For use with 07-1805
- 22-6586 Tip For use with 22-6585



BARON SUCTION TUBES

- 50-1953 3 French
- 50-1955 5 French
- 50-1957 7 French

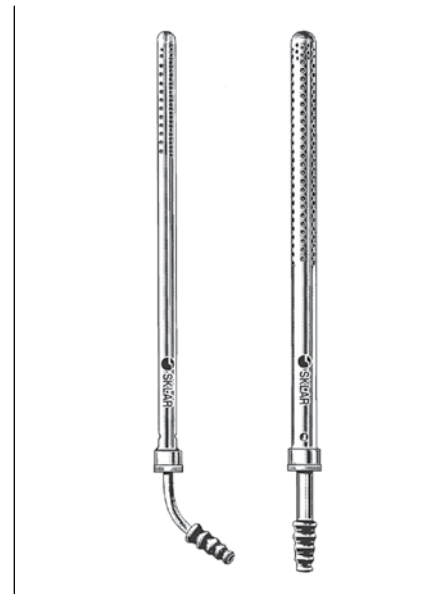

POOLE SUCTION TUBES

- 22-6577 7¾" 16 French
- 34-2023 9¼" 23 French
- 34-2230 8½" 30 French Slip On, Straight

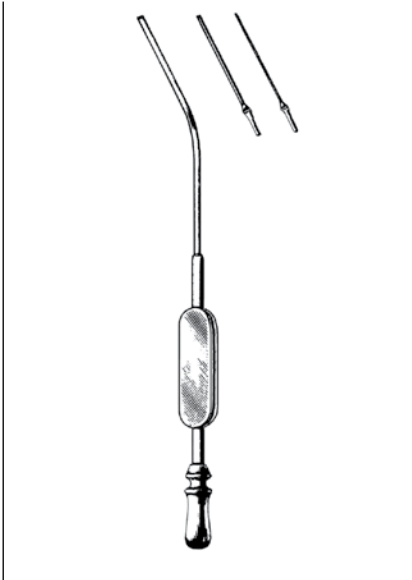

EAR SUCTION TUBE

50-1950 7" With 2 tips
20GA and 22GA

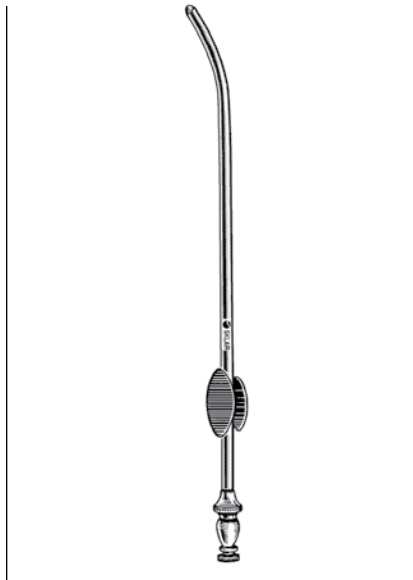

ADSON SUCTION TUBES

50-1982 6" Shaft 12 French
50-1985 7½" Shaft 15 French

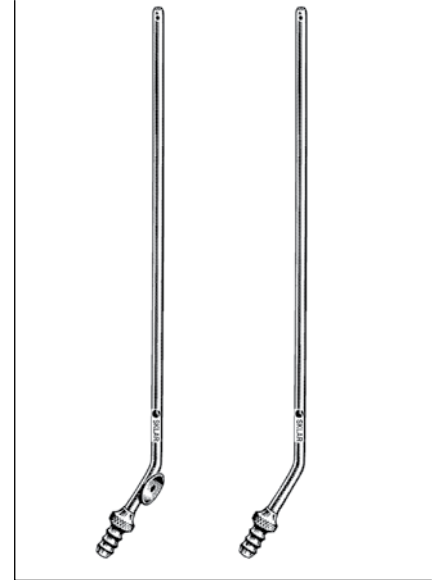

BIUE SUCTION TUBES

80-2715 16" With Valve 15 French
80-2815 16" Without Valve 15 French

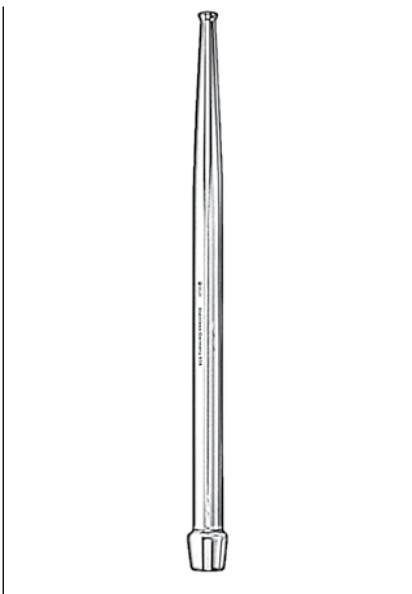

ANTHONY MASTOID SUCTION TUBES

50-2830 6½" 2mm Lumen
50-2831 6½" 3mm Lumen

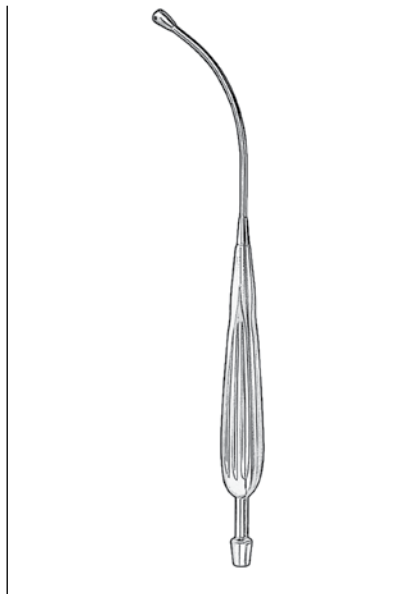

ANDREWS-PYNCHON SUCTION TUBE

22-6590 10" Delicate Pattern
22-6591 Tip For use with
22-6590

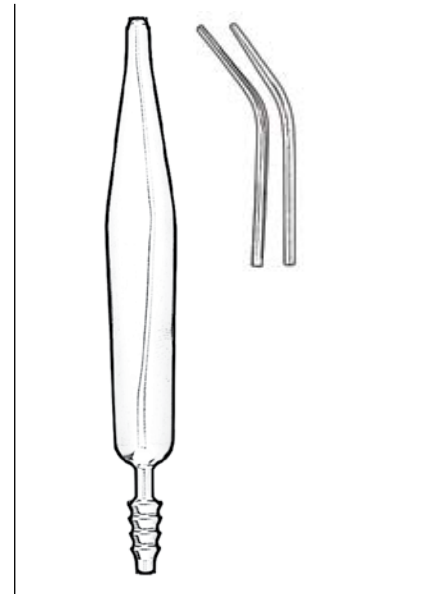

COUPLAND SUCTION TUBE

50-2825 10" 2 Interchangeable Tips
1.5mm and 2.0mm



JACKSON IMPROVED TRACHEOSTOMY TUBES

STAINLESS, REGULAR

78-2000 #00	78-2015 #5
78-2010 #0	78-2016 #6
78-2011 #1	78-2017 #7
78-2012 #2	78-2018 #8
78-2013 #3	78-2019 #9
78-2014 #4	78-2020 #10



JACKSON IMPROVED TRACHEOSTOMY TUBES

STAINLESS, SHORT LENGTH

78-2100 #00	78-2115 #5
78-2110 #0	78-2116 #6
78-2111 #1	78-2117 #7
78-2112 #2	78-2118 #8
78-2113 #3	78-2119 #9
78-2114 #4	78-2120 #10



JACKSON IMPROVED TRACHEOSTOMY TUBES

STAINLESS, EXTRA LONG

78-2214 #4	
78-2214A #4	With Adapter
78-2215 #5	
78-2216 #6	
78-2216A #6	With Adapter
78-2217 #7	
78-2218 #8	
78-2219 #9	



JACKSON IMPROVED TRACHEOSTOMY TUBES

STAINLESS, WITH ADAPTOR

78-2144 #4	78-2147 #7
78-2145 #5	78-2148 #8
78-2146 #6	78-2150 #10



JACKSON IMPROVED TRACHEOSTOMY TUBES

FOUR PIECE SET

INCLUDES OUTER, INNER, 15MM ADAPTER AND OBTURATOR

78-2030 #00	78-2024 #4
78-2029 #0	78-2025 #5
78-2031 #1	78-2026 #6
78-2032 #2	78-2027 #7
78-2033 #3	78-2028 #8



JACKSON ORIGINAL TRACHEOSTOMY TUBES
STAINLESS, REGULAR

78-1700	#00	78-1715	#5
78-1710	#0	78-1716	#6
78-1711	#1	78-1717	#7
78-1712	#2	78-1718	#8
78-1713	#3	78-1719	#9
78-1714	#4	78-1720	#10



JACKSON ORIGINAL TRACHEOSTOMY TUBES
STAINLESS, SHORT

78-1300	#00	78-1316	#6
78-1312	#2	78-1317	#7
78-1313	#3	78-1318	#8
78-1314	#4	78-1319	#9
78-1315	#5	78-1320	#10



JACKSON IMPROVED LARYNGECTOMY TUBES
STAINLESS

78-2284	#4
78-2285	#5
78-2286	#6
78-2287	#7
78-2288	#8
78-2289	#9
78-2290	#10



JACKSON ORIGINAL LARYNGECTOMY TUBES
STAINLESS

78-2254	#4	78-2258	#8
78-2255	#5	78-2259	#9
78-2256	#6	78-2260	#10
78-2257	#7		



SKLAR DECANNULATION STOPPERS
FULL SIZE

78-3130	#0	78-3135	#5
78-3131	#1	78-3136	#6
78-3132	#2	78-3137	#7
78-3133	#3	78-3138	#8
78-3134	#4	78-3139	#9



**MILLER LARYNGOSCOPE
BLADES**

ENGLISH STYLE, STANDARD

- 07-1212 Size 0
- 07-1213 Size 1
- 07-1214 Size 2
- 07-1215 Size 3
- 07-1216 Size 4



**MILLER LARYNGOSCOPE
HANDLE**

07-1420 Hook-On Medium, Standard



**MACINTOSH LARYNGOSCOPE
BLADES**

ENGLISH STYLE, FIBER OPTIC

- 07-1272 Size 0
- 07-1268 Size 1
- 07-1269 Size 2
- 07-1270 Size 3
- 07-1271 Size 4



**MACINTOSH LARYNGOSCOPE
HANDLE**

FIBER OPTIC

- 07-1400 Hook-On Medium
- 07-1170 Replacement Lamp, 6/pk



**DISPOSABLE LARYNGOSCOPE SET
SET OF 7 WITH HANDLE**

- 07-1374 Miller Blades Sizes 0, 1, 2, 3
- Macintosh Blades Sizes 2, 3, 4

SABER GROOMING SHEARS

PRODUCT NUMBER	FEATURES
93-8500	8½", Straight, Clear Finger Pads, Ergo Finger Rest
93-8501	8½", Curved, Clear Finger Pads, Ergo Finger Rest

CANINE CLASSIC GROOMING SHEARS

PRODUCT NUMBER	FEATURES
93-8504	6½", Straight, Fushia Finger Pads, Ergo Finger Rest
93-8505	7½", Straight, Green Finger Pads, Ergo Finger Rest
93-8506	8", Straight, Fushia Finger Pads, Ergo Finger Rest

CANINE SWIVEL GROOMING SHEARS

PRODUCT NUMBER	FEATURES
93-8510	8½", Straight with Tension Dial, Purple Finger Pads, Ergo Finger Rest

CANINE CONVEX GROOMING SHEARS

PRODUCT NUMBER	FEATURES
93-8512	8½", Straight with Tension Dial

STILLETTO GROOMING SHEARS

PRODUCT NUMBER	FEATURES
93-8515	8½", Curved with Semi-oval Blades, Pink Finger Pads, Ergo Finger Rest





STILLETO GROOMING SHEARS

PRODUCT NUMBER	FEATURES
93-8518	8½", Straight with Semi-oval Blades, Purple Finger Rings, Ergo Finger Rest
93-8519	10", Straight with Semi-oval Blades, Purple Finger Rings, Ergo Finger Rest



CONVEX CANINE THINNING SHEARS

PRODUCT NUMBER	FEATURES
93-8520	7", Straight with Tension Dial, Single Blade with 32 Teeth, Blue Finger Pads
93-8521	7½", Straight with Tension Dial, Single Blade with 40 Teeth, Blue Finger Pads



BLENDING SHEARS

PRODUCT NUMBER	FEATURES
93-8525	7", Straight, Single Blade with 30 Teeth, Blue Finger Pads, Ergo Finger Rest



NOSE & EAR GROOMING SHEARS

PRODUCT NUMBER	FEATURES
93-8527	4¾", Straight with Safety Tips, Blue Finger Pads



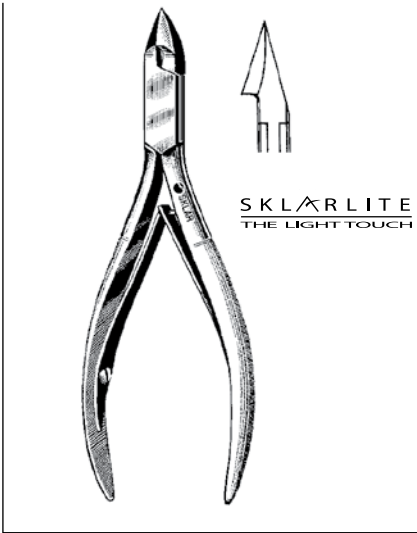

SKLARLITE
THE LIGHT TOUCH

SKLARLITE™ TISSUE NIPPER
DOUBLE SPRING, CONVEX

23-9292 4½" 11mm

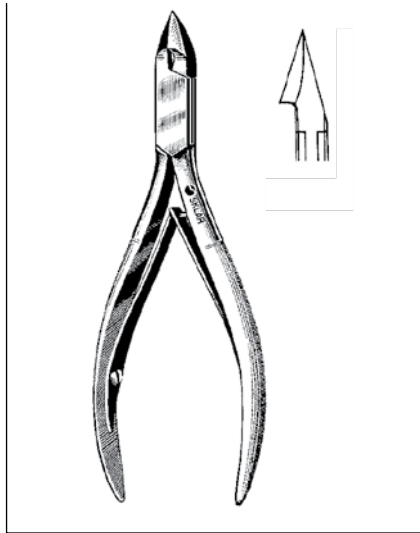

TISSUE NIPPERS
DOUBLE SPRING, CONVEX

97-1241	4"	6mm	
97-0335	4"	9mm	
97-1300	4"	9mm	Chrome
97-1242	4½"	11mm	
97-1243	5"	14mm	

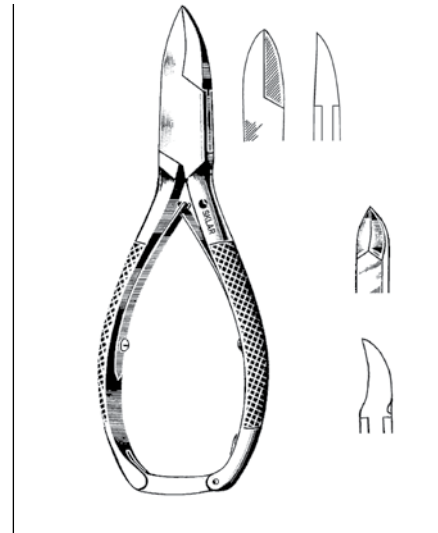

NAIL NIPPERS

DOUBLE SPRING WITH LOCK
97-1055 5½" Concave
97-1056 5½" Straight Back

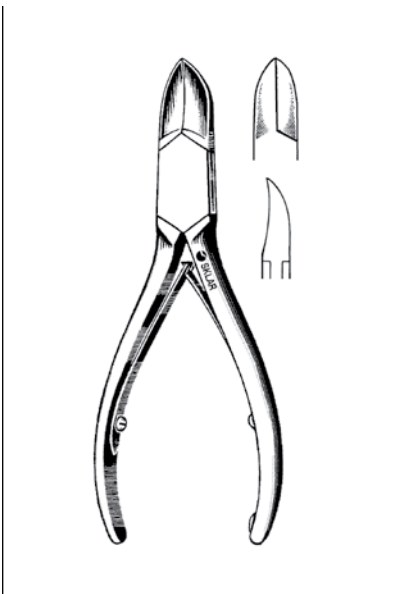

NAIL NIPPERS
CONCAVE, DOUBLE SPRING

97-1309 5½" Heavy
97-1308 6" Narrow

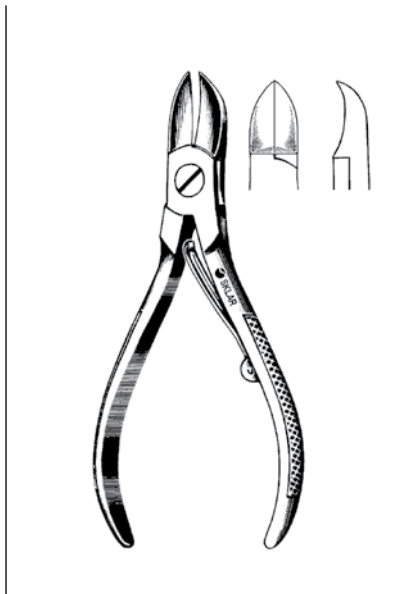

NAIL NIPPER
CONCAVE, FOLDING SPRING

97-1146 4½" Stainless Steel

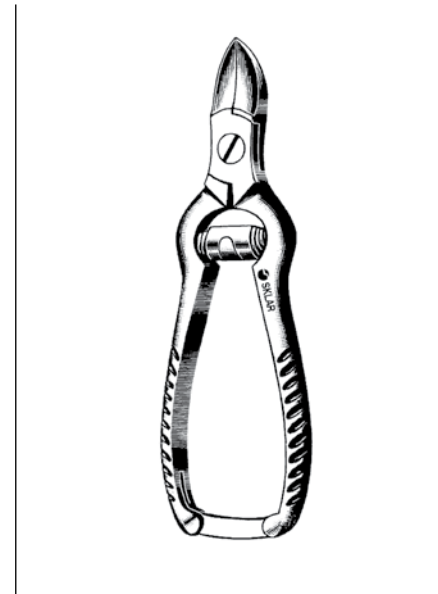

NAIL NIPPERS
CONCAVE, BARREL SPRING

97-1045 4½"
97-1046 5½"

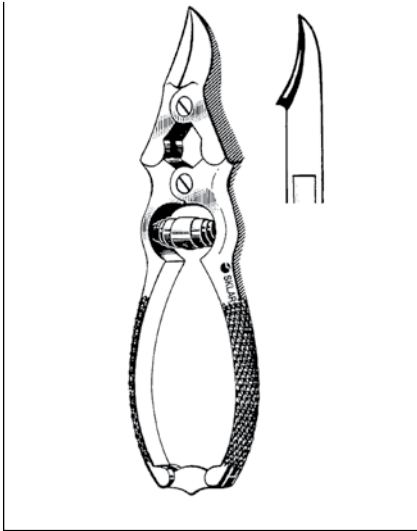

MYCOTY NAIL NIPPER
DOUBLE ACTION BARREL SPRING
97-1057 5¾"

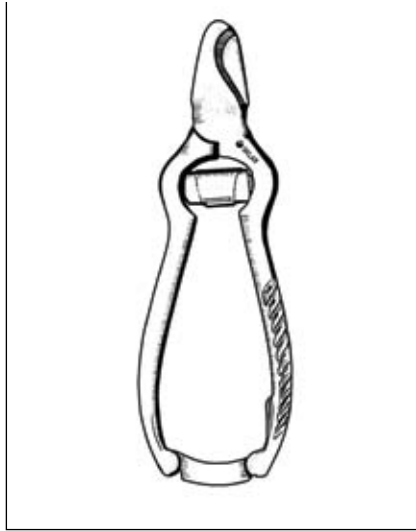

SMALL ANIMAL TOENAIL NIPPER
WITH LOCK
93-8110 5¼"

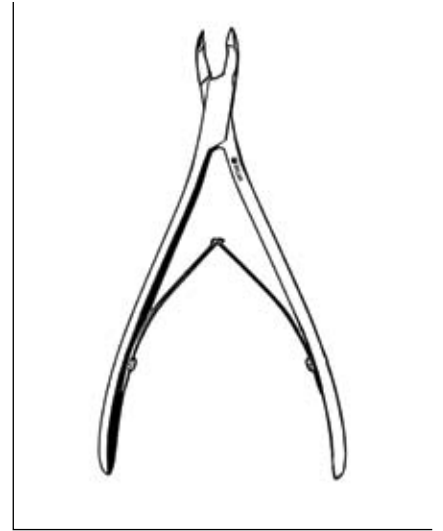

TISSUE & CUTICLE NIPPER
HEAVY
93-8135 5" Convex

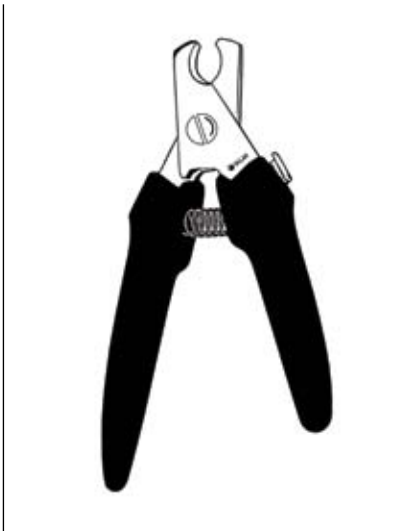

HEAVY DUTY NAIL TRIMMER
NYLON HANDLE
93-8136 6½"

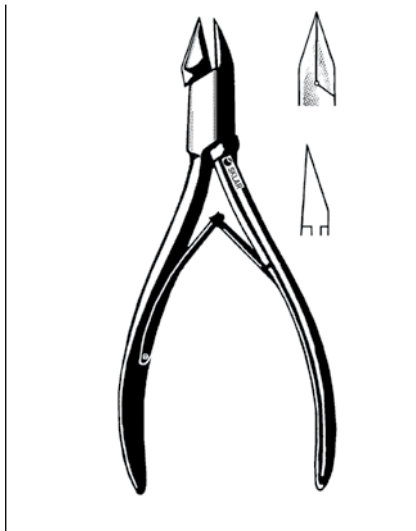

NAIL SPLITTERS
DOUBLE SPRING, STRAIGHT BACK, TAPERED JAW
97-1660 4"
97-1661 4½"
97-1662 5"
97-1663 6"

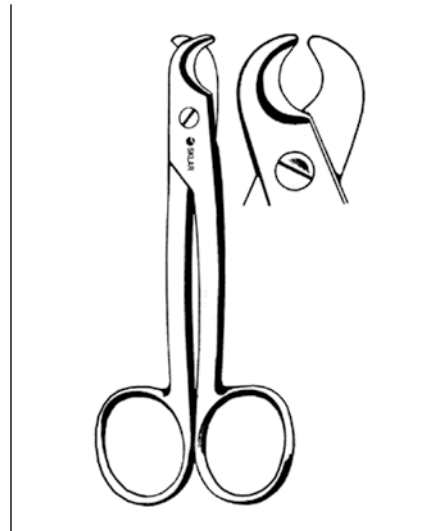

WHITE NAIL CLIPPERS
93-1445 4½"
93-8445 4½" Office Grade



CAT CLAW SCISSOR

STAINLESS

93-8115 3½"

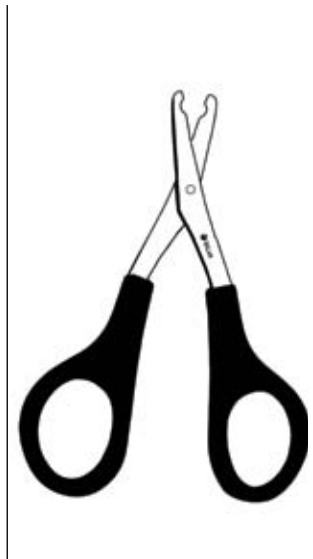

BIRD NAIL TRIMMER

NOTCHED BLADES

93-8118 3½"

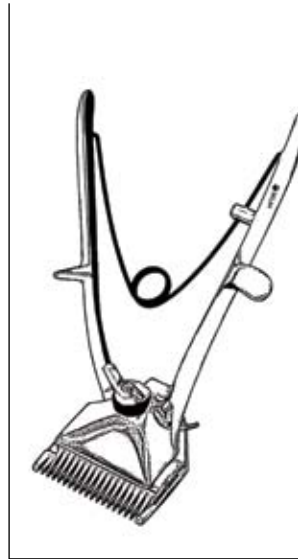

FETLOCK CLIPPERS

FOLDING SPRING, 17 X 19 TEETH

93-8120 5¾"
93-8121 Set of 2 Blades
93-8122 Wing Nut Only

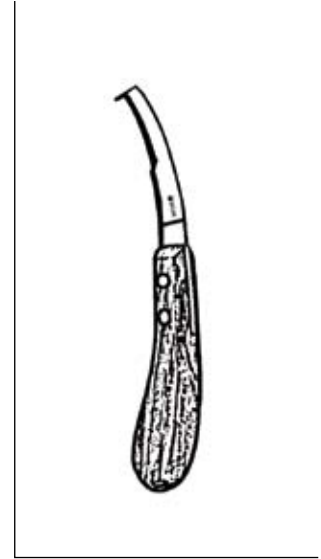

HOOF KNIVES

93-8003 8" 3/8" Blade
93-8005 8" 5/8" Blade

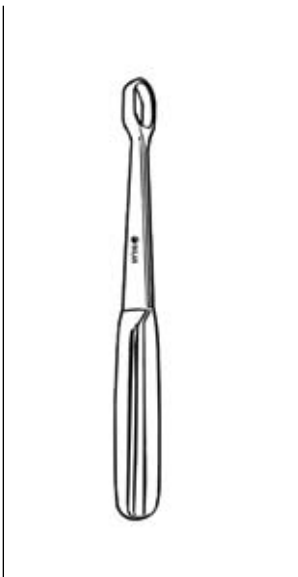

HUGHES HOOF GROOVERS

V-SHAPE

93-409 6¼"
93-8409 6¼" Office Grade

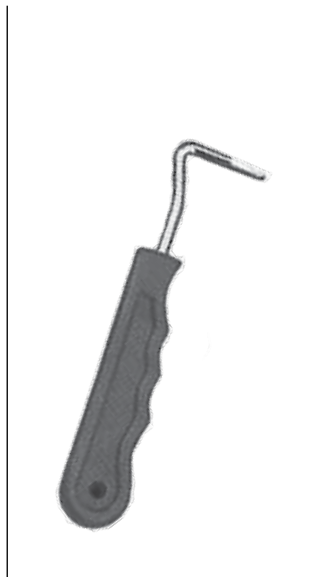

HOOF PICK

93-8130 6½"

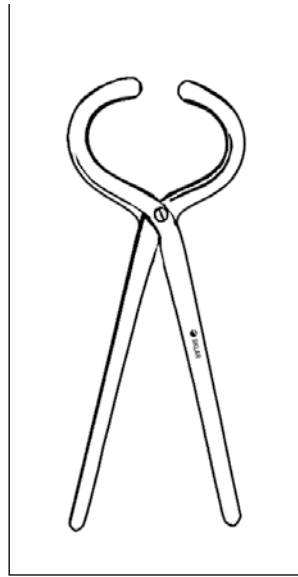

HOOF TESTERS

93-8128 13" Stainless
93-8129 13" Heavy Duty

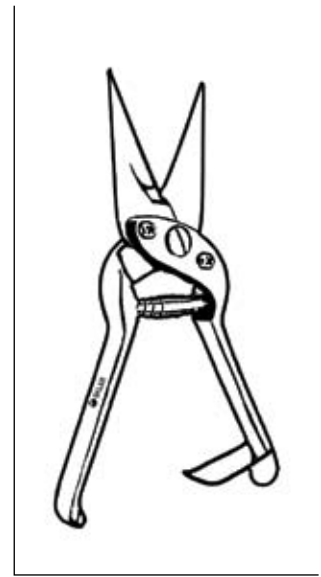

FOOT ROT SHEAR

HEAVY DUTY SPRING

93-8131 9"

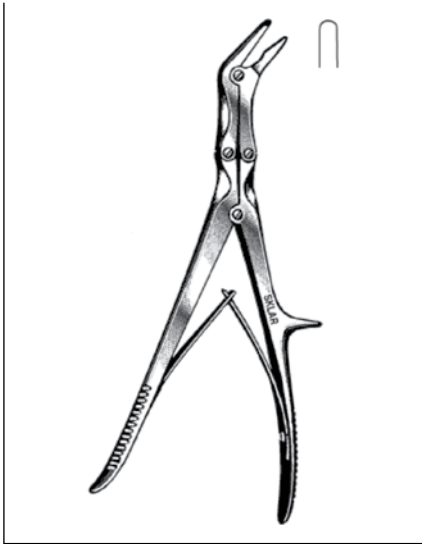

ECHLIN RONGEURS

ANGLED

40-4100	9"	2mm x 15mm Bite
40-4102	9"	3mm x 15mm Bite
40-4104	9"	4mm x 15mm Bite

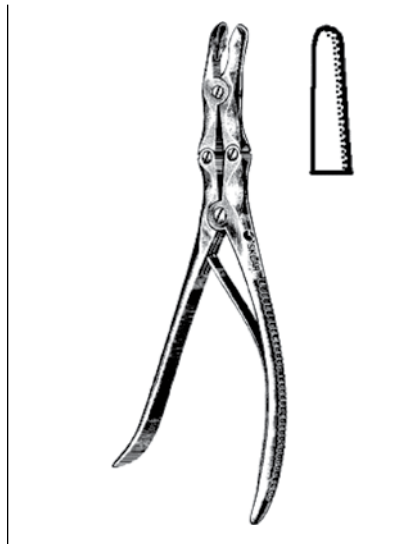

LEKSELL RONGEURS

DOUBLE ACTION, SLIGHT CURVE

40-4095	9"	3mm x 16mm Bite
40-4092	9"	8mm x 16mm Bite

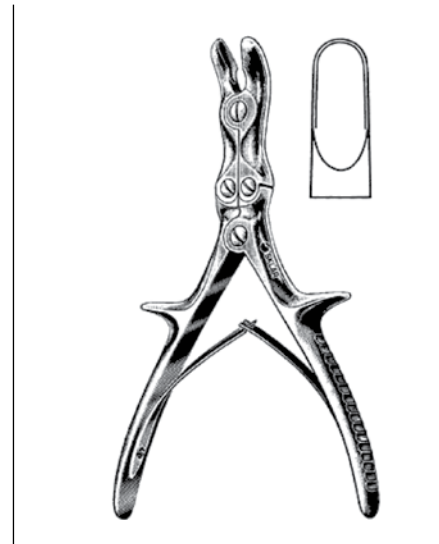

STILLE-LUER BONE RONGEURS

DOUBLE ACTION

40-3985	8½"	Straight
40-4085	8½"	Curved
40-4090	8½"	Angled

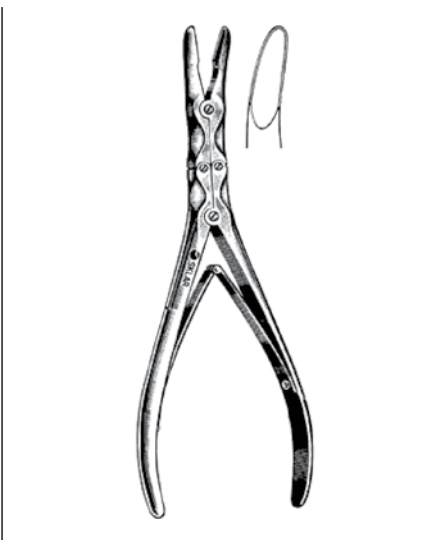

ZAUFEL JANSEN RONGEUR

DOUBLE ACTION

40-4265	7"	Curved 5mm x 15mm Bite
---------	----	------------------------

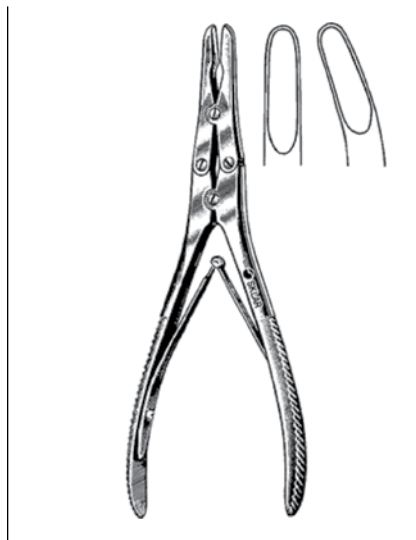

RUSKIN RONGEURS

40-4360	6"	2mm Straight
40-4365	6"	2mm Curved
40-4272	7¼"	5mm Straight
40-4372	7¼"	5mm Curved
40-4472	7¼"	5mm Angled To Side
40-4512	9½"	5mm Curved

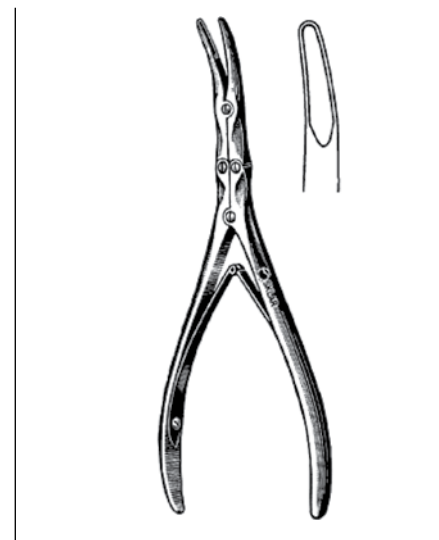

KLEINERT-KUTZ RONGEURS

DOUBLE ACTION, 6"

40-4190	Slight Curve	2mm x 13mm Bite
40-4192	Curved	3mm x 16mm Bite
40-4194	Full Curve	3mm x 8mm Bite

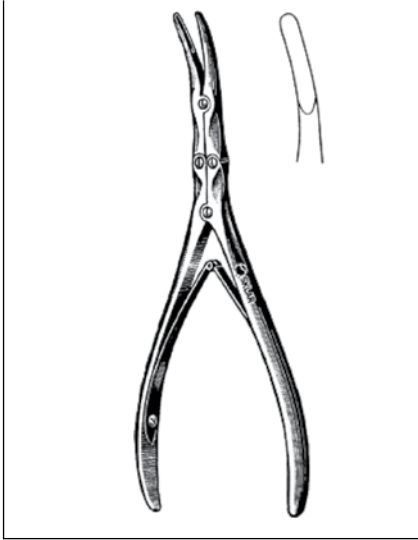

BEYER BONE RONGEURS

DOUBLE ACTION, CURVED

- 40-4268 7" 3mm x 14mm Bite
- 40-4270 7" 4mm x 15mm Bite

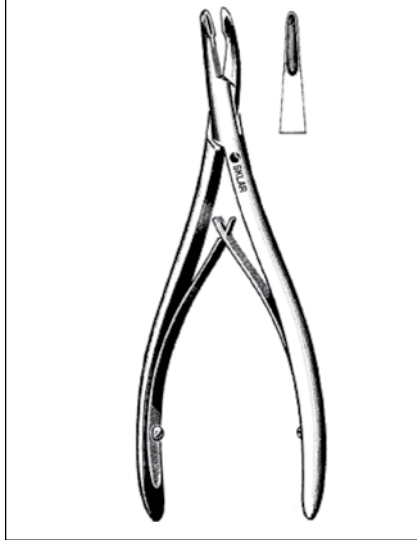

LEMPERT RONGEURS

DOUBLE ACTION

- 47-2467 6¼" Straight
- 47-2468 6¼" Curved
- 47-2465 7½" Straight
- 47-2466 7½" Curved

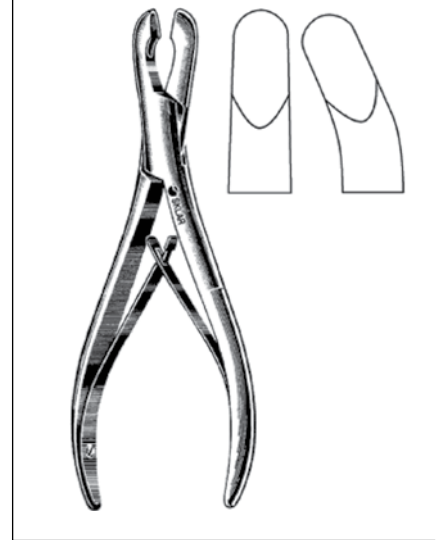

LUER BONE RONGEURS

DOUBLE ACTION, 8MM X 10MM BITE

- 40-3570 7" Straight
- 40-3670 7" Curved

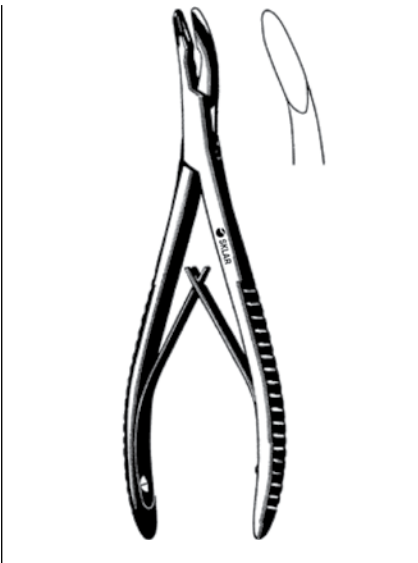

BANE RONGEUR

- 67-5175 7" Curved 3mm x 16mm Bite

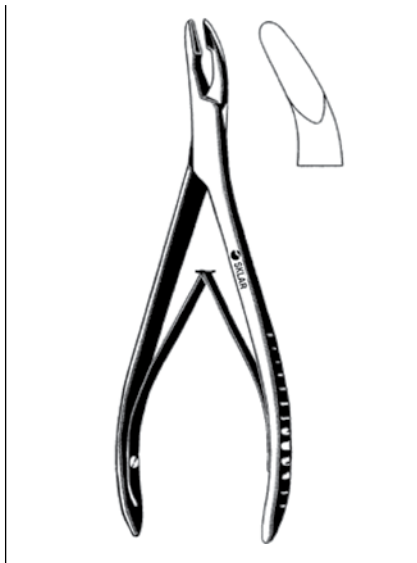

HARTMAN RONGEUR

- 67-5458 5¾" Full Curve



MEAD RONGEURS

4MM X 13MM BITE

- 40-3206 6½" Slight Curve
- 40-3208 6½" Curved



BLUMENTHAL RONGEURS

- 67-5990 6" 30° Angle
- 67-5992 6" 45° Angle
- 67-5994 6" 90° Angle



FRIEDMAN RONGEURS

- DELICATE, CURVED**
- 40-3190 5½"
 - 40-3192 6"



MICRO FRIEDMAN RONGEURS

- 1.3MM JAWS, VERY DELICATE**
- 40-3186 5½" Straight
 - 40-3189 5½" Curved
 - 40-3191 5½" 90° Angle



KERRISON RONGEURS

- 3" SHAFT**
- 65-7400 3.5mm Size 0
 - 65-7401 4.5mm Size 1
 - 65-7402 5.5mm Size 2
 - 65-7403 6.5mm Size 3

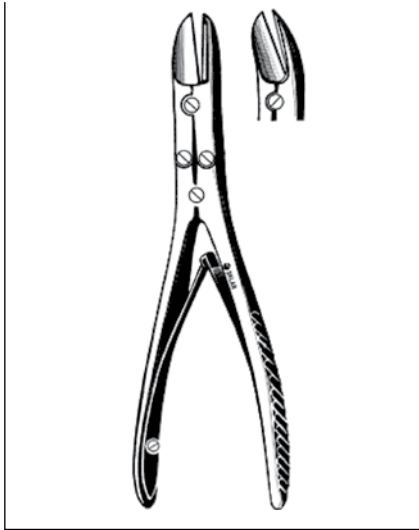

RUSKIN-LISTON BONE FORCEPS

40-4572 7¼" Straight
40-4575 7¼" Angled

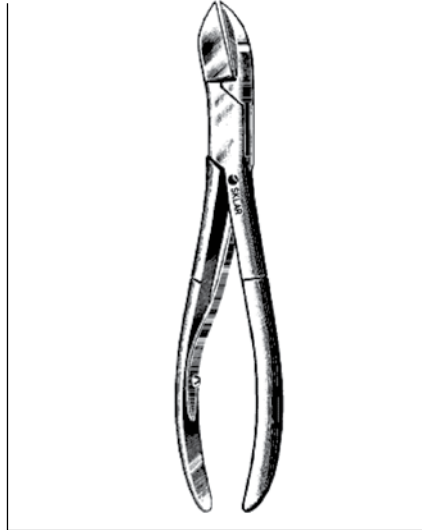

LISTON BONE FORCEPS

ANGLED
40-3155 5½"
40-3177 7¾"
40-3187 8¾"

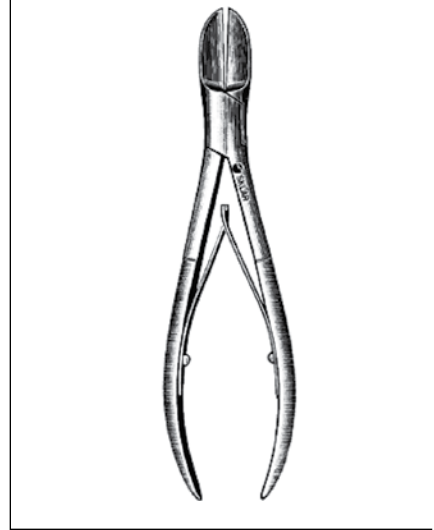

LISTON BONE FORCEPS

STRAIGHT
40-3055 5½"
40-3077 7¾"
40-3087 8¾"



STILLE-LISTON BONE FORCEPS

40-3710 10½" Straight
40-3810 10½" Curved



STILLE-HORSLEY BONE FORCEP

40-3910 10½"



GIGLI SAW HANDLES

- 40-5520 Solid Bar
- 40-5535 Wire Loop

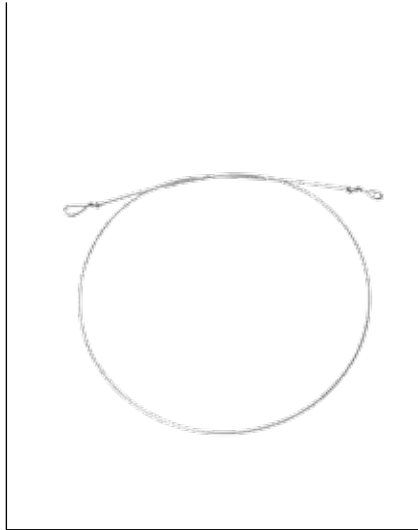

GIGLI SAW WIRES

- 40-5540 9"
- 40-5542 12"
- 40-5544 20"
- 40-5546 30"

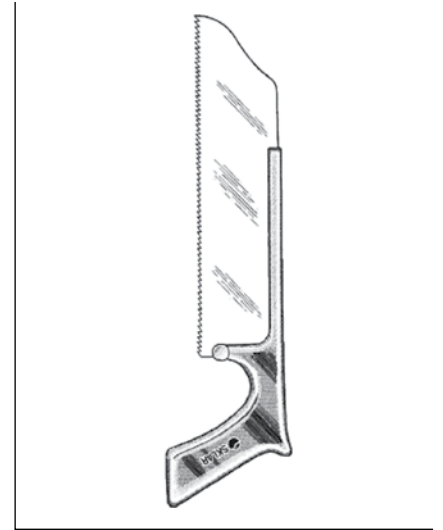

SATTERLEE BONE SAW

- 40-5311 12"
- 40-5312 8" Replacement Blade

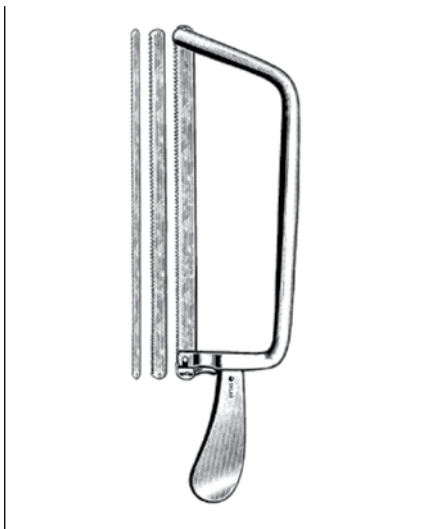

CHARRIERE BONE SAW

WITH BOW HANDLE

- 40-5213 13½" With Three 8" Blades (12mm, 15mm, 18mm)
- 40-5212 12mm Replacement Blade
- 40-5215 15mm Replacement Blade
- 40-5218 18mm Replacement Blade

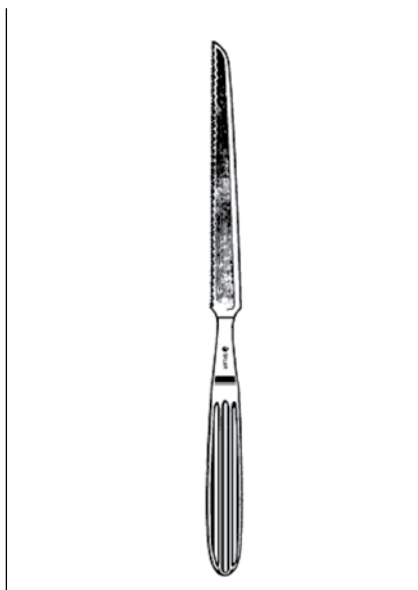

LANGENBECK METACARPAL SAW

- 40-5395 9½" 4½" Blade

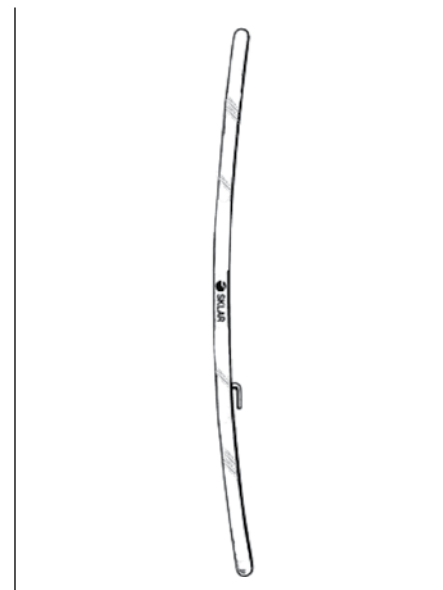

BAILEY GIGLI SAW GUIDE

- 50-2412

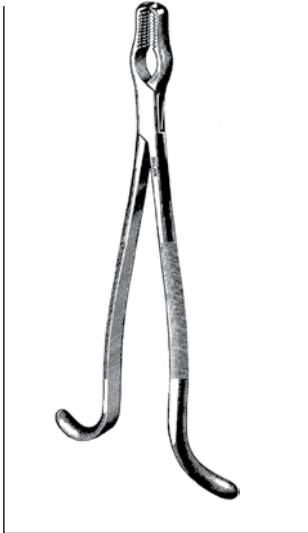

KERN BONE HOLDING FORCEPS

WITHOUT RATCHET

40-2480 5¼" Extra Small
40-2485 8½"

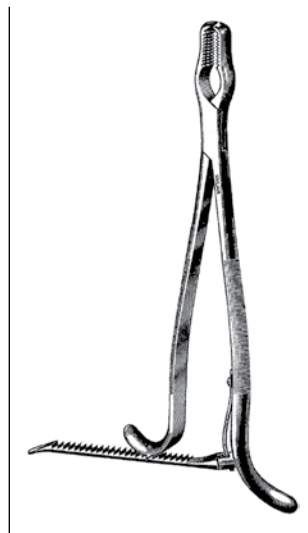

KERN BONE HOLDING FORCEPS

WITH RATCHET

40-2580 5¼" Extra Small
40-2585 8½"

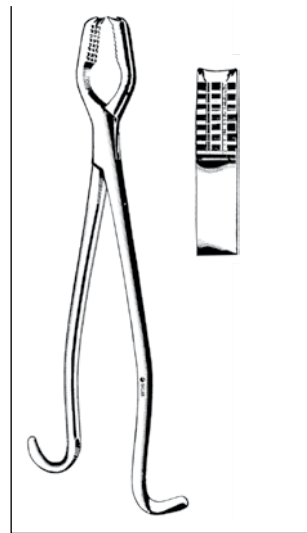

LANE BONE HOLDING FORCEPS

WITHOUT RATCHET

40-2313 13"
40-2417 17"

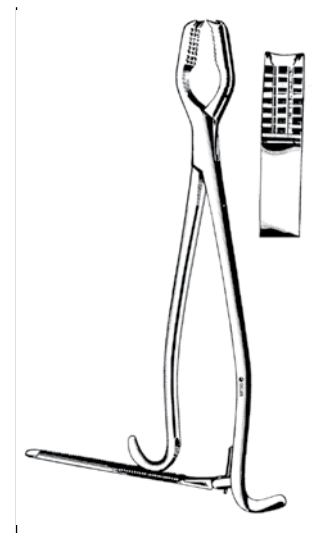

LANE BONE HOLDING FORCEPS

WITH RATCHET

40-2413 13"
40-2418 17"



FARABEU-F-LAMBOTTE BONE FORCEP

40-2810 10"

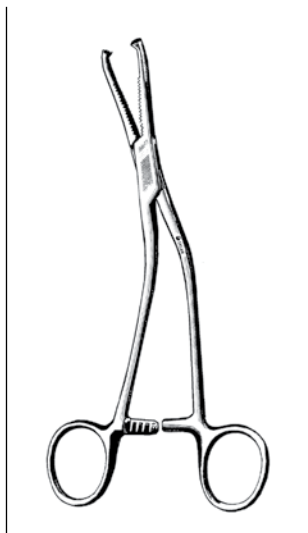

DINGMAN CLAMP

4MM

40-2660 7½" 2x2 Teeth

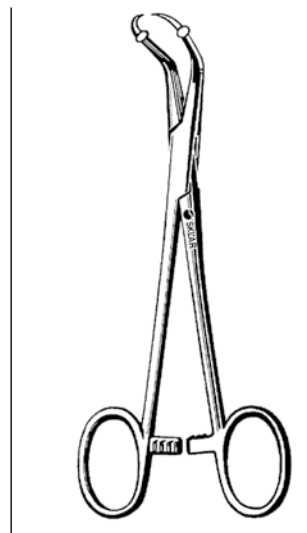

ROEDER TOWEL CLAMP

87-1052 5¼" With Ball Stops



LEWIN BONE FORCEP

40-2670 7" Serrated



VERBRUGGE BONE HOLDING FORCEPS

RATCHET HANDLE

40-2598	7"	5mm
40-2599	10¼"	10.5mm
40-2600	11"	12mm



VERBRUGGE BONE HOLDING FORCEPS

SELF-CENTERING

40-2597	6"	2.5mm
40-2596	7½"	6.5mm
40-2594	9½"	9.5mm
40-2593	10¼"	10mm
40-2592	11"	11mm

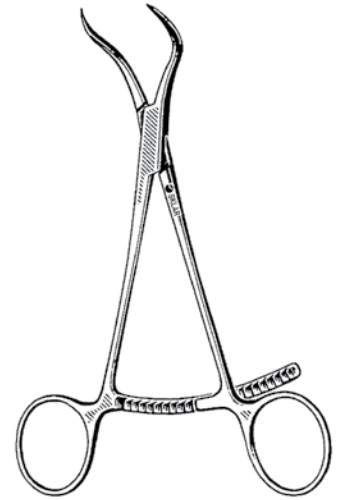

BONE COMPRESSION FORCEP

WITH LONG RATCHET AND POINTED TIP

40-2675	5½"
---------	-----



LOWMAN CLAMPS

1X1 PRONG

40-2925	4¾"	¾" Jaw
40-2927	7¼"	1⅛" Jaw
40-2928	8"	1½" Jaw



LOWMAN CLAMPS

1X2 PRONG

40-2921	4¾"	¾" Jaw
40-2922	7¼"	1⅛" Jaw
40-2923	8"	1½" Jaw



LAMBERT-LOWMAN BONE CLAMP

2X2 PRONG

40-2838	7"	1" Jaw
---------	----	--------



LOWMAN-HOGLUND BONE CLAMP

2X2 PRONG, SWIVEL HEAD

40-2828	7½"	1" Jaw
---------	-----	--------

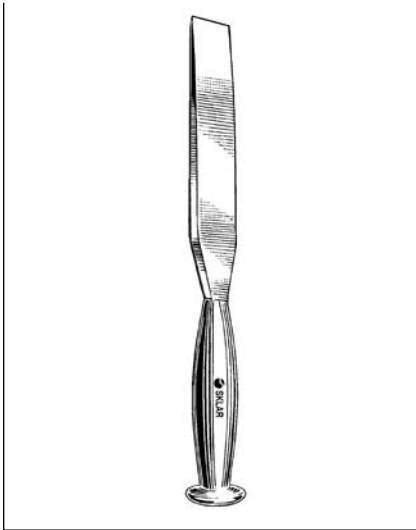

**SMITH PETERSON
OSTEOTOMES**

STRAIGHT, 8"		CURVED, 8"	
40-6771	6mm	40-6781	6mm
40-6772	10mm	40-6782	10mm
40-6773	13mm	40-6783	13mm
40-6774	16mm	40-6784	16mm
40-6775	19mm	40-6785	19mm
40-6776	25mm	40-6786	25mm
40-6777	31mm	40-6787	31mm

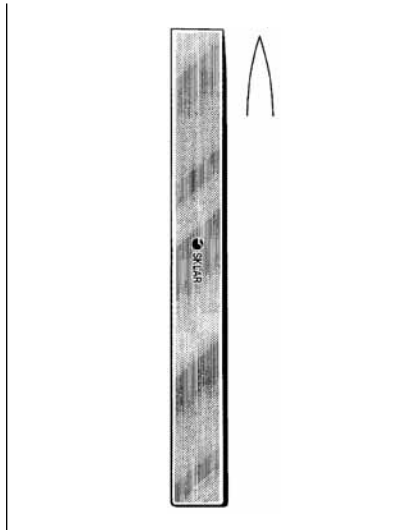

**LAMBOTTE OSTEOTOMES
STRAIGHT, DELICATE, 5"**

40-6532	2mm	40-6544	14mm
40-6534	4mm	40-6545	15mm
40-6536	6mm	40-6548	18mm
40-6538	8mm	40-6549	19mm
40-6540	10mm	40-6550	20mm
40-6542	12mm		
40-6552	Set of 9, Includes: 2, 4, 6, 8, 10, 12, 14, 18 and 20mm		

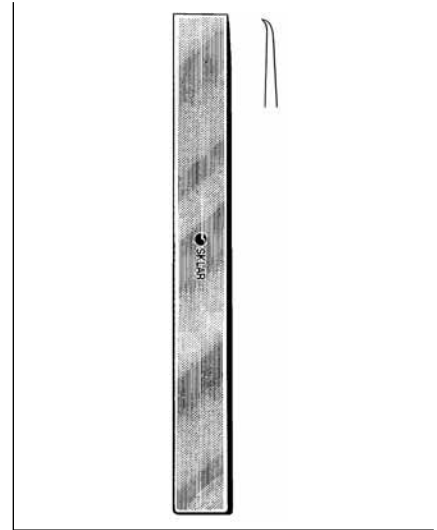

**LAMBOTTE
OSTEOTOMES**

STRAIGHT, 9"		CURVED, 9"	
40-6560	6mm	40-6570	6mm
40-6561	13mm	40-6571	13mm
40-6562	19mm	40-6572	19mm
40-6563	25mm	40-6573	25mm
40-6564	31mm	40-6574	31mm
40-6565	38mm	40-6575	38mm

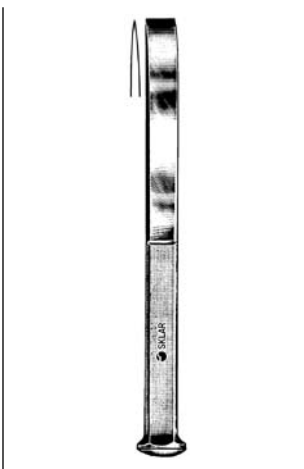

ARMY OSTEOTOMES

STRAIGHT, 6½"	
40-6206	6mm
40-6212	12mm
40-6218	18mm

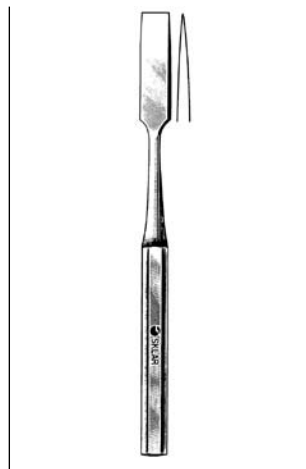

HIBBS OSTEOTOMES

STRAIGHT, 9½"	
40-6666	6mm
40-6667	10mm
40-6668	13mm
40-6669	16mm
40-6670	19mm
40-6671	22mm
40-6672	25mm
40-6673	28mm
40-6674	32mm
40-6675	38mm

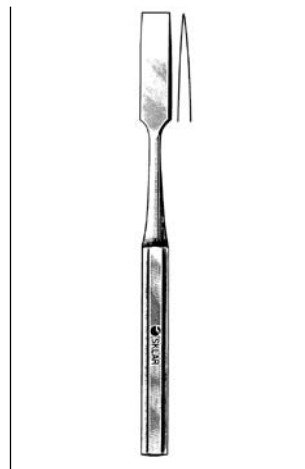

HIBBS OSTEOTOMES

CURVED, 9½"	
40-6680	6mm
40-6681	10mm
40-6682	13mm
40-6683	16mm
40-6684	19mm
40-6685	22mm
40-6686	25mm
40-6687	28mm
40-6688	31mm
40-6689	38mm

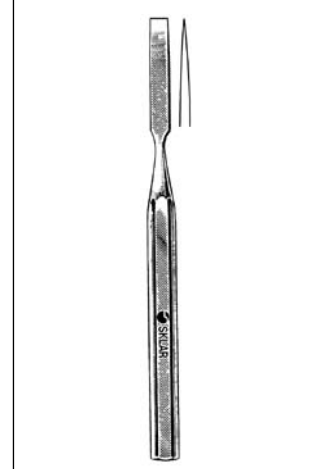

HOKE OSTEOTOMES

STRAIGHT, 5½"	
40-6953	3mm
40-6954	4mm
40-6956	6mm
40-6958	8mm
40-6970	10mm
40-6973	13mm
40-6976	16mm
40-6979	19mm



ARMY CHISELS

40-6106	6½"	6mm
40-6112	6½"	12mm
40-6118	6½"	18mm



HIBBS CHISELS

STRAIGHT, 9½"		CURVED, 9½"	
40-6701	6mm	40-6731	6mm
40-6711	10mm	40-6732	10mm
40-6715	13mm	40-6733	13mm
40-6716	16mm	40-6734	16mm
40-6717	19mm	40-6735	19mm
40-6723	22mm	40-6736	22mm
40-6724	25mm	40-6737	25mm
40-6725	28mm	40-6738	28mm
40-6726	31mm	40-6739	31mm
40-6728	38mm	40-6740	38mm



ALEXANDER CHISELS

67-4604	7"	4mm
67-4606	7"	6mm
67-4608	7"	8mm
67-4610	7"	10mm
67-4612	7"	12mm
67-4614	7"	14mm



FREER CHISELS

41-1330	6½"	Straight, 4mm
41-1332	6½"	Curved, 4mm



ARMY GOUGES

40-6306	6½"	6mm
40-6312	6½"	10mm
40-6318	6½"	14mm



SMITH PETERSON GOUGES

STRAIGHT, 8"		CURVED, 8"	
40-6791	6mm	40-6799	6mm
40-6792	9mm	40-6800	9mm
40-6793	13mm	40-6801	13mm
40-6794	16mm	40-6802	16mm
40-6795	19mm	40-6803	19mm
40-6796	25mm	40-6804	25mm
40-6797	32mm	40-6805	32mm

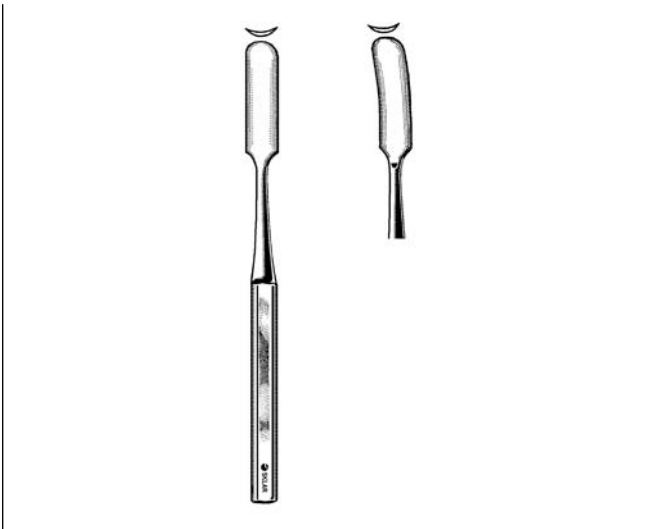

HIBBS GOUGES

STRAIGHT, 9½"		CURVED, 9½"	
40-6828	6mm	40-6850	6mm
40-6829	9mm	40-6851	9mm
40-6830	10mm	40-6852	10mm
40-6831	13mm	40-6853	13mm
40-6833	16mm	40-6843	16mm
40-6832	19mm	40-6844	19mm
40-6835	22mm	40-6845	22mm
40-6836	25mm	40-6846	25mm
40-6837	29mm	40-6847	29mm
40-6838	32mm	40-6848	32mm
40-6839	38mm	40-6849	38mm



ALEXANDER GOUGES

67-4508	7"	8mm
67-4510	7"	10mm
67-4512	7"	12mm
67-4514	7"	14mm



GERZOG MALLET

40-5765 7½" Lead Fill

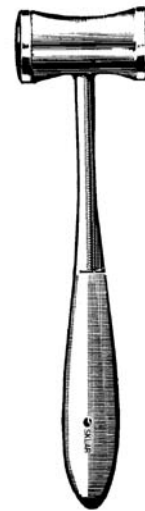

LUCAE BONE MALLET

40-5875 Small

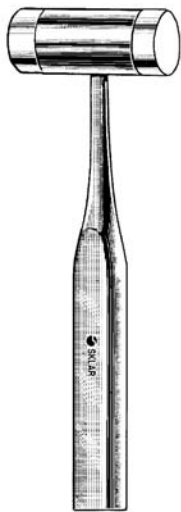

MALLET

40-5925 With 2 Plastic Flat Ends
40-5926 Replacement Ends

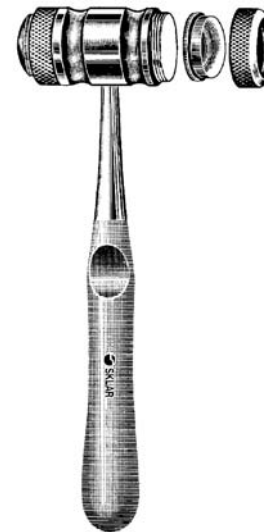

SKLAR MALLET

40-5870 With Plastic Ends
40-5871 Replacement Ends



PEET (COTTLE) RASPS

DIAMOND COATED

- 97-1520 7½" Straight
- 97-1521 7½" Curved

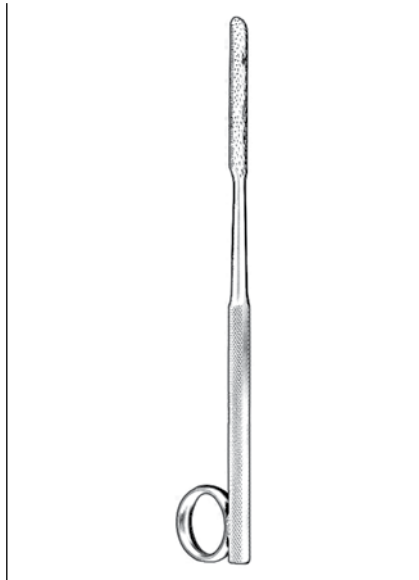

GALLAHER RASPS

COARSE

- 70-2295 6⅔" Straight
- 70-2296 6⅔" Curved Left
- 70-2297 6⅔" Curved Right

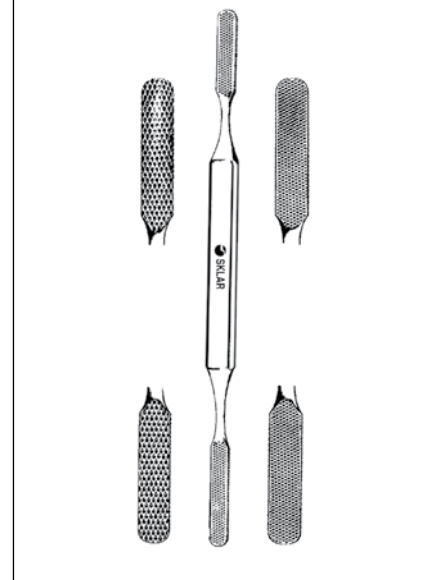

FOMON RASPS

DOUBLE ENDED, FLAT & CONVEX

- 40-9686 8¼" 2 Sided, Coarse
- 40-9688 8½" 4 Sided, Coarse & Fine

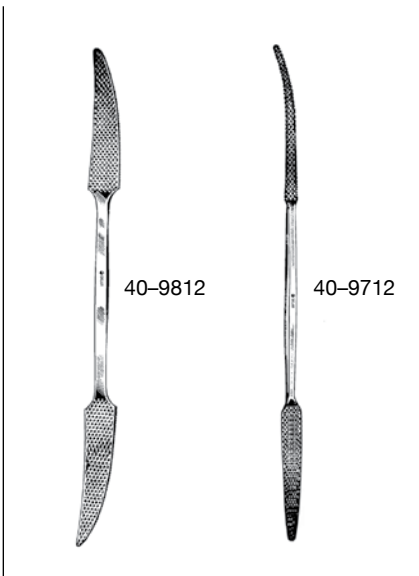

PUTTI BONE RASPS

TAPERED TIPS

- 40-9812 10¾" One Side Curved on Flat
One Side Curved Sideways
- 40-9712 12" One Side Straight, Flat/
Rounded. One Side Curved,
Conical

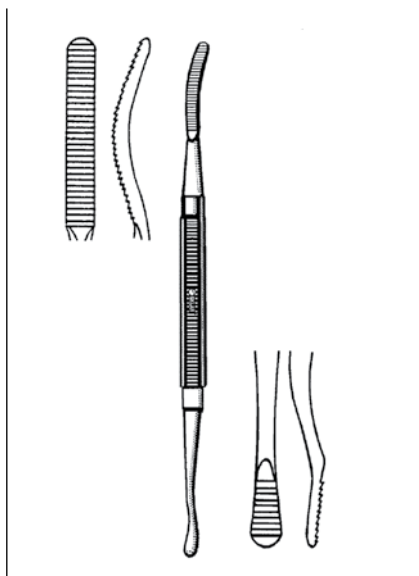

BONE FILE #10

DOUBLE END, PLAIN SERRATIONS

- 97-1615 7½" One End Curved
One End Flat

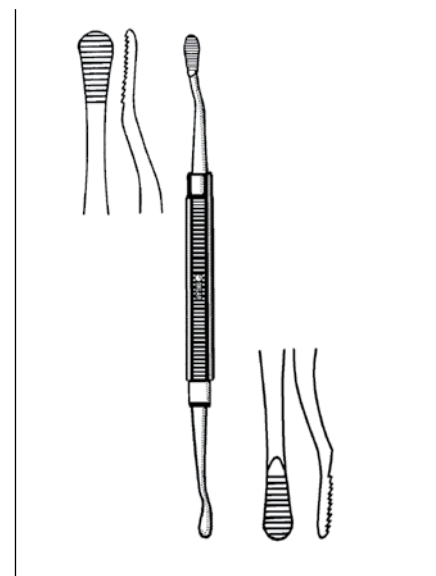

BONE FILE #12

DOUBLE END

- 97-1620 7" Plain Serrations

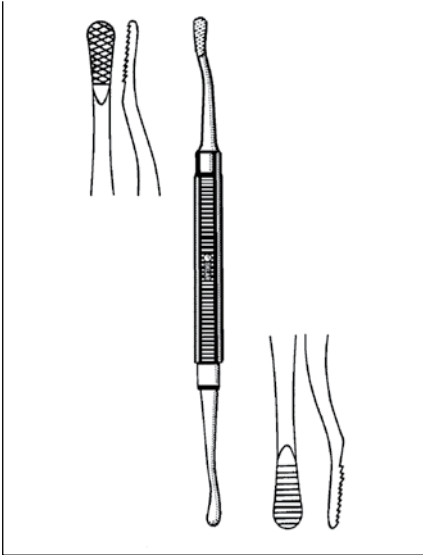

BONE FILE #12A
DOUBLE END
 97-1625 7" One End Plain Serrations
 One End Cross Serrations

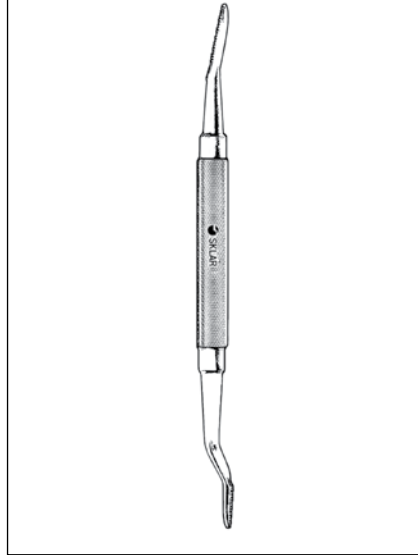

BONE FILE (MILLER) #33
DOUBLE END
 97-1533 7" Plain Serrations

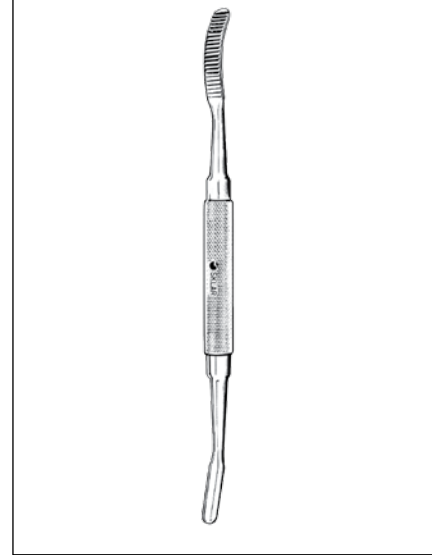

BONE FILE (MILLER) #45
DOUBLE END
 97-1545 7" Plain Serrations



BONE FILE (MILLER) #64
DOUBLE END
 97-1564 7" Plain Serrations

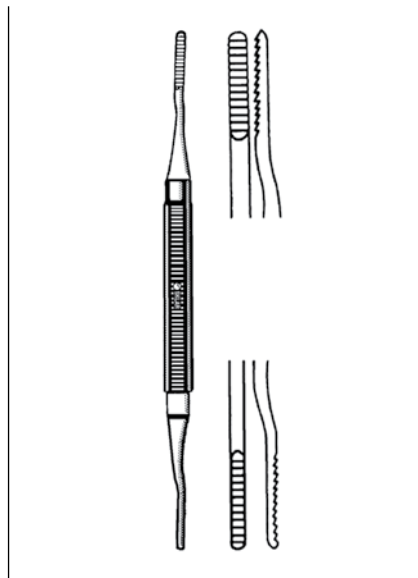

NAIL/BONE FILES
DOUBLE END
 97-1640 7" 3-4mm
 97-1635 8½" 5-6mm

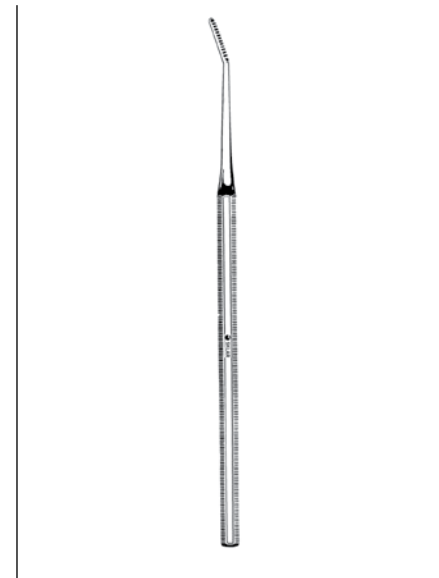

POLOKOFF RASP
SINGLE END
 97-1642 6½" Medium Serrations



FREER ELEVATOR
DOUBLE END
 47-2380 7¼" Blunt/Sharp

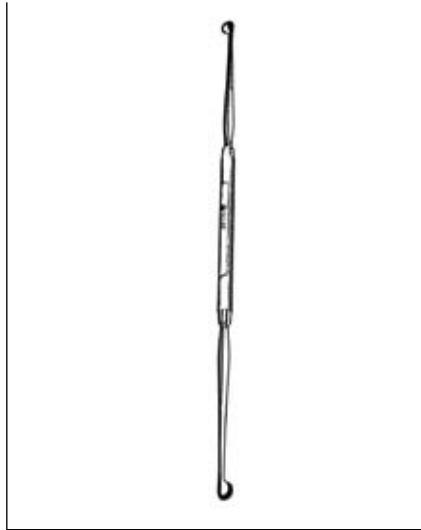

PIERCE ELEVATOR
DOUBLE END
 40-2379 8½" Right and Left Blades

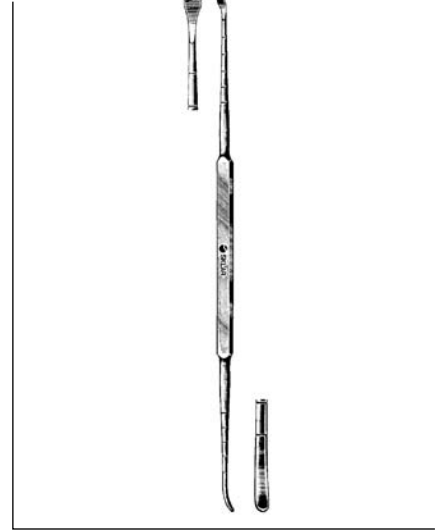

COTTLE ELEVATOR
DOUBLE END
 41-1235 9" Centimeter Graduations

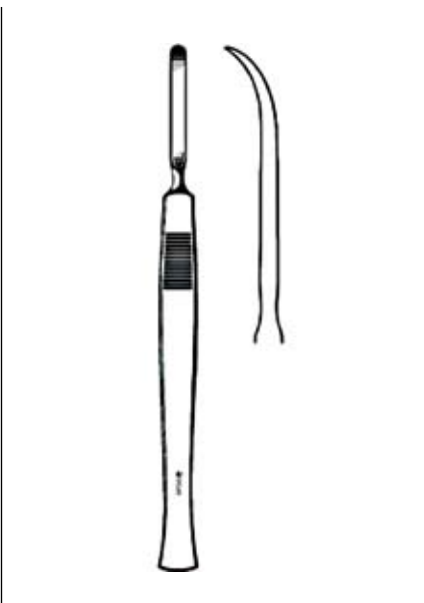

McKENTY SEPTUM ELEVATORS
CURVED
 47-2385 6" 4mm
 47-2388 6" 5mm

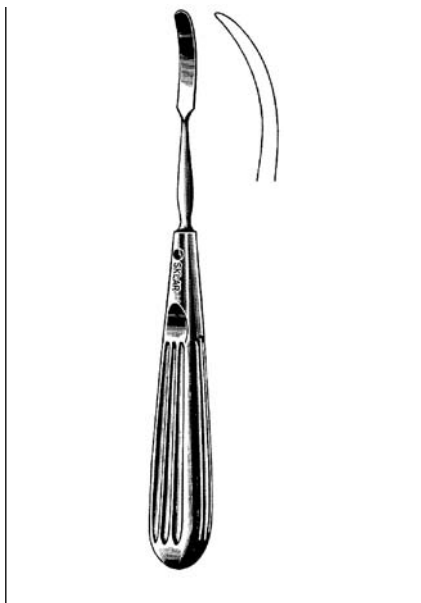

JOSEPH PERIOSTEAL ELEVATORS
STRONG CURVE
 41-1245 6¼" 4.5mm
 41-1240 7" 6.5mm

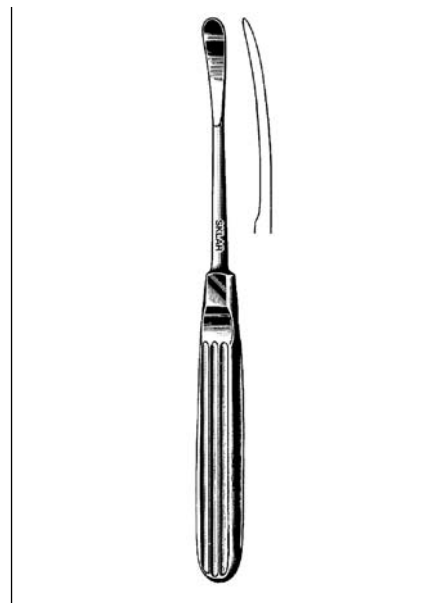

COTTLE PERIOSTEAL ELEVATOR
SLIGHT CURVE
 41-1250 7½" 9mm



SEDILLOT PERIOSTEAL ELEVATOR

40-9370 7" 16mm Sharp

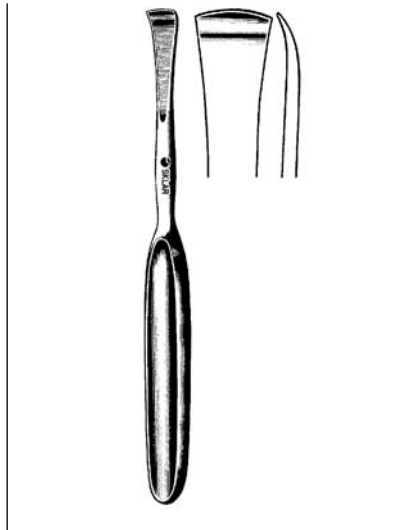

LANGENBECK ELEVATORS

40-8675 7½" Narrow
40-8775 7½" Broad

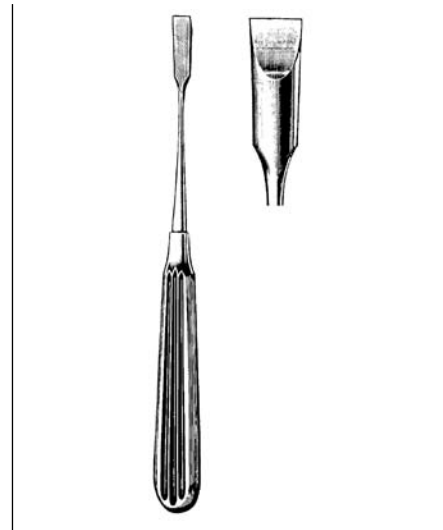

ADSON ELEVATORS

40-8270 6¾" Square End
40-8272 6¾" Round End

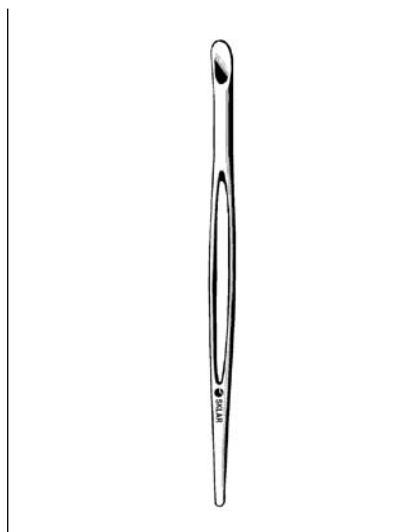

SAYRE ELEVATORS

DOUBLE END

40-9265 6½" Sharp
40-9365 6½" Blunt

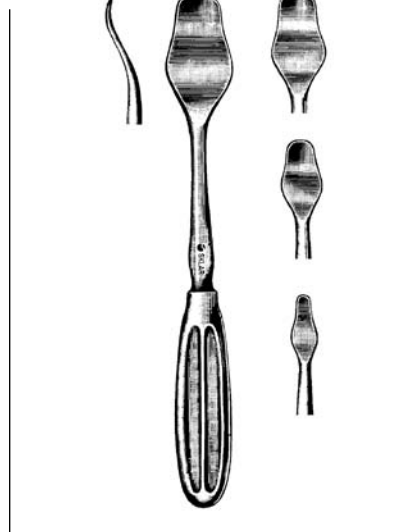

CHANDLER ELEVATORS

40-7430 7" ½" Width
40-7435 8" ¾" Width
40-7440 9" 1" Width
40-7445 10" 1¼" Width



CREGO ELEVATORS

40-7420 8" Slight Curve 6mm
40-7415 8" Full Curve 6mm



CREGO ELEVATOR

FULL CURVE

40-7410 7¾" 14mm

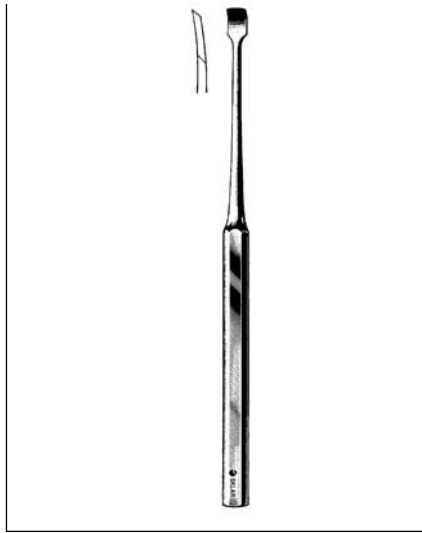

KEY ELEVATORS

40-7400 7½" ¼" Width

40-7401 7½" ⅜" Width

40-7402 7½" ½" Width

40-7404 7½" ¾" Width

40-7406 7½" 1" Width



SELDIN ELEVATOR

DOUBLE END

97-0527 8"

SKLARSAFE™ SAFETY SCALPELS



LATEX-FREE

- Protective, transparent sheath can be opened, closed, and locked with a single hand.
- Precision stainless steel blade made in England.
- Sturdy, "Sure-Grip" handle.
- Audible "click" when sheath advanced to locked position.
- OSHA Compliant.
- Individually sealed in sturdy film and Tyvek® pack.

STERILE

PRODUCT NUMBER	FEATURES	QUANTITIES
06-3094	#10	10/box
06-3095	#11	10/box
06-3096	#15	10/box

NON-STERILE

06-3130	#10	500/cs
06-3132	#11	500/cs
06-3134	#15	500/cs

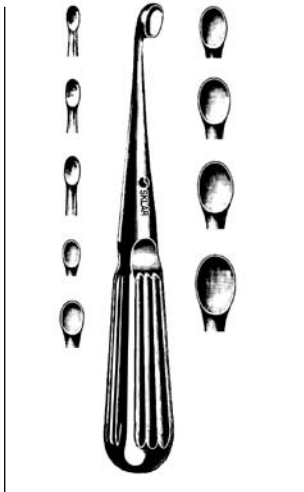

BRUNS CURETTES

SINGLE END-OVAL	STRAIGHT 6¾"
40-7118	#00000
40-7120	#0000
40-7000	#000
40-7100	#00
40-7110	#0
40-7111	#1
40-7112	#2
40-7113	#3
40-7114	#4
40-7115	#5
40-7116	#6

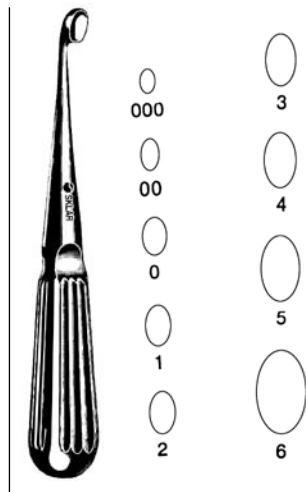

BRUNS CURETTES

SINGLE END-OVAL	STRAIGHT 9"
40-7202	#000
40-7203	#00
40-7204	#0
40-7205	#1
40-7206	#2
40-7207	#3
40-7208	#4
40-7209	#5
40-7210	#6

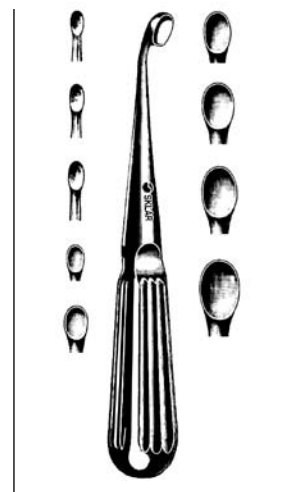

BRUNS CURETTES

SINGLE END-OVAL	ANGLED 9"
40-7220	#00000
40-7221	#0000
40-7222	#000
40-7223	#00
40-7224	#0
40-7225	#1
40-7226	#2
40-7227	#3
40-7228	#4
40-7229	#5
40-7230	#6

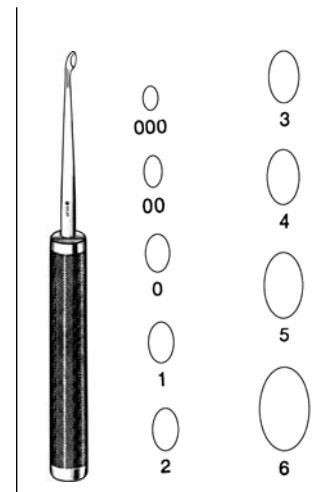

COBB BONE CURETTES

SINGLE END-OVAL	STRAIGHT 11"
40-8100	#000
40-8101	#00
40-8102	#0
40-8103	#1
40-8104	#2
40-8105	#3
40-8106	#4
40-8107	#5
40-8108	#6

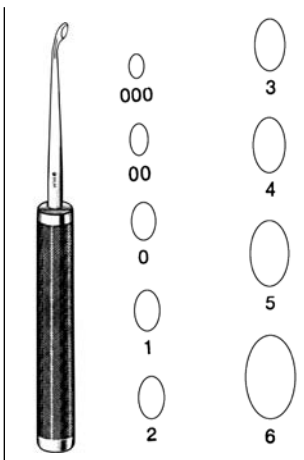

COBB BONE CURETTES

SINGLE END-OVAL	ANGLED 11"
40-8110	#000
40-8111	#00
40-8112	#0
40-8113	#1
40-8114	#2
40-8115	#3
40-8116	#4
40-8117	#5
40-8118	#6

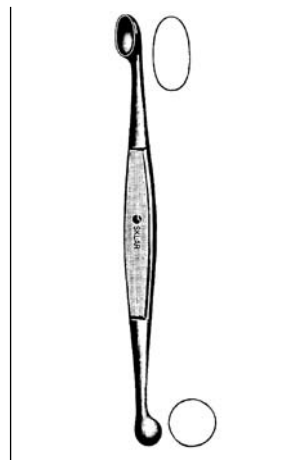

VOLKMAN BONE CURETTES

DOUBLE END		
40-7250	5"	Oval/Round
40-7165	6½"	Oval/Oval
40-7265	6½"	Oval/Round
40-7280	8"	Oval/Round

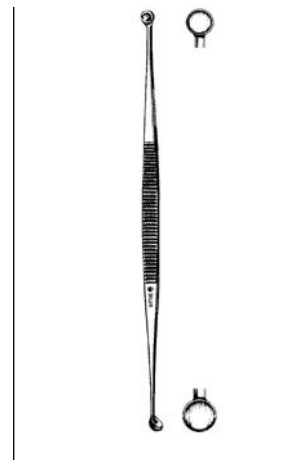

MARTINI BONE CURETTE

DOUBLE END		
40-7284	5½"	4mm & 5mm Round Cups

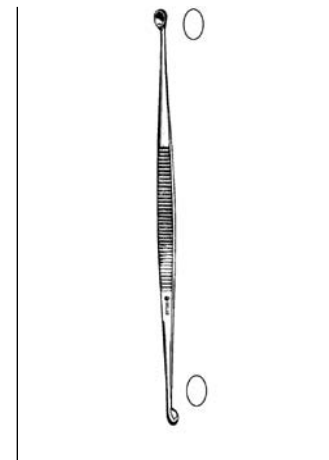

WILLIGER BONE CURETTE

DOUBLE END		
40-7286	5½"	3mm & 4mm Oval Cups

VOLKMAN RETRACTORS
HOLLOW HANDLE
BLUNT, 8½"

- 60-5612 2 Prong
- 60-5613 3 Prong
- 60-5614 4 Prong

SHARP, 8½"

- 60-5622 2 Prong
- 60-5623 3 Prong
- 60-5624 4 Prong

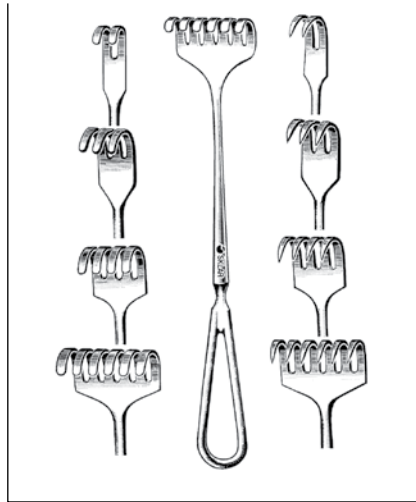
VOLKMAN RETRACTORS
BLUNT, 4½"

- 60-4252 2 Prong
- 60-4253 3 Prong
- 60-4254 4 Prong
- 60-4256 6 Prong

SHARP, 4½"

- 60-4242 2 Prong
- 60-4243 3 Prong
- 60-4244 4 Prong
- 60-4246 6 Prong

BLUNT, 8½"

- 60-5502 2 Prong
- 60-5503 3 Prong
- 60-5504 4 Prong
- 60-5506 6 Prong

SHARP, 8½"

- 60-5602 2 Prong
- 60-5603 3 Prong
- 60-5604 4 Prong
- 60-5606 6 Prong

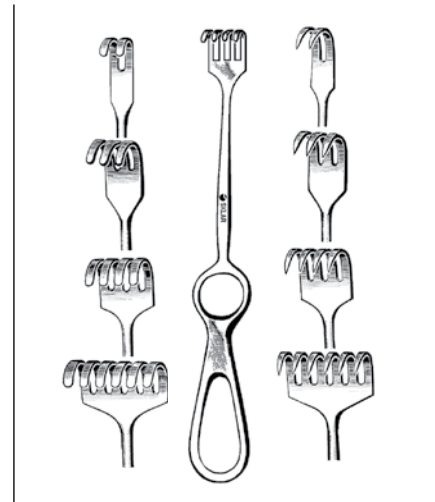
VOLKMAN RETRACTORS
RING HANDLES
BLUNT, 8½"

- 60-5812 2 Prong
- 60-5813 3 Prong
- 60-5814 4 Prong
- 60-5816 6 Prong

SHARP, 8½"

- 60-5822 2 Prong
- 60-5823 3 Prong
- 60-5824 4 Prong
- 60-5826 6 Prong

ISRAEL RETRACTORS

- 60-6100 10" 4 Prong 1½" x 1½"
- 60-6101 10" 5 Prong 1¾" x 2"
- 60-6102 10" 6 Prong 1¾" x 2"
- 60-6103 10" 6 Prong 2¾" x 2¾"

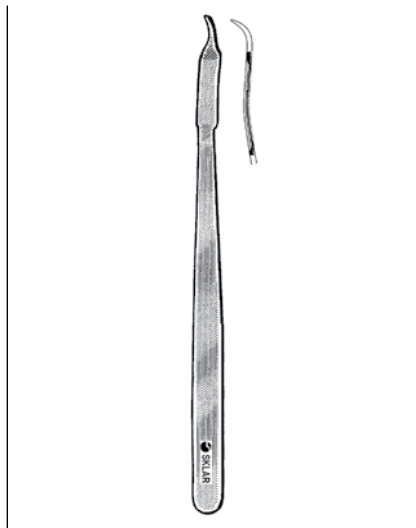
MINI HOHMANN ELEVATORS

- 40-7450 6½" 6mm
- 40-7451 6½" 8mm

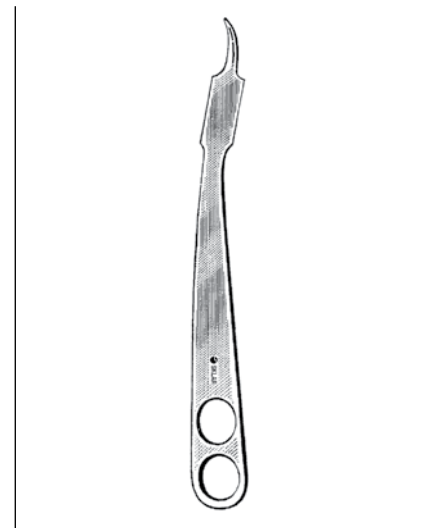

HOHMANN BONE ELEVATORS

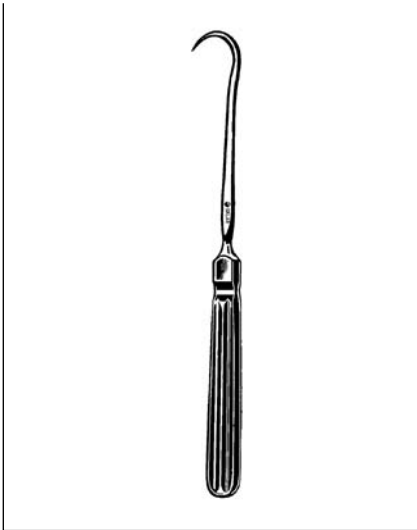
- 40-7447 8½" 8mm
- 40-7448 9" 10mm
- 40-7452 9½" 18mm
- 40-7453 9½" 43mm
- 40-7454 10" 24mm
- 40-7455 10" 20mm
- 40-7458 10½" 65mm
- 40-7456 11" 22mm

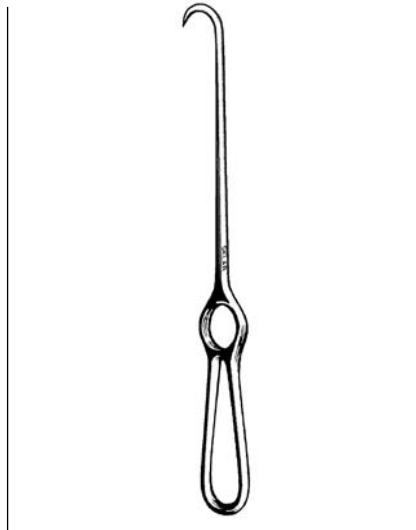

SKLAR SINGLE PRONG HOOK

60-6280 8"



VOLKMAN HOOK

SHARP, RING HANDLE

60-5810 8½"

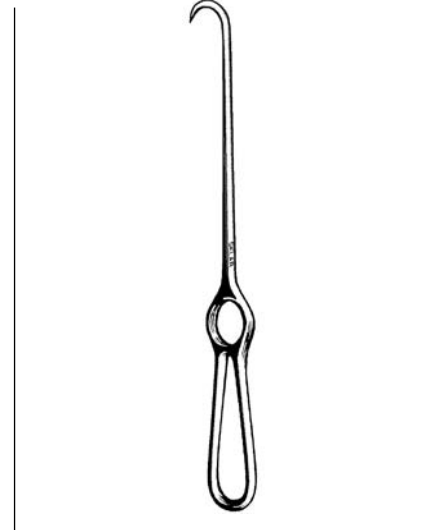

VOLKMAN BONE HOOKS

60-5820 8" Sharp

60-5821 9" Blunt

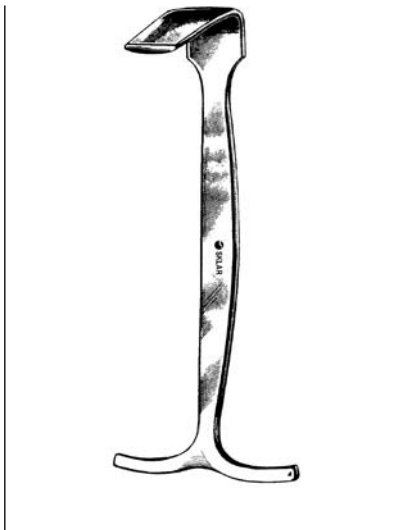

**RETRACTOR HOOK SMILLE
MENISCUS**

40-2290 5¾" Blade ¾" x 1⅛"

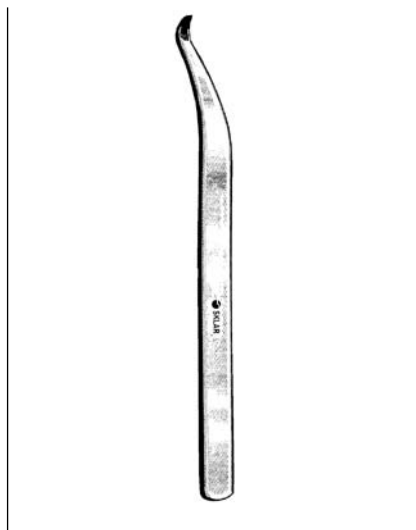

**HAYS HAND AND FINGER
RETRACTOR**

40-8265 6" 1½" Long Blade, Tapered
from ⅜" to ⅛" Wide

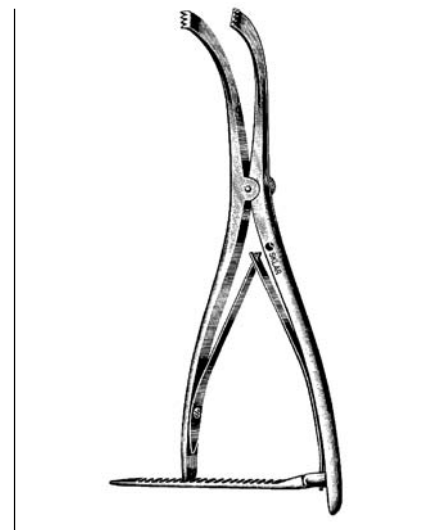

INGE RETRACTORS

WITH TEETH

42-1420 6½"

42-1425 10½"

WITHOUT TEETH

42-1421 6½"

42-1422 10½"

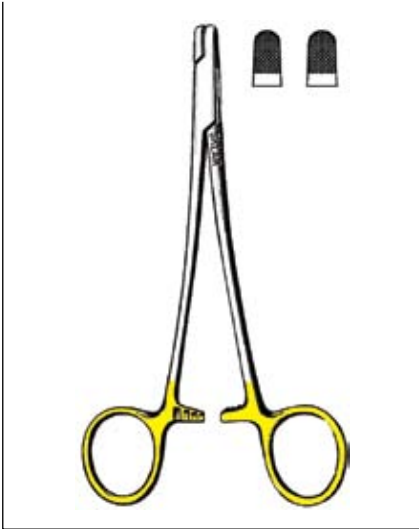

TC STERNAL WIRE TWISTERS

21-9060 5"
21-9065 7"

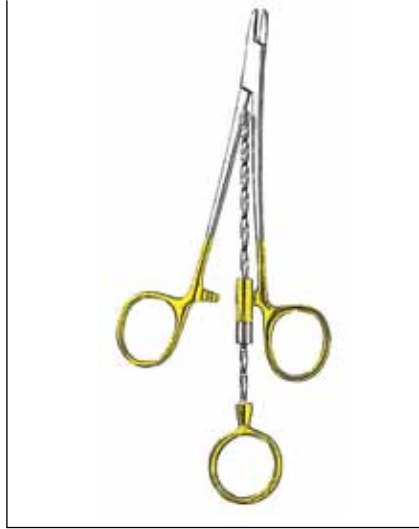

TC CORWIN WIRE TWISTERS

SERRATED
21-9050 6" Flat
21-9051 6" Round
21-9052 6½" Round Narrow

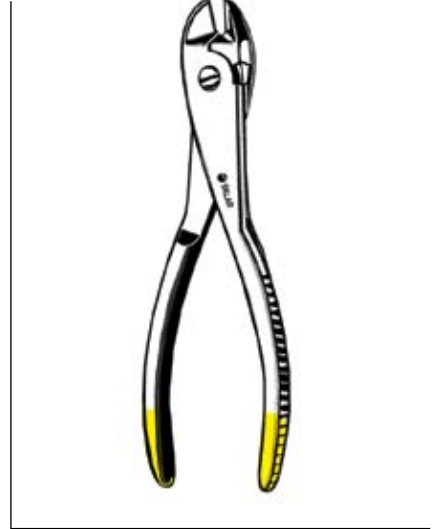

TC WIRE AND PIN CUTTER

40-1018 8"



TC PIN CUTTER

DOUBLE ACTION
40-1045 7" End Cut/Side Cut



TC PIN CUTTERS

DOUBLE ACTION, SIDE CUT
40-1023 7" Straight
40-1024 8½" Angled

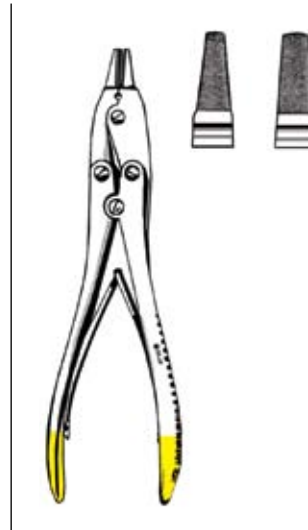

TC WIRE PULLERS

DOUBLE ACTION
40-1735 7" 4mm
40-1738 7" 6mm

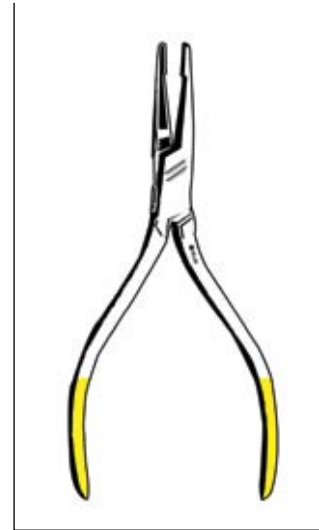

TC PIN PULLER

40-1740 5½"

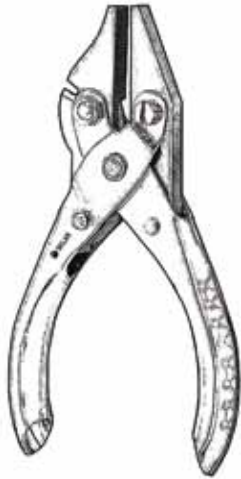

PARALLEL PLIERS AND WIRE CUTTER

DOUBLE ACTION

40-1726 4½"



BONE PIN CUTTER

DOUBLE ACTION

40-1715 15" Cuts up to 5/32"

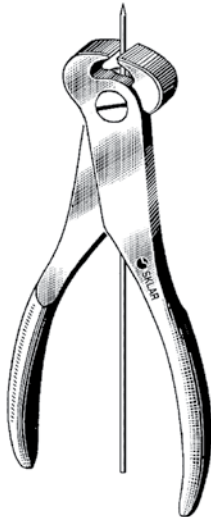

SKLAR PIN CUTTER

40-1048 7" End Cutting

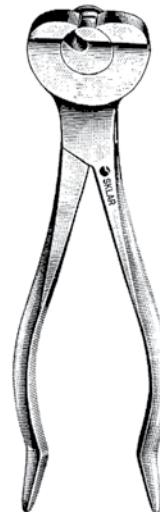

DIAMOND PIN CUTTER

40-1762 6¼" Cuts up to 5/64"

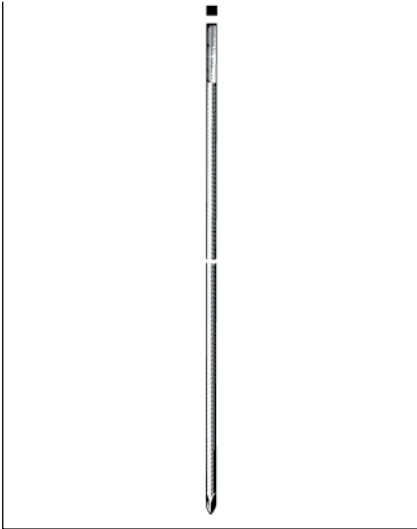

STEINMANN PINS

TROCAR POINT

40-1590	9" x 2.0mm
40-1591	9" x 2.4mm
40-1592	9" x 2.8mm
40-1593	9" x 3.2mm
40-1594	9" x 3.5mm
40-1595	9" x 4.0mm
40-1596	9" x 4.5mm

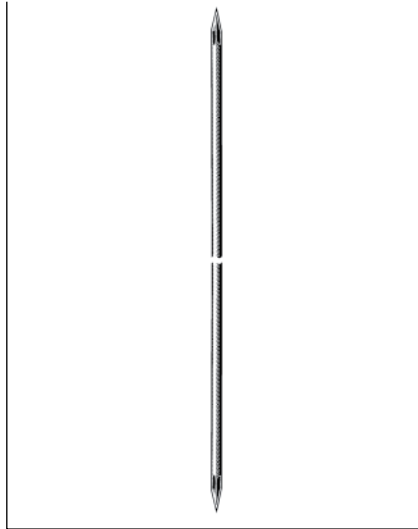

KIRSCHNER WIRES

WITH TWO TROCAR ENDS

40-1565	4" x .028
40-1566	4" x .035
40-1567	4" x .045
40-1568	4" x .054
40-1569	4" x .062
40-1580	9" x .035
40-1582	9" x .045
40-1584	9" x .062
40-1535	12" x .035
40-1545	12" x .045
40-1562	12" x .062

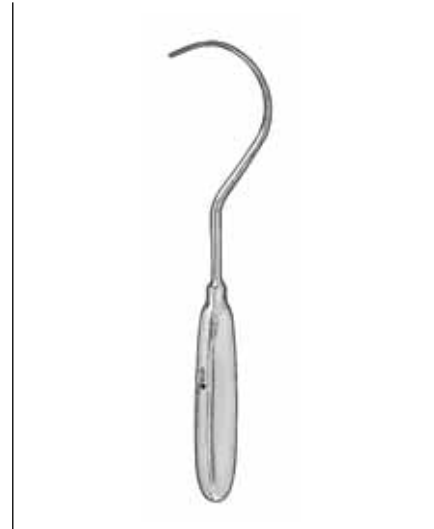

BONE WIRE GUIDE

26-1035 8¾"



SUTURE WIRE

24-2218	18 Gauge	.040" Diameter
24-2220	20 Gauge	.032" Diameter
24-2222	22 Gauge	.025" Diameter
24-2224	24 Gauge	.020" Diameter
24-2226	26 Gauge	.016" Diameter
24-2228	28 Gauge	.012" Diameter
24-2230	30 Gauge	.010" Diameter
24-2232	32 Gauge	.008" Diameter
24-2234	34 Gauge	.006" Diameter
24-2236	36 Gauge	.005" Diameter

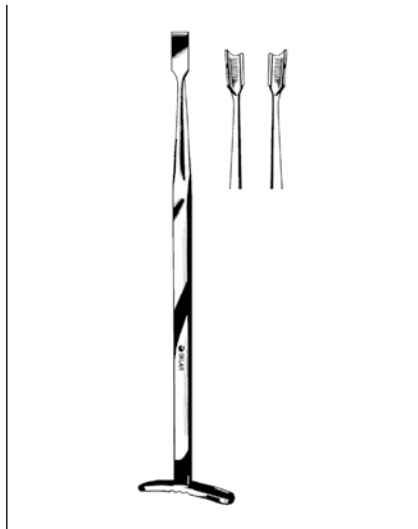

SMILLIE MENISCUS KNIVES

47-3420	6¾"	Straight Chisel Blade
47-3422	6¾"	Guarded Left
47-3424	6¾"	Guarded Right



LOWE-BRECK CARTILAGE KNIFE

47-3418 10½" Straight



DOWNING CARTILAGE KNIFE

47-3415 10"



MARTIN SCISSOR

41-1120 8" Curved, Heavy, Serrated

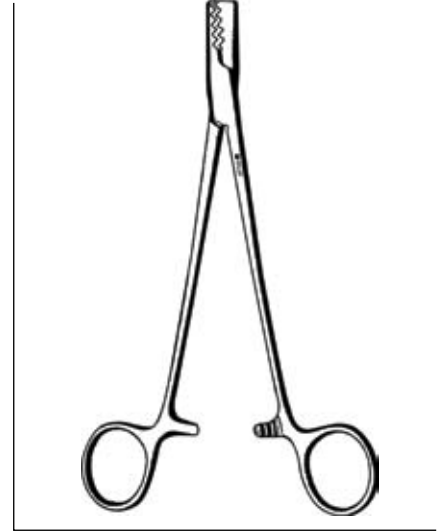

MARTIN CARTILAGE CLAMP

40-2273 7½"

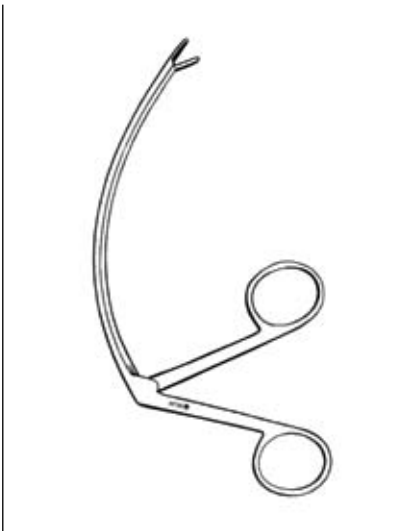

CAROLL TENDON PULLING FORCEP

ALLIGATOR TYPE

47-3520 4¼" Curved

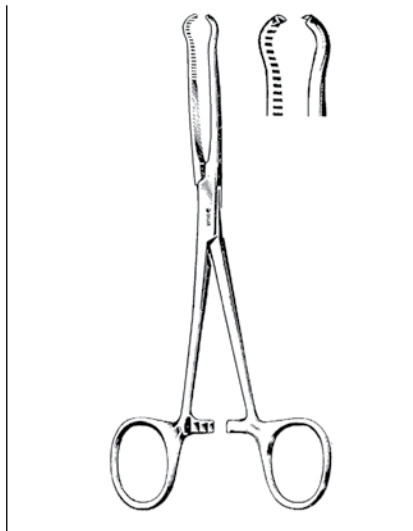

LOCKE PHALANGEAL FORCEP

40-2650 6"

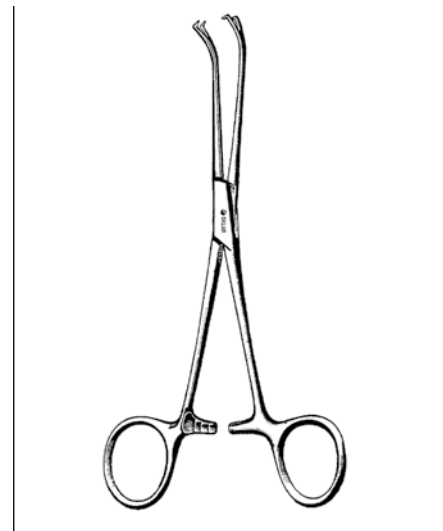

SESAMOID CLAMP

40-2655 6½"



TEAT KNIFE, DANISH MODEL
93-8375 Short Cutting and Probe Point

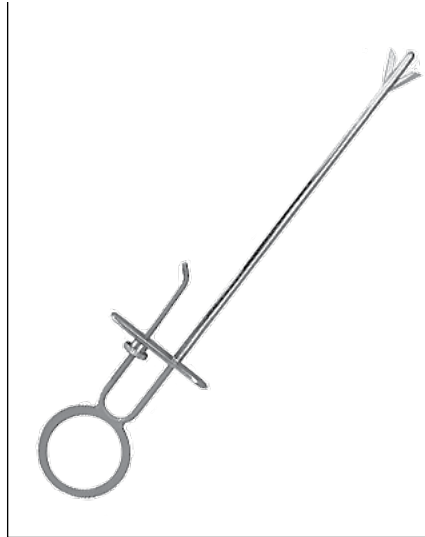

TEAT SLITTER, DANISH MODEL
93-8380 7"



UDALL BISTOURI TEAT
93-1349 6" Blunt



CHRISTENSEN TEAT SCISSOR
93-8310 6" Outside Blade With Cutting Edge



HUGS TEAT KNIFE
93-8383 6" Blunt



LICHTY TEAT KNIFE
93-1372 5½" Blunt
93-1361 5½" Sharp

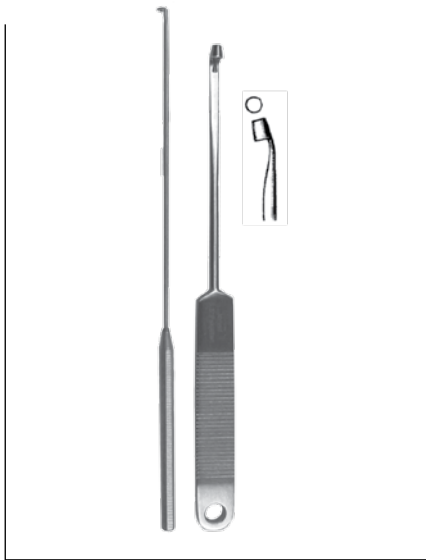

CORNELL TEAT CURETTES

- 93-8318 6 3/4"
- 93-8312 7" Swedish Model

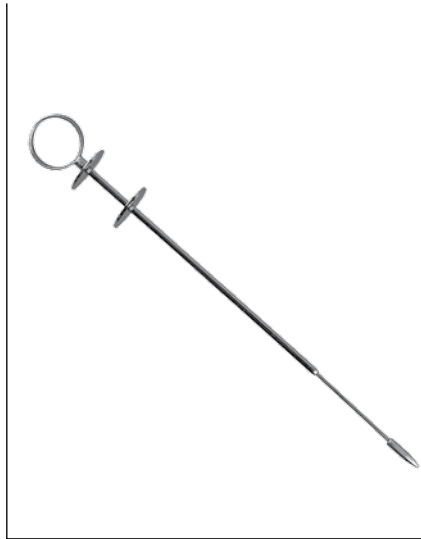

TEAT TUMOR EXTRACTORS WITH TWO CUTTING EDGES

- 93-8330 4.0mm
- 93-8331 4.5mm
- 93-8332 5.0mm

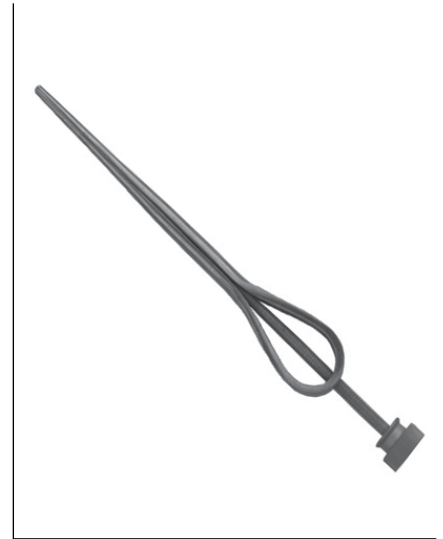

TEAT DILATOR

- 93-8340 6 3/4" Screw Action

SKLAR SOAK™

THE FIRST LINE OF DEFENSE

Immersing soiled instruments in SKLAR SOAK effectively pre-cleans and decontaminates, without fear of rusting!

SKLAR SOAK is an effective pre-cleaner that breaks down bio-burden, lifting blood and other organic debris from the surface, while penetrating box locks and crevices. The rust inhibitor protects the delicate chromium oxide layer of the instrument, thus defending against rust and corrosion. Using SKLAR SOAK as a pre-cleaner is the first line of defense against rust, prolonging the life of the instrument and therefore protecting your investment!

Soaking for only two minutes thoroughly decontaminates instruments, reducing the risk of exposure to pathogens such as H1N1, MRSA, Salmonella, Parvo, Feline Leukemia, Herpes Simplex, Distemper, Ringworm, Strangles. However, because SKLAR SOAK contains a rust inhibitor, instruments may soak for several hours without fear of rusting! Employees are protected from cross contamination, and at the same time can enjoy the freedom to reprocess instruments when it's convenient!



PRODUCT NUMBER	FEATURES	QUANTITIES
10-1603	1 Gallon Bottles	4/case
10-1609	1 Gallon Bottle	1 bottle

GRAVES VAGINAL SPECULUMS

90-3800	3" x 1/2"	Extra Small
90-3700	3" x 3/4"	Small
90-3701	4" x 1 1/4"	Medium
90-3702	4 1/2" x 1 3/8"	Large
90-3802	4 3/4" x 1 1/2"	Extra Large
90-3803	6" x 1 1/2"	Extra Long

PEDERSON VAGINAL SPECULUMS

90-3849	2 3/4" x 1/2"	Extra Small
90-3710	3" x 1/2"	Small
90-3712	4" x 5/8"	Slender
90-3713	4" x 7/8"	Medium
90-3711	4 3/4" x 1"	Large
90-3851	4 3/4" x 1 5/8"	Extra Large

VIENNA SPECULUMS

70-1070	Small
70-1071	Medium
70-1072	Large
70-1075	Large, Wrought Metal

GRAVES VAGINAL SPECULUMS
GOLD SCREWS

90-3720	3" x 3/4"	Small
90-3721	4" x 1 1/4"	Medium
90-3722	4 1/2" x 1 3/8"	Large

PEDERSON VAGINAL SPECULUMS
GOLD SCREWS

90-3730	3" x 3/4"	Small
90-3731	4" x 7/8"	Medium
90-3732	4 3/4" x 1"	Large

TIECK HALLE SPECULUMS

70-1040	Small
70-1041	Large

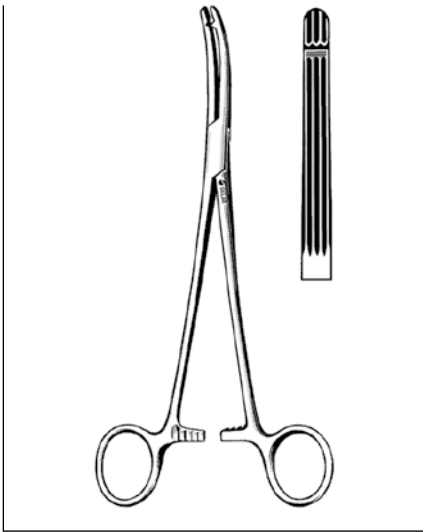

**HEANEY BALLENTINE
FORCEPS**

LONGITUDINAL SERRATIONS

90-2480	8"	Straight
90-2580	8"	Curved

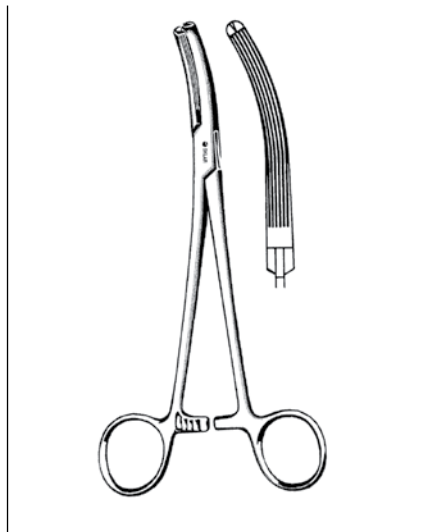

LONG FORCEP

LONGITUDINAL SERRATIONS

90-2690	7½"
---------	-----

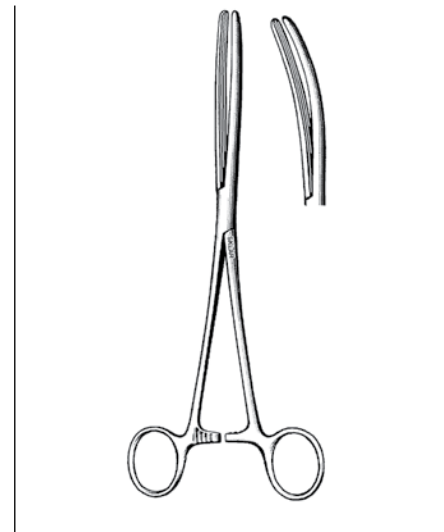

**PEAN GASTRO-INTESTINAL
FORCEPS**

LONGITUDINAL SERRATIONS

36-2962	6¼"	Curved
36-2890	9"	Straight
36-2990	9"	Curved
36-2895	9½"	Straight
36-2995	9½"	Curved



BOZEMAN FORCEPS

90-7610	10½"	Straight
80-1410	10¼"	S-Curve



BOZEMAN FORCEP

ONE LARGE RING

90-7710	10¼"	S-Curve
---------	------	---------

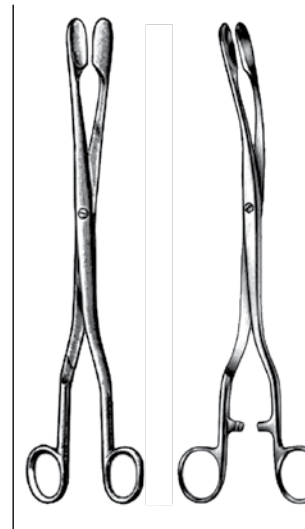

**WINTER PLACENTA
& OVUM FORCEPS**

CUP JAWS

90-5292	11"	Straight
90-5293	11"	Curved

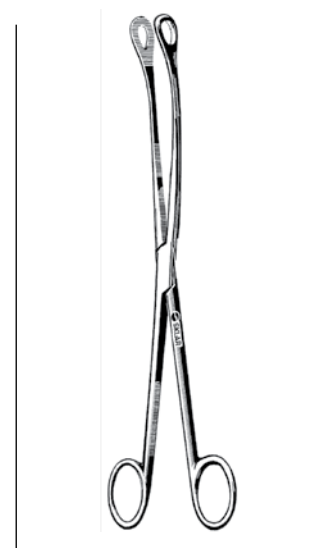

**KELLY PLACENTA
FORCEP**

SERRATED

92-5012	12"	Slightly Curved
---------	-----	-----------------

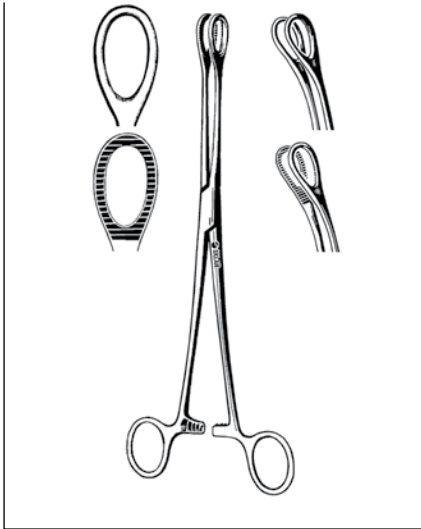
FOERSTER SPONGE FORCEPS

87-2095	9½"	Straight	Smooth
87-2295	9½"	Curved	Smooth
87-2195	9½"	Straight	Serrated
87-2395	9½"	Curved	Serrated

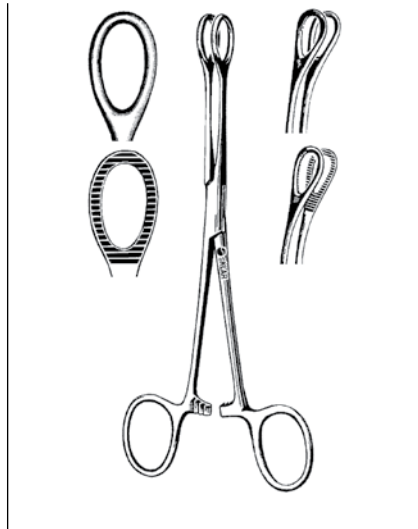
BALLENGER SPONGE FORCEPS

74-1370	7"	Straight	Smooth
74-1570	7"	Curved	Smooth
74-1470	7"	Straight	Serrated
74-1670	7"	Curved	Serrated

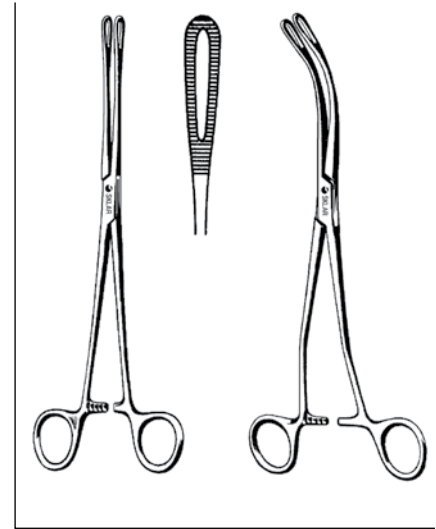
FLETCHER SPONGE FORCEPS

SERRATED		
93-1222	9½"	Straight
93-1226	9½"	Curved

OBSTETRICAL CAESAREAN FORCEP

REMOVABLE RUBBER JAWS
93-8000 12"

McLEAN WHELPING FORCEP

93-8004 8"

BOVINE CERVICAL FORCEP

93-8001 8"



RUGGEBERGS OBSTETRICAL HOOK

DOUBLE EYE HOOK

93-8009 5½" Spring Type



OSTERTAGS HOOK

BLUNT EYE HOOK

93-8006 2" 5/8" Finger Ring
With 3/4" Hook

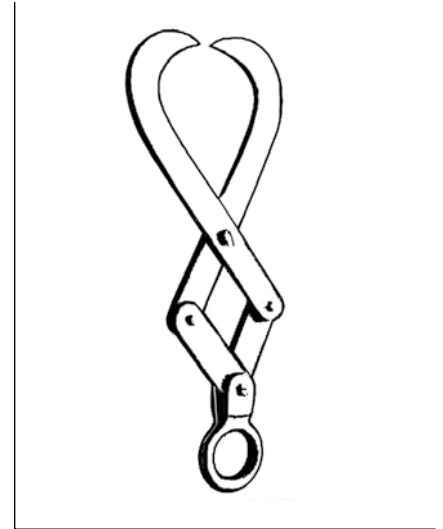

KREY HOOK

93-8007 8" Double Action



LINDES EMBROYOTOMY KNIFE

93-8002 5"

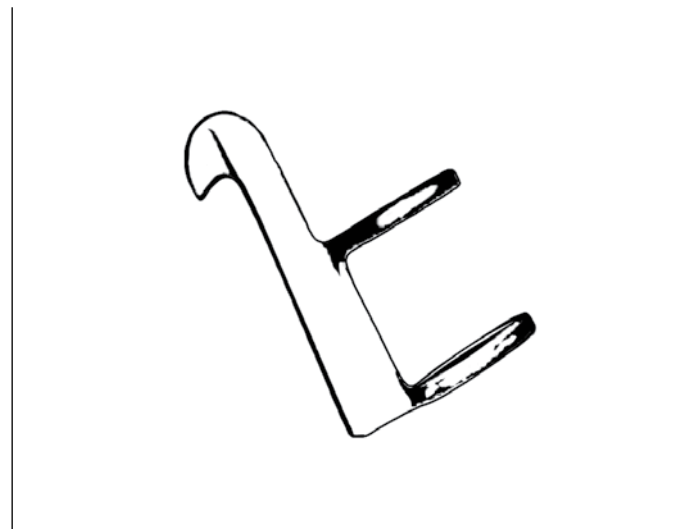

GUENTHERS EMBROYOTOMY KNIFE

93-8008 10½"



WHITE EMASCULATORS

DOUBLE CRUSH

- 93-8106 8" Chrome
- 93-1106 12" Chrome
- 93-1122 12" Stainless Steel

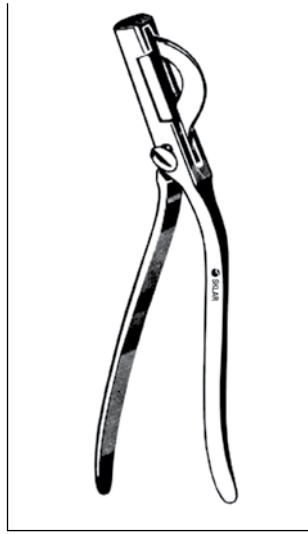

PLAIN EMASCULATORS

- 93-1147 12" Chrome
- 93-1158 12" Stainless Steel



FRANK EMASCULATORS

- 93-1175 9" Chrome
- 93-1189 9" Stainless steel

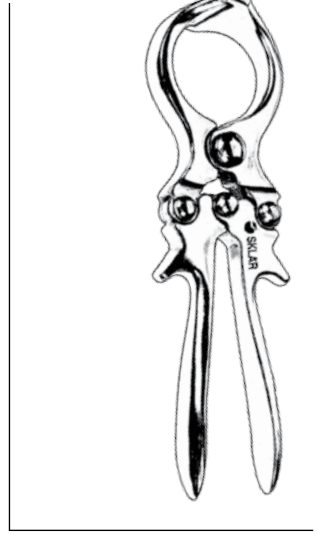

EMASCULATOMES

WITH CORD STOP

- 93-8109 9"
- 93-8112 12"
- 93-8114 14"

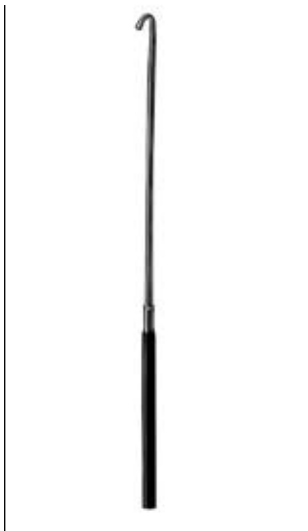

COVAULT OVARIECTOMY HOOK

WITH PROBE TIP

- 93-1479 8 3/4"

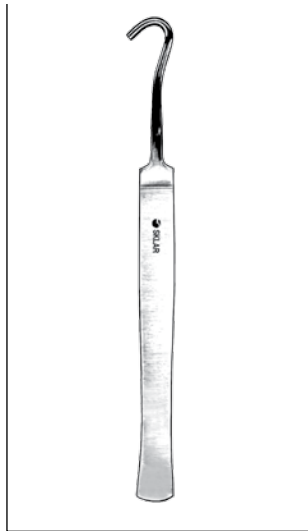

SNOOK OVARIOHYSTERECTOMY HOOK

- 93-1475 8"



REIMER EMASCULATOR

- 93-8190



Electrosurgery



Sklar Blue™ Instruments

Sklar Blue Electro-surgery Instruments are designed to provide an effective, non-conductive, patient-safe surface. Sklar's line of electro-surgical instruments features our exclusive Sklar Blue insulated coating that prevents transmission of RF current through the instrument. Manufactured of the highest quality stainless steel, these instruments are fully autoclavable. All Sklar Blue electro-surgical coatings are guaranteed for one year against manufacturing defects.

Electrosurgical Disposables

Sklar's long held tradition of providing quality surgical instruments continues with the establishment of disposable electro-surgical pencils, grounding pads, active electrodes and accessories. Offering unsurpassed performance and design features. Sklar Electro-surgical products deliver quality you can feel, see and trust for even the most challenging surgical procedure.

Electrosurgical Bipolar Forceps

Sklar Bipolar Forceps are made of high quality materials and insulation to ensure reliability, safety and performance. Properly applied, bipolar desiccation and coagulation minimizes collateral damage to surrounding tissue. Offering a wide range of patterns, Sklar has the exact instrument for your surgery or laparoscopic procedure.



Sklar Blue™ Electrosurgery Instruments are designed to provide an effective, non-conductive, patient-safe surface. Sklar's line of electrosurgical instruments features our exclusive Sklar Blue™ insulated coating that prevents transmission of RF current through the instrument. Manufactured of the highest quality stainless steel, these instruments are fully autoclavable. All Sklar Blue™ electrosurgical coatings are guaranteed for one year against manufacturing defects.



KOGAN ENDOCERVICAL SPECULUM
WITH GAUGE AND SCREW
 91-5230 Narrow Wire Blades



KOGAN ENDOCERVICAL SPECULUM
WITH SPRING HANDLE
 91-5228 Narrow Wire Blades



KOGAN ENDOCERVICAL SPECULUM
WITH RATCHET HANDLE
 91-5235 Narrow Wire Blades

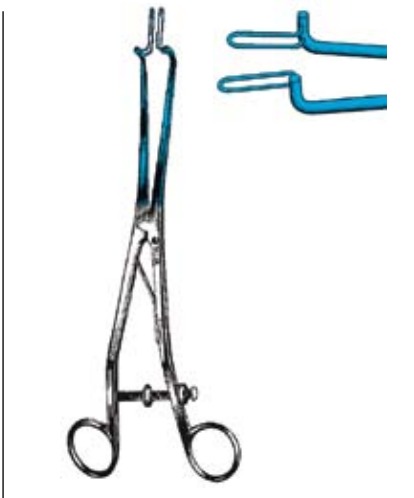

KOGAN ENDOCERVICAL SPECULUM
WITH GAUGE AND SCREW
 91-5232 Wide Wire Blades

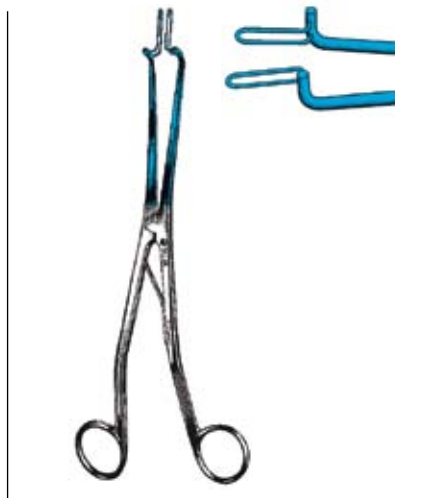

KOGAN ENDOCERVICAL SPECULUM
WITH SPRING HANDLE
 91-5226 Wide Wire Blades



KOGAN ENDOCERVICAL SPECULUM
WITH RATCHET HANDLE
 91-5234 Wide Wire Blades



Autoclavable



**GRAVES VAGINAL SPECULUMS
WITHOUT TUBE OR LOOPS**

91-5066	3" x 1/2"	Extra Small
91-5060	3" x 3/4"	Small
91-5062	4" x 1 1/4"	Medium
91-5064	4 1/2" x 1 3/8"	Large
91-5068	4 3/4" x 1 1/2"	Extra Large



**PEDERSON VAGINAL SPECULUMS
WITHOUT TUBE OR LOOPS**

91-5088	2 3/4" x 1/2"	Extra Small
91-5082	3" x 1/2"	Small
91-5092	4" x 5/8"	Slender
91-5084	4" x 7/8"	Medium
91-5086	4 3/4" x 1"	Large



**LATERAL VAGINAL RETRACTOR
WITH RATCHET**

91-5190 Fits Inside Speculum



**SCHROEDER TENACULUM
FORCEPS**

91-5450	10"	Braun	Flat Tips
91-5452	10"	Pozzi	Round Tips



BABCOCK FORCEPS

91-5268	8"
91-5270	9 1/2"

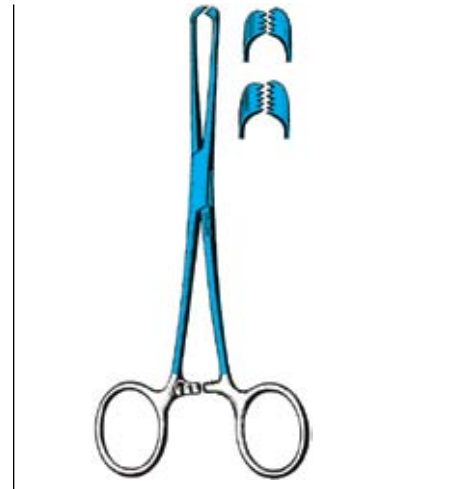

ALLIS TISSUE FORCEPS

91-5278	7 1/2"	5x6 Teeth
91-5440	9 1/2"	5x6 Teeth



Autoclavable

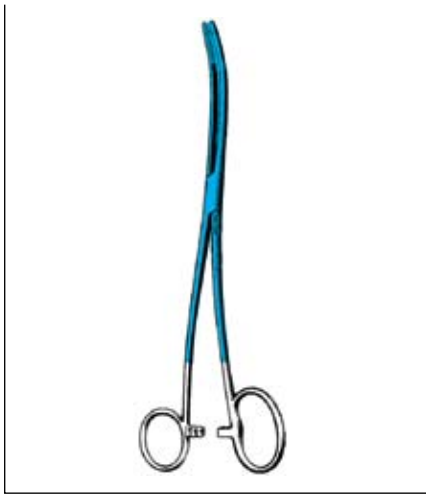

BOZEMAN FORCEP

91-5310 10¼" S-Curve, One Large Ring



BOZEMAN FORCEPS

91-5307 10½" Straight
91-5308 10¼" S-Curve

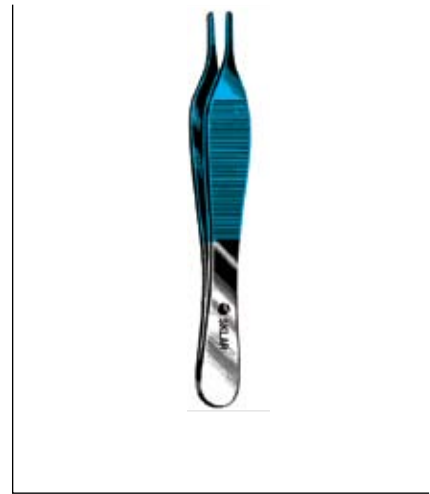

ADSON DRESSING FORCEP

91-5428 4¾" Serrated

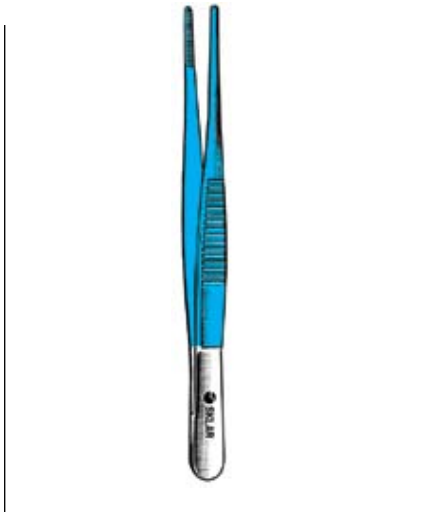

DRESSING FORCEPS

91-5420 8" Serrated
91-5422 10" Serrated
91-5424 12" Serrated



POTTS-SMITH FORCEPS

91-5411 7" Serrated
91-5412 10" Serrated
91-5413 8¼" 1x2 Teeth
91-5414 10" 1x2 Teeth



TUTTLE/ SINGLEY FORCEPS

91-5300 7" Tuttle
91-5302 9" Singley



Autoclavable

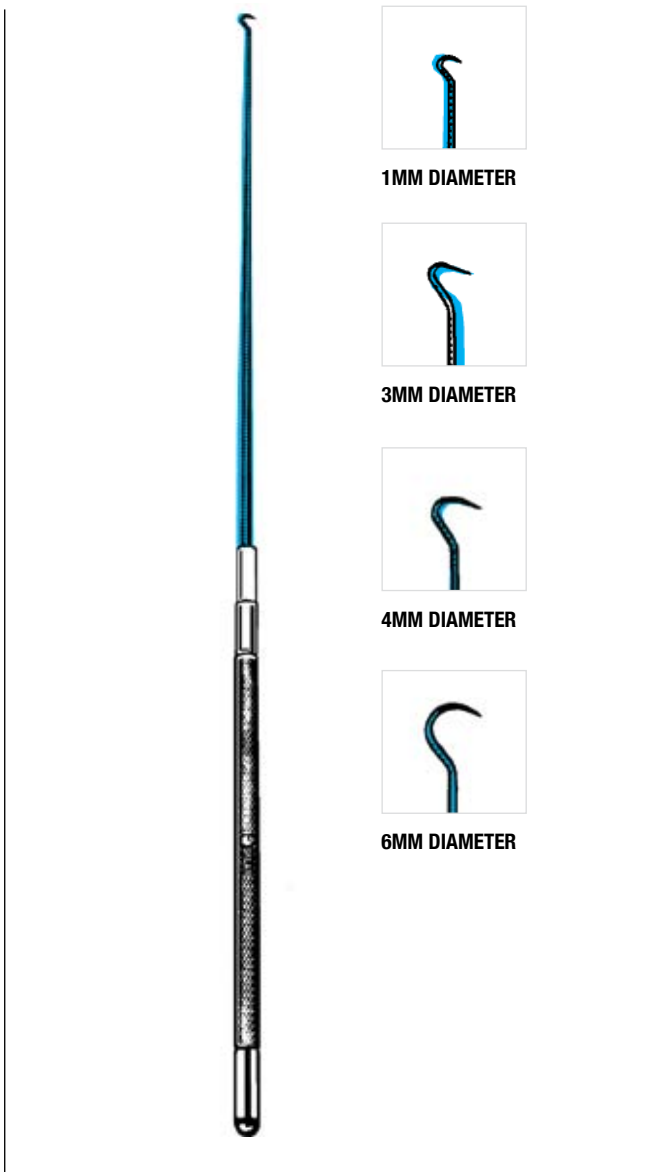

1MM DIAMETER



3MM DIAMETER



4MM DIAMETER



6MM DIAMETER



STYLE 1



STYLE 2



STYLE 3



STYLE 4



STYLE 5

IRIS HOOKS

QUICK RELEASE

91-5244	9"	1mm	91-5248	12"	1mm
91-5243	9"	3mm	91-5247	12"	3mm
91-5242	9"	4mm	91-5246	12"	4mm
91-5241	9"	6mm	91-5245	12"	6mm
91-5236	9"	Set of 4	91-5238	12"	Set of 4

EMMETT HOOKS

91-5251	9"	Style 1
91-5252	9"	Style 2
91-5253	9"	Style 3
91-5254	9"	Style 4
91-5255	9"	Style 5
91-5250	9"	Set of 5



Autoclavable



Single Use / Sterile

Sklar Premium Electrosurgical Pencils are available in a push button, foot switch or rocker switch configuration. Sklar pencils are ergonomically designed to provide maximum balance and comfort for the surgeon. Each pencil features a removable 2.75" stainless steel blade electrode, with hex locking feature to provide stability during difficult surgical procedures.

Unsurpassed performance and design features, like sealed switching components, make the Sklar Premium Electrosurgical Pencil the right choice. Pencil tips are interchangeable with any of Sklar's electrodes and most other manufacturer's electrodes. Sklar Pencils come standard with a pre-attached 3 meter cord with a standard three prong plug. All Electrosurgical Pencils are provided in a single use, sterile pouch.

PUSH BUTTON SWITCH

PRODUCT NUMBER	FEATURES	ACCESSORIES	QUANTITIES
96-9601	2.75" Blade Electrode	-	50/Box
96-9602	2.75" Blade Electrode	-	50/bx, 2bx/cs, 100/cs
96-9603	2.75" Blade Electrode	Holster	50/Box
96-9604	2.75" Blade Electrode	Holster	50/bx, 2bx/cs, 100/cs
96-9605	2.75" Blade Electrode	Holster, Tip Cleaner	50/Box
96-9606	2.75" Blade Electrode	Holster, Tip Cleaner	50/bx, 2bx/cs, 100/cs
96-9607	2.75" Coated Blade Electrode	-	50/Box
96-9608	2.75" Coated Blade Electrode	-	50/bx, 2bx/cs, 100/cs
96-9609	2.75" Coated Blade Electrode	Holster	50/Box
96-9610	2.75" Coated Blade Electrode	Holster	50/bx, 2bx/cs, 100/cs



ROCKER SWITCH

PRODUCT NUMBER	FEATURES	ACCESSORIES	QUANTITIES
96-9611	2.75" Blade Electrode	-	50/Box
96-9612	2.75" Blade Electrode	-	50/bx, 2bx/cs, 100/cs
96-9613	2.75" Blade Electrode	Holster	50/Box
96-9614	2.75" Blade Electrode	Holster	50/bx, 2bx/cs, 100/cs
96-9615	2.75" Blade Electrode	Holster, Tip Cleaner	50/Box
96-9616	2.75" Blade Electrode	Holster, Tip Cleaner	50/bx, 2bx/cs, 100/cs
96-9617	2.75" Coated Blade Electrode	-	50/Box
96-9618	2.75" Coated Blade Electrode	-	50/bx, 2bx/cs, 100/cs
96-9619	2.75" Coated Blade Electrode	Holster	50/Box
96-9620	2.75" Coated Blade Electrode	Holster	50/bx, 2bx/cs, 100/cs



FOOT SWITCH

PRODUCT NUMBER	FEATURES	ACCESSORIES	QUANTITIES
96-9621	2.75" Blade Electrode	-	50/Box
96-9622	2.75" Blade Electrode	-	50/bx, 2bx/cs, 100/cs
96-9623	2.75" Blade Electrode	Holster	50/Box
96-9624	2.75" Blade Electrode	Holster	50/bx, 2bx/cs, 100/cs
96-9625	2.75" Blade Electrode	Holster, Tip Cleaner	50/Box
96-9626	2.75" Blade Electrode	Holster, Tip Cleaner	50/bx, 2bx/cs, 100/cs
96-9627	2.75" Coated Blade Electrode	-	50/Box
96-9628	2.75" Coated Blade Electrode	-	50/bx, 2bx/cs, 100/cs
96-9629	2.75" Coated Blade Electrode	Holster	50/Box
96-9630	2.75" Coated Blade Electrode	Holster	50/bx, 2bx/cs, 100/cs



Single Use / Sterile

Sklar Premium Blade Electrodes feature a ribbed molded insulator, which allows the surgeon or technician easy removal of the electrode during procedures. They are available with a hex lock feature that assures stability and prohibits rotation of the blade during difficult procedures. They are also available coated with an anti-stick material that allows easy clean up of accumulated debris.

BLADE ELECTRODES

PRODUCT NUMBER	FEATURES	QUANTITIES
96-9632	Flex Tip Blade, 2.4"	10/Box
96-9633	Flex Tip Blade, 2.4"	10/bx, 10bx/cs, 100/cs
96-9634	Flex Tip Blade, Hex Lock Hub, 2.4"	10/Box
96-9635	Flex Tip Blade, Hex Lock Hub, 2.4"	10/bx, 10bx/cs, 100/cs
96-9636	Solid Steel Blade, 2.75"	10/Box
96-9637	Solid Steel Blade, 2.75"	10/bx, 10bx/cs, 100/cs
96-9638	Solid Steel Coated Blade, 2.75"	10/Box
96-9639	Solid Steel Coated Blade 2.75"	10/bx, 10bx/cs, 100/cs
96-9640	Solid Steel Blade, Hex Lock Hub, 2.75"	10/Box
96-9641	Solid Steel Blade, Hex Lock Hub, 2.75"	10/bx, 10bx/cs, 100/cs
96-9642	Solid Steel Coated Blade, Hex Lock Hub, 2.75"	10/Box
96-9643	Solid Steel Coated Blade, Hex Lock Hub, 2.75"	10/bx, 10bx/cs, 100/cs



PRODUCT NUMBER	FEATURES	QUANTITIES
96-9644	Solid Steel Blade, 6"	10/Box
96-9645	Solid Steel Blade, 6"	10/bx, 10bx/cs, 100/cs



PRODUCT NUMBER	FEATURES	QUANTITIES
96-9646	Solid Steel Coated Blade, 6"	10/Box
96-9647	Solid Steel Coated Blade, 6"	10/bx, 10bx/cs, 100/cs



PRODUCT NUMBER	FEATURES	QUANTITIES
96-9648	Solid Steel Blade, 10"	10/Box
96-9649	Solid Steel Blade, 10"	10/bx, 10bx/cs, 100/cs



PRODUCT NUMBER	FEATURES	QUANTITIES
96-9650	Solid Steel Coated Blade, 10"	10/Box
96-9651	Solid Steel Coated Blade, 10"	10/bx, 10bx/cs, 100/cs





ELECTROSURGERY | ELECTRODES

Single Use / Sterile

Sklar Premium Loop Electrodes feature a strong and durable tungsten steel loop incorporated into a reinforced T-molded head for added stability during difficult and delicate surgical procedures. All electrodes are a standard five inches in length and feature an extended insulation covering to protect the surgeon and patient.

LOOP ELECTRODES

PRODUCT NUMBER	FEATURES	QUANTITIES
96-9652	Tungsten Loop, 10 MM x 5 MM, 5"	5/Box
96-9653	Tungsten Loop, 10 MM x 5 MM, 5"	5/bx, 10bx/cs, 50/cs
		
96-9654	Tungsten Loop, 10 MM x 10 MM, 5"	5/Box
96-9655	Tungsten Loop, 10 MM x 10 MM, 5"	5/bx, 10bx/cs, 50/cs
		
96-9656	Tungsten Loop, 15 MM x 10 MM, 5"	5/Box
96-9657	Tungsten Loop, 15 MM x 10 MM, 5"	5/bx, 10bx/cs, 50/cs
		
96-9658	Tungsten Loop, 15 MM x 15 MM, 5"	5/Box
96-9659	Tungsten Loop, 15 MM x 15 MM, 5"	5/bx, 10bx/cs, 50/cs
		
96-9660	Tungsten Loop, 20 MM x 10 MM, 5"	5/Box
96-9661	Tungsten Loop, 20 MM x 10 MM, 5"	5/bx, 10bx/cs, 50/cs
		
96-9662	Tungsten Loop, 20 MM x 15 MM, 5"	5/Box
96-9663	Tungsten Loop, 20 MM x 15 MM, 5"	5/bx, 10bx/cs, 50/cs
		



Single Use / Sterile

LLETZ BALL ELECTRODES

PRODUCT NUMBER	FEATURES	QUANTITIES
96-1040	3 MM / 0.3 CM	5/Box

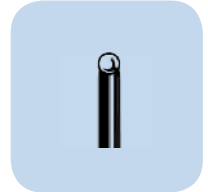

LLETZ SQUARE ELECTRODES

PRODUCT NUMBER	FEATURES	QUANTITIES
96-1099	10 x 8 MM / 1.0 x 0.8 CM	5/Box



LLETZ LOOP ELECTRODES

PRODUCT NUMBER	FEATURES	QUANTITIES
96-1060	15 x 8 MM / 1.5 x 0.8 CM	5/Box
96-1075	20 x 8 MM / 2.0 x 0.8 CM	5/Box
96-1085	20 x 20 MM / 2.0 x 2.0 CM	5/Box

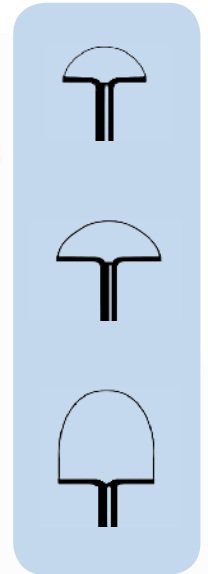



Single Use / Sterile

Sklar Premium Needle Electrodes feature a durable and ultra fine needle point for precise locations during the surgical procedure. All electrodes feature a ribbed molded insulation for easy removal and extended insulation to protect the surgeon and patient.

STRAIGHT NEEDLE ELECTRODES

PRODUCT NUMBER	FEATURES	QUANTITIES
96-9664	Solid Stainless Steel Needle, 2.8"	10/Box
96-9665	Solid Stainless Steel Needle, 2.8"	10/bx, 10bx/cs, 100/cs
96-9666	Solid Stainless Steel Coated Needle, 2.8"	10/Box
96-9667	Solid Stainless Steel Coated Needle, 2.8"	10/bx, 10bx/cs, 100/cs
96-9668	Solid Stainless Steel Needle, 6"	10/Box
96-9669	Solid Stainless Steel Needle, 6"	10/bx, 10bx/cs, 100/cs



96-9670	Solid Stainless Steel Coated Needle, 6"	10/Box
96-9671	Solid Stainless Steel Coated Needle, 6"	10/bx, 10bx/cs, 100/cs



96-9672	Solid Stainless Steel Needle, 10"	10/Box
96-9673	Solid Stainless Steel Needle, 10"	10/bx, 10bx/cs, 100/cs



96-9674	Solid Stainless Steel Coated Needle, 10"	10/Box
96-9675	Solid Stainless Steel Coated Needle, 10"	10/bx, 10bx/cs, 100/cs





Single Use / Sterile

Sklar Premium Straight Ball Electrodes feature our Hex Locking system to assure stability during difficult procedures. They also have our Ribbed Molded insulation for easy removal and extended insulation for protection of the surgeon and patient.

STRAIGHT BALL ELECTRODES

PRODUCT NUMBER	FEATURES	QUANTITIES
96-9676	Stainless Steel 4mm Ball, 2"	10/Box
96-9677	Stainless Steel 4mm Ball, 2"	10/bx, 10bx/cs, 100/cs
96-9678	Stainless Steel 4mm Coated Ball, 2"	10/Box
96-9679	Stainless Steel 4mm Coated Ball, 2"	10/bx, 10bx/cs, 100/cs
96-9680	Stainless Steel 5mm Ball, 2"	10/Box
96-9681	Stainless Steel 5mm Ball, 2"	10/bx, 10bx/cs, 100/cs
96-9682	Stainless Steel 5mm Coated Ball, 2"	10/Box
96-9683	Stainless Steel 5mm Coated Ball, 2"	10/bx, 10bx/cs, 100/cs



96-9684	Stainless Steel 5mm Ball, 5.3"	10/Box
96-9685	Stainless Steel 5mm Ball, 5.3"	10/bx, 10bx/cs, 100/cs



96-9686	Stainless Steel 5mm Coated Ball, 5.3"	10/Box
96-9687	Stainless Steel 5mm Coated Ball, 5.3"	10/bx, 10bx/cs, 100/cs





Single Use / Non-Sterile

Sklar Premium Patient Return Pads are manufactured using an advanced design hydro-gel adhesive that, incorporated with a gel overlay system, provide a much safer return pad for both the patient and surgeon. Sklar offers Patient Return Pads in five different configurations.

RETURN ELECTRODES / GROUNDING PADS

PRODUCT NUMBER	FEATURES	QUANTITIES
96-9688	Dual Element, 9' Cord Attached, Standard	50/cs
96-9690	Dual Element, Non-Corded, Standard	5/pk, 40pk/cs, 200/cs

96-9688 and 96-9690 are dual element return pads designed to be used with electrosurgical units that are equipped with REM or Neutral Electrode safety systems that continually monitor impedance levels. The 96-9688 comes with a pre-attached 9 foot cord with standard plug. The 96-9690 requires the use of a reusable cable, 96-9698, and come in a resealable foil pouch.



PRODUCT NUMBER	FEATURES	QUANTITIES
96-9692	Single Element, 9' Cord Attached, Standard	50/cs
96-9694	Single Element, Non-Corded, Standard	5/pk, 40pk/cs, 200/cs

96-9692 and 96-9694 are traditional single element return pads manufactured using the same hydro-gel technology. Both are designed for use with all electrosurgical generators. The 96-9692 comes with a pre-attached 9 foot cord, with standard connector. The 96-9694 requires the use of a reusable cable, 96-9698, and come in a resealable foil pouch.



PRODUCT NUMBER	FEATURES	QUANTITIES
96-9696	Dual Element, 9' Cord Attached, Pediatric / Infant	50/cs





CORDS AND CABLES

PRODUCT NUMBER	FEATURES	QUANTITIES
96-9698	Reusable Return Pad Cable For Use With Non-Corded Pads, 15' Non-Sterile	10/Box

PRODUCT NUMBER	FEATURES	QUANTITIES
96-9700	Single Use, Non-Sterile, Bipolar Forceps Cord, Flying Lead, 12'	10/Box
96-9701	Single Use, Non-Sterile, Bipolar Forceps Cord, Flying Lead, 12'	10/bx, 5bx/cs, 50/cs

PRODUCT NUMBER	FEATURES	QUANTITIES
96-9702	Single Use, Non-Sterile, Bipolar Forceps Cord, Solid Connector, 12'	10/Box
96-9703	Single Use, Non-Sterile, Bipolar Forceps Cord, Solid Connector, 12'	10/bx, 5bx/cs, 50/cs



TIP CLEANERS-DISPOSABLE

PRODUCT NUMBER	FEATURES	QUANTITIES
96-9704	Sterile	50/Box
96-9706	Non-Sterile	500/Box

42.5 MM X 42.5 MM
(1.7" X 1.7")



HOLSTERS-DISPOSABLE

PRODUCT NUMBER	FEATURES	QUANTITIES
96-9708	Sterile	100/Box
96-9710	Non-Sterile	500/Box





ADSON FORCEP

PRODUCT NUMBER	FEATURES
91-6100	1 MM, 4¾"



COAPTATION FORCEP

PRODUCT NUMBER	FEATURES
91-6101	.5 MM, 4"



CUSHING FORCEP

PRODUCT NUMBER	FEATURES
91-6102	1 MM, 6"



GERALD BAYONET FORCEP

PRODUCT NUMBER	FEATURES
91-6103	1 MM, 7"



GERALD FORCEP

PRODUCT NUMBER	FEATURES
91-6104	1 MM, 7"



HARDY BAYONET FORCEP

PRODUCT NUMBER	FEATURES
91-6105	1 MM, 8½"



REUSABLE SILICONE BIPOLAR CABLE

PRODUCT NUMBER	FEATURES
91-6113	10"

2-Pin US Instrument Plug with 4mm Generator Plug.
Compatible with most US Generators



WARNING: STERILIZATION GUIDELINES

Follow manufacturer's recommendations and AAMI standards for sterilization.

STEAM: steam autoclave at 250°F / 121°C for 20 minutes.

FLASH: steam autoclave at 275°F / 134°C for 10 minutes.

GAS (ETO): follow manufacturer's guide for the unit which you are using.



JANSEN BAYONET FORCEP

PRODUCT NUMBER	FEATURES
91-6106	1 MM, 6"



JEWELER #5 FORCEP

PRODUCT NUMBER	FEATURES
91-6107	.5 MM 4½"



MALIS FORCEP

PRODUCT NUMBER	FEATURES
91-6108	1 MM, 7"



MCPHERSON FORCEP

PRODUCT NUMBER	FEATURES
91-6109	.5 MM, 3½" Curved



MCPHERSON FORCEP

PRODUCT NUMBER	FEATURES
91-6110	.5 MM, 3½" Straight



SEMKIN FORCEP

PRODUCT NUMBER	FEATURES
91-6111	.5 MM, 5½"



TENZEL FORCEP

PRODUCT NUMBER	FEATURES
91-6112	.5 MM, 4"





READY-TO-USE, PRE-MOISTENED TOWELETTES

DISINFECTANT™ SURFACE WIPES



2 MINUTE KILL TIME! SAME EFFECTIVE FORMULA AS SKLAR DISINFECTANT!

- Ready to use, non-toxic formula.
- Specially formulated for the control of cross contamination.
- Effective against H1N1, MRSA, Salmonella, Parvo, Feline Leukemia, Herpes Simplex, Distemper, Ringworm, Strangles.
- Safe for all areas of the facility.
- Satisfies OSHA's Bloodborne Pathogen Standards.
- Destroys odor-causing bacteria.
- 7" x 10" non-woven, tear resistant towelette.
- Clean scent.
- EPA registered.

KILLS MRSA AND H1N1 VIRUS

PRODUCT NUMBER	FEATURES	QUANTITIES
10-1616	100 Towelettes / Canister	6/case
10-1617	100 Towelettes / Canister	12/case



Sklartech 5000

Sklartech 5000

The Sklartech 5000 Laparoscopic Instrument line provides a full range of the most popular patterns. Instruments can be purchased as a complete set or individually. When purchased as a complete instrument, Sklartech Laparoscopic Scissors, Dissectors and Forceps include the insert with tip, insulated cannula and handle with locking collar.

As with all Sklar complete Laparoscopic instruments, the handles and replacement inserts are easily interchangeable to perform intended and required by the surgeon. Each Sklartech 5000 scope is constructed of the highest quality German grade stainless steel to provide reliable durability and ease of use.

FEATURES:

INSULATED SHAFT provides vital protection against electro-surgical transfer.

INSERT WITH TIP is easily separated from cannula for cleaning and reprocessing with a convenient screw design.

LOCKING COLLAR features 360° rotation for ideal jaw position. Activate lock to provide tension and prevent accidental movement.

CARBON FIBER HANDLES are a comfortable ring construction that allows for precise hold of tissue. Choose from ratchet (YC) or non-ratchet (XC) designs.



SINGLE PORT LAPAROSCOPY

Discover the **New Evolution** in minimally invasive Laparoscopic Surgery

Single Port Laparoscopic surgery is an innovative procedure in which the skilled surgeon operates almost exclusively through a single entry point, typically the patients navel. Unlike the traditional multi-port laparoscopic approach, SPL leaves only a single small scar and most patients report less discomfort and faster recovery.

- Decreased trauma and risk for herniation
- Enhanced cosmetic benefits with minimal visible scarring
- Reduced post-operative pain
- Accelerated recovery time



Item Number 31-9415
20mm Diameter

Trocar that supports (2) 5mm and (1) 10mm Trocar/Obturator

SINGLE PORT TROCARS

INSTRUMENT	DIAMETER	FEATURES
31-9415	20mm	Trocar that supports (2) 5mm and (1) 10mm Trocar/Obturator
31-9416	5mm	Trocar/Obturator Support
31-9417	10mm	Trocar/Obturator Support
31-9418	12.5mm	Trocar/Obturator Support



SUCTION IRRIGATION

INSTRUMENT	DIAMETER	LENGTH	FEATURES
31-9411	5mm	35cm	Non-Ratcheted Handle

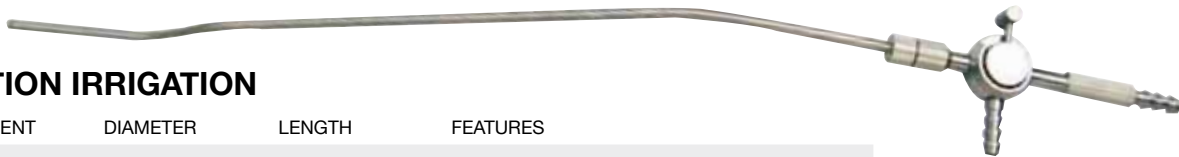

ETH NEEDLE HOLDERS

INSTRUMENT	DIAMETER	LENGTH	FEATURES
31-9404	5mm	35cm	Single Curve, Non-Ratcheted Handle
31-9412	5mm	35cm	Double Curve, Non-Ratcheted Handle

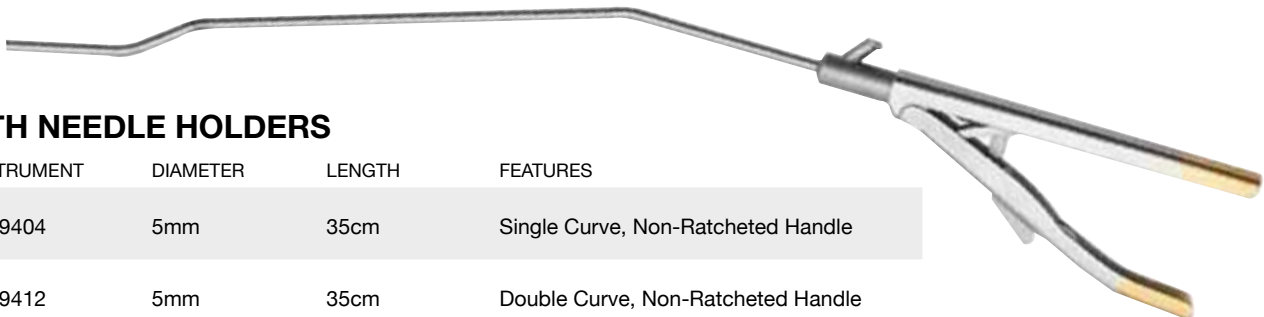

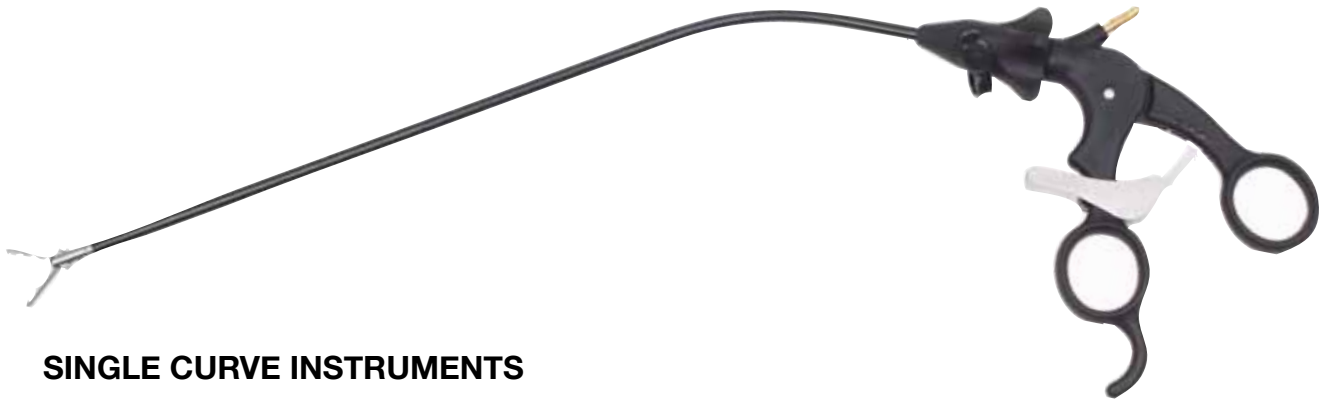

SINGLE CURVE INSTRUMENTS

INSTRUMENT	DIAMETER	LENGTH	FEATURES
31-9400	5mm	35cm	Metzenbaum Scissor, Non-Ratcheted Handle
31-9401	5mm	35cm	Maryland Dissector, Non-Ratcheted Handle
31-9402	5mm	35cm	Endo Clinch Grasping Forcep, Ratchet Handle
31-9403	5mm	35cm	Maxi Grasping Forcep, Ratchet Handle

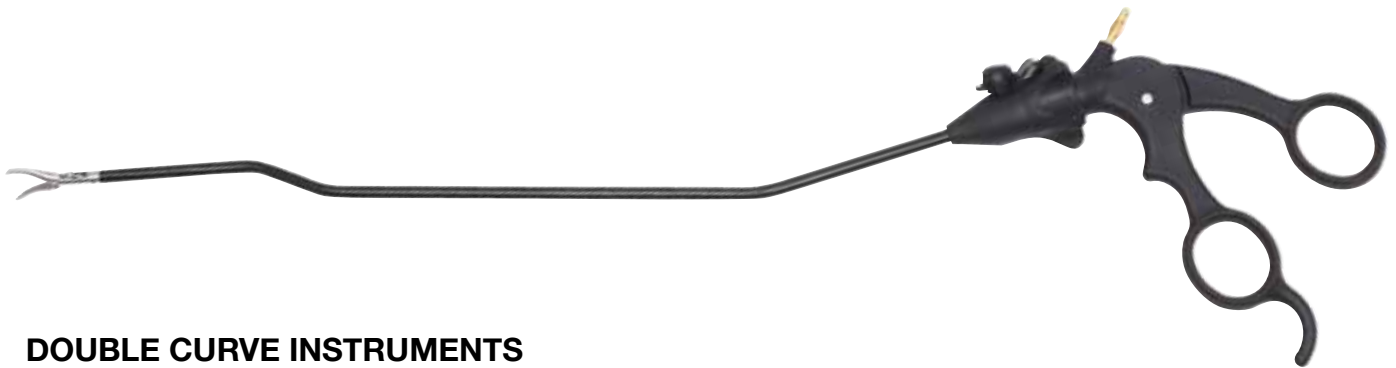

DOUBLE CURVE INSTRUMENTS

INSTRUMENT	DIAMETER	LENGTH	FEATURES
31-9405	5mm	35cm	Metzenbaum Scissor, Non-Ratcheted Handle
31-9406	5mm	35cm	Maryland Dissector, Non-Ratcheted Handle
31-9407	5mm	35cm	Endo Clinch Grasping Forcep, Ratcheted Handle
31-9408	5mm	35cm	Maxi Grasping Forcep, Ratcheted Handle
31-9409	5mm	35cm	L-Hook Electrode, Non-Ratcheted Handle
31-9410	5mm	35cm	Button Electrode, Non-Ratcheted Handle





SKLARTECH 5000 | SCISSORS

Offering a full range of the most popular patterns and sizes, SklarTech 5000 Laparoscopic complete instruments come standard with insert and tip, insulated cannula and handle with locking collar. Sklar also carries a full line of interchangeable replacement parts, accessories and miniature instruments for your surgical preference.

PERITONEAL SCISSORS

COMPLETE INSTRUMENT	REPLACEMENT INSERT	DIAMETER	LENGTH	FEATURES
31-9026XC	31-9026	5mm	33cm	Straight, Blunt Tips, XC Handle



OPERATING SCISSORS

COMPLETE INSTRUMENT	REPLACEMENT INSERT	DIAMETER	LENGTH	FEATURES
31-9027XC	31-9027	10mm	33cm	Straight, XC Handle

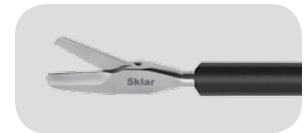

METZENBAUM SCISSORS

COMPLETE INSTRUMENT	REPLACEMENT INSERT	DIAMETER	LENGTH	FEATURES
31-9005XC	31-9005	5mm	33cm	Straight, XC Handle
31-9005YC	31-9005	5mm	33cm	Straight, YC Handle



COMPLETE INSTRUMENT	REPLACEMENT INSERT	DIAMETER	LENGTH	FEATURES
31-9010XC	31-9010	5mm	33cm	Curved, XC Handle
31-9010XC-45	31-9010-45	5mm	45cm	Curved, XC Handle



COMPLETE INSTRUMENT	REPLACEMENT INSERT	DIAMETER	LENGTH	FEATURES
31-9012XC	31-9012	5mm	33cm	Curved, Serrated, XC Handle
31-9012XC-45	31-9012-45	5mm	45cm	Curved, Serrated, XC Handle





HOOK SCISSORS

COMPLETE INSTRUMENT	REPLACEMENT INSERT	DIAMETER	LENGTH	FEATURES
31-9016XC	31-9016	5mm	33cm	Standard, Flush Tips, XC Handle



COMPLETE INSTRUMENT	REPLACEMENT INSERT	DIAMETER	LENGTH	FEATURES
31-9015XC	31-9015	5mm	33cm	Sharp Cutting Edge, Overlapping Tips, XC Handle
31-9015XC-45	31-9015-45	5mm	45cm	Sharp Cutting Edge, Overlapping Tips, XC Handle



MICRO SCISSORS

COMPLETE INSTRUMENT	REPLACEMENT INSERT	DIAMETER	LENGTH	FEATURES
31-9020XC	31-9020	5mm	33cm	Straight, Extremely Delicate, XC Handle



COMPLETE INSTRUMENT	REPLACEMENT INSERT	DIAMETER	LENGTH	FEATURES
31-9025XC	31-9025	5mm	33cm	Curved, Extremely Delicate, XC Handle



MARYLAND DISSECTORS

COMPLETE INSTRUMENT	REPLACEMENT INSERT	DIAMETER	LENGTH	FEATURES
31-9030XC	31-9030	5mm	33cm	Cross Serration, XC Handle
31-9030XC-45	31-9030-45	5mm	45cm	Cross Serration, XC Handle



COMPLETE INSTRUMENT	REPLACEMENT INSERT	DIAMETER	LENGTH	FEATURES
31-9031XC	31-9031	5mm	33cm	Diamond Serration, XC Handle
31-9120XC	31-9120	10mm	33cm	Diamond Serration, XC Handle

MIXTER FORCEPS

COMPLETE INSTRUMENT	REPLACEMENT INSERT	DIAMETER	LENGTH	FEATURES
31-9033XC	31-9033	5mm	33cm	90° Angle, Cross Serration, XC Handle



COMPLETE INSTRUMENT	REPLACEMENT INSERT	DIAMETER	LENGTH	FEATURES
31-9035XC	31-9035	5mm	33cm	90° Angle, Diamond Serration XC Handle
31-9125XC	31-9125	10mm	33cm	90° Angle, Diamond Serration XC Handle
31-9125XC-45	31-9125-45	10mm	45cm	90° Angle, Diamond Serration XC Handle

DISSECTING FORCEP

COMPLETE INSTRUMENT	REPLACEMENT INSERT	DIAMETER	LENGTH	FEATURES
31-9036XC	31-9036	5mm	33cm	Curved, Serrated, XC Handle

DOLPHIN FORCEP

COMPLETE INSTRUMENT	REPLACEMENT INSERT	DIAMETER	LENGTH	FEATURES
31-9040XC	31-9040	5mm	33cm	Short, XC Handle





KELLY FORCEP

COMPLETE INSTRUMENT	REPLACEMENT INSERT	DIAMETER	LENGTH	FEATURES
31-9043XC	31-9043	5mm	33cm	Double Action, XC Handle



GLASSMANN FORCEP

COMPLETE INSTRUMENT	REPLACEMENT INSERT	DIAMETER	LENGTH	FEATURES
31-9096YC	31-9096	5mm	33cm	Atraumatic Clamp, YC Handle



TENACULUM FORCEPS

COMPLETE INSTRUMENT	REPLACEMENT INSERT	DIAMETER	LENGTH	FEATURES
31-9111YC	31-9111	5mm	33cm	1x1 Sharp Teeth, YC Handle
31-9113YC	31-9113	10mm	33cm	1x1 Sharp Teeth, YC Handle



KOCHER FORCEP

COMPLETE INSTRUMENT	REPLACEMENT INSERT	DIAMETER	LENGTH	FEATURES
31-9128XC	31-9128	10mm	33cm	60mm Jaws, Axial Serration, XC Handle



SPOON FORCEP

COMPLETE INSTRUMENT	REPLACEMENT INSERT	DIAMETER	LENGTH	FEATURES
31-9135XC	31-9135	10mm	33cm	XC Handle



CLAW FORCEPS

COMPLETE INSTRUMENT	REPLACEMENT INSERT	DIAMETER	LENGTH	FEATURES
31-9045XC	31-9045	5mm	33cm	Traumatic Jaws, XC Handle
31-9045YC	31-9045	5mm	33cm	Traumatic Jaws, YC Handle
COMPLETE INSTRUMENT	REPLACEMENT INSERT	DIAMETER	LENGTH	FEATURES
31-9130XC	31-9130	10mm	33cm	Traumatic Jaws, XC Handle





BABCOCK FORCEPS

COMPLETE INSTRUMENT	REPLACEMENT INSERT	DIAMETER	LENGTH	FEATURES
31-9105YC	31-9105	5mm	33cm	YC Handle



COMPLETE INSTRUMENT	REPLACEMENT INSERT	DIAMETER	LENGTH	FEATURES
31-9140YC	31-9140	10mm	33cm	YC Handle
31-9140XC	31-9140	10mm	33cm	XC Handle
31-9140YC-45	31-9140-45	10mm	45cm	YC Handle



ALLIS FORCEPS

COMPLETE INSTRUMENT	REPLACEMENT INSERT	DIAMETER	LENGTH	FEATURES
31-9067YC	31-9067	5mm	33cm	TC Inserted Jaws, Atraumatic Clamp, YC Handle



COMPLETE INSTRUMENT	REPLACEMENT INSERT	DIAMETER	LENGTH	FEATURES
31-9144YC	31-9144	10mm	33cm	TC Inserted Jaws, Diamond Serrations, YC Handle



STRONG ATRAUMATIC CLAMP

COMPLETE INSTRUMENT	REPLACEMENT INSERT	DIAMETER	LENGTH	FEATURES
31-9145YC	31-9145	10mm	33cm	40mm Jaws, Straight, YC Handle



NEEDLE HOLDER

COMPLETE INSTRUMENT	REPLACEMENT INSERT	DIAMETER	LENGTH	FEATURES
31-9112YC	31-9112	5mm	33cm	10mm Jaws, Pointed, YC Handle



GRASPING FORCEPS

COMPLETE INSTRUMENT	REPLACEMENT INSERT	DIAMETER	LENGTH	FEATURES
31-9050XC	31-9050	5mm	33cm	Standard, Cross Serrations, XC Handle
31-9050YC	31-9050	5mm	33cm	Standard, Cross Serrations, YC Handle
31-9050YC-45	31-9050-45	5mm	45cm	Standard, Cross Serrations, YC Handle



COMPLETE INSTRUMENT	REPLACEMENT INSERT	DIAMETER	LENGTH	FEATURES
31-9051YC	31-9051	5mm	33cm	Tapered, Rounded Jaws, YC Handle



COMPLETE INSTRUMENT	REPLACEMENT INSERT	DIAMETER	LENGTH	FEATURES
31-9055YC	31-9055	5mm	33cm	Endo Clinch, Extremely Atraumatic Serrations, YC Handle



COMPLETE INSTRUMENT	REPLACEMENT INSERT	DIAMETER	LENGTH	FEATURES
31-9080YC	31-9080	5mm	33cm	With Spoon, YC Handle
31-9080XC	31-9080	5mm	33cm	With Spoon, XC Handle



COMPLETE INSTRUMENT	REPLACEMENT INSERT	DIAMETER	LENGTH	FEATURES
31-9085YC	31-9085	5mm	33cm	Pointed with Spoon, YC Handle



COMPLETE INSTRUMENT	REPLACEMENT INSERT	DIAMETER	LENGTH	FEATURES
31-9100YC	31-9100	5mm	33cm	Maxi (Fundus), YC Handle



WAVE FORCEPS

COMPLETE INSTRUMENT	REPLACEMENT INSERT	DIAMETER	LENGTH	FEATURES
31-9060YC	31-9060	5mm	33cm	Atraumatic Wavelike Serrations, Single Action, YC Handle
31-9060YC-45	31-9060-45	5mm	45cm	Atraumatic Wavelike Serrations, Single Action, YC Handle
31-9061YC	31-9061	5mm	33cm	Atraumatic Wavelike Serrations, Double Action, YC Handle

DEBAKEY FORCEPS

COMPLETE INSTRUMENT	REPLACEMENT INSERT	DIAMETER	LENGTH	FEATURES
31-9065YC	31-9065	5mm	33cm	40mm Jaws, YC Handle
31-9065XC	31-9065	5mm	33cm	40mm Jaws, XC Handle
31-9065YC-45	31-9065-45	5mm	45cm	40mm Jaws, YC Handle
31-9065XC-45	31-9065-45	5mm	45cm	40mm Jaws, XC Handle

BABCOCK/DEBAKEY FORCEP

COMPLETE INSTRUMENT	REPLACEMENT INSERT	DIAMETER	LENGTH	FEATURES
31-9142XC	31-9142	10mm	33cm	Atraumatic Serrations, XC Handle

COBRA FORCEP

COMPLETE INSTRUMENT	REPLACEMENT INSERT	DIAMETER	LENGTH	FEATURES
31-9075YC	31-9075	5mm	33cm	2x3 Teeth, Double Action, YC Handle

ALLIGATOR FORCEP

COMPLETE INSTRUMENT	REPLACEMENT INSERT	DIAMETER	LENGTH	FEATURES
31-9070YC	31-9070	5mm	33cm	Double Action, YC Handle





ATRAUMATIC GRASPERS

COMPLETE INSTRUMENT	REPLACEMENT INSERT	DIAMETER	LENGTH	FEATURES
31-9098YC	31-9098	5mm	33cm	Single Action, YC Handle



COMPLETE INSTRUMENT	REPLACEMENT INSERT	DIAMETER	LENGTH	FEATURES
31-9097XC	31-9097	5mm	33cm	Diamond Serrations, XC Handle
31-9097YC	31-9097	5mm	33cm	Diamond Serrations, YC Handle



FENESTRATED GRASPING DISSECTOR

COMPLETE INSTRUMENT	REPLACEMENT INSERT	DIAMETER	LENGTH	FEATURES
31-9042XC	31-9042	5mm	33cm	16mm Double Action Jaw, XC Handle



FENESTRATED GRASPING FORCEPS

COMPLETE INSTRUMENT	REPLACEMENT INSERT	DIAMETER	LENGTH	FEATURES
31-9090YC	31-9090	5mm	33cm	22mm Double Action Jaw, YC Handle
31-9090XC-45	31-9090-45	5mm	45cm	22mm Double Action Jaw, XC Handle



COMPLETE INSTRUMENT	REPLACEMENT INSERT	DIAMETER	LENGTH	FEATURES
31-9095XC	31-9095	5mm	33cm	40mm Double Action Jaw, XC Handle
31-9095YC	31-9095	5mm	33cm	40mm Double Action Jaw, YC Handle
31-9095XC-45	31-9095-45	5mm	45cm	40mm Double Action Jaw, XC Handle
31-9095YC-45	31-9095-45	5mm	45cm	40mm Double Action Jaw, YC Handle





SKLARTECH 5000 | PUNCHES

PUNCH

COMPLETE INSTRUMENT	REPLACEMENT INSERT	DIAMETER	LENGTH	FEATURES
31-9046XC	31-9046	5mm	33cm	Probe Excision



BIOPSY PUNCH

COMPLETE INSTRUMENT	REPLACEMENT INSERT	DIAMETER	LENGTH	FEATURES
31-9047XC	31-9047	5mm	33cm	No Tooth, XC Handle



COMPLETE INSTRUMENT	REPLACEMENT INSERT	DIAMETER	LENGTH	FEATURES
31-9110YC	31-9110	5mm	33cm	With Tooth, YC Handle
31-9110YC-45	31-9110-45	5mm	45cm	With Tooth, YC Handle



COMPLETE INSTRUMENT	REPLACEMENT INSERT	DIAMETER	LENGTH	FEATURES
31-9115XC	31-9115	5mm	33cm	Spoon with Teeth, XC Handle
31-9115YC	31-9115	5mm	33cm	Spoon with Teeth, YC Handle
31-9115YC-45	31-9115-45	5mm	45cm	Spoon with Teeth, YC Handle



SKLAR STERILE TRAYS

Sklar Sterile provides high quality products competitively priced to ensure unsurpassed value. Our procedure trays feature high quality Econo Floor Grade instruments from Sklar.

96-4413
STAPLE REMOVAL TRAY 50/CASE

941-0049B
GENERAL TRAY 10/CASE

96-4414
SUTURE REMOVAL TRAY 50/CASE

Additional trays available on pages 365-370.





SKLAR “XC” CARBON HANDLE

INSTRUMENT	FEATURES
31-9001XC	Standard, non-ratchet, lightweight, carbon fiber reinforced non-conductive safety handle with locking collar. Fully rotating with a proximally positioned high-frequency connector.

SKLAR “YC” CARBON HANDLE

INSTRUMENT	FEATURES
31-9002YC	Standard, ratchet, lightweight, carbon fiber reinforced non-conductive safety handle with locking collar. Fully rotating with a proximally positioned high-frequency connector.

REPLACEMENT LOCKING COLLAR

INSTRUMENT	FEATURES
31-9160	For Sklar Standard Handles



Instruments may be ordered as complete sets or assembled from components ordered separately. Optional handles for customizing instruments – interchangeable for 3mm, 5mm or 10mm – are available for special order. Contact your Sklar Sales Representative for details.

CANNULAS

INSTRUMENT	DIAMETER	LENGTH	FEATURES
31-9155	5mm	33cm	Insulated
31-9155-45	5mm	45cm	Insulated



31-9150	10mm	33cm	Insulated With Permanent Locking Collar Attached
31-9150-45	10mm	45cm	Insulated With Permanent Locking Collar Attached





HASSON TROCAR WITH TRUMPET VALVE

COMPLETE INSTRUMENT	REPLACEMENT OBTURATOR	LENGTH	FEATURES
31-1002	31-0004	11mm	Hasson Trumpet Valve Cannula with 11mm Blunt Tip Obturator



STANDARD TROCAR WITH TRUMPET VALVE

COMPLETE INSTRUMENT	REPLACEMENT OBTURATOR	LENGTH	FEATURES
31-1007	31-1010	5.5mm	Trumpet Valve Cannula With 5.5mm Sharp Obturator



STANDARD TROCAR WITH TRAP DOOR

COMPLETE INSTRUMENT	REPLACEMENT OBTURATOR	LENGTH	FEATURES
31-1004	31-1011	11mm	Trap Door Cannula With 11mm Sharp Obturator



STANDARD TROCAR WITH AUTOMATIC VALVE

COMPLETE INSTRUMENT	REPLACEMENT OBTURATOR	LENGTH	FEATURES
31-1015	31-1010	5.5mm	Automatic Valve Cannula with 5.5mm Sharp Obturator, Dismountable
31-1016	31-1011	11mm	Automatic Valve Cannula with 11mm Sharp Obturator, Dismountable



STANDARD TROCAR WITH SILICON VALVE

COMPLETE INSTRUMENT	REPLACEMENT OBTURATOR	LENGTH	FEATURES
31-1017	31-1010	5.5mm	Silicon Valve Cannula with LL Stopcock & 5.5mm Sharp Obturator, Dismountable
31-1018	31-1011	11mm	Silicon Valve Cannula with LL Stopcock & 11mm Sharp Obturator, Dismountable





OBTURATORS

INSTRUMENT	LENGTH	FEATURES
31-0004	11mm	Blunt Tip Obturator for 11mm Hasson Cannula
31-1011	11mm	Extremely Sharp Pyramidal Tip Obturator for Standard Trocar
31-1010	5.5mm	Extremely Sharp Pyramidal Tip Obturator for Standard Trocar

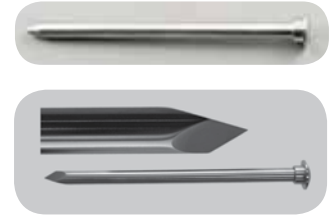

THREADED CANNULA SLEEVE

INSTRUMENT	LENGTH	FEATURES
31-1020	5.5mm	Interchangeable with Standard Smooth Cannulas



SNAP ON FLIP REDUCER

INSTRUMENT	LENGTH	FEATURES
31-1042	-	Reduces from 11mm to 5.5mm



S-RETRACTOR

INSTRUMENT	LENGTH	FEATURES
60-6130	6¼"	Set of 2



TROCAR CANNULA PARTS

FOR USE WITH STANDARD & HASSON VALVE CANNULAS				
EXTERNAL SEALS	5.5mm	11mm	11mm (Hasson)	11mm (Hasson)
	RED	BLUE	BLUE	GRAY
	31-0003	31-0001	31-0001	31-0002
FOR USE WITH TRAP DOOR CANNULAS				
INTERNAL SEAL	5.5mm		11mm	
	GRAY		YELLOW	
	31-4323		31-4324	
FOR USE WITH SILICON VALVE CANNULAS				
SILICON VALVE	5.5mm		11mm	
	31-4328		31-4329	



**SKLARTECH
5000**



Each coagulating Electrode is able to connect to the suction control valve of your choice (Listed below). Insulated Electrodes and Control Valves sold separately.

INSULATED ELECTRODES, WITH SUCTION

INSTRUMENT	DIAMETER	FEATURES
31-2235 (A)	5mm	Spatula
31-2237 (B)	5mm	L-Hook
31-2241 (C)	5mm	Knife
31-2243 (D)	5mm	J-Hook
31-2244 (E)	5mm	Blunt

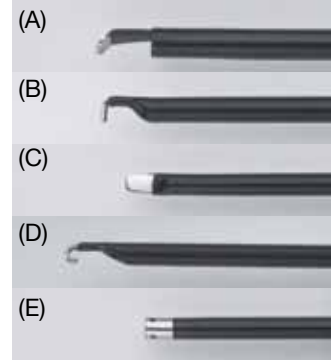

HIGH FREQUENCY SUCTION CONTROL VALVES

INSTRUMENT	DIAMETER	FEATURES
31-2227 (A)	5mm	Insulated Suction Control with Single Trumpet Valve
31-2233 (B)	5mm	Insulated Suction Control with Double Trumpet Valve
31-2229 (C)	5mm	Insulated Suction Control with Double Trumpet Valve and Handle

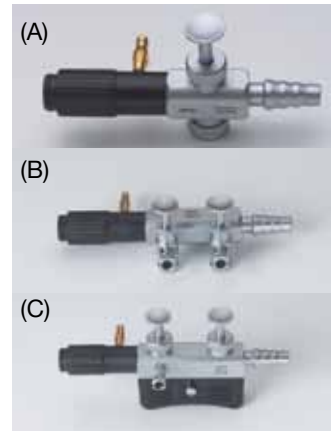

INSULATED ELECTRODES, WITHOUT SUCTION

Each Electrode has a permanently fitted adapter for connecting to the Electrosurgical Cable. Insulated Electrodes and Cables sold separately.

INSTRUMENT	DIAMETER	FEATURES
31-2435 (A)	5mm	Spatula
31-2437 (B)	5mm	L-Hook
31-2443 (C)	5mm	J-Hook
31-2445 (D)	5mm	Button
31-2447 (E)	5mm	Cone

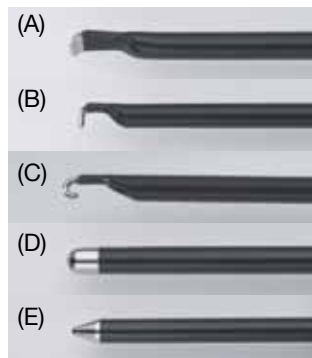

ELECTROSURGICAL CABLE

INSTRUMENT	LENGTH	FEATURES
31-2242	277cm	Monopolar





METZENBAUM SCISSORS

COMPLETE INSTRUMENT	REPLACEMENT INSERT	DIAMETER	LENGTH	FEATURES
31-4306XC	31-4306	3mm	33cm	Mini, Straight, XC Handle
31-4303XC	31-4303	3mm	33cm	Mini, Curved, XC Handle
31-4307XC	31-4307	3mm	33cm	Mini, Curved, Serrated, XC Handle



HOOK SCISSORS

COMPLETE INSTRUMENT	REPLACEMENT INSERT	DIAMETER	LENGTH	FEATURES
31-4304XC	31-4304	3mm	33cm	Mini, Delicate, Straight, XC Handle



MARYLAND DISSECTOR

COMPLETE INSTRUMENT	REPLACEMENT INSERT	DIAMETER	LENGTH	FEATURES
31-4310XC	31-4310	3mm	33cm	Mini, Cross Serrations, Curved XC Handle



FORCEPS

COMPLETE INSTRUMENT	REPLACEMENT INSERT	DIAMETER	LENGTH	FEATURES
31-4314YC	31-4314	3mm	33cm	Mini Duck Nose, Cross Serrations, Straight, YC Handle
31-4309XC	31-4309	3mm	33cm	Mini Kelly, Double Action Delicate Jaws, XC Handle
31-4315XC	31-4315	3mm	33cm	Mini Spoon, XC Handle
31-4316XC	31-4316	3mm	33cm	Mini Spoon, Serrated, XC Handle





GRASPING FORCEPS

COMPLETE INSTRUMENT	REPLACEMENT INSERT	DIAMETER	LENGTH	FEATURES
31-4308YC	31-4308	3mm	33cm	Mini Grasping Forcep, YC Handle
31-4311XC	31-4311	3mm	33cm	Mini Atraumatic, Dissector, Straight XC Handle
31-4312YC	31-4312	3mm	33cm	Mini Grasping Forcep, Heavy Serrations YC Handle
31-4313YC	31-4313	3mm	33cm	Mini Cobra, Heavy Serrations YC Handle
31-4317YC	31-4317	3mm	33cm	Mini Fenestrated, 8mm Double Action Jaws, YC Handle

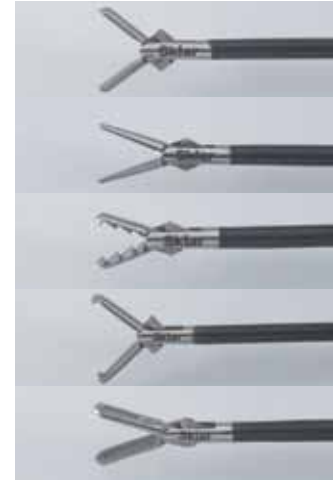

PUNCH

COMPLETE INSTRUMENT	REPLACEMENT INSERT	DIAMETER	LENGTH	FEATURES
31-4305XC	31-4305	3mm	33cm	Mini Punch, Delicate



NEEDLE HOLDER

NON-INSULATED WITH TUNGSTEN CARBIDE JAW INSERTS AND AXIAL HANDLE

COMPLETE INSTRUMENT	DIAMETER	LENGTH	FEATURES
31-9360AX	3mm	33cm	Mini, Straight, Axial Ring Handle
31-9362AX	3mm	33cm	Mini, Curved Right, Axial Ring Handle
31-9364AX	3mm	33cm	Mini, Curved Left, Axial Ring Handle



COMPLETE INSTRUMENT





MINIATURE ENDOSCOPE

COMPLETE INSTRUMENT	DIAMETER	LENGTH	FEATURES
31-4301	2.7mm	30cm	Miniature, Autoclavable



MINIATURE TROCAR

COMPLETE INSTRUMENT	REPLACEMENT OBTURATOR	DIAMETER	FEATURES
31-4302	31-4318	3mm	Mini, with Trap Door Cannula, Resusable, Includes 3mm Obturator
31-4320	-	3mm	External Seal, Red For use with Standard and Hasson Cannulas
31-4321	-	3mm	Internal Seal, Gray For use with Trap Door Cannulas only



ELECTROSURGERY

INSULATED ELECTRODES WITHOUT SUCTION

Each Electrode has a permanently fitted adapter for connecting to the Electrosurgical Cable. Insulated Electrodes and Cables sold separately.

INSTRUMENT	DIAMETER	FEATURES
31-4325 (A)	3mm	Mini, Spatula
31-4326 (B)	3mm	Mini, L-Hook
31-4327 (C)	3mm	Mini, J-Hook

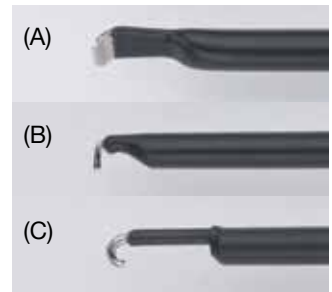

ELECTROSURGICAL CABLE

INSTRUMENT	LENGTH	FEATURES
31-2242	277cm	Monopolar





VERRES NEEDLE WITH STOPCOCK

INSTRUMENT	DIAMETER	LENGTH	FEATURES
31-2327	2.3mm	100mm	Stopcock
31-2350	2.3mm	120mm	Stopcock
31-2352	2.3mm	150mm	Stopcock



NEEDLE FOR INJECTION AND IRRIGATION

INSTRUMENT	DIAMETER	LENGTH	FEATURES
31-2355	5mm	33cm	Luer Lock, 2mm Hollow Needle
31-2355-45	5mm	45cm	Luer Lock, 2mm Hollow Needle



GRADUATED PROBE

INSTRUMENT	DIAMETER	LENGTH	FEATURES
31-2365	5.5mm	33cm	Graduated



ESOPHAGUS RETRACTOR

INSTRUMENT	DIAMETER	LENGTH	FEATURES
31-4565	5mm	33cm	For Gastric Band Application



FAN RETRACTOR

INSTRUMENT	DIAMETER	LENGTH	FEATURES
31-4562	5mm	33cm	3 Finger Articulating Fan, Slightly Bent



FAN RETRACTOR

INSTRUMENT	DIAMETER	LENGTH	FEATURES
31-4563	10mm	33cm	5 Finger Articulating Fan, Slightly Bent



SUCTION IRRIGATION SYSTEM

COMPLETE INSTRUMENT	DIAMETER	LENGTH	FEATURES
31-2238	5mm	33cm	Dual Trumpet Valve (also fits 10mm Sheath)
31-2238-45	5mm	45cm	Dual Trumpet Valve (also fits 10mm Sheath)
31-2258	5mm	33cm	Single Trumpet Valve (also fits 10mm Sheath)
31-4003	5mm	33cm	Sheath Only
31-4004	10mm	33cm	Sheath Only
31-2205	5mm	33cm	Tube Channel, for Laser-Fiber
31-2238OR	-	-	O-Ring, Replacement Pk/10



HIGH-VOLUME SUCTION IRRIGATION SYSTEM

COMPLETE INSTRUMENT	DIAMETER	LENGTH	FEATURES
31-2239	5mm 10mm	33cm	Dual Trumpet Valve (includes both 5mm and 10mm Sheaths)
31-2347	5mm	33cm	Sheath Only
31-2349	10mm	33cm	Sheath Only



TC NEEDLEHOLDER
NON-INSULATED WITH TUNGSTEN CARBIDE JAW INSERTS AND AXIAL HANDLE

COMPLETE INSTRUMENT	DIAMETER	LENGTH	FEATURES
31-2550	5mm	33cm	Standard, Straight, Flushable Shaft, 10mm Jaw Axial Handle
31-2550-45	5mm	45cm	Standard, Straight, Flushable Shaft, 10mm Jaw Axial Handle
31-2551	5mm	33cm	Standard, Curved Right, Flushable Shaft, 10mm Jaw Axial Handle
31-2552	5mm	33cm	Standard, Curved Left, Flushable Shaft, 10mm Jaw Axial Handle
31-2552-45	5mm	45cm	Standard, Curved Left, Flushable Shaft, 10mm Jaw Axial Handle
31-2553	5mm	33cm	Standard, Straight, Solid Shaft, 8mm Jaw Axial Handle



NEW

LIGATION CLIPS

Sklar is pleased to offer the most atraumatic shaped clip on the market. Sklar Ligation Clips' unique "U-Shape" design provides a stronger, more permanent hold. The unique and highly-advanced cross-serrations on each clip make it extremely secure, eliminating slippage from the vessel after closure. And the solid titanium gives a scatter-free CT image and is MRI compatible.

Sklar Ligation Clips are conveniently packaged in sterile cartridges holding six single clips, eliminating waste. Cartridges feature an adhesive backing to easily affix to any surface.

Perfect compatibility between special applicators and clips allow for an effortless loading system while the chevron shape facilitates a surgeon's choice "tip-first" closing action. Vessels are contained within the clip so full control is available before ligation.



STERILE

INSTRUMENT	SIZE	FEATURES	QUANTITIES
31-7300	Small	Yellow	6/pk, 20pk/cs, 120/cs
31-7301	Medium	Blue	6/pk, 20pk/cs, 120/cs
31-7302	Medium/Large	Green	6/pk, 20pk/cs, 120/cs
31-7303	Large	Orange	6/pk, 20pk/cs, 120/cs





OPEN SURGERY APPLIERS

- Easy and Convenient Loading System
- Spring Action controls jaw compression
- Firm Grasp of clips
- Safe and precise closing action
- Color Coded for easy identification
- Full Range of Sizes to fit any application

SMALL

INSTRUMENT	LENGTH	FEATURES
31-7305	6" 150mm	Straight, Yellow
31-7306	7½" 190mm	Straight, Yellow
31-7307	7½" 190mm	Right Angle, Yellow

MEDIUM

INSTRUMENT	LENGTH	FEATURES
31-7308	6" 150mm	Straight, Blue
31-7309	7½" 190mm	Straight, Blue
31-7310	7½" 190mm	Right Angle, Blue
31-7311	11" 280mm	Straight, Blue
31-7312	11" 280mm	Right Angle, Blue

MEDIUM/LARGE

INSTRUMENT	LENGTH	FEATURES
31-7313	7½" 190mm	Straight, Green
31-7314	7½" 190mm	Right Angle, Green
31-7315	11" 280mm	Straight, Green
31-7316	11" 280mm	Right Angle, Green

LARGE

INSTRUMENT	LENGTH	FEATURES
31-7317	7½" 190mm	Straight, Orange
31-7318	7½" 190mm	Right Angle, Orange
31-7319	11" 280mm	Straight, Orange
31-7320	11" 280mm	Right Angle, Orange



Clips and Appliers sold separately.

ROTATABLE APPLIERS

- Easy and Convenient Loading System
- Full 360° Rotation of applicator shape
- Sized to match popular clip sizes



INSTRUMENT	DIAMETER	LENGTH	FEATURES
31-7321	5mm	35cm	Clip Applicator for Small Ligation Clips



INSTRUMENT	DIAMETER	LENGTH	FEATURES
31-7322	8mm	35cm	Clip Applicator for Medium Ligation Clips

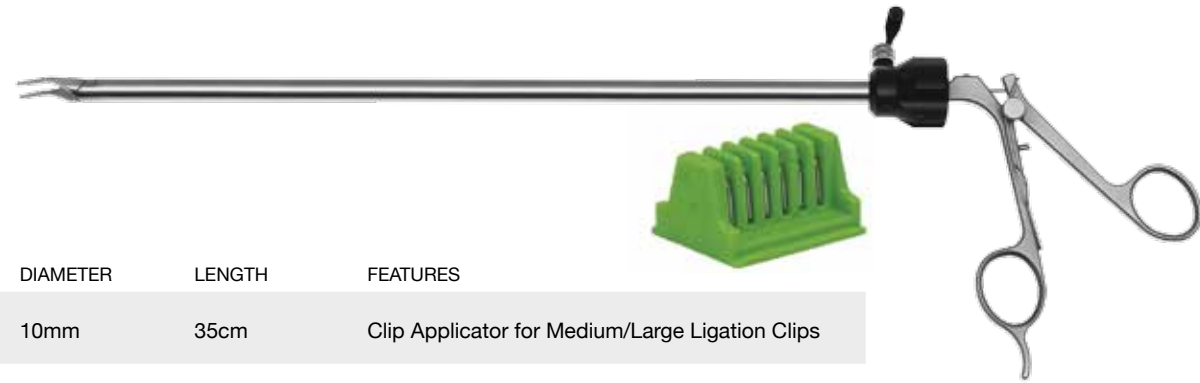

INSTRUMENT	DIAMETER	LENGTH	FEATURES
31-7323	10mm	35cm	Clip Applicator for Medium/Large Ligation Clips



INSTRUMENT	DIAMETER	LENGTH	FEATURES
31-7324	12.5mm	35cm	Clip Applicator for Large Ligation Clips

Clips and Appliers sold separately.



HX-LINE Disposable Sheath/Insert with Reusable Handles

Sklar is proud to introduce the SKLARTECH 5000HX-Line of Disposable Laparoscopic Instruments featuring a disposable sheath/insert combination and reusable carbon fiber handle. With a disposable sheath/insert combination, all parts of the instrument that had direct contact during surgery can be disposed of immediately after procedures. The carbon fiber handles, available with or without ratchet, can quickly and easily be cleaned and sterilized for continued use.

- Choose from a full line of the most popular patterns.
- Benefit from factory-honed instrument edge with every use.
- Improved operating room efficiency.
- Eliminate difficult reprocessing procedures.
- Enhanced efficiency and cost savings.

NEW!

Sklartech 5000HX



REUSABLE HANDLES

INSTRUMENT	DESCRIPTION	QUANTITIES
31-7001XC	Carbon Fiber without Ratchet	Each
31-7002YC	Carbon Fiber with Ratchet	Each

DISPOSABLE SHEATH/INSERT

INSTRUMENT	DIAMETER	LENGTH	FEATURES	QUANTITIES
31-7070	5mm	33cm	Fenestrated Grasping Forcep, Serrated	10/pk
31-7070-45	5mm	45cm	Fenestrated Grasping Forcep, Serrated	10/pk
31-7030	5mm	33cm	Maryland Dissector, Curved, Cross Serrations	10/pk
31-7030-45	5mm	45cm	Maryland Dissector, Curved, Cross Serrations	10/pk
31-7055	5mm	33cm	Endo Clinch Forcep, Extremely Atraumatic, Serrated	10/pk
31-7055-45	5mm	45cm	Endo Clinch Forcep, Extremely Atraumatic, Serrated	10/pk
31-7061	5mm	33cm	Wave Grasper Forcep, Wavelike Serrations	10/pk
31-7061-45	5mm	45cm	Wave Grasper Forcep, Wavelike Serrations	10/pk
31-7035	5mm	33cm	Mixer Clamp Forcep, 90° Angle	10/pk
31-7035-45	5mm	45cm	Mixer Clamp Forcep, 90° Angle	10/pk
31-7040	5mm	33cm	Dolphin Nose Forcep, Serrated	10/pk
31-7040-45	5mm	45cm	Dolphin Nose Forcep, Serrated	10/pk
31-7073	5mm	33cm	Allis Forcep, 3x4 Teeth	10/pk
31-7073-45	5mm	45cm	Allis Forcep, 3x4 teeth	10/pk
31-7016	5mm	33cm	Hook Scissors, Single Action	10/pk
31-7016-45	5mm	45cm	Hook Scissors, Single Action	10/pk
31-7012	5mm	33cm	Metzenbaum Scissors, Curved, Serrated	10/pk
31-7012-45	5mm	45cm	Metzenbaum Scissors, Curved, Serrated	10/pk
31-7007	5mm	33cm	Metzenbaum Scissors, Straight, Serrated	10/pk
31-7007-45	5mm	45cm	Metzenbaum Scissors, Straight, Serrated	10/pk
31-7107	5mm	33cm	Babcock-Debaquey Forcep, Atraumatic Serrations	10/pk
31-7107-45	5mm	45cm	Babcock-Debaquey Forcep, Atraumatic Serrations	10/pk



Item Number 31-7030
Maryland Forcep, Curved, Cross Serrations



SKLARTECH 5000X

Sklar is pleased to introduce a new line of sterile, 100% Disposable Laparoscopic instruments. Complete with HF Port, the X-Line delivers quality and performance at an economical price. Improve safety and reduce the risk of cross contamination to patient and staff by disposing of the entire instrument immediately following procedures.

- Advantage of factory-hone instruments with every use.
- Simplify cost-accounting per operation.
- Eliminate reprocessing time and expense.
- Eliminate Maintenance.
- Reduce inventory.

NEW!

Sklartech 5000X



X-LINE DISPOSABLE INSTRUMENTS, COMPLETE UNIT

COMPLETE INSTRUMENT	DIAMETER	LENGTH	FEATURES	QUANTITIES
31-7012XC	5mm	33cm	Metzenbaum Scissors, Curved with Non-Ratcheted Handle, Red	6/pk
31-7030XC	5mm	33cm	Maryland Dissector, Cross Serrations with Non-Ratcheted Handle, Yellow	6/pk
31-7055XC	5mm	33cm	Endo Clinch Forcep, Cross Serrations with Non-Ratcheted Handle, Blue	6/pk
31-7055YC	5mm	33cm	Endo Clinch Forcep, Cross Serrations with Ratchet Handle, Blue	6/pk



DISPOSABLE TROCARS

INSTRUMENT	DIAMETER	LENGTH	FEATURES	QUANTITIES
31-7200	10mm	10cm	Hasson, Blunt	10/pk
31-7205	12.5mm	10cm	Hasson, Blunt	10/pk
31-7210	5mm	10cm	Safety Shield	10/pk
31-7215	10mm	10cm	Safety Shield	10/pk
31-7220	12.5mm	10cm	Safety Shield	10/pk
31-7225	5mm	10cm	Conical Tip, Pyramidal Obturator	10/pk
31-7230	10mm	10cm	Conical Tip, Conical Obturator	10/pk
31-7235	5mm	10cm	Dilating Tip Obturator	10/pk
31-7240	10mm	10cm	Dilating Tip Obturator	10/pk
31-7245	12.5mm	10cm	Dilating Tip Obturator	10/pk
31-7250	5mm	10cm	Sheath Only	10/pk
31-7255	10mm	10cm	Sheath Only	10/pk
31-7260	12.5mm	10cm	Sheath Only	10/pk





Sklar is pleased to offer a full line of Care & Cleaning agents to disinfect, decontaminate, sterilize, lubricate and protect your stainless steel surgical instruments and equipment. For expert care of your surgical instruments at every stage of the cleaning process, trust Sklar to deliver the right cleaning agent for you.



3 EASY STEPS FOR THE CARE AND CLEANING OF YOUR INSTRUMENTS

1 DECONTAMINATION

Sklar Disinfectants are a pre-cleaner and disinfectant for the safe decontamination of soiled surgical instruments, medical and surgical equipment and inanimate surfaces including plastics, stainless steel, chrome, glass, Plexiglas and baked on painted surfaces. Disinfectants are effective against a broad range of pathogens in as little as 2 minutes.



2 CLEANING

Sklar carries a complete line of effective detergents and enzymatics for cleaning, not only for your surgical instruments, but also metals, glassware, plastic and rubber. Available in your choice of powder, liquid concentrate or spray foams.



3 LUBRICATION

To guarantee extended life and performance of your surgical instruments, choose one of Sklar's lubricants or sprays as the final step in your instrument processing regimen. Specifically designed to protect against corrosion, rust and staining, Sklar offers several different types of lubricants to protect your investments.





SKLAR-CIDE™

HIGH LEVEL DISINFECTING/STERILIZING SOLUTION

Sporicidal • Bactericidal • Virucidal • Fungicidal

SKLAR-CIDE provides a safe and efficient means for the high-level disinfection or sterilization of medical, ophthalmic, dental and surgical devices including endoscopes and lensed instruments. It may be used as a standard soak solution or in automatic reprocessing units set at room temperature. Unlike other solutions, there is no need to increase the solution temperature to provide high-level disinfection in 25 minutes.

SKLAR-CIDE is a surfactant-free, activated glutaraldehyde liquid chemical sterilant and high-level disinfectant. Its active ingredient is glutaraldehyde in a nominal concentration of 3%. When the powdered activator is added, the solution turns green in color to indicate its readiness for use. In addition to the active ingredient, this ready-to-use solution contains buffers, wetting agents, and a rust and corrosion inhibitor and it has a pleasant fragrance.

SKLAR-CIDE produces high-level disinfection at room temperature in as little time as 25 minutes, and complete sterilization in 10 hours at room temperature.

- Reusable for 28 days instead of 14, safer and saves time and money.
- Surfactant free - Will not damage scope surfaces or cloud lenses.
- Can be used safely on all devices, including instruments and endoscopes. No need to stock several products.



PRODUCT NUMBER	FEATURES	QUANTITIES
10-1623	28 HLD 1 Gallon Bottles	4/case
10-1624	28 HLD 1 Gallon Bottle	1 bottle

GLUTARALDEHYDE STRIPS

PRODUCT NUMBER	FEATURES	QUANTITIES
96-4105	2.1% MEC 60 Strips / Bottle	2 bottles/ case



SKLAR DISINFECTANT

READY-TO-USE SPRAY SURFACE DISINFECTANT

2 MINUTE KILL TIME!

- Ready to use, non-toxic formula.
- Specially formulated for the control of cross contamination.
- Effective against H1N1, MRSA, Salmonella, Parvo, Feline Leukemia, Herpes Simplex, Distemper, Ringworm, Strangles.
- Safe for all areas of the facility.
- Satisfies OSHA's Bloodborne Pathogen Standards.
- Non-irritating formula.
- EPA registered.

PRODUCT NUMBER	FEATURES	QUANTITIES
10-1643	24 oz. Spray Bottles	6/case
10-1642	24 oz. Spray Bottle	1 bottle
10-1653	1 Gallon Bottles	4/case
10-1654	1 Gallon Bottle	1 bottle
10-1644	2.5 Gallon Bottles	2/case





SKLAR DISINFECTANT SURFACE WIPES

READY-TO-USE, PRE-MOISTENED TOWELETTES

2 MINUTE KILL TIME!

**SAME EFFECTIVE FORMULA AS
SKLAR DISINFECTANT!**

- Ready to use, non-toxic formula.
- Specially formulated for the control of cross contamination.
- Effective against H1N1, MRSA, Salmonella, Parvo, Feline Leukemia, Herpes Simplex, Distemper, Ringworm, Strangles.
- Safe for all areas of the facility.
- Satisfies OSHA's Bloodborne Pathogen Standards.
- Destroys odor-causing bacteria.
- 7" x 10" non-woven, tear resistant towelette.
- Clean scent.
- EPA registered.



KILLS MRSA AND H1N1 VIRUS

PRODUCT NUMBER	FEATURES	QUANTITIES
10-1616	100 Towelettes / Canister	6/case
10-1617	100 Towelettes / Canister	12/case



SKLAR SPRAY-ZYME™

SURGICAL INSTRUMENT PRE-CLEANER

Multi-Enzyme Based Instrument Presoak & Cleaner Foam Spray Cleaner

The newest product from Sklar for expert care of your surgical instruments. This multi-enzymatic spray creates a heavy foam which lasts for hours, keeping soiled instruments moist to avoid encrustation while also pre-cleaning prior to processing.

- Prevents Organic Encrustation - enzyme foam stops blood and bodily fluids from drying onto surgical instruments.
- No More Spills - messy spills between the operating room and central cleaning /processing department are eliminated.
- Neutral pH - safe and effective for stainless steel, tungsten carbide, aluminum and brass instruments.
- Bacteriostatic - microbiological control agents inhibit bacterial growth in the ready-to-use foam solution.
- Long Lasting Foam - saves time, foam lasts many hours after application.
- Multi-Enzymatic - contains a synergistic blend of lipase and protease enzymes.

PRODUCT NUMBER	FEATURES	QUANTITIES
10-2722	22 oz. Refillable Spray Bottles	12/case
10-2724	1 Gallon Bottles	4/case

SKLAR-ZYME™ POUCHES

CONVENIENT VALUE

Each pouch of SKLAR-ZYME produces one gallon of enzymatic detergent. This convenient, easy to use product guarantees very little waste and is ideal for the office or smaller surgical setting.

PRODUCT NUMBER	FEATURES	QUANTITIES
10-2774	½ oz. Pouches	32/box





SKLAR SOAK™

INSTRUMENT PRE-SOAK & DECONTAMINANT RUST RESISTANT!

Immersing soiled instruments in SKLAR SOAK effectively pre-cleans and decontaminates, without fear of rusting! SKLAR SOAK is an effective pre-cleaner that breaks down bio-burden, lifting blood and other organic debris from the surface, while penetrating box locks and crevices. The rust inhibitor protects the delicate chromium oxide layer of the instrument, thus defending against rust and corrosion. Using SKLAR SOAK™ as a pre-cleaner is the first line of defense against rust, prolonging the life of the instrument and therefore protecting your investment!

Soaking for only two minutes thoroughly decontaminates instruments, reducing the risk of exposure to pathogens such as N1H1, MRSA, Salmonella, Parvo, Feline Leukemia, Herpes Simplex, Distemper, Ringworm, Strangles. However, because SKLAR SOAK™ contains a rust inhibitor, instruments may soak for several hours without fear of rusting! Employees are protected from cross contamination, and at the same time can enjoy the freedom to reprocess instruments when it's convenient!

SKLAR SOAK is ideal for use on all stainless steel instruments:

- PH balanced, designed specifically for stainless steel instruments.
- Intermediate level disinfectant with broad spectrum of efficacy.
- Rust resistant.
- Non-caustic.
- Ready to use.
- No special handling or disposal.
- Fragrant, no offensive odors.
- Non-glutaraldehyde.



PRODUCT NUMBER	FEATURES	QUANTITIES
10-1603	1 Gallon Bottles	4/case
10-1609	1 Gallon Bottle	1 bottle



SKLAR INSTRU-GUARD™ ONE STEP

**A “ONE STEP” INSTRUMENT
CLEANER AND LUBRICANT**

EXTENDS INSTRUMENT LIFE!

SKLAR INSTRU-GUARD ONE STEP contains a penetrating lubricant that protects and helps extend the life of surgical instruments. The detergents and emulsifiers quickly break up and remove organic soils from box locks and other hard to reach places.

SKLAR INSTRU-GUARD ONE STEP contains four rust inhibitors to control corrosion and eliminate scaling and spotting. It does not contain phosphates and can reduce the time and cost involved in processing your instruments by cleaning and lubricating in one easy step.

PRODUCT NUMBER	FEATURES	QUANTITIES
10-2800	1 Gallon Bottles	4/case
10-2801	1 Gallon Bottle	1 bottle





SKLAR INSTRU-GUARD™ LUBE

SURGICAL INSTRUMENT LUBRICANT / RUST INHIBITOR

- Extends the Life of Instruments.
- Protects all Surgical Instruments.

SKLAR INSTRU-GUARD LUBE is an easy-to-use, water soluble, lubricant and rust inhibitor. When used daily as a rinse after every cleaning it keeps moving parts operating smoothly and remains effective after autoclaving, but without leaving an oily residue.

Regular lubrication is essential no matter which cleaning method is employed (including ultrasonic). SKLAR INSTRU-GUARD LUBE is ideal for maintaining instrument quality and performance.

PRODUCT NUMBER	FEATURES	QUANTITIES
10-1635	1 Gallon Containers Concentrated	4/case
10-1634	1 Gallon Container Concentrated	1 container
10-1636	8 oz. Spray Bottles	12/case
10-1637	8 oz. Spray Bottle	1 bottle





SKLAR KLEEN™

LOW FOAM, LIQUID DETERGENT AND POWDERED FORMULA

Regular Formula for Manual and Ultrasonic Cleaning

SKLAR KLEEN is non-corrosive, non aggressive, phosphate free and biodegradable. We have specifically developed SKLAR KLEEN for manual and ultrasonic cleaning. It is moderately alkaline, affording optimum cleaning without etching glassware or attacking instrument metal.

Low Foam Formula for Automatic Cleaning

The SKLAR KLEEN Low Foam Liquid is concentrated in order to provide a very cost-effective solution. It is especially formulated to maintain low foam, ensuring effective and trouble-free action in washer/sterilizers and tunnel washers. Dispersing quickly, the SKLAR KLEEN Low Foam formula is also well suited for automatic injection systems.

PRODUCT NUMBER	FEATURES	QUANTITIES
10-2701	Low Foam 1 Gallon Bottles	4/case
10-1608	Powdered 5 lb. Containers	4/case
10-1607	Powdered 5 lb. Container	1 container
10-1630	Powdered 3.5 lb. Pitchers	6/case
10-2765	Powdered 3.5 lb. Pitcher	1 pitcher
10-1612	Liquid 8 oz. Bottles	6/case
10-1614	Liquid 8 oz. Bottle	1 bottle
10-1613	Liquid 1 Gallon Bottles	4/case
10-1627	Liquid 1 Gallon Bottle	1 bottle





SKLAR-SHEEN™

AUTOCLAVE AND INSTRUMENT CLEANER AND CONDITIONER

With an efficacious phosphoric acid cleaning agent, Sklar Sheen is a robust spot, stain and rust remover. Ideal for dissolving hard water deposits, use in autoclaves to quickly cut through steam sterilizer scale and deposits.

Verstile and effective, SKLAR SHEEN couples powerful stain and rust removers with corrosion inhibitors, making it tough on stains but gentle on instruments. Recondition instruments to restore them to nearly brand new working condition.

Use to clean and recondition any stainless steel surface to its original luster, including carts, trays and basins.

- Conditions for lasting protection.
- Dissolves hard water deposits.
- Frees up frozen box locks.
- Restores and extends surgical instrument life.

PRODUCT NUMBER	FEATURES	QUANTITIES
10-2730	Stain & Rust Remover	1 gallon bottle
10-2732	Stain & Rust Remover	4/case
10-2736	Spray Foam Autoclave Cleaner & Conditioner	22oz. bottle
10-2738	Spray Foam Autoclave Cleaner & Conditioner	12/case





SKLAR ENZYMATIC™ DETERGENT

MULTI-ENZYME DETERGENT CONCENTRATE

100% Biodegradable

SKLAR ENZYMATIC Detergent is a low-foaming, fast acting detergent specifically designed for use when instruments and/or cloth materials become soiled with organic debris.

SKLAR ENZYMATIC Detergent may be used as a manual instrument cleaner as well as a pre-soak for blood-contaminated linens, clothing and instruments. It is also used in ultrasonic units and in washer/sterilizer/decontaminators. When used as directed, the enzymatic pH neutral formula is safe for use on rubber, plastic, stainless steel instruments, and surgical equipment as well as cloth.

PRODUCT NUMBER	FEATURES	QUANTITIES
10-2777	1 Gallon Bottles	4/case
10-2775	1 Gallon Bottles	2/case
10-2776	1 Gallon Bottle	1 bottle





SKLAR STAT™

INSTANT FOAM HAND SANITIZER

KILLS 99% OF GERMS IN LESS THAN 15 SECONDS!

SKLAR-STAT Instant Foam Hand Sanitizer, based on the active ingredient Benzalkonium Chloride, is a unique formulation featuring exceptional skin feel, conditioning and moisturizing properties. The efficacy of this product has been confirmed to reduce *S. Aureus* 99.999% and *S. Aureus* MRSA 99.9% in as little as 15 seconds. SKLAR-STAT Instant Foaming Hand Sanitizer produces a fast drying, non-sticky foam that contains unique conditioning and moisturizing ingredients, leaving the skin with a soft, silky after-feel.

PRODUCT NUMBER	FEATURES	QUANTITIES
10-2850	50 ml Pump Dispensers	24/case
10-2852	550 ml Pump Dispensers	12/case

SKLAR STAT™

AUTOMATIC FOAM DISPENSER

Motion activated, battery powered and wall-mounted, Sklar's AUTOMATIC FOAM DISPENSER allows for easy access and reduced risk of cross contamination. Ideal for use in hospitals, medical centers, offices, schools and any high-traffic public area with multiple users.



PRODUCT NUMBER	FEATURES	QUANTITIES
10-2856	Wall Mount Dispenser	1 Each
10-2854	1000ml Refill Bottles	6/case
10-2858	(2) Cases 1000ml Refill Bottles plus Free Wall Mount Dispenser	1 Set

- Alcohol-Free
- Non-Sticky
- Moisturizes and Conditions Hands

1. Pump a small amount into palm of hand.
2. Rub thoroughly over both surfaces of both hands.
3. Rub hands together briskly until dry.





SKLAR FRESH™

LIQUID SPRAY ODOR ABSORBER

SKLAR FRESH is an environmentally friendly blend of pure biodegradable organic essential oils and trace elements. It is a non-allergenic liquid spray that neutralizes odors at their source. Simply spray SKLAR FRESH directly in the air or on the source (i.e. bathrooms, refuse, soiled items from vomitus, incontinence odors, etc.)

PRODUCT NUMBER	FEATURES	QUANTITIES
10-2842	22 oz. Spray Bottles	12/case

SKLAR POLISH™

INSTRUMENT STAIN REMOVER

Non-Abrasive

SKLAR POLISH is an effective stain remover for use on all your metal surgical instruments, including stainless steel, chrome and brass. It will brighten instrument trays, basins and racks and may also be used on porcelain and tile surfaces.



PRODUCT NUMBER	FEATURES	QUANTITIES
10-1626	8 oz. Jars	12/case
10-1629	8 oz. Jars	6/case
10-1927	8 oz. Jar	1 jar





SKLAR INSTRUMENT CARE KIT

A Trio of Sklar's Care and Cleaning products to keep instruments in tiptop shape.

PRODUCT NUMBER	FEATURES	QUANTITIES
10-1625		
	Sklar Lube™ 8 oz. Spray Bottle	1 each
	Sklar Kleen™ Liquid 8 oz. Bottle	1 each
	Sklar Polish™ 8 oz. Jar	1 each
	Stainless Steel Bristle Cleaning Brush	1 each
	Nylon Bristle Cleaning Brush	1 each



TROUBLE SHOOTING

NO STEEL IS TRULY “STAINLESS”

It's a fact that so-called stainless steel is subject to both water-spotting and staining. However what many people identify as a “rust” problem usually turns out to be something else.

Most often the problem is actually a stain caused by a surface deposit. These deposits appear in a variety of colors depending upon the type of deposit involved. Once the cause is found and eliminated, most of the time the problem quickly diminishes or disappears completely.

As you probably know, stainless steel is ideally suited for the surgical suite because it is rust resistant, it can be honed to an extremely sharp edge or fine point,

and it can be hardened to maintain the delicate, yet precise, requirements of the surgeon. But it is this hardenable quality – the amount of carbon used during the manufacturing process – coupled with harsh chemicals and improper care that renders stainless steel susceptible to corrosion.

To protect your instrument investment, Sklar cleaning agents have been specifically formulated to provide cost effective instrument care solutions that help maintain the life and performance of your valuable stainless steel instruments.



TROUBLE SHOOTING

CORROSION

Problem: Debris and residue in box locks, serrations and ratchets.

Solution: Serrations, box locks and ratchets should be carefully cleaned and rinsed. A soft bristle brush is effective in these difficult areas.

Problem: Moisture remaining on the instruments within the sterile wrapped packs; excessive moisture in autoclave during sterilization and termination of cycle.

Solution: Preheat autoclave, drying time cannot be accelerated, open autoclave door slightly. Routinely inspect valves. Malfunctioning valves can precipitate corrosion.

Problem: Some local water supplies contain excessive quantities of alkali. This can manifest itself by depositing corrosive matter on the instruments.

Solution: It is generally accepted that cold distilled or demineralized water be used during sterilization. An alternative is to use the local water supply, while instituting a program of preventive maintenance. Carefully clean surfaces with SKLAR KLEEN™, using SKLAR POLISH™ to remove difficult stains and SKLAR LUBE™ for proper lubrication.

PITTING

Problem: Instruments are inevitably exposed to chemical compounds that initiate pitting. The most common are saline solutions and blood.

Solution: It is essential that instruments be rinsed with distilled or demineralized water and then cleaned routinely.

Problem: Some Non-Sklar detergents contain a chloride or have an acid base. If rinsing is not thorough, the residual detergent can precipitate pitting. Hydrochloric acid can be formed by the combination of chloride in the cleaner and steam, causing the instrument to pit.

Solution: Evaluate detergents without a chloride base. SKLAR KLEEN™ is recommended.

Problem: Instruments may be pitted when the detergent used has an excessively high pH. If instruments are not rinsed thoroughly and then autoclaved, the heat increases the effect of the solution on the instruments.

Solution: Use only detergents specifically developed for instrument cleaning. SKLAR KLEEN™ products are pH balanced.

BROWNISH STAIN

Problem: This stain is more obvious on dull finish instruments. Most likely, it is a deposit of chromium oxide. The thin hard layer protects stainless steel from corrosion precipitated by the atmosphere. The brownish film (sometimes dull blue) occurs naturally when stainless is heated. Occasionally this stain can be traced to the sterilizer. Improper cleaning compounds could contain poly phosphates that cause the copper components in the sterilizer to be deposited by electrolytic action on the stainless steel instruments.

Solution: Water supply to autoclave should be cold and demineralized. Use the correct amount of SKLAR KLEEN™ as recommended for best results.

BLUISH GRAY STAINS

Problem: Cold sterilizing solutions.

Solution: In the preparation of the solution make certain the manufacturer's directions are followed accurately. To minimize discoloration use distilled water and add a rust inhibitor. Using the solution beyond recommended time limitations will cause the solution to become corrosive.

RUST DEPOSIT

Problem: Sterilizing instruments of different metals in the same cycle will cause rusting. An electrolytic action carries the carbon particles from the exposed metal and deposits them on the stainless steel instruments. The rapid oxidation of molecules results in a surface film of rust.

Solution: The ideal technique would be to sterilize the two types of instruments separately. It is recommended that chrome plated instruments that indicate signs of peeling or flaking be replaced with stainless steel instruments.

Problem: The rust film on the surface of stainless steel instruments can be caused by chemicals in the detergent. Excess amounts of iron or other minerals from the local water supply may cause the rust deposits.

Solution: It is recommended that instruments be rinsed with distilled or demineralized water. Surface rust can be removed by light buffing or an application of SKLAR POLISH™.

LIGHT AND DARK COLORED SPOTS

Problem: Spotting caused by slow evaporation of water drops identified with the mineral content of the water.

Solution: Eliminate water droplets by adhering to autoclave manufacturer's operating instructions. Autoclave door should not be opened until steam has been completely vented.



Sklar Surgical Needles are offered in multiple configurations. For wound and laceration care, the Reverse Cutting Needles are made with a sharp outer edge to allow for smooth and atraumatic penetration of tough skin and fascia. Tapered needles are used almost exclusively on soft, less dense tissue and when the smallest diameter hole is desired. All needles have Regular Surgeon Eyes unless otherwise specified.

All needles are sold Non-Sterile in packages of 12. When ordering simply add the corresponding needle size number to the end of the needle family product number, ie. needle size #4 would be 93-1760-4 or size #16 would be 93-1760-16. Needles are not shown to actual size.

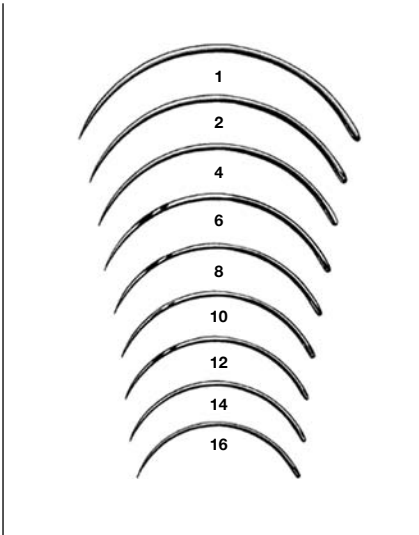

REGULAR SURGEON NEEDLE
 $\frac{3}{8}$ CIRCLE WITH SPRING EYE
 93-1760-# Cutting Edge

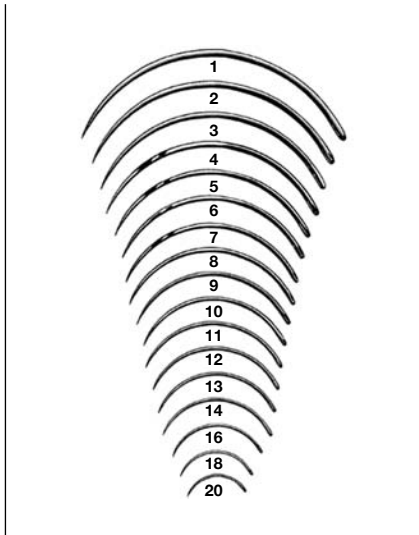

REGULAR SURGEON NEEDLE
 $\frac{3}{8}$ CIRCLE
 93-1762-# Reverse Cutting Edge

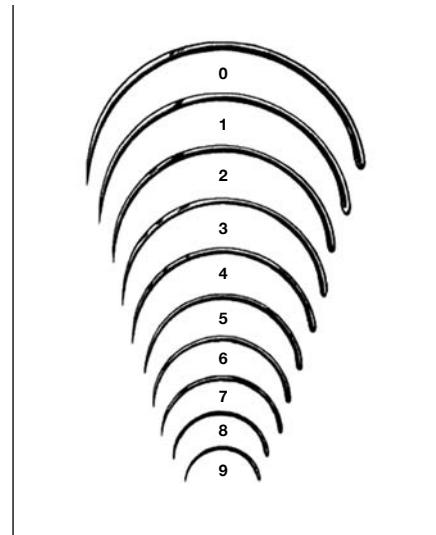

REGULAR SURGEON NEEDLE
 $\frac{1}{2}$ CIRCLE
 93-1770-# Cutting Edge

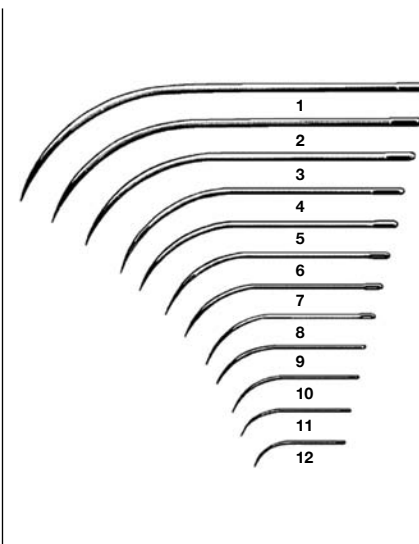

REGULAR SURGEON NEEDLE
 HALF CURVE
 93-1780-# Cutting Edge

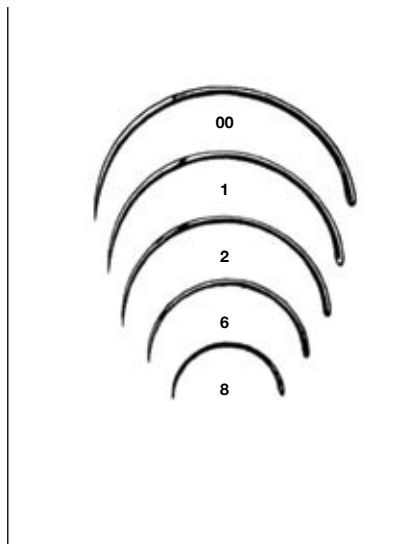

FISTULA NEEDLE
 $\frac{1}{2}$ CIRCLE
 93-1710-# Cutting Edge

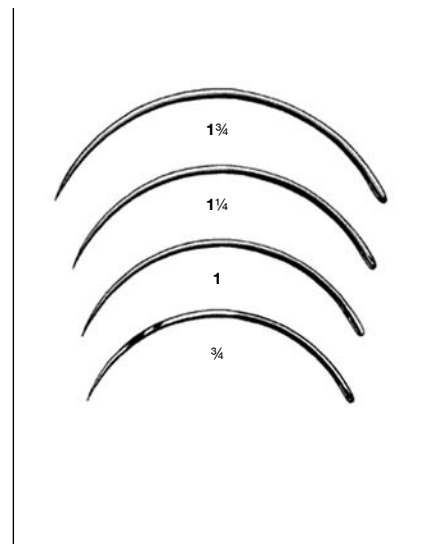

MAYO INTESTINAL NEEDLE
 $\frac{3}{8}$ CIRCLE
 93-1712-# Taper Point

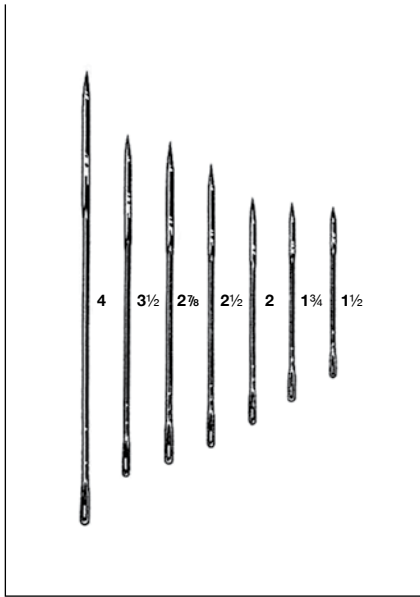

KEITH ABDOMINAL NEEDLE
STRAIGHT
 93-1714-# Triangular Point

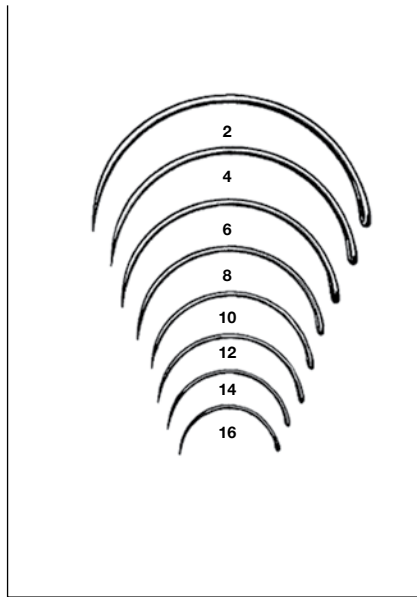

FERGUSON NEEDLE
1/2 CIRCLE
 93-1716-# Taper Point

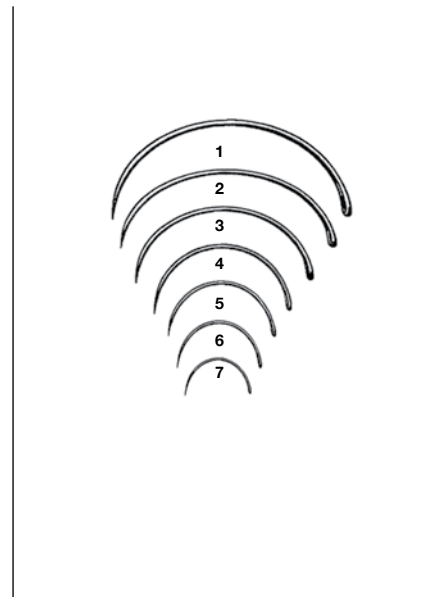

MAYO CAT GUT NEEDLE
1/2 CIRCLE
 93-1718-# Taper Point

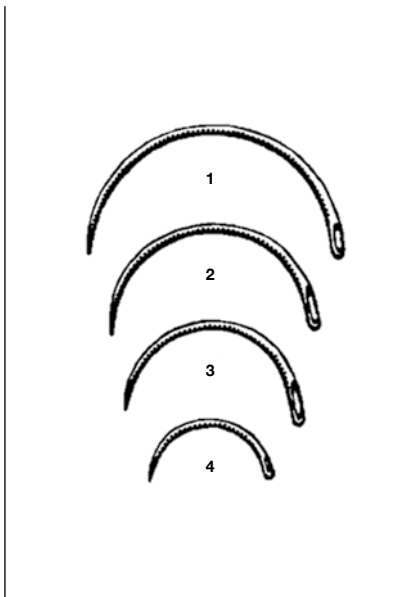

MURPHY'S INTESTINAL NEEDLE
1/2 CIRCLE
 93-1720-# Taper Point

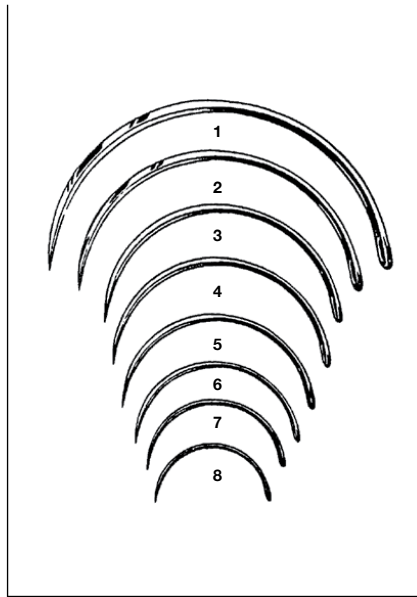

MARTIN'S UTERINE NEEDLE
1/2 CIRCLE
 93-1722-# Cutting Edge



POST MORTEM NEEDLE
HALF CURVE
 93-1730-# Cutting Edge

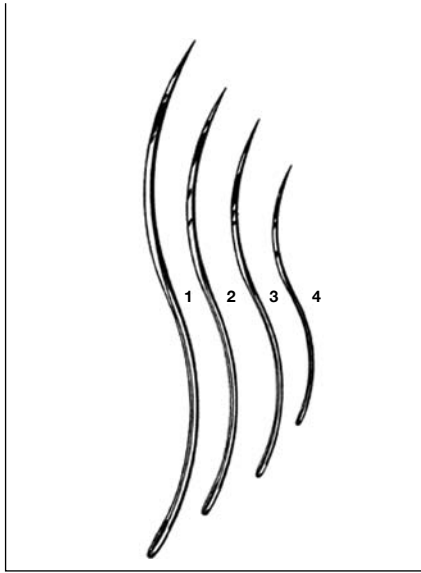

POST MORTEM NEEDLE
DOUBLE CURVE
 93-1731-# Cutting Edge

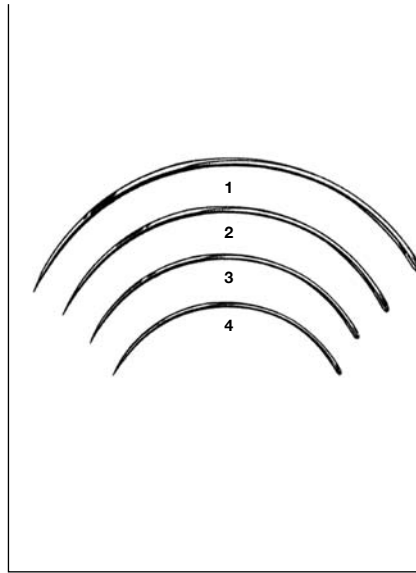

VETERINARY NEEDLE
 $\frac{3}{8}$ CIRCLE WITH SPRING EYE
 93-1732-# Cutting Edge

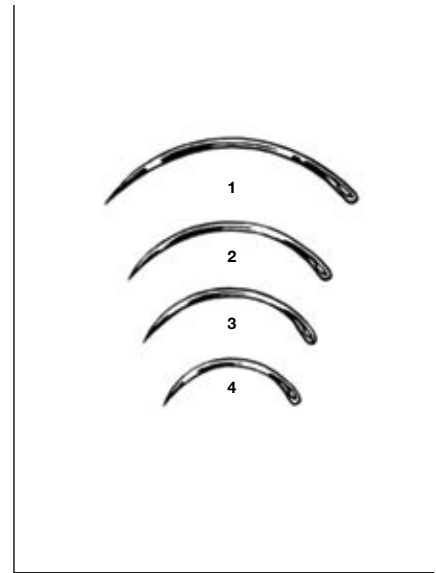

EYE NEEDLE
 $\frac{3}{8}$ CIRCLE
 93-1740-# Cutting Edge

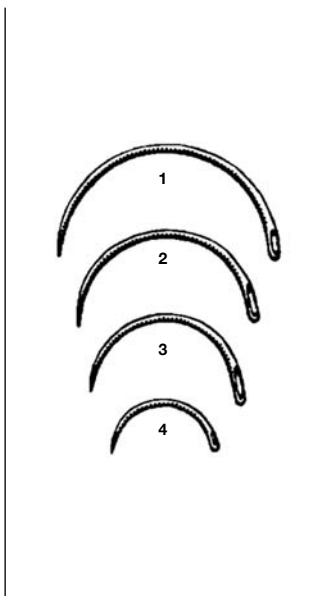

EYE NEEDLE
 $\frac{1}{2}$ CIRCLE
 93-1741-# Cutting Edge

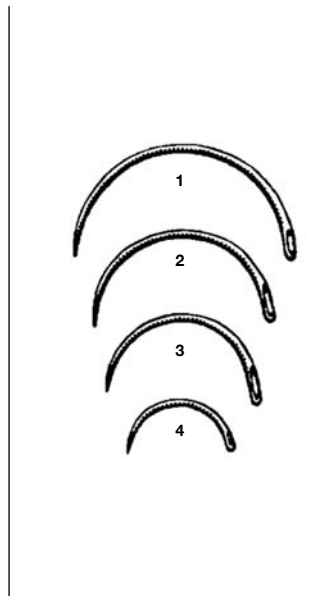

EYE NEEDLE
 $\frac{1}{2}$ CIRCLE
 93-1742-# Taper Point

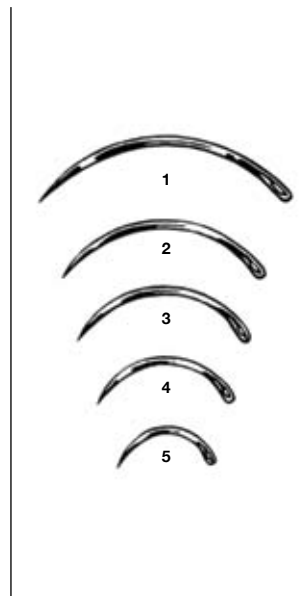

LANE CLEFT PALATE NEEDLE
 $\frac{3}{8}$ CIRCLE
 93-1750-# Cutting Edge

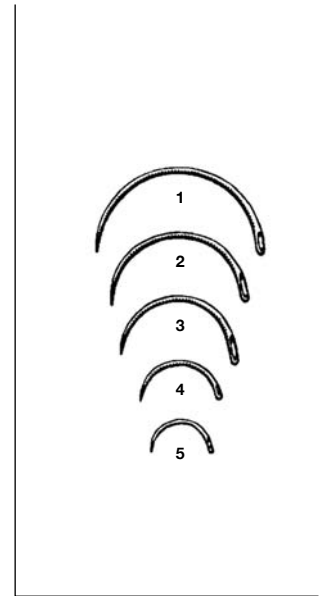

LANE CLEFT PALATE NEEDLE
 $\frac{1}{2}$ CIRCLE
 93-1751-# Cutting Edge

All needles are sold Non-Sterile in packages of 12. When ordering simply add the corresponding needle size number to the end of the needle family product number, ie. needle size #4 would be 93-1760-4 or size #16 would be 93-1760-16. Needles are not shown to actual size.

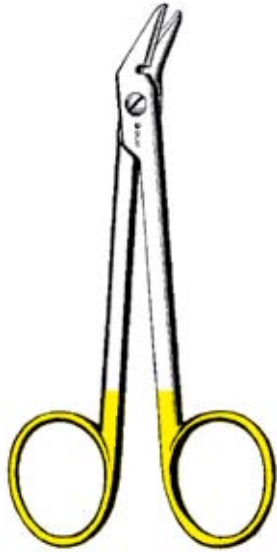

SKLAREDEGE™ TC WIRE CUTTING SCISSORS

16-2800 4¾" Angled, Serrated



TC STERNAL WIRE TWISTERS

21-9060 5"
21-9065 7"



TC CORWIN WIRE TWISTERS

SERRATED

21-9050 6" Flat
21-9051 6" Round
21-9052 6½" Round Narrow



TC PIN PULLER

40-1740 5½"

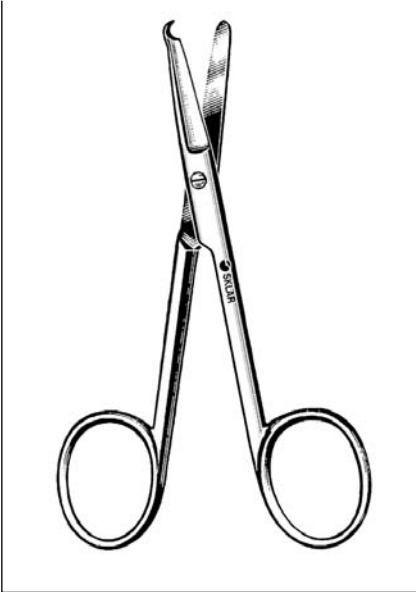

STITCH SCISSORS

- 22-2835 3½" Spencer
- 22-2845 4½" Spencer
- 15-1355 5½" Littauer

DELICATE

- 22-2834 3½" Spencer
- 22-2844 4½" Spencer
- 22-1354 5½" Littauer



SUTURE SCISSORS

- 22-2935 3½" Shortbent
- 22-2934 3½" Shortbent, Delicate
- 22-2947 4¾" Northbent



SKLARLITE™ SUTURE SCISSOR

- 23-1191 3½" Shortbent

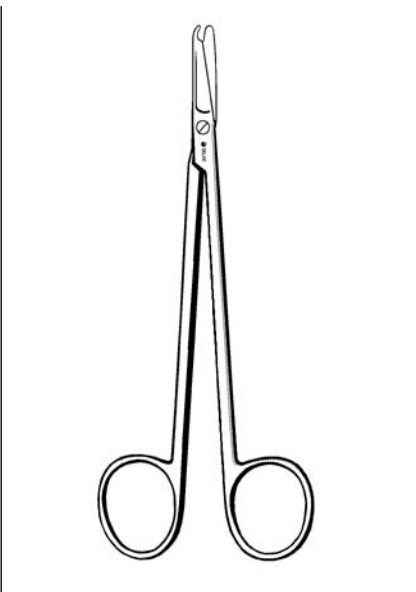

LONG STITCH SCISSOR

- 15-1358 6¼"



SKLAR STITCH SCISSORS

- 15-3150 4½" Angled
- 22-2950 5" Curved

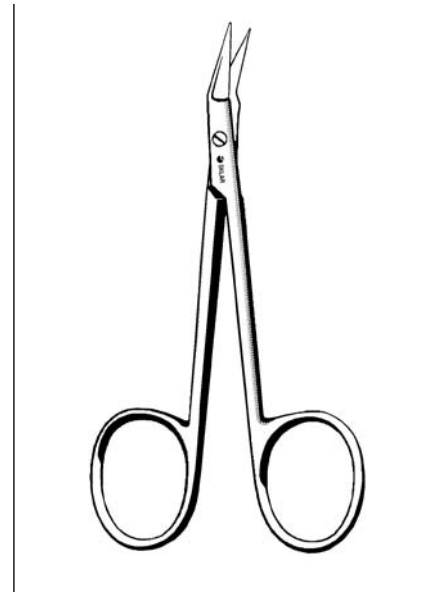

O'BRIEN STITCH SCISSOR

- 22-2837 3¾" Angled

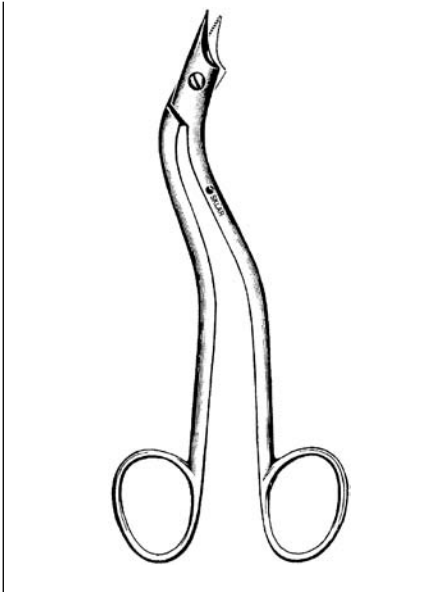

HEATH SCISSOR
24-1962 6¼" Serrated

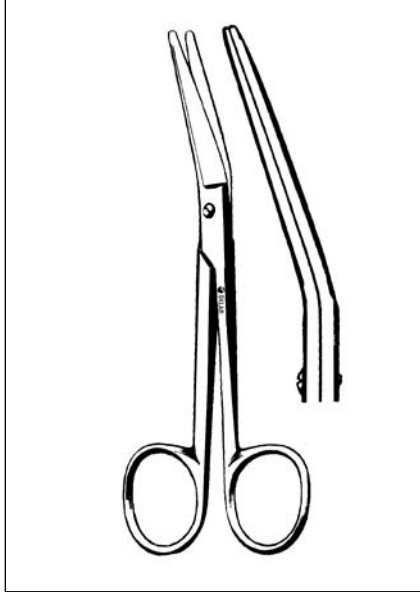

NEW'S SUTURE SCISSOR
41-1163 5½" Angled on Flat

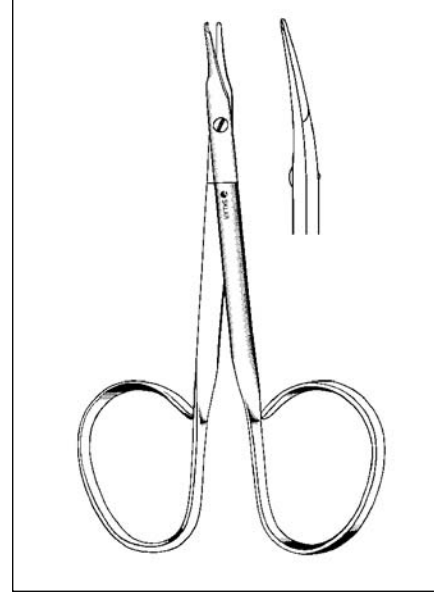

REEH RIB STITCH SCISSOR
64-1348 3¾"

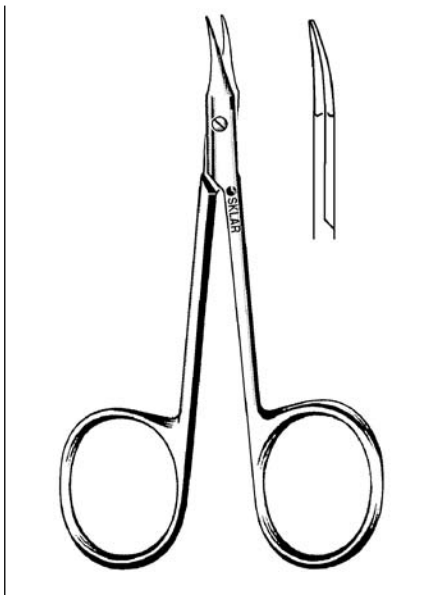

GRADLE SCISSOR
64-3280 3¾" Slight Curve, Sharp

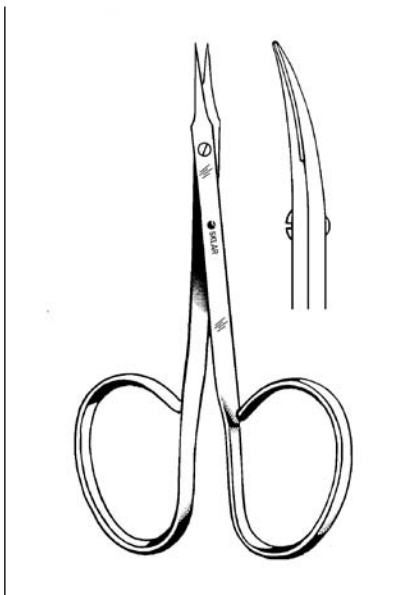

RIBBON STITCH SCISSORS
64-1345 4" Straight
64-1445 4" Curved

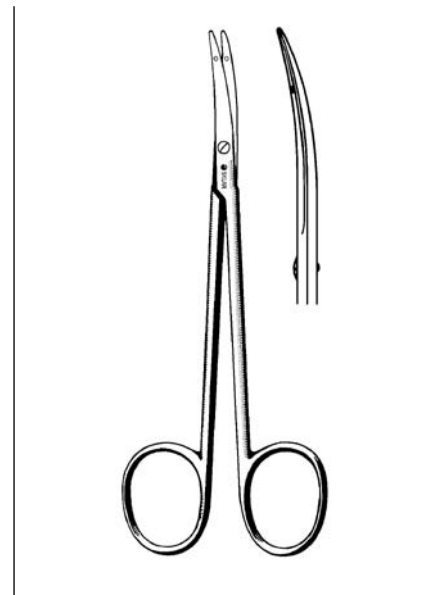

LITTLER SUTURE CARRYING SCISSOR
22-2645 4½" Curved



CROWN SCISSORS

- 24-2345 4" Straight, Smooth
- 24-2340 4" Straight, Serrated
- 24-2346 4" Curved, Smooth
- 24-2341 4" Curved, Serrated

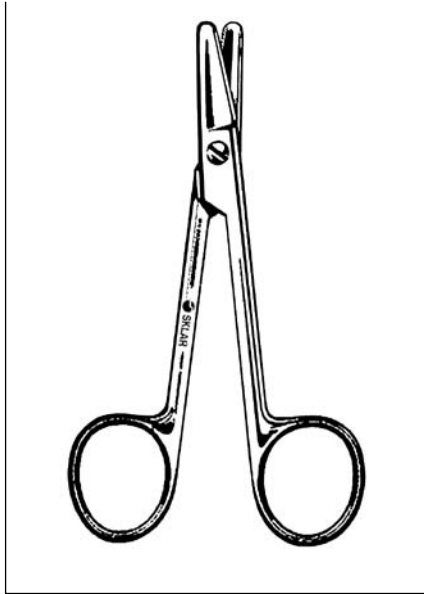

SUTURE SCISSOR

- 24-2347 4 3/4" Straight, Heavy Serrations

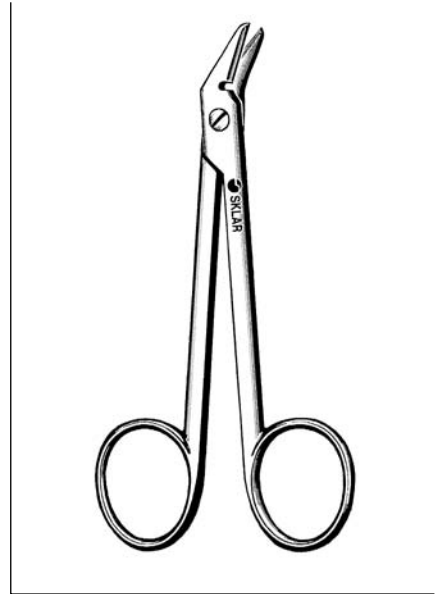

SUTURE WIRE CUTTING SCISSOR

- 24-2342 4 3/4" Angled, Serrated

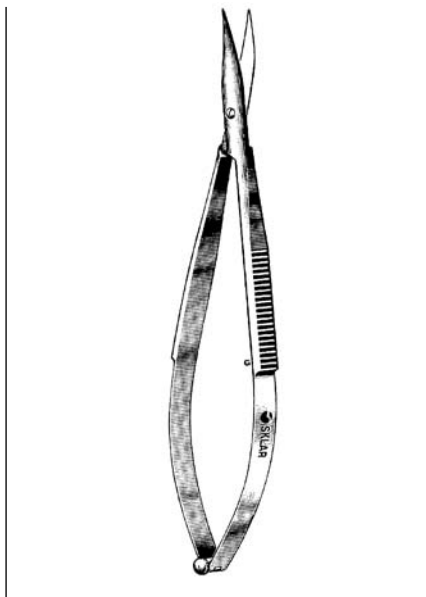

WESTCOTT TENOTOMY SCISSORS

- 64-3146 4 1/4" Blunt
- 64-3145 4 1/4" Sharp
- 64-3142 5" Right
- 64-3144 5" Left

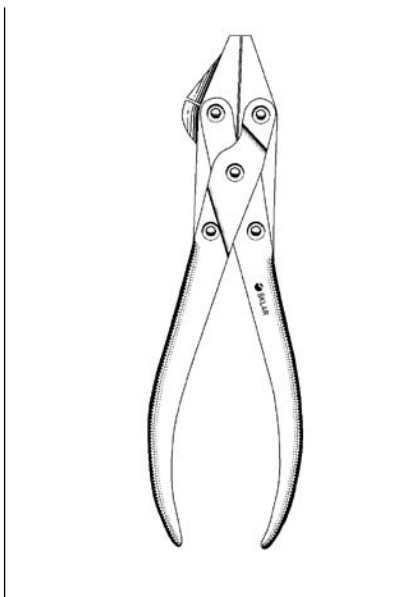

DOUBLE ACTION PARALLEL PLIERS SIDE WIRE CUTTER

- 40-1727 6 3/4"

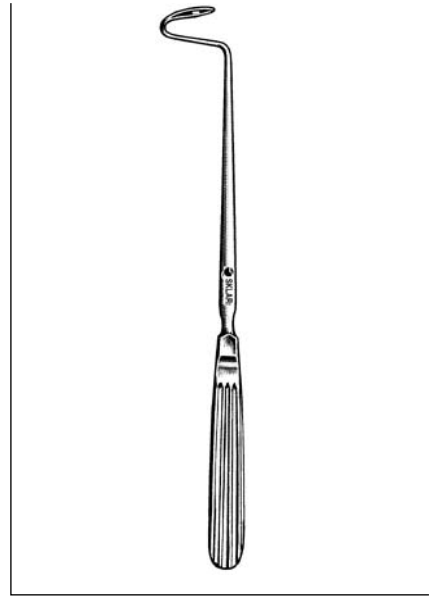

DESCHAMP NEEDLES

- | | | | |
|---------------|----|-------|-------|
| CURVED | | | |
| 26-1280 | 8" | Right | Blunt |
| 26-1480 | 8" | Right | Sharp |
| 26-1380 | 8" | Left | Blunt |
| 26-1580 | 8" | Left | Sharp |



**DUPUY-WEISS
LIGATURE CARRIERS**

26-1585 8½" Right
26-1586 8½" Left

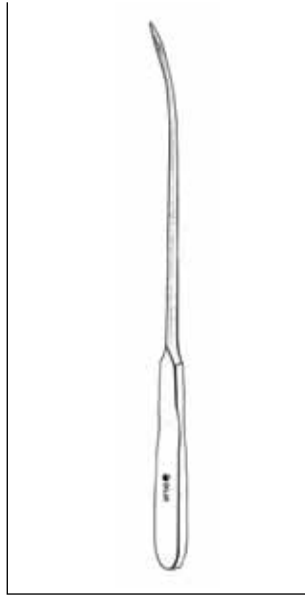

**OBWEGESER
MANDIBULAR AWL**

FOR WIRE SUTURING, SLIGHT CURVE
26-2005 5"
26-2006 6"
26-2007 7"
26-2009 9"

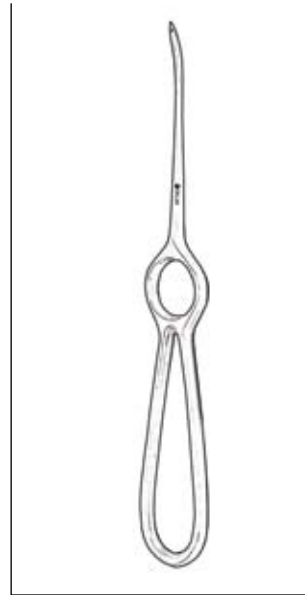

**OBWEGESER
MAXILLARY
AWL**

FOR WIRING SUTURING, STRONG CURVE
26-2010 7"

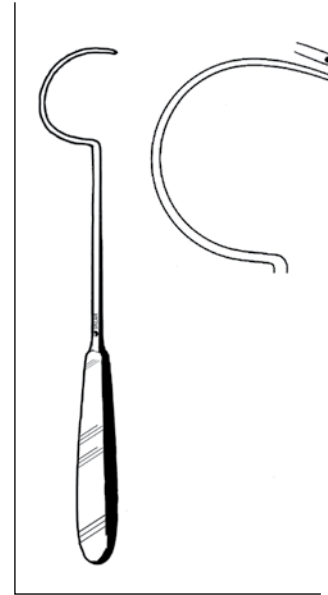

**DEMEL BONE
WIRE GUIDES**

26-1031 10¾"
26-1032 11¼"
26-1033 12"

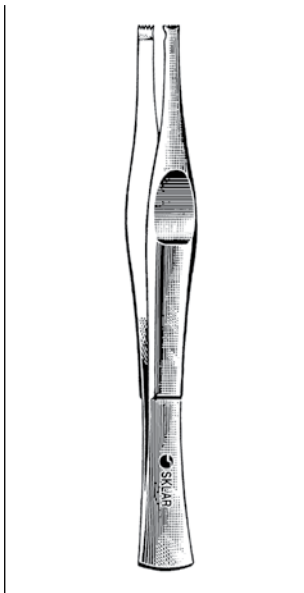

**MICHEL WOUND
CLIP FORCEP**

24-1150 5"

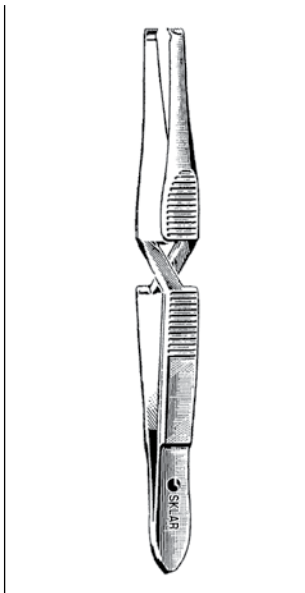

**HEGENBARTH CLIP
APPLYING FORCEP**

24-1650 5"

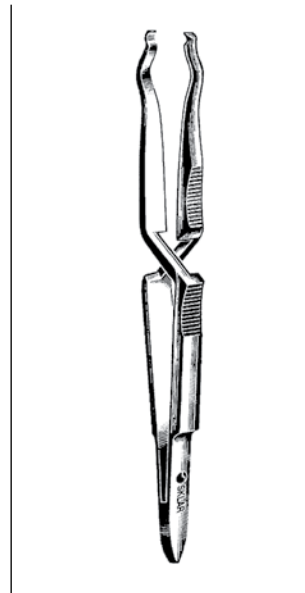

**WACHENFELDT CLIP
APPLYING / REMOVING
FORCEP**

CROSS ACTION
24-1450 5"

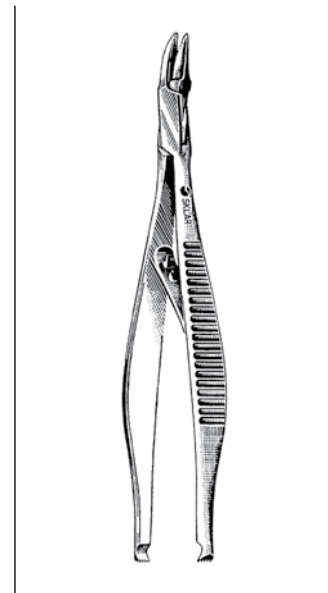

**MICHEL CLIP
APPLYING / REMOVING
FORCEP**

24-1250 5"

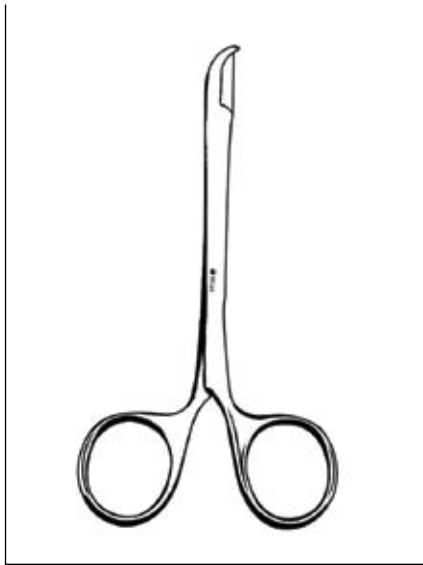

WOUND CLIP REMOVER
24-2047 5"

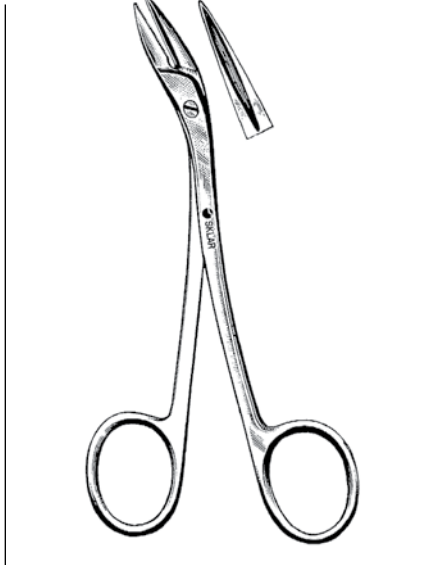

MICHEL CLIP REMOVING FORCEP
24-2055 5½"

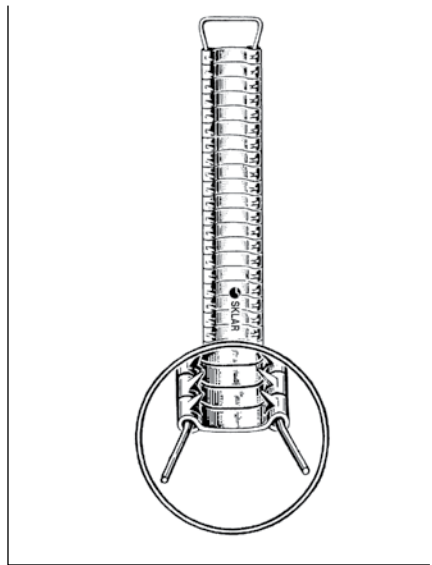

MICHEL CLIPS
UNIT 1000

24-1007	7.5mm	24-1016	16mm
24-1011	11mm	24-1018	18mm
24-1012	12mm	24-1020	20mm
24-1014	14mm	24-1022	22mm

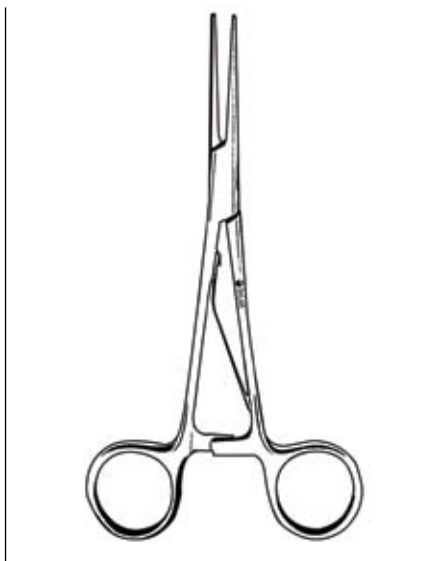

MCKENZIE BRAIN CLIP FORCEP
50-4157 5¾"

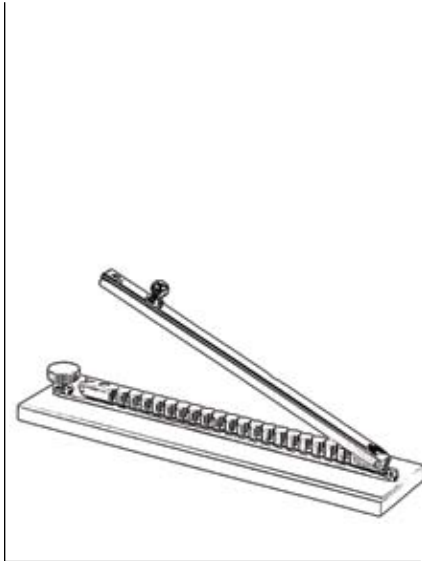

MCKENZIE BRAIN CLIP HOLDING RACK
50-4200 For 20 clips
50-4202 For 40 clips

MCKENZIE BRAIN CLIPS
50-4190 Vial of 100 Clips

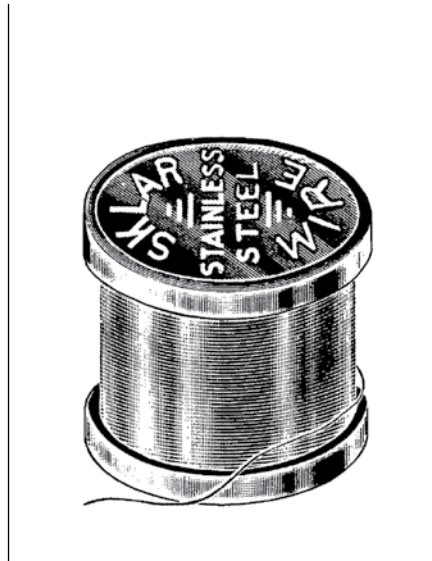

SUTURE WIRE

24-2218	18 Gauge, .040" Diameter
24-2220	20 Gauge, .032" Diameter
24-2222	22 Gauge, .025" Diameter
24-2224	24 Gauge, .020" Diameter
24-2226	26 Gauge, .016" Diameter
24-2228	28 Gauge, .012" Diameter
24-2230	30 Gauge, .010" Diameter
24-2232	32 Gauge, .008" Diameter
24-2234	34 Gauge, .006" Diameter
24-2236	36 Gauge, .005" Diameter



Sutures



Material

Suture material is permanently attached to all needles, eliminating the need for threading and providing a crisp new needle for each procedure. Suture characteristics (ie. color, length, material) are denoted in sub-headings. Suture length is shown in both metric and inches. Suture size, that is the diameter of the material, is in accordance with the United States Pharmacopeia (USP).

Needle

All needles are made from high quality stainless steel and finished to allow for easy passage through tissue with minimal resistance. Needle sharpness is classified as Standard or Supra-Sharp. Surgical needle tips are offered as taper point or reverse cutting. Needle curvature is available as $\frac{3}{8}$ or $\frac{1}{2}$. Needle silhouettes are not shown to actual size.

Size

Some needle sizes are offered with various gauge suture to meet the surgeon's needs by procedure (ie. finer gauges for use in soft or delicate tissues or heavier gauges for use in tough or fibrosed tissues).

Packaging

All Sutures come in packages of 3 dozen per box unless otherwise noted. Product codes ending in "D" are packaged 1 dozen per box. Product codes ending in "T" are packaged 2 dozen per box. All sutures are sold in sterile packaging.



SUTURES | ABSORBABLE

ABSORBABLE SUTURES

Absorbable Sutures are designed to minimize tissue drag, allow for smooth passage through tissue and provide excellent tissue support and reliable absorption rates.

CHROMIC GUT

Complete Absorption between 60-90 DAYS



Frequently used in easy healing tissues and recommended for General, Gynecology, Obstetrics, Ophthalmic, Urology and other procedures that do not require permanent artificial support.

TAPER POINT			SIZE
NEEDLE	CHROMIC MONOFILAMENT	LENGTH	3-0
26 mm		75cm - 30"	93-C50130

EPISYN

Complete Absorption between 90-120 DAYS

Recommended for General, Urology, Plastic and Gynecological surgery.

PRECISION REVERSE CUTTING			SIZE	
NEEDLE	UNDYED MONOFILAMENT	LENGTH	3-0	4-0
19 mm		45cm - 18"	93-E50130D	93-E50140D
19 mm		70cm - 27"	93-E50230	93-E50240

DIOXSON



Complete Absorption between 180-210 DAYS

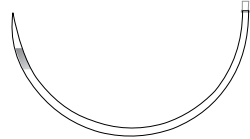
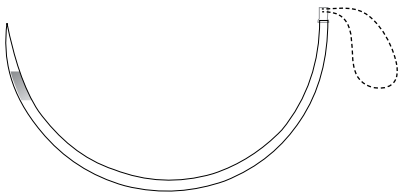

Recommended for any surgical procedure, including General, Gastroenterology, Urology, Plastic, Gynecology and Cardiovascular surgery, when tissue coaptation requires a longer healing period. Presented in violet color for improved visibility.

TAPER POINT, EXTRA HEAVY			SIZE
NEEDLE	VIOLET MONOFILAMENT	LENGTH	1
48 mm		90cm - 36"	93-D51601T
65 mm		250cm - 98" Loop	93-D52001D

PROCRYLIN
Complete Absorption between 56-70 DAYS

Recommended for General, Gastroenterology, Gynecology, Obstetrics, Ophthalmic, Urology, Plastic and Orthopedic surgery. Its progressive absorption rate and high tensile strength exceeds USP standards.

PRECISION REVERSE CUTTING			SIZE		
SUPRA-SHARP $\frac{3}{8}$ CIRCLE					
NEEDLE	UNDYED BRAIDED COATED	LENGTH	3-0	4-0	5-0
13 mm		45cm - 18"	-	93-P50740D	93-P50750D
19 mm		45cm - 18"	93-P50830D	93-P50840D	-

TAPER POINT			SIZE		
$\frac{1}{2}$ CIRCLE					
NEEDLE	UNDYED BRAIDED COATED	LENGTH	2-0	3-0	
26 mm		45cm - 18"	-	93-P52630D	
26 mm		70cm - 27"	93-P52820	93-P52830	

TAPER POINT, HEAVY			SIZE		
$\frac{1}{2}$ CIRCLE					
NEEDLE	UNDYED BRAIDED COATED	LENGTH	0	2-0	
36 mm		90cm - 36"	93-P53400	93-P53420	







NON-ABSORBABLE SUTURES

Extraordinarily stable with minimal tissue reaction, Non-Absorbable Sutures are an ideal choice when extensive tissue support and cosmetic results are a priority.



SURGICRON

With excellent visibility in the surgical field, these sutures are typically chosen for Neurological, Ophthalmic and Plastic Surgery.

PRECISION POINT REVERSE CUTTING SUPRA-SHARP $\frac{3}{8}$ CIRCLE				SIZE			
NEEDLE	BLACK MONOFILAMENT	LENGTH	3-0	4-0	5-0	6-0	
11 mm		45cm - 18"	-	-	-	93-U70360D	
13 mm		45cm - 18"	-	93-U70440D	93-U70450D	93-U70460D	
19 mm		45cm - 18"	93-U70730	93-U70740	-	-	
24 mm		45cm - 18"	93-U70830	-	-	-	

BIOXAPRO

Optimum geometric design, innovative thermal coating and 300 + Stainless steel alloy combines for a superior needle in both strength and penetration. Ideal for Cardiovascular procedures requiring support for heart propulsion. Also recommended for use during General, Gynecology, Obstetrics, Orthopedic and Plastic & Reconstructive Surgery.

TAPER POINT, ATRALLOY $\frac{3}{8}$ CIRCLE				SIZE	
NEEDLE	BLUE MONOFILAMENT	LENGTH	6-0	7-0	
9.3 mm		60cm - 24"	93-B71860	93-B71870	

STAINLESS STEEL

Recommended for use in Orthopedics, including Sternum closure.

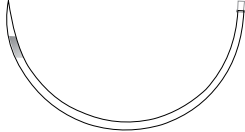
CONVENTIONAL CUTTING STERNUM $\frac{1}{2}$ CIRCLE				SIZE	
NEEDLE	B&S 20	LENGTH	7	6	
48 mm		45cm - 18"	93-L70107D	93-L70106D	



MOUTH MIRRORS

SIMPLE STEM, PACK OF 12

41-166	#3	Regular, Plane	20mm
41-168	#4	Regular, Plane	22mm
41-170	#5	Regular, Plane	24mm
41-172	#6	Regular, Plane	26mm
41-179	#3	Regular, Magnifying	20mm
41-181	#4	Regular, Magnifying	22mm
41-183	#5	Regular, Magnifying	24mm
41-121	#3	Front Surface	20mm
41-123	#4	Front Surface	22mm
41-125	#5	Front Surface	24mm



MOUTH MIRRORS

CONE SOCKET, PACK OF 12

41-136	#3	Regular, Plane	20mm
41-138	#4	Regular, Plane	22mm
41-142	#5	Regular, Plane	24mm
41-153	#3	Regular, Magnifying	20mm
41-155	#4	Regular, Magnifying	22mm
41-157	#5	Regular, Magnifying	24mm
41-102	#2	Front Surface	18mm
41-104	#3	Front Surface	20mm
41-106	#4	Front Surface	22mm
41-108	#5	Front Surface	24mm



MOUTH MIRROR HANDLE

FITS CONE SOCKET AND SIMPLE STEM MIRRORS

41-209



LARYNGEAL MIRRORS

WITH HANDLE

73-1188	#000	73-1193	#3
73-1189	#00	73-1194	#4
73-1190	#0	73-1195	#5
73-1191	#1	73-1196	#6
73-1192	#2	73-1197	#7



PERRY PLIERS #312

SERRATED

41-315	
48-315	Office Grade



COLLEGE PLIERS #49

NON-PINCH FINE POINTS, SERRATED

41-350	
48-350	Office Grade

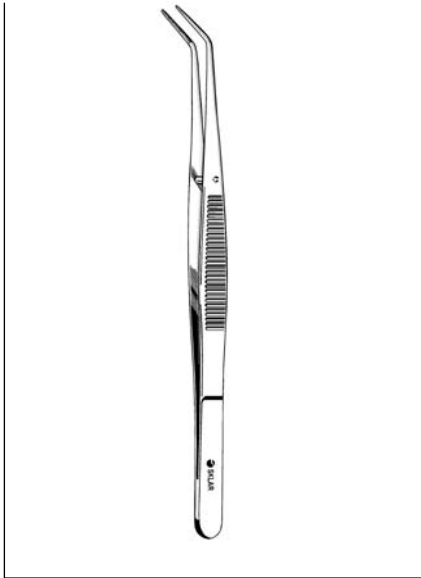

COLLEGE PLIERS #317/S

41-324 317S Smooth
48-116 317 Serrated, Office Grade

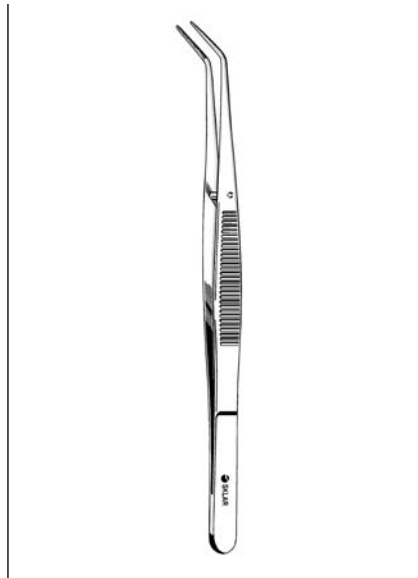

**COLLEGE PLIERS #317A
EXTRA FINE, NARROW, SERRATED**

41-318
48-318 Office Grade

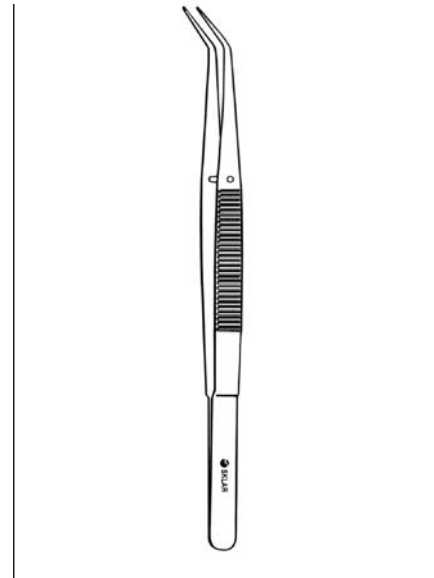

**COLLEGE PLIERS
NON-PINCH**

41-330 Serrated
41-334 Smooth

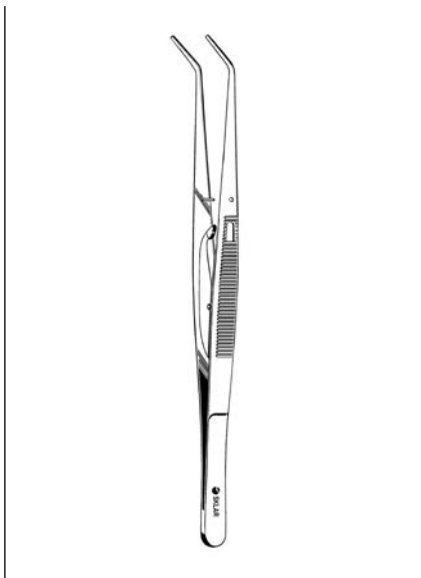

**LOCKING COLLEGE
PLIERS**

41-372 Serrated
48-128 Serrated Office Grade
41-378 Grooved
48-378 Grooved Office Grade

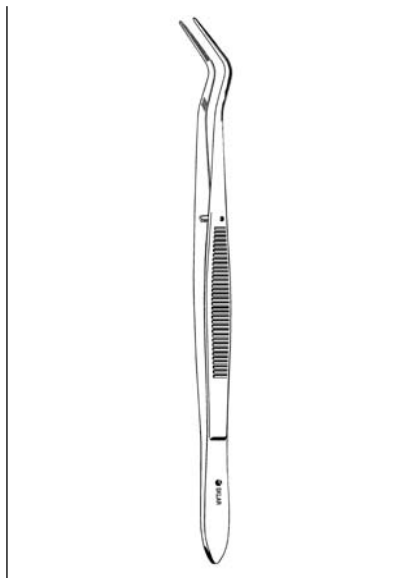

MERIAM PLIERS #318

41-368 Serrated

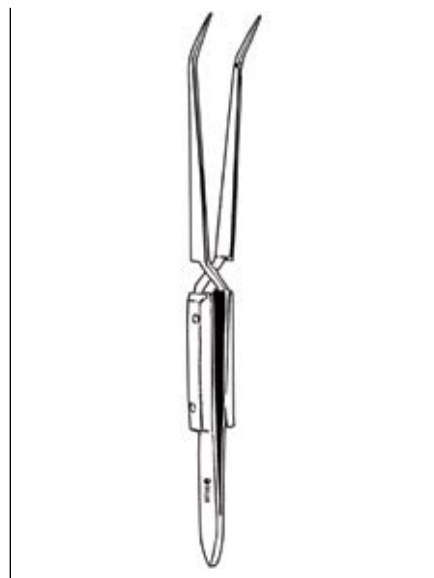

**PROTECTOR SOLDERING
TWEezer**

41-395

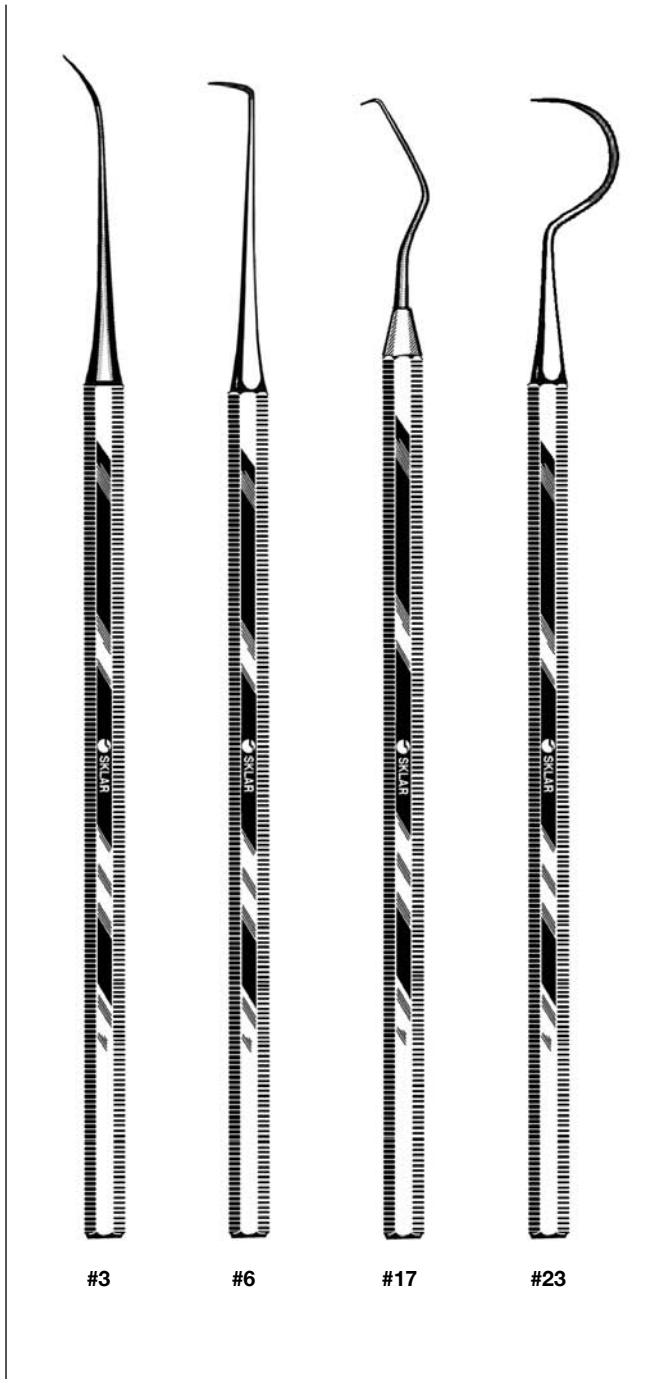

EXPLORERS

SINGLE END

- 41-402 #3
- 41-410 #6
- 41-422 #17
- 41-434 #23

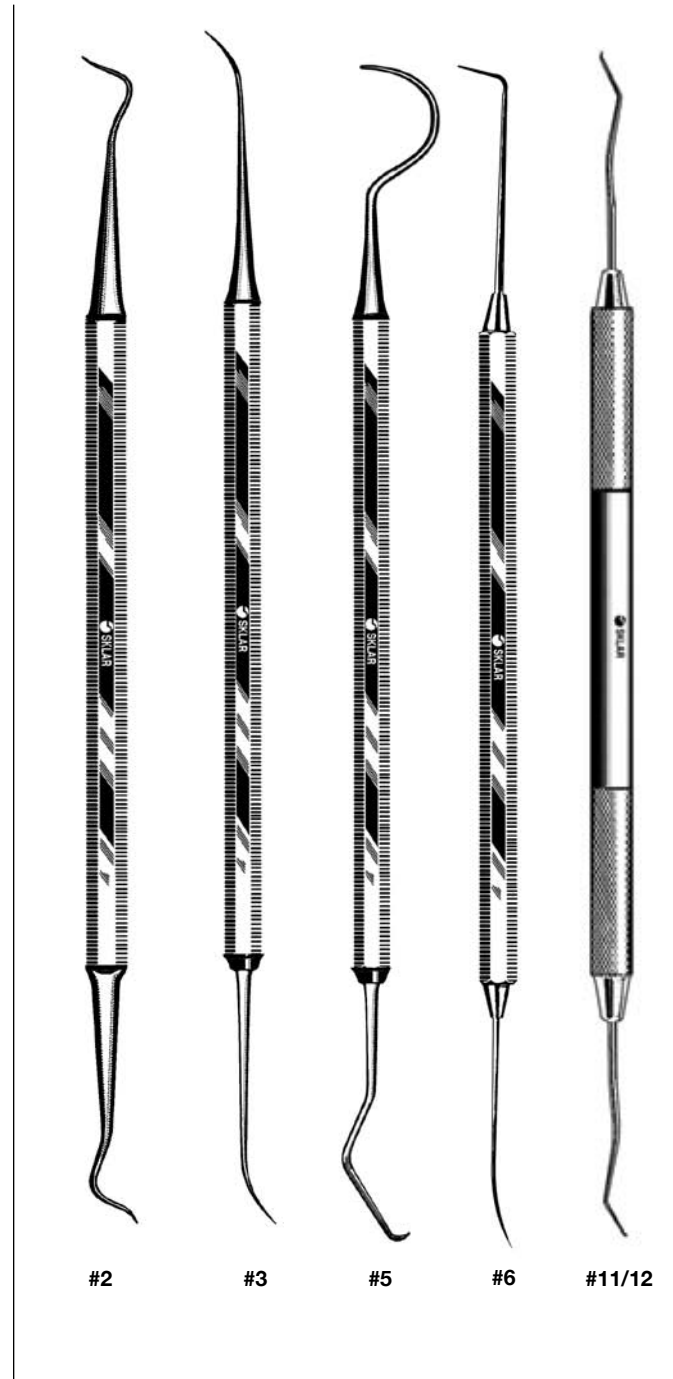

EXPLORERS

DOUBLE END

- 41-452 #2
- 41-468 #3
- 41-472 #5
- 41-484 #6
- 41-486 #11 / #12

DOUBLE END, OFFICE GRADE

- 48-561 #3
- 48-130 #5

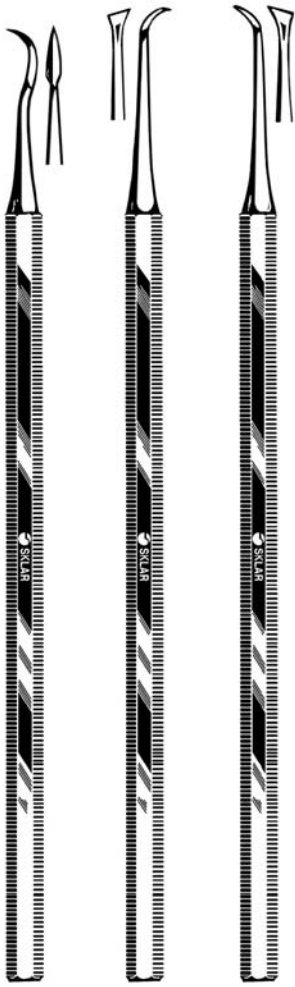

#3 #33 #34

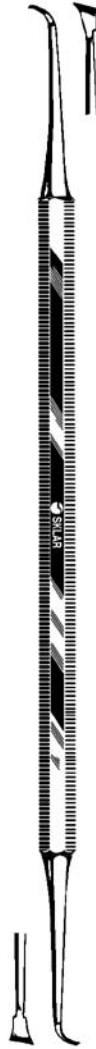

#15/33

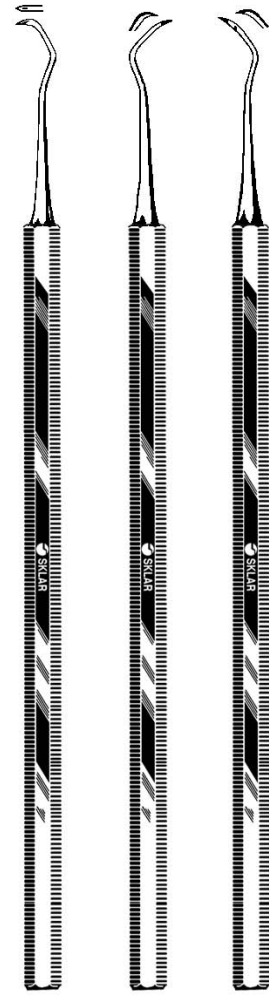

#1S #2S #3S

UNIVERSAL SCALERS

SINGLE END

- 41-604 #3
- 41-612 #33
- 41-626 #34

UNIVERSAL SCALER

DOUBLE END

- 41-640 #15/33

JACQUETTE SCALERS

SINGLE END

- 41-652 #1S
- 41-654 #2S
- 41-658 #3S

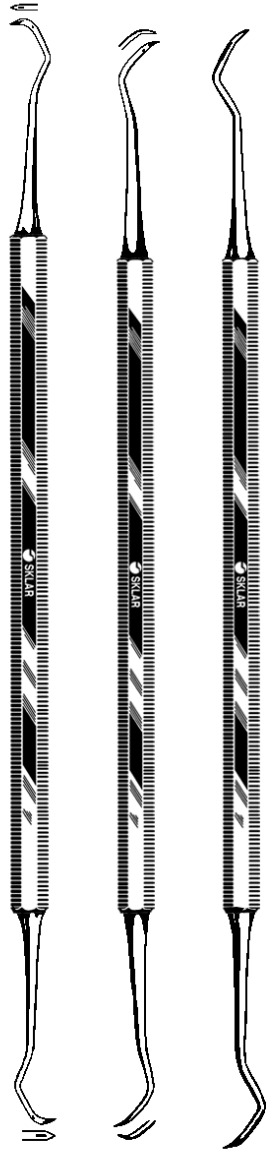

#1S/#1S #2S/#3S #2/#3

JACQUETTE SCALERS

DOUBLE END

- 41-662 #1S / #1S, Delicate
- 41-666 #2S / #3S, Delicate
- 41-674 #2 / #3

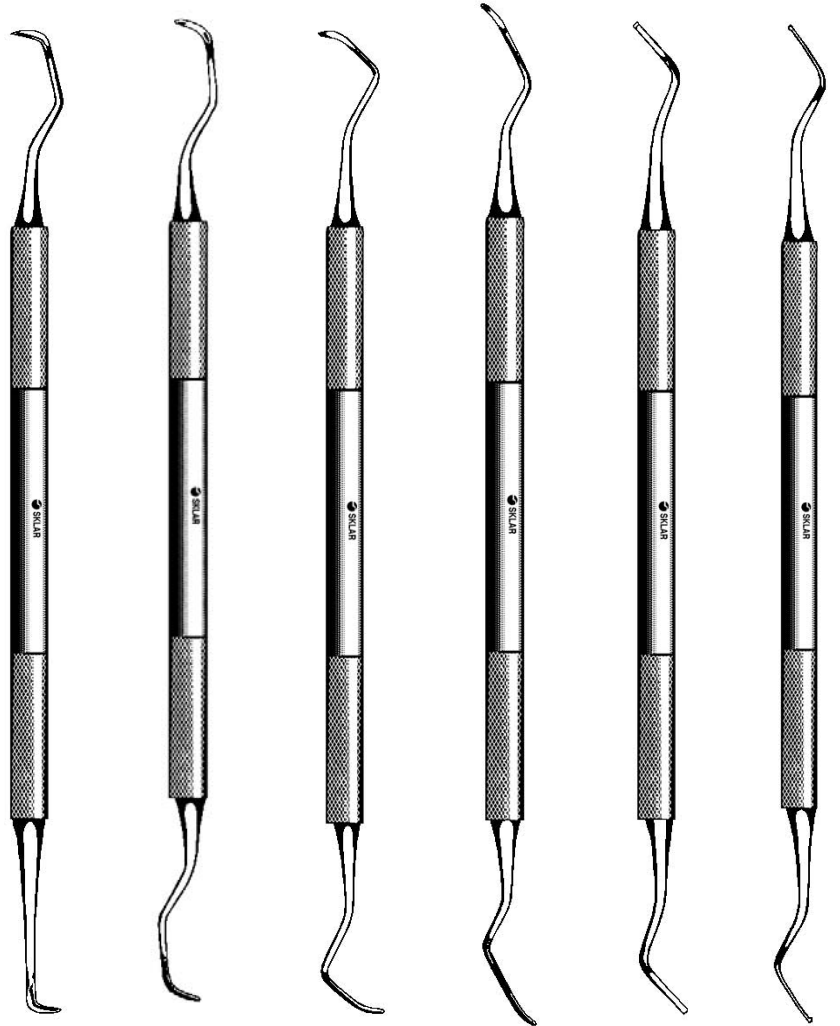

#1 #2 #3 #4 #5 #6

GOLDMAN-FOX SCALERS

DOUBLE END

- 41-757 #1
- 41-761 #2
- 41-765 #3
- 41-769 #4
- 41-773 #5
- 41-777 #6



#2/#3

TAYLOR SCALER
DOUBLE END

41-721 #2 / #3



U-15/30

TOWNER SCALER
DOUBLE END

41-709 U-15/30



#7/#8

YOUNGER GOOD SCALER
DOUBLE END

41-733 #7 / #8



#6

CRANE KAPLAN SCALER
DOUBLE END

41-792 #6

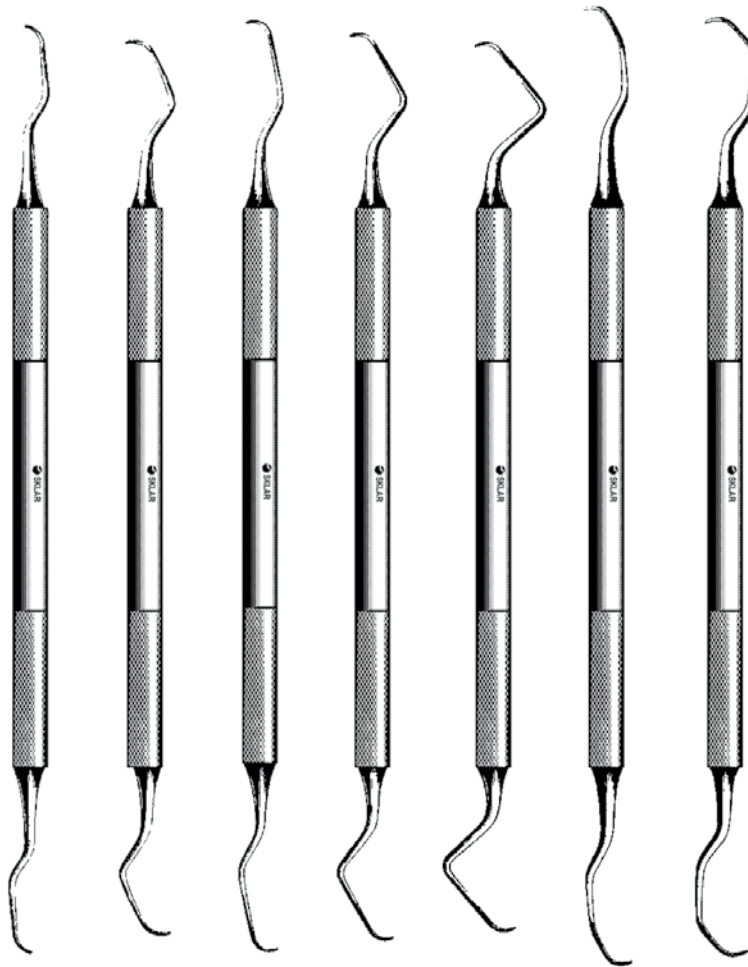

#1/#2 #3/#4 #5/#6 #7/#8 #9/#10 #11/#12 #13/#14



#85 #86 #87

GRACEY CURETTES

DOUBLE END

- 41-800 #1 / #2
- 41-808 #3 / #4
- 41-812 #5 / #6
- 41-820 #7 / #8
- 41-824 #9 / #10
- 41-828 #11 / #12
- 41-832 #13 / #14

LUCAS CURETTES

DOUBLE END, ANGLED

- 43-583 #85
- 43-587 #86
- 43-591 #87

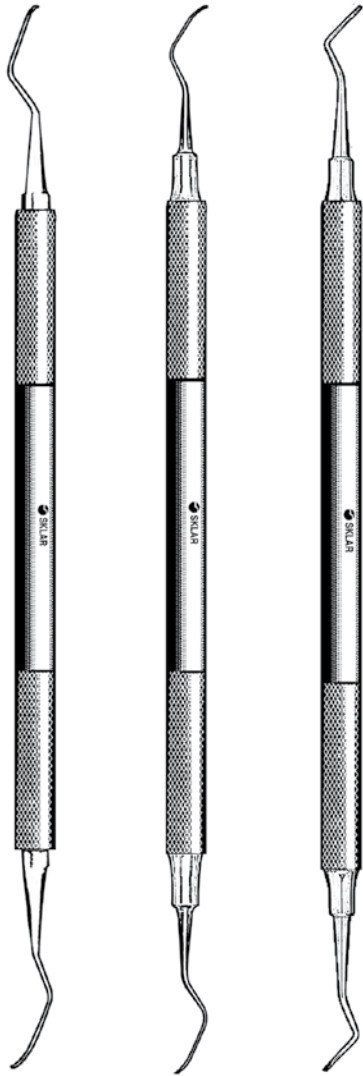

#2L/#2R

#4L/#4R

#13/#14

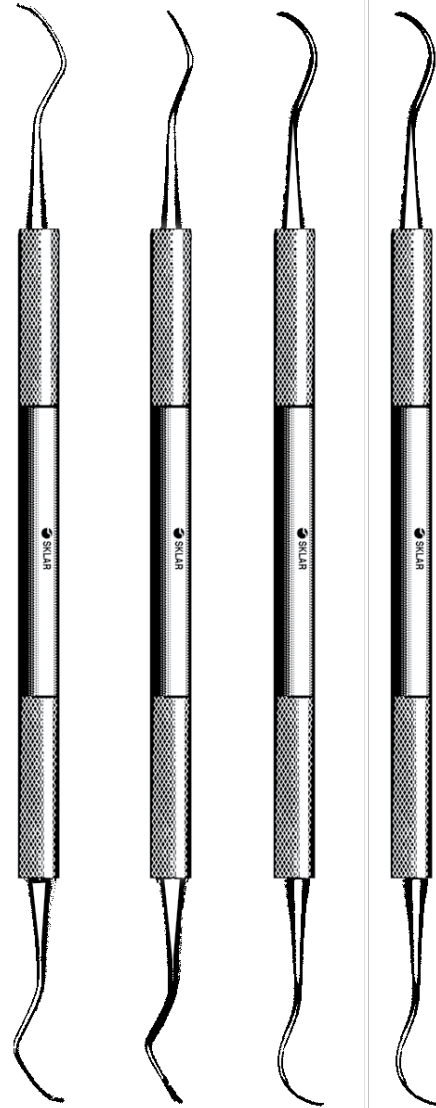

#13/#14

#13S/#14S

#17/#18

#17S/#18S

COLUMBIA CURETTES

DOUBLE END

41-848	#2L / #2R
41-852	#4L / #4R
41-856	#13 / #14

McCALLS CURETTES

DOUBLE END

41-864	#13 / #14
41-870	#13S / #14S
41-875	#17 / #18
41-878	#17S / #18S

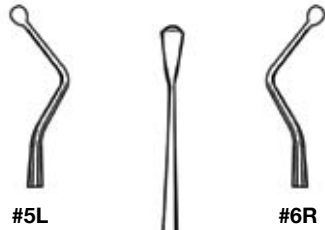

MOLT CURETTES

- 43-593 #2 Straight, Medium
- 43-597 #5L Angled, Left, Small
- 43-595 #6R Angled, Right, Small

GOLDMAN9-FOX KNIFE

DOUBLE END

- 41-902 #7
- 41-906 #8
- 41-910 #9
- 41-922 #10
- 48-922 #10 Office Grade
- 41-926 #11

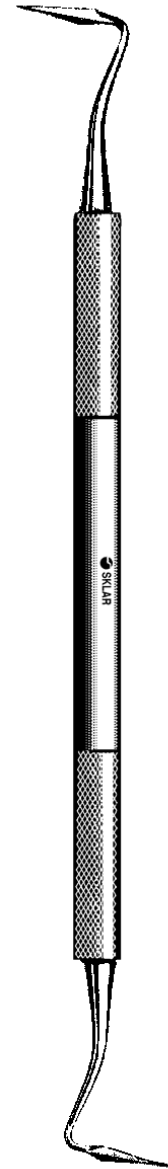

ORBAN KNIFE
DOUBLE END
41-932 #1 / #2

KIRKLAND KNIFE
DOUBLE END
41-938 #15 / #16

BUCK KNIFE
DOUBLE END
41-944 #5 / #6

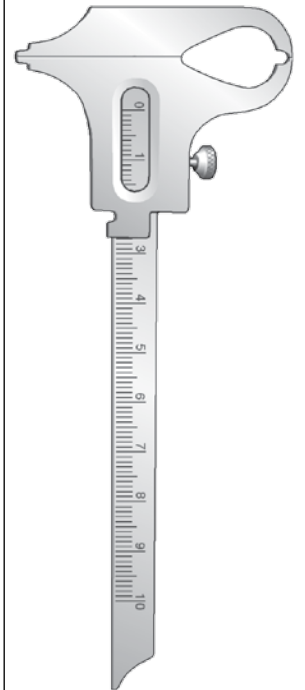
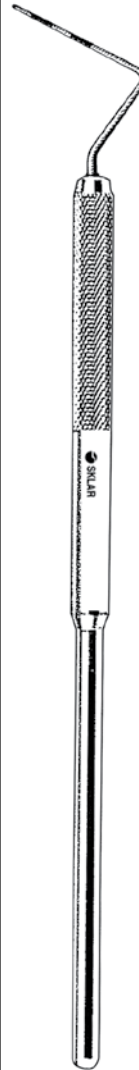

#11

#12

WILLIAMS PROBE

ROUND

41-972 1-2-3-5-7-8-9-10mm

GOLDMAN-FOX PROBE

FLAT

41-952 1-2-3-5-7-8-9-10mm

CODED PROBES

41-982 #11 3-6-8-11mm

41-994 #12 3-6-8-11mm

BOLEY GAUGE

STAINLESS

45-202

48-202 Office Grade

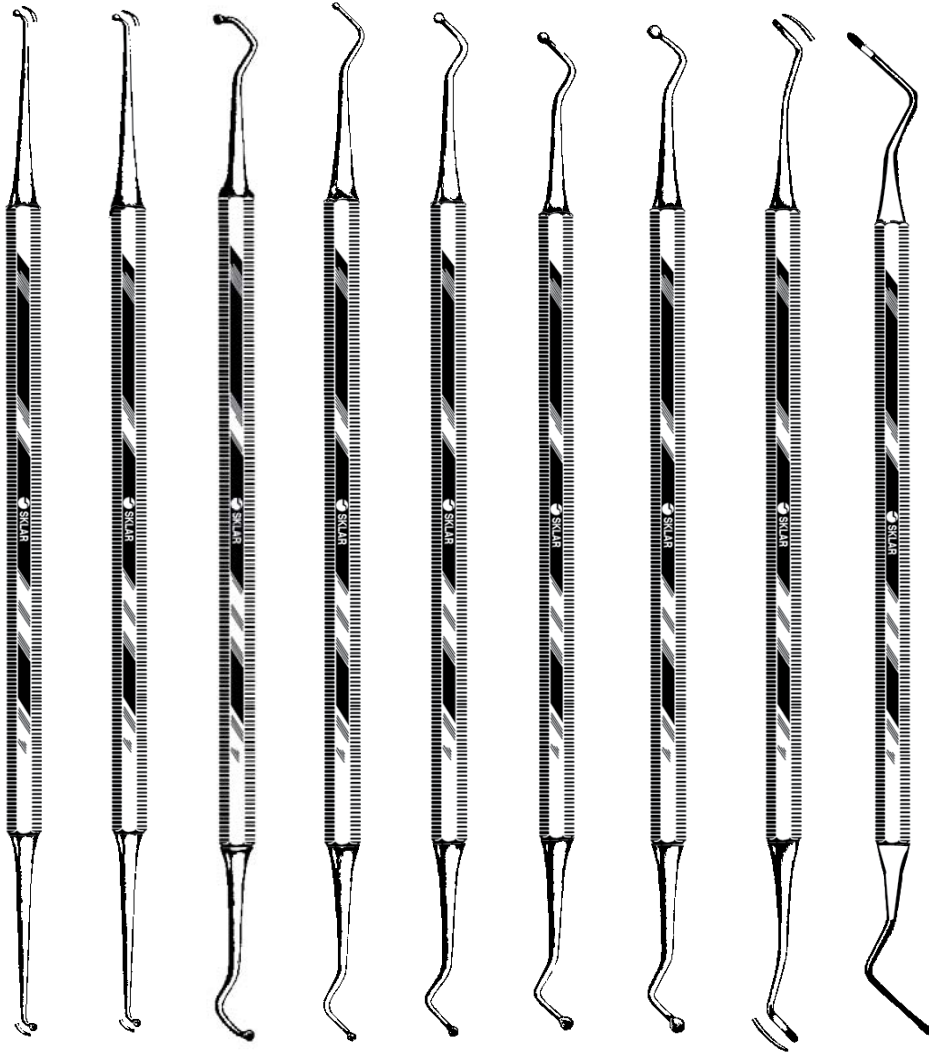

#5 #6 #14 #17 #18 #19 #20 #24 #31L

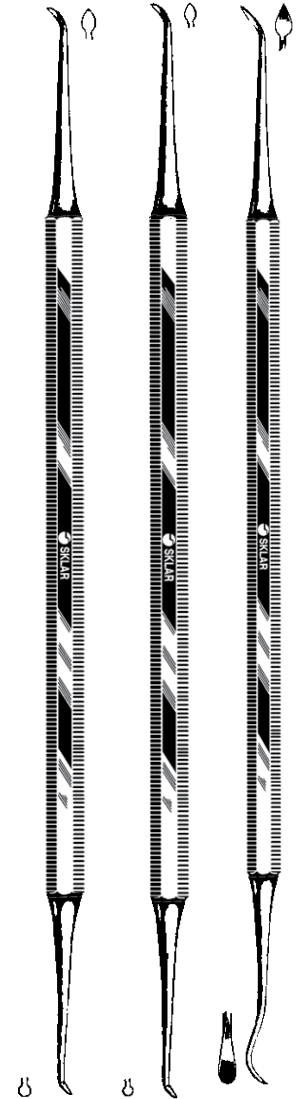

#89/#92 #90/#93 LARGE

EXCAVATORS

DOUBLE END

42-103	#5	42-135	#19
42-105	#6	42-139	#20
42-121	#14	42-145	#24
42-127	#17	42-149	#31L
42-133	#18		

CLEOID & DISCOID CARVERS

42-157	#89 / #92
42-154	#90 / #93
42-163	Large



AKERS KNIFE/SPOON

DOUBLE END

- 42-183 Knife
- 42-187 Spoon
- 42-197 Handle
- 42-171 Complete Set



EVANS KNIFE/SPOON

DOUBLE END

- 42-191 Knife
- 42-193 Spoon
- 42-197 Handle
- 42-177 Complete Set

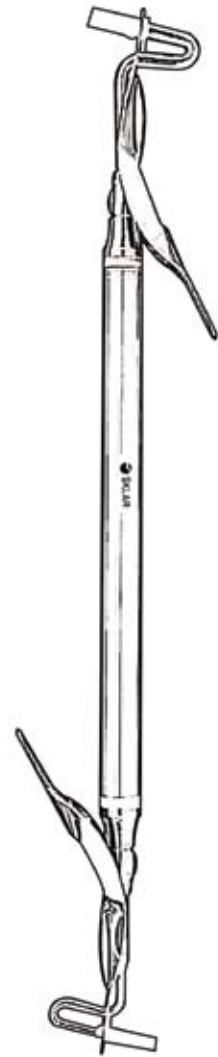

AMALGAM CARRIER

MEDIUM/LARGE, DELRIN BARRELS

- 45-178

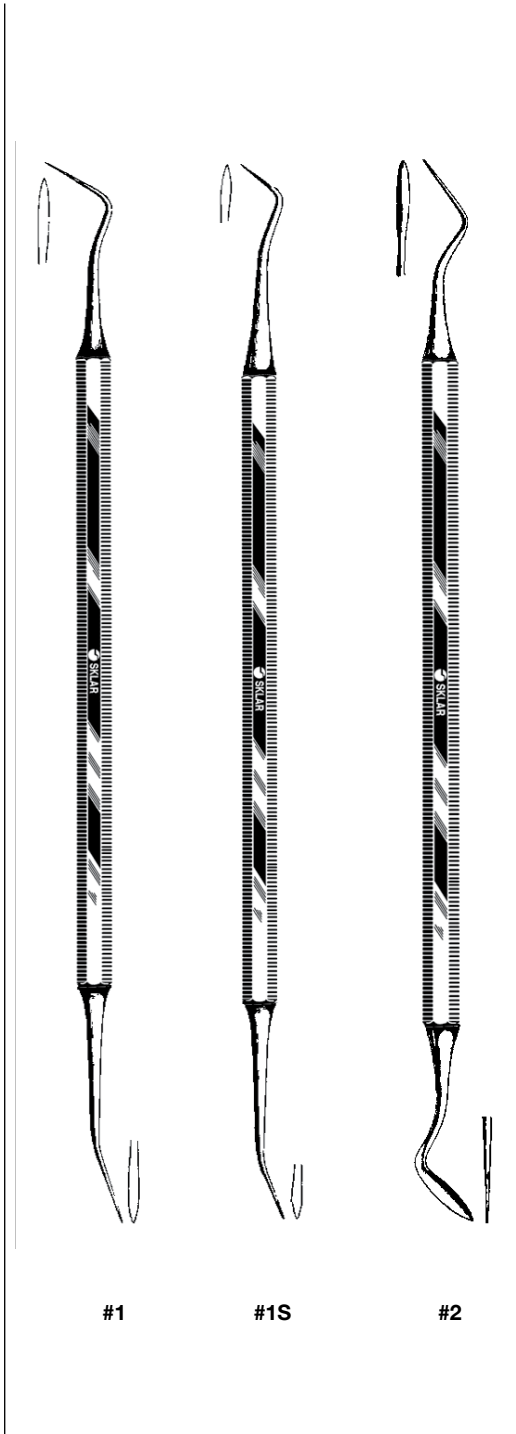

#1

#1S

#2

WARD CARVERS

DOUBLE END

- | | |
|--------|-----|
| 42-246 | #1 |
| 42-248 | #1S |
| 42-252 | #2 |

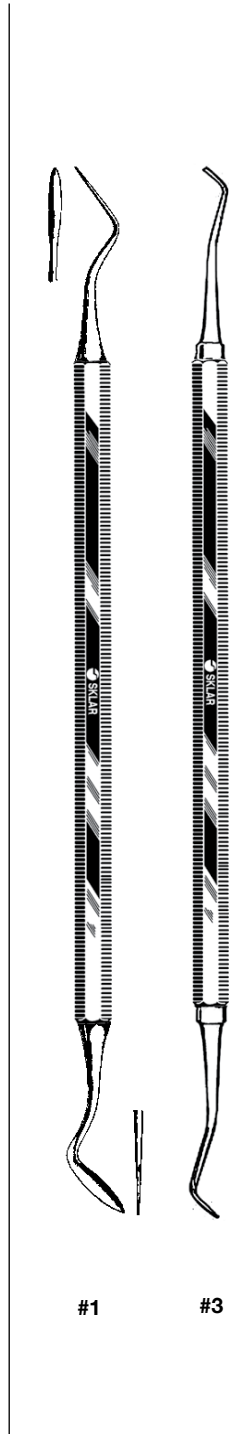

#1

#3

WALLS CARVERS

DOUBLE END

- | | |
|--------|----|
| 42-256 | #1 |
| 42-266 | #3 |

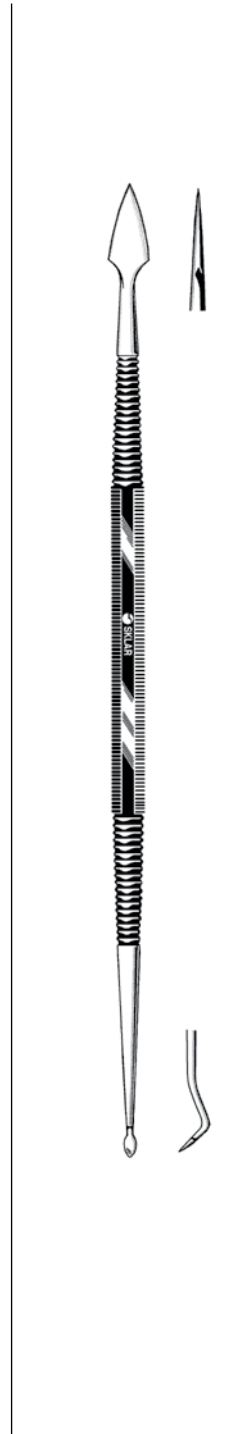

VEHE CARVERS

**DOUBLE END,
PORCELAIN / WAX**

- | | |
|--------|--------------|
| 42-271 | |
| 48-424 | Office Grade |

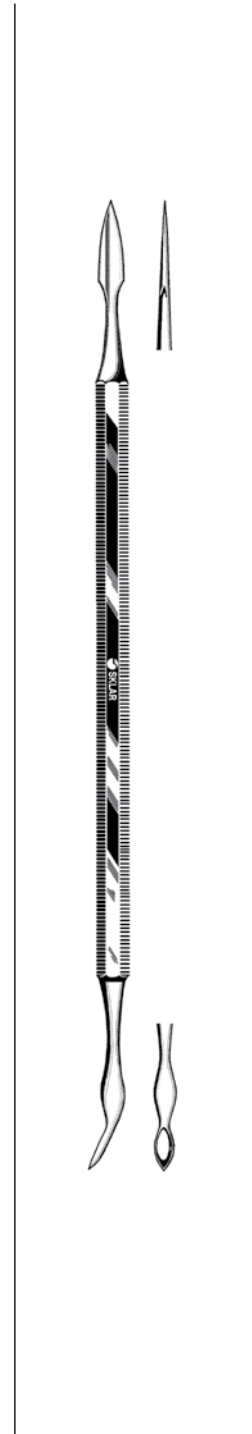

ROACH CARVER

DOUBLE END, PORCELAIN/WAX

- | | |
|--------|-----------|
| 42-273 | #90 / #93 |
|--------|-----------|

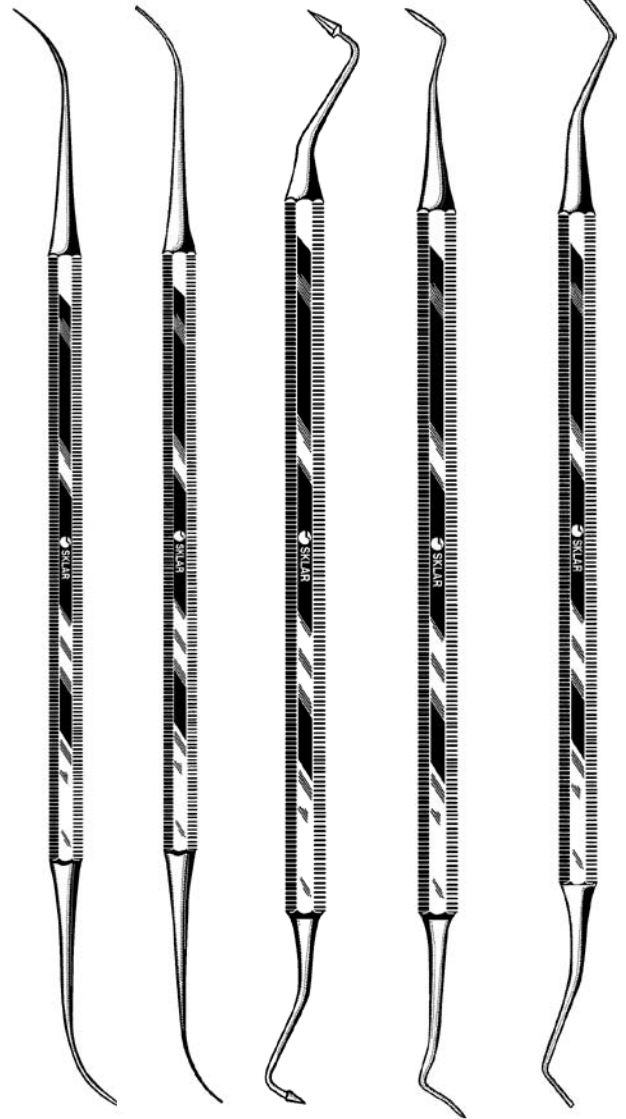

#1 #2 #3 #4 #5

HOLLENBACK CARVERS

DOUBLE END

- 42-228 #3
- 48-228 #3 Office Grade
- 42-234 #3S Small

LE CRON CARVER

DOUBLE END

- 42-270
- 48-422 Office Grade

PK THOMAS WAX PLACERS

DOUBLE END

- 42-274 #1
- 42-278 #2
- 42-282 #3
- 42-288 #4
- 42-296 #5

DOUBLE END, OFFICE GRADE

- 48-274 #1
- 48-278 #2
- 48-282 #3
- 48-288 #4
- 48-296 #5

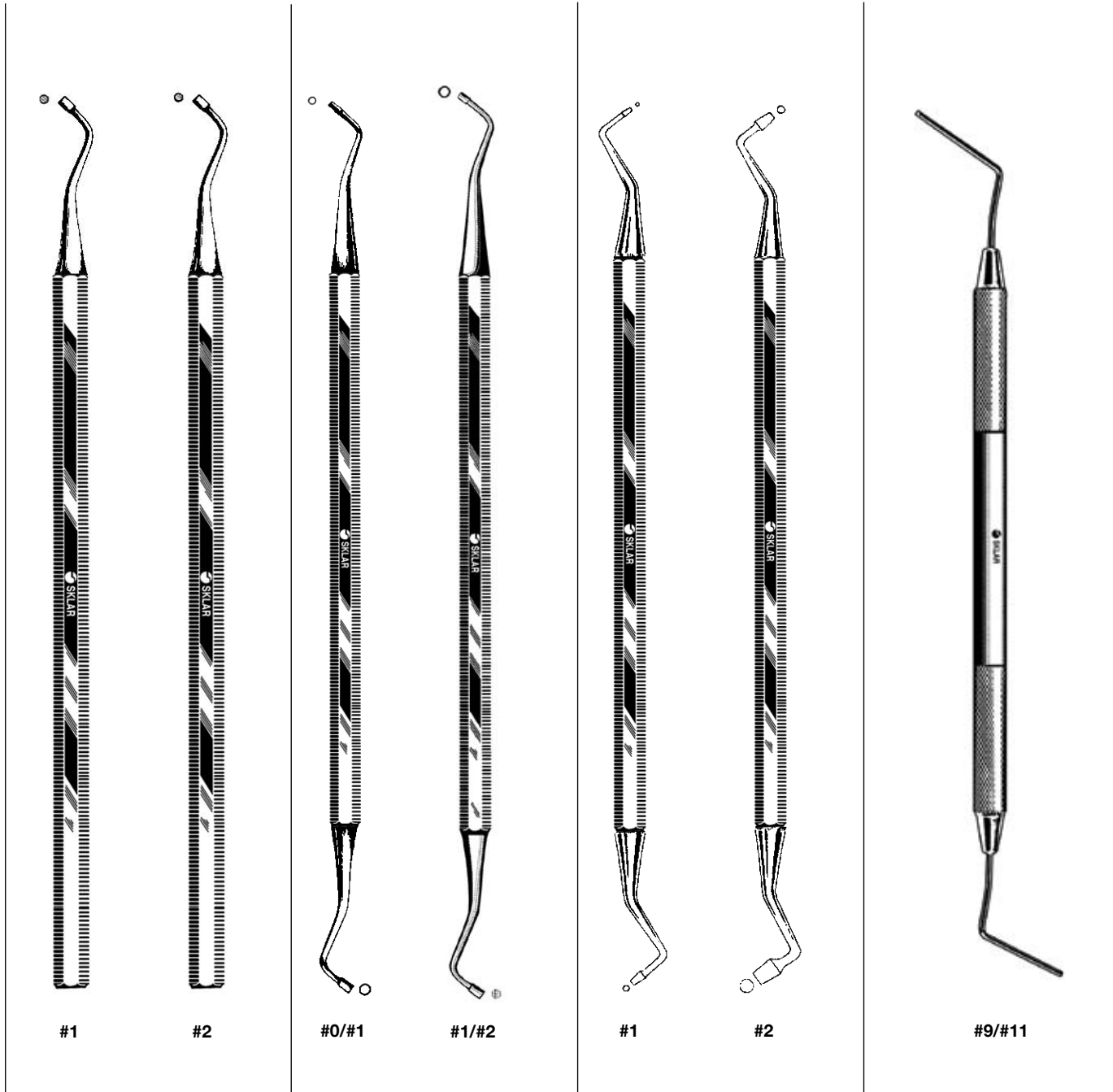

BLACK PLUGGERS

SINGLE END, SERRATED

- 42-301 #1
- 42-307 #2

BLACK PLUGGERS

DOUBLE END, SMOOTH

- 42-327 #0 / #1
- 42-328 #1 / #2

DOUBLE END, SERRATED

- 42-321 #0 / #1
- 48-321 #0 / #1 Office Grade
- 42-325 #1 / #2

**HOLLENBACK
CONDENSERS**

DOUBLE END, SMOOTH

- 42-329 #1
- 42-330 #2

**ROOT CANAL
PLUGGER**

DOUBLE END

- 42-315 #9 / #11

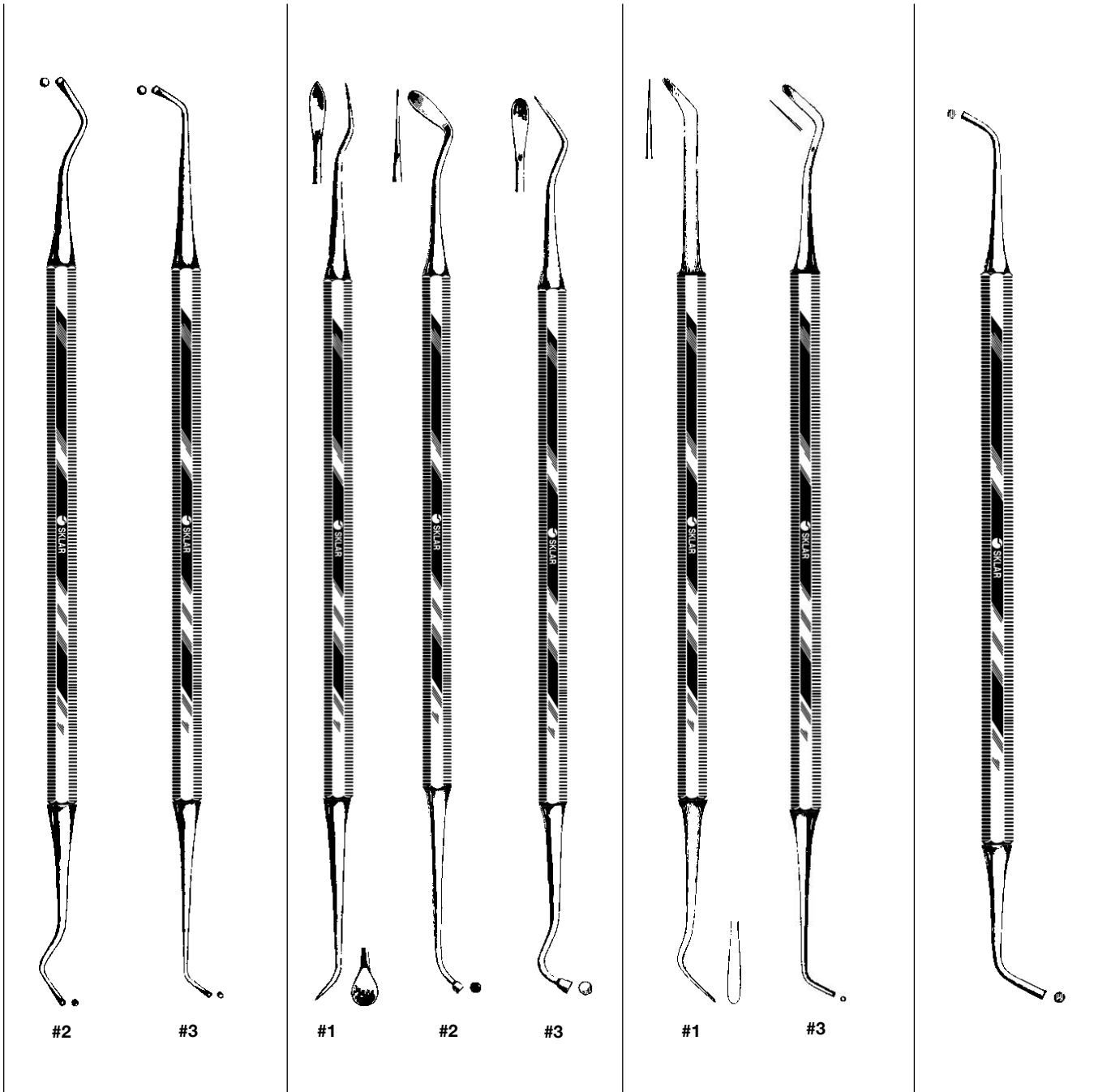

LADMORE FILLING INSTRUMENTS

DOUBLE END

- 42-331 #2
- 42-335 #3

WOODSON FILLING INSTRUMENTS

DOUBLE END

- 42-339 #1
- 42-443 #2
- 42-447 #3

PLASTIC FILLING INSTRUMENTS

DOUBLE END

- 42-455 #1
- 42-461 #3

SMITH SPECIAL INSTRUMENT

DOUBLE END

- 42-465

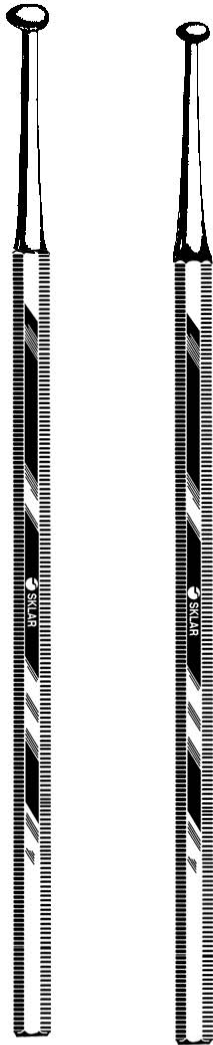

#28

#29

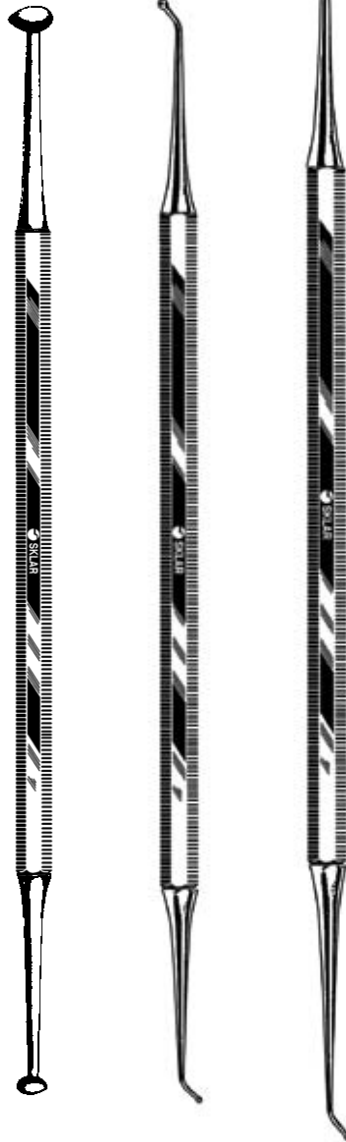

#28/#29

#26/#27S

#1

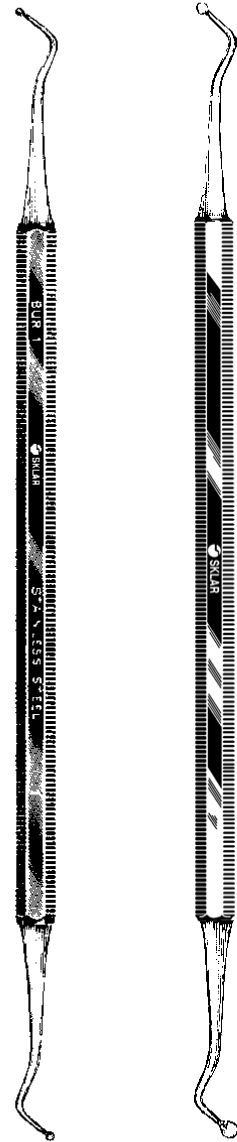

#1

#2

BURNISHERS

SINGLE END

42-473 #28
42-475 #29

BURNISHERS

DOUBLE END

42-479 #28 / #29, With Football End
42-471 #26 / #27S, With Ball End
42-483 #1, With Ball End

BURNISHERS

DOUBLE END, UNIVERSITY OF MICHIGAN

42-489 #1
42-493 #2



**ACORN
BURNISHER**
42-497



#22



#24



#24A



#324

CEMENT SPATULAS

SINGLE END

- 42-512 #22
- 42-532 #24
- 42-524 #24A
- 42-538 #324

SINGLE END, OFFICE GRADE

- 48-526 #24
- 48-524 #24A
- 48-538 #324

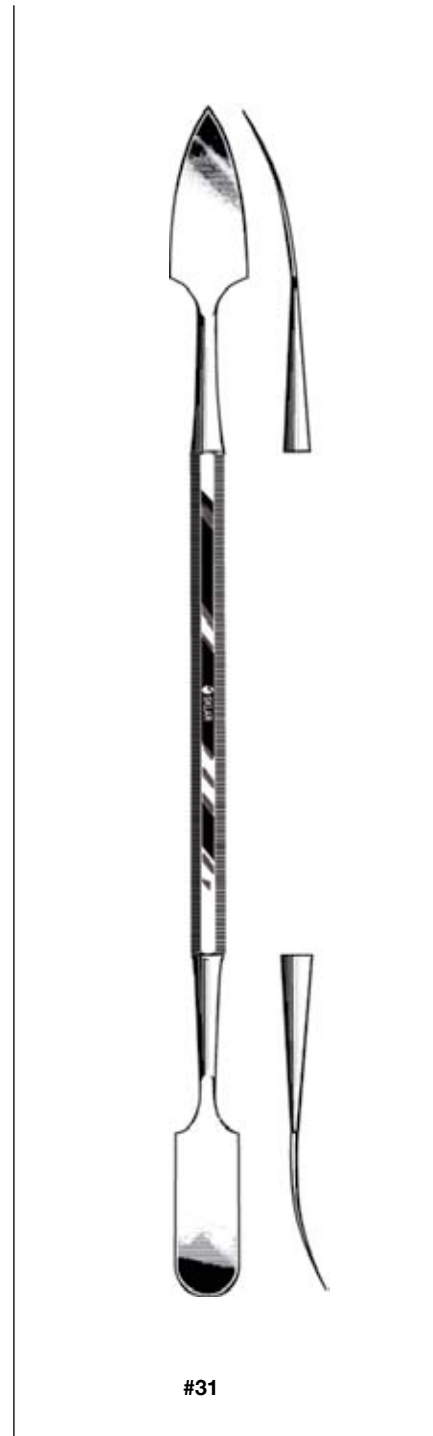

WAX SPATULAS

DOUBLE END

- 42-552 #7
- 48-542 #7 Office Grade
- 42-558 #7A (St. Louis), Narrow End Flat
- 42-564 #7½ (Baltimore)
- 42-576 #45

GRITMAN WAX SPATULA

DOUBLE END

- 42-572 #31
- 48-572 #31 Office Grade

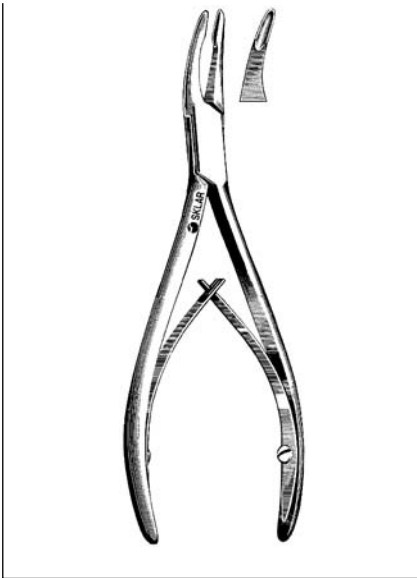

FRIEDMAN RONGEURS

DELICATE, CURVED

40-3190 5½"
40-3192 6½"

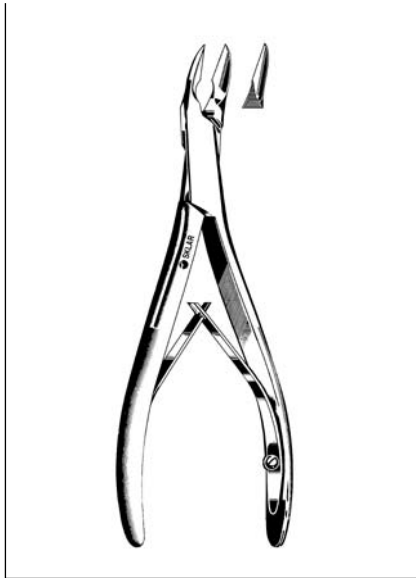

RONGEUR #5

SIDE CUTTING

40-3198 6½"

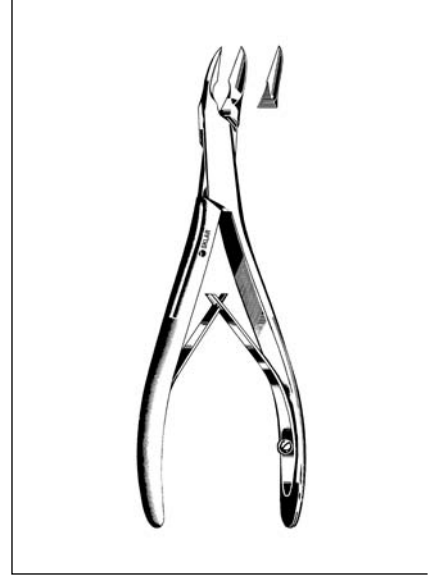

RONGEUR #5S

SIDE CUTTING

42-3196 5¾"

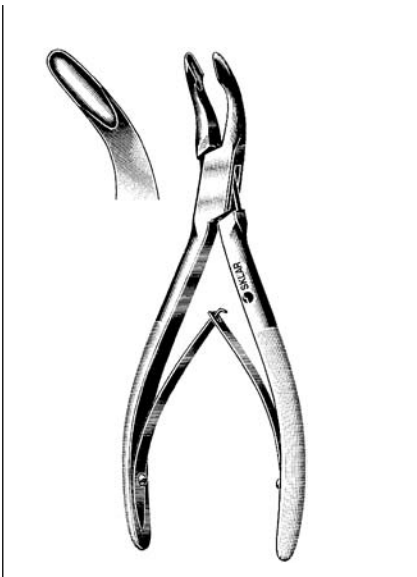

DEAN BONE RONGEUR

47-2455 5½" Curved

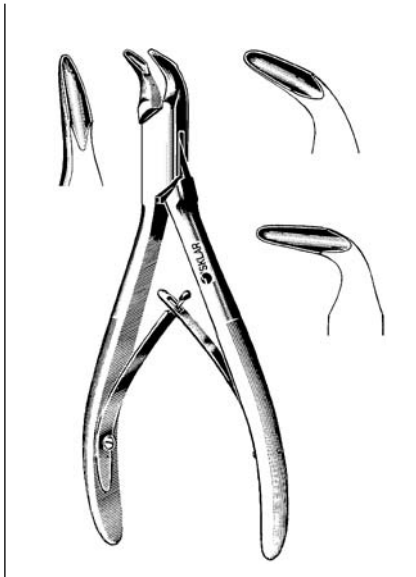

BLUMENTHAL RONGEUR

67-5990 6" 30° Angle
67-5992 6" 45° Angle
67-5994 6" 90° Angle

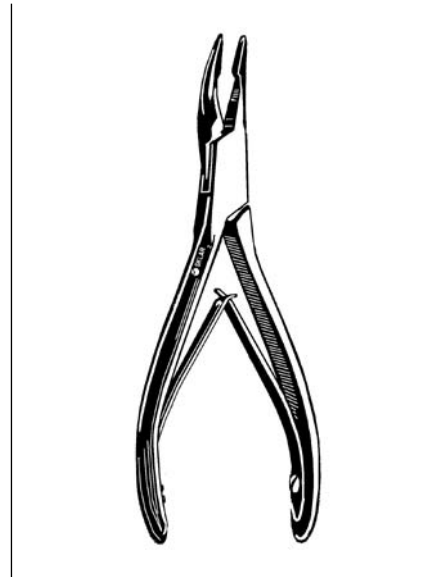

MINI-BLUMENTHAL ORAL SURGERY RONGEUR

67-5987 4¾" 30° Angle

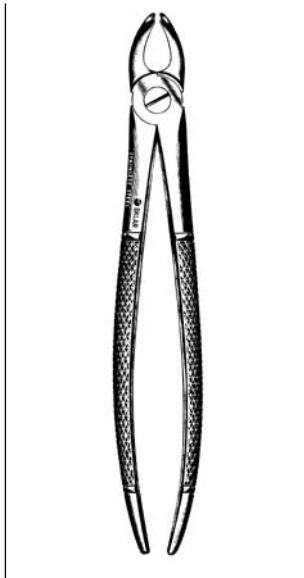

MEAD EXTRACTING FORCEP #MD2
UPPER UNIVERSAL
43-105

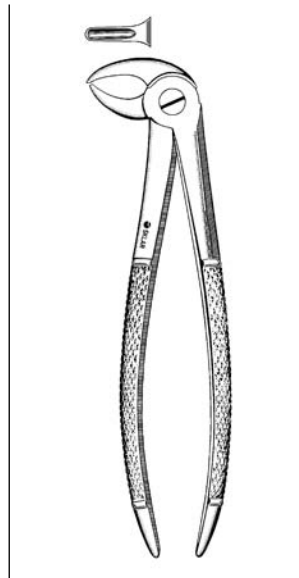

MEAD EXTRACTING FORCEP #MD3
LOWER UNIVERSAL
43-109
48-109 Office Grade



EXTRACTING FORCEP #1E
UPPER BICUSPID
43-125

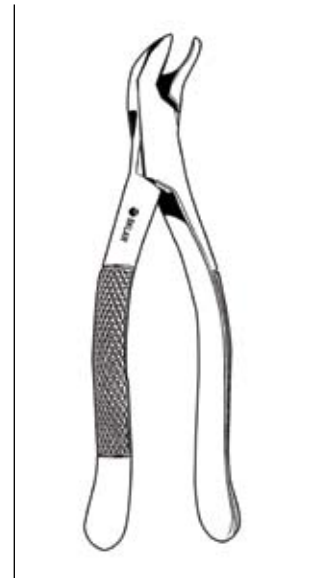

EXTRACTING FORCEP #5
LOWER THIRD MOLAR
42-825 Universal

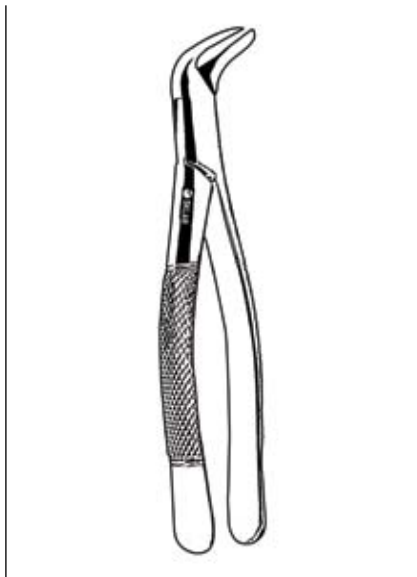

EXTRACTING FORCEP #6
42-985

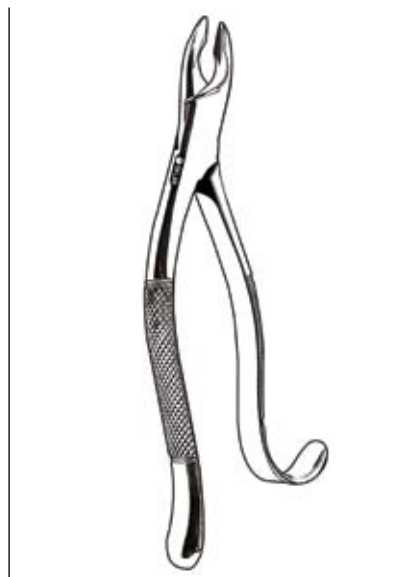

EXTRACTING FORCEP #10
42-912 Hook Handle

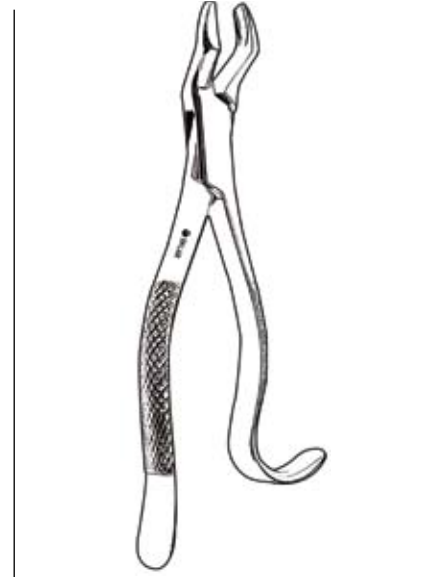

EXTRACTING FORCEP #10H
42-772 Hook Handle

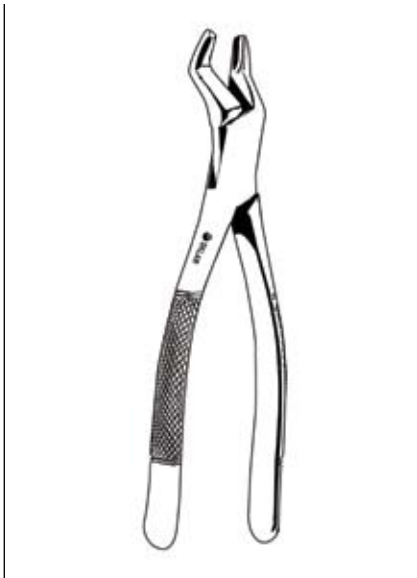

EXTRACTING FORCEP #10S
42-776 Upper Molar

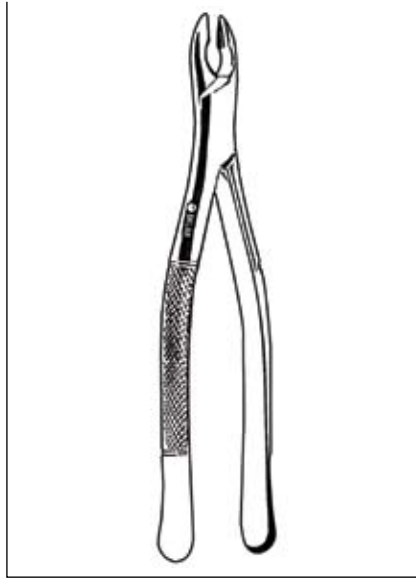

EXTRACTING FORCEP #10S
NEVIUS
42-908 Upper Cuspid

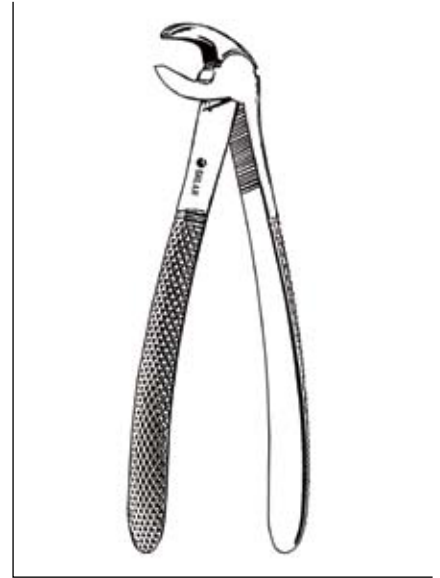

EXTRACTING FORCEP #13
ENGLISH PATTERN
43-153

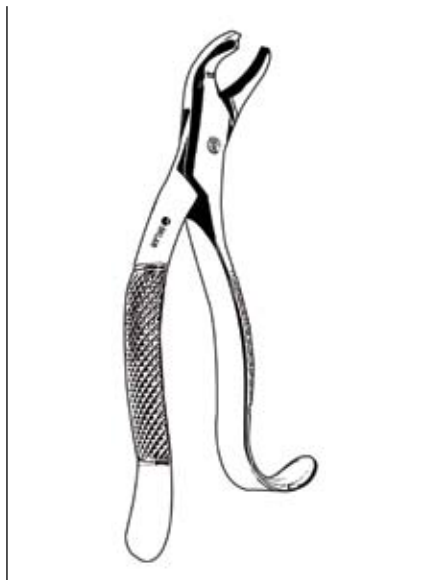

EXTRACTING FORCEP #15
42-801 Hook Handle

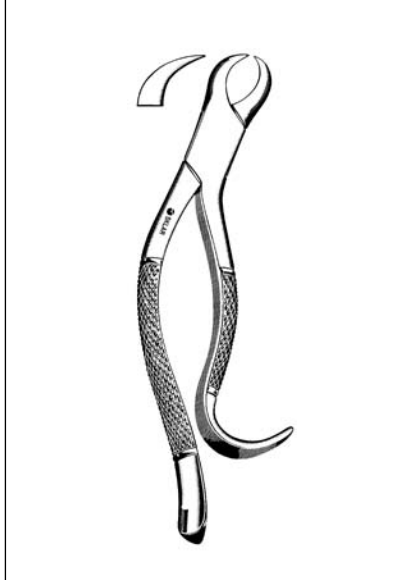

EXTRACTING FORCEP #16
HOOK HANDLE
42-792
48-264 Office Grade

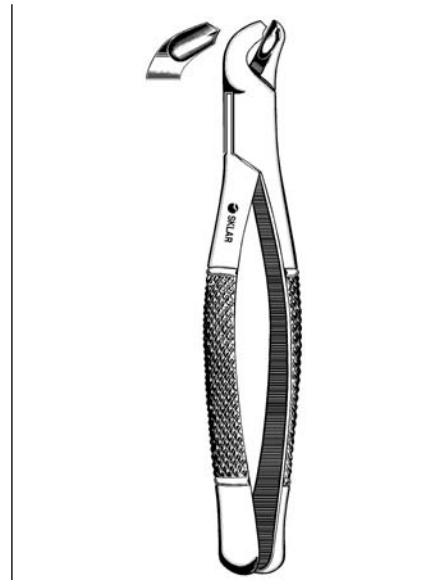

EXTRACTING FORCEP #17
42-807
48-289 Office Grade



EXTRACTING FORCEP #18E
43-149



**EXTRACTING FORCEP
UPPER FIRST AND SECOND MOLAR**
42-744 #18R
42-752 #18L
48-752 #18L Office Grade



EXTRACTING FORCEP #22
ENGLISH PATTERN
43-173



EXTRACTING FORCEP #23
42-798
48-276 Office Grade



EXTRACTING FORCEP #24
42-724
48-226 Office Grade



EXTRACTING FORCEP #33
ENGLISH PATTERN
43-161

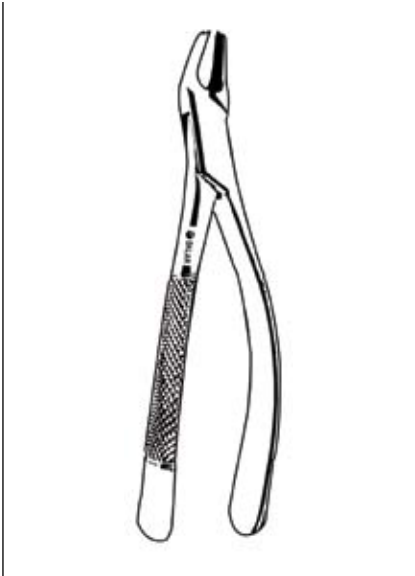

EXTRACTING FORCEP #44
42-873

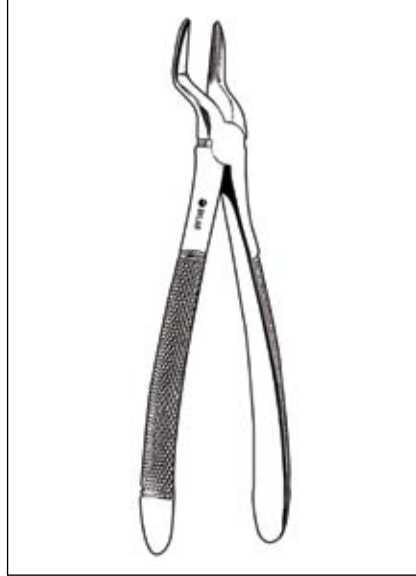

EXTRACTING FORCEP #51
ENGLISH PATTERN
43-137

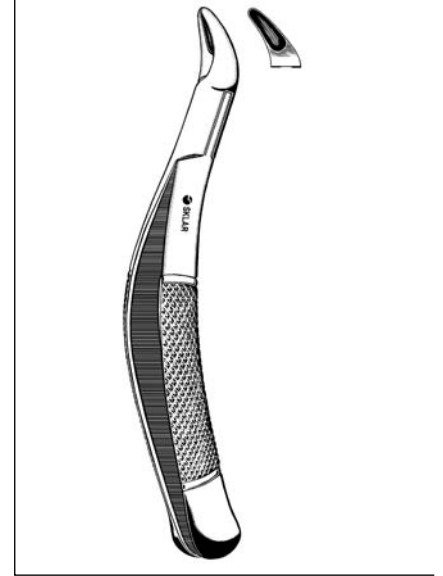

EXTRACTING FORCEP #62
42-875
48-339 Office Grade

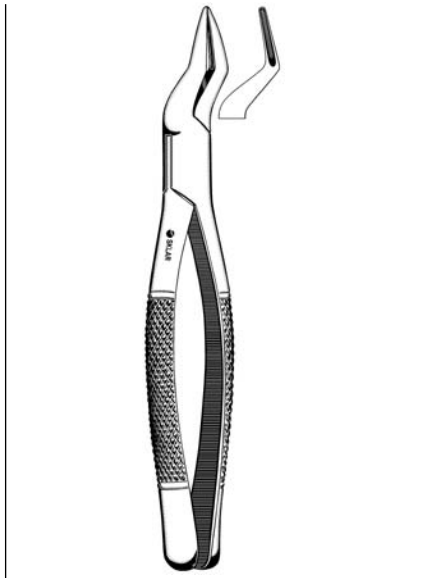

EXTRACTING FORCEP #65
42-707
48-204 Office Grade

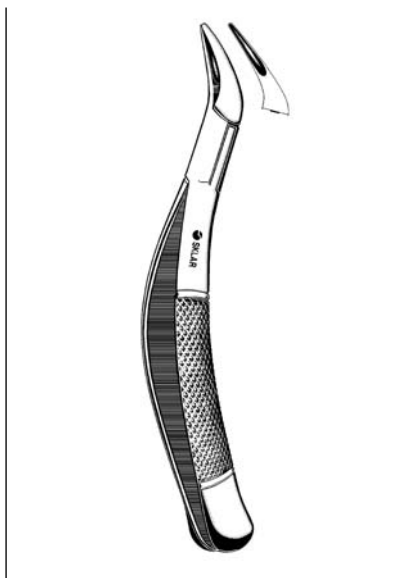

EXTRACTING FORCEP #69
42-857
48-351 Office Grade

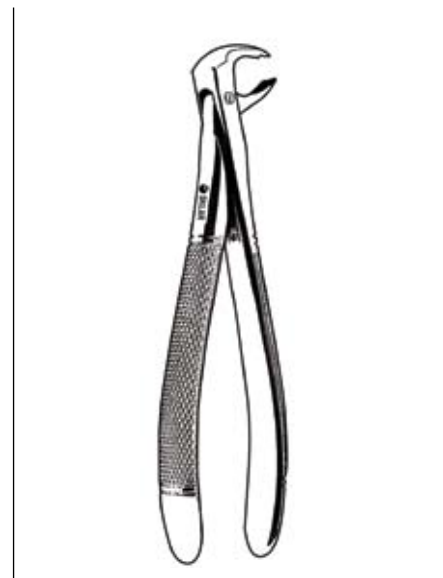

EXTRACTING FORCEP #73
ENGLISH PATTERN
43-177

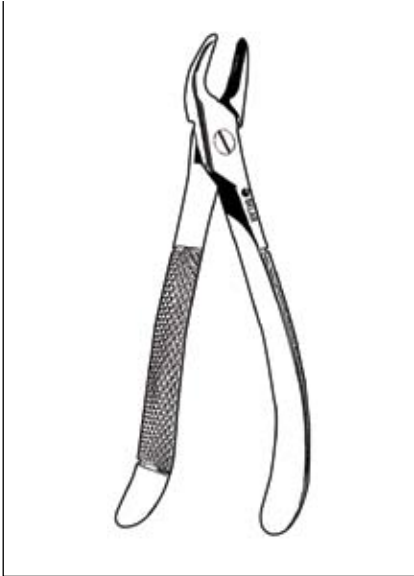

EXTRACTING FORCEP #76
ENGLISH PATTERN
43-133

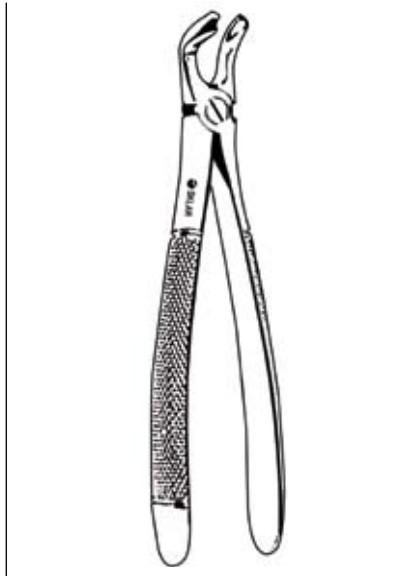

EXTRACTING FORCEP #79
ENGLISH PATTERN
43-189

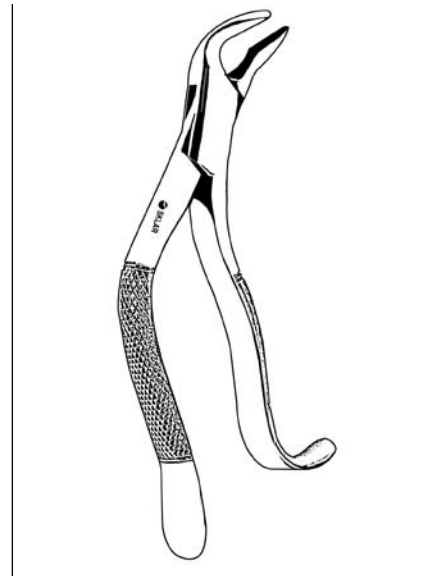

EXTRACTING FORCEP #85
42-849 Hook Handle

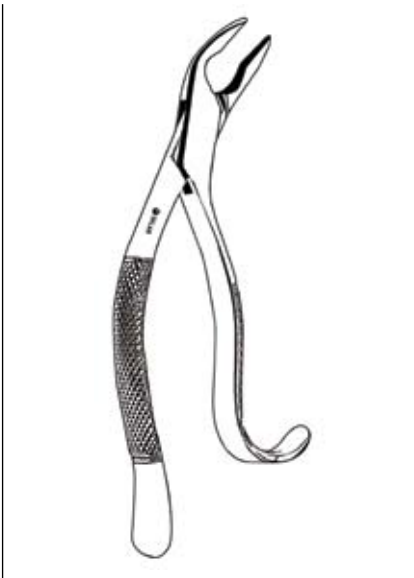

EXTRACTING FORCEP #85A
42-853 Hook Handle

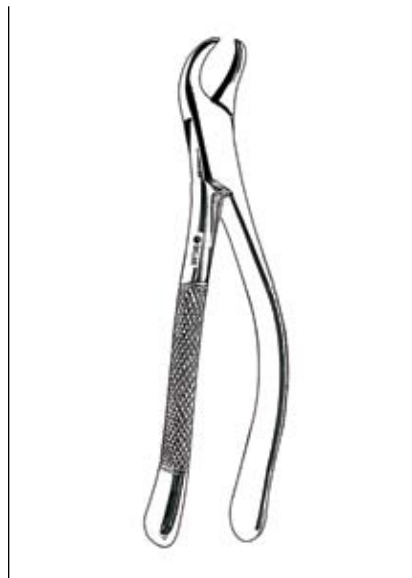

EXTRACTING FORCEP #87
ENGLISH PATTERN
43-185

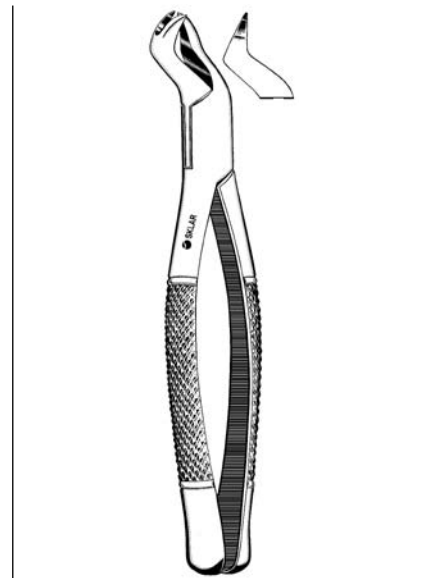

EXTRACTING FORCEP #88L
42-783
48-252 Office Grade

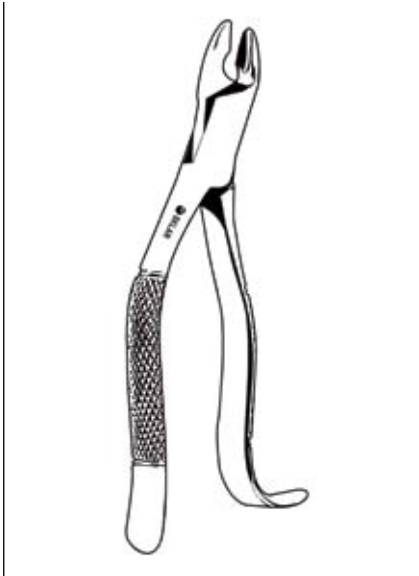

EXTRACTING FORCEP #99A
42-883 Hook Handle

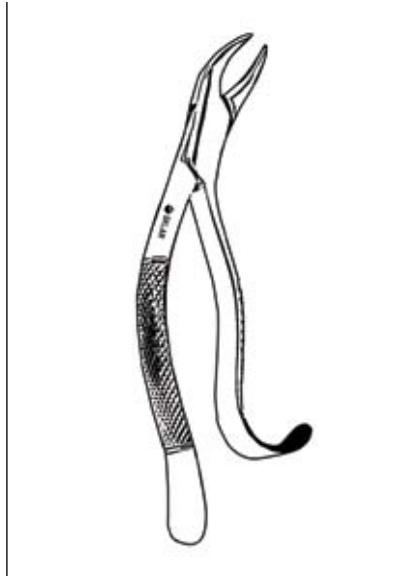

EXTRACTING FORCEP #103
42-833 Hook Handle

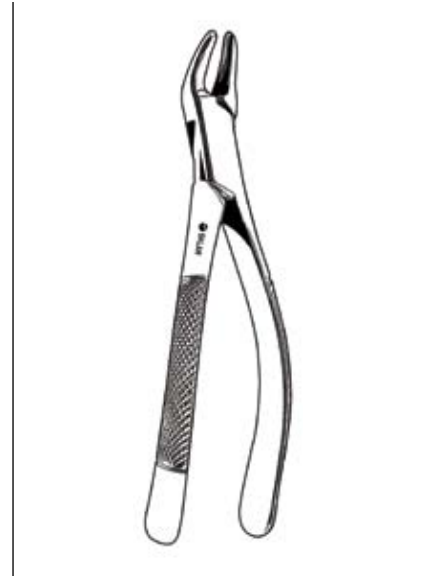

EXTRACTING FORCEP #150
42-859 Office Grade
48-301

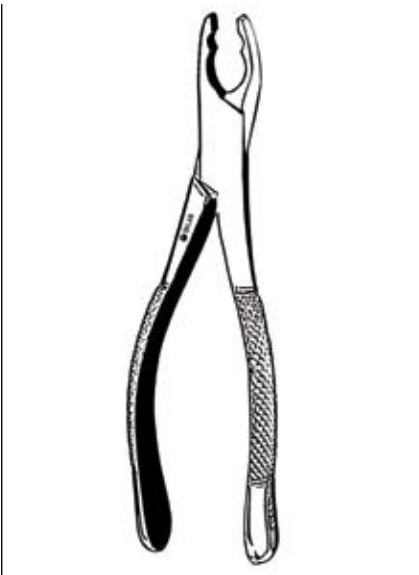

EXTRACTING FORCEP #150AS
42-860

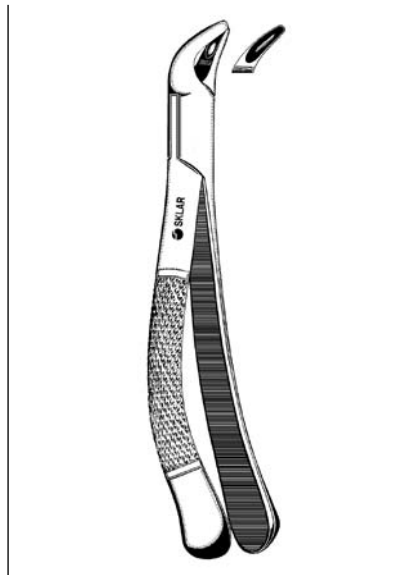

EXTRACTING FORCEP #151
42-863 Office Grade
48-327

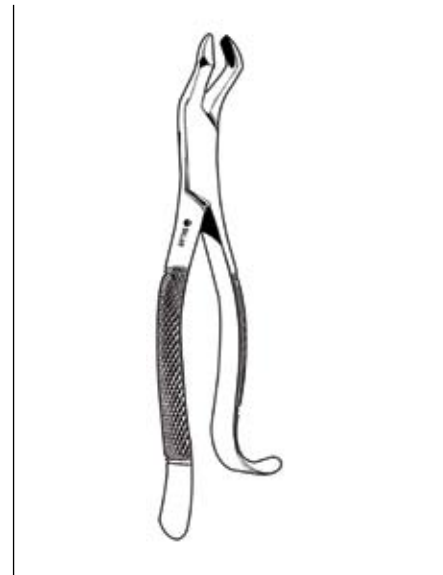

EXTRACTING FORCEP #210
42-732 Hook Handle

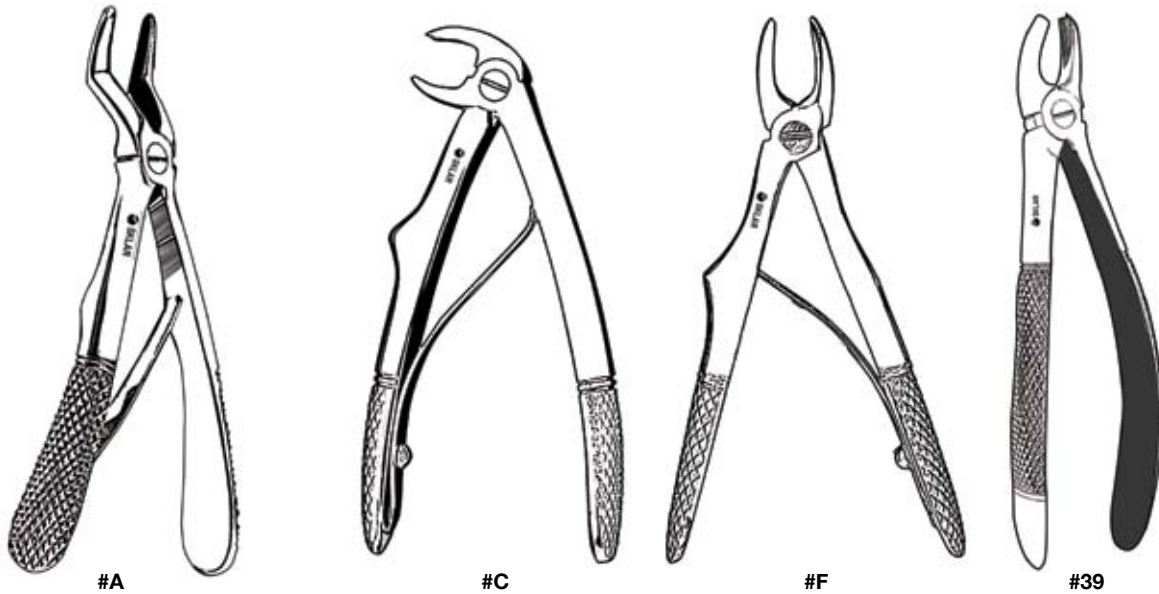

SMALL EXTRACTING FORCEPS

- 43-204 #A
- 43-208 #C
- 43-226 #F
- 43-238 #39

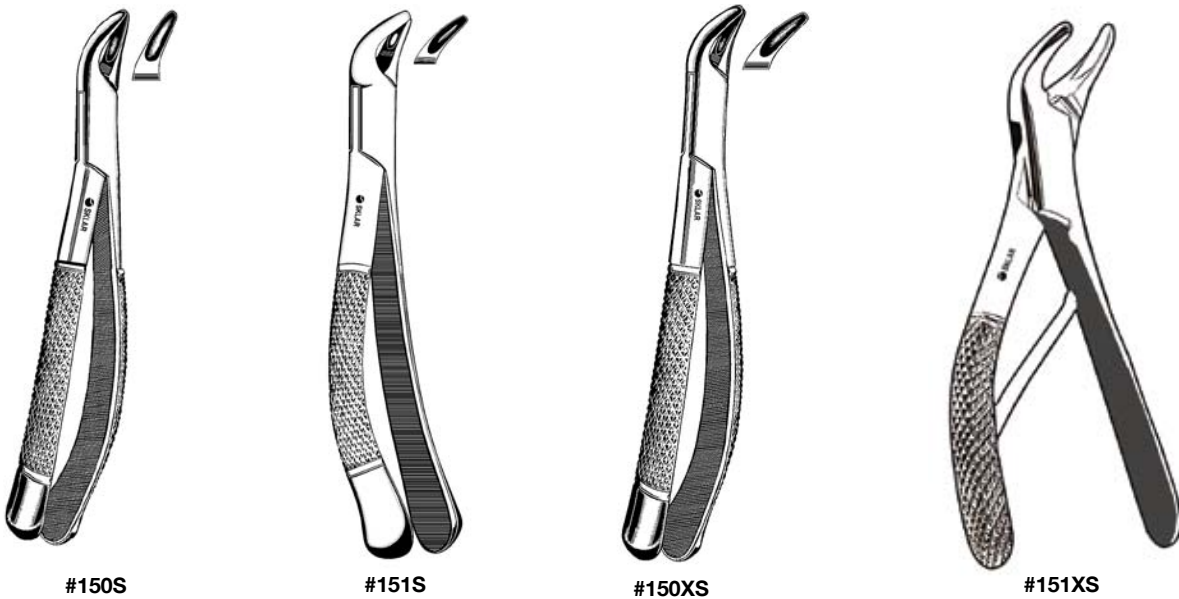

SMALL EXTRACTING FORCEPS

- 43-252 #150S
- 48-363 #150S Office Grade
- 43-258 #151S
- 43-375 #151S Office Grade
- 43-266 #150XS
- 43-272 #151XS



GOSLEE PLIERS #136

45-507
48-507 Office Grade



FLAT NOSE PLIERS

SQUARE END
40-1778 5½"



RUBBER DAM PUNCH

W TYPE
45-266
48-266 Office Grade

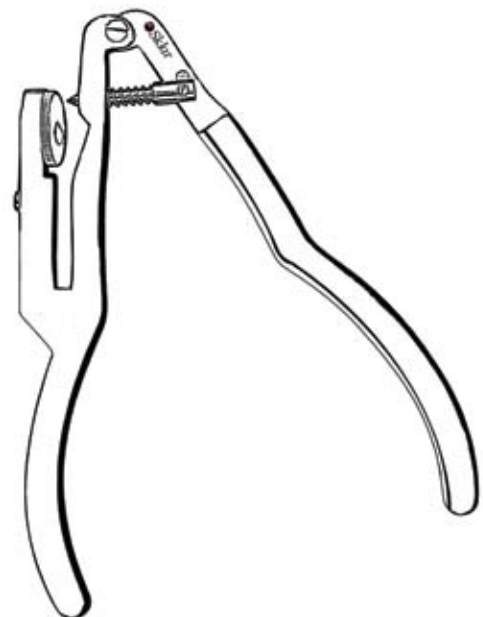

RUBBER DAM PUNCH

IV TYPE
45-282

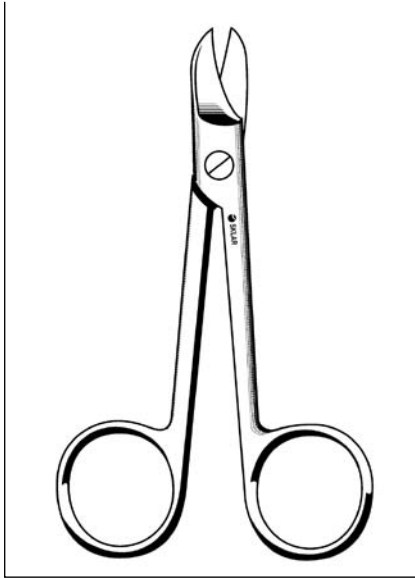
CROWN SCISSORS

24-2345	4"	Straight	Smooth
24-2340	4"	Straight	Serrated
24-2346	4"	Curved	Smooth
24-2341	4"	Curved	Serrated

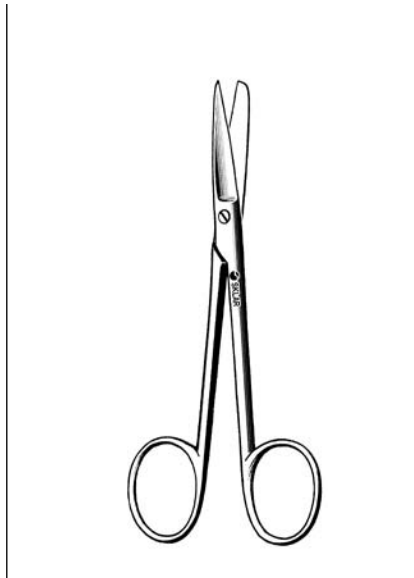
WAGNER SCISSORS
STRAIGHT, 4½"

47-1070	Smooth	Blunt/Blunt
47-1048	Smooth	Sharp/Blunt
47-1047	Smooth	Sharp/Sharp
47-1071	Serrated	Blunt/Blunt
47-1060	Serrated	Sharp/Blunt
47-1049	Serrated	Sharp/Sharp

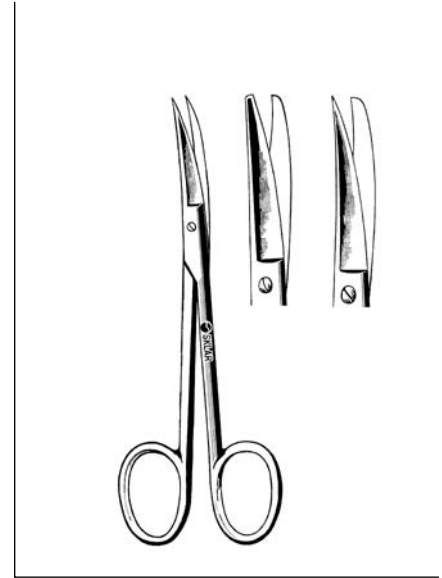
WAGNER SCISSORS
CURVED, 4½"

47-1075	Smooth	Blunt/Blunt
47-1068	Smooth	Sharp/Blunt
47-1058	Smooth	Sharp/Sharp
47-1072	Serrated	Blunt/Blunt
47-1069	Serrated	Sharp/Blunt
47-1059	Serrated	Sharp/Sharp

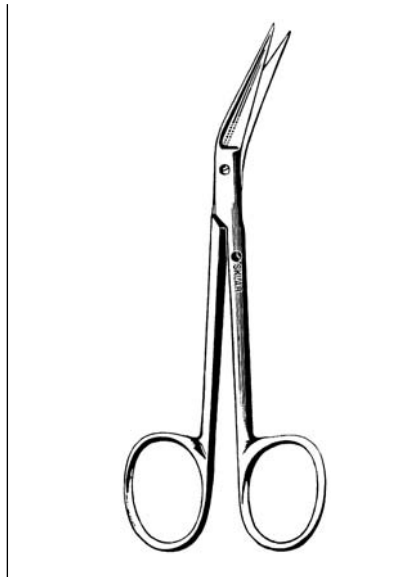
SKLAR ANGULAR SCISSORS
SHARP/SHARP

47-1080	4¾"	Smooth
47-1081	4¾"	Serrated

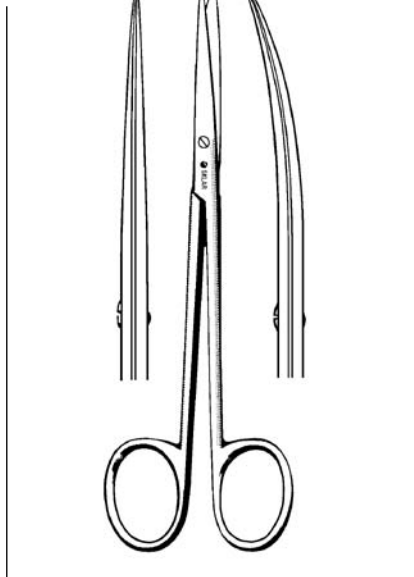

BROPHY SCISSORS

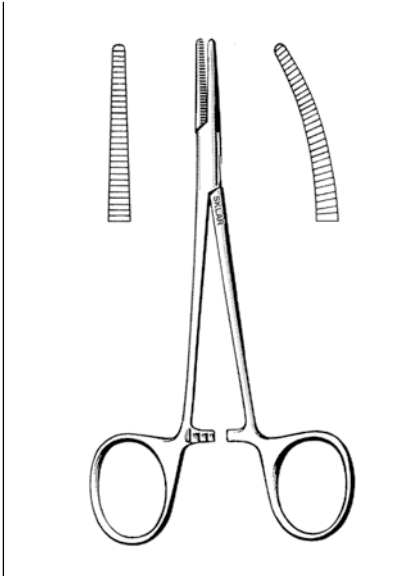
64-1160	5½"	Straight
64-1161	5½"	Curved

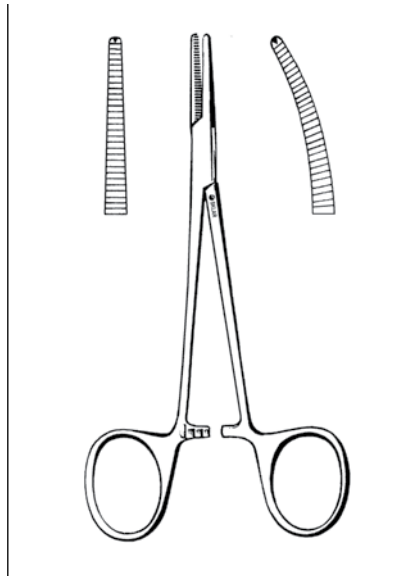

HALSTED MOSQUITO FORCEPS
SERRATED

- 17-1450 5" Straight
- 17-1550 5" Curved
- 17-1455 5" Straight, Non-Magnetic
- 17-1555 5" Curved, Non-Magnetic
- 18-1050 5" Straight, Delicate
- 18-1150 5" Curved, Delicate



HALSTED MOSQUITO FORCEPS
SERRATED, 1X2 TEETH

- 17-1650 5" Straight
- 17-1750 5" Curved

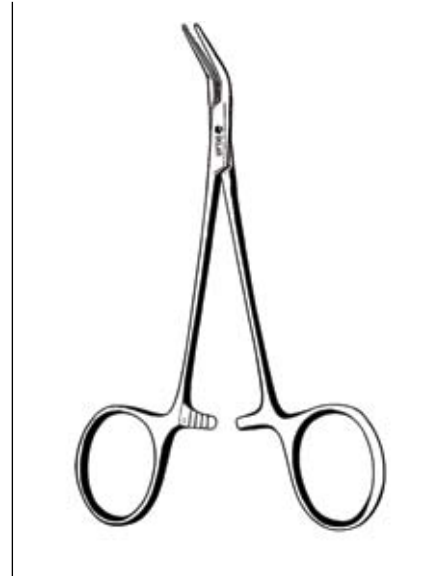

HALSTED MOSQUITO FORCEPS
SERRATED

- 17-1850 5" 45° Angled on Flat,
Extra Delicate

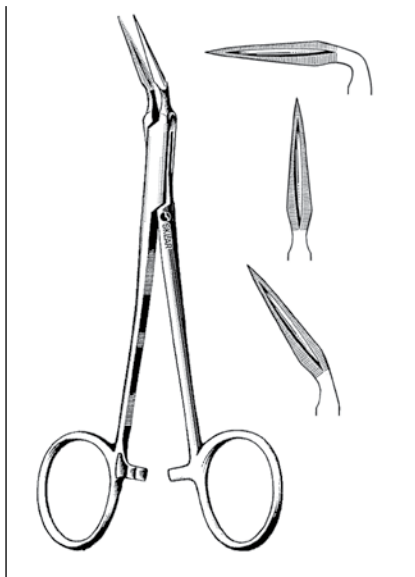

WILLIAMS SPLINTER FORCEPS

- 19-3056 4¾" Right Angle
- 19-3161 5½" Straight
- 19-3055 5½" 45° Angle

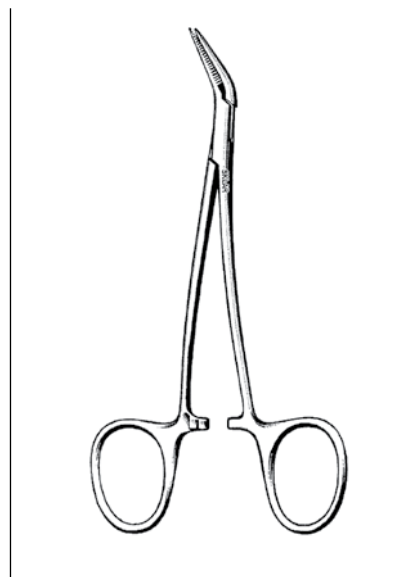

PEET SPLINTER FORCEP

- ANGLED**
- 19-3147 4¾" Double Curve

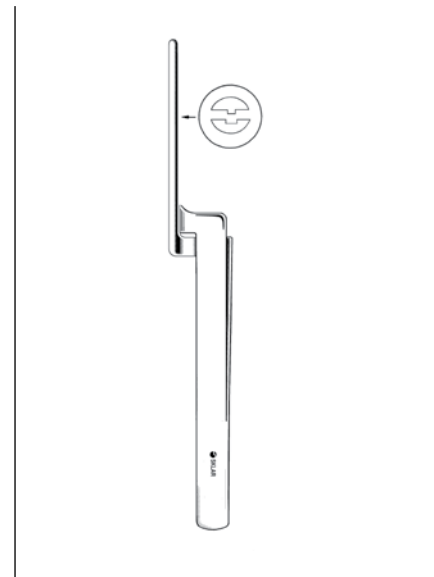

MILLER GROOVELOK
ARTICULATING PAPER FORCEPS

- GROOVED TIPS**
- 41-388
- 48-388 Office Grade



STERILIZER FORCEP
STRAIGHT, THREE PRONG
 44-455 8"
 48-761 8" Office Grade



FREER ELEVATOR
DOUBLE END
 47-2380 7¼" Sharp/Blunt



MOLT PERIO ELEVATOR #9
 43-523



COGSWELL ELEVATOR #D
 43-412



ELEVATOR #30
 43-371



ELEVATOR #31
 43-373

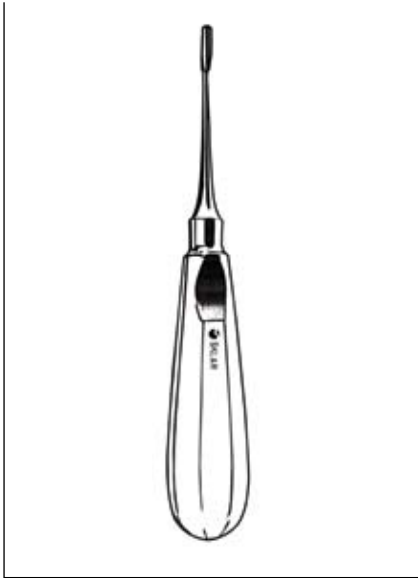

ELEVATOR #34
43-325

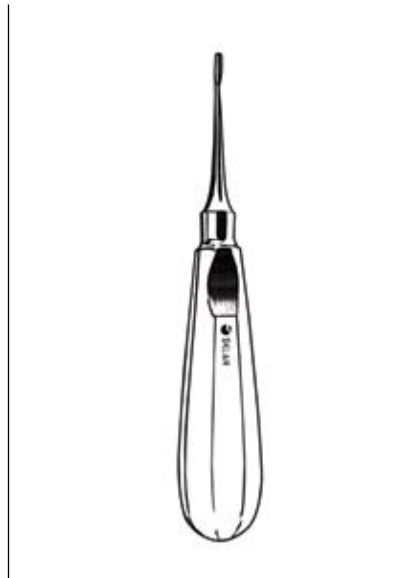

ELEVATOR #34S
43-329

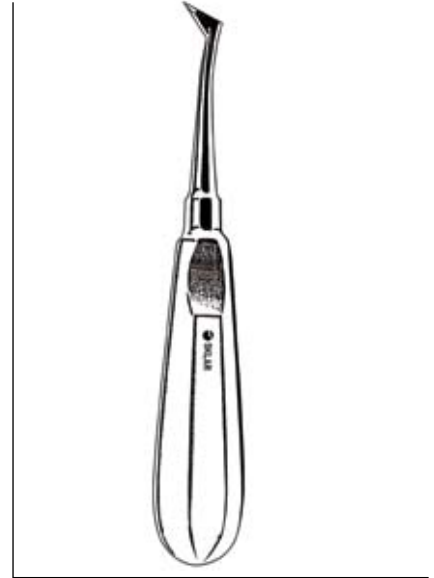

CRYER ELEVATOR #39
43-355



CRYER ELEVATOR #40
43-359

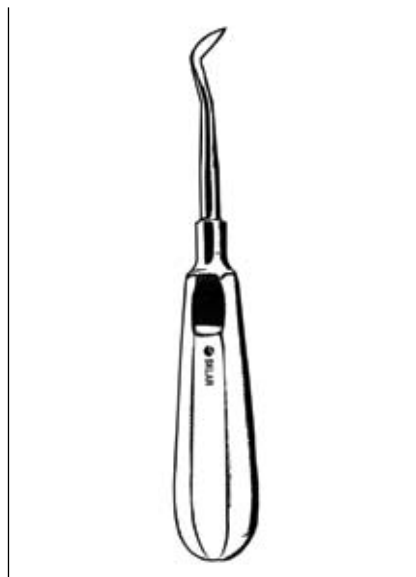

ELEVATOR #50
43-365

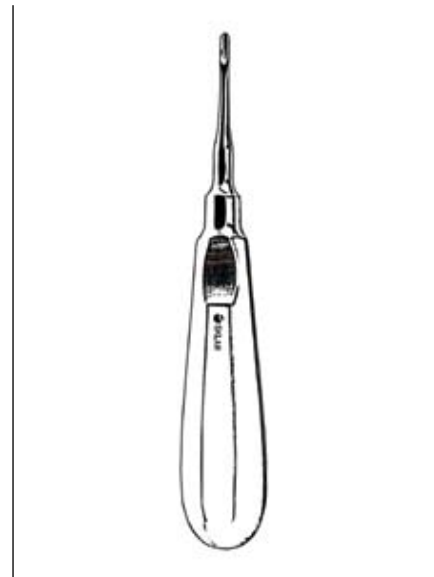

ELEVATOR #81
43-391

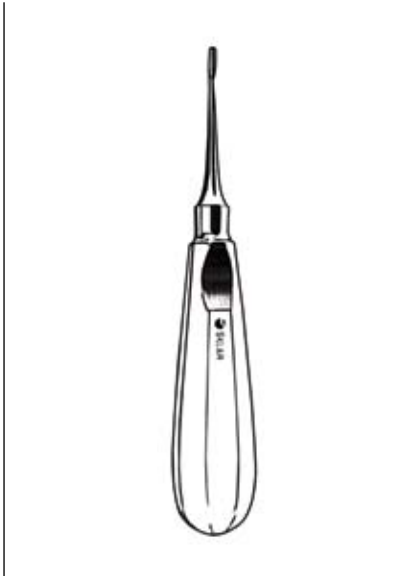

ELEVATOR #301
43-305



ELEVATOR #302
43-309



ELEVATOR #303
43-321

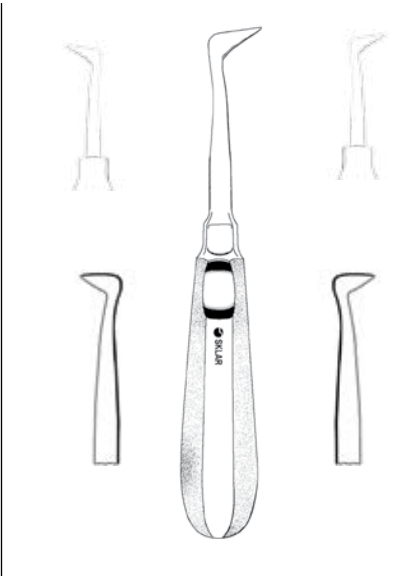

SELDIN ELEVATORS
43-379 #1L
43-381 #1R
43-383 #4L
43-385 #4R



SELDIN ELEVATOR #23
97-0527 Periosteal

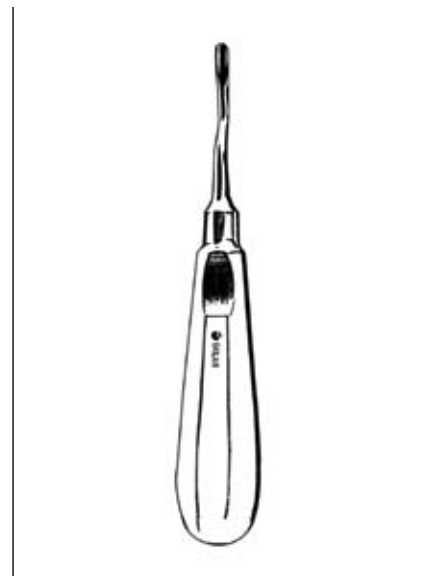

BAYONET ELEVATORS
43-393 #1
43-395 #2

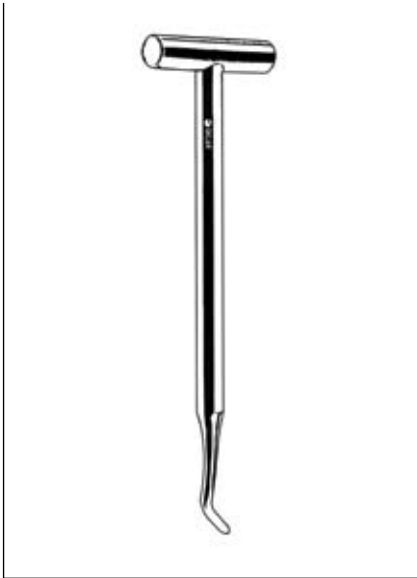

POTTS CROSS BAR ELEVATORS

43-424 #1L
43-426 #2R

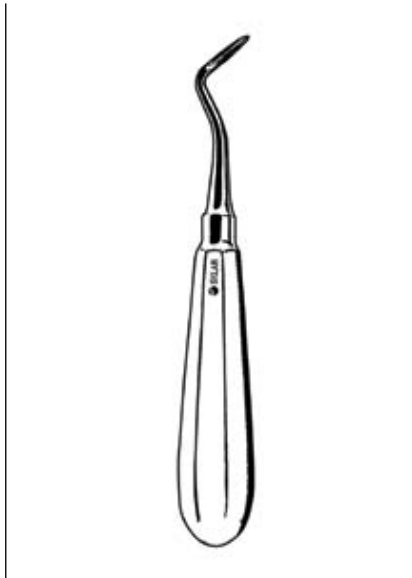

APICAL ELEVATORS

43-432 #301 Straight, Serrated
43-444 #303 Angled Left

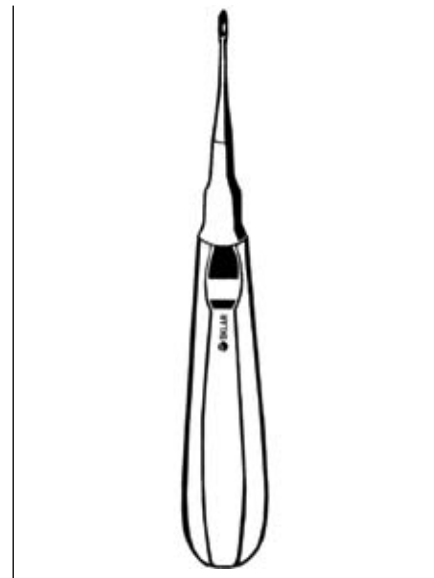

CRANE PICK ELEVATOR #41

43-351

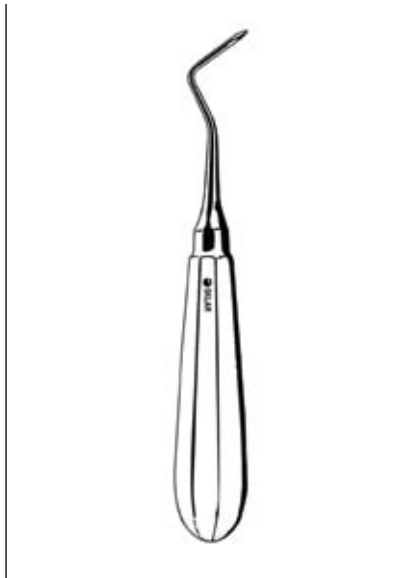

ROOT TIP ELEVATORS

43-531 #78 Straight
43-535 #79 Angled Right
43-539 #80 Angled Left

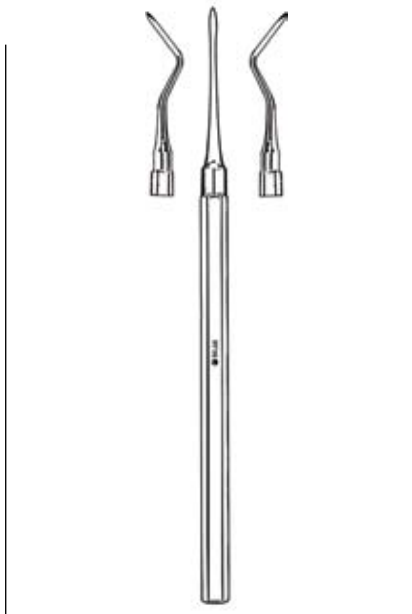

HEIDBRINK ROOT TIP PICKS

SINGLE END

43-543 #1 Straight
43-547 #2 Angled Right
43-549 #3 Angled Left

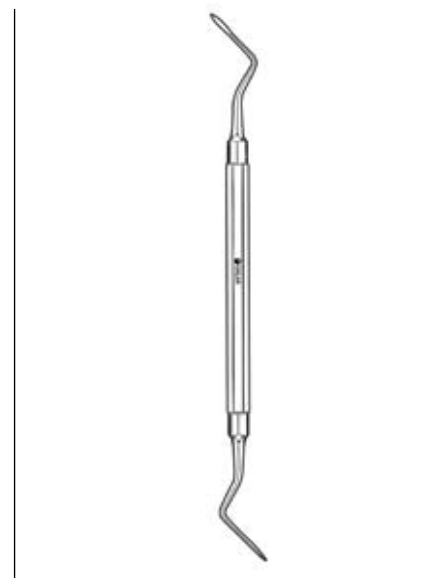

HEIDBRINK ROOT TIP PICK

DOUBLE END

43-551 #2 / #3

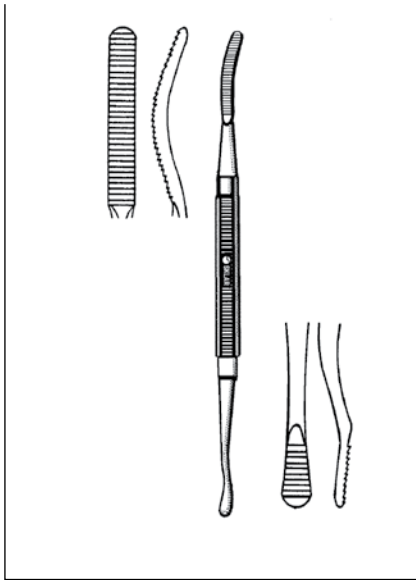

BONE FILE #10
DOUBLE END, PLAIN SERRATIONS
 97-1615 7½" One End Curved,
 One End Flat

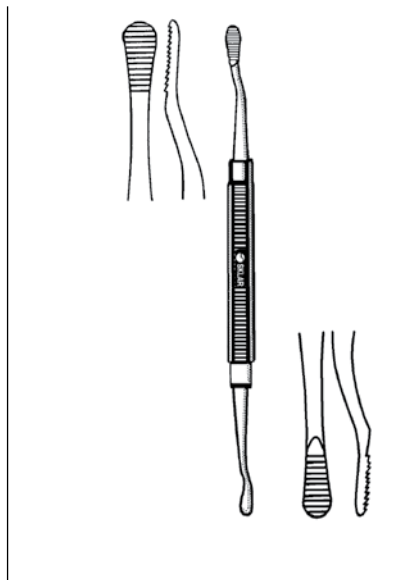

BONE FILE #12
DOUBLE END
 97-1620 7" Plain Serrations

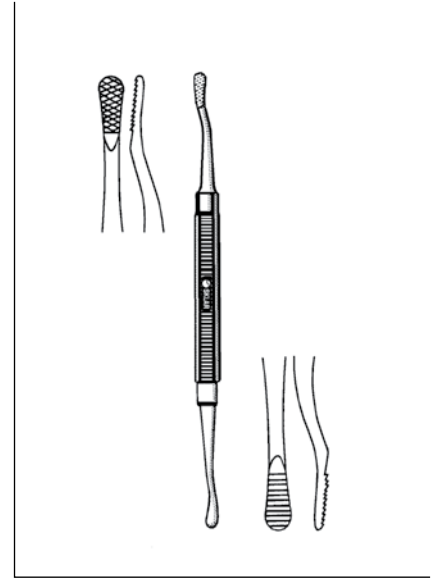

BONE FILE #12A
DOUBLE END
 97-1625 7" One End Plain Serrations
 One End Cross Serrations

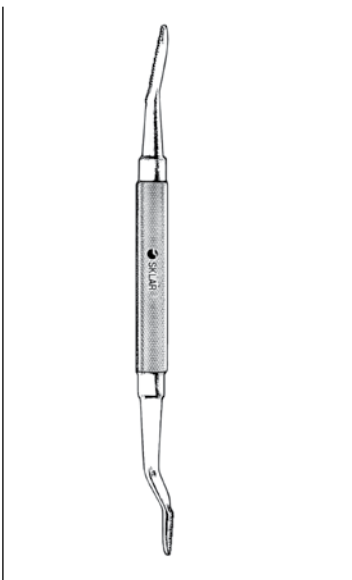

BONE FILE (MILLER) #33
DOUBLE END
 97-1533 7" Plain Serrations

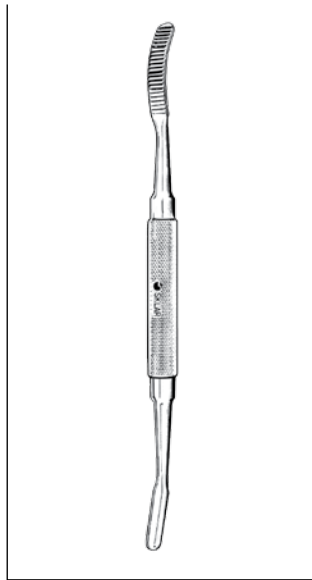

BONE FILE (MILLER) #45
DOUBLE END
 97-1545 7" Plain
 Serrations



BONE FILE (MILLER) #64
DOUBLE END
 97-1564 7" Plain
 Serrations

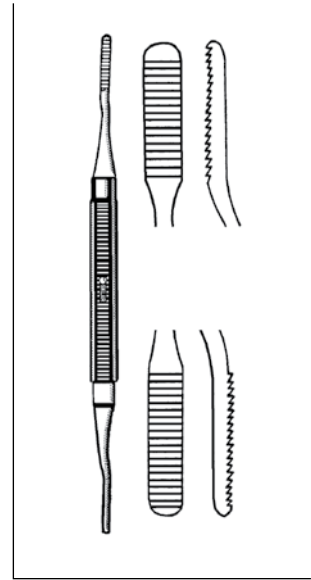

NAIL / BONE FILE
DOUBLE END
 97-1645 7½" 6mm

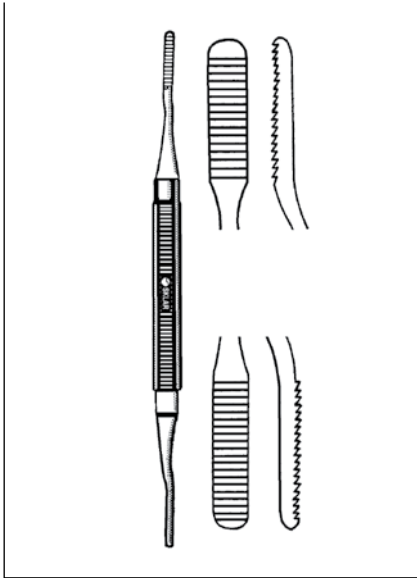

NAIL / BONE FILE

DOUBLE END

97-1640 7" 3-4mm
97-1635 8½" 5-6mm

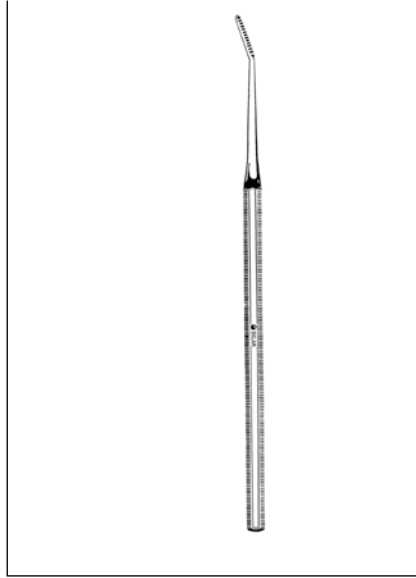

POLOKOFF RASP

SINGLE END

97-1642 6½" Medium Serrations

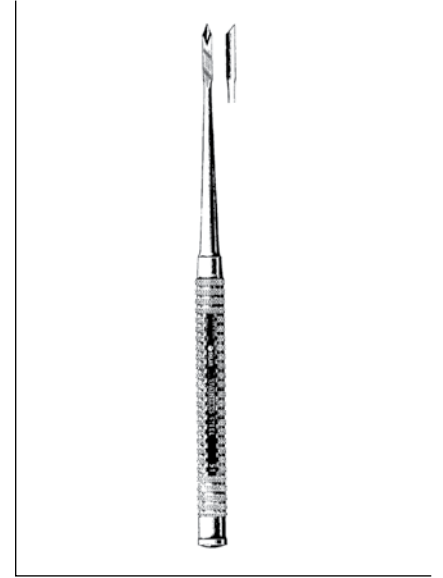

GARDNER CHISELS

43-622 #51
43-626 #52
43-634 #53
43-638 #54

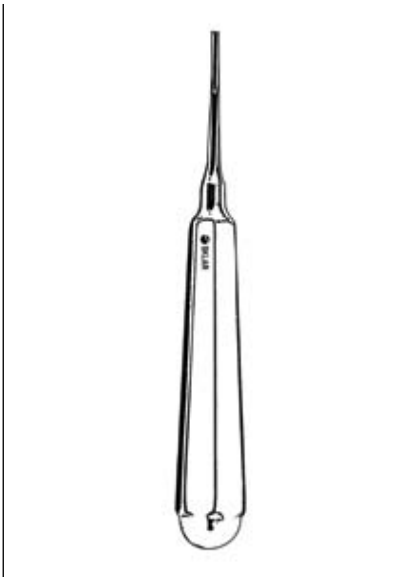

COUPLAND CHISELS

43-606 #1
43-612 #2

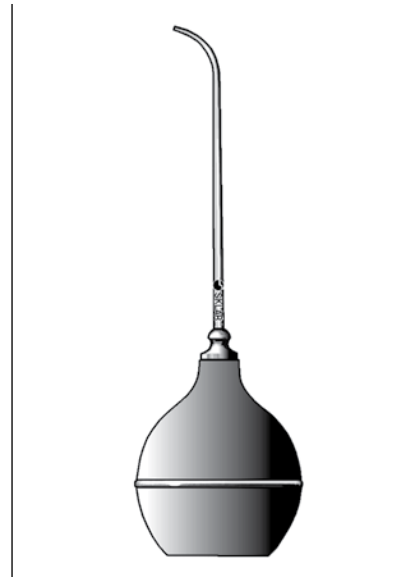

CHIP BLOWER

97-1650 Complete
97-1652 Tip Only
97-1654 Bulb Only



MOLT MOUTH GAGS

44-463 Small
48-774 Small Office Grade
44-475 Large
48-785 Large Office Grade

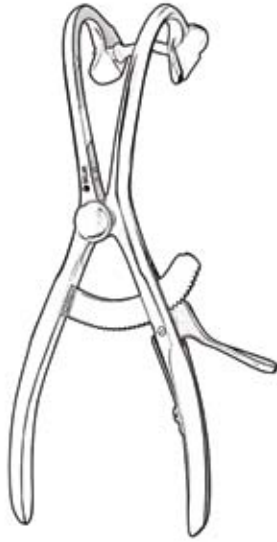

DENHARDT MOUTH GAG
75-1007



DOYEN JANSEN MOUTH GAGS (MOLT)

WITH CUSHIONS
22-8945 4" Small
75-1025 5½" Large

75-1026 Replacement Cushion for 75-1025

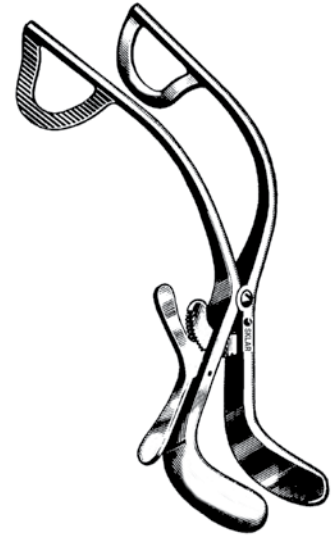

WESSON MOUTH GAG
75-1010



JENNINGS MOUTH GAGS
75-1015 Small
75-1016 Medium
75-1017 Large

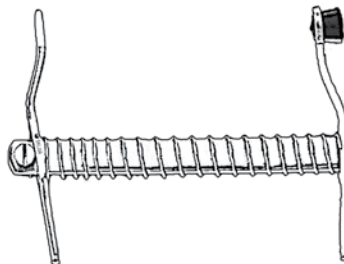

FELINE MOUTH GAG
93-8034 3" Lightweight



CANINE MOUTH GAGS
93-8038 3½" Small
93-8039 5½" Medium
93-8040 7½" Large

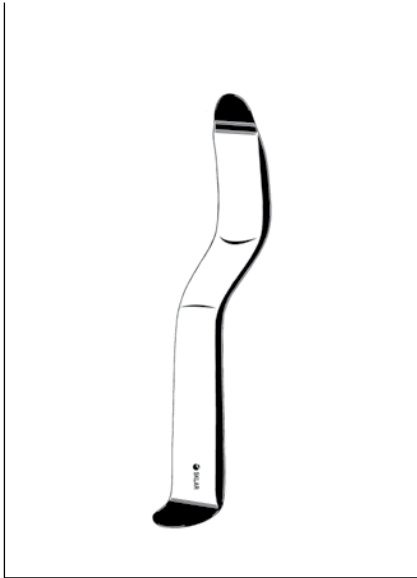

CHEEK RETRACTOR
UNIVERSITY OF MINNESOTA
 75-1120
 48-489 Office Grade

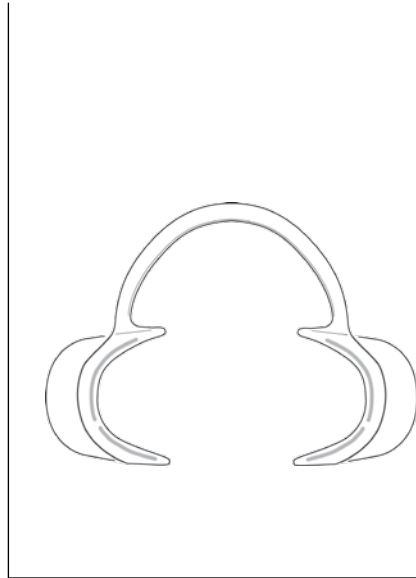

CHEEK RETRACTOR
CLEAR PLASTIC
 75-1141 Small, Set of 2
 75-1140 Large, Set of 2

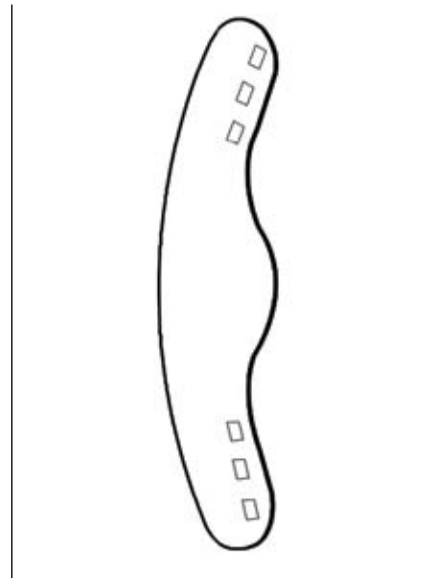

MATRIX BANDS
MOLAR, #1
 43-751 Wide
 43-752 Medium
 43-753 Narrow
 43-754 Assorted

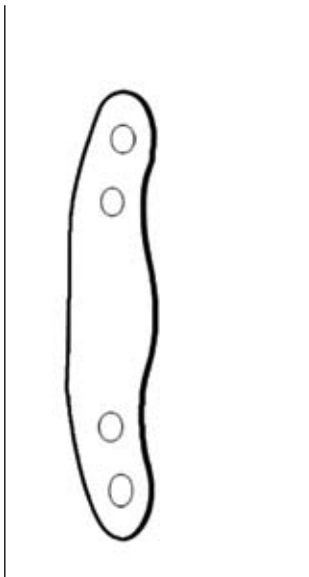

MATRIX BANDS
BICUSPID, #1
 43-755 Wide
 43-757 Narrow
 43-758 Assorted

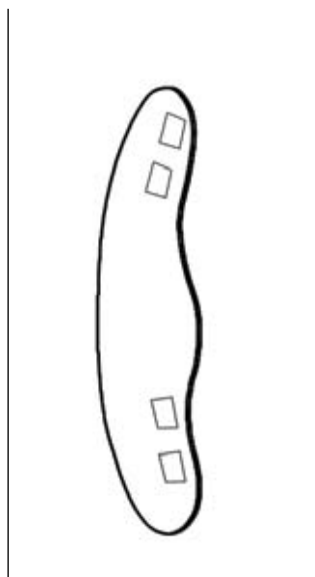

MATRIX BANDS
MOLAR/BICUSPID #1
 43-759 Assorted

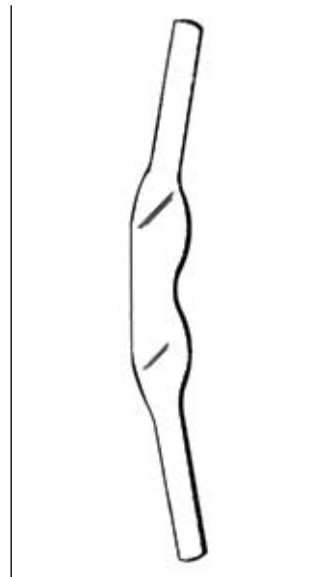

MATRIX BANDS
MOLAR, #8
 43-760 Medium
 43-761 Narrow
 43-762 Extra Narrow
 43-763 Assorted

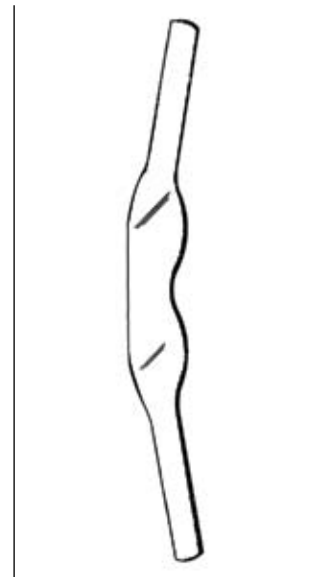

MATRIX BANDS
BICUSPID, #8
 43-767 Medium
 43-768 Narrow
 43-769 Extra Narrow

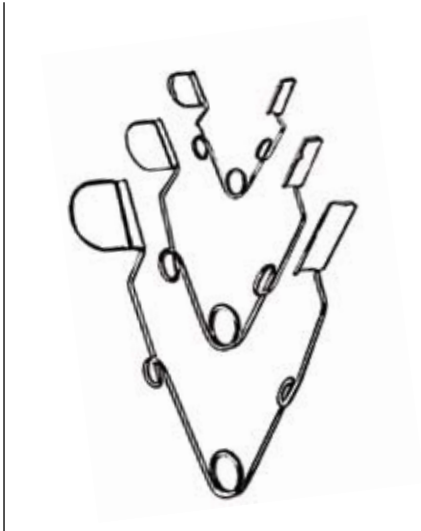

CHEEK DILATOR

- 93-8700 Extra Small, Suitable for small animals
- 93-8701 Small, Suitable for smaller animals such as Chinchillas and Guinea Pigs
- 93-8702 Large, Suitable for Larger Rabbits

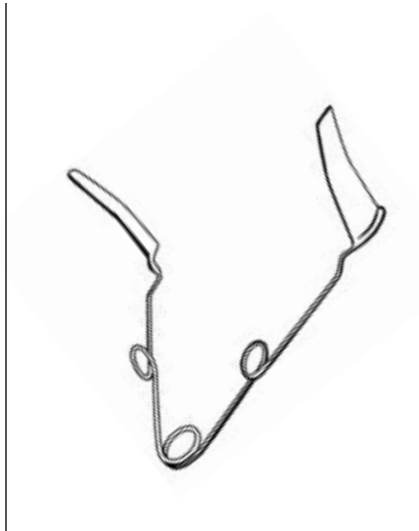

CHEEK DILATOR

- 93-8703 Large 40mm Blades for longer reach

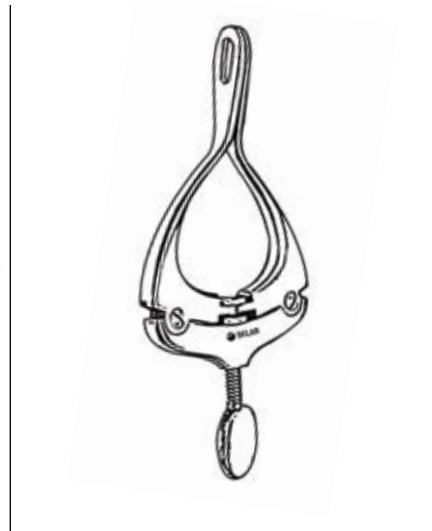

MOUTH GAG

- 93-8706 Small, Lightweight, less bulky than the standard mouth gag
- 93-8708 Large, Essential for examination of rabbit mouth

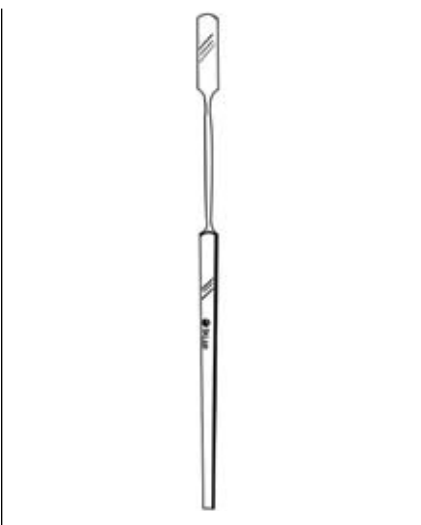

SPATULA

- 93-8715 Deflect tongue and enhance view

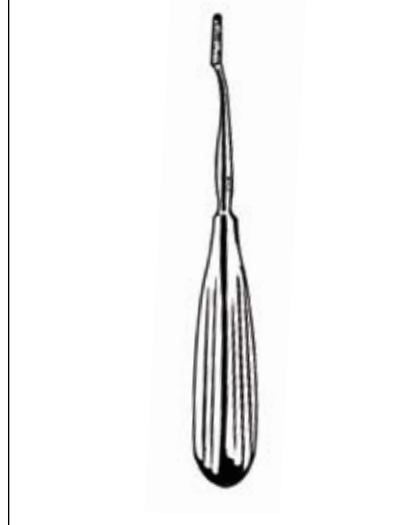

MOLAR RASP

- 93-8720 Narrow, Fine. Good for removal of small burrs. For Guinea Pigs and Chinchillas



DIAMOND MOLAR RASP

- 93-8721 Ideal material for removal of tooth spurs without damage of root structure. For Rabbits



MOLAR EXTRACTION FORCEP

93-8725 Slim and angled for improved visualization

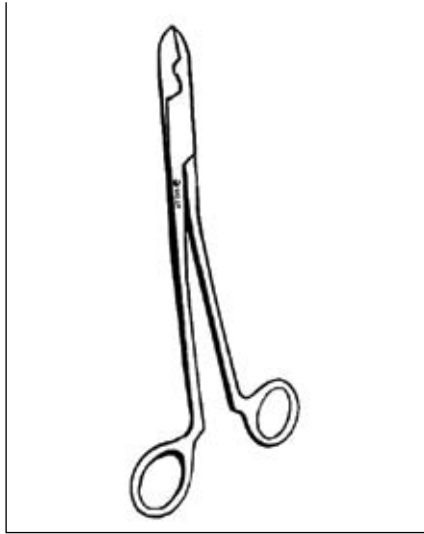

MOLAR CUTTER

93-8727 Use to debulk and trim spurs



INCISOR LUXATOR

93-8730 Especially designed for optimal extraction of rabbit incisors

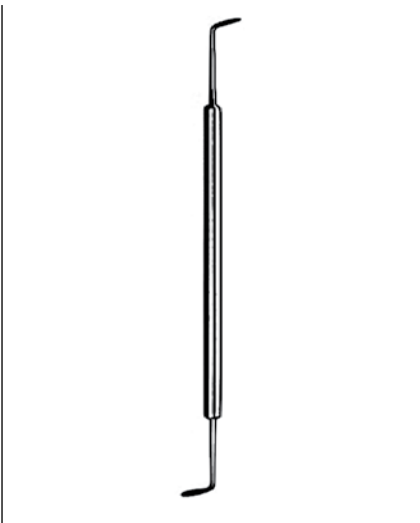

MOLAR LUXATOR

93-8732 Designed for extraction of molars with minimal damage to surrounding soft tissue



RODENT / RABBIT STARTER SET

93-8740 Standard Mouth Gag
Small Cheek Dilator
Large Cheek Dilator
Molar Extraction Forcep
Molar Cutters
Spatula
Molar Rasp
Incisor Luxator
Molar Luxator

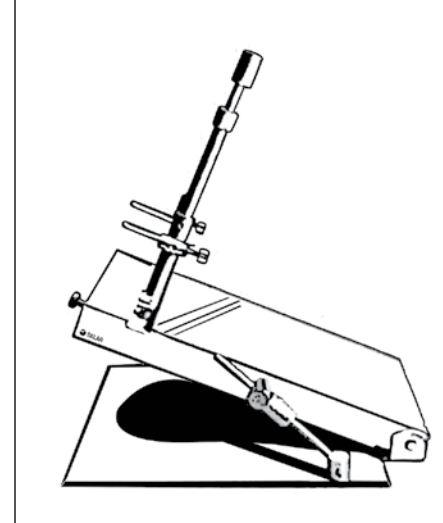

RABBIT HEAD SUPPORT

93-8735 Special device designed for hands-free dental work on rodents and rabbits. Support tilts to hold the animal's head steady while keeping the mouth open to the desired size.

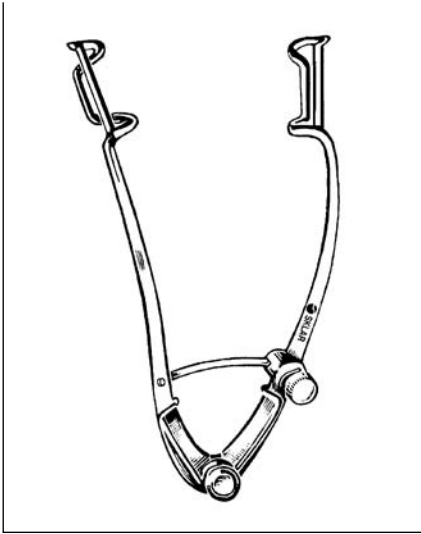

WILLIAMS SPECULUM

65-1227 2¾" Small

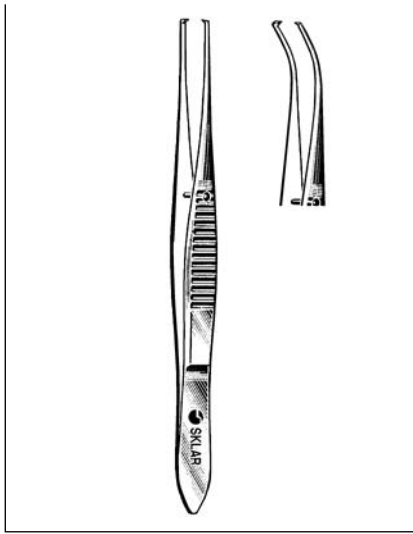

TISSUE FORCEP

1X2 TEETH, 4", 0.8MM

- 66-3340 Straight
- 66-3240 Straight, Non-Magnetic
- 66-3540 Half Curve
- 66-3740 Full Curve

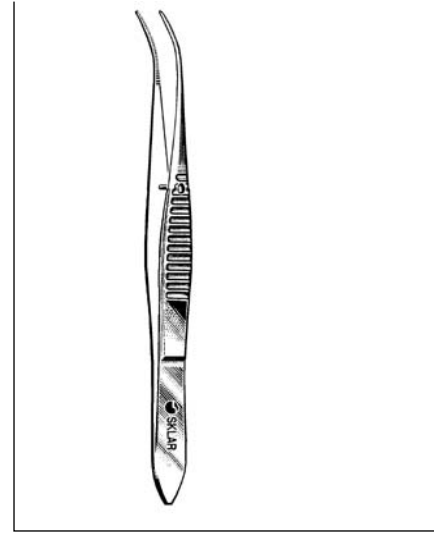

DRESSING FORCEP

SERRATED, 4", 0.8MM

- 66-2740 Straight
- 66-2840 Straight, Non-Magnetic
- 66-2940 Half Curve
- 66-3140 Full Curve

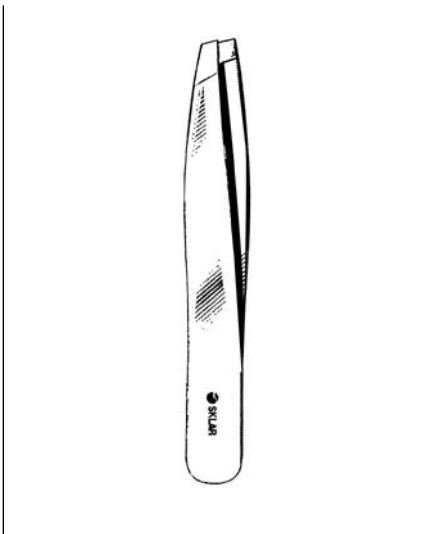

SWISS / SUTURE FORCEP

DIAGONAL JAWS

66-1740 3¾" 3mm

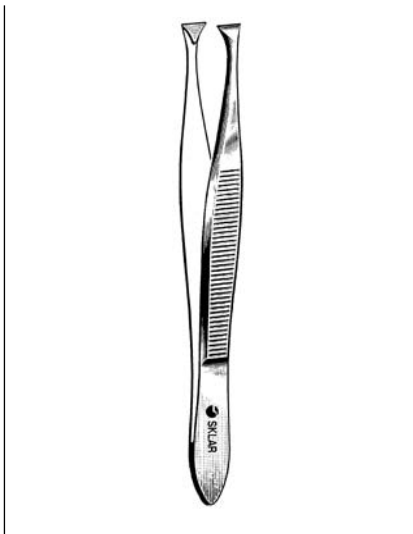

LITTAUER FORCEP

FINE HORIZONTAL SERRATIONS

65-1735 3½" 4mm

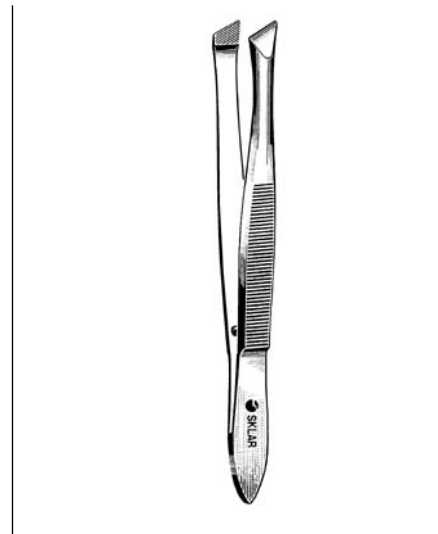

BERGH FORCEP

HORIZONTAL SERRATIONS

66-1635 3½" 5mm

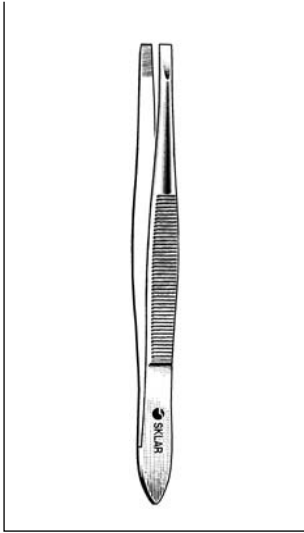

DOUGLASS FORCEP
FINE HORIZONTAL SERRATIONS
66-1830 3½" 2.5mm, Thin Tips

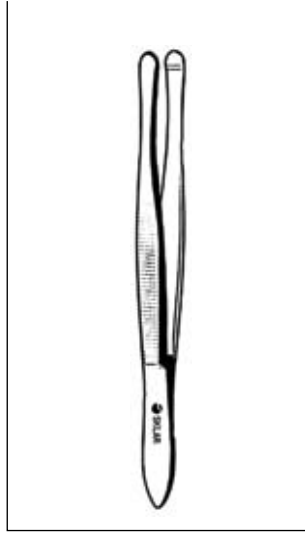

BEER FORCEP
66-1770 3½" 4mm, Smooth

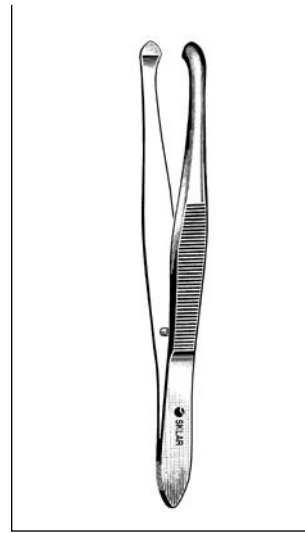

ZIEGLER FORCEP
66-1535 3½" 2mm, Smooth

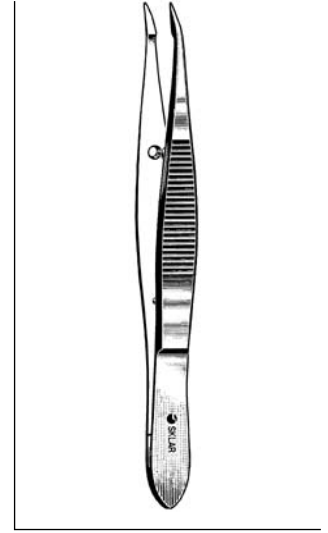

BARRAQUER FORCEP
66-1742 4¼" 5mm, Smooth

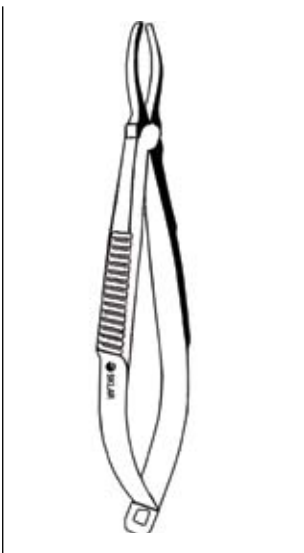

GRADLE FORCEP
PRECISION GROUND JAWS
66-1745 4"

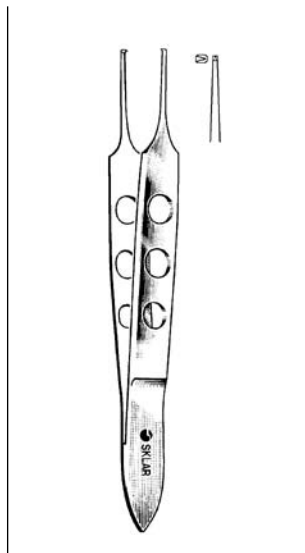

BISHOP-HARMON IRIS FORCEP
DELICATE
66-4232 3½"

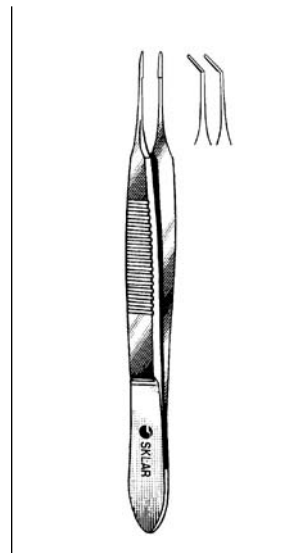

McPHERSON MICRO TYING FORCEPS
WITH TYING PLATFORM
66-6150 3¼" Straight
66-6152 4" Angled

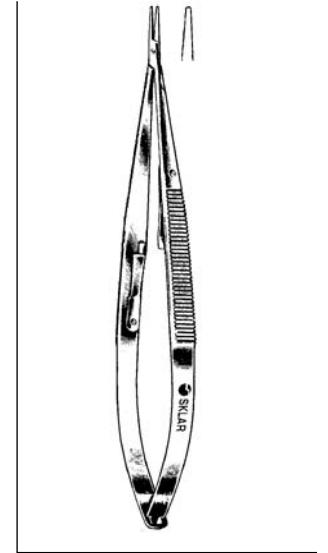

CASTROVIEJO NEEDLE HOLDER
WITH LOCK
65-6352 5½" Delicate, Smooth

ASPIRATING SYRINGE

PRODUCT NUMBER	FEATURES
62-8000	C-W Type

PETITE ASPIRATING SYRINGE

PRODUCT NUMBER	FEATURES
62-8001	C-W Type

ASPIRATING SYRINGE

PRODUCT NUMBER	FEATURES
62-8002	CW Type, Blue Silicone Grips
62-8003	CW Type, Pink Silicone Grips
62-8004	CW Type, Red Silicone Grips
62-8005	CW Type, Purple Silicone Grips

PETITE ASPIRATING SYRINGE

PRODUCT NUMBER	FEATURES
62-8006	CW Type, Blue Silicone Grips
62-8007	CW Type, Pink Silicone Grips
62-8008	CW Type, Red Silicone Grips
62-8009	CW Type, Purple Silicone Grips



NOT INTENDED FOR HUMAN USE. FOR VETERINARY APPLICATIONS ONLY.



DISSECTING SCISSORS

STRAIGHT

15-1270	4¼"	Straight
15-1273	4¼"	Curved
15-1271	5"	Straight
15-1274	5"	Curved
15-1272	5½"	Straight
15-1275	5½"	Curved

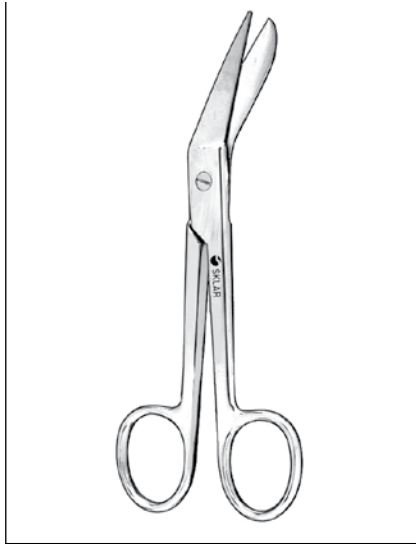

RICHTER DISSECTING SCISSOR

15-1276	5"	Angled	Sharp/Blunt
---------	----	--------	-------------

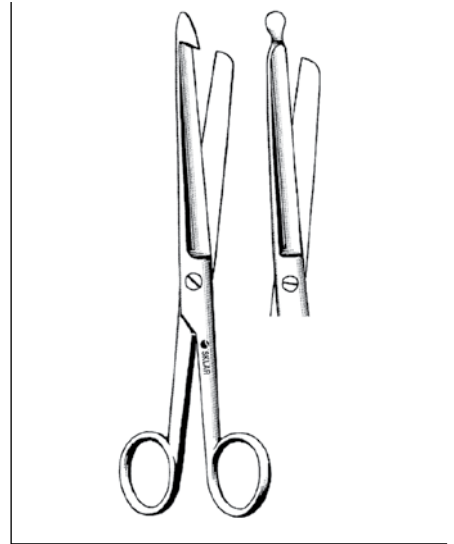

ENTEROTOME SCISSORS

15-1282	8¼"	Hook
15-1285	8¼"	Probe

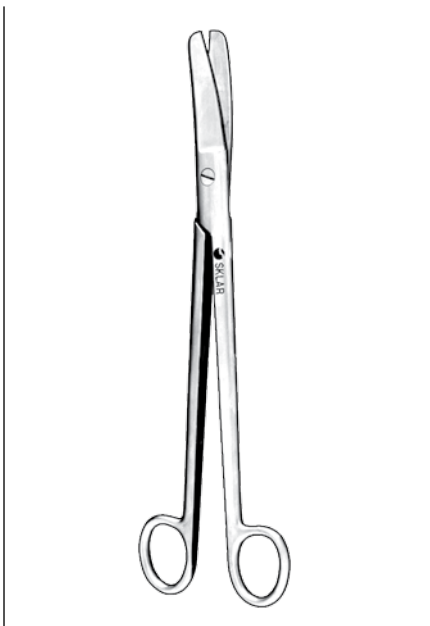

DUBOIS SCISSOR

CURVED

90-1295	10½"
---------	------

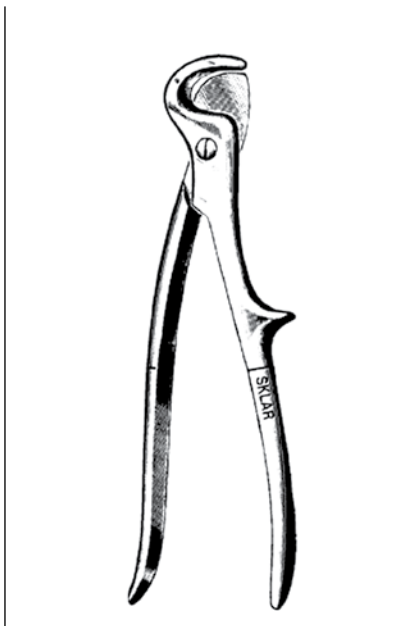

STILLE RIB SHEAR

55-1685	8½"
---------	-----

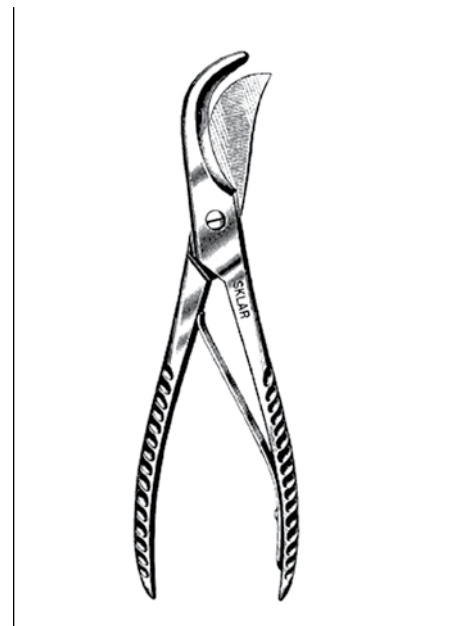

COLLINS RIB SHEAR

55-1692	9¼"
---------	-----



LISTON BONE FORCEPS

STRAIGHT

- 40-3055 5½"
- 40-3077 7¾"
- 40-3087 8¾"



VIRCHOW SKULL BREAKER

50-3060 3" Wide ½" Blade



VIRCHOW BRAIN SECTIONING KNIVES

DOUBLE EDGE

- 40-3061 6¼" ¾" Blade
- 40-3062 7¾" ¼" Blade
- 40-3063 9½" 1½" Blade



STEEL BONE Mallet WITH HOOK HANDLE

40-5910 9½"



SURGI-OR™

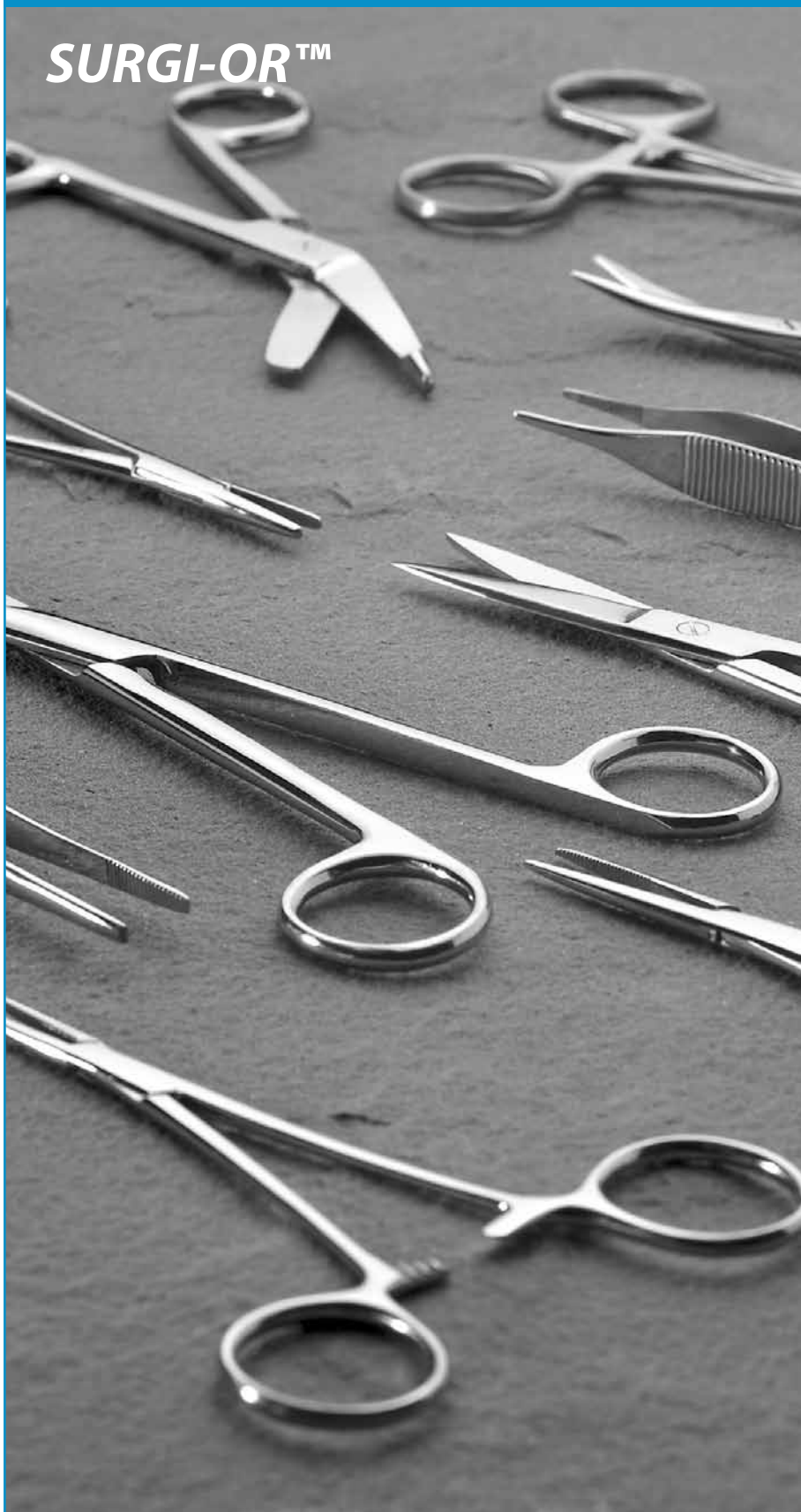

Surgi-OR™ is a full line of high-quality, Mid-Grade OR instruments, hand-crafted and forged from Japanese surgical grade stainless steel. This cost-effective line of instruments are designed to give you maximum performance at affordable cost and offers significant value to the Operating Room as well as other important surgical settings.

Sklar is pleased to offer Surgi-OR Tungsten Carbide Instruments that feature this extremely hard alloy resulting in a superior instrument.

Surgi-OR Needle Holders feature solid Tungsten Carbide insert jaws for exceptional control and unbeatable strength. These perfectly balanced instruments are readily identified by the dual gold finger rings and afford quality and performance you can trust in a variety of surgical settings.

MADE IN PAKISTAN.



TUNGSTEN CARBIDE SCISSORS

PRODUCT NUMBER	DESCRIPTION	FEATURES	LENGTH
95-124	Surgi-OR™ TC Iris Scissor	Straight, Sharp/Sharp	4½"
95-125	Surgi-OR™ TC Iris Scissor	Curved, Sharp/Sharp	4½"
95-112	Surgi-OR™ TC Mayo Dissecting Scissor	Straight	6¾"
95-113	Surgi-OR™ TC Mayo Dissecting Scissor	Curved	6¾"
95-114	Surgi-OR™ TC Metzenbaum Dissecting Scissor	Straight, Delicate	7"
95-115	Surgi-OR™ TC Metzenbaum Dissecting Scissor	Straight	7"
95-116	Surgi-OR™ TC Metzenbaum Dissecting Scissor	Curved, Delicate	7"
95-117	Surgi-OR™ TC Metzenbaum Dissecting Scissor	Curved	7"
95-118	Surgi-OR™ TC Metzenbaum Dissecting Scissor	Straight, Delicate	5¾"
95-119	Surgi-OR™ TC Metzenbaum Dissecting Scissor	Straight	5¾"
95-120	Surgi-OR™ TC Metzenbaum Dissecting Scissor	Curved, Delicate	5¾"
95-122	Surgi-OR™ TC Metzenbaum Dissecting Scissor	Curved	5¾"
95-110	Surgi-OR™ TC Operating Scissor	Straight, Sharp/Blunt	5½"
95-111	Surgi-OR™ TC Operating Scissor	Curved, Sharp/Blunt	5½"
95-126	Surgi-OR™ TC Strabismus Scissor	Straight, Blunt/Blunt	4½"
95-127	Surgi-OR™ TC Strabismus Scissor	Curved, Blunt/Blunt	4½"
95-128	Surgi-OR™ TC Wire Cutting Scissor	Angled, Serrated	4¾"

SCISSORS

PRODUCT NUMBER	DESCRIPTION	FEATURES	LENGTH
95-375	Surgi-OR™ Braun Episiotomy Scissor	Angled	5½"
95-103	Surgi-OR™ Iris Scissor	Straight	3½"
95-107	Surgi-OR™ Iris Scissor	Curved	3½"
95-104	Surgi-OR™ Iris Scissor	Straight	4½"
95-109	Surgi-OR™ Iris Scissor	Curved	4½"
95-254	Surgi-OR™ Knowles Bandage Scissor	-	5½"
95-222	Surgi-OR™ Lister Bandage Scissor	-	3½"
95-226	Surgi-OR™ Lister Bandage Scissor	-	4½"
95-231	Surgi-OR™ Lister Bandage Scissor	-	5½"
95-232	Surgi-OR™ Lister Bandage Scissor	With Pocket Clip	5½"
95-232B	Surgi-OR™ Lister Bandage Scissor	With Pocket Clip, Blue Ring Handle	5½"
95-232P	Surgi-OR™ Lister Bandage Scissor	With Pocket Clip, Pink Ring Handle	5½"
95-241	Surgi-OR™ Lister Bandage Scissor	-	7¼"
95-243	Surgi-OR™ Lister Bandage Scissor	-	8"
95-308	Surgi-OR™ Mayo Dissecting Scissor	Straight	5½"

SCISSORS CONTINUED

PRODUCT NUMBER	DESCRIPTION	FEATURES	LENGTH
95-330	Surgi-OR™ Mayo Dissecting Scissor	Curved	5½"
95-321	Surgi-OR™ Mayo Dissecting Scissor	Straight	6¾"
95-329	Surgi-OR™ Mayo Dissecting Scissor	Straight, Serrated	6¾"
95-325	Surgi-OR™ Mayo Dissecting Scissor	Curved	6¾"
95-332	Surgi-OR™ Mayo Dissecting Scissor	Curved, Serrated	6¾"
95-327	Surgi-OR™ Mayo Dissecting Scissor	Straight	9"
95-328	Surgi-OR™ Mayo Dissecting Scissor	Curved	9"
95-335	Surgi-OR™ Metzenbaum Dissecting Scissor	Straight	5¾"
95-336	Surgi-OR™ Metzenbaum Dissecting Scissor	Curved	5¾"
95-339	Surgi-OR™ Metzenbaum Dissecting Scissor	Straight	7"
95-340	Surgi-OR™ Metzenbaum Dissecting Scissor	Curved	7"
95-354	Surgi-OR™ Metzenbaum Dissecting Scissor	Straight	9"
95-356	Surgi-OR™ Metzenbaum Dissecting Scissor	Curved	9"
95-265	Surgi-OR™ Operating Scissor	Straight, Sharp/Blunt	4½"
95-266	Surgi-OR™ Operating Scissor	Straight, Sharp/Sharp	4½"
95-294	Surgi-OR™ Operating Scissor	Curved, Sharp/Sharp	4½"
95-278	Surgi-OR™ Operating Scissor	Straight, Blunt/Blunt	5½"
95-299	Surgi-OR™ Operating Scissor	Curved, Blunt/Blunt	5½"
95-272	Surgi-OR™ Operating Scissor	Straight, Sharp/Blunt	5½"
95-292	Surgi-OR™ Operating Scissor	Curved, Sharp/Blunt	5½"
95-275	Surgi-OR™ Operating Scissor	Straight, Sharp/Sharp	5½"
95-295	Surgi-OR™ Operating Scissor	Curved, Sharp/Sharp	5½"
95-281	Surgi-OR™ Operating Scissor	Straight, Sharp/Blunt	6½"
95-284	Surgi-OR™ Operating Scissor	Straight, Sharp/Sharp	6½"
95-160	Surgi-OR™ Stevens Tenotomy Scissor	Straight, Blunt/Blunt	4⅛"
95-161	Surgi-OR™ Stevens Tenotomy Scissor	Curved, Blunt/Blunt	4⅛"
95-346	Surgi-OR™ Stitch Scissor	Spencer	3½"
95-352	Surgi-OR™ Stitch Scissor	Spencer	4½"
95-358	Surgi-OR™ Stitch Scissor	Littauer	5½"
95-360	Surgi-OR™ Strabismus Scissor	Straight	4½"
95-361	Surgi-OR™ Strabismus Scissor	Curved	4½"
95-369	Surgi-OR™ Suture Scissor	Shortbent	3½"
95-100	Surgi-OR™ Utility Scissor	Serrated	6"
95-105	Surgi-OR™ Utility Shears	Serrated, Black Handles	7½"
95-364	Surgi-OR™ Wire Cutting Scissor	Angled, Serrated	4¾"



DRESSING AND TISSUE FORCEPS

PRODUCT NUMBER	DESCRIPTION	FEATURES	LENGTH
95-188	Surgi-OR™ Adson Bayonet Forcep	Delicate	7½"
95-778	Surgi-OR™ Adson Brown Tissue Forcep	Side Grasping, 7x7 Teeth	4¾"
95-771	Surgi-OR™ Adson Dressing Forcep	Serrated	4¾"
95-772	Surgi-OR™ Adson Dressing Forcep	Serrated, Delicate	4¾"
95-775	Surgi-OR™ Adson Tissue Forcep	1x2 Teeth	4¾"
95-776	Surgi-OR™ Adson Tissue Forcep	1x2 Teeth, Delicate	4¾"
95-705	Surgi-OR™ Dressing Forcep	Serrated	4½"
95-710	Surgi-OR™ Dressing Forcep	Serrated	5"
95-727	Surgi-OR™ Dressing Forcep	Serrated	5½"
95-731	Surgi-OR™ Dressing Forcep	Serrated	6"
95-736	Surgi-OR™ Dressing Forcep	Serrated	8"
95-742	Surgi-OR™ Dressing Forcep	Serrated	10"
95-449	Surgi-OR™ Ferris Smith Tissue Forcep	1x2 Teeth	7"
95-605	Surgi-OR™ Jansen Nasal Forcep	Bayonet	6½"
95-182	Surgi-OR™ Lucae Forcep	Bayonet, Serrated	5½"
95-777	Surgi-OR™ Plain Splinter Forcep	Serrated	3½"
95-781	Surgi-OR™ Plain Splinter Forcep	Serrated	4½"
95-604	Surgi-OR™ Russian Tissue Forcep	-	6"
95-607	Surgi-OR™ Russian Tissue Forcep	-	8"
95-790	Surgi-OR™ Splinter Forcep	Fine Point	4"
95-753	Surgi-OR™ Tissue Forcep	1x2 Teeth	4½"
95-757	Surgi-OR™ Tissue Forcep	1x2 Teeth	5"
95-762	Surgi-OR™ Tissue Forcep	1x2 Teeth	5½"
95-766	Surgi-OR™ Tissue Forcep	1x2 Teeth	6"
95-770	Surgi-OR™ Tissue Forcep	1x2 Teeth	8"
95-774	Surgi-OR™ Tissue Forcep	1x2 Teeth	10"

RING FORCEPS

PRODUCT NUMBER	DESCRIPTION	FEATURES	LENGTH
95-934	Surgi-OR™ Allis Tissue Forcep	5x6 Teeth	6"
95-938	Surgi-OR™ Allis Tissue Forcep	5x6 Teeth	7½"
95-930	Surgi-OR™ Allis Tissue Forcep	4x5 Teeth	6"
95-952	Surgi-OR™ Babcock Grasping Forcep		6¼"
95-956	Surgi-OR™ Babcock Grasping Forcep		8"
95-374	Surgi-OR™ Bozeman Uterine Dressing Forcep	S-Curve	10¼"
95-447	Surgi-OR™ Crile Forcep	Straight	5½"
95-452	Surgi-OR™ Crile Forcep	Curved	5½"

RING FORCEPS CONTINUED

PRODUCT NUMBER	DESCRIPTION	FEATURES	LENGTH
95-458	Surgi-OR™ Crile Forcep	Straight	6¼"
95-463	Surgi-OR™ Crile Forcep	Curved	6¼"
95-456	Surgi-OR™ Dunaway Dissecting Forcep	Straight, With Bead Tip	4"
95-466	Surgi-OR™ Dunaway Dissecting Forcep	Straight, With Bead Tip	6"
95-467	Surgi-OR™ Dunaway Dissecting Forcep	Curved, With Bead Tip	6"
95-571	Surgi-OR™ Foerster Sponge Forcep	Straight, Serrated	7"
95-577	Surgi-OR™ Foerster Sponge Forcep	Straight, Serrated	9½"
95-586	Surgi-OR™ Foerster Sponge Forcep	Curved, Serrated	9½"
95-426	Surgi-OR™ Halsted Mosquito Forcep	Straight	5"
95-431	Surgi-OR™ Halsted Mosquito Forcep	Curved	5"
95-409	Surgi-OR™ Hartmann Mosquito Forcep	Straight	3½"
95-421	Surgi-OR™ Hartmann Mosquito Forcep	Curved	3½"
95-436	Surgi-OR™ Kelly Forcep	Straight	5½"
95-442	Surgi-OR™ Kelly Forcep	Curved	5½"
95-285	Surgi-OR™ Magill Catheter Forcep	Child	8"
95-289	Surgi-OR™ Magill Catheter Forcep	Adult	10"
95-465	Surgi-OR™ Rankin Kelly Forcep	Straight	6¼"
95-469	Surgi-OR™ Rankin Kelly Forcep	Curved	6¼"
95-500	Surgi-OR™ Rochester-Ochsner Forcep	Straight, 1x2 Teeth	5½"
95-501	Surgi-OR™ Rochester-Ochsner Forcep	Curved, 1x2 Teeth	5½"
95-504	Surgi-OR™ Rochester-Ochsner Forcep	Straight, 1x2 Teeth	6¼"
95-512	Surgi-OR™ Rochester-Ochsner Forcep	Curved, 1x2 Teeth	6¼"
95-521	Surgi-OR™ Rochester-Ochsner Forcep	Straight, 1x2 Teeth	7¼"
95-525	Surgi-OR™ Rochester-Ochsner Forcep	Curved, 1x2 Teeth	7¼"
95-513	Surgi-OR™ Rochester-Ochsner Forcep	Straight, 1x2 Teeth	8"
95-514	Surgi-OR™ Rochester-Ochsner Forcep	Curved, 1x2 Teeth	8"
95-515	Surgi-OR™ Rochester-Ochsner Forcep	Straight, 1x2 Teeth	9"
95-516	Surgi-OR™ Rochester-Ochsner Forcep	Curved, 1x2 Teeth	9"
95-517	Surgi-OR™ Rochester-Ochsner Forcep	Straight, 1x2 Teeth	10"
95-518	Surgi-OR™ Rochester-Ochsner Forcep	Curved, 1x2 Teeth	10"
95-470	Surgi-OR™ Rochester-Pean Forcep	Straight	5½"
95-471	Surgi-OR™ Rochester-Pean Forcep	Curved	5½"
95-473	Surgi-OR™ Rochester-Pean Forcep	Straight	6¼"
95-477	Surgi-OR™ Rochester-Pean Forcep	Curved	6¼"
95-481	Surgi-OR™ Rochester-Pean Forcep	Straight	7¼"



RING FORCEPS CONTINUED

PRODUCT NUMBER	DESCRIPTION	FEATURES	LENGTH
95-485	Surgi-OR™ Rochester-Pean Forcep	Curved	7¼"
95-492	Surgi-OR™ Rochester-Pean Forcep	Straight	8"
95-498	Surgi-OR™ Rochester-Pean Forcep	Curved	8"
95-483	Surgi-OR™ Rochester-Pean Forcep	Straight	9"
95-487	Surgi-OR™ Rochester-Pean Forcep	Curved	9"
95-494	Surgi-OR™ Rochester-Pean Forcep	Straight	10¼"
95-496	Surgi-OR™ Rochester-Pean Forcep	Curved	10¼"
95-434	Surgi-OR™ Schnidt Tonsil Forcep	Half Curved	7½"
95-386	Surgi-OR™ Schroeder Tenaculum Forcep	Straight	9½"
95-459	Surgi-OR™ Schroeder Tenaculum Forcep	Straight	10¼"
95-437	Surgi-OR™ Schweizer Forcep	Straight	9½"

CLAMPS

PRODUCT NUMBER	DESCRIPTION	FEATURES	LENGTH
95-606	Surgi-OR™ Backhaus Towel Clamp	-	3½"
95-611	Surgi-OR™ Backhaus Towel Clamp	-	5¼"
95-629	Surgi-OR™ Lorna Edna Towel Clamp	Non-Perforating	3½"
95-635	Surgi-OR™ Lorna Edna Towel Clamp	Non-Perforating	5¼"
95-592	Surgi-OR™ Presbyterian Tube Occluding Clamp	Straight, Smooth	7"

TUNGSTEN CARBIDE NEEDLE HOLDERS

PRODUCT NUMBER	DESCRIPTION	FEATURES	LENGTH
95-135	Surgi-OR™ TC Baumgartner Needle Holder	Serrated	5¼"
95-137	Surgi-OR™ TC Crile-Wood Needle Holder	Serrated	6"
95-138	Surgi-OR™ TC Crile-Wood Needle Holder	Serrated	7"
95-139	Surgi-OR™ TC Crile-Wood Needle Holder	Serrated	8"
95-136	Surgi-OR™ TC Derf Needle Holder	Serrated	4¾"
95-132	Surgi-OR™ TC Halsey Needle Holder	Smooth	5¼"
95-133	Surgi-OR™ TC Halsey Needle Holder	Serrated	5¼"
95-140	Surgi-OR™ TC Mayo-Hegar Needle Holder	Serrated	5¼"
95-141	Surgi-OR™ TC Mayo-Hegar Needle Holder	Serrated	6"
95-142	Surgi-OR™ TC Mayo-Hegar Needle Holder	Serrated	7"
95-143	Surgi-OR™ TC Mayo-Hegar Needle Holder	Serrated	8"
95-146	Surgi-OR™ TC Olsen-Hegar Needle Holder	Serrated, Delicate	4¾"
95-147	Surgi-OR™ TC Olsen-Hegar Needle Holder	Serrated	5½"
95-130	Surgi-OR™ TC Webster Needle Holder	Smooth	5¼"



NEEDLE HOLDERS

PRODUCT NUMBER	DESCRIPTION	FEATURES	LENGTH
95-832	Surgi-OR™ Baumgartner Needle Holder	Serrated	5¼"
95-834	Surgi-OR™ Brown Needle Holder	Round	5¼"
95-885	Surgi-OR™ Collier Needle Holder	Fenestrated	5¼"
95-826	Surgi-OR™ Derf Needle Holder	Serrated	4¾"
95-810	Surgi-OR™ Halsey Needle Holder	Smooth	5¼"
95-842	Surgi-OR™ Mayo-Hegar Needle Holder	Serrated	5¼"
95-847	Surgi-OR™ Mayo-Hegar Needle Holder	Serrated	6"
95-853	Surgi-OR™ Mayo-Hegar Needle Holder	Serrated	7"
95-869	Surgi-OR™ Mayo-Hegar Needle Holder	Serrated	8"
95-872	Surgi-OR™ Olsen-Hegar Needle Holder	Serrated	5½"
95-813	Surgi-OR™ Webster Needle Holder	Serrated	5¼"
95-809	Surgi-OR™ Webster Needle Holder	Smooth	5¼"

GYNEGOLOGY

PRODUCT NUMBER	DESCRIPTION	FEATURES	LENGTH
95-304	Surgi-OR™ Graves Vaginal Speculum	Extra Small	3" x ½"
95-303	Surgi-OR™ Graves Vaginal Speculum	Small	3" x ¾"
95-312	Surgi-OR™ Graves Vaginal Speculum	Medium	4" x 1¼"
95-324	Surgi-OR™ Graves Vaginal Speculum	Large	4½" x 1⅜"
95-322	Surgi-OR™ Graves Vaginal Speculum	Extra Large	4¾" x 1½"
95-347	Surgi-OR™ Pederson Vaginal Speculum	Small	3" x ½"
95-348	Surgi-OR™ Pederson Vaginal Speculum	Medium	4" x 7⁄8"
95-362	Surgi-OR™ Pederson Vaginal Speculum	Large	4¾" x 1"

HOOKS AND RETRACTORS

PRODUCT NUMBER	DESCRIPTION	FEATURES	LENGTH
95-390	Surgi-OR™ Joseph Hook	1 Sharp Prong	6¼"
95-392	Surgi-OR™ Joseph Hook	2 Sharp Prongs, 2mm	6¼"
95-394	Surgi-OR™ Joseph Hook	2 Sharp Prongs, 5mm	6¼"
95-365	Surgi-OR™ Senn Retractor	Double Ended, Blunt	6"
95-366	Surgi-OR™ Senn Retractor	Double Ended, Sharp	6"



DERMAL, ENT AND PODIATRY

PRODUCT NUMBER	DESCRIPTION	FEATURES	LENGTH
95-748	Surgi-OR™ Freer Elevator	Double Ended, Blunt/Sharp	7¼"
95-740	Surgi-OR™ Schamberg Comedone Extractor	Regular	-
95-741	Surgi-OR™ Schamberg Comedone Extractor	Extra Fine	-
95-743	Surgi-OR™ Schamberg Comedone Extractor	Square	-
95-797	Surgi-OR™ Spatula & Packer	Double Ended	5¾"

DIAGNOSTICS

PRODUCT NUMBER	DESCRIPTION	FEATURES	LENGTH
95-499	Surgi-OR™ Probe	With Eye	5"
95-502	Surgi-OR™ Probe	With Eye	6"
95-008	Surgi-OR™ Taylor Hammer	Small	7"
95-010	Surgi-OR™ Taylor Hammer	Large	7½"

SCALPELS

PRODUCT NUMBER	DESCRIPTION	FEATURES	LENGTH
95-033	Surgi-OR™ Scalpel Handle	#3	-
95-038	Surgi-OR™ Scalpel Handle	#4	-
95-042	Surgi-OR™ Scalpel Handle	#7	-

CUTTERS

PRODUCT NUMBER	DESCRIPTION	FEATURES	LENGTH
95-486	Surgi-OR™ Nail Nipper	Barrel Spring	4½"
95-472	Surgi-OR™ Nail Nipper	Barrel Spring	5½"
95-493	Surgi-OR™ Nail Nipper	Double Spring With Lock	5½"
95-482	Surgi-OR™ Nail Nipper	Double Spring, Concave	5½"
95-479	Surgi-OR™ Nail Splitter Forcep	English Anvil	5"



Merit™

The most cost-effective line of quality instruments from Pakistan, Merit Instruments are designed for routine surgical use in the office setting.

- All instruments are forged from surgical grade stainless steel
- Crafted in FDA registered manufacturing facilities by skilled instrument makers
- Designed to meet OR tolerances for surgical quality
- 10 year guarantee
- Same day shipment on orders received by 3:00 PM
- No charge for drop shipments
- Available and invoiced by your distributor
- Backed by Sklar Instruments for value pricing
- Custom pricing available in minutes for volume orders
- Ask about our "Bid Pricing"

SCISSORS

PRODUCT NUMBER	DESCRIPTION	FEATURES	LENGTH
97-258	Merit™ Army Gauze Scissors	-	8"
97-375	Merit™ Braun Episiotomy Scissors	Angled	5½"
98-495	Merit™ Cuticle Nail Scissors	-	3½"
98-496	Merit™ Cuticle Nail Scissors	-	4"
97-256	Merit™ Esmarch Plaster Shears	-	8"
97-121	Merit™ First Aid Shears	-	8¼"
98-110	Merit™ Gradle Eye Suture Scissors	Delicate, Curved	4¼"
98-103	Merit™ Iris Scissors	Straight	3½"
98-107	Merit™ Iris Scissors	Curved	3½"
98-104	Merit™ Iris Scissors	Straight	4½"
98-109	Merit™ Iris Scissors	Curved	4½"
97-254	Merit™ Knowles Bandage Scissors	-	5½"
97-222	Merit™ Lister Bandage Scissors	-	3½"
97-226	Merit™ Lister Bandage Scissors	-	4½"
97-205	Merit™ Lister Bandage Scissors	Chrome	4½"
97-231	Merit™ Lister Bandage Scissors	-	5½"
97-237	Merit™ Lister Bandage Scissors	With Clip	5½"
97-241	Merit™ Lister Bandage Scissors	-	7¼"
97-245	Merit™ Lister Bandage Scissors	Large Ring	8"
97-243	Merit™ Lister Bandage Scissors	-	8"
97-308	Merit™ Mayo Dissecting Scissors	Straight	5½"
97-312	Merit™ Mayo Dissecting Scissors	Curved	5½"
97-321	Merit™ Mayo Dissecting Scissors	Straight	6¾"
97-325	Merit™ Mayo Dissecting Scissors	Curved	6¾"
97-327	Merit™ Mayo Dissecting Scissors	Straight	9"
97-328	Merit™ Mayo Dissecting Scissors	Curved	9"
97-335	Merit™ Metzenbaum Dissecting Scissors	Straight	5¾"
97-336	Merit™ Metzenbaum Dissecting Scissors	Curved	5¾"
97-339	Merit™ Metzenbaum Dissecting Scissors	Straight	7"
97-340	Merit™ Metzenbaum Dissecting Scissors	Curved	7"
97-354	Merit™ Metzenbaum Dissecting Scissors	Straight	9"
97-356	Merit™ Metzenbaum Dissecting Scissors	Curved	9"
98-490	Merit™ Nail Splitting Scissors	Serrated	6½"

SCISSORS CONTINUED

PRODUCT NUMBER	DESCRIPTION	FEATURES	LENGTH
97-269	Merit™ Operating Scissors	Straight, Blunt/Blunt	4½"
97-270	Merit™ Operating Scissors	Curved, Blunt/Blunt	4½"
97-263	Merit™ Operating Scissors	Straight, Sharp/Blunt	4½"
97-291	Merit™ Operating Scissors	Curved, Sharp/Blunt	4½"
97-266	Merit™ Operating Scissors	Straight, Sharp/Sharp	4½"
97-294	Merit™ Operating Scissors	Curved, Sharp/Sharp	4½"
97-278	Merit™ Operating Scissors	Straight, Blunt/Blunt	5½"
97-299	Merit™ Operating Scissors	Curved, Blunt/Blunt	5½"
97-272	Merit™ Operating Scissors	Straight, Sharp/Blunt	5½"
97-292	Merit™ Operating Scissors	Curved, Sharp/Blunt	5½"
97-275	Merit™ Operating Scissors	Straight, Sharp/Sharp	5½"
97-295	Merit™ Operating Scissors	Curved, Sharp/Sharp	5½"
97-288	Merit™ Operating Scissors	Straight, Blunt/Blunt	6½"
97-300	Merit™ Operating Scissors	Curved, Blunt/Blunt	6½"
97-281	Merit™ Operating Scissors	Straight, Sharp/Blunt	6½"
97-293	Merit™ Operating Scissors	Curved, Sharp/Blunt	6½"
97-284	Merit™ Operating Scissors	Straight, Sharp/Sharp	6½"
97-297	Merit™ Operating Scissors	Curved, Sharp/Sharp	6½"
97-346	Merit™ Stitch Scissors	Spencer	3½"
97-352	Merit™ Stitch Scissors	Spencer	4½"
97-358	Merit™ Stitch Scissors	Littauer	5½"
98-160	Merit™ Stevens Tenotomy Scissors	Straight, Blunt/Blunt	4⅞"
98-161	Merit™ Stevens Tenotomy Scissors	Curved, Blunt/Blunt	4⅞"
97-360	Merit™ Strabismus Scissors	Straight	4½"
97-361	Merit™ Strabismus Scissors	Curved	4½"
97-369	Merit™ Suture Scissors	Shortbent	3½"
97-367	Merit™ Umbilical Scissors	-	4"
97-100	Merit™ Utility Scissors	Black	6"
97-105	Merit™ Utility Scissors	Black	7½"
97-107	Merit™ Utility Scissors	Blue	7½"
97-109	Merit™ Utility Scissors	Green	7½"
97-108	Merit™ Utility Scissors	Purple	7½"
97-364	Merit™ Wire Cutting Scissors	Angled, Serrated	4¾"

DRESSING & TISSUE FORCEPS

PRODUCT NUMBER	DESCRIPTION	FEATURES	LENGTH
98-188	Merit™ Adson Bayonet Forcep	Delicate	7½"
97-778	Merit™ Adson Brown Tissue Forcep	7x7 Teeth, Side Grasping	4¾"
97-771	Merit™ Adson Dressing Forcep	Serrated	4¾"
97-772	Merit™ Adson Dressing Forcep	Serrated, Delicate	4¾"
97-775	Merit™ Adson Tissue Forcep	1x2 Teeth	4¾"
97-776	Merit™ Adson Tissue Forcep	1x2 Teeth, Delicate	4¾"
98-155	Merit™ Bergh Cilia Forcep	Horizontal Serrations	3½"
97-763	Merit™ Bishop-Harmon Forcep	Serrated	3½"
97-764	Merit™ Bishop-Harmon Forcep	1x2 Teeth	3½"
97-791	Merit™ Carmalt Splinter Forcep	Straight	4½"
97-793	Merit™ Carmalt Splinter Forcep	Curved	4½"
97-705	Merit™ Dressing Forcep	Serrated	4½"
97-710	Merit™ Dressing Forcep	Serrated	5"
97-727	Merit™ Dressing Forcep	Serrated	5½"
97-731	Merit™ Dressing Forcep	Serrated	6"
97-736	Merit™ Dressing Forcep	Serrated	8"
97-742	Merit™ Dressing Forcep	Serrated	10"
97-748	Merit™ Dressing Forcep	Serrated	12"
97-784	Merit™ Feilchenfeld Forcep	-	3"
97-787	Merit™ Feilchenfeld Forcep	-	4½"
97-449	Merit™ Ferris Smith Tissue Forcep	1x2 Teeth	7"
97-751	Merit™ Graefe Tissue Forcep	Fine Teeth	4¾"
98-123	Merit™ Iris Dressing Forcep	Straight, Serrated	4"
98-142	Merit™ Iris Tissue Forcep	Straight, 1x2 Teeth	4"
98-129	Merit™ Iris Dressing Forcep	Half Curve, Serrated	4"
98-146	Merit™ Iris Tissue Forcep	Half Curve, 1x2 Teeth	4"
98-135	Merit™ Iris Dressing Forcep	Full Curve, Serrated	4"
98-151	Merit™ Iris Tissue Forcep	Full Curve, 1x2 Teeth	4"
97-605	Merit™ Jansen Nasal Forcep	Bayonet	6½"
98-276	Merit™ Michel Clip Forcep	Applying/Removing	5¼"
97-777	Merit™ Plain Splinter Forcep	Serrated	3½"
97-781	Merit™ Plain Splinter Forcep	Serrated	4½"
98-494	Merit™ Platypus Nail Forcep	Plier Handle	5¼"
97-604	Merit™ Russian Tissue Forcep	-	6"
97-607	Merit™ Russian Tissue Forcep	-	8"
97-749	Merit™ Semkin Forcep	Serrated	5"
97-747	Merit™ Semkin Forcep	1x2 Teeth	5"

DRESSING & TISSUE FORCEPS CONTINUED

PRODUCT NUMBER	DESCRIPTION	FEATURES	LENGTH
97-788	Merit™ Splinter Forcep	With Magnifier	3"
97-790	Merit™ Splinter Forcep	Fine Point	4"
97-753	Merit™ Tissue Forcep	1x2 Teeth	4½"
97-757	Merit™ Tissue Forcep	1x2 Teeth	5"
97-762	Merit™ Tissue Forcep	1x2 Teeth	5½"
97-769	Merit™ Tissue Forcep	2x3 Teeth	5½"
97-766	Merit™ Tissue Forcep	1x2 Teeth	6"
97-770	Merit™ Tissue Forcep	1x2 Teeth	8"
97-774	Merit™ Tissue Forcep	1x2 Teeth	10"
98-140	Merit™ Utility Forcep	Smooth	4"
97-795	Merit™ Virtus Splinter Forcep	Straight	6"
98-180	Merit™ Wilde Ear Forcep	Serrated	5"

RING FORCEPS

PRODUCT NUMBER	DESCRIPTION	FEATURES	LENGTH
97-930	Merit™ Allis Tissue Forcep	4x5 Teeth	6"
97-934	Merit™ Allis Tissue Forcep	5x6 Teeth	6"
97-938	Merit™ Allis Tissue Forcep	5x6 Teeth	7½"
97-952	Merit™ Babcock Grasping Forcep	-	6¼"
97-956	Merit™ Babcock Grasping Forcep	-	8"
98-374	Merit™ Bozeman Uterine Dressing Forcep	S-Curve	10¼"
97-447	Merit™ Crile Forcep	Straight	5½"
97-452	Merit™ Crile Forcep	Curved	5½"
97-458	Merit™ Crile Forcep	Straight	6¼"
97-463	Merit™ Crile Forcep	Curved	6¼"
97-561	Merit™ Doyen Intestinal Forcep	Straight	9"
97-563	Merit™ Doyen Intestinal Forcep	Curved	9"
97-571	Merit™ Foerster Sponge Forcep	Straight, Serrated	7"
97-577	Merit™ Foerster Sponge Forcep	Straight, Serrated	9½"
97-586	Merit™ Foerster Sponge Forcep	Curved, Serrated	9½"
97-426	Merit™ Halsted Mosquito Forcep	Straight	5"
97-431	Merit™ Halsted Mosquito Forcep	Curved	5"
97-409	Merit™ Hartmann Mosquito Forcep	Straight	3½"
97-421	Merit™ Hartmann Mosquito Forcep	Curved	3½"
97-546	Merit™ Jones Forcep	Straight Broad Jaw	5¼"

RING FORCEPS CONTINUED

PRODUCT NUMBER	DESCRIPTION	FEATURES	LENGTH
97-436	Merit™ Kelly Forcep	Straight	5½"
97-442	Merit™ Kelly Forcep	Curved	5½"
98-285	Merit™ Magill Catheter Forcep	Medium	8"
98-289	Merit™ Magill Catheter Forcep	Large	10"
97-465	Merit™ Rankin Kelly Forcep	Straight	6¼"
97-469	Merit™ Rankin Kelly Forcep	Curved	6¼"
97-528	Merit™ Rochester-Carmalt Forcep	Straight	6¼"
97-534	Merit™ Rochester-Carmalt Forcep	Curved	6¼"
97-537	Merit™ Rochester-Carmalt Forcep	Straight	8"
97-542	Merit™ Rochester-Carmalt Forcep	Curved	8"
97-500	Merit™ Rochester-Ochsner Forcep	Straight, 1x2 Teeth	5½"
97-501	Merit™ Rochester-Ochsner Forcep	Curved, 1x2 Teeth	5½"
97-504	Merit™ Rochester-Ochsner Forcep	Straight, 1x2 Teeth	6½"
97-512	Merit™ Rochester-Ochsner Forcep	Curved, 1x2 Teeth	6½"
97-521	Merit™ Rochester-Ochsner Forcep	Straight, 1x2 Teeth	7¼"
97-525	Merit™ Rochester-Ochsner Forcep	Curved, 1x2 Teeth	7¼"
97-513	Merit™ Rochester-Ochsner Forcep	Straight, 1x2 Teeth	8"
97-514	Merit™ Rochester-Ochsner Forcep	Curved, 1x2 Teeth	8"
97-515	Merit™ Rochester-Ochsner Forcep	Straight, 1x2 Teeth	9"
97-516	Merit™ Rochester-Ochsner Forcep	Curved, 1x2 Teeth	9"
97-517	Merit™ Rochester-Ochsner Forcep	Straight, 1x2 Teeth	10"
97-518	Merit™ Rochester-Ochsner Forcep	Curved, 1x2 Teeth	10"
97-470	Merit™ Rochester-Pean Forcep	Straight	5½"
97-471	Merit™ Rochester-Pean Forcep	Curved	5½"
97-473	Merit™ Rochester-Pean Forcep	Straight	6¼"
97-477	Merit™ Rochester-Pean Forcep	Curved	6¼"
97-481	Merit™ Rochester-Pean Forcep	Straight	7¼"
97-485	Merit™ Rochester-Pean Forcep	Curved	7¼"
97-492	Merit™ Rochester-Pean Forcep	Straight	8"
97-498	Merit™ Rochester-Pean Forcep	Curved	8"
97-483	Merit™ Rochester-Pean Forcep	Straight	9"
97-487	Merit™ Rochester-Pean Forcep	Curved	9"
97-494	Merit™ Rochester-Pean Forcep	Straight	10¼"
97-496	Merit™ Rochester-Pean Forcep	Curved	10¼"
97-434	Merit™ Schnidt Tonsil Forcep	Half Curved	7½"
98-386	Merit™ Schroeder Tenaculum Forcep	Straight	9½"
97-459	Merit™ Schroeder Tenaculum Forcep	Straight	10¼"
97-437	Merit™ Schweizer Forcep	Straight	9½"



CLAMPS

PRODUCT NUMBER	DESCRIPTION	FEATURES	LENGTH
97-606	Merit™ Backhaus Towel Clamp	-	3½"
97-611	Merit™ Backhaus Towel Clamp	-	5¼"
97-601	Merit™ Jones Towel Clamp	-	3"
97-629	Merit™ Lorna Edna Towel Clamp	Non-Perforating	3½"
97-635	Merit™ Lorna Edna Towel Clamp	Non-Perforating	5¼"
97-639	Merit™ Peers Towel Clamp	Non-Perforating	5¾"
97-592	Merit™ Presbyterian Tube Occluding Clamp	Straight, Smooth	6½"
97-623	Merit™ Roeder Towel Clamp	With Stop	5¼"
97-587	Merit™ St. Vincent Tube Occluding Forcep	-	6½"
97-599	Merit™ Sterilizer Forcep	Three Prong	8"
97-645	Merit™ Vessells Towel Clamp	Non-Perforating	4½"
97-655	Merit™ Vessells Towel Clamp	Non-Perforating	5½"
97-598	Merit™ Vorse Tubing Clamp	Serrated With Guard	6"

NEEDLE HOLDERS

PRODUCT NUMBER	DESCRIPTION	FEATURES	LENGTH
97-894	Merit™ Abbey Needle Holder	-	5"
97-832	Merit™ Baumgartner Needle Holder	-	5¼"
97-834	Merit™ Brown Needle Holder	Rounded	5¼"
97-885	Merit™ Collier Needle Holder	Fenestrated	5¼"
97-838	Merit™ Crile-Wood Needle Holder	-	6"
97-826	Merit™ Derf Needle Holder	-	4¾"
97-810	Merit™ Halsey Needle Holder	Smooth	5¼"
97-883	Merit™ Mathieu Needle Holder	-	5½"
97-842	Merit™ Mayo-Hegar Needle Holder	-	5¼"
97-847	Merit™ Mayo-Hegar Needle Holder	-	6"
97-853	Merit™ Mayo-Hegar Needle Holder	-	7"
97-869	Merit™ Mayo-Hegar Needle Holder	-	8"
97-872	Merit™ Olsen Hegar Needle Holder	-	5½"
97-877	Merit™ Olsen Hegar Needle Holder	-	6½"
97-881	Merit™ Olsen Hegar Needle Holder	-	7½"
97-813	Merit™ Webster Needle Holder	Serrated	5¼"
97-809	Merit™ Webster Needle Holder	Smooth	5¼"



GYNECOLOGY

PRODUCT NUMBER	DESCRIPTION	FEATURES	LENGTH
98-303	Merit™ Graves Vaginal Speculum	Small	3" x ¾"
98-312	Merit™ Graves Vaginal Speculum	Medium	4" x 1¼"
98-324	Merit™ Graves Vaginal Speculum	Large	4½" x 1⅜"
98-325	Merit™ Graves Vaginal Speculum	X-Large	4¾" x 1½"
98-370	Merit™ Hegar Dilators	Set of 6	-
98-336	Merit™ Pederson Vaginal Speculum	Small	3" x ½"
98-364	Merit™ Pederson Vaginal Speculum	Slender	4" x ⅝"
98-348	Merit™ Pederson Vaginal Speculum	Medium	4" x ⅞"
98-362	Merit™ Pederson Vaginal Speculum	Large	4¾" x 1"
98-366	Merit™ Pederson Vaginal Speculum	X-Long	6½" x 1½"
98-382	Merit™ Simpson Sound	Graduated in Centimeters	12½"
98-384	Merit™ Sims Uterine Sound	Plain	12½"

HOOKS, RETRACTORS & SPREADERS

PRODUCT NUMBER	DESCRIPTION	FEATURES	LENGTH
97-384	Merit™ Alm Retractor	-	2¾"
97-382	Merit™ Army Retractor	Set of 2	8"
98-179	Merit™ Cast Spreader	Three Prong	9"
97-380	Merit™ Cushing Nerve Retractor	-	8½"
97-388	Merit™ Gelpi Retractor	-	6¼"
97-390	Merit™ Joseph Hook	1 Prong Sharp	6¼"
97-392	Merit™ Joseph Hook	2 Prongs Sharp, 2mm	6¼"
97-394	Merit™ Joseph Hook	2 Prongs Sharp, 5mm	6¼"
98-178	Merit™ Plaster Spreader	-	11"
97-365	Merit™ Senn Retractor	Double End, Blunt	6¼"
97-366	Merit™ Senn Retractor	Double End, Sharp	6¼"
98-521	Merit™ Snook Hook	-	8"
97-391	Merit™ Tyrell Hook	Sharp	5"
97-371	Merit™ Weitlaner Retractor	2x3 Teeth, Blunt	4"
97-370	Merit™ Weitlaner Retractor	2x3 Teeth, Sharp	4"
97-373	Merit™ Weitlaner Retractor	3x4 Teeth, Blunt	5½"
97-372	Merit™ Weitlaner Retractor	3x4 Teeth, Sharp	5½"
97-376	Merit™ Weitlaner Retractor	3x4 Teeth, Blunt	6½"

DERMAL

PRODUCT NUMBER	DESCRIPTION	FEATURES	LENGTH
98-755	Merit™ Comedone Extractor	Spear Point	-
98-413	Merit™ Fox Dermal Curette	#1, 3mm	5½"
98-414	Merit™ Fox Dermal Curette	#2, 4mm	5½"
98-415	Merit™ Fox Dermal Curette	#3, 5mm	5½"
98-416	Merit™ Fox Dermal Curette	#4, 6mm	5½"
98-402	Merit™ Keyes Cutaneous Punch	2mm	4"
98-403	Merit™ Keyes Cutaneous Punch	3mm	4"
98-404	Merit™ Keyes Cutaneous Punch	4mm	4"
98-405	Merit™ Keyes Cutaneous Punch	5mm	4"
98-406	Merit™ Keyes Cutaneous Punch	6mm	4"
98-425	Merit™ Ring Cutter	-	-
98-426	Merit™ Ring Cutter Blade	Replacement Blade for 98-425	-
98-740	Merit™ Shamberg Comedone Extractor	Regular	3¾"
98-741	Merit™ Shamberg Comedone Extractor	Fine	3¾"
98-742	Merit™ Shamberg Comedone Extractor	Square	3¾"
97-545	Merit™ Splinter Liberator	With Reversible Handle	-
97-799	Merit™ Splinter Removal Kit	4½" Carmalt Forcep, Liberator and Case	-
98-750	Merit™ Unna Comedone	Double End	-

PODIATRY

PRODUCT NUMBER	DESCRIPTION	FEATURES	LENGTH
98-503	Merit™ Curette Excavator	Single End, 1mm	5"
98-505	Merit™ Curette Excavator	Double End, 1mm and 2mm	6"
98-508	Merit™ Probe & Excavator	Double End	6"
98-797	Merit™ Spatula And Packer	Double End	-

DIAGNOSTIC

PRODUCT NUMBER	DESCRIPTION	FEATURES	LENGTH
97-014	Merit™ Babinski Percussion Hammer	Chrome	9"
97-021	Merit™ Buck Neuro Hammer	Chrome	7"
98-200	Merit™ Dental Probe	-	-
97-020	Merit™ EKG Caliper	-	4"
97-902	Merit™ Grooved Director	Probe End & Tongue Tie	6"
98-499	Merit™ Probe	With Eye	5"
98-502	Merit™ Probe	With Eye	6"
97-012	Merit™ Rabiner Neuro Hammer	Chrome	9"
97-008	Merit™ Taylor Hammer	Small	7"
97-010	Merit™ Taylor Hammer	Large	7½"
97-029	Merit™ Wartenberg Pinwheel	Chrome	-

ENT

PRODUCT NUMBER	DESCRIPTION	FEATURES	LENGTH
98-170	Merit™ Buck Ear Curette	Size 00, Blunt, Straight	-
98-162	Merit™ Buck Ear Curette	Size 00, Blunt, Angled	-
98-171	Merit™ Buck Ear Curette	Size 0, Blunt, Straight	-
98-164	Merit™ Buck Ear Curette	Size 0, Blunt, Angled	-
98-172	Merit™ Buck Ear Curette	Size 1, Blunt, Straight	-
98-165	Merit™ Buck Ear Curette	Size 1, Blunt, Angled	-
98-173	Merit™ Buck Ear Curette	Size 2, Blunt, Straight	-
98-166	Merit™ Buck Ear Curette	Size 2, Blunt, Angled	-
98-174	Merit™ Buck Ear Curette	Size 3, Blunt, Straight	-
98-167	Merit™ Buck Ear Curette	Size 3, Blunt, Angled	-
98-243	Merit™ Ear Syringe	Chrome, 2oz. With Tips and Shield	-
98-247	Merit™ Ear Syringe	Chrome, 3oz. With Tips and Shield	-
98-251	Merit™ Ear Syringe	Chrome, 4oz. With Tips and Shield	-
97-913	Merit™ Ear Syringe	Chrome, 4oz. Without Tips and Shield	-
98-257	Merit™ Ear Syringe Shield	Chrome	-
98-255	Merit™ Ear Syringe Tip	Chrome, Bulbous Tip	-
98-256	Merit™ Ear Syringe Tip	Chrome, Conical Tip	-
98-748	Merit™ Freer Elevator	Double End, Sharp/Blunt	7¼"
98-253	Merit™ Gruber Ear Speculum	Set of 3	-
98-209	Merit™ Hartmann Alligator Forcep	Serrated	3½"
98-224	Merit™ Hartmann Alligator Forcep	Serrated	5½"
98-232	Merit™ Hartmann Alligator Forcep	Serrated	6½"
98-252	Merit™ Knapp Eye Speculum	-	-



ENT CONTINUED

PRODUCT NUMBER	DESCRIPTION	FEATURES	LENGTH
98-182	Merit™ Lucae Forcep	Delicate, Bayonet	5½"
98-234	Merit™ Micro Alligator Forcep	1.0mm Cup	2¾"
98-236	Merit™ Micro Alligator Forcep	1.5mm Cup	2¾"
98-239	Merit™ Micro Alligator Forcep	Serrated	2¾"
98-268	Merit™ Vienna Nasal Speculum	Small	5¾"
98-267	Merit™ Vienna Nasal Speculum	Medium	5¾"
98-258	Merit™ Vienna Nasal Speculum	Large	5¾"

SCALPELS

PRODUCT NUMBER	DESCRIPTION	FEATURES	LENGTH
97-033	Merit™ Scalpel Handle	#3	-
97-038	Merit™ Scalpel Handle	#4	-
97-042	Merit™ Scalpel Handle	#7	-

CUTTERS

PRODUCT NUMBER	DESCRIPTION	FEATURES	LENGTH
98-201	Merit™ Kern Bone Forcep	With Ratchet	6½"
98-207	Merit™ Kern Bone Forcep	With Ratchet	9½"
98-211	Merit™ Liston Bone Cutting Forcep	Straight	5½"
98-475	Merit™ Littauer Cutting Forcep	Straight Back	4"
98-476	Merit™ Littauer Cutting Forcep	Straight Back	4½"
98-477	Merit™ Littauer Cutting Forcep	Straight Back	5"
98-478	Merit™ Littauer Cutting Forcep	Straight Back	6"
98-485	Merit™ Nail Nipper	Concave, Barrel Spring	4½"
98-472	Merit™ Nail Nipper	Concave, Barrel Spring	5½"
98-484	Merit™ Nail Nipper	Concave, Angled	5½"
98-482	Merit™ Nail Nipper	Concave With Lock	5½"
98-480	Merit™ Nail Nipper	Straight With Lock	5½"
98-493	Merit™ Nail Nipper	Double Spring With Lock	5½"
98-492	Merit™ Nail Splitter Forcep	English Anvil	5"
98-489	Merit™ Tissue Nipper	Convex Blade	4½"



Econo™ Sterile Instruments

Econo™ Sterile instruments are suitable in a number of surgical venues where economical choice with reliable performance is most important.

- Combines high quality with low cost
- Saves labor costs
- Convenient & Safe
- Eliminates costly cleaning, processing and sterilization
- Sterile one-time use

CALL FOR PRICE QUOTES

MADE IN PAKISTAN.



OPERATING SCISSORS

STRAIGHT

- 96-2597 4½" Sharp/Blunt 25/cs
- 96-2592 4½" Sharp/Sharp 25/cs
- 96-2521 5½" Sharp/Blunt 25/cs
- 96-2523 5½" Sharp/Sharp 25/cs
- 96-2728 4½" Sharp/Blunt 50/cs
- 96-2593 4½" Sharp/Sharp 50/cs

- 96-2514 5½" Blunt/Blunt 50/cs
- 96-2520 5½" Sharp/Blunt 50/cs
- 96-2522 5½" Sharp/Sharp 50/cs
- 96-2726 6½" Sharp/Blunt 50/cs
- 96-2649 5½" Sharp/Blunt 100/cs

OPERATING SCISSORS

CURVED

- 96-2526 5½" Sharp/Blunt 25/cs
- 96-2527 5½" Sharp/Sharp 25/cs
- 96-2524 5½" Sharp/Blunt 50/cs
- 96-2525 5½" Sharp/Sharp 50/cs

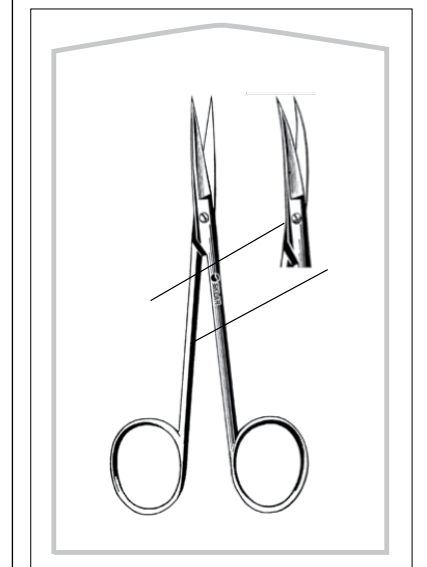
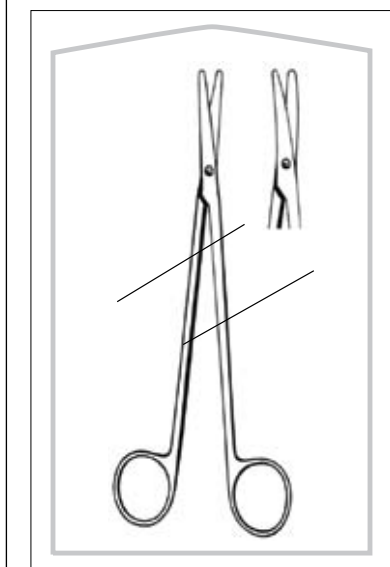
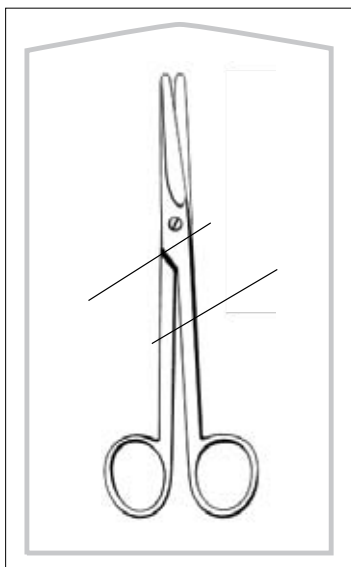

MAYO SCISSORS

- 96-2531 5½" Straight 25/cs
- 96-2530 5½" Straight 50/cs

METZENBAUM SCISSORS

- 96-2517 5½" Straight 25/cs
- 96-2720 5½" Curved 25/cs
- 96-2682 7" Curved 25/cs
- 96-2516 5½" Straight 50/cs
- 96-2721 5½" Curved 50/cs
- 96-2680 7" Curved 50/cs

IRIS SCISSORS

- 96-2505 4½" Straight 25/cs
- 96-2507 4½" Curved 25/cs
- 96-2497 3½" Straight 50/cs
- 96-2499 3½" Curved 50/cs
- 96-2504 4½" Straight 50/cs
- 96-2506 4½" Curved 50/cs
- 96-2650 4½" Straight 100/cs
- 96-2651 4½" Curved 100/cs

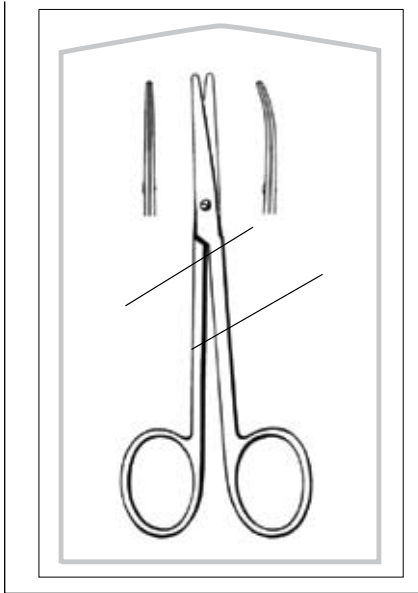

STRABISMUS SCISSORS

- 96-2542 4½" Straight 25/cs
- 96-2543 4½" Curved 25/cs
- 96-2540 4½" Straight 50/cs
- 96-2541 4½" Curved 50/cs

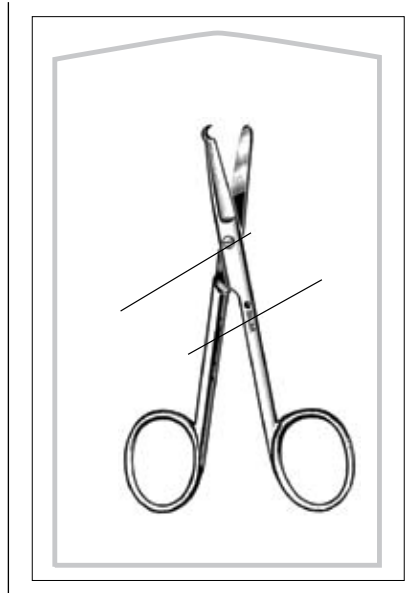

SPENCER STITCH SCISSORS

- 96-2598 4½" 25/cs
- 96-2672 3½" 50/cs
- 96-2596 4½" 50/cs

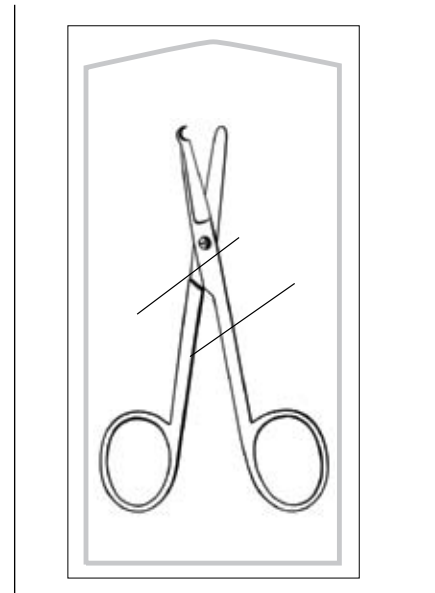

LITTAUER SUTURE SCISSORS

- 96-2511 3½" 25/cs
- 96-2513 5½" 25/cs
- 96-2510 3½" 50/cs
- 96-2512 5½" 50/cs
- 96-2663 3½" 100/cs
- 96-2662 5½" 100/cs

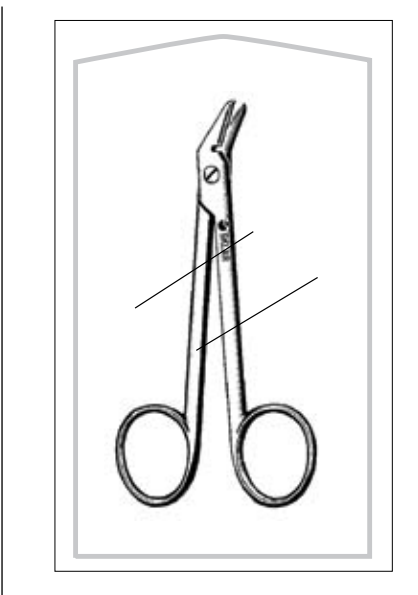

WIRE CUTTING SCISSORS

- 96-2519 4¾" Angled 25/cs
- 96-2518 4¾" Angled 50/cs

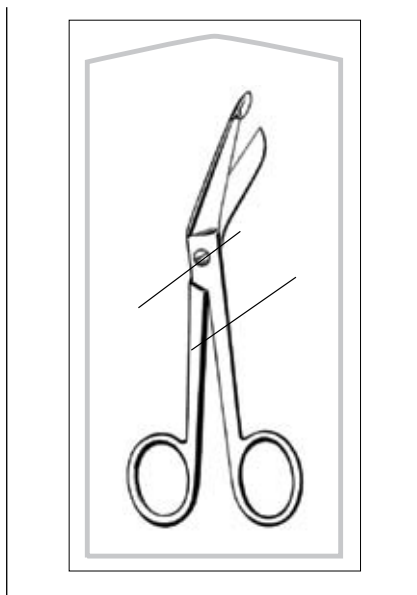

LISTER BANDAGE SCISSORS

- 96-2503 5½" 25/cs
- 96-2501 4½" 50/cs
- 96-2502 5½" 50/cs
- 96-2654 5½" 100/cs

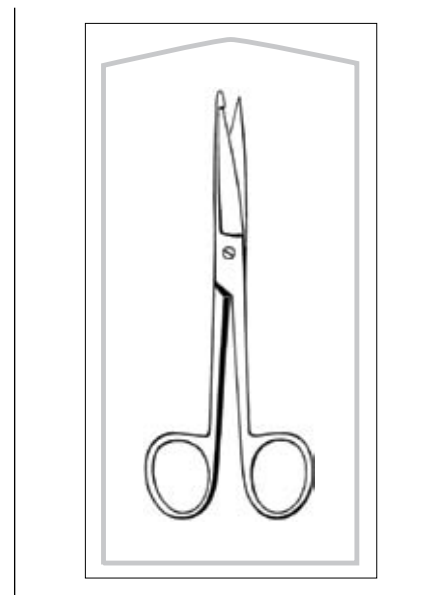

KNOWLES BANDAGE SCISSORS

- 96-2404 5½" 25/cs
- 96-2402 5½" 50/cs

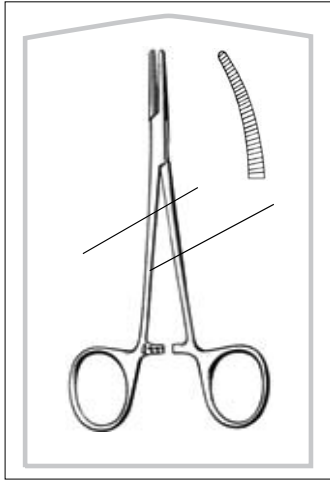

HALSTEAD FORCEPS

96-2537	5"	Straight	25/cs
96-2539	5"	Curved	25/cs
96-2536	5"	Straight	50/cs
96-2538	5"	Curved	50/cs
96-2657	5"	Straight	100/cs
96-2658	5"	Curved	100/cs

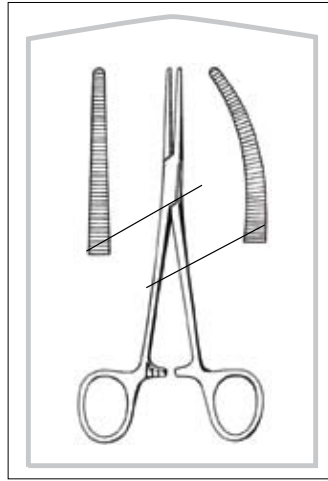

CRILE FORCEPS

96-2551	5½"	Straight	25/cs
96-2553	5½"	Curved	25/cs
96-2550	5½"	Straight	50/cs
96-2552	5½"	Curved	50/cs

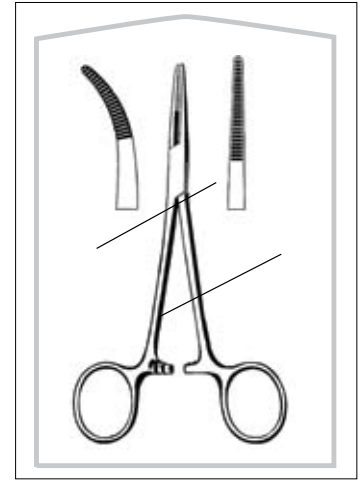

KELLY FORCEPS

96-2561	5½"	Straight	25/cs
96-2563	5½"	Curved	25/cs
96-2560	5½"	Straight	50/cs
96-2562	5½"	Curved	50/cs
96-2652	5½"	Straight	100/cs
96-2653	5½"	Curved	100/cs

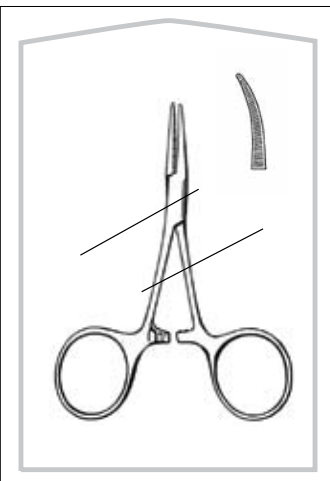

HARTMANN FORCEPS

96-2556	3½"	Straight	25/cs
96-2557	3½"	Curved	25/cs
96-2554	3½"	Straight	50/cs
96-2555	3½"	Curved	50/cs

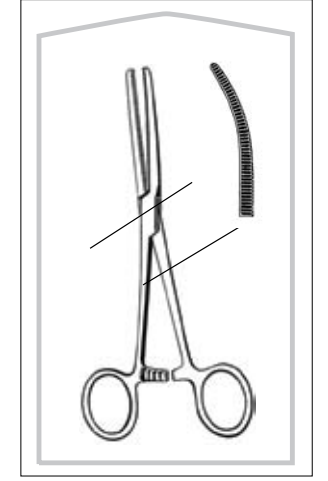

ROCHESTER PEAN FORCEPS

96-2545	6¼"	Straight	25/cs
96-2547	6¼"	Curved	25/cs
96-3006	7¼"	Straight	25/cs
96-3008	7¼"	Curved	25/cs
96-2548	8½"	Curved	25/cs
96-2544	6¼"	Straight	50/cs
96-2546	6¼"	Curved	50/cs
96-2549	8½"	Curved	50/cs
96-2664	8½"	Curved	100/cs

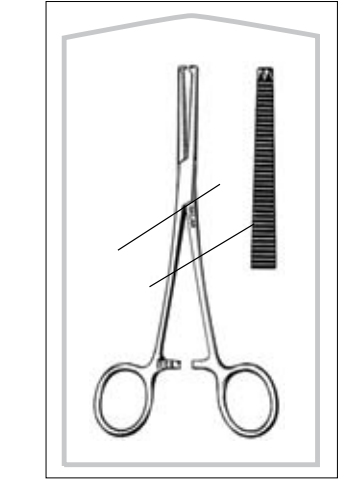

ROCHESTER-OSHSNER FORCEPS

96-2566	6¼"	Straight	25/cs
96-2567	6¼"	Curved	25/cs
96-2707	6¼"	Straight	50/cs
96-2708	6¼"	Curved	50/cs

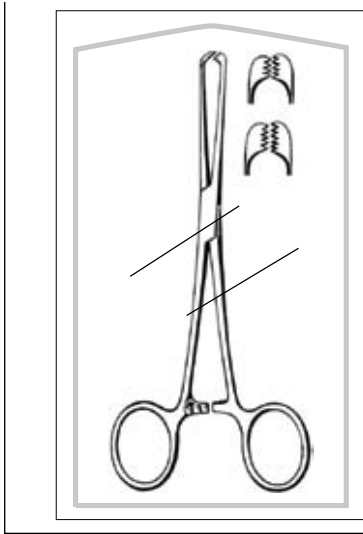

ALLIS TISSUE FORCEPS

96-2575	6"	4x5 Teeth	25/cs
96-2576	6"	4x5 Teeth	50/cs
96-2774	7¼"	6x7 Teeth	50/cs

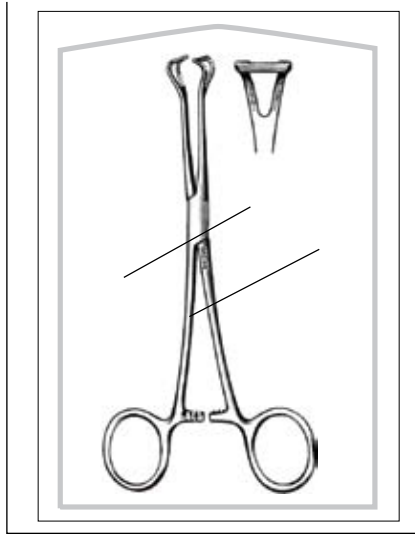

BABCOCK FORCEPS

96-2706	6¼"	Straight	25/cs
96-2705	6¼"	Straight	50/cs

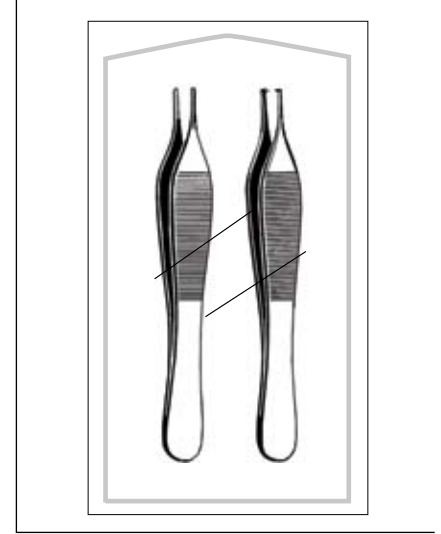

ADSON FORCEPS

96-2571	4¾"	Serrated	25/cs
96-2573	4¾"	1x2 Teeth	25/cs
96-2570	4¾"	Serrated	50/cs
96-2572	4¾"	1x2 Teeth	50/cs
96-2577	4¾"	Serrated Delicate	50/cs
96-2775	4¾"	1x2 Teeth Delicate	50/cs
96-2655	4¾"	Serrated	100/cs
96-2656	4¾"	1x2 Teeth	100/cs

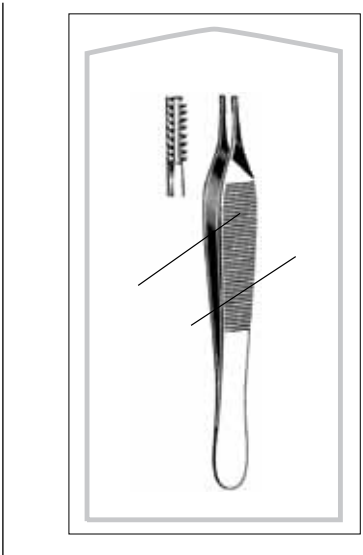

ADSON-BROWN FORCEPS

96-2559	4¾"	Side Grasping	25/cs
96-2558	4¾"	Side Grasping	50/cs

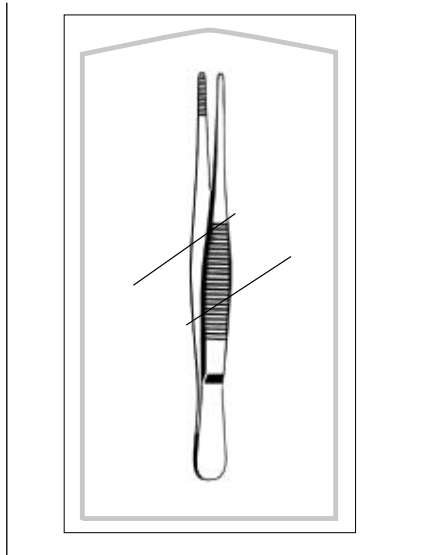

DRESSING FORCEPS

96-2569	5"	Serrated	25/cs
96-2921	8"	Serrated	25/cs
96-2688	4½"	Serrated	50/cs
96-2568	5"	Serrated	50/cs
96-2660	5"	Serrated	100/cs

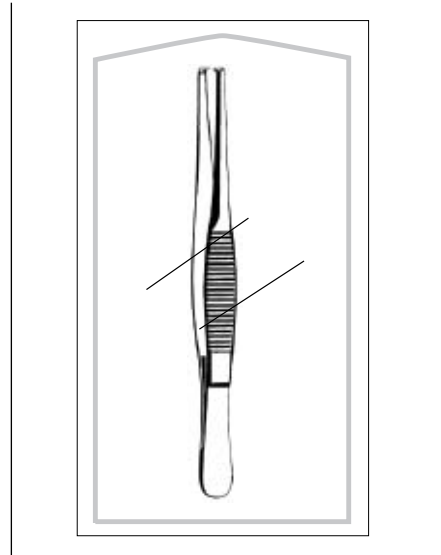

TISSUE FORCEPS

96-2579	5"	1x2 Teeth	25/cs
96-2578	5"	1x2 Teeth	50/cs
96-2661	5"	1x2 Teeth	100/cs

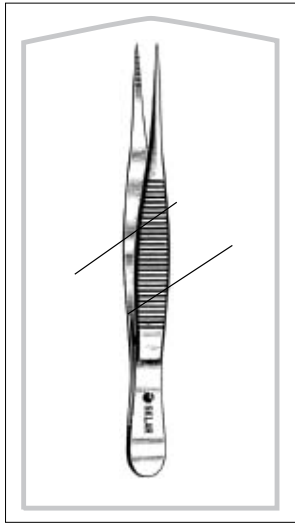

FINE POINT SPLINTER FORCEPS

96-2412 4½" 25/cs
 96-2410 4½" 50/cs

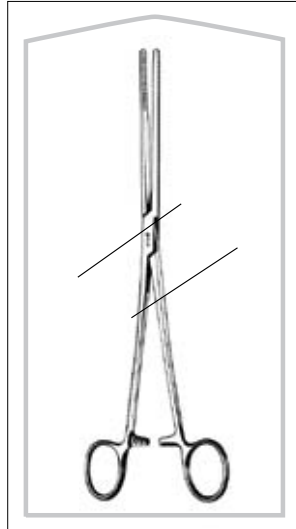

BOZEMAN FORCEPS

96-2622 10¼" S-Curve 25/cs
 96-2620 10¼" S-Curve 50/cs

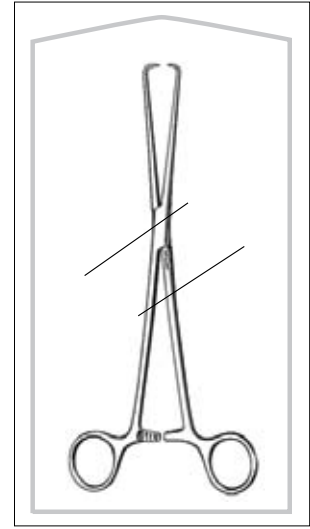

SCHROEDER TENACULUM FORCEPS

96-2624 9½" 25/cs
 96-2626 9½" 50/cs

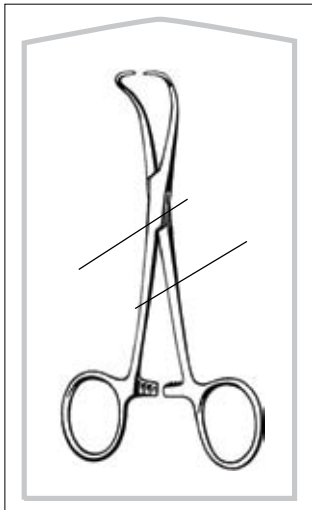

BACKHAUS TOWEL CLAMPS

96-2632 3½" 25/cs
 96-2636 5¼" 25/cs
 96-2630 3½" 50/cs
 96-2634 5¼" 50/cs

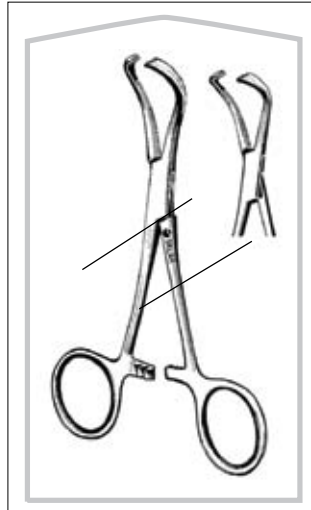

LORNA EDNA TOWEL CLAMPS

96-2529 3½" 25/cs
 96-2528 3½" 50/cs

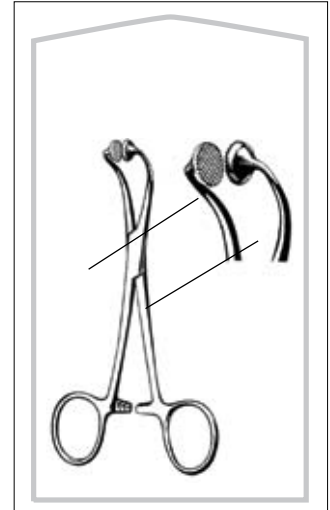

HOFF TOWEL CLAMPS

96-2565 5¼" 25/cs
 96-2564 5¼" 50/cs

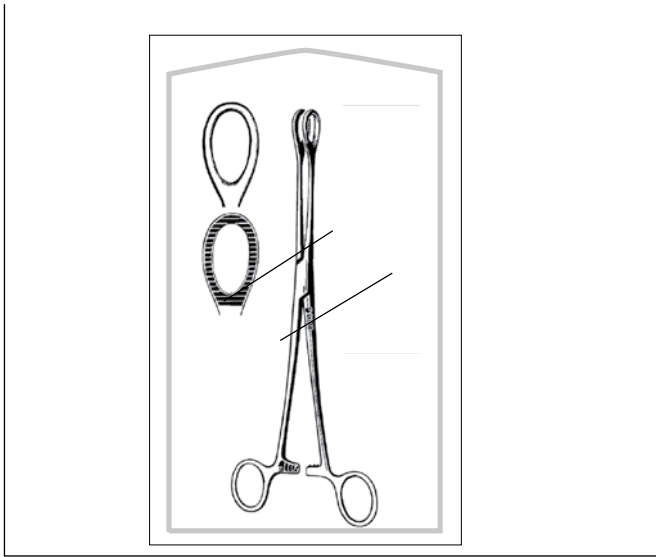

SPONGE FORCEPS

96-2533 9½" Straight, Serrated 25/cs
 96-2532 9½" Straight, Serrated 50/cs

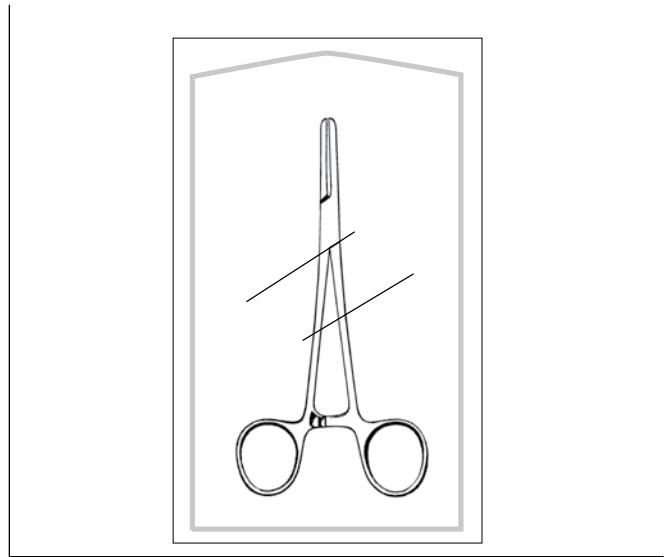

PRESBYTERIAN TUBE OCCLUDING FORCEPS

96-2408 7" Smooth 25/cs
 96-2406 7" Smooth 50/cs



SKLAR SURGICAL SKIN MARKERS

Sklar Surgical Skin markers are designed to allow the surgeon to conveniently demarcate selected sites prior to or during surgical procedures. Latex free.

- Scrub resistant ink
- Durable tip
- Non-smearing
- Sterile

STERILE	PRODUCT NUMBER	FEATURES	QUANTITIES
	10-1440	Fine/Regular Tip Scrub Resistant	50/bx

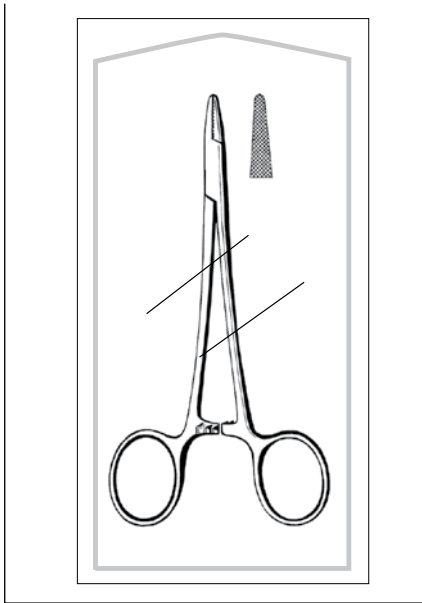

BAUMGARTNER NEEDLE HOLDERS

- 96-2581 5½" Serrated 25/cs
- 96-2580 5½" Serrated 50/cs

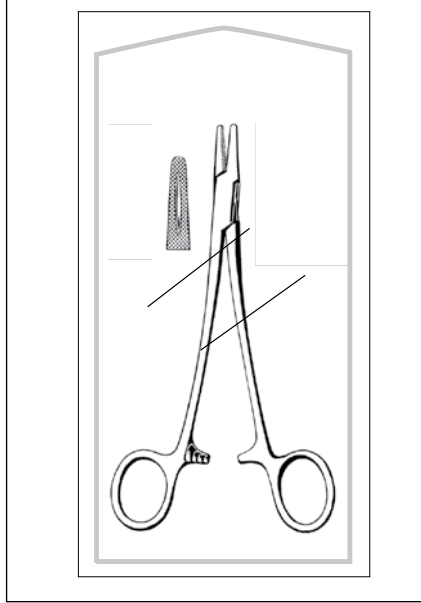

MAYO-HEGAR NEEDLE HOLDERS

- 96-2599 5" Serrated 25/cs
- 96-2595 6" Serrated 25/cs
- 96-2594 6" Serrated 50/cs
- 96-2710 7" Serrated 50/cs
- 96-2712 8" Serrated 50/cs

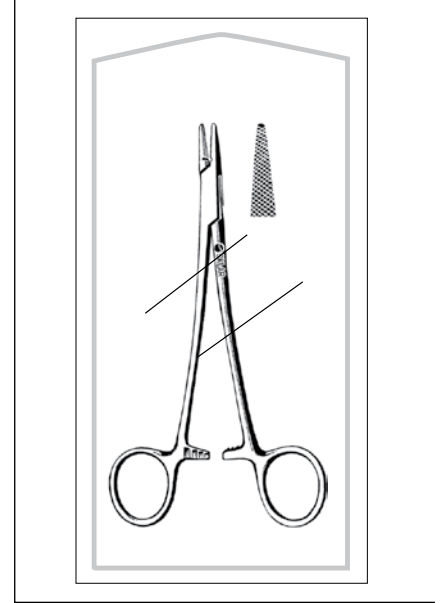

CRILE-WOOD NEEDLE HOLDERS

- 96-2591 6" Serrated 25/cs
- 96-2590 6" Serrated 50/cs

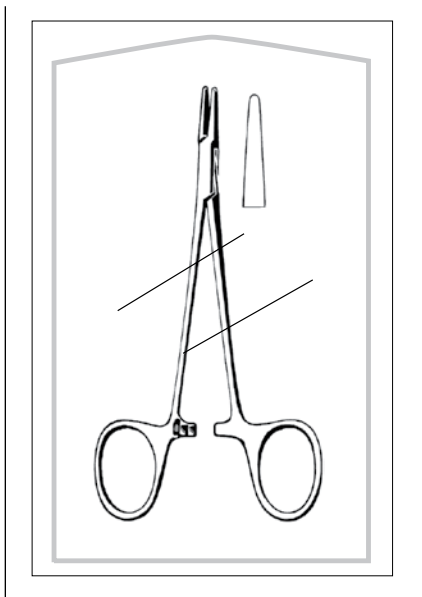

WEBSTER NEEDLE HOLDERS

- 96-2587 5¼" Smooth 25/cs
- 96-2586 5¼" Smooth 50/cs
- 96-2659 5¼" Smooth 100/cs

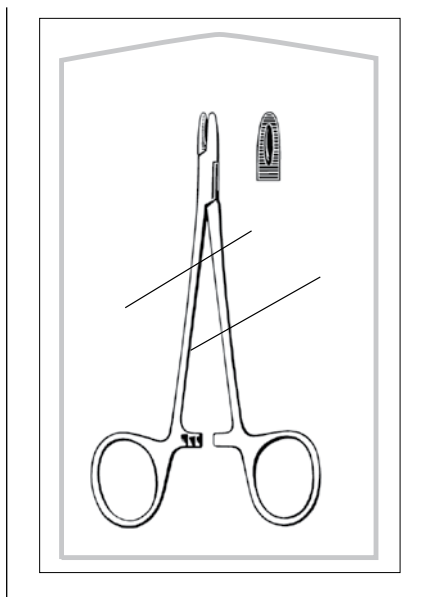

DERF NEEDLE HOLDERS

- 96-2583 4¾" Serrated 25/cs
- 96-2582 4¾" Serrated 50/cs

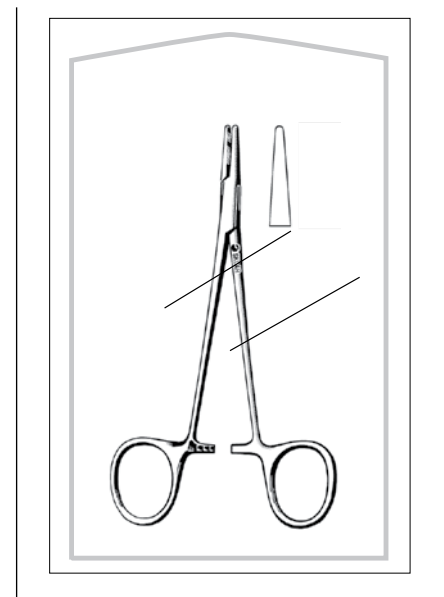

HALSEY NEEDLE HOLDERS

- 96-2585 5" Smooth 25/cs
- 96-2584 5" Smooth 50/cs

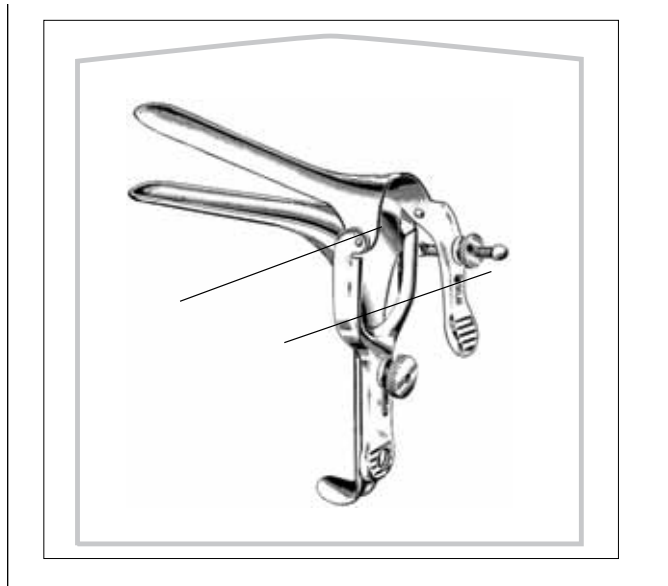
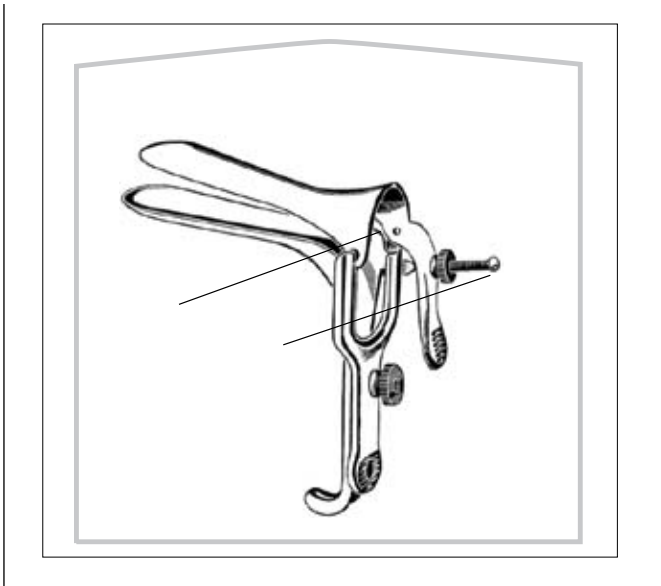

GRAVES SPECULUMS

96-2603	Small	25/cs	96-3000	Small	50/cs
96-2605	Medium	25/cs	96-3001	Medium	50/cs
96-2607	Large	25/cs	96-3002	Large	50/cs

PEDERSON SPECULUMS

96-2613	Small	25/cs	96-2612	Small	50/cs
96-2615	Medium	25/cs	96-2614	Medium	50/cs
96-2617	Large	25/cs	96-2616	Large	50/cs

GAUZE SPONGES



WOVEN, NON-STERILE

PRODUCT NUMBER	FEATURES		QUANTITIES
96-5280	2" x 2"	8Ply	5000/cs
96-5281	2" x 2"	12Ply	8000/cs
96-5282	3" x 3"	8Ply	4000/cs
96-5283	3" x 3"	12Ply	4000/cs
96-5284	4" x 4"	8Ply	4000/cs
96-5285	4" x 4"	12Ply	5000/cs
96-5286	4" x 4"	16Ply	2000/cs
96-5267	4" x 8"	12Ply	2000/cs

NON-WOVEN, NON-STERILE

PRODUCT NUMBER	FEATURES		QUANTITIES
96-5628	2" x 2"	4Ply	5000/cs
96-5629	3" x 3"	4Ply	4000/cs
96-5630	4" x 4"	4Ply	2000/cs



STITCH SCISSORS

- 96-8971 4½" Littauer 50/cs
- 96-8973 4½" Littauer S/B 50/cs
- 96-8972 5¼" Littauer S/B 50/cs
- 96-8975 5¼" Littauer S/S 50/cs

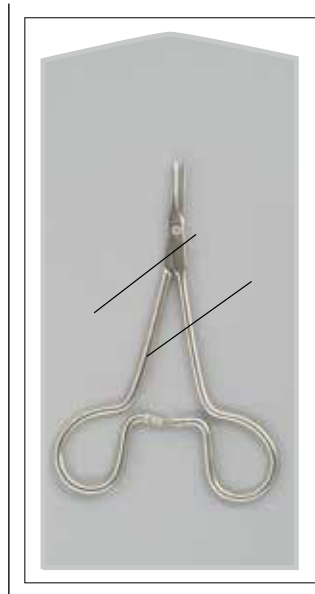

HALSTEAD FORCEPS

- 96-8964 5" Straight 50/cs
- 96-8965 5" Curved 50/cs

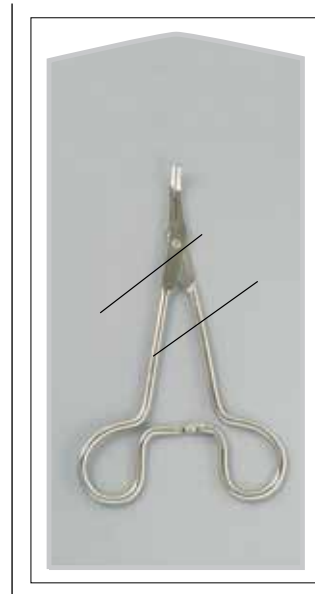

KELLY FORCEPS

- 96-8967 5½" Straight 50/cs
- 96-8966 5½" Curved 50/cs

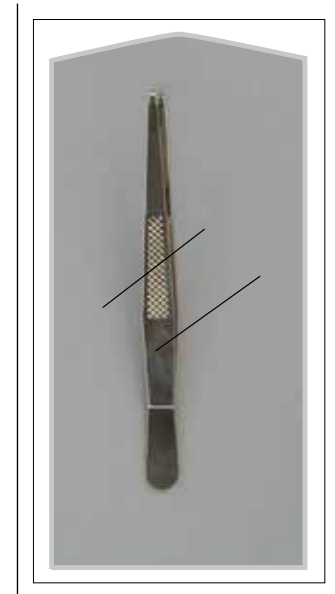

THUMB FORCEP

- 96-8963 4½" 1x2 Teeth 50/cs



TISSUE FORCEP

- 96-8976 5" 50/cs

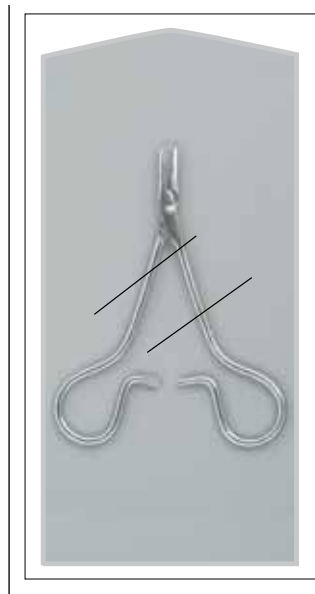

NEEDLE HOLDERS

- 96-8968 5¼" Smooth 50/cs
- 96-8974 5¼" Serrated 50/cs

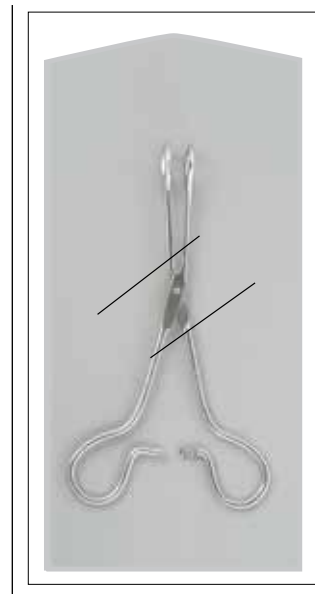

SPONGE FORCEPS

- 96-8969 7" Serrated 50/cs
- 96-8970 9½" Serrated 50/cs

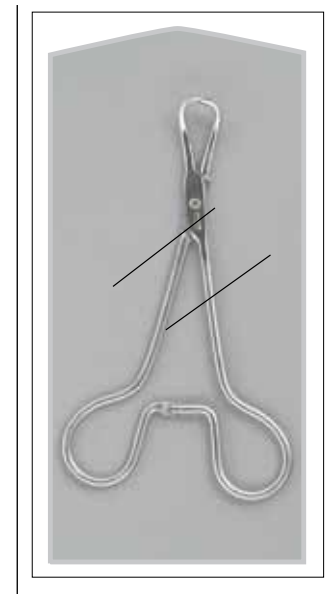

TOWEL FORCEP

- 96-8962 5¼" 50/cs

98-1274—SPAY PACK SET

PRODUCT NUMBER	DESCRIPTION	FEATURES	QUANTITIES
47-1447	Adson Brown Tissue Forcep	Side Grasping, 4¾"	1
36-2160	Allis Tissue Forcep	4x5 Teeth, 6"	1
47-2935	Backhaus Towel Clamp	3½"	4
17-1550	Halsted Mosquito Forcep	Curved, 5"	2
17-2155	Kelly Forcep	Curved, 5½"	2
15-1567	Mayo Dissecting Scissor	Straight, 6¾"	1
75-5670	Metzenbaum Scissor	Curved, 7"	1
21-8027	Olsen Hegar Needle Holder (Feline)	Tungsten Carbide, Serrated, 5½"	1
21-8028	Olsen Hegar Needle Holder (Canine)	Tungsten Carbide, Serrated, 6½"	1
17-1162	Rochester Carmalt Forcep	Curved, 6¼"	2
06-2910	Scalpel Handle	#3 with Metric Scale	1
93-1475	Snook Hook		1
19-1255	Tissue Forceps	1x2 Teeth, 5½"	1

98-1275—GENERAL SURGERY SET

PRODUCT NUMBER	DESCRIPTION	FEATURES	QUANTITIES
47-1447	Adson Brown Tissue Forcep	Side Grasping, 4¾"	1
47-2955	Backhaus Towel Clamp	5¼"	4
17-1550	Halsted Mosquito Forcep	Curved, 5"	3
17-2055	Kelly Forcep	Straight, 5½"	2
15-1567	Mayo Dissecting Scissor	Straight, 6¾"	1
75-5670	Metzenbaum Scissor	Curved, 7"	1
21-8027	Olsen Hegar Needle Holder	Tungsten Carbide, Serrated, 5½"	1
17-1162	Rochester Carmalt Forcep	Curved, 6¼"	4
06-2910	Scalpel Handle	#3 with Metric Scale	1
93-1475	Snook Hook		1

98-1276—ORTHOPEDIC SET

PRODUCT NUMBER	DESCRIPTION	FEATURES	QUANTITIES
40-7110	Bruns Bone Curette	#0, Oval	1
40-9688	Fomon Rasp	With 4 Sides, 8½"	1
47-2380	Freer Elevator	Double-Ended, Sharp/Blunt, 7¼"	1
40-5520	Gigli Saw Solid Bar Handle	Pair	1
40-5542	Gigli Saw Wire	12"	1
40-2580	Kern Bone Forcep	With Ratchet, 5¾"	1
40-2585	Kern Bone Forcep	With Ratchet, 8½"	1
40-6545	Lambotte Osteotome	15mm, 5"	1
40-3055	Liston Bone Forcep	Straight, 5½"	1
40-1048	Pin Cutter	End Cutting, 7"	1
60-6164	Senn Retractor	Double End, Blunt, 6¼"	1
60-6162	Senn Retractor	Double End, Sharp, 6¼"	1
40-5875	Lucae Bone Mallet	Small, 7½" x 1"	1
21-9060	Sternal Wire Twister	Tungsten Carbide, 5"	1
24-2220	Suture Wire	20 Gauge, 4oz. Spool	1
24-2230	Suture Wire	30 Gauge, 1oz. Spool	1
24-2342	Suture Wire Cutting Scissor	Angled, Serrated, 4¾"	1
22-8255	Weitlaner Retractor	3x4 Teeth, Sharp, 5½"	1

98-1277—BASIC EYE SET

PRODUCT NUMBER	DESCRIPTION	FEATURES	QUANTITIES
65-1742	Barraq Wire Speculum	Large, 15mm, 1½"	1
65-6357	Castroviejo Needle Holder	Straight, Smooth with Lock, 5½"	1
66-1036	Desmarres Chalazion Forcep	Medium, 3½"	1
66-2740	Eye Dressing Forcep	Straight, Serrated, 4"	1
06-2910	Scalpel Handle	#3 with Metric Scale	1
22-1240	Stevens Tenotomy Scissor	Straight, Delicate, Sharp/Sharp, 4½"	1

98-1311 – MICRO SET

PRODUCT NUMBER	DESCRIPTION	FEATURES	QUANTITIES
20-1547	Derf Needle Holder	Serrated, 4¾"	1
47-1135	Iris Scissors	Straight, Sharp/Sharp, 3½"	1
66-7642	Jeweler Style Forcep	#5, Straight	1
66-6164	McPherson Iris Micro Forcep	Straight, 3½"	1
64-1960	McPherson Vannas Scissors	Straight, 3"	1
65-1127	Plain Wire Speculum	Large	1
30-1545	Probe	Double-Ended, 4½"	1

98-1313 – EQUINE SET

PRODUCT NUMBER	DESCRIPTION	FEATURES	QUANTITIES
36-2295	Allis Tissue Forcep	5x6 Teeth, Delicate, 9½"	1
47-2935	Backhaus Towel Clamp	3½"	4
19-1070	Dressing Forcep	Serrated, 7"	4
17-1450	Halsted Mosquito Forcep	Straight, 5"	12
17-2055	Kelly Forcep	Straight, 5½"	2
15-1567	Mayo Dissecting Scissor	Straight, 6¾"	1
47-1360	Metzenbaum Scissor	Curved, 5¾"	1
22-9480	Peanut Sponge Forcep	Curved, Serrated, 8"	1
19-2260	Russian Tissue Forcep	6"	1
19-1250	Tissue Forcep	1x2 Teeth, 5"	6
20-1352	Webster Needle Holder	Serrated, 5¼"	1

98-1431 – TIE BACK SET

PRODUCT NUMBER	DESCRIPTION	FEATURES	QUANTITIES
50-3147	Adson Dressing Forcep	Serrated, 4¾"	1
74-3270	Kelly Forcep	Curved, 7", Extra Heavy	1
20-2765	Olsen Hegar Needle Holder	6½"	1
13-1065	Operating Scissor	Straight, 6½", Sharp/Sharp	1



SCALPEL HANDLES

PRODUCT NUMBER	FEATURES
06-2910	#3 with metric scale



PRODUCT NUMBER	FEATURES
06-2903	#3 fits Blade #10, 11, 12, 15
06-2915	#3L



PRODUCT NUMBER	FEATURES
06-2904	#4 fits Blade #20, 21, 22, 23
06-2920	#4L



PRODUCT NUMBER	FEATURES
06-2907	#7 fits Blade #10, 11, 12, 15



PRODUCT NUMBER	FEATURES
06-2912	#8 fits Blade #60



PRODUCT NUMBER	FEATURES
06-2925	Large Lab Type Handle #3
06-2930	Large Lab Type Handle #4



PRODUCT NUMBER	FEATURES
06-2908	Round Scalpel Handle, Straight #3R, fits Blade #10, 11, 12, 15



PRODUCT NUMBER	FEATURES
06-3090	Blade Remover



BLADES, STAINLESS STEEL

STERILE

PRODUCT NUMBER	FEATURES	QUANTITIES
06-3100	#10	100/box
06-3101	#11	100/box
06-3102	#12	100/box
06-3103	#15	100/box
06-3108	#15C	100/box
06-3104	#20	100/box
06-3105	#21	100/box
06-3106	#22	100/box
06-3107	#23	100/box

BLADES, CARBON STEEL

STERILE

PRODUCT NUMBER	FEATURES	QUANTITIES
06-3010	#10	100/box
06-3011	#11	100/box
06-3012	#12	100/box
06-3013	#12D	100/box
06-3015	#15	100/box
06-3016	#15C	100/box
06-3020	#20	100/box
06-3021	#21	100/box
06-3022	#22	100/box
06-3023	#23	100/box

SCALPELS, DISPOSABLE

STERILE

PRODUCT NUMBER	FEATURES	QUANTITIES
06-3110	#10	10/box
06-3111	#11	10/box
06-3112	#12	10/box
06-3115	#15	10/box
06-3120	#20	10/box
06-3121	#21	10/box
06-3122	#22	10/box
06-3123	#23	10/box



MINI BLADES AND SCALPELS
STERILE

PRODUCT NUMBER	FEATURES	QUANTITIES
97-1822	#61	25/box
97-1721	#62	12/box
97-1821	#62	25/box
97-1820	#63	25/box
97-1826	#64	25/box
97-1825	#65	25/box
97-1824	#67	25/box
97-1823	#69	25/box

MINI PODIATRY HANDLE
NON-STERILE

PRODUCT NUMBER	FEATURES	QUANTITIES
97-1450	#3K	1 Each

SPECIALTY BLADES
NON-STERILE

PRODUCT NUMBER	FEATURES	QUANTITIES
97-1400	#318, Curved Edge	12/box
97-1405	#312, Curved Edge	12/box
97-1410	#313, Curved Edge	12/box
97-1415	#314, Curved Edge	12/box
97-1420	#316, Straight Edge	12/box
97-1425	#300, Straight Edge	12/box
97-1430	#361, Knife Edge	12/box

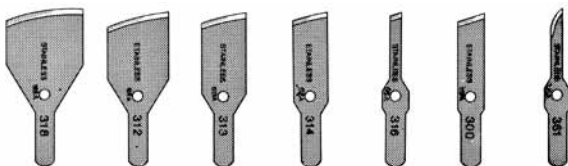
SELF-LOCKING HANDLE
NON-STERILE

PRODUCT NUMBER	FEATURES	QUANTITIES
97-1445	#6	1 Each

CARBON P-M BLADE
NON-STERILE

PRODUCT NUMBER	FEATURES	QUANTITIES
06-3024	#60	50/box

MINI THUMB SCALPEL
NON-STERILE

PRODUCT NUMBER	FEATURES	QUANTITIES
06-7052	#11	1500/cs

STITCH CUTTER
STERILE

PRODUCT NUMBER	FEATURES	QUANTITIES
06-3030	Stainless Steel	100/box





SKLARSAFE™ SAFETY SCALPELS

- Protective, transparent sheath can be opened, closed, and locked with a single hand.
- Precision stainless steel blade made in England.
- Sturdy, “Sure-Grip” handle.
- Audible “click” when sheath advanced to locked position.
- OSHA Compliant.
- Individually sealed in sturdy film and Tyvek® pack.

STERILE

PRODUCT NUMBER	FEATURES	QUANTITIES
06-3094	#10	10/box
06-3095	#11	10/box
06-3096	#15	10/box
NON-STERILE		
06-3130	#10	500/cs
06-3132	#11	500/cs
06-3134	#15	500/cs

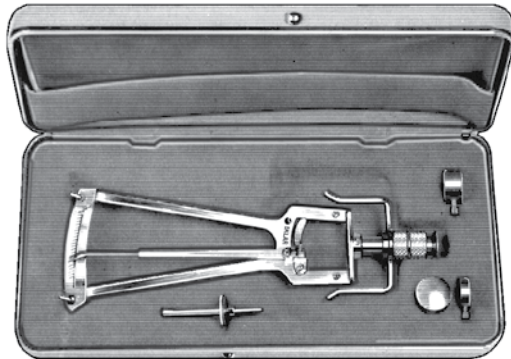

SCHIOTZ ORIGINAL TONOMETER

65-7523 Contains
Screw on 5.5 gr. weight, 2 additional weights 7.5 and 10 gr.
Test Block, Plunger and Fitted Case



TAYLOR HAMMER

06-3170	7"	Small
95-008	7"	Small
06-3175	7½"	Large
95-010	7½"	Large



BUCK NEURO HAMMER

06-3370 6¾" With Brush and Needle attached

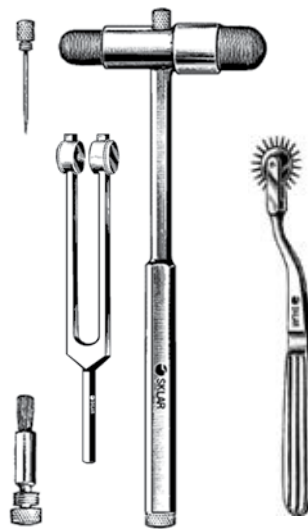

NEURO DIAGNOSTIC SETS

06-3380	Buck Hammer with Brush and Needle, Pin Wheel
06-3390	C-128 Tuning Fork, Buck Hammer with Brush and Needle, Pin Wheel
06-3391	C-256 Tuning Fork, Buck Hammer with Brush and Needle, Pin Wheel



ALUMINUM ALLOY TUNING FORK

67-7064	C-64
67-7128	C-128
67-7256	C-256
67-7512	C-512
67-7524	C-1024
67-7548	C-2048
67-7596	C-4096

TUNING FORK SET OF 5

67-7605 C-128, 256, 512, 1024, 2048



GRAVES VAGINAL SPECULUMS

90-3800	3" x 1/2"	Extra Small
90-3700	3" x 3/4"	Small
90-3701	4" x 1 1/4"	Medium
90-3702	4 1/2" x 1 3/8"	Large
90-3802	4 3/4" x 1 1/2"	Extra Large
90-3803	6" x 1 1/2"	Extra Long

PEDERSON VAGINAL SPECULUMS

90-3849	2 3/4" x 1/2"	Extra Small
90-3710	3" x 1/2"	Small
90-3712	4" x 5/8"	Slender
90-3713	4" x 7/8"	Medium
90-3711	4 3/4" x 1"	Large
90-3851	4 3/4" x 1 1/8"	Extra Large



VIENNA SPECULUMS

70-1070	Small	
70-1071	Medium	
70-1072	Large	
70-1075	Large	Wrought Metal

KILLIAN SPECULUMS

WITH SET SCREW

70-1020	2"	Small
70-1030	3"	Medium
70-1035	3 1/2"	Large

AVIAN ORAL SPECULUMS

93-8045	4 3/4"	Small
93-8046	4 3/4"	Medium
93-8047	7 1/2"	Large
SET OF 3		
93-8048	Contains one small, medium and large speculum	

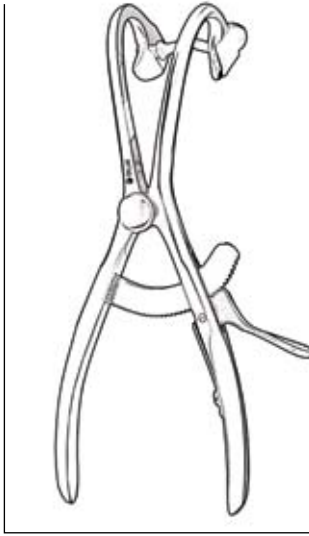

DENHARDT MOUTH GAG
75-1007 4¾" with Ratchet

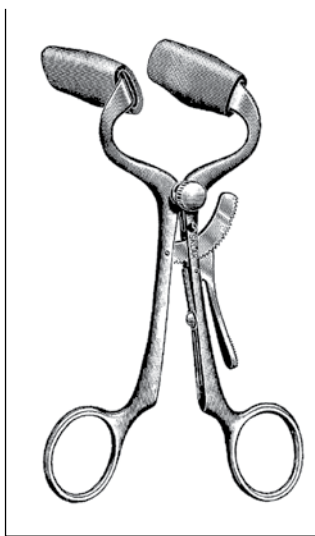

DOYEN-JANSEN MOUTH GAG (MOLT) WITH CUSHIONS
22-8945 4" Small
75-1025 5½" Large

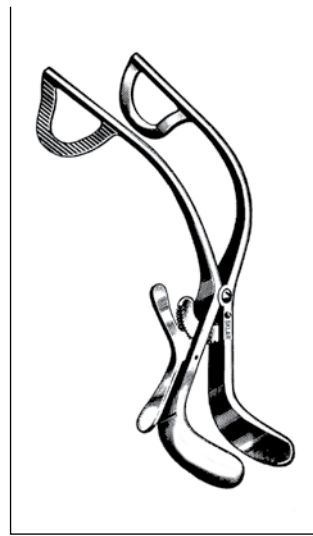

WESSON MOUTH GAG TRU-GRIP RATCHET
75-1010 5¾"

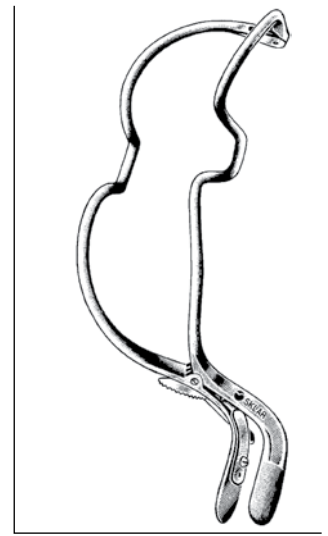

JENNINGS MOUTH GAG TRU-GRIP RATCHET
75-1015 6½" Small
75-1016 7" Medium
75-1017 8" Large

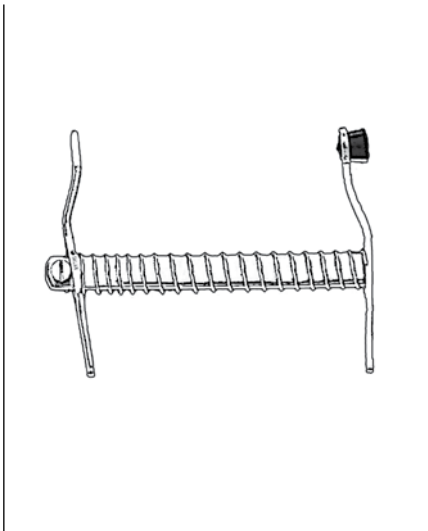

FELINE MOUTH GAG
93-8034 3" Feline Lightweight



CANINE MOUTH GAG
93-8038 3½" Small
93-8039 5½" Medium
93-8040 7½" Large



N-1 TOURNIQUET
40-1915 Complete Black
40-1916 Black Tubing Only
40-1917 Clip Only

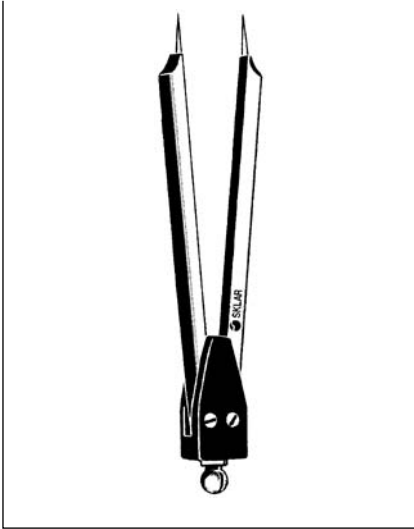

EKG CALIPER

06-2808 7"

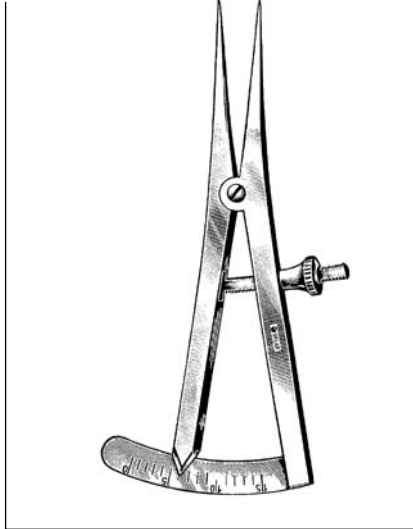

CASTROVIEJO CALIPER

GRADUATED MEASURE, 3/4"

- 65-6730 0-15mm Straight
- 65-6732 0-20mm Straight
- 65-6734 0-20mm Curved

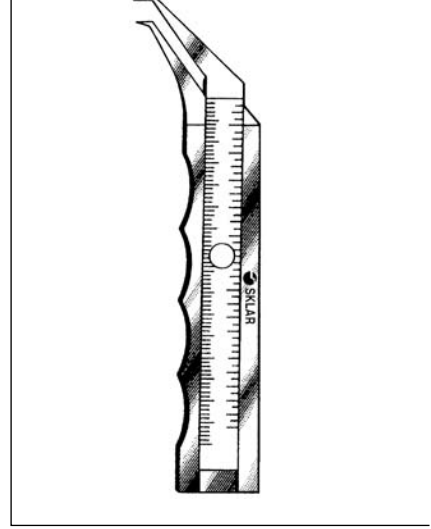

THORPE CALIPER

65-6735 4 1/2" Inch and mm

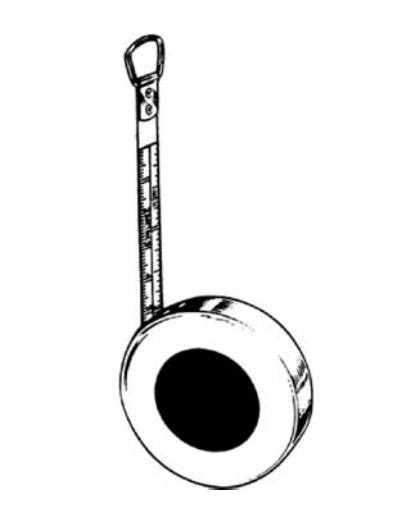

TAPE MEASURE

06-2852 60"

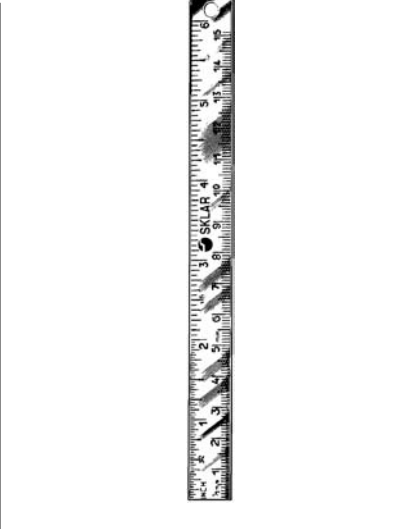

STEEL RULER

- 06-2860 6"
- 06-2862 8"
- 06-2861 12"
- 06-2863 20"

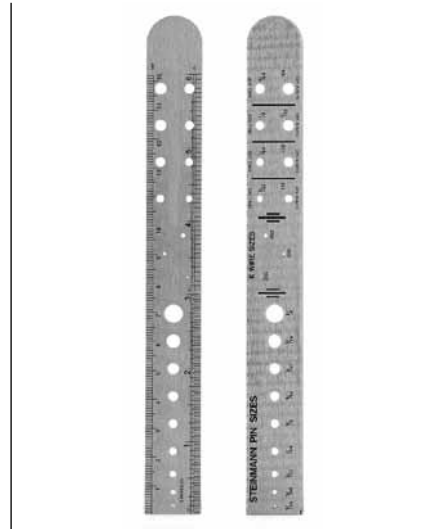

PIN & WIRE GAUGE

06-2865



Designed to meet the exacting standards of health care professionals who demand precise acoustic response in various settings, Sklar offers a full range of Stethoscopes that feature superb craftsmanship and performance.

SPRAGUE RAPPAPORT STETHOSCOPES

- The most popular stethoscope style on the market, worldwide.
- Includes five easily interchangeable chest pieces: 3 Bells (Large, Medium and Small) and 2 Diaphragms (Small and Large) allowing for a full range of diagnostic capabilities. Also includes 3 different size ear tips.
- Superior high and low frequency sensitivity; designed to detect the entire range of heart and chest sounds. Clinically proven to deliver more faint heart sounds and murmurs than other stethoscopes.
- Chest piece is equipped with a full rotational dual-output acoustic valve mechanism that ensures smooth rotation and accurate acoustic transmission.
- All components are individually machined and precisely assembled to deliver the choice stethoscope of medical professionals.
- Comfortably angled, anatomically correct headset with patented soft ear tips and excellent acoustic seal.
- Latex Free.



SPRAGUE RAPPAPORT STETHOSCOPES

DUAL HEAD

PRODUCT NUMBER	FEATURES
06-1625	28" Gray
06-1627	28" Black
06-2304	28" Blue



CARDIOLOGY STETHOSCOPIES

- Superb craftsmanship, construction and materials to offer the ultimate performance and sound transmission.
- Available in single-sided or dual-sided design with very high acoustic response.
- Offered as a double-lumen tube design in a variety of color choices to meet individual preferences.
- Comfortably angled, anatomically correct headset with patented soft ear tips and excellent acoustic seal.
- Latex Free.

SINGLE SIDED

PRODUCT NUMBER	FEATURES
06-2750	27" Black
06-2800	28" Black
06-2802	28" Blue
06-2803	28" Green

DUAL HEAD

Deluxe, two-sided traditional combination chest piece with patented turnable diaphragm to allow for high, medium and low frequency sounds to be heard.

PRODUCT NUMBER	FEATURES
06-1670	28" Black
06-1671	28" Burgundy
06-1672	28" Navy Blue
06-1673	28" Green

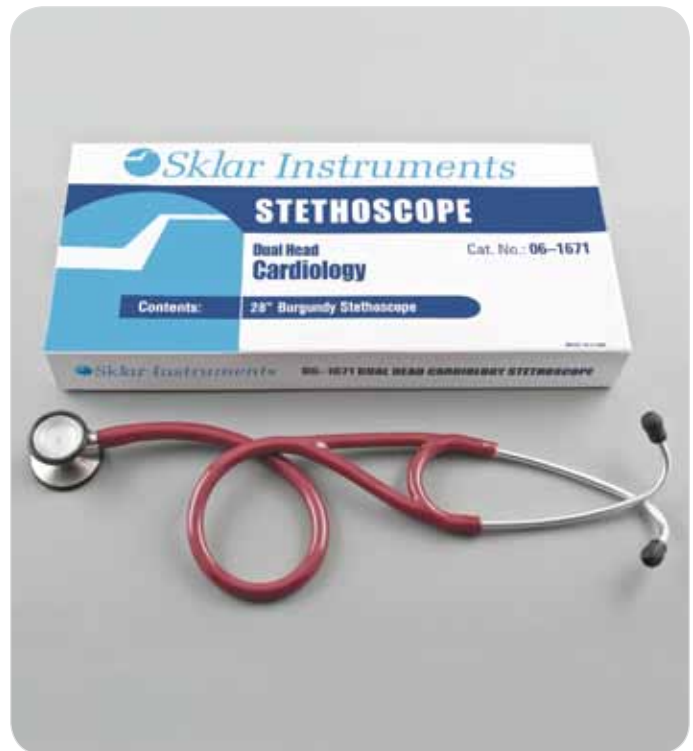



ADULT STETHOSCOPES

- Unsurpassed quality and value.
- Available in single-sided or dual-sided design, in a variety of color choices, with very high acoustic response.
- Specifically designed, sized and acoustically precisioned for adults.
- Patient friendly non-chill rim and diaphragm, excellent acoustic seal and comfortable fit with patented soft ear tips and a comfortably angled, anatomically correct headset.
- Unlimited flexibility and portable convenience.
- Latex Free.



SINGLE SIDED

PRODUCT NUMBER	FEATURES
06-2760	30" Black

DUAL HEAD

Deluxe, stainless steel, two-sided traditional combination chest piece with high and low frequency capabilities.

PRODUCT NUMBER	FEATURES
06-1601	30" Gray
06-2298	30" Purple
06-2299	30" Hunter Green
06-2300	30" Black
06-2302	30" Blue



LIGHT ADULT STETHOSCOPES

DUAL HEAD

Lighter construction reduces fatigue while maintaining performance.

PRODUCT NUMBER	FEATURES
06-1630	30" Black
06-1632	30" Gray





PEDIATRIC AND INFANT STETHOSCOPES

- Traditional bell/diaphragm chest pieces are specifically designed, sized and acoustically precise for small animal applications.
- Features Solid Stainless Steel chest piece with a Traditional 1" Bell or smaller ¾" Bell.
- Easy rotation between diaphragm or open bell side of stethoscope and sensitive to both high and low frequencies.
- Available as a dual-sided design, in a variety of attractive colors.
- Excellent acoustic seal and comfortable fit with patented soft ear tips and a comfortably angled, anatomically correct headset.
- Latex Free.



PEDIATRIC STETHOSCOPES

DUAL HEAD

PRODUCT NUMBER FEATURES

06-1640 30" Gray

06-2415 30" Pink

06-2417 30" Black

06-2418 30" Burgundy

06-2422 30" Blue



INFANT STETHOSCOPES

DUAL HEAD

PRODUCT NUMBER FEATURES

06-1642 30" Gray

06-2426 30" Pink

06-2427 30" Light Blue

06-2428 30" Black



FETAL STETHOSCOPE

CHROME-PLATED INNER SPRING BINAURAL AND VINYL COATED HEADREST

PRODUCT NUMBER FEATURES

06-1662 22" Y-Tubing Black

NURSES STETHOSCOPES
SINGLE SIDED

- Economic solution for situations that require a quality listening device.
- Latex Free.

PRODUCT NUMBER	FEATURES
06-1004	30" Blue
06-1635	30" Black
06-1638	30" Gray

TEACHING TRAINING STETHOSCOPE
SINGLE SIDED

- Specifically designed for multi-function teaching applications.
- Elongated tubing for comfortable two-person use.
- Latex Free.

PRODUCT NUMBER	FEATURES
06-1668	40" Black

DISPOSABLE STETHOSCOPES
SINGLE SIDED

- Designed for single use to prevent cross contamination in infectious situations.
- Plastic, ultra sensitive chest piece with remarkable acoustic performance.
- Latex Free.

PRODUCT NUMBER	FEATURES
96-1201	30" Blue
96-1202	30" Yellow





BOWLES STETHOSCOPE

PRODUCT NUMBER

06-1000



PERRELL FETOSCOPE

PRODUCT NUMBER

06-1701

FEATURES

With Slip on Tubing Adaptor



PINARD FETOSCOPE

PRODUCT NUMBER

06-1101

FEATURES

Aluminum



**96-1679
SINGLE BASIN TRAY 5/CASE**

DESCRIPTION	QUANTITIES
OR Basin 7 Qt.	1
CSR Wrap 45" x 45"	1

**96-4330
SINGLE BASIN TRAY 5/CASE**

DESCRIPTION	QUANTITIES
OR Basin 7 Qt.	1
CSR Wrap 54" x 54"	1

**96-4331
SINGLE BASIN TRAY 5/CASE**

DESCRIPTION	QUANTITIES
OR Basin 7 Qt.	1
CSR Wrap 54" x 54"	2

**96-4329
SINGLE BASIN TRAY 5/CASE**

DESCRIPTION	QUANTITIES
OR Basin 7 Qt.	1
CSR Wrap 55" x 72"	1

**96-4332
BASIC BASIN TRAY 4/CASE**

DESCRIPTION	QUANTITIES
Emesis Basin, 700 cc	1
Medicine Cup 2oz.	1
Medicine Cup Lid, 2oz.	1
OR Basin 7 Qt.	1
Pitcher 1200ml, Open Handle	1
Specimen Cup with Lid, 4oz.	1
Sponge Bowl 32oz.	1
Suction Tubing ¼" x 12'	1
Syringe, 60cc, Bulb	1
Yankauer Suction Tube, Non-Vented	1

**96-4335
BASIN START-UP TRAY 5/CASE**

DESCRIPTION	QUANTITIES
Emesis Basin, 700cc	1
Light Handle Cover	2
Medicine Cup 2oz.	1
Needle Counter	1
OR Basin 7 Qt.	1
Pitcher 1200ml, Open Handle	1
Specimen Cup with Lid, 4oz.	1
Sponge Bowl 32oz.	1

**96-4334
SINGLE START-UP TRAY 4/CASE**

DESCRIPTION	QUANTITIES
Emesis Basin, 700cc	1
Medicine Cup 2oz.	1
OR Basin 7 Qt.	1
Sponge Bowl 32oz.	1

**96-1710
MAJOR LACERATION TRAY 12/CASE**

DESCRIPTION	QUANTITIES
Adson Forcep, 1x2 Teeth, 4¾"	1
Adson Forcep, Serrated, 4¾"	1
Gauze, 12Ply, 2" x 2"	5
Gauze, 12Ply, 4" x 4"	10
Halsted Mosquito Forcep, Curved, 5"	1
Iris Scissor, Straight, 4½"	1
Lidocaine 1%, 30ml	1
Medicine Cup 2oz.	2
Needle, 18GA x 1½"	1
Needle, 25GA x 5⁄8"	1
Needle, 27GA x 1½"	1
Needle, 30GA x 1"	1
OR Towel, 18" x 26" Fenestrated	1
OR Towel, Blue	2
Syringe, 10cc, Control, L/L	1
Webster Needle Holder, Smooth, 5"	1

**96-1715
MINOR LACERATION TRAY A 12/CASE**

DESCRIPTION	QUANTITIES
Adson Forcep, Serrated, 4¾"	1
Gauze, 12Ply, 2" x 2"	5
Gauze, 12Ply, 4" x 4"	10
Halsted Mosquito Forcep, Curved, 5"	1
Iris Scissor, Straight, 4½"	1
Medicine Cup 2oz.	2
Needle, 18GA x 1½"	1
Needle, 25GA x 5⁄8"	1
Needle, 27GA x 1¼"	1
OR Towel, 18" x 26" Fenestrated	1
OR Towel, Blue	2
Syringe, 10cc, NT, L/L	1
Webster Needle Holder, Smooth, 5"	1

**96-1718
MINOR LACERATION TRAY B 12/CASE**

DESCRIPTION	QUANTITIES
Absorbent Towel, 3Ply, 17" x 19"	1
Adson Forcep, 1x2 Teeth, 4¾"	1
Baumgartner Needle Holder, 5"	1
Drape, 18" x 26" Fenestrated	1
Gauze, 12Ply, 2" x 2"	5
Gauze, 12Ply, 4" x 4"	10
OR Scissors, Straight, Sharp/Sharp, 5½"	1



**96-4413
STAPLE REMOVAL TRAY 50/CASE**

DESCRIPTION	QUANTITIES
Alcohol Prep Pad Large	1
Gauze, 12Ply, 3" x 3"	1
PVP-I Prep Pad	1
Skin Staple Remover	1

**96-4412
SUTURE REMOVAL TRAY 50/CASE**

DESCRIPTION	QUANTITIES
Adson Forcep, Serrated, 4¾"	1
Alcohol Prep Pad, Large	1
Gauze, 12Ply, 3" x 3"	1
Littauer Stitch Scissor, 5½"	1
PVP-I Prep Pad	1

**96-4414
SUTURE REMOVAL TRAY 50/CASE**

DESCRIPTION	QUANTITIES
Gauze, 12Ply, 3" x 3"	1
Kelly Forcep, Straight, 5½"	1
OR Scissors, Straight, Sharp/Blunt, 5"	1
Thumb Forcep, Serrated, 4½"	1

**96-4415
SUTURE REMOVAL TRAY 50/CASE**

DESCRIPTION	QUANTITIES
Adson Forcep, Serrated, 4¾"	1
Gauze, 12Ply, 3" x 3"	1
Iris Scissor, Straight, 4½"	1

**96-4416
SUTURE REMOVAL TRAY 50/CASE**

DESCRIPTION	QUANTITIES
Adson Forcep, Serrated, 4¾"	1
Gauze, 12Ply, 3" x 3"	1
Hemostat Mosquito Forcep, Curved, 5"	1
Iris Scissor, Curved, 4½"	1

**96-4417
SUTURE REMOVAL TRAY 50/CASE**

DESCRIPTION	QUANTITIES
Adson Forcep, Serrated, 4¾"	1
Gauze, 12Ply, 3" x 3"	1
Littauer Stitch Scissor, 5½"	1

**941-0049B
GENERAL TRAY 10/CASE**

DESCRIPTION	QUANTITIES
Backhaus Towel Clamp, 3½"	2
Kelly Forcep, Straight, 5½"	4





STERILE TRAYS

96-4403 INCISION & DRAINAGE TRAY

20/CASE

DESCRIPTION	QUANTITIES
Alcohol Prep Pad, Large	1
Drape, 18" x 26" Fenestrated	1
Drape, Polylined, 13" x 18"	1
Forcep Insert, 5" Wireform	1
Gauze, 8Ply, 4" x 4"	4
Kelly Forcep, Straight, 5½", Wireform	1
Polybag with Twist Tie	1
PVP-I Prep Pad	1
#11 SklarSafe Safety Scalpel	1

96-4404 INCISION & DRAINAGE TRAY

20/CASE

DESCRIPTION	QUANTITIES
Alcohol Prep Pad, Large	1
Drape, 18" x 26" Fenestrated	1
Drape, Polylined, 13" x 18"	1
Forcep Insert, 5" Wireform	1
Gauze, 8Ply, 4" x 4"	4
Kelly Forcep, Straight, 5½", Wireform	1
Polybag with Twist Tie	1
PVP-I Prep Pad	1
#11 Scalpel	1

96-4405 INCISION & DRAINAGE TRAY

20/CASE

DESCRIPTION	QUANTITIES
Alcohol Prep Pad, Large	1
Drape, 18" x 26" Fenestrated	1
Drape, Polylined, 13" x 18"	1
Gauze, 8Ply, 4" x 4"	4
Kelly Forcep, Straight, 5½"	1
Polybag with Twist Tie	1
PVP-I Prep Pad	1
#11 Scalpel	1
Thumb Forcep, 4" Wireform	1

941-0347 OR TOWEL TRAY

50/CASE

DESCRIPTION	QUANTITIES
OR Towel, Blue	1

941-0046 LACERATION TRAY

10/CASE

DESCRIPTION	QUANTITIES
Adson-Brown Tissue Forcep, 4¾"	1
Baumgartner Needle Holder, 5"	1
#10 Blade, Stainless Steel	1
Kelly Forcep, Straight, 5½"	2
OR Scissors, Straight, Sharp/Blunt, 5½"	1
#3 Surgical Knife Handle	1
OR Towel, Blue	1



**941-0293A
EQUINE DRAPE TRAY 25/CASE**

DESCRIPTION	QUANTITIES
Back Table Cover, 44" x 75"	1
Filler Needle, 19GA x 1½"	5
Gauze, 8Ply, 4" x 4"	10
Ziplock Bag, 6" x 6"	1

**941-0260A
EQUINE ER ECONO TRAY 10/CASE**

DESCRIPTION	QUANTITIES
Alcohol Swabstick, Triple	1
Animalintex Pad, 8" x 16"	1
CHG 4% Solution, 118ml Bottle	1
Gamgee Roll, 12"	1
Gauze Roll, Brown, 6" x 5yd.	2
Gauze, 8Ply, 4" x 4"	40
Gauze, Conforming Stretch, 4" x 4yd.	2
Gloves, Vinyl, Medium	10
Needle, 18GA x 1½"	1
Non-Adherent Dressing, 3" x 4"	2
OR Scissors, Straight, Sharp/Blunt, 5½"	1
Saline Solution .9%, 100ml	1
Syringe, 60cc, L/L	1
Vet Wrap 4"	2
Ziplock Bag, 6" x 6"	1

**941-0259
EQUINE ER DELUXE TRAY 10/CASE**

DESCRIPTION	QUANTITIES
Alcohol Swabstick, Triple	1
Animalintex Pad, 8" x 16"	1
CHG 4% Solution, 118ml Bottle	1
Cold Pack	1
Gamgee Roll, 12"	1
Gauze Roll, Brown, 6" x 5yd.	2
Gauze, 4" x 4"	40
Non-Adherent Dressing, 3" x 4"	2
OR Scissors, Straight, Sharp/Blunt, 5½"	1
Saline Solution .9%, 100ml	1
#10 SklarSafe Safety Scalpel	1
Stretch Gauze	2
Syringe, 60cc, L/L	1
Tongue Depressor	1
Vet Wrap 4"	2
Vinyl Glove, Walleted, Large	1
Water-Jel Burn Pad, 4" x 4"	1

**941-0258
EQUINE WOUND
CLOSURE TRAY 10/CASE**

DESCRIPTION	QUANTITIES
Dressing Forcep, 5"	1
Durapore Tape 1" x 36"	1
Gamgee Roll, 12"	1
Gauze Roll, Brown, 6" x 5yd.	2
Gauze, 8Ply, 4" x 4"	10
Gloves, Vinyl, Walleted, Large	1
Lister Bandage Scissor, 5½"	1
Non-Adherent Dressing, 3" x 4"	3
Sterile Water	1
Syringe, 60cc, L/L	1
Vet Wrap 4"	2





STERILE TRAYS

941-0310

MARE TRAY

20/CASE

DESCRIPTION	QUANTITIES
Adson Forcep, 1x2 Teeth, 4¾"	1
Gauze, 8Ply, 4" x 4"	10
Olsen Hegar Needle Holder, 5½"	1
OR Scissors, Straight, Blunt/Blunt, 5½"	1
#10 Suture Needle, ¾" Circle	1
#14 Suture Needle, ¾" Circle	1

941-0047B

EYE TRAY

10/CASE

DESCRIPTION	QUANTITIES
Iris Scissor, Straight, 4½"	1
Adson-Brown Tissue Forcep, 4¾"	1
Mayo-Hegar Needle Holder, 7"	1

941-0048B

CASTRATION TRAY

10/CASE

DESCRIPTION	QUANTITIES
Allis Tissue Forcep, 6x7 Teeth, 7¼"	1
#10 Blade, Stainless Steel	1
Kelly Rankin Forcep, Straight, 6½"	2
Rochester-Pean Forcep, Straight, 8½"	1
#3 Surgical Knife Handle	1

941-0033A

FIELD SERVICE TRAY

10/CASE

DESCRIPTION	QUANTITIES
Allis Tissue Forcep, 4x5 Teeth, 6"	2
Backhaus Towel Clamp, 3½"	2
Baumgartner Needle Holder, 5¼"	1
#10 Blade, Stainless Steel	1
Kelly Forcep, Curved, 5½"	3
Mayo Scissors, Curved, 5½"	1
Metzenbaum Scissors, Curved, 5½"	1
OR Towel, Blue	1
#3 Surgical Knife Handle	1
Tissue Forcep, 2x3 Teeth, 5½"	1

941-0308

THROAT TRAY

25/CASE

DESCRIPTION	QUANTITIES
#10 Blade, Stainless Steel	1
Gauze, 8Ply, 4" x 4"	10
Gloves, Vinyl, Medium, Walleted Pair	1
OR Scissors, Straight, Sharp/Sharp, 5½"	1
Instrument Tip	1





GAUZE SPONGES

WOVEN, NON-STERILE

PRODUCT NUMBER	FEATURES	QUANTITIES
96-5280	2" x 2" 8Ply	5000/cs
96-5281	2" x 2" 12Ply	8000/cs
96-5282	3" x 3" 8Ply	4000/cs
96-5283	3" x 3" 12Ply	4000/cs
96-5284	4" x 4" 8Ply	4000/cs
96-5285	4" x 4" 12Ply	5000/cs
96-5286	4" x 4" 16Ply	2000/cs
96-5267	4" x 8" 12Ply	2000/cs

NON-WOVEN, NON-STERILE

PRODUCT NUMBER	FEATURES	QUANTITIES
96-5628	2" x 2" 4Ply	5000/cs
96-5629	3" x 3" 4Ply	4000/cs
96-5630	4" x 4" 4Ply	2000/cs



SUPER SPONGES

NON-STERILE

PRODUCT NUMBER	FEATURES	QUANTITIES
96-5631	6" x 6¾" 12Ply	600/pk
96-5632	7¾" x 8¾" 12Ply	400/pk
96-5633	9¾" x 10¾" 16Ply	200/pk

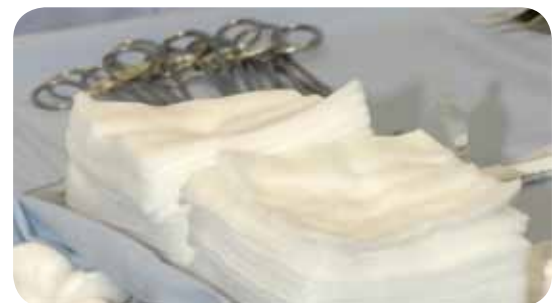

X-RAY DETECTABLE GAUZE

NON-STERILE

PRODUCT NUMBER	FEATURES	QUANTITIES
96-5615	4" x 4" 12Ply	2000/cs
96-5616	4" x 4" 16Ply	2000/cs
96-5617	4" x 4" 32Ply	2000/cs
96-5618	4" x 8" 12Ply	2000/cs
96-5691	4" x 8" 16Ply	1000/cs
96-5619	4" x 8" 24Ply	1000/cs





COHESIVE BANDAGES

NON-STERILE / LATEX-FREE

PRODUCT NUMBER	FEATURES	QUANTITIES
96-1340	1" Dark Blue	30 rolls/cs
96-1341	1" White	30 rolls/cs
96-1342	1" Tan	30 rolls/cs
96-1343	1" Assorted	30 rolls/cs
96-1344	2" Dark Blue	36 rolls/cs
96-1345	2" White	36 rolls/cs
96-1346	2" Tan	36 rolls/cs
96-1347	2" Assorted	36 rolls/cs
96-1348	3" Dark Blue	24 rolls/cs
96-1349	3" White	24 rolls/cs
96-1350	3" Tan	24 rolls/cs
96-1351	3" Assorted	24 rolls/cs



TOURNIQUETS

NON-STERILE / LATEX-FREE

PRODUCT NUMBER	FEATURES	QUANTITIES
96-8933	1" x 18" Flat / Boxed	250/bx, 4bx/cs, 1000/cs
96-8934	1" x 18" Roll / Banded	100/bx, 12bx/cs, 1200/cs
96-1159	1" x 18" Reel / Perforated	25/bx, 20bx/cs, 500/cs



N-I TOURNIQUETS

NON-STERILE / LATEX FREE

PRODUCT NUMBER	FEATURES	QUANTITIES
40-1915	Complete, Black	1 Each
40-1916	Black Tubing Only	1 Each
40-1917	Clip Only	1 Each





ESMARK BANDAGE KITS

STERILE / LATEX

PRODUCT NUMBER	FEATURES	QUANTITIES
96-1792	3" x 9'	20/cs
96-1793	3" x 12'	20/cs
96-1794	4" x 9'	20/cs
96-1795	4" x 12'	20/cs
96-1796	6" x 9'	20/cs
96-1797	6" x 12'	20/cs

STERILE / LATEX-FREE

96-1649	3" x 9'	20/cs
96-1680	3" x 12'	20/cs
96-1650	4" x 9'	20/cs
96-1651	4" x 12'	20/cs
96-1652	6" x 9'	20/cs
96-1653	6" x 12'	20/cs



**EACH ESMARK BANDAGE KIT CONTAINS:
1 BANDAGE AND 1 CSR WRAP**

SKLARLITE™

**RIGID STERILIZATION
CONTAINER SYSTEM**

**REUSEABLE RIGID CONTAINER
MADE FROM ANODIZED
ALUMINUM ALLOY AND
DESIGNED TO BE DURABLE
YET LIGHTWEIGHT.**

- **50% LIGHTER**
- **PRE-VACUUM STEAM**
- **STACKABLE BASKETS**
- **STACKABLE CONTAINERS**
- **TRANSPORTABLE**





TRIANGULAR BANDAGES

NON-STERILE

PRODUCT NUMBER	FEATURES	QUANTITIES
96-5259	40" x 40" x 56"	10/pk, 12pk/bg, 20bg/cs, 240/cs



COTTON BALLS

NON-STERILE

PRODUCT NUMBER	FEATURES	QUANTITIES
96-5700	Medium	1000/pk, 10pk/cs, 10,000/cs
96-5699	Large	500/pk, 10pk/cs, 5000/cs

STERILE

96-1669	Medium	2/pk, 50pk/cs, 100/cs
96-1670	Large	2/pk, 50pk/cs, 100/cs



RAYON SWABS

STERILE

PRODUCT NUMBER	FEATURES	QUANTITIES
96-8925	8"	2/pk, 50pk/cs, 100/cs
96-7051	8"	3/pk, 50pk/cs, 150/cs
96-8926	8"	6/pk, 50pk/cs, 300/cs

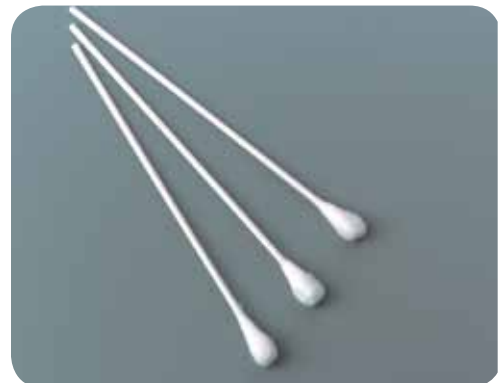

COTTON TIP APPLICATORS

STERILE

PRODUCT NUMBER	FEATURES	QUANTITIES
96-8923	3" Plastic Handle	2/pk, 50pk/bx, 10bx/cs, 1000/cs
96-8924	6" Plastic Handle	6/pk, 50pk/bx, 10bx/cs, 3000/cs
96-8936	3" Wooden Handle	2/pk, 50pk/bx, 10bx/cs, 1000/cs
96-8937	6" Wooden Handle	6/pk, 50pk/bx, 10bx/cs, 3000/cs





SKLAR DISPOSABLE FACE MASKS

The Sklar Disposable Face Mask is offered in the most popular style to meet clinical requirements in the operating room, general medicine, or any other areas requiring facial protection. Protecting against infectious pathogens, Sklar masks are $\geq 98\%$ BFE, non-woven, soft and breathable. Convenient ear loops and adjustable nose-bridge ensure a proper fit. Latex Free.



NON-STERILE

PRODUCT NUMBER	FEATURES	QUANTITIES
96-5557	Mask Earloop, Blue	50/bx
96-5557A	Mask Earloop, Blue	500/cs
96-5557BNS	Mask Earloop, Blue, Bulk	2000/cs

SKLAR SURGICAL GOWNS

NON-REINFORCED

NON-STERILE

PRODUCT NUMBER	FEATURES	QUANTITIES
96-5329	Non-Reinforced, Large	40/cs
96-5331	Non-Reinforced, X-Large	40/cs
96-5333	Non-Reinforced, XX-Large	40/cs

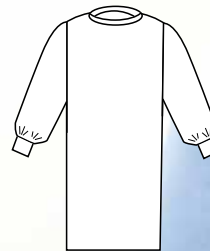

NON-REINFORCED

REINFORCED CHEST AND SLEEVE

NON-STERILE

PRODUCT NUMBER	FEATURES	QUANTITIES
96-5335	Reinforced, Large	25/cs
96-5337	Reinforced, X-Large	25/cs
96-5339	Reinforced, XX-Large	25/cs



REINFORCED CHEST AND SLEEVE

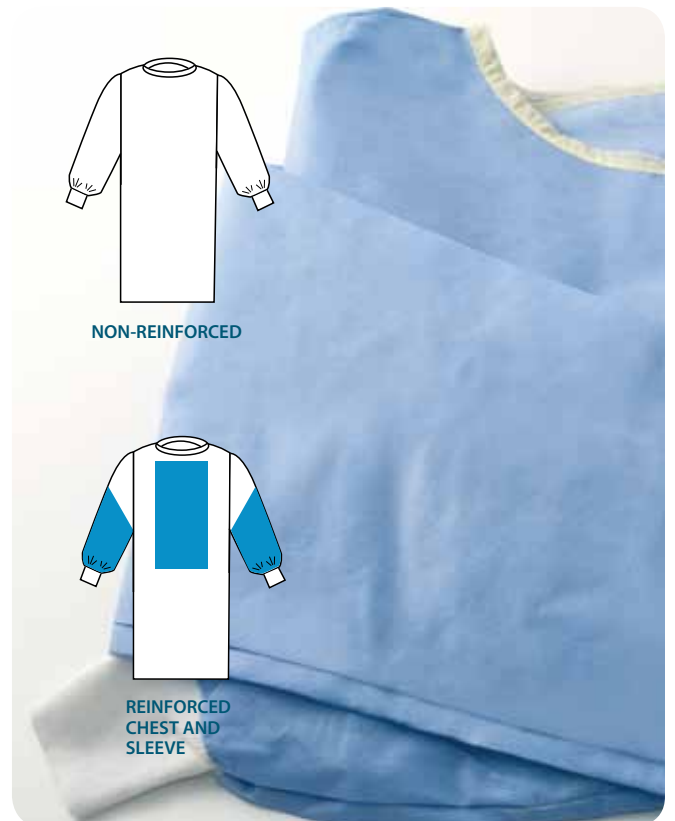



DISPOSABLE PRODUCTS

SKLAR OR TOWELS

STERILE

PRODUCT NUMBER	QUANTITIES
96-1662	2/pk, 50pk/cs, 100/cs
96-1621	4/pk, 20pk/cs, 80/cs
96-8939	6/pk, 12pk/cs, 72/cs
96-8938	8/pk, 10pk/cs, 80/cs

BULK, NON-STERILE

96-5627	100 Towels
---------	------------



SKLAR OR TOWELS, FENESTRATED

STERILE

PRODUCT NUMBER	QUANTITIES
96-7548	1/pk, 25pk/cs, 25/cs
96-8948	2/pk, 50pk/cs, 100/cs
96-8940	4/pk, 20pk/cs, 80/cs
96-8941	6/pk, 12pk/cs, 72/cs
96-8942	8/pk, 10pk/cs, 80/cs



SKLAR PURCOTTON OR TOWELS

100% COTTON WEAVE

FEATURES AND BENEFITS

- 100% pure cotton with natural feel.
- Less abrasive to wounds.
- Superior absorbency rate.
- Biodegradable and environmentally friendly.
- Compact for shipping & storage.

STERILE

PRODUCT NUMBER	QUANTITIES
96-1940	2/pk, 50pk/cs, 100/cs
96-1942	4/pk, 20pk/cs, 80/cs
96-1944	6/pk, 12pk/cs, 72/cs
96-1946	8/pk, 10pk/cs, 80/cs

BULK, NON-STERILE

96-1949	420 Towels
---------	------------





SKLAR SURGICAL SKIN MARKER

Sklar Surgical Skin markers are designed to allow the surgeon to conveniently demarcate selected sites prior to or during surgical procedures. Latex free.

Scrub resistant ink • Durable tip • Non-smearing

STERILE

PRODUCT NUMBER	FEATURES	QUANTITIES
10-1440	Fine/Regular Tip, Scrub Resistant	50/bx



YANKAUER SUCTION TUBE

The Sklar Yankauer is a rigid, curved, one-piece design, made from a blend of clear, blue-tinted, shatterproof plastic. Edges are smooth and clean, with no flash or parting lines. Clear tips permit visual monitoring of suction fluids. A ribbed, universal connector fits securely on all types of tubing. Sklar Yankauers are available with or without a suction control vent.

STERILE

PRODUCT NUMBER	FEATURES	QUANTITIES
96-4174	Vented	10/bx
96-4175	Non-Vented	10/bx
NON-STERILE		
96-4171	Vented	50/cs
96-4172	Non-Vented	50/cs



SUCTION CONNECTING TUBE

Choose from several lengths. Durable 5 or 6 mm inner diameter tubing withstands heavy duty suctioning. Each end has two soft female connectors that securely fit any male connector.

STERILE

PRODUCT NUMBER	FEATURES	QUANTITIES
96-5620	3/16" x 6'	50/cs
96-5621	3/16" x 10'	50/cs
96-5622	3/16" x 12'	50/cs
96-5623	1/4" x 6'	50/cs
96-5624	1/4" x 10'	50/cs
96-5625	1/4" x 12'	50/cs





SKLARSAFE™ SAFETY SCALPEL

- Protective, transparent sheath can be opened, closed, and locked with a single hand.
- Precision stainless steel blade made in England.
- Sturdy, "sure-grip" handle.
- Audible "click" when sheath advanced to locked position.
- OSHA compliant.
- Individually sealed in sturdy film and Tyvek® pack.

STERILE

PRODUCT NUMBER	FEATURES	QUANTITIES
06-3094	#10	10/bx
06-3095	#11	10/bx
06-3096	#15	10/bx

BULK, NON-STERILE

06-3130	#10	500/cs
06-3132	#11	500/cs
06-3134	#15	500/cs



**SKLAR CERVIX BRUSH
CERVICAL CELL SAMPLER**

Sklar's Cervix Brush is made of polyethylene and has a total length of 20 centimeters. The top portion uses a soft flexible brush to obtain cell samples. The brush consists of 57 semi-circular plastic bristles of various lengths. The shape is such that the top edges of the brush follow the contours of the cervix. The longer middle bristles reach deep into the endocervical canal. The shorter bristles touch both the ectocervical area and transformation zone at the same time.

STERILE

PRODUCT NUMBER	QUANTITIES
96-4140	100/cs

NON-STERILE

96-4140NS	100/cs
-----------	--------

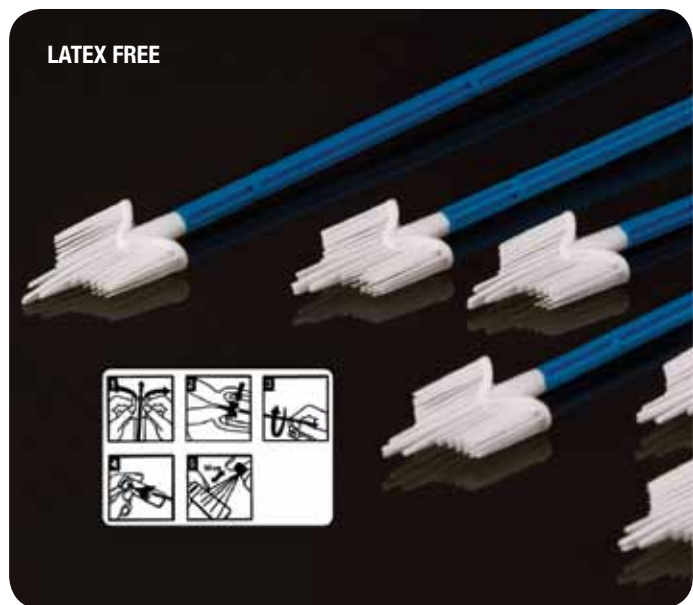



SKLAR BLADES AND SCALPELS



BLADES, STAINLESS STEEL

STERILE

PRODUCT NUMBER	FEATURES	QUANTITIES
06-3100	#10	100/box
06-3101	#11	100/box
06-3102	#12	100/box
06-3103	#15	100/box
06-3108	#15C	100/box
06-3104	#20	100/box
06-3105	#21	100/box
06-3106	#22	100/box
06-3107	#23	100/box

BLADES, CARBON STEEL

STERILE

PRODUCT NUMBER	FEATURES	QUANTITIES
06-3010	#10	100/box
06-3011	#11	100/box
06-3012	#12	100/box
06-3013	#12D	100/box
06-3015	#15	100/box
06-3016	#15C	100/box
06-3020	#20	100/box
06-3021	#21	100/box
06-3022	#22	100/box
06-3023	#23	100/box

SCALPELS, DISPOSABLE

STERILE

PRODUCT NUMBER	FEATURES	QUANTITIES
06-3110	#10	10/box
06-3111	#11	10/box
06-3112	#12	10/box
06-3115	#15	10/box
06-3120	#20	10/box
06-3121	#21	10/box
06-3122	#22	10/box
06-3123	#23	10/box





SKLAR DISPOSABLE EAR CURETTES



STERILE

PRODUCT NUMBER	FEATURES	QUANTITIES
96-1002	Cup	50/bx
96-1007	Loop	50/bx
96-1022	Small Ring Tip	50/bx
96-1012	Medium Ring Tip	50/bx
96-1017	Large Ring Tip	50/bx
96-1036	Assorted, 10 each	50/bx

NON-STERILE

PRODUCT NUMBER	FEATURES	QUANTITIES
96-1001	Cup	50/bx
96-1006	Loop	50/bx
96-1031	Spoon	50/bx
96-1021	Small Ring Tip	50/bx
96-1011	Medium Ring Tip	50/bx
96-1016	Large Ring Tip	50/bx
96-1035	Assorted, 10 each (no Pedi Ring Tip)	50/bx

NON-STERILE

PRODUCT NUMBER	FEATURES	QUANTITIES
96-1000	Cup	12/pk
96-1005	Loop	12/pk
96-1030	Spoon	12/pk
96-1020	Small Ring Tip	12/pk
96-1010	Medium Ring Tip	12/pk
96-1015	Large Ring Tip	12/pk

SKLAR DISPOSABLE DERMAL CURETTES SURGICAL STEEL TIPS



STERILE

PRODUCT NUMBER	FEATURES	QUANTITIES
96-1190	2 mm	25/bx
96-1192	3 mm	25/bx
96-1194	4 mm	25/bx
96-1196	5 mm	25/bx
96-1198	7 mm	25/bx
96-1199	Assorted, 5 each	25/bx



LATEX FREE

SKLAR TRU-PUNCH™ DISPOSABLE VULVAR BIOPSY PUNCH

The Sklar Tru-Punch has a seamless steel tip carefully honed for a razor sharp incision and perfect sample. The ribbed and hollow handle permits tissue to be easily dislodged. Latex free.

STERILE			STERILE		
PRODUCT NUMBER	DESCRIPTION	QUANTITY	PRODUCT NUMBER	DESCRIPTION	QUANTITY
96-0192	1mm	25/bx	96-1092	1mm	50/bx
96-1097	1.5mm	25/bx	96-1098	1.5mm	50/bx
96-1140	2mm	25/bx	96-1100	2mm	50/bx
96-0102	2.5mm	25/bx	96-1102	2.5mm	50/bx
96-1142	3mm	25/bx	96-1105	3mm	50/bx
96-1144	3.5mm	25/bx	96-1110	3.5mm	50/bx
96-1146	4mm	25/bx	96-1115	4mm	50/bx
96-1148	5mm	25/bx	96-1120	5mm	50/bx
96-1150	6mm	25/bx	96-1125	6mm	50/bx
96-1152	8mm	25/bx	96-1130	8mm	50/bx
96-1160	Assorted – 5 of each: 2, 3, 3.5, 4 & 5mm	25/bx	96-0160	Assorted – 5 of each: 2, 3, 3.5, 4 & 5mm	50/bx



SYRINGES

STERILE

PRODUCT NUMBER	DESCRIPTION	QUANTITIES
62-1659	1cc Luer-Slip	1000/cs
62-3718	3cc Luer-Lock	1000/cs
62-4707	5cc Luer-Lock	1000/cs
62-4628	5cc Luer-Slip	1000/cs
62-6707	10cc Luer-Lock	1000/cs
62-6633	10cc Luer-Slip	1000/cs
62-7701	20cc Luer-Lock	500/cs
62-7801	30cc Luer-Lock	500/cs
62-8453	60cc Luer-Lock	100/cs
62-8455	60cc Luer-Slip	100/cs
62-8454	60cc Catheter Tip	100/cs

BULK NON-STERILE

PRODUCT NUMBER	DESCRIPTION	QUANTITIES
62-1661	1cc Luer-Slip	3000/cs
62-3726	3cc Luer-Lock	5000/cs
62-3728	3cc Luer-Slip	1600/cs
62-4714	5cc Luer-Lock	3000/cs
62-4629	5cc Luer-Slip	3000/cs
62-6714	10cc Luer-Lock	1800/cs
62-6716	10cc Luer-Slip	1800/cs
62-7706	20cc Luer-Lock	900/cs
62-7708	20cc Luer-Slip	900/cs
62-7807	30cc Luer-Lock	225/cs
62-7809	30cc Luer-Slip	225/cs
62-8465	60cc Luer-Lock	400/cs
62-8466	60cc Luer-Slip	400/cs
62-8464	60cc Catheter Tip	400/cs

SYRINGES WITH NEEDLE



STERILE

PRODUCT NUMBER	DESCRIPTION	QUANTITIES
62-3715	3cc Luer-Lock, 20 Gauge x 1" Needle	1000/cs
62-3716	3cc Luer-Lock, 20 Gauge x 1½" Needle	1000/cs
62-3711	3cc Luer-Lock, 21 Gauge x 1" Needle	1000/cs
62-3713	3cc Luer-Lock, 21 Gauge x 1½" Needle	1000/cs
62-3702	3cc Luer-Lock, 22 Gauge x 5/8" Needle	1000/cs
62-3708	3cc Luer-Lock, 22 Gauge x 1" Needle	1000/cs
62-3710	3cc Luer-Lock, 22 Gauge x 1½" Needle	1000/cs
62-3706	3cc Luer-Lock, 23 Gauge x 1" Needle	1000/cs
62-3703	3cc Luer-Lock, 25 Gauge x 1" Needle	1000/cs
62-4705	5cc Luer-Lock, 20 Gauge x 1" Needle	1000/cs
62-4706	5cc Luer-Lock, 20 Gauge x 1½" Needle	1000/cs
62-4703	5cc Luer-Lock, 21 Gauge x 1" Needle	1000/cs
62-4704	5cc Luer-Lock, 21 Gauge x 1½" Needle	1000/cs
62-6705	10cc Luer-Lock, 20 Gauge x 1" Needle	1000/cs
62-6706	10cc Luer-Lock, 20 Gauge x 1½" Needle	1000/cs
62-6703	10cc Luer-Lock, 21 Gauge x 1" Needle	1000/cs
62-6704	10cc Luer-Lock, 21 Gauge x 1½" Needle	1000/cs



WASTE CAN LINERS

Designed for non-medical waste disposal, Waste Can Liners are used throughout animal health facilities to collect and contain refuse. Bags are available in a wide variety of sizes and film gauges to meet your specific application.

Choose the right plastic types:

- LLDPE (Linear Low Density Polyethylene) provides maximum puncture and tear resistance under tough transport conditions and is best suited for handling objects with sharper edges.
- HDPE (High Density Polyethylene) provides high resistance to puncturing, durability and greater load capacity for paper or non-sharp objects under moderate transport conditions.

All bags are designed with Star Seals to eliminate gaps, maximize carrying capacity and minimize leaks. Conveniently offered in flat packs or coreless rolls for easy dispensing.

PRODUCT NUMBER	FEATURES	SIZE	GAUGE	CAPACITY	QUANTITIES
10-6000	HDPE, Natural	24" x 33"	8 MIC	12-16 Gallon	50/Roll, 20 Rolls/cs
10-6005	HDPE, Natural	30" x 37"	10 MIC	20-30 Gallon	25/Roll, 20 Rolls/cs
10-6025	HDPE, Natural	33" x 40"	12 MIC	33 Gallon	25/Roll, 10 Rolls/cs
10-6045	HDPE, Natural	40" x 48"	13 MIC	40-45 Gallon	25/Roll, 10 Rolls/cs
10-6055	HDPE, Natural	40" x 48"	16 MIC	40-45 Gallon	25/Roll, 10 Rolls/cs
10-6060	HDPE, Natural	40" x 48"	17 MIC	40-45 Gallon	25/Roll, 10 Rolls/cs
10-6080	LLDPE, Clear	30" x 36"	0.8 MIL	20-30 Gallon	250 Flat/cs
10-6085	LLDPE, Clear	33" x 39"	0.6 MIL	33 Gallon	150 Flat/cs
10-6090	LLDPE, Clear	40" x 46"	0.8 MIL	40-45 Gallon	125 Flat/cs
10-6095	LLDPE, Clear	38" x 45"	1.0 MIL	44 Gallon	125 Flat/cs
10-6120	LLDPE, Super Heavy, Gray	40" x 46"	1.1 MIL	40-45 Gallon	125 Flat/cs
10-6125	LLDPE, Super Heavy, Clear	43" x 47"	1.1 MIL	56 Gallon	100 Flat/cs

LINEN BAGS



PRODUCT NUMBER	DESCRIPTION	QUANTITIES
10-6155	Printed: Soiled Linen, Blue, 30" x 43", 20 Gallon	200/cs

RECLOSABLE BAGS

PRODUCT NUMBER	DESCRIPTION	QUANTITIES
10-6390	6" x 6", 2 MIL, Clear	1000/cs
10-6395	6" x 8", 2MIL, Clear	1000/cs
10-6405	8" x 10", 2MIL, Clear	1000/cs



APPLICATOR PREP STICK

STERILE

PRODUCT NUMBER	FEATURES	QUANTITIES
96-7040	6"	2/pk, 50pk/cs, 100/cs

LATEX FREE

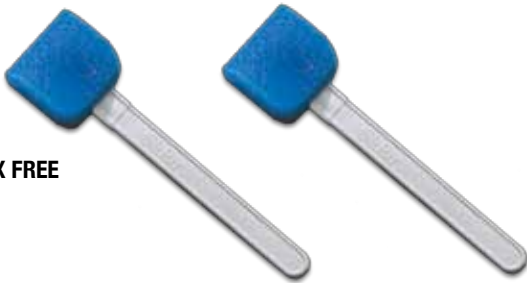

ANGLED SPONGE STICK

STERILE

PRODUCT NUMBER	QUANTITIES
96-7187	2/pk, 50pk/cs, 100/cs

LATEX FREE



BULB IRRIGATION SYRINGE, 60 CC

STERILE

PRODUCT NUMBER	QUANTITIES
96-8989	50/cs

LATEX FREE



PISTON IRRIGATION SYRINGE, 60 CC

STERILE

PRODUCT NUMBER	QUANTITIES
96-8990	50/cs



EAR / ULCER SYRINGES

STERILE

PRODUCT NUMBER	FEATURES	QUANTITIES
96-9321	1 oz.	50/cs
96-9256	2 oz.	50/cs
96-9257	3 oz.	50/cs



LATEX FREE

PLASTIC RULER

STERILE

PRODUCT NUMBER	FEATURES	QUANTITIES
96-1674	6", US/Metric Scale	100/cs

TAPE MEASURE, PAPER

STERILE

PRODUCT NUMBER	FEATURES	QUANTITIES
96-7635	36", US/Metric Scale	25/cs

DENTAL MIRROR

STERILE

PRODUCT NUMBER	FEATURES	QUANTITIES
96-7887	14mm, #1	50/cs

NON-STERILE

96-2452	14mm, #1	144/cs
---------	----------	--------

LATEX FREE
PLASTIC NOSE CLIP

STERILE

PRODUCT NUMBER	FEATURES	QUANTITIES
96-2951	Foam	100/cs

NON-STERILE

96-2950	Foam	100/cs
---------	------	--------

LATEX FREE
PLASTIC TOWEL CLAMP

STERILE

PRODUCT NUMBER	FEATURES	QUANTITIES
96-5655	2½"	50/cs

NON-STERILE

96-5655BNS	Non-Sterile	5000/cs
------------	-------------	---------

LATEX FREE
SAFETY PINS

STERILE

PRODUCT NUMBER	FEATURES	QUANTITIES
96-8105	#1, 1 1/16"	2/pk, 50pk/cs, 100/cs
96-1667	#2, 1 1/2"	2/pk, 50pk/cs, 100/cs
96-1668	#3, 2"	2/pk, 50pk/cs, 100/cs





DISPOSABLE PRODUCTS

RUBBER BANDS

STERILE

PRODUCT NUMBER	FEATURES	QUANTITIES
96-1671	#16	2/pk, 50pk/cs, 100/cs
96-5906	#18	2/pk, 50pk/cs, 100/cs
96-1672	#31	2/pk, 50pk/cs, 100/cs
96-1673	#32	2/pk, 50pk/cs, 100/cs
96-5908	#64	2/pk, 25pk/cs, 50/cs



PLASTIC PREP RAZOR

STERILE

PRODUCT NUMBER	QUANTITIES
96-2956	100/cs

NON-STERILE

96-2955	100/cs
---------	--------



SKIN STAPLE REMOVER

STERILE

PRODUCT NUMBER	QUANTITIES
96-8949	100/cs



BLADE REMOVER

STERILE

PRODUCT NUMBER	QUANTITIES
96-7460	100/cs



TOOTHBRUSH

NON-STERILE

PRODUCT NUMBER	FEATURES	QUANTITIES
96-2445	Pre-Pasted	144/cs





LATEX EXAM GLOVES

POWDER FREE NON-STERILE

PRODUCT NUMBER	SIZE	QUANTITIES
96-2168	Extra Small	100/Box
96-3168	Extra Small	1000/Box
96-2160	Small	100/Box
96-3160	Small	1000/Box
96-2162	Medium	100/Box
96-3162	Medium	1000/Box
96-2164	Large	100/Box
96-3164	Large	1000/Box
96-2166	Extra Large	100/Box
96-3166	Extra Large	1000/Box

POWDERED NON-STERILE

PRODUCT NUMBER	SIZE	QUANTITIES
96-2181	Extra Small	100/Box
96-3179	Extra Small	1000/Box
96-2180	Small	100/Box
96-3180	Small	1000/Box
96-2182	Medium	100/Box
96-3182	Medium	1000/Box
96-2184	Large	100/Box
96-3184	Large	1000/Box
96-2186	Extra Large	100/Box
96-3186	Extra Large	1000/Box

VINYL EXAM GLOVES

POWDERED FREE NON-STERILE, LATEX FREE

PRODUCT NUMBER	SIZE	QUANTITIES
96-1161	Extra Small	100/Box
96-1162	Small	100/Box
96-1163	Medium	100/Box
96-1164	Large	100/Box
96-1175	Extra Large	100/Box



NITRILE EXAM GLOVES

POWDER FREE NON-STERILE

PRODUCT NUMBER	SIZE	QUANTITIES
96-2190	Small	100/Box
96-3190	Small	1000/Box
96-2192	Medium	100/Box
96-3192	Medium	1000/Box
96-2194	Large	100/Box
96-3194	Large	1000/Box
96-2196	Extra Large	100/Box
96-3196	Extra Large	1000/Box
96-2198	Extra, Extra Large	100/Bx
96-3198	Extra, Extra Large	1000/Box

POWDERED NON-STERILE

PRODUCT NUMBER	SIZE	QUANTITIES
96-2170	Small	100/Box
96-3170	Small	1000/Box
96-2172	Medium	100/Box
96-3172	Medium	1000/Box
96-2174	Large	100/Box
96-3174	Large	1000/Box
96-2176	Extra Large	100/Box
96-3176	Extra Large	1000/Box
96-2178	Extra, Extra Large	100/Bx
96-3178	Extra, Extra Large	1000/Box



All Sklar Stainless Steelware is produced according to the strictest standards to ensure superior performance and durability.

*All products are packaged individually. Select products are available in bulk. To order larger quantities, simply add the package quantity to the end of the product number when ordering, ie. 10-1670-12 for 12/cs or 10-1670-48 for 48/cs.

IODINE CUP*

PRODUCT NUMBER	DESCRIPTION	QUANTITIES
10-1670	6 oz., 3 ⁷ / ₁₆ " x 2"	1, 12, 24 or 48/cs
10-1671	14 oz., 4 ³ / ₈ " x 2 ⁵ / ₈ "	1, 12, 24 or 48/cs

MEDICINE CUP*

PRODUCT NUMBER	DESCRIPTION	QUANTITIES
10-1675	2 oz., 2 ¹ / ₈ " x 2" Graduated Measure	1, 12, 24 or 48/cs

TUMBLER*

PRODUCT NUMBER	DESCRIPTION	QUANTITIES
10-1536	2 ⁷ / ₈ " x 3 ¹ / ₈ "	1, 12/cs

PITCHER / BEAKER*

PRODUCT NUMBER	DESCRIPTION	QUANTITIES
10-1172	125ml, 2 ¹ / ₈ " x 2 ⁵ / ₈ " w/o Handle	1 Each
10-1173	250ml, 2 ⁵ / ₈ " x 3 ¹ / ₄ " w/o Handle	1 Each
10-1174	600ml, 3 ³ / ₈ " x 4 ⁵ / ₈ " w/o Handle	1 Each
10-1176	2000ml, 4 ⁷ / ₈ " x 7 ¹ / ₈ " w/o Handle	1 Each
10-1177	3000ml, 5 ¹ / ₂ " x 8 ¹ / ₄ " w/o Handle	1 Each
10-1178	4000ml, 6 ¹ / ₈ " x 8 ⁷ / ₈ " w/o Handle	1 Each
10-1175	1200ml, 4 ¹ / ₈ " x 6 ¹ / ₈ " with closed Handle	1 Each
10-1539	2000ml, 5 ¹ / ₁₆ " x 6 ⁵ / ₈ " with closed Handle	1, 6 or 12/cs
10-1180	3000ml, 6 ¹ / ₁₆ " x 7" with closed Handle	1 Each
10-1181	4000ml, 6 ⁷ / ₈ " x 8 ⁷ / ₈ " with closed Handle	1 Each



GRADUATED MEASURE*

PRODUCT NUMBER	DESCRIPTION	QUANTITIES
10-1552	16 oz., 3 $\frac{3}{4}$ " x 4 $\frac{5}{8}$ "	1, 6 or 12/cs
10-1510	32 oz., 4 $\frac{3}{4}$ " x 5 $\frac{1}{4}$ "	1, 6 or 12/cs
10-1674	64 oz., 5 $\frac{1}{2}$ " x 6 $\frac{1}{2}$ "	1, 6 or 12cs

MIXING/SOLUTION BOWLS*

PRODUCT NUMBER	DESCRIPTION	QUANTITIES
10-1488	$\frac{7}{8}$ qt., 6 $\frac{5}{8}$ " x 2 $\frac{1}{2}$ "	1 or 12/cs
10-1491	1 $\frac{1}{8}$ qt., 8 $\frac{1}{8}$ " x 3"	1 or 12/cs
10-1492	3 qt., 9 $\frac{3}{4}$ " x 4"	1 or 12/cs
10-1493	5 qt., 11 $\frac{7}{8}$ " x 4 $\frac{1}{2}$ "	1 or 12/cs
10-1494	6 $\frac{3}{4}$ qt., 12 $\frac{3}{4}$ " x 5 $\frac{1}{4}$ "	1, 6 or 12/cs
10-1495	8 qt., 13 $\frac{5}{16}$ " x 5 $\frac{7}{16}$ "	1, 6 or 12/cs

SPONGE BOWLS*

PRODUCT NUMBER	DESCRIPTION	QUANTITIES
10-1496	12 oz., 4 $\frac{1}{4}$ " x 2"	1 or 12/cs
10-1498	22 oz., 5" x 2 $\frac{3}{8}$ "	1 or 12/cs
10-1484	29 oz., 5 $\frac{5}{16}$ " x 2 $\frac{9}{16}$ "	1 or 12/cs
10-1485	36 oz., 6 $\frac{1}{4}$ " x 2 $\frac{3}{4}$ "	1 or 12/cs
10-1483	48 oz., 7 $\frac{1}{8}$ " x 2 $\frac{3}{4}$ "	1 or 12/cs
10-1486	64 oz., 7 $\frac{9}{16}$ " x 3"	1 or 12/cs

SOLUTION BASINS*

PRODUCT NUMBER	DESCRIPTION	QUANTITIES
10-1489	4 $\frac{1}{2}$ qt., 12" x 4 $\frac{1}{4}$ "	1 or 12/cs
10-1505	7 qt., 13 $\frac{5}{8}$ " x 4 $\frac{5}{8}$ "	1, 6 or 12/cs
10-1507	9 $\frac{1}{2}$ qt., 14 $\frac{1}{2}$ " x 5"	1, 6 or 12/cs



*All products are packaged individually. Select products are available in bulk. To order larger quantities, simply add the package quantity to the end of the product number when ordering, ie. 10-1670-12 for 12/cs or 10-1670-48 for 48/cs.

EMESIS BASINS*

PRODUCT NUMBER	DESCRIPTION	QUANTITIES
10-1497	10 oz., 6 ⁵ / ₈ " x 3 ¹ / ₂ " x 1 ¹ / ₂ "	1 or 12/cs
10-1698	12 oz., 8 ¹ / ₈ " x 3 ³ / ₈ " x 1 ⁵ / ₈ "	1 or 12/cs
10-1699	26 oz., 9 ⁷ / ₈ " x 4 ¹ / ₂ " x 2 ¹ / ₈ "	1 or 12/cs
10-1487	48 oz., 12 ¹ / ₈ " x 5 ³ / ₄ " x 2 ¹ / ₄ "	1 Each

HOSPITAL BUCKETS

PRODUCT NUMBER	DESCRIPTION	QUANTITIES
10-1182	13 qt., 11 ⁵ / ₈ " x 9 ¹ / ₄ " w/o lid	1 Each
10-1450	13 qt., 11 ⁵ / ₈ " x 9 ¹ / ₄ " with lid	1 Each
10-1183	16 qt., 11 ³ / ₄ " x 10 ¹ / ₈ " w/o lid	1 Each
10-1451	16 qt., 11 ³ / ₄ " x 10 ¹ / ₈ " with lid	1 Each
10-1184	20 qt., 13 ³ / ₄ " x 11 ¹³ / ₁₆ " w/o lid	1 Each

HOSPITAL KICK BUCKET WITHOUT LID

PRODUCT NUMBER	DESCRIPTION	QUANTITIES
10-1551	13 qt., 11 ⁵ / ₈ " x 9 ¹ / ₄ "	1 Each

STORAGE CONTAINERS*

PRODUCT NUMBER	DESCRIPTION	QUANTITIES
10-1540	1/2 gal., 5 ⁷ / ₁₆ " x 6 ⁵ / ₈ " no handles	1, 6 or 12/cs
10-1186	3 gal., 10 ³ / ₁₆ " x 9"	1 Each
10-1188	4 gal., 13" x 9"	1 Each
10-1189	5 gal., 13" x 11"	1 Each
10-1190	6 gal., 13" x 13"	1 Each



*All products are packaged individually. Select products are available in bulk. To order larger quantities, simply add the package quantity to the end of the product number when ordering, ie. 10-1670-12 for 12/cs or 10-1670-48 for 48/cs.

DRESSING JAR WITH LID*

PRODUCT NUMBER	DESCRIPTION	QUANTITIES
10-1523	½ qt., 4½" x 2¼"	1 or 12/cs
10-1533	1¼ qt., 4" x 5"	1 or 12/cs
10-1538	1⅞ qt., 4⅞" x 6¼"	1 or 12/cs
10-1527	3 qt., 5⅞" x 6¾"	1 or 12/cs
10-1543	4¾ qt., 6¾" x 7¾"	1 or 12/cs
10-1544	6 qt., 7¼" x 8⅜"	1, 6 or 12/cs
10-1547	8 qt., 8" x 9⅝"	1, 6 or 12/cs

FORCEP/THERMOMETER JAR*

PRODUCT NUMBER	DESCRIPTION	QUANTITIES
10-1550	1½" x 3"	1, 6 or 12/cs
10-1541	2¼" x 4½"	1, 6 or 12/cs
10-1545	2¼" x 7"	1, 6 or 12/cs

FUNNELS WITH HANGING HOOK

PRODUCT NUMBER	DESCRIPTION	QUANTITIES
10-1157	2¾ oz., 3" x 3¾"	1 Each
10-1158	6⅞ oz., 4⅞" x 4⅞"	1 Each
10-1159	13 oz., 5⅞" x 5⅞"	1 Each
10-1160	22¼ oz., 6¼" x 6⅝"	1 Each
10-1170	32 oz., 7" x 8⅜"	1 Each
10-1171	64 oz., 8⅝" x 9½"	1 Each

LAB / UTILITY SCOOP

PRODUCT NUMBER	DESCRIPTION	QUANTITIES
10-1192	5 oz., 5" x 2½" (Overall length 9½")	1 Each



*All products are packaged individually. Select products are available in bulk. To order larger quantities, simply add the package quantity to the end of the product number when ordering, ie. 10-1670-12 for 12/cs or 10-1670-48 for 48/cs.

OINTMENT JAR WITH LID*

PRODUCT NUMBER	DESCRIPTION	QUANTITIES
10-1525	9 oz., 3 1/8" x 2 3/4"	1 or 12/cs

MINI TRAY WITH LID

PRODUCT NUMBER	DESCRIPTION	QUANTITIES
10-1768	8 1/2" x 3" x 1 1/2"	1 Each



SKLAR DISINFECTANT™ SURFACE WIPES

READY-TO-USE, PRE-MOISTENED TOWELETTES

2 MINUTE KILL TIME!

**SAME EFFECTIVE FORMULA AS
SKLAR DISINFECTANT!**

- Ready to use, non-toxic formula.
- Specially formulated for the control of cross contamination.
- Effective against H1N1, MRSA, Salmonella, Parvo, Feline Leukemia, Herpes Simplex, Distemper, Ringworm, Strangles.
- Safe for all areas of the facility.
- Satisfies OSHA's Bloodborne Pathogen Standards.
- Destroys odor-causing bacteria.
- 7" x 10" non-woven, tear resistant towelette.
- Clean scent.
- EPA registered.

PRODUCT NUMBER	DESCRIPTION	QUANTITIES
10-1616	100 Towelettes/Canister	6/case
10-1617	100 Towelettes/Canister	12/case





*All products are packaged individually. Instrument trays and covers are sold separately unless otherwise noted. Select products are available in bulk. To order larger quantities, simply add the package quantity to the end of the product number when ordering, ie. 10-1670-12 for 12/cs or 10-1670-48 for 48/cs.

MAYO TRAYS (SOLID)*

PRODUCT NUMBER	DESCRIPTION	QUANTITIES
10-1690	10" x 6½" x ¾"	1, 6 or 12/cs
10-1691	13⅛" x 9⅜" x ¾"	1, 6 or 12/cs
10-1692	15⅞" x 10⅝" x ¾"	1, 6 or 12/cs
10-1693	17" x 11⅞" x ¾"	1, 6 or 12/cs
10-1694	19 ⅞" x 12⅝" x ¾"	1, 6 or 12/cs
10-1695	21¼" x 16¼" x ⅞"	1, 6 or 12/cs

MAYO TRAYS (PERFORATED)*

PRODUCT NUMBER	DESCRIPTION	QUANTITIES
10-1684	10" x 6½" x ¾"	1, 6 or 12/cs
10-1685	13¾" x 9¾" x ¾"	1, 6 or 12/cs
10-1686	15⅞" x 10⅝" x ¾"	1, 6 or 12/cs
10-1687	17" x 11⅞" x ¾"	1, 6 or 12/cs
10-1688	19⅞" x 12⅝" x ¾"	1, 6 or 12/cs
10-1689	21¼" x 16¼" x ⅞"	1 or 6/cs

CATHETER INSTRUMENT TRAYS*

PRODUCT NUMBER	DESCRIPTION	COVERS	QUANTITIES
10-1955	8¾" x 3¼" x 1½"	10-1956 - Dome	1, 6 or 12/cs
10-1738	8⅞" x 5" x 2"	10-1722 - Dome	1, 6 or 12/cs
10-1760	8⅞" x 5" x 3"	10-1722 - Dome	1, 6 or 12/cs
10-1886	17¼" x 4½" x 2"	10-1887 - Flat	1, 6 or 12/cs



MESH CLEANING BASKET*

PRODUCT NUMBER	DESCRIPTION	QUANTITIES
10-1729	4¼" x 7¼" x 2"	1 Each
10-1731	6" x 9" x 3"	1 Each
10-1732	20" x 10½" x 3½"	1 Each
10-1733	9½" x 16" x 4"	1 Each
10-1734	12" x 21" x 5"	1 Each
10-1736	14" x 20" x 5"	1 or 12/cs

PERFORATED CLEANING BASKET

PRODUCT NUMBER	DESCRIPTION	QUANTITIES
10-1560	12¾" x 10¾" x 6"	1 Each

INSTRUMENT DRYING TRAYS*

PRODUCT NUMBER	DESCRIPTION	QUANTITIES
10-1876	10" x 6½" x ¾"	1, 6 or 12/cs
10-1883	13⅛" x 9⅜" x ¾"	1, 6 or 12/cs
10-1884	15⅞" x 10⅝" x ¾"	1, 6 or 12/cs
10-1683	17" x 11⅝" x ¾"	1, 6 or 12/cs
10-1888	19⅞" x 12⅝" x ¾"	1, 6 or 12/cs
10-1680	21¼" x 16¼" x ⅞"	1, 6 or 12/cs



*All products are packaged individually. Select products are available in bulk. To order larger quantities, simply add the package quantity to the end of the product number when ordering, ie. 10-1670-12 for 12/pk or 10-1670-48 for 48/pk.

INSTRUMENT TRAYS, PERFORATED BOTTOM

PRODUCT NUMBER	DESCRIPTION	QUANTITIES
10-1740	8 ⁷ / ₈ " x 5" x 2"	1 Each
10-1874	10" x 6 ¹ / ₂ " x 2"	1 Each
10-1892	12" x 7 ³ / ₄ " x 2"	1 Each
10-1879	12" x 7 ³ / ₄ " x 2 ¹ / ₂ "	1 Each
10-1758	12 ³ / ₄ " x 10 ¹ / ₂ " x 2 ¹ / ₂ "	1 Each
10-1862	12 ³ / ₄ " x 10 ¹ / ₂ " x 4"	1 Each
10-1894	16 ¹ / ₂ " x 10" x 2 ¹ / ₂ "	1 Each
10-1895	20 ³ / ₄ " x 12 ³ / ₄ " x 2 ¹ / ₂ "	1 Each

INSTRUMENT TRAYS, PERFORATED BOTTOM / SIDES*

PRODUCT NUMBER	DESCRIPTION	QUANTITIES
10-1757	12 ³ / ₄ " x 10 ¹ / ₂ " x 1 ¹ / ₄ "	1 Each
10-1697	12 ³ / ₄ " x 10 ¹ / ₂ " x 2 ¹ / ₂ "	1 Each
10-1943	12 ³ / ₄ " x 10 ¹ / ₂ " x 4"	1 Each
10-1944	12 ³ / ₄ " x 10 ¹ / ₂ " x 6"	1 Each
10-1941	20 ³ / ₄ " x 12 ³ / ₄ " x 1 ¹ / ₄ "	1 Each
10-1759	20 ³ / ₄ " x 12 ³ / ₄ " x 2 ¹ / ₂ "	1 Each
10-1949	20 ³ / ₄ " x 12 ³ / ₄ " x 4"	1, 6 or 12/cs
10-1942	20 ³ / ₄ " x 12 ³ / ₄ " x 6"	1 Each

INSTRUMENT TRAYS, SOLID*

PRODUCT NUMBER	DESCRIPTION	COVERS	QUANTITIES
10-1755	6 ⁷ / ₈ " x 4 ¹ / ₄ " x 2"	10-1737	1, 6 or 12/cs
10-1741	6 ⁷ / ₈ " x 6 ³ / ₈ " x 4" Heavyweight	10-1835	1 or 6/cs
10-1764	10" x 6 ¹ / ₂ " x 2"	10-1766	1 Each
10-1742	10 ³ / ₈ " x 6 ³ / ₈ " x 2 ¹ / ₂ "	10-1542	1, 6 or 12/cs
10-1877	12" x 7 ³ / ₄ " x 2 ¹ / ₄ "	10-1878	1, 6 or 12/cs
10-1744	12 ³ / ₄ " x 6 ⁷ / ₈ " x 2 ¹ / ₂ "	10-1724	1, 6 or 12/cs
10-1746	12 ³ / ₄ " x 10 ¹ / ₂ " x 2 ¹ / ₂ "	10-1882	1, 6 or 12/cs
10-1950	12 ³ / ₄ " x 10 ¹ / ₂ " x 2 ¹ / ₂ " Heavyweight	10-1882	1, 6 or 12/cs
10-1747	12 ³ / ₄ " x 10 ¹ / ₂ " x 4"	10-1882	1, 6 or 12/cs
10-1952	12 ³ / ₄ " x 10 ¹ / ₂ " x 4" Heavyweight	10-1882	1, 6 or 12/cs
10-1870	12 ³ / ₄ " x 10 ¹ / ₂ " x 6"	10-1882	1, 6 or 12/cs
10-1753	13 ⁷ / ₈ " x 12 ⁷ / ₈ " x 2 ¹ / ₂ "	10-1754	1, 6 or 12/cs
10-1748	16 ¹ / ₂ " x 10" x 2 ¹ / ₂ "	10-1756	1, 6 or 12/cs
10-1749	16 ¹ / ₂ " x 10" x 4"	10-1756	1 Each
10-1953	20 ³ / ₄ " x 12 ³ / ₄ " x 2 ¹ / ₂ " Heavyweight	10-1535	1, 6 or 12/cs
10-1954	20 ³ / ₄ " x 12 ³ / ₄ " x 4" Heavyweight	10-1535	1, 6 or 12/cs
10-1948	20 ³ / ₄ " x 12 ³ / ₄ " x 6"	10-1535	1, 6 or 12/cs



*All products are packaged individually. Instrument trays and covers are sold separately unless otherwise noted. Select products are available in bulk. To order larger quantities, simply add the package quantity to the end of the product number when ordering, ie. 10-1670-12 for 12/cs or 10-1670-48 for 48/cs.

STERILIZATION TRAY / BATH SETS

PRODUCT NUMBER	DESCRIPTION	QUANTITIES
10-1947	Large Set Includes:	
	Solid Tray 10-1948 20¾" x 12¾" x 6"	1
	Perforated Tray 10-1949 20¾" x 12¾" x 4"	1
	Cover 10-1535 20¾" x 12¾"	1
10-1679	Small Set Includes:	
	Solid Tray 10-1747 12¾" x 10½" x 4"	1
	Perforated Tray 10-1697 12¾" x 10½" x 2½"	1
	Cover 10-1882 12¾" x 10½"	1

STERILIZATION TRAYS*

PRODUCT NUMBER	DESCRIPTION	COVERS	QUANTITIES
10-1850	4 qt., 12¾" x 10½" x 2½"	10-1864	1 Each
10-1860	7 qt., 12¾" x 10½" x 4"	10-1864	1 Each
10-1750	5 ¼ qt., 20¾" x 6¾" x 4"	10-1854	1, 6 or 12/cs
10-1752	9 qt., 20¾" x 6¾" x 6"	10-1854	1, 6 or 12/cs
10-1953	8 ½ qt., 20¾" x 12¾" x 2½", Heavyweight	10-1535	1, 6 or 12/cs
10-1954	14 ½ qt., 20¾" x 12¾" x 4", Heavyweight	10-1535	1, 6 or 12/cs
10-1948	24 qt., 20¾" x 12¾" x 6"	10-1535	1, 6 or 12/cs

PERFORATED STERILIZATION TRAYS

PRODUCT NUMBER	DESCRIPTION	QUANTITIES
10-1710	10" x 6½" x 2½"	1 Each
10-1713	10" x 10½" x 3½"	1 Each
10-1714	15" x 10½" x 3½"	1 Each
10-1720	20" x 10½" x 3½"	1 Each
10-1957	20¾" x 12¾" x 4" Mesh bottom	1 Each



*All products are packaged individually. Instrument trays and covers are sold separately unless otherwise noted. Select products are available in bulk. To order larger quantities, simply add the package quantity to the end of the product number when ordering, ie. 10-1670-12 for 12/cs or 10-1670-48 for 48/cs

LIFTING HANDLES

PRODUCT NUMBER	DESCRIPTION	QUANTITIES
10-1725	For Sterilization Trays	1 Pair

FLASH STERILIZATION TRAY

PRODUCT NUMBER	DESCRIPTION	QUANTITIES
10-1711	10" x 6½" x 2"	1 Each
10-1712	Single Handle for Flash Sterilization Tray 10-1711	1 Each

DOUBLE DECKER MICRO TRAY

PRODUCT NUMBER	DESCRIPTION	QUANTITIES
10-1717	10" x 15" x 2¼"	1 Each

MICRO TRAY WITH HINGED LID

PRODUCT NUMBER	DESCRIPTION	QUANTITIES
10-1706	8½" x 8" x 1¼" with 2½" x 2½" Compartment	1 Each
10-1707	8½" x 12" x 1⅞"	1 Each
10-1708	8½" x 14" x 1⅞"	1 Each
10-1702	10½" x 10" x 1⅞"	1 Each
10-1716	10½" x 20" x 2½" with 10½" x 5" Compartment	1 Each

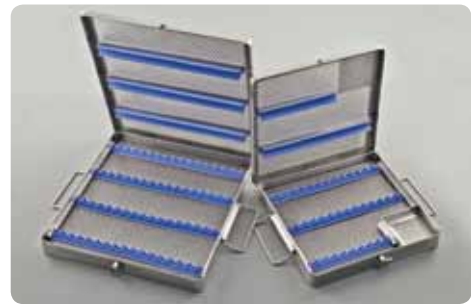

PRODUCT NUMBER	DESCRIPTION	QUANTITIES
10-1700	8½" x 8" x 1¼"	1 Each
10-1703	10½" x 15" x 1¼"	1 Each

MICRO TRAY WITH HINGED LID (Not pictured)

PRODUCT NUMBER	DESCRIPTION	QUANTITIES
10-1701	10" x 6½" x 7⁄8"	1 Each

STERILIZATION BOX (Not pictured)

PRODUCT NUMBER	DESCRIPTION	QUANTITIES
10-1705	6⅜" x 3⅜" x 1¼"	1 Each

WEINSTEIN INSTRUMENT STRINGERS

PRODUCT NUMBER	DESCRIPTION	QUANTITIES
10-1800	5½" x 3¼"	1 Each
10-1805	11¼" x 3¼"	1 Each

E-Z LOCK INSTRUMENT STRINGERS

PRODUCT NUMBER	DESCRIPTION	QUANTITIES
10-1806	2½" x 6"	1 Each
10-1808	2½" x 8"	1 Each
10-1810	2½" x 10"	1 Each
10-1812	2½" x 12"	1 Each
10-1814	2½" x 14"	1 Each
10-1816	2½" x 16"	1 Each
10-1818	2½" x 18"	1 Each
10-1826	5" x 6"	1 Each
10-1828	5" x 8"	1 Each
10-1830	5" x 10"	1 Each
10-1832	5" x 12"	1 Each
10-1834	5" x 14"	1 Each
10-1836	5" x 16"	1 Each
10-1838	5" x 18"	1 Each

INSTRUMENT STRINGERS

PRODUCT NUMBER	DESCRIPTION	QUANTITIES
10-1340	2½" x 6"	1 Each
10-1342	2½" x 8"	1 Each
10-1344	2½" x 10"	1 Each
10-1346	2½" x 12"	1 Each
10-1347	2½" x 14"	1 Each
10-1348	2½" x 16"	1 Each
10-1349	2½" x 18"	1 Each





WEISENBACH INSTRUMENT HOLDER

PRODUCT NUMBER	DESCRIPTION	QUANTITIES
10-1775	6"	1 Each
10-1776	12"	1 Each



WORCESTER INSTRUMENT HOLDER

PRODUCT NUMBER	DESCRIPTION	QUANTITIES
10-1839	13" x 3"	1 Each

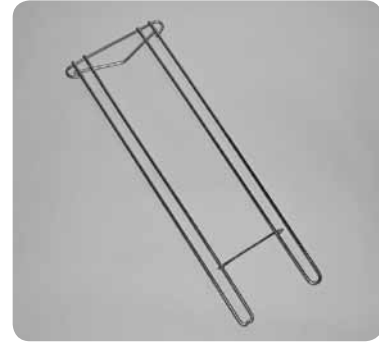

BUNT INSTRUMENT STRINGER

PRODUCT NUMBER	DESCRIPTION	QUANTITIES
10-1770	5¼" x 1½"	1 Each

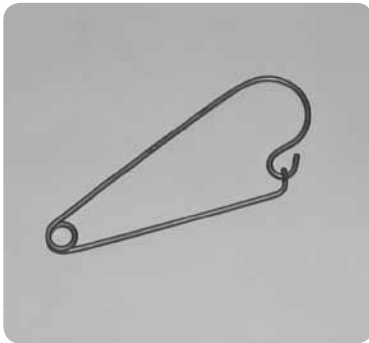

SAUNDERS INSTRUMENT RACK

PRODUCT NUMBER	DESCRIPTION	QUANTITIES
10-1780	6" x 4"	1 Each

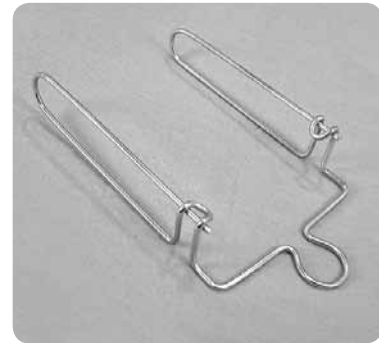

MAYO INSTRUMENT HOLDER

PRODUCT NUMBER	DESCRIPTION	QUANTITIES
10-1772	5½"	1 Each

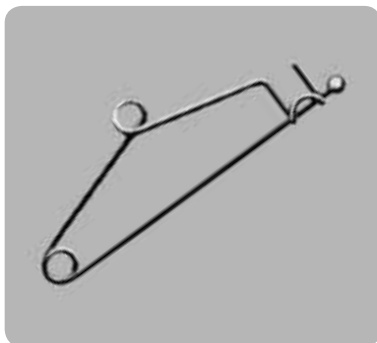

POSILOCK INSTRUMENT RACK

PRODUCT NUMBER	DESCRIPTION	QUANTITIES
10-1763		1 Each

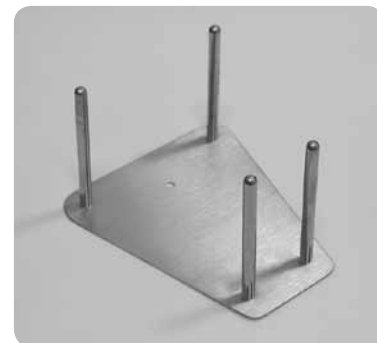



SKLARLITE™

STERILIZATION CONTAINER SYSTEM

Pre-Vacuum Steam Sterilization

The SklarLite™ Rigid Sterilization Container System provides an organized, routine and secure approach to the sterilization of surgical instruments. Customize your SklarLite™ System by selecting colored lids and ID labels. Available in your choice of six vibrant colors for easy identification of instrument sets by procedure and/or department. Choose from various configurations to fit your surgery center needs.

- Anodized aluminum alloy is strong and durable yet lightweight and easy to handle.
- Stackable Containers maximizes space in the autoclave and storage shelf space; reduces cycle runs.
- Stackable Baskets provide ease of instrument transfer per procedure and maximizes space inside containers.
- Silicon mats secure delicate and laparoscopic instruments to minimize damage.
- Tamper evident seals prevent accidental sterile field breach.
- Long Lasting Sterilization.



STANDARD CONTAINERS



Consists of a body and perforated lid and used with Sklar's disposable filters and other compatible accessories for sterilization. Choose from either perforated or non-perforated bottoms. Lids available in six different colors for easy identification by procedure or department.

SAFE CONTAINERS



Consists of identical body and perforated lid, but features an additional solid cover that safeguards the perforation field and contents during transportation and storage. Choose from either perforated or non-perforated bottoms. Safety lids available in six different colors for easy identification by procedure or department.



SKLARLITE™ HALF-SIZE CONTAINERS

11¼" L X 11" W

STANDARD CONTAINERS			SAFE CONTAINERS	
Non-Perforated Bottom	Perforated Bottom	Size	Non-Perforated Bottom	Perforated Bottom
10-4500	10-4512	4"	10-4524	10-4536
10-4502	10-4514	4"	10-4526	10-4538
10-4504	10-4516	4"	10-4528	10-4540
10-4506	10-4518	4"	10-4530	10-4542
10-4508	10-4520	4"	10-4532	10-4544
10-4510	10-4522	4"	10-4534	10-4546
10-4548	10-4560	5"	10-4572	10-4584
10-4550	10-4562	5"	10-4574	10-4586
10-4552	10-4564	5"	10-4576	10-4588
10-4554	10-4566	5"	10-4578	10-4590
10-4556	10-4568	5"	10-4580	10-4592
10-4558	10-4570	5"	10-4582	10-4594
10-4596	10-4608	6"	10-4620	10-4632
10-4598	10-4610	6"	10-4622	10-4634
10-4600	10-4612	6"	10-4624	10-4636
10-4602	10-4614	6"	10-4626	10-4638
10-4604	10-4616	6"	10-4628	10-4640
10-4606	10-4618	6"	10-4630	10-4642
10-4644	10-4656	8"	10-4668	10-4680
10-4646	10-4658	8"	10-4670	10-4682
10-4648	10-4660	8"	10-4672	10-4684
10-4650	10-4662	8"	10-4674	10-4686
10-4652	10-4664	8"	10-4676	10-4688
10-4654	10-4666	8"	10-4678	10-4690
10-4692	10-4704	10"	10-4716	10-4728
10-4694	10-4706	10"	10-4718	10-4730
10-4696	10-4708	10"	10-4720	10-4732
10-4698	10-4710	10"	10-4722	10-4734
10-4700	10-4712	10"	10-4724	10-4736
10-4702	10-4714	10"	10-4726	10-4738



ACCESSORIES

PRODUCT NUMBER	MODEL	FEATURES
10-4784	Half Size Wire Basket	9½" x 10" x 1"
10-4786	Half Size Wire Basket	9½" x 10" x 2"
10-4788	Half Size Wire Basket	9½" x 10" x 3"
10-4790	Half Size Wire Basket	9½" x 10" x 4"
10-4970	Half Size Silicon Mat	8½" x 9"





STEELWARE | STERILIZATION

SKLARLITE™ MID-SIZE CONTAINERS

18¼" L X 11" W

STANDARD CONTAINERS			SAFE CONTAINERS	
Non-Perforated Bottom	Perforated Bottom	Size	Non-Perforated Bottom	Perforated Bottom
10-4300	10-4312	4"	10-4324	10-4336
10-4302	10-4314	4"	10-4326	10-4338
10-4304	10-4316	4"	10-4328	10-4340
10-4306	10-4318	4"	10-4330	10-4342
10-4308	10-4320	4"	10-4332	10-4344
10-4310	10-4322	4"	10-4334	10-4346
10-4348	10-4360	5"	10-4370	10-4382
10-4350	10-4361	5"	10-4372	10-4384
10-4352	10-4362	5"	10-4374	10-4386
10-4354	10-4364	5"	10-4376	10-4388
10-4356	10-4366	5"	10-4378	10-4390
10-4358	10-4368	5"	10-4380	10-4392
10-4394	10-4406	6"	10-4418	10-4430
10-4396	10-4408	6"	10-4420	10-4432
10-4398	10-4410	6"	10-4422	10-4434
10-4400	10-4412	6"	10-4424	10-4436
10-4402	10-4414	6"	10-4426	10-4438
10-4404	10-4416	6"	10-4428	10-4440



ACCESSORIES

PRODUCT NUMBER	MODEL	FEATURES
10-4478	Mid Size Wire Basket	16" x 10" x 1"
10-4480	Mid Size Wire Basket	16" x 10" x 2"
10-4482	Mid Size Wire Basket	16" x 10" x 3"
10-4484	Mid Size Wire Basket	16" x 10" x 4"
10-4975	Mid Size Silicon Mat	15" x 9"



GENERAL ACCESSORIES

Complete any SklarLite™ Container System by selecting disposable filters, indicators and labels to maximize security in preparation and maintenance of surgical sets and sterile materials.

PRODUCT NUMBER	MODEL	FEATURES
10-4900	Process Indicator Cards	Steam, 250/Bx
10-4910	Disposable Filters	100/Pk
10-4925	Security Seals	100/Pk
10-4930	ID Labels*	Silver
10-4930ENG	ID Labels*	Silver Custom Engraved, Max. 16 Characters

*Choose from six vibrant colors including Silver, Yellow, Red, Blue, Green or Black. Contact your Sklar Account Manager for information on the complete product line.



SKLARLITE™ FULL-SIZE CONTAINERS
23" L X 11" W

STANDARD CONTAINERS			SAFE CONTAINERS	
Non-Perforated Bottom	Perforated Bottom	Size	Non-Perforated Bottom	Perforated Bottom
10-4000	10-4012	4"	10-4024	10-4036
10-4002	10-4014	4"	10-4026	10-4038
10-4004	10-4016	4"	10-4028	10-4040
10-4006	10-4018	4"	10-4030	10-4042
10-4008	10-4020	4"	10-4032	10-4044
10-4010	10-4022	4"	10-4034	10-4046
10-4048	10-4060	5"	10-4072	10-4084
10-4050	10-4062	5"	10-4074	10-4086
10-4052	10-4064	5"	10-4076	10-4088
10-4054	10-4066	5"	10-4078	10-4090
10-4056	10-4068	5"	10-4080	10-4092
10-4058	10-4070	5"	10-4082	10-4094
10-4096	10-4108	6"	10-4120	10-4132
10-4098	10-4110	6"	10-4122	10-4134
10-4100	10-4112	6"	10-4124	10-4136
10-4102	10-4114	6"	10-4126	10-4138
10-4104	10-4116	6"	10-4128	10-4140
10-4106	10-4118	6"	10-4130	10-4142
10-4144	10-4156	8"	10-4168	10-4180
10-4146	10-4158	8"	10-4170	10-4182
10-4148	10-4160	8"	10-4172	10-4184
10-4150	10-4162	8"	10-4174	10-4186
10-4152	10-4164	8"	10-4176	10-4188
10-4154	10-4166	8"	10-4178	10-4190
10-4192	10-4204	10"	10-4216	10-4228
10-4194	10-4206	10"	10-4218	10-4230
10-4196	10-4208	10"	10-4220	10-4232
10-4198	10-4210	10"	10-4222	10-4234
10-4200	10-4212	10"	10-4224	10-4236
10-4202	10-4214	10"	10-4226	10-4238

ACCESSORIES

PRODUCT NUMBER	MODEL	FEATURES
10-4284	Full Size Wire Basket	21¼" x 10" x 1"
10-4286	Full Size Wire Basket	21¼" x 10" x 2"
10-4288	Full Size Wire Basket	21¼" x 10" x 3"
10-4290	Full Size Wire Basket	21¼" x 10" x 4"
10-4985	Full Size Silicon Mat	20½" x 9"





INSTRUMENT CASSETTES

Organized Procedure Kits save time and improve safety! Sklar is pleased to introduce a new line of cassette trays to organize and protect instruments during handling and transportation. Removable, silicone instrument holders afford you the option of an open configuration in any cassette. Cassettes with detachable lids feature moveable instrument holders to customize instrument configuration. Choose from various cassette sizes and styles to fit your needs.

- High quality, heavy gauge stainless steel.
- Optimum slot position for effective cleaning and drainage.
- Easy open/closing latch system.
- Silicone Inserts for secure instrument placement.

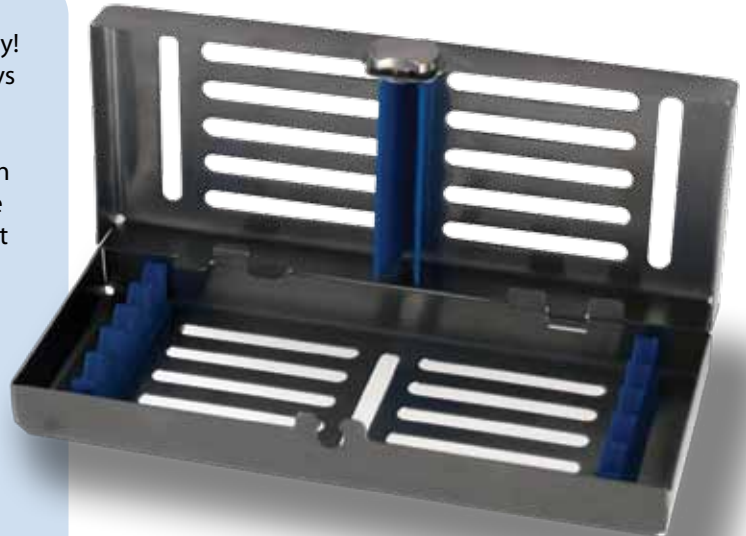

SMALL CASSETTES

Typical Applications Include:

- Diagnostic Kit
- Root Planning Kit
- New Patient Kit
- Composite Kit

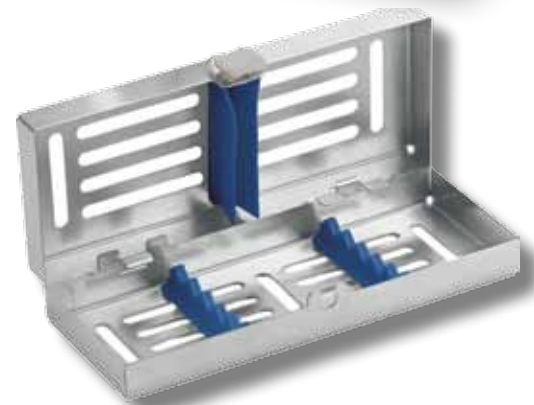

PRODUCT NUMBER	SIZE	CONFIGURATION	FEATURES
10-6500	7" x 2 ³ / ₄ " x 1 ¹ / ₃ "	5 Instruments	Detachable Lid/Instrument Holders
10-6501	7" x 2 ¹ / ₃ " x ⁹ / ₇ "	5 Instruments	Fixed Lid/Instrument Holders

MEDIUM CASSETTES

Typical Applications Include:

- Hygiene Kit
- Restoration Kit
- Cavity Prep Kit
- Endo Kit
- Crown & Bridge Kit

PRODUCT NUMBER	SIZE	CONFIGURATION	FEATURES
10-6505	7" x 4 ¹ / ₃ " x 1 ¹ / ₃ "	7 Instruments	Detachable Lid/Instrument Holders
10-6506	7" x 3 ¹ / ₂ " x ⁶ / ₇ "	7 Instruments	Fixed Lid/Instrument Holders





MEDIUM CASSETTES, CONTINUED

PRODUCT NUMBER	SIZE	CONFIGURATION	FEATURES
10-6510	7" x 5¾" x 1⅓"	10 Instruments	Detachable Lid/Instrument Holders
10-6511	7" x 5" x ⅞"	10 Instruments	Fixed Lid/Instrument Holders



LARGE CASSETTES

Typical Applications Include:

- Periodontal Surgery
- Restoration Kit
- Extraction

PRODUCT NUMBER	SIZE	CONFIGURATION	FEATURES
10-6515	11½" x 7" x 1⅓"	20 Instruments	Detachable Lid/Instrument Holders
10-6516	11" x 7¼" x 1"	20 Instruments	Fixed Lid/Instrument Holders



EXTRA LARGE CASSETTE

Available with specially designed silicone inserts to hold up to 12 extracting forceps. Or choose the open configuration recommended for large surgical instrument sets.

PRODUCT NUMBER	SIZE	CONFIGURATION	FEATURES
10-6520	15" x 8¼" x 1½"	12 Forceps	Detachable Lid/Instrument Holders
10-6521	15" x 8¼" x 1½"	Open	Detachable Lid





INSTRUMENT HOLDERS

UNIVERSAL

PRODUCT NUMBER	SIZE	CONFIGURATION	FEATURES
10-6531	5"	10 Instruments	3 pc Silicone Set, Blue
10-6536	10½"	20 Instruments	3 pc Silicone Set, Blue



CLIP IN CASSETTES

PRODUCT NUMBER	SIZE	CONFIGURATION	FEATURES
10-6525	7" x 2⅓" x ⅞"	5 Instruments	Open top and bottom



PRODUCT NUMBER	SIZE	CONFIGURATION	FEATURES
10-6526	7" x 3½" x 1"	10 Instruments	Open Top with Instrument Holders



Replacement instrument holders, in various colors are also available. Contact your Sklar Account Manager for more information.



MEDICINE CUPS

STERILE

PRODUCT NUMBER	FEATURES	QUANTITIES
96-7027	2 oz.	25/cs



PITCHERS*

STERILE

PRODUCT NUMBER	FEATURES	QUANTITIES
96-7268	Open Handle, 1200ml	5/cs

NON-STERILE

96-7270	Open Handle, 1200ml	35/cs
---------	---------------------	-------



NON-STERILE

PRODUCT NUMBER	FEATURES	QUANTITIES
10-1546	Graduated Measure, 16 oz., Reusable	1 or 6/cs



SPECIMEN TUBES

STERILE

PRODUCT NUMBER	FEATURES	QUANTITIES
96-7459	3½" x ½"	3/pk, 50pk/cs, 150/cs



PLASTIC BOWLS

STERILE

PRODUCT NUMBER	FEATURES	QUANTITIES
96-7028	8 oz.	25/cs
96-7020	16 oz.	10/cs
96-7174	32 oz.	20/cs
96-7451	48 oz.	5/cs



*Select products are available individually or in bulk packaging. To order large quantities, simply add the package quantity to the end of the product number when ordering, ie. 10-1670-12 for 12/pk or 10-1670-48 for 48/pk.



EMESIS BASINS

NON-STERILE

PRODUCT NUMBER	FEATURES	QUANTITIES
96-7543	700cc	25/cs



OR BASINS

STERILE

PRODUCT NUMBER	FEATURES	QUANTITIES
96-1679	Round, 7 qt., Blue	5/cs

NON-STERILE

08-1011	Round, 5 qt., Pink	50/cs
---------	--------------------	-------

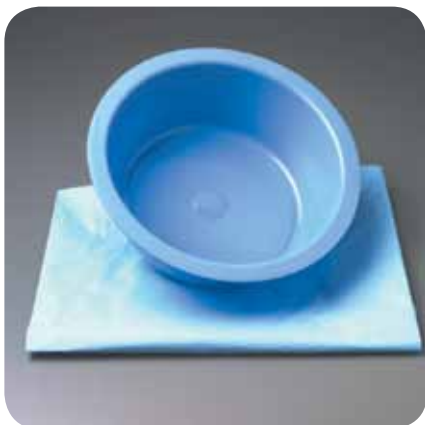

GUIDEWIRE BOWLS

STERILE

PRODUCT NUMBER	FEATURES	QUANTITIES
96-1630	8¼" x 3"	10/cs



UTILITY BOWLS*

NON-STERILE

PRODUCT NUMBER	FEATURES	QUANTITIES
10-1502	Sponge/Utility Bowl, Aqua, 1¼ qt.	1 or 12/cs



NON-STERILE

PRODUCT NUMBER	FEATURES	QUANTITIES
10-1504	Solution Bowl, Reusable, Lt Green, 7 qt.	1 or 12/cs



*Select products are available individually or in bulk packaging. To order large quantities, simply add the package quantity to the end of the product number when ordering, ie. 10-1670-12 for 12/pk or 10-1670-48 for 48/pk.



PLASTIC TRAYS

STERILE

PRODUCT NUMBER	FEATURES	QUANTITIES
96-7025	Small Shallow Prep	25/cs
96-7033	Half Shallow	25/cs
96-7024	Half Deep	25/cs
96-7175	Full Deep	25/cs
96-7177	2-Compartment	25/cs
96-7178	3-Compartment	25/cs



PROCEDURE TRAYS*

NON-STERILE

PRODUCT NUMBER	FEATURES	QUANTITIES
10-1960	Mini, Non-Perforated, Blue, 10 ¹ / ₈ " x 6 ⁵ / ₈ "	1 Each
10-1965	Mini, Perforated, Blue, 10 ¹ / ₈ " x 6 ⁵ / ₈ "	1, 6 or 12/cs
10-1961	Small, Non-Perforated, Blue, 10 ⁷ / ₁₆ " x 13 ⁹ / ₁₆ "	1 Each
10-1966	Small, Perforated, Blue, 10 ⁷ / ₁₆ " x 13 ⁹ / ₁₆ "	1, 6 or 12/cs
10-1962	Medium, Non-Perforated, Blue, 11 ³ / ₄ " x 16"	1 Each
10-1967	Medium, Perforated, Blue, 11 ³ / ₄ " x 16"	1, 6 or 12/cs
10-1964	Large, Heavy Duty, Non-Perforated, Blue, 15" x 20"	1 Each



SOAKING TRAYS WITH REMOVABLE BASKET

NON-STERILE

PRODUCT NUMBER	FEATURES	QUANTITIES
10-2555	Small Instrument Tray, 8" x 3 ¹ / ₂ " x 2"	1 Each
10-2556	Large Instrument Tray, 10" x 5" x 2 ¹ / ₂ "	1 Each
10-2557 (not pictured)	Round Cup Size Tray, 3" x 3", 4 oz.	1 Each



*Select products are available individually or in bulk packaging. To order large quantities, simply add the package quantity to the end of the product number when ordering, ie. 10-1670-12 for 12/pk or 10-1670-48 for 48/pk.

UTILITY FORCEPS
NARROW JAW

PRODUCT NUMBER	SIZE	FEATURES	QUANTITIES
96-2914	4"	Non-Sterile	100/box
96-2915	4"	Sterile	100/box

DRESSING FORCEPS

PRODUCT NUMBER	SIZE	FEATURES	QUANTITIES
96-2916	5"	Non-Sterile	100/box
96-2917	5"	Sterile	100/box

LITTAUER SUTURE SCISSORS

PRODUCT NUMBER	SIZE	FEATURES	QUANTITIES
96-2905	4½"	Non-Sterile	100/box
96-2906	4½"	Sterile	100/box

TUBING CLAMPS

PRODUCT NUMBER	SIZE	FEATURES	QUANTITIES
96-2902	Small	Non-Sterile	100/box
96-2903	Small	Sterile	100/box

HEMOSTATIC FORCEPS

PRODUCT NUMBER	SIZE	FEATURES	QUANTITIES
96-2907	5¼"	Straight, Non-Sterile	100/box
96-2909	5¼"	Straight, Sterile	100/box
96-2908	5"	Curved, Non-Sterile	100/box
96-2910	5"	Curved, Sterile	100/box





SPONGE FORCEPS

PRODUCT NUMBER	SIZE	FEATURES	QUANTITIES
96-2918	9½"	Non-Sterile	100/box
96-2919	9½"	Sterile	100/box



HOFF STYLE TOWEL CLAMPS

ROUND TIPS

PRODUCT NUMBER	SIZE	FEATURES	QUANTITIES
96-5658	4¾"	Curved, Non-Sterile	100/box
96-5659	4¾"	Curved, Sterile	100/box



HOFF STYLE TOWEL CLAMPS

OVAL TIPS

PRODUCT NUMBER	SIZE	FEATURES	QUANTITIES
96-5660	4¾"	Curved, Non-Sterile	100/box
96-5661	4¾"	Curved, Sterile	100/box

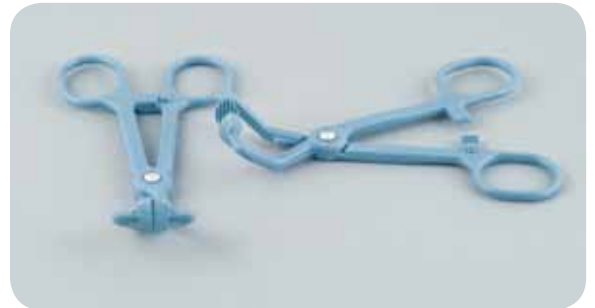

TOWEL CLAMPS

NON-PEFORATING

PRODUCT NUMBER	SIZE	FEATURES	QUANTITIES
96-2930	5"	Blue, Non-Sterile	100/box
96-2931	5"	Blue, Sterile	100/box
96-2929	5"	Green, Non-Sterile	100/box



DISPOSABLE NASAL SPECULUMS

PRODUCT NUMBER	SIZE	FEATURES	QUANTITIES
96-0670	6¼"	Non-Sterile	48/box
96-2665	6¼"	Sterile	48/box





PLASTIC INSTRUMENTS

SURGERY PREP RAZORS

PRODUCT NUMBER	FEATURES	QUANTITIES
96-2955	Non-Sterile	100/box
96-2956	Sterile	100/box



TOWEL CLAMP

PRODUCT NUMBER	FEATURES	QUANTITIES
96-5655BNS	Non-Sterile	5000/box
96-5655	Sterile	50/box



YANKAUER SUCTION TUBE

PRODUCT NUMBER	FEATURES	QUANTITIES
96-4171	Vented, Non-Sterile	50/box
96-4174	Vented, Sterile, Vented	10/box
96-4172	Non-Vented, Non-Sterile	50/box
96-4175	Non-Vented, Sterile	10/box





Sklar Instrument Protectors provide a convenient, color-coded means of protecting surgical instrument tips and edges. Auto-clavable, steam and gas permeable, and available in a wide variety of shapes and sizes, SklarTip™ Instrument Protectors provide exceptional protection during handling and sterilization. Latex Free.

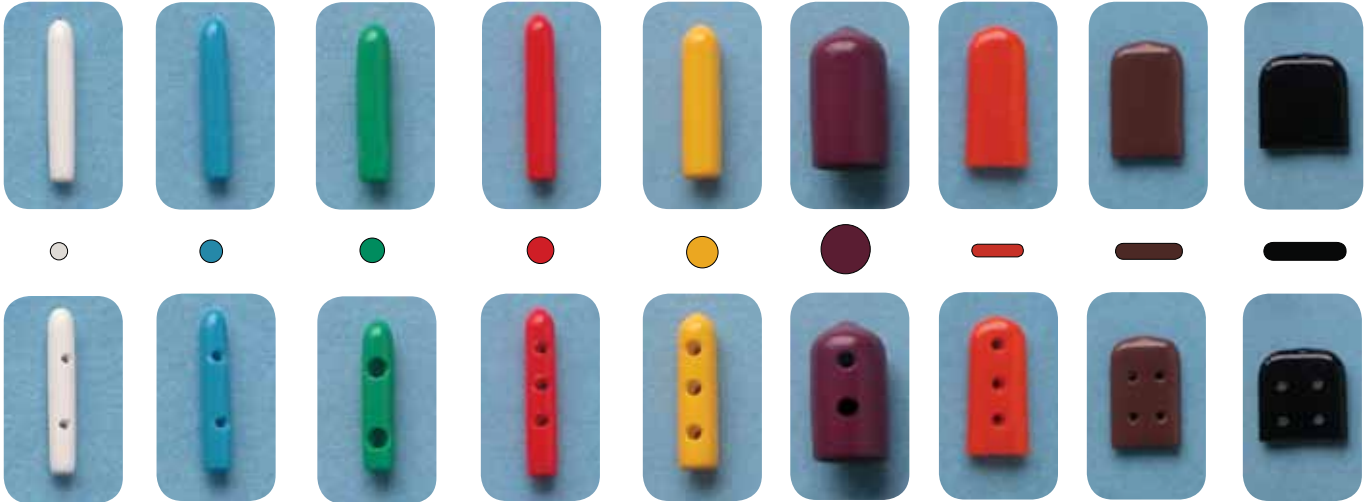

INSTRUMENT PROTECTORS - NON-VENTED

PRODUCT NUMBER	FEATURES	QUANTITIES
96-1510	19 x 1.5mm, 3/4" x 1/16"	White 100/pk
96-1508	19 x 2.0mm, 3/4" x 5/64"	Blue 100/pk
96-1506	19 x 3.0mm, 3/4" x 1/8"	Green 100/pk
96-1504	25 x 3.0mm, 1" x 1/8"	Red 100/pk
96-1502	25 x 5.0mm, 1" x 3/16"	Yellow 100/pk
96-1500	19 x 1.0mm, 3/4" x 3/64"	Maroon 100/pk
96-1516	25 x 1.5mm, 1" x 3/8" x 1/16"	Orange 100/pk
96-1514	25 x 2.0mm, 1" x 5/8" x 5/64"	Brown 100/pk
96-1512	25 x 3.0mm, 1" x 1" x 1/8"	Black 100/pk
96-1518	Assorted	100/pk

INSTRUMENT PROTECTORS - VENTED

PRODUCT NUMBER	FEATURES	QUANTITIES
96-1410	19 x 1.5mm, 3/4" x 1/16"	White 100/pk
96-1408	19 x 2.0mm, 3/4" x 5/64"	Blue 100/pk
96-1406	19 x 3.0mm, 3/4" x 1/8"	Green 100/pk
96-1404	25 x 3.0mm, 1" x 1/8"	Red 100/pk
96-1402	25 x 5.0mm, 1" x 3/16"	Yellow 100/pk
96-1400	19 x 1.0mm, 3/4" x 3/64"	Maroon 100/pk
96-1416	25 x 1.5mm, 1" x 3/8" x 1/16"	Orange 100/pk
96-1414	25 x 2.0mm, 1" x 5/8" x 5/64"	Brown 100/pk
96-1412	25 x 3.0mm, 1" x 1" x 1/8"	Black 100/pk
96-1418	Assorted	100/pk

OSTEOTOME GUARDS - VENTED

PRODUCT NUMBER	FEATURES	QUANTITIES
96-1440	3/4" x 1/4"	50/pk
96-1442	1" x 3/8"	50/pk
96-1444	1" x 1/2"	50/pk
96-1446	1 1/2" x 1 1/2"	50/pk

TIP GRIPS

PRODUCT NUMBER	FEATURES	QUANTITIES
96-1550	.062" Yellow	3pr/pk, 5pks
96-1552	.062" Yellow	5pr/pk, 5pks

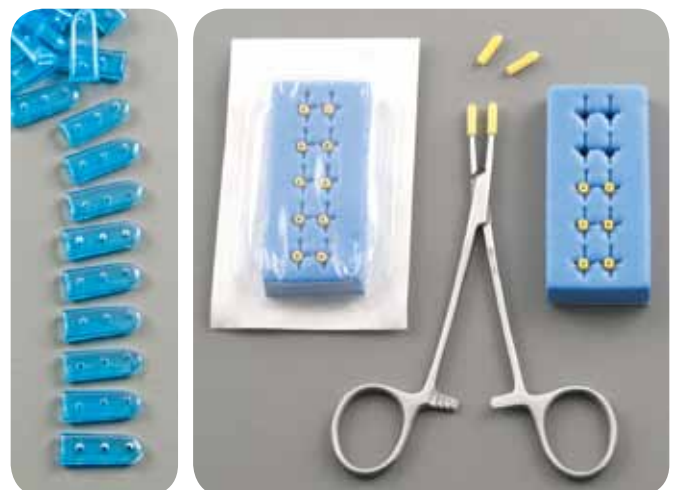



SKLARTIP™ INSTRUMENT PROTECTORS

Instrument recognition is key to efficient processing in a busy clinical setting. SklarTip™ Instrument ID products offer a convenient color coded system for identifying instruments. Offered in various combinations including tape sheets, tape rolls and tags, products last through many autoclaving and gas sterilization processes. Latex Free.

ID SHEET TAPE

PRODUCT NUMBER	FEATURES	QUANTITIES
96-1845	Blue with White Stripes	1 Each
96-1846	Green with White Stripes	1 Each
96-1847	Red with White Stripes	1 Each
96-1848	Yellow with White Stripes	1 Each
96-1849	Orange with White Stripes	1 Each
96-1850	Brown with White Stripes	1 Each
96-1851	Lavender with White Stripes	1 Each
96-1852	Light Blue with White Stripes	1 Each
96-1853	Pink with White Stripes	1 Each



ID ROLL TAPE

PRODUCT NUMBER	FEATURES	QUANTITIES
96-1860	White 300" x ¼"	1 Each
96-1862	Green 300" x ¼"	1 Each
96-1864	Yellow 300" x ¼"	1 Each
96-1866	Orange 300" x ¼"	1 Each
96-1868	Black 300" x ¼"	1 Each
96-1870	Purple 300" x ¼"	1 Each
96-1872	Blue 300" x ¼"	1 Each
96-1874	Red 300" x ¼"	1 Each
96-1876	Brown 300" x ¼"	1 Each



INSTRUMENT ID TAGS

PRODUCT NUMBER	FEATURES	QUANTITIES
96-1900	ID Repair Tags, Red	100/pk
96-1901	ID Repair Tags, Red	1000/pk
96-1903	Sklar Tags, White	100/pk
96-1905	ID Tags for Sharpen, Blue	100/pk
96-1906	ID Tags for Sharpen, Blue	1000/pk



CANNULA CLEANING BRUSHES

PRODUCT NUMBER	FEATURES		QUANTITIES
10-1350	12"	2mm Diameter	3/pk
10-1660	12"	3mm Diameter	3/pk
10-1661	12"	3mm Diameter	12/pk
10-1663	12"	3mm Diameter	24/pk
10-1352	12"	4mm Diameter	3/pk
10-1354	12"	5mm Diameter	3/pk
10-1356	12"	6mm Diameter	3/pk
10-1664	15"	9mm Diameter	3/pk
10-1665	15"	9mm Diameter	12/pk
10-1666	15"	9mm Diameter	24/pk
10-1668	15"	25mm Diameter	3/pk
10-1669	15"	25mm Diameter	12/pk
10-1672	15"	25mm Diameter	24/pk
10-1362	18"	5mm Diameter	3/pk
10-1364	18"	10mm Diameter	3/pk
10-1366	18"	15mm Diameter	3/pk
78-2824	19"	8mm Diameter	3/pk
10-1370	24"	2.5mm Diameter	3/pk
10-1372	24"	5mm Diameter	3/pk
10-1374	24"	7mm Diameter	3/pk
10-1376	24"	10mm Diameter	3/pk





BRUSHES

TRACHEAL TUBE BRUSHES

PRODUCT NUMBER	FEATURES	QUANTITIES
78-2821	Small, 6" x ½" Diameter	6/pk
78-2822	Medium, 7" x ⅝" Diameter	6/pk



INSTRUMENT CLEANING BRUSHES (STAINLESS BRISTLES)

PRODUCT NUMBER	FEATURES	QUANTITIES
10-1650	Stainless Steel Bristles	3/pk
10-1652	Stainless Steel Bristles	12/pk
10-1658	Stainless Steel Bristles	24/pk
10-1655	Stainless Steel Brushes	48/pk



INSTRUMENT CLEANING BRUSHES (NYLON BRISTLES)

PRODUCT NUMBER	FEATURES	QUANTITIES
10-1651	Nylon Bristles	3/pk
10-1657	Nylon Bristles	12/pk
10-1659	Nylon Bristles	24/pk
10-1656	Nylon Bristles	48/pk
10-1465	Nylon Bristles, Disposable	12/pk
10-1468	Nylon Bristles, Disposable	24/pk



INSTRUMENT CLEANING BRUSHES (DOUBLE ENDED)

PRODUCT NUMBER	FEATURES	QUANTITIES
10-1444	Nylon Bristles	3/pk



INSTRUMENT CLEANING BRUSHES (DOUBLE TAPERED)

PRODUCT NUMBER	FEATURES	QUANTITIES
10-1384	6", Double Tapered Brush	3/pk
10-1388	8", Double Tapered Brush	3/pk





SUCTION TUBE CLEANING BRUSHES (BARON & FRAZIER)

PRODUCT NUMBER	FEATURES		QUANTITIES
10-1396	6"	1.6mm	3/pk
10-1400	8"	2mm	3/pk
10-1401	8"	2.3mm	3/pk
10-1402	8"	2.6mm	3/pk
10-1403	8"	3mm	3/pk
10-1404	8"	3.3mm	3/pk
10-1405	8"	3.6mm	3/pk
10-1406	8"	4mm	3/pk



SURGICAL SCRUB BRUSHES

PRODUCT NUMBER	FEATURES	QUANTITIES
06-2880	With Channel Back	1 Each
06-2870	With Channel Back	12/pk
06-2882	With Nail Scrubber	1 Each
06-2873	With Nail Scrubber	12/pk
06-2881	Standard	1 Each
06-2872	Standard	12/pk

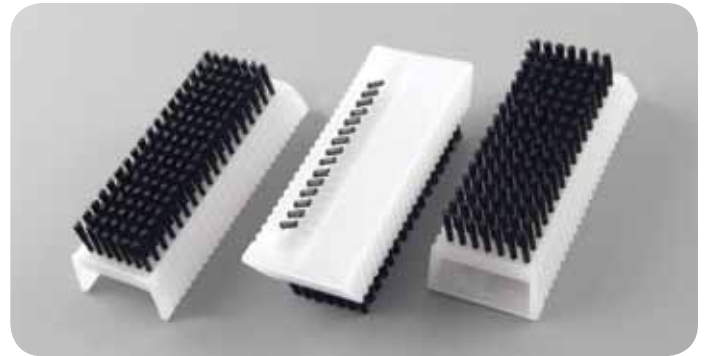

CANNULA INSTRUMENT (PIPE) CLEANERS

PRODUCT NUMBER	FEATURES	QUANTITIES
10-1470	12" Length 1/8" Diameter	3/pk
10-1472	12" Length 1/4" Diameter	3/pk



DOUBLE END VALVE BRUSHES

PRODUCT NUMBER	FEATURES	QUANTITIES
10-1398	5 3/4" Length 9mm and 5mm Diameter Nylon Tips	3/pk





BRUSHES

SURFACE CLEANING BRUSH

FOR USE ON SINKS, AUTOCLAVES, ULTRASONIC CLEANERS, BOWLS, BASINS, ETC.

PRODUCT NUMBER	FEATURES	QUANTITIES
10-1418	3 ¼" L x 3" W Brush Head 4 ½" Plastic handle 2" White medical grade Nylon bristles	3/pk



LARGE INSTRUMENT CLEANING BRUSH

FOR USE ON RETRACTORS, SPECULA, ETC.

PRODUCT NUMBER	FEATURES	QUANTITIES
10-1420	7" L x 1 ¼" W Brush Head 7 ½" Plastic Handle Overall Length 14 ½" 1" White medical grade Nylon bristles	3/pk



AUTOCLAVE CLEANING BRUSH

FOR USE ON AUTOCLAVE CHAMBERS AND DOORS, SINKS, CARTS, ETC.

PRODUCT NUMBER	FEATURES	QUANTITIES
10-1422	3 ¼" L x 3" W Brush Head 16" Plastic handle 2" White medical grade Nylon bristles	3/pk



INSTRUMENT SPOT REMOVER PAD

FOR USE ON O.R. GRADE SATIN FINISH INSTRUMENTS

PRODUCT NUMBER	FEATURES	QUANTITIES
10-1414	6" x 9"	1 Each
10-1415	6" x 9"	10/pk



BRUSH DRYING RACK & BRUSH HOLDER

PRODUCT NUMBER	FEATURES	QUANTITIES
10-1399	Brush Rack	1 Each
10-1545	Brush Holder	1 Each

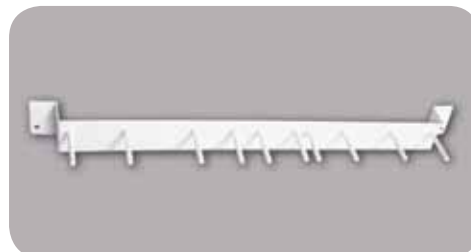



10-1426—INSTRUMENT CLEANING BRUSH SET

PRODUCT NUMBER	DESCRIPTION	QUANTITIES
10-1660	Cannula Cleaning Brush 12" 3mm, 3/pk	1 pk
10-1362	Cannula Cleaning Brush 18" 5mm, 3/pk	1 pk
10-1374	Cannula Cleaning Brush 24" 7mm, 3/pk	1 pk
10-1376	Cannula Cleaning Brush 24" 10mm, 3/pk	1 pk
10-1396	Suction Tube Brush 6" 1.6mm, 3/pk	1 pk
10-1400	Suction Tube Brush 8" 2mm, 3/pk	1 pk
10-1402	Suction Tube Brush 8" 2.6mm, 3/pk	1 pk
10-1404	Suction Tube Brush 8" 3.3mm, 3/pk	1 pk
10-1406	Suction Tube Brush 8" 4mm, 3/pk	1 pk
10-1418	Surface Cleaning Brush, 3/pk	1 pk
10-1444	Double End Brush Nylon, 3/pk	2 pks
10-1650	Brush Stainless Steel Bristle, 3/pk	1 pk
10-1651	Brush Nylon Bristle, 3/pk	2 pks



10-1428—ENDOSCOPIC BRUSH SET

PRODUCT NUMBER	DESCRIPTION	QUANTITIES
10-1350	Cannula Cleaning Brush 12" 2mm, 3/pk	1 pk
10-1660	Cannula Cleaning Brush 12" 3mm, 3/pk	1 pk
10-1354	Cannula Cleaning Brush 12" 5mm, 3/pk	1 pk
10-1362	Cannula Cleaning Brush 18" 5mm, 3/pk	1 pk
10-1364	Cannula Cleaning Brush 18" 10mm, 3/pk	1 pk
10-1370	Cannula Cleaning Brush 24" 2.5mm, 3/pk	1 pk
10-1372	Cannula Cleaning Brush 24" 5mm, 3/pk	1 pk
10-1376	Cannula Cleaning Brush 24" 10mm, 3/pk	1 pk
10-1398	Double End Valve Brush Nylon, 3/pk	2 pks
10-1444	Double End Brush Nylon, 3/pk	2 pks





10-1424—KENNEL CLEANING BRUSH SET

PRODUCT NUMBER	DESCRIPTION	QUANTITIES
10-1424HDL	Telescopic Handle extends from 24" to 48"	1 Each
10-1424PBR	Large Cleaning Brush 7½" L x 5½" W with round corner bristles	1 Each
10-1424BHD	Surface Cleaning Brush, 4½" handle	1 Each



10-1432—MICRO BRUSH SET

PRODUCT NUMBER	DESCRIPTION	QUANTITIES
10-1350	Cannula Cleaning Brush 12" 2mm, 3/pk	1 pk
10-1660	Cannula Cleaning Brush 12" 3mm, 3/pk	1 pk
10-1396	Suction Tube Brush 6" 1.6mm, 3/pk	1 pk
10-1400	Suction Tube Brush 8" 2mm, 3/pk	1 pk
10-1402	Suction Tube Brush 8" 2.6mm, 3/pk	1 pk
10-1404	Suction Tube Brush 8" 3.3mm, 3/pk	1 pk
10-1406	Suction Tube Brush 8" 4mm, 3/pk	1 pk
10-1444	Double End Brush Nylon, 3/pk	1 pk

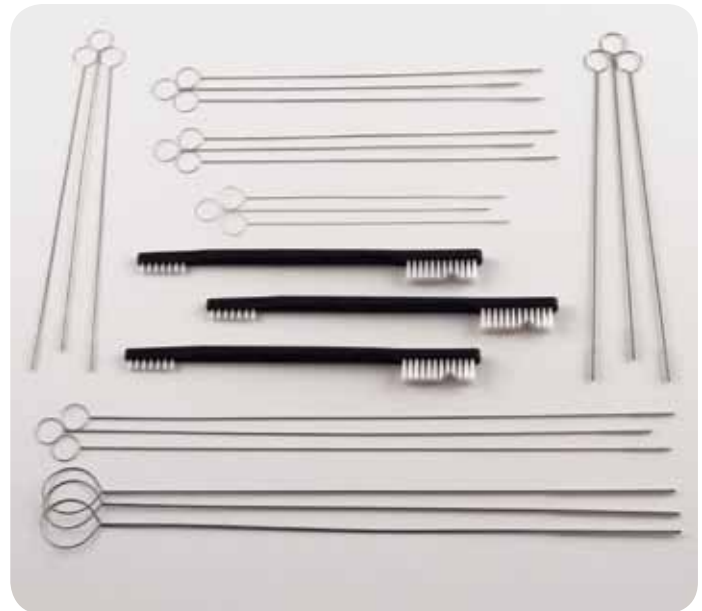

10-1434—VETERINARY ALL PURPOSE BRUSH SET

PRODUCT NUMBER	DESCRIPTION	QUANTITIES
10-1650	Brush Stainless Steel Bristle 3/pk	1 pk
10-1651	Brush Nylon Bristle 3/pk	1 pk
10-1420	Large Instrument Cleaning Brush 3/pk	1 pk
10-1418	Surface Cleaning Brush 3/pk	1 pk





Sklar is pleased to offer a full line of Care & Cleaning agents to disinfect, decontaminate, sterilize, lubricate and protect your stainless steel surgical instruments and equipment. For expert care of your surgical instruments at every stage of the cleaning process, trust Sklar to deliver the right cleaning agent for you.



3 EASY STEPS FOR THE CARE AND CLEANING OF YOUR INSTRUMENTS

1 DECONTAMINATION

Sklar Disinfectants are a pre-cleaner and disinfectant for the safe decontamination of soiled surgical instruments, medical and surgical equipment and inanimate surfaces including plastics, stainless steel, chrome, glass, Plexiglas and baked on painted surfaces. Disinfectants are effective against a broad range of pathogens in as little as 2 minutes.



2 CLEANING

Sklar carries a complete line of effective detergents and enzymatics for cleaning, not only for your surgical instruments, but also metals, glassware, plastic and rubber. Available in your choice of powder, liquid concentrate or spray foams.



3 LUBRICATION

To guarantee extended life and performance of your surgical instruments, choose one of Sklar's lubricants or sprays as the final step in your instrument processing regimen. Specifically designed to protect against corrosion, rust and staining, Sklar offers several different types of lubricants to protect your investments.





SKLAR-CIDE™

HIGH LEVEL DISINFECTING/STERILIZING SOLUTION

Sporicidal • Bactericidal • Virucidal • Fungicidal

SKLAR-CIDE provides a safe and efficient means for the high-level disinfection or sterilization of medical, ophthalmic, dental and surgical devices including endoscopes and lensed instruments. It may be used as a standard soak solution or in automatic reprocessing units set at room temperature. Unlike other solutions, there is no need to increase the solution temperature to provide high-level disinfection in 25 minutes.

SKLAR-CIDE is a surfactant-free, activated glutaraldehyde liquid chemical sterilant and high-level disinfectant. Its active ingredient is glutaraldehyde in a nominal concentration of 3%. When the powdered activator is added, the solution turns green in color to indicate its readiness for use. In addition to the active ingredient, this ready-to-use solution contains buffers, wetting agents, and a rust and corrosion inhibitor and it has a pleasant fragrance.

SKLAR-CIDE produces high-level disinfection at room temperature in as little time as 25 minutes, and complete sterilization in 10 hours at room temperature.

- Reusable for 28 days instead of 14, safer and saves time and money.
- Surfactant free - Will not damage scope surfaces or cloud lenses.
- Can be used safely on all devices, including instruments and endoscopes. No need to stock several products.



PRODUCT NUMBER	FEATURES	QUANTITIES
10-1623	28 HLD 1 Gallon Bottles	4/case
10-1624	28 HLD 1 Gallon Bottle	1 bottle

GLUTARALDEHYDE STRIPS

PRODUCT NUMBER	FEATURES	QUANTITIES
96-4105	2.1% MEC 60 Strips / Bottle	2 bottles/ case





SKLAR DISINFECTANT

READY-TO-USE SPRAY SURFACE DISINFECTANT

2 MINUTE KILL TIME!

- Ready to use, non-toxic formula.
- Specially formulated for the control of cross contamination.
- Effective against H1N1, MRSA, Salmonella, Parvo, Feline Leukemia, Herpes Simplex, Distemper, Ringworm, Strangles.
- Safe for all areas of the facility.
- Satisfies OSHA's Bloodborne Pathogen Standards.
- Non-irritating formula.
- EPA registered.

PRODUCT NUMBER	FEATURES	QUANTITIES
10-1643	24 oz. Spray Bottles	6/case
10-1642	24 oz. Spray Bottle	1 bottle
10-1653	1 Gallon Bottles	4/case
10-1654	1 Gallon Bottle	1 bottle
10-1644	2.5 Gallon Bottles	2/case





SKLAR DISINFECTANT SURFACE WIPES

READY-TO-USE, PRE-MOISTENED TOWELETTES

2 MINUTE KILL TIME!

**SAME EFFECTIVE FORMULA AS
SKLAR DISINFECTANT!**

- Ready to use, non-toxic formula.
- Specially formulated for the control of cross contamination.
- Effective against H1N1, MRSA, Salmonella, Parvo, Feline Leukemia, Herpes Simplex, Distemper, Ringworm, Strangles.
- Safe for all areas of the facility.
- Satisfies OSHA's Bloodborne Pathogen Standards.
- Destroys odor-causing bacteria.
- 7" x 10" non-woven, tear resistant towelette.
- Clean scent.
- EPA registered.



KILLS MRSA AND H1N1 VIRUS

PRODUCT NUMBER	FEATURES	QUANTITIES
10-1616	100 Towelettes / Canister	6/case
10-1617	100 Towelettes / Canister	12/case



SKLAR SPRAY-ZYME™

SURGICAL INSTRUMENT PRE-CLEANER

Multi-Enzyme Based Instrument Presoak & Cleaner Foam Spray Cleaner

The newest product from Sklar for expert care of your surgical instruments. This multi-enzymatic spray creates a heavy foam which lasts for hours, keeping soiled instruments moist to avoid encrustation while also pre-cleaning prior to processing.

- Prevents Organic Encrustation - enzyme foam stops blood and bodily fluids from drying onto surgical instruments.
- No More Spills - messy spills between the operating room and central cleaning /processing department are eliminated.
- Neutral pH - safe and effective for stainless steel, tungsten carbide, aluminum and brass instruments.
- Bacteriostatic - microbiological control agents inhibit bacterial growth in the ready-to-use foam solution.
- Long Lasting Foam - saves time, foam lasts many hours after application.
- Multi-Enzymatic - contains a synergistic blend of lipase and protease enzymes.

PRODUCT NUMBER	FEATURES	QUANTITIES
10-2722	22 oz. Refillable Spray Bottles	12/case
10-2724	1 Gallon Bottles	4/case

SKLAR-ZYME™ POUCHES

CONVENIENT VALUE

Each pouch of SKLAR-ZYME produces one gallon of enzymatic detergent. This convenient, easy to use product guarantees very little waste and is ideal for the office or smaller surgical setting.

PRODUCT NUMBER	FEATURES	QUANTITIES
10-2774	½ oz. Pouches	32/box





SKLAR SOAK™

INSTRUMENT PRE-SOAK & DECONTAMINANT RUST RESISTANT!

Immersing soiled instruments in SKLAR SOAK effectively pre-cleans and decontaminates, without fear of rusting! SKLAR SOAK is an effective pre-cleaner that breaks down bio-burden, lifting blood and other organic debris from the surface, while penetrating box locks and crevices. The rust inhibitor protects the delicate chromium oxide layer of the instrument, thus defending against rust and corrosion. Using SKLAR SOAK™ as a pre-cleaner is the first line of defense against rust, prolonging the life of the instrument and therefore protecting your investment!

Soaking for only two minutes thoroughly decontaminates instruments, reducing the risk of exposure to pathogens such as N1H1, MRSA, Salmonella, Parvo, Feline Leukemia, Herpes Simplex, Distemper, Ringworm, Strangles. However, because SKLAR SOAK™ contains a rust inhibitor, instruments may soak for several hours without fear of rusting! Employees are protected from cross contamination, and at the same time can enjoy the freedom to reprocess instruments when it's convenient!

SKLAR SOAK is ideal for use on all stainless steel instruments:

- PH balanced, designed specifically for stainless steel instruments.
- Intermediate level disinfectant with broad spectrum of efficacy.
- Rust resistant.
- Non-caustic.
- Ready to use.
- No special handling or disposal.
- Fragrant, no offensive odors.
- Non-glutaraldehyde.



PRODUCT NUMBER	FEATURES	QUANTITIES
10-1603	1 Gallon Bottles	4/case
10-1609	1 Gallon Bottle	1 bottle



SKLAR INSTRU-GUARD™ ONE STEP

**A “ONE STEP” INSTRUMENT
CLEANER AND LUBRICANT**

EXTENDS INSTRUMENT LIFE!

SKLAR INSTRU-GUARD ONE STEP contains a penetrating lubricant that protects and helps extend the life of surgical instruments. The detergents and emulsifiers quickly break up and remove organic soils from box locks and other hard to reach places.

SKLAR INSTRU-GUARD ONE STEP contains four rust inhibitors to control corrosion and eliminate scaling and spotting. It does not contain phosphates and can reduce the time and cost involved in processing your instruments by cleaning and lubricating in one easy step.

PRODUCT NUMBER	FEATURES	QUANTITIES
10-2800	1 Gallon Bottles	4/case
10-2801	1 Gallon Bottle	1 bottle





SKLAR INSTRU-GUARD™ LUBE

SURGICAL INSTRUMENT LUBRICANT / RUST INHIBITOR

- Extends the Life of Instruments.
- Protects all Surgical Instruments.

SKLAR INSTRU-GUARD LUBE is an easy-to-use, water soluble, lubricant and rust inhibitor. When used daily as a rinse after every cleaning it keeps moving parts operating smoothly and remains effective after autoclaving, but without leaving an oily residue.

Regular lubrication is essential no matter which cleaning method is employed (including ultrasonic). SKLAR INSTRU-GUARD LUBE is ideal for maintaining instrument quality and performance.

PRODUCT NUMBER	FEATURES	QUANTITIES
10-1635	1 Gallon Containers Concentrated	4/case
10-1634	1 Gallon Container Concentrated	1 container
10-1636	8 oz. Spray Bottles	12/case
10-1637	8 oz. Spray Bottle	1 bottle





SKLAR KLEEN™

LOW FOAM, LIQUID DETERGENT AND POWDERED FORMULA

Regular Formula for Manual and Ultrasonic Cleaning

SKLAR KLEEN is non-corrosive, non aggressive, phosphate free and biodegradable. We have specifically developed SKLAR KLEEN for manual and ultrasonic cleaning. It is moderately alkaline, affording optimum cleaning without etching glassware or attacking instrument metal.

Low Foam Formula for Automatic Cleaning

The SKLAR KLEEN Low Foam Liquid is concentrated in order to provide a very cost-effective solution. It is especially formulated to maintain low foam, ensuring effective and trouble-free action in washer/sterilizers and tunnel washers. Dispersing quickly, the SKLAR KLEEN Low Foam formula is also well suited for automatic injection systems.

PRODUCT NUMBER	FEATURES	QUANTITIES
10-2701	Low Foam 1 Gallon Bottles	4/case
10-1608	Powdered 5 lb. Containers	4/case
10-1607	Powdered 5 lb. Container	1 container
10-1630	Powdered 3.5 lb. Pitchers	6/case
10-2765	Powdered 3.5 lb. Pitcher	1 pitcher
10-1612	Liquid 8 oz. Bottles	6/case
10-1614	Liquid 8 oz. Bottle	1 bottle
10-1613	Liquid 1 Gallon Bottles	4/case
10-1627	Liquid 1 Gallon Bottle	1 bottle





SKLAR-SHEEN™

AUTOCLAVE AND INSTRUMENT CLEANER AND CONDITIONER

With an efficacious phosphoric acid cleaning agent, Sklar Sheen is a robust spot, stain and rust remover. Ideal for dissolving hard water deposits, use in autoclaves to quickly cut through steam sterilizer scale and deposits.

Verstile and effective, SKLAR SHEEN couples powerful stain and rust removers with corrosion inhibitors, making it tough on stains but gentle on instruments. Recondition instruments to restore them to nearly brand new working condition.

Use to clean and recondition any stainless steel surface to its original luster, including carts, trays and basins.

- Conditions for lasting protection.
- Dissolves hard water deposits.
- Frees up frozen box locks.
- Restores and extends surgical instrument life.

PRODUCT NUMBER	FEATURES	QUANTITIES
10-2730	Stain & Rust Remover	1 gallon bottle
10-2732	Stain & Rust Remover	4/case
10-2736	Spray Foam Autoclave Cleaner & Conditioner	22oz. bottle
10-2738	Spray Foam Autoclave Cleaner & Conditioner	12/case





SKLAR ENZYMATIC™ DETERGENT

MULTI-ENZYME DETERGENT CONCENTRATE

100% Biodegradable

SKLAR ENZYMATIC Detergent is a low-foaming, fast acting detergent specifically designed for use when instruments and/or cloth materials become soiled with organic debris.

SKLAR ENZYMATIC Detergent may be used as a manual instrument cleaner as well as a pre-soak for blood-contaminated linens, clothing and instruments. It is also used in ultrasonic units and in washer/sterilizer/decontaminators. When used as directed, the enzymatic pH neutral formula is safe for use on rubber, plastic, stainless steel instruments, and surgical equipment as well as cloth.

PRODUCT NUMBER	FEATURES	QUANTITIES
10-2777	1 Gallon Bottles	4/case
10-2775	1 Gallon Bottles	2/case
10-2776	1 Gallon Bottle	1 bottle





SKLAR STAT™

INSTANT FOAM HAND SANITIZER

KILLS 99% OF GERMS IN LESS THAN 15 SECONDS!

SKLAR-STAT Instant Foam Hand Sanitizer, based on the active ingredient Benzalkonium Chloride, is a unique formulation featuring exceptional skin feel, conditioning and moisturizing properties. The efficacy of this product has been confirmed to reduce *S. Aureus* 99.999% and *S. Aureus* MRSA 99.9% in as little as 15 seconds. SKLAR-STAT Instant Foaming Hand Sanitizer produces a fast drying, non-sticky foam that contains unique conditioning and moisturizing ingredients, leaving the skin with a soft, silky after-feel.

PRODUCT NUMBER	FEATURES	QUANTITIES
10-2850	50 ml Pump Dispensers	24/case
10-2852	550 ml Pump Dispensers	12/case

SKLAR STAT™

AUTOMATIC FOAM DISPENSER

Motion activated, battery powered and wall-mounted, Sklar's AUTOMATIC FOAM DISPENSER allows for easy access and reduced risk of cross contamination. Ideal for use in hospitals, medical centers, offices, schools and any high-traffic public area with multiple users.



PRODUCT NUMBER	FEATURES	QUANTITIES
10-2856	Wall Mount Dispenser	1 Each
10-2854	1000ml Refill Bottles	6/case
10-2858	(2) Cases 1000ml Refill Bottles plus Free Wall Mount Dispenser	1 Set

- Alcohol-Free
- Non-Sticky
- Moisturizes and Conditions Hands

1. Pump a small amount into palm of hand.
2. Rub thoroughly over both surfaces of both hands.
3. Rub hands together briskly until dry.





SKLAR FRESH™

LIQUID SPRAY ODOR ABSORBER

SKLAR FRESH is an environmentally friendly blend of pure biodegradable organic essential oils and trace elements. It is a non-allergenic liquid spray that neutralizes odors at their source. Simply spray SKLAR FRESH directly in the air or on the source (i.e. bathrooms, refuse, soiled items from vomitus, incontinence odors, etc.)

PRODUCT NUMBER	FEATURES	QUANTITIES
10-2842	22 oz. Spray Bottles	12/case

SKLAR POLISH™

INSTRUMENT STAIN REMOVER

Non-Abrasive

SKLAR POLISH is an effective stain remover for use on all your metal surgical instruments, including stainless steel, chrome and brass. It will brighten instrument trays, basins and racks and may also be used on porcelain and tile surfaces.



PRODUCT NUMBER	FEATURES	QUANTITIES
10-1626	8 oz. Jars	12/case
10-1629	8 oz. Jars	6/case
10-1927	8 oz. Jar	1 jar





SKLAR INSTRUMENT CARE KIT

A Trio of Sklar's Care and Cleaning products to keep instruments in tiptop shape.

PRODUCT NUMBER	FEATURES	QUANTITIES
10-1625		
	Sklar Lube™ 8 oz. Spray Bottle	1 each
	Sklar Kleen™ Liquid 8 oz. Bottle	1 each
	Sklar Polish™ 8 oz. Jar	1 each
	Stainless Steel Bristle Cleaning Brush	1 each
	Nylon Bristle Cleaning Brush	1 each



TROUBLE SHOOTING

NO STEEL IS TRULY “STAINLESS”

It's a fact that so-called stainless steel is subject to both water-spotting and staining. However what many people identify as a “rust” problem usually turns out to be something else.

Most often the problem is actually a stain caused by a surface deposit. These deposits appear in a variety of colors depending upon the type of deposit involved. Once the cause is found and eliminated, most of the time the problem quickly diminishes or disappears completely.

As you probably know, stainless steel is ideally suited for the surgical suite because it is rust resistant, it can be honed to an extremely sharp edge or fine point,

and it can be hardened to maintain the delicate, yet precise, requirements of the surgeon. But it is this hardenable quality – the amount of carbon used during the manufacturing process – coupled with harsh chemicals and improper care that renders stainless steel susceptible to corrosion.

To protect your instrument investment, Sklar cleaning agents have been specifically formulated to provide cost effective instrument care solutions that help maintain the life and performance of your valuable stainless steel instruments.



TROUBLE SHOOTING

CORROSION

- Problem:** Debris and residue in box locks, serrations and ratchets.
- Solution:** Serrations, box locks and ratchets should be carefully cleaned and rinsed. A soft bristle brush is effective in these difficult areas.
- Problem:** Moisture remaining on the instruments within the sterile wrapped packs; excessive moisture in autoclave during sterilization and termination of cycle.
- Solution:** Preheat autoclave, drying time cannot be accelerated, open autoclave door slightly. Routinely inspect valves. Malfunctioning valves can precipitate corrosion.
- Problem:** Some local water supplies contain excessive quantities of alkali. This can manifest itself by depositing corrosive matter on the instruments.
- Solution:** It is generally accepted that cold distilled or demineralized water be used during sterilization. An alternative is to use the local water supply, while instituting a program of preventive maintenance. Carefully clean surfaces with SKLAR KLEEN™, using SKLAR POLISH™ to remove difficult stains and SKLAR LUBE™ for proper lubrication.

PITTING

- Problem:** Instruments are inevitably exposed to chemical compounds that initiate pitting. The most common are saline solutions and blood.
- Solution:** It is essential that instruments be rinsed with distilled or demineralized water and then cleaned routinely.
- Problem:** Some Non-Sklar detergents contain a chloride or have an acid base. If rinsing is not thorough, the residual detergent can precipitate pitting. Hydrochloric acid can be formed by the combination of chloride in the cleaner and steam, causing the instrument to pit.
- Solution:** Evaluate detergents without a chloride base. SKLAR KLEEN™ is recommended.
- Problem:** Instruments may be pitted when the detergent used has an excessively high pH. If instruments are not rinsed thoroughly and then autoclaved, the heat increases the effect of the solution on the instruments.
- Solution:** Use only detergents specifically developed for instrument cleaning. SKLAR KLEEN™ products are pH balanced.

BROWNISH STAIN

- Problem:** This stain is more obvious on dull finish instruments. Most likely, it is a deposit of chromium oxide. The thin hard layer protects stainless steel from corrosion precipitated by the atmosphere. The brownish film (sometimes dull blue) occurs naturally when stainless is heated. Occasionally this stain can be traced to the sterilizer. Improper cleaning compounds could contain poly phosphates that cause the copper components in the sterilizer to be deposited by electrolytic action on the stainless steel instruments.
- Solution:** Water supply to autoclave should be cold and demineralized. Use the correct amount of SKLAR KLEEN™ as recommended for best results.

BLUISH GRAY STAINS

- Problem:** Cold sterilizing solutions.
- Solution:** In the preparation of the solution make certain the manufacturer's directions are followed accurately. To minimize discoloration use distilled water and add a rust inhibitor. Using the solution beyond recommended time limitations will cause the solution to become corrosive.

RUST DEPOSIT

- Problem:** Sterilizing instruments of different metals in the same cycle will cause rusting. An electrolytic action carries the carbon particles from the exposed metal and deposits them on the stainless steel instruments. The rapid oxidation of molecules results in a surface film of rust.
- Solution:** The ideal technique would be to sterilize the two types of instruments separately. It is recommended that chrome plated instruments that indicate signs of peeling or flaking be replaced with stainless steel instruments.
- Problem:** The rust film on the surface of stainless steel instruments can be caused by chemicals in the detergent. Excess amounts of iron or other minerals from the local water supply may cause the rust deposits.
- Solution:** It is recommended that instruments be rinsed with distilled or demineralized water. Surface rust can be removed by light buffing or an application of SKLAR POLISH™.

LIGHT AND DARK COLORED SPOTS

- Problem:** Spotting caused by slow evaporation of water drops identified with the mineral content of the water.
- Solution:** Eliminate water droplets by adhering to autoclave manufacturer's operating instructions. Autoclave door should not be opened until steam has been completely vented.

09-0010
COMPACT 150 RODENT ANESTHESIA MACHINE

- Non-rebreathing anesthesia machine with O2 flush valve.
- Used on rodents, birds, and exotics.
- Ability to incorporate both induction chamber and anesthesia mask with Y-piece connection to anesthetize more than one patient.
- Vaporizer: Isoflurane or Sevoflurane Cagemount.
- 2-year warranty.

 ◀ **COMPACT 150**
09-0011
COMPACT MINI ANESTHESIA MACHINE

- Small, easy to use, non-rebreathing unit best for rodents, birds and exotics.
- Used throughout many research and laboratory settings.
- Ability to incorporate both induction chamber and anesthesia mask with Y-piece connection to anesthetize more than one patient.
- Vaporizer: Isoflurane or Sevoflurane Cagemount.
- 2-year warranty.

COMPACT MINI ▶

09-0012
PREMIER XP ANESTHESIA MACHINE

- Perfect for spaying, neutering, dental, emergency and pre-op induction procedures.
- Machine comes patient ready.
- Vaporizer: Isoflurane or Sevoflurane Selectatec.
- Optional: Bain circuit adaptor for non-rebreathing applications, top shelf, and e-tank holders.
- MRI compatible version also available.
- 5-year warranty.

 ◀ **PREMIER XP**

OPTIMAX ▶

09-0013
OPTIMAX ANESTHESIA MACHINE

- Sophisticated anesthesia workstation adapts to the needs of your facility.
- Vaporizer: Isoflurane or Sevoflurane Selectatec.
- Dual Vaporizer manifold with interlocking capability.
- Additional N₂O flow meter, air flow meter, and bain circuit adapter available.
- 5-year warranty.

 ◀ **TITAN**

09-0014
TITAN LARGE ANIMAL ANESTHESIA MACHINE

- Complete large animal anesthesia system with built-in ventilator.
- Ventilator is time-cycled, electronically controlled and pneumatically-powered.
- Dual vaporizer manifold with vapor exclusion system.
- Designed not to tip.
- Optional Foal Absorber.
- 3-year warranty.

09-0015 AV800 ANESTHESIA VENTILATOR

- Ideal for research, university, emergency and critical care facilities.
- Time cycled and volume or pressure controlled.
- Flexible, easy to use ventilators with large LED displays for closed circuit or Mapleson D circuit.
- Includes 50-1600ml bellows as standard assembly.
- Features adjustable low and high pressure alarms, low tidal volume, incorrect rate or ratio, low battery, low drive gas pressure.
- 60 minute battery backup.
- 1 year warranty.





▲
MAXX LUXX II

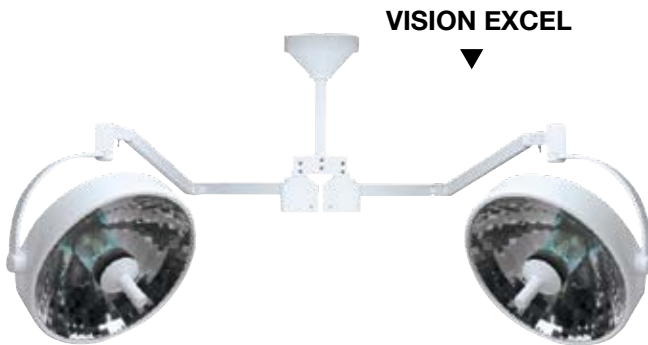

▼
VISION EXCEL



◀ VISTA



VORTEX ▶



◀ VISION LED

09-0020

MAXX LUXX II

- The MAXX LUXX II offers advanced features for demanding surgical environments at a cost far below comparable lights on the market.
- Surgery light provides cool, color-corrected light.
- 9,500 ft candles per head at one meter; 102,000 lux.
- Electronic touch controls for on/off and dimming.
- Auto-bulb change mechanism.
- Excellent shadow and focus control.
- Adjustable pattern sizes.
- 3-year warranty.

V-SERIES: SURGERY AND EXAM LIGHTS

Choose from compact and economic exam lights or full-featured, high performance operating room lighting. All V-Series Lights are available in ceiling, floor or wall mount configurations. Count on first-class surgery and exam quality lighting at reasonable cost.

09-0025

VISION EXCEL

- Surgery light features a larger reflector, higher output, a larger pattern and improved shadow control.
- 6,000 ft candles at one-meter distance; 64,500 lux.
- 3-year warranty.

09-0026

VISTA

- Flexible light ideal for dental procedures, the Vista has expanded the parameters of diagnostic and procedure lighting considerably.
- Compact size and cool, white light output.
- 4,000 ft candles; 43,000 lux.
- 3-year warranty.

09-0027

VORTEX

- Surgery spotlight creates a high intensity, focused light pattern.
- 2000 ft candles; 21,500 lux.
- 3-year warranty.

09-0028

VISION LED

- Designed for low heat and high efficiency.
- Consumes as little as half of the electricity of standard halogen lights, and can last as long as 50,000 hours.
- Produces rich color temperatures and provides excellent shadow reduction.
- Features 5-stage dimming and on/off switch control on sterilizable handle.
- 3-year warranty.

**09-0030
OP TABLE**

- High-end specialty procedure table designed for Ophthalmology and advanced Orthopedic surgery.
- Remote control height adjustment: 33.5" to 45".
- Power Trendelenburg and Reverse Trendelenburg to 15°.
- Power lateral tilt to 43°.
- 250 lb. weight capacity.
- Exclusive x-ray translucent sliding top.

**09-0031
AERON TABLE**

- Premium table designed for C-arm use and advanced surgical procedures.
- Remote control height adjustment: 31" to 43".
- Trendelenburg and Reverse Trendelenburg to 15°.
- C-arm compatible.
- X-ray translucent top measures 55" x 19.5".
- 250 lb. weight capacity.
- Select from Flat Top or fixed V-Top version.

**09-0032
TREND TABLE**

- State-of-the art surgery table great for dental and general surgery procedures.
- Electronic height adjustment: 28" to 40".
- Stainless steel top with drain: 51" x 23".
- One way longitudinal tilt that adjusts to an almost vertical position.
- 264 lb. weight capacity.



09-0033
EPT TABLE

- Exam/procedure table.
- Foot control electronic height adjustment from 12" to 40".
- Top measures: 51" x 23.5".
- 250 lb. load capacity.
- Available configurations: Stainless Steel or Synthetic Top.

09-0034
EDGE TABLE

- V-Top surgery table with built in drain trough and heavy duty hydraulic foot pump with brake.
- Stainless Steel table leaves can be positioned independently to create the perfect angle for various procedures.
- Fully adjustable from 29" high to 37" high.
- 360° revolving top, locks in any position.
- Extra heavy duty H-base with a durable FDA white baked powder epoxy finish.
- Accommodates up to 300 lbs.
- Heavy-duty floor levelers included.
- Included accessory rail on both sides for mounting needed accessories.
- Choose from 48" or 60" table top.
- Available with or without locking caster.

09-0035
ELEMENT PLUS TABLE

- Stable, versatile, cost efficient table ideal for veterinary exam procedure and surgery.
- Features marine edge to prevent fluid runoff.
- Heavy duty, foot operated hydraulic lift raises table from approximately 29" to 37" working level.
- 300 lb. weight capacity and 360° rotation.
- Table dimensions of 44" long x 22" deep.
- Available with your choice of stationary feet or locking castors.
- Optional pull out drawer, drain hole and pail hook available.



09-0040
WAVELINE PROVET

The Waveline ProVet can be used on small, medium, or large animals. An applicable monitor for veterinary surgical suites and research facilities.

- 15" Multi-parameter Monitor.
- Standard parameters: ECG, NIBP, SpO₂, 2x Temp, Respiration, Printer and Battery Backup.
- Optional: EtCO₂ (Mainstream or Sidestream).
- Optional: Suntech Blood Pressure upgrade.
- Optional: Nellcor SpO₂ upgrade.
- Includes all veterinary accessories with each parameter.
- CO₂ and IBP upgradable. Modules sold separately.
- 18-month warranty on monitor.

09-0041
WAVELINE TOUCHVET

The Waveline TouchVet can be used on small, medium, or large animals. An applicable monitor for veterinary hospitals and clinics performing general surgical procedures.

- 12.1" Touchscreen Multi-parameter Monitor.
- Standard parameters: ECG, NIBP, SpO₂, 2x Temp, Respiration, Printer and Battery Backup.
- Optional: EtCO₂ (Mainstream or Sidestream).
- Optional: Nellcor SpO₂ upgrade.
- Optional: Suntech Blood Pressure upgrade.
- Includes all veterinary accessories with each parameter.
- CO₂ and IBP upgradable. Modules sold separately.
- 18-month warranty on monitor.

09-0042
WAVELINE EZ

A convenient portable patient Monitor, the Waveline EZ can be used on small, medium and large animals (excluding rabbits, rats and small rodents). An applicable monitor for veterinary clinics, hospitals, universities or research facilities.

- 8" Touchscreen Multi-parameter Monitor.
- Standard parameters: ECG, Respiration, SpO₂, NIBP and temperature.
- Advanced ST and arrhythmia detection.
- Audible and visual alarms.
- QuickBP readings recall.
- Optional EtCO₂ (Mainstream or Sidestream) and Printer.
- Optional: Nellcor SpO₂ upgrade.
- Includes all veterinary accessories with each parameter.
- 18-month warranty.



06-1000.....	364	06-3012.....	352, 379	09-0010.....	436	10-1376.....	415
06-1004.....	363	06-3013.....	352, 379	09-0011.....	436	10-1384.....	416
06-1101.....	364	06-3015.....	352, 379	09-0012.....	436	10-1388.....	416
06-1601.....	361	06-3016.....	352, 379	09-0013.....	436	10-1396.....	417
06-1625.....	359	06-3020.....	352, 379	09-0014.....	436	10-1398.....	417
06-1627.....	359	06-3021.....	352, 379	09-0015.....	436	10-1399.....	418
06-1630.....	361	06-3022.....	352, 379	09-0020.....	437	10-1400.....	417
06-1632.....	361	06-3023.....	352, 379	09-0025.....	437	10-1401.....	417
06-1635.....	363	06-3024.....	353	09-0026.....	437	10-1402.....	417
06-1638.....	363	06-3030.....	353	09-0027.....	437	10-1403.....	417
06-1640.....	362	06-3090.....	351	09-0028.....	437	10-1404.....	417
06-1642.....	362	06-3094.....	354, 184, 378	09-0030.....	438	10-1405.....	417
06-1662.....	362	06-3095.....	354, 184, 378	09-0031.....	438	10-1406.....	417
06-1668.....	363	06-3096.....	354, 184, 378	09-0032.....	438	10-1414.....	418
06-1670.....	360	06-3100.....	352, 379	09-0033.....	439	10-1415.....	418
06-1671.....	360	06-3101.....	352, 379	09-0034.....	439	10-1418.....	418
06-1672.....	360	06-3102.....	352, 379	09-0035.....	439	10-1420.....	418
06-1673.....	360	06-3103.....	352, 379	09-0040.....	440	10-1422.....	418
06-1701.....	364	06-3104.....	352, 379	09-0041.....	440	10-1424.....	420
06-2298.....	361	06-3105.....	352, 379	09-0042.....	440	10-1426.....	419
06-2299.....	361	06-3106.....	352, 379	10-1157.....	391	10-1428.....	419
06-2300.....	361	06-3107.....	352, 379	10-1158.....	391	10-1432.....	420
06-2302.....	361	06-3108.....	352, 379	10-1159.....	391	10-1434.....	420
06-2304.....	359	06-3110.....	352, 379	10-1160.....	391	10-1440.....	344, 377
06-2415.....	362	06-3111.....	352, 379	10-1170.....	391	10-1444.....	416
06-2417.....	362	06-3112.....	352, 379	10-1171.....	391	10-1450.....	390
06-2418.....	362	06-3115.....	352, 379	10-1172.....	388	10-1451.....	390
06-2422.....	362	06-3120.....	352, 379	10-1173.....	388	10-1465.....	416
06-2426.....	362	06-3121.....	352, 379	10-1174.....	388	10-1468.....	416
06-2427.....	362	06-3122.....	352, 379	10-1175.....	388	10-1470.....	417
06-2428.....	362	06-3123.....	352, 379	10-1176.....	388	10-1472.....	417
06-2750.....	360	06-3130.....	184, 354, 378	10-1177.....	388	10-1483.....	389
06-2760.....	361	06-3132.....	184, 354, 378	10-1178.....	388	10-1483-12.....	389
06-2800.....	360	06-3134.....	184, 354, 378	10-1180.....	388	10-1484.....	389
06-2802.....	360	06-3170.....	355	10-1181.....	388	10-1484-12.....	389
06-2803.....	360	06-3175.....	355	10-1182.....	390	10-1485.....	389
06-2808.....	358	06-3370.....	355	10-1183.....	390	10-1485-12.....	389
06-2852.....	358	06-3380.....	355	10-1184.....	390	10-1486.....	389
06-2860.....	358	06-3390.....	355	10-1186.....	390	10-1486-12.....	389
06-2861.....	358	06-3391.....	355	10-1188.....	390	10-1487.....	390
06-2862.....	358	06-7052.....	353	10-1189.....	390	10-1488.....	389
06-2863.....	358	07-1170.....	163	10-1190.....	390	10-1488-12.....	389
06-2870.....	417	07-1212.....	163	10-1192.....	391	10-1489.....	389
06-2872.....	417	07-1213.....	163	10-1340.....	398	10-1489-12.....	389
06-2873.....	417	07-1214.....	163	10-1342.....	398	10-1491.....	389
06-2880.....	417	07-1215.....	163	10-1344.....	398	10-1491-12.....	389
06-2881.....	417	07-1216.....	163	10-1346.....	398	10-1492.....	389
06-2882.....	417	07-1268.....	163	10-1347.....	398	10-1492-12.....	389
06-2903.....	351	07-1269.....	163	10-1348.....	398	10-1493.....	389
06-2904.....	351	07-1270.....	163	10-1349.....	398	10-1493-12.....	389
06-2907.....	351	07-1271.....	163	10-1350.....	415	10-1494.....	389
06-2908.....	351	07-1272.....	163	10-1352.....	415	10-1494-12.....	389
06-2910.....	351	07-1374.....	163	10-1354.....	415	10-1494-6.....	389
06-2912.....	351	07-1400.....	163	10-1356.....	415	10-1495.....	389
06-2915.....	351	07-1420.....	163	10-1362.....	415	10-1495-12.....	389
06-2920.....	351	07-1801.....	159	10-1364.....	415	10-1495-6.....	389
06-2925.....	351	07-1802.....	159	10-1366.....	415	10-1496.....	389
06-2930.....	351	07-1805.....	159	10-1370.....	415	10-1496-12.....	389
06-3010.....	352, 379	07-1806.....	159	10-1372.....	415	10-1497.....	390
06-3011.....	352, 379	08-1011.....	408	10-1374.....	415	10-1497-12.....	390



NUMERICAL INDEX

10-1498.....	389	10-1552-12.....	389	10-1679.....	396	10-1716.....	397
10-1498-12.....	389	10-1552-6.....	389	10-1680.....	394	10-1717.....	397
10-1502.....	408	10-1560.....	394	10-1680-12.....	394	10-1720.....	396
10-1502-12.....	408	10-1603.. 8, 193, 250, 426, 193		10-1680-6.....	394	10-1722.....	393
10-1504.....	408	10-1607.....	11, 253, 429	10-1683.....	394	10-1722-12.....	393
10-1504-12.....	408	10-1608.....	11, 253, 429	10-1683-12.....	394	10-1722-6.....	393
10-1505.....	389	10-1609.. 8, 193, 250, 426, 193		10-1683-6.....	394	10-1724.....	395
10-1505-12.....	389	10-1612.....	11, 253, 429	10-1684.....	393	10-1724-12.....	395
10-1505-6.....	389	10-1613.....	11, 253, 429	10-1684-12.....	393	10-1724-6.....	395
10-1507.....	389	10-1614.....	11, 253, 429	10-1684-6.....	393	10-1725.....	397
10-1507-12.....	389	10-1616.. 6, 214, 248, 392, 424		10-1685.....	393	10-1729.....	394
10-1507-6.....	389	10-1617.. 6, 214, 248, 392, 424		10-1685-12.....	393	10-1731.....	394
10-1510.....	389	10-1623.....	4, 246, 422	10-1685-6.....	393	10-1732.....	394
10-1510-12.....	389	10-1624.....	4, 246, 422	10-1686.....	393	10-1733.....	394
10-1510-6.....	389	10-1625.....	16, 258, 434	10-1686-12.....	393	10-1734.....	394
10-1523.....	391	10-1626.....	15, 257, 433	10-1686-6.....	393	10-1736.....	394
10-1523-12.....	391	10-1627.....	11, 253, 429	10-1687.....	393	10-1736-12.....	394
10-1525.....	392	10-1629.....	15, 257, 433	10-1687-12.....	393	10-1737.....	395
10-1525-12.....	392	10-1630.....	11, 253, 429	10-1687-6.....	393	10-1737-12.....	395
10-1527.....	391	10-1634.....	10, 49, 252, 428	10-1688.....	393	10-1737-6.....	395
10-1527-12.....	391	10-1635.....	10, 49, 252, 428	10-1688-12.....	393	10-1738.....	393
10-1533.....	391	10-1636.....	10, 49, 252, 428	10-1688-6.....	393	10-1738-12.....	393
10-1533-12.....	391	10-1637.....	10, 49, 252, 428	10-1689.....	393	10-1738-6.....	393
10-1535.....	395-396	10-1642.....	5, 148, 247, 423	10-1689-6.....	393	10-1740.....	395
10-1535-12.....	395-396	10-1643.....	5, 148, 247, 423	10-1690.....	393	10-1741.....	395
10-1535-6.....	395-396	10-1644.....	5, 148, 247, 423	10-1690-12.....	393	10-1741-6.....	395
10-1536.....	388	10-1650.....	416	10-1690-6.....	393	10-1742.....	395
10-1536-12.....	388	10-1651.....	416	10-1691.....	393	10-1742-12.....	395
10-1538.....	391	10-1652.....	416	10-1691-12.....	393	10-1742-6.....	395
10-1538-12.....	391	10-1653.....	5, 148, 247, 423	10-1691-6.....	393	10-1744.....	395
10-1539.....	388	10-1654.....	5, 148, 247, 423	10-1692.....	393	10-1744-12.....	395
10-1539-12.....	388	10-1655.....	416	10-1692-12.....	393	10-1744-6.....	395
10-1539-6.....	388	10-1656.....	416	10-1692-6.....	393	10-1746.....	395
10-1540.....	390	10-1657.....	416	10-1693.....	393	10-1746-12.....	395
10-1540-12.....	390	10-1658.....	416	10-1693-12.....	393	10-1746-6.....	395
10-1540-6.....	390	10-1659.....	416	10-1693-6.....	393	10-1747.....	395
10-1541.....	391	10-1660.....	415	10-1694.....	393	10-1747-12.....	395
10-1541-12.....	391	10-1661.....	415	10-1694-12.....	393	10-1747-6.....	395
10-1541-6.....	391	10-1663.....	415	10-1694-6.....	393	10-1748.....	395
10-1542.....	395	10-1664.....	415	10-1695.....	393	10-1748-12.....	395
10-1542-12.....	395	10-1665.....	415	10-1695-12.....	393	10-1748-6.....	395
10-1542-6.....	395	10-1666.....	415	10-1695-6.....	393	10-1749.....	395
10-1543.....	391	10-1668.....	415	10-1697.....	395	10-1750.....	396
10-1543-12.....	391	10-1669.....	415	10-1698.....	390	10-1750-12.....	396
10-1544.....	391	10-1670.....	388	10-1698-12.....	390	10-1750-6.....	396
10-1544-12.....	391	10-1670-12.....	388	10-1699.....	390	10-1752.....	396
10-1544-6.....	391	10-1670-24.....	388	10-1699-12.....	390	10-1752-12.....	396
10-1545.....	391, 418	10-1670-48.....	388	10-1700.....	397	10-1752-6.....	396
10-1545-12.....	391	10-1671.....	388	10-1701.....	397	10-1753.....	395
10-1545-6.....	391	10-1671-12.....	388	10-1702.....	397	10-1753-12.....	395
10-1546.....	407	10-1671-24.....	388	10-1703.....	397	10-1753-6.....	395
10-1546-6.....	407	10-1671-48.....	388	10-1705.....	397	10-1754.....	395
10-1547.....	391	10-1672.....	415	10-1706.....	397	10-1754-12.....	395
10-1547-12.....	391	10-1674.....	389	10-1707.....	397	10-1754-6.....	395
10-1547-6.....	391	10-1674-12.....	389	10-1708.....	397	10-1755.....	395
10-1550.....	391	10-1674-6.....	389	10-1710.....	396	10-1755-12.....	395
10-1550-12.....	391	10-1675.....	388	10-1711.....	397	10-1755-6.....	395
10-1550-6.....	391	10-1675-12.....	388	10-1712.....	397	10-1756.....	395
10-1551.....	390	10-1675-24.....	388	10-1713.....	396	10-1756-12.....	395
10-1552.....	389	10-1675-48.....	388	10-1714.....	396	10-1756-6.....	395



10-1757.....	395	10-1883-6.....	394	10-1967-6.....	409	10-4072.....	403
10-1758.....	395	10-1884.....	394	10-2555.....	409	10-4074.....	403
10-1759.....	395	10-1884-12.....	394	10-2556.....	409	10-4076.....	403
10-1760.....	393	10-1884-6.....	394	10-2557.....	409	10-4078.....	403
10-1760-12.....	393	10-1886.....	393	10-2701.....	11, 253, 429	10-4080.....	403
10-1760-6.....	393	10-1886-12.....	393	10-2722.....	7, 249, 429	10-4082.....	403
10-1763.....	399	10-1886-6.....	393	10-2724.....	7, 249, 425	10-4084.....	403
10-1764.....	395	10-1887.....	393	10-2730.....	12, 254, 430	10-4086.....	403
10-1766.....	395	10-1887-12.....	393	10-2732.....	12, 254, 430	10-4088.....	403
10-1768.....	392	10-1887-6.....	393	10-2736.....	12, 254, 430	10-4090.....	403
10-1770.....	399	10-1888.....	394	10-2738.....	12, 254, 430	10-4092.....	403
10-1772.....	399	10-1888-12.....	394	10-2765.....	11, 253, 429	10-4094.....	403
10-1775.....	399	10-1888-6.....	394	10-2774.....	7, 249, 425	10-4096.....	403
10-1776.....	399	10-1892.....	395	10-2775.....	13, 255, 431	10-4098.....	403
10-1780.....	399	10-1894.....	395	10-2776.....	13, 255, 431	10-4100.....	403
10-1800.....	398	10-1895.....	395	10-2777.....	13, 255, 431	10-4102.....	403
10-1805.....	398	10-1927.....	15, 257, 433	10-2800.....	9, 251, 427	10-4104.....	403
10-1806.....	398	10-1941.....	395	10-2801.....	9, 251, 427	10-4106.....	403
10-1808.....	398	10-1942.....	395	10-2842.....	15, 257, 433	10-4108.....	403
10-1810.....	398	10-1943.....	395	10-2850.....	14, 256, 432	10-4110.....	403
10-1812.....	398	10-1944.....	395	10-2852.....	14, 256, 432	10-4112.....	403
10-1814.....	398	10-1947.....	396	10-2854.....	14, 32, 256, 432	10-4114.....	403
10-1816.....	398	10-1948.....	395-396	10-2856.....	14, 32, 256, 432	10-4116.....	403
10-1818.....	398	10-1948-12.....	395-396	10-2858.....	14, 32, 256, 432	10-4118.....	403
10-1826.....	398	10-1948-6.....	395-396	10-4000.....	403	10-4120.....	403
10-1828.....	398	10-1949.....	395	10-4002.....	403	10-4122.....	403
10-1830.....	398	10-1949-12.....	395	10-4004.....	403	10-4124.....	403
10-1832.....	398	10-1949-6.....	395	10-4006.....	403	10-4126.....	403
10-1834.....	398	10-1950.....	395	10-4008.....	403	10-4128.....	403
10-1835.....	395	10-1950-12.....	395	10-4010.....	403	10-4130.....	403
10-1835-6.....	395	10-1950-6.....	395	10-4012.....	403	10-4132.....	403
10-1836.....	398	10-1952.....	395	10-4014.....	403	10-4134.....	403
10-1838.....	398	10-1952-12.....	395	10-4016.....	403	10-4136.....	403
10-1839.....	399	10-1952-6.....	395	10-4018.....	403	10-4138.....	403
10-1850.....	396	10-1953.....	395-396	10-4020.....	403	10-4140.....	403
10-1854.....	396	10-1953-12.....	395-396	10-4022.....	403	10-4142.....	403
10-1854-12.....	396	10-1953-6.....	395-396	10-4024.....	403	10-4144.....	403
10-1854-6.....	396	10-1954.....	395-396	10-4026.....	403	10-4146.....	403
10-1860.....	396	10-1954-12.....	395-396	10-4028.....	403	10-4148.....	403
10-1862.....	395	10-1954-6.....	395-396	10-4030.....	403	10-4150.....	403
10-1864.....	396	10-1955.....	393	10-4032.....	403	10-4152.....	403
10-1870.....	395	10-1955-12.....	393	10-4034.....	403	10-4154.....	403
10-1870-12.....	395	10-1955-6.....	393	10-4036.....	403	10-4156.....	403
10-1870-6.....	395	10-1956.....	393	10-4038.....	403	10-4158.....	403
10-1874.....	395	10-1956-12.....	393	10-4040.....	403	10-4160.....	403
10-1876.....	394	10-1956-6.....	393	10-4042.....	403	10-4162.....	403
10-1876-12.....	394	10-1957.....	396	10-4044.....	403	10-4164.....	403
10-1876-6.....	394	10-1960.....	409	10-4046.....	403	10-4166.....	403
10-1877.....	395	10-1961.....	409	10-4048.....	403	10-4168.....	403
10-1877-12.....	395	10-1962.....	409	10-4050.....	403	10-4170.....	403
10-1877-6.....	395	10-1964.....	409	10-4052.....	403	10-4172.....	403
10-1878.....	395	10-1965.....	409	10-4054.....	403	10-4174.....	403
10-1878-12.....	395	10-1965-12.....	409	10-4056.....	403	10-4176.....	403
10-1878-6.....	395	10-1965-6.....	409	10-4058.....	403	10-4178.....	403
10-1879.....	395	10-1966.....	409	10-4060.....	403	10-4180.....	403
10-1882.....	395	10-1966-12.....	409	10-4062.....	403	10-4182.....	403
10-1882-12.....	395	10-1966-6.....	409	10-4064.....	403	10-4184.....	403
10-1882-6.....	395	10-1967.....	409	10-4066.....	403	10-4186.....	403
10-1883.....	394	10-1967-12.....	409	10-4068.....	403	10-4190.....	403
10-1883-12.....	394			10-4070.....	403	10-4192.....	403



NUMERICAL INDEX

10-4194	403	10-4364	402	10-4534	401	10-4654	401
10-4196	403	10-4366	402	10-4536	401	10-4656	401
10-4198	403	10-4368	402	10-4538	401	10-4658	401
10-4200	403	10-4370	402	10-4540	401	10-4660	401
10-4202	403	10-4372	402	10-4542	401	10-4662	401
10-4204	403	10-4374	402	10-4544	401	10-4664	401
10-4206	403	10-4376	402	10-4546	401	10-4666	401
10-4208	403	10-4378	402	10-4548	401	10-4668	401
10-4210	403	10-4380	402	10-4550	401	10-4670	401
10-4212	403	10-4382	402	10-4552	401	10-4672	401
10-4214	403	10-4384	402	10-4554	401	10-4674	401
10-4216	403	10-4386	402	10-4556	401	10-4676	401
10-4218	403	10-4388	402	10-4558	401	10-4678	401
10-4220	403	10-4390	402	10-4560	401	10-4680	401
10-4222	403	10-4392	402	10-4562	401	10-4682	401
10-4224	403	10-4394	402	10-4564	401	10-4684	401
10-4226	403	10-4396	402	10-4566	401	10-4686	401
10-4228	403	10-4398	402	10-4568	401	10-4688	401
10-4230	403	10-4400	402	10-4570	401	10-4690	401
10-4232	403	10-4402	402	10-4572	401	10-4692	401
10-4234	403	10-4404	402	10-4574	401	10-4694	401
10-4236	403	10-4406	402	10-4576	401	10-4696	401
10-4238	403	10-4408	402	10-4578	401	10-4698	401
10-4284	403	10-4410	402	10-4580	401	10-4700	401
10-4286	403	10-4412	402	10-4582	401	10-4702	401
10-4288	403	10-4414	402	10-4584	401	10-4704	401
10-4290	403	10-4416	402	10-4586	401	10-4706	401
10-4300	402	10-4418	402	10-4588	401	10-4708	401
10-4302	402	10-4420	402	10-4590	401	10-4710	401
10-4304	402	10-4422	402	10-4592	401	10-4712	401
10-4306	402	10-4424	402	10-4594	401	10-4714	401
10-4308	402	10-4426	402	10-4596	401	10-4716	401
10-4310	402	10-4428	402	10-4598	401	10-4718	401
10-4312	402	10-4430	402	10-4600	401	10-4720	401
10-4314	402	10-4432	402	10-4602	401	10-4722	401
10-4316	402	10-4434	402	10-4604	401	10-4724	401
10-4318	402	10-4436	402	10-4606	401	10-4726	401
10-4320	402	10-4438	402	10-4608	401	10-4728	401
10-4322	402	10-4440	402	10-4610	401	10-4730	401
10-4324	402	10-4478	402	10-4612	401	10-4732	401
10-4326	402	10-4480	402	10-4614	401	10-4734	401
10-4328	402	10-4482	402	10-4616	401	10-4736	401
10-4330	402	10-4484	402	10-4618	401	10-4738	401
10-4332	402	10-4500	401	10-4620	401	10-4784	401
10-4334	402	10-4502	401	10-4622	401	10-4786	401
10-4336	402	10-4504	401	10-4624	401	10-4788	401
10-4338	402	10-4506	401	10-4626	401	10-4790	401
10-4340	402	10-4508	401	10-4628	401	10-4900	402
10-4342	402	10-4510	401	10-4630	401	10-4910	402
10-4344	402	10-4512	401	10-4632	401	10-4925	402
10-4346	402	10-4514	401	10-4634	401	10-4930	402
10-4348	402	10-4516	401	10-4636	401	10-4930ENG.....	402
10-4350	402	10-4518	401	10-4638	401	10-4970	401
10-4352	402	10-4520	401	10-4640	401	10-4975	402
10-4354	402	10-4522	401	10-4642	401	10-4985	403
10-4356	402	10-4524	401	10-4644	401	10-6000	383
10-4358	402	10-4526	401	10-4646	401	10-6005	383
10-4360	402	10-4528	401	10-4648	401	10-6025	383
10-4361	402	10-4530	401	10-4650	401	10-6045	383
10-4362	402	10-4532	401	10-4652	401	10-6055	383



10-6060	383	13-2065	35	15-2667	37	15-3448	24
10-6080	383	13-2072	35	15-2762	36	15-3449	24
10-6085	383	13-2155	36	15-2862	36	15-3450	26
10-6090	383	14-1045	35	15-3150	44, 264	15-3451	26
10-6095	383	14-1050	35	15-3172	40	15-3452	24
10-6120	383	14-1055	35	15-3210	40	15-3457	24
10-6125	383	14-1060	35	15-3244	30	15-3460	25
10-6155	383	14-1065	35	15-3305	25	15-3461	25
10-6390	383	14-1072	35	15-3306	25	15-3464	27
10-6395	383	14-1155	36	15-3307	25	15-3466	27
10-6405	383	14-2045	35	15-3308	25	15-3468	27
10-6500	404	14-2050	35	15-3309	25	15-3500	28
10-6501	404	14-2055	35	15-3310	25	15-3505	28
10-6505	404	14-2060	35	15-3311	25	15-3507	25
10-6506	404	14-2065	35	15-3315	25	15-3508	25
10-6510	405	14-2072	35	15-3317	25	15-3509	25
10-6511	405	14-2155	36	15-3318	25	15-3510	28
10-6515	405	15-1045	35	15-3319	25	15-3515	28
10-6516	405	15-1050	35	15-3320	30	15-3520	30
10-6520	405	15-1055	35	15-3325	24	15-3525	30
10-6521	405	15-1060	35	15-3326	24	15-3535	30
10-6525	406	15-1065	35	15-3330	24	15-3536	29
10-6526	406	15-1155	36	15-3331	24	15-3542	29
10-6531	406	15-1242	26	15-3335	25	15-3548	31
10-6536	406	15-1243	26	15-3336	25	15-3550	28
11-1035	51	15-1270	317	15-3340	26	15-3555	28
11-1045	51	15-1271	317	15-3342	24	15-3560	28
11-1055	51	15-1272	317	15-3343	24	15-3565	28
11-1060	51	15-1273	317	15-3348	24	15-3566	28
11-1072	51	15-1274	317	15-3349	24	15-3567	29
11-1080	51	15-1275	317	15-3352	24	15-3568	28
11-1180	52	15-1276	317	15-3354	27	15-3569	29
11-1252	52	15-1282	43, 317	15-3355	27	15-3570	29
11-1255	52	15-1285	43, 317	15-3356	27	15-3571	29
11-1278	51	15-1307	38	15-3357	24	15-3574	29
11-1280	51	15-1308	38	15-3358	27	15-3575	29
11-1281	51	15-1342	26	15-3360	25	15-3577	30
11-1282	51	15-1343	26	15-3361	25	15-3578	30
11-1283	51	15-1355	44, 149, 264	15-3364	27	15-3579	31
11-1284	51	15-1358	44, 264	15-3366	27	15-3580	31
11-1285	51	15-1360	36	15-3368	27	15-3583	31
11-1286	51	15-1361	36	15-3370	28	15-3584	31
11-1287	51	15-1555	36	15-3372	28	15-3585	28
11-1297	51	15-1567	36	15-3405	25	15-3590	28
11-1298	52	15-1655	37	15-3406	25	15-7032	27
11-1380	51	15-1667	37	15-3407	25	15-9107	25
11-1390	51	15-1762	36	15-3408	25	15-9108	25
11-1495	52	15-1862	36	15-3409	25	15-9109	25
11-1496	52	15-2045	35	15-3410	25	15-9117	25
13-1045	35	15-2050	35	15-3411	25	15-9118	25
13-1050	35	15-2055	35	15-3412	25	15-9119	25
13-1055	35	15-2060	35	15-3426	24	16-1055	20
13-1060	35	15-2065	35	15-3427	24	16-1056	20
13-1065	35	15-2307	38	15-3429	24	16-1057	20
13-1072	35	15-2308	38	15-3430	24	16-1155	20
13-1155	36	15-2445	38	15-3434	24	16-1156	20
13-2045	35	15-2455	38	15-3435	24	16-1157	20
13-2050	35	15-2555	36	15-3442	24	16-1505	20
13-2055	35	15-2567	36	15-3443	24	16-1510	20
13-2060	35	15-2655	37	15-3444	26	16-1515	20



NUMERICAL INDEX

16-1605	20	16-3614	21	17-2680	77	19-1245	59
16-1610	20	16-3615	21	17-2685	77	19-1250	59
16-1615	20	16-3620	21	17-2690	77	19-1255	59
16-1805	20	16-4000	22	17-2762	77	19-1260	59
16-1810	20	16-4001	22	17-2855	77	19-1270	59
16-1815	20	16-4002	22	17-2862	77	19-1280	59
16-1905	20	16-4004	22	17-2872	77	19-1310	59
16-1910	20	16-4005	22	17-2880	77	19-1312	59
16-1915	20	16-4006	22	17-2885	77	19-1445	59
16-2005	21	16-4008	22	17-2890	77	19-1450	59
16-2010	21	16-4009	22	17-2957	78	19-1455	59
16-2015	21	16-4010	22	17-2958	78	19-1460	59
16-2105	21	16-4012	22	17-2962	77	19-1480	59
16-2110	21	16-4013	22	17-3055	76	19-1510	59
16-2115	21	16-4014	22	17-3062	76	19-1512	59
16-2205	21	17-1055	78	17-3075	76	19-1650	59
16-2210	21	17-1062	77	17-3155	76	19-1655	59
16-2211	21	17-1080	77	17-3162	76	19-1660	59
16-2215	21	17-1162	77	17-3175	76	19-1850	59
16-2305	21	17-1180	77	17-3255	77	19-1855	59
16-2310	21	17-1230	75, 151	17-3265	77	19-1905	59
16-2311	21	17-1232	75, 151	17-3275	77	19-1910	59
16-2312	21	17-1235	75, 151	17-3355	77	19-2050	60
16-2405	20	17-1238	76	17-3365	77	19-2160	62
16-2505	20	17-1250	78	17-3375	77	19-2166	63
16-2605	21	17-1255	77	17-3455	77	19-2167	63
16-2610	21	17-1260	78	17-3460	78	19-2168	63
16-2705	21	17-1262	78	17-3555	77	19-2170	63
16-2800	22, 263	17-1335	75, 151	17-3660	81	19-2172	63
16-3503	23	17-1350	78	17-3670	81	19-2200	62
16-3504	23	17-1355	77	17-3760	81	19-2260	63
16-3505	23	17-1360	78	17-3762	81	19-2280	63
16-3506	23	17-1362	78	17-3815	87	19-2310	63
16-3507	23	17-1450	75, 303	17-3817	87	19-2320	63
16-3508	23	17-1455	75, 303	17-3915	87	19-2860	63
16-3509	23	17-1550	75, 303	17-3917	87	19-2880	63
16-3510	23	17-1555	75, 303	18-1050	75, 303	19-2910	63
16-3511	23	17-1650	75, 303	18-1150	75, 303	19-2930	72
16-3513	23	17-1750	75, 303	18-1250	79	19-2945	72
16-3514	23	17-1762	79	18-1352	76	19-3030	73
16-3515	23	17-1772	79	18-1452	76	19-3035	72
16-3526	23	17-1850	75, 303	18-1552	76	19-3040	72
16-3527	23	17-1855	76	18-1652	76	19-3045	72
16-3528	23	17-1955	76	18-1752	77	19-3055	73, 303
16-3530	23	17-2055	76	18-1852	77	19-3056	73, 303
16-3531	23	17-2155	76	18-1952	76	19-3147	73, 303
16-3532	23	17-2255	76	18-2052	76	19-3160	73
16-3533	23	17-2262	76	18-2140	81	19-3161	73, 303
16-3540	23	17-2267	76	18-2155	81	19-3162	73
16-3541	23	17-2272	76	18-2162	81	19-3240	72
16-3545	23	17-2280	76	18-2164	81	19-3250	73
16-3546	23	17-2362	76	19-1040	59	19-3252	73
16-3552	20	17-2455	76	19-1045	59	19-3340	72
16-3557	20	17-2462	76	19-1050	59	19-3350	73
16-3562	20	17-2467	76	19-1055	59	19-3360	74
16-3567	20	17-2472	76	19-1060	59	20-1160	100
16-3572	23	17-2480	76	19-1070	59	20-1260	98
16-3577	23	17-2655	77	19-1080	59	20-1265	98
16-3582	23	17-2662	77	19-1110	59	20-1270	98
16-3587	23	17-2672	77	19-1112	59	20-1280	98



20-1290.....	98	21-8013.....	91	21-8250.....	94, 141	22-1655.....	35
20-1295.....	98	21-8014.....	91	21-8251.....	94, 141	22-2154.....	82
20-1350.....	97	21-8016.....	91	21-8253.....	94, 141	22-2155.....	82
20-1352.....	97	21-8019.....	91	21-8254.....	94, 141	22-2272.....	76
20-1450.....	97	21-8020.....	91	21-8255.....	94, 141	22-2280.....	76
20-1547.....	97	21-8021.....	91	21-8257.....	94, 141	22-2450.....	37
20-1750.....	97	21-8022.....	91	21-8258.....	94, 141	22-2460.....	37
20-1751.....	97	21-8023.....	91	21-8259.....	94, 141	22-2520.....	41
20-1760.....	97, 142	21-8024.....	91	21-9012.....	93	22-2545.....	37
20-1870.....	98	21-8025.....	91, 141	21-9016.....	93	22-2550.....	37
20-2052.....	98	21-8026.....	91, 141	21-9018.....	93	22-2555.....	36
20-2060.....	98	21-8027.....	91, 141	21-9030.....	93	22-2567.....	36
20-2070.....	98	21-8028.....	91, 141	21-9035.....	93	22-2645.....	265
20-2270.....	98	21-8029.....	91, 141	21-9045.....	93	22-2652.....	39
20-2480.....	98	21-8030.....	91	21-9050.....	188, 263	22-2657.....	39
20-2490.....	98	21-8031.....	91	21-9051.....	188, 263	22-2722.....	38
20-2662.....	99	21-8032.....	91	21-9052.....	188, 263	22-2745.....	42
20-2730.....	99	21-8033.....	91	21-9060.....	91, 188, 263	22-2755.....	47
20-2733.....	99	21-8034.....	91	21-9065.....	91, 188, 263	22-2758.....	38
20-2734.....	99	21-8035.....	91	22-1054.....	51	22-2759.....	38
20-2740.....	99	21-8036.....	91	22-1057.....	37	22-2760.....	38
20-2747.....	99	21-8037.....	91	22-1061.....	59	22-2762.....	38
20-2748.....	99	21-8039.....	92	22-1062.....	59	22-2768.....	38
20-2755.....	99	21-8040.....	94	22-1063.....	59	22-2770.....	38
20-2765.....	99	21-8042.....	94	22-1064.....	59	22-2772.....	38
20-2775.....	99	21-8043.....	94	22-1070.....	37	22-2834.....	44, 149, 264
20-2780.....	100	21-8044.....	94	22-1071.....	37	22-2835.....	44, 149, 264
20-2781.....	100	21-8045.....	94	22-1072.....	51	22-2837.....	264
20-2910.....	98	21-8046.....	94	22-1135.....	46, 150	22-2844.....	44, 149, 264
20-2911.....	98	21-8047.....	94	22-1145.....	35	22-2845.....	44, 149, 264
20-3055.....	100	21-8051.....	91	22-1150.....	35	22-2855.....	47
20-3075.....	100	21-8052.....	94, 141	22-1155.....	35	22-2934.....	44, 149, 264
20-3080.....	100, 155	21-8053.....	94, 141	22-1161.....	59	22-2935.....	44, 149, 264
20-3350.....	97	21-8054.....	94, 141	22-1162.....	59	22-2947.....	44, 149, 264
20-3910.....	98	21-8055.....	94, 141	22-1163.....	59	22-2950.....	44, 264
20-4170.....	98	21-8056.....	94, 141	22-1164.....	59	22-3129.....	87
20-4510.....	100	21-8057.....	94, 141	22-1235.....	46, 150	22-3255.....	79
20-4682.....	100	21-8058.....	94, 141	22-1240.....	41, 150	22-3257.....	79
20-4795.....	99	21-8059.....	94, 141	22-1241.....	41, 150	22-3270.....	79
20-4852.....	98	21-8060.....	92	22-1242.....	41, 150	22-3452.....	79
20-4867.....	98	21-8061.....	92	22-1245.....	35	22-3555.....	76
21-707.....	73	21-8065.....	92	22-1250.....	35	22-3655.....	76
21-708.....	73	21-8070.....	94	22-1255.....	35	22-3755.....	77
21-2662.....	91	21-8071.....	94	22-1342.....	41, 150	22-3855.....	77
21-3510.....	92	21-8075.....	90	22-1345.....	35	22-4050.....	61
21-7012.....	90	21-8079.....	92	22-1350.....	35	22-4150.....	61
21-7013.....	90	21-8080.....	90	22-1354.....	44, 149, 264	22-4152.....	61
21-8000.....	90	21-8082.....	91	22-1355.....	35	22-4154.....	61
21-8001.....	90	21-8086.....	90	22-1442.....	47, 149	22-4156.....	61
21-8002.....	90	21-8095.....	92	22-1445.....	35	22-4350.....	61
21-8003.....	90	21-8096.....	92	22-1450.....	35	22-4352.....	61
21-8004.....	90, 141	21-8097.....	92	22-1455.....	35	22-4354.....	61
21-8005.....	90	21-8150.....	94, 141	22-1542.....	47, 149	22-4356.....	61
21-8006.....	90	21-8151.....	94, 141	22-1545.....	35	22-4550.....	61
21-8007.....	90	21-8152.....	94, 141	22-1550.....	35	22-5050.....	98
21-8008.....	90	21-8156.....	94, 141	22-1555.....	35	22-6155.....	81
21-8009.....	90	21-8157.....	94, 141	22-1556.....	36	22-6157.....	81
21-8010.....	90	21-8158.....	94, 141	22-1567.....	36	22-6160.....	82
21-8011.....	90	21-8159.....	94, 141	22-1645.....	35	22-6260.....	82
21-8012.....	91	21-8160.....	94, 141	22-1650.....	35	22-6577.....	159



NUMERICAL INDEX

22-6585	159	23-1130	32	23-1268	28	23-2568	58
22-6586	159	23-1136	32	23-1270	28	23-2577	58
22-6590	160	23-1138	32	23-1274	29	23-2585	58
22-6591	160	23-1140	32	23-1278	29	23-2600	56
22-6670	62	23-1142	32	23-1280	29	23-2602	56
22-6770	62	23-1148	33, 147	23-1290	34	23-2603	56
22-6870	62	23-1149	33, 147	23-1292	34	23-2604	56
22-6970	62	23-1150	33, 147	23-1294	34	23-2606	56
22-7470	64	23-1151	33, 147	23-1296	34	23-2608	56
22-8067	106	23-1152	33, 147	23-1300	34	23-2811	56
22-8075	106	23-1153	33, 147	23-1302	34	23-2819	56
22-8080	107	23-1154	33, 147	23-1304	34	23-2824	56
22-8180	107	23-1155	33, 147	23-1306	34	23-2826	56
22-8210	103	23-1156	33, 147	23-2100	57, 148	23-2828	56
22-8211	103	23-1157	33, 147	23-2101	57, 148	23-2830	56
22-8212	103	23-1158	33, 146	23-2105	57, 148	23-2834	56
22-8213	103	23-1159	33, 146	23-2106	57, 148	23-2836	56
22-8214	103	23-1160	33, 147	23-2107	57	23-2838	56
22-8215	103	23-1161	33, 147	23-2108	57	23-2851	58
22-8245	113	23-1162	33, 146	23-2110	57	23-2852	58
22-8255	113	23-1163	33, 146	23-2113	57	23-2861	58
22-8270	108	23-1164	32	23-2120	95	23-2862	58
22-8345	112	23-1165	32	23-2124	95	23-2864	58
22-8355	112	23-1166	32	23-2125	95	23-2865	58
22-8760	113	23-1167	32	23-2128	96	23-9292	166
22-8824	111	23-1168	32	23-2130	95	24-1007	268
22-8826	111	23-1169	32	23-2132	96	24-1011	268
22-8828	111	23-1170	32	23-2134	96	24-1012	268
22-8832	111	23-1171	32	23-2135	95	24-1014	268
22-8834	111	23-1172	32	23-2136	96	24-1016	268
22-8850	113	23-1173	32	23-2220	95	24-1018	268
22-8853	113	23-1174	32	23-2224	95	24-1020	268
22-8855	113	23-1175	32	23-2225	95	24-1022	268
22-8920	112	23-1176	32	23-2228	96	24-1150	267
22-8940	112	23-1177	32	23-2230	95	24-1250	267
22-8945	310, 357	23-1178	32	23-2232	96	24-1450	267
22-9027	111	23-1179	32	23-2234	96	24-1650	267
22-9029	111	23-1180	33	23-2235	95	24-1962	43, 265
22-9030	114	23-1182	33	23-2236	96	24-2047	268
22-9132	104	23-1184	33	23-2500	57, 148	24-2055	268
22-9133	104	23-1186	33	23-2501	57, 148	24-2218	190, 268
22-9141	104	23-1188	34, 146	23-2505	57, 148	24-2220	190, 268
22-9142	104	23-1189	34, 146	23-2506	57, 148	24-2222	190, 268
22-9143	104	23-1190	34, 146	23-2507	57	24-2224	190, 268
22-9144	104	23-1191	34, 147, 264	23-2508	57	24-2226	190, 268
23-1100	32	23-1193	34, 146	23-2510	57	24-2228	190, 268
23-1101	32	23-1194	34, 146	23-2513	57	24-2230	190, 268
23-1102	32	23-1195	34, 146	23-2516	58	24-2232	190, 268
23-1104	32	23-1196	34, 147	23-2520	58	24-2234	190, 268
23-1105	32	23-1199	34	23-2521	58	24-2236	190, 268
23-1106	32	23-1200	34	23-2525	58	24-2340	45, 266, 302
23-1112	32	23-1202	34	23-2532	58	24-2341	45, 266, 302
23-1113	32	23-1203	34	23-2534	58	24-2342	45, 266
23-1114	32	23-1250	30	23-2538	58	24-2345	45, 266, 302
23-1116	32	23-1254	30	23-2542	58	24-2346	45, 266, 302
23-1117	32	23-1260	28	23-2552	58	24-2347	45, 266
23-1118	32	23-1262	28	23-2554	58	26-1031	267
23-1124	32	23-1264	28	23-2560	58	26-1032	267
23-1126	32	23-1266	28	23-2561	58	26-1033	267
23-1128	32	23-1267	29	23-2563	58	26-1035	190



26-1280.....	266	31-1042.....	229	31-4313YC.....	232	31-7250.....	244
26-1380.....	266	31-2205.....	236	31-4314.....	231	31-7255.....	244
26-1480.....	266	31-2227.....	230	31-4314YC.....	231	31-7260.....	244
26-1580.....	266	31-2229.....	230	31-4315.....	231	31-7300.....	238
26-1585.....	267	31-2233.....	230	31-4315XC.....	231	31-7301.....	238
26-1586.....	267	31-2235.....	230	31-4316.....	231	31-7302.....	238
26-2005.....	267	31-2237.....	230	31-4316XC.....	231	31-7303.....	238
26-2006.....	267	31-2238.....	236	31-4317.....	232	31-7305.....	239
26-2007.....	267	31-2238-45.....	236	31-4317YC.....	232	31-7306.....	239
26-2009.....	267	31-2238OR.....	236	31-4318.....	233	31-7307.....	239
26-2010.....	267	31-2239.....	236	31-4320.....	233	31-7308.....	239
30-1030.....	126	31-2241.....	230	31-4321.....	233	31-7309.....	239
30-1045.....	125	31-2242.....	230, 233	31-4322.....	229	31-7310.....	239
30-1050.....	125	31-2243.....	230	31-4323.....	229	31-7311.....	239
30-1055.....	125	31-2244.....	230	31-4324.....	229	31-7312.....	239
30-1060.....	125	31-2258.....	236	31-4325.....	233	31-7313.....	239
30-1070.....	125	31-2327.....	234	31-4326.....	233	31-7314.....	239
30-1080.....	125	31-2347.....	236	31-4327.....	233	31-7315.....	239
30-1145.....	125	31-2349.....	236	31-4328.....	229	31-7316.....	239
30-1150.....	125	31-2350.....	234	31-4329.....	229	31-7317.....	239
30-1155.....	125	31-2352.....	234	31-4562.....	235	31-7318.....	239
30-1160.....	125	31-2355.....	234	31-4563.....	235	31-7319.....	239
30-1170.....	125	31-2355-45.....	234	31-4565.....	235	31-7320.....	239
30-1180.....	125	31-2365.....	234	31-7001XC.....	241	31-7321.....	240
30-1240.....	126	31-2435.....	230	31-7002YC.....	241	31-7322.....	240
30-1250.....	126	31-2437.....	230	31-7007.....	242	31-7323.....	240
30-1450.....	125	31-2443.....	230	31-7007-45.....	242	31-7324.....	240
30-1545.....	125, 145	31-2445.....	230	31-7012.....	242	31-9001XC.....	227
30-1550.....	125	31-2447.....	230	31-7012-45.....	242	31-9002YC.....	227
30-1555.....	125	31-2550.....	237	31-7012XC.....	243	31-9005.....	218
30-1560.....	125	31-2550-45.....	237	31-7016.....	242	31-9005XC.....	218
30-1580.....	125	31-2551.....	237	31-7016-45.....	242	31-9005YC.....	218
30-1610.....	125	31-2552.....	237	31-7030.....	242	31-9010.....	218
30-1612.....	125	31-2552-45.....	237	31-7030-45.....	242	31-9010-45.....	218
30-1945.....	125	31-2553.....	237	31-7030XC.....	243	31-9010XC.....	218
30-1950.....	125	31-4003.....	236	31-7035.....	242	31-9010XC-45.....	218
30-1955.....	125	31-4004.....	236	31-7035-45.....	242	31-9012.....	218
30-1960.....	125	31-4301.....	233	31-7040.....	242	31-9012-45.....	218
30-1970.....	125	31-4302.....	233	31-7040-45.....	242	31-9012XC.....	218
30-1980.....	125	31-4303.....	231	31-7055.....	242	31-9012XC-45.....	218
30-2010.....	125	31-4303XC.....	231	31-7055-45.....	242	31-9015.....	219
30-2012.....	125	31-4304.....	231	31-7055XC.....	243	31-9015-45.....	219
30-2145.....	125	31-4304XC.....	231	31-7055YC.....	243	31-9015XC.....	219
30-2150.....	125	31-4305.....	232	31-7061.....	242	31-9015XC-45.....	219
30-2155.....	125	31-4305XC.....	232	31-7061-45.....	242	31-9016.....	219
30-2160.....	125	31-4306.....	231	31-7070.....	242	31-9016XC.....	219
31-0001.....	229	31-4306XC.....	231	31-7070-45.....	242	31-9020.....	219
31-0002.....	229	31-4307.....	231	31-7073.....	242	31-9020XC.....	219
31-0003.....	229	31-4307XC.....	231	31-7073-45.....	242	31-9025.....	219
31-0004.....	228-229	31-4308.....	232	31-7107.....	242	31-9025XC.....	219
31-1002.....	228	31-4308YC.....	232	31-7107-45.....	242	31-9026.....	218
31-1004.....	228	31-4309.....	231	31-7200.....	244	31-9026XC.....	218
31-1007.....	228	31-4309XC.....	231	31-7205.....	244	31-9027.....	218
31-1010.....	228-229	31-4310.....	231	31-7210.....	244	31-9027XC.....	218
31-1011.....	228-229	31-4310XC.....	231	31-7215.....	244	31-9030.....	220
31-1015.....	228	31-4311.....	232	31-7220.....	244	31-9030-45.....	220
31-1016.....	228	31-4311XC.....	232	31-7225.....	244	31-9030XC.....	220
31-1017.....	228	31-4312.....	232	31-7230.....	244	31-9030XC-45.....	220
31-1018.....	228	31-4312YC.....	232	31-7235.....	244	31-9031.....	220
31-1020.....	229	31-4313.....	232	31-7240.....	244	31-9031XC.....	220
				31-7245.....	244		



NUMERICAL INDEX

31-9033	220	31-9095YC-45	225	31-9402	217	34-2428	129
31-9033XC	220	31-9096	221	31-9403	217	34-2434	129
31-9035	220	31-9096YC	221	31-9404	216	34-2438	129
31-9035XC	220	31-9097	225	31-9405	217	34-2522	129
31-9036	220	31-9097XC	225	31-9406	217	34-2526	129
31-9036XC	220	31-9097YC	225	31-9407	217	34-2536	129
31-9040	220	31-9098	225	31-9408	217	36-1290	64
31-9040XC	220	31-9098YC	225	31-9409	217	36-1310	64
31-9042	225	31-9100	223	31-9410	217	36-1602	82
31-9042XC	225	31-9100YC	223	31-9411	216	36-1662	81
31-9043	221	31-9105	222	31-9412	216	36-1677	81
31-9043XC	221	31-9105YC	222	31-9415	216	36-1692	81
31-9045	221	31-9110	226	31-9416	216	36-2060	81
31-9045XC	221	31-9110-45	226	31-9417	216	36-2160	81
31-9045YC	221	31-9110YC	226	31-9418	216	36-2260	81
31-9046	226	31-9110YC-45	226	32-1035	128	36-2275	81
31-9046XC	226	31-9111	221	32-1036	128	36-2295	81
31-9047	226	31-9111YC	221	32-1037	128	36-2690	76
31-9047XC	226	31-9112	222	32-1040	128	36-2710	76
31-9050	223	31-9112YC	222	32-1530	126	36-2712	76
31-9050-45	223	31-9113	221	32-1533	126	36-2790	76
31-9050XC	223	31-9113YC	221	32-1534	126	36-2810	76
31-9050YC	223	31-9115	226	32-1535	126	36-2812	76
31-9050YC-45	223	31-9115-45	226	32-1536	126	36-2890	81, 195
31-9051	223	31-9115XC	226	32-1537	126	36-2895	81, 195
31-9051YC	223	31-9115YC	226	32-1538	126	36-2962	81, 195
31-9055	223	31-9115YC-45	226	32-1539	126	36-2990	81, 195
31-9055YC	223	31-9120	220	32-1610	126	36-2995	81, 195
31-9060	224	31-9120XC	220	32-1611	126	36-3180	82
31-9060-45	224	31-9125	220	32-1785	80	36-3195	82
31-9060YC	224	31-9125-45	220	32-1850	80	36-3210	82
31-9060YC-45	224	31-9125XC	220	32-1860	80	36-3310	82
31-9061	224	31-9125XC-45	220	32-1870	80	36-3510	82
31-9061YC	224	31-9128	221	32-1875	79	36-3590	81
31-9065	224	31-9128XC	221	32-1890	79	36-3690	81
31-9065-45	224	31-9130	221	32-1990	79	40-1018	188
31-9065XC	224	31-9130XC	221	32-2066	87	40-1023	188
31-9065XC-45	224	31-9135	221	32-2070	80	40-1024	188
31-9065YC	224	31-9135XC	221	32-2090	80	40-1045	188
31-9065YC-45	224	31-9140	222	32-2470	81	40-1048	189
31-9067	222	31-9140-45	222	32-2477	81	40-1535	190
31-9067YC	222	31-9140XC	222	32-3092	128	40-1545	190
31-9070	224	31-9140YC	222	32-3094	128	40-1562	190
31-9070YC	224	31-9140YC-45	222	32-3096	128	40-1565	190
31-9075	224	31-9142	224	32-3098	128	40-1566	190
31-9075YC	224	31-9142XC	224	33-1375	88	40-1567	190
31-9080	223	31-9144	222	33-1376	88	40-1568	190
31-9080XC	223	31-9144YC	222	34-1014	129	40-1569	190
31-9080YC	223	31-9145	222	34-1017	129	40-1580	190
31-9085	223	31-9145YC	222	34-1410	129	40-1582	190
31-9085YC	223	31-9150	227	34-1414	129	40-1584	190
31-9090	225	31-9150-45	227	34-1417	129	40-1590	190
31-9090-45	225	31-9155	227	34-1418	129	40-1591	190
31-9090XC-45	225	31-9155-45	227	34-1420	129	40-1592	190
31-9090YC	225	31-9160	227	34-1422	129	40-1593	190
31-9095	225	31-9360AX	232	34-1424	129	40-1594	190
31-9095-45	225	31-9362AX	232	34-1428	129	40-1595	190
31-9095XC	225	31-9364AX	232	34-2023	159	40-1596	190
31-9095XC-45	225	31-9400	217	34-2230	159	40-1715	189
31-9095YC	225	31-9401	217	34-2422	129	40-1726	189



40-1727.....	266	40-3810.....	172	40-6545.....	176	40-6774.....	176
40-1735.....	188	40-3910.....	172	40-6548.....	176	40-6775.....	176
40-1738.....	188	40-3985.....	169	40-6549.....	176	40-6776.....	176
40-1740.....	188, 263	40-4085.....	169	40-6550.....	176	40-6777.....	176
40-1762.....	189	40-4090.....	169	40-6552.....	176	40-6781.....	176
40-1778.....	301	40-4092.....	169	40-6560.....	176	40-6782.....	176
40-1915.....	357, 372	40-4095.....	169	40-6561.....	176	40-6783.....	176
40-1916.....	357, 372	40-4100.....	169	40-6562.....	176	40-6784.....	176
40-1917.....	357, 372	40-4102.....	169	40-6563.....	176	40-6785.....	176
40-2273.....	191	40-4104.....	169	40-6564.....	176	40-6786.....	176
40-2290.....	108, 187	40-4190.....	169	40-6565.....	176	40-6787.....	176
40-2313.....	174	40-4192.....	169	40-6570.....	176	40-6791.....	178
40-2379.....	182	40-4194.....	169	40-6571.....	176	40-6792.....	178
40-2413.....	174	40-4265.....	169	40-6572.....	176	40-6793.....	178
40-2417.....	174	40-4268.....	170	40-6573.....	176	40-6794.....	178
40-2418.....	174	40-4270.....	170	40-6574.....	176	40-6795.....	178
40-2480.....	174	40-4272.....	169	40-6575.....	176	40-6796.....	178
40-2485.....	174	40-4360.....	169	40-6666.....	176	40-6797.....	178
40-2580.....	174	40-4365.....	169	40-6667.....	176	40-6799.....	178
40-2585.....	174	40-4372.....	169	40-6668.....	176	40-6800.....	178
40-2592.....	175	40-4472.....	169	40-6669.....	176	40-6801.....	178
40-2593.....	175	40-4512.....	169	40-6670.....	176	40-6802.....	178
40-2594.....	175	40-4572.....	172	40-6671.....	176	40-6803.....	178
40-2596.....	175	40-4575.....	172	40-6672.....	176	40-6804.....	178
40-2597.....	175	40-5212.....	173	40-6673.....	176	40-6805.....	178
40-2598.....	175	40-5213.....	173	40-6674.....	176	40-6828.....	178
40-2599.....	175	40-5215.....	173	40-6675.....	176	40-6829.....	178
40-2600.....	175	40-5218.....	173	40-6680.....	176	40-6830.....	178
40-2650.....	191	40-5311.....	173	40-6681.....	176	40-6831.....	178
40-2655.....	191	40-5312.....	173	40-6682.....	176	40-6832.....	178
40-2660.....	174	40-5395.....	173	40-6683.....	176	40-6833.....	178
40-2670.....	174	40-5520.....	173	40-6684.....	176	40-6835.....	178
40-2675.....	175	40-5535.....	173	40-6685.....	176	40-6836.....	178
40-2810.....	174	40-5540.....	173	40-6686.....	176	40-6837.....	178
40-2828.....	175	40-5542.....	173	40-6687.....	176	40-6838.....	178
40-2838.....	175	40-5544.....	173	40-6688.....	176	40-6839.....	178
40-2921.....	175	40-5546.....	173	40-6689.....	176	40-6843.....	178
40-2922.....	175	40-5765.....	179	40-6701.....	177	40-6844.....	178
40-2923.....	175	40-5870.....	179	40-6711.....	177	40-6845.....	178
40-2925.....	175	40-5871.....	179	40-6715.....	177	40-6846.....	178
40-2927.....	175	40-5875.....	179	40-6716.....	177	40-6847.....	178
40-2928.....	175	40-5910.....	318	40-6717.....	177	40-6848.....	178
40-3055.....	172, 318	40-5925.....	179	40-6723.....	177	40-6849.....	178
40-3077.....	172, 318	40-5926.....	179	40-6724.....	177	40-6850.....	178
40-3087.....	172, 318	40-6106.....	177	40-6725.....	177	40-6851.....	178
40-3155.....	172	40-6112.....	177	40-6726.....	177	40-6852.....	178
40-3177.....	172	40-6118.....	177	40-6728.....	177	40-6853.....	178
40-3186.....	142, 171	40-6206.....	176	40-6731.....	177	40-6953.....	176
40-3187.....	172	40-6212.....	176	40-6732.....	177	40-6954.....	176
40-3189.....	142, 171	40-6218.....	176	40-6733.....	177	40-6956.....	176
40-3190.....	171, 293	40-6306.....	178	40-6734.....	177	40-6958.....	176
40-3191.....	142, 171	40-6312.....	178	40-6735.....	177	40-6970.....	176
40-3192.....	171, 293	40-6318.....	178	40-6736.....	177	40-6973.....	176
40-3196.....	293	40-6532.....	176	40-6737.....	177	40-6976.....	176
40-3198.....	293	40-6534.....	176	40-6738.....	177	40-6979.....	176
40-3206.....	170	40-6536.....	176	40-6739.....	177	40-7000.....	185
40-3208.....	170	40-6538.....	176	40-6740.....	177	40-7100.....	185
40-3570.....	170	40-6540.....	176	40-6771.....	176	40-7110.....	185
40-3670.....	170	40-6542.....	176	40-6772.....	176	40-7111.....	185
40-3710.....	172	40-6544.....	176	40-6773.....	176	40-7112.....	185



NUMERICAL INDEX

40-7113	185	40-8106	185	41-388	303	41-1120	43, 191
40-7114	185	40-8107	185	41-395	274	41-1125	43
40-7115	185	40-8108	185	41-402	275	41-1132	39
40-7116	185	40-8110	185	41-410	275	41-1134	39
40-7118	185	40-8111	185	41-422	275	41-1136	39
40-7120	185	40-8112	185	41-434	275	41-1138	39
40-7165	185	40-8113	185	41-452	275	41-1147	42
40-7202	185	40-8114	185	41-468	275	41-1163	44, 265
40-7203	185	40-8115	185	41-472	275	41-1165	47
40-7204	185	40-8116	185	41-484	275	41-1235	182
40-7205	185	40-8117	185	41-486	275	41-1240	182
40-7206	185	40-8118	185	41-604	276	41-1245	182
40-7207	185	40-8265	108, 187	41-612	276	41-1250	182
40-7208	185	40-8270	183	41-626	276	41-1330	177
40-7209	185	40-8272	183	41-640	276	41-1332	177
40-7210	185	40-8675	183	41-652	276	41-1385	105
40-7220	185	40-8775	183	41-654	276	42-103	284
40-7221	185	40-9265	183	41-658	276	42-105	284
40-7222	185	40-9365	183	41-662	277	42-121	284
40-7223	185	40-9370	183	41-666	277	42-127	284
40-7224	185	40-9685	124	41-674	277	42-133	284
40-7225	185	40-9686	122, 180	41-709	278	42-135	284
40-7226	185	40-9688	122, 180	41-721	278	42-139	284
40-7227	185	40-9712	123, 180	41-733	278	42-145	284
40-7228	185	40-9812	122, 180	41-757	277	42-149	284
40-7229	185	40-9815	122	41-761	277	42-154	284
40-7230	185	40-9820	122	41-765	277	42-157	284
40-7250	185	40-9825	122	41-769	277	42-163	284
40-7265	185	40-9840	122	41-773	277	42-171	285
40-7280	185	40-9841	122	41-777	277	42-177	285
40-7284	185	41-102	273	41-792	278	42-183	285
40-7286	185	41-104	273	41-800	279	42-187	285
40-7400	184	41-106	273	41-808	279	42-191	285
40-7401	184	41-108	273	41-812	279	42-193	285
40-7402	184	41-121	273	41-820	279	42-197	285
40-7404	184	41-123	273	41-824	279	42-228	287
40-7406	184	41-125	273	41-828	279	42-234	287
40-7410	184	41-136	273	41-832	279	42-246	286
40-7415	183	41-138	273	41-848	280	42-248	286
40-7420	183	41-142	273	41-852	280	42-252	286
40-7430	183	41-153	273	41-856	280	42-256	286
40-7435	183	41-155	273	41-864	280	42-266	286
40-7440	183	41-157	273	41-870	280	42-270	287
40-7445	183	41-166	273	41-875	280	42-271	286
40-7447	108, 186	41-168	273	41-878	280	42-273	286
40-7448	108, 186	41-170	273	41-902	281	42-274	287
40-7450	108, 186	41-172	273	41-906	281	42-278	287
40-7451	108, 186	41-179	273	41-910	281	42-282	287
40-7452	108, 186	41-181	273	41-922	281	42-288	287
40-7453	108, 186	41-183	273	41-926	281	42-296	287
40-7454	108, 186	41-209	273	41-932	282	42-301	288
40-7455	108, 186	41-315	273	41-938	282	42-307	288
40-7456	108, 186	41-318	274	41-944	282	42-315	288
40-7458	108, 186	41-324	274	41-952	283	42-321	288
40-8100	185	41-330	274	41-972	283	42-325	288
40-8101	185	41-334	274	41-982	283	42-327	288
40-8102	185	41-350	273	41-994	283	42-328	288
40-8103	185	41-368	274	41-1076	48	42-329	288
40-8104	185	41-372	274	41-1100	42	42-330	288
40-8105	185	41-378	274	41-1105	42	42-331	289



42-335	289	42-1766	113	43-523	304	47-1140	45, 150
42-339	289	42-1767	113	43-531	307	47-1143	45, 150
42-443	289	42-1820	113	43-535	307	47-1144	45, 150
42-447	289	42-1865	112	43-539	307	47-1145	45, 150
42-455	289	42-1875	112	43-543	307	47-1146	46
42-461	289	42-1895	112	43-547	307	47-1147	42
42-465	289	42-1965	113	43-549	307	47-1148	22
42-471	290	42-1975	113	43-551	307	47-1173	62
42-473	290	42-1995	113	43-583	279	47-1175	62
42-475	290	42-2075	113	43-587	279	47-1180	62
42-479	290	42-2076	113	43-591	279	47-1186	62
42-483	290	42-2077	113	43-593	281	47-1235	45, 150
42-489	290	42-2078	113	43-595	281	47-1240	45, 150
42-493	290	42-2085	107	43-597	281	47-1243	45, 150
42-497	291	42-2092	107	43-606	309	47-1244	45, 150
42-512	291	42-2095	107	43-612	309	47-1245	45, 150
42-524	291	42-2787	39	43-622	309	47-1246	46, 150
42-532	291	43-105	294	43-626	309	47-1247	46
42-538	291	43-109	294	43-634	309	47-1248	46, 150
42-552	292	43-125	294	43-638	309	47-1250	46
42-558	292	43-133	298	43-751	311	47-1255	46
42-564	292	43-137	297	43-752	311	47-1360	37
42-572	292	43-149	296	43-753	311	47-1440	46, 150
42-576	292	43-153	295	43-754	311	47-1441	45, 150
42-707	297	43-161	296	43-755	311	47-1442	45, 150
42-724	296	43-173	296	43-757	311	47-1447	60
42-732	299	43-177	297	43-758	311	47-1448	61
42-744	296	43-185	298	43-759	311	47-1450	60
42-752	296	43-189	298	43-760	311	47-1470	64
42-772	294	43-204	300	43-761	311	47-2047	60
42-776	295	43-208	300	43-762	311	47-2049	60
42-783	298	43-226	300	43-763	311	47-2147	60
42-792	295	43-238	300	43-767	311	47-2148	60
42-798	296	43-252	300	43-768	311	47-2380	182, 304
42-801	295	43-258	300	43-769	311	47-2385	182
42-807	295	43-266	300	44-455	304	47-2388	182
42-825	294	43-272	300	44-463	309	47-2447	60
42-833	299	43-305	306	44-475	309	47-2455	293
42-849	298	43-309	306	45-178	285	47-2462	107, 120
42-853	298	43-321	306	45-202	283	47-2465	170
42-857	297	43-325	305	45-266	145, 301	47-2466	170
42-859	299	43-329	305	45-282	301	47-2467	170
42-860	299	43-351	307	45-507	301	47-2468	170
42-863	299	43-355	305	47-1047	40, 302	47-2500	118
42-873	297	43-359	305	47-1048	40, 302	47-2502	118
42-875	297	43-365	305	47-1049	40, 302	47-2505	118
42-883	299	43-371	304	47-1058	40, 302	47-2507	118
42-908	295	43-373	304	47-1059	40, 302	47-2510	118
42-912	294	43-379	306	47-1060	40, 302	47-2550	117
42-985	294	43-381	306	47-1068	40, 302	47-2555	117
42-1420	187	43-383	306	47-1069	40, 302	47-2556	117
42-1421	187	43-385	306	47-1070	40, 302	47-2560	120
42-1422	187	43-391	305	47-1071	40, 302	47-2564	120
42-1425	187	43-393	306	47-1072	40, 302	47-2570	117
42-1654	113	43-395	306	47-1075	40, 302	47-2572	117
42-1655	113	43-412	304	47-1080	43, 302	47-2580	120
42-1656	113	43-424	307	47-1081	43, 302	47-2646	118
42-1657	113	43-426	307	47-1089	42	47-2650	118
42-1764	113	43-432	307	47-1091	42	47-2651	118
42-1765	113	43-444	307	47-1135	45, 150	47-2655	104



NUMERICAL INDEX

47-2656	118	48-526	291	50-3148	61	52-5162	63
47-2752	104	48-538	291	50-3371	133	52-5177	63
47-2758	118	48-542	292	50-4157	268	52-5195	63
47-2760	118	48-561	275	50-4190	268	52-5198	63
47-2832	112	48-572	292	50-4200	268	52-5262	63
47-2834	112	48-752	296	50-4202	268	52-5277	63
47-2836	112	48-761	304	50-4462	39	52-5295	63
47-2837	85	48-774	309	50-4562	38	52-5362	61
47-2838	112	48-785	309	50-4563	38	52-6690	64
47-2840	112	48-922	281	50-4655	48	52-6694	64
47-2852	85	50-1290	103	50-4662	38	52-6696	64
47-2913	111, 145	50-1355	78	50-6063	318	55-1685	317
47-2925	85	50-1357	78	51-1446	54	55-1692	317
47-2930	85	50-1372	79	51-1447	54	55-2021	85
47-2935	85	50-1472	79	51-1448	54	55-2022	85
47-2955	85	50-1585	119	51-3049	54	55-2023	85
47-3040	84	50-1685	119	51-3050	54	55-2024	85
47-3057	84	50-1790	120	51-3051	54	55-2025	85
47-3415	191	50-1950	160	51-3447	54	55-2026	85
47-3418	190	50-1953	159	51-3448	54	55-2027	85
47-3420	190	50-1955	159	51-3460	54	55-2028	85
47-3422	190	50-1957	159	51-3480	54	55-2775	86
47-3424	190	50-1982	160	51-4360	54	55-2795	86
47-3520	191	50-1985	160	51-4370	54	55-2810	86
47-3833	112	50-2006	159	51-4382	54	55-2855	85
48-109	294	50-2007	159	51-4395	54	55-2870	85
48-116	274	50-2008	159	51-4398	55	55-2880	85
48-128	274	50-2009	159	51-4450	55	55-2890	85
48-130	275	50-2010	159	51-4451	55	55-2892	79
48-202	283	50-2011	159	52-1415	87	55-2893	86
48-204	297	50-2012	159	52-1416	87	55-2894	86
48-226	296	50-2014	159	52-1420	87	55-2898	85
48-228	287	50-2106	159	52-1421	87	55-2912	86
48-252	298	50-2108	159	52-1425	87	55-3012	86
48-264	295	50-2109	159	52-1426	87	55-3080	86
48-266	145, 301	50-2110	159	52-1430	87	55-3110	86
48-274	287	50-2112	159	52-1431	87	55-3123	87
48-276	296	50-2206	159	52-1435	87	55-3125	87
48-278	287	50-2207	159	52-1436	87	55-3127	87
48-282	287	50-2208	159	52-1975	86	55-3136	86
48-288	287	50-2210	159	52-1980	86	55-3138	86
48-289	295	50-2212	159	52-2080	86	55-7167	106
48-296	287	50-2412	173	52-2082	86	55-7175	106
48-301	299	50-2670	61	52-2825	38	55-7192	106
48-315	273	50-2770	62	52-2845	38	55-7355	114
48-318	274	50-2825	160	52-2860	38	55-7445	115
48-321	288	50-2830	160	52-2970	40	55-7465	115
48-327	299	50-2831	160	52-3270	61	55-8611	36
48-339	297	50-2870	61	52-3282	61	55-8711	36
48-350	273	50-2970	62	52-3310	61	55-9080	37
48-351	297	50-3046	60	52-3312	61	55-9084	37
48-363	300	50-3047	60	52-3370	61	55-9090	37
48-375	300	50-3048	60	52-3382	61	55-9094	37
48-378	274	50-3049	60	52-3410	61	55-9180	37
48-388	303	50-3050	61	52-3412	61	55-9184	37
48-422	287	50-3052	61	52-3970	64	55-9190	37
48-424	286	50-3060	318	52-3975	64	55-9194	37
48-489	311	50-3061	318	52-5062	64	55-9210	37
48-507	301	50-3062	318	52-5077	64	55-9310	37
48-524	291	50-3147	60	52-5095	64	55-9311	37



55-9314.....	37	60-5606.....	103, 186	62-3726.....	382	64-1735.....	41
55-9411.....	37	60-5612.....	103, 186	62-3728.....	382	64-1740.....	42
55-9414.....	37	60-5613.....	103, 186	62-4628.....	382	64-1742.....	49, 138
55-9612.....	37	60-5614.....	103, 186	62-4629.....	382	64-1842.....	49, 138
55-9614.....	37	60-5622.....	103, 186	62-4703.....	382	64-1850.....	50, 138
57-1445.....	105	60-5623.....	103, 186	62-4704.....	382	64-1851.....	50, 138
60-1075.....	105	60-5624.....	103, 186	62-4705.....	382	64-1852.....	50, 138
60-1085.....	105	60-5810.....	119, 187	62-4706.....	382	64-1853.....	50, 138
60-1100.....	106	60-5812.....	103, 186	62-4707.....	382	64-1942.....	49, 138
60-1101.....	106	60-5813.....	103, 186	62-4714.....	382	64-1945.....	138
60-1102.....	106	60-5814.....	103, 186	62-6633.....	382	64-1946.....	138
60-1103.....	106	60-5816.....	103, 186	62-6703.....	382	64-1950.....	50, 137
60-1350.....	106	60-5820.....	119, 187	62-6704.....	382	64-1951.....	50, 137
60-1370.....	106	60-5821.....	119, 187	62-6705.....	382	64-1952.....	50, 137
60-1460.....	106	60-5822.....	103, 186	62-6706.....	382	64-1955.....	50, 137
60-1461.....	106	60-5823.....	103, 186	62-6707.....	382	64-1960.....	50, 137
60-1676.....	105	60-5824.....	103, 186	62-6714.....	382	64-1961.....	50, 137
60-1681.....	105	60-5826.....	103, 186	62-6716.....	382	64-2035.....	45
60-1686.....	105	60-5840.....	119	62-7701.....	382	64-2036.....	45
60-1691.....	105	60-6062.....	104	62-7706.....	382	64-2042.....	46, 150
60-1891.....	107	60-6064.....	104	62-7708.....	382	64-2046.....	40
60-1892.....	107	60-6100.....	104, 186	62-7801.....	382	64-2048.....	40
60-1893.....	107	60-6101.....	104, 186	62-7807.....	382	64-2142.....	46, 150
60-1894.....	107	60-6102.....	104, 186	62-7809.....	382	64-2143.....	46, 150
60-1895.....	107	60-6103.....	104, 186	62-8000.....	316	64-2242.....	50, 137, 149
60-3070.....	107	60-6130.....	229	62-8001.....	316	64-2342.....	50, 137, 149
60-3085.....	107	60-6162.....	105	62-8002.....	316	64-2442.....	50, 136, 149
60-3090.....	107	60-6164.....	105	62-8003.....	316	64-2535.....	50, 136, 149
60-3112.....	107	60-6240.....	114	62-8004.....	316	64-3050.....	50, 137
60-3113.....	107	60-6280.....	117, 187	62-8005.....	316	64-3052.....	50, 137
60-3114.....	107	60-6320.....	112	62-8006.....	316	64-3138.....	136
60-3212.....	107	60-6340.....	111	62-8007.....	316	64-3140.....	136
60-3312.....	107	60-6342.....	111	62-8008.....	316	64-3142.....	49, 136, 266
60-3412.....	107	60-6370.....	113	62-8009.....	316	64-3144.....	49, 136, 266
60-3594.....	106	60-6570.....	113	62-8453.....	382	64-3145.....	49, 136, 266
60-3596.....	106	60-6580.....	113	62-8454.....	382	64-3146.....	49, 136, 266
60-3598.....	106	60-6670.....	114	62-8455.....	382	64-3210.....	49
60-3607.....	106	60-6710.....	114	62-8464.....	382	64-3211.....	49
60-3610.....	106	60-6870.....	114	62-8465.....	382	64-3212.....	49
60-3612.....	106	60-7070.....	114	62-8466.....	382	64-3215.....	49
60-3615.....	106	60-7110.....	114	64-1150.....	47	64-3230.....	46
60-3617.....	106	60-7112.....	115	64-1151.....	47	64-3235.....	46
60-3620.....	106	60-7115.....	115	64-1152.....	47	64-3260.....	149
60-3625.....	106	60-7120.....	115	64-1160.....	47, 302	64-3270.....	47
60-4242.....	103, 186	60-7125.....	115	64-1161.....	47, 302	64-3280.....	46, 150, 265
60-4243.....	103, 186	60-7130.....	115	64-1240.....	41	64-3290.....	50, 137
60-4244.....	103, 186	60-7135.....	115	64-1241.....	41	64-3292.....	50, 137
60-4246.....	103, 186	60-7140.....	115	64-1242.....	41, 150	64-3294.....	49, 137, 149
60-4252.....	103, 186	62-1659.....	382	64-1243.....	41, 150	64-3296.....	49, 137, 149
60-4253.....	103, 186	62-1661.....	382	64-1250.....	48	64-3297.....	47
60-4254.....	103, 186	62-3702.....	382	64-1340.....	41	64-3298.....	47
60-4256.....	103, 186	62-3703.....	382	64-1341.....	41	64-3430.....	46
60-5472.....	107	62-3706.....	382	64-1342.....	41, 150	64-3435.....	46
60-5502.....	103, 186	62-3708.....	382	64-1343.....	41, 150	65-1012.....	108, 143, 156
60-5503.....	103, 186	62-3710.....	382	64-1345.....	45, 265	65-1127.....	110, 144, 156
60-5504.....	103, 186	62-3711.....	382	64-1348.....	44, 265	65-1227.....	109, 143, 314
60-5506.....	103, 186	62-3713.....	382	64-1442.....	47, 149	65-1332.....	109, 143
60-5602.....	103, 186	62-3715.....	382	64-1445.....	45, 265	65-1426.....	110, 144, 156
60-5603.....	103, 186	62-3716.....	382	64-1542.....	47, 149	65-1427.....	110, 144, 156
60-5604.....	103, 186	62-3718.....	382			65-1528.....	109, 143



65-1532	109, 143	65-6354	101, 142	66-2734	59	66-6166	67, 139
65-1535	109, 143	65-6357	101, 142	66-2736	59	66-6168	68
65-1536	109, 143	65-6358	101, 142	66-2738	59	66-6240	67
65-1540	109, 144, 156	65-6360	102	66-2740	59, 152, 314	66-6242	67
65-1545	109, 143	65-6365	102, 155	66-2750	65	66-6268	67
65-1740	110, 144, 156	65-6366	102, 155	66-2755	65	66-6330	68
65-1742	110, 144, 156	65-6445	102, 142, 155	66-2760	65	66-6338	67
65-1744	110, 144, 156	65-6446	102, 142, 155	66-2840	59, 152, 314	66-6340	67
65-1746	110, 144, 156	65-6448	102, 142, 155	66-2940	59, 152, 314	66-7234	68
65-1756	110, 144, 156	65-6449	102, 142, 155	66-3140	59, 152, 314	66-7236	68
65-1758	110, 144, 156	65-6450	102, 142, 155	66-3240	60, 152, 314	66-7238	69
65-1760	110	65-6452	101, 142, 155	66-3340	60, 152, 314	66-7240	69
65-1765	110, 144, 156	65-6454	101, 142, 155	66-3341	60	66-7244	69
65-1766	110, 144, 156	65-6455	101, 142, 155	66-3450	69	66-7246	69
65-1815	111, 145	65-6456	101, 142, 155	66-3540	60, 152, 314	66-7250	69, 151
65-1830	111, 145	65-6457	101, 142, 155	66-3541	60	66-7258	69
65-1831	111	65-6470	142	66-3740	60, 152, 314	66-7259	69, 151
65-1835	158	65-6475	142	66-3741	60	66-7261	69, 151
65-1841	107, 157	65-6550	97	66-4032	68, 152	66-7347	74
65-1842	107, 157	65-6730	158, 358	66-4132	68, 152	66-7438	74, 139
65-1843	107, 157	65-6732	158, 358	66-4133	68, 152	66-7440	74, 139
65-1844	107, 157	65-6734	158, 358	66-4232	68, 152, 315	66-7442	74, 139
65-3015	157	65-6735	358	66-4235	66	66-7443	74, 139
65-3025	157	65-7240	158	66-4237	66	66-7446	74, 139
65-3028	157	65-7254	158	66-4238	66	66-7447	74, 139
65-3205	117	65-7257	158	66-4525	66, 151	66-7542	74, 139
65-3206	117	65-7260	157	66-4526	66, 151	66-7642	74, 139
65-3215	117	65-7270	157	66-4625	66, 151	66-7643	74, 139
65-3216	117	65-7272	157	66-4626	66, 151	66-7644	74, 139
65-3217	117	65-7400	171	66-4840	70	66-7645	74, 139
65-3221	134	65-7401	171	66-4947	65	66-7785	135
65-3222	135	65-7402	171	66-4948	65	66-7786	135
65-3223	135	65-7403	171	66-4949	65	67-1020	130
65-3240	134	65-7523	158, 355	66-4950	65	67-1021	130
65-3241	134	66-1035	154	66-4951	65	67-1030	131
65-3242	134	66-1036	154	66-4955	65	67-1032	131
65-3244	134	66-1037	154	66-4956	65	67-1033	131
65-3245	134	66-1038	154	66-4958	66	67-1034	131
65-3246	134	66-1137	154	66-6036	68	67-1035	130
65-3248	119	66-1255	154	66-6037	68	67-1036	130
65-3250	119	66-1275	154	66-6038	68	67-1038	130
65-3258	104	66-1435	154	66-6039	68	67-1039	130
65-4098	126	66-1535	71, 153, 315	66-6103	67	67-1040	130
65-4099	126	66-1635	71, 153, 314	66-6105	67	67-1045	130
65-4100	126	66-1735	70, 153, 314	66-6109	67	67-1050	130
65-4101	126	66-1740	71, 153, 314	66-6110	67	67-1052	131
65-4103	126	66-1742	71, 153, 315	66-6112	67	67-1058	72, 133
65-4105	126	66-1745	72, 153, 315	66-6114	67	67-1150	72, 133
65-4107	126	66-1770	71, 153, 315	66-6115	67	67-1350	72, 133
65-4120	126	66-1830	71, 153, 315	66-6118	67	67-1450	72, 133
65-4121	126	66-1930	70	66-6119	67	67-1455	65, 133
65-4123	126	66-1940	70, 152	66-6125	70, 139, 151	67-1465	65, 133
65-4125	126	66-2005	68	66-6126	70, 139, 151	67-2480	134
65-4127	126	66-2009	68	66-6140	66, 152	67-2481	134
65-4128	126	66-2012	68	66-6142	66, 152	67-2488	134
65-4129	126	66-2140	70, 152	66-6150	70, 139, 315	67-2489	134
65-6055	101	66-2350	66	66-6152	70, 139, 315	67-2490	134
65-6350	101, 142	66-2351	66	66-6160	70, 139, 151	67-2491	134
65-6351	101, 142	66-2352	66	66-6162	70, 139, 151	67-2492	134
65-6352	101, 142, 315	66-2440	66	66-6164	67, 139	67-2493	134



67-2498	134	67-8026	132	74-3270	76	78-2028	161
67-2499	134	67-8028	132	75-1007	310, 357	78-2029	161
67-2500	134	67-8030	132	75-1010	310, 357	78-2030	161
67-2501	134	67-8031	132	75-1015	310, 357	78-2031	161
67-2502	134	67-8150	130	75-1016	310, 357	78-2032	161
67-2503	134	67-8152	130	75-1017	310, 357	78-2033	161
67-2508	134	67-8155	131	75-1025	310, 357	78-2100	161
67-2509	134	67-8170	132, 140	75-1026	310	78-2110	161
67-2510	134	67-8172	132, 140	75-1120	311	78-2111	161
67-2511	134	67-8173	132, 140	75-1140	311	78-2112	161
67-2512	134	67-8174	132, 140	75-1141	311	78-2113	161
67-2513	134	67-8175	132, 140	75-5070	39	78-2114	161
67-2514	134	67-8176	132, 140	75-5267	39	78-2115	161
67-2515	134	67-8177	132, 140	75-5460	37	78-2116	161
67-2516	134	67-8178	132, 140	75-5570	37	78-2117	161
67-2517	134	67-8180	132, 140	75-5670	37	78-2118	161
67-2518	134	67-8187	51, 130, 138	78-1001	104, 118	78-2119	161
67-2519	134	67-8188	51, 130, 138	78-1002	104, 118	78-2120	161
67-2521	134	67-8189	51, 130, 138	78-1003	104, 118	78-2144	161
67-2522	134	67-8191	51, 130, 138	78-1101	104, 118	78-2145	161
67-2523	134	67-8193	51, 130, 138	78-1102	104, 118	78-2146	161
67-2525	134	70-1020	356	78-1103	104, 118	78-2147	161
67-2526	134	70-1030	356	78-1300	162	78-2148	161
67-2540	120, 135	70-1035	356	78-1312	162	78-2150	161
67-2550	119, 135	70-1040	194	78-1313	162	78-2214	161
67-2552	119, 135	70-1041	194	78-1314	162	78-2214A	161
67-2560	120	70-1070	194, 356	78-1315	162	78-2215	161
67-4508	178	70-1071	194, 356	78-1316	162	78-2216	161
67-4510	178	70-1072	194, 356	78-1317	162	78-2216A	161
67-4512	178	70-1075	194, 356	78-1318	162	78-2217	161
67-4514	178	70-2292	122	78-1319	162	78-2218	161
67-4604	177	70-2293	122	78-1320	162	78-2219	161
67-4606	177	70-2295	122, 180	78-1700	162	78-2254	162
67-4608	177	70-2296	122, 180	78-1710	162	78-2255	162
67-4610	177	70-2297	122, 180	78-1711	162	78-2256	162
67-4612	177	70-4350	48	78-1712	162	78-2257	162
67-4614	177	70-4352	48	78-1713	162	78-2258	162
67-5175	170	70-4375	65, 133	78-1714	162	78-2259	162
67-5458	170	70-4385	65, 133	78-1715	162	78-2260	162
67-5987	293	70-4470	72, 133	78-1716	162	78-2284	162
67-5990	171, 293	73-1188	273	78-1717	162	78-2285	162
67-5992	171, 293	73-1189	273	78-1718	162	78-2286	162
67-5994	171, 293	73-1190	273	78-1719	162	78-2287	162
67-7064	355	73-1191	273	78-1720	162	78-2288	162
67-7128	355	73-1192	273	78-2000	161	78-2289	162
67-7256	355	73-1193	273	78-2010	161	78-2290	162
67-7512	355	73-1194	273	78-2011	161	78-2821	416
67-7524	355	73-1195	273	78-2012	161	78-2822	416
67-7548	355	73-1196	273	78-2013	161	78-2824	415
67-7596	355	73-1197	273	78-2014	161	78-3130	162
67-7605	355	74-1370	84, 196	78-2015	161	78-3131	162
67-8000	132	74-1470	84, 196	78-2016	161	78-3132	162
67-8006	132	74-1570	84, 196	78-2017	161	78-3133	162
67-8008	132	74-1670	84, 196	78-2018	161	78-3134	162
67-8010	132	74-2475	83	78-2019	161	78-3135	162
67-8014	51, 130	74-3073	83	78-2020	161	78-3136	162
67-8016	51, 130	74-3075	83	78-2024	161	78-3137	162
67-8018	51, 130	74-3173	83	78-2025	161	78-3138	162
67-8020	51, 130	74-3175	83	78-2026	161	78-3139	162
67-8024	132	74-3260	76	78-2027	161	78-3545	120



NUMERICAL INDEX

80-1260.....	125, 145	85-2426.....	128	91-2908.....	83	91-6103.....	212
80-1410.....	84, 195	85-2428.....	128	91-2910.....	83	91-6104.....	212
80-2715.....	160	85-2430.....	128	91-3006.....	83	91-6105.....	212
80-2815.....	160	85-2432.....	128	91-3008.....	83	91-6106.....	213
80-2870.....	125	85-2434.....	128	91-3010.....	83	91-6107.....	213
80-2910.....	145	85-2436.....	128	91-5060.....	201	91-6108.....	213
85-1008.....	128	87-1052.....	85, 174	91-5062.....	201	91-6109.....	213
85-1010.....	128	87-2095.....	84, 196	91-5064.....	201	91-6110.....	213
85-1012.....	128	87-2195.....	84, 196	91-5066.....	201	91-6111.....	213
85-1014.....	128	87-2295.....	84, 196	91-5068.....	201	91-6112.....	213
85-1016.....	128	87-2395.....	84, 196	91-5082.....	201	91-6113.....	212
85-1018.....	128	90-1080.....	40	91-5084.....	201	92-5012.....	84, 195
85-1020.....	128	90-1180.....	40	91-5086.....	201	93-1106.....	198
85-1022.....	128	90-1280.....	40	91-5088.....	201	93-1122.....	198
85-1024.....	128	90-1295.....	317	91-5092.....	201	93-1147.....	198
85-1026.....	128	90-1380.....	40	91-5190.....	201	93-1158.....	198
85-1028.....	128	90-1480.....	40	91-5226.....	200	93-1175.....	198
85-1030.....	128	90-1580.....	40	91-5228.....	200	93-1189.....	198
85-1032.....	128	90-1590.....	36	91-5230.....	200	93-1222.....	84, 196
85-1034.....	128	90-1690.....	36	91-5232.....	200	93-1226.....	84, 196
85-1036.....	128	90-1977.....	88	91-5234.....	200	93-1349.....	192
85-1038.....	128	90-2177.....	88	91-5235.....	200	93-1361.....	192
85-1040.....	128	90-2280.....	88	91-5236.....	203	93-1372.....	192
85-1065.....	128	90-2387.....	88	91-5238.....	203	93-1445.....	167
85-1070.....	128	90-2480.....	88, 195	91-5241.....	203	93-1475.....	198
85-1075.....	128	90-2574.....	82	91-5242.....	203	93-1479.....	198
85-1076.....	128	90-2576.....	82	91-5243.....	203	93-1710-00.....	260
85-2010.....	127	90-2580.....	88, 195	91-5244.....	203	93-1710-1.....	260
85-2012.....	127	90-2584.....	83	91-5245.....	203	93-1710-2.....	260
85-2014.....	127	90-2640.....	87	91-5246.....	203	93-1710-6.....	260
85-2016.....	127	90-2641.....	87	91-5247.....	203	93-1710-8.....	260
85-2018.....	127	90-2680.....	88	91-5248.....	203	93-1712-1.....	260
85-2020.....	127	90-2682.....	88	91-5250.....	203	93-1712-1-1/4.....	260
85-2022.....	127	90-2690.....	88, 195	91-5251.....	203	93-1712-1-3/4.....	260
85-2024.....	127	90-2695.....	88	91-5252.....	203	93-1712-3/4.....	260
85-2026.....	127	90-3700.....	194, 356	91-5253.....	203	93-1714-1-1/2.....	261
85-2028.....	127	90-3701.....	194, 356	91-5254.....	203	93-1714-1-3/4.....	261
85-2030.....	127	90-3702.....	194, 356	91-5255.....	203	93-1714-2.....	261
85-2032.....	127	90-3710.....	194, 356	91-5268.....	201	93-1714-2-1/2.....	261
85-2034.....	127	90-3711.....	194, 356	91-5270.....	201	93-1714-2-7/8.....	261
85-2036.....	127	90-3712.....	194, 356	91-5278.....	201	93-1714-3-1/2.....	261
85-2038.....	127	90-3713.....	194, 356	91-5300.....	202	93-1714-4.....	261
85-2210.....	127	90-3720.....	194	91-5302.....	202	93-1716-10.....	261
85-2212.....	127	90-3721.....	194	91-5307.....	202	93-1716-12.....	261
85-2214.....	127	90-3722.....	194	91-5308.....	202	93-1716-14.....	261
85-2216.....	127	90-3730.....	194	91-5310.....	202	93-1716-16.....	261
85-2218.....	127	90-3731.....	194	91-5411.....	202	93-1716-2.....	261
85-2220.....	127	90-3732.....	194	91-5412.....	202	93-1716-4.....	261
85-2355.....	127	90-3800.....	194, 356	91-5413.....	202	93-1716-6.....	261
85-2360.....	127	90-3802.....	194, 356	91-5414.....	202	93-1716-8.....	261
85-2365.....	127	90-3803.....	194, 356	91-5420.....	202	93-1718-1.....	261
85-2408.....	128	90-3849.....	194, 356	91-5422.....	202	93-1718-2.....	261
85-2410.....	128	90-3851.....	194, 356	91-5424.....	202	93-1718-3.....	261
85-2412.....	128	90-5292.....	195	91-5428.....	202	93-1718-4.....	261
85-2414.....	128	90-5293.....	195	91-5440.....	201	93-1718-5.....	261
85-2416.....	128	90-7610.....	84, 195	91-5450.....	201	93-1718-6.....	261
85-2418.....	128	90-7710.....	84, 195	91-5452.....	201	93-1718-7.....	261
85-2420.....	128	91-2282.....	83	91-6100.....	212	93-1720-1.....	261
85-2422.....	128	91-2382.....	83	91-6101.....	212	93-1720-2.....	261
85-2424.....	128	91-2906.....	83	91-6102.....	212	93-1720-3.....	261



93-1720-4.....	261	93-1762-18.....	260	93-8122.....	168	93-P50740D.....	271
93-1722-1.....	261	93-1762-2.....	260	93-8128.....	168	93-P50750D.....	271
93-1722-2.....	261	93-1762-20.....	260	93-8129.....	168	93-P50830D.....	271
93-1722-3.....	261	93-1762-3.....	260	93-8130.....	168	93-P50840D.....	271
93-1722-4.....	261	93-1762-4.....	260	93-8131.....	168	93-P52630D.....	271
93-1722-5.....	261	93-1762-5.....	260	93-8135.....	167	93-P52820.....	271
93-1722-6.....	261	93-1762-6.....	260	93-8136.....	167	93-P52830.....	271
93-1722-7.....	261	93-1762-7.....	260	93-8190.....	198	93-P53400.....	271
93-1722-8.....	261	93-1762-8.....	260	93-8310.....	192	93-P53420.....	271
93-1730-1.....	261	93-1762-9.....	260	93-8312.....	193	93-U70360D.....	272
93-1730-2.....	261	93-1770-0.....	260	93-8318.....	193	93-U70440D.....	272
93-1730-3.....	261	93-1770-1.....	260	93-8330.....	193	93-U70450D.....	272
93-1730-4.....	261	93-1770-2.....	260	93-8331.....	193	93-U70460D.....	272
93-1730-5.....	261	93-1770-3.....	260	93-8332.....	193	93-U70730.....	272
93-1731-1.....	262	93-1770-4.....	260	93-8340.....	193	93-U70740.....	272
93-1731-2.....	262	93-1770-5.....	260	93-8375.....	192	93-U70830.....	272
93-1731-3.....	262	93-1770-6.....	260	93-8380.....	192	94-7001.....	73
93-1731-4.....	262	93-1770-7.....	260	93-8383.....	192	941-0033A.....	370
93-1732-1.....	262	93-1770-8.....	260	93-8409.....	168	941-0046.....	368
93-1732-2.....	262	93-1770-9.....	260	93-8445.....	167	941-0047B.....	370
93-1732-3.....	262	93-1780-1.....	260	93-8500.....	164	941-0048B.....	370
93-1732-4.....	262	93-1780-10.....	260	93-8501.....	164	941-0049B.....	226, 367
93-1740-1.....	262	93-1780-11.....	260	93-8504.....	164	941-0258.....	369
93-1740-2.....	262	93-1780-12.....	260	93-8505.....	164	941-0259.....	369
93-1740-3.....	262	93-1780-2.....	260	93-8506.....	164	941-0260A.....	369
93-1740-4.....	262	93-1780-3.....	260	93-8510.....	164	941-0293A.....	369
93-1741-1.....	262	93-1780-4.....	260	93-8512.....	164	941-0308.....	370
93-1741-2.....	262	93-1780-5.....	260	93-8515.....	164	941-0310.....	370
93-1741-3.....	262	93-1780-6.....	260	93-8518.....	165	941-0347.....	368
93-1741-4.....	262	93-1780-7.....	260	93-8519.....	165	95-008.....	326, 355
93-1742-1.....	262	93-1780-8.....	260	93-8520.....	165	95-010.....	326, 355
93-1742-2.....	262	93-1780-9.....	260	93-8521.....	165	95-033.....	326
93-1742-3.....	262	93-409.....	168	93-8525.....	165	95-038.....	326
93-1742-4.....	262	93-8000.....	196	93-8527.....	165	95-042.....	326
93-1750-1.....	262	93-8001.....	196	93-8700.....	312	95-100.....	321
93-1750-2.....	262	93-8002.....	197	93-8701.....	312	95-103.....	320
93-1750-3.....	262	93-8003.....	168	93-8702.....	312	95-104.....	320
93-1750-4.....	262	93-8004.....	196	93-8703.....	312	95-105.....	321
93-1750-5.....	262	93-8005.....	168	93-8706.....	312	95-107.....	320
93-1751-1.....	262	93-8006.....	197	93-8708.....	312	95-109.....	320
93-1751-2.....	262	93-8007.....	197	93-8715.....	312	95-110.....	320
93-1751-3.....	262	93-8008.....	197	93-8720.....	312	95-111.....	320
93-1751-4.....	262	93-8009.....	197	93-8721.....	312	95-112.....	320
93-1751-5.....	262	93-8034.....	310, 357	93-8725.....	313	95-113.....	320
93-1760-1.....	260	93-8038.....	310, 357	93-8727.....	313	95-114.....	320
93-1760-10.....	260	93-8039.....	310, 357	93-8730.....	313	95-115.....	320
93-1760-12.....	260	93-8040.....	310, 357	93-8732.....	313	95-116.....	320
93-1760-14.....	260	93-8045.....	356	93-8735.....	313	95-117.....	320
93-1760-16.....	260	93-8046.....	356	93-8740.....	313	95-118.....	320
93-1760-2.....	260	93-8047.....	356	93-B71860.....	272	95-119.....	320
93-1760-4.....	260	93-8048.....	356	93-B71870.....	272	95-120.....	320
93-1760-6.....	260	93-8106.....	198	93-C50130.....	270	95-122.....	320
93-1760-8.....	260	93-8109.....	198	93-D51601.....	270	95-124.....	320
93-1762-1.....	260	93-8110.....	167	93-D52001D.....	270	95-125.....	320
93-1762-10.....	260	93-8112.....	198	93-E50130D.....	270	95-126.....	320
93-1762-11.....	260	93-8114.....	198	93-E50140D.....	270	95-127.....	320
93-1762-12.....	260	93-8115.....	168	93-E50230.....	270	95-128.....	320
93-1762-13.....	260	93-8118.....	168	93-E50240.....	270	95-130.....	324
93-1762-14.....	260	93-8120.....	168	93-L70106D.....	272	95-132.....	324
93-1762-16.....	260	93-8121.....	168	93-L70107D.....	272	95-133.....	324



NUMERICAL INDEX

95-135	324	95-358	321	95-517	323	96-0192	381
95-136	324	95-360	321	95-518	323	96-0670	411
95-137	324	95-361	321	95-521	323	96-1000	380
95-138	324	95-362	325	95-525	323	96-1001	380
95-139	324	95-364	321	95-571	323	96-1002	380
95-140	324	95-365	325	95-577	323	96-1005	380
95-141	324	95-366	325	95-586	323	96-1006	380
95-142	324	95-369	321	95-592	324	96-1007	380
95-143	324	95-374	322	95-604	322	96-1010	380
95-146	324	95-375	320	95-605	322	96-1011	380
95-147	324	95-386	324	95-606	324	96-1012	380
95-160	321	95-390	325	95-607	322	96-1015	380
95-161	321	95-392	325	95-611	324	96-1016	380
95-182	322	95-394	325	95-629	324	96-1017	380
95-188	322	95-409	323	95-635	324	96-1020	380
95-222	320	95-421	323	95-705	322	96-1021	380
95-226	320	95-426	323	95-710	322	96-1022	380
95-231	320	95-431	323	95-727	322	96-1030	380
95-232	320	95-434	324	95-731	322	96-1031	380
95-232B	320	95-436	323	95-736	322	96-1035	380
95-232P	320	95-437	324	95-740	326	96-1036	380
95-241	320	95-442	323	95-741	326	96-1040	207
95-243	320	95-447	322	95-742	322	96-1060	207
95-254	320	95-449	322	95-743	326	96-1075	207
95-265	321	95-452	322	95-748	326	96-1085	207
95-266	321	95-456	323	95-753	322	96-1092	381
95-272	321	95-458	323	95-757	322	96-1097	381
95-275	321	95-459	324	95-762	322	96-1098	381
95-278	321	95-463	323	95-766	322	96-1099	207
95-281	321	95-465	323	95-770	322	96-1100	381
95-284	321	95-466	323	95-771	322	96-1102	381
95-285	323	95-467	323	95-772	322	96-1105	381
95-289	323	95-469	323	95-774	322	96-1110	381
95-292	321	95-470	323	95-775	322	96-1115	381
95-294	321	95-471	323	95-776	322	96-1120	381
95-295	321	95-472	326	95-777	322	96-1125	381
95-299	321	95-473	323	95-778	322	96-1130	381
95-303	325	95-477	323	95-781	322	96-1140	381
95-304	325	95-479	326	95-790	322	96-1142	381
95-308	320	95-481	323	95-797	326	96-1144	381
95-312	325	95-482	326	95-809	325	96-1146	381
95-321	321	95-483	324	95-810	325	96-1148	381
95-322	325	95-485	324	95-813	325	96-1150	381
95-324	325	95-486	326	95-826	325	96-1152	381
95-325	321	95-487	324	95-832	325	96-1159	372
95-327	321	95-492	324	95-834	325	96-1160	381
95-328	321	95-493	326	95-842	325	96-1161	387
95-329	321	95-494	324	95-847	325	96-1162	387
95-330	321	95-496	324	95-853	325	96-1163	387
95-332	321	95-498	324	95-869	325	96-1164	387
95-335	321	95-499	326	95-872	325	96-1175	387
95-336	321	95-500	323	95-885	325	96-1190	380
95-339	321	95-501	323	95-930	322	96-1192	380
95-340	321	95-502	326	95-934	322	96-1194	380
95-346	321	95-504	323	95-938	322	96-1196	380
95-347	325	95-512	323	95-952	322	96-1198	380
95-348	325	95-513	323	95-956	322	96-1199	380
95-352	321	95-514	323	95-2865	358	96-1201	363
95-354	321	95-515	323	96-0102	381	96-1202	363
95-356	321	95-516	323	96-0160	381	96-1340	121, 372



96-1341	121, 372	96-1794	373	96-2497	339	96-2564	343
96-1342	121, 372	96-1795	373	96-2499	339	96-2565	343
96-1343	121, 372	96-1796	373	96-2501	340	96-2566	341
96-1344	121, 372	96-1797	373	96-2502	340	96-2567	341
96-1345	121, 372	96-1845	414	96-2503	340	96-2568	342
96-1346	121, 372	96-1846	414	96-2504	339	96-2569	342
96-1347	121, 372	96-1847	414	96-2505	339	96-2570	342
96-1348	121, 372	96-1848	414	96-2506	339	96-2571	342
96-1349	121, 372	96-1849	414	96-2507	339	96-2572	342
96-1350	121, 372	96-1850	414	96-2510	340	96-2573	342
96-1351	121, 372	96-1851	414	96-2511	340	96-2575	342
96-1400	413	96-1852	414	96-2512	340	96-2576	342
96-1402	413	96-1853	414	96-2513	340	96-2577	342
96-1404	413	96-1860	414	96-2514	339	96-2578	342
96-1406	413	96-1862	414	96-2516	339	96-2579	342
96-1408	413	96-1864	414	96-2517	339	96-2580	345
96-1410	413	96-1866	414	96-2518	340	96-2581	345
96-1412	413	96-1868	414	96-2519	340	96-2582	345
96-1414	413	96-1870	414	96-2520	339	96-2583	345
96-1416	413	96-1872	414	96-2521	339	96-2584	345
96-1418	413	96-1874	414	96-2522	339	96-2585	345
96-1440	413	96-1876	414	96-2523	339	96-2586	345
96-1442	413	96-1900	414	96-2524	339	96-2587	345
96-1444	413	96-1901	414	96-2525	339	96-2590	345
96-1446	413	96-1903	414	96-2526	339	96-2591	345
96-1500	413	96-1905	414	96-2527	339	96-2592	339
96-1502	413	96-1906	414	96-2528	343	96-2593	339
96-1504	413	96-1940	18, 376	96-2529	343	96-2594	345
96-1506	413	96-1942	18, 376	96-2530	339	96-2595	345
96-1508	413	96-1944	18, 376	96-2531	339	96-2596	340
96-1510	413	96-1946	18, 376	96-2532	344	96-2597	339
96-1512	413	96-1949	18, 376	96-2533	344	96-2598	340
96-1514	413	96-2160	387	96-2536	341	96-2599	345
96-1516	413	96-2162	387	96-2537	341	96-2603	346
96-1518	413	96-2164	387	96-2538	341	96-2605	346
96-1550	413	96-2166	387	96-2539	341	96-2607	346
96-1552	413	96-2168	387	96-2540	340	96-2612	346
96-1621	376	96-2170	387	96-2541	340	96-2613	346
96-1630	408	96-2172	387	96-2542	340	96-2614	346
96-1649	373	96-2174	387	96-2543	340	96-2615	346
96-1650	373	96-2176	387	96-2544	341	96-2616	346
96-1651	373	96-2178	387	96-2545	341	96-2617	346
96-1652	373	96-2180	387	96-2546	341	96-2620	343
96-1653	373	96-2181	387	96-2547	341	96-2622	343
96-1662	376	96-2182	387	96-2548	341	96-2624	343
96-1667	385	96-2184	387	96-2549	341	96-2626	343
96-1668	385	96-2186	387	96-2550	341	96-2630	343
96-1669	374	96-2190	387	96-2551	341	96-2632	343
96-1670	374	96-2192	387	96-2552	341	96-2634	343
96-1671	386	96-2194	387	96-2553	341	96-2636	343
96-1672	386	96-2196	387	96-2554	341	96-2649	339
96-1673	386	96-2198	387	96-2555	341	96-2650	339
96-1674	385	96-2402	340	96-2556	341	96-2651	339
96-1679	365, 408	96-2404	340	96-2557	341	96-2652	341
96-1680	373	96-2406	344	96-2558	342	96-2653	341
96-1710	366	96-2408	344	96-2559	342	96-2654	340
96-1715	366	96-2410	343	96-2560	341	96-2655	342
96-1718	366	96-2412	343	96-2561	341	96-2656	342
96-1792	373	96-2445	386	96-2562	341	96-2657	341
96-1793	373	96-2452	385	96-2563	341	96-2658	341



NUMERICAL INDEX

96-2659	345	96-3180	387	96-5628	346, 371	96-8968	347
96-2660	342	96-3182	387	96-5629	346, 371	96-8969	347
96-2661	342	96-3184	387	96-5630	346, 371	96-8970	347
96-2662	340	96-3186	387	96-5631	371	96-8971	347
96-2663	340	96-3190	387	96-5632	371	96-8972	347
96-2664	341	96-3192	387	96-5633	371	96-8973	347
96-2665	411	96-3194	387	96-5655	385, 412	96-8974	347
96-2672	340	96-3196	387	96-5655BNS	385, 412	96-8975	347
96-2680	339	96-3198	387	96-5658	411	96-8976	347
96-2682	339	96-4105	4, 246, 422	96-5659	411	96-8989	384
96-2688	342	96-4140	378	96-5660	411	96-8990	384
96-2705	342	96-4140NS	378	96-5661	411	96-9256	384
96-2706	342	96-4171	377, 412	96-5691	371	96-9257	384
96-2707	341	96-4172	377, 412	96-5699	374	96-9321	384
96-2708	341	96-4174	377, 412	96-5700	374	96-9601	204
96-2710	345	96-4175	377, 412	96-5906	386	96-9602	204
96-2712	345	96-4329	365	96-5908	386	96-9603	204
96-2720	339	96-4330	365	96-7020	407	96-9604	204
96-2721	339	96-4331	365	96-7024	409	96-9605	204
96-2726	339	96-4332	365	96-7025	409	96-9606	204
96-2728	339	96-4334	365	96-7027	407	96-9607	204
96-2774	342	96-4335	365	96-7028	407	96-9608	204
96-2775	342	96-4403	368	96-7033	409	96-9609	204
96-2902	410	96-4404	368	96-7040	384	96-9610	204
96-2903	410	96-4405	368	96-7051	374	96-9611	204
96-2905	410	96-4412	367	96-7174	407	96-9612	204
96-2906	410	96-4413	367, 226	96-7175	409	96-9613	204
96-2907	410	96-4414	367, 226	96-7177	409	96-9614	204
96-2908	410	96-4415	367	96-7178	409	96-9615	204
96-2909	410	96-4416	367	96-7187	384	96-9616	204
96-2910	410	96-4417	367	96-7268	407	96-9617	204
96-2914	410	96-5259	374	96-7270	407	96-9618	204
96-2915	410	96-5267	346, 371	96-7451	407	96-9619	204
96-2916	410	96-5280	346, 371	96-7459	407	96-9620	204
96-2917	410	96-5281	346, 371	96-7460	386	96-9621	204
96-2918	411	96-5282	346, 371	96-7543	408	96-9622	204
96-2919	411	96-5283	346, 371	96-7548	376	96-9623	204
96-2921	342	96-5284	346, 371	96-7635	385	96-9624	204
96-2929	411	96-5285	346, 371	96-7887	385	96-9625	204
96-2930	411	96-5286	346, 371	96-8105	385	96-9626	204
96-2931	411	96-5329	375	96-8923	374	96-9627	204
96-2950	385	96-5331	375	96-8924	374	96-9628	204
96-2951	385	96-5333	375	96-8925	374	96-9629	204
96-2955	386, 412	96-5335	375	96-8926	374	96-9630	204
96-2956	386, 412	96-5337	375	96-8933	372	96-9632	205
96-3000	346	96-5339	375	96-8934	372	96-9633	205
96-3001	346	96-5557	116, 375	96-8936	374	96-9634	205
96-3002	346	96-5557A	116, 375	96-8937	374	96-9635	205
96-3006	341	96-5557BNS	116, 375	96-8938	376	96-9636	205
96-3008	341	96-5615	371	96-8939	376	96-9637	205
96-3160	387	96-5616	371	96-8940	376	96-9638	205
96-3162	387	96-5617	371	96-8941	376	96-9639	205
96-3164	387	96-5618	371	96-8942	376	96-9640	205
96-3166	387	96-5619	371	96-8948	376	96-9641	205
96-3168	387	96-5620	377	96-8949	386	96-9642	205
96-3170	387	96-5621	377	96-8962	347	96-9643	205
96-3172	387	96-5622	377	96-8963	347	96-9644	205
96-3174	387	96-5623	377	96-8964	347	96-9645	205
96-3176	387	96-5624	377	96-8965	347	96-9646	205
96-3178	387	96-5625	377	96-8966	347	96-9647	205
96-3179	387	96-5627	376	96-8967	347	96-9648	205



96-9649.....	205	97-033.....	337	97-371.....	334	97-563.....	331
96-9650.....	205	97-038.....	337	97-372.....	334	97-571.....	331
96-9651.....	205	97-042.....	337	97-373.....	334	97-577.....	331
96-9652.....	206	97-100.....	329	97-375.....	328	97-586.....	331
96-9653.....	206	97-105.....	329	97-376.....	334	97-587.....	333
96-9654.....	206	97-107.....	329	97-380.....	334	97-592.....	333
96-9655.....	206	97-108.....	329	97-382.....	334	97-598.....	333
96-9656.....	206	97-109.....	329	97-384.....	334	97-599.....	333
96-9657.....	206	97-121.....	328	97-388.....	334	97-601.....	333
96-9658.....	206	97-205.....	328	97-390.....	334	97-604.....	330
96-9659.....	206	97-222.....	328	97-391.....	334	97-605.....	330
96-9660.....	206	97-226.....	328	97-392.....	334	97-606.....	333
96-9661.....	206	97-231.....	328	97-394.....	334	97-607.....	330
96-9662.....	206	97-237.....	328	97-409.....	331	97-611.....	333
96-9663.....	206	97-241.....	328	97-421.....	331	97-623.....	333
96-9664.....	208	97-243.....	328	97-426.....	331	97-629.....	333
96-9665.....	208	97-245.....	328	97-431.....	331	97-635.....	333
96-9666.....	208	97-254.....	328	97-434.....	332	97-639.....	333
96-9667.....	208	97-256.....	328	97-436.....	332	97-645.....	333
96-9668.....	208	97-258.....	328	97-437.....	332	97-655.....	333
96-9669.....	208	97-263.....	329	97-442.....	332	97-705.....	330
96-9670.....	208	97-266.....	329	97-447.....	331	97-710.....	330
96-9671.....	208	97-269.....	329	97-449.....	330	97-727.....	330
96-9672.....	208	97-270.....	329	97-452.....	331	97-731.....	330
96-9673.....	208	97-272.....	329	97-452.....	331	97-736.....	330
96-9674.....	208	97-272.....	329	97-458.....	331	97-736.....	330
96-9675.....	208	97-275.....	329	97-459.....	332	97-742.....	330
96-9675.....	208	97-278.....	329	97-463.....	331	97-747.....	330
96-9676.....	209	97-281.....	329	97-465.....	332	97-748.....	330
96-9677.....	209	97-284.....	329	97-469.....	332	97-749.....	330
96-9678.....	209	97-288.....	329	97-470.....	332	97-751.....	330
96-9679.....	209	97-291.....	329	97-471.....	332	97-753.....	331
96-9680.....	209	97-292.....	329	97-473.....	332	97-757.....	331
96-9681.....	209	97-293.....	329	97-477.....	332	97-762.....	331
96-9682.....	209	97-294.....	329	97-481.....	332	97-763.....	330
96-9683.....	209	97-295.....	329	97-483.....	332	97-764.....	330
96-9684.....	209	97-297.....	329	97-485.....	332	97-766.....	331
96-9685.....	209	97-299.....	329	97-487.....	332	97-769.....	331
96-9686.....	209	97-300.....	329	97-492.....	332	97-770.....	331
96-9687.....	209	97-308.....	328	97-494.....	332	97-771.....	330
96-9688.....	210	97-312.....	328	97-494.....	332	97-772.....	330
96-9690.....	210	97-312.....	328	97-496.....	332	97-772.....	330
96-9692.....	210	97-321.....	328	97-498.....	332	97-774.....	331
96-9694.....	210	97-325.....	328	97-498.....	332	97-774.....	331
96-9696.....	210	97-325.....	328	97-500.....	332	97-775.....	330
96-9698.....	211	97-327.....	328	97-501.....	332	97-776.....	330
96-9700.....	211	97-328.....	328	97-504.....	332	97-777.....	330
96-9701.....	211	97-335.....	328	97-504.....	332	97-777.....	330
96-9702.....	211	97-336.....	328	97-512.....	332	97-778.....	330
96-9703.....	211	97-336.....	328	97-513.....	332	97-781.....	330
96-9704.....	211	97-339.....	328	97-514.....	332	97-784.....	330
96-9706.....	211	97-339.....	328	97-514.....	332	97-784.....	330
96-9708.....	211	97-340.....	328	97-515.....	332	97-787.....	330
96-9710.....	211	97-340.....	328	97-515.....	332	97-787.....	330
97-008.....	336	97-346.....	329	97-516.....	332	97-788.....	331
97-010.....	336	97-352.....	329	97-517.....	332	97-790.....	331
97-012.....	336	97-352.....	329	97-517.....	332	97-790.....	331
97-014.....	336	97-354.....	328	97-518.....	332	97-791.....	330
97-020.....	336	97-354.....	328	97-518.....	332	97-791.....	330
97-021.....	336	97-356.....	328	97-521.....	332	97-793.....	330
97-029.....	336	97-356.....	328	97-521.....	332	97-793.....	330
		97-358.....	329	97-525.....	332	97-795.....	331
		97-358.....	329	97-528.....	332	97-799.....	335
		97-360.....	329	97-528.....	332	97-799.....	335
		97-361.....	329	97-534.....	332	97-809.....	333
		97-361.....	329	97-534.....	332	97-809.....	333
		97-364.....	329	97-537.....	332	97-810.....	333
		97-364.....	329	97-537.....	332	97-810.....	333
		97-365.....	334	97-542.....	332	97-813.....	333
		97-365.....	334	97-542.....	332	97-813.....	333
		97-366.....	334	97-545.....	335	97-826.....	333
		97-366.....	334	97-545.....	335	97-826.....	333
		97-369.....	329	97-546.....	331	97-832.....	333
		97-369.....	329	97-546.....	331	97-832.....	333
		97-370.....	334	97-561.....	331	97-834.....	333
		97-370.....	334	97-561.....	331	97-834.....	333



NUMERICAL INDEX

97-838.....	333	97-1545.....	123, 181, 308	98-201.....	337	98-492.....	337
97-842.....	333	97-1555.....	55	98-207.....	337	98-493.....	337
97-847.....	333	97-1560.....	55	98-209.....	336	98-494.....	330
97-853.....	333	97-1564.....	124, 181, 308	98-211.....	337	98-495.....	328
97-869.....	333	97-1565.....	55	98-224.....	336	98-496.....	328
97-872.....	333	97-1570.....	55	98-232.....	336	98-499.....	336
97-877.....	333	97-1615.....	123, 180, 308	98-234.....	337	98-502.....	336
97-881.....	333	97-1620.....	123, 180, 308	98-236.....	337	98-503.....	335
97-883.....	333	97-1625.....	123, 180, 308	98-239.....	337	98-505.....	335
97-885.....	333	97-1635.....	124, 181, 309	98-243.....	336	98-508.....	335
97-894.....	333	97-1640.....	124, 181, 309	98-247.....	336	98-521.....	334
97-902.....	336	97-1642.....	124, 181, 309	98-251.....	336	98-740.....	335
97-913.....	336	97-1645.....	124, 308	98-252.....	336	98-741.....	335
97-930.....	331	97-1650.....	124, 309	98-253.....	336	98-742.....	335
97-934.....	331	97-1652.....	124, 309	98-255.....	336	98-748.....	336
97-938.....	331	97-1654.....	124, 309	98-256.....	336	98-750.....	335
97-952.....	331	97-1660.....	167	98-257.....	336	98-755.....	335
97-956.....	331	97-1661.....	167	98-258.....	337	98-797.....	335
97-0335.....	166	97-1662.....	167	98-267.....	337	98-1052.....	49, 138
97-0527.....	184, 306	97-1663.....	167	98-268.....	337	98-1055.....	49, 138
97-0555.....	52	97-1721.....	353	98-276.....	330	98-1067.....	49, 138
97-1045.....	166	97-1820.....	353	98-285.....	332	98-1274.....	348
97-1046.....	166	97-1821.....	353	98-289.....	332	98-1275.....	348
97-1055.....	166	97-1822.....	353	98-303.....	334	98-1276.....	349
97-1056.....	166	97-1823.....	353	98-312.....	334	98-1277.....	349
97-1057.....	167	97-1824.....	353	98-324.....	334	98-1311.....	350
97-1146.....	166	97-1825.....	353	98-325.....	334	98-1313.....	350
97-1235.....	52	97-1826.....	353	98-336.....	334	98-1431.....	350
97-1241.....	166	97-5045.....	114	98-348.....	334	98-2047.....	60, 140
97-1242.....	166	98-103.....	328	98-362.....	334	98-2048.....	60, 140
97-1243.....	166	98-104.....	328	98-364.....	334	98-2050.....	75, 140, 151
97-1245.....	52	98-107.....	328	98-366.....	334	98-2051.....	75, 140, 151
97-1300.....	166	98-109.....	328	98-367.....	329	98-2054.....	75
97-1308.....	166	98-110.....	328	98-370.....	334	98-2056.....	75
97-1309.....	166	98-123.....	330	98-374.....	331	98-2070.....	75, 140, 151
97-1350.....	43	98-129.....	330	98-382.....	334	98-2071.....	75, 140, 151
97-1351.....	43	98-135.....	330	98-384.....	334	98-3055.....	65, 140
97-1400.....	353	98-140.....	331	98-386.....	332	98-3056.....	65, 140
97-1405.....	353	98-142.....	330	98-402.....	335	98-3182.....	101, 142, 155
97-1410.....	353	98-146.....	330	98-403.....	335	98-3183.....	101, 142, 155
97-1415.....	353	98-151.....	330	98-404.....	335	98-3184.....	101, 142, 155
97-1420.....	353	98-155.....	330	98-405.....	335	98-3185.....	101, 142, 155
97-1425.....	353	98-160.....	329	98-406.....	335	98-3186.....	101, 142, 155
97-1430.....	353	98-161.....	329	98-413.....	335	98-3188.....	101, 142, 155
97-1445.....	353	98-162.....	336	98-414.....	335	98-3190.....	101, 142, 155
97-1450.....	353	98-164.....	336	98-415.....	335	98-3192.....	101, 142, 155
97-1505.....	121	98-165.....	336	98-416.....	335	98-4008.....	87
97-1506.....	121	98-166.....	336	98-425.....	335	98-4012.....	87
97-1510.....	121	98-167.....	336	98-426.....	335	98-4020.....	87
97-1511.....	121	98-170.....	336	98-472.....	337	98-4108.....	87
97-1512.....	121	98-171.....	336	98-475.....	337	98-4112.....	87
97-1513.....	121	98-172.....	336	98-476.....	337	98-4120.....	87
97-1514.....	121	98-173.....	336	98-477.....	337	98-7810.....	136
97-1520.....	121, 180	98-174.....	336	98-478.....	337	98-7812.....	136
97-1521.....	121, 180	98-178.....	334	98-480.....	337	98-7814.....	49, 136
97-1530.....	55	98-179.....	334	98-482.....	337	98-7815.....	49, 136
97-1531.....	55	98-180.....	331	98-484.....	337	98-7816.....	49, 136
97-1533.....	123, 181, 308	98-182.....	337	98-485.....	337	98-7817.....	49, 136
97-1540.....	55	98-188.....	330	98-489.....	337		
97-1541.....	55	98-200.....	336	98-490.....	328		

A

Abbey Needle Holder, Merit™	333
Accessories, Disposable, Electrosurgical	211
Accessories, SklarLite™	402
Acorn Burnisher	291
Adson (Ewald) Dressing Forcep	60
Adson Bayonet Forcep, Merit™	330
Adson Bayonet Forcep, Surgi-OR™	322
Adson Bipolar Forcep, Electrosurgical	212
Adson Debakey Forcep	61
Adson Dressing Forcep	60
Adson Dressing Forcep, Econo-Sterile™	342
Adson Dressing Forcep, LiteGrip™	61
Adson Dressing Forcep, Merit™	330
Adson Dressing Forcep, Sklarlite XD™	56
Adson Dressing Forcep, Sklarlite™	56
Adson Dressing Forcep, Surgi-OR™	322
Adson Dressing Forcep, TC	54
Adson Dura Hook	119
Adson Elevator	183
Adson Forcep	79
Adson Forcep, Bayonet	133
Adson Forcep, Micro	60, 140
Adson Forcep, Sklar Blue™	202
Adson Hook	119
Adson Needle Holder	99
Adson Suction Tube	160
Adson Tissue Forcep	60
Adson Tissue Forcep, Econo-Sterile™	342
Adson Tissue Forcep, Merit™	330
Adson Tissue Forcep, Sklarlite XD™	56
Adson Tissue Forcep, Sklarlite™	56
Adson Tissue Forcep, Surgi-OR™	322
Adson Tissue Forcep, TC	54
Adson-Brown Tissue Forcep	60
Adson-Brown Tissue Forcep, Econo-Sterile™	342
Adson-Brown Tissue Forcep, Merit™	330
Adson-Brown Tissue Forcep, Sklarlite XD™	56
Adson-Brown Tissue Forcep, Sklarlite™	56
Adson-Brown Tissue Forcep, Surgi-OR™	322
Adson-Brown Tissue Forcep, TC	54
Adson-Gorney Tissue Forcep, TC	54
Adult Stethoscope	361
Aebli Corneal Scissors	47
Aeron Table	438
Akers Knife	285
Akers Set	285
Akers Spoon	285
Akers/Evans Handle	285
Alexander Chisel	177
Alexander Gouge	178
Allen Clamp	82
Alligator Ear Forcep	132, 140
Alligator Ear Scissors	51, 130
Alligator Forcep, Hartmann	130
Alligator Forcep, Merit™ Micro	337
Allis Forcep, Laparoscopic	222

Allis Forcep, Laparoscopic, Disposable	242
Allis Tissue Forcep	81
Allis Tissue Forcep, Econo-Sterile™	342
Allis Tissue Forcep, Merit™	331
Allis Tissue Forcep, Sklar Blue™	201
Allis Tissue Forcep, Sklarlite XD™	58
Allis Tissue Forcep, Sklarlite™	58
Allis Tissue Forcep, Surgi-OR™	322
Allis Tissue Forcep, TC	55
Allport Retractor	112
Allport Searcher	120
Alm Retractor	111
Alm Retractor, Merit™	334
Aluminum Alloy Tuning Fork	355
Amalgam Carrier	285
Andrews-Pynchon Suction Tip	160
Andrews-Pynchon Suction Tube	160
Anesthesia Machine	436
Anthony Suction Tube	160
Apical Elevator	307
Applicator, Cotton Tip	374
Appliers, Ligation Clip	239-240
Army Chisel	177
Army Gauze Scissors, Merit™	328
Army Gouge	178
Army Osteotome	176
Army Retractor, Merit™	334
Aspriating Syringe	316
Aufricht Rasp	122
AV800 Anesthesia Machine	436
Avian Speculum	356
Awl, Obwegeser Mandibular	267
Awl, Obwegeser Maxillary	267
Ayers Chalazion Forcep	154

B

Babcock Forcep	81
Babcock Forcep, Econo-Sterile™	342
Babcock Forcep, Laparoscopic	222
Babcock Forcep, Sklar Blue™	201
Babcock Forcep, Surgi-OR™	322
Babcock Forcep, TC	55
Babcock Forcep, Merit™	331
Babcock/DeBakey Forcep, Laparoscopic	224
Babcock/DeBakey Forcep, Laparoscopic, Disposable	242
Babinski Hammer, Merit™	336
Backhaus Towel Clamp, Surgi-OR™	324
Backhaus Towel Forcep	85
Backhaus Towel Forcep, Econo-Sterile™	343
Backhaus Towel Forcep, Merit™	333
Badgley Retractor	115
Bag, Linen, Disposable	383
Bag, Reclosable, Disposable	383
Bailey Gigli Bone Saw Guide	173
Bainbridge Forcep	81
Bakes Dilator	126

Balfour Retractor	114-115
Balfour Retractor Blade	115
Ball, Cotton	374
Ballenger Sponge Forcep	84, 196
Band, Matrix	311
Band, Rubber, Disposable	386
Bandage, Cohesive	121, 372
Bandage, Esmark	373
Bandage, Triangle	374
Bar Fistula Probe	145
Baron Suction Tube	159
Barraquer Cilia Forcep	71, 153, 315
Barraquer Needle Holder	101, 142, 155
Barraquer Speculum, Wire	110, 144, 156
Barraquer Wire Speculum	110, 144, 156
Basic Basin Tray	365
Basic Eye Set	349
Basin Start-up Tray	365
Basin, Emesis, Stainless Steel	390
Basin, Plastic Emesis	408
Basin, Plastic OR	365, 408
Basin, Plastic Round	408
Basin, Solution, Stainless Steel	389
Basket, Cleaning, Stainless Steel	394
Basket, Sterilization, SklarLite™	401-403
Baumgartner Needle Holder	97
Baumgartner Needle Holder, Econo-Sterile™	345
Baumgartner Needle Holder, Merit™	333
Baumgartner Needle Holder, Sklarlite XD™	96
Baumgartner Needle Holder, Sklarlite™	96
Baumgartner Needle Holder, Surgi-OR™	325
Baumgartner Needle Holder, Surgi-OR™ TC	324
Baumgartner Needle Holder, TC	90
Bayonet Elevator	306
Bayonet Forcep, Adson	133
Bayonet Forcep, Adson, Merit™	330
Bayonet Forcep, Lucae	65, 133
Beer Cilia Forcep	71, 153, 315
Bellucci Ear Forcep	132
Bellucci Ear Scissors	51, 130, 138
Bellucci Scissors	51, 130, 138
Bellucci Scissors, Micro	51, 130, 138
Benique Catheter Guide	127
Bergh Cilia Forcep	71, 153, 314
Bergh Cilia Forcep, Merit™	330
Beyer Ronguer	170
Bihrie Needle Holder, TC	92
Billeau Loop	134
Biopsy Punch Set, Tru-Punch™, Disposable	381
Biopsy Punch, Laparoscopic	226
Biopsy Punch, Tru-Punch™, Disposable	381
Bioxapro Suture, Non-Absorbable	272
Bipolar Cable, Electrosurgical	212
Bipolar Forcep, Electrosurgical Adson	212
Bipolar Forcep, Electrosurgical Coaptation	212
Bipolar Forcep, Electrosurgical Cord	211
Bipolar Forcep, Electrosurgical Cushing	212
Bipolar Forcep, Electrosurgical Gerald	212



Bipolar Forcep, Electrosurgical Gerald Bayonet.....	212	Bone Ronguer	170	Bulldog Clamp, Diethrich	87
Bipolar Forcep, Electrosurgical Hardy Bayonet.....	212	Bone Saw Blade, Satterlee.....	173	Bulldog Clamp, Johns Hopkins.....	87
Bipolar Forcep, Electrosurgical Jansen Bayonet.....	213	Bone Saw Guide, Bailey Gigli.....	173	Burnisher	290
Bipolar Forcep, Electrosurgical Jeweler	213	Bone Saw Handles, Gigli.....	172	Burnisher, Acorn	291
Bipolar Forcep, Electrosurgical Malis	213	Bone Saw Wire, Gigli.....	173	Burnisher, University of Michigan	290
Bipolar Forcep, Electrosurgical McPherson	213	Bone Saw, Charriere	173	Button, Laparoscopic, Single Port	217
Bipolar Forcep, Electrosurgical Semkin.....	213	Bone Saw, Langenbeck.....	173		
Bipolar Forcep, Electrosurgical Tenzel	213	Bone Saw, Satterlee	173		
Bird Nail Trimmer	168	Bone Wire Guide	190		
Biro Derm Naevuss Scissors.....	42	Bone Wire Guide, Demel.....	267		
Bishop-Harmon Forcep	68, 152, 315	Bonn Iris Scissors.....	45		
Bishop-Harmon Forcep, Merit™	330	Bonn Suture Forcep	70, 139, 151		
Bistoury, Udall Teat.....	192	Bonney Tissue Forcep.....	63		
Black Plugger	288	Bottle, Sklar-Stat™ Dispenser.....	14, 32, 256, 432		
Blade Electrode Disposable, Electrosurgical.....	205	Bovine Forcep	196		
Blade Remover, Disposable	386	Bowl, Mixing/Solution, Stainless Steel.....	389		
Blade, Carbon P-M.....	353	Bowl, Plastic Guidewire.....	408		
Blade, Disposable Surgical	352, 379	Bowl, Plastic Multi-Purpose Utility.....	407		
Blade, Laryngoscope, MacIntosh	163	Bowl, Plastic Utility	408		
Blade, Laryngoscope, Miller	163	Bowl, Sponge, Stainless Steel.....	389		
Blade, Remover.....	351	Bowles Stethoscope.....	364		
Blade, Retractor, Balfour	115	Bowman Lachrymal Probe	126		
Blade, Saw	173	Boynton Needle Holder	100, 155		
Blade, Scalpel.....	353	Bozeman Forcep	84, 195		
Blade, Surgical, Disposable.....	352, 379	Bozeman Forcep, Econo-Sterile™	343		
Blair-Roll Retractor	104	Bozeman Forcep, Merit™.....	331		
Blake Forcep	72, 133	Bozeman Forcep, Sklar Blue™	202		
Blending Thinners.....	165	Bozeman Forcep, Surgi-OR™	322		
Blepharoplasty Scissors	42	Bracken Iris Forcep	66		
Blepharoplasty Scissors, Sklar Edge™ TC	22	Braun Epistomy Scissors, Merit™	328		
Blumenthal Ronguer.....	171, 293	Braun Epistomy Scissors, Surgi-OR™	320		
Boetcher Scissors.....	39	Bridge Thoracic Forcep	87		
Boley Gauge.....	283	Brophy Scissors.....	47, 302		
Bonaccolto Utility Forcep.....	67	Brown Needle Holder	98		
Bone Clamp, Lambert-Lowman.....	175	Brown Needle Holder, Merit™	333		
Bone Clamp, Lowman	175	Brown Needle Holder, Surgi-OR™	325		
Bone Clamp, Lowman-Hoglund.....	175	Brown Tissue Forcep.....	63		
Bone Curette, Cobbs.....	185	Bruns Curette	185		
Bone Curette, Martini.....	185	Brush, Cleaning.....	415-420		
Bone Curette, Volkman.....	185	Brush, Cleaning Set.....	419-420		
Bone Curette, Williger.....	185	Brush, Drying Rack.....	418		
Bone File	123-124, 180-181, 308-309	Brush, Instrument Cleaning.....	415-417		
Bone File, Miller.....	123-124, 181, 308	Brush, Suction Tube Cleaning.....	417		
Bone Forcep, Compression.....	175	Brush, Surgical Scrub.....	417		
Bone Forcep, Farabeur-Lamotte.....	174	Brush, Tracheal Tube Cleaning.....	416		
Bone Forcep, Kern	174	Buck Curette, Merit™	336		
Bone Forcep, Kern, Merit™	337	Buck Ear Curette	134		
Bone Forcep, Lane.....	174	Buck Ear Probe	126		
Bone Forcep, Lewin.....	174	Buck Hammer.....	355		
Bone Forcep, Liston	172, 318	Buck Hammer, Merit™	336		
Bone Forcep, Liston, Merit™	337	Buck Knife	282		
Bone Forcep, Ruskin-Liston	172	Bucket, Hospital Kick, Stainless Steel.....	390		
Bone Forcep, Stille-Luer.....	172	Bucket, Hospital, Stainless Steel.....	390		
Bone Forcep, Verbrugge	175	Buie Fistula Probe	126		
Bone Hook, Volkman	119, 187	Buie Suction Tube	160		
Bone Mallet.....	318	Bulb Syringe, Disposable	384		
Bone Pin Cutter	189	Bulb, Chip Blower	124, 309		
Bone Rasp, Putti.....	122-123, 180	Bulldog Clamp, Diefenbach.....	87		

C

Cable, Disposable, Electrosurgical.....	211
Cable, Electrosurgical.....	212
Caliper, Castroviejo	158, 358
Caliper, EKG	358
Caliper, EKG, Merit™	336
Caliper, Thorpe.....	358
Can Liner, Disposable	383
Canine Grooming Shears	164
Canine Mouth Gag	310, 357
Canine Thinners	165
Cannula, Laparoscopic.....	227
Carbon P-M Blade.....	353
Cardiology Stethoscope	360
Care & Cleaning Solutions ...	3-17, 245-259, 421-435
Carmalt Splinter Forcep.....	72
Carmalt Splinter Forcep, Merit™	330
Caroll Forcep	191
Carrier, Amalgam.....	285
Carrier, Dupuys-Weiss Ligature.....	267
Carver, Cleoid & Discoid.....	284
Carver, Hollenback.....	287
Carver, Le Cron.....	287
Carver, Roach.....	286
Carver, Vehe.....	286
Carver, Walls	286
Carver, Ward.....	286
Cassette, Instrument	404-406
Cast Spreader, Merit™	334
Castration Tray	370
Castroviejo Caliper	158, 358
Castroviejo Cataract Scissors	50, 137
Castroviejo Corneal Scissors	49-50, 136-137, 149
Castroviejo Corneal Forcep.....	69
Castroviejo Eye Speculum	109, 143
Castroviejo Needle Holder.....	101, 142, 315
Castroviejo Needle Holder, TC	94
Castroviejo Suture Forcep.....	67
Castroviejo-Kalt Needle Holder	101
Cat Claw Scissors	168
Cataract Scissors, Castroviejo	50, 137
Catheter Guide	127
Catheter Guide, Benique.....	127
Catheter Guide, Guyon.....	127
Catheter Instrument Tray Cover, Stainless Steel... 393	
Catheter Instrument Tray, Stainless Steel	393
Catheter Instrument Tray, Stainless Steel, Miniature.....	392
Cement Spatula.....	291
Cervex Brush, Disposable	378



Chalazion Forcep, Ayers	154	Clamp, Presbyterian Tube Occluding, Surgi-OR™	324	Cord Bipolar Forcep, Electrosurgical.....	211
Chalazion Forcep, Desmarres.....	154	Clamp, Roeder Towel	85, 174	Corneal Forcep, Castroviejo.....	69
Chalazion Forcep, Francis.....	154	Clamp, Sesamoid	191	Corneal Forcep, Colibri.....	69, 151
Chalazion Forcep, Heath.....	154	Clamp, Sklar Thoracic	86	Corneal Forcep, Troutman Barraquer.....	69, 151
Chandler Elevator.....	183	Clamp, Towel, Hoff, Plastic	411	Corneal Hook, Wiener	119
Charriere Bone Saw	173	Clamp, Towel, Plastic	385, 411-412	Corneal Scissors, Castroviejo	49-50, 136-137, 149
Cheek Dilator.....	312	Clamp, Tubing, Plastic.....	410	Corneal Scissors, Scheie-Westcott	136
Cheek Retractor	311	Clamp, Tubing, Vorse, Merit™.....	333	Cornell Teat Curette.....	193
Cheek Retractor, University of Minnesota	311	Clamp, Werthiem.....	88	Corneoscleral Forcep, Thorpe.....	74
Chip Blower	124, 309	Claw Forcep, Laparoscopic.....	221	Corwin Wire Twister, TC	188, 263
Chip Blower Bulb.....	124, 309	Claw Scissors, Cat	168	Cottle Double Hook	118
Chip Blower Tip	124, 309	Cleaning Basket, Stainless Steel.....	394	Cottle Elevator.....	182
Chisel, Alexander.....	177	Cleaning Brush.....	415-420	Cottle Periosteal Elevator	182
Chisel, Army	177	Cleaning Brush Set.....	419-420	Cottle Rasp.....	122
Chisel, Coupland.....	309	Cleaning, Instrument Brush.....	415-417	Cottle Retractor	105
Chisel, Foreign Body, Davis	157	Cleaning, Suction Tube Brush.....	417	Cotton Ball	374
Chisel, Freer.....	177	Cleaning, Tracheal Tube Brush	416	Cotton Swab	374
Chisel, Gardner	309	Cleoid & Discoid Carver	284	Cotton Tip Applicator	374
Chisel, Hibbs	177	Clip Applicators, Ligation.....	239-240	Coupland Chisel	309
Christensen Teat Scissors	192	Clip Forcep, Michel, Merit™	330	Coupland Suction Tube	160
Cilia Forcep, Barraquer	71, 153, 315	Clip Rack, McKenzie	268	Covault Hook	198
Cilia Forcep, Beer.....	71, 153, 315	Clip, Ligation.....	238	Crane Kaplan Scaler	278
Cilia Forcep, Bergh.....	71, 153, 314	Clip, McKenzie.....	268	Crane Pick Elevator.....	307
Cilia Forcep, Bergh, Merit™	330	Clip, Michel	268	Crego Elevator.....	183-184
Cilia Forcep, Douglass	71, 153, 315	Clip, Nose, Disposable	385	Crile Forcep.....	76
Cilia Forcep, Gradle.....	72, 153, 315	Clip, Tourniquet, N-1	357, 372	Crile Forcep, Econo-Sterile™	341
Cilia Forcep, Littauer	70, 153, 314	Clipper, Fetlock.....	168	Crile Forcep, Merit™	331
Cilia Forcep, Swiss	71, 153, 314	Clippers, Nail, White.....	167	Crile Forcep, Sklarlite XD™	57
Cilia Forcep, Ziegler	71, 153, 315	Coaptation Bipolar Forcep, Electrosurgical	212	Crile Forcep, Surgi-OR™	322-323
Clamp, Allen	82	Coarctation Clamp.....	86	Crile Needle Holder	100
Clamp, Backhaus Towel, Surgi-OR™	324	Cobbs Bone Curette.....	185	Crile Retractor	105
Clamp, Coactation.....	86	Coded Probe	283	Crile-Murray Needle Holder.....	98
Clamp, Dennis.....	82	Cogswell Elevator	304	Crile-Murray Needle Holder, TC	90
Clamp, Diefenbach Bulldog.....	87	Cohan Needle Holder	142	Crile-Wood Needle Holder.....	98
Clamp, Diethrich Bulldog.....	87	Cohesive Bandage	121, 372	Crile-Wood Needle Holder, Econo-Sterile™	345
Clamp, Dingman.....	174	Colibri Corneal Forcep.....	69, 151	Crile-Wood Needle Holder, Merit™	333
Clamp, Finochietto Thoracic.....	86	Collar, Laparoscopic.....	227	Crile-Wood Needle Holder, Sklarlite XD™	96
Clamp, Gemini.....	85	College Pliers	273-274	Crile-Wood Needle Holder, Sklarlite™	96
Clamp, Hoff Towel.....	84	Coller Forcep.....	77	Crile-Wood Needle Holder, Surgi-OR™ TC.....	324
Clamp, Johns Hopkins Bulldog.....	87	Collier Needle Holder	97	Crile-Wood Needle Holder, TC	90
Clamp, Jones.....	85	Collier Needle Holder, Merit™	333	Crimper/Wire Forcep, McGee.....	132
Clamp, Jones Towel, Merit™	333	Collier Needle Holder, Surgi-OR™	325	Crown Scissors.....	45, 266, 302
Clamp, Lambert-Lowman Bone.....	175	Collins Shears	317	Crypt Hook, Rosser	119
Clamp, Lorna Edna Towel	85	Columbia Curette.....	280	Cup, Graduated Measure, Plastic	407
Clamp, Lorna Edna Towel, Econo-Sterile™	343	Colver-Coakley Forcep.....	83	Cup, Graduated Measure, Stainless Steel	389
Clamp, Lorna Edna Towel, Merit™	333	Comedone Extractor, Merit™	335	Cup, Iodine, Stainless Steel	388
Clamp, Lorna Edna Towel, Surgi-OR™	324	Comedone, Unna, Merit™	335	Cup, Medicine, Stainless Steel.....	388
Clamp, Lowman Bone	175	Commander Utility Scissors	52	Cup, Plastic Medicine	407
Clamp, Lowman-Hoglund Bone.....	175	Compact Anesthesia Machine.....	436	Curette Excavator, Merit™	335
Clamp, Martin	191	Compression Bone Forcep.....	175	Curette, Bruns	185
Clamp, Patent Ductus.....	86	Condenser, Hollenback	288	Curette, Buck Ear	134
Clamp, Peers Towel, Merit™	333	Container, Sterilization, SklarLite™	400-403	Curette, Buck, Merit™	336
Clamp, Pennington.....	78	Container, Storage, Stainless Steel.....	390	Curette, Cobbs Bone.....	185
Clamp, Pratt.....	78	Converse Needle Holder	97	Curette, Columbia.....	280
Clamp, Presbyterian Tube Occluding, Econo-Sterile™	344	Cook Eye Speculum	110, 144, 156	Curette, Cornell Teat.....	193
Clamp, Presbyterian Tube Occluding, Merit™	333	Cook Speculum, Eye.....	110, 144, 156	Curette, Dermal, Disposable	380
		Cooley Tissue Forcep.....	64	Curette, Ear, Disposable.....	380
				Curette, Fox Dermal, Merit™.....	335



Dressing Forcep, Potts-Smith..... 61
 Dressing Forcep, Potts-Smith, TC..... 54
 Dressing Forcep, Semkin 61
 Dressing Forcep, Sklar Blue™..... 202
 Dressing Forcep, Sklarlite XD™..... 56
 Dressing Forcep, Sklarlite™..... 56
 Dressing Forcep, Surgi-OR™..... 322
 Dressing Forcep, TC 54
 Dressing Jar, Stainless Steel..... 391
 Drying Rack Brush..... 418
 Dubois Scissors..... 317
 Duckbill Ear Forcep 131
 Duke Improved Trocar 129
 Dunaway Forcep, Dissecting, Surgi-OR™ 323
 Dupuy-Weiss Ligature Carrier 267
 Dura Hook, Adson 119
 Dura Hook, Cushing 118

E

Ear Curette, Buck 134
 Ear Curette, Buck, Merit™..... 336
 Ear Curette, Disposable 380
 Ear Curette, Shapleigh 134
 Ear Forcep, Alligator 132, 140
 Ear Forcep, Bellucci 132
 Ear Forcep, Blake 72, 133
 Ear Forcep, Duckbill 131
 Ear Forcep, Goodhill..... 132
 Ear Forcep, Greven..... 132
 Ear Forcep, Hoffman 131
 Ear Forcep, Struempel 131
 Ear Forcep, Weingartner 131
 Ear Forcep, Wilde..... 72, 133
 Ear Forcep, Wilde, Merit™ 331
 Ear Hook, Day 119, 135
 Ear Loop, Billeau 134
 Ear Scissors, Alligator..... 51, 130
 Ear Scissors, Bellucci..... 51, 130, 138
 Ear Speculum, Gruber, Merit™ 336
 Ear Suction Tube 160
 Ear Syringe Shield, Merit™ 336
 Ear Syringe Tip, Merit™ 336
 Ear Syringe, Merit™ 336
 Ear/Ulcer Syringe, Disposable..... 384
 Echlin Ronguer 169

ECONO™-STERILE

Econo-Sterile Adson Dressing Forcep..... 342
 Econo-Sterile Adson Tissue Forcep 342
 Econo-Sterile Adson-Brown Forcep 342
 Econo-Sterile Allis Tissue Forcep..... 342
 Econo-Sterile Babcock Forcep 342
 Econo-Sterile Backhaus Towel Forcep..... 343
 Econo-Sterile Baumgartner Needle Holder 345
 Econo-Sterile Bozeman Forcep..... 343
 Econo-Sterile Crile Forcep 341

Econo-Sterile Crile-Wood Needle Holder 345
 Econo-Sterile Derf Needle Holder 345
 Econo-Sterile Dressing Forcep..... 342
 Econo-Sterile Fine Point Splinter Forcep 343
 Econo-Sterile Graves Vaginal Speculum..... 346
 Econo-Sterile Halsey Needle Holder 345
 Econo-Sterile Halsted Mosquito Forcep 341
 Econo-Sterile Hartmann Mosquito Forcep 341
 Econo-Sterile Hoff Towel Forcep 343
 Econo-Sterile Iris Scissors..... 339
 Econo-Sterile Kelly Forcep..... 341
 Econo-Sterile Knowles Bandage Scissors 340
 Econo-Sterile Lister Bandage Scissors 340
 Econo-Sterile Littauer Stitch Scissors 340
 Econo-Sterile Lorna Edna Towel Clamp..... 343
 Econo-Sterile Mayo Scissors..... 339
 Econo-Sterile Mayo-Hegar Needle Holder 345
 Econo-Sterile Metzenbaum Scissors..... 339
 Econo-Sterile Operating Scissors..... 339
 Econo-Sterile Pederson Vaginal Speculum..... 346
 Econo-Sterile Presbyterian Tube
 Occluding Clamp 344
 Econo-Sterile Rochester-Ochsner Forcep..... 341
 Econo-Sterile Rochester-Pean Forcep..... 341
 Econo-Sterile Schroeder Tenaculum Forcep..... 343
 Econo-Sterile Spencer Stitch Scissors 340
 Econo-Sterile Sponge Forcep 344
 Econo-Sterile Strabismus Scissors 340
 Econo-Sterile Tissue Forcep 342
 Econo-Sterile Webster Needle Holder..... 345
 Econo-Sterile Wire Cutting Scissors..... 340
 Econo-Sterile Wireform Halsted Forcep 347
 Econo-Sterile Wireform Kelly Forcep 347
 Econo-Sterile Wireform Needle Holder 347
 Econo-Sterile Wireform Scissors..... 347
 Econo-Sterile Wireform Sponge Forcep..... 347
 Econo-Sterile Wireform Thumb Forcep..... 347
 Econo-Sterile Wireform Tissue Forcep..... 347
 Econo-Sterile Wireform Towel Forcep 347

EDGE Table..... 439
 EKG Caliper..... 358
 EKG Caliper, Merit™ 336
 Electrode, Disposable, Electrosurgical..... 205-209
 Electrode, Laparoscopic 230
 Electrode, Laparoscopic, Miniature 233
 Electrode, Laparoscopic, Single Port 217
 Electrosurgical Blade Electrode, Disposable..... 205
 Electrosurgical Cable, Bipolar 212
 Electrosurgical Cable, Disposable..... 211
 Electrosurgical Cable, Laparoscopic 230, 233
 Electrosurgical Cord, Bipolar Forcep..... 211
 Electrosurgical Electrode, Disposable..... 205-209
 Electrosurgical Forcep, Bipolar..... 212-213
 Electrosurgical Grounding Pad, Disposable..... 210
 Electrosurgical Holster, Disposable..... 211
 Electrosurgical Lletz Electrode, Disposable 207
 Electrosurgical Loop Electrode, Disposable..... 206

Electrosurgical Pencil, Disposable 204
 Electrosurgical Straight Electrode, Disposable..... 208-209
 Electrosurgical Tip Cleaner, Disposable..... 211
 Element Plus Table..... 439
 Elevator 304-307
 Elevator, Adson..... 183
 Elevator, Apical 307
 Elevator, Bayonet 306
 Elevator, Chandler 183
 Elevator, Cogswell..... 304
 Elevator, Cottle 182
 Elevator, Cottle Periosteal 182
 Elevator, Crane Pick..... 307
 Elevator, Crego 183-184
 Elevator, Freer 182, 304
 Elevator, Freer, Merit™..... 336
 Elevator, Freer, Surgi-OR™..... 326
 Elevator, Hohmann 108, 186
 Elevator, Joseph Periosteal..... 182
 Elevator, Key 184
 Elevator, Langenbeck..... 183
 Elevator, McKenty Septum 182
 Elevator, Molt..... 304
 Elevator, Pierce 182
 Elevator, Potts 307
 Elevator, Root Tip 307
 Elevator, Sayre 183
 Elevator, Sedillot Periosteal..... 183
 Elevator, Seldin..... 184, 306
 Elschmig Forcep..... 66
 Emasculatome..... 198
 Emasculator, Frank..... 198
 Emasculator, Plain..... 198
 Emasculator, Reimer 198
 Emasculator, White..... 198
 Emesis Basin, Plastic 408
 Emesis Basin, Stainless Steel..... 390
 Emmett Hook Set, Sklar Blue™ 203
 Emmett Hook, Sklar Blue™ 203
 Endo Clinch Forcep, Laparoscopic..... 223
 Endo Clinch Forcep, Laparoscopic,
 Disposable..... 242-243
 Endo Clinch Forcep, Laparoscopic, Single Port... 217
 Endocervical Speculum, Kogan, Sklar Blue™..... 200
 Endoscope, Laparoscopic, Miniature 233
 Enterotome Scissors 43, 317
 Enucleation Scissors 47
 Epistomy Scissors, Braun, Merit™ 328
 Episyn Suture, Absorbable 270
 EPT Table..... 439
 Equine Set..... 350
 Equine Tray 369
 Esmarch Plaster Shears..... 51
 Esmarch Plaster Shears, Merit™ 328
 Esmark Bandage..... 373
 Esophagus Retractor, Laparoscopic..... 235
 Evans Knife 285
 Evans Set..... 285



Evans Spoon.....	285
Excavator.....	284
Excavator, Curette, Merit™.....	335
Explorer.....	275
Extracting Forcep.....	294-300
Extracting Forcep, Mead.....	294
Extractor, Comedone, Merit™.....	335
Extractor, Shamburg Comedone, Merit™.....	335
Extractor, Shamburg Comedone, Surgi-OR™.....	326
Extractor, Teat.....	193
Eye Forcep, Dressing.....	59, 152, 314
Eye Forcep, Tissue.....	60, 152, 314
Eye Needle.....	262
Eye Speculum, Cook.....	110, 144, 156
Eye Speculum, Knapp.....	109, 143
Eye Speculum, Knapp, Merit™.....	336
Eye Speculum, Lancaster.....	109, 143
Eye Speculum, Maumenee Park.....	109, 143
Eye Speculum, Mellinger.....	110, 144, 156
Eye Speculum, Murdock.....	109, 144, 156
Eye Speculum, Sauer.....	108, 143, 156
Eye Tray.....	370

F

Fan Retractor, Laparoscopic.....	235
Farabeuf Retractor.....	106
Farabeuf-Lamotte Bone Forcep.....	174
Feaster Wire Speculum.....	110
Feichenfeld Splinter Forcep.....	72
Feichenfeld Splinter Forcep, Merit™.....	330
Feline Mouth Gag.....	310, 357
Female Catheter Dilator.....	127
Ferguson Forcep.....	78
Ferguson Needle.....	261
Ferguson Scoop.....	128
Ferris Smith Tissue Forcep.....	64
Ferris Smith Tissue Forcep, Merit™.....	330
Ferris Smith Tissue Forcep, Surgi-OR™.....	322
Fetal Stethoscope.....	362
Fetlock Clipper.....	168
Fetoscope, Perrell.....	364
Fetoscope, Pinard.....	364
Field Service Tray.....	370
File, Bone.....	123-124, 180-181, 308-309
File, Bone, Miller.....	123-124, 181, 308
File, Nail/Bone.....	124, 181, 308-309
Filling Instrument, Ladmore.....	289
Filling Instrument, Plastic.....	289
Filling Instrument, Woodson.....	289
Fine Point Splinter Forcep.....	72
Fine Point Splinter Forcep, Econo-Sterile™.....	343
Fine Stitch Scissors.....	149
Finocchio Needle Holder.....	100
Finocchio Needle Holder, TC.....	92
Finocchio Thoracic Clamp.....	86
First Aid Shears, Merit™.....	328
Fistula Needle.....	260

Flat Nose Pliers.....	301
Fletcher Sponge Forcep.....	84, 196
Foam Dispenser, Sklar-Stat™.....	14, 32, 256, 432
Foaming Hand Sanitizer, Sklar-Stat™.....	14, 256, 432
Foerster Forcep.....	68
Foerster Sponge Forcep.....	84, 196
Foerster Sponge Forcep, Merit™.....	331
Foerster Sponge Forcep, Surgi-OR™.....	323
Fomon Lateral Scissors, Sklarcut™.....	31
Fomon Rasp.....	122, 180
Fomon Rasp, TC.....	121
Fomon Scissors.....	48
Foot Rot Shears.....	168
Forcep Jar, Stainless Steel.....	391, 418

FORCEPS

Forcep, Adson.....	79
Forcep, Adson (Ewald) Dressing.....	60
Forcep, Adson Bayonet.....	133
Forcep, Adson Bayonet, Merit™.....	330
Forcep, Adson Bayonet, Surgi-OR™.....	322
Forcep, Adson Debakey.....	61
Forcep, Adson Dressing.....	60
Forcep, Adson Dressing, Econo-Sterile™.....	342
Forcep, Adson Dressing, LiteGrip™.....	61
Forcep, Adson Dressing, Merit™.....	330
Forcep, Adson Dressing, Sklar Blue™.....	202
Forcep, Adson Dressing, Sklarlite XD™.....	56
Forcep, Adson Dressing, Sklarlite™.....	56
Forcep, Adson Dressing, Surgi-OR™.....	322
Forcep, Adson Dressing, TC.....	54
Forcep, Adson Micro.....	60, 140
Forcep, Adson Tissue.....	60
Forcep, Adson Tissue, Econo-Sterile™.....	342
Forcep, Adson Tissue, Merit™.....	330
Forcep, Adson Tissue, Sklarlite XD™.....	56
Forcep, Adson Tissue, Sklarlite™.....	56
Forcep, Adson Tissue, Surgi-OR™.....	322
Forcep, Adson Tissue, TC.....	54
Forcep, Adson-Brown Tissue.....	60
Forcep, Adson-Brown Tissue, Merit™.....	330
Forcep, Adson-Brown Tissue, Sklarlite XD™.....	56
Forcep, Adson-Brown Tissue, Sklarlite™.....	56
Forcep, Adson-Brown Tissue, Surgi-OR™.....	322
Forcep, Adson-Brown Tissue, TC.....	54
Forcep, Adson-Brown, Econo-Sterile™.....	342
Forcep, Adson-Gorney Tissue, TC.....	54
Forcep, Allis Tissue.....	81
Forcep, Allis Tissue, Econo-Sterile™.....	342
Forcep, Allis Tissue, Merit™.....	331
Forcep, Allis Tissue, Sklar Blue™.....	201
Forcep, Allis Tissue, Sklarlite XD™.....	58
Forcep, Allis Tissue, Sklarlite™.....	58
Forcep, Allis Tissue, Surgi-OR™.....	322
Forcep, Allis Tissue, TC.....	55
Forcep, Ayers Chalazion.....	154
Forcep, Babcock.....	81

Forcep, Babcock, Econo-Sterile™.....	342
Forcep, Babcock, Merit™.....	331
Forcep, Babcock, Sklar Blue™.....	201
Forcep, Babcock, Surgi-OR™.....	322
Forcep, Babcock, TC.....	55
Forcep, Backhaus Towel.....	85
Forcep, Backhaus Towel, Econo-Sterile™.....	343
Forcep, Backhaus Towel, Merit™.....	333
Forcep, Bainbridge.....	81
Forcep, Ballenger Sponge.....	84, 196
Forcep, Barraquer Cilia.....	71, 153, 315
Forcep, Beer Cilia.....	71, 153, 315
Forcep, Bergh Cilia.....	71, 153, 314
Forcep, Bergh Cilia, Merit™.....	330
Forcep, Bishop-Harmon.....	68, 152, 315
Forcep, Bishop-Harmon, Merit™.....	330
Forcep, Blake.....	72, 133
Forcep, Bonaccolto Utility.....	67
Forcep, Bonn Suture.....	70, 139, 151
Forcep, Bonney Tissue.....	63
Forcep, Bovine.....	196
Forcep, Bozeman.....	84, 195
Forcep, Bozeman, Econo-Sterile™.....	343
Forcep, Bozeman, Merit™.....	331
Forcep, Bozeman, Sklar Blue™.....	202
Forcep, Bozeman, Surgi-OR™.....	322
Forcep, Bracken Iris.....	66
Forcep, Bridge Thoracic.....	87
Forcep, Brown Tissue.....	63
Forcep, Carmalt Splinter.....	72
Forcep, Carmalt Splinter, Merit™.....	330
Forcep, Caroll.....	191
Forcep, Castroviejo Corneal.....	69
Forcep, Castroviejo Suture.....	67
Forcep, Colibri Corneal.....	69, 151
Forcep, Coller.....	77
Forcep, Colver-Coakley.....	83
Forcep, Compression Bone.....	175
Forcep, Cooley Tissue.....	64
Forcep, Crile.....	76
Forcep, Crile, Econo-Sterile™.....	341
Forcep, Crile, Merit™.....	331
Forcep, Crile, Sklarlite XD™.....	57
Forcep, Crile, Sklarlite™.....	57
Forcep, Crile, Surgi-OR™.....	322-323
Forcep, Cushing.....	61-62
Forcep, Cushing, TC.....	55
Forcep, Dandy.....	78
Forcep, Debakey.....	63-64
Forcep, Debakey, TC.....	55
Forcep, Depilatory.....	64
Forcep, Desmarres Chalazion.....	154
Forcep, Douglass Cilia.....	71, 153, 315
Forcep, Doyen Intestinal.....	81-82
Forcep, Doyen Intestinal, Merit™.....	331
Forcep, Dressing.....	59
Forcep, Dressing, Econo-Sterile™.....	342
Forcep, Dressing, Eye.....	59, 152, 314



Forcep, Dressing, Merit™	330	Forcep, Hartmann Alligator	130	Forcep, Lucae	65, 133
Forcep, Dressing, Plastic	410	Forcep, Hartmann Alligator, Merit™	336	Forcep, Lucae, Merit™	337
Forcep, Dressing, Sklar Blue™	202	Forcep, Hartmann Lee Mosquito	76	Forcep, Lucae, Surgi-OR™	322
Forcep, Dressing, Sklarlite XD™	56	Forcep, Hartmann Mosquito	75, 151	Forcep, Magill Catheter, Merit™	332
Forcep, Dressing, Sklarlite™	56	Forcep, Hartmann Mosquito, Econo-Sterile™	341	Forcep, Magill Catheter, Surgi-OR™	323
Forcep, Dressing, Surgi-OR™	322	Forcep, Hartmann Mosquito, Merit™	331	Forcep, Manhattan Suture	68
Forcep, Dressing, TC	54	Forcep, Hartmann Mosquito, Sklarlite XD™	57, 148	Forcep, Martin Tissue	63
Forcep, Dunaway Dissecting, Surgi-OR™	323	Forcep, Hartmann Mosquito, Sklarlite™	57, 148	Forcep, Mayo-Robson	82
Forcep, Ear, Alligator	132, 140	Forcep, Hartmann Mosquito, Surgi-OR™	323	Forcep, McCullough Utility	67
Forcep, Ear, Bellucci	132	Forcep, Heaney	88	Forcep, McKenzie	268
Forcep, Ear, Duckbill	131	Forcep, Heaney Tissue	62	Forcep, McLean	196
Forcep, Ear, Goodhill	132	Forcep, Heaney-Ballentine	88, 195	Forcep, McPherson	70, 139, 315
Forcep, Ear, Greven	132	Forcep, Heath Chalazion	154	Forcep, McPherson Iris	67, 139
Forcep, Ear, Hoffman	131	Forcep, Hegebarth	267	Forcep, Michel Clip	267-268
Forcep, Ear, Littauer	131	Forcep, Hemostatic, Plastic	410	Forcep, Michel Clip, Merit™	330
Forcep, Ear, McGee	132	Forcep, Hoff Towel, Econo-Sterile™	343	Forcep, Micro Adson	60, 140
Forcep, Ear, Struempel	131	Forcep, Iris Botvin	69	Forcep, Micro Alligator, Merit™	337
Forcep, Ear, Weingartner	131	Forcep, Iris Dressing, Merit™	330	Forcep, Mikulicz	83
Forcep, Electrosurgical	212-213	Forcep, Iris Kirby	65	Forcep, Miller Groovelok	303
Forcep, Elschmig	66	Forcep, Iris Tissue, Merit™	330	Forcep, Mixer	79, 86
Forcep, Extracting	294-300	Forcep, Jacobs Vulsellum	83	Forcep, Mixer, Sklarlite XD™	58
Forcep, Extracting, Mead	294	Forcep, Jacobson Mosquito	75, 140, 151	Forcep, Mixer, Sklarlite™	58
Forcep, Farabeur-Lamotte Bone	174	Forcep, Jansen Nasal	65, 133	Forcep, Molar Extraction	313
Forcep, Feichenfeld Splinter	72	Forcep, Jansen Nasal, Merit™	330	Forcep, Mosquito	85
Forcep, Feichenfeld Splinter, Merit™	330	Forcep, Jansen Nasal, Surgi-OR™	322	Forcep, Moynihan Gall Duct	80
Forcep, Ferguson	78	Forcep, Jeweler	74, 139	Forcep, Museux Vulsellum	83
Forcep, Ferris Smith Tissue	64	Forcep, Jeweler's, Diamond Dust	55	Forcep, Nail Splitter, Merit™	337
Forcep, Ferris Smith Tissue, Merit™	330	Forcep, Johns Hopkins Gall Bladder	80	Forcep, Nail Splitter, Surgi-OR™	326
Forcep, Ferris Smith Tissue, Surgi-OR™	322	Forcep, Jones	77	Forcep, Nugent Utility	67
Forcep, Fine Point Splinter	72	Forcep, Jones, Merit™	331	Forcep, O'Brien	66
Forcep, Fine Point Splinter, Econo-Sterile™	343	Forcep, Kantrowitz	86	Forcep, Obstetrical	196
Forcep, Fletcher Sponge	84, 196	Forcep, Kelly	76, 84, 195	Forcep, O'Connor	65
Forcep, Foerster	68	Forcep, Kelly, Econo-Sterile™	341	Forcep, Packer Mosquito	75
Forcep, Foerster Sponge	84, 196	Forcep, Kelly, Merit™	332	Forcep, Pean Gastro-Intestinal	81, 195
Forcep, Foerster Sponge, Merit™	331	Forcep, Kelly, Sklarlite XD™	57	Forcep, Peet Splinter	73, 303
Forcep, Foerster Sponge, Surgi-OR™	323	Forcep, Kelly, Sklarlite™	57	Forcep, Phaneuf Uterine Artery	88
Forcep, Francis Chalazion	154	Forcep, Kelly, Surgi-OR™	323	Forcep, Pierser	68
Forcep, Garland	88	Forcep, Kern Bone	174	Forcep, Plain Splinter, Merit™	330
Forcep, Gerald Dressing	62	Forcep, Kern Bone, Merit™	337	Forcep, Plain Splinter, Surgi-OR™	322
Forcep, Gerald Tissue	62	Forcep, Kirby	65	Forcep, Platypus Nail, Merit™	330
Forcep, Gill Hess Iris	69	Forcep, Kocher	82	Forcep, Potts-Smith Dressing	61
Forcep, Gradle Cilia	72, 153, 315	Forcep, Lahey	77	Forcep, Potts-Smith Dressing, TC	54
Forcep, Graefe Fixation	70, 152	Forcep, Lahey Gall Duct	79	Forcep, Potts-Smith Tissue	61
Forcep, Graefe Iris	66, 151	Forcep, Lane Bone	174	Forcep, Potts-Smith, Sklar Blue™	202
Forcep, Graefe Tissue, Merit™	330	Forcep, Laparoscopic	220-225	Forcep, Prince Trachoma	154
Forcep, Gray Cystic Duct	80	Forcep, Laparoscopic, Disposable	242-243	Forcep, Providence	76
Forcep, Green	68	Forcep, Laparoscopic, Single Port	217	Forcep, Rankin	78
Forcep, Green Cystic Duct	80	Forcep, Lester	66	Forcep, Rankin Kelly, Merit™	332
Forcep, Halsted Mosquito	75, 303	Forcep, Lewin Bone	174	Forcep, Rankin Kelly, Surgi-OR™	323
Forcep, Halsted Mosquito, Econo-Sterile™	341	Forcep, Liston Bone	172, 318	Forcep, Rhoton	65, 140
Forcep, Halsted Mosquito, Merit™	331	Forcep, Liston Bone, Merit™	337	Forcep, Rochester-Carmalt	77
Forcep, Halsted Mosquito, Sklarlite XD™	57, 148	Forcep, Littauer Cilia	70, 153, 314	Forcep, Rochester-Carmalt, Merit™	332
Forcep, Halsted Mosquito, Sklarlite™	57, 148	Forcep, Littauer, Merit™	337	Forcep, Rochester-Ochsner	77
Forcep, Halsted Mosquito, Surgi-OR™	323	Forcep, Locke	191	Forcep, Rochester-Ochsner, Econo-Sterile™	341
Forcep, Harmon	70	Forcep, Long	88, 195	Forcep, Rochester-Ochsner, Merit™	332
Forcep, Harms	66, 152	Forcep, Lovelace	78	Forcep, Rochester-Ochsner, Sklarlite XD™	58
Forcep, Hartmann Herzfeld	130	Forcep, Lovelace Gall Bladder	81	Forcep, Rochester-Ochsner, Merit™	58
Forcep, Hartmann Ear	130	Forcep, Lower Gall Duct	80	Forcep, Rochester-Ochsner, Surgi-OR™	323



Forcep, Rochester-Pean	76	Forcep, Vessells Towel, Merit™	333	Gallstone Scoop, Ferguson	128
Forcep, Rochester-Pean, Econo-Sterile™	341	Forcep, Virtus Splinter	73	Gallstone Scoop, Mayo	128
Forcep, Rochester-Pean, Merit™	332	Forcep, Virtus Splinter, Merit™	331	Gardner Chisel	309
Forcep, Rochester-Pean, Sklarlite XD™	58	Forcep, Wachenfeldt	267	Garland Forcep	88
Forcep, Rochester-Pean, Sklarlite™	58	Forcep, Walter Splinter	73	Gastro-Intestinal Forcep, Pean	81, 195
Forcep, Rochester-Pean, Surgi-OR™	323-324	Forcep, Wangenstein Tissue	64	Gauge, Boley	283
Forcep, Rumel Thoracic	87	Forcep, Wertheim-Cullen Pedicle	88	Gauge, Pin & Wire	358
Forcep, Ruskin-Liston Bone	172	Forcep, Wilde	72, 133	Gauze Scissors, Army, Merit™	328
Forcep, Russian Tissue	63	Forcep, Wilde, Merit™	331	Gauze Sponge	346, 371
Forcep, Russian Tissue, Merit™	330	Forcep, Williams Splinter	73, 303	Gauze Sponge, X-Ray	371
Forcep, Russian Tissue, Surgi-OR™	322	Forcep, Wills Utility	67	Gelpi Retractor	113
Forcep, Sarot Thoracic	87	Forcep, Winter Placenta and Ovum	195	Gelpi Retractor, Merit™	334
Forcep, Sauer Suture	68	Forcep, Wireform Halsted, Econo-Sterile™	347	Gemini Clamp	85
Forcep, Sawtell Tonsil	83	Forcep, Wireform Kelly, Econo-Sterile™	347	General Surgery Set	348
Forcep, Scheizer, Surgi-OR™	324	Forcep, Wireform Sponge, Econo-Sterile™	347	General Tray	226, 367
Forcep, Schmidt Tonsil	83	Forcep, Wireform Thumb, Econo-Sterile™	347	Gerald Bayonet Bipolar Forcep, Electrosurgical	212
Forcep, Schmidt Tonsil, Merit™	332	Forcep, Wireform Tissue, Econo-Sterile™	347	Gerald Bipolar Forcep, Electrosurgical	212
Forcep, Schmidt Tonsil, Surgi-OR™	324	Forcep, Wireform Towel, Econo-Sterile™	347	Gerald Dressing Forcep	62
Forcep, Schroeder Tenaculum, Econo-Sterile™	343	Forcep, Wound Clip	268	Gerald Tissue Forcep	62
Forcep, Schroeder Tenaculum, Merit™	332	Forcep, Ziegler Cilia	71, 153, 315	Gerzog Mallet	179
Forcep, Schroeder Tenaculum, Sklar Blue™	201			Gigli Bone Saw Handles	172
Forcep, Schroeder Tenaculum, Surgi-OR™	324	Foreign Body Chisel, Davis	157	Gigli Bone Saw Wire	173
Forcep, Schweizer, Merit™	332	Foreign Body Gouge, Walton	158	Gill Hess Iris Forcep	69
Forcep, Scudder	82	Foreign Body Needle	157	Gill Knife	157
Forcep, Semkin Dressing	61	Foreign Body Spud, Dix	158	Gillies Hook	117
Forcep, Semkin Tissue	61	Foreign Body Spud, Francis	158	Gillies Needle Holder	99
Forcep, Semkin, Merit™	330	Fox Dermal Curette, Merit™	335	Gillies Needle Holder, TC	91
Forcep, Shallcross	80	Francis Chalazion Forcep	154	Glabella Rasp, Aufricht	122
Forcep, Singley	64	Francis Foreign Body Spud	158	Glassman Forcep, Laparoscopic	221
Forcep, Singley, Sklar Blue™	202	Frank Emasculator	198	Gloves, Latex	387
Forcep, Splinter	73	Frazier Ferguson Suction Tube	159	Gloves, Nitrile	387
Forcep, Splinter, Merit™	331	Frazier Suction Tube	159	Gloves, Vinyl	387
Forcep, Splinter, Surgi-OR™	322	Frazier Tissue Hook	117	Gluteraldehyde Strips	4, 246, 422
Forcep, Sponge, Econo-Sterile™	344	Freer Chisel	177	Goelet Retractor	105
Forcep, Sponge, Plastic	411	Freer Elevator	182, 304	Goldman-Fox Knife	281
Forcep, St. Vincent Occluding, Merit™	333	Freer Elevator, Merit™	336	Goldman-Fox Probe	283
Forcep, Sterilizer, Merit™	333	Freer Elevator, Surgi-OR™	326	Goldman-Fox Scaler	277
Forcep, Sterilizing	304	Freer Hook	118	Goldman-Fox Scissors	41
Forcep, Stevens Iris	65	Friedman Ronguer	171, 293	Goldman-Fox Scissors, Sklar Edge™ TC	21
Forcep, Stille-Luer Bone	172	Friedman Ronguer, Micro	142, 171	Goldman-Fox Scissors, Sklarcut™	29
Forcep, Stone Tissue	62	Funnel, Stainless Steel	391	Goldman-Fox Scissors, Sklarhone™	26
Forcep, Strabismus	70			Goldstein Retractor	111, 145
Forcep, Swiss Cilia	71, 153, 314			Goodhill Ear Forcep	132
Forcep, Thorpe Corneoscleral	74			Gorney Face Lift Scissors	42
Forcep, Tissue	59			Gorney Face Lift Scissors, Sklarcut™	31
Forcep, Tissue Eye	59, 152, 314			Gorney Plastic Surgery Scissors, Sklarcut™	30
Forcep, Tissue, Econo-Sterile™	342			Gorney Plastic Surgery Scissors, Sklarhone™	26
Forcep, Tissue, Merit™	331			Goslee Pliers	301
Forcep, Tissue, Sklarlite XD™	56			Gosset Retractor	114
Forcep, Tissue, Sklarlite™	56			Gouge, Alexander	178
Forcep, Tissue, Stille	60			Gouge, Army	178
Forcep, Tissue, Surgi-OR™	322			Gouge, Foreign Body, Walton	158
Forcep, Troutman Barraquer Corneal	69, 151			Gouge, Hibbs	178
Forcep, Tuttle	64			Gouge, Smith Peterson	178
Forcep, Tuttle, Sklar Blue™	202			Gown, Surgical	375
Forcep, Utility, Merit™	331			Gracey Curette	279
Forcep, Utility, Plastic	410			Gradle Cilia Forcep	72, 153, 315
Forcep, Verbrugge Bone	175			Gradle Scissors	46, 150, 265

G

Gag, Mouth	309-310
Gag, Mouth, Canine	310, 357
Gag, Mouth, Denhardt	310, 357
Gag, Mouth, Doyen Jansen	310, 357
Gag, Mouth, Feline	310, 357
Gag, Mouth, Jennings	310, 357
Gag, Mouth, Molt	309
Gag, Mouth, Wesson	310, 357
Gall Bladder Forcep, Johns Hopkins	80
Gall Bladder Forcep, Lovelace	81
Gall Duct Forcep, Lahey	79
Gall Duct Forcep, Lower	80
Gall Duct Forcep, Moynihan	80
Gallaher Rasp	122, 180



Gradle Scissors, Merit™.....	328	Halsted Mosquito Forcep, Surgi-OR™.....	323	Hoke Osteotome.....	176	
Gradle Scissors, Sklarcut™.....	30	Hammer, Babinski, Merit™.....	336	Hollenback Carver.....	287	
Gradle Scissors, Sklarhone™.....	26	Hammer, Buck.....	355	Hollenback Condenser.....	288	
Graduated Measure Cup, Plastic.....	407	Hammer, Buck, Merit™.....	336	Holster Disposable, Electrosurgical.....	211	
Graduated Measure Cup, Stainless Steel.....	389	Hammer, Rabiner, Merit™.....	336	Holzheimer Retractor.....	112	
Graduated Probe, Laparoscopic.....	234	Hammer, Taylor.....	355	Hoof Groover, Hughes.....	168	
Graefe Fixation Forcep.....	70, 152	Hammer, Taylor, Merit™.....	336	Hoof Knife.....	168	
Graefe Iris Forcep.....	66, 151	Hammer, Taylor, Surgi-OR™.....	326, 355	Hoof Pick.....	168	
Graefe Strabismus Hook.....	117	Handle, Akers/Evans.....	285	Hoof Tester.....	168	
Graefe Tissue Forcep, Merit™.....	330	Handle, Laparoscopic.....	227, 241	Hook and Spoon, Gross.....	120, 135	
Graham Hook.....	120	Handle, Laryngoscope, MacIntosh.....	163	Hook Retractor, Volkman.....	119, 187	
Grasping Forcep, Laparoscopic.....	223-225	Handle, Laryngoscope, Miller.....	163	Hook Scissors, Enterotomy.....	43, 317	
Grasping Forcep, Laparoscopic, Disposable.....	242	Handle, Scalpel.....	351, 353	Hook Scissors, Laparoscopic.....	219	
Graves Vaginal Speculum.....	194, 356	Handle, Scalpel, Merit™.....	337	Hook Scissors, Laparoscopic, Disposable.....	242	
Graves Vaginal Speculum, Econo-Sterile™.....	346	Handle, Scalpel, Surgi-OR™.....	326	Hook, Joseph, Surgi-OR™.....	325	
Graves Vaginal Speculum, Merit™.....	334	Handle, Sterilization Tray, Stainless Steel.....	397	Hook, Adson.....	119	
Graves Vaginal Speculum, Sklar Blue™.....	201	Handles, Lifting, Stainless Steel.....	397	Hook, Adson Dura.....	119	
Graves Vaginal Speculum, Surgi-OR™.....	325	Hardy Bayonet Bipolar Forcep, Electrosurgical.....	212	Hook, Cottle Double.....	118	
Gray Cystic Duct Forcep.....	80	Harmon Forcep.....	70	Hook, Covault.....	198	
Green Cystic Duct Forcep.....	80	Harms Forcep.....	66, 152	Hook, Cushing Dura.....	118	
Green Forcep.....	68	Harrington-Mayo Scissors.....	36	Hook, Dandy Nerve.....	120	
Greven Ear Forcep.....	132	Hartman Ronguer.....	170	Hook, Day.....	119, 135	
Gritman Wax Spatula.....	292	Hartmann Alligator Forcep.....	130	Hook, Emmett Set, Sklar Blue™.....	203	
Grooming Shears.....	164-165	Hartmann Alligator Forcep, Merit™.....	336	Hook, Emmett, Sklar Blue™.....	203	
Grooved Director, Merit™.....	336	Hartmann Ear Forcep.....	130	Hook, Frazier Tissue.....	117	
Groover, Hoof, Hughes.....	168	Hartmann Herzfeld Forcep.....	130	Hook, Freer.....	118	
Gross Hook and Spoon.....	120, 135	Hartmann Lee Mosquito Forcep.....	76	Hook, Gillies.....	117	
Grounding Pad Disposable, Electrosurgical.....	210	Hartmann Mosquito Forcep.....	75, 151	Hook, Graefe Strabismus.....	117	
Gruber Speculum, Merit™.....	336	Hartmann Mosquito Forcep, Econo-Sterile™.....	341	Hook, Graham.....	120	
Guard, Osteotome.....	413	Hartmann Mosquito Forcep, Merit™.....	331	Hook, Guthrie Double.....	118	
Guard, TipGrips™ Instrument Guard.....	413	Hartmann Mosquito Forcep, Sklarlite XD™.....	57, 148	Hook, House.....	135	
Guenthers Knife.....	197	Hartmann Mosquito Forcep, Sklarlite™.....	57, 148	Hook, Iris Set, Sklar Blue™.....	203	
Guide, Bone Wire.....	190	Hartmann Mosquito Forcep, Surgi-OR™.....	323	Hook, Iris, Sklar Blue™.....	203	
Guide, Catheter.....	127	Hartmann Punch.....	131	Hook, Joseph.....	118	
Guide, Catheter, Benique.....	127	Hays Retractor.....	108, 187	Hook, Joseph, Merit™.....	334	
Guide, Catheter, Guyon.....	127	Head Support.....	313	Hook, Krey.....	197	
Guide, Demel Bone Wire.....	267	Heaney Forcep.....	88	Hook, Meyerding.....	107, 120	
Guidewire Bowl, Plastic.....	408	Heaney Needle Holder.....	100	Hook, News.....	120	
Gut Chromic Suture, Absorbable.....	270	Heaney Needle Holder, TC.....	92	Hook, Ostertags.....	197	
Guthrie Double Hook.....	118	Heaney Tissue Forcep.....	62	Hook, Rosser Crypt.....	119	
Guyon Catheter Guide.....	127	Heaney-Ballentine Forcep.....	88, 195	Hook, Ruggebergs.....	197	
			Heath Chalazion Forcep.....	154	Hook, Skin.....	117
			Heath Scissors.....	43, 265	Hook, Sklar.....	117, 187
			Hegar Uterine Dilator, Merit™.....	334	Hook, Smille Meniscus.....	108, 187
			Hegenbarth Forcep.....	267	Hook, Smithwick.....	120
			Hemostatic Forcep, Plastic.....	410	Hook, Snook.....	198
			Hercules Utility Scissors.....	51	Hook, Snook, Merit™.....	334
			Hibbs Chisel.....	177	Hook, Tyrell Iris.....	117
			Hibbs Gouge.....	178	Hook, Tyrell, Merit™.....	334
			Hibbs Osteotome.....	176	Hook, Volkman.....	119, 187
			Hibbs Retractor.....	106	Hook, Wiener Corneal.....	119
			Hi-Level Bandage Scissors.....	52	Hospital Bucket, Stainless Steel.....	390
			Hi-Level Bandage Scissors, Sklarhone™.....	27	Hospital Kick Bucket, Stainless Steel.....	390
			Hoff Towel Clamp.....	84	House Hook.....	135
			Hoff Towel Clamp, Plastic.....	411	Hughes Hoof Groover.....	168
			Hoff Towel Forcep, Econo-Sterile™.....	343	Hugs Teat Knife.....	192
			Hoffmann Ear Forcep.....	131	Hurwitz Trocar.....	129
			Hohmann Elevator.....	108, 186	HX-Line, Disposable Laparoscopic.....	241-242
Halsey Needle Holder.....	97					
Halsey Needle Holder, Econo-Sterile™.....	345					
Halsey Needle Holder, Merit™.....	333					
Halsey Needle Holder, Sklarlite XD™.....	95					
Halsey Needle Holder, Sklarlite™.....	95					
Halsey Needle Holder, Surgi-OR™.....	325					
Halsey Needle Holder, Surgi-OR™ TC.....	324					
Halsey Needle Holder, TC.....	90					
Halsted Forcep, Wireform Econo-Sterile™.....	347					
Halsted Mosquito Forcep.....	75, 303					
Halsted Mosquito Forcep, Econo-Sterile™.....	341					
Halsted Mosquito Forcep, Merit™.....	331					
Halsted Mosquito Forcep, Sklarlite XD™.....	57, 148					
Halsted Mosquito Forcep, Sklarlite™.....	57, 148					

H



I

ID Roll Tape, Sklar.....	414
ID Sheet Tape.....	414
ID Tags, Instrument.....	414
Incision & Drainage Tray.....	368
Incisor Luxator.....	313
Infant Stethoscope.....	362
Inge Retractor.....	187
Instrument Care Kit, Sklar.....	16, 258, 434
Instrument Cassette.....	404,406
Instrument Drying Tray, Stainless Steel.....	394
Instrument Guard Guard, TipGrips™.....	413
Instrument Holder Set.....	406
Instrument ID Tags.....	414
Instrument Polish, Sklar.....	15, 257, 433
Instrument Protectors, SklarTip™.....	413
Instrument Rack, Stainless Steel.....	399
Instrument Soaking Tray, Plastic.....	409
Instrument Spot Remover Pad.....	418
Instrument Stringer, Stainless Steel.....	398-399
Instrument Tray Cover, Stainless Steel.....	395-396
Instrument Tray, Stainless Steel.....	393-397
Instrument, Cleaning Brush.....	415-417
Intestinal Forcep, Doyen.....	81
Intestinal Forcep, Doyen, Merit™.....	331
Iodine Cup, Stainless Steel.....	388
Iris Botvin Forcep.....	69
Iris Dressing Forcep, Merit™.....	330
Iris Hook Set, Sklar Blue™.....	203
Iris Hook, Sklar Blue™.....	203
Iris Kirby Forcep.....	65
Iris Micro Mini Scissors.....	50, 137
Iris Scissors.....	40, 45-46, 150
Iris Scissors, Econo-Sterile™.....	339
Iris Scissors, Merit™.....	328
Iris Scissors, Sklar Edge™ TC.....	20
Iris Scissors, Sklarcut™.....	28
Iris Scissors, Sklarhone™.....	24
Iris Scissors, Sklarhone™ TC.....	23
Iris Scissors, Sklarlite XD™.....	33, 147
Iris Scissors, Sklarlite™.....	33, 147
Iris Scissors, Sklarlite™ Sklarcut™.....	28
Iris Scissors, Surgi-OR™.....	320
Iris Scissors, Surgi-OR™ TC.....	320
Iris Tissue Forcep, Merit™.....	330
Israel Retractor.....	104, 186

J

Jackson Laryngectomy Tube.....	162
Jackson Tracheotomy Tube.....	161-162
Jackson Tracheotomy Tube Set.....	161
Jacobs Vulsellum Forcep.....	83
Jacobson Mosquito Forcep.....	75, 140, 151
Jacobson Needle Holder, TC Micro.....	94, 141
Jacobson Scissors.....	49, 138

Jaeger Retractor.....	158
Jameson Scissors, Sklarhone™.....	27
Jansen Bayonet Bipolar Forcep, Electrosurgical... 213	
Jansen Nasal Forcep.....	65, 133
Jansen Nasal Forcep, Merit™.....	330
Jansen Nasal Forcep, Surgi-OR™.....	322
Jansen Retractor.....	112
Jaquette Scaler.....	276-277
Jar, Dressing, Stainless Steel.....	391
Jar, Forcep, Stainless Steel.....	391, 418
Jar, Ointment, Stainless Steel.....	392
Jennings Mouth Gag.....	310, 357
Jeweler Bipolar Forcep, Electrosurgical.....	213
Jeweler Forcep.....	74, 139
Jeweler's Forcep, Diamond Dust.....	55
Johns Hopkins Bulldog Clamp.....	87
Johns Hopkins Gall Bladder Forcep.....	80
Jones Clamp.....	85
Jones Forcep.....	77
Jones Forcep, Merit™.....	331
Jones Towel Clamp, Merit™.....	333
Jorgenson Scissors.....	40
Joseph Hook.....	118
Joseph Hook, Merit™.....	334
Joseph Hook, Surgi-OR™.....	325
Joseph Periosteal Elevator.....	182
Joseph Rasp.....	122
Julian Needle Holder, TC.....	92

K

Kahn Scissors.....	39
Kantrowitz Forcep.....	86
Kaye Dissecting Scissors, Sklar Edge™ TC.....	21
Kaye Face Lift Scissors, Sklarcut™.....	31
Keith Abdominal Needle.....	261
Kelly Forcep.....	76, 84, 195
Kelly Forcep, Econo-Sterile™.....	341
Kelly Forcep, Laparoscopic.....	221
Kelly Forcep, Merit™.....	332
Kelly Forcep, Sklarlite XD™.....	57
Kelly Forcep, Sklarlite™.....	57
Kelly Forcep, Surgi-OR™.....	323
Kelly Forcep, Wireform Econo-Sterile™.....	347
Kelly-Adson Scissors.....	38-39
Kern Bone Forcep.....	174
Kern Bone Forcep, Merit™.....	337
Kerrison Ronguer.....	171
Key Elevator.....	184
Keyes Cutaneous Punch, Merit™.....	335
Khaki Roll, Sound Set.....	128
Killian Speculum.....	356
Kirby Forcep.....	65
Kirkland Knife.....	282
Kirschner Wire.....	190
Kit, Sklar Instrument Care.....	16, 258, 434
Kit, Splinter Removal.....	74
Kleinert-Kutz Ronguer.....	169

Kleinert-Kutz Scissors.....	48
Knapp Iris Scissors.....	46
Knapp Speculum, Eye.....	109, 143
Knapp Speculum, Merit™.....	336
Knife Curette, Rosen.....	134
Knife, Akers.....	285
Knife, Buck.....	282
Knife, Danish Teat.....	192
Knife, Downing.....	191
Knife, Evans.....	285
Knife, Gill.....	157
Knife, Goldman-Fox.....	281
Knife, Guenthers.....	197
Knife, Hoof.....	168
Knife, Hugs Teat.....	192
Knife, Kirkland.....	282
Knife, Lichty Teat.....	192
Knife, Lindes.....	197
Knife, Lowe-Breck.....	190
Knife, Orban.....	282
Knife, Smillie.....	190
Knife, Tooke.....	157
Knife, Virchow.....	318
Knowles Bandage Scissors.....	52
Knowles Bandage Scissors, Econo-Sterile™.....	340
Knowles Bandage Scissors, Merit™.....	328
Knowles Bandage Scissors, Surgi-OR™.....	320
Kocher Forcep.....	82
Kocher Forcep, Laparoscopic.....	221
Kogan Endocervical Speculum, Sklar Blue™.....	200
Krey Hook.....	197

L

Lab/Utility Scoop, Stainless Steel.....	391
Laceration Tray.....	366
Lachrymal Probe, Bowman.....	126
Lachrymal Probe, Williams.....	126
Ladmores Filling Instrument.....	289
Lagrange Scissors.....	42
Lahey Forcep.....	77
Lahey Gall Duct Forcep.....	79
Lambert-Lowman Bone Clamp.....	175
Lamotte Osteotome.....	176
Lamotte Osteotome Set.....	176
Lamp, Laryngoscope, MacIntosh.....	163
Lancaster Speculum, Eye.....	109, 143
Lane Bone Forcep.....	174
Lane Cleft Palate Needle.....	262
Langenbeck Bone Saw.....	173
Langenbeck Elevator.....	183
Langenbeck Retractor.....	107

LAPAROSCOPIC

Laparoscopic Biopsy Punch.....	226
Laparoscopic Cannula.....	227
Laparoscopic Clip.....	238



Laparoscopic Clip Appliers.....	239-240	Lichty Teat Knife.....	192	Luer Ronguer.....	170
Laparoscopic Collar.....	227	Lifting Handles, Stainless Steel.....	397	M	
Laparoscopic Electrode.....	230	Ligation Clip.....	238	M.G.H. Needle Holder.....	99
Laparoscopic Electrode, Miniature.....	233	Ligation Clip Appliers.....	239-240	Machine, Anesthesia.....	436
Laparoscopic Electrosurgical Cable.....	230, 233	Ligature Carrier, Dupuys-Weiss.....	267	MacIntosh Laryngoscope Blade.....	163
Laparoscopic Endoscope, Miniature.....	233	Light, Maxx Luzz II.....	437	MacIntosh Laryngoscope Handle.....	163
Laparoscopic Forcep.....	220-225	Light, Vision Excel.....	437	MacIntosh Laryngoscope Lamp.....	163
Laparoscopic Forcep, Disposable.....	242-243	Light, Vision LED.....	437	Magill Catheter Forcep, Merit™.....	332
Laparoscopic Forcep, Miniature.....	232	Light, Vista.....	437	Magill Catheter Forcep, Surgi-OR™.....	323
Laparoscopic Forcep, Single Port.....	217	Light, Vortex.....	437	Malis Bipolar Forcep, Electrosurgical.....	213
Laparoscopic Handle.....	227, 241	Lilly Scissors.....	42	Mallet.....	179
Laparoscopic Needle.....	234	Lindes Knife.....	197	Mallet Ends.....	179
Laparoscopic Needle Holder.....	222	Linen Bag, Disposable.....	383	Mallet Ends, Sklar.....	179
Laparoscopic Needle Holder, Miniature, TC.....	232	Liner, Can, Disposable.....	383	Mallet, Bone.....	318
Laparoscopic Needle Holder, Single Port.....	216	Liquid Detergent, Sklar Kleen™.....	11, 253, 429	Mallet, Gerzog.....	179
Laparoscopic Needle Holder, TC.....	237	Lister Bandage Scissors.....	51	Mallet, Lucae.....	179
Laparoscopic Oblurator.....	228-229	Lister Bandage Scissors, Econo-Sterile™.....	340	Mallet, Sklar.....	179
Laparoscopic Oblurator, Miniature.....	233	Lister Bandage Scissors, Merit™.....	328	Maltz Rasp.....	122
Laparoscopic Punch.....	226	Lister Bandage Scissors, Sklarhone™.....	27	Maltz Rasp, TC.....	121
Laparoscopic Punch, Miniature.....	232	Lister Bandage Scissors, Sklarlite XD™.....	34	Mandibular Awl, Obwegeser.....	267
Laparoscopic Reducer.....	229	Lister Bandage Scissors, Sklarlite™.....	34	Manhattan Suture Forcep.....	68
Laparoscopic Retractor Esophagus.....	235	Lister Bandage Scissors, Surgi-OR™.....	320	Mare Tray.....	370
Laparoscopic Retractor Fan.....	235	Liston Bone Forcep.....	172, 318	Marker, Skin, Disposable.....	344, 377
Laparoscopic Retractor Graduated.....	234	Liston Bone Forcep, Merit™.....	337	Martin Clamp.....	191
Laparoscopic Scissors.....	218-219	LiteGrip™ Adson Dressing Forcep.....	61	Martin Scissors.....	43, 191
Laparoscopic Scissors, Disposable.....	242-243	Littauer Cilia Forcep.....	70, 153, 314	Martin Tissue Forcep.....	63
Laparoscopic Scissors, Miniature.....	231	Littauer Ear Forcep.....	131	Martini Bone Curette.....	185
Laparoscopic Scissors, Single Port.....	217	Littauer Forcep, Merit™.....	337	Martin's Uterine Needle.....	261
Laparoscopic S-Retractor.....	229	Littauer Stitch Scissors.....	44, 149, 264	Maryland Dissector, Laparoscopic.....	220
Laparoscopic Suction Irrigation System.....	236	Littauer Stitch Scissors, Econo-Sterile™.....	340	Maryland Dissector, Laparoscopic, Disposable.....	242-243
Laparoscopic Trocar.....	228-229	Littauer Stitch Scissors, Merit™.....	329	Maryland Dissector, Laparoscopic, Single Port.....	217
Laparoscopic Trocar, Miniature.....	233	Littauer Stitch Scissors, Plastic.....	410	Mask, Procedure.....	375
Laparoscopic Trocar, Miniature, Set.....	233	Littauer Stitch Scissors, Surgi-OR™.....	321	Mastoid Searcher, Allport.....	120
Laparoscopic Trocar, Disposable.....	244	Little Retractor.....	107-108	Mat, Silicon, SklarLite™.....	401-403
Laparoscopic Trocar, Single Port.....	216	Littler Suture Scissors.....	265	Mathieu Needle Holder.....	100
Laparoscopic Valve.....	229	Lietz Electrode Disposable, Electrosurgical.....	207	Mathieu Needle Holder, Merit™.....	333
Laparoscopic, Single Port.....	216-217	Locke Forcep.....	191	Mathieu Needle Holder, TC.....	94
Laparoscopic, Single Port, Suction Irrigation.....	216	Long Forcep.....	88, 195	Mathieu Retractor.....	104
Larry Rectal Probe.....	125	Long Stitch Scissors.....	44, 264	Matrix Band.....	311
Laryngeal Mirror.....	273	Loop Electrode Disposable, Electrosurgical.....	206	Maumenee Park Eye Speculum.....	109, 143
Laryngectomy Tube, Jackson.....	162	Loop, Billeau.....	134	Maxi, Laparoscopic, Single Port.....	217
Laryngoscope Blade, MacIntosh.....	163	Lorna Edna Towel Clamp.....	85	Maxx Luzz II Light.....	437
Laryngoscope Blade, Miller.....	163	Lorna Edna Towel Clamp, Econo-Sterile™.....	343	Mayo Cat Gut Needle.....	261
Laryngoscope Handle, MacIntosh.....	163	Lorna Edna Towel Clamp, Merit™.....	333	Mayo Intestinal Needle.....	260
Laryngoscope Handle, Miller.....	163	Lorna Edna Towel Clamp, Surgi-OR™.....	324	Mayo Scissors.....	36
Laryngoscope Lamp, MacIntosh.....	163	Lovelace Forcep.....	78	Mayo Scissors, Econo-Sterile™.....	339
Laryngoscope Set, Disposable.....	163	Lovelace Gall Bladder Forcep.....	81	Mayo Scissors, Merit™.....	328
Lateral Vaginal Retractor, Sklar Blue™.....	201	Low Foam Detergent, Sklar Kleen™.....	11, 253, 429	Mayo Scissors, Sklar Edge™ TC.....	20
Latex Gloves.....	387	Lowe-Breck Knife.....	190	Mayo Scissors, Sklarcut™.....	28
Le Cron Carver.....	287	Lower Gall Duct Forcep.....	80	Mayo Scissors, Sklarhone™.....	24
Leksell Ronguer.....	169	Lowman Bone Clamp.....	175	Mayo Scissors, Sklarhone™ TC.....	23
Lempert Ronguer.....	170	Lowman-Hoglund Bone Clamp.....	175	Mayo Scissors, Sklarlite XD™.....	32
Lester Forcep.....	66	Lube, Sklar Instru-Guard™.....	10, 49, 252, 428	Mayo Scissors, Sklarlite™.....	32
Lewin Bone Forcep.....	174	Lucae Forcep.....	65, 133	Mayo Scissors, Sklarlite™ Sklarcut™.....	29
Lewis Rasp.....	122	Lucae Forcep, Merit™.....	337	Mayo Scissors, Surgi-OR™.....	320-321
L-Hook, Laparoscopic, Single Port.....	217	Lucae Forcep, Surgi-OR™.....	322		
Liberator, Splinter, Merit™.....	335	Lucas Mallet.....	179		
		Lucas Curette.....	279		



Mayo Scissors, Surgi-OR™ TC.....	320	Merit Baumgartner Needle Holder.....	333	Merit Littauer Stitch Scissors.....	329
Mayo Scoop.....	128	Merit Bergh Cilia Forcep.....	330	Merit Lorna Edna Towel Clamp.....	333
Mayo Tray, Stainless Steel.....	393	Merit Bishop-Harmon Forcep.....	330	Merit Lucae Forcep.....	337
Mayo-Hegar Needle Holder.....	98	Merit Bozeman Forcep.....	331	Merit Magill Catheter Forcep.....	332
Mayo-Hegar Needle Holder, Econo-Sterile™.....	345	Merit Braun Epistomy Scissors.....	328	Merit Mathieu Needle Holder.....	333
Mayo-Hegar Needle Holder, Merit™.....	333	Merit Brown Needle Holder.....	333	Merit Mayo Scissors.....	328
Mayo-Hegar Needle Holder, Sklarlite XD™.....	96	Merit Buck Curette.....	336	Merit Mayo-Hegar Needle Holder.....	333
Mayo-Hegar Needle Holder, Sklarlite™.....	96	Merit Buck Hammer.....	336	Merit Metzenbaum Scissors.....	328
Mayo-Hegar Needle Holder, Surgi-OR™.....	325	Merit Carmalt Splinter Forcep.....	330	Merit Michel Clip Forcep.....	330
Mayo-Hegar Needle Holder, Surgi-OR™ TC.....	324	Merit Cast Spreader.....	334	Merit Micro Alligator Forcep.....	337
Mayo-Hegar Needle Holder, TC.....	91	Merit Collier Needle Holder.....	333	Merit Nail Nipper.....	337
Mayo-Hegar Needle Holder, TC, Left.....	93	Merit Comedone Extractor.....	335	Merit Nail Splitter Forcep.....	337
Mayo-Noble Scissors.....	36	Merit Crile Forcep.....	331	Merit Nail Splitting Scissors.....	328
Mayo-Noble-Stille Scissors.....	36	Merit Crile-Wood Needle Holder.....	333	Merit Olsen-Hegar Needle Holder.....	333
Mayo-Robson Forcep.....	82	Merit Curette Excavator.....	335	Merit Operating Scissors.....	329
Mayo-Stille Scissors.....	37	Merit Cushing Retractor.....	334	Merit Pederson Vaginal Speculum.....	334
Mayo-Stille Scissors, Sklar Edge™ TC.....	20	Merit Cuticle Nail Scissors.....	328	Merit Peers Towel Clamp.....	333
Mayo-Stille Scissors, Sklarhone™ TC.....	23	Merit Dental Probe.....	336	Merit Plain Splinter Forcep.....	330
McCalls Curette.....	280	Merit Derf Needle Holder.....	333	Merit Plaster Spreader.....	334
McClure Iris Scissors.....	49, 138	Merit Doyen Intestinal Forcep.....	331	Merit Platypus Nail Forcep.....	330
McCrea Sound.....	128	Merit Dressing Forcep.....	330	Merit Presbyterian Tube Occluding Clamp.....	333
McCullough Utility Forcep.....	67	Merit Ear Syringe.....	336	Merit Probe.....	336
McGannon Iris Retractor.....	104	Merit Ear Syringe Shield.....	336	Merit Probe & Excavator.....	335
McGee Ear Forcep.....	132	Merit Ear Syringe Tip.....	336	Merit Rabiner Hammer.....	336
McGuire Corneal Scissors.....	47	Merit EKG Caliper.....	336	Merit Rankin Kelly Forcep.....	332
McKenty Septum Elevator.....	182	Merit Esmarch Plaster Shears.....	328	Merit Ring Cutter.....	335
McKenzie Clip.....	268	Merit Feilchenfeld Splinter Forcep.....	330	Merit Ring Cutter Blade.....	335
McKenzie Clip Rack.....	268	Merit Ferris Smith Tissue Forcep.....	330	Merit Rochester-Carmalt Forcep.....	332
McKenzie Forcep.....	268	Merit First Aid Shears.....	328	Merit Rochester-Pean Forcep.....	332
McLean Forcep.....	196	Merit Foerster Sponge Forcep.....	331	Merit Russian Tissue Forcep.....	330
McPherson Bipolar Forcep, Electrosurgical.....	213	Merit Fox Dermal Curette.....	335	Merit Scalpel Handle.....	337
McPherson Forcep.....	70, 139, 315	Merit Freer Elevator.....	336	Merit Schnidt Tonsil Forcep.....	332
McPherson Iris Forcep.....	67, 139	Merit Gelpi Retractor.....	334	Merit Schroeder Tenaculum Forcep.....	332
McPherson Needle Holder.....	102, 155	Merit Gradle Scissors.....	328	Merit Schweizer Forcep.....	332
McPherson Vannas Scissors.....	50, 137	Merit Graefe Tissue Forcep.....	330	Merit Semkin Forcep.....	330
Mead Extracting Forcep.....	294	Merit Graves Vaginal Speculum.....	334	Merit Senn Retractor.....	334
Mead Ronguer.....	170	Merit Grooved Director.....	336	Merit Shamberg Comedone Extractor.....	335
Measure, Tape.....	358	Merit Gruber Speculum.....	336	Merit Simpson Sound.....	334
Medicine Cup, Plastic.....	407	Merit Halsey Needle Holder.....	333	Merit Sims Uterine Sound.....	334
Medicine Cup, Stainless Steel.....	388	Merit Halsted Mosquito Forcep.....	331	Merit Snook Hook.....	334
Meller Retractor.....	111, 145	Merit Hartmann Alligator Forcep.....	336	Merit Spatula & Packer.....	335
Mellinger Eye Speculum.....	110, 144, 156	Merit Hartmann Mosquito Forcep.....	331	Merit Spencer Stitch Scissors.....	329
Meriam Pliers.....	274	Merit Hegar Uterine Dilator.....	334	Merit Splinter Forcep.....	331
		Merit Iris Dressing Forcep.....	330	Merit Splinter Liberator.....	335
		Merit Iris Scissors.....	328	Merit Splinter Removal Kit.....	335
		Merit Iris Tissue Forcep.....	330	Merit St. Vincent Tube Occluding Forcep.....	333
		Merit Jansen Nasal Forcep.....	330	Merit Sterilizer Forcep.....	333
		Merit Jones Forcep.....	331	Merit Stevens Scissors.....	329
		Merit Jones Towel Clamp.....	333	Merit Strabismus Scissors.....	329
		Merit Joseph Hook.....	334	Merit Suture Scissors.....	329
		Merit Kelly Forcep.....	332	Merit Taylor Hammer.....	336
		Merit Kern Bone Forcep.....	337	Merit Tissue Forcep.....	331
		Merit Keyes Cutaneous Punch.....	335	Merit Tissue Nipper.....	337
		Merit Knapp Speculum.....	336	Merit Tyrell Hook.....	334
		Merit Knowles Bandage Scissors.....	328	Merit Umbilical Scissors.....	329
		Merit Lister Bandage Scissors.....	328	Merit Unna Comedone.....	335
		Merit Liston Bone Forcep.....	337	Merit Utility Forcep.....	331
		Merit Littauer Forcep.....	337	Merit Utility Scissors.....	329

MERIT™

Merit Abbey Needle Holder.....	333
Merit Adson Bayonet Forcep.....	330
Merit Adson Dressing Forcep.....	330
Merit Adson Tissue Forcep.....	330
Merit Adson-Brown Tissue Forcep.....	330
Merit Allis Tissue Forcep.....	331
Merit Alm Retractor.....	334
Merit Army Gauze Scissors.....	328
Merit Army Retractor.....	334
Merit Babcock Forcep.....	331
Merit Babinski Hammer.....	336
Merit Backhaus Towel Forcep.....	333



Merit Vessells Towel Forcep	333
Merit Vienna Speculum	337
Merit Virtus Splinter Forcep	331
Merit Vorse Tubing Clamp	333
Merit Wartenberg Pinwheel	336
Merit Webster Needle Holder	333
Merit Weitlaner Retractor	334
Merit Wilde Forcep	331
Merit Wire Cutting Scissors	329
Metzenbaum Needle Holder	99
Metzenbaum Scissors	37
Metzenbaum Scissors, Econo-Sterile™	339
Metzenbaum Scissors, Laparoscopic	218
Metzenbaum Scissors, Laparoscopic, Disposable	242-243
Metzenbaum Scissors, Laparoscopic, Single Port	217
Metzenbaum Scissors, Merit™	328
Metzenbaum Scissors, Sklar Edge™ TC	20-21
Metzenbaum Scissors, Sklarcut™	29
Metzenbaum Scissors, Sklarhone™	25
Metzenbaum Scissors, Sklarhone™ Sklarlite™	25
Metzenbaum Scissors, Sklarhone™ TC	23
Metzenbaum Scissors, Sklarlite XD™	32-33
Metzenbaum Scissors, Sklarlite™	32-33
Metzenbaum Scissors, Sklarlite™ Sklarcut™	29
Metzenbaum Scissors, Surgi-OR™	321
Metzenbaum Scissors, Surgi-OR™ TC	320
Meyerdling Hook	107, 120
Meyerdling Retractor	103, 107, 113
Michel Clip	268
Michel Clip Forcep	267-268
Michel Clip Forcep, Merit™	330
Micro Adson Forcep	60, 140
Micro Alligator Forcep, Merit™	337
Micro Bellucci Scissors	51, 130, 138
Micro Friedman Ronguer	142, 171
Micro Scissors, Laparoscopic	219
Micro Scissors, Vannas	50, 138
Micro Set	350
Micro Sterilization Tray Cover, Stainless Steel	397
Micro Sterilization Tray, Stainless Steel	397
Micro Surgery Needle Holder	101, 142, 155
Micro Surgery Scissors	49, 136
Micro Vannas Scissors	50, 138
Micro-Mini Scissors, Iris	50, 137
Mikulicz Forcep	83
Miller Bone File	123-124, 181, 308
Miller Groovelok Forcep	303
Miller Laryngoscope Blade	163
Miller Laryngoscope Handle	163
Miller Scissors	43
Mini Thumb Scalpel	353
Miniature Electrode, Laparoscopic	233
Miniature Endoscope, Laparoscopic	233
Miniature Instrument Tray, Stainless Steel	392
Miniature Needle Holder, Laparoscopic TC	232

Miniature Obturator, Laparoscopic	233
Miniature Punch, Laparoscopic	232
Miniature Scissors, Laparoscopic	231
Miniature Trocar Set, Laparoscopic	233
Miniature Trocar, Laparoscopic	233
Mirror Handle, Mouth	273
Mirror, Dental	273
Mirror, Dental, Disposable	385
Mirror, Laryngeal	273
Mirror, Mouth	273
Mixing/Solution Bowl, Stainless Steel	389
Mixer Forcep	79, 86
Mixer Forcep, Laparoscopic	220
Mixer Forcep, Laparoscopic, Disposable	242
Mixer Forcep, Sklarlite XD™	58
Mixer Forcep, Sklarlite™	58
Mixer Scissors	36
Molar Cutters	313
Molar Extraction Forcep	313
Molar Luxator	313
Molar Rasp	312
Molar Rasp, Diamond	312
Moleskin Scissors	43
Molt Curette	281
Molt Elevator	304
Molt Mouth Gag	309
Monitor, Waveline EZ	440
Monitor, Waveline Provet	440
Monitor, Waveline Touchvet	440
Mosquito Forcep	85
Mosquito Forcep, Halsted, Econo-Sterile™	341
Mosquito Forcep, Halsted, Merit™	331
Mosquito Forcep, Halsted, Sklarlite XD™	57, 148
Mosquito Forcep, Halsted, Sklarlite™	57, 148
Mosquito Forcep, Halsted, Surgi-OR™	323
Mosquito Forcep, Hartmann, Econo-Sterile™	341
Mosquito Forcep, Hartmann, Merit™	331
Mosquito Forcep, Hartmann, Sklarlite XD™	57, 148
Mosquito Forcep, Hartmann, Sklarlite™	57, 148
Mosquito Forcep, Hartmann, Surgi-OR™	323
Mosquito Forcep, Jacobson	75, 140, 151
Mosquito Forcep, Packer	75
Mouth Gag	309-310
Mouth Gag, Canine	310, 357
Mouth Gag, Denhardt	310, 357
Mouth Gag, Doyen Jansen	310, 357
Mouth Gag, Doyen Jansen Cushion	310
Mouth Gag, Feline	310, 357
Mouth Gag, Jennings	310, 357
Mouth Gag, Molt	309
Mouth Gag, Wesson	310, 357
Mouth Mirror	273
Mouth Mirror Handle	273
Moynihan Gall Duct Forcep	80
Multi-Purpose Utility Bowl, Plastic	407
Murdoch Eye Speculum	109, 144, 156
Murphy's Intestinal Needle	261
Museux Vulsellum Forcep	83

Mycotic Nail Nipper	167
---------------------------	-----

N

N-1 Tourniquet	357, 372
N-1 Tourniquet Clip	357, 372
N-1 Tourniquet Tubing	357, 372
Nail Clippers, White	167
Nail Forcep, Platypus, Merit™	330
Nail Nipper	166-167
Nail Nipper, Merit™	337
Nail Nipper, Mycotic	167
Nail Nipper, Surgi-OR™	326
Nail Scissors, Cuticle, Merit™	328
Nail Scissors, Sklar	52
Nail Splitter	167
Nail Splitter Forcep, Surgi-OR™	326
Nail Splitter Forcep, Merit™	337
Nail Splitting Scissors	52
Nail Splitting Scissors, Merit™	328
Nail Trimmer	167
Nail Trimmer, Bird	168
Nail/Bone File	124, 181, 308-309
Nasal Forcep, Jansen	65, 133
Nasal Forcep, Jansen, Merit™	330
Nasal Forcep, Jansen, Surgi-OR™	322
Nasal Rasp, Lewis	122
Nasal Speculum, Plastic	411
Nasal Speculum, Tieck Halle	194
Nasal Speculum, Vienna	194, 356
Nasal Speculum, Vienna, Merit™	337

NEEDLE HOLDERS

Needle Holder, Abbey, Merit™	333
Needle Holder, Adson	99
Needle Holder, Barraquer	101, 142, 155
Needle Holder, Baumgartner	97
Needle Holder, Baumgartner, Econo-Sterile™	345
Needle Holder, Baumgartner, Merit™	333
Needle Holder, Baumgartner, Sklarlite XD™	96
Needle Holder, Baumgartner, Sklarlite™	96
Needle Holder, Baumgartner, Surgi-OR™	325
Needle Holder, Baumgartner, Surgi-OR™ TC	324
Needle Holder, Baumgartner, TC	90
Needle Holder, Bihle, TC	92
Needle Holder, Boynton	100, 155
Needle Holder, Brown	98
Needle Holder, Brown, Merit™	333
Needle Holder, Brown, Surgi-OR™	325
Needle Holder, Castroviejo	101, 142, 315
Needle Holder, Castroviejo, TC	94
Needle Holder, Castroviejo-Kalt	101
Needle Holder, Cohan	142
Needle Holder, Collier	97
Needle Holder, Collier, Merit™	333
Needle Holder, Collier, Surgi-OR™	325
Needle Holder, Converse	97



Needle Holder, Crile	100	Needle Holder, Olsen-Hegar	99	Nipper, Tissue & Cuticle	167
Needle Holder, Crile-Murray	98	Needle Holder, Olsen-Hegar, Merit™	333	Nipper, Tissue, Merit™	337
Needle Holder, Crile-Murray, TC	90	Needle Holder, Olsen-Hegar, Sklarlite XD™	96	Nipper, Tissue, SklarLite™	166
Needle Holder, Crile-Wood	98	Needle Holder, Olsen-Hegar, Sklarlite™	96	Nipper, Toenail, Small Animal	167
Needle Holder, Crile-Wood, Econo-Sterile™	345	Needle Holder, Olsen-Hegar, Surgi-OR™	325	Nitrile Gloves	387
Needle Holder, Crile-Wood, Merit™	333	Needle Holder, Olsen-Hegar, Surgi-OR™ TC	324	Nose & Ear Grooming Shears	165
Needle Holder, Crile-Wood, Sklarlite XD™	96	Needle Holder, Olsen-Hegar, TC	91, 141	Nose Clip, Disposable	385
Needle Holder, Crile-Wood, Sklarlite™	96	Needle Holder, PAR, TC	90	Noyes Iris Scissors	49
Needle Holder, Crile-Wood, Surgi-OR™ TC	324	Needle Holder, Patton	102	Nugent Utility Forcep	67
Needle Holder, Crile-Wood, TC	90	Needle Holder, Ryder, TC	91	Nurse's Bandage Scissors	52
Needle Holder, Crile-Wood, TC, Left	93	Needle Holder, Ryder, TC, Left	93	Nurses Stethoscope	363
Needle Holder, Derf	97	Needle Holder, Sarot	98		
Needle Holder, Derf, Econo-Sterile™	345	Needle Holder, Sarot, TC	91		
Needle Holder, Derf, Merit™	333	Needle Holder, Sternal Wire Twister, TC	91, 188, 263		
Needle Holder, Derf, Sklarlite XD™	95	Needle Holder, Stratte	99		
Needle Holder, Derf, Sklarlite™	95	Needle Holder, Stratte, TC	92		
Needle Holder, Derf, Surgi-OR™	325	Needle Holder, Swedish, TC	92		
Needle Holder, Derf, Surgi-OR™ TC	324	Needle Holder, Wangenstein	100		
Needle Holder, Derf, TC	90, 141	Needle Holder, Wangenstein, TC	92		
Needle Holder, Finochietto	100	Needle Holder, Webster	97		
Needle Holder, Finochietto, TC	92	Needle Holder, Webster, Econo-Sterile™	345		
Needle Holder, Gillies	99	Needle Holder, Webster, Merit™	333		
Needle Holder, Gillies, TC	91	Needle Holder, Webster, Sklarlite XD™	95		
Needle Holder, Halsey	97	Needle Holder, Webster, Sklarlite™	95		
Needle Holder, Halsey, Econo-Sterile™	345	Needle Holder, Webster, Surgi-OR™	325		
Needle Holder, Halsey, Merit™	333	Needle Holder, Webster, Surgi-OR™ TC	324		
Needle Holder, Halsey, Sklarlite XD™	95	Needle Holder, Webster, TC	90		
Needle Holder, Halsey, Sklarlite™	95	Needle Holder, Wireform, Econo-Sterile™	347		
Needle Holder, Halsey, Surgi-OR™	325				
Needle Holder, Halsey, Surgi-OR™ TC	324	Needle, Deschamp	266		
Needle Holder, Halsey, TC	90	Needle, Eye	262		
Needle Holder, Heaney	100	Needle, Ferguson	261		
Needle Holder, Heaney, TC	92	Needle, Fistula	260		
Needle Holder, Jacobson, TC Micro	94, 141	Needle, Foreign Body	157		
Needle Holder, Julian, TC	92	Needle, Keith Abdominal	261		
Needle Holder, Laparoscopic	222	Needle, Lane Cleft Palate	262		
Needle Holder, Laparoscopic, Single Port	216	Needle, Laparoscopic	234		
Needle Holder, Laparoscopic, TC	237	Needle, Martin's Uterine	261		
Needle Holder, Laparoscopic, TC, Miniature	232	Needle, Mayo Cat Gut	261		
Needle Holder, M.G.H.	99	Needle, Mayo Intestinal	260		
Needle Holder, Mathieu	100	Needle, Murphy's Intestinal	261		
Needle Holder, Mathieu, Merit™	333	Needle, Post Mortem	261-262		
Needle Holder, Mathieu, TC	94	Needle, Regular Surgeon	260		
Needle Holder, Mayo-Hegar	98	Needle, Veterinary	262		
Needle Holder, Mayo-Hegar, Econo-Sterile™	345	Neivert Needle Holder	97, 142		
Needle Holder, Mayo-Hegar, Merit™	333	Neivert Needle Holder, TC	90		
Needle Holder, Mayo-Hegar, Sklarlite XD™	96	Nelson Trocar	129		
Needle Holder, Mayo-Hegar, Sklarlite™	96	Nerve Hook, Dandy	120		
Needle Holder, Mayo-Hegar, Surgi-OR™	325	Nerve Hook, Graham	120		
Needle Holder, Mayo-Hegar, Surgi-OR™ TC	324	New Orleans Needle Holder	98		
Needle Holder, Mayo-Hegar, TC	91	New Orleans Needle Holder, TC	91		
Needle Holder, Mayo-Hegar, TC, Left	93	News Hook	120		
Needle Holder, McPherson	102, 155	New's Suture Scissors	44, 265		
Needle Holder, Metzzenbaum	99	Nipper, Nail	166-167		
Needle Holder, Micro Surgery	101, 142, 155	Nipper, Nail, Merit™	337		
Needle Holder, Neivert	97, 142	Nipper, Nail, Mycotic	167		
Needle Holder, Neivert, TC	90	Nipper, Nail, Surgi-OR™	326		
Needle Holder, New Orleans	98	Nipper, Tissue	166		
Needle Holder, New Orleans, TC	91				



Osteotome, Lambotte Set..... 176
 Osteotome, Smith Peterson 176
 Ostertags Hook..... 197

P

Packer Mosquito Forcep..... 75
 Pad, Instrument Spot Remover 418
 Paper Tape Measure, Disposable 385
 PAR Needle Holder, TC..... 90
 Parallel Pliers..... 266
 Parallel Pliers & Wire Cutter..... 189
 Parametrium Scissors, Z-Type, TC 22
 Parker Retractor 106
 Patent Ductus Clamp..... 86
 Patton Needle Holder 102
 Pean Gastro-Intestinal Forcep..... 81, 195
 Pederson Vaginal Speculum 194, 356
 Pederson Vaginal Speculum, Econo-Sterile™ 346
 Pederson Vaginal Speculum, Merit™ 334
 Pederson Vaginal Speculum, Sklar Blue™ 201
 Pederson Vaginal Speculum, Surgi-OR™ 325
 Pediatric Stethoscope..... 362
 Peers Towel Clamp, Merit™ 333
 Peet (Cottle) Rasp, Diamond..... 121, 180
 Peet Splinter Forcep..... 73, 303
 Pencil Disposable, Electrosurgical 204
 Pennington Clamp 78
 Periosteal, Elevator, Cottle 182
 Periosteal, Elevator, Joseph..... 182
 Periosteal, Elevator, Sedillot..... 183
 Peritoneal Scissors, Laparoscopic 218
 Perrell Fetoscope 364
 Perry Pliers..... 273
 Phaneuf Uterine Artery Forcep..... 88
 Pick, Hoof 168
 Pick, Root Tip 307
 Pick, Rosen 135
 Pick, Vanguard Splinter 73
 Pierce Elevator 182
 Pierse Forcep 68
 Pin & Wire Gauge..... 358
 Pin Cutter..... 189
 Pin Cutter, TC..... 188
 Pin Puller 188, 263
 Pin Puller, TC..... 188, 263
 Pin, Safety, Disposable..... 385
 Pin, Steinmann 190
 Pinard Fetoscope 364
 Pinwheel, Wartenberg, Merit™ 336
 Piston Syringe, Disposable..... 384
 Pitcher, Plastic..... 407
 Pitcher/Beaker, Stainless Steel 388
 Placer, Wax, Thomas..... 287
 Plain Emasculator..... 198
 Plain Splinter Forcep 73
 Plain Splinter Forcep, Merit™ 330
 Plain Splinter Forcep, Surgi-OR™ 322

Plaster Shears, Esmarch, Merit™ 328
 Plaster Spreader, Merit™ 334
 Plastic Clamp, Towel 385, 411-412
 Plastic Clamp, Tubing..... 410
 Plastic Emesis Basin 408
 Plastic Filling Instrument..... 289
 Plastic Forcep, Dressing..... 410
 Plastic Forcep, Hemostatic..... 410
 Plastic Forcep, Sponge 411
 Plastic Forcep, Utility..... 410
 Plastic Graduated Measure Cup 407
 Plastic Guidewire Bowl..... 408
 Plastic Hoff Towel Clamp..... 411
 Plastic Instrument Soaking Tray..... 409
 Plastic Littauer Stitch Scissors 410
 Plastic Medicine Cup..... 407
 Plastic Multi-Purpose Utility Bowl 407
 Plastic OR Basin..... 365, 408
 Plastic Pitcher 407
 Plastic Procedure Tray 409
 Plastic Razor 386, 412
 Plastic Round Basin 408
 Plastic Ruler, Disposable..... 385
 Plastic Specimen Tube..... 407
 Plastic Speculum, Nasal..... 411
 Plastic Surgery Retractor..... 104
 Plastic Surgery Scissors, Sklarcut™ 30
 Plastic Surgery Scissors, Sklarcut™ Gorney 30
 Plastic Surgery Scissors, Sklarhone™ 25
 Plastic Tip, Yankauer Suction..... 377, 412
 Plastic Tray 409
 Plastic Tube, Yankauer Suction..... 377, 412
 Plastic Utility Bowl 408
 Plate, Jaeger 158
 Platypus Nail Forcep, Merit™ 330
 Pliers, College 273-274
 Pliers, Flat Nose 301
 Pliers, Goslee 301
 Pliers, Meriam..... 274
 Pliers, Parallel..... 266
 Pliers, Parallel, & Wire Cutter 189
 Pliers, Perry..... 273
 Plugger, Black..... 288
 Plugger, Root Canal 288
 Polish, Sklar Instrument..... 15, 257, 433
 Polokoff Rasp 124, 181, 309
 Poole Suction Tube 159
 Post Mortem Needle..... 261-262
 Potts Elevator 307
 Potts-Smith Dressing Forcep..... 61
 Potts-Smith Dressing Forcep, TC..... 54
 Potts-Smith Forcep, Sklar Blue™ 202
 Potts-Smith Scissors 38
 Potts-Smith Scissors, Sklarhone™ 27
 Potts-Smith Tissue Forcep 61
 Powder Detergent, Sklar Kleen™ 11, 253, 429
 Pratt Clamp..... 78
 Pratt Rectal Probe 125, 145

Precision Suture Scissors, Sklarlite XD™ 34
 Precision Suture Scissors, Sklarlite™ 34
 Premier XP Anesthesia Machine 436
 Prep Razor, Disposable..... 386, 412
 Prep Stick, Disposable 384
 Presbyterian Tube Occluding Clamp,
 Surgi-OR™ 324
 Presbyterian Tube Occluding
 Clamp, Econo-Sterile™ 344
 Presbyterian Tube Occluding Clamp, Merit™ 333
 Prince Trachoma Forcep 154
 Probe..... 125, 145
 Probe & Excavator, Merit™ 335
 Probe Scissors, Enterotome..... 43, 317
 Probe, Bar Fistula 145
 Probe, Bowman Lachrymal 126
 Probe, Buck Ear 126
 Probe, Buie Fistula 126
 Probe, Coded 283
 Probe, Dental, Merit™ 336
 Probe, Goldman-Fox 283
 Probe, Graduated Laparoscopic..... 234
 Probe, Larry, Rectal..... 125
 Probe, Merit™ 336
 Probe, Pratt Rectal 125, 145
 Probe, Pratt, Rectal 125, 145
 Probe, Surgi-OR™ 326
 Probe, Theobald 126
 Probe, Williams..... 283
 Probe, Williams Lachrymal..... 126
 Procedure Mask 375
 Procedure Tray, Plastic..... 409
 Procylin Suture, Absorbable..... 271
 Protector Soldering Tweezer 274
 Protectors, SklarTip™ Instrument 413
 Providence Forcep 76
 Puller, Pin, TC..... 188, 263
 Puller, Wire, TC 188
 Punch, Biopsy, Laparoscopic 226
 Punch, Hartmann..... 131
 Punch, Keyes Cutaneous, Merit™ 335
 Punch, Laparoscopic, Miniature 232
 Punch, Rubber Dam..... 145, 301
 Punch, Tru-Punch™ Disposable Biopsy..... 381
 Putti Bone Rasp..... 122-123, 180

R

Rabiner Hammer, Merit™ 336
 Rack, Instrument, Stainless Steel..... 399
 Ragnell Scissors..... 39
 Ragnell Scissors, Sklarcut™ 30
 Ragnell Scissors, Sklarhone™ 25
 Ragnell Scissors, Sklarlite™ Sklarcut™ 30
 Rankin Kelly Forcep 78
 Rankin Kelly Forcep, Merit™ 332
 Rankin Kelly Forcep, Surgi-OR™ 323
 Rasp, Aufricht..... 122



Rasp, Bone, Putti..... 122-123, 180
 Rasp, Cottle..... 122
 Rasp, Fomon..... 122, 180
 Rasp, Fomon, TC..... 121
 Rasp, Gallaher..... 122, 180
 Rasp, Joseph..... 122
 Rasp, Lewis..... 122
 Rasp, Maltz..... 122
 Rasp, Maltz, TC..... 121
 Rasp, Molar..... 312
 Rasp, Molar, Diamond..... 312
 Rasp, Peet (Cottle), Diamond..... 121, 180
 Rasp, Polokoff..... 124, 181, 309
 Razor, Plastic..... 386, 412
 Razor, Prep, Disposable..... 386, 412
 Reclosable Bag, Disposable..... 383
 Reconditioner, Sklar Sheen™..... 12, 254, 430
 Reducer, Laparoscopic..... 229
 Reeh Stitch Scissors..... 44, 265
 Regular Surgeon Needle..... 260
 Reimer Emasculator..... 198
 Removal Kit, Splinter, Merit™..... 335
 Remover, Blade..... 351
 Remover, Blade, Disposable..... 386
 Remover, Staple, Disposable..... 386
 Retractor Blade, Balfour..... 115

RETRACTORS

Retractor, Allport..... 112
 Retractor, Alm..... 111
 Retractor, Alm, Merit™..... 334
 Retractor, Army, Merit™..... 334
 Retractor, Badgley..... 115
 Retractor, Balfour..... 114-115
 Retractor, Blair-Roll..... 104
 Retractor, Cheek..... 311
 Retractor, Cheek, University of Minnesota..... 311
 Retractor, Cottle..... 105
 Retractor, Crile..... 105
 Retractor, Cushing..... 103
 Retractor, Cushing, Merit™..... 334
 Retractor, Davis..... 112
 Retractor, Deaver..... 107
 Retractor, Desmarres..... 107, 157
 Retractor, Esophagus Laparoscopic..... 235
 Retractor, Fan Laparoscopic..... 235
 Retractor, Farabeuf..... 106
 Retractor, Gelpi..... 113
 Retractor, Gelpi, Merit™..... 334
 Retractor, Goelet..... 105
 Retractor, Goldstein..... 111, 145
 Retractor, Gosset..... 114
 Retractor, Hays..... 108, 187
 Retractor, Hibbs..... 106
 Retractor, Holzheimer..... 112
 Retractor, Inge..... 187
 Retractor, Israel..... 104, 186

Retractor, Jaeger..... 158
 Retractor, Jansen..... 112
 Retractor, Langenbeck..... 107
 Retractor, Lateral Vaginal, Sklar Blue™..... 201
 Retractor, Little..... 107-108
 Retractor, Mathieu..... 104
 Retractor, McGannon Iris..... 104
 Retractor, Meller..... 111, 145
 Retractor, Meyerding..... 103, 107, 113
 Retractor, Parker..... 106
 Retractor, Plastic Surgery..... 104
 Retractor, Richardson..... 105
 Retractor, Rigby..... 113
 Retractor, Roux..... 106
 Retractor, Senn..... 105
 Retractor, Senn, Merit™..... 334
 Retractor, Senn, Surgi-OR™..... 325
 Retractor, Stevenson..... 111
 Retractor, Tracheal..... 104, 118
 Retractor, US Army..... 105
 Retractor, Volkman..... 103, 186
 Retractor, Weitlaner..... 112-113
 Retractor, Weitlaner, Merit™..... 334
 Retractor, Weitlaner-Beckman..... 113
 Retractor, Weitlaner-Paparella..... 113
 Retractor, Wire Retaining..... 111
 Retractor, Zalkind Ribbon..... 106

Reynolds Scissors..... 38
 Rhoton Forcep..... 65, 140
 Rhoton Suture Forcep..... 65, 140
 Rhytidectomy Scissors..... 42
 Rib Shears, Collins..... 317
 Rib Shears, Stille..... 317
 Ribbon Iris Scissors..... 46
 Ribbon Stevens Scissors..... 41
 Ribbon Stitch Scissors..... 45, 265
 Ribbon Strabismus Scissors..... 41
 Ribbon Utility Scissors..... 46
 Richardson Retractor..... 105
 Richter Scissors..... 317
 Rigby Retractor..... 113
 Ring Cutter Blade, Merit™..... 335
 Ring Cutter, Merit™..... 335
 Roach Carver..... 286
 Rochester-Carmalt Forcep..... 77
 Rochester-Carmalt Forcep, Merit™..... 332
 Rochester-Ochsner Forcep..... 77
 Rochester-Ochsner Forcep, Econo-Sterile™..... 341
 Rochester-Ochsner Forcep, Merit™..... 332
 Rochester-Ochsner Forcep, Sklarlite XD™..... 58
 Rochester-Ochsner Forcep, Sklarlite™..... 58
 Rochester-Ochsner Forcep, Surgi-OR™..... 323
 Rochester-Pean Forcep..... 76
 Rochester-Pean Forcep, Econo-Sterile™..... 341
 Rochester-Pean Forcep, Merit™..... 332
 Rochester-Pean Forcep, Sklarlite XD™..... 58
 Rochester-Pean Forcep, Sklarlite™..... 58

Rochester-Pean Forcep, Surgi-OR™..... 323-324
 Rodent/Rabbit Set..... 313
 Roeder Towel Clamp..... 85, 174
 Ronguer..... 169-171, 293
 Ronguer, Beyer..... 170
 Ronguer, Blumenthal..... 171, 293
 Ronguer, Bone..... 170
 Ronguer, Dean..... 293
 Ronguer, Echlin..... 169
 Ronguer, Friedman..... 171, 293
 Ronguer, Friedman, Micro..... 142, 171
 Ronguer, Hartman..... 170
 Ronguer, Kerrison..... 171
 Ronguer, Kleinert-Kutz..... 169
 Ronguer, Leksell..... 169
 Ronguer, Lempert..... 170
 Ronguer, Luer..... 170
 Ronguer, Mead..... 170
 Ronguer, Ruskin..... 169
 Ronguer, Stille-Luer..... 169
 Ronguer, Zaufel Jansen..... 169
 Root Canal Plugger..... 288
 Root Tip Elevator..... 307
 Root Tip Pick..... 307
 Rosen Knife Curette..... 134
 Rosen Pick..... 135
 Rosser Crypt Hook..... 119
 Round Basin, Plastic..... 408
 Roux Retractor..... 106
 Rubber Band, Disposable..... 386
 Rubber Dam Punch..... 145, 301
 Ruggebergs Hook..... 197
 Ruler, Plastic, Disposable..... 385
 Ruler, Steel..... 358
 Rumel Thoracic Forcep..... 87
 Ruskin Ronguer..... 169
 Ruskin-Liston Bone Forcep..... 172
 Russian Tissue Forcep..... 63
 Russian Tissue Forcep, Merit™..... 330
 Russian Tissue Forcep, Surgi-OR™..... 322
 Ryder Needle Holder, TC..... 91
 Ryder Needle Holder, TC, Left..... 93

S

Saber Grooming Shears..... 164
 Safety Pin, Disposable..... 385
 Safety Scalpel, SklarSafe™..... 354, 184, 378
 Sanitizer, Sklar-Stat™ Foaming Hand..... 14, 256, 432
 Sarot Needle Holder..... 98
 Sarot Needle Holder, TC..... 91
 Sarot Thoracic Forcep..... 87
 Satterlee Bone Saw..... 173
 Satterlee Bone Saw Blade..... 173
 Sauer Eye Speculum..... 108, 143, 156
 Sauer Suture Forcep..... 68
 Saw Blade..... 173
 Saw Guide, Bailey Gigli Bone..... 173



Saw Handles, Gigli Bone..... 172
 Saw Wire, Gigli Bone..... 173
 Saw, Charriere, Bone..... 173
 Saw, Langenbeck Bone..... 173
 Saw, Satterlee Bone..... 173
 Sawtell Forcep..... 83
 Sayre Elevator..... 183
 Scaler..... 276-278
 Scaler, Crane Kaplan..... 278
 Scaler, Goldman-Fox..... 277
 Scaler, Jaquette..... 276-277
 Scaler, Taylor..... 278
 Scaler, Towner..... 278
 Scaler, Universal..... 276
 Scaler, Younger Good..... 278
 Scalpel Blade..... 353
 Scalpel Handle..... 351, 353
 Scalpel Handle, Merit™..... 337
 Scalpel Handle, Surgi-OR™..... 326
 Scalpel, Disposable..... 352, 379
 Scalpel, Mini Thumb..... 353
 Scalpel, SklarSafe™ Safety..... 354, 184, 378
 Scheie-Westcott Corneal Scissors..... 136
 Schink Metatarsal Spreader..... 114
 Schiotz Tonometer..... 158, 355
 Schnidt Tonsil Forcep..... 83
 Schnidt Tonsil Forcep, Merit™..... 332
 Schnidt Tonsil Forcep, Surgi-OR™..... 324
 Schroeder Tenaculum Forcep, Econo-Sterile™..... 343
 Schroeder Tenaculum Forcep, Merit™..... 332
 Schroeder Tenaculum Forcep, Sklar Blue™..... 201
 Schroeder Tenaculum Forcep, Surgi-OR™..... 324
 Schweizer Forcep, Merit™..... 332
 Schweizer Forcep, Surgi-OR™..... 324

SCISSORS

Scissors, Aebli Corneal..... 47
 Scissors, Alligator Ear..... 51, 130
 Scissors, Army Gauze, Merit™..... 328
 Scissors, Bellucci..... 51, 130, 138
 Scissors, Biro Derm Naveus..... 42
 Scissors, Blepharoplasty..... 42
 Scissors, Blepharoplasty, Sklar Edge™ TC..... 22
 Scissors, Boetcher..... 39
 Scissors, Bonn Iris..... 45
 Scissors, Braun Epistomy, Merit™..... 328
 Scissors, Braun Epistomy, Surgi-OR™..... 320
 Scissors, Brophy..... 47, 302
 Scissors, Castroviejo Cataract..... 50, 137
 Scissors, Castroviejo Corneal..... 49-50, 136-137, 149
 Scissors, Cat Claw..... 168
 Scissors, Christensen Teat..... 192
 Scissors, Commander Utility..... 52
 Scissors, Crown..... 45, 266, 302
 Scissors, Cuticle Nail, Merit™..... 328
 Scissors, Dean..... 39
 Scissors, Deaver..... 36

Scissors, Dissecting..... 317
 Scissors, Dissecting, Sklar Edge™ TC..... 21
 Scissors, Doyen..... 38
 Scissors, Dubois..... 317
 Scissors, Ear, Alligator..... 51, 130
 Scissors, Ear, Bellucci..... 51, 130, 138
 Scissors, Enterotome..... 43, 317
 Scissors, Enucleation..... 47
 Scissors, Fomon..... 48
 Scissors, Fomon Lateral, Sklarcut™..... 31
 Scissors, Goldman-Fox..... 41
 Scissors, Goldman-Fox, Sklar Edge™ TC..... 21
 Scissors, Goldman-Fox, Sklarcut™..... 29
 Scissors, Goldman-Fox, Sklarhone™..... 26
 Scissors, Gorney Face Lift..... 42
 Scissors, Gorney Face Lift, Sklarcut™..... 31
 Scissors, Gorney Plastic Surgery, Sklarcut™..... 30
 Scissors, Gorney Plastic Surgery, Sklarhone™..... 26
 Scissors, Gradle..... 46, 150, 265
 Scissors, Gradle, Merit™..... 328
 Scissors, Gradle, Sklarcut™..... 30
 Scissors, Gradle, Sklarhone™..... 26
 Scissors, Harrington-Mayo..... 36
 Scissors, Heath..... 43, 265
 Scissors, Hercules Utility..... 51
 Scissors, Hi-Level Bandage..... 52
 Scissors, Hi-Level Bandage, Sklarhone™..... 27
 Scissors, Iris..... 40, 45-46, 150
 Scissors, Iris, Econo-Sterile™..... 339
 Scissors, Iris, Merit™..... 328
 Scissors, Iris, Micro Mini..... 50, 137
 Scissors, Iris, Sklar Edge™ TC..... 20
 Scissors, Iris, Sklarcut™..... 28
 Scissors, Iris, Sklarhone™..... 24
 Scissors, Iris, Sklarhone™ TC..... 23
 Scissors, Iris, Sklarlite XD™..... 33, 147
 Scissors, Iris, Sklarlite™..... 33, 147
 Scissors, Iris, Sklarlite™ Sklarcut™..... 28
 Scissors, Iris, Surgi-OR™..... 320
 Scissors, Iris, Surgi-OR™ TC..... 320
 Scissors, Jacobson..... 49, 138
 Scissors, Jameson, Sklarhone™..... 27
 Scissors, Jorgenson..... 40
 Scissors, Kahn..... 39
 Scissors, Kaye Dissecting, Sklar Edge™ TC..... 21
 Scissors, Kaye Face Lift, Sklarcut™..... 31
 Scissors, Kelly-Adson..... 38-39
 Scissors, Kleinert-Kutz..... 48
 Scissors, Knapp Iris..... 46
 Scissors, Knowles Bandage..... 52
 Scissors, Knowles Bandage, Econo-Sterile™..... 340
 Scissors, Knowles Bandage, Merit™..... 328
 Scissors, Knowles Bandage, Surgi-OR™..... 320
 Scissors, Lagrange..... 42
 Scissors, Laparoscopic..... 218-219
 Scissors, Laparoscopic, Disposable..... 242-243
 Scissors, Laparoscopic, Miniature..... 231
 Scissors, Laparoscopic, Single Port..... 217

Scissors, Lilly..... 42
 Scissors, Lister Bandage..... 51
 Scissors, Lister Bandage, Econo-Sterile™..... 340
 Scissors, Lister Bandage, Merit™..... 328
 Scissors, Lister Bandage, Sklarhone™..... 27
 Scissors, Lister Bandage, Sklarlite XD™..... 34
 Scissors, Lister Bandage, Sklarlite™..... 34
 Scissors, Lister Bandage, Surgi-OR™..... 320
 Scissors, Littauer Stitch..... 44, 149, 264
 Scissors, Littauer Stitch, Econo-Sterile™..... 340
 Scissors, Littauer Stitch, Merit™..... 329
 Scissors, Littauer Stitch, Surgi-OR™..... 321
 Scissors, Martin..... 43, 191
 Scissors, Mayo..... 36
 Scissors, Mayo, Econo-Sterile™..... 339
 Scissors, Mayo, Merit™..... 328
 Scissors, Mayo, Sklar Edge™ TC..... 20
 Scissors, Mayo, Sklarcut™..... 28
 Scissors, Mayo, Sklarhone™..... 24
 Scissors, Mayo, Sklarhone™ TC..... 23
 Scissors, Mayo, Sklarlite XD™..... 32
 Scissors, Mayo, Sklarlite™..... 32
 Scissors, Mayo, Sklarlite™ Sklarcut™..... 29
 Scissors, Mayo, Surgi-OR™..... 320-321
 Scissors, Mayo, Surgi-OR™ TC..... 320
 Scissors, Mayo-Noble..... 36
 Scissors, Mayo-Noble-Stille..... 36
 Scissors, Mayo-Stille..... 37
 Scissors, Mayo-Stille, Sklar Edge™ TC..... 20
 Scissors, Mayo-Stille, Sklarhone™ TC..... 23
 Scissors, McClure Iris..... 49, 138
 Scissors, McGuire Corneal..... 47
 Scissors, McPherson Vannas..... 50, 137
 Scissors, Metzenbaum..... 37
 Scissors, Metzenbaum, Econo-Sterile™..... 339
 Scissors, Metzenbaum, Merit™..... 328
 Scissors, Metzenbaum, Sklar Edge™ TC..... 20-21
 Scissors, Metzenbaum, Sklarcut™..... 29
 Scissors, Metzenbaum, Sklarhone™..... 25
 Scissors, Metzenbaum, Sklarhone™ Sklarlite™..... 25
 Scissors, Metzenbaum, Sklarhone™ TC..... 23
 Scissors, Metzenbaum, Sklarlite XD™..... 32-33
 Scissors, Metzenbaum, Sklarlite™..... 32-33
 Scissors, Metzenbaum, Sklarlite™ Sklarcut™..... 29
 Scissors, Metzenbaum, Surgi-OR™..... 321
 Scissors, Metzenbaum, Surgi-OR™ TC..... 320
 Scissors, Micro Bellucci..... 51, 130, 138
 Scissors, Micro Surgery..... 49, 136
 Scissors, Micro Vannas..... 50, 138
 Scissors, Miller..... 43
 Scissors, Mixer..... 36
 Scissors, Moleskin..... 43
 Scissors, Nail Splitting..... 52
 Scissors, Nail Splitting, Merit™..... 328
 Scissors, Noyes Iris..... 49
 Scissors, Nurse's Bandage..... 52
 Scissors, Operating..... 35
 Scissors, Operating, Econo-Sterile™..... 339



Scissors, Operating, Merit™.....	329	Scissors, Strabismus, Sklarlite XD™.....	33, 146	Set, Hegar Uterine Dilator, Merit™.....	334	
Scissors, Operating, Sklar Edge™ TC.....	20	Scissors, Strabismus, Sklarlite™.....	33, 146	Set, Instrument Holder.....	406	
Scissors, Operating, Sklarcut™.....	28	Scissors, Strabismus, Surgi-OR™.....	321	Set, Iris Hook, Sklar Blue™.....	203	
Scissors, Operating, Sklarhone™.....	24	Scissors, Strabismus, Surgi-OR™ TC.....	320	Set, Jackson Tracheotomy Tube.....	161	
Scissors, Operating, Sklarlite XD™.....	32	Scissors, Strully.....	39	Set, Lambotte Osteotome.....	176	
Scissors, Operating, Sklarlite™.....	32	Scissors, Suture.....	44-45, 149, 264-266	Set, Laparoscopic Trocar, Miniature.....	233	
Scissors, Operating, Sklarlite™ Sklarcut™.....	28	Scissors, Suture, Littler.....	265	Set, Laryngoscope, Disposable.....	163	
Scissors, Operating, Surgi-OR™.....	321	Scissors, Suture, Merit™.....	329	Set, Micro.....	350	
Scissors, Operating, Surgi-OR™ TC.....	320	Scissors, Suture, New's.....	44, 265	Set, Orthopedic.....	349	
Scissors, Plastic Surgery, Sklarcut™.....	30	Scissors, Suture, Surgi-OR™.....	321	Set, Rodent/Rabbit.....	313	
Scissors, Plastic Surgery, Sklarhone™.....	25	Scissors, Taylor Dural.....	48	Set, Spay Pack.....	348	
Scissors, Potts-Smith.....	38	Scissors, Thorek.....	40	Set, Tie Back.....	350	
Scissors, Potts-Smith, Sklarhone™.....	27	Scissors, Umbilical, Merit™.....	329	Set, Trocar.....	129	
Scissors, Precision Suture, Sklarlite XD™.....	34	Scissors, US Army.....	52	Set, Tru-Punch™ Disposable Biopsy Punch.....	381	
Scissors, Precision Suture, Sklarlite™.....	34	Scissors, Utility.....	46	Set, Tuning Fork.....	355	
Scissors, Ragnell.....	39	Scissors, Utility, Merit™.....	329	Set, Van Buren Sound.....	128	
Scissors, Ragnell, Sklarcut™.....	30	Scissors, Utility, Surgi-OR™.....	321	Set, Van Buren Urethral Sound.....	128	
Scissors, Ragnell, Sklarhone™.....	25	Scissors, Vannas.....	50, 137	Set, Walther Dilator.....	127	
Scissors, Reynolds.....	38	Scissors, Vannas Micro.....	50, 138	Shallcross Forcep.....	80	
Scissors, Rhytidectomy.....	42	Scissors, Wagner.....	40, 302	Shamberg Comedone Extractor, Merit™.....	335	
Scissors, Ribbon Utility.....	46	Scissors, Westcott Tenotomy.....	49, 136, 266	Shamburg Comedone Extractor, Surgi-OR™.....	326	
Scissors, Ribbon Iris.....	46	Scissors, Wilmer.....	41	Shapleigh Curette.....	134	
Scissors, Ribbon Stevens.....	41	Scissors, Wire Cutting, Econo-Sterile™.....	340	Shears, Grooming.....	164-165	
Scissors, Ribbon Stitch.....	45, 265	Scissors, Wire Cutting, Merit™.....	329	Shears, Collins.....	317	
Scissors, Ribbon Strabismus.....	41	Scissors, Wire Cutting, Sklar Edge™ TC.....	22, 263	Shears, Esmarch Plaster.....	51	
Scissors, Richter.....	317	Scissors, Wire Cutting, Surgi-OR™.....	321	Shears, Esmarch Plaster, Merit™.....	328	
Scissors, Scheie-Westcott Corneal.....	136	Scissors, Wire Cutting, Surgi-OR™ TC.....	320	Shears, First Aid, Merit™.....	328	
Scissors, Seiler Turbinate.....	47	Scissors, Wireform Econo-Sterile™.....	347	Shears, Foot Rot.....	168	
Scissors, Shortbent Suture, Sklarlite XD™.....	34, 147	Scissors, Z-Type Parametrium, TC.....	22	Shears, Stille.....	317	
Scissors, Shortbent Suture, Sklarlite™.....	34, 147, 264	Scoop, Desjardin.....	128	Shield, Ear Syringe, Merit™.....	336	
Scissors, Sims.....	40	Scoop, Ferguson.....	128	Shortbent Suture Scissors, Sklarlite XD™.....	34, 147	
Scissors, Sistrunk, Dissecting.....	38	Scoop, Lab/Utility, Stainless Steel.....	391	Shortbent Suture Scissors, Sklarlite™.....	34, 147, 264	
Scissors, Sklar.....	43, 302	Scoop, Mayo.....	128	Silicon Mat, SklarLite™.....	401-403	
Scissors, Sklar Nail.....	52	Scudder Forcep.....	82	Simpson Sound, Merit™.....	334	
Scissors, Spencer Stitch.....	44, 149, 264	Searcher, Allport.....	120	Sims Scissors.....	40	
Scissors, Spencer Stitch, Econo-Sterile™.....	340	Sedillot Periosteal Elevator.....	183	Sims Uterine Sound, Merit™.....	334	
Scissors, Spencer Stitch, Merit™.....	329	Seiler Turbinate Scissors.....	47	Single Port Laparoscopic Electrode.....	217	
Scissors, Spencer Stitch, Sklarlite XD™.....	34, 146	Seldin Elevator.....	184, 306	Single Port Laparoscopic Forcep.....	217	
Scissors, Spencer Stitch, Sklarlite™.....	34, 146	Semkin Bipolar Forcep, Electrosurgical.....	213	Single Port Laparoscopic Needle Holder.....	216	
Scissors, Spencer Stitch, Surgi-OR™.....	321	Semkin Dressing Forcep.....	61	Single Port Laparoscopic Scissors.....	217	
Scissors, Stevens.....	41, 150	Semkin Forcep, Merit™.....	330	Single Port Laparoscopic Suction Irrigation.....	216	
Scissors, Stevens, Merit™.....	329	Semkin Tissue Forcep.....	61	Single Port Laparoscopic Trocar.....	216	
Scissors, Stevens, Sklarcut™.....	28	Senn Retractor.....	105	Singley Forcep.....	64	
Scissors, Stevens, Sklarhone™.....	26	Senn Retractor, Merit™.....	334	Singley Forcep, Sklar Blue™.....	202	
Scissors, Stevens, Sklarhone™ TC.....	23	Senn Retractor, Surgi-OR™.....	325	Sistrunk Dissecting Scissors.....	38	
Scissors, Stevens, Sklarlite XD™.....	33, 147	Sesamoid Clamp.....	191	Skin Hook.....	117	
Scissors, Stevens, Sklarlite™.....	33, 147	SETS			Skin Hook, Freer.....	118
Scissors, Stevens, Surgi-OR™.....	321	Set, Akers.....	285	Skin Hook, Meyerding.....	107, 120	
Scissors, Stitch.....	44, 264	Set, Brush, Cleaning.....	419-420	Skin Marker, Disposable.....	344, 377	
Scissors, Stitch, Fine.....	149	Set, Diagnostic.....	355	SKLAR BLUE™		
Scissors, Stitch, Littauer, Plastic.....	410	Set, Emmett Hook, Sklar Blue™.....	203	Sklar Blue Adson Forcep.....	202	
Scissors, Stitch, Long.....	44, 264	Set, Equine.....	350	Sklar Blue Allis Tissue Forcep.....	201	
Scissors, Stitch, O'Brien.....	264	Set, Evans.....	285	Sklar Blue Babcock Forcep.....	201	
Scissors, Stitch, Reeh.....	44, 265	Set, Eye, Basic.....	349	Sklar Blue Bozeman Forcep.....	202	
Scissors, Strabismus.....	47, 149	Set, General Surgery.....	348	Sklar Blue Dressing Forcep.....	202	
Scissors, Strabismus, Econo-Sterile™.....	340					
Scissors, Strabismus, Merit™.....	329					
Scissors, Strabismus, Sklar Edge™ TC.....	21					



Sklar Blue Emmett Hook	203
Sklar Blue Emmett Hook Set	203
Sklar Blue Graves Vaginal Speculum	201
Sklar Blue Iris Hook	203
Sklar Blue Iris Hook Set	203
Sklar Blue Kogan Endocervical Speculum	200
Sklar Blue Lateral Vaginal Retractor	201
Sklar Blue Pederson Vaginal Speculum	201
Sklar Blue Potts-Smith Forcep	202
Sklar Blue Schroeder Tenaculum Forcep	201
Sklar Blue Singley Forcep	202
Sklar Blue Tuttle Forcep	202
Sklar Cide™	4, 246, 422
Sklar Disinfectant	5, 148, 247, 423
Sklar Edge TC Blepharoplasty Scissors	22
Sklar Edge TC Dissecting Scissors	21
Sklar Edge TC Goldman-Fox Scissors	21
Sklar Edge TC Iris Scissors	20
Sklar Edge TC Kaye Dissecting Scissors	21
Sklar Edge TC Mayo Scissors	20
Sklar Edge TC Mayo-Stille Scissors	20
Sklar Edge TC Metzenbaum Scissors	20-21
Sklar Edge TC Operating Scissors	20
Sklar Edge TC Strabismus Scissors	21
Sklar Edge TC Wire Cutting Scissors	22, 263
Sklar Enzymatic™ Detergent	13, 255, 431
Sklar Fresh™ Odor Neutralizer Spray	15, 257, 433
Sklar Hook	117, 187
Sklar ID Roll Tape	414
Sklar Instru-Guard™ Lube	10, 49, 252, 428
Sklar Instru-Guard™ One Step	9, 251, 427
Sklar Instrument Care Kit	16, 258, 434
Sklar Instrument Polish	15, 257, 433
Sklar Kleen™ Liquid Detergent	11, 253, 429
Sklar Kleen™ Low Foam Detergent	11, 253, 429
Sklar Kleen™ Powder Detergent	11, 253, 429
Sklar Mallet	179
Sklar Nail Scissors	52
Sklar Scissors	43, 302
Sklar Sheen™ Foam Spray	12, 254, 430
Sklar Sheen™ Reconditioner	12, 254, 430
Sklar Soak™	8, 193, 250, 426, 193
Sklar Stat™	14, 256, 432
Sklar Spray-Zyme™	7, 249, 429
Sklar Surface Wipes	
Disinfectant	6, 214, 248, 392, 424
Sklar Thoracic Clamp	86

SKLARCUT™

Sklarcut Fomon Lateral Scissors	31
Sklarcut Goldman-Fox Scissors	29
Sklarcut Gorney Face Lift Scissors	31
Sklarcut Gorney Plastic Surgery Scissors	30
Sklarcut Gradle Scissors	30
Sklarcut Iris Scissors	28
Sklarcut Iris Scissors, Sklarlite	28

Sklarcut Kaye Face Lift Scissors	31
Sklarcut Mayo Scissors	28
Sklarcut Mayo Scissors, Sklarlite	29
Sklarcut Metzenbaum Scissors	29
Sklarcut Metzenbaum Scissors, Sklarlite	29
Sklarcut Operating Scissors	28
Sklarcut Operating Scissors, Sklarlite	28
Sklarcut Plastic Surgery Scissors	30
Sklarcut Ragnell Scissors	30
Sklarcut Ragnell Scissors, Sklarlite	30
Sklarcut Stevens Scissors	28
Sklarcut Wagner Scissors	29
Sklarcut Wagner Scissors, Sklarlite	30

SKLARHONE™

Sklarhone Goldman-Fox Scissors	26
Sklarhone Gorney Plastic Surgery Scissors	26
Sklarhone Gradle Scissors	26
Sklarhone Hi-Level Bandage Scissors	27
Sklarhone Iris Scissors	24
Sklarhone Iris Scissors, TC	23
Sklarhone Jameson Scissors	27
Sklarhone Lister Bandage Scissors	27
Sklarhone Mayo Scissors	24
Sklarhone Mayo Scissors, TC	23
Sklarhone Mayo-Stille Scissors, TC	23
Sklarhone Metzenbaum Scissors	25
Sklarhone Metzenbaum Scissors, Sklarlite	25
Sklarhone Metzenbaum Scissors, TC	23
Sklarhone Operating Scissors	24
Sklarhone Plastic Surgery Scissors	25
Sklarhone Potts-Smith Scissors	27
Sklarhone Ragnell Scissors	25
Sklarhone Stevens Scissors	26
Sklarhone Stevens Scissors, TC	23

SKLARLITE XD™

Sklarlite XD Adson Dressing Forcep	56
Sklarlite XD Adson Tissue Forcep	56
Sklarlite XD Adson-Brown Tissue Forcep	56
Sklarlite XD Allis Tissue Forcep	58
Sklarlite XD Baumgartner Needle Holder	96
Sklarlite XD Crile Forcep	57
Sklarlite XD Crile-Wood Needle Holder	96
Sklarlite XD Derf Needle Holder	95
Sklarlite XD Dressing Forcep	56
Sklarlite XD Halsey Needle Holder	95
Sklarlite XD Halsted Mosquito Forcep	57, 148
Sklarlite XD Hartmann Mosquito Forcep	57, 148
Sklarlite XD Iris Scissors	33, 147
Sklarlite XD Kelly Forcep	57
Sklarlite XD Lister Bandage Scissors	34
Sklarlite XD Mayo Scissors	32
Sklarlite XD Mayo-Hegar Needle Holder	96
Sklarlite XD Metzenbaum Scissors	32-33
Sklarlite XD Mixer Forcep	58

Sklarlite XD Olsen-Hegar Needle Holder	96
Sklarlite XD Operating Scissors	32
Sklarlite XD Precision Suture Scissors	34
Sklarlite XD Rochester-Ochsner Forcep	58
Sklarlite XD Rochester-Pean Forcep	58
Sklarlite XD Shortbent Suture Scissors	34, 147
Sklarlite XD Spencer Stitch Scissors	34, 146
Sklarlite XD Stevens Scissors	33, 147
Sklarlite XD Strabismus Scissors	33, 146
Sklarlite XD Tissue Forcep	56
Sklarlite XD Webster Needle Holder	95

SKLARLITE™

SklarLite Accessories	402
Sklarlite Adson Dressing Forcep	56
Sklarlite Adson Tissue Forcep	56
Sklarlite Adson-Brown Tissue Forcep	56
Sklarlite Allis Tissue Forcep	58
Sklarlite Baumgartner Needle Holder	96
Sklarlite Crile Forcep	57
Sklarlite Crile-Wood Needle Holder	96
Sklarlite Derf Needle Holder	95
Sklarlite Dressing Forcep	56
Sklarlite Halsey Needle Holder	95
Sklarlite Halsted Mosquito Forcep	57, 148
Sklarlite Hartmann Mosquito Forcep	57, 148
Sklarlite Iris Scissors	33, 147
Sklarlite Iris Scissors, Sklarcut	28
Sklarlite Kelly Forcep	57
Sklarlite Lister Bandage Scissors	34
Sklarlite Mayo Scissors	32
Sklarlite Mayo Scissors, Sklarcut	29
Sklarlite Mayo-Hegar Needle Holder	96
Sklarlite Metzenbaum Scissors	32-33
Sklarlite Metzenbaum Scissors, Sklarcut	29
Sklarlite Metzenbaum Scissors, Sklarhone	25
Sklarlite Mixer Forcep	58
Sklarlite Olsen-Hegar Needle Holder	96
Sklarlite Operating Scissors	32
Sklarlite Operating Scissors, Sklarcut	28
Sklarlite Precision Suture Scissors	34
Sklarlite Ragnell Scissors, Sklarcut	30
Sklarlite Rochester-Ochsner Forcep	58
Sklarlite Rochester-Pean Forcep	58
Sklarlite Shortbent Suture Scissors	34, 147, 264
SklarLite Silicon Mat	401-403
Sklarlite Spencer Stitch Scissors	34, 146
SklarLite Sterilization Basket	401-403
SklarLite Sterilization Container	400-403
Sklarlite Stevens Scissors	33, 147
Sklarlite Strabismus Scissors	33, 146
Sklarlite Tissue Forcep	56
Sklarlite Tissue Nipper	166
Sklarlite Wagner Scissors, Sklarcut	30
Sklarlite Webster Needle Holder	95



SklarSafe Safety Scalpel 354, 184, 378
 Sklar-Stat Dispenser Bottle 14, 32, 256, 432
 Sklar-Stat Foam Dispenser 14, 32, 256, 432
 Sklar-Stat Foaming Hand Sanitizer 14, 256, 432
 SklarTip™ Instrument Protectors / ID 413, 414
 Skull Breaker, Virchow 318
 Slitter, Danish Teat 192
 Small Animal Toenail Nipper 167
 Smille Meniscus Hook 108, 187
 Smillie Knife 190
 Smith Peterson Gouge 178
 Smith Peterson Osteotome 176
 Smith Special Instrument 289
 Smithwick Hook 120
 Snook Hook 198
 Snook Hook, Merit™ 334
 Solution Basin, Stainless Steel 389
 Sound Set, Khaki Roll 128
 Sound Set, Van Buren 128
 Sound, McCrea 128
 Sound, Simpson, Merit™ 334
 Sound, Sims Uterine, Merit™ 334
 Sound, Van Buren 128
 Spatula 312
 Spatula & Packer, Merit™ 335
 Spatula & Packer, Surgi-OR™ 326
 Spatula, Cement 291
 Spatula, Wax 292
 Spatula, Wax, Gritman 292
 Spay Pack Set 348
 Special Instrument, Smith 289
 Specimen Tube, Plastic 407
 Speculum, Avian 356
 Speculum, Castroviejo 109, 143
 Speculum, Eye, Cook 110, 144, 156
 Speculum, Eye, Knapp 109, 143
 Speculum, Eye, Lancaster 109, 143
 Speculum, Eye, Maumenee Park 109, 143
 Speculum, Eye, Mellinger 110, 144, 156
 Speculum, Eye, Murdock 109, 144, 156
 Speculum, Eye, Sauer 108, 143, 156
 Speculum, Graves Vaginal 194, 356
 Speculum, Graves Vaginal, Econo-Sterile™ 346
 Speculum, Graves Vaginal, Merit™ 334
 Speculum, Graves Vaginal, Sklar Blue™ 201
 Speculum, Graves Vaginal, Surgi-OR™ 325
 Speculum, Gruber, Merit™ 336
 Speculum, Killian 356
 Speculum, Knapp, Merit™ 336
 Speculum, Kogan Endocervical, Sklar Blue™ 200
 Speculum, Nasal, Plastic 411
 Speculum, Pederson Vaginal 194, 356
 Speculum, Pederson Vaginal, Econo-Sterile™ 346
 Speculum, Pederson Vaginal, Merit™ 334
 Speculum, Pederson Vaginal, Sklar Blue™ 201
 Speculum, Pederson Vaginal, Surgi-OR™ 325
 Speculum, Tieck Halle 194
 Speculum, Vienna 194, 356

Speculum, Vienna, Merit™ 337
 Speculum, Williams 109, 143, 314
 Speculum, Wire 110, 144, 156
 Speculum, Wire, Barraquer 110, 144, 156
 Speculum, Wire, Feaster 110
 Speculum, Wire, Temporal 111
 Spencer Stitch Scissors 44, 149, 264
 Spencer Stitch Scissors, Econo-Sterile™ 340
 Spencer Stitch Scissors, Merit™ 329
 Spencer Stitch Scissors, Sklarlite XD™ 34, 146
 Spencer Stitch Scissors, Sklarlite™ 34, 146
 Spencer Stitch Scissors, Surgi-OR™ 321
 Splinter Forcep, Carmalt 72
 Splinter Forcep, Carmalt, Merit™ 330
 Splinter Forcep, Feichenfeld 72
 Splinter Forcep, Feilchenfeld, Merit™ 330
 Splinter Forcep, Merit™ 331
 Splinter Forcep, Peet 73, 303
 Splinter Forcep, Plain 73
 Splinter Forcep, Surgi-OR™ 322
 Splinter Forcep, Virtus 73
 Splinter Forcep, Virtus, Merit™ 331
 Splinter Forcep, Walter 73
 Splinter Forcep, Williams 73, 303
 Splinter Liberator, Merit™ 335
 Splinter Pick, Vanguard 73
 Splinter Removal Kit 74
 Splinter Removal Kit, Merit™ 335
 Splitter, Nail 167
 Splitter, Nail, Merit™ 337
 Splitter, Nail, SurgiOR™ 326
 Sponge Bowl, Stainless Steel 389
 Sponge Forcep, Ballenger 84, 196
 Sponge Forcep, Econo-Sterile™ 344
 Sponge Forcep, Fletcher 84, 196
 Sponge Forcep, Plastic 411
 Sponge Forcep, Wireform Econo-Sterile™ 347
 Sponge Stick, Disposable 384
 Sponge, Gauze 346, 371
 Sponge, Gauze, X-Ray 371
 Sponge, Super 371
 Spoon Forcep, Laparoscopic 221
 Spoon, Akers 285
 Spoon, Evans 285
 Sprague Rappaport Stethoscope 359
 Spray, Foam, Sklar Sheen™ 12, 254, 430
 Spray, Sklar Fresh™ Odor Neutralizer 15, 257, 433
 Spreader, Cast, Merit™ 334
 Spreader, Plaster, Merit™ 334
 Spreader, Schink Metatarsal 114
 Spreader, Tuffier 115
 Spud, Foreign Body, Dix 158
 Spud, Foreign Body, Francis 158
 S-Retractor, Laparoscopic 229
 St. Vincent Tube Occluding Forcep, Merit™ 333
 Stabismus Scissors, Merit™ 329

STAINLESS STEEL

Stainless Steel Catheter Instrument Tray 393
 Stainless Steel Catheter Instrument Tray Cover ... 393
 Stainless Steel Catheter Instrument Tray,
 Miniature 392
 Stainless Steel Cleaning Basket 394
 Stainless Steel Dressing Jar 391
 Stainless Steel Emesis Basin 390
 Stainless Steel Forcep Jar 391, 418
 Stainless Steel Funnel 391
 Stainless Steel Graduated Measure Cup 389
 Stainless Steel Hospital Bucket 390
 Stainless Steel Hospital Kick Bucket 390
 Stainless Steel Instrument Drying Tray 394
 Stainless Steel Instrument Rack 399
 Stainless Steel Instrument Stringer 398-399
 Stainless Steel Instrument Tray 393-397
 Stainless Steel Instrument Tray Cover 395-396
 Stainless Steel Iodine Cup 388
 Stainless Steel Lab/Utility Scoop 391
 Stainless Steel Lifting Handles 397
 Stainless Steel Mayo Tray 393
 Stainless Steel Medicine Cup 388
 Stainless Steel Micro Sterilization Tray 397
 Stainless Steel Micro Sterilization Tray Cover 397
 Stainless Steel Mixing/Solution Bowl 389
 Stainless Steel Ointment Jar 392
 Stainless Steel Pitcher/Beaker 388
 Stainless Steel Solution Basin 389
 Stainless Steel Sponge Bowl 389
 Stainless Steel Sterilization Tray 396-397
 Stainless Steel Sterilization Tray Cover 396
 Stainless Steel Sterilization Tray Handle 397
 Stainless Steel Sterilization Tray, Micro 397
 Stainless Steel Sterilization/Bath Set Tray 396
 Stainless Steel Storage Container 390
 Stainless Steel Suture, Non-Absorbable 272
 Stainless Steel Tumbler 388

 Staple Removal Tray 367, 226
 Staple Remover, Disposable 386
 Start-up Tray 365
 Steel Ruler 358
 Steinmann Pin 190
 Sterilization Basket, SklarLite™ 401-403
 Sterilization Cassette 404-406
 Sterilization Container, SklarLite™ 400-403
 Sterilization Tray Cover, Stainless Steel 396
 Sterilization Tray Handle, Stainless Steel 397
 Sterilization Tray, Stainless Steel 396-397
 Sterilization/Bath Set Tray, Stainless Steel 396
 Sterilizer Forcep, Merit™ 333
 Sterilizing Forcep 304
 Sternal Wire Twister Needle Holder, TC... 91, 188, 263
 Stethoscope, Adult 361
 Stethoscope, Bowles 364



Stethoscope, Cardiology 360
 Stethoscope, Disposable 363
 Stethoscope, Fetal 362
 Stethoscope, Infant 362
 Stethoscope, Nurses 363
 Stethoscope, Pediatric 362
 Stethoscope, Sprague Rappaport 359
 Stethoscope, Teaching/Training 363
 Stevens Iris Forcep 65
 Stevens Scissors 41, 150
 Stevens Scissors, Merit™ 329
 Stevens Scissors, Sklarcut™ 28
 Stevens Scissors, Sklarhone™ 26
 Stevens Scissors, Sklarhone™ TC 23
 Stevens Scissors, Sklarlite XD™ 33, 147
 Stevens Scissors, Sklarlite™ 33, 147
 Stevens Scissors, Surgi-OR™ 321
 Stevenson Retractor 111
 Stick, Prep, Disposable 384
 Stick, Sponge, Disposable 384
 Stille Shears 317
 Stille Tissue Forcep 60
 Stille-Luer Bone Forcep 172
 Stille-Luer Ronguer 169
 Stilletto Grooming Shears 164
 Stitch Cutter 353
 Stitch Scissors 44, 264
 Stitch Scissors, Fine 149
 Stitch Scissors, Littauer, Plastic 410
 Stitch Scissors, Long 44, 264
 Stitch Scissors, O'Brien 264
 Stitch Scissors, Reeh 44, 265
 Stitch Scissors, Ribbon 45, 265
 Stone Tissue Forcep 62
 Stoppers, Decannulation 162
 Storage Container, Stainless Steel 390
 Strabismus Forcep 70
 Strabismus Hook, Graefe 117
 Strabismus Scissors 47, 149
 Strabismus Scissors, Econo-Sterile™ 340
 Strabismus Scissors, Sklar Edge™ TC 21
 Strabismus Scissors, Sklarlite XD™ 33, 146
 Strabismus Scissors, Sklarlite™ 33, 146
 Strabismus Scissors, Surgi-OR™ 321
 Strabismus Scissors, Surgi-OR™ TC 320
 Straight Electrode Disposable,
 Electrosurgical 208-209
 Stratte Needle Holder 99
 Stratte Needle Holder, TC 92
 Stringer, Instrument, Stainless Steel 398-399
 Strips, Gluteraldehyde 4, 246, 422
 Struempel Ear Forcep 131
 Strully Scissors 39
 Suction Irrigation, Laparoscopic 236
 Suction Irrigation, Laparoscopic, Single Port 216
 Suction Tip, Andrews-Pynchon 160
 Suction Tip, Yankauer, Plastic 377, 412
 Suction Tube, Adson 160

Suction Tube, Andrews-Pynchon 160
 Suction Tube, Anthony 160
 Suction Tube, Baron 159
 Suction Tube, Buie 160
 Suction Tube, Cleaning Brush 417
 Suction Tube, Coupland 160
 Suction Tube, Disposable 377
 Suction Tube, Ear 160
 Suction Tube, Frazier 159
 Suction Tube, Frazier Ferguson 159
 Suction Tube, Poole 159
 Suction Tube, Yankauer 159
 Suction Tube, Yankauer, Plastic 377, 412
 Super Sponge 371

SUPERCUT

Supercut Goldman-Fox Scissors, Sklarhone™ 26
 Supercut Gorney Plastic Surgery Scissors,
 Sklarhone™ 26
 Supercut Gradle Scissors, Sklarhone™ 26
 Supercut Hi-Level Bandage Scissors, Sklarhone™ 27
 Supercut Iris Scissors, Sklarhone™ 24
 Supercut Iris Scissors, Sklarhone™ TC 23
 Supercut Jameson Scissors, Sklarhone™ 27
 Supercut Lister Bandage Scissors, Sklarhone™ 27
 Supercut Mayo Scissors, Sklarhone™ 24
 Supercut Mayo Scissors, Sklarhone™ TC 23
 Supercut Mayo-Stille Scissors, Sklarhone™ TC 23
 Supercut Metzenbaum Scissors, Sklarhone™ 25
 Supercut Metzenbaum Scissors, Sklarhone™
 Sklarlite™ 25
 Supercut Metzenbaum Scissors, Sklarhone™ TC 23
 Supercut Operating Scissors, Sklarhone™ 24
 Supercut Plastic Surgery Scissors, Sklarhone™ 25
 Supercut Potts-Smith Scissors, Sklarhone™ 27
 Supercut Ragnell Scissors, Sklarhone™ 25
 Supercut Stevens Scissors, Sklarhone™ 26
 Supercut Stevens Scissors, Sklarhone™ TC 23

Support, Head 313
 Surface Wipes Disinfectant 6, 214, 248, 392, 424
 Surgical Gown 375
 Surgical Scrub Brush 417
 Surgicron Suture, Non-Absorbable 272

SURGI-OR™

Surgi-OR Adson Bayonet Forcep 322
 Surgi-OR Adson Dressing Forcep 322
 Surgi-OR Adson Tissue Forcep 322
 Surgi-OR Adson-Brown Tissue Forcep 322
 Surgi-OR Allis Tissue Forcep 322
 Surgi-OR Babcock Forcep 322
 Surgi-OR Backhaus Towel Clamp 324
 Surgi-OR Baumgartner Needle Holder 325
 Surgi-OR Baumgartner Needle Holder TC 324
 Surgi-OR Bozeman Forcep 322

Surgi-OR Braun Epistomy Scissors 320
 Surgi-OR Brown Needle Holder 325
 Surgi-OR Collier Needle Holder 325
 Surgi-OR Crile Forcep 322-323
 Surgi-OR Crile-Wood Needle Holder TC 324
 Surgi-OR Derf Needle Holder 325
 Surgi-OR Derf Needle Holder TC 324
 Surgi-OR Dressing Forcep 322
 Surgi-OR Dunaway Dissecting Forcep 323
 Surgi-OR Ferris Smith Tissue Forcep 322
 Surgi-OR Foerster Sponge Forcep 323
 Surgi-OR Freer Elevator 326
 Surgi-OR Graves Vaginal Speculum 325
 Surgi-OR Halsey Needle Holder 325
 Surgi-OR Halsey Needle Holder TC 324
 Surgi-OR Halsted Mosquito Forcep 323
 Surgi-OR Hartmann Mosquito Forcep 323
 Surgi-OR Iris Scissors 320
 Surgi-OR Iris Scissors TC 320
 Surgi-OR Jansen Nasal Forcep 322
 Surgi-OR Joseph Hook 325
 Surgi-OR Kelly Forcep 323
 Surgi-OR Knowles Bandage Scissors 320
 Surgi-OR Lister Bandage Scissors 320
 Surgi-OR Littauer Slitch Scissors 321
 Surgi-OR Lorna Edna Towel Clamp 324
 Surgi-OR Lucae Forcep 322
 Surgi-OR Magill Catheter Forcep 323
 Surgi-OR Mayo Scissors 320-321
 Surgi-OR Mayo Scissors TC 320
 Surgi-OR Mayo-Hegar Needle Holder 325
 Surgi-OR Mayo-Hegar Needle Holder TC 324
 Surgi-OR Metzenbaum Scissors 321
 Surgi-OR Metzenbaum Scissors TC 320
 Surgi-OR Nail Nipper 326
 Surgi-OR Nail Splitter Forcep 326
 Surgi-OR Olsen-Hegar Needle Holder 325
 Surgi-OR Olsen-Hegar Needle Holder TC 324
 Surgi-OR Operating Scissors 321
 Surgi-OR Operating Scissors TC 320
 Surgi-OR Pederson Vaginal Speculum 325
 Surgi-OR Plain Splinter Forcep 322
 Surgi-OR Presbyterian Tube Occluding Clamp 324
 Surgi-OR Probe 326
 Surgi-OR Rankin Kelly Forcep 323
 Surgi-OR Rochester-Ochsner Forcep 323
 Surgi-OR Rochester-Pean Forcep 323-324
 Surgi-OR Russian Tissue Forcep 322
 Surgi-OR Scalpel Handle 326
 Surgi-OR Schmidt Tonsil Forcep 324
 Surgi-OR Schroeder Tenaculum Forcep 324
 Surgi-OR Schweizer Forcep 324
 Surgi-OR Senn Retractor 325
 Surgi-OR Shamburg Comedone Extractor 326
 Surgi-OR Spatula & Packer 326
 Surgi-OR Spencer Stitch Scissors 321
 Surgi-OR Splinter Forcep 322
 Surgi-OR Stevens Scissors 321



Surgi-OR Strabismus Scissors 321
 Surgi-OR Strabismus Scissors TC 320
 Surgi-OR Suture Scissors 321
 Surgi-OR Taylor Hammer 326, 355
 Surgi-OR Tissue Forcep 322
 Surgi-OR Utility Scissors 321
 Surgi-OR Webster Needle Holder 325
 Surgi-OR Webster Needle Holder TC 324
 Surgi-OR Wire Cutting Scissors 321
 Surgi-OR Wire Cutting Scissors TC 320

Suture Forcep, Bonn 70, 139, 151
 Suture Forcep, Castroviejo 67
 Suture Forcep, Manhattan 68
 Suture Forcep, Rhoton 65, 140
 Suture Forcep, Sauer 68
 Suture Removal Tray 367, 226
 Suture Scissors 44-45, 149, 264-266
 Suture Scissors, Littler 265
 Suture Scissors, Merit™ 329
 Suture Scissors, New's 44, 265
 Suture Scissors, Surgi-OR™ 321
 Suture Wire 190, 268
 Suture, Absorbable, Diaxson 270
 Suture, Absorbable, Episyn 270
 Suture, Absorbable, Gut Chromic 270
 Suture, Absorbable, Procrylin 271
 Suture, Non-Absorbable, Bioxapro 272
 Suture, Non-Absorbable, Stainless Steel 272
 Suture, Non-Absorbable, Surgicron 272
 Swab, Cotton 374
 Swedish Needle Holder, TC 92
 Swedish Teat Curette 193
 Swiss Cilia Forcep 71, 153, 314
 Syringe 382
 Syringe Shield, Ear, Merit™ 336
 Syringe Tip, Ear, Merit™ 336
 Syringe, Aspirating 316
 Syringe, Bulb, Disposable 384
 Syringe, Ear, Merit™ 336
 Syringe, Ear/Ulcer, Disposable 384
 Syringe, Piston, Disposable 384

T

Table, Aeron 438
 Table, EDGE 439
 Table, Element Plus 439
 Table, EPT 439
 Table, Optimax 438
 Table, Trend 438
 Tags, Instrument ID 414
 Tape Measure 358
 Tape Measure, Paper, Disposable 385
 Tape, ID Roll, Sklar 414
 Tape, ID Sheet 414
 Taylor Dural Scissors 48
 Taylor Hammer 355

Taylor Hammer, Merit™ 336
 Taylor Hammer, Surgi-OR™ 326, 355
 Taylor Scaler 278

TUNGSTEN CARBIDE

TC Adson Dressing Forcep 54
 TC Adson Tissue Forcep 54
 TC Adson-Brown Tissue Forcep 54
 TC Adson-Gorney Tissue Forcep 54
 TC Allis Tissue Forcep 55
 TC Babcock Forcep 55
 TC Baumgartner Needle Holder 90
 TC Baumgartner Needle Holder, Surgi-OR™ 324
 TC Bihrlle Needle Holder 92
 TC Blepharoplasty Scissors, Sklar Edge™ 22
 TC Castroviejo Needle Holder 94
 TC Corwin Wire Twister 188, 263
 TC Crile-Murray Needle Holder 90
 TC Crile-Wood Needle Holder 90
 TC Crile-Wood Needle Holder, Left 93
 TC Crile-Wood Needle Holder, Surgi-OR™ 324
 TC Cushing Dressing Forcep 55
 TC Debakey Forcep 55
 TC Derf Needle Holder 90, 141
 TC Derf Needle Holder, Surgi-OR™ 324
 TC Dissecting Scissors, Sklar Edge™ 21
 TC Dressing Forcep 54
 TC Finochietto Needle Holder 92
 TC Fomon Rasp 121
 TC Gillies Needle Holder 91
 TC Goldman-Fox Scissors, Sklar Edge™ 21
 TC Halsey Needle Holder 90
 TC Halsey Needle Holder, Surgi-OR™ 324
 TC Heaney Needle Holder 92
 TC Iris Scissors, Sklar Edge™ 20
 TC Iris Scissors, Sklarhone™ 23
 TC Iris Scissors, Surgi-OR™ 320
 TC Jacobson Needle Holder, Micro 94, 141
 TC Julian Needle Holder 92
 TC Kaye Dissecting Scissors, Sklar Edge™ 21
 TC Maltz Rasp 121
 TC Mathieu Needle Holder 94
 TC Mayo Scissors, Sklar Edge™ 20
 TC Mayo Scissors, Sklarhone™ 23
 TC Mayo Scissors, Surgi-OR™ 320
 TC Mayo-Hegar Needle Holder 91
 TC Mayo-Hegar Needle Holder, Left 93
 TC Mayo-Hegar Needle Holder, Surgi-OR™ 324
 TC Mayo-Stille Scissors, Sklar Edge™ 20
 TC Mayo-Stille Scissors, Sklarhone™ 23
 TC Metzenbaum Scissors, Sklar Edge™ 20-21
 TC Metzenbaum Scissors, Sklarhone™ 23
 TC Metzenbaum Scissors, Surgi-OR™ 320
 TC Needle Holder, Laparoscopic 237
 TC Needle Holder, Laparoscopic, Miniature 232
 TC Neivert Needle Holder 90
 TC New Orleans Needle Holder 91

TC Olsen-Hegar Needle Holder 91, 141
 TC Olsen-Hegar Needle Holder, Surgi-OR™ 324
 TC Operating Scissors, Sklar Edge™ 20
 TC Operating Scissors, Surgi-OR™ 320
 TC PAR Needle Holder 90
 TC Pin Cutter 188
 TC Pin Puller 188, 263
 TC Potts-Smith Dressing Forcep 54
 TC Ryder Needle Holder 91
 TC Ryder Needle Holder, Left 93
 TC Sarot Needle Holder 91
 TC Sternal Wire Twister Needle Holder... 91, 188, 263
 TC Stevens Scissors, Sklarhone™ 23
 TC Strabismus Scissors, Sklar Edge™ 21
 TC Strabismus Scissors, Surgi-OR™ 320
 TC Stratte Needle Holder 92
 TC Swedish Needle Holder 92
 TC Wangenstein Needle Holder 92
 TC Webster Needle Holder 90
 TC Webster Needle Holder, Surgi-OR™ 324
 TC Wire & Pin Cutter 188
 TC Wire Cutting Scissors, Sklar Edge™ 22, 263
 TC Wire Cutting Scissors, Surgi-OR™ 320
 TC Wire Puller 188
 TC, Z-Type Parametrium Scissors 22

Teaching/Training Stethoscope 363
 Teat Bistoury, Udall 192
 Teat Curette, Cornell 193
 Teat Curette, Swedish 193
 Teat Dilator 193
 Teat Extractor 193
 Teat Knife, Danish 192
 Teat Knife, Hugs 192
 Teat Knife, Lichty 192
 Teat Scissors, Christensen 192
 Teat Slitter, Danish 192
 Teat, Bistoury, Udall 192
 Teat, Knife, Danish 192
 Teat, Knife, Hugs 192
 Teat, Knife, Lichty 192
 Teat, Scissors, Christensen 192
 Teat, Slitter, Danish 192
 Temporal Wire Speculum 111
 Tenaculum Forcep, Laparoscopic 221
 Tenotomy Scissors, Westcott 49, 136, 266
 Tenzel Bipolar Forcep, Electrosurgical 213
 Tester, hoof 168
 Theobald Probe 126
 Thinners, Blending 165
 Thinners, Canine 165
 Thomas Wax Placer 287
 Thoracic Clamp, Finochietto 86
 Thoracic Clamp, Sklar 86
 Thoracic Forcep, Bridge 87
 Thoracic Forcep, Rumel 87
 Thoracic Forcep, Sarot 87
 Thorek Scissors 40



Thorpe Caliper.....	358
Thorpe Corneoscleral Forcep.....	74
Throat Tray.....	370
Thumb Forcep, Wireform Econo-Sterile™.....	347
Tie Back Set.....	350
Tieck Halle Speculum.....	194
Tip Cleaner Disposable, Electrosurgical.....	211
Tip, Chip Blower.....	124, 309
Tip, Ear Syringe, Merit™.....	336
Tip, Suction, Andrews-Pynchon.....	160
Tip, Yankauer Suction Plastic.....	377, 412
TipGrips™ Instrument Guard Guard.....	413
Tissue & Cuticle Nipper.....	167
Tissue Eye Forcep.....	60, 152, 314
Tissue Forcep.....	59
Tissue Forcep, Adson Sklarlite XD™.....	56
Tissue Forcep, Adson Sklarlite™.....	56
Tissue Forcep, Adson, TC.....	54
Tissue Forcep, Adson-Brown Sklarlite XD™.....	56
Tissue Forcep, Adson-Brown Sklarlite™.....	56
Tissue Forcep, Adson-Gorney, TC.....	54
Tissue Forcep, Allis Surgi-OR™.....	322
Tissue Forcep, Allis, TC.....	55
Tissue Forcep, Babcock, TC.....	55
Tissue Forcep, Bonney.....	63
Tissue Forcep, Brown.....	63
Tissue Forcep, Cooley.....	64
Tissue Forcep, Econo-Sterile™.....	342
Tissue Forcep, Ferris Smith.....	64
Tissue Forcep, Ferris Smith, Merit™.....	330
Tissue Forcep, Gerald.....	62
Tissue Forcep, Graefe, Merit™.....	330
Tissue Forcep, Heaney.....	62
Tissue Forcep, Martin.....	63
Tissue Forcep, Merit™.....	331
Tissue Forcep, Potts-Smith.....	61
Tissue Forcep, Russian.....	63
Tissue Forcep, Russian, Merit™.....	330
Tissue Forcep, Russian, Surgi-OR™.....	322
Tissue Forcep, Semkin.....	61
Tissue Forcep, Sklarlite XD™.....	56
Tissue Forcep, Sklarlite™.....	56
Tissue Forcep, Stille.....	60
Tissue Forcep, Stone.....	62
Tissue Forcep, Surgi-OR™.....	322
Tissue Forcep, Wangenstein.....	64
Tissue Forcep, Wireform Econo-Sterile™.....	347
Tissue Nipper.....	166
Tissue Nipper, Merit™.....	337
Tissue Nipper, Sklarlite™.....	166
Titan Anesthesia Machine.....	436
Toenail Nipper, Small Animal.....	167
Tonometer, Schiotz.....	158, 355
Tonsil Forcep, Colver-Coakley.....	83
Tonsil Forcep, Sawtell.....	83
Tonsil Forcep, Schmidt.....	83
Tonsil Forcep, Schmidt, Merit™.....	332
Tonsil Forcep, Schmidt, Surgi-OR™.....	324

Tooke Knife.....	157
Toothbrush.....	386
Tourniquet.....	372
Tourniquet, N-1.....	357, 372
Tourniquet, N-1, Clip.....	357, 372
Tourniquet, N-1, Tubing.....	357, 372
Towel Clamp, Disposable.....	385, 411-412
Towel Clamp, Hoff.....	84
Towel Clamp, Hoff, Plastic.....	411
Towel Clamp, Jones, Merit™.....	333
Towel Clamp, Peers, Merit™.....	333
Towel Clamp, Plastic.....	385, 411-412
Towel Clamp, Roeder.....	85, 174
Towel Forcep, Wireform Econo-Sterile™.....	347
Towel, OR, Disposable.....	376
Towel, OR, Disposable, PurCotton.....	18, 376
Towner Scaler.....	278
Tracheal Hook, News.....	120
Tracheal Retractor.....	104, 118
Tracheal Tube, Cleaning Brush.....	416
Tracheotomy Tube, Jackson.....	161-162
Tracheotomy Tube, Jackson, Set.....	161
Trachoma Forcep, Prince.....	154

TRAYS

Tray Cover, Catheter Instrument, Stainless Steel.....	393
Tray Cover, Instrument, Stainless Steel.....	395-396
Tray Cover, Sterilization, Stainless Steel.....	396
Tray, Basin, Basic.....	365
Tray, Basin, Start-up.....	365
Tray, Castration.....	370
Tray, Catheter Instrument, Stainless Steel.....	393
Tray, Catheter Instrument, Stainless Steel, Miniature.....	392
Tray, Equine.....	369
Tray, Eye.....	370
Tray, Field Service.....	370
Tray, General.....	226, 367
Tray, Incision & Drainage.....	368
Tray, Instrument Drying, Stainless Steel.....	394
Tray, Instrument, Stainless Steel.....	393-397
Tray, Laceration.....	366
Tray, Mare.....	370
Tray, Mayo, Stainless Steel.....	393
Tray, Micro Sterilization, Stainless Steel.....	397
Tray, OR Towel.....	368
Tray, Plastic.....	409
Tray, Plastic Instrument Soaking.....	409
Tray, Plastic Procedure.....	409
Tray, Staple Removal.....	367, 226
Tray, Start-up.....	365
Tray, Sterilization, Stainless Steel.....	396-397
Tray, Sterilization/Bath Set, Stainless Steel.....	396
Tray, Suture Removal.....	367, 226
Tray, Throat.....	370

Trend Table.....	438
Triangle Bandage.....	374
Trimmer, Nail.....	167
Trimmer, Nail, Bird.....	168
Trocar, Duke Improved.....	129
Trocar, Hurwitz.....	129
Trocar, Laparoscopic.....	228-229
Trocar, Laparoscopic, Disposable.....	244
Trocar, Laparoscopic, Miniature.....	233
Trocar, Laparoscopic, Single Port.....	216
Trocar, Nelson.....	129
Trocar, Ochsner.....	129
Trocar, Set.....	129
Troutman Barraquer Corneal Forcep.....	69, 151
Tru-Punch™ Biopsy Punch, Disposable.....	381
Tru-Punch™ Biopsy Punch, Disposable, Set.....	381
Tube Occluding Clamp, Presbyterian, Econo-Sterile™.....	344
Tube Occluding Clamp, Presbyterian, Merit™.....	333
Tube Occluding Clamp, Presbyterian, Surgi-OR™.....	324
Tube Occluding Forcep, St. Vincent, Merit™.....	333
Tube, Laryngectomy, Jackson.....	162
Tube, Plastic Specimen.....	407
Tube, Suction, Adson.....	160
Tube, Suction, Andrews-Pynchon.....	160
Tube, Suction, Anthony.....	160
Tube, Suction, Buie.....	160
Tube, Suction, Coupland.....	160
Tube, Suction, Disposable.....	377
Tube, Suction, Ear.....	160
Tube, Suction, Frazier.....	159
Tube, Suction, Frazier Ferguson.....	159
Tube, Suction, Poole.....	159
Tube, Suction, Yankauer.....	159
Tube, Suction, Yankauer, Plastic.....	377, 412
Tube, Tracheotomy Set, Jackson.....	161
Tube, Tracheotomy, Jackson.....	161-162
Tubing Clamp, Plastic.....	410
Tubing Clamp, Vorse, Merit™.....	333
Tubing, Tourniquet, N-1.....	357, 372
Tuffier Spreader.....	115
Tumbler, Stainless Steel.....	388
Tuning Fork Set.....	355
Tuning Fork, Aluminum Alloy.....	355
Tuttle Forcep.....	64
Tuttle Forcep, Sklar Blue™.....	202
Tweezer, Protector Soldering.....	274
Twister, Corwin Wire, TC.....	188, 263
Tyrell Hook, Merit™.....	334
Tyrell Iris Hook.....	117

U

Udall Teat Bistoury.....	192
Umbilical Scissors, Merit™.....	329
Universal Scaler.....	276
University of Michigan Burnisher.....	290



University of Minnesota Cheek Retractor.....	311
Unna Comedone, Merit™.....	335
US Army Retractor.....	105
US Army Scissors.....	52
Utility Bowl, Plastic.....	408
Utility Forcep, Bonaccolto.....	67
Utility Forcep, Colibri Corneal.....	69, 151
Utility Forcep, McCullough.....	67
Utility Forcep, Merit™.....	331
Utility Forcep, Nugent.....	67
Utility Forcep, Plastic.....	410
Utility Forcep, Wills.....	67
Utility Scissors.....	46
Utility Scissors, Commander.....	52
Utility Scissors, Hercules.....	51
Utility Scissors, Merit™.....	329
Utility Scissors, Ribbon.....	46
Utility Scissors, Surgi-OR™.....	321

V

Vaginal Retractor, Lateral, Sklar Blue™.....	201
Vaginal Speculum, Graves.....	194, 356
Vaginal Speculum, Graves, Econo-Sterile™.....	346
Vaginal Speculum, Graves, Merit™.....	334
Vaginal Speculum, Graves, Sklar Blue™.....	201
Vaginal Speculum, Graves, Surgi-OR™.....	325
Vaginal Speculum, Pederson.....	194, 356
Vaginal Speculum, Pederson, Econo-Sterile™.....	346
Vaginal Speculum, Pederson, Merit™.....	334
Vaginal Speculum, Pederson, Sklar Blue™.....	201
Vaginal Speculum, Pederson, Surgi-OR™.....	325
Valve, Laparoscopic.....	229
Van Buren Sound.....	128
Van Buren Sound Set.....	128
Vanguard Splinter Pick.....	73
Vannas Scissors.....	50, 137
Vannas Scissors, Micro.....	50, 138
Vehe Carver.....	286
Verbrugge Bone Forcep.....	175
Vessells Towel Forcep, Merit™.....	333
Veterinary Needle.....	262
Vienna Speculum.....	194, 356
Vienna Speculum, Merit™.....	337
Vinyl Gloves.....	387
Virchow Knife.....	318
Virchow Skull Breaker.....	318
Virtus Splinter Forcep.....	73
Virtus Splinter Forcep, Merit™.....	331
Vision Excel Light.....	437
Vision LED Light.....	437
Vista Light.....	437
Volkman Bone Curette.....	185
Volkman Hook.....	119, 187
Volkman Retractor.....	103, 186
Vorse Tubing Clamp, Merit™.....	333
Vortex Light.....	437

W

Wachenfeldt Forcep.....	267
Wagner Scissors.....	40, 302
Wagner Scissors, Sklarcut™.....	29
Wagner Scissors, Sklarlite™ Sklarcut™.....	30
Walls Carver.....	286
Walter Splinter Forcep.....	73
Walther Dilator.....	127
Walton Foreign Body Gouge.....	158
Wangensteen Needle Holder.....	100
Wangensteen Needle Holder, TC.....	92
Wangensteen Tissue Forcep.....	64
Ward Carver.....	286
Wartenberg Pinwheel, Merit™.....	336
Wave Forcep, Laparoscopic, Disposable.....	242
Waveline EZ Monitor.....	440
Waveline Provet Monitor.....	440
Waveline Touchvet Monitor.....	440
Wax Carver, Hollenback.....	287
Wax Carver, Le Cron.....	287
Wax Carver, Roach.....	286
Wax Carver, Thomas.....	287
Wax Carver, Vehe.....	286
Wax Carver, Walls.....	286
Wax Carver, Ward.....	286
Wax Spatula.....	292
Wax Spatula, Gritman.....	292
Webster Needle Holder.....	97
Webster Needle Holder, Econo-Sterile™.....	345
Webster Needle Holder, Merit™.....	333
Webster Needle Holder, Sklarlite XD™.....	95
Webster Needle Holder, Sklarlite™.....	95
Webster Needle Holder, Surgi-OR™.....	325
Webster Needle Holder, Surgi-OR™ TC.....	324
Webster Needle Holder, TC.....	90
Weingartner Ear Forcep.....	131
Weisman Curette.....	134
Weitlaner Retractor.....	112-113
Weitlaner Retractor, Merit™.....	334
Weitlaner-Beckman Retractor.....	113
Weitlaner-Paparella Retractor.....	113
Wertheim-Cullen Pedicle Forcep.....	88
Werthiem Clamp.....	88
Wesson Mouth Gag.....	310, 357
Westcott Tenotomy Scissors.....	49, 136, 266
White Emasculator.....	198
White Nail Clippers.....	167
Wiener Corneal Hook.....	119
Wilde Forcep.....	72, 133
Wilde Forcep, Merit™.....	331
Williams Lachrymal Probe.....	126
Williams Probe.....	283
Williams Speculum.....	109, 143, 314
Williams Speculum, Eye.....	109, 143
Williams Splinter Forcep.....	73, 303
Williger Bone Curette.....	185

Wills Utility Forcep.....	67
Wilmer Scissors.....	41
Winter Placenta and Ovum Forcep.....	195
Wire & Pin Cutter, TC.....	188
Wire Cutter & Parallel Pliers.....	189
Wire Cutting Scissors.....	45, 266
Wire Cutting Scissors, Econo-Sterile™.....	340
Wire Cutting Scissors, Merit™.....	329
Wire Cutting Scissors, Sklar Edge™ TC.....	22, 263
Wire Cutting Scissors, Surgi-OR™.....	321
Wire Cutting Scissors, Surgi-OR™ TC.....	320
Wire Puller, TC.....	188
Wire Retaining Retractor.....	111
Wire Speculum.....	110, 144, 156
Wire Speculum, Barraquer.....	110, 144, 156
Wire Speculum, Feaster.....	110
Wire Speculum, Temporal.....	111
Wire Twister, Corwin, TC.....	188, 263
Wire, Kirschner.....	190
Wire, Suture.....	190, 268
Wireform Halsted Forcep, Econo-Sterile™.....	347
Wireform Kelly Forcep, Econo-Sterile™.....	347
Wireform Needle Holder, Econo-Sterile™.....	347
Wireform Scissors, Econo-Sterile™.....	347
Wireform Sponge Forcep, Econo-Sterile™.....	347
Wireform Thumb Forcep, Econo-Sterile™.....	347
Wireform Tissue Forcep, Econo-Sterile™.....	347
Wireform Towel Forcep, Econo-Sterile™.....	347
Woodson Filling Instrument.....	289
Wound Clip Forcep.....	268

X

X-Line, Disposable Laparoscopic.....	243
X-Ray Sponge, Gauze.....	371

Y

Yankauer Suction Tip, Plastic.....	377, 412
Yankauer Suction Tube.....	159
Yankauer Suction Tube, Plastic.....	377, 412
Younger Good Scaler.....	278

Z

Zalkind Ribbon Retractor.....	106
Zaufel Jansen Ronguer.....	169
Ziegler Cilia Forcep.....	71, 153, 315
Z-Type Parametrium Scissors, TC.....	22



SKLARLITE™

STERILIZATION CONTAINER SYSTEM

The SklarLite™ Rigid Sterilization Container System provides an organized, routine and secure approach to the sterilization of surgical instruments. Customize your SklarLite™ System by selecting colored lids and ID labels. Available in your choice of six vibrant colors for easy identification of instrument sets by procedure and/or department. Choose from various configurations to fit your needs.



VISIT OUR WEBSITE WWW.SKLARCORP.COM FOR MORE INFORMATION



The Tradition Continues

SKLAR-STAT™ Automatic Foam Dispenser

Motion activated, battery powered and wall-mounted, Sklar's Automatic Foam Dispenser allows for easy access and reduced risk of cross contamination. Ideal for use in hospitals, medical centers, offices, schools and any high-traffic public area with multiple users.



PRODUCT NUMBER	FEATURES	QUANTITIES
10-2856	Wall Mount Dispenser	1 Each
10-2854	1000ml Refil Bottles	6/Case
10-2858	(2) cs 1000ml Refill Bottles Plus Free Wall Mount Dispenser	1 Set



889 South Matlack Street
West Chester, PA 19382

800.221.2166

610.430.3200

Fax: 610.696.9007

International Phone: 610.430.3200

International Fax: 610.430.3941

surgi@sklarcorp.com

international@sklarcorp.com

www.sklarcorp.com

DISTRIBUTED BY:

