



DENTAL

GENERAL/SPECIALTY
INSTRUMENTS AND ACCESSORIES



Orthodontic Instrumentation
Endodontic Solutions
Instrument Care & Cleaning
Disposable Instruments & Accessories

800.221.2166 | www.sklarcorp.com



SKLAR SOAK™

INSTRUMENT PRE-SOAK & DECONTAMINANT

SKLAR SOAK is an effective pre-cleaner that breaks down bio-burden, lifting blood and other organic debris from the surface, while penetrating box locks and crevices. The rust inhibitor protects the delicate chromium oxide layer of the instrument, thus defending against rust and corrosion. Using SKLAR SOAK™ as a pre-cleaner is the first line of defense against rust, prolonging the life of the instrument and therefore protecting your investment!

SKLAR SOAK is ideal for use on all stainless steel instruments:

- PH balanced, designed specifically for stainless steel instruments.
- Intermediate level disinfectant with broad spectrum of efficacy.
- Rust resistant.
- Non-caustic.
- Ready to use.
- No special handling or disposal.
- Fragrant, no offensive odors.
- Non-glutaraldehyde.



KEEP OUT OF REACH OF CHILDREN
CAUTION
 See back panel for additional precautionary statements

PRODUCT NUMBER	FEATURES	QUANTITIES
10-1603	1 Gallon Bottles	4/case
10-1609	1 Gallon Bottle	1 bottle

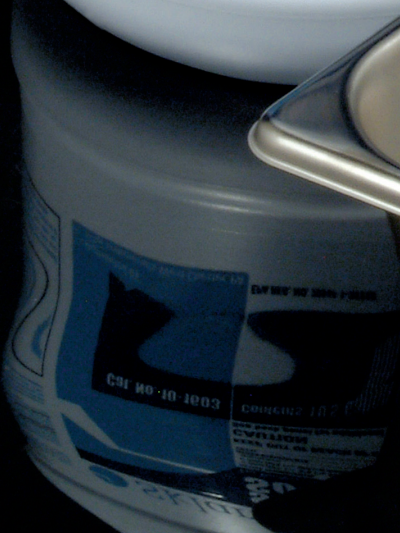



Care & Cleaning 3-18

General Dentistry 19-47

Diagnostics 48-56

Endodontics 57-60

Orthodontics 61-77

Periodontal 78-89

Prosthodontic 90

Surgical 91-155

Dental Sets 156-165

Econo Sterile 166-173

Dental Accessories 174-188

Literature 189-191

Blades and Scalpels 192-195

Protective Apparel 196

Stainless Steelware 197-215

Plasticware..... 216-218

Instrument Protectors & ID 219-220

Brushes 221-226

Care and Cleaning 227-242

Index 243-264



DISCLAIMERS:

Sklar offers a full line of quality surgical products and services to meet your needs.

Product information within this catalog is intended to provide general information about Sklar, its products and services and makes no representation either expressed or implied to the contrary. It is not meant to provide specialist advice or instructions concerning the products available from Sklar. For additional information and special inquiries concerning our products and services, please contact Sklar directly.

In an effort to continually improve our product line, Sklar reserves the right to change patterns without notice. Contact your sales representative to verify availability.

In no event is Sklar liable for any incidental, special or exemplary damages or loss of profits in connection with the use of a Sklar Instrument or Product.

Convenience Kits (FDA recognized term) illustrated in this catalog are representative of Sklar's assembly capability. The final design and approval of the kit is the responsibility of the customer and will be managed in accordance with the Sklar Design and Development process.

©Copyright 2013
Sklar Corporation
889 S. Matlack Street
West Chester, PA 19382

Phone: 800.221.2166
Fax: 610.696.9007
Email: Surgi@sklarcorp.com

International
Phone: 610.430.3200
Fax: 610.430.3941
Email: International@sklarcorp.com

ORDERS

- Sklar's full line of Instrument Products are available through any authorized Sklar Distributor. Contact our Customer Service Department at 800.221.2166 to locate a Sales Representative in your area.
- Customers with established accounts and in good standing are subject to Net 30 days from date of invoice. Poor credit conditions can result in denial, delay or cancellation of orders.

SHIPMENTS

- Pricing is FOB West Chester PA unless otherwise noted and may be subject to change. Shipping schedules are approximate and subject to change without notice. Same day shipping is available. Standard orders will be shipped via the carrier of Sklar's choice. Special shipping requests will be accepted but additional handling charges are applicable.
- All Sklar instruments and product are carefully inspected prior to shipment. Customers shall inspect all items upon receipt and file a claim within (10) days of receipt of shipment.

WARRANTY

- Instruments and Products are recommended for their intended use only, and require continuous and proper care. Misuse can damage instruments and products and void the warranty.
- All Sklar instruments are guaranteed to be free from defect in material and workmanship. Defective instruments may be returned for repair or replacement at no charge. Repair or replacement is at the discretion of Sklar. Warranty is void on any instrument serviced by any company other than Sklar Instrument Repair Services.
- Sklar offers a variety of supplementary surgical products. These products are held to high standards for material and craftsmanship and some are subject to a limited warranty (vary by product).
- Standard sterile kits may be returned within 30 days, provided sterility of the inner packs have not been compromised, package is unopened and resalable.
- Most cleaning products are non-returnable.

RETURNS

- A Returned Goods Authorization (RGA) number must be obtained prior to returning products to Sklar. Contact our Customer Service Department at 800.221.2166 for authorization and complete return instructions. Following an investigation, any credit, repair or replacement will be issued at Sklar's discretion.





Sklar is pleased to offer a full line of Care & Cleaning agents to disinfect, decontaminate, sterilize, lubricate and protect your stainless steel surgical instruments and equipment. For expert care of your surgical instruments at every stage of the cleaning process, trust Sklar to deliver the right cleaning agent for you.



3 EASY STEPS FOR THE CARE AND CLEANING OF YOUR INSTRUMENTS

1 DECONTAMINATION

Sklar Disinfectants are a pre-cleaner and disinfectant for the safe decontamination of soiled surgical instruments, medical and surgical equipment and inanimate surfaces including plastics, stainless steel, chrome, glass, Plexiglas and baked on painted surfaces.

Disinfectants are effective against a broad range of pathogens in as little as 2 minutes.



2 CLEANING

Sklar carries a complete line of effective detergents and enzymatics for cleaning, not only for your surgical instruments, but also metals, glassware, plastic and rubber. Available in your choice of powder, liquid concentrate or spray foams.



3 LUBRICATION

To guarantee extended life and performance of your surgical instruments, choose one of Sklar's lubricants or sprays as the final step in your instrument processing regimen. Specifically designed to protect against corrosion, rust and staining, Sklar offers several different types of lubricants to protect your investments.



SKLAR-CIDE™

HIGH LEVEL DISINFECTING/STERILIZING SOLUTION

Sporicidal • Bactericidal • Virucidal • Fungicidal

SKLAR-CIDE provides a safe and efficient means for the high-level disinfection or sterilization of medical, ophthalmic, dental and surgical devices including endoscopes and lensed instruments. It may be used as a standard soak solution or in automatic reprocessing units set at room temperature. Unlike other solutions, there is no need to increase the solution temperature to provide high-level disinfection in 25 minutes.

SKLAR-CIDE is a surfactant-free, activated glutaraldehyde liquid chemical sterilant and high-level disinfectant. Its active ingredient is glutaraldehyde in a nominal concentration of 3%. When the powdered activator is added, the solution turns green in color to indicate its readiness for use. In addition to the active ingredient, this ready-to-use solution contains buffers, wetting agents, and a rust and corrosion inhibitor and it has a pleasant fragrance.

SKLAR-CIDE produces high-level disinfection at room temperature in as little time as 25 minutes, and complete sterilization in 10 hours at room temperature.

- Reusable for 28 days instead of 14, safer and saves time and money.
- Surfactant free - Will not damage scope surfaces or cloud lenses.
- Can be used safely on all devices, including instruments and endoscopes. No need to stock several products.

PRODUCT NUMBER	FEATURES	QUANTITIES
10-1623	28 HLD 1 Gallon Bottles	4/case
10-1624	28 HLD 1 Gallon Bottle	1 bottle

GLUTARALDEHYDE STRIPS

PRODUCT NUMBER	FEATURES	QUANTITIES
96-4105	2.1% MEC 60 Strips / Bottle	2 bottles/case





SKLAR DISINFECTANT

2 MINUTE KILL TIME

READY-TO-USE SPRAY SURFACE DISINFECTANT

- Ready to use, non-toxic formula.
- Specially formulated for the control of cross contamination.
- Effective against a broad range of pathogens including H1N1, HIV-1, HPV, VRE, Norovirus, Hep B & C as well as TB, MRSA and A. Baumannii.
- Safe for all areas of the facility including the NICU, operating rooms, isolation rooms, patient care areas and laboratories.
- Satisfies OSHA's Bloodborne Pathogen Standards.
- Non-irritating formula.
- EPA registered.

PRODUCT NUMBER	FEATURES	QUANTITIES
10-1643	24 oz. Spray Bottles	6/case
10-1642	24 oz. Spray Bottle	1 bottle
10-1653	1 Gallon Bottles	4/case
10-1654	1 Gallon Bottle	1 bottle
10-1644	2.5 Gallon Bottles	2/case



SKLAR DISINFECTANT SURFACE WIPES

READY-TO-USE, PRE-MOISTENED TOWELETTES

SAME EFFECTIVE FORMULA AS
SKLAR DISINFECTANT!

- Ready to use, non-toxic formula.
- Specially formulated for the control of cross contamination.
- Effective against a broad range of pathogens including H1N1, HIV-1, HPV, VRE, Norovirus, Hep B & C as well as TB, MRSA and A. Baumannii.
- Safe for all areas of the facility.
- Satisfies OSHA's Bloodborne Pathogen Standards.
- Destroys odor-causing bacteria.
- 7" x 10" non-woven, tear resistant towelette.
- Clean scent.
- EPA registered.



PRODUCT NUMBER	FEATURES	QUANTITIES
10-1616	100 Towelettes / Canister	6/case
10-1617	100 Towelettes / Canister	12/case



SKLAR SPRAY-ZYME™

SURGICAL INSTRUMENT PRE-CLEANER

Multi-Enzyme Based Instrument Presoak & Cleaner Foam Spray Cleaner

The newest product from Sklar for expert care of your surgical instruments. This multi-enzymatic spray creates a heavy foam which lasts for hours, keeping soiled instruments moist to avoid encrustation while also pre-cleaning prior to processing.

- Prevents Organic Encrustation - enzyme foam stops blood and bodily fluids from drying onto surgical instruments.
- No More Spills - messy spills between the operating room and central cleaning / processing department are eliminated.
- Neutral pH - safe and effective for stainless steel, tungsten carbide, aluminum and brass instruments.
- Bacteriostatic - microbiological control agents inhibit bacterial growth in the ready-to-use foam solution.
- Long Lasting Foam - saves time, foam lasts many hours after application.
- Multi-Enzymatic - contains a synergistic blend of lipase and protease enzymes.

PRODUCT NUMBER	FEATURES	QUANTITIES
10-2722	22 oz. Refillable Spray Bottles	12/case
10-2724	1 Gallon Bottles	4/case



SKLAR SOAK™

INSTRUMENT PRE-SOAK & DECONTAMINANT RUST RESISTANT!

Immersing soiled instruments in SKLAR SOAK effectively pre-cleans and decontaminates, without fear of rusting!

SKLAR SOAK is an effective pre-cleaner that breaks down bio-burden, lifting blood and other organic debris from the surface, while penetrating box locks and crevices. The rust inhibitor protects the delicate chromium oxide layer of the instrument, thus defending against rust and corrosion. Using SKLAR SOAK™ as a pre-cleaner is the first line of defense against rust, prolonging the life of the instrument and therefore protecting your investment!

Soaking for only two minutes thoroughly decontaminates instruments, reducing the risk of exposure to pathogens such as H1N1, HIV-1, HPV, VRE, Norovirus, Hep B & C as well as TB, MRSA and A. Baumannii. However, because SKLAR SOAK™ contains a rust inhibitor, instruments may soak for several hours without fear of rusting! Employees are protected from cross contamination, and at the same time can enjoy the freedom to reprocess instruments when it's convenient!

SKLAR SOAK is ideal for use on all stainless steel instruments:

- PH balanced, designed specifically for stainless steel instruments.
- Intermediate level disinfectant with broad spectrum of efficacy.
- Rust resistant.
- Non-caustic.
- Ready to use.
- No special handling or disposal.
- Fragrant, no offensive odors.
- Non-glutaraldehyde.

PRODUCT NUMBER	FEATURES	QUANTITIES
10-1603	1 Gallon Bottles	4/case
10-1609	1 Gallon Bottle	1 bottle





SKLAR INSTRU-GUARD™ ONE STEP

**A “ONE STEP” INSTRUMENT
CLEANER AND LUBRICANT**

EXTENDS INSTRUMENT LIFE!

SKLAR INSTRU-GUARD ONE STEP contains a penetrating lubricant that protects and helps extend the life of surgical instruments. The detergents and emulsifiers quickly break up and remove organic soils from box locks and other hard to reach places.

SKLAR INSTRU-GUARD ONE STEP contains four rust inhibitors to control corrosion and eliminate scaling and spotting. It does not contain phosphates and can reduce the time and cost involved in processing your instruments by cleaning and lubricating in one easy step.

PRODUCT NUMBER	FEATURES	QUANTITIES
10-2800	1 Gallon Bottles	4/case
10-2801	1 Gallon Bottle	1 bottle



SKLAR INSTRU-GUARD™ LUBE

SURGICAL INSTRUMENT LUBRICANT / RUST INHIBITOR

- Increase the Life of Instruments.
- Protects all Surgical Instruments.

SKLAR INSTRU-GUARD LUBE is an easy-to-use, water soluble, lubricant and rust inhibitor. When used daily as a rinse after every cleaning it keeps moving parts operating smoothly and remains effective after autoclaving, but without leaving an oily residue.

Regular lubrication is essential no matter which cleaning method is employed (including ultrasonic). SKLAR INSTRU-GUARD LUBE is ideal for maintaining instrument quality and performance.

PRODUCT NUMBER	FEATURES	QUANTITIES
10-1635	1 Gallon Containers Concentrated	4/case
10-1634	1 Gallon Container Concentrated	1 container
10-1636	8 oz. Spray Bottles	12/case
10-1637	8 oz. Spray Bottle	1 bottle





SKLAR KLEEN™

LOW FOAM, LIQUID DETERGENT AND POWDERED FORMULA

Regular Formula for Manual and Ultrasonic Cleaning

SKLAR KLEEN is non-corrosive, non aggressive, phosphate free and biodegradable. We have specifically developed SKLAR KLEEN for manual and ultrasonic cleaning. It is moderately alkaline, affording optimum cleaning without etching glassware or attacking instrument metal.

Low Foam Formula for Automatic Cleaning

The SKLAR KLEEN Low Foam Liquid is concentrated in order to provide a very cost-effective solution. It is especially formulated to maintain low foam, ensuring effective and trouble-free action in washer/sterilizers and tunnel washers. Dispersing quickly, the SKLAR KLEEN Low Foam formula is also well suited for automatic injection systems.

PRODUCT NUMBER	FEATURES	QUANTITIES
10-2701	Low Foam 1 Gallon Bottles	4/case
10-1608	Powdered 5 lb. Containers	4/case
10-1607	Powdered 5 lb. Container	1 container
10-1630	Powdered 3.5 lb. Pitchers	6/case
10-2765	Powdered 3.5 lb. Pitcher	1 pitcher
10-1612	Liquid 8 oz. Bottles	6/case
10-1614	Liquid 8 oz. Bottle	1 bottle
10-1613	Liquid 1 Gallon Bottles	4/case
10-1627	Liquid 1 Gallon Bottle	1 bottle



SKLAR-SHEEN™

AUTOCLAVE AND INSTRUMENT CLEANER AND CONDITIONER

With an efficacious phosphoric acid cleaning agent, Sklar Sheen is a robust spot, stain and rust remover. Ideal for dissolving hard water deposits, use in autoclaves to quickly cut through steam sterilizer scale and deposits.

Verstile and effective, SKLAR SHEEN couples powerful stain and rust removers with corrosion inhibitors, making it tough on stains but gentle on instruments. Recondition instruments to restore them to nearly brand new working condition.

Use to clean and recondition any stainless steel surface to its original luster, including carts, trays and basins.

- Conditions for lasting protection.
- Dissolves hard water deposits.
- Frees up frozen box locks.
- Restores and extends surgical instrument life.

PRODUCT NUMBER	FEATURES	QUANTITIES
10-2730	Stain & Rust Remover	1 gallon bottle
10-2732	Stain & Rust Remover	4/case
10-2736	Spray Foam Autoclave Cleaner & Conditioner	22oz. bottle
10-2738	Spray Foam Autoclave Cleaner & Conditioner	12/case





SKLAR ENZYMATIC™ DETERGENT

MULTI-ENZYME DETERGENT CONCENTRATE

100% Biodegradable

SKLAR ENZYMATIC Detergent is a low-foaming, fast acting detergent specifically designed for use when instruments and/or cloth materials become soiled with organic debris.

SKLAR ENZYMATIC Detergent may be used as a manual instrument cleaner as well as a pre-soak for blood-contaminated linens, clothing and instruments. It is also used in ultrasonic units and in washer/sterilizer/decontaminators. When used as directed, the enzymatic pH neutral formula is safe for use on rubber, plastic, stainless steel instruments, and surgical equipment as well as cloth.

PRODUCT NUMBER	FEATURES	QUANTITIES
10-2777	1 Gallon Bottles	4/case
10-2775	1 Gallon Bottles	2/case
10-2776	1 Gallon Bottle	1 bottle



3 EASY STEPS FOR THE CARE AND CLEANING OF YOUR INSTRUMENTS

DECONTAMINATION

1 SKLAR SPRAY DISINFECTANT™ Disinfectant / Decontaminant Cleaner

SKLAR DISINFECTANT is a pre-cleaner and disinfectant for the safe decontamination of soiled surgical instruments, medical and surgical equipment, and inanimate surfaces including plastics, stainless steel, chrome, glass, Plexiglas and baked on painted surfaces. The use of SKLAR DISINFECTANT for 2 minutes kills infectious organisms including H1N1, HIV-1, HPV, VRE, Norovirus, Hep B & C, as well as TB, MRSA, and A-Baumannii.



CLEANING

2 SKLAR KLEEN™ DETERGENTS AND ENZYMATICS

Sklar has an array of agents for effectively cleaning not only your surgical instruments, but for other metals, glassware, plastic, and rubber. SKLAR KLEEN detergent is available as a powder or liquid. Our enzymatic products, specially formulated for processing instruments heavily laden with organic debris, are concentrated and available in a variety of sizes. Sklar also offers SPRAY-ZYME™ a new foam spray pre-cleaner.



Choose The Cleaning Product Right For You!

LUBRICATION

3 SKLAR LUBRICANT AND SPRAY LUBE™

SKLAR LUBE should be a part of your instrument processing regimen to guarantee extending the life and performance of this very important investment. Sklar offers several different types of lubricant to suit your needs. All designed specifically for surgical instruments, they each contain rust inhibitors to protect against corrosion, rusting, and staining.



YOUR FINAL STEP IS AUTOCLAVE STERILIZATION Your Instruments Will Look And Work Like New!



SKLAR STAT™

INSTANT FOAM HAND SANITIZER

KILLS 99% OF GERMS IN LESS THAN 15 SECONDS!

SKLAR-STAT Instant Foam Hand Sanitizer, based on the active ingredient Benzalkonium Chloride, is a unique formulation featuring exceptional skin feel, conditioning and moisturizing properties. The efficacy of this product has been confirmed to reduce *S. Aureus* 99.999% and *S. Aureus* MRSA 99.9% in as little as 15 seconds. SKLAR-STAT Instant Foaming Hand Sanitizer produces a fast drying, non-sticky foam that contains unique conditioning and moisturizing ingredients, leaving the skin with a soft, silky after-feel.

PRODUCT NUMBER	FEATURES	QUANTITIES
10-2850	50 ml Pump Dispensers	24/case
10-2852	550 ml Pump Dispensers	12/case

SKLAR STAT™

AUTOMATIC FOAM DISPENSER

Motion activated, battery powered and wall-mounted, Sklar's AUTOMATIC FOAM DISPENSER allows for easy access and reduced risk of cross contamination. Ideal for use in hospitals, medical centers, offices, schools and any high-traffic public area with multiple users.



PRODUCT NUMBER	FEATURES	QUANTITIES
10-2856	Wall Mount Dispenser	1 Each
10-2854	1000ml Refill Bottles	6/case
10-2858	(2) Cases 1000ml Refill Bottles plus Free Wall Mount Dispenser	1 Set

- Alcohol-Free
- Non-Sticky
- Moisturizes and Conditions Hands

1. Pump a small amount into palm of hand.
2. Rub thoroughly over both surfaces of both hands.
3. Rub hands together briskly until dry.



SKLAR FRESH™

LIQUID SPRAY ODOR ABSORBER

SKLAR FRESH is an environmentally friendly blend of pure biodegradable organic essential oils and trace elements. It is a non-allergenic liquid spray that neutralizes odors at their source. Simply spray SKLAR FRESH directly in the air or on the source (i.e. bathrooms, refuse, soiled items from vomitus, incontinence odors, etc.)

PRODUCT NUMBER	FEATURES	QUANTITIES
10-2842	22 oz. Spray Bottles	12/case

SKLAR POLISH™

INSTRUMENT STAIN REMOVER

Non-Abrasive

SKLAR POLISH is an effective stain remover for use on all your metal surgical instruments, including stainless steel, chrome and brass. It will brighten instrument trays, basins and racks and may also be used on porcelain and tile surfaces.



PRODUCT NUMBER	FEATURES	QUANTITIES
10-1626	8 oz. Jars	12/case
10-1629	8 oz. Jars	6/case
10-1927	8 oz. Jar	1 jar





SKLAR INSTRUMENT CARE KIT

A Trio of Sklar's Care and Cleaning products to keep instruments in tiptop shape.

PRODUCT NUMBER	FEATURES	QUANTITIES
10-1625		
	Sklar Lube™ 8 oz. Spray Bottle	1 each
	Sklar Kleen™ Liquid 8 oz. Bottle	1 each
	Sklar Polish™ 8 oz. Jar	1 each
	Stainless Steel Bristle Cleaning Brush	1 each
	Nylon Bristle Cleaning Brush	1 each



TROUBLE SHOOTING

NO STEEL IS TRULY "STAINLESS"

It's a fact that so-called stainless steel is subject to both water-spotting and staining. However what many people identify as a "rust" problem usually turns out to be something else.

Most often the problem is actually a stain caused by a surface deposit. These deposits appear in a variety of colors depending upon the type of deposit involved. Once the cause is found and eliminated, most of the time the problem quickly diminishes or disappears completely.

As you probably know, stainless steel is ideally suited for the surgical suite because it is rust resistant, it can be honed to an extremely sharp edge or fine point,

and it can be hardened to maintain the delicate, yet precise, requirements of the surgeon. But it is this hardenable quality – the amount of carbon used during the manufacturing process – coupled with harsh chemicals and improper care that renders stainless steel susceptible to corrosion.

To protect your instrument investment, Sklar cleaning agents have been specifically formulated to provide cost effective instrument care solutions that help maintain the life and performance of your valuable stainless steel instruments.

TROUBLE SHOOTING

CORROSION

- Problem:** Debris and residue in box locks, serrations and ratchets.
- Solution:** Serrations, box locks and ratchets should be carefully cleaned and rinsed. A soft bristle brush is effective in these difficult areas.
- Problem:** Moisture remaining on the instruments within the sterile wrapped packs; excessive moisture in autoclave during sterilization and termination of cycle.
- Solution:** Preheat autoclave, drying time cannot be accelerated, open autoclave door slightly. Routinely inspect valves. Malfunctioning valves can precipitate corrosion.
- Problem:** Some local water supplies contain excessive quantities of alkali. This can manifest itself by depositing corrosive matter on the instruments.
- Solution:** It is generally accepted that cold distilled or demineralized water be used during sterilization. An alternative is to use the local water supply, while instituting a program of preventive maintenance. Carefully clean surfaces with SKLAR KLEEN™, using SKLAR POLISH™ to remove difficult stains and SKLAR LUBE™ for proper lubrication.

PITTING

- Problem:** Instruments are inevitably exposed to chemical compounds that initiate pitting. The most common are saline solutions and blood.
- Solution:** It is essential that instruments be rinsed with distilled or demineralized water and then cleaned routinely.
- Problem:** Some Non-Sklar detergents contain a chloride or have an acid base. If rinsing is not thorough, the residual detergent can precipitate pitting. Hydrochloric acid can be formed by the combination of chloride in the cleaner and steam, causing the instrument to pit.
- Solution:** Evaluate detergents without a chloride base. SKLAR KLEEN™ is recommended.
- Problem:** Instruments may be pitted when the detergent used has an excessively high pH. If instruments are not rinsed thoroughly and then autoclaved, the heat increases the effect of the solution on the instruments.
- Solution:** Use only detergents specifically developed for instrument cleaning. SKLAR KLEEN™ products are pH balanced.

BROWNISH STAIN

- Problem:** This stain is more obvious on dull finish instruments. Most likely, it is a deposit of chromium oxide. The thin hard layer protects stainless steel from corrosion precipitated by the atmosphere. The brownish film (sometimes dull blue) occurs naturally when stainless is heated. Occasionally this stain can be traced to the sterilizer. Improper cleaning compounds could contain poly phosphates that cause the copper components in the sterilizer to be deposited by electrolytic action on the stainless steel instruments.
- Solution:** Water supply to autoclave should be cold and demineralized. Use the correct amount of SKLAR KLEEN™ as recommended for best results.

BLUISH GRAY STAINS

- Problem:** Cold sterilizing solutions.
- Solution:** In the preparation of the solution make certain the manufacturer's directions are followed accurately. To minimize discoloration use distilled water and add a rust inhibitor. Using the solution beyond recommended time limitations will cause the solution to become corrosive.

RUST DEPOSIT

- Problem:** Sterilizing instruments of different metals in the same cycle will cause rusting. An electrolytic action carries the carbon particles from the exposed metal and deposits them on the stainless steel instruments. The rapid oxidation of molecules results in a surface film of rust.
- Solution:** The ideal technique would be to sterilize the two types of instruments separately. It is recommended that chrome plated instruments that indicate signs of peeling or flaking be replaced with stainless steel instruments.
- Problem:** The rust film on the surface of stainless steel instruments can be caused by chemicals in the detergent. Excess amounts of iron or other minerals from the local water supply may cause the rust deposits.
- Solution:** It is recommended that instruments be rinsed with distilled or demineralized water. Surface rust can be removed by light buffing or an application of SKLAR POLISH™.

LIGHT AND DARK COLORED SPOTS

- Problem:** Spotting caused by slow evaporation of water drops identified with the mineral content of the water.
- Solution:** Eliminate water droplets by adhering to autoclave manufacturer's operating instructions. Autoclave door should not be opened until steam has been completely vented.

Amalgam Carriers | Tungsten Carbide

TUNGSTEN CARBIDE AMALGAM CARRIERS

SINGLE END, STAINLESS STEEL

PRODUCT NUMBER	TYPE	
49-0001	Medium	
49-0002	Large	
49-0003	Jumbo	

TUNGSTEN CARBIDE AMALGAM CARRIERS

DOUBLE END, STAINLESS STEEL

PRODUCT NUMBER	TYPE	
49-0004	Medium / Large	
49-0005	Medium / Jumbo	
49-0006	Large / Jumbo	
49-0007	Jumbo / Jumbo	

AMALGAM CARRIER, LEVER TYPE
SINGLE END, STAINLESS STEEL TIP

PRODUCT NUMBER	TYPE
49-0010	Medium
49-0011	Large
49-0012	Jumbo



AMALGAM CARRIER, LEVER TYPE
SINGLE END, DELRIN TIP

PRODUCT NUMBER	TYPE
49-0013	Medium
49-0014	Large
49-0015	Jumbo

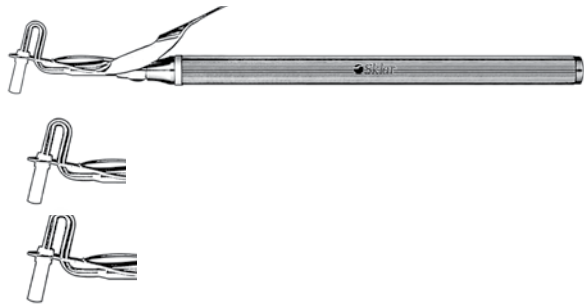

AMALGAM CARRIER, LEVER TYPE
DOUBLE END, STAINLESS STEEL TIP

PRODUCT NUMBER	TYPE
49-0016	Medium / Large
49-0017	Medium / Large, Tip Only
49-0018	Medium / Jumbo
49-0019	Medium / Jumbo, Tip Only
49-0020	Large / Jumbo
49-0021	Large / Jumbo, Tip Only

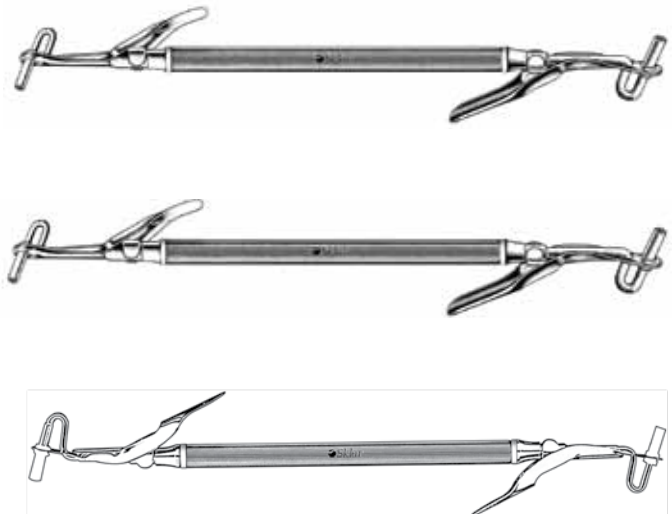

AMALGAM CARRIER, LEVER TYPE

DOUBLE END, DELRIN TIP

PRODUCT NUMBER	TYPE
49-0026	Medium / Large
49-0027	Medium / Large, Tip Only
49-0028	Medium / Jumbo
49-0029	Medium / Jumbo, Tip Only
49-0030	Large / Jumbo
49-0031	Large / Jumbo, Tip Only



AMALGAM CARRIER

PRODUCT NUMBER	TYPE
49-0032	Gun-Type



AMALGAM WELL

PRODUCT NUMBER	TYPE
49-0036	Non-Slip



AMALGAM CARRIER

PRODUCT NUMBER	TYPE
49-0034	Spring Only

OCTAGONAL HANDLE - SINGLE END



OCTAGONAL HANDLE - DOUBLE END



AMALGAM PLUGGERS / CONDENSERS

SINGLE END

PRODUCT NUMBER	TYPE	SIZE	
49-0100	Black	1	
49-0101	Black	2	

AMALGAM PLUGGERS / CONDENSERS

DOUBLE END

PRODUCT NUMBER	TYPE	SIZE		
49-0105	Andrews	1 / 2		
49-0110	Back Action	11 / 12		
49-0115	Behrman	1		
49-0120	Black	0 / 1, Smooth		
49-0125	Black	1 / 2, Smooth		

Amalgam Pluggers / Condensers

AMALGAM PLUGGERS / CONDENSERS

DOUBLE END

PRODUCT NUMBER	TYPE	SIZE		
49-0130	Black (Marquette)	0 / 1, Serrated		
48-321	Black (Marquette) Mid-Grade	0 / 1, Serrated		
49-0135	Black	1 / 2, Serrated		
49-0140	Hollenback	1, Smooth		
49-0145	Hollenback	2, Smooth		
49-0150	Hollenback	3, Smooth		
49-0155	Hollenback	4, Smooth		
49-0160	Markley	2		
49-0165	Mortonson	2		
49-0170	Smith			
49-0175	Tanner	1T		
49-0180	Tanner	2T		
49-0185	Tanner	3T		

BURNISHERS

SINGLE END, OCTAGONAL HANDLE

PRODUCT NUMBER TYPE

49-0200

2



49-0205

28



49-0210

29



49-0215

33



49-0220

34



DOUBLE END, ROUND HANDLE

PRODUCT NUMBER TYPE

49-0225

18



49-0230

Ladmore 2



49-0235

Ladmore 3



DOUBLE END, OCTAGONAL HANDLE

PRODUCT NUMBER TYPE

49-0240

1



49-0245

Acorn 21



49-0250

Acorn 21B



BURNISHERS

DOUBLE END, OCTAGONAL HANDLE

PRODUCT NUMBER TYPE

49-0255

26 / 27S



49-0260

27 / 29



49-0265

28 / 29



49-0270

University of Michigan 1



49-0275

University of Michigan 2



SKLAR INSTRUMENT CARE KIT

A TRIO OF SKLAR'S CARE AND CLEANING PRODUCTS TO KEEP INSTRUMENTS IN TIPTOP SHAPE.

Each Kit Contains:

- 1 Sklar Lube™ 8 oz. Spray Bottle
- 1 Sklar Kleen™ Liquid 8 oz. Bottle
- 1 Sklar Polish™ 8 oz. Jar
- 1 Stainless Steel Bristle Cleaning Brush
- 1 Nylon Bristle Cleaning Brush

PRODUCT NUMBER

10-1625



EXCAVATORS

DOUBLE END, ROUND HANDLE

PRODUCT NUMBER

TYPE

49-0400

5



49-0405

22



49-0410

32L



49-0415

33L



49-0420

36 / 37



49-0425

38 / 39



49-0430

40 / 41



49-0435

44 / 49



49-0440

61 / 62



49-0445

63 / 64



49-0450



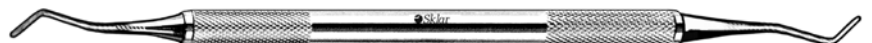







65 / 66



EXCAVATORS

DOUBLE END, OCTAGONAL HANDLE

PRODUCT NUMBER TYPE

49-0455	2, Glick	
49-0460	6	
49-0465	13	
49-0470	14	
49-0475	17	
49-0480	18	
49-0485	19	
49-0490	20	
49-0495	24	
49-0500	31L	

ROUND HANDLE – SINGLE END



OCTAGONAL HANDLE – SINGLE END



EXPLORERS

SINGLE END

PRODUCT NUMBER	TYPE	HANDLE	
49-0600	3	Round	
49-0605	3A	Round	
49-0610	3A	Octagonal	
49-0615	6	Octagonal	
49-0620	7	Octagonal	
49-0625	17	Round	
49-0630	17	Octagonal	
49-0635	23	Octagonal	
48-434	23, Mid-Grade	Round	

Explorers

ROUND HANDLE - DOUBLE END



OCTAGONAL HANDLE - DOUBLE END



EXPLORERS

DOUBLE END

PRODUCT NUMBER	TYPE	HANDLE		
49-0640	1	Octagonal		
49-0645	2	Octagonal		
49-0650	3	Octagonal		
48-561	3, Mid-Grade	Round		
49-0655	3CH	Round		
49-0660	5	Round		
48-130	5, Mid-Grade	Round		
49-0665	5	Octagonal		
48-472	5, Mid-Grade	Octagonal		
49-0670	6	Octagonal		
49-0675	7	Octagonal		

ROUND HANDLE - DOUBLE END



EXPLORERS

DOUBLE END

PRODUCT NUMBER	TYPE	HANDLE	
49-0680	11 / 12	Round	
49-0685	16	Round	
49-0690	DG16	Round	
49-0695	DG16 / 17	Round	
49-0700	DG16 / 23	Round	
49-0705	G16	Round	



Probes

ROUND HANDLE – SINGLE END



OCTAGONAL HANDLE – SINGLE END



PROBES

SINGLE END

PRODUCT NUMBER TYPE HANDLE

49-0800	C 3-6-9-12mm	Round	
49-0805	X2 3-6-9-12mm	Octagonal	
49-0810	Goldman-Fox 1-2-3-5-7-8-9-10mm	Round	
49-0815	Michigan 3-6-8mm	Round	
49-0820	WHO (PSR) 3.5-5.5-8.5-11.5mm	Round	
49-0825	Williams 1-2-3-5-7-8-9-10mm	Round	
49-0830	UNC 15 1-15mm	Round	

**PROBES
SINGLE END**

PRODUCT NUMBER	TYPE	HANDLE
49-0835	Coded Probe, 11 3-6-8-11mm, Color	Round

49-0840	Coded Probe, 12 3-6-9-12mm, Color	Round
---------	--------------------------------------	-------



48-885	Probe and Seeker Mid-Grade	Round
--------	-------------------------------	-------



ROUND HANDLE - DOUBLE END



OCTAGONAL HANDLE - DOUBLE END



**PROBES
DOUBLE END**

PRODUCT NUMBER	TYPE	HANDLE
49-0845	2N Nabers	Round

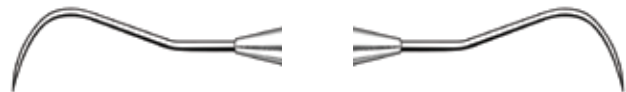

49-0850	Goldman-Fox 1-2-3-5-7-8-9-10mm	Octagonal
---------	-----------------------------------	-----------

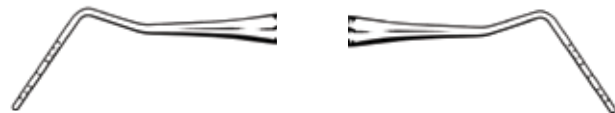

49-0855	Goldman-Fox Probe / Explorer 1-2-3-5-7-8-9-10mm	Octagonal
---------	---	-----------

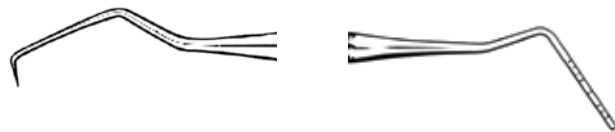

49-0860	Fox / Williams 1-2-3-5-7-8-9-10mm	Round
---------	--------------------------------------	-------



PROBE / EXPLORER

PRODUCT NUMBER	TYPE
49-0865	Probe 1-2-3-5-7-8-9-10mm / Explorer #23



RETRACTION CORD PACKERS

PRODUCT NUMBER	TYPE
49-0890	Smooth
49-0895	Serrated



LATEX EXAMINATION GLOVES

- Disposable
- Non-Sterile
- Powdered or Powder-Free
- Ambidextrous
- Dispensing Box
- 10" Length
- Sizes Include Extra Small, Small, Medium, Large and Extra Large
- Quantities offered are 100 per box or 1000 per case

For a complete listing of Sklar's extensive Glove product line see page 188. For more information contact your Sklar Account Manager or Distributor Sales Representative.

PLASTIC FILLING INSTRUMENTS

DOUBLE END

PRODUCT NUMBER

TYPE

49-0900

1



49-0905

3



49-0910

4



49-0915

5



49-0920

8A



49-0925

11



49-0930

A6









49-0935

Gregg 4 / 5

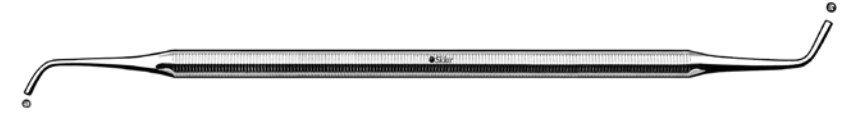

PLASTIC FILLING INSTRUMENTS

DOUBLE END

PRODUCT NUMBER	TYPE	
49-0940	Ladmore 2	
49-0945	Ladmore 3	
49-0950	Smith Special	
49-0955	Woodson 1	
49-0960	Woodson 2	
49-0965	Woodson 3	
49-0970	W-3	

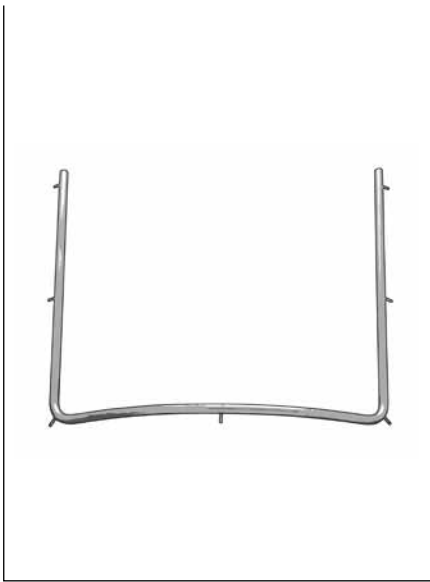

RUBBER DAM HOLDER
STAINLESS PINS
49-1000

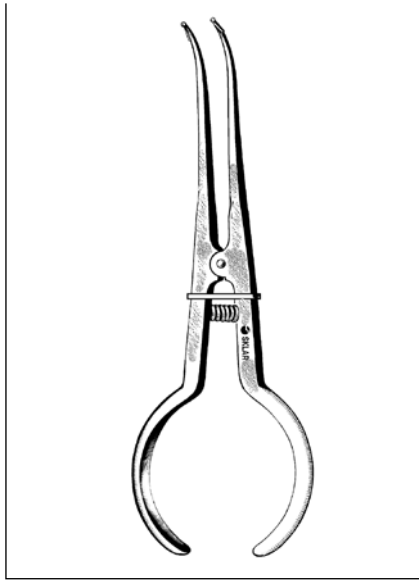

RUBBER DAM FORCEPS
UNIVERSITY OF WASHINGTON
49-1005
48-236 Mid-Grade

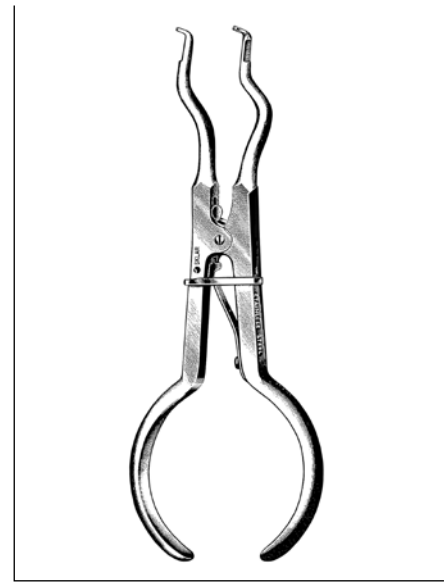

RUBBER DAM FORCEP
BREWER
49-1015

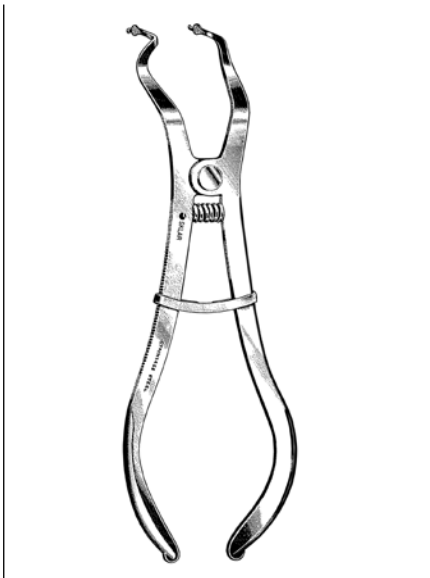

RUBBER DAM FORCEP
IV TYPE
49-1020 Lightweight

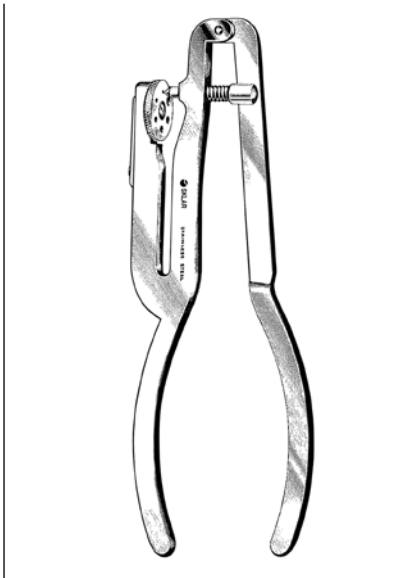

RUBBER DAM PUNCH
IV TYPE
49-1025

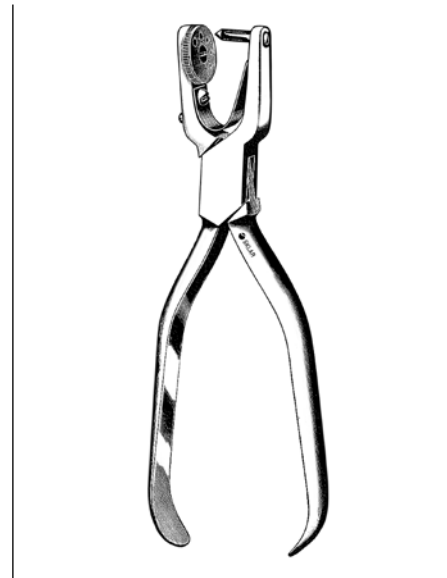

RUBBER DAM PUNCHES
W TYPE
49-1030
48-266 Mid-Grade



Scissors

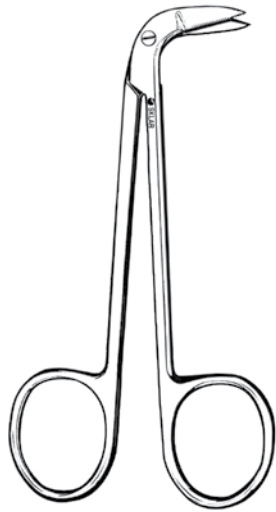

RA MATRIX SCISSOR

ONE SERRATED BLADE

24-2335 4 1/4"

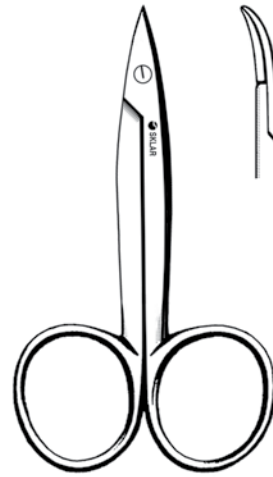

PEDO CROWN-FESTOONING SCISSOR

CURVED

24-2337 3 1/2"

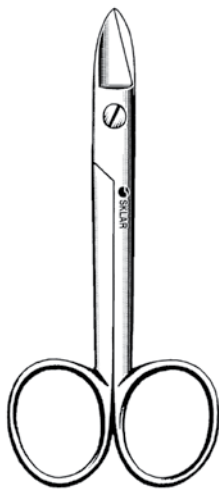

CROWN & COLLAR CUTTING SCISSORS

STRAIGHT

24-2345 4" Smooth
24-2340 4" Serrated

STRAIGHT, MID-GRADE

48-708 4" Smooth
48-729 4" Serrated

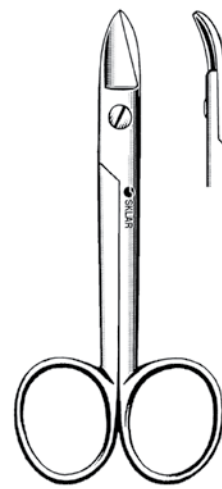

CROWN & COLLAR CUTTING SCISSORS

CURVED

24-2346 4" Smooth
24-2341 4" Serrated

CURVED, MID-GRADE

48-721 4" Smooth
48-735 4" Serrated

P.K. THOMAS WAX PLACERS

DOUBLE END

PRODUCT NUMBER

TYPE

49-1050

1



48-274

1, Mid-Grade

49-1055

2



48-278

2, Mid-Grade

49-1060

3

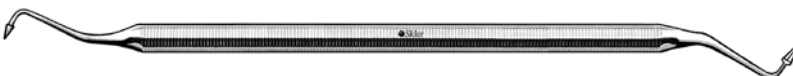

48-282

3, Mid-Grade

49-1065

4



48-288

4, Mid-Grade

49-1070

5



48-296

5, Mid-Grade

98-1480

1-5, Set of 5



Carvers

CLEOID DISCOID CARVERS

DOUBLE END, ROUND HANDLE

PRODUCT NUMBER	TYPE
49-1200	1 / 2
49-1205	4 / 5
49-1210	WACD







CLEOID DISCOID CARVERS

DOUBLE END, OCTAGONAL HANDLE

PRODUCT NUMBER	TYPE
49-1215	3 / 6
49-1220	5T
49-1225	89 / 92
49-1230	90 / 93
49-1235	Extra Large



HOLLENBACK CARVERS
DOUBLE END

PRODUCT NUMBER	TYPE	
49-1250	1 / 2	
49-1255	3	
48-228	3, Mid-Grade	
49-1260	3S	

SKLAR FACE MASKS

The Sklar Disposable Face Mask is offered in the most popular style to meet clinical requirements in the operating room, general medicine, or any other areas requiring facial protection. Protecting against infectious pathogens, Sklar masks are ≥98% BFE, non-woven, soft and breathable. Convenient ear loops and adjustable nose-bridge ensures a proper fit. Latex Free.





NON-STERILE

PRODUCT NUMBER	FEATURES	QUANTITIES
96-5557	Mask Earloop, Blue	50/bx
96-5557A	Mask Earloop, Blue	500/cs
96-5557BNS	Mask Earloop, Blue Bulk	2000/cs





TANNER CARVERS
DOUBLE END

PRODUCT NUMBER TYPE

49-1270	3	
49-1271	4	
49-1272	5	
49-1273	6	



WALLS CARVERS
DOUBLE END

PRODUCT NUMBER TYPE

49-1280	1	
49-1285	3	

WARD CARVERS
DOUBLE END

PRODUCT NUMBER TYPE

49-1290	1	
49-1295	1S	
49-1300	2	

INTERPROXIMAL CARVER

DOUBLE END

PRODUCT NUMBER

49-1305



LECRON PORCELAIN AND WAX CARVERS

DOUBLE END

PRODUCT NUMBER

TYPE

49-1310

48-422

Mid-Grade



REEVES PORCELAIN AND WAX CARVER

DOUBLE END

PRODUCT NUMBER

49-1315



VEHE PORCELAIN AND WAX CARVERS

DOUBLE END

PRODUCT NUMBER

TYPE

49-1320

48-424

Mid-Grade



ROACH PORCELAIN AND WAX CARVERS

DOUBLE END

PRODUCT NUMBER

TYPE





49-1325

48-428

Mid-Grade



WAX SPATULAS
DOUBLE END

PRODUCT NUMBER	TYPE	
49-1350	5	
49-1355	7	
49-1360	7 Long	
49-1365	7A	
49-1370	31	

Model Boxes

Store dental models and impressions safely with the selection of model boxes available from Sklar.

96-3350	4 Compartment, 6½" x 6¼" x 2"	50/bx
96-3352	6 Compartment, 6½" x 9⅞" x 2"	50/bx



CEMENT SPATULAS

PRODUCT NUMBER	TYPE	
49-1800	5	
49-1805	7	
49-1810	11S	
49-1815	22	
49-1820	24	
48-526	24, Mid-Grade	
49-1825	24A	
48-524	24A, Mid-Grade	
49-1830	313	
49-1835	324	
48-538	324, Mid-Grade	
49-1840	Agathe 33	



Gauges

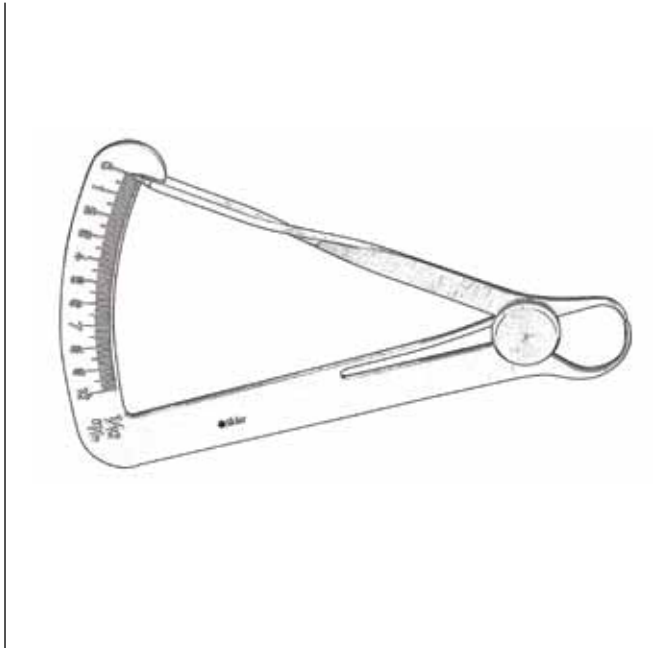

CROWN GAUGE

49-1600



BOLEY GAUGE

49-1605
48-202 Mid-Grade



Product No.: 96-3358

KNO-KURL™ ACETATE

FEATURES AND BENEFITS

- 100 Sheets per pad.
- Superior optical clarity.
- Dimensional stability.
- Smooth matte surface.
- Remains flat while tracing.
- Uniform Gauge.
- Resistant to common solvents.

For more information contact your Sklar Account Manager or Distributor Sales Representative.



MATRIX RETAINER

TOFFLEMIRE TYPE

49-1440 Universal



MATRIX RETAINERS

TOFFLEMIRE TYPE, CONTRA ANGLE

49-1445 Child
49-1450 Adult



MATRIX BANDS

TOFFLEMIRE TYPE, 12/PK

1	2	3	13
49-1455 .0015 Gauge	49-1465 .0015 Gauge	49-1475 .0015 Gauge	49-1485 .0015 Gauge
49-1460 .002 Gauge	49-1470 .002 Gauge	49-1480 .002 Gauge	49-1490 .002 Gauge

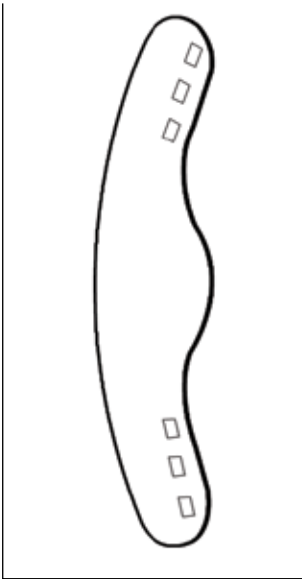

MATRIX BANDS

MOLAR, #1, 12/PK

- 49-1500 Wide
- 49-1505 Medium
- 49-1510 Narrow
- 49-1515 Assorted

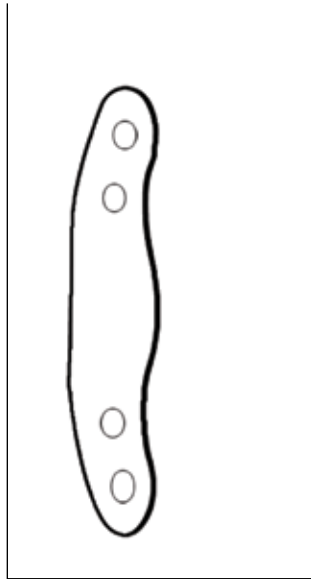

MATRIX BANDS

BICUSPID, #1, 12/PK

- 49-1520 Wide
- 49-1525 Medium
- 49-1530 Narrow
- 49-1535 Assorted

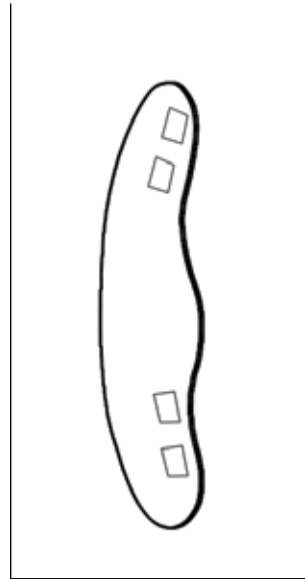

MATRIX BANDS

MOLAR/BICUSPID #1, 12/PK

- 49-1540 Assorted

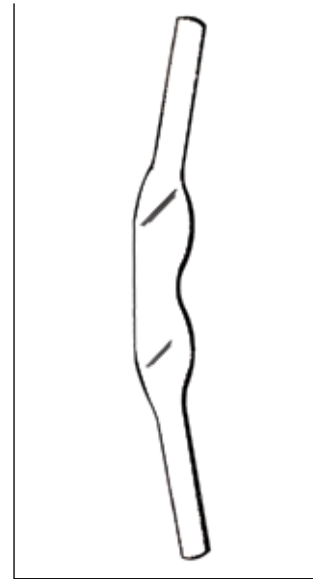

MATRIX BANDS

MOLAR, #8, 12/PK

- 49-1545 Medium
- 49-1550 Narrow
- 49-1555 Extra Narrow
- 49-1560 Assorted

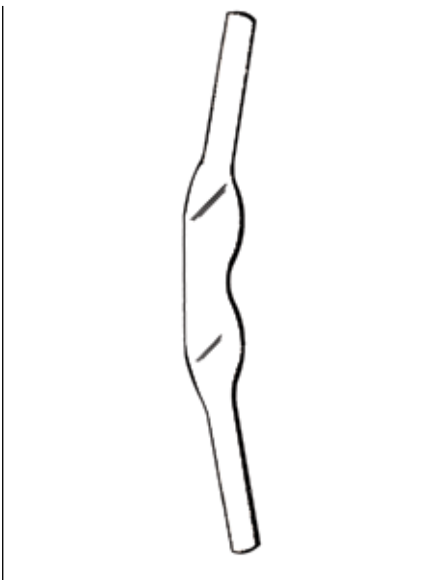

MATRIX BANDS

BICUSPID, #8, 12/PK

- 49-1565 Medium
- 49-1570 Narrow
- 49-1575 Extra Narrow

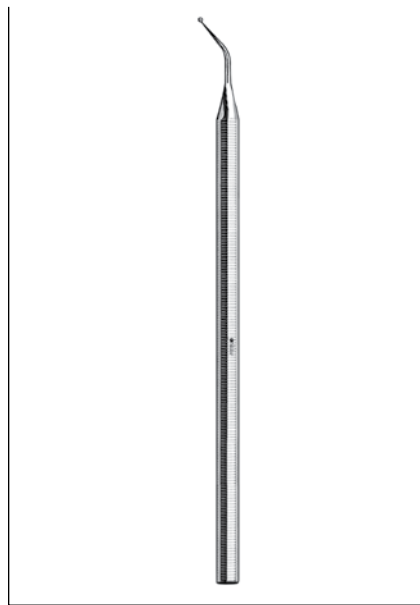

CALCIUM HYDROXIDE PLACER

49-1580

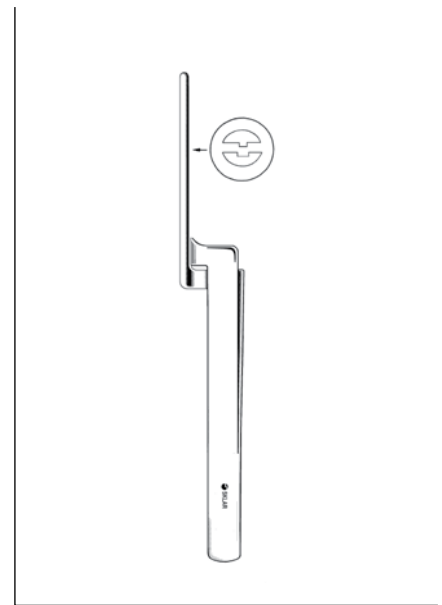

**MILLER GROOVELOK
ARTICULATING PAPER
FORCEPS**

GROOVED TIPS

- 49-1590
- 48-388 Mid-Grade

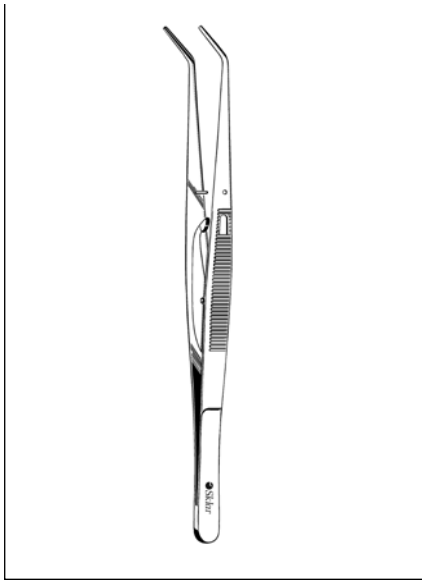

SELF-LOCKING COLLEGE PLIERS

GROOVED

49-1700

48-378

Mid-Grade

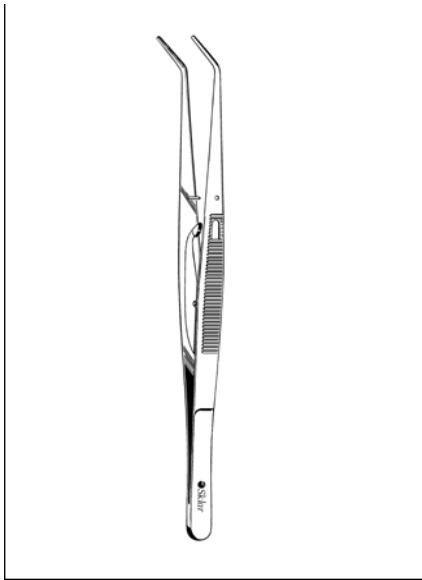

SELF-LOCKING COLLEGE PLIERS

SERRATED

49-1705

48-128

Mid-Grade

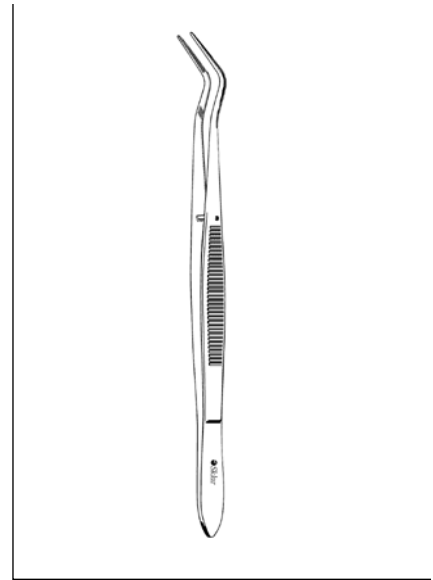

MERIAM PLIERS 318

SERRATED

49-1710

48-368

Mid-Grade

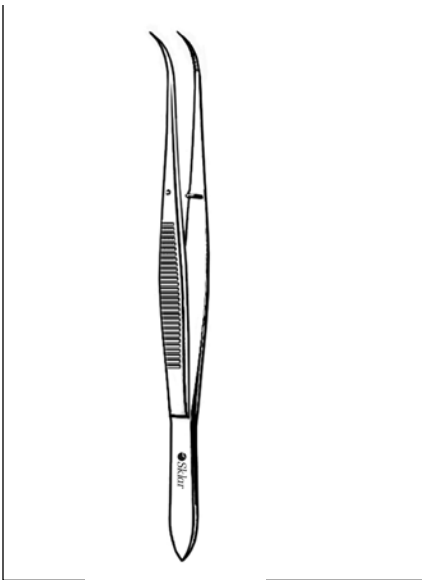

PERRY PLIER 1

SERRATED

49-1715

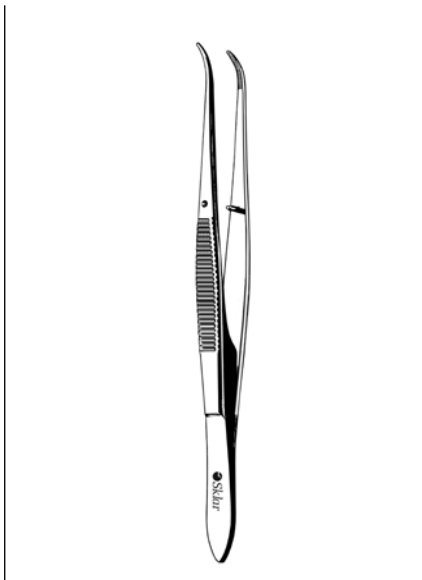

PERRY PLIERS 312

SERRATED

49-1720

48-315

Mid-Grade

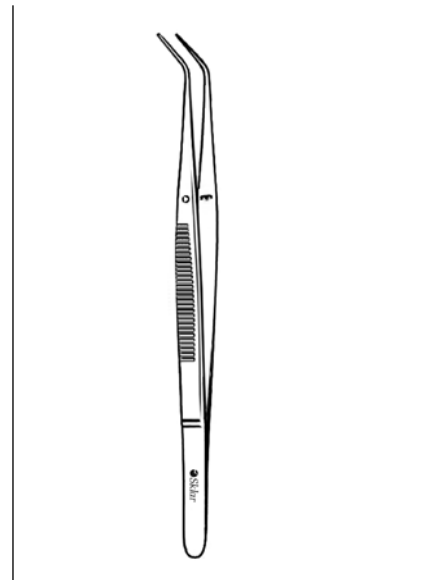

DIAMOND TIPPED PLIER

49-1725

6"

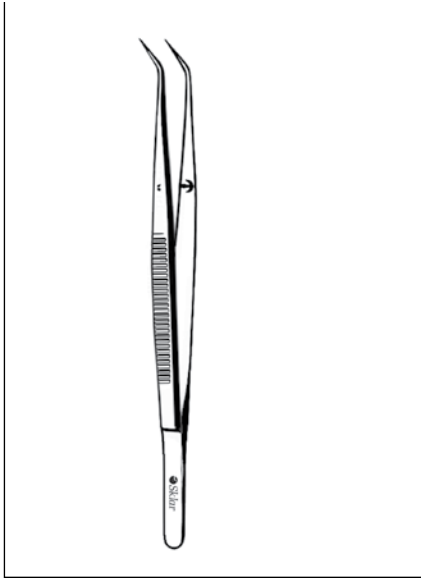

COLLEGE PLIER 2
49-1730

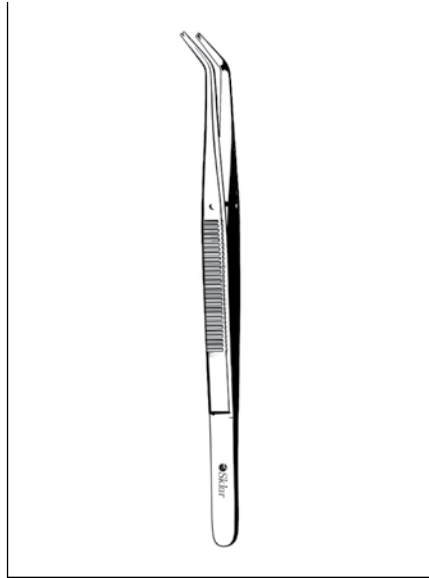

COLLEGE PLIER 311
SMOOTH
49-1735 Forked Tips



COLLEGE PLIERS
49-1740 317 Serrated
48-116 317 Serrated, Mid-Grade
49-1745 317S Smooth

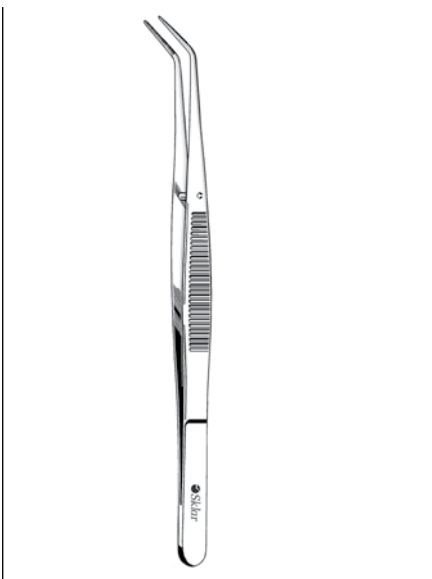

COLLEGE PLIERS
#317A, EXTRA FINE SERRATIONS
49-1750
48-318 Mid-Grade
#317B, EXTRA FINE SERRATIONS, LONG
49-1755
48-322 Mid-Grade

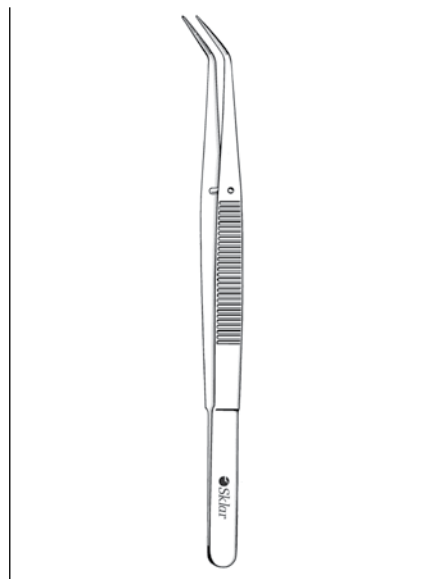

NON-PINCH COLLEGE PLIERS
49-1760 Smooth
49-1765 Serrated

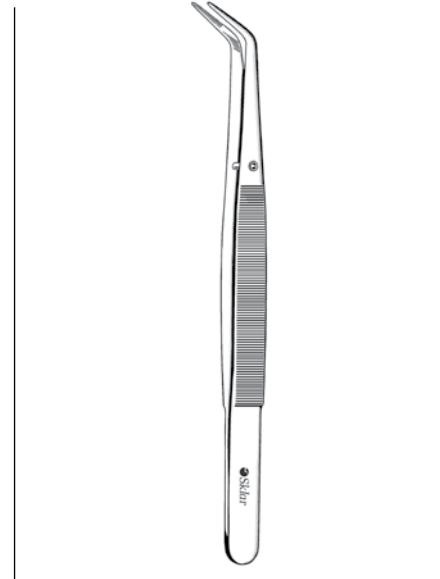

NON-PINCH COLLEGE PLIERS 49
SERRATED
49-1770
48-350 Mid-Grade

ROUND HANDLE – SINGLE END



OCTAGONAL HANDLE – SINGLE END



EXPLORERS

SINGLE END

PRODUCT NUMBER	TYPE	HANDLE	
49-0600	3	Round	
49-0605	3A	Round	
49-0610	3A	Octagonal	
49-0615	6	Octagonal	
49-0620	7	Octagonal	
49-0625	17	Round	
49-0630	17	Octagonal	
49-0635	23	Octagonal	
48-434	23, Mid-Grade	Round	

ROUND HANDLE - DOUBLE END



OCTAGONAL HANDLE - DOUBLE END



EXPLORERS

DOUBLE END

INSTRUMENT	TYPE	HANDLE		
49-0640	1	Octagonal		
49-0645	2	Octagonal		
49-0650	3	Octagonal		
48-561	3, Mid-Grade	Round		
49-0655	3CH	Round		
49-0660	5	Round		
48-130	5, Mid-Grade	Round		
49-0665	5	Octagonal		
48-472	5, Mid-Grade	Octagonal		
49-0670	6	Octagonal		
49-0675	7	Octagonal		

ROUND HANDLE - DOUBLE END



EXPLORERS

DOUBLE END

INSTRUMENT	TYPE	HANDLE	
49-0680	11 / 12	Round	
49-0685	16	Round	
49-0690	DG16	Round	
49-0695	DG16 / 17	Round	
49-0700	DG16 / 23	Round	
49-0705	G16	Round	

ROUND HANDLE – SINGLE END



OCTAGONAL HANDLE – SINGLE END



PROBES

SINGLE END

PRODUCT NUMBER	TYPE	HANDLE	
49-0800	C 3-6-9-12mm	Round	
49-0805	X2 3-6-9-12mm	Octagonal	
49-0810	Goldman-Fox 1-2-3-5-7-8-9-10mm	Round	
49-0815	Michigan 3-6-8mm	Round	
49-0820	WHO (PSR) 3.5-5.5-8.5-11.5mm	Round	
49-0825	Williams 1-2-3-5-7-8-9-10mm	Round	
49-0830	UNC 15 1-15mm	Round	

PROBES

SINGLE END

PRODUCT NUMBER	TYPE	HANDLE
49-0835	Coded Probe, 11 3-6-8-11mm, Color	Round

49-0840	Coded Probe, 12 3-6-9-12mm, Color	Round
---------	--------------------------------------	-------

48-885	Probe and Seeker Mid-Grade	Round
--------	-------------------------------	-------



ROUND HANDLE - DOUBLE END



OCTAGONAL HANDLE - DOUBLE END



PROBES

DOUBLE END

PRODUCT NUMBER	TYPE	HANDLE
49-0845	2N, Nabers	Round

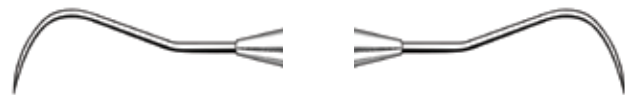

49-0850	Goldman-Fox 1-2-3-5-7-8-9-10mm	Octagonal
---------	-----------------------------------	-----------

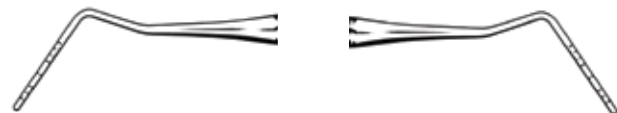

49-0855	Goldman-Fox Probe / Explorer 1-2-3-5-7-8-9-10mm	Octagonal
---------	---	-----------

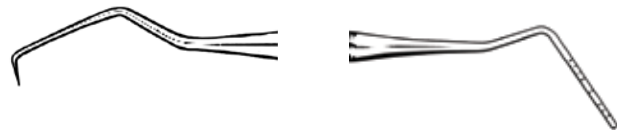

49-0860	Fox / Williams 1-2-3-5-7-8-9-10mm	Round
---------	--------------------------------------	-------

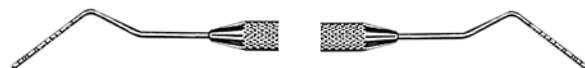

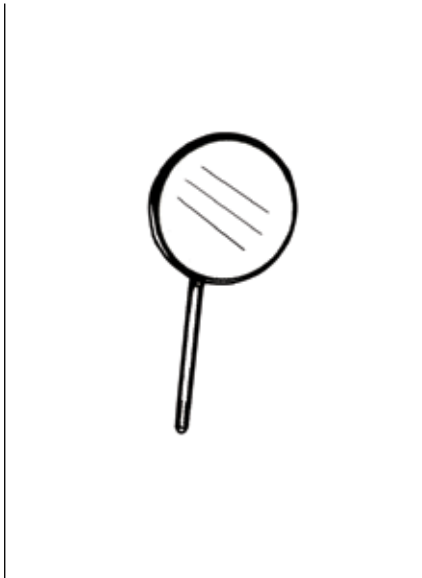

MOUTH MIRRORS

SIMPLE STEM, REGULAR, PACK OF 12

73-1450 #3	Regular, Plane	20mm
73-1455 #4	Regular, Plane	22mm
73-1460 #5	Regular, Plane	24mm
73-1465 #6	Regular, Plane	26mm
73-1470 #3	Regular, Magnifying	20mm
73-1475 #4	Regular, Magnifying	22mm
73-1480 #5	Regular, Magnifying	24mm
73-1485 #3	Front Surface	20mm
73-1490 #4	Front Surface	22mm
73-1495 #5	Front Surface	24mm

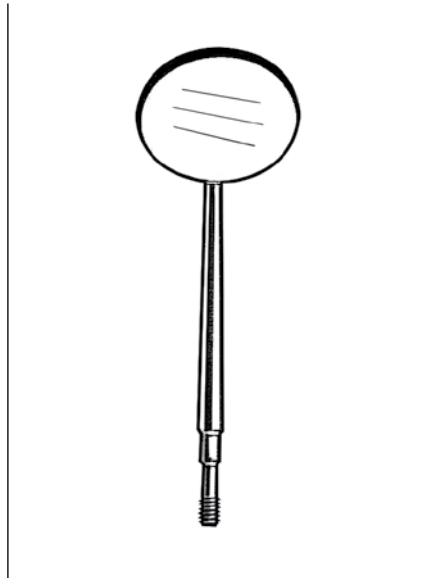

MOUTH MIRRORS

CONE SOCKET, REGULAR, PACK OF 12

73-1500 #3	Regular, Plane	20mm
73-1505 #4	Regular, Plane	22mm
73-1510 #5	Regular, Plane	24mm
73-1515 #3	Regular, Magnifying	20mm
73-1520 #4	Regular, Magnifying	22mm
73-1525 #5	Regular, Magnifying	24mm
73-1530 #2	Front Surface	18mm
73-1535 #3	Front Surface	20mm
73-1540 #4	Front Surface	22mm

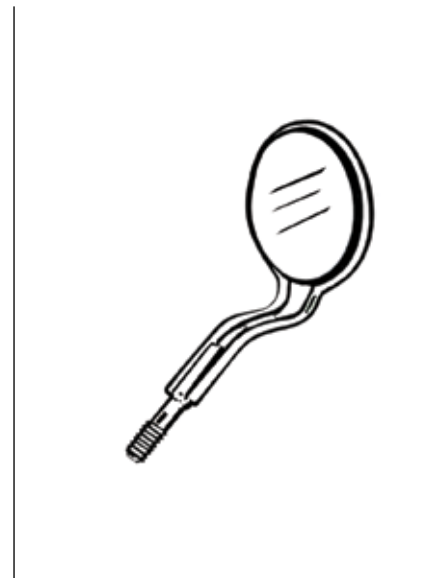

MOUTH MIRRORS

CONE SOCKET, DOUBLE SIDED, PACK OF 12

73-1545 #4	Front Surface	22mm
73-1550 #5	Front Surface	24mm

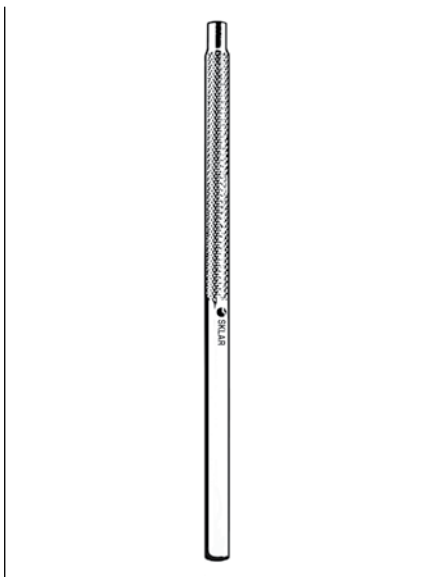

ROUND MIRROR HANDLES

73-1400	Cone Socket
73-1405	Simple Stem
48-105	Simple Stem, Mid-Grade

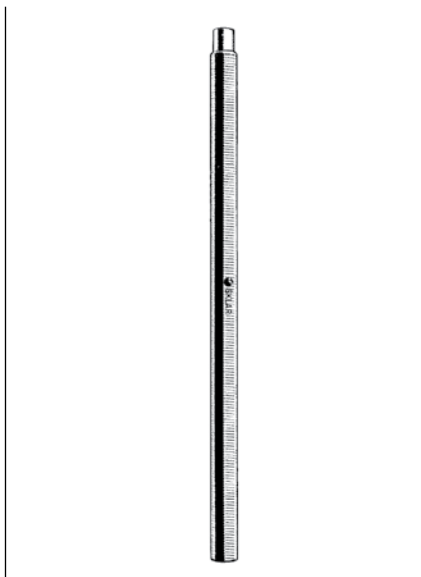

OCTAGONAL MIRROR HANDLES

73-1410	Cone Socket
48-102	Cone Socket, Mid-Grade
73-1415	Simple Stem

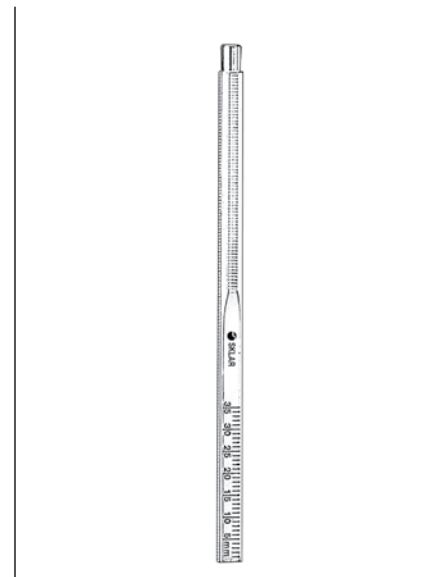

OCTAGONAL MIRROR HANDLE WITH MILLIMETER RULER

73-1420	Cone Socket
---------	-------------

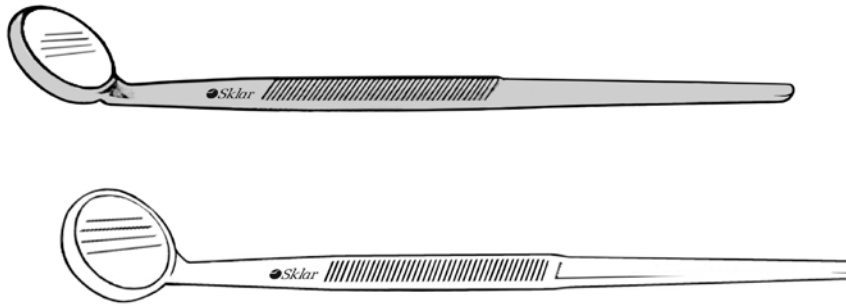

FRONT SURFACE FIBERGLASS MIRRORS

WHITE

73-1600	Size 3
73-1605	Size 4
73-1610	Size 5

BLUE

73-1615	Size 3
73-1620	Size 4
73-1625	Size 5

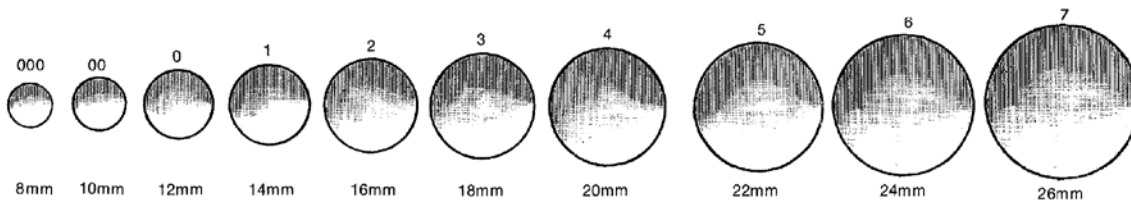

LARYNGEAL MIRRORS

WITH HANDLE

73-1188	Size 000	73-1193	Size 3
73-1189	Size 00	73-1194	Size 4
73-1190	Size 0	73-1195	Size 5
73-1191	Size 1	73-1196	Size 6
73-1192	Size 2	73-1197	Size 7

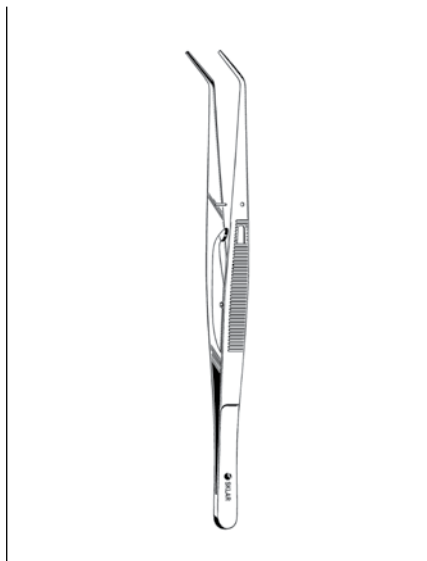

SELF-LOCKING COLLEGE PLIERS

GROOVED

49-1700
48-378 Mid-Grade

SERRATED

49-1705
48-128 Mid-Grade

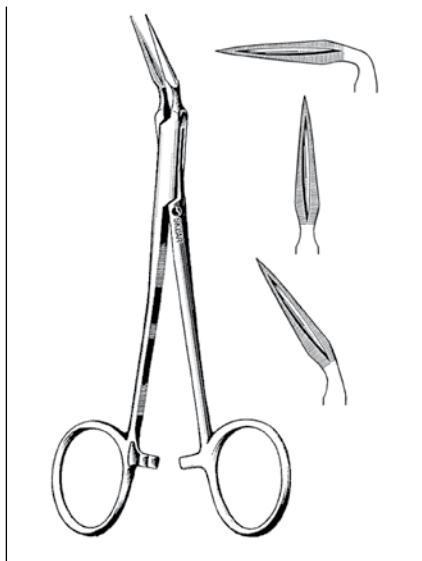

WILLIAMS (STIEGLITZ) SPLINTER FORCEPS

19-3056 4¾" Right Angle
19-3161 5½" Straight
19-3055 5½" Angled

MID-GRADE

48-965 4¾" Right Angle
48-966 5½" Straight
48-967 5½" Angled

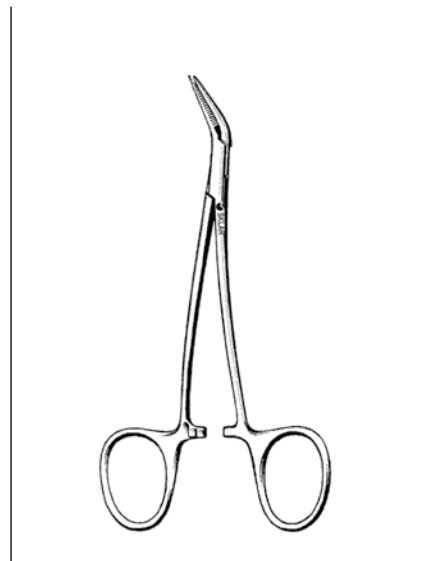

PEET SPLINTER FORCEP

DOUBLE CURVE

19-3147 4¾" Angled

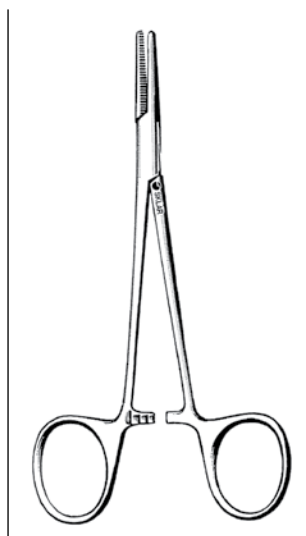

HALSTED MOSQUITO FORCEPS

STRAIGHT, SERRATED

17-1450 5"
97-426 5" Mid-Grade
17-1455 5" Non-Magnetic
18-1050 5" Delicate

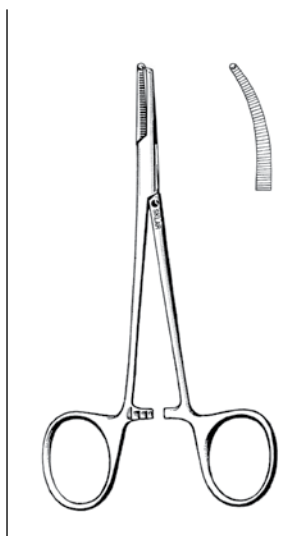

HALSTED MOSQUITO FORCEPS

CURVED, SERRATED

17-1550 5"
97-431 5" Mid-Grade
17-1555 5" Non-Magnetic
18-1150 5" Delicate

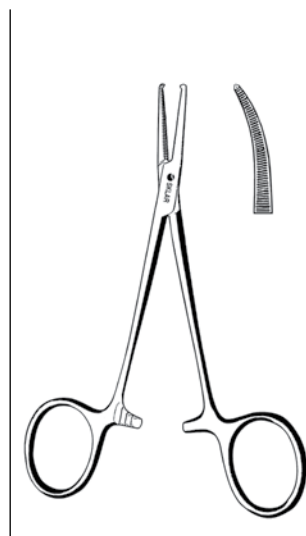

HALSTED MOSQUITO FORCEPS

1X2 TEETH, DELICATE, SERRATED

17-1650 5" Straight
17-1750 5" Curved

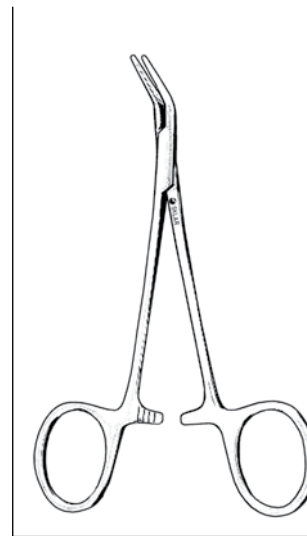

HALSTED MOSQUITO FORCEPS

SERRATED

17-1850 5" 45° Angled on Flat, Extra Delicate











EXCAVATORS

DOUBLE END, ROUND HANDLE

PRODUCT NUMBER	TYPE	
49-0400	5	
49-0405	22	
49-0410	32L	
49-0415	33L	
49-0420	36 / 37	
49-0425	38 / 39	
49-0430	40 / 41	
49-0435	44 / 45	
49-0440	61 / 62	
49-0445	63 / 64	
49-0450	65 / 66	

EXCAVATORS

DOUBLE END, OCTAGONAL HANDLE

PRODUCT NUMBER	TYPE	
49-0455	2, Glick	
49-0460	6	
49-0465	13	
49-0470	14	
49-0475	17	
49-0480	18	
49-0485	19	
49-0490	20	
49-0495	24	
49-0500	31L	

CLEOID DISCOID CARVERS

DOUBLE END, ROUND HANDLE

PRODUCT NUMBER	TYPE
49-1200	1 / 2
49-1205	4 / 5
49-1210	WACD



CLEOID DISCOID CARVERS

DOUBLE END, OCTAGONAL HANDLE

PRODUCT NUMBER	TYPE
49-1215	3 / 6
49-1220	5T
49-1225	89 / 92
49-1230	90 / 93
49-1235	Extra Large

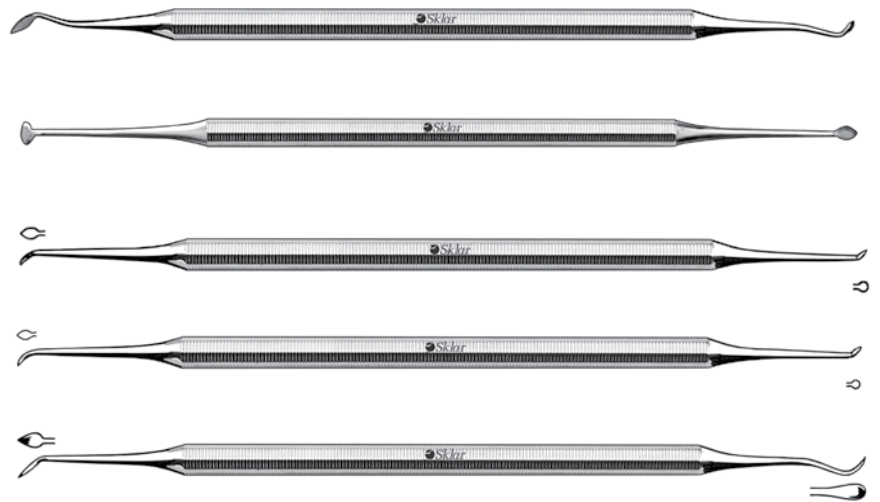

ORTHODONTICS

Pliers

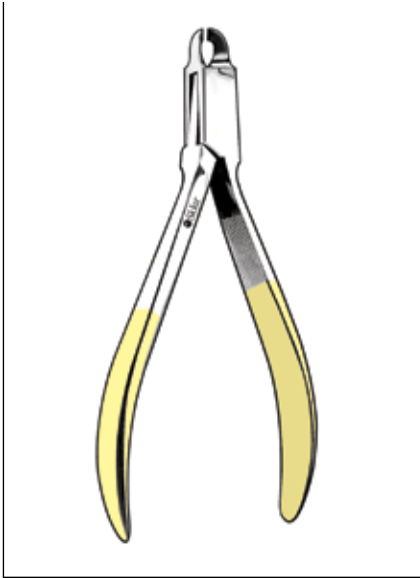

TC PIN & LIGATURE PLIER 150
49-1900 5"



TC HOW PLIER 110
49-1905

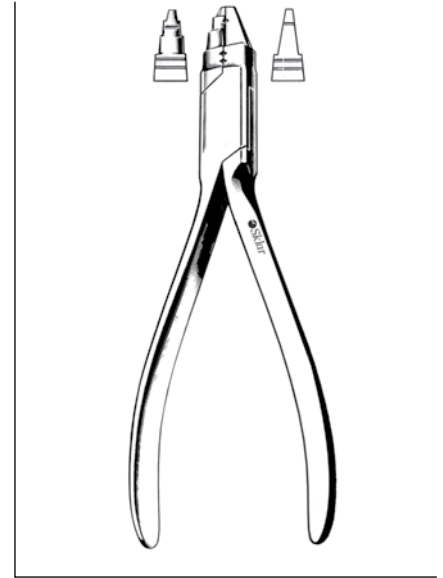

YOUNG WIRE BENDING PLIER 12
49-1910



WIRE BENDING PLIERS 101
49-1915
48-796 Mid-Grade

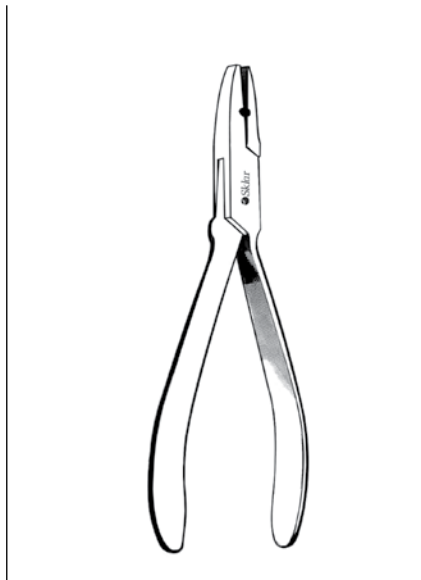

CONE SOCKET PLIERS 102
49-1920
48-309 Mid-Grade

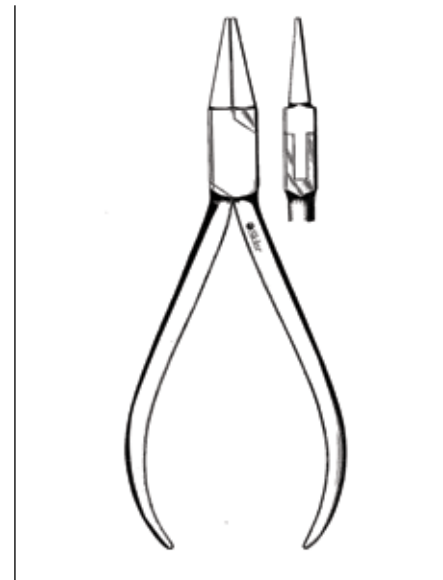

ROUND NOSE PLIER 107
49-1925

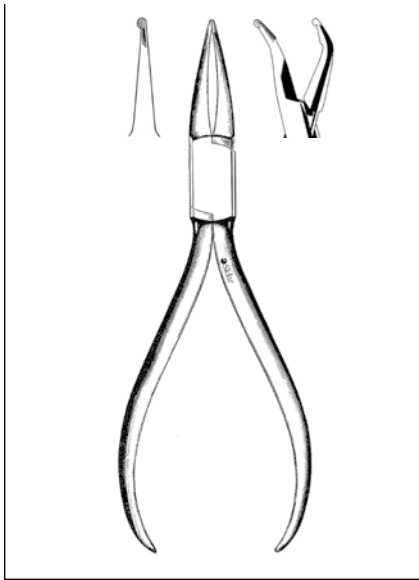

HOW PLIERS 110

SERRATED

- 49-1930 Straight
- 48-355 Straight, Mid-Grade
- 49-1935 Angled

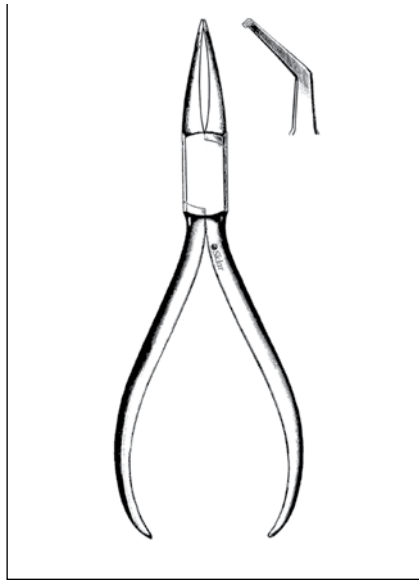

HOW PLIERS 111

CURVED, SERRATED

- 49-1940
- 48-356 Mid-Grade

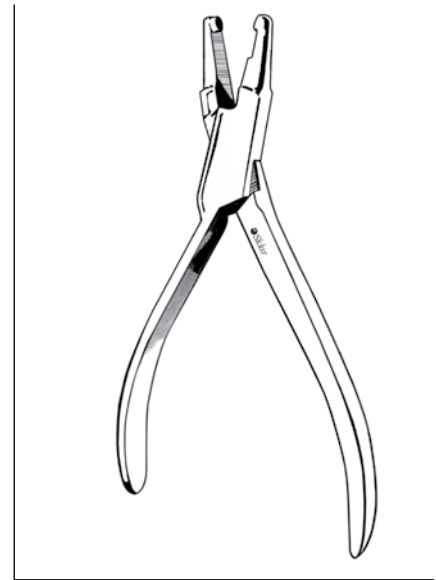

ABEL PLIERS 112

- 49-1945
- 48-358 Mid-Grade

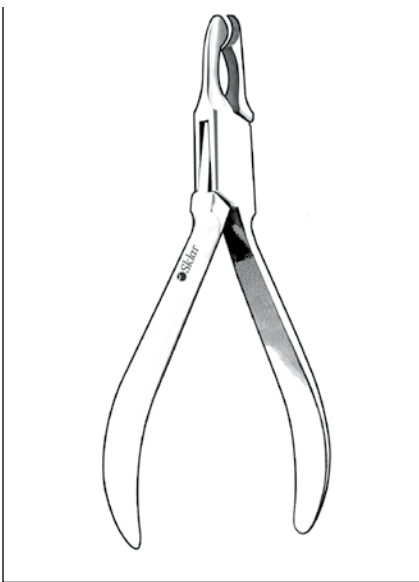

JOHNSON CONTOURING PLIERS 114

- 49-1950
- 48-389 Mid-Grade

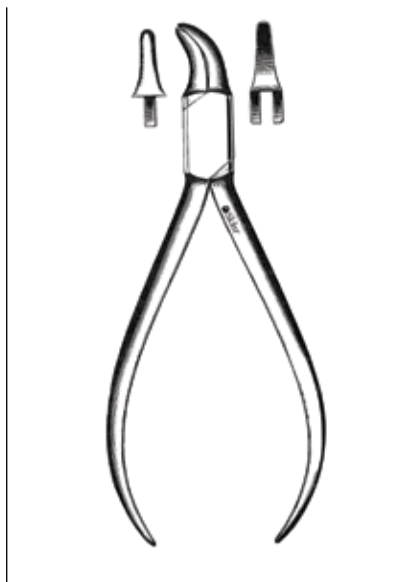

REYNOLDS CONTOURING PLIERS 115

- 49-1955
- 48-500 Mid-Grade



PEESO COLLAR PLIERS 118

- 49-1960
- 48-425 Mid-Grade

ORTHODONTICS

Pliers

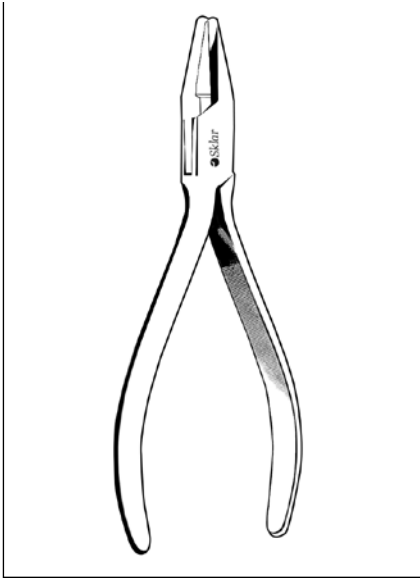

ROBINSON COLLAR PLIER 120
CHROME
 49-1965

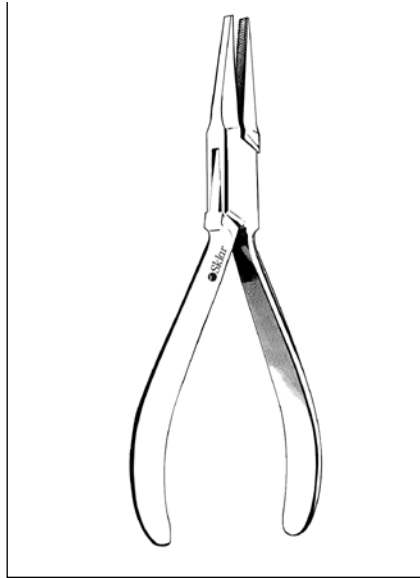

LABORATORY & OFFICE PLIERS 121
SERRATED
 49-1970
 48-462 Mid-Grade

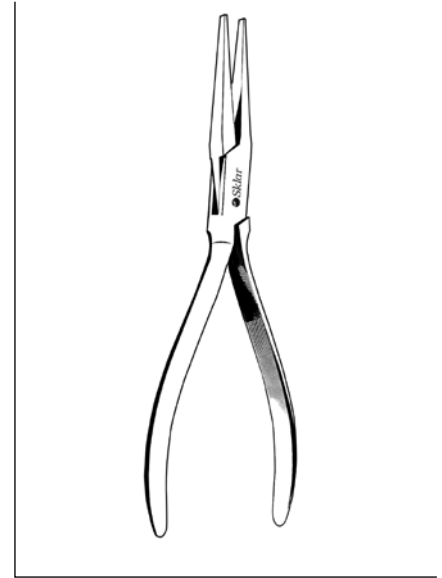

LABORATORY & OFFICE PLIER 122
SMOOTH
 49-1975

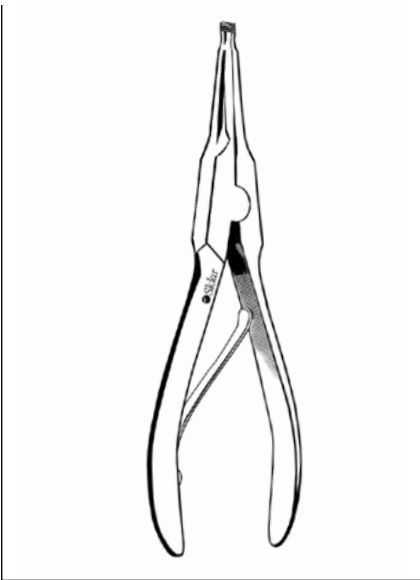

POSTERIOR CROWN STRETCHING PLIER 129S
 49-1980

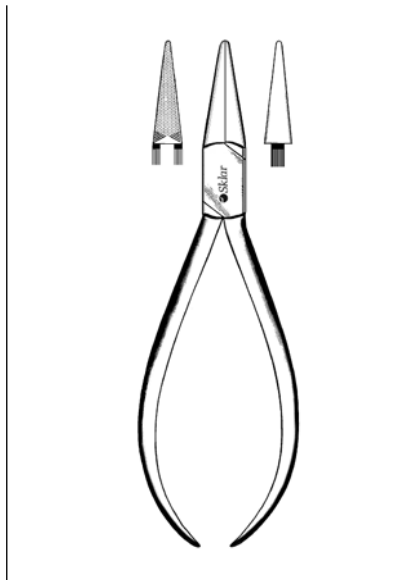

McKELLOPS CLASP BENDING PLIERS 134
 49-1985
 48-498 Mid-Grade

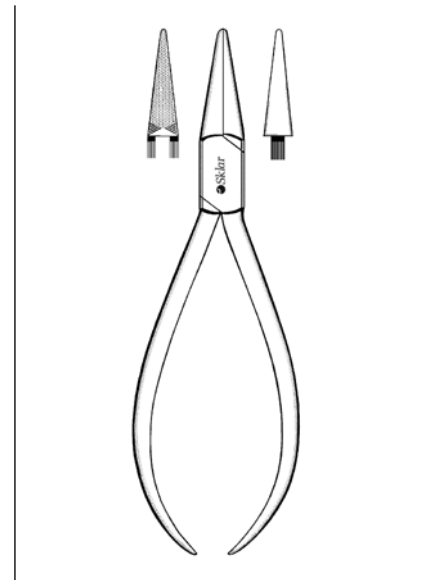

GOSLEE CONTOURING PLIERS 136
 49-1990
 48-507 Mid-Grade

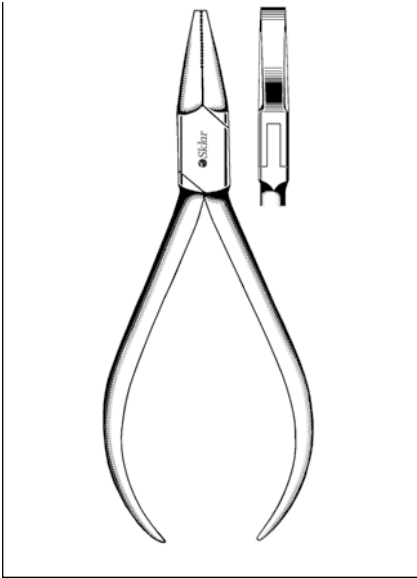

FLAT NOSE PLIER

49-1995 5½"

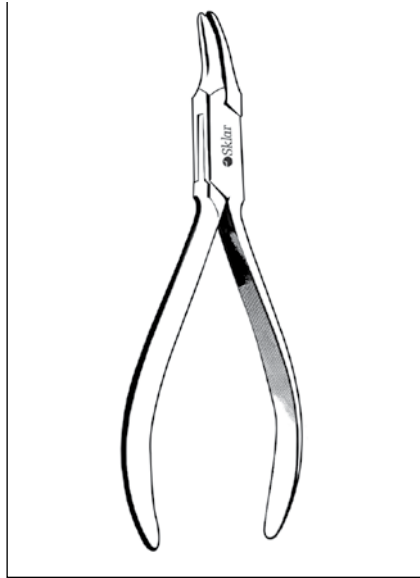

GORDON CONTOURING PLIERS 137

49-2000
48-533 Mid-Grade
49-2005 Chrome

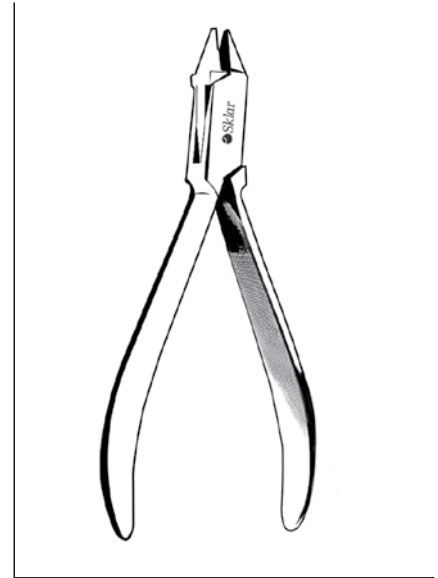

WIRE BENDING PLIERS 139

49-2010
48-562 Mid-Grade



RIBBON ARCH PLIER 142AS

49-2015

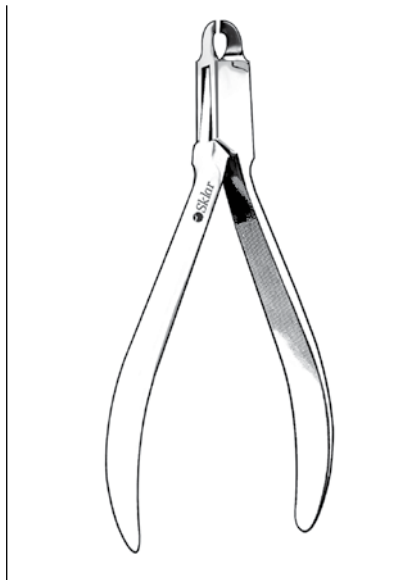

PIN & LIGATURE PLIER 150

49-2020 Chrome

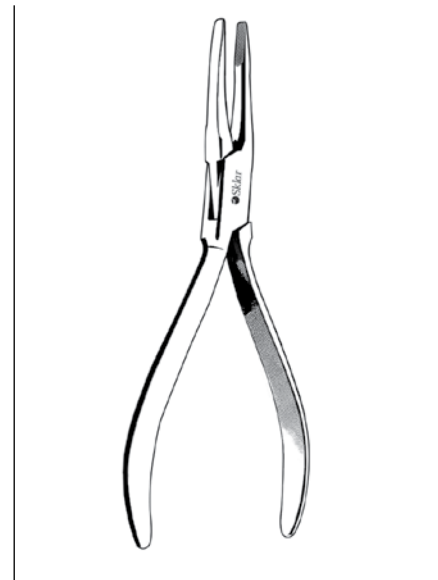

FISCHER FLAT NOSE PLIERS 156

49-2025
48-648 Mid-Grade
49-2030 Chrome

ORTHODONTICS



Pliers

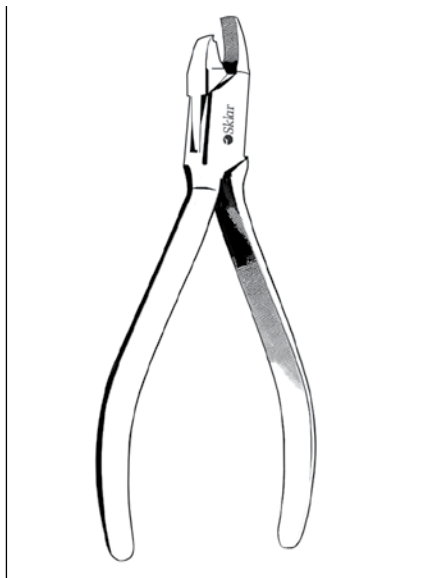

**ANTERIOR BAND REMOVING
PLIER 160S**

49-2035

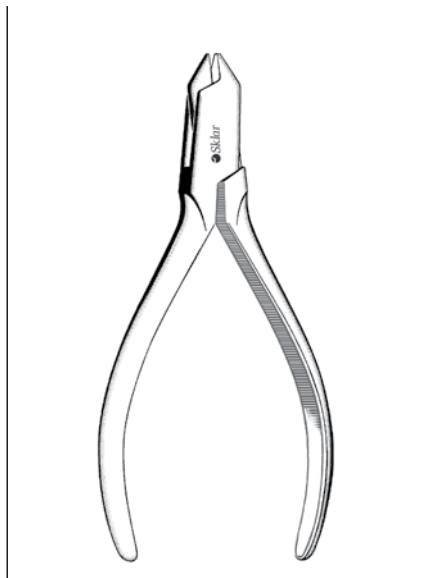

CLASP ADJUSTING PLIERS 200

49-2040

48-738 Mid-Grade

49-2045 Chrome

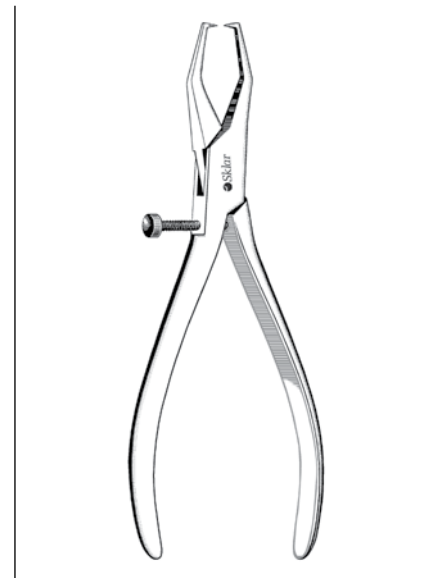

**BAADE CROWN & BAND
REMOVING PLIERS 255**

49-2050

48-835 Mid-Grade



**OLIVER SPRING BENDING
PLIER B325**

49-2055

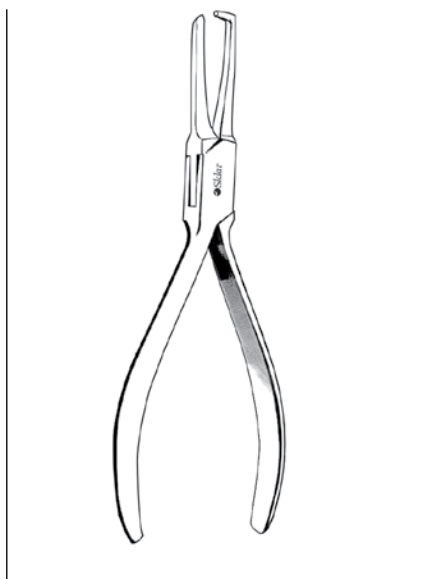

**OLIVER BAND REMOVING
PLIERS 347**

49-2060

48-698 Mid-Grade

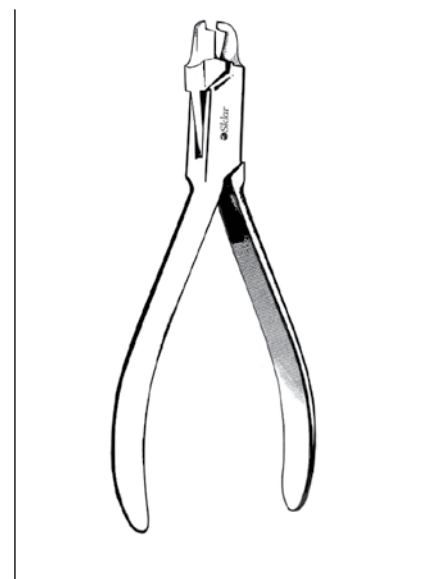

CROWN CRIMPING PLIER 417

49-2065

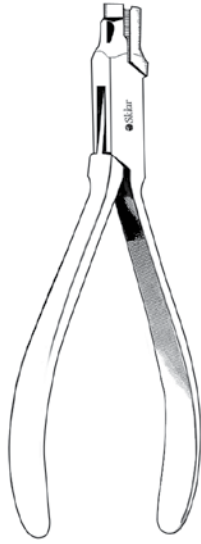

ARROW HEAD FORMING PLIER

49-2070 5"



RIBBON ARCH PLIER 442S

49-2075

SKLAR FACE MASKS

The Sklar Disposable Face Mask features slip-on convenience and protects against infectious pathogens. Sklar masks are $\geq 98\%$ BFE, non-woven, soft and breathable. Convenient ear loops and adjustable nose-bridge ensures a proper fit.

Latex Free.



NON-STERILE

PRODUCT NUMBER	FEATURES	QUANTITIES
96-5557	Mask Earloop, Blue	50/bx
96-5557A	Mask Earloop, Blue	500/cs
96-5557BNS	Mask Earloop, Blue, Bulk	2000/cs

ORTHODONTICS

Pliers



BAND CRIMPING PLIER
49-2080

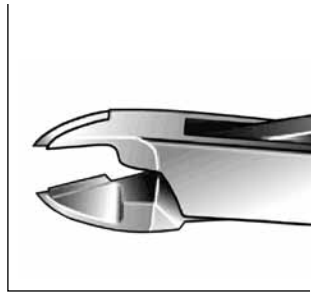

BAND SLITTING PLIER
49-2085

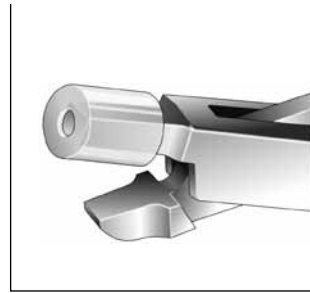

BAND REMOVING PLIER
49-2090 Anterior



BAND REMOVING PLIER 347
49-2100 Posterior



BAND REMOVING PLIER
49-2095 Posterior



BRACKET REMOVING PLIER
49-2105 Straight

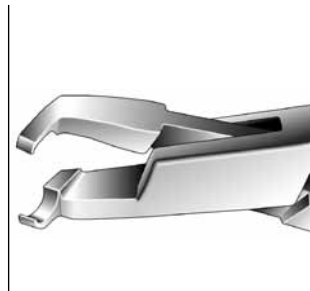

BRACKET REMOVING PLIER
49-2110 60° Angle

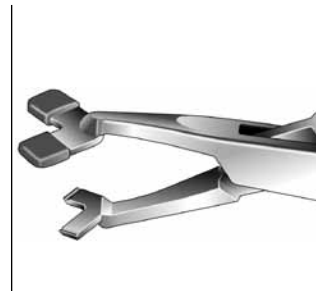

BRACKET & BAND REMOVING PLIER
49-2115 Double Sided

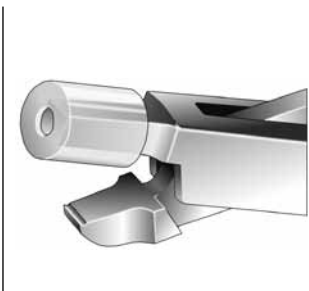

BRACKET & ADHESIVE REMOVING PLIER
49-2120 Concave Lower Beak



BRACKET & ADHESIVE REMOVING PLIER
49-2125 Nylon Tipped Upper Beak

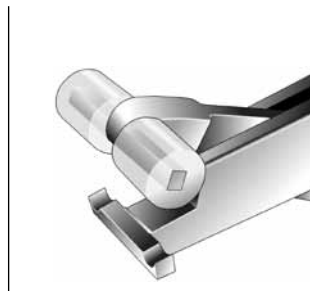

BRACKET & ADHESIVE REMOVING PLIER
49-2130 Replaceable Vinyl Tips

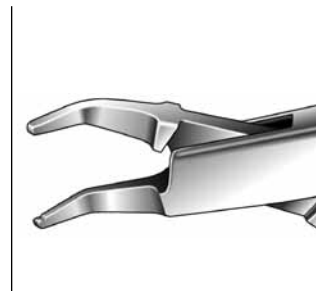

LINGUAL ARCH REMOVING PLIER
49-2135

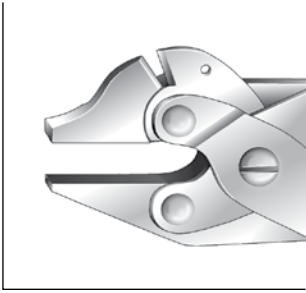

**BERNARD FACEBOW
PLIER**

49-2140 With Cutter

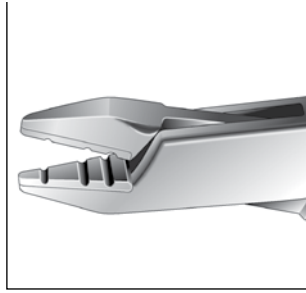

**FACEBOW ADJUSTING
PLIER**

49-2145 Narrow

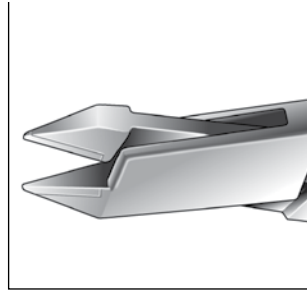

ADAMS PLIER

49-2150

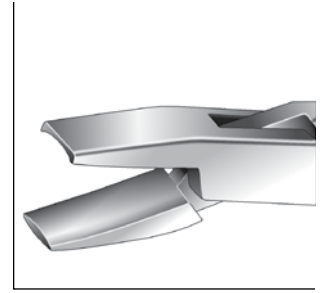

ARCH FORMING PLIER

49-2155

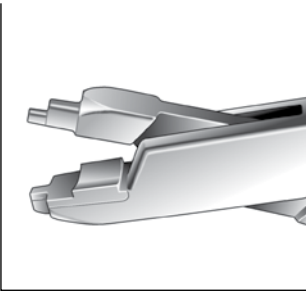

**HAWLEY RETAINER
FORMING PLIER**

49-2160 Non-Holding

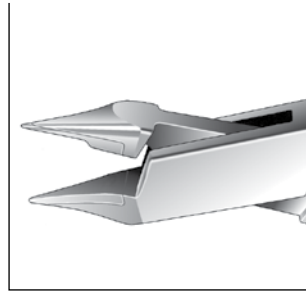

**LIGHT WIRE FORMING
PLIERS**

49-2165
49-2170 With Cutter

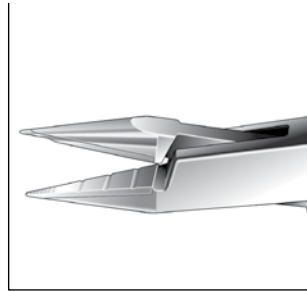

JARABAK PLIER

49-2175 Three Grooves



**FOUR STEP LOOP
FORMING PLIER**

49-2180 Automatic

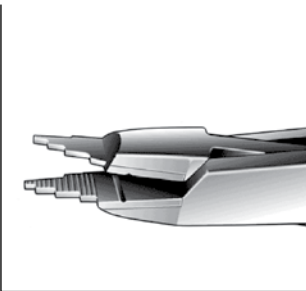

**FOUR STEP LOOP
FORMING PLIER**

49-2185

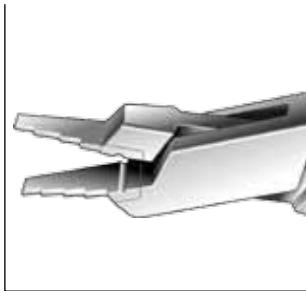

**LOOP FORMING
& CLOSING PLIER**

49-2190

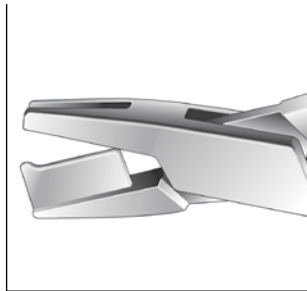

**LIGATURE FORMING
PLIER**

49-2195



LOOP TIE BACK PLIER

49-2200

ORTHODONTICS

Pliers

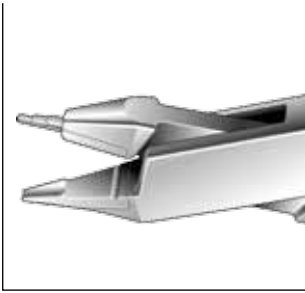

TWEED LOOP & HELIX FORMING PLIER
49-2205

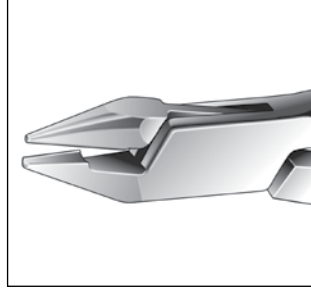

OPTICAL PLIER
49-2210

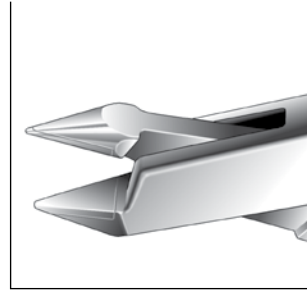

BIRD BEAK BENDING PLIER
49-2215

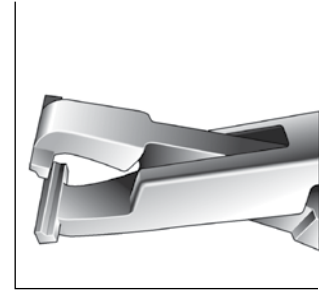

BAYONET BENDING PLIERS
49-2220 .5mm
49-2225 .75mm
49-2230 1mm

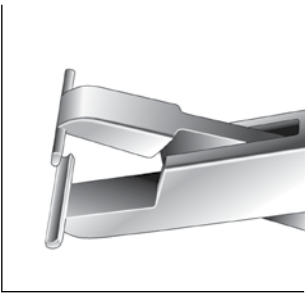

STEP BENDING PLIER
49-2235

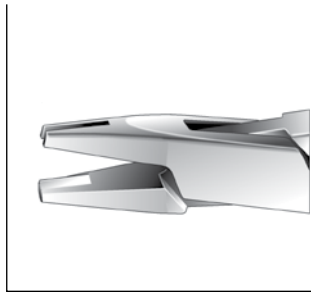

STOP PLIER
49-2240

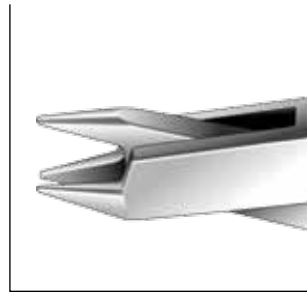

THREE PRONG ADJUSTING PLIER
49-2245 Small Tips

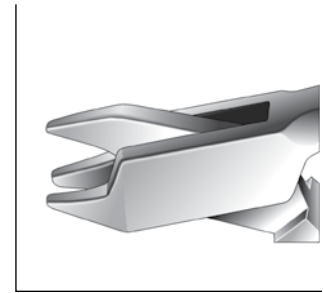

THREE PRONG ADJUSTING PLIER
49-2250 With Clasp

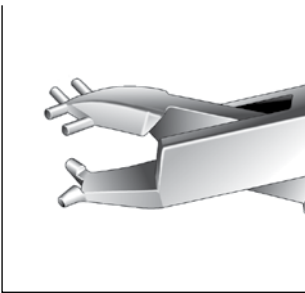

THREE JAW OFFSET PLIER
49-2255

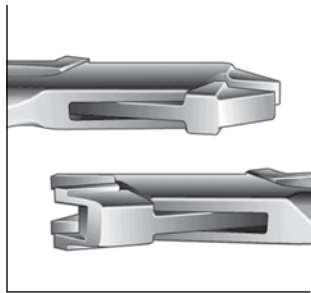

TORQUING PLIER SET
49-2260 Keyless

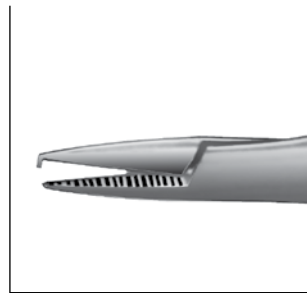

MATHIEU ELASTICS INSERTING PLIER
49-2265 Hook Tip

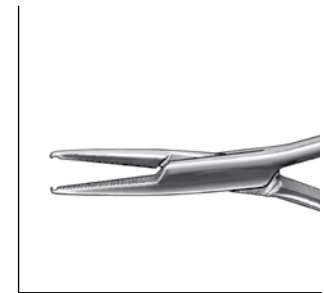

MATHIEU ELASTICS INSERTING PLIER
49-2270 Grooved Tip

ORTHODONTICS

Pliers

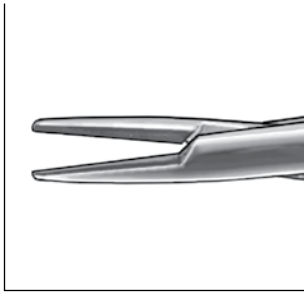

MATHIEU ELASTICS INSERTING PLIER
49-2275 Ligating

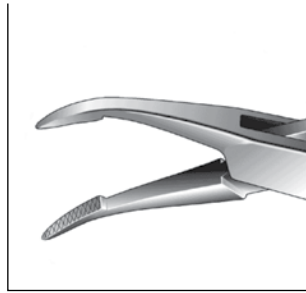

WEINGART UTILITY PLIER
49-2280 Narrow

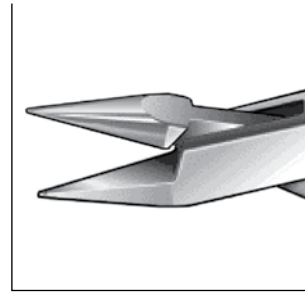

ELASTICS INSERTING PLIER
49-2285 Grooved Tip

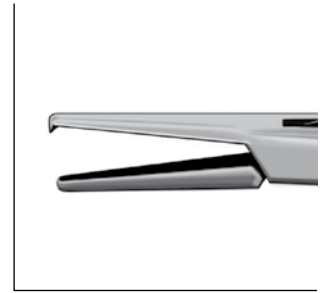

ELASTICS INSERTING PLIER
49-2290 Hook Tip

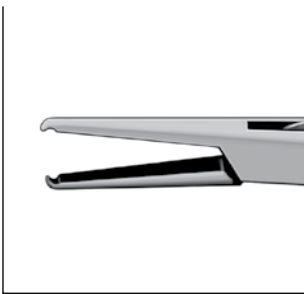

ELASTICS INSERTING PLIER
49-2295 Grooved Tip

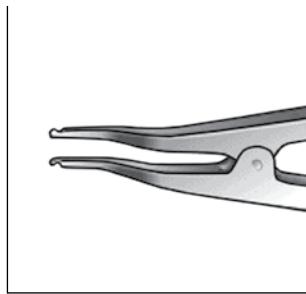

ELASTOMERIC SEPARATING PLIER
49-2300

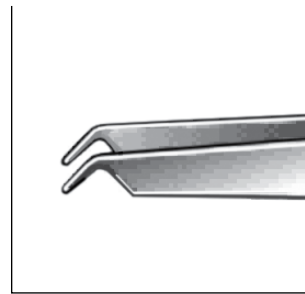

BRACKET PLACEMENT PLIER
49-2305 Hook Tip

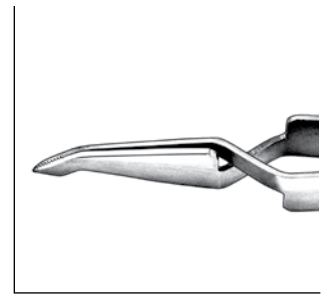

BRACKET PLACEMENT PLIER
49-2310 Curved

**KILLS 99% OF GERMS
IN LESS THAN 15 SECONDS!**

SKLAR STAT™

Instant Foam Hand Sanitizer

SKLAR-STAT Instant Foam Hand Sanitizer, based on the active ingredient Benzalkonium Chloride, is a unique formulation featuring exceptional skin feel, conditioning and moisturizing properties. The efficacy of this product has been confirmed to reduce *S. Aureus* 99.999% and *S. Aureus* MRSA 99.9% in as little as 15 seconds.

Automatic Foam Dispenser

Motion activated battery powered and wall-mounted, Sklar's Automatic Foam Dispenser allows for easy access and reduced risk of cross contamination.

PRODUCT NUMBER	FEATURES	QUANTITIES
10-2856	Wall Mount Dispenser	1 Each
10-2854	1000ml Refill Bottles	6/case
10-2858	(2) Cases 1000ml Refill Bottles plus Free Wall Mount Dispenser	1 Set

ORTHODONTICS

Wire Cutters

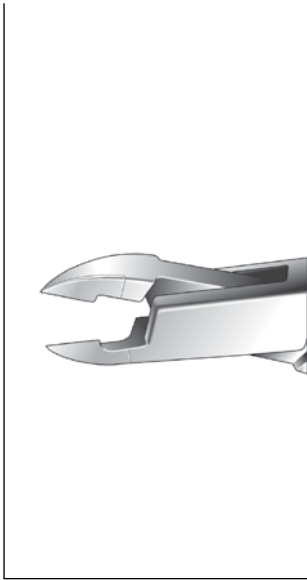

PIN & LIGATURE WIRE CUTTERS
TUNGSTEN CARBIDE INSERTS
 49-2405 Straight
 49-2410 Straight, Small

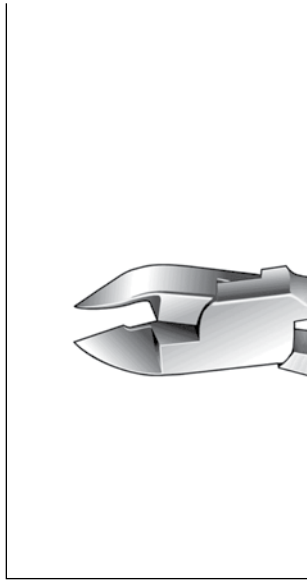

PIN & LIGATURE WIRE CUTTER
 49-2415 Small, For Soft Wire Only

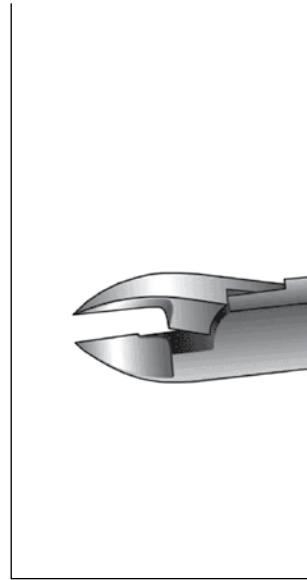

PIN & LIGATURE WIRE CUTTER
 49-2420 Long for Soft Wire Only

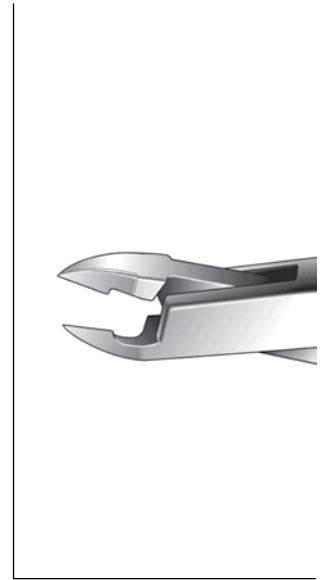

PIN & LIGATURE WIRE CUTTER
 49-2425 15° Angle for Soft Wire Only



PIN & LIGATURE WIRE CUTTER
 49-2430 Angled



DISTAL END CUTTERS CUT AND HOLD
 49-2435 Flush Cut
 49-2440 Flush Cut Small
 49-2445 Long Handle

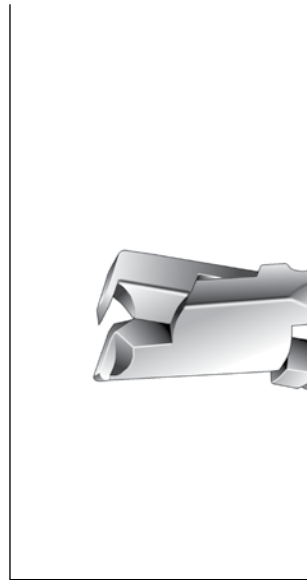

DISTAL END CUTTER NON-HOLDING
 49-2450



SHEAR DISTAL END CUTTER
 49-2455 With Safety Hold

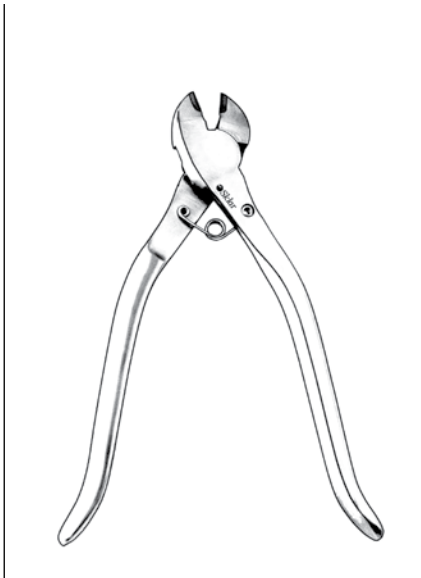

HARD WIRE CUTTER
CHROME
 49-2460 Angled

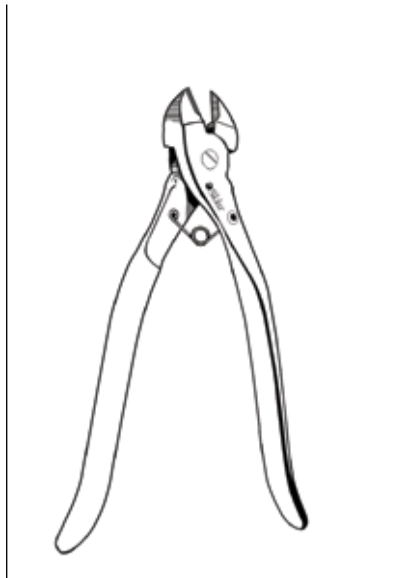

HARD WIRE CUTTER
TUNGSTEN CARBIDE INSERTS
 49-2400 Straight

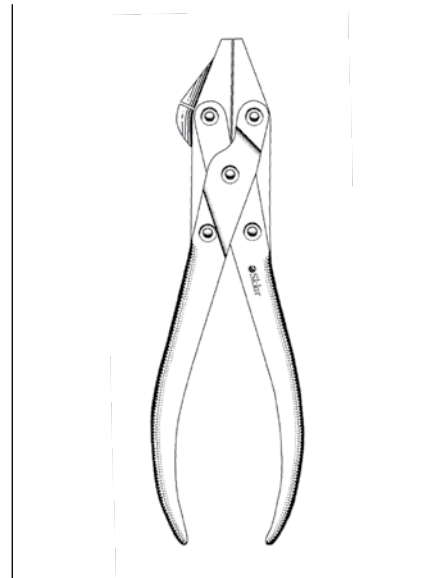

PARALLEL PLIER
DOUBLE ACTION
 49-2465 6¾" With Side, Wire Cutter

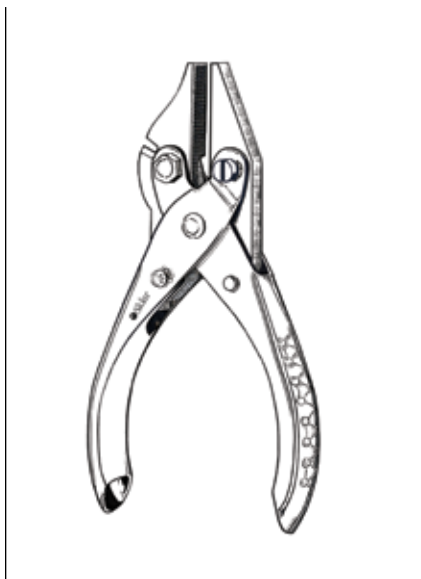

PARALLEL ACTION
WIRE CUTTER
 49-2470 4½"

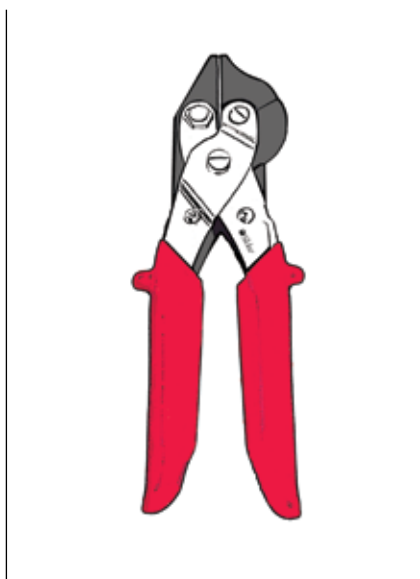

PARALLEL ACTION
WIRE CUTTER
 49-2475 6½" Black Jaws, Vinyl Grip

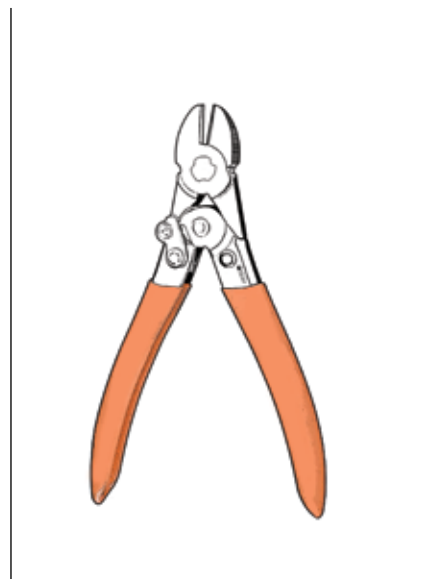

DIAGONAL WIRE CUTTER
 49-2480 5½" Vinyl Grip

ORTHODONTICS

Scissors



SKLAR EDGE™ TC WIRE CUTTING SCISSOR

16-2800 4¾" Angled, Serrated

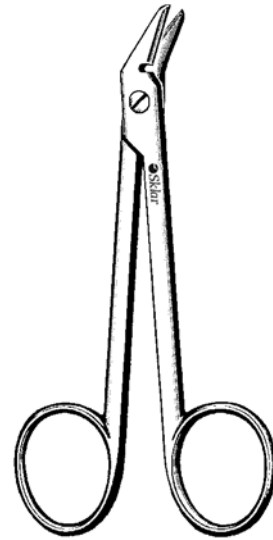

WIRE CUTTING SCISSORS

4¾", ANGLED, SERRATED
24-2342
97-364 Mid-Grade



CROWN & COLLAR CUTTING SCISSORS

STRAIGHT

24-2345 4" Smooth
24-2340 4" Serrated

STRAIGHT, MID-GRADE

48-708 4" Smooth
48-729 4" Serrated



CROWN & COLLAR CUTTING SCISSORS

CURVED

24-2346 4" Smooth
24-2341 4" Serrated

CURVED, MID-GRADE

48-721 4" Smooth
48-735 4" Serrated

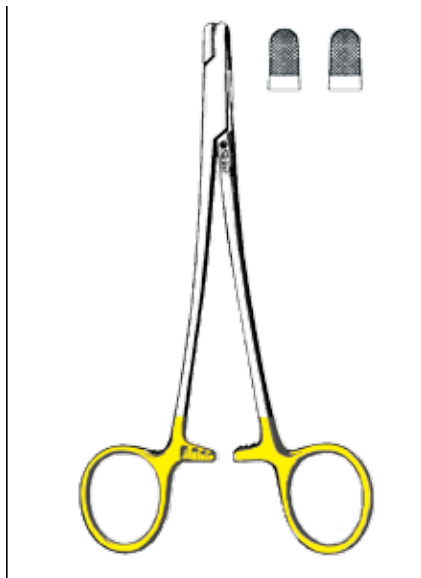

TC WIRE TWISTERS

BLUNT

- 21-9060 5"
- 21-9065 7"

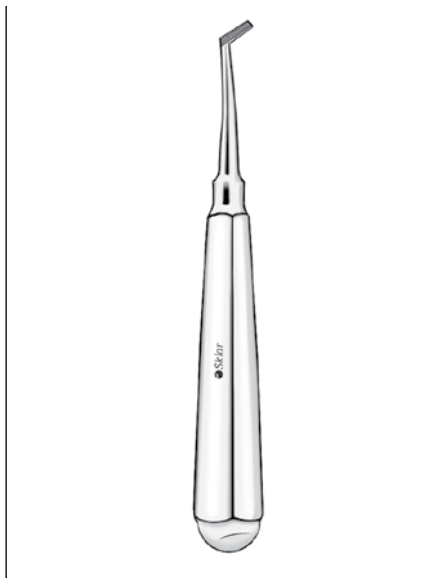

BAND PUSHER 300

49-2500

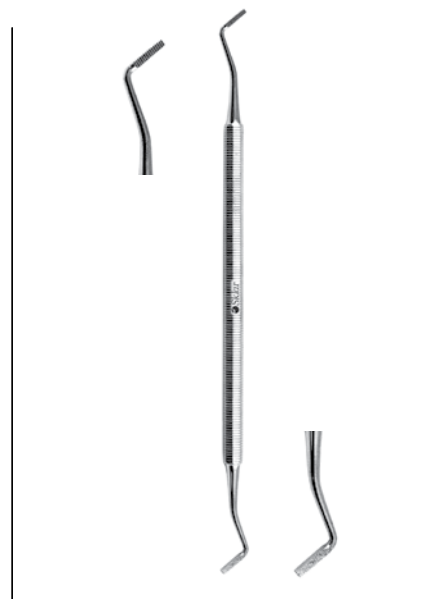

BAND PUSHER

DOUBLE ENDED

49-2505

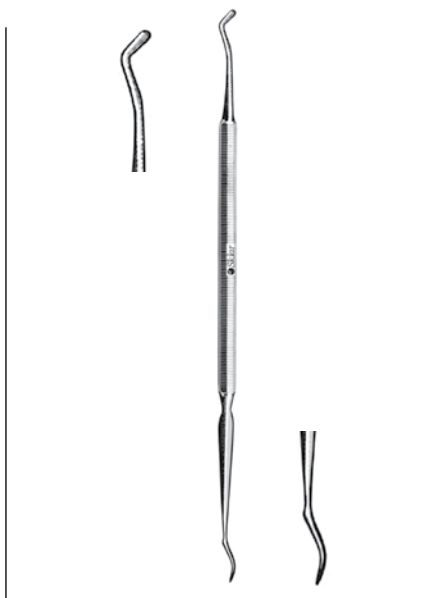

BAND PUSHER / DIRECTOR

DOUBLE ENDED

49-2510

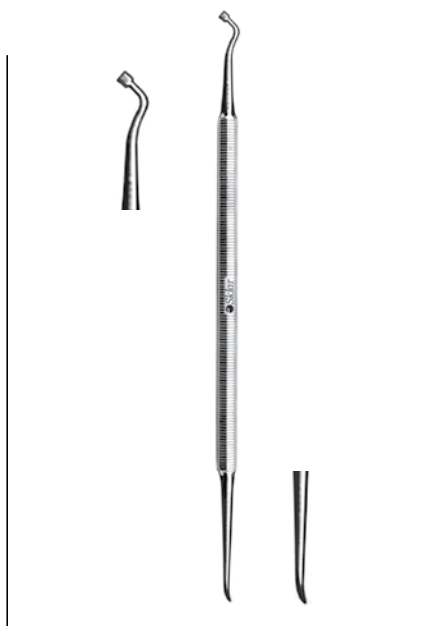

BAND PLUGGER / DIRECTOR

DOUBLE ENDED

49-2515

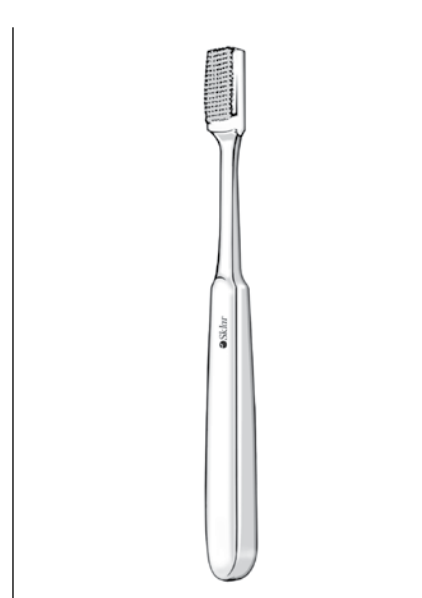

BAND SETTER

49-2520

ORTHODONTICS

Miscellaneous



LIGATURE DIRECTOR AND SCALER
DOUBLE END
49-2525

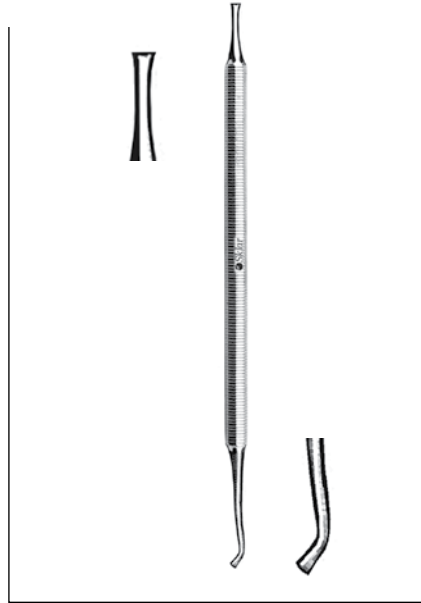

LIGATURE TUCKER AND DIRECTOR
DOUBLE END
49-2530

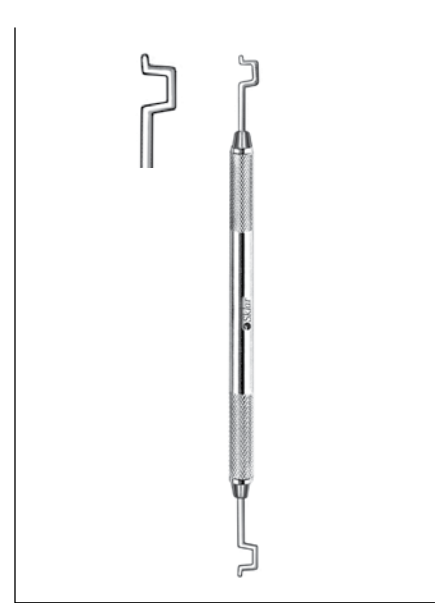

ELASTIC PLACING INSTRUMENT
DOUBLE END
49-2535 Twirl On

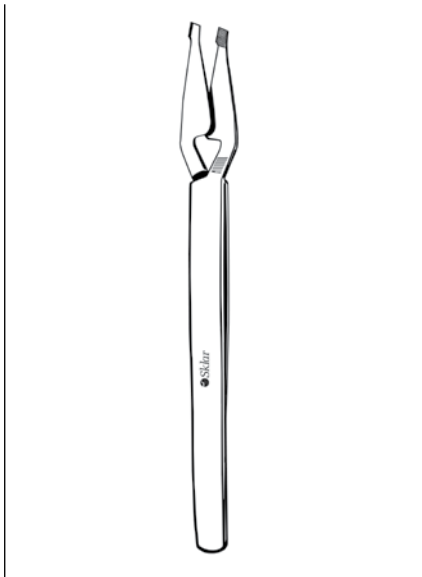

DIRECT BOND AND BRACKET HOLDER
49-2540

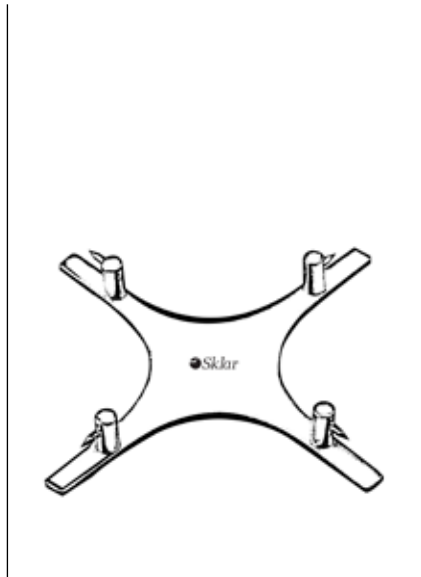

BRACKET POSITIONING GAUGE
49-2545

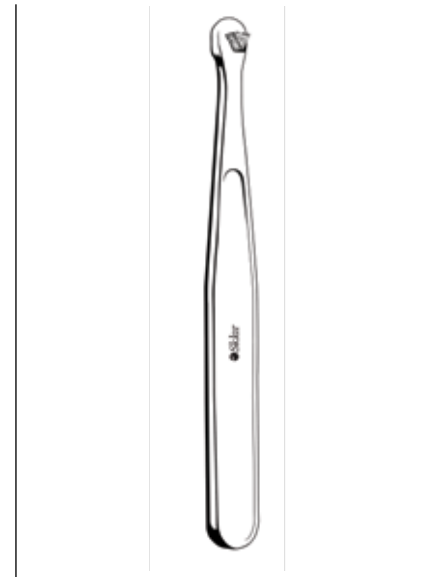

BITE STICK
49-2550 Dry Heat

LIP RETRACTORS

UNIVERSAL

PRODUCT NUMBER	FEATURES	QUANTITIES
96-3298	Child	2/pk
96-3299	Adult	2/pk
96-3300	Universal	2/pk



RETAINER BRIGHT

PRODUCT NUMBER	FEATURES	QUANTITIES
96-3354	Individually Wrapped	36/bx
96-3356	Individually Wrapped	96/bx



BUCHIN CEPHALOMETRIC TRACING TEMPLATE

PRODUCT NUMBER	FEATURES	QUANTITIES
96-3362	Clear Plastic	1 Each



KROMOPAN™ ALGINATE

PRODUCT NUMBER	FEATURES	QUANTITIES
96-3360	Class A, 1lb	1 Each



LATEX ORTHODONTIC ELASTICS

LIGHT

PRODUCT NUMBER	FEATURES	QUANTITIES
96-3370	3/16"	100/pk, 100pk/cs
96-3372	1/4"	100/pk, 100pk/cs
96-3374	5/16"	100/pk, 100pk/cs
96-3376	3/8"	100/pk, 100pk/cs

MEDIUM

96-3380	3/16"	100/pk, 100pk/cs
96-3382	1/4"	100/pk, 100pk/cs
96-3384	5/16"	100/pk, 100pk/cs
96-3386	3/8"	100/pk, 100pk/cs

HEAVY

96-3388	3/16"	100/pk, 100pk/cs
96-3390	1/4"	100/pk, 100pk/cs
96-3392	5/16"	100/pk, 100pk/cs
96-3394	3/8"	100/pk, 100pk/cs





ORTHODONTICS

Accessories

INTRAORAL PHOTOGRAPHIC MIRRORS

PRODUCT NUMBER	FEATURES	QUANTITIES
96-3410	Palatal Child	1 Each
96-3412	Palatal Adult	1 Each
96-3414	Buccal - Wide Inside	1 Each
96-3416	Buccal - Narrow Inside	1 Each
96-3418	Lingual - Wide Outside	1 Each
96-3420	Lingual - Narrow Outside	1 Each
96-3422	Set of 6	1 Set



SUPER "C" ORTHO ADHESIVE KIT

PRODUCT NUMBER	FEATURES	QUANTITIES
96-3396		1 Set

REPLACEMENT PARTS

96-3398	10cc Liquid	1 Each
96-3400	15cc Etch Gel	1 Each
96-3402	20gm Powder	1 Each



MODEL BOXES

PRODUCT NUMBER	FEATURES	QUANTITIES
96-3350	4 Compartment, 6½" x 6¼" x 2"	50/bx
96-3352	6 Compartment, 6½" x 9⅛" x 2"	50/bx



SONIC CLEANER

PRODUCT NUMBER	FEATURES	QUANTITIES
49-4800	Personal, Cordless	1 Each



KNO-KURL™ ACETATE

PRODUCT NUMBER	FEATURES	QUANTITIES
96-3358	100 Sheets	1 Pad



COLUMBIA CURETTES

DOUBLE END, ROUND HANDLE

PRODUCT NUMBER	TYPE
49-2600	2L / 2R
49-2605	4L / 4R
49-2610	13 / 14



McCALLS CURETTES





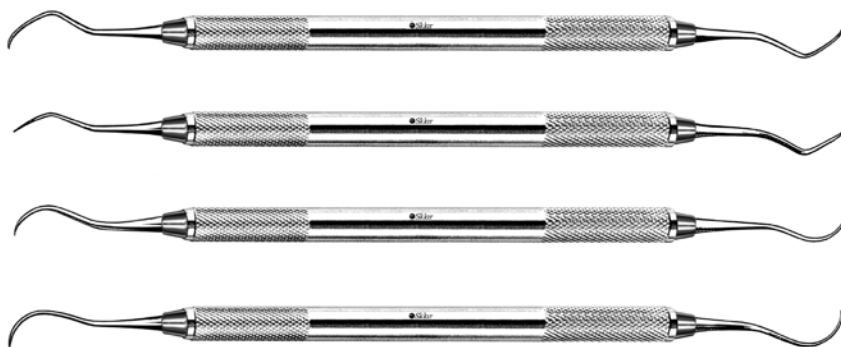



DOUBLE END, ROUND HANDLE

PRODUCT NUMBER	TYPE
49-2615	13 / 14
49-2620	13S / 14S
49-2625	17 / 18
49-2630	17S / 18S



GRACEY CURETTES
DOUBLE END, ROUND HANDLE

PRODUCT NUMBER TYPE

49-2635	1 / 2	
49-2640	3 / 4	
49-2645	5 / 6	
49-2650	7 / 8	
49-2655	9 / 10	
49-2660	11 / 12	
49-2665	13 / 14	
49-2670	15 / 16	
49-2675	17 / 18	

CRANE-KAPLAN SCALER
DOUBLE END, ROUND HANDLE

PRODUCT NUMBER	TYPE
49-2700	6



GOLDMAN-FOX SCALERS
DOUBLE END, ROUND HANDLE

PRODUCT NUMBER	TYPE
49-2705	1
49-2710	2
49-2715	3
49-2720	4
49-2725	5
49-2730	6



JACQUETTE SCALERS
DOUBLE END, ROUND HANDLE

PRODUCT NUMBER	TYPE
49-2755	U15 / 30
49-2750	H5 / 33



JACQUETTE SCALERS
DOUBLE END, LIGHTWEIGHT HANDLE

PRODUCT NUMBER	TYPE
49-2760	1Y / 1YS
49-2765	2Y / 3Y
49-2770	2YS / 3YS
49-2775	2 / 3

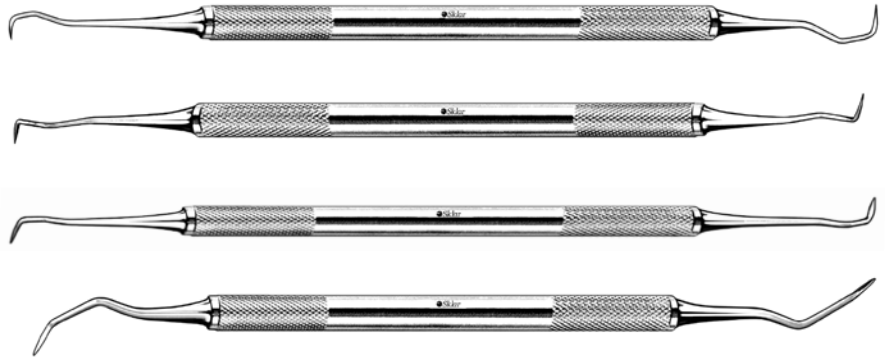

JACQUETTE SCALERS
DOUBLE END, OCTAGONAL HANDLE

PRODUCT NUMBER	TYPE
49-2800	1S / 1S
49-2805	1Y / 1Y
49-2810	1Y / 1YS
49-2815	2Y / 3Y
49-2820	2YS / 3YS
49-2825	2 / 3
49-2830	2S / 3S
49-2835	30 / 33
49-2840	31 / 32
49-2845	34 / 35



JACQUETTE SCALERS

SINGLE END, OCTAGONAL HANDLE

PRODUCT NUMBER TYPE

49-2870

1



49-2875

1S



49-2880

2S



49-2885

3S



TOWNER-JACQUETTE SCALER

DOUBLE END, ROUND HANDLE

PRODUCT NUMBER TYPE

49-2900

U15 / 33



TOWNER SCALER

DOUBLE END, ROUND HANDLE

PRODUCT NUMBER TYPE

49-2905

U15 / 30



TAYLOR SCALER

DOUBLE END, ROUND HANDLE

PRODUCT NUMBER TYPE

49-2910

2 / 3



WHITESIDE SCALERS

SINGLE END, OCTAGONAL HANDLE

PRODUCT NUMBER TYPE

49-2920 1 - 0



49-2925 2 - 0



YOUNGER SCALER

DOUBLE END, ROUND HANDLE

PRODUCT NUMBER TYPE

49-2930 7 / 8



SCALERS

DOUBLE END, OCTAGONAL HANDLE

PRODUCT NUMBER TYPE

49-2940 204



49-2945 204S



49-2950 204SD



49-2955 H6 / H7



49-2960 12



SCALERS

SINGLE END, OCTAGONAL HANDLE

PRODUCT NUMBER	TYPE
49-2965	3
49-2970	33
49-2975	34



UNIVERSAL SCALER

DOUBLE END, ROUND HANDLE

PRODUCT NUMBER	TYPE
49-2980	U15 / 33



SKLAR DISINFECTANT

READY-TO-USE SPRAY SURFACE DISINFECTANT

2 MINUTE KILL TIME!

- Ready to use, non-toxic formula.
- Specially formulated for the control of cross contamination.
- Effective against a broad range of pathogens including H1N1, HIV-1, HPV, VRE, Norovirus, Hep B & C as well as TB, MRSA, A. Baumannii.
- Safe for all areas of the facility.
- Satisfies OSHA's Bloodborne Pathogen Standards.
- Non-irritating formula.
- EPA registered.

PRODUCT NUMBER	FEATURES	QUANTITIES
10-1643	24 oz. Spray Bottles	6/case
10-1642	24 oz. Spray Bottle	1 bottle
10-1653	1 Gallon Bottles	4/case
10-1654	1 Gallon Bottle	1 bottle
10-1644	2.5 Gallon Bottles	2/case



GOLDMAN-FOX KNIVES

DOUBLE END, ROUND HANDLE

PRODUCT NUMBER	TYPE
49-3000	7
49-3005	8
49-3010	9
49-3015	10
48-922	10, Mid-Grade
49-3020	11
49-3025	21

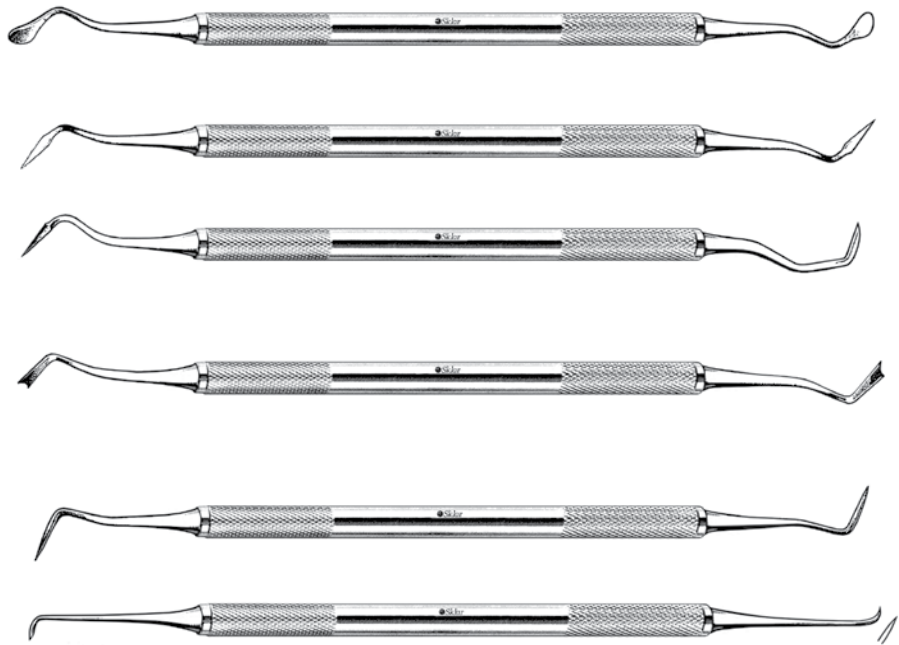

CRANE-KAPLAN KNIFE

DOUBLE END

PRODUCT NUMBER	TYPE
49-3050	



ORBAN KNIFE

DOUBLE END

PRODUCT NUMBER	TYPE
49-3055	1 / 2



BUCK KNIFE

DOUBLE END

PRODUCT NUMBER TYPE

49-3060 5 / 6



KIRKLAND KNIFE

DOUBLE END

PRODUCT NUMBER TYPE

49-3065 15 / 16



AKERS / EVANS KNIFE AND SPOON WITH HANDLE

CONE SOCKET

PRODUCT NUMBER TYPE

49-3080 Akers Complete Set

49-3081 Akers Knife Only

49-3082 Akers Spoon Only

49-3083 Double End Handle Only



PRODUCT NUMBER TYPE

49-3084 Evans Complete Set

49-3085 Evans Knife Only

49-3086 Evans Spoon Only

49-3083 Double End Handle Only



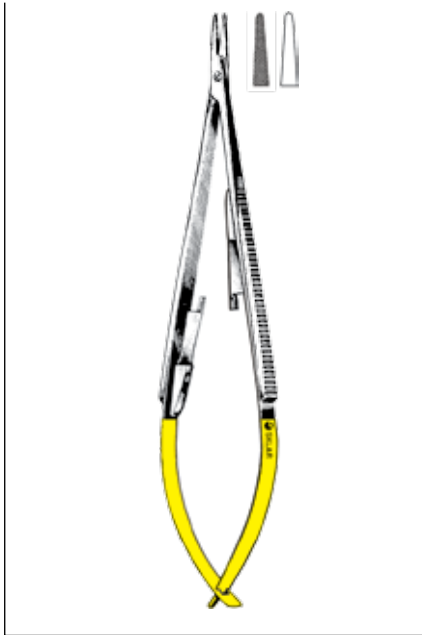

**TC CASTROVIEJO
NEEDLE HOLDERS**

STRAIGHT, WITH LOCK

21-8040	5½"	Smooth
21-8046	5½"	Serrated

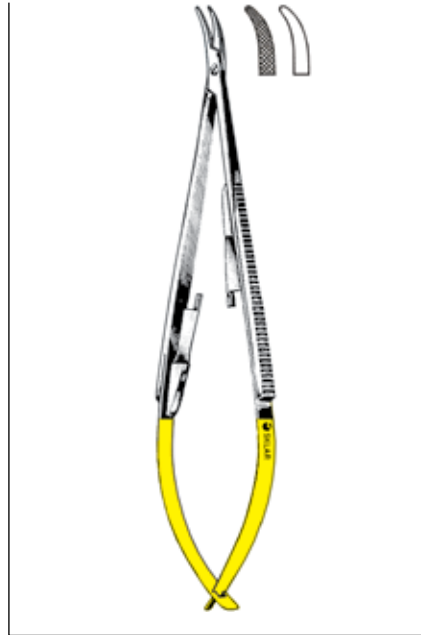

**TC CASTROVIEJO
NEEDLE HOLDERS**

CURVED, WITH LOCK

21-8043	5½"	Smooth
21-8047	5½"	Serrated

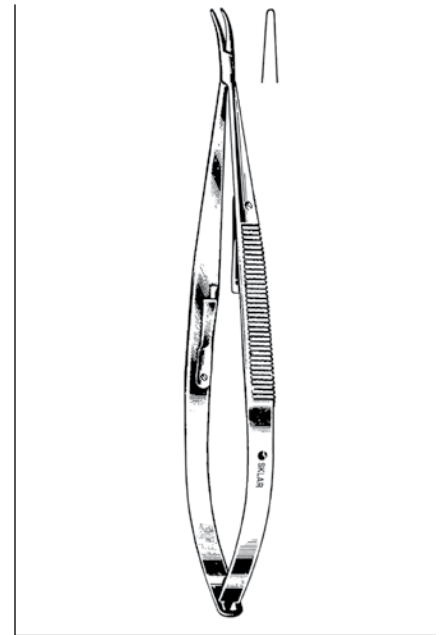

**CASTROVIEJO
NEEDLE HOLDERS**

WITH LOCK

65-6357	5½"	Straight, Smooth
65-6358	5½"	Curved, Smooth



ROSS NEEDLE HOLDER

WITH CATCH

65-6554	5½"	Curved
---------	-----	--------



STEVENS NEEDLE HOLDER

65-6265	6"
---------	----



CRANE-KAPLAN DISSECTOR
SINGLE END
49-3100



CRANE-KAPLAN POCKET MARKERS
49-3125 Type 1
49-3130 Type 2



OCHSENBEIN CHISEL 1
49-3200

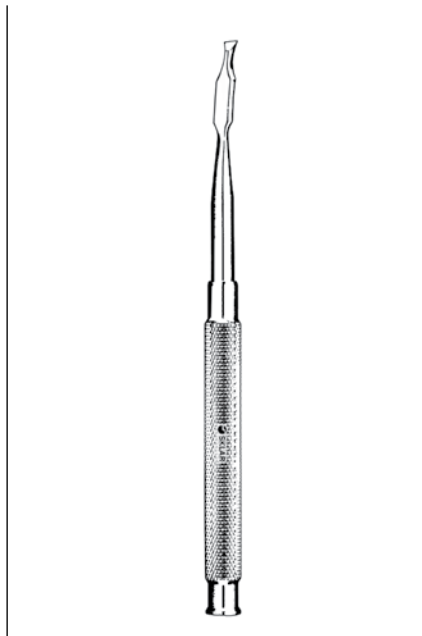

OCHSENBEIN CHISEL 2
49-3205

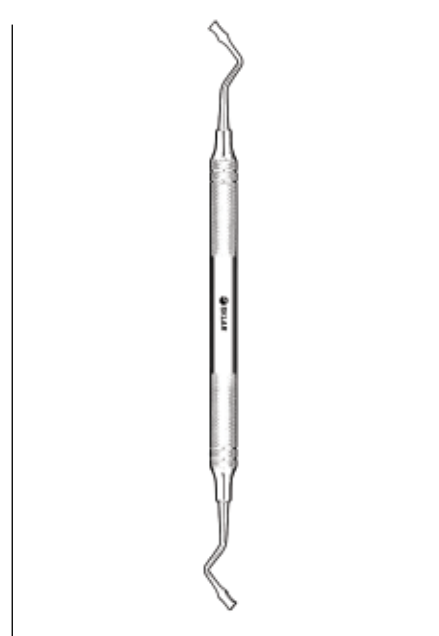

OCHSENBEIN CHISEL 4
49-3210



McCLURE SCISSOR

SPRING HANDLE

64-1942 4 1/4" Curved

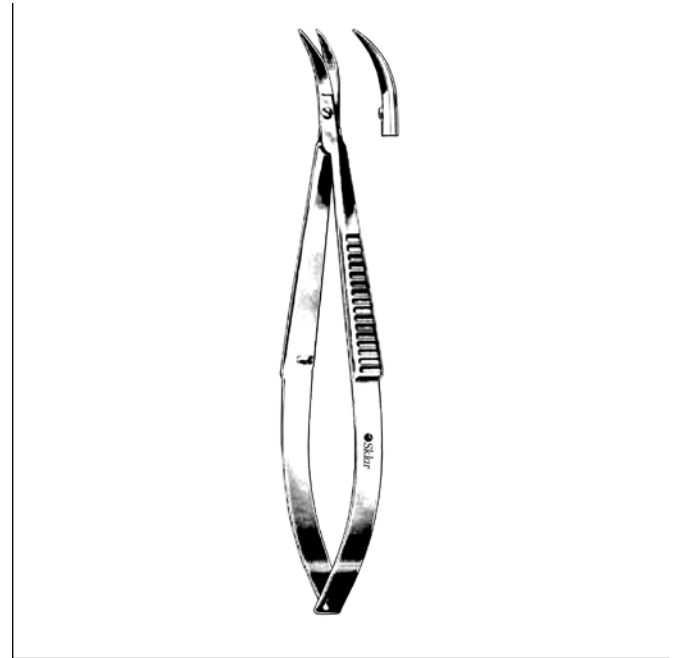

CASTROVIEJO SCISSORS

CURVED

64-2440 4" Sharp
64-2442 4" Blunt

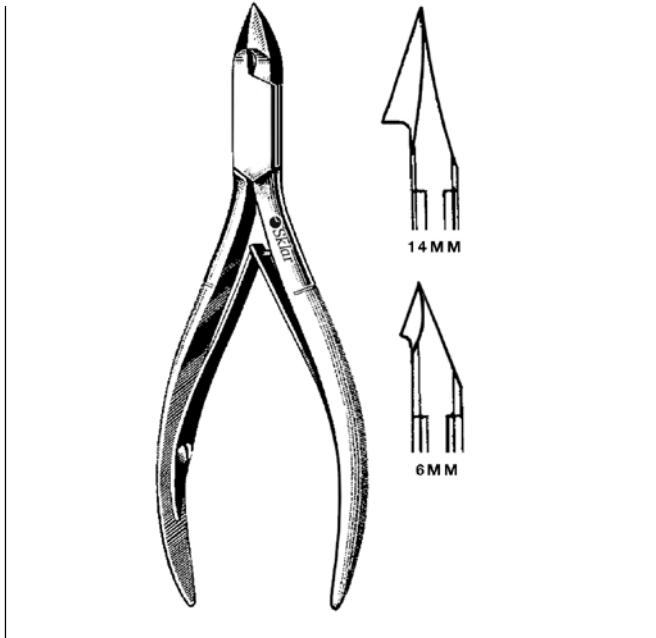

TISSUE NIPPERS

CONVEX BLADES

97-1241 4" Stainless, 6mm
97-1243 5" Stainless, 14mm



MICRO-FRIEDMAN RONGEURS

1.3MM JAW

40-3186 5 1/2" Straight
40-3189 5 1/2" Curved
40-3191 5 1/2" 90° Angled Jaws

PROSTHODONTIC
CROWN REMOVERS



**TC WYNMAN CROWN GRIPPER
WITHOUT RATCHET**

49-3800 5½"



MORRELL CROWN REMOVER

- 49-3805 Complete with Points A, B and C
- 49-3810 Complete with Points A, B, C and D
- 49-3815 Point A Only
- 49-3820 Point B Only
- 49-3825 Point C Only
- 49-3830 Point D Only

RETAINER BRITE™

- Effervescent appliance cleaning tablets.
- Removes stubborn stains and kills germs.
- Leaves a fresh, minty flavor.
- A clean appliance encourages patient use.
- Individually wrapped tablets.

Product Number	Quantities
96-3354	Box of 36 Tablets
96-3356	Box of 96 Tablets

LUCAS CURETTES

DOUBLE END

PRODUCT NUMBER TYPE

49-3300 75

49-3305 85

49-3310 86

49-3315 87



MOLT CURETTES

SINGLE END

PRODUCT NUMBER TYPE

49-3330 1

49-3335 2

49-3340 4

49-3345 5L

49-3350 6R

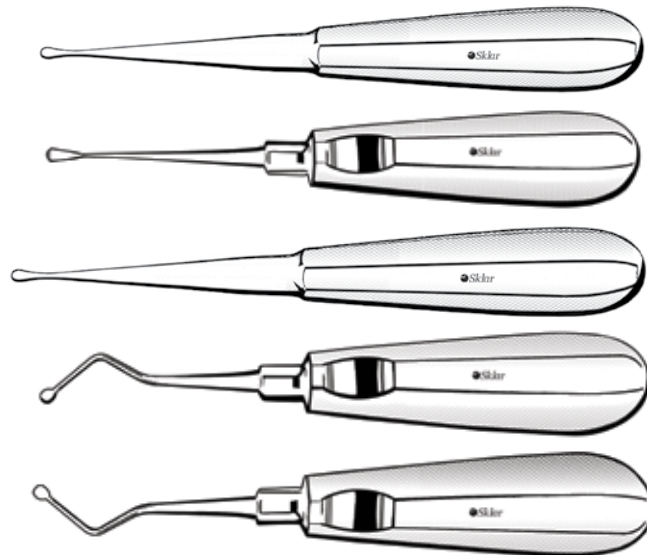

DOUBLE END

PRODUCT NUMBER TYPE

49-3355 2 / 4



BONE FILES

DOUBLE END

PRODUCT NUMBER TYPE

97-1615 10



97-1617 11



97-1620 12



97-1625 12A



MILLER BONE FILES

DOUBLE END, PLAIN SERRATIONS 7"

PRODUCT NUMBER TYPE

97-1533 33



97-1545 45



97-1564 64



POLOKOFF FILE

SINGLE END

PRODUCT NUMBER TYPE

97-1642 1



BONE RASPS

DOUBLE END

PRODUCT NUMBER TYPE

97-1640 3-4mm, 7"



97-1635 5-6mm, 8½"

97-1645 6mm, 7½"



COUPLAND CHISEL

PRODUCT NUMBER TYPE

49-3215 1



GARDNER CHISELS

PRODUCT NUMBER TYPE

49-3240 51

49-3245 52

49-3250 53

49-3255 54

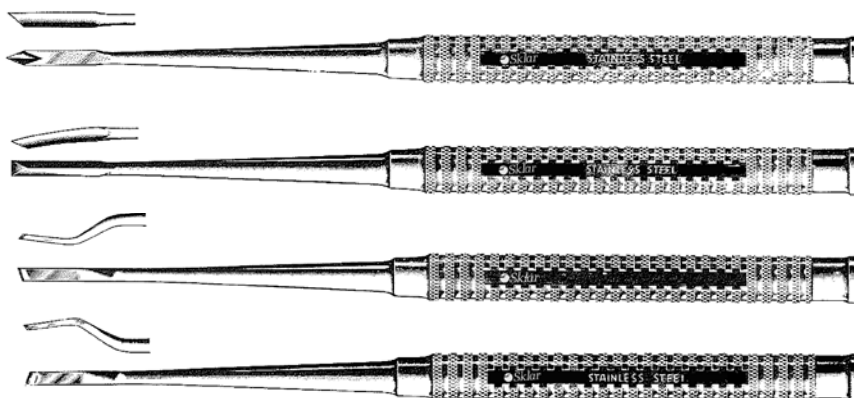

WAKEFIELD CHISELS

PRODUCT NUMBER TYPE

49-3260 1W

49-3265 2W

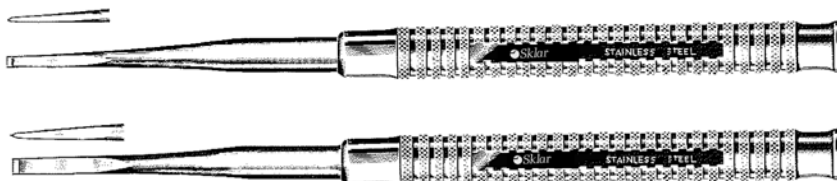

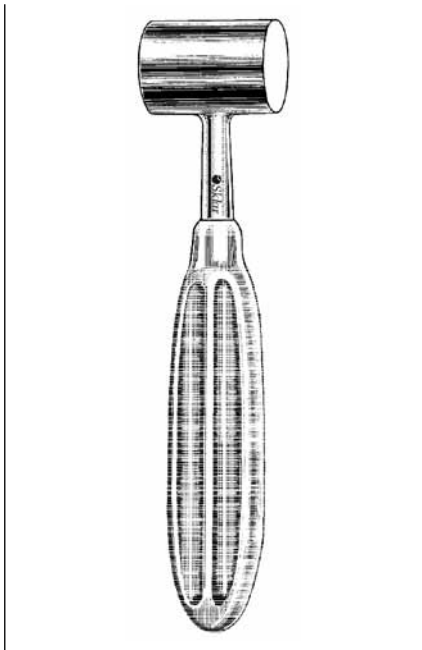

GERZOG BONE Mallet
LEAD FILLED, 14OZ.
40-5765 7½", 1" Diameter

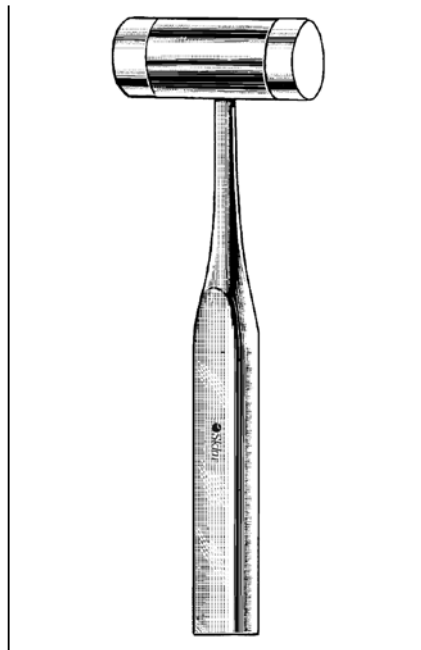

Mallet
WITH TWO PLASTIC FLAT ENDS, 8OZ.
40-5925 7¼"
40-5926 Replacement Ends

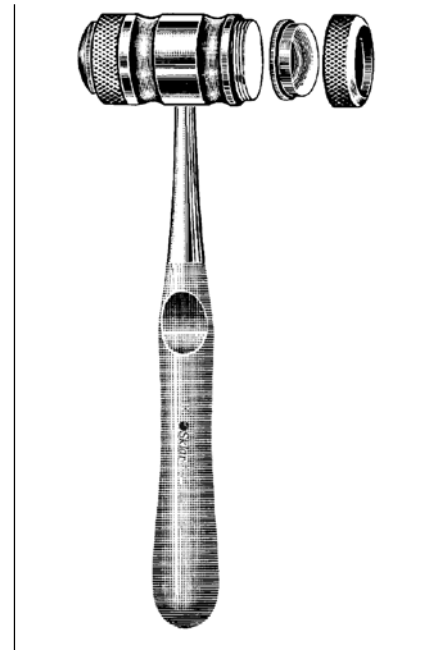

SKLAR Mallet
WITH TWO PLASTIC ROUND ENDS, 8OZ.
40-5870 7½"
40-5871 Replacement Ends

SKLAR DISINFECTANT™ SURFACE WIPES

READY-TO-USE, PRE-MOISTENED TOWELETTES

- Ready to use, non-toxic formula.
- Specially formulated for the control of cross contamination.
- Effective against a broad range of pathogens including H1N1, HIV-1, HPV, VRE, Norovirus, Hep B & C as well as TB, MRSA and A. Baumannii.
- Safe for all areas of the facility.
- Satisfies OSHA's Bloodborne Pathogen Standards.
- Destroys odor-causing bacteria.
- 7" x 10" non-woven, tear resistant towelette.
- EPA registered.



Convenient
Dispensing
Canister

PRODUCT NUMBER	DESCRIPTION	QUANTITIES
10-1616	100 Towelettes/Canister	6/case
10-1617	100 Towelettes/Canister	12/case

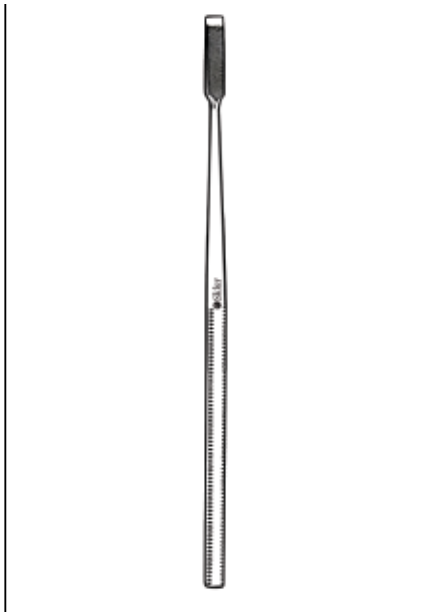

WEST OSTEOTOME

41-1339 6¾" 4mm, 16mm

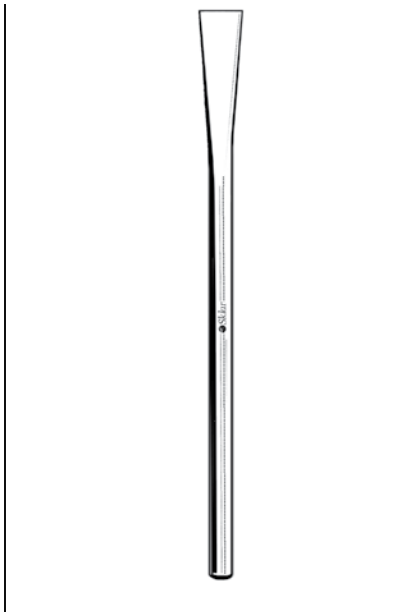

SHEEHAN OSTEOTOMES

STRAIGHT, 6¼"

67-4620 2mm
67-4621 3mm
67-4622 4mm

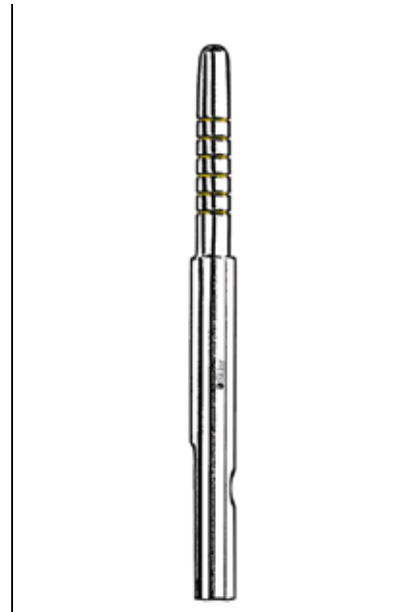

OSTEOTOME INSERTS

CONVEX TIP, STRAIGHT

49-3400 2.7mm
49-3405 3.2mm
49-3410 3.7mm
49-3415 4.2mm
49-3420 5.0mm

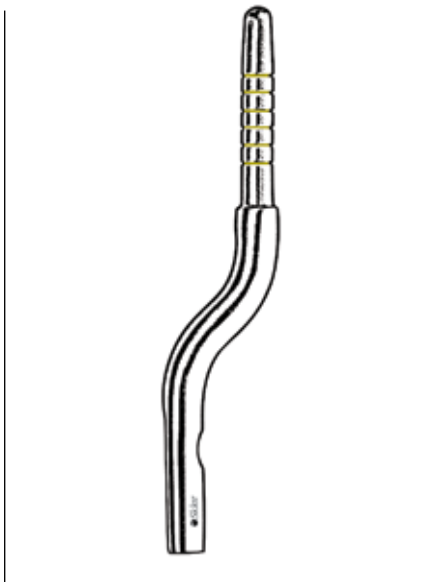

OSTEOTOME INSERTS

CONVEX TIP, BAYONET

49-3425 2.7mm
49-3430 3.2mm
49-3435 3.7mm
49-3440 4.2mm
49-3445 5.0mm

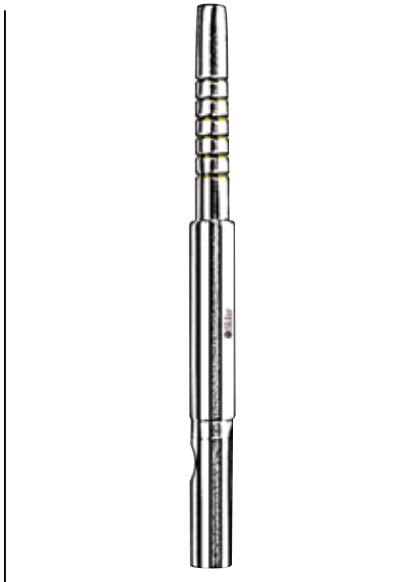

OSTEOTOME INSERTS

CONCAVE TIP, STRAIGHT

49-3450 2.7mm
49-3455 3.2mm
49-3460 3.7mm
49-3465 4.2mm
49-3470 5.0mm

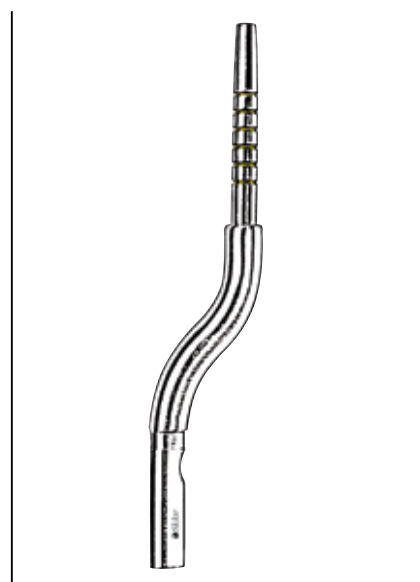

OSTEOTOME INSERTS

CONCAVE TIP, BAYONET

49-3475 2.7mm
49-3480 3.2mm
49-3485 3.7mm
49-3490 4.2mm
49-3495 5.0mm



BONE PUSHER INSERTS

CONVEX TIP, STRAIGHT

- 49-3500 2.7mm
- 49-3505 3.2mm
- 49-3510 3.7mm
- 49-3515 4.2mm
- 49-3520 5.0mm



BONE PUSHER INSERTS

CONVEX TIP, BAYONET

- 49-3525 2.7mm
- 49-3530 3.2mm
- 49-3535 3.7mm
- 49-3540 4.2mm
- 49-3545 5.0mm

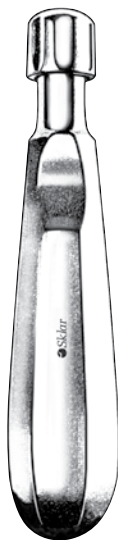

OSTEOTOME HANDLE

FOR INTERCHANGEABLE INSERTS

- 49-3550 6 $\frac{3}{4}$ "



ELEVATORS

PRODUCT NUMBER

TYPE

49-3600

30



49-3605

31



49-3610

34



49-3615

34S



49-3620

46, Serrated



49-3625

50



49-3630

77R, Serrated



49-3635

81





ELEVATORS

APICAL

PRODUCT NUMBER TYPE

49-3640

301



49-3645

302



49-3650

303



49-3655

304



CRANE

PRODUCT NUMBER TYPE

49-3660

41



SELDIN

PRODUCT NUMBER TYPE

49-3665

1L



49-3670

1R



49-3675

4L



49-3680

4R



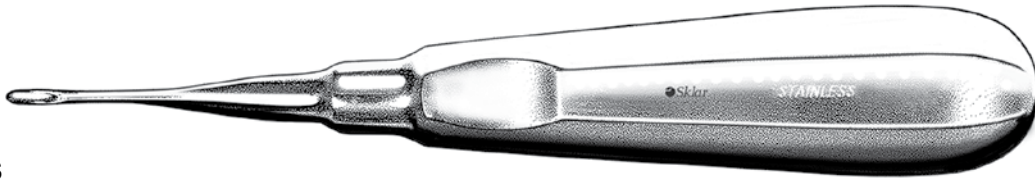

ELEVATORS

CRYER

PRODUCT NUMBER

TYPE

49-3685

27



49-3690

28



49-3695

27S



49-3700

28S



49-3705

39



49-3710

40



BAYONET

PRODUCT NUMBER

TYPE

49-3715

1



49-3720

2



COGSWELL

PRODUCT NUMBER

TYPE

49-3725

A



ROOT TIP ELEVATORS

PRODUCT NUMBER	TYPE
49-3730	78, Straight
49-3735	79, Angled Right
49-3740	80, Angled Left

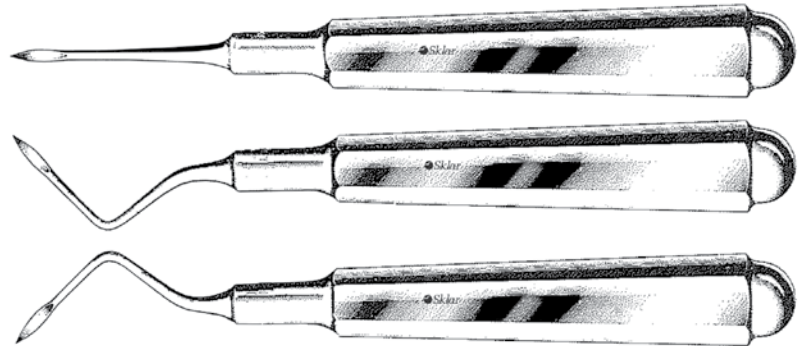

HEIDBRINK ROOT TIP PICKS

SINGLE END

PRODUCT NUMBER	TYPE
49-3745	1, Straight
49-3750	2, Angled Right
49-3755	3, Angled Left

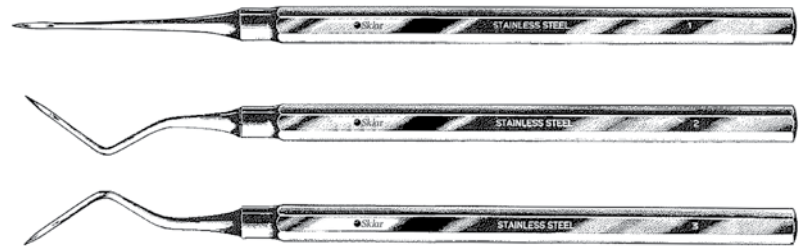

HEIDBRINK ROOT TIP PICK

DOUBLE END

PRODUCT NUMBER	TYPE
49-3760	2 / 3



POTTS ELEVATORS

PRODUCT NUMBER	TYPE
49-3765	1L
49-3770	2R

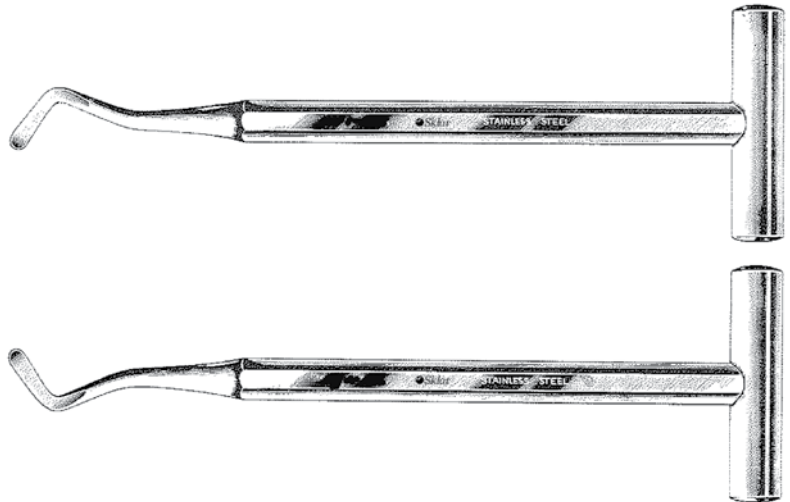

FREER ELEVATOR
DOUBLE END, SHARP/BLUNT

PRODUCT NUMBER	TYPE
47-2380	7 1/4"



SKLAR STAT™

Instant Foam Hand Sanitizer

SKLAR-STAT Instant Foam Hand Sanitizer, based on the active ingredient Benzalkonium Chloride, is a unique formulation featuring exceptional skin feel, conditioning and moisturizing properties. The efficacy of this product has been confirmed to reduce *S. Aureus* 99.999% and *S. Aureus* MRSA 99.9% in as little as 15 seconds.

Automatic Foam Dispenser

Motion activated battery powered and wall-mounted, Sklar's Automatic Foam Dispenser allows for easy access and reduced risk of cross contamination.



**KILLS 99% OF GERMS
IN LESS THAN 15 SECONDS!**

PRODUCT NUMBER	FEATURES	QUANTITIES
10-2856	Wall Mount Dispenser	1 Each
10-2854	1000ml Refill Bottles	6/case
10-2858	(2) Cases 1000ml Refill Bottles plus Free Wall Mount Dispenser	1 Set

WEST PERIOSTEAL ELEVATOR

DOUBLE END

PRODUCT NUMBER TYPE

97-0511 2



OHL PERIOSTEAL ELEVATOR

DOUBLE END

PRODUCT NUMBER TYPE

97-0050 7"



SELDIN PERIOSTEAL ELEVATOR

DOUBLE END

PRODUCT NUMBER TYPE

97-0527 23



MOLT PERIOSTEAL ELEVATOR

DOUBLE END

PRODUCT NUMBER TYPE

97-0530 9



PRICHARD PERIOSTEAL ELEVATOR

DOUBLE END

PRODUCT NUMBER

97-0535



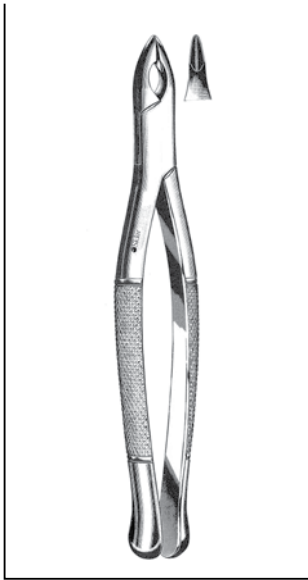

STANDARD EXTRACTING FORCEPS 1
UPPER INCISORS
 49-4000
 48-904 Mid-Grade

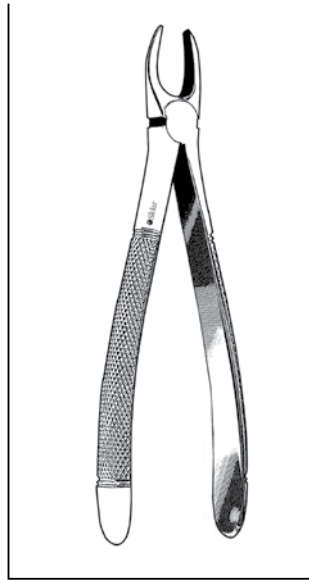

EXTRACTING FORCEP 1
ENGLISH PATTERN
 49-4005 Upper Bicuspid

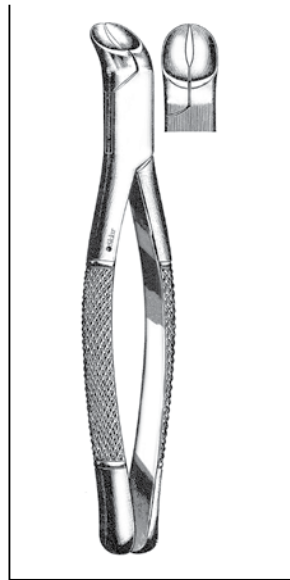

EXTRACTING FORCEP 5
 49-4010 Lower Third Molar

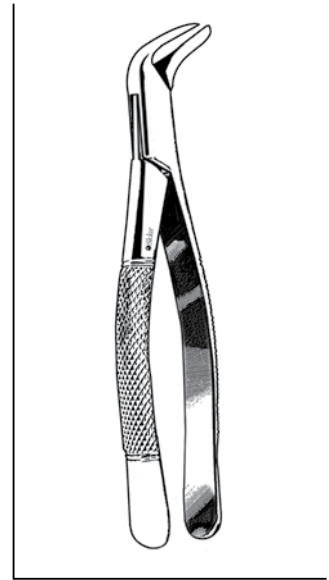

EXTRACTING FORCEP 6
 49-4015

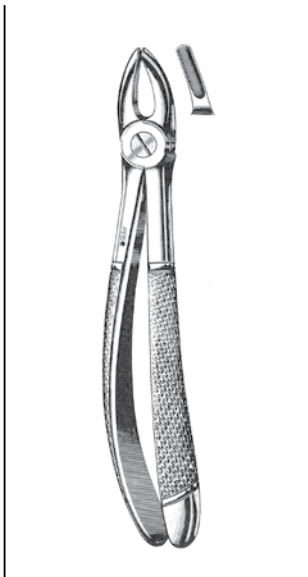

EXTRACTING FORCEP 7
ENGLISH PATTERN
 49-4020



EXTRACTING FORCEP 10
 49-4025 Hook Handle



EXTRACTING FORCEPS 10S
STRAIGHT HANDLE, UPPER MOLAR
 49-4030
 48-776 Mid-Grade
STRAIGHT HANDLE, UPPER CUSPID
 49-4035 Nevius



EXTRACTING FORCEP 10H
 49-4040 Hook Handle

Extracting Forceps



EXTRACTING FORCEP 13
ENGLISH PATTERN
 49-4045



EXTRACTING FORCEP 15
HOOK HANDLE
 49-4050

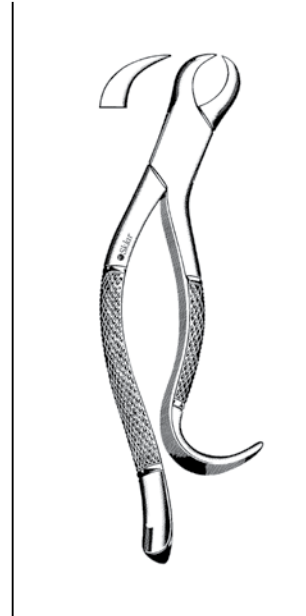

EXTRACTING FORCEPS 16
HOOK HANDLE
 49-4055
 48-264 Mid-Grade

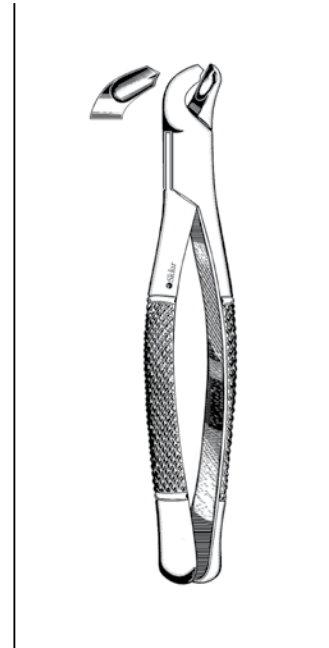

EXTRACTING FORCEPS 17
STRAIGHT HANDLE
 49-4060
 48-289 Mid-Grade

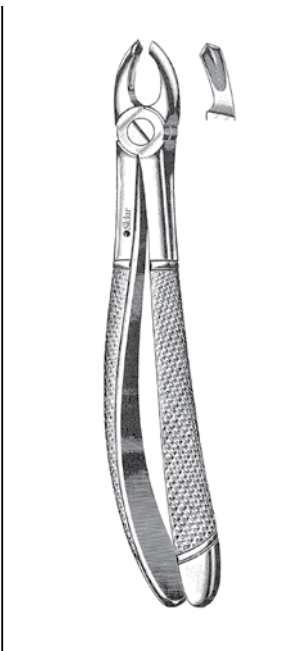

EXTRACTING FORCEP 17
ENGLISH PATTERN
 49-4065 Right



EXTRACTING FORCEP 18
ENGLISH PATTERN
 49-4070 Left

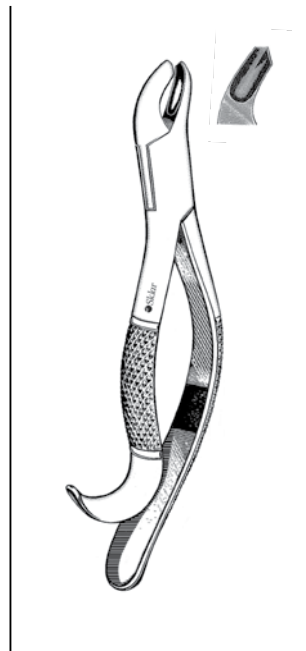

EXTRACTING FORCEPS
UPPER FIRST AND SECOND MOLAR
 49-4075 18L
 48-752 18L, Mid-Grade
 49-4080 18R

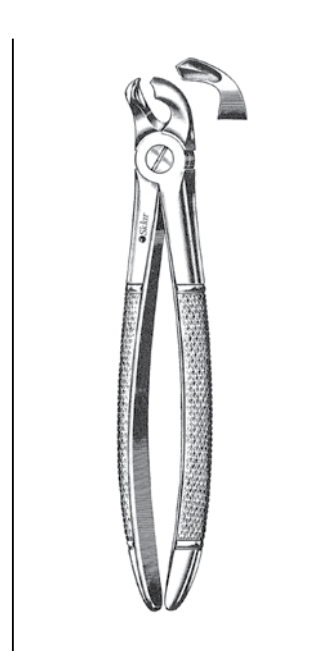

EXTRACTING FORCEP 21
ENGLISH PATTERN
 49-4085

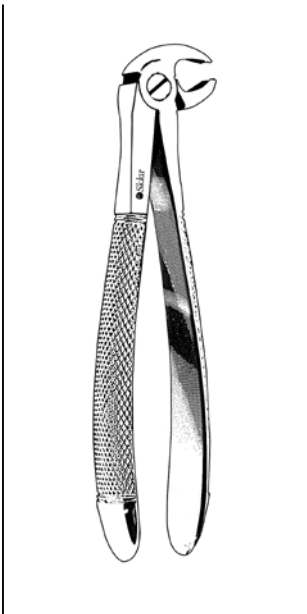

EXTRACTING FORCEP 22
ENGLISH PATTERN
49-4090

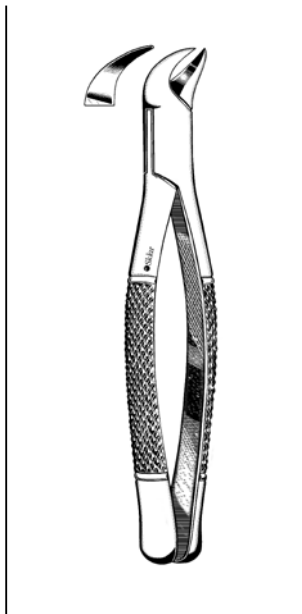

EXTRACTING FORCEPS 23
STRAIGHT HANDLE
49-4095
48-276 Mid-Grade

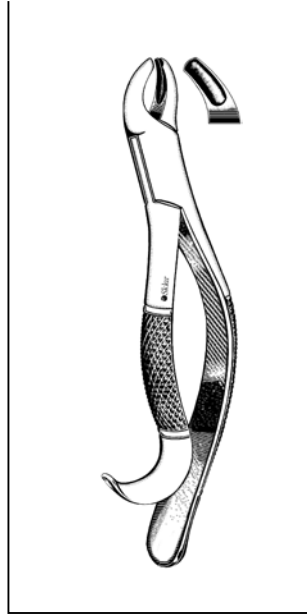

EXTRACTING FORCEPS 24
HOOK HANDLE
49-4100
48-226 Mid-Grade



EXTRACTING FORCEP 31
ENGLISH PATTERN
49-4105

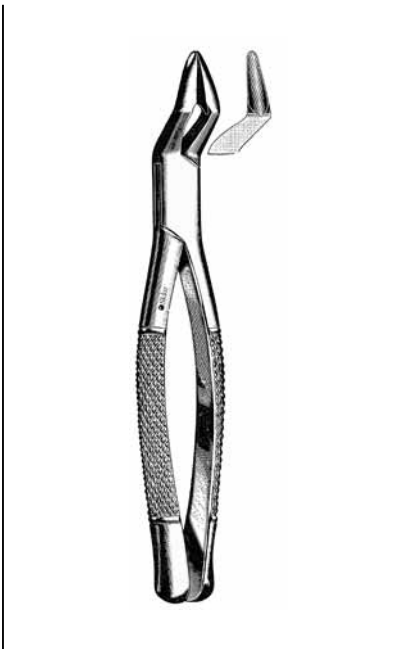

EXTRACTING FORCEP 32
49-4110

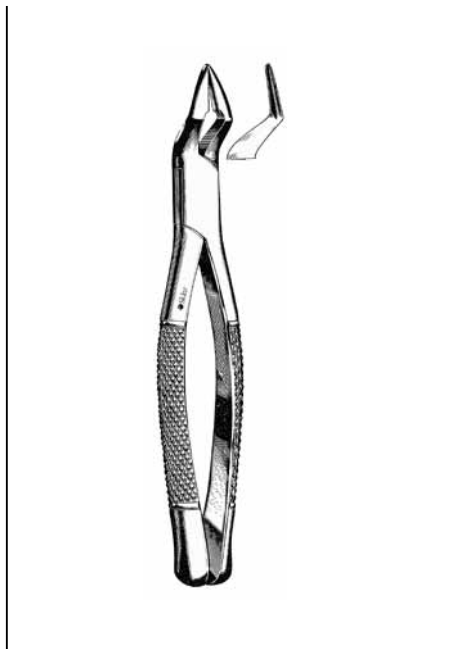

EXTRACTING FORCEP 32A
49-4115

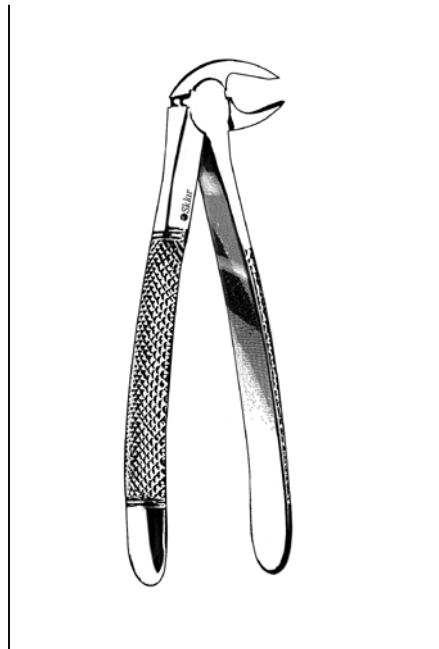

EXTRACTING FORCEP 33
ENGLISH PATTERN
49-4120



EXTRACTING FORCEP 44
49-4125



EXTRACTING FORCEP 49
49-4130



EXTRACTING FORCEP 51
ENGLISH PATTERN
49-4135



EXTRACTING FORCEPS
UPPER FIRST AND SECOND MOLAR
49-4140 53L
48-766 53L, Mid-Grade
49-4145 53R
48-756 53R, Mid-Grade



EXTRACTING FORCEP 59GH
49-4150 Fine Serrations



EXTRACTING FORCEP 60
49-4155

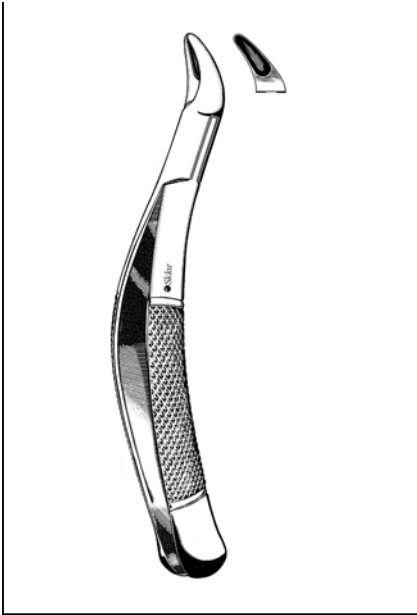

EXTRACTING FORCEPS 62

49-4160
48-339 Mid-Grade

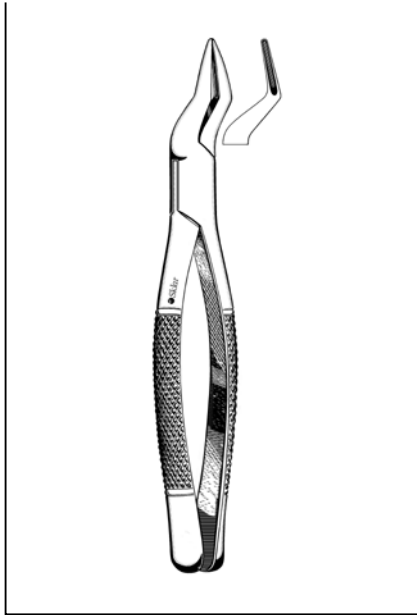

EXTRACTING FORCEPS 65

49-4165
48-204 Mid-Grade

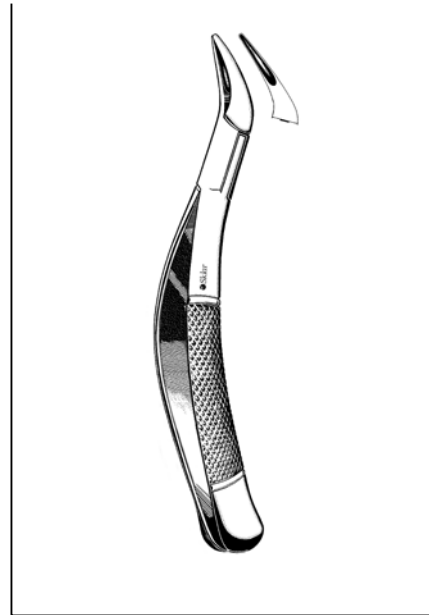

EXTRACTING FORCEPS 69

49-4170
48-351 Mid-Grade

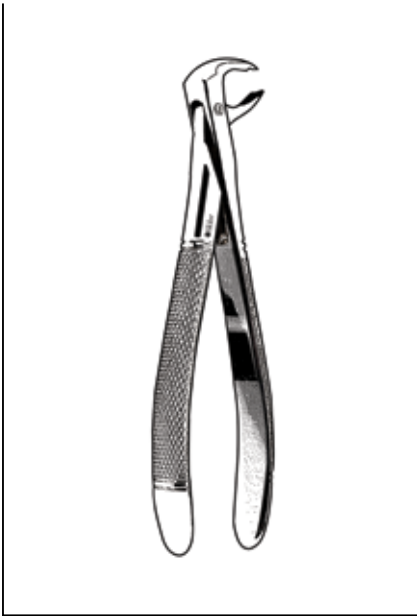

EXTRACTING FORCEP 73

ENGLISH PATTERN
49-4175

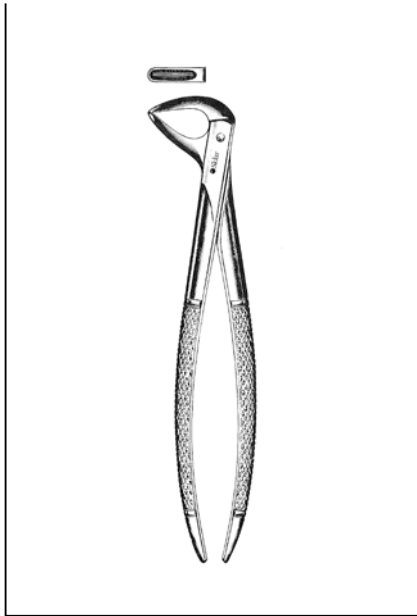

EXTRACTING FORCEP 74

ENGLISH PATTERN
49-4180

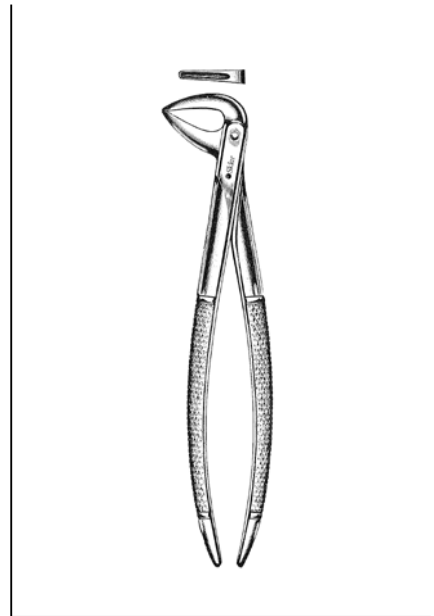

EXTRACTING FORCEP 74N

ENGLISH PATTERN
49-4185



EXTRACTING FORCEP 76S
ENGLISH PATTERN
49-4190



EXTRACTING FORCEP 79
ENGLISH PATTERN
49-4195



EXTRACTING FORCEP 79GH
49-4200 Fine Serrations

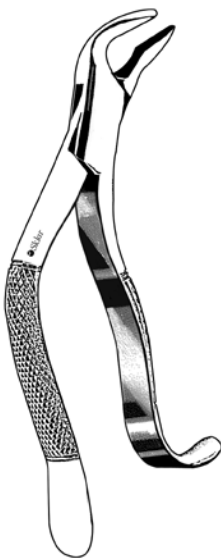

EXTRACTING FORCEP 85
49-4205 Hook Handle



EXTRACTING FORCEP 85A
49-4210 Hook Handle



EXTRACTING FORCEP 87
ENGLISH PATTERN
49-4215

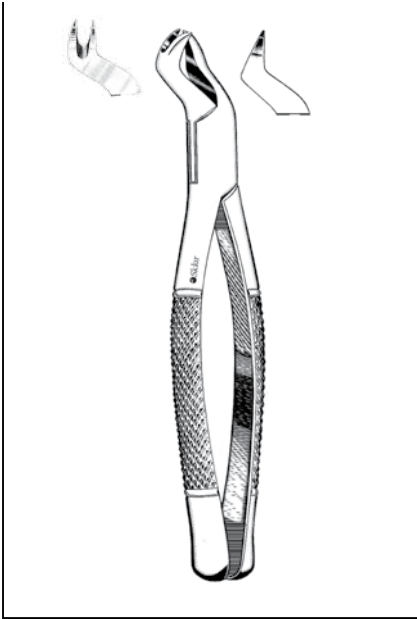

EXTRACTING FORCEPS

- 49-4220 88L
- 48-252 88L, Mid-Grade
- 49-4225 88R
- 48-238 88R, Mid-Grade

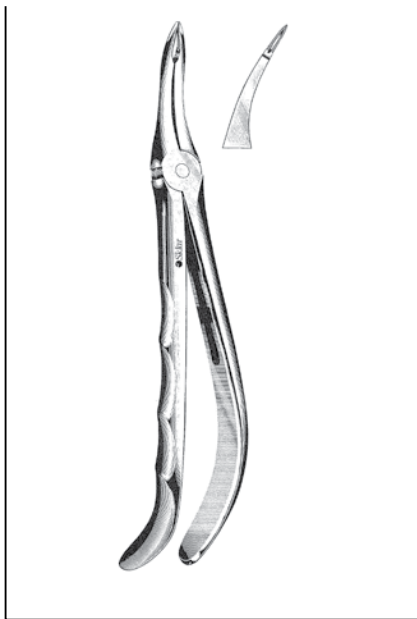

EXTRACTING FORCEP 89GH

- 49-4230 Fine Serrations

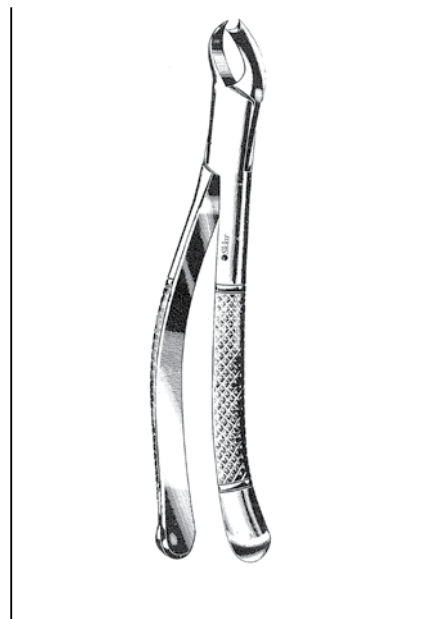

EXTRACTING FORCEP 89

- 49-4235 Right

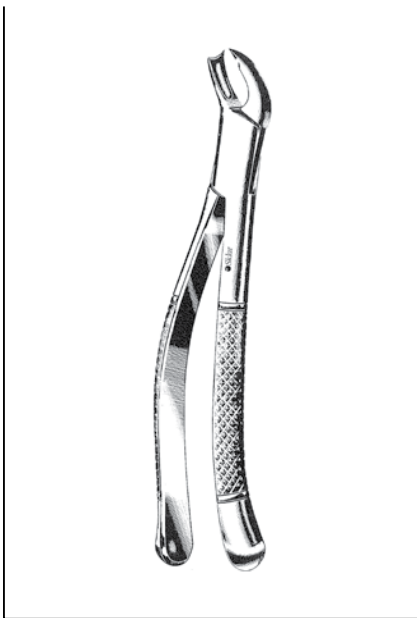

EXTRACTING FORCEP 90

- 49-4240 Left

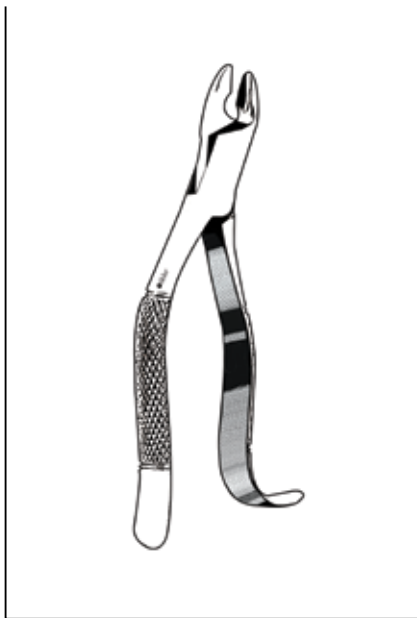

EXTRACTING FORCEP 99A

- 49-4245 Hook Handle

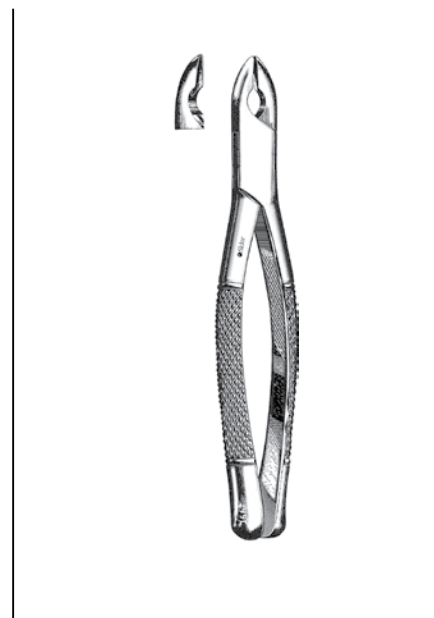

EXTRACTING FORCEP 99C

- 49-4250

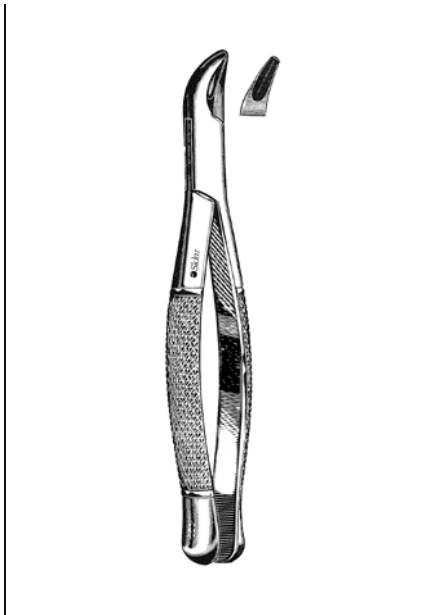

EXTRACTING FORCEP 101
49-4255

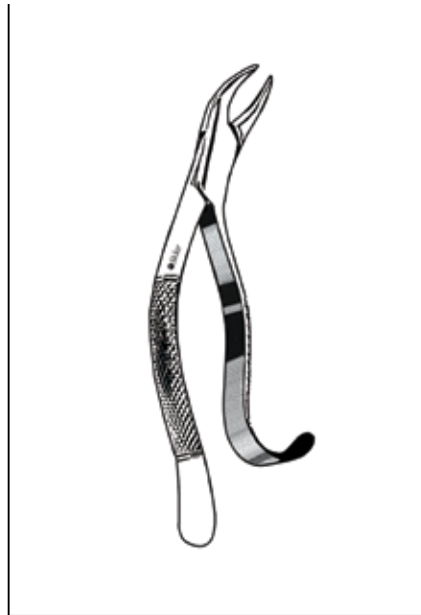

EXTRACTING FORCEP 103
49-4260 Hook Handle



EXTRACTING FORCEPS 150
49-4265
48-301 Mid-Grade

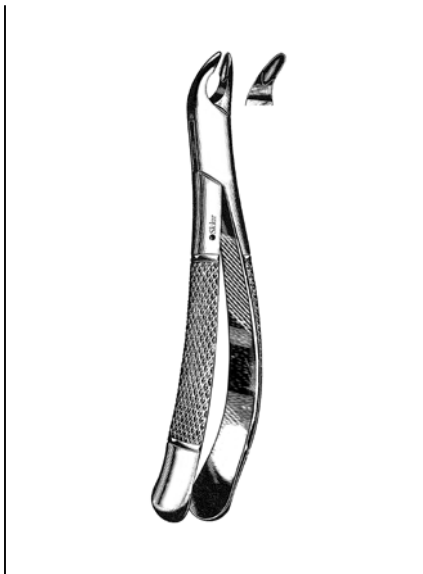

EXTRACTING FORCEP 150A
49-4270



EXTRACTING FORCEP 150AS
49-4275

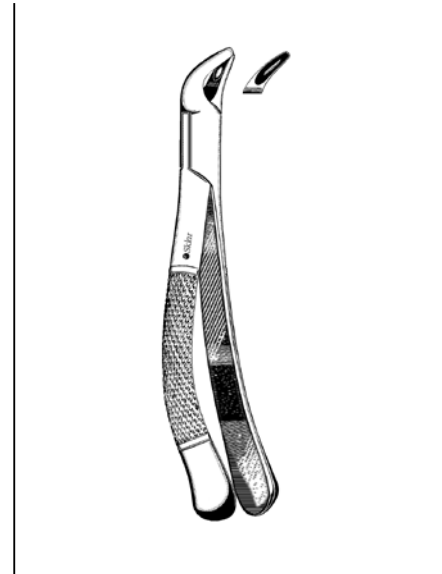

EXTRACTING FORCEPS 151
49-4280
48-327 Mid-Grade

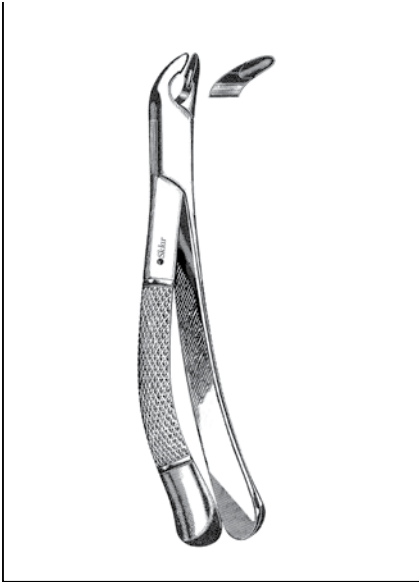

EXTRACTING FORCEP 151A
49-4285

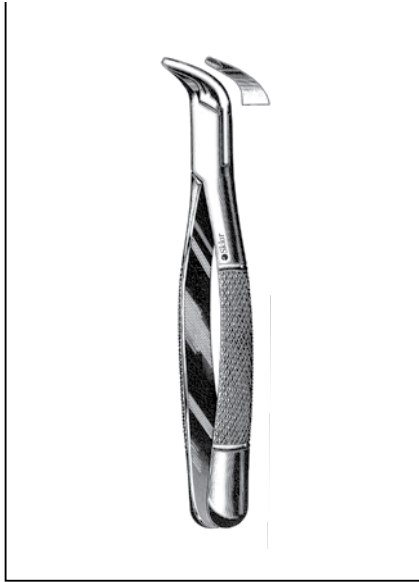

EXTRACTING FORCEP 203
49-4290

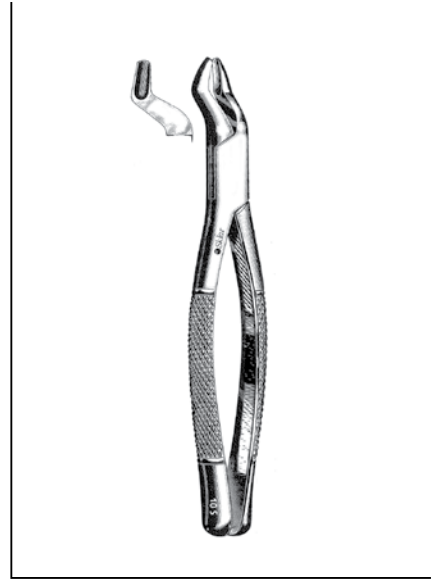

EXTRACTING FORCEP 210S
49-4295 Straight Handle



EXTRACTING FORCEP 210H
49-4300 Hook Handle

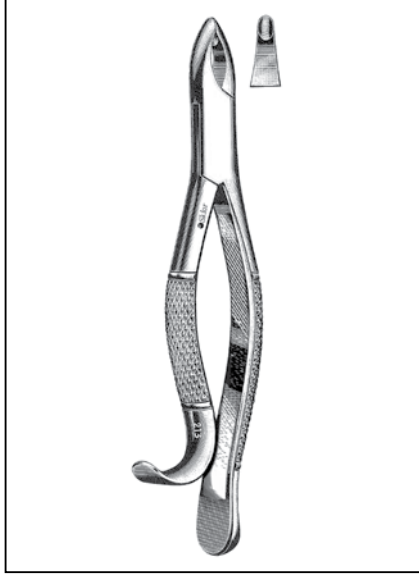

EXTRACTING FORCEP 213
49-4305 Hook Handle

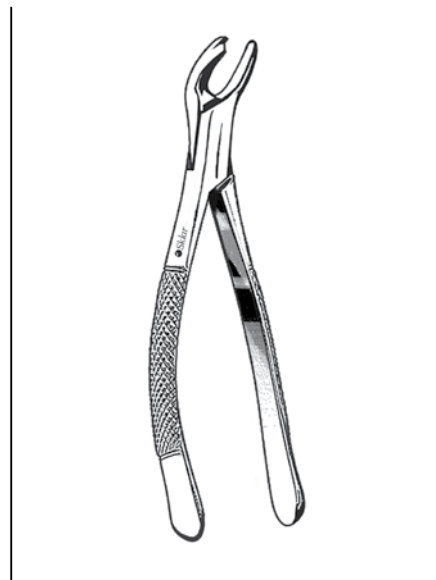

EXTRACTING FORCEP 217
49-4310

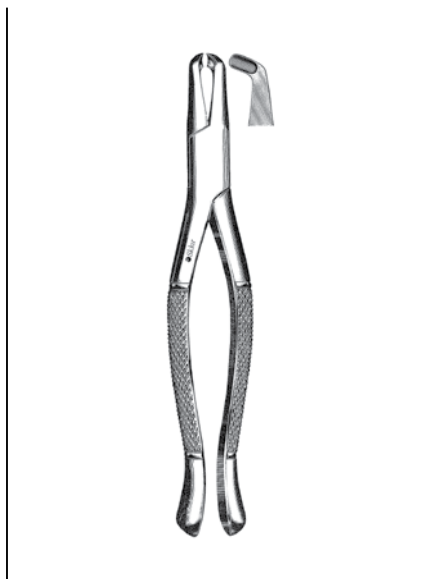

EXTRACTING FORCEP 222
49-4315

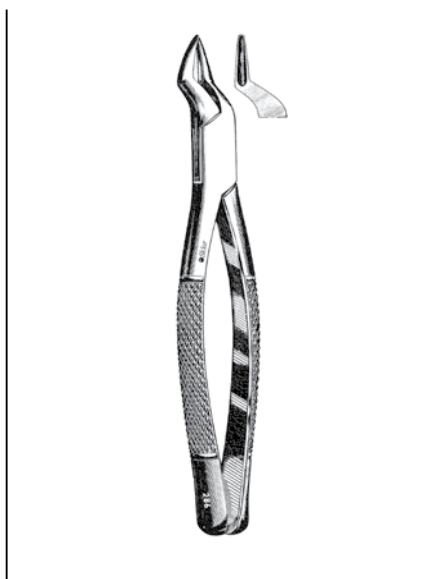

EXTRACTING FORCEP 286
49-4320

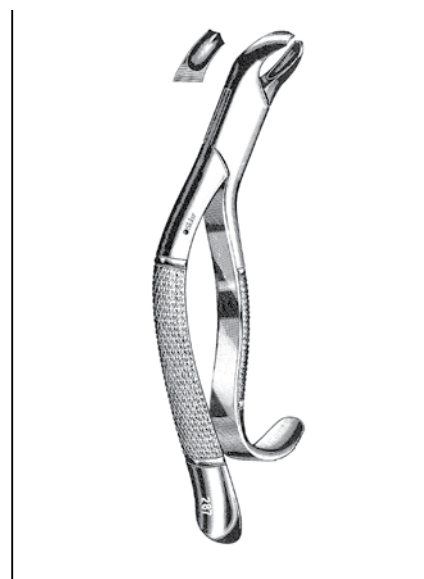

EXTRACTING FORCEP 287
49-4325

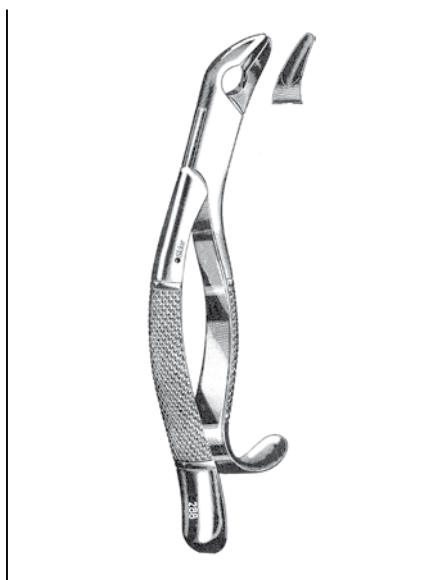

EXTRACTING FORCEP 288
49-4350

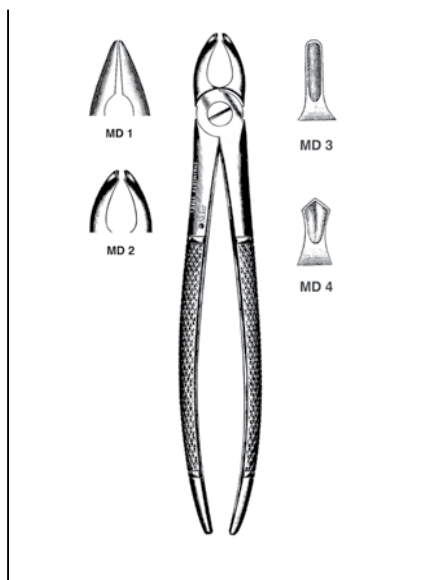

MEAD EXTRACTING FORCEPS
ENGLISH PATTERN
49-4355 MD1
49-4360 MD2
49-4365 MD3
48-109 MD3 Mid-Grade
49-4370 MD4

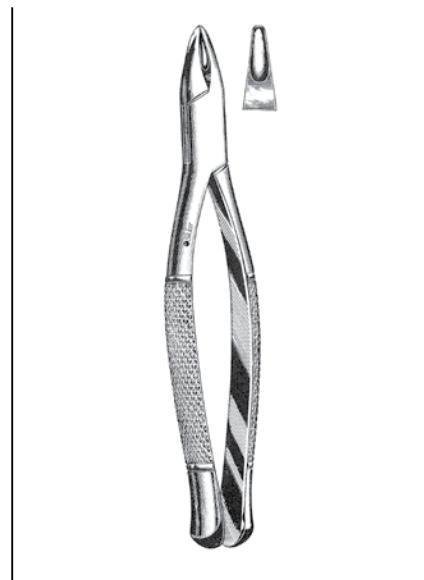

HENAHAN EXTRACTING FORCEP 1
49-4380



WITZEL EXTRACTING FORCEPS

49-4385 Lower
49-4390 Upper



WOODWARD EXTRACTING FORCEP 3F

49-4395 Straight Handle

NON-WOVEN, 3 PLY WITH ELASTIC EAR LOOPS

SKLAR FACE MASKS

- ELASTIC EAR LOOPS
- 3-PLY COMPOSITION REDUCES THE SPREAD OF BACTERIA
- NON-WOVEN MATERIAL IS SOFT, LIGHTWEIGHT AND BREATHABLE
- MOLDABLE NOSEPIECE ASSURES PROPER FIT
- UNIVERSAL, GENEROUS MASK SIZE
- BFE OF \geq 98%
- DISPOSABLE
- LATEX FREE
- NON-STERILE

PRODUCT NUMBER	QUANTITIES
96-5557	50/bx
96-5557A	500/cs
96-5557BNS	2000/cs

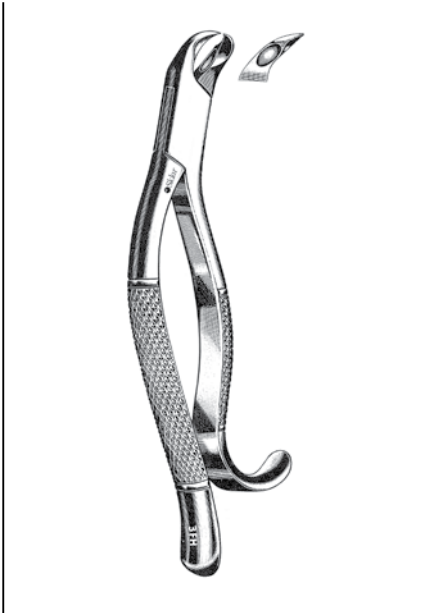

**WOODWARD EXTRACTING
FORCEP 3F**
49-4400 Hook Handle

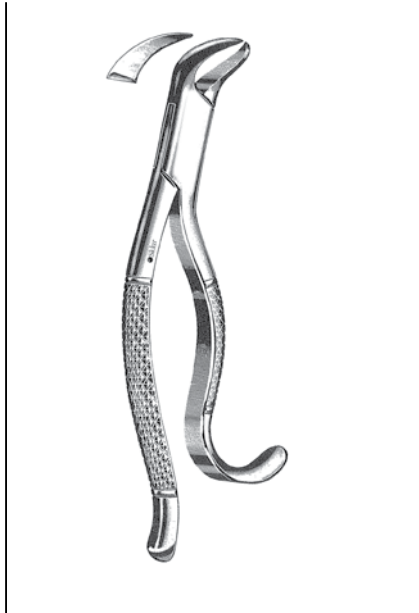

**CHILDRENS EXTRACTING
FORCEP 16S**
49-4405

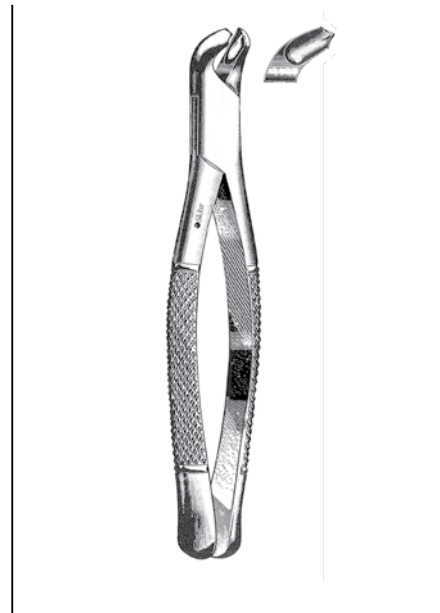

**CHILDRENS EXTRACTING
FORCEP 17S**
49-4410

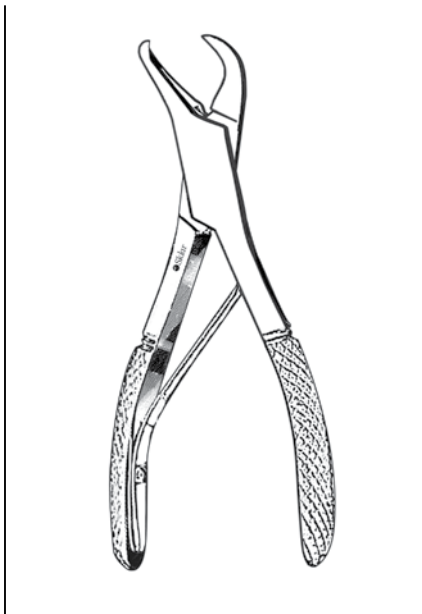

**CHILDRENS EXTRACTING
FORCEP 23S**
49-4415

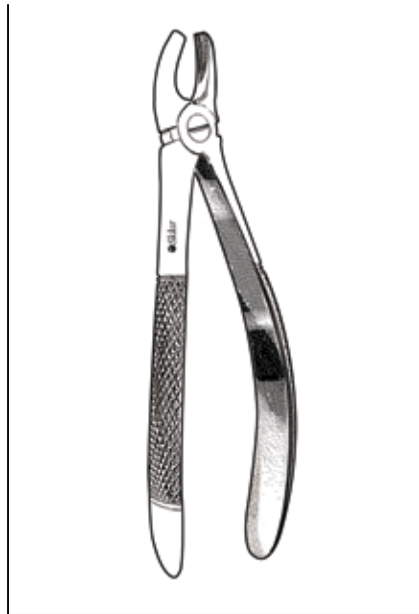

**CHILDRENS EXTRACTING
FORCEP 39**
49-4420

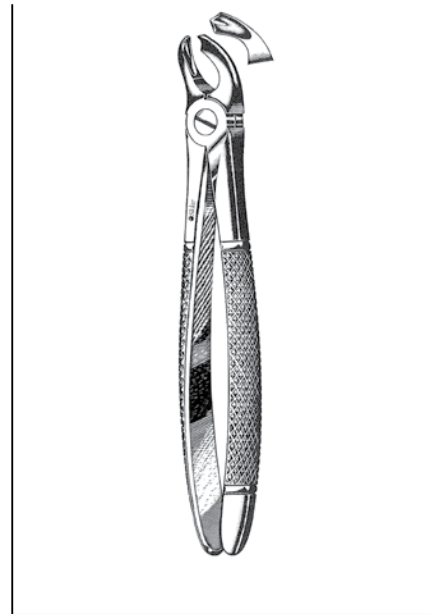

**CHILDRENS EXTRACTING
FORCEP 40**
49-4425



CHILDRENS EXTRACTING FORCEPS 150S

49-4430
48-363 Mid-Grade



CHILDRENS EXTRACTING FORCEP 150XS

49-4435



CHILDRENS EXTRACTING FORCEPS 151S

49-4440
48-375 Mid-Grade



CHILDRENS EXTRACTING FORCEP 151XS

49-4445



CHILDRENS EXTRACTING FORCEP A

49-4450



CHILDRENS EXTRACTING FORCEP B

49-4455

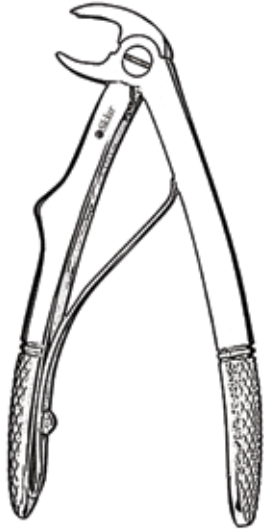

**CHILDRENS EXTRACTING
FORCEP C**
49-4460

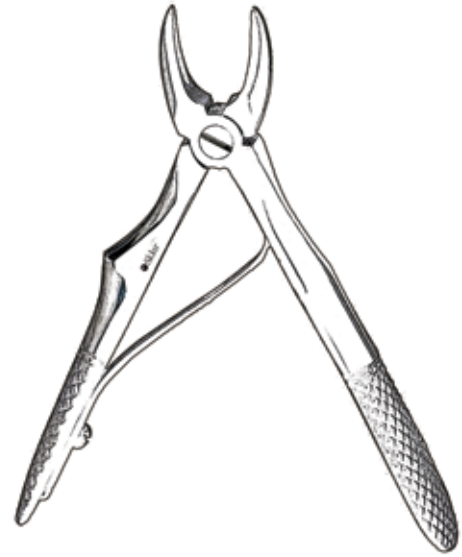

**CHILDRENS EXTRACTING
FORCEP E**
49-4465

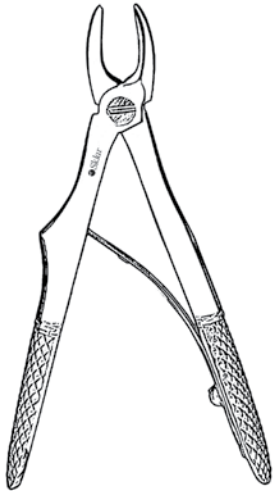

**CHILDRENS EXTRACTING
FORCEP F**
49-4470

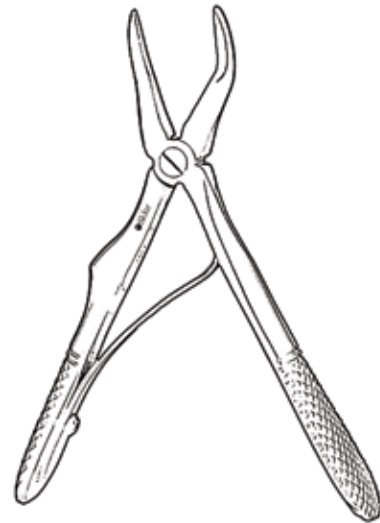

**CHILDRENS EXTRACTING
FORCEP H**
49-4475



TC DRESSING FORCEPS

SERRATED

- 51-3460 6"
- 51-3480 8"

TC ADSON FORCEPS

SERRATED

- 51-3447 4 3/4"
- 51-3448 6"

PATIENT LITERATURE

Sklar's wide array of patient literature gives orthodontists/dentists a way to communicate with their patients in bright colorful examples. The literature teaches technique, helps with patient responsibility, offer rewards at the end of treatment as well as helping patients track their office visits and payments.

For a complete listing of Sklar's extensive Literature product line see pages 189-191. For more information contact your Sklar Account Manager or Distributor Sales Representative.



SKLARLITE
THE LIGHT TOUCH

SKLARLITE XD
EXTRA DELICATE

**SKLARLITE™ AND SKLARLITE XD™
PROVIDES LIGHTNESS
AND DURABILITY**

Sklar has developed a new line of premium operating room instruments that offers the surgeon maximum control and precision. Our research determined a need for instruments that were lighter patterns while maintaining the strength and durability of a standard pattern.

Sklar has recognized the need for a manufacturing technique that mills scant microns off our standard pattern while maintaining the structural integrity of the original instrument. The result is a noticeably lighter, extremely sensitive instrument that can withstand the daily rigors of surgery.

SKLARLITE™ and SKLARLITE XD™ instruments carry the same day-in and day-out reliability that you have come to expect from all Sklar instruments. Sklar has applied its more than 100 years of experience in developing this superior instrument.



SKLARLITE
THE LIGHT TOUCH

**SKLARLITE™ DRESSING
FORCEPS**

SERRATED

23-2824	4½"
23-2826	5"
23-2828	5½"
23-2830	6"

SKLARLITE XD
EXTRA DELICATE

**SKLARLITE™
EXTRA DELICATE DRESS-
ING FORCEPS**

SERRATED

23-2834	4½"
23-2836	5"
23-2838	5½"

SKLARLITE
THE LIGHT TOUCH

**SKLARLITE™ ADSON
FORCEPS**

DRESSING

23-2600	4¾"	Serrated
---------	-----	----------

TISSUE

23-2602	4¾"	1x2 Teeth
---------	-----	-----------

ADSON-BROWN

23-2603	4¾"	Side Grasping
---------	-----	---------------

SKLARLITE XD
EXTRA DELICATE

**SKLARLITE™ EXTRA
DELICATE ADSON
FORCEPS**

DRESSING

23-2604	4¾"	Serrated
---------	-----	----------

TISSUE

23-2606	4¾"	1x2 Teeth
---------	-----	-----------

ADSON-BROWN

23-2608	4¾"	Side Grasping
---------	-----	---------------

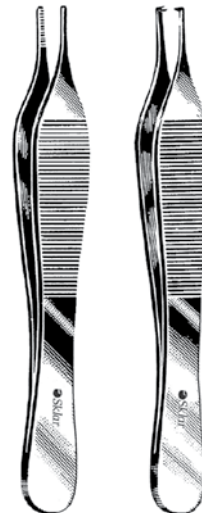

SKLARLITE
THE LIGHT TOUCH

**SKLARLITE™ TISSUE
FORCEP**

23-2811	5½"	1x2 Teeth
---------	-----	-----------

SKLARLITE XD
EXTRA DELICATE

**SKLARLITE™ EXTRA
DELICATE TISSUE
FORCEP**

23-2819	5½"	1x2 Teeth
---------	-----	-----------

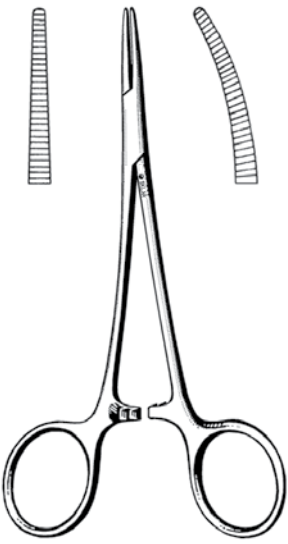

SKLARLITE™
THE LIGHT TOUCH

**SKLARLITE™
HALSTED
MOSQUITO
FORCEPS**

23-2105	5"	Straight
23-2106	5"	Curved

SKLARLITE™ XD
EXTRA DELICATE

**SKLARLITE™
EXTRA DELICATE
HALSTED
MOSQUITO
FORCEPS**

23-2505	5"	Straight
23-2506	5"	Curved

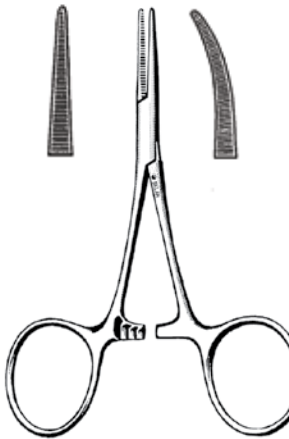

SKLARLITE™
THE LIGHT TOUCH

**SKLARLITE™
HARTMANN
MOSQUITO
FORCEPS**

23-2100	3½"	Straight
23-2101	3½"	Curved

SKLARLITE™ XD
EXTRA DELICATE

**SKLARLITE™
EXTRA DELICATE
HARTMANN
MOSQUITO
FORCEPS**

23-2500	3½"	Straight
23-2501	3½"	Curved

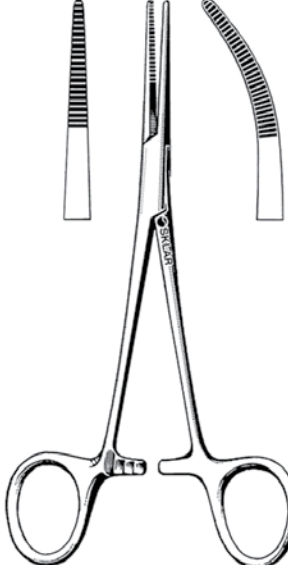

SKLARLITE™
THE LIGHT TOUCH

**SKLARLITE™
KELLY HEMOSTATIC
FORCEPS**

23-2107	5½"	Straight
23-2108	5½"	Curved

SKLARLITE™ XD
EXTRA DELICATE

**SKLARLITE™
EXTRA DELICATE KELLY
HEMOSTATIC FORCEPS**

23-2507	5½"	Straight
23-2508	5½"	Curved



SKLARLITE™
THE LIGHT TOUCH

**SKLARLITE™
ALLIS TISSUE
FORCEPS**

23-2851	6"	4x5 Teeth
23-2852	6"	5x6 Teeth

SKLARLITE™ XD
EXTRA DELICATE

**SKLARLITE™
EXTRA DELICATE
ALLIS TISSUE
FORCEPS**

23-2861	5"	4x5 Teeth
23-2862	5½"	4x5 Teeth
23-2864	6"	4x5 Teeth
23-2865	6"	5x6 Teeth

**HALSTED MOSQUITO FORCEPS
STRAIGHT, SERRATED**

17-1450	5"	
97-426	5"	Mid-Grade
17-1455	5"	Non-Magnetic
18-1050	5"	Delicate

**HALSTED MOSQUITO FORCEPS
CURVED, SERRATED**

17-1550	5"	
97-431	5"	Mid-Grade
17-1555	5"	Non-Magnetic
18-1150	5"	Delicate

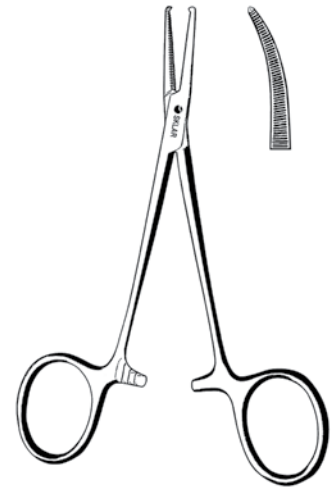
**HALSTED MOSQUITO FORCEPS
1X2 TEETH, DELICATE, SERRATED**

17-1650	5"	Straight
17-1750	5"	Curved

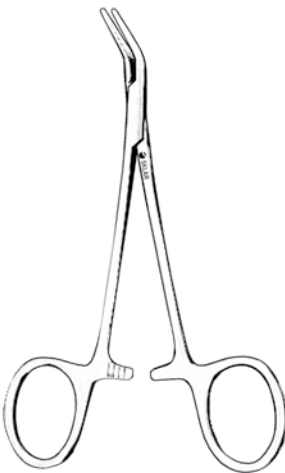
**HALSTED MOSQUITO FORCEPS
SERRATED**

17-1850	5"	45° Angled on Flat, Extra Delicate
---------	----	---------------------------------------

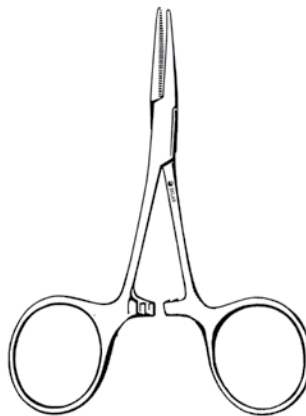
**HARTMANN MOSQUITO
FORCEPS
STRAIGHT, SERRATED**

17-1235	3½"	
97-409	3½"	Mid-Grade
17-1230	3½"	Delicate

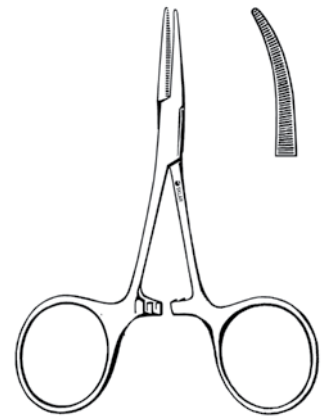
**HARTMANN MOSQUITO
FORCEPS
CURVED, SERRATED**

17-1335	3½"	
97-421	3½"	Mid-Grade
17-1232	3½"	Delicate

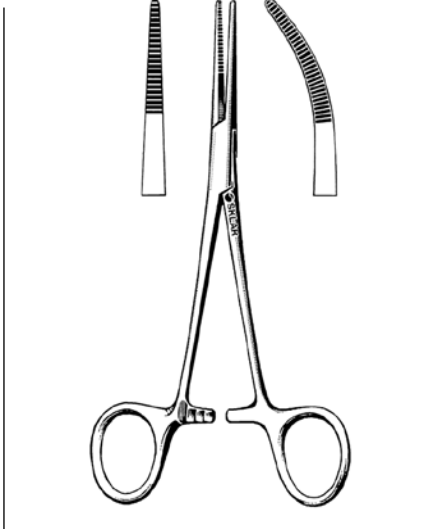

KELLY HEMOSTATIC FORCEPS

STRAIGHT

17-2055	5½"	
97-436	5½"	Mid-Grade
18-1552	5½"	Delicate
74-3260	7"	Extra Heavy

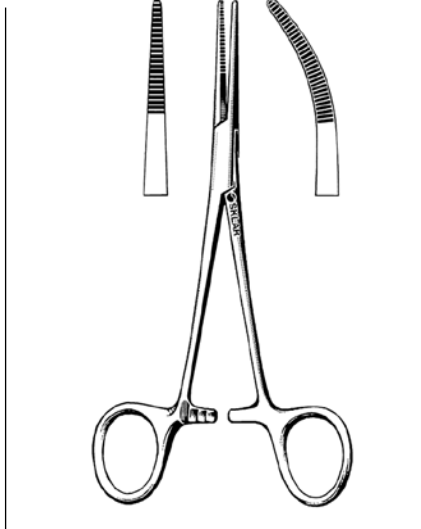

KELLY HEMOSTATIC FORCEPS

CURVED

17-2155	5½"	
97-442	5½"	Mid-Grade
18-1652	5½"	Delicate
74-3270	7"	Extra Heavy

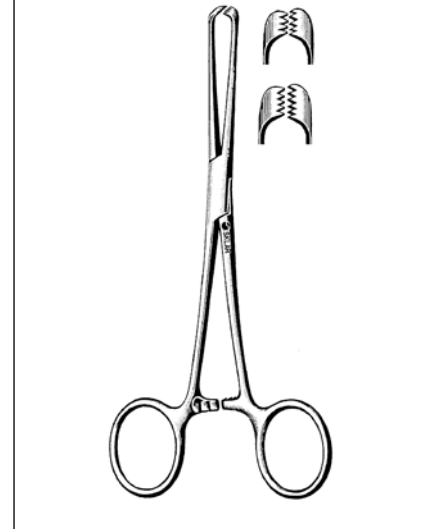

ALLIS TISSUE FORCEPS

36-2060	6"	3x4 Teeth
36-2160	6"	4x5 Teeth
36-2260	6"	5x6 Teeth
36-2275	7½"	5x6 Teeth

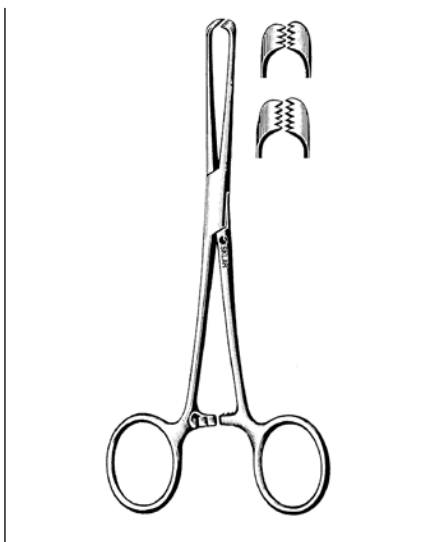

ALLIS TISSUE FORCEPS

DELICATE

18-2140	4"	4x5 Teeth
18-2155	5"	4x5 Teeth
22-6157	5½"	4x5 Teeth
18-2162	6"	4x5 Teeth
18-2164	6"	5x6 Teeth
36-2295	9½"	5x6 Teeth

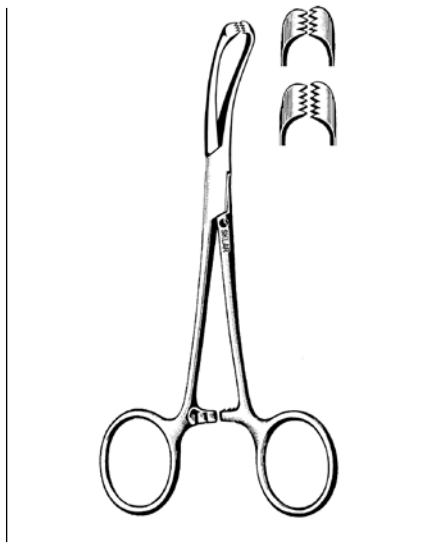

ALLIS TISSUE FORCEPS

ANGLED

36-2162	6"	4x5 Teeth
36-2262	6"	5x6 Teeth

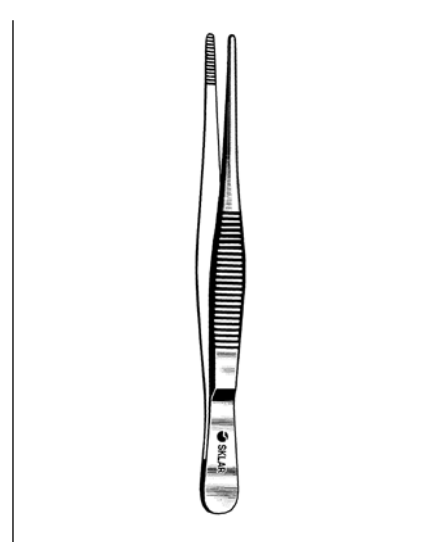

DRESSING FORCEPS

SERRATED

19-1040	4"	19-1070	7"
19-1045	4½"	19-1080	8"
19-1050	5"	19-1110	10"
19-1055	5½"	19-1112	12"
19-1060	6"		

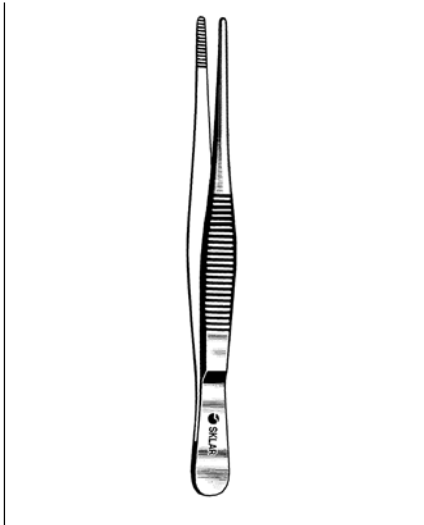
DRESSING FORCEPS
SERRATED, DELICATE

22-1161	4½"
22-1162	5"
22-1163	5½"
22-1164	6"

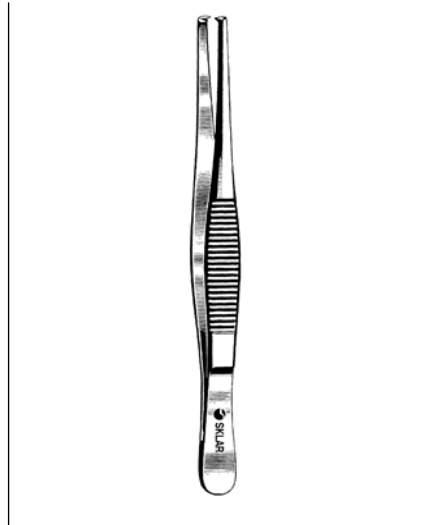
TISSUE FORCEPS
1X2 TEETH

19-1245	4½"	19-1270	7"
19-1250	5"	19-1280	8"
19-1255	5½"	19-1310	10"
19-1260	6"	19-1312	12"

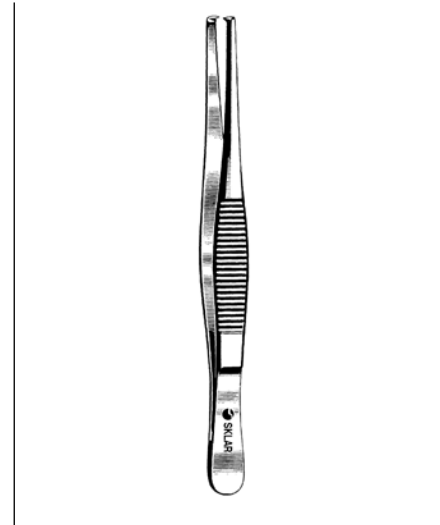
TISSUE FORCEPS
1X2 TEETH, DELICATE

22-1061	4½"
22-1062	5"
22-1063	5½"
22-1064	6"

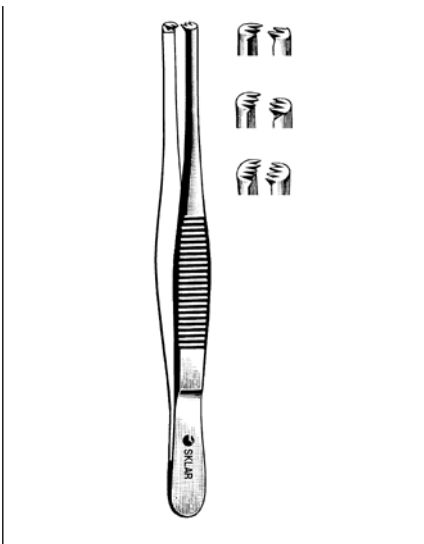
TISSUE FORCEPS
2X3 TEETH

19-1445	4½"	3X4 TEETH	19-1650	5"
19-1450	5"		19-1655	5½"
19-1455	5½"		19-1660	6"
19-1460	6"	4X5 TEETH	19-1850	5"
19-1480	8"		19-1855	5½"
19-1510	10"		19-1905	6"
19-1512	12"		19-1910	10"

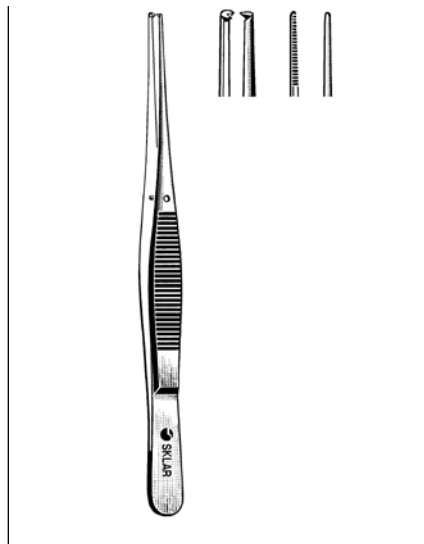
SEMKIN FORCEPS
DRESSING, SERRATED

22-4150	5"	Straight
22-4152	5"	Curved
22-4154	6"	Straight
22-4156	6"	Curved

TISSUE, 1X2 TEETH

22-4350	5"	Straight
22-4352	5"	Curved
22-4354	6"	Straight
22-4356	6"	Curved

TISSUE, 2X3 TEETH

22-4550	5"	Straight
---------	----	----------

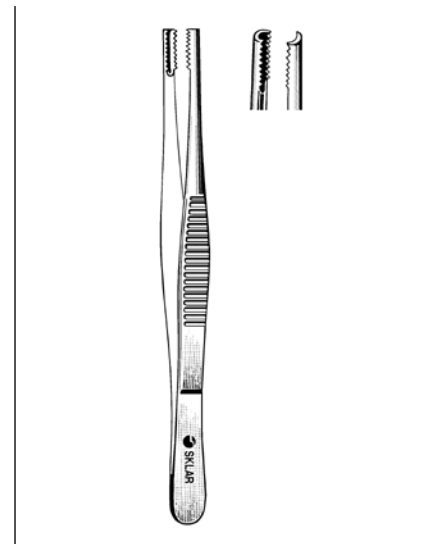

BROWN TISSUE FORCEPS
SIDE GRASPING, 8X8 TEETH

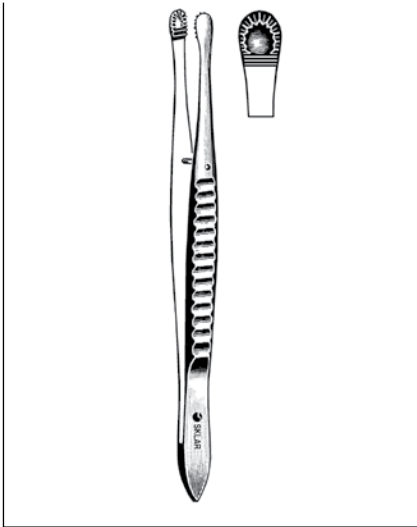
19-2860	6"
19-2880	8"
19-2910	10"

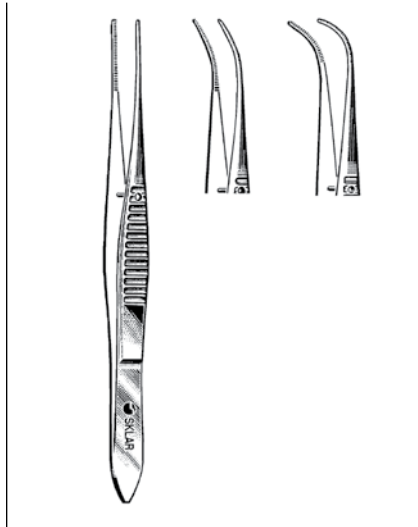

RUSSIAN TISSUE FORCEPS

19-2260	6"
19-2280	8"
19-2320	9"
19-2310	10"



EYE DRESSING FORCEPS

4", SERRATED, DELICATE

66-2734	Straight	0.5mm
66-2736	Half Curve	0.5mm
66-2738	Full Curve	0.5mm

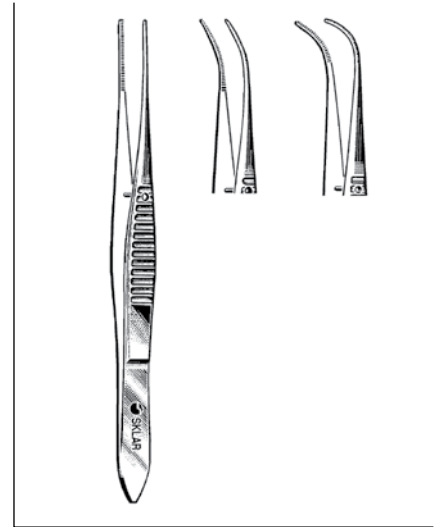

EYE DRESSING FORCEPS

4", SERRATED

66-2740	Straight	0.8mm
66-2840	Straight, Non-Magnetic	0.8mm
66-2940	Half Curve	0.8mm
66-3140	Full Curve	0.8mm

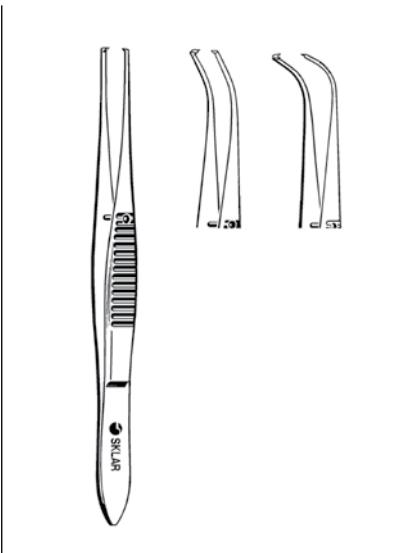

EYE TISSUE FORCEPS

4" 1X2 TEETH, STRAIGHT

66-3340		0.8mm
66-3341	Delicate	0.5mm
66-3240	Non-Magnetic	0.8mm

4" 1X2 TEETH, CURVED

66-3540	Half Curve	0.8mm
66-3541	Half Curve, Delicate	0.5mm
66-3740	Full Curve	0.8mm
66-3741	Full Curve, Delicate	0.5mm

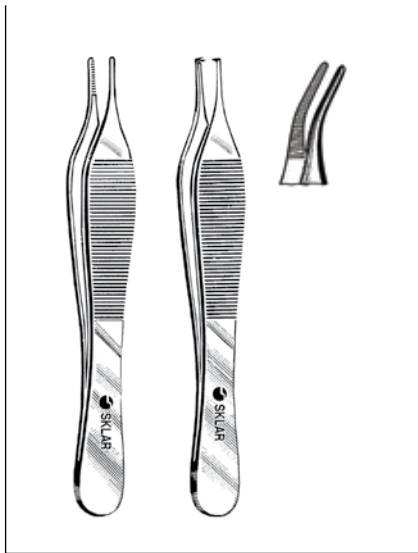

ADSON FORCEPS

DRESSING, SERRATED

50-3147	4¾"	
47-2147	4¾"	Delicate
47-2148	4¾"	Angled

TISSUE

50-3047	4¾"	1x2 Teeth
47-2047	4¾"	1x2 Teeth, Delicate
50-3046	4¾"	1x2 Teeth, Angled
47-2049	4¾"	2x3 Teeth, Delicate

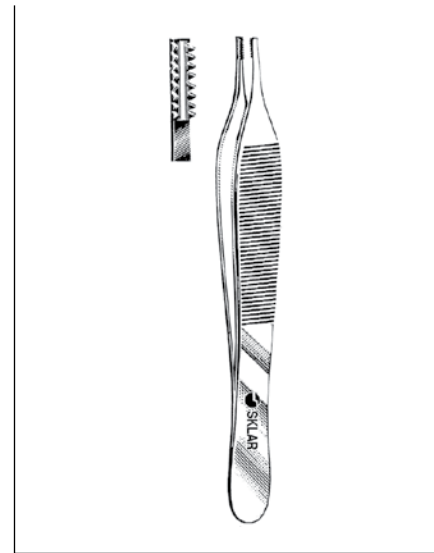

ADSON BROWN FORCEPS

7X7 TEETH, SIDE GRASPING

47-1447	4¾"	
47-2447	4¾"	Delicate
47-1450	4¾"	Angled



YOUNG TONGUE SEIZING FORCEPS

07-1562 6¼"
07-1563 Replacement Jaws, 2/Pack

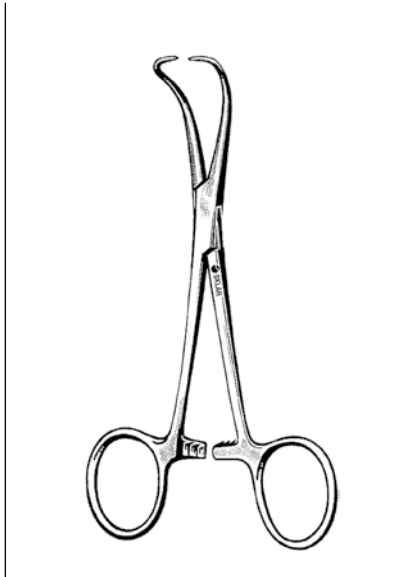

BACKHAUS TOWEL CLAMPS

47-2935 3½"
47-2955 5¼"



**LORNA-EDNA TOWEL CLAMPS
NON-PERFORATING**

47-2837 4"
47-2852 5¼"



**JONES TOWEL CLAMPS
CROSS ACTION TIPS**

47-2925 2¼" Delicate
47-2930 3½" Standard



DESMARRES CHALAZION FORCEPS

66-1038 3½" Small
66-1036 3½" Medium
66-1035 3½" Large



**STERILIZATION FORCEPS
3 PRONG, 8"**

10-1280
48-761 Mid-Grade

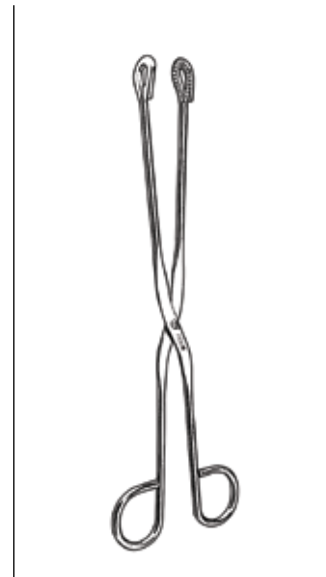

**UTILITY STERILIZATION FORCEPS
8" STRAIGHT**

10-1080
48-768 Mid-Grade

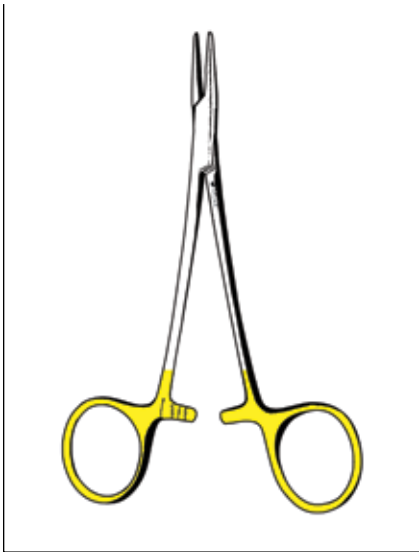

TC PAR NEEDLE HOLDERS

DELICATE, SERRATED

- 21-7012 4½"
- 21-7013 5"



TC DERF NEEDLE HOLDER

SERRATED

- 21-8004 4¾"

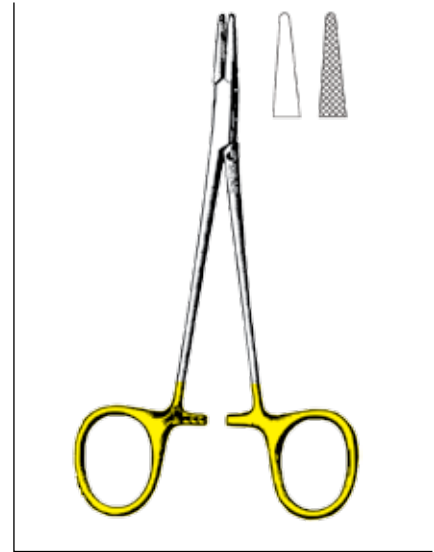

TC HALSEY NEEDLE HOLDERS

- 21-8000 5¼" Smooth
- 21-8001 5¼" Serrated

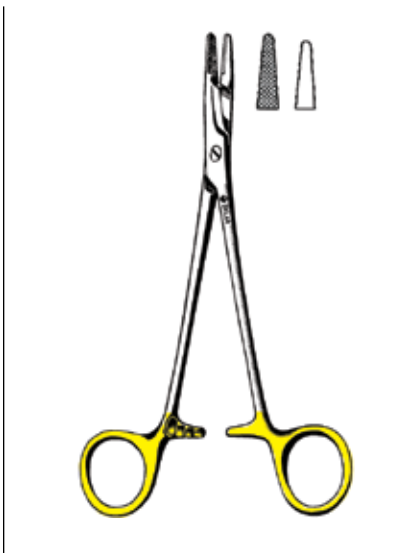

TC OLSEN-HEGAR NEEDLE HOLDERS

- 21-8026 4¾" Smooth, Delicate
- 21-8025 4¾" Serrated, Delicate
- 21-8027 5½" Serrated
- 21-8028 6½" Serrated
- 21-8029 7½" Serrated

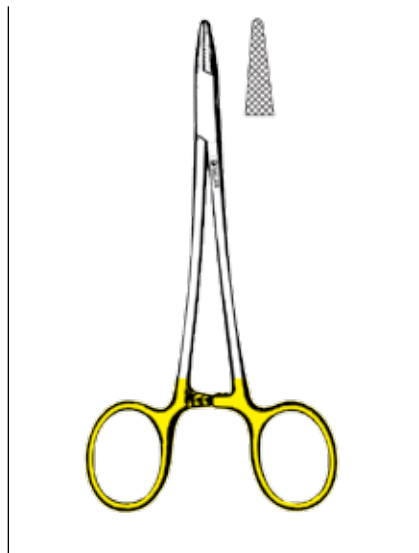

TC BAUMGARTNER NEEDLE HOLDER

SERRATED

- 21-8005 5¼"

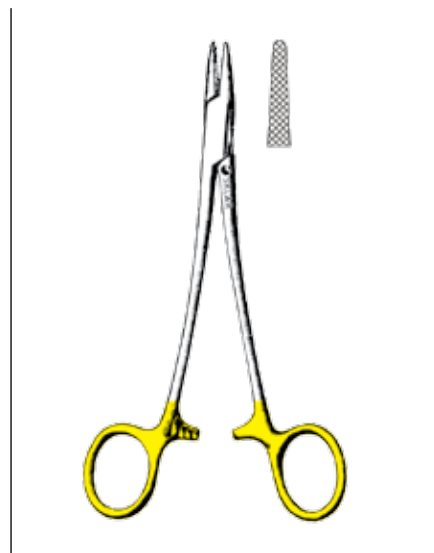

TC MAYO-HEGAR NEEDLE HOLDERS

SERRATED

- 21-8030 5½"
- 21-8031 6"
- 21-8032 7"
- 21-8033 8"
- 21-8051 9½"
- 21-8034 10½"
- 21-8035 12"

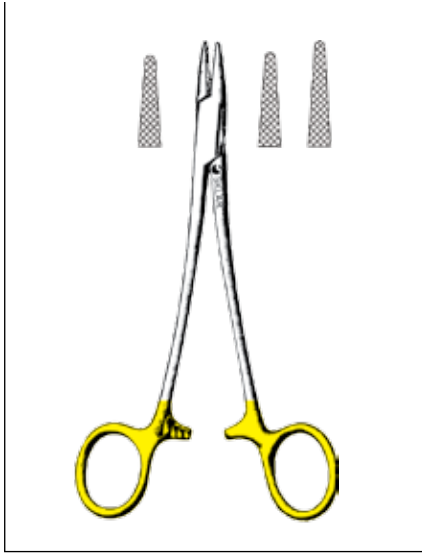

**TC CRILE-WOOD
NEEDLE HOLDERS**

SERRATED

- 21-8006 6" Narrow Jaw
- 21-8007 7"
- 21-8008 8"
- 21-8009 9"
- 21-8010 10½"
- 21-8011 12"

SMOOTH

- 21-8003 6"

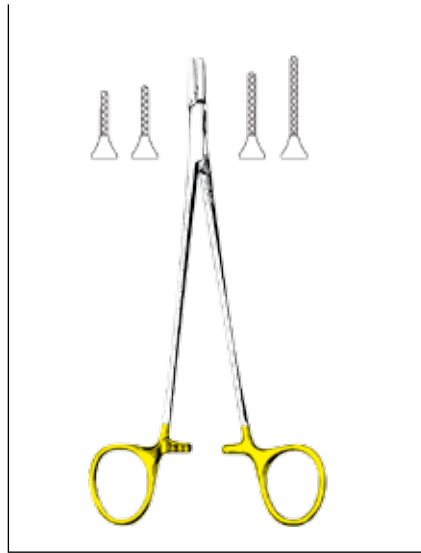

**TC RYDER
NEEDLE HOLDERS**

MICRO SERRATED

- 21-8012 5"
- 21-8013 6"
- 21-8014 7"
- 21-8016 9"

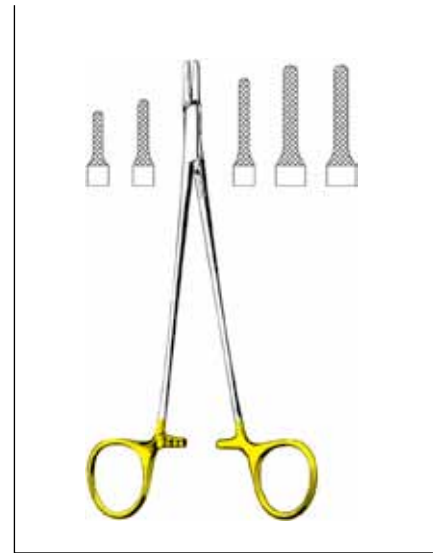

TC RYDER NEEDLE HOLDERS

SERRATED

- 21-8019 5"
- 21-8020 6"
- 21-8021 7"
- 21-8022 8"
- 21-8023 9"
- 21-8024 10¼"



**TC WEBSTER
NEEDLE HOLDERS**

- 21-2240 4¼" Smooth
- 21-8002 5¼" Smooth
- 21-8080 5¼" Serrated

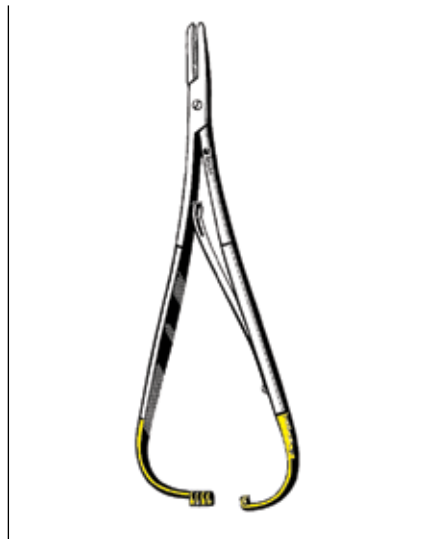

TC MATHIEU NEEDLE HOLDERS

SERRATED

- 21-8070 5½"
- 21-8071 6¼"

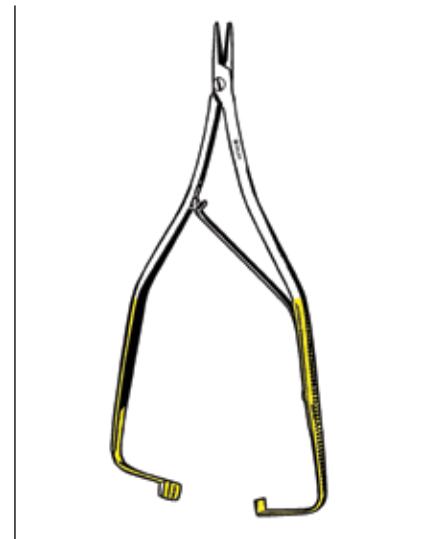

**TC BOYNTON
NEEDLE HOLDER**

- 21-8041 5"



Sklar's Left-Handed Needle Holders

Now there's a ring-handled needle holder created for the needs of left-handed surgeons.

Sklar's left-handed needle holder features a unique ratchet design that makes it possible for surgeons to easily control the needle holder with their left hand. As a result surgeons experience less fatigue and hand strain than ever before.

Suitable for left hand use.



TC WEBSTER NEEDLE HOLDER

21-9012 5" Smooth



TC CRILE-WOOD NEEDLE HOLDERS

21-9030 6" Serrated
21-9035 7" Serrated



TC MAYO-HEGAR NEEDLE HOLDERS

21-9016 6" Serrated
21-9018 7" Serrated



TC RYDER NEEDLE HOLDER

21-9045 6" Serrated

SKLARLITE
THE LIGHT TOUCH

SKLARLITE XD
EXTRA DELICATE

**SKLARLITE™ AND SKLARLITE XD™
PROVIDES LIGHTNESS
AND DURABILITY**

Sklar has developed a new line of premium operating room instruments that offers the surgeon maximum control and precision. Our research determined a need for instruments that were lighter patterns while maintaining the strength and durability of a standard pattern.

Sklar has recognized the need for a manufacturing technique that mills scant microns off our standard pattern while maintaining the structural integrity of the original instrument. The result is a noticeably lighter, extremely sensitive instrument that can withstand the daily rigors of surgery.

SKLARLITE™ and SKLARLITE XD™ instruments carry the same day-in and day-out reliability that you have come to expect from all Sklar instruments. Sklar has applied its more than 100 years of experience in developing this superior instrument.

**SKLARLITE™
DERF NEEDLE HOLDER**
23-2124 4¾" Serrated

**SKLARLITE XD™
EXTRA DELICATE
DERF NEEDLE HOLDER**
23-2224 4¾" Serrated

**SKLARLITE™
WEBSTER
NEEDLE HOLDERS**
23-2125 5¼" Smooth
23-2120 5¼" Serrated

**SKLARLITE XD™
EXTRA DELICATE
WEBSTER
NEEDLE HOLDERS**
23-2225 5¼" Smooth
23-2220 5¼" Serrated

**SKLARLITE™
OLSEN-HEGAR
NEEDLE HOLDER**
23-2136 5½" Serrated

**SKLARLITE XD™
EXTRA DELICATE
OLSEN-HEGAR
NEEDLE HOLDER**
23-2236 5½" Serrated

SKLARLITE
THE LIGHT TOUCH

**SKLARLITE™
BAUMGARTNER
NEEDLE HOLDER**

23-2132 5¼" Serrated



SKLARLITE XD
EXTRA DELICATE

**SKLARLITE™
EXTRA DELICATE
BAUMGARTNER
NEEDLE HOLDER**

23-2232 5¼" Serrated

SKLARLITE
THE LIGHT TOUCH

**SKLARLITE™
CRILE-WOOD
NEEDLE HOLDER**

23-2134 6" Serrated



SKLARLITE XD
EXTRA DELICATE

**SKLARLITE™
EXTRA DELICATE
CRILE-WOOD
NEEDLE HOLDER**

23-2234 6" Serrated

SKLARLITE
THE LIGHT TOUCH

**SKLARLITE™
MAYO-HEGAR
NEEDLE HOLDER**

23-2128 7" Serrated



SKLARLITE XD
EXTRA DELICATE

**SKLARLITE™
EXTRA DELICATE
MAYO-HEGAR
NEEDLE HOLDER**

23-2228 7" Serrated

SKLARLITE
THE LIGHT TOUCH

**SKLARLITE™
HALSEY
NEEDLE HOLDERS**

23-2135 5¼" Smooth
23-2130 5¼" Serrated

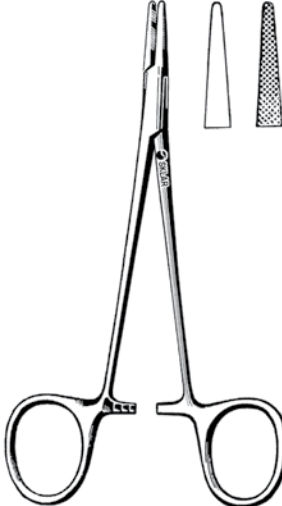

SKLARLITE XD
EXTRA DELICATE

**SKLARLITE™
EXTRA DELICATE
HALSEY
NEEDLE HOLDERS**

23-2235 5¼" Smooth
23-2230 5¼" Serrated



DERF NEEDLE HOLDERS

SERRATED

- 20-1547 4¾"
- 97-826 4¾" Mid-Grade

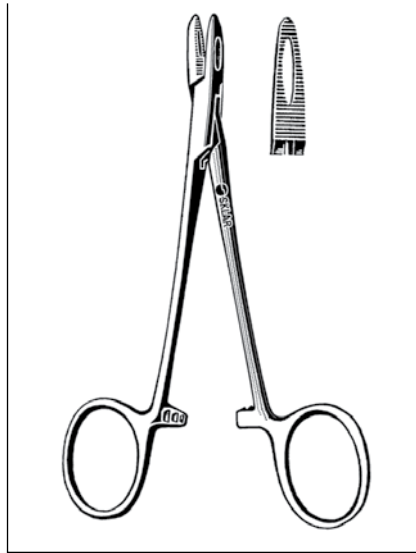

COLLIER NEEDLE HOLDER

- 65-6550 5¼" Serrated, Fenestrated

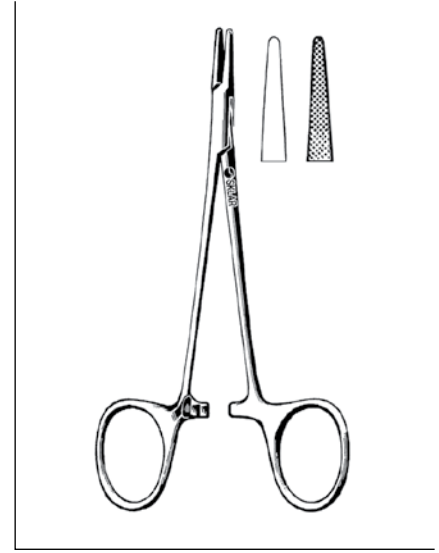

WEBSTER NEEDLE HOLDERS

- 20-1350 5¼" Smooth
- 97-809 5¼" Smooth, Mid-Grade
- 20-1352 5¼" Serrated

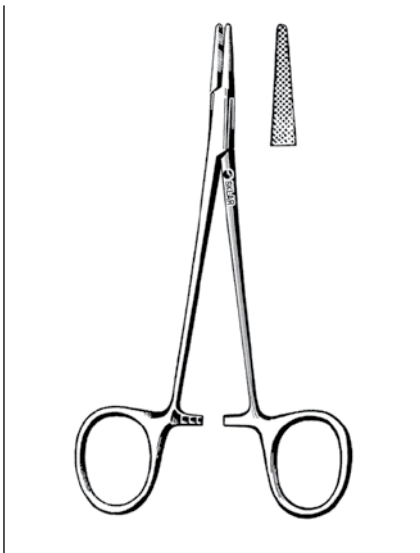

BAUMGARTNER NEEDLE HOLDERS

SERRATED

- 20-1450 5¼"
- 97-832 5¼" Mid-Grade

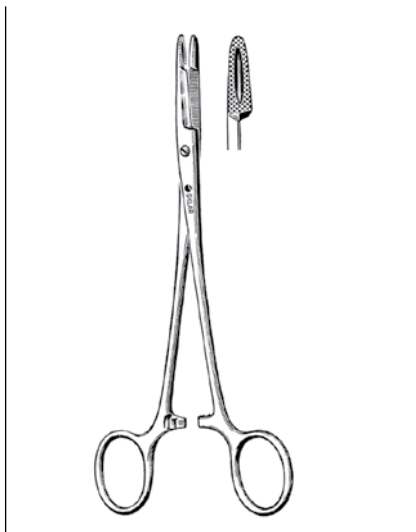

OLSEN-HEGAR NEEDLE HOLDERS

SCISSOR COMBINATION

- 20-2748 4¾" Smooth
- 20-2747 4¾" Serrated
- 20-2755 5½"
- 20-2765 6½"
- 20-2775 7"

SCISSOR COMBINATION, MID-GRADE

- 97-872 5½"
- 97-877 6½"

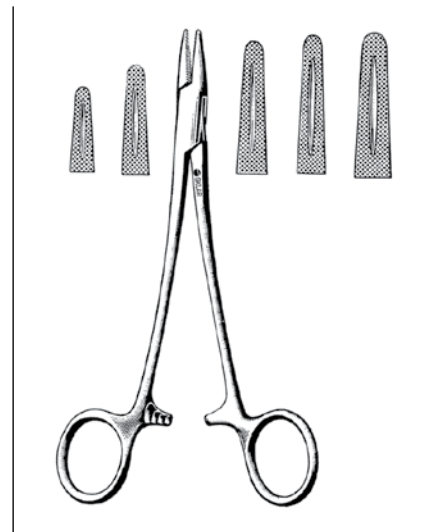

MAYO-HEGAR NEEDLE HOLDERS

SERRATED

- 20-2052 5¼"
- 20-2060 6"
- 20-2070 7"
- 20-2270 7" Broad Jaw
- 20-2480 8"
- 20-2490 9½"
- 20-2910 10½" Masson
- 20-2911 11½" Masson

SERRATED, MID-GRADE

- 97-842 5¼"
- 97-847 6"



CRILE-WOOD NEEDLE HOLDERS

SERRATED

20-1265	6"	Narrow Jaws
97-838	6"	Mid-Grade
20-1270	7"	
20-1280	8"	
20-1290	9"	
20-1295	10½"	

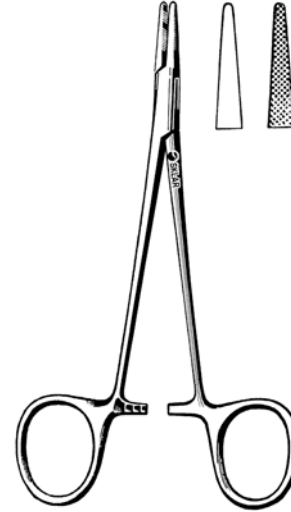

HALSEY NEEDLE HOLDERS

20-1750	5¼"	Smooth
20-1751	5¼"	Serrated



BOYNTON NEEDLE HOLDER

20-3080	4¾"	Delicate
---------	-----	----------



MATHIEU NEEDLE HOLDERS

SERRATED

20-3055	5½"	
97-883	5½"	Mid-Grade
20-3070	6¼"	
20-3075	7½"	

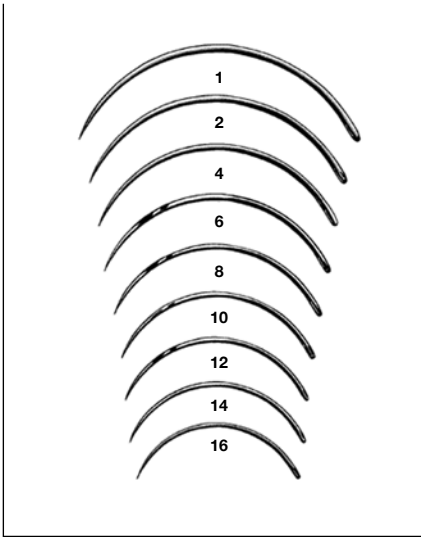

REGULAR SURGEON NEEDLE
3/8 CIRCLE, SPRING EYE ONLY
93-1760-# Cutting Edge

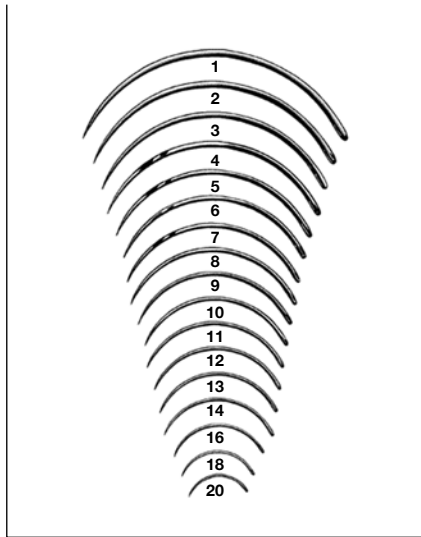

REGULAR SURGEON NEEDLE
3/8 CIRCLE
93-1762-# Reverse Cutting Edge

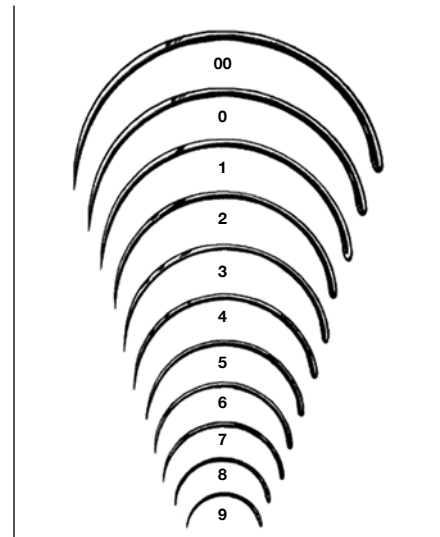

REGULAR SURGEON NEEDLE
1/2 CIRCLE
93-1770-# Cutting Edge

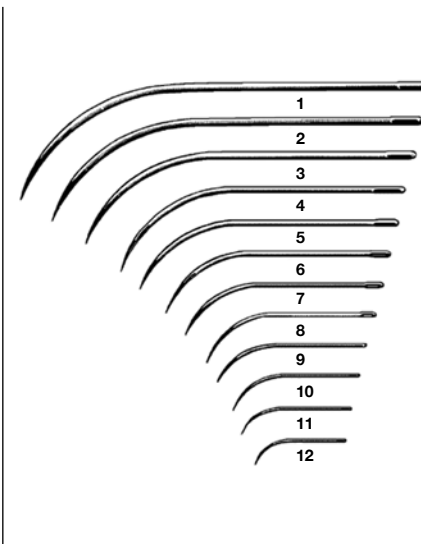

REGULAR SURGEON NEEDLE
HALF CURVE
93-1780-# Cutting Edge

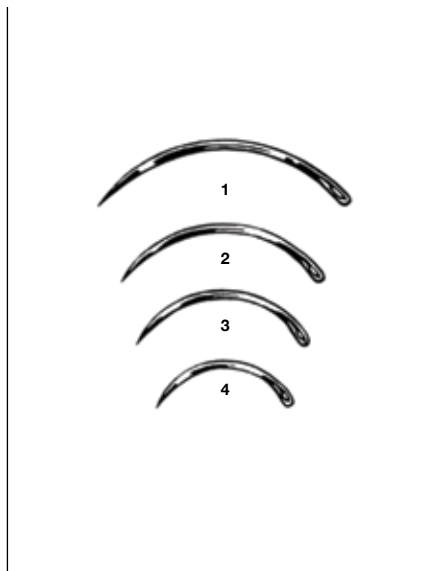

EYE NEEDLE
3/8 CIRCLE
93-1740-# Cutting Edge

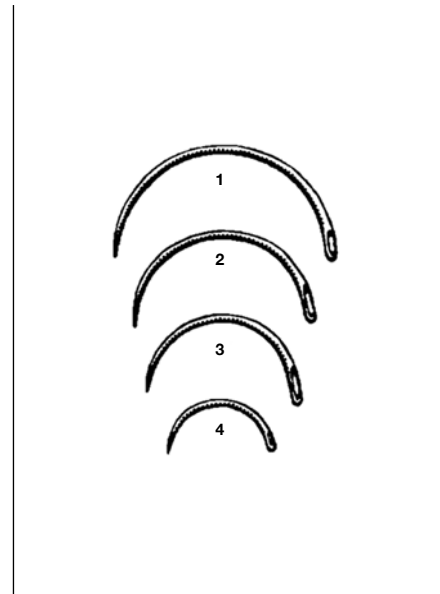

EYE NEEDLE
1/2 CIRCLE
93-1741-# Cutting Edge

All needles are sold Non-Sterile in packages of 12. When ordering simply add the corresponding needle size number to the end of the needle family product number, ie. needle size #4 would be 93-1760-4 or size #16 would be 93-1760-16. Needles are not shown to actual size.

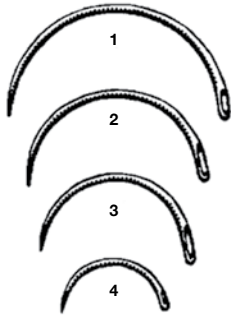
**EYE NEEDLE**

½ CIRCLE

93-1742-# Taper Point

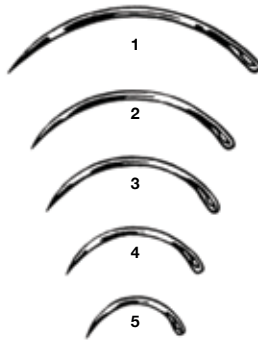
**LANE CLEFT PALATE NEEDLE**

¾ CIRCLE

93-1750-# Cutting Edge

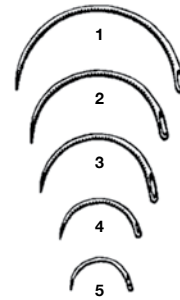
**LANE CLEFT PALATE NEEDLE**

½ CIRCLE

93-1751-# Cutting Edge

All needles are sold Non-Sterile in packages of 12. When ordering simply add the corresponding needle size number to the end of the needle family product number, ie. needle size #4 would be 93-1760-4 or size #16 would be 93-1760-16. Needles are not shown to actual size.

SKLARLITE™

STERILIZATION CONTAINER SYSTEM

The SklarLite™ Rigid Sterilization Container System provides an organized, routine and secure approach to the sterilization of surgical instruments. Customize your SklarLite™ System by selecting colored lids and ID labels. Available in your choice of six vibrant colors for easy identification of instrument sets by procedure and/or department. Choose from various configurations to fit your surgery center needs.

- Anodized aluminum alloy is strong and durable yet lightweight and easy to handle.
- Stackable Containers maximizes space in the autoclave and storage shelf space; reduces cycle runs.
- Stackable Baskets provide ease of instrument transfer per procedure and maximizes space inside containers.
- Silicon mats secure delicate and laparoscopic instruments to minimize damage.
- Tamper evident seals prevent accidental sterile field breach.



See page 209-212 for the complete product line.

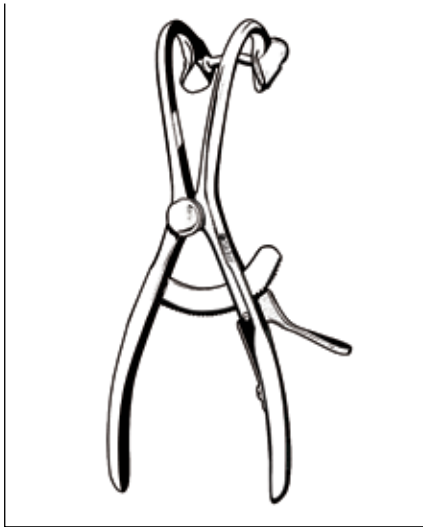

DENHARDT MOUTH GAG WITH RATCHET

75-1007 4¾"
SILICONE GUARDS
 75-1006 2/pk

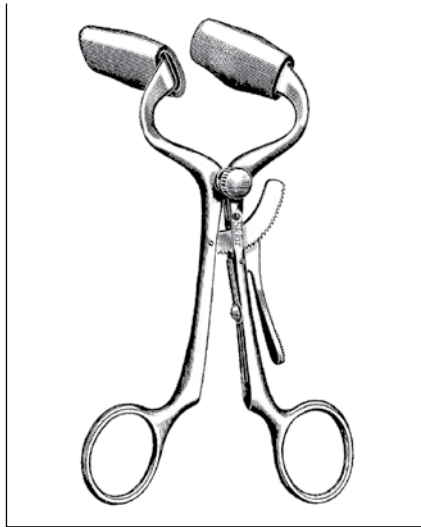

DOYEN-JANSEN (MOLT) MOUTH GAGS WITH CUSHIONS

22-8945 4" Child
 75-1025 5½" Adult
MID-GRADE
 48-774 4" Child
 48-785 5½" Adult
REPLACEMENT CUSHIONS
 22-8946 2/pk Child
 75-1026 2/pk Adult

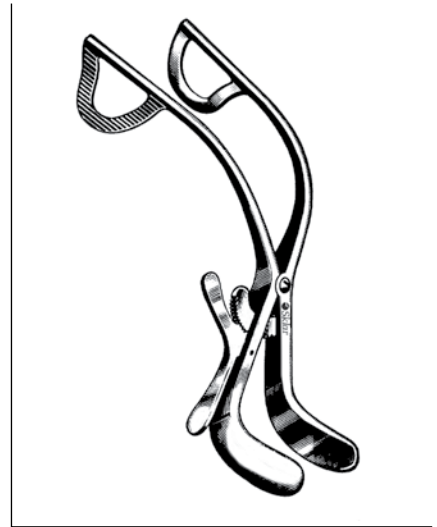

WESSON MOUTH GAG WITH TRU-GRIP RATCHET

75-1010



JENNINGS MOUTH GAGS

75-1015 3½" Small
 75-1016 4¼" Medium
 75-1017 5" Large



MOUTH PROPS

2/PK
 75-1034 Child Small
 75-1033 Child Large
 75-1032 Adult Small
 75-1031 Adult Medium
 75-1030 Adult Large

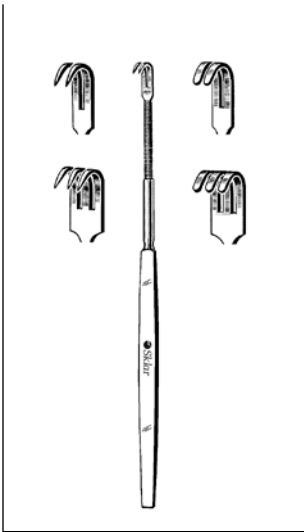

**PLASTIC SURGERY
RETRACTORS**

FLEXIBLE NECK

BLUNT		
22-9141	6"	1 Prong
22-9142	6"	2 Prong
22-9143	6"	3 Prong
SHARP		
22-9144	6"	1 Prong
22-9132	6"	2 Prong
22-9133	6"	3 Prong

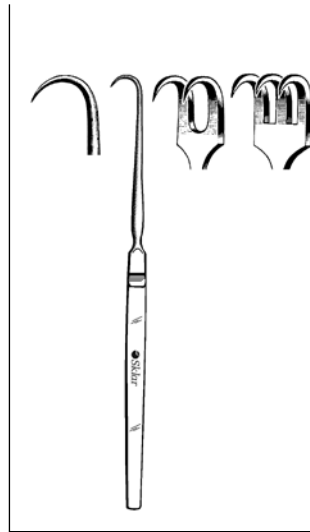

**TRACHEAL
RETRACTORS**

BLUNT		
78-1101	6½"	1 Prong
78-1102	6½"	2 Prong
78-1103	6½"	3 Prong
SHARP		
78-1001	6½"	1 Prong
78-1002	6½"	2 Prong
78-1003	6½"	3 Prong



OBWEGESER RETRACTORS

9½"			
CURVED UP		CURVED DOWN	
41-1460	7x25mm	41-1450	7x25mm
41-1461	10x35mm	41-1451	10x35mm
41-1462	10x42mm	41-1452	10x42mm
41-1463	12x55mm	41-1453	12x55mm
41-1464	14x70mm	41-1454	14x70mm
41-1465	16x80mm	41-1455	16x80mm

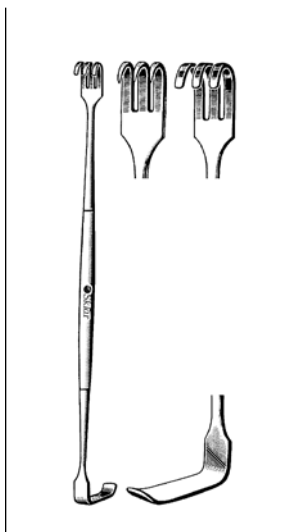

SENN RETRACTORS

DOUBLE END		
60-6164	6¼"	Blunt
60-6162	6¼"	Sharp

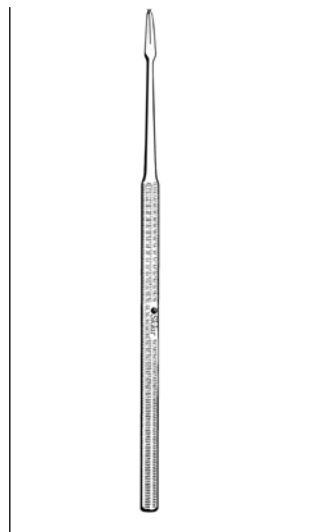

**TISSUE TWIST
HOOK**

1X2 TEETH		
47-2670	5½"	

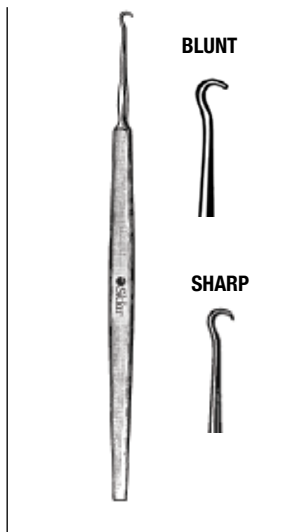

**FRAZIER TISSUE
HOOKS**

EXTRA DELICATE		
47-2556	5"	Blunt
47-2555	5"	Sharp

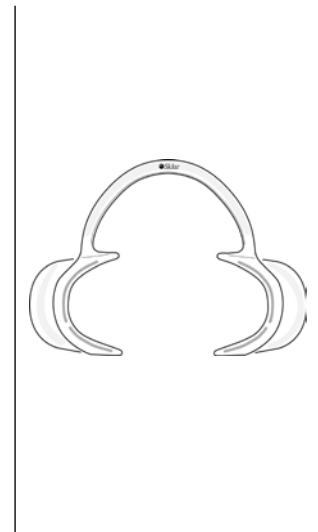

**SKLAR CHEEK
RETRACTORS**

CLEAR PLASTIC, 2/PK		
75-1141		Child
75-1140		Adult

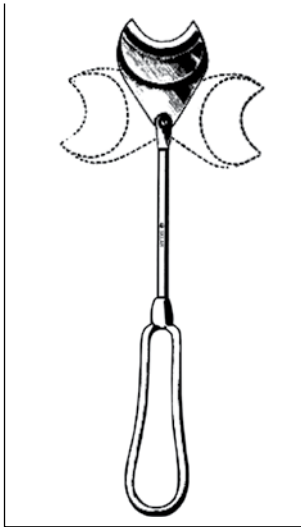

**CHEEK RETRACTOR
WITH SWIVEL BLADE**

75-1124 7¼"



**UNIVERSITY OF
MINNESOTA CHEEK
RETRACTORS
DOUBLE END**

75-1120 5½"
48-489 5½" Mid-Grade

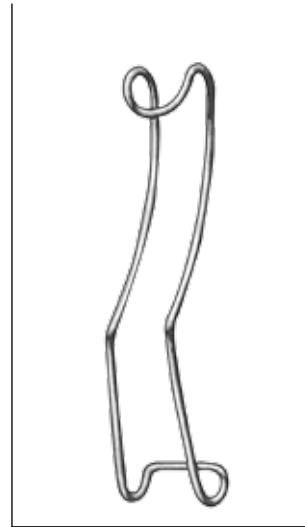

**LIP RETRACTOR
DOUBLE END**

75-1118 5½"

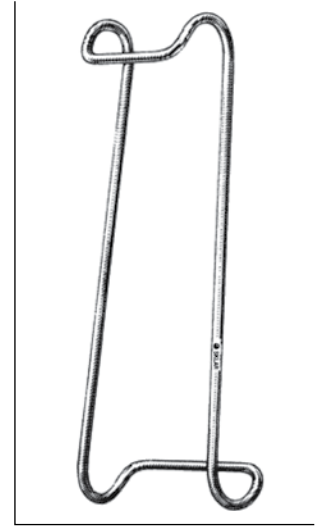

**COLUMBIA
LIP RETRACTOR
DOUBLE END**

75-1122 5½"



**WIEDER TONGUE
DEPRESSORS
FENESTRATED AND
SERRATED BLADE**

75-2160 Small
75-2161 Large



**ANDREWS TONGUE
DEPRESSOR
SERRATED**

75-2155 4¼"

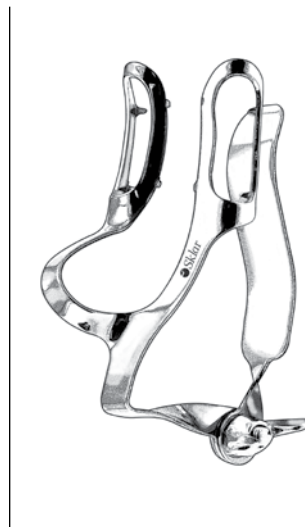

**COTTON ROLL
HOLDERS**

49-4500 Child
49-4505 Adult

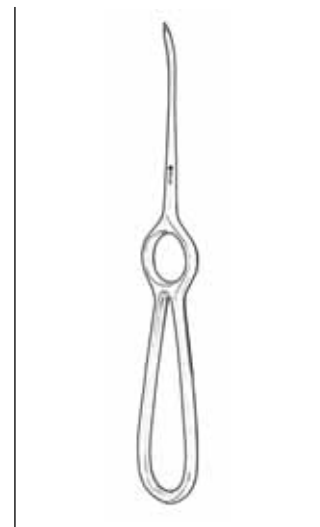

**OBWEGESER AWL
FOR WIRE SUTURING**

26-2010 7" Strong Curve
26-2009 9" Slight Curve

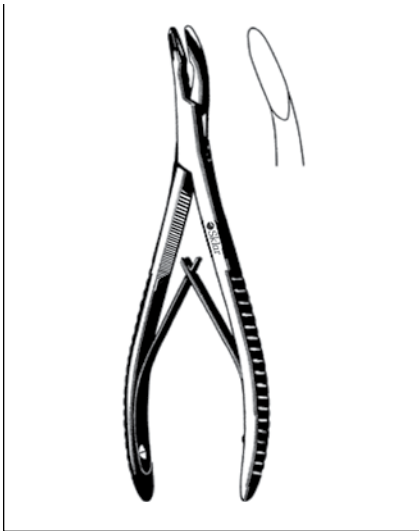

BANE RONGEUR
CURVED
 67-5175 7" 3mm x 16mm Bite

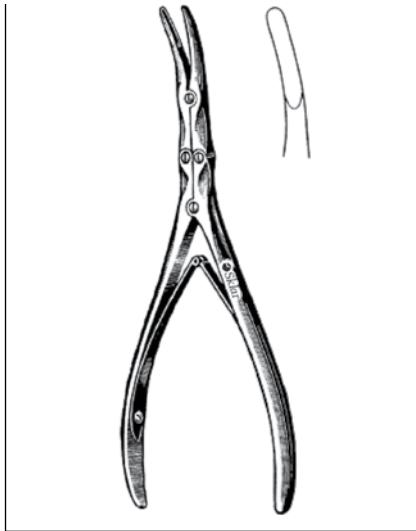

BEYER RONGEURS
CURVED, DOUBLE ACTION
 40-4268 7" 3mm x 14mm Bite
 40-4270 7" 4mm x 15mm Bite

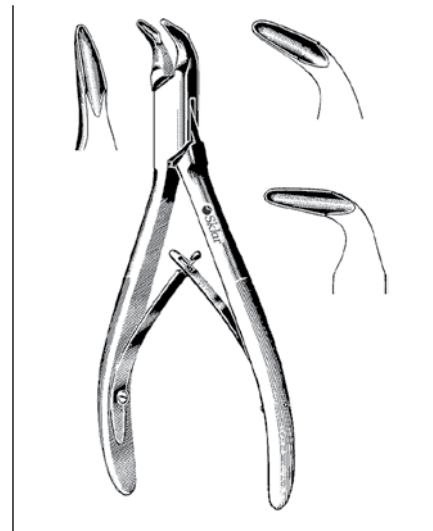

BLUMENTHAL RONGEURS
 67-5990 6" 30° Angle
 67-5991 7" 30° Angle
 67-5992 6" 45° Angle
 67-5994 6" 90° Angle

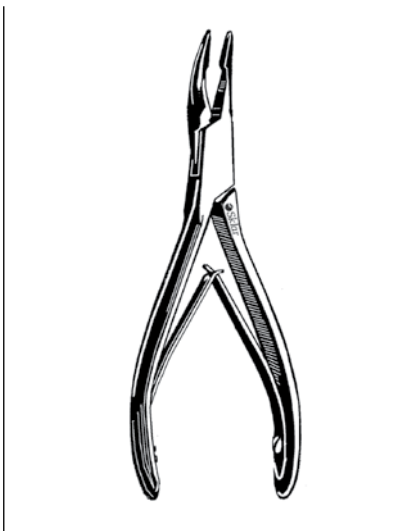

MINI-BLUMENTHAL RONGEURS
CURVED
 67-5987 4¾" 30° Angle
 67-5988 4¾" 45° Angle



DEAN BONE RONGEUR
 47-2455 5½" Curved

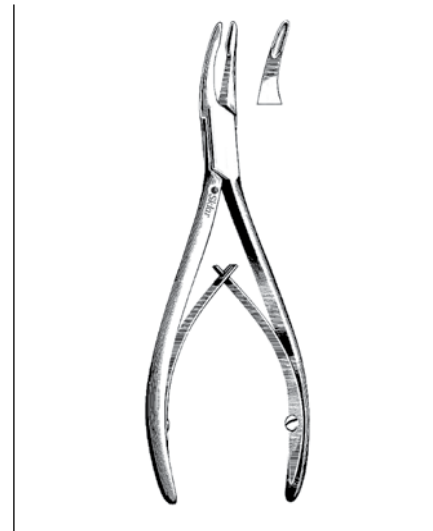

FRIEDMAN RONGEURS
CURVED, DELICATE
 40-3190 5½"
 40-3192 6½"

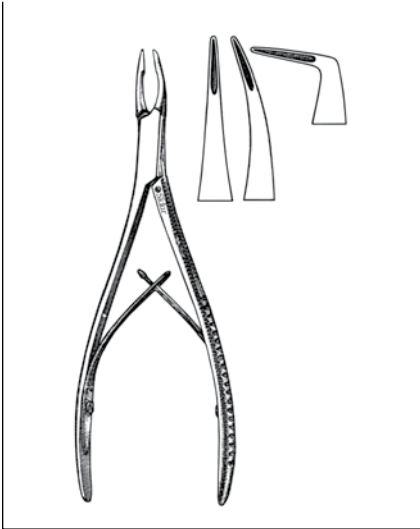

MICRO FRIEDMAN RONGEURS

1.3MM JAWS, VERY DELICATE

- 40-3186 5½" Straight
- 40-3189 5½" Curved
- 40-3191 5½" 90° Angle

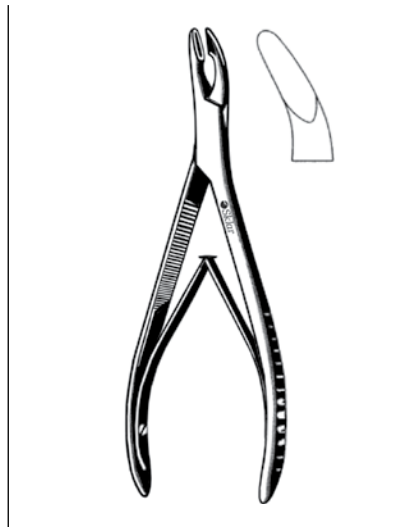

HARTMAN RONGEUR

67-5458 5¾" Full Curve



MEAD RONGEURS

4MM X 13MM BITE

- 40-3206 6½" Slight Curve
- 40-3208 6½" Curved

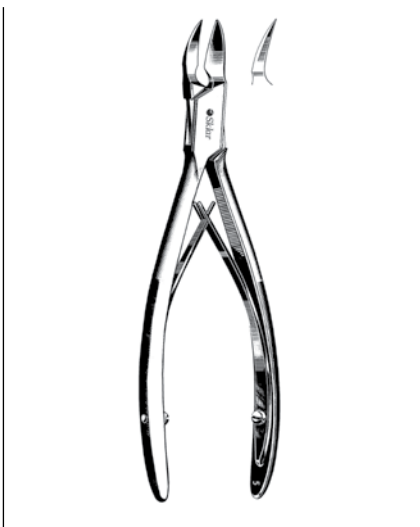

CLEVELAND RONGEURS

- 40-3215 4 5½"
- 40-3220 4A 6½"

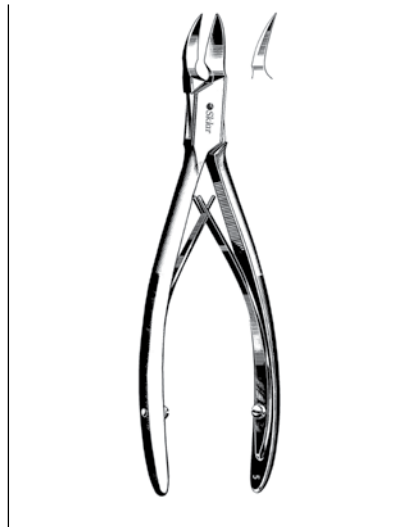

CLEVELAND RONGEURS

SIDE CUTTING, SLIGHTLY CURVED

- 40-3196 5S 5¾"
- 40-3198 5 6½"

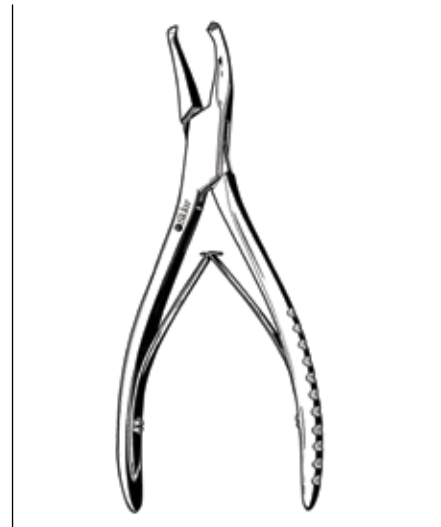

RONGEUR 6A

END CUTTING

- 40-3225 6½"



SKLAR EDGE™ TC GOLDMAN-FOX SCISSORS

BLUNT
 16-3614 5" Straight
 16-3615 5" Curved

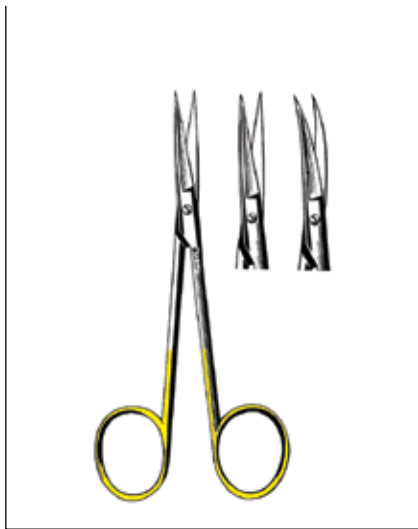

SKLAR EDGE™ TC IRIS SCISSORS

SHARP/SHARP
 16-2405 4½" Straight
 16-2505 4½" Curved

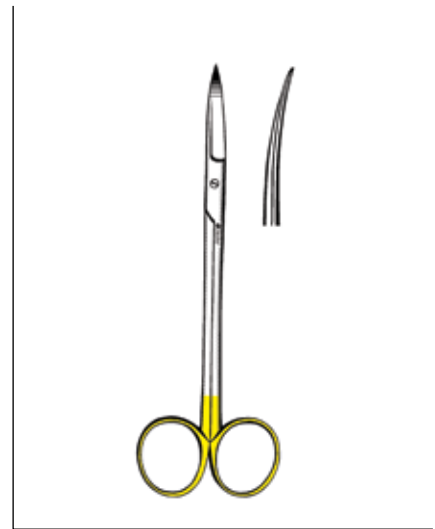

SKLAR EDGE™ TC KAYE RHYTIDECTOMY & DISSECTING SCISSORS

16-3621 4½" Curved
 16-3620 5¾" Curved



SKLAR EDGE™ TC METZENBAUM (LAHEY) SCISSORS

BLUNT/BLUNT
 16-1810 5¾" Straight
 16-1910 5¾" Curved
 16-1805 5¾" Straight Delicate
 16-1905 5¾" Curved Delicate
SHARP/SHARP
 16-1815 5¾" Straight
 16-1915 5¾" Curved

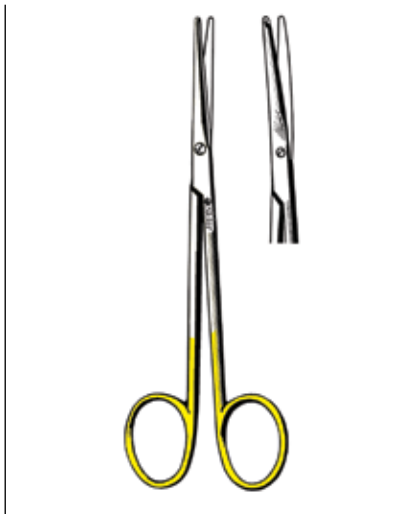

SKLAR EDGE™ TC METZENBAUM SCISSORS

STRAIGHT, BLUNT/BLUNT
 16-2010 7"
 16-2005 7" Delicate
 16-2210 9"
 16-2205 9" Delicate
STRAIGHT, SHARP/SHARP
 16-2015 7" Delicate

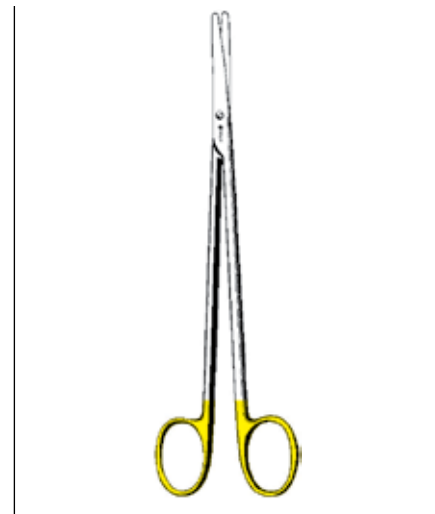

SKLAR EDGE™ TC METZENBAUM SCISSORS

CURVED, BLUNT/BLUNT
 16-2110 7"
 16-2105 7" Delicate
 16-2215 8"
 16-2310 9"
 16-2305 9" Delicate
 16-2211 10" Delicate
 16-2311 11"
 16-2312 12"
CURVED, SHARP/SHARP
 16-2115 7" Delicate

SKLAR EDGE
 TUNGSTEN CARBIDE



SKLAR EDGE™ TC OPERATING SCISSORS

STRAIGHT

16-1055	5½"	Sharp/Sharp
16-1056	5½"	Sharp/Blunt
16-1057	5½"	Blunt/Blunt



SKLAR EDGE™ TC OPERATING SCISSORS

CURVED

16-1155	5½"	Sharp/Sharp
16-1156	5½"	Sharp/Blunt
16-1157	5½"	Blunt/Blunt



SKLAR EDGE™ TC MAYO DISSECTING SCISSORS

BLUNT/BLUNT

16-1505	5½"	Straight
16-1605	5½"	Curved
16-1510	6¾"	Straight
16-1610	6¾"	Curved
16-1515	9"	Straight
16-1615	9"	Curved

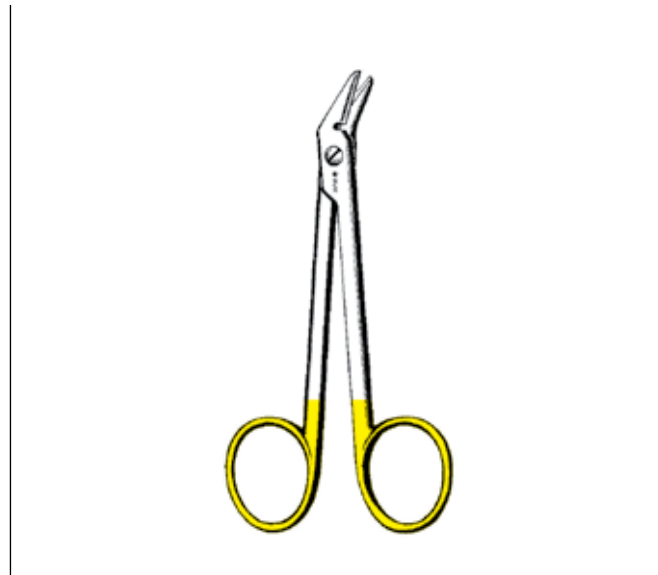

SKLAR EDGE™ TC WIRE CUTTING SCISSOR

16-2800	4¾"	Serrated Angled
---------	-----	-----------------

SUPER-CUT
SKLARHONE™

SUPERCUT SKLAR EDGE™ TUNGSTEN CARBIDE SKLARHONE™ scissors combine all the advantages of durable tungsten carbide with the precision performance of Supercut SklarHone™ blades, featuring the razor sharp cutting edge of a knife on one blade and micro-serrations on the other. Easily identified with one gold handle and one black handle.



SUPERCUT TC SKLARHONE™ METZENBAUM SCISSORS

STRAIGHT, BLUNT/BLUNT TIPS

16-3503	5 3/4"		16-3514	7"	Delicate
16-3513	5 3/4"	Delicate	16-3505	8"	
16-3504	7"		16-3515	8"	Delicate



SUPERCUT TC SKLARHONE™ METZENBAUM SCISSORS

CURVED, BLUNT/BLUNT TIPS

16-3506	5 3/4"		16-3528	8"	Delicate
16-3526	5 3/4"	Delicate	16-3509	9"	
16-3507	7"		16-3510	10"	
16-3527	7"	Delicate	16-3511	11"	
16-3508	8"				



SUPERCUT TC SKLARHONE™ IRIS SCISSORS

16-3545	4 1/2"	Straight
16-3546	4 1/2"	Curved

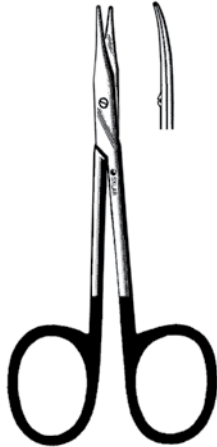

SUPER-CUT
SKLARHONOR™

**SUPERCUT SKLARHONOR™
STEVENS TENOTOMY
SCISSORS**

SERRATED

15-1242	4½"	Straight	Blunt
15-1243	4½"	Straight	Sharp
15-1342	4½"	Curved	Blunt
15-1343	4½"	Curved	Sharp

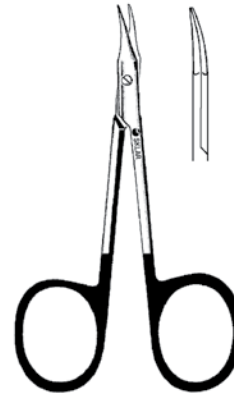

SUPER-CUT
SKLARHONOR™

**SUPERCUT SKLARHONOR™
GRADLE SCISSOR**

SERRATED

15-3444	3¾"	Slight Curve
---------	-----	--------------



**SKLARHONOR™
SKLARHONOR™
METZENBAUM
SCISSORS**

SMOOTH

15-3305	5¾"	Straight	Lahey
15-3306	5¾"	Curved	Lahey
15-3507	7"	Straight	
15-3310	7"	Curved	
15-3508	8"	Straight	
15-3311	8"	Curved	
15-3509	9"	Straight	
15-3315	9"	Curved	

SUPER-CUT
SKLARHONOR™

**SUPERCUT SKLARHONOR™
METZENBAUM
SCISSORS**

SERRATED

15-3403	4½"	Straight	Lahey
15-3404	4½"	Curved	Lahey
15-3405	5¾"	Straight	Lahey
15-3406	5¾"	Curved	Lahey
15-3407	7"	Straight	
15-3410	7"	Curved	
15-3408	8"	Straight	
15-3411	8"	Curved	
15-3409	9"	Straight	
15-3412	9"	Curved	



SKLARHONOR™

**SKLARHONOR™
IRIS SCISSORS**

SMOOTH

15-3352	4½"	Straight
15-3357	4½"	Curved

SUPER-CUT
SKLARHONOR™

**SUPERCUT SKLARHONOR™
IRIS SCISSORS**

SERRATED

15-3452	4½"	Straight
15-3457	4½"	Curved

SUPER-CUT
SKLARHONE™

**SUPERCUT SKLARHONE™
GOLDMAN-FOX SCISSOR**

SERRATED

15-3340 5" Straight

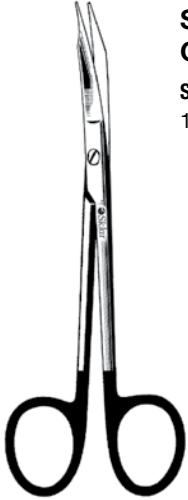

SKLARHONE™

**SKLARHONE™
OPERATING SCISSORS**

STRAIGHT, SMOOTH

15-3343 5½" Sharp/Blunt
15-3342 5½" Sharp/Sharp

SUPER-CUT
SKLARHONE™

**SUPERCUT SKLARHONE™
OPERATING SCISSORS**

STRAIGHT, SERRATED

15-3443 5½" Sharp/Blunt
15-3442 5½" Sharp/Sharp

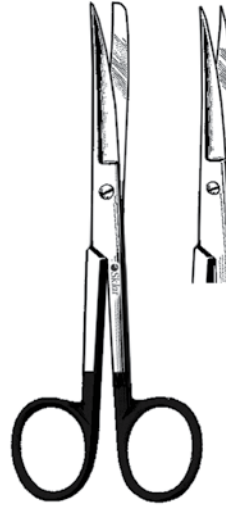

SKLARHONE™
**SKLARHONE™
OPERATING SCISSORS**

CURVED, SMOOTH

15-3349 5½" Sharp/Blunt
15-3348 5½" Sharp/Sharp

SUPER-CUT
SKLARHONE™

**SUPERCUT SKLARHONE™
OPERATING SCISSORS**

CURVED, SERRATED

15-3449 5½" Sharp/Blunt
15-3448 5½" Sharp/Sharp

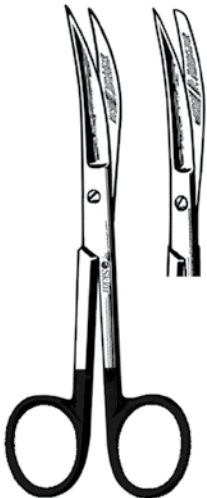

SKLARHONE™
**SKLARHONE™
MAYO SCISSORS**

SMOOTH

15-3325 5½" Straight
15-3330 5½" Curved
15-3326 6¾" Straight
15-3331 6¾" Curved

SUPER-CUT
SKLARHONE™

**SUPERCUT SKLARHONE™
MAYO SCISSORS**

SERRATED

15-3429 5½" Straight
15-3430 5½" Curved
15-3426 6¾" Straight
15-3427 6¾" Curved
15-3434 9" Straight
15-3435 9" Curved



OPERATING SCISSORS
STRAIGHT

13-1045	4½"	Sharp/Sharp
14-1045	4½"	Sharp/Blunt
15-1045	4½"	Blunt/Blunt
13-1050	5"	Sharp/Sharp
14-1050	5"	Sharp/Blunt
15-1050	5"	Blunt/Blunt
13-1055	5½"	Sharp/Sharp
14-1055	5½"	Sharp/Blunt
15-1055	5½"	Blunt/Blunt
13-1060	6"	Sharp/Sharp
14-1060	6"	Sharp/Blunt
15-1060	6"	Blunt/Blunt
13-1065	6½"	Sharp/Sharp
14-1065	6½"	Sharp/Blunt
15-1065	6½"	Blunt/Blunt
13-1072	7¼"	Sharp/Sharp
14-1072	7¼"	Sharp/Blunt

DELICATE

22-1145	4½"	Sharp/Sharp
22-1245	4½"	Sharp/Blunt
22-1345	4½"	Blunt/Blunt
22-1150	5"	Sharp/Sharp
22-1250	5"	Sharp/Blunt
22-1350	5"	Blunt/Blunt
22-1155	5½"	Sharp/Sharp
22-1255	5½"	Sharp/Blunt
22-1355	5½"	Blunt/Blunt

MID-GRADE

97-275	5½"	Sharp/Sharp
97-272	5½"	Sharp/Blunt

OPERATING SCISSORS
CURVED

13-2045	4½"	Sharp/Sharp
14-2045	4½"	Sharp/Blunt
15-2045	4½"	Blunt/Blunt
13-2050	5"	Sharp/Sharp
14-2050	5"	Sharp/Blunt
15-2050	5"	Blunt/Blunt
13-2055	5½"	Sharp/Sharp
14-2055	5½"	Sharp/Blunt
15-2055	5½"	Blunt/Blunt
13-2060	6"	Sharp/Sharp
14-2060	6"	Sharp/Blunt
15-2060	6"	Blunt/Blunt
13-2065	6½"	Sharp/Sharp
14-2065	6½"	Sharp/Blunt
15-2065	6½"	Blunt/Blunt
13-2072	7¼"	Sharp/Sharp
14-2072	7¼"	Sharp/Blunt

DELICATE

22-1445	4½"	Sharp/Sharp
22-1545	4½"	Sharp/Blunt
22-1645	4½"	Blunt/Blunt
22-1450	5"	Sharp/Sharp
22-1550	5"	Sharp/Blunt
22-1650	5"	Blunt/Blunt
22-1455	5½"	Sharp/Sharp
22-1555	5½"	Sharp/Blunt
22-1655	5½"	Blunt/Blunt



MAYO DISSECTING SCISSORS

15-1555	5½"	Straight	Mid-Grade
97-308	5½"	Straight	
15-2555	5½"	Curved	Mid-Grade
97-312	5½"	Curved	
15-1567	6¾"	Straight	
15-2567	6¾"	Curved	
90-1590	9"	Straight	
90-1690	9"	Curved	

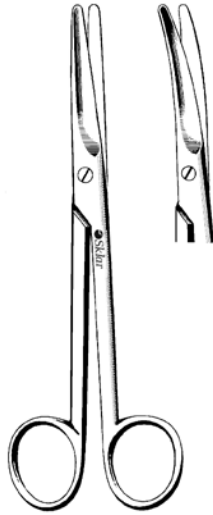

MAYO DISSECTING SCISSORS

DELICATE			
22-1556	5½"	Straight	
22-2555	5½"	Curved	
22-1567	6¾"	Straight	
22-2567	6¾"	Curved	



METZENBAUM (LAHEY) SCISSORS

22-2550	4½"	Straight
22-2545	4½"	Curved
75-5460	5¾"	Straight
47-1360	5¾"	Curved

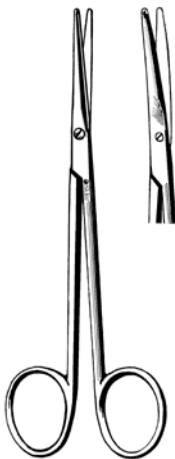

METZENBAUM (LAHEY) SCISSORS

DELICATE			
22-2450	4½"	Straight	
22-2650	4½"	Curved	
22-2460	5¾"	Straight	
22-1057	5¾"	Curved	



WAGNER SCISSORS

STRAIGHT			
47-1070	4½"	Blunt/Blunt	Smooth
47-1048	4½"	Sharp/Blunt	Smooth
47-1047	4½"	Sharp/Sharp	Smooth
47-1071	4½"	Blunt/Blunt	Serrated
47-1060	4½"	Sharp/Blunt	Serrated
47-1049	4½"	Sharp/Sharp	Serrated

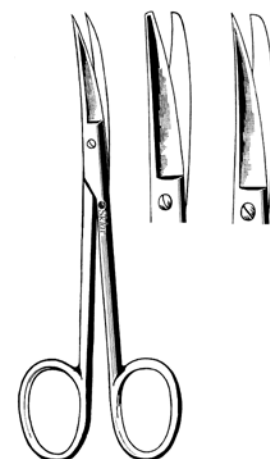

WAGNER SCISSORS

CURVED			
47-1075	4½"	Blunt/Blunt	Smooth
47-1068	4½"	Sharp/Blunt	Smooth
47-1058	4½"	Sharp/Sharp	Smooth
47-1072	4½"	Blunt/Blunt	Serrated
47-1069	4½"	Sharp/Blunt	Serrated
47-1059	4½"	Sharp/Sharp	Serrated



IRIS SCISSORS

STRAIGHT

- 47-1135 3½" Sharp/Sharp
- 47-1140 3½" Blunt/Blunt
- 47-1143 4" Sharp/Sharp
- 47-1441 4" Sharp/Sharp, Heavy
- 47-1145 4½" Sharp/Sharp
- 98-104 4½" Sharp/Sharp, Mid-Grade
- 47-1144 4½" Blunt/Blunt

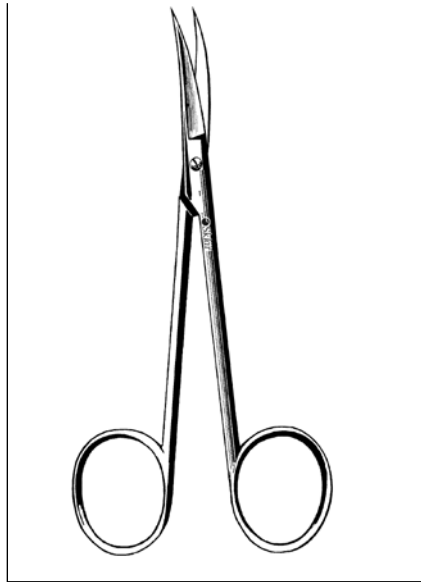

IRIS SCISSORS

CURVED

- 47-1235 3½" Sharp/Sharp
- 47-1240 3½" Blunt/Blunt
- 47-1243 4" Sharp/Sharp
- 47-1442 4" Sharp/Sharp, Heavy
- 47-1245 4½" Sharp/Sharp
- 98-109 4½" Sharp/Sharp, Mid-Grade
- 47-1244 4½" Blunt/Blunt

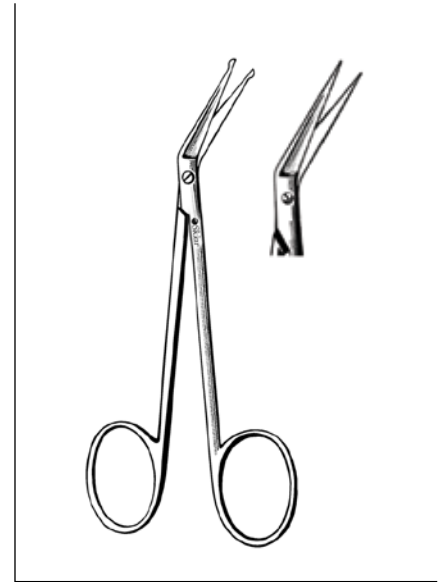

IRIS SCISSORS

- 64-2142 4½" Angled
- 64-2143 4½" Curved Sideways
- 64-2042 4¼" Angled, Probe Point

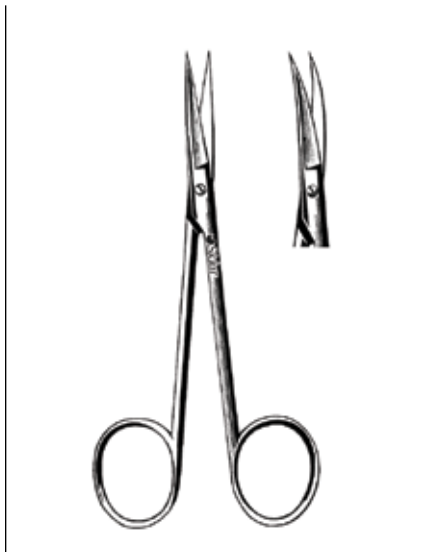

IRIS SCISSORS

DELICATE

- 22-1135 3½" Straight
- 22-1235 3½" Curved
- 47-1440 4" Straight
- 47-1340 4" Curved
- 47-1246 4½" Straight
- 47-1248 4½" Curved

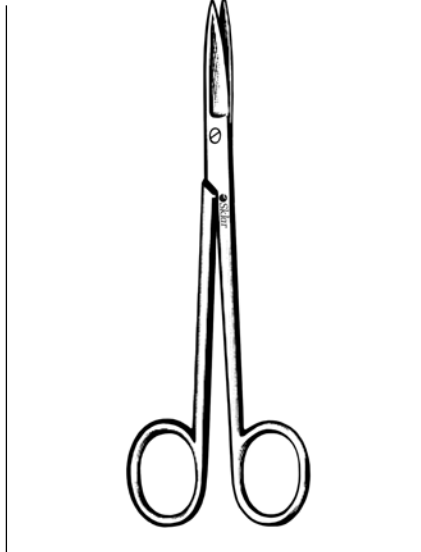

JOSEPH SCISSORS

- 41-1050 5¾" Straight
- 41-1054 5¾" Curved

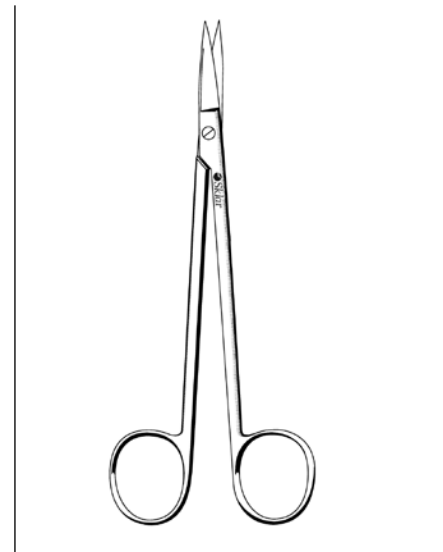

KELLY-ADSON SCISSORS

STRAIGHT

- 50-4562 6¼" Smooth
- 50-4563 6¼" Serrated



KELLY-ADSON SCISSORS

CURVED

- 50-4662 6¼" Smooth
- 50-4664 6¼" Serrated
- 97-314 6¼" Smooth Mid-Grade
- 97-316 6¼" Serrated Mid-Grade



KELLY-ADSON SCISSORS

ANGLED

- 50-4462 6¼" Smooth
- 50-4465 6¼" Serrated
- 97-318 6¼" Serrated, Mid-Grade

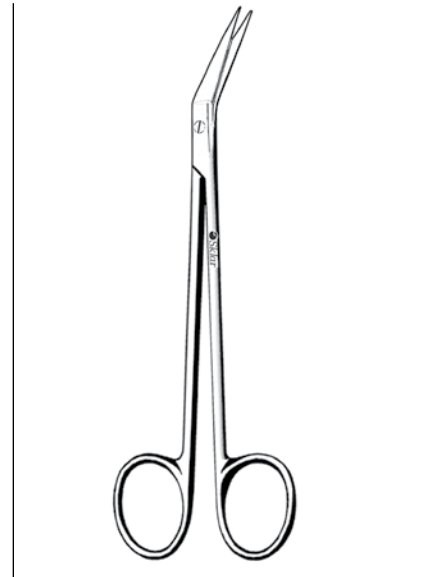

LOCKLIN SCISSORS

ANGLED 25°, ONE SERRATED BLADE

- 47-1078 6¼"
- 47-1079 6¼" Curved Shank

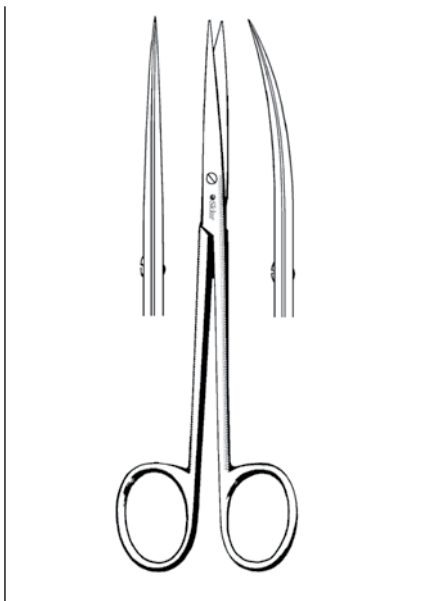

BROPHY SCISSORS

- 64-1160 5½" Straight, Sharp
- 64-1161 5½" Curved, Sharp

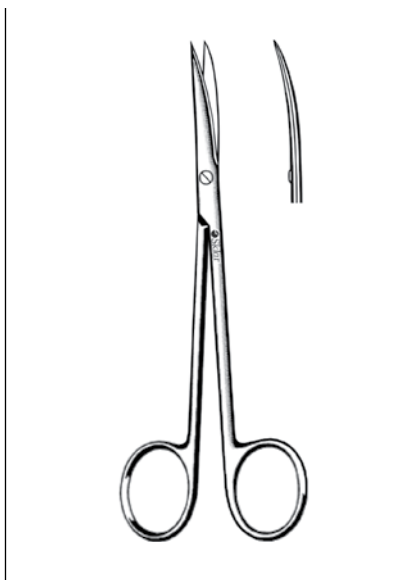

BROPHY SULLIVAN SCISSORS

SERRATED

- 22-2855 5¾" Straight, Sharp
- 22-2755 5¾" Curved, Sharp

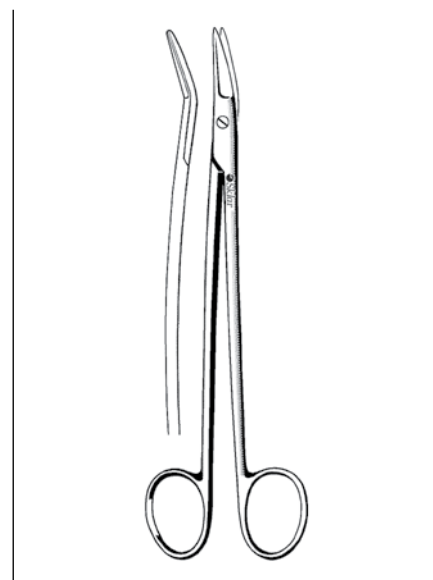

DEAN TONSIL SCISSORS

ANGLED, SERRATED

- 75-5267 6¾"
- 97-247 6¾" Mid-Grade

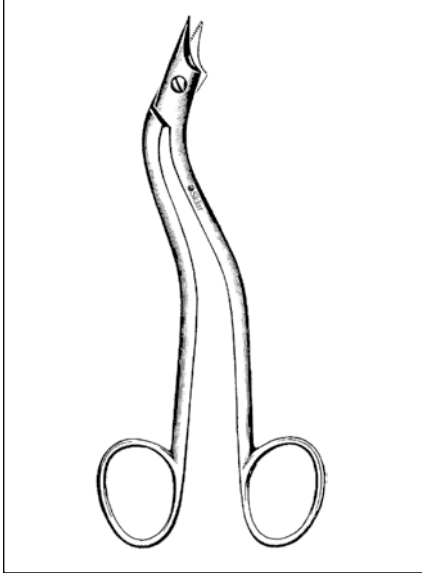

HEATH SUTURE SCISSOR

24-1962 6¼" Serrated

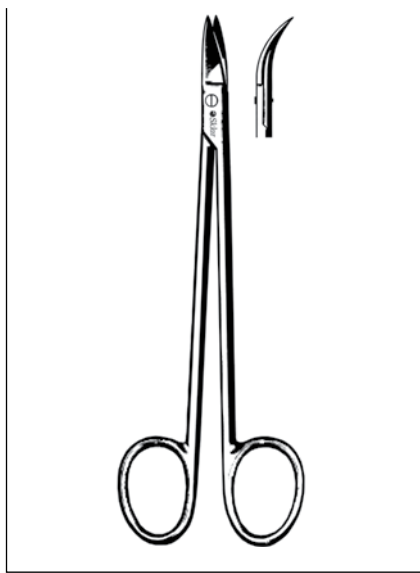

QUIMBY GUM SCISSORS

5"
22-2750 Straight
22-2751 Curved

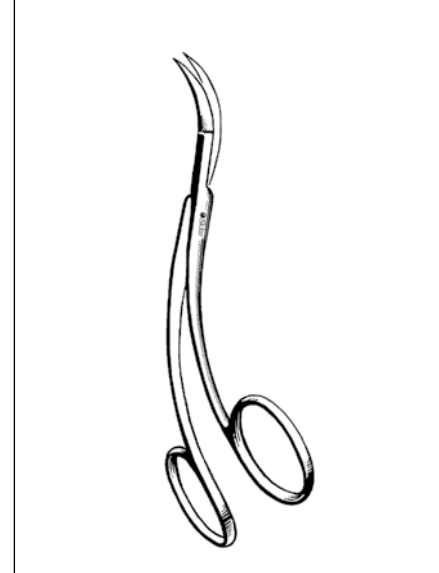

LA GRANGE SCISSOR

S-SHAPE
22-2745 4½" One Serrated Blade
Sharp/Sharp

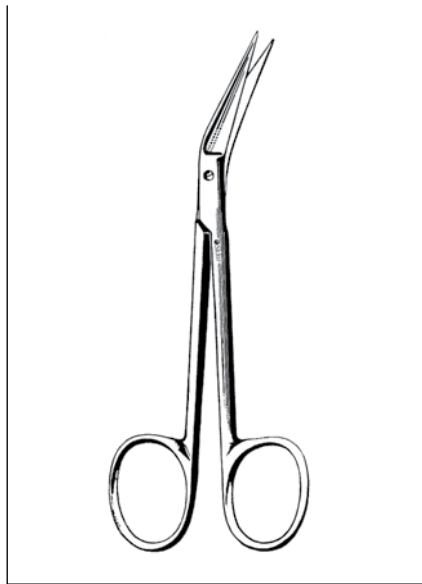

SKLAR SCISSORS

ANGLED
47-1080 4¾" Smooth
47-1081 4¾" Serrated

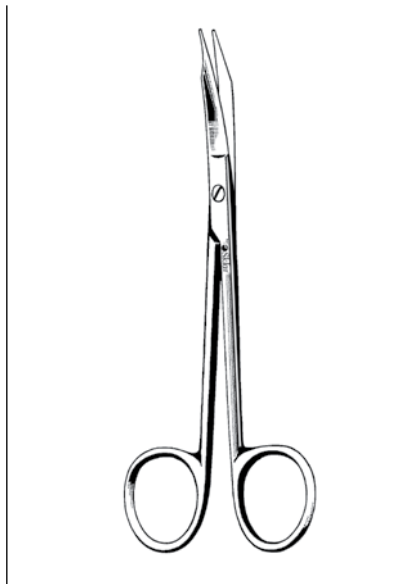

GOLDMAN-FOX SCISSOR

CURVED, SERRATED
22-2520 5"
97-249 5" Mid-Grade
22-2522 5" Angled Shank

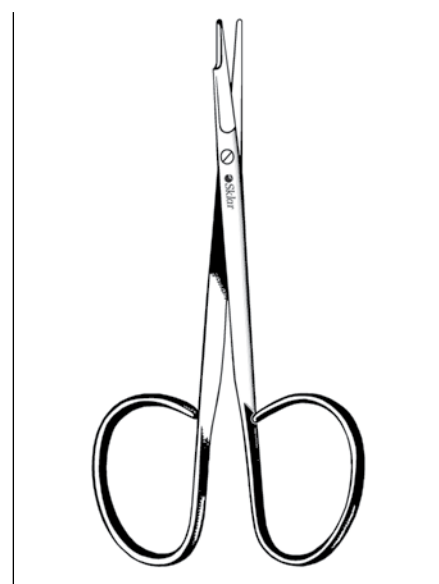

KAYE DISSECTING SCISSORS

47-1084 4¼" Straight
47-1085 5½" Curved, One Serrated Blade
47-1086 6" Curved
47-1087 7½" Curved

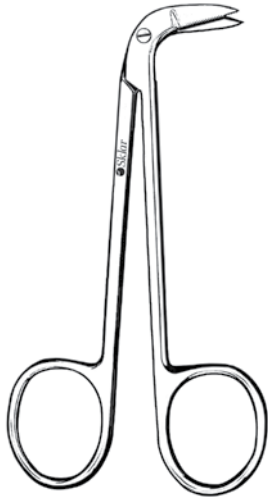

RA MATRIX SCISSOR
24-2335 4¼" One Serrated Blade

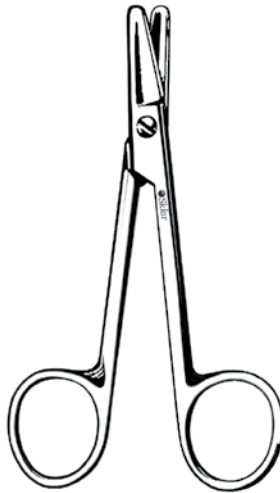

SUTURE WIRE CUTTING SCISSOR
SERRATED
24-2347 4¾" Straight

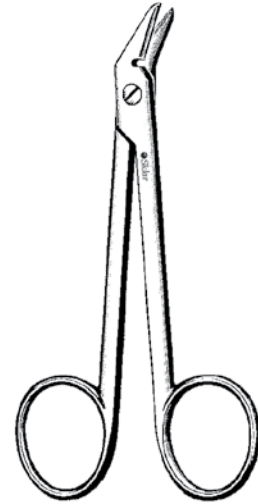

SUTURE WIRE CUTTING SCISSOR
SERRATED
24-2342 4¾" Angled

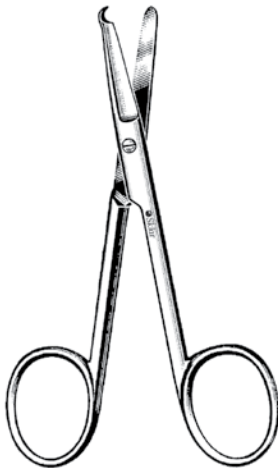

STITCH SCISSORS
22-2835 3½" Spencer
22-2845 4½" Spencer
15-1355 5½" Littauer

MID-GRADE
97-346 3½" Spencer
97-352 4½" Spencer
97-358 5½" Littauer



STITCH SCISSORS
DELICATE
22-2834 3½" Spencer
22-2844 4½" Spencer
22-1354 5½" Littauer



SUTURE SCISSORS
22-2935 3½" Shortbent
22-2934 3½" Shortbent Delicate
22-2947 4¾" Northbent

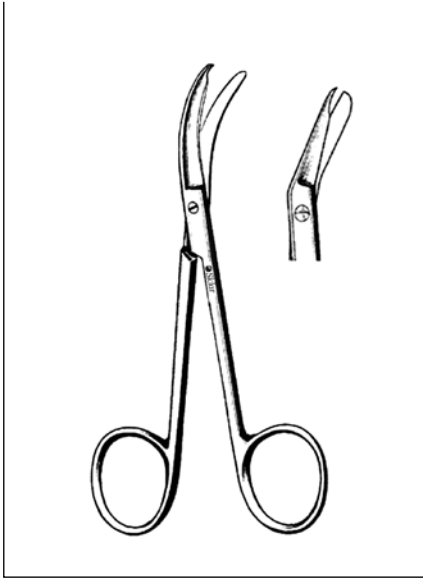

SKLAR STITCH SCISSORS

15-3150 4½" Angled
22-2950 5" Curved Sideways

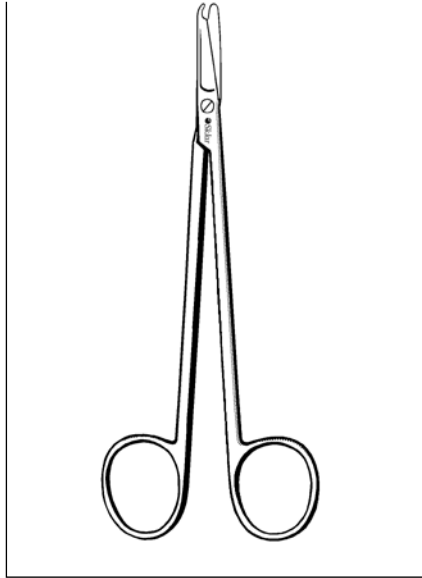

LONG STITCH SCISSOR

15-1358 6¼"

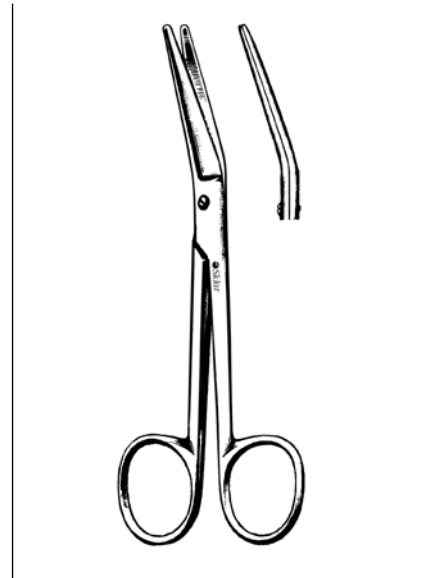

NEW'S SUTURE SCISSOR

41-1163 5½" Angled Flat

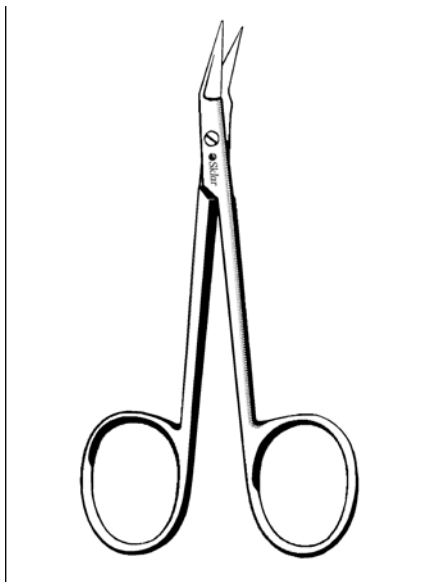

O'BRIEN STITCH SCISSOR

22-2837 3¾" Angled

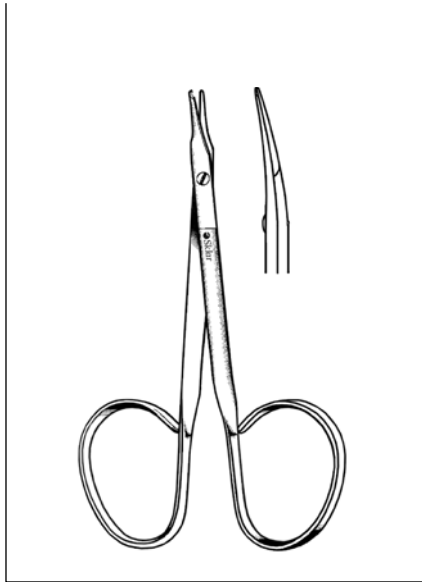

REEH STITCH SCISSOR

SHARP TIPS
64-1348 3¾" Small Hook at the End of One Blade

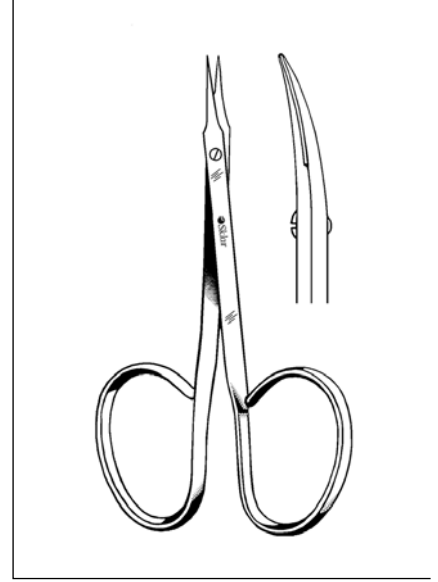

RIBBON STITCH SCISSORS

64-1345 4" Straight
64-1445 4" Curved

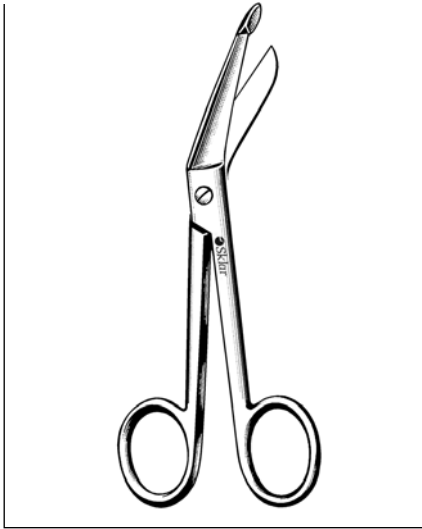

LISTER BANDAGE SCISSORS

11-1035	3½"	
11-1045	4½"	
11-1055	5½"	
97-231	5½"	Mid-Grade
22-1054	5½"	Delicate
11-1072	7¼"	
97-241	7¼"	Mid-Grade
22-1072	7¼"	Delicate
11-1080	8"	
11-1060	8"	Large Ring

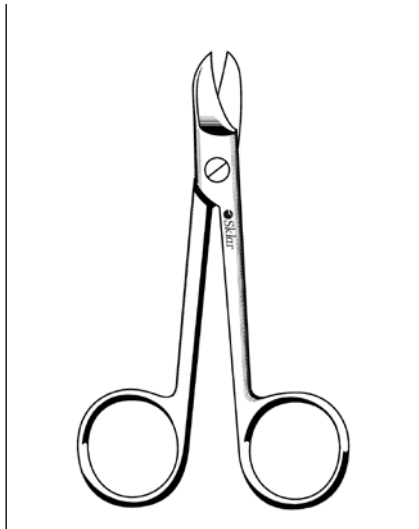

CROWN & COLLAR CUTTING SCISSORS

STRAIGHT		
24-2345	4"	Smooth
24-2340	4"	Serrated
STRAIGHT, MID-GRADE		
48-708	4"	Smooth
48-729	4"	Serrated

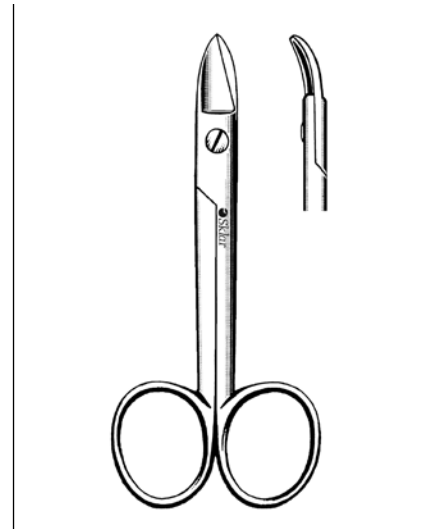

CROWN & COLLAR CUTTING SCISSORS

CURVED		
24-2346	4"	Smooth
24-2341	4"	Serrated
CURVED, MID-GRADE		
48-721	4"	Smooth
48-735	4"	Serrated

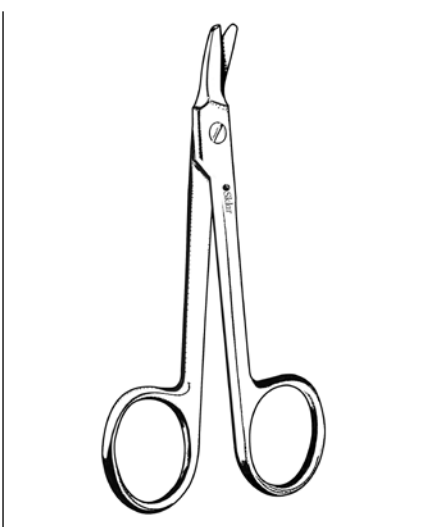

BAKER CROWN SCISSOR

24-2355

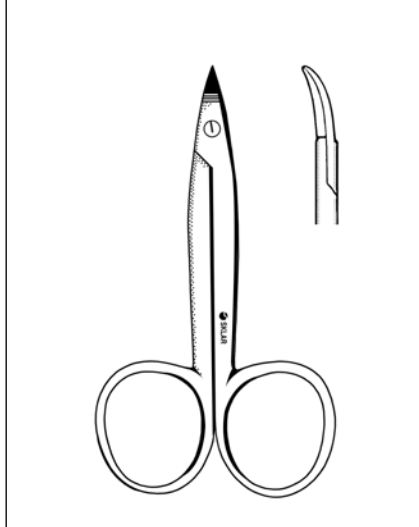

PEDO CROWN-FESTOONING SCISSOR

24-2337 3½" Curved

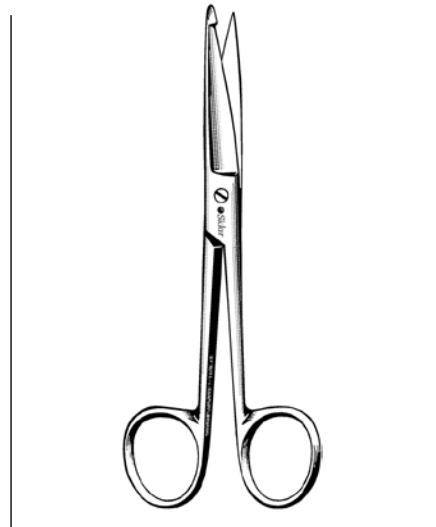

KNOWLES BANDAGE SCISSOR

11-1255 5½"

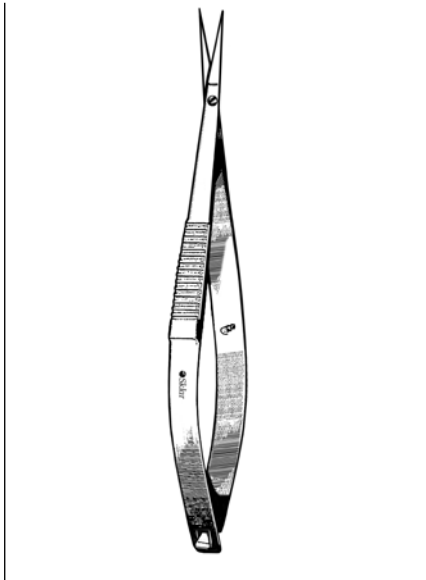

NOYES IRIS SCISSORS

STRAIGHT

64-3212	4½"	Sharp/Sharp
64-3211	4½"	Sharp/Blunt
64-3210	4½"	Blunt/Blunt

CURVED

64-3215	4½"	Sharp/Sharp
---------	-----	-------------

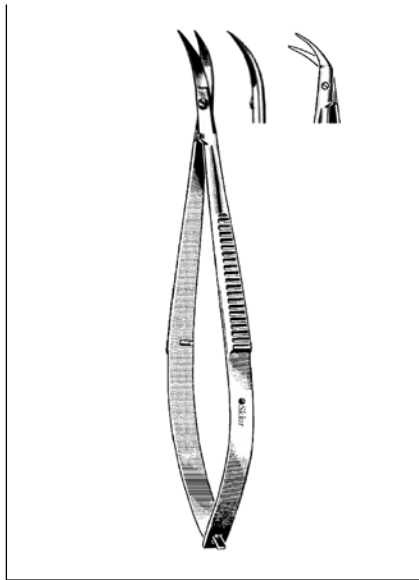

CASTROVIEJO CORNEAL SCISSORS

CURVED

64-2440	4"	Sharp
64-2442	4"	Blunt

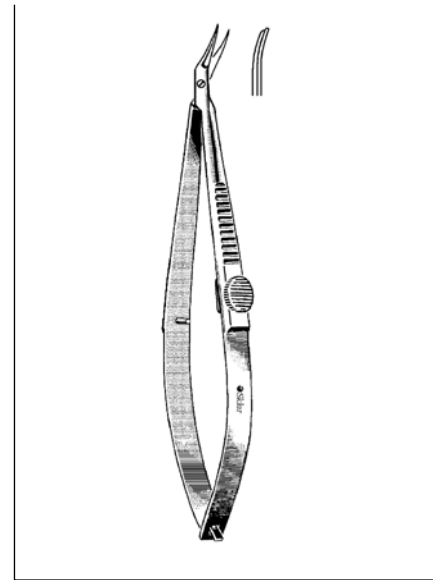

CASTROVIEJO CORNEAL SCISSORS

INNER BLADE LONGER THAN OUTER BLADE

64-3294	4"	Right
64-3296	4"	Left



CASTROVIEJO CORNEAL SCISSORS

INNER BLADE .5MM LONGER THAN OUTER BLADE

64-2242	4¼"	Curved Right
64-2342	4¼"	Curved Left



CASTROVIEJO CORNEAL SCISSOR

ANGLED

64-2535	4"	Blunt
---------	----	-------

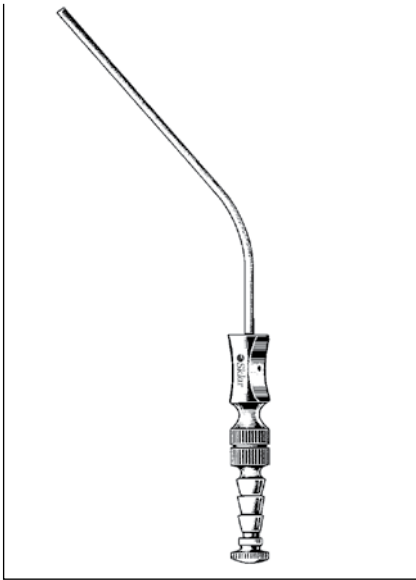

FRAZIER SUCTION TUBES

- 50-2006 6 French
- 50-2007 7 French
- 50-2008 8 French
- 50-2009 9 French
- 50-2010 10 French
- 50-2011 11 French
- 50-2012 12 French
- 50-2014 14 French



**FRAZIER SUCTION TUBES
90 DEGREE**

- 50-2206 6 French
- 50-2207 7 French
- 50-2208 8 French
- 50-2210 10 French
- 50-2212 12 French

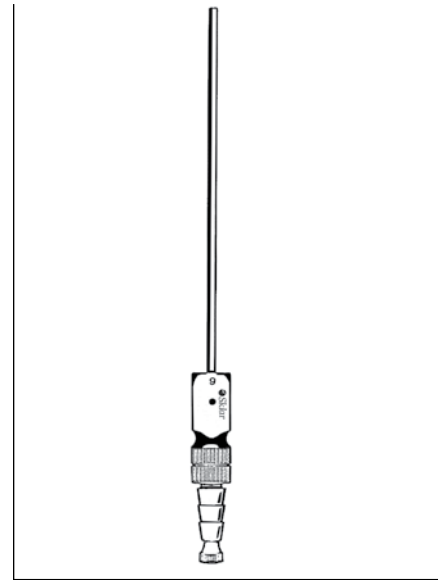

**FRAZIER FERGUSON
SUCTION TUBES**

- STRAIGHT WITH THUMB CONTROL**
- 50-2106 6 French
 - 50-2108 8 French
 - 50-2109 9 French
 - 50-2110 10 French
 - 50-2112 12 French

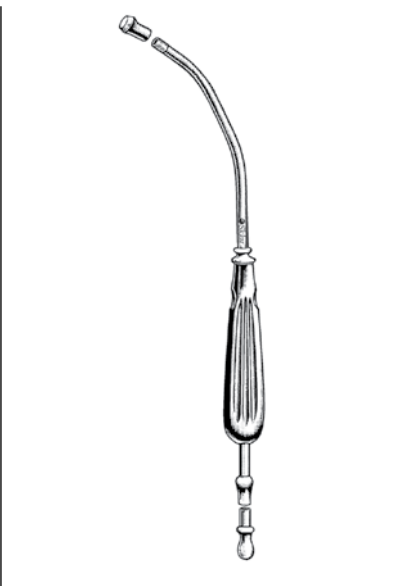

YANKAUER SUCTION TUBES

- 07-1801 11" Chrome Plated
- 07-1805 11" Stainless Steel
- 22-6585 8½" Stainless Steel, Pediatric
- 07-1802 Tip For use with 07-1801
- 07-1806 Tip For use with 07-1805
- 22-6586 Tip For use with 22-6585

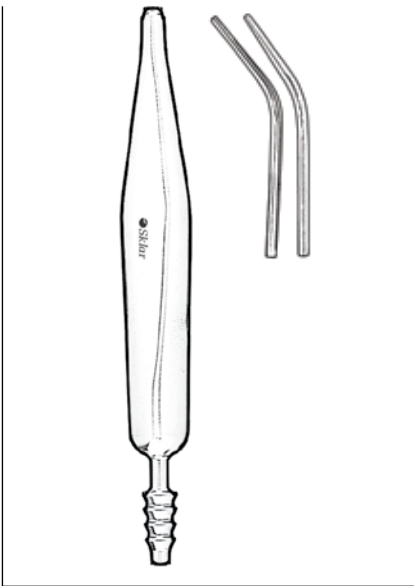

COUPLAND SUCTION TUBE

- 50-2825 6½" 2 Interchangeable Tips
1.5mm and 2.0mm

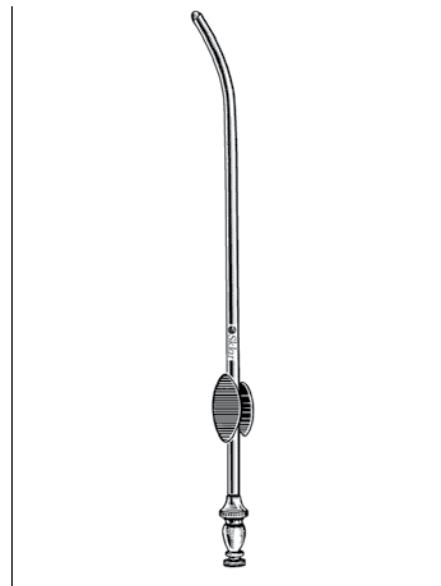

ADSON SUCTION TUBES

- 50-1982 6" Shaft 12 French
- 50-1985 7½" Shaft 15 French



ANDREWS-PYNCHON SUCTION TUBE

22-6590 10" Delicate Pattern
 22-6591 Tip For use with 22-6590



BARON SUCTION TUBES

50-1953 3 French
 50-1955 5 French
 50-1957 7 French



BOWMAN LACRIMAL PROBES

STERLING SILVER

65-4098 Size 0000-000
 65-4099 Size 00-0
 65-4101 Size 1-2
 65-4103 Size 3-4
 65-4105 Size 5-6
 65-4107 Size 7-8
 65-4100 Sizes 1-8 Set of 4

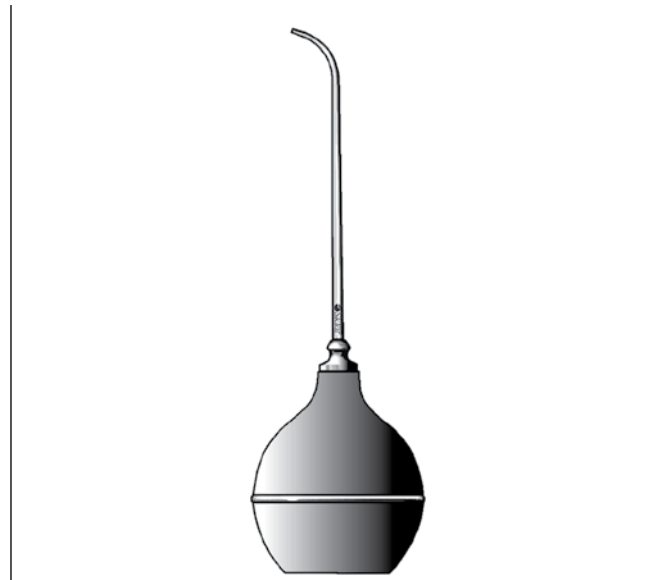

CHIP BLOWER

97-1650 Complete
 97-1652 Tip Only
 97-1654 Bulb Only

98-1476—PLIER SET

PRODUCT NUMBER	DESCRIPTION	FEATURES	QUANTITIES
49-1730	College Plier	#2	1
49-1740	College Plier	Serrated, #317	1
49-1750	College Plier	Extra Fine, Serrated, Narrow, #317A	1
49-1755	College Plier	Extra Fine, Serrated, Long, #317B	1
49-1745	College Plier	Smooth, #317S	1
49-1735	College Plier	Smooth, Forked Tip, #311	1
49-1710	Meriam Plier	Serrated, #318	1
49-1765	Non-Pinch College Plier	Serrated	1
49-1770	Non-Pinch College Plier	Serrated, #49	1
49-1760	Non-Pinch College Plier	Smooth	1
49-1715	Perry Plier	#1	1
49-1720	Perry Plier	Serrated, Curved, #312	1
49-1700	Self-Locking College Plier	Grooved	1
49-1705	Self-Locking College Plier	Serrated	1

98-1477—EXPLORER SET

PRODUCT NUMBER	DESCRIPTION	FEATURES	QUANTITIES
49-0600	Explorer	Single End, #3	1
49-0605	Explorer	Single End, #3A	1
49-0615	Explorer	Single End, #6	1
49-0620	Explorer	Single End, #7	1
49-0625	Explorer	Single End, #17	1
49-0635	Explorer	Single End, #23	1
49-0645	Explorer	Double End, #2	1
49-0650	Explorer	Double End, #3	1
49-0655	Explorer	Double End, #3CH	1
49-0660	Explorer	Double End, #5	1
49-0680	Explorer	Double End, #11 / 12	1
49-0685	Explorer	Double End, #16	1
49-0690	Explorer	Double End, #DG16	1
49-0695	Explorer	Double End, #DG16 / 17	1
49-0700	Explorer	Double End, #DG16 / 23	1
49-0705	Explorer	Double End, #G16	1



**98-1478—EXTRACTING FORCEP SET**

PRODUCT NUMBER	DESCRIPTION	FEATURES	QUANTITIES
49-4430	Childrens Extracting Forcep	#150S	1
49-4440	Childrens Extracting Forcep	#151S	1
49-4005	Extracting Forcep	#1	1
49-4030	Extracting Forcep	#10S	1
49-4060	Extracting Forcep	#17	1
49-4315	Extracting Forcep	#222	1
49-4140	Extracting Forcep	#53L	1
49-4145	Extracting Forcep	#53R	1
49-4255	Extracting Forcep	#101	1
49-4265	Extracting Forcep	#150	1
49-4280	Extracting Forcep	#151	1

98-1479—GRACEY CURETTE SET

PRODUCT NUMBER	DESCRIPTION	FEATURES	QUANTITIES
49-2635	Gracey Curette	Double End, #1 / 2	1
49-2640	Gracey Curette	Double End, #3 / 4	1
49-2645	Gracey Curette	Double End, #5 / 6	1
49-2650	Gracey Curette	Double End, #7 / 8	1
49-2655	Gracey Curette	Double End, #9 / 10	1
49-2660	Gracey Curette	Double End, #11 / 12	1
49-2665	Gracey Curette	Double End, #13 / 14	1
49-2670	Gracey Curette	Double End, #15 / 16	1
49-2675	Gracey Curette	Double End, #17 / 18	1

98-1480—P.K. THOMAS WAX PLACER SET

PRODUCT NUMBER	DESCRIPTION	FEATURES	QUANTITIES
49-1050	P.K. Thomas Wax Placer	Double End, #1	1
49-1055	P.K. Thomas Wax Placer	Double End, #2	1
49-1060	P.K. Thomas Wax Placer	Double End, #3	1
49-1065	P.K. Thomas Wax Placer	Double End, #4	1
49-1070	P.K. Thomas Wax Placer	Double End, #5	1

98-1481—BASIC DENTAL SET

PRODUCT NUMBER	DESCRIPTION	FEATURES	QUANTITIES
49-1730	College Plier	#2	1
49-0660	Explorer	Double End, #5	1
73-1400	Mirror Handle	Round, Cone Socket	1
73-1495	Mouth Mirror	Front Surface, #5	1

98-1482—BASIC EXAMINATION SET I

PRODUCT NUMBER	DESCRIPTION	FEATURES	QUANTITIES
49-1730	College Plier	#2	1
49-0660	Explorer	Double End, #5	1
49-0615	Explorer	Single End, #6	1
49-0625	Explorer	Single End, #17	1
49-0635	Explorer	Single End, #23	1
73-1400	Mirror Handle	Round, Cone Socket	1
73-1495	Mouth Mirror	Front Surface, #5	1
49-0800	Probe	Single End, C	1

98-1483—BASIC EXAMINATION SET II

PRODUCT NUMBER	DESCRIPTION	FEATURES	QUANTITIES
49-0840	Coded Probe	Single End, #12	1
49-1745	College Plier	Smooth, #317S	1
49-0660	Explorer	Double End, #5	1
73-1400	Mirror Handle	Round, Cone Socket	1
73-1495	Mouth Mirror	Front Surface, #5	1



**98-1484—BASIC DENTAL SURGERY SET**

PRODUCT NUMBER	DESCRIPTION	FEATURES	QUANTITIES
50-3147	Adson Forcep	Serrated, 4¾"	1
50-3047	Adson Forcep	1x2 Teeth, 4¾"	1
97-1615	Bone File	Double End	1
49-1730	College Plier	#2	1
21-8006	Crile-Wood Needle Holder	Tungsten Carbide, Serrated, 6"	1
49-0625	Explorer	Single End, #17	1
49-0635	Explorer	Single End, #23	1
49-3240	Gardner Chisel	#51	1
22-2745	La Grange Scissor	S-Shape, 4½", 1 Blade Serrated	1
49-3310	Lucas Curette	Double End, #56	1
73-1410	Mirror Handle	Octagonal, Cone Socket	1
97-0530	Molt Periosteal Elevator	#9	1
73-1520	Mouth Mirror	Cone Socket, Magnifying #4	1
73-1505	Mouth Mirror	Cone Socket, Plane #4	1
49-3055	Orban Knife	Double End, #1 / 2	1
06-2903	Scalpel Handle	#3 Fits Blades 10, 11, 12, 15	1
06-3011	Surgical Blade	Carbon, #11	1
06-3015	Surgical Blade	Carbon, #15	1
75-1120	University of Minnesota Cheek Retractor	Double End, 5½"	1

98-1485—PERIODONTAL INSTRUMENT SET I

PRODUCT NUMBER	DESCRIPTION	FEATURES	QUANTITIES
49-0840	Coded Probe	Single End, #12	1
49-2610	Columbia Curette	Double End, #13 / 14	1
49-0680	Explorer	Double End, #11 / 12	1
49-2635	Gracey Curette	Double End, #1 / 2	1
49-2650	Gracey Curette	Double End, #7 / 8	1
49-2660	Gracey Curette	Double End, #11 / 12	1
49-2665	Gracey Curette	Double End, #13 / 14	1
73-1400	Mirror Handle	Round, Cone Socket	1
73-1495	Mouth Mirror	Front Surface, #5	1
49-2955	Scaler	#H6 / H7	1
49-2945	Scaler	Double End, #204S	1

98-1486—PERIODONTAL INSTRUMENT SET II

PRODUCT NUMBER	DESCRIPTION	FEATURES	QUANTITIES
49-3125	Crane-Kaplan Pocket Marker	#1	1
49-3130	Crane-Kaplan Pocket Marker	#2	1
49-3000	Goldman-Fox Knife	#7	1
49-3005	Goldman-Fox Knife	#8	1
49-3010	Goldman-Fox Knife	#9	1
49-3015	Goldman-Fox Knife	#10	1
49-3020	Goldman-Fox Knife	#11	1
49-0810	Goldman-Fox Probe	Single End, Round	1
49-2705	Goldman-Fox Scaler	Double End, #1	1
49-2710	Goldman-Fox Scaler	Double End, #2	1
49-2715	Goldman-Fox Scaler	Double End, #3	1
49-2720	Goldman-Fox Scaler	Double End, #4	1
49-2725	Goldman-Fox Scaler	Double End, #5	1
49-2730	Goldman-Fox Scaler	Double End, #6	1
22-2751	Quimby Gum Scissor	Curved, 5"	1

98-1487—PERIODONTAL INSTRUMENT SET III

PRODUCT NUMBER	DESCRIPTION	FEATURES	QUANTITIES
49-3125	Crane-Kaplan Pocket Marker	#1	1
49-3130	Crane-Kaplan Pocket Marker	#2	1
49-2700	Crane-Kaplan Scaler	Double End, #6	1
20-1265	Crile-Wood Needle Holder	Serrated, 6"	1
49-3005	Goldman-Fox Knife	#8	1
49-0810	Goldman-Fox Probe	Single End, Round	1
49-2710	Goldman-Fox Scaler	Double End, #2	1
49-2715	Goldman-Fox Scaler	Double End, #3	1
49-2720	Goldman-Fox Scaler	Double End, #4	1
22-2520	Goldman-Fox Scissor	Curved, Serrated, 5"	1
22-2751	Quimby Gum Scissor	Curved, 5"	1
49-2965	Scaler	Single End, #3	1

98-1488—PEDODONTAL IMPLANT SET

PRODUCT NUMBER	DESCRIPTION	FEATURES	QUANTITIES
49-1740	College Plier	Serrated, #317	1
49-2610	Columbia Curette	Double End, #13 / 14	1
49-0635	Explorer	Single End, #23	1
49-1590	Miller Groovelok Articulating Paper Forcep	Stainless, Grooved	1
73-1400	Mirror Handle	Round, Cone Socket	1
73-1495	Mouth Mirror	Front Surface, #5	1
49-0865	Probe / Explorer	Probe 1-10mm / Explorer #23	1
49-2955	Scaler	Double End, #H6 / H7	1
49-2945	Scaler	Double End, #204S	1
49-0820	WHO (PSR) Probe	Single End	1

**98-1489—SMALL PROPHY SET**

PRODUCT NUMBER	DESCRIPTION	FEATURES	QUANTITIES
49-2610	Columbia Curette	Double End, #13 / 14	1
49-0660	Explorer	Double End, #5	1
49-2635	Gracey Curette	Double End, #1 / 2	1
49-2645	Gracey Curette	Double End, #5 / 6	1
73-1400	Mirror Handle	Round, Cone Socket	1
73-1495	Mouth Mirror	Front Surface, #5	1
49-2955	Scaler	Double End, #H6 / H7	1
49-2945	Scaler	Double End, #204S	1
49-0830	UNC Probe	Single End, #15	1
49-0820	WHO (PSR) Probe	Single End	1

98-1490—LARGE PROPHY SET

PRODUCT NUMBER	DESCRIPTION	FEATURES	QUANTITIES
49-0840	Coded Probe	Single End, #12	1
49-1740	College Plier	Serrated, #317	1
49-2610	Columbia Curette	Double End, #13 / 14	1
49-0660	Explorer	Double End, #5	1
49-0680	Explorer	Double End, #11 / 12	1
49-2635	Gracey Curette	Double End, #1 / 2	1
49-2650	Gracey Curette	Double End, #7 / 8	1
49-2660	Gracey Curette	Double End, #11 / 12	1
49-2665	Gracey Curette	Double End, #13 / 14	1
73-1400	Mirror Handle	Round, Cone Socket	1
73-1495	Mouth Mirror	Front Surface, #5	1
49-2955	Scaler	Double End, #H6 / H7	1
49-2945	Scaler	Double End, #204S	1
49-0830	UNC Probe	Single End, #15	1
49-0820	WHO (PSR) Probe	Single End	1

98-1491—ORTHODONTIC BANDING / BONDING SET

PRODUCT NUMBER	DESCRIPTION	FEATURES	QUANTITIES
49-2510	Band Pusher/ Director		1
49-1730	College Plier	#2	1
49-2540	Direct Bond Bracket Holder		1
49-2445	Distal End Cutter		1
49-1250	Hollenback Carver	Double End, #1 / 2	1
49-1255	Hollenback Carver	Double End, #3	1
49-1260	Hollenback Carver	Double End, #3S	1
49-2275	Mathieu Plier		1
73-1400	Mirror Handle	Round, Cone Socket	1
73-1495	Mouth Mirror	Front Surface, #5	1
49-2410	Pin & Ligature Wire Cutter		1
49-2280	Weingart Utility Plier		1

98-1492—ORTHODONTIC ARCHWIRE ADJUSTMENT SET

PRODUCT NUMBER	DESCRIPTION	FEATURES	QUANTITIES
49-2215	Bending Plier	Bird Beak	1
49-2540	Direct Bond Bracket Holder		1
49-2445	Distal End Cutter		1
49-2400	Hard Wire Cutter		1
49-2525	Ligature Director and Scaler		1
49-2275	Mathieu Plier		1
73-1400	Mirror Handle	Round, Cone Socket	1
73-1495	Mouth Mirror	Front Surface, #5	1
49-2410	Pin & Ligature Wire Cutter		1
49-2255	Three Jaw Offset Plier		1
49-2280	Weingart Utility Plier		1

98-1493—COMPOSITE / CROWN PREP SET

PRODUCT NUMBER	DESCRIPTION	FEATURES	QUANTITIES
49-1820	Cement Spatula	#24	1
49-1730	College Plier	#2	1
49-0890	Cord Packer	Double End, Retraction Cord	1
49-0480	Excavator	Double End, #18	1
49-0660	Explorer	Double End, #5	1
49-1305	Interproximal Carver	Double End	1
47-1245	Iris Scissor	Curved, 4½"	1
49-1590	Miller Groovelok Articulating Paper Forcep	Stainless, Grooved	1
73-1400	Mirror Handle	Round, Cone Socket	1
73-1495	Mouth Mirror	Front Surface, #5	1
49-0905	Plastic Filling Instrument	Double End, #3	1
49-0910	Plastic Filing Instrument	Double End, #4	1

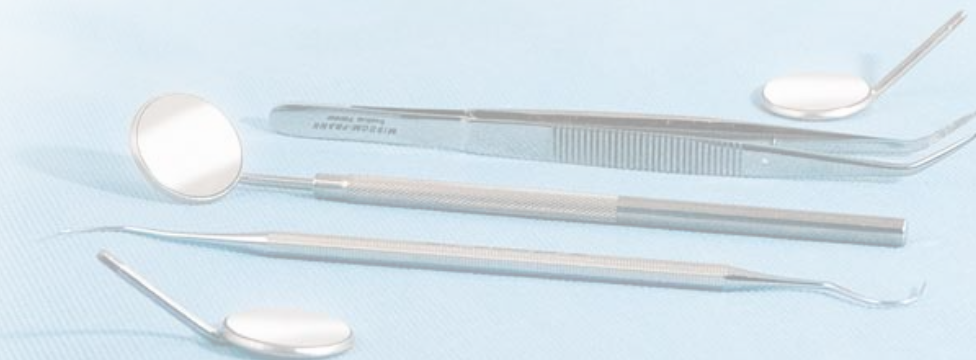

**98-1494—TOTAL RESTORATIVE SET**

PRODUCT NUMBER	DESCRIPTION	FEATURES	QUANTITIES
49-0004	Amalgam Carrier	Tungsten Carbide, Double End, Medium / Large	1
49-0036	Amalgam Well		1
49-0130	Black Amalgam Plugger / Condenser	Serrated (Marquette), #0 / 1	1
49-0125	Black Amalgam Plugger / Condenser	Smooth, #1 / 2	1
49-0260	Burnisher	Double End, #27 / 29	1
49-1580	Calcium Hydroxide Placer		1
49-1820	Cement Spatula	#24	1
49-1215	Cleoid Discoid Carver	Double End, #3 / 6	1
49-1730	College Plier	#2	1
49-0890	Cord Packer	Double End, Retraction Cord	1
49-0480	Excavator	Double End, #18	1
49-1250	Hollenback Carver	Double End, #1 / 2	1
49-1255	Hollenback Carver	Double End, #3	1
49-1260	Hollenback Carver	Double End, #3S	1
49-1305	Interproximal Carver	Double End	1
47-1245	Iris Scissor	Curved, 4½"	1
49-1590	Miller Groovelok Articulating Paper Forcep	Stainless, Grooved	1
73-1400	Mirror Handle	Round, Cone Socket	1
73-1495	Mouth Mirror	Front Surface, #5	1
49-0905	Plastic Filing Instrument	Double End, #3	1
49-0910	Plastic Filing Instrument	Double End, #4	1
49-0865	Probe / Explorer	Probe 1-10mm / Explorer #23	1

98-1495—AMALGAM SET

PRODUCT NUMBER	DESCRIPTION	FEATURES	QUANTITIES
49-0004	Amalgam Carrier	Tungsten Carbide, Double End, Medium / Large	1
49-0036	Amalgam Well		1
49-0130	Black Amalgam Plugger / Condenser	Serrated (Marquette), #0 / 1	1
49-0125	Black Amalgam Plugger / Condenser	Double End, Smooth, #1 / 2	1
49-0260	Burnisher	Double End, #27 / 29	1
49-0250	Burnisher	Single End, #21B	1
49-1580	Calcium Hydroxide Placer		1
49-1215	Cleoid Discoid Carver	Double End, #3 / 6	1
49-1225	Cleoid Discoid Carver	Double End, #89 / 92	1
49-1730	College Plier	#2	1
49-0480	Excavator	Double End, #18	1
49-0660	Explorer	Double End, #5	1
49-1250	Hollenback Carver	Double End, #1 / 2	1
49-1255	Hollenback Carver	Double End, #3	1
49-1260	Hollenback Carver	Double End, #3S	1
49-1590	Miller Groovelok Articulating Paper Forcep	Stainless, Grooved	1
73-1400	Mirror Handle	Round, Cone Socket	1
73-1495	Mouth Mirror	Front Surface, #5	1

98-1496—CROWN AND BRIDGE SET

PRODUCT NUMBER	DESCRIPTION	FEATURES	QUANTITIES
49-1820	Cement Spatula	#24	1
49-0840	Coded Probe	Single End, #12	1
49-1730	College Plier	#2	1
49-0890	Cord Packer	Double End, Retraction Cord	1
49-0480	Excavator	Double End, #18	1
49-0660	Explorer	Double End, #5	1
49-1305	Interproximal Carver	Double End	1
47-1245	Iris Scissor	Curved, 4½"	1
49-1590	Miller Groovelok Articulating Paper Forcep	Stainless, Grooved	1
73-1400	Mirror Handle	Round, Cone Socket	1
73-1495	Mouth Mirror	Front Surface, #5	1
49-0905	Plastic Filing Instrument	Double End, #3	1

98-1497—CEMENT (CROWN SEAT) SET

PRODUCT NUMBER	DESCRIPTION	FEATURES	QUANTITIES
49-1820	Cement Spatula	#24	1
49-1730	College Plier	#2	1
49-0660	Explorer	Double End, #5	1
49-1305	Interproximal Carver	Double End	1
49-1590	Miller Groovelok Articulating Paper Forcep	Stainless, Grooved	1
73-1400	Mirror Handle	Round, Cone Socket	1
73-1495	Mouth Mirror	Front Surface, #5	1

98-1498—SINUS LIFT SET

PRODUCT NUMBER	DESCRIPTION	FEATURES	QUANTITIES
40-7368	Bone Tamper	Serrated, 6mm Diameter, 6"	1
49-2600	Columbia Curette	Double End, #2L / 2R	1
49-2605	Columbia Curette	Double End, #4L / 4R	1
21-8006	Crile-Wood Needle Holder	Tungsten Carbide, Serrated, 6"	1
52-1277	Lahey Retractor	7"	1
40-5925	Mallet	7¼" With Two Plastic Flat Ends, 8 oz.	1
49-3355	Molt Curette	Double End, #2 / 4	1
97-0530	Molt Periosteal Elevator	#9	1
97-0527	Seldin Periosteal Elevator	Double End, 8"	1
49-0830	UNC Probe	Single End, #15	1

**98-1499—SUTURE REMOVAL SET**

PRODUCT NUMBER	DESCRIPTION	FEATURES	QUANTITIES
49-1730	College Plier	#2	1
49-2610	Columbia Curette	Double End, #13 / 14	1
49-0660	Explorer	Double End, #5	1
15-1355	Littauer Stitch Scissor	5½"	1
73-1400	Mirror Handle	Round, Cone Socket	1
73-1495	Mouth Mirror	Front Surface, #5	1

98-1500—ROOT PLANING SET

PRODUCT NUMBER	DESCRIPTION	FEATURES	QUANTITIES
49-1740	College Plier	Serrated, #317	1
49-0635	Explorer	Single End, #23	1
49-0660	Explorer	Double End, #5	1
49-2635	Gracey Curette	Double End, #1 / 2	1
49-2650	Gracey Curette	Double End, #7 / 8	1
49-2675	Gracey Curette	Double End, #17 / 18	1
49-2625	McCalls Curette	Double End, #17 / 18	1
73-1400	Mirror Handle	Round, Cone Socket	1
73-1495	Mouth Mirror	Front Surface, #5	1
49-0865	Probe / Explorer	Probe 1-10mm / Explorer #23	1
49-2955	Scaler	Double End, #H6 / H7	1
49-2945	Scaler	Double End, #204S	1
49-0830	UNC Probe	Single End, #15	1
49-0820	WHO (PSR) Probe	Single End	1



Econo™ Sterile Instruments

Econo™ Sterile instruments are suitable in a number of surgical venues where economical choice with reliable performance is most important.

- Combines high quality with low cost
- Saves labor costs
- Convenient & Safe
- Eliminates costly cleaning, processing and sterilization
- Sterile one-time use

CALL FOR PRICE QUOTES

MADE IN PAKISTAN.



OPERATING SCISSORS
STRAIGHT

96-2597	4½"	Sharp/Blunt	25/cs
96-2592	4½"	Sharp/Sharp	25/cs
96-2521	5½"	Sharp/Blunt	25/cs
96-2523	5½"	Sharp/Sharp	25/cs
96-2728	4½"	Sharp/Blunt	50/cs
96-2593	4½"	Sharp/Sharp	50/cs

96-2514	5½"	Blunt/Blunt	50/cs
96-2520	5½"	Sharp/Blunt	50/cs
96-2522	5½"	Sharp/Sharp	50/cs
96-2726	6½"	Sharp/Blunt	50/cs
96-2649	5½"	Sharp/Blunt	100/cs

OPERATING SCISSORS
CURVED

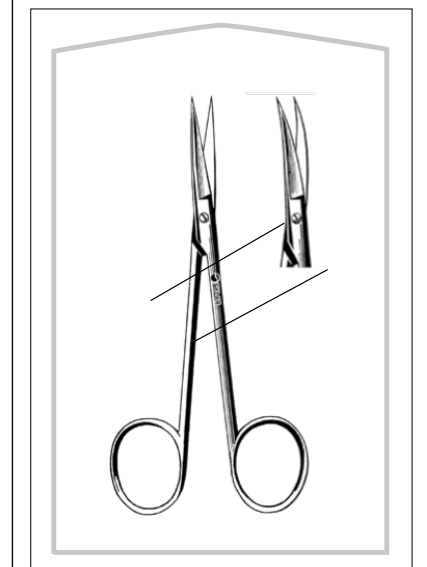
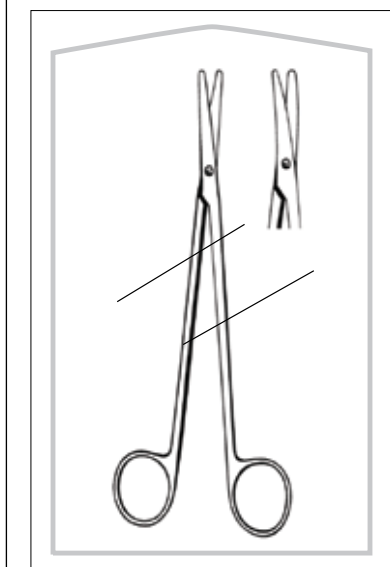
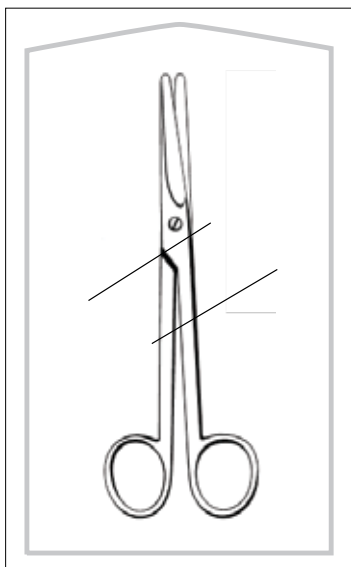
96-2526	5½"	Sharp/Blunt	25/cs
96-2527	5½"	Sharp/Sharp	25/cs
96-2524	5½"	Sharp/Blunt	50/cs
96-2525	5½"	Sharp/Sharp	50/cs

MAYO SCISSORS

96-2531	5½"	Straight	25/cs
96-2530	5½"	Straight	50/cs

METZENBAUM SCISSORS

96-2517	5½"	Straight	25/cs
96-2720	5½"	Curved	25/cs
96-2682	7"	Curved	25/cs
96-2516	5½"	Straight	50/cs
96-2721	5½"	Curved	50/cs
96-2680	7"	Curved	50/cs

IRIS SCISSORS

96-2505	4½"	Straight	25/cs
96-2507	4½"	Curved	25/cs
96-2497	3½"	Straight	50/cs
96-2499	3½"	Curved	50/cs
96-2504	4½"	Straight	50/cs
96-2506	4½"	Curved	50/cs
96-2650	4½"	Straight	100/cs
96-2651	4½"	Curved	100/cs

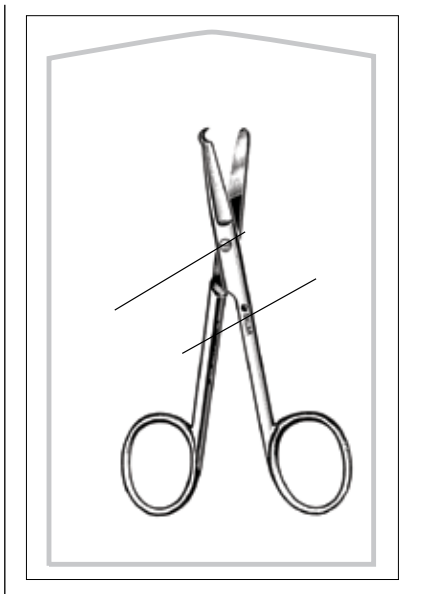

SPENCER STITCH SCISSORS

96-2598	4½"	25/cs
96-2672	3½"	50/cs
96-2596	4½"	50/cs

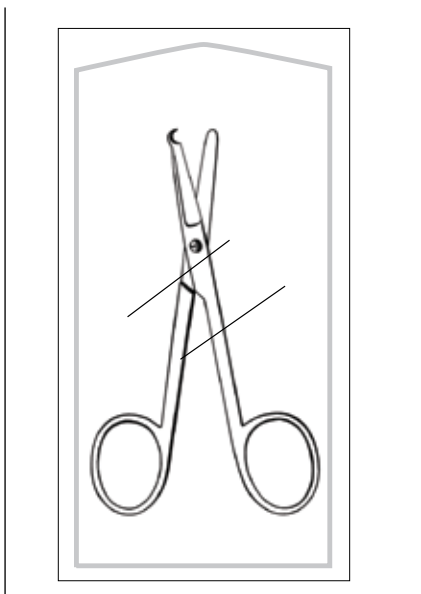

LITTAUER STITCH SCISSORS

96-2511	3½"	25/cs
96-2513	5½"	25/cs
96-2510	3½"	50/cs
96-2512	5½"	50/cs
96-2663	3½"	100/cs
96-2662	5½"	100/cs

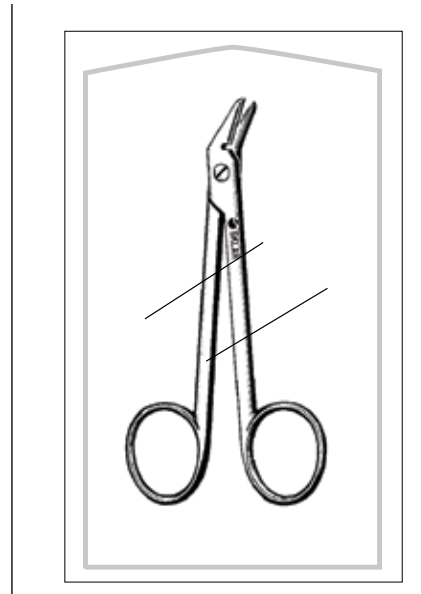

WIRE CUTTING SCISSORS

96-2519	4¾" Angled	25/cs
96-2518	4¾" Angled	50/cs

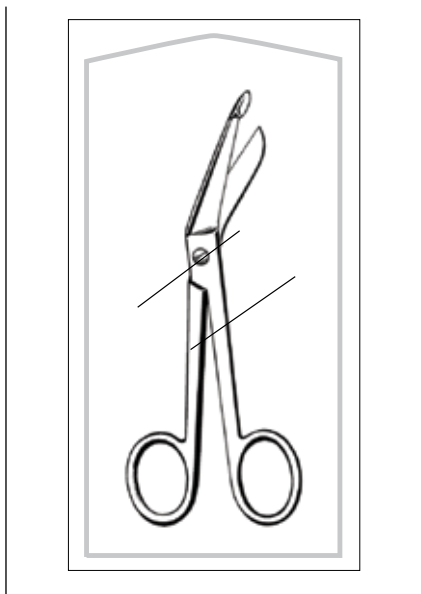

LISTER BANDAGE SCISSORS

96-2503	5½"	25/cs
96-2500	7¼"	25/cs
96-2501	4½"	50/cs
96-2502	5½"	50/cs
96-2654	5½"	100/cs

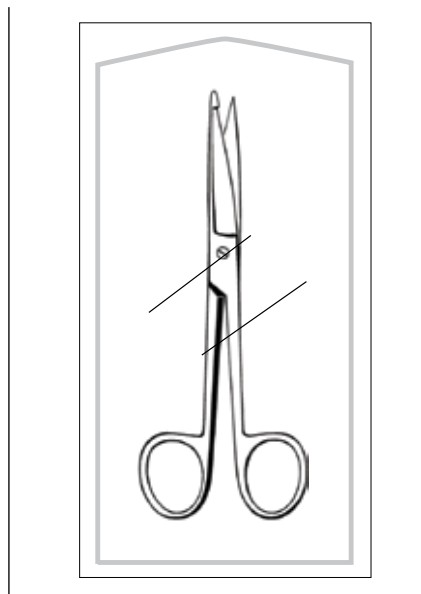

KNOWLES BANDAGE SCISSORS

96-2404	5½"	25/cs
96-2402	5½"	50/cs

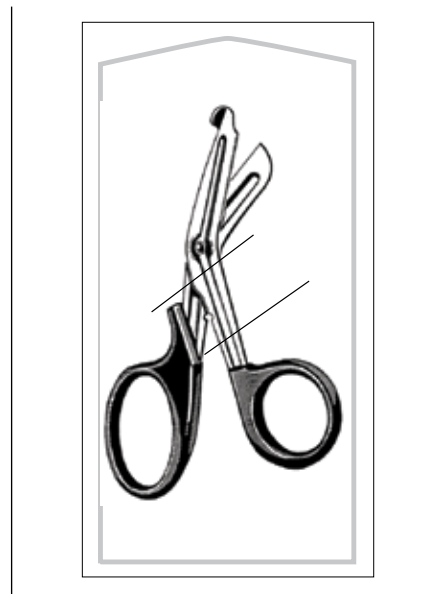

UTILITY SCISSORS

96-2701	5½"	25/cs
96-2703	7"	25/cs
96-2702	5½"	50/cs
96-2704	7"	50/cs

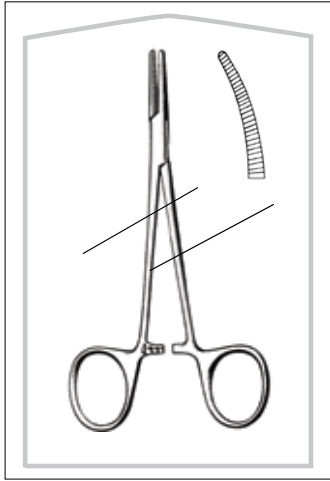
HALSTED FORCEPS

96-2537	5"	Straight	25/cs
96-2539	5"	Curved	25/cs
96-2536	5"	Straight	50/cs
96-2538	5"	Curved	50/cs
96-2657	5"	Straight	100/cs
96-2658	5"	Curved	100/cs

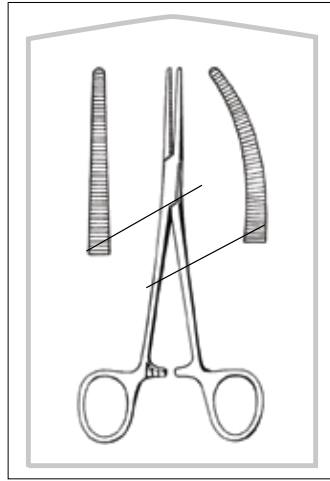
CRILE FORCEPS

96-2551	5½"	Straight	25/cs
96-2553	5½"	Curved	25/cs
96-2550	5½"	Straight	50/cs
96-2552	5½"	Curved	50/cs

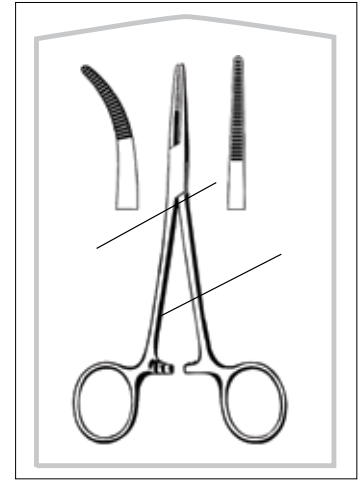
KELLY FORCEPS

96-2561	5½"	Straight	25/cs
96-2563	5½"	Curved	25/cs
96-2560	5½"	Straight	50/cs
96-2562	5½"	Curved	50/cs
96-2652	5½"	Straight	100/cs
96-2653	5½"	Curved	100/cs

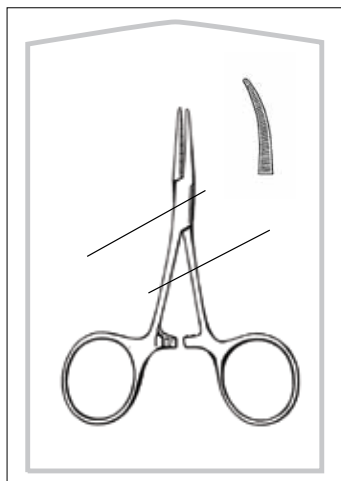
HARTMANN FORCEPS

96-2556	3½"	Straight	25/cs
96-2557	3½"	Curved	25/cs
96-2554	3½"	Straight	50/cs
96-2555	3½"	Curved	50/cs

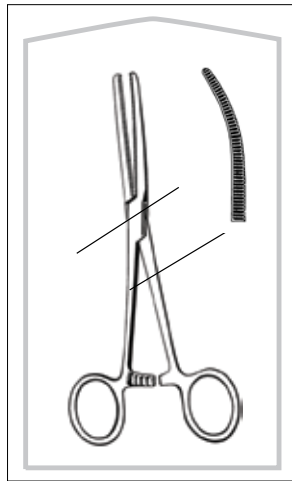
ROCHESTER PEAN FORCEPS

96-2545	6¼"	Straight	25/cs
96-2547	6¼"	Curved	25/cs
96-3006	7¼"	Straight	25/cs
96-3008	7¼"	Curved	25/cs
96-3010	8"	Curved	25/cs
96-2548	8½"	Curved	25/cs
96-2544	6¼"	Straight	50/cs
96-2546	6¼"	Curved	50/cs
96-2549	8½"	Curved	50/cs
96-2664	8½"	Curved	100/cs

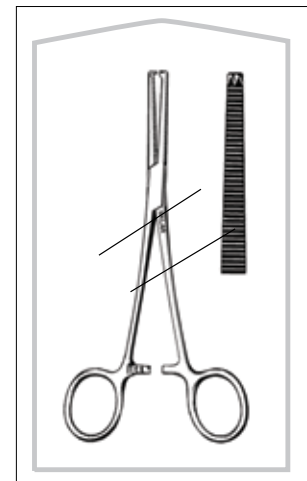

ROCHESTER-OSHSNER FORCEPS

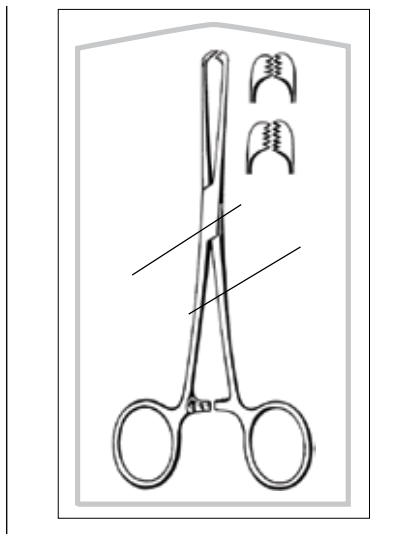
96-2566	6¼"	Straight	25/cs
96-2567	6¼"	Curved	25/cs
96-2707	6¼"	Straight	50/cs
96-2708	6¼"	Curved	50/cs

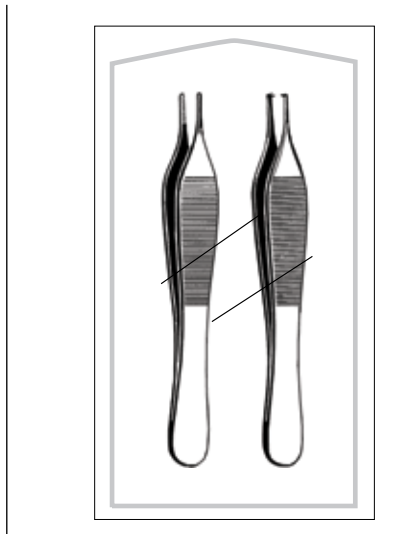

ALLIS TISSUE FORCEPS

96-2575	6"	4x5 Teeth	25/cs
96-2576	6"	4x5 Teeth	50/cs
96-2774	7¼"	6x7 Teeth	50/cs



ADSON FORCEPS

96-2571	4¾"	Serrated	25/cs
96-2573	4¾"	1x2 Teeth	25/cs
96-2570	4¾"	Serrated	50/cs
96-2572	4¾"	1x2 Teeth	50/cs
96-2577	4¾"	Serrated Delicate	50/cs
96-2775	4¾"	1x2 Teeth Delicate	50/cs
96-2655	4¾"	Serrated	100/cs
96-2656	4¾"	1x2 Teeth	100/cs

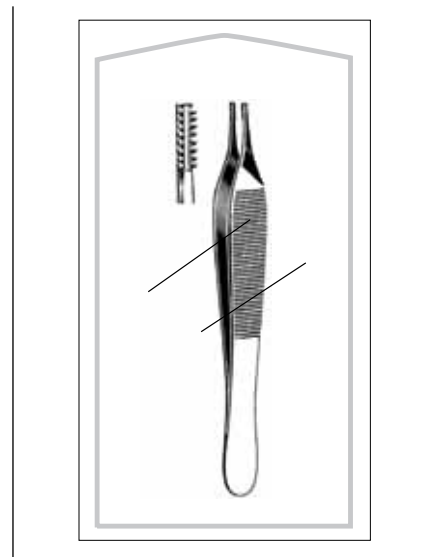

ADSON-BROWN FORCEPS

96-2559	4¾"	Side Grasping	25/cs
96-2558	4¾"	Side Grasping	50/cs

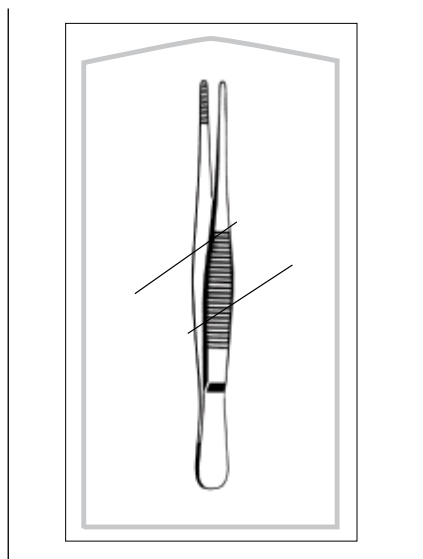

DRESSING FORCEPS

96-2569	5"	Serrated	25/cs
96-2670	5½"	Serrated	25/cs
96-2921	8"	Serrated	25/cs
96-2688	4½"	Serrated	50/cs
96-2568	5"	Serrated	50/cs
96-2660	5"	Serrated	100/cs

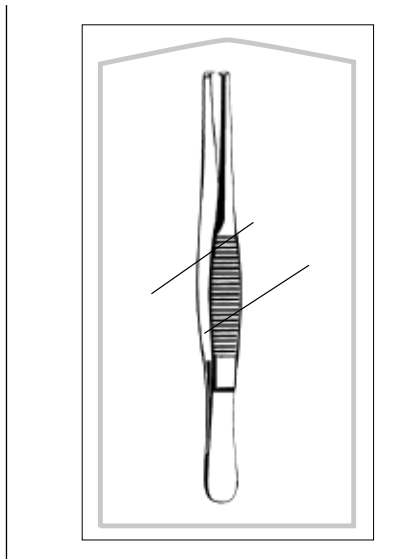

TISSUE FORCEPS

96-2579	5"	1x2 Teeth	25/cs
96-2574	4½"	1x2 Teeth	50/cs
96-2578	5"	1x2 Teeth	50/cs
96-2661	5"	1x2 Teeth	100/cs

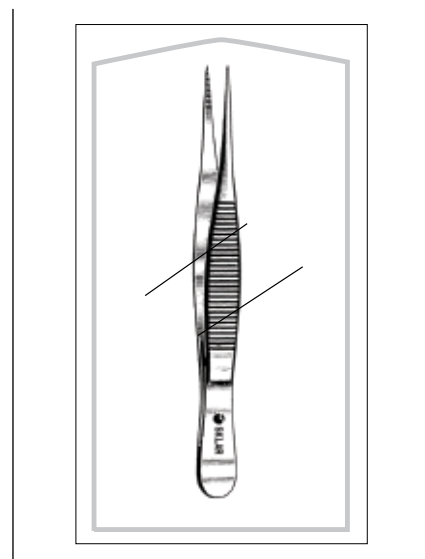

SPLINTER FORCEPS

96-2765	3½"		50/cs
96-2412	4½"	Fine Point	25/cs
96-2410	4½"	Fine Point	50/cs

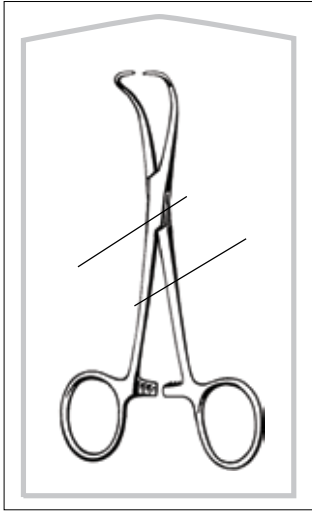

BACKHAUS TOWEL CLAMPS

96-2632	3½"	25/cs
96-2636	5¼"	25/cs
96-2630	3½"	50/cs
96-2634	5¼"	50/cs

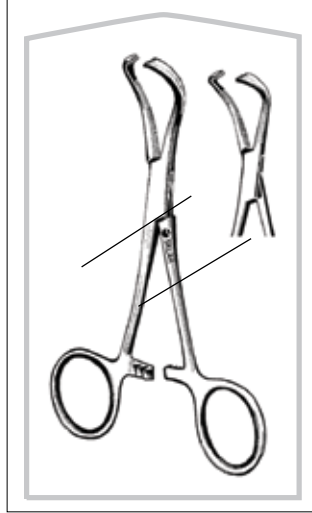

LORNA EDNA TOWEL CLAMPS

96-2529	3½"	25/cs
96-2528	3½"	50/cs

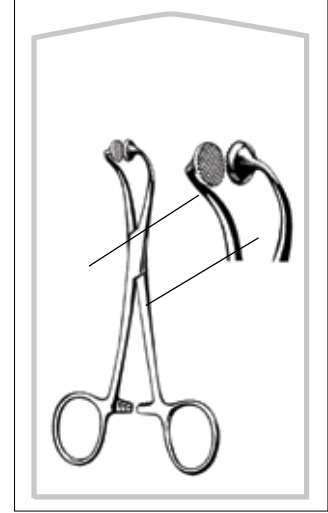

HOFF TOWEL CLAMPS

96-2565	5¼"	25/cs
96-2564	5¼"	50/cs

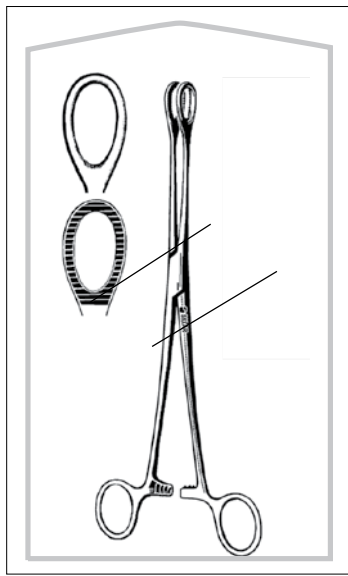

SPONGE FORCEPS

96-2533	9½" Straight, Serrated	25/cs
96-2532	9½" Straight, Serrated	50/cs

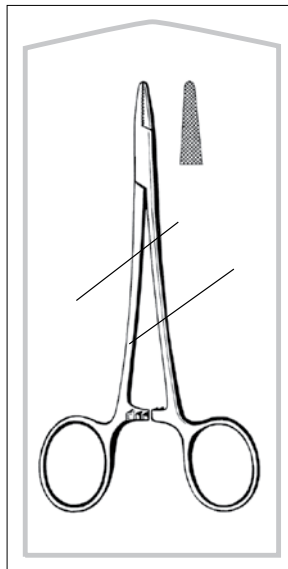

BAUMGARTNER NEEDLE HOLDERS

96-2581	5½" Serrated	25/cs
96-2580	5½" Serrated	50/cs

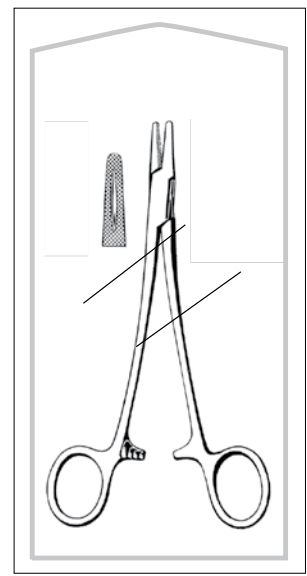

MAYO-HEGAR NEEDLE HOLDERS

96-2599	5" Serrated	25/cs
96-2595	6" Serrated	25/cs
96-2594	6" Serrated	50/cs
96-2710	7" Serrated	50/cs
96-2712	8" Serrated	50/cs

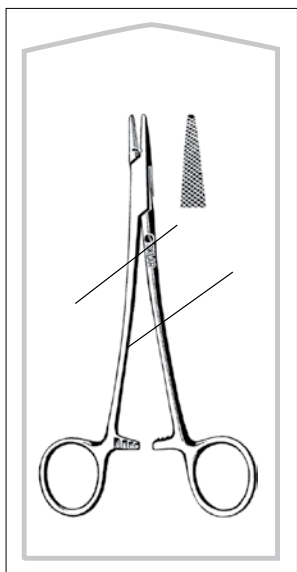

CRILE-WOOD NEEDLE HOLDERS

- 96-2591 6" Serrated 25/cs
- 96-2590 6" Serrated 50/cs

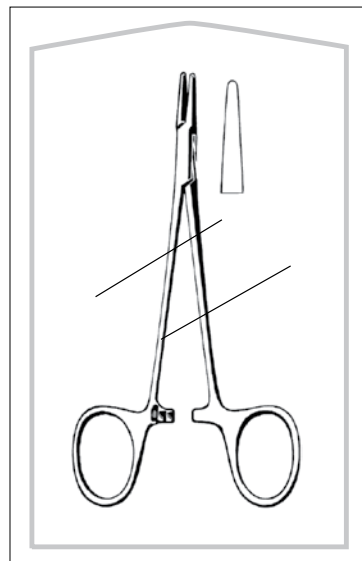

WEBSTER NEEDLE HOLDERS

- 96-2587 5¼" Smooth 25/cs
- 96-2586 5¼" Smooth 50/cs
- 96-2659 5¼" Smooth 100/cs

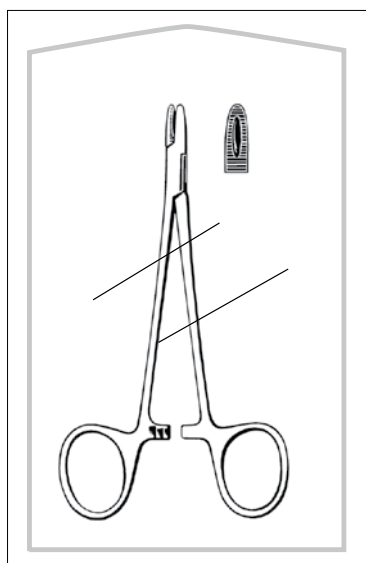

DERF NEEDLE HOLDERS

- 96-2583 4¾" Serrated 25/cs
- 96-2582 4¾" Serrated 50/cs

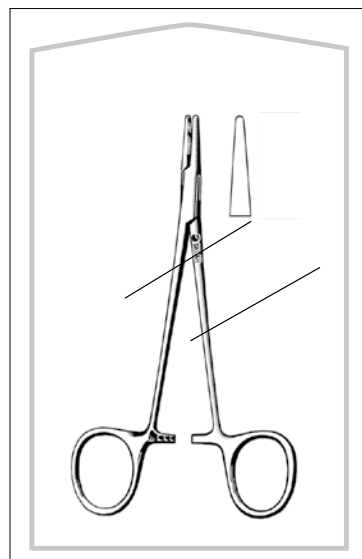

HALSEY NEEDLE HOLDERS

- 96-2585 5" Smooth 25/cs
- 96-2584 5" Smooth 50/cs



STITCH SCISSORS

96-8971 4½" Littauer 50/cs



SCISSORS

96-8973 4½" S/B 50/cs
 96-8977 5¼" B/B 50/cs
 96-8972 5¼" S/B 50/cs
 96-8975 5¼" S/S 50/cs

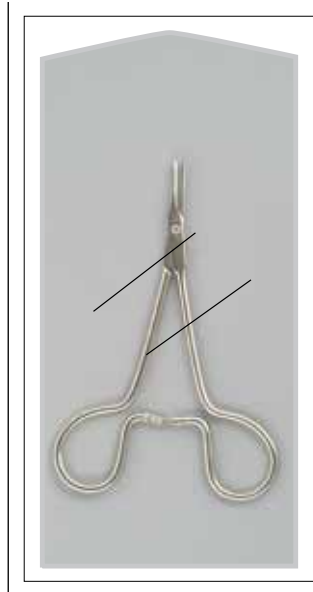

HALSTEAD FORCEPS

96-8964 5" Straight 50/cs
 96-8965 5" Curved 50/cs

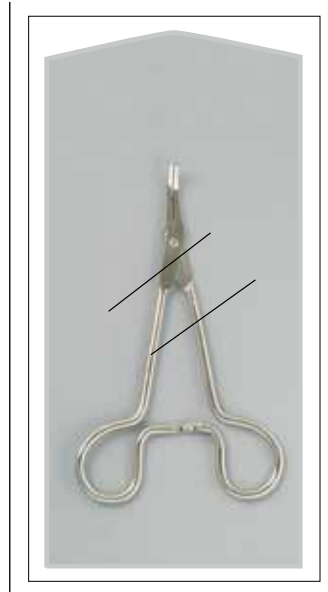

KELLY FORCEPS

96-8967 5½" Straight 50/cs
 96-8966 5½" Curved 50/cs

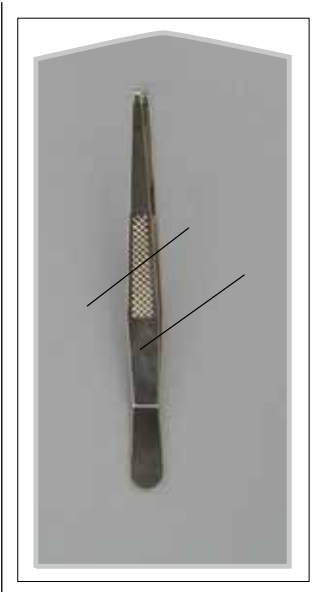

THUMB FORCEP

96-8963 4½" 1x2 Teeth 50/cs

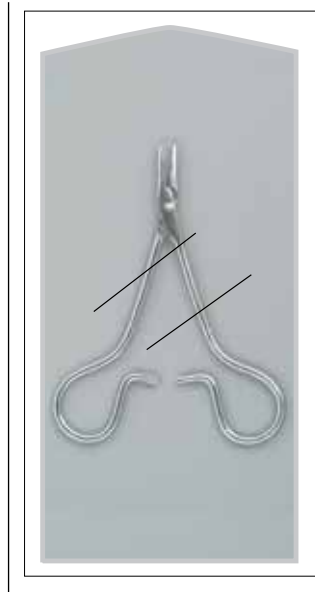

NEEDLE HOLDERS

96-8968 5¼" Smooth 50/cs
 96-8974 5¼" Serrated 50/cs

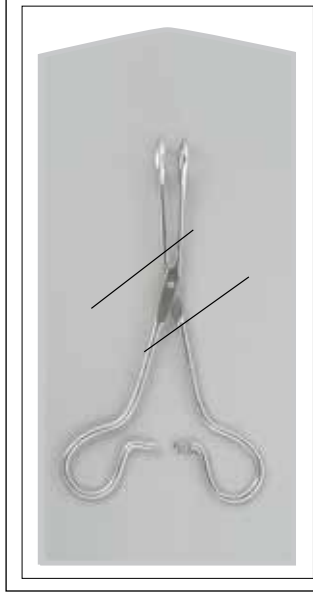

SPONGE FORCEPS

96-8969 7" Serrated 50/cs
 96-8970 9½" Serrated 50/cs

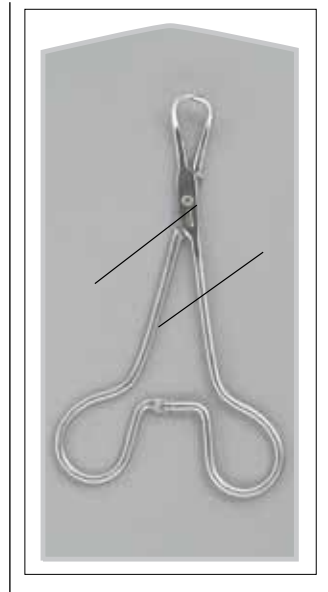

TOWEL FORCEP

96-8962 5¼" 50/cs

GRASPING FORCEP

PRODUCT NUMBER	FEATURES
10-1013	6¼"



MESH BUR AND DIAMOND HOLDERS

PRODUCT NUMBER	FEATURES
49-3155	1⅜", Small
49-3150	2⅛", Large



THREE PRONG STERILIZER FORCEP

PRODUCT NUMBER	FEATURES
10-1280	8"



UTILITY STERILIZER FORCEPS

PRODUCT NUMBER	FEATURES
10-1080	8", Straight
10-1111	11", Straight



UTILITY STERILIZER FORCEPS

PRODUCT NUMBER	FEATURES
10-1081	8", Curved
10-1211	11", Curved



JEWELER STYLE FORCEPS

PRODUCT NUMBER	FEATURES
66-7447	#3, Straight
66-7642	#5, Straight
66-7644	#7, Curved





FAHNENSTOCK WAX CARVER / KNIFE

PRODUCT NUMBER	FEATURES
49-3105	5", Small
49-3110	6 3/4", Large



MURPHY PLASTER KNIFE

PRODUCT NUMBER	FEATURES
49-3115	6 1/2"



PLASTER AND COMPOUND KNIFE

PRODUCT NUMBER
49-3120



PLASTER NIPPER

STAINLESS STEEL	
PRODUCT NUMBER	FEATURES
49-3140	8"



ALLIGATOR NAPKIN CLIPS

PRODUCT NUMBER	FEATURES
49-3170	With Plastic Guard, Assorted Colors
49-3175	With Plastic Guard, Black
49-3180	Without Plastic Guard



SONIC CLEANER

PRODUCT NUMBER	FEATURES	QUANTITIES
49-4800	Personal, Cordless	1 Each



METAL IMPRESSION TRAYS

PRODUCT NUMBER	FEATURES	SIZE
49-4600	Lower, Solid	15
49-4605	Lower, Perforated	15
49-4610	Lower, Solid	16
49-4615	Lower, Perforated	16
49-4620	Lower, Solid	17
49-4625	Lower, Perforated	17
49-4630	Lower, Solid	18
49-4635	Lower, Perforated	18
49-4640	Lower, Solid	19
49-4645	Lower, Perforated	19
49-4650	Lower, Solid	20
49-4655	Lower, Perforated	20
49-4660	Upper, Solid	39
49-4665	Upper, Perforated	39
49-4670	Upper, Solid	40
49-4675	Upper, Perforated	40
49-4680	Upper, Solid	41
49-4685	Upper, Perforated	41
49-4690	Upper, Solid	42
49-4695	Upper, Perforated	42
49-4700	Upper, Solid	43
49-4705	Upper, Perforated	43
49-4710	Upper, Solid	44
49-4715	Upper, Perforated	44





Disposables

IMPRESSION TRAYS

PRODUCT NUMBER	FEATURES	QUANTITIES
96-3250	#1 Upper, Red	50/pk
96-3251	#1 Lower, Red	50/pk
96-3252	#2 Upper, Orange	50/pk
96-3253	#2 Lower, Orange	50/pk
96-3254	#3 Upper, Blue	50/pk
96-3255	#3 Lower, Blue	50/pk
96-3256	#4 Upper, Green	50/pk
96-3257	#4 Lower, Green	50/pk
96-3258	#5 Upper, Yellow	50/pk
96-3259	#5 Lower, Yellow	50/pk
96-3260	#6 Upper, Purple	50/pk
96-3261	#6 Lower, Purple	50/pk
96-3262	#7 Upper Right, Blue	12/pk
96-3264	#8 Upper Left, Blue	12/pk
96-3266	#9 Small Whole, Blue	12/pk



BITE REGISTRATION TRAYS

LIGHT YELLOW / WHITE

PRODUCT NUMBER	FEATURES	QUANTITIES
96-3270	Extra Small, Posterior Sideless	50/pk
96-3271	Small, Posterior	50/pk
96-3272	Small, Anterior	35/pk
96-3273	Large, Quadrant	35/pk
96-3274	Large, Wide Posterior	30/pk



INTERORAL PHOTOGRAPHIC MIRRORS

PRODUCT NUMBER	FEATURES	QUANTITIES
96-3410	Palatal Child	1 Each
96-3412	Palatal Adult	1 Each
96-3414	Buccal - Wide Outside	1 Each
96-3416	Buccal - Narrow Outside	1 Each
96-3418	Lingual - Wide Inside	1 Each
96-3420	Lingual - Narrow Outside	1 Each
96-3422	Set of 6	1 Each



CHEEK RETRACTORS

PRODUCT NUMBER	FEATURES	QUANTITIES
96-3280	Child	10/pk
96-3281	Adult	10/pk



APPLIANCE CASES

PRODUCT NUMBER	FEATURES	QUANTITIES
96-3283	Small, Royal Blue	48/pk
96-3284	Small, Assorted Neon Colors	48/pk
96-3285	Regular, Powder Blue	48/pk
96-3286	Regular, Black	48/pk
96-3287	Large, Assorted Colors	24/pk
96-3288	X-Large, Royal Blue	24/pk
96-3289	X-Large, Assorted Colors	24/pk



MOUTH PROTECTORS

PRODUCT NUMBER	FEATURES	QUANTITIES
96-3295	White	12/pk
96-3296	Yellow	12/pk



**HINGED APPLIANCE CASES
VENTED, ASSORTED COLORS**

PRODUCT NUMBER	FEATURES	QUANTITIES
96-3290	Regular	25/pk
96-3292	Regular, Economy	50/pk
96-3291	Large	25/pk



LIP RETRACTORS

PRODUCT NUMBER	FEATURES	QUANTITIES
96-3298	Child	2/pk
96-3299	Adult	2/pk
96-3300	Universal	2/pk



TONGUE SHIELDS

PRODUCT NUMBER	FEATURES	QUANTITIES
96-3301	Small	3/pk
96-3302	Medium	3/pk
96-3303	Large	3/pk
96-3304	Extra Large	3/pk





Disposables

TOOTHBRUSHES

PRODUCT NUMBER	FEATURES	QUANTITIES
96-2445	Pre-Pasted	144/cs
96-2447	Junior	144/cs



**TOOTHBRUSHES
ASSORTED COLORS**

PRODUCT NUMBER	FEATURES	QUANTITIES
96-2449	Travel	50/cs



**TOOTHBRUSHES
ASSORTED COLORS**

PRODUCT NUMBER	FEATURES	QUANTITIES
96-2456	Spiral	72/cs



HEADREST COVERS

PRODUCT NUMBER	FEATURES	QUANTITIES
96-3315	10" x 10"	500/cs
96-3316	10" x 13"	500/cs



**TRAY SLEEVES
WHITE**

PRODUCT NUMBER	FEATURES	QUANTITIES
96-3321	10½" x 14"	500/cs
96-3322	11 ⁵ / ₈ " x 14½"	500/cs



**DENTAL BIBS
13" X 18"**

PRODUCT NUMBER	FEATURES	QUANTITIES
96-3325	1 Layer Paper + 1 Layer Poly	500/cs
96-3326	2 Layers Paper + 1 Layer Poly	500/cs



EVACUATOR TIPS

PRODUCT NUMBER	FEATURES	QUANTITIES
96-3330	Non-Vented, White	100/cs



EVACUATOR TIPS

PRODUCT NUMBER	FEATURES	QUANTITIES
96-3331	Slotted, Assorted Colors	100/cs



ASPIRATING SURGICAL TIPS

PRODUCT NUMBER	FEATURES	QUANTITIES
96-3333	1/8", White	25/cs
96-3332	1/4", Blue	25/cs

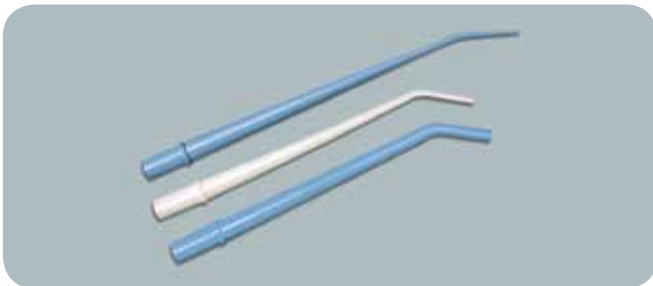

SALIVA EJECTORS

PRODUCT NUMBER	FEATURES	QUANTITIES
96-3336	White	100/cs



TONGUE DEPRESSORS

PRODUCT NUMBER	FEATURES	QUANTITIES
96-3341	Junior	100/cs
96-3340	Regular	100/cs



MODEL BOXES

PRODUCT NUMBER	FEATURES	QUANTITIES
96-3350	4 Compartment, 6 1/2" x 6 1/4" x 2"	50/bx
96-3352	6 Compartment, 6 1/2" x 9 1/8" x 2"	50/bx





Disposables

RETAINER BRIGHT

PRODUCT NUMBER	FEATURES	QUANTITIES
96-3354	Individually Wrapped	36/bx
96-3356	Individually Wrapped	96/BX



KNO-KURL™ ACETATE

PRODUCT NUMBER	FEATURES	QUANTITIES
96-3358	100 Sheets	1 Pad



BUCHIN CEPHALOMETRIC TRACING TEMPLATE

PRODUCT NUMBER	FEATURES	QUANTITIES
96-3362	Clear Plastic	1 Each



KROMOPAN™ ALGINATE

PRODUCT NUMBER	FEATURES	QUANTITIES
96-3360	Class A, 1lb	1 Each



MEDICINE CUPS

STERILE

PRODUCT NUMBER	FEATURES	QUANTITIES
96-8951	1 oz.	50/cs
96-7027	2 oz.	25/cs
96-7154	4 oz.	25/cs



PLASTIC DENTAL MIRRORS

STERILE

PRODUCT NUMBER	FEATURES	QUANTITIES
96-7887	½"	50/cs

NON-STERILE

96-2452	½"	144/cs
---------	----	--------



SKLAR OR TOWELS

STERILE, 17" X 27"

PRODUCT NUMBER	QUANTITIES
96-1662	2/pk, 50pk/cs, 100/cs
96-1621	4/pk, 20pk/cs, 80/cs
96-8939	6/pk, 12pk/cs, 72/cs
96-8938	8/pk, 10pk/cs, 80/cs

BULK, NON-STERILE, 17" X 24"

PRODUCT NUMBER	QUANTITIES
96-5627	100 Towels

SKLAR OR TOWELS, FENESTRATED

STERILE, 18" X 26" WITH 3" FENESTRATION

PRODUCT NUMBER	QUANTITIES
96-7548	1/pk, 25pk/cs, 25/cs
96-8948	2/pk, 50pk/cs, 100/cs
96-8940	4/pk, 20pk/cs, 80/cs
96-8941	6/pk, 12pk/cs, 72/cs
96-8942	8/pk, 10pk/cs, 80/cs



SKLAR COTTON OR TOWELS

100% COTTON WEAVE

FEATURES AND BENEFITS

- 100% pure cotton with natural feel.
- Less abrasive to wounds.
- Superior absorbency rate.
- Biodegradable and environmentally friendly.
- Compact for shipping & storage.

STERILE, 16½" X 26"

PRODUCT NUMBER	QUANTITIES
96-1940	2/pk, 50pk/cs, 100/cs
96-1942	4/pk, 20pk/cs, 80/cs
96-1944	6/pk, 12pk/cs, 72/cs
96-1946	8/pk, 10pk/cs, 80/cs

BULK, NON-STERILE

96-1949	420 Towels
---------	------------





Disposables

COTTON BALLS

NON-STERILE

PRODUCT NUMBER	FEATURES	QUANTITIES
96-5700	Medium	1000/pk, 10pk/cs, 10,000/cs
96-5699	Large	500/pk, 10pk/cs, 5000/cs

STERILE

96-1669	Medium	2/pk, 50pk/cs, 100/cs
96-1670	Large	2/pk, 50pk/cs, 100/cs



COTTON TIP APPLICATORS

LATEX FREE, STERILE

PRODUCT NUMBER	FEATURES	QUANTITIES
96-8923	3", Plastic Handle	2/pk, 50pk/bx, 10bx/cs, 1000/cs
96-8924	6", Plastic Handle	6/pk, 50pk/bx, 10bx/cs, 3000/cs
96-8936	3", Wooden Handle	2/pk, 50pk/bx, 10bx/cs, 1000/cs
96-8937	6", Wooden Handle	6/pk, 50pk/bx, 10bx/cs, 3000/cs
96-1665	6", Wooden Handle	10/pk, 50pk/bx, 500/cs



COTTON ROLLS

PRODUCT NUMBER	FEATURES	QUANTITIES
96-5296	1/3" x 1 1/2"	50/pk
96-5297	2/5" x 1 1/2"	50/pk
96-5298	1/2" x 1 1/2"	50/pk



GAUZE SPONGES**WOVEN, NON-STERILE**

PRODUCT NUMBER	FEATURES	QUANTITIES
96-5280	2" x 2" 8Ply	5000/cs
96-5281	2" x 2" 12Ply	8000/cs
96-5282	3" x 3" 8Ply	4000/cs
96-5283	3" x 3" 12Ply	4000/cs
96-5284	4" x 4" 8Ply	4000/cs
96-5285	4" x 4" 12Ply	5000/cs
96-5286	4" x 4" 16Ply	2000/cs
96-5267	4" x 8" 12Ply	2000/cs

NON-WOVEN, NON-STERILE

PRODUCT NUMBER	FEATURES	QUANTITIES
96-5628	2" x 2" 4Ply	5000/cs
96-5629	3" x 3" 4Ply	4000/cs

**SKLAR DISPOSABLE FACE MASKS**

The Sklar Disposable Face Mask is offered in the most popular style to meet clinical requirements in the operating room, general medicine, or any other areas requiring facial protection. Protecting against infectious pathogens, Sklar masks are $\geq 98\%$ BFE, non-woven, soft and breathable. Convenient ear loops and adjustable nose-bridge ensure a proper fit. Latex Free.

NON-STERILE

PRODUCT NUMBER	FEATURES	QUANTITIES
96-5557	Mask Earloop, Blue	50/bx
96-5557A	Mask Earloop, Blue	500/cs
96-5557BNS	Mask Earloop, Blue, Bulk	2000/cs





WASTE CAN LINERS

Designed for non-medical waste disposal, Waste Can Liners are used throughout health care facilities to collect and contain refuse. Bags are available in a wide variety of sizes and film gauges to meet your specific application.

Choose the right plastic types:

- LLDPE (Linear Low Density Polyethylene) provides maximum puncture and tear resistance under tough transport conditions and is best suited for handling objects with sharper edges.
- HDPE (High Density Polyethylene) provides high resistance to puncturing, durability and greater load capacity for paper or non-sharp objects under moderate transport conditions.

All bags are designed with Star Seals to eliminate gaps, maximize carrying capacity and minimize leaks. Conveniently offered in flat packs or coreless rolls for easy dispensing.

PRODUCT NUMBER	FEATURES	SIZE	GAUGE	CAPACITY	QUANTITIES
10-6000	HDPE, Natural	24" x 33"	8 MIC	12-16 Gallon	50/Roll, 20 Rolls/cs
10-6005	HDPE, Natural	30" x 37"	10 MIC	20-30 Gallon	25/Roll, 20 Rolls/cs
10-6025	HDPE, Natural	33" x 40"	12 MIC	33 Gallon	25/Roll, 10 Rolls/cs
10-6045	HDPE, Natural	40" x 48"	13 MIC	40-45 Gallon	25/Roll, 10 Rolls/cs
10-6055	HDPE, Natural	40" x 48"	16 MIC	40-45 Gallon	25/Roll, 10 Rolls/cs
10-6060	HDPE, Natural	40" x 48"	17 MIC	40-45 Gallon	25/Roll, 10 Rolls/cs
10-6080	LLDPE, Clear	30" x 36"	0.8 MIL	20-30 Gallon	250 Flat/cs
10-6085	LLDPE, Clear	33" x 39"	0.6 MIL	33 Gallon	150 Flat/cs
10-6090	LLDPE, Clear	40" x 46"	0.8 MIL	40-45 Gallon	125 Flat/cs
10-6095	LLDPE, Clear	38" x 45"	1.0 MIL	44 Gallon	125 Flat/cs
10-6120	LLDPE, Super Heavy, Gray	40" x 46"	1.1 MIL	40-45 Gallon	125 Flat/cs
10-6125	LLDPE, Super Heavy, Clear	43" x 47"	1.1 MIL	56 Gallon	100 Flat/cs

LINEN BAGS



PRODUCT NUMBER	DESCRIPTION	QUANTITIES
10-6155	Printed: Soiled Linen, Blue, 30" x 43", 20 Gallon	200/cs

RECLOSABLE BAGS

SINGLE ZIPPER

PRODUCT NUMBER	DESCRIPTION	QUANTITIES
10-6390	6" x 6", 2MIL, Clear	1000/cs
10-6395	6" x 8", 2MIL, Clear	1000/cs
10-6405	8" x 10", 2MIL, Clear	1000/cs

UTILITY FORCEPS**NARROW JAW**

PRODUCT NUMBER	SIZE	FEATURES	QUANTITIES
96-2914	4"	Non-Sterile	100/bx
96-2915	4"	Sterile	100/bx

DRESSING FORCEPS

PRODUCT NUMBER	SIZE	FEATURES	QUANTITIES
96-2916	5"	Non-Sterile	100/bx
96-2917	5"	Sterile	100/bx

LITTAUER SUTURE SCISSORS

PRODUCT NUMBER	SIZE	FEATURES	QUANTITIES
96-2905	4½"	Non-Sterile	100/bx
96-2906	4½"	Sterile	100/bx

TUBING CLAMPS

PRODUCT NUMBER	SIZE	FEATURES	QUANTITIES
96-2902	4½"	Non-Sterile	100/bx
96-2903	4½"	Sterile	100/bx

HEMOSTATIC FORCEPS

PRODUCT NUMBER	SIZE	FEATURES	QUANTITIES
96-2907	5¼"	Straight, Non-Sterile	100/bx
96-2909	5¼"	Straight, Sterile	100/bx
96-2908	5"	Curved, Non-Sterile	100/bx
96-2910	5"	Curved, Sterile	100/bx

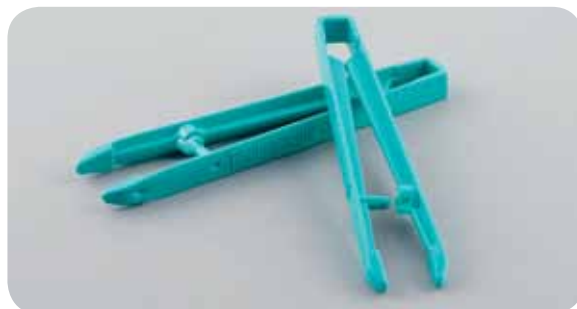



Disposables

SPONGE FORCEPS

PRODUCT NUMBER	SIZE	FEATURES	QUANTITIES
96-2918	9½"	Non-Sterile	100/bx
96-2919	9½"	Sterile	100/bx



HOFF STYLE TOWEL CLAMPS

ROUND TIPS

PRODUCT NUMBER	SIZE	FEATURES	QUANTITIES
96-5658	4¾"	Curved, Non-Sterile	100/bx
96-5659	4¾"	Curved, Sterile	100/bx



HOFF STYLE TOWEL CLAMPS

OVAL TIPS

PRODUCT NUMBER	SIZE	FEATURES	QUANTITIES
96-5660	4¾"	Curved, Non-Sterile	100/bx
96-5661	4¾"	Curved, Sterile	100/bx



TOWEL CLAMPS

NON-PEFORATING

PRODUCT NUMBER	SIZE	FEATURES	QUANTITIES
96-2930	5"	Blue, Non-Sterile	100/bx
96-2931	5"	Blue, Sterile	100/bx
96-2929	5"	Green, Non-Sterile	100/bx



LATEX EXAM GLOVES

POWDER FREE NON-STERILE

PRODUCT NUMBER	SIZE	QUANTITIES
96-2168	Extra Small	100/bx
96-3168	Extra Small	100/bx, 10bx/cs, 1000/cs
96-2160	Small	100/bx
96-3160	Small	100/bx, 10bx/cs, 1000/cs
96-2162	Medium	100/bx
96-3162	Medium	100/bx, 10bx/cs, 1000/cs
96-2164	Large	100/bx
96-3164	Large	100/bx, 10bx/cs, 1000/cs
96-2166	Extra Large	100/bx
96-3166	Extra Large	100/bx, 10bx/cs, 1000/cs

POWDERED NON-STERILE

PRODUCT NUMBER	SIZE	QUANTITIES
96-2181	Extra Small	100/bx
96-3179	Extra Small	100/bx, 10bx/cs, 1000/cs
96-2180	Small	100/bx
96-3180	Small	100/bx, 10bx/cs, 1000/cs
96-2182	Medium	100/bx
96-3182	Medium	100/bx, 10bx/cs, 1000/cs
96-2184	Large	100/bx
96-3184	Large	100/bx, 10bx/cs, 1000/cs
96-2186	Extra Large	100/bx
96-3186	Extra Large	100/bx, 10bx/cs, 1000/cs

VINYL EXAM GLOVES

POWDER FREE NON-STERILE, LATEX FREE

PRODUCT NUMBER	SIZE	QUANTITIES
96-1161	Extra Small	100/bx
96-1162	Small	100/bx
96-1163	Medium	100/bx
96-1164	Large	100/bx
96-1175	Extra Large	100/bx

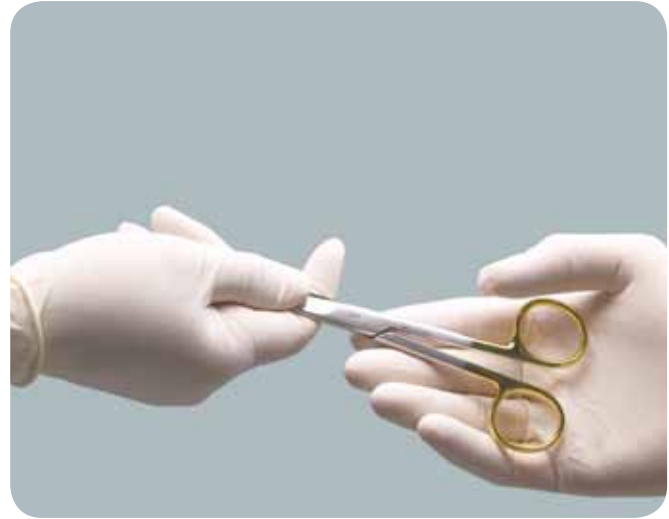

NITRILE EXAM GLOVES

POWDER FREE NON-STERILE

PRODUCT NUMBER	SIZE	QUANTITIES
96-2190	Small	100/bx
96-3190	Small	100/bx, 10bx/cs, 1000/cs
96-2192	Medium	100/bx
96-3192	Medium	100/bx, 10bx/cs, 1000/cs
96-2194	Large	100/bx
96-3194	Large	1000/bx
96-2196	Extra Large	100/bx
96-3196	Extra Large	100/bx, 10bx/cs, 1000/cs
96-2198	Extra, Extra Large	100/bx
96-3198	Extra, Extra Large	100/bx, 10bx/cs, 1000/cs

POWDERED NON-STERILE

PRODUCT NUMBER	SIZE	QUANTITIES
96-2170	Small	100/bx
96-3170	Small	100/bx, 10bx/cs, 1000/cs
96-2172	Medium	100/bx
96-3172	Medium	100/bx, 10bx/cs, 1000/cs
96-2174	Large	100/bx
96-3174	Large	100/bx, 10bx/cs, 1000/cs
96-2176	Extra Large	100/bx
96-3176	Extra Large	100/bx, 10bx/cs, 1000/cs
96-2178	Extra, Extra Large	100/bx
96-3178	Extra, Extra Large	100/bx, 10bx/cs, 1000/cs



YOU AND YOUR TOOTHBRUSH

PRODUCT NUMBER	FEATURES	QUANTITIES
49-5008	7½" X 8½"	100/bx

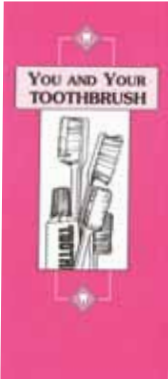

This pamphlet on toothbrushing discusses why it is important to keep teeth clean. It gives a general toothbrushing technique and basic do's and don'ts regarding eating habits.

A THREE WAY PARTNERSHIP

PRODUCT NUMBER	FEATURES	QUANTITIES
49-5014	Tri-Fold, 8½" X 11"	100/bx

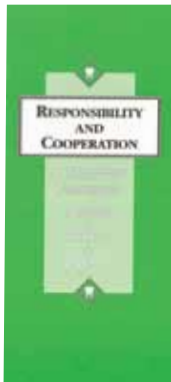

This pamphlet is best given to the patient and parent when treatment is agreed upon. Since responsibility and cooperation are the key to successful treatment, this brochure outlines patient's, parent's and orthodontist's responsibility.

YOUR CHILD AND ORTHODONTICS

PRODUCT NUMBER	FEATURES	QUANTITIES
49-5002	7½" X 8½"	100/bx



This pamphlet establishes a proper attitude at the beginning of orthodontic treatment. It emphasizes the major areas of parent and patient responsibility.

YOUR FIRST DAYS IN TREATMENT

PRODUCT NUMBER	FEATURES	QUANTITIES
49-5018 / 49-5018S	English and Spanish, 8½" X 11"	100/bx



This Pamphlet is similar to "Your Child and Orthodontics", but is geared to the adult patient. It includes a labeled illustration of the appliance.

A Spanish version of our most popular pamphlet. It includes a labeled illustration of the appliance.

BEST FACE FORWARD

PRODUCT NUMBER	FEATURES	QUANTITIES
49-5026	Tri-Fold, 8½" X 11"	100/bx



This popular publication explains the basics of orthodontic treatment to parents. It should be mailed to the parents with the initial appointment card because it answers most questions asked at the first consultation.

YOUR CHILD'S FIRST DAY

PRODUCT NUMBER	FEATURES	QUANTITIES
49-5016	Tri-Fold, 8½" X 11"	100/bx

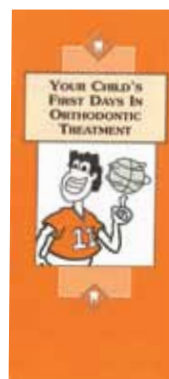

This is a handy pamphlet to assist the parents during the first days their child is in appliances. Reassures the parent when minor problems occur and enables the family to deal with them without having to rush to the office.

YOUR CHILD'S PALATE WIDENING APPLIANCE

PRODUCT NUMBER	FEATURES	QUANTITIES
49-5024	Tri-Fold, 8½" X 11"	100/bx



This pamphlet features a simple explanation of the palate widening appliance. It explains how it is used, what to expect wearing it and how to care for it. Includes illustrations showing how the appliance is activated to help eliminate errors.

AN ORTHODONTIC MILESTONE

PRODUCT NUMBER	FEATURES	QUANTITIES
49-5028	Tri-Fold, 8½" X 11"	100/bx



This two-part pamphlet is used when the bands or brackets are removed. The patient's part tells what changes come with appliance removal and stresses cooperation during retention. The second part is a postcard to send to the referring dentist.

YOU AND YOUR APPLIANCES

PRODUCT NUMBER	FEATURES	QUANTITIES
49-5004	7½" X 8½"	100/bx



A large, labeled diagram of the orthodontic appliance is featured in this pamphlet. Each part of the appliance and its particular function are explained. Also included are diagrams of an Edgewise bracket and a Begg bracket.

YOU AND YOUR RETAINER

PRODUCT NUMBER	FEATURES	QUANTITIES
49-5000	7½" X 8½"	100/bx



This pamphlet gives two reasons for wearing retainers and five rules to follow while wearing them, including maintenance of the appliance. "It won't be broken or lost if it's worn correctly" is the point emphasized on the backside of the pamphlet.

YOU AND YOUR ELASTICS

PRODUCT NUMBER	FEATURES	QUANTITIES
49-5006	7½" X 8½"	100/bx



This pamphlet explains the reason for wearing elastics. It emphasizes how very important it is for the patient to wear the correct size of elastics and to attach them exactly as instructed by the orthodontist. Five basic rules for the wearing of elastics are listed.

YOU AND YOUR BANDLESS BRACES

PRODUCT NUMBER	FEATURES	QUANTITIES
49-5012	7½" X 8½"	100/bx



Direct bonded brackets are introduced in this pamphlet and advantages are explained. It tells the patient that proper maintenance is especially important given the delicate nature of the bracket.



YOU AND YOUR HEADGEAR

PRODUCT NUMBER	FEATURES	QUANTITIES
49-5010	7½" X 8½"	100/bx



This pamphlet is a basic introduction to the headgear. It stresses to the patient that one of the most important aspects of headgear wear is consistency in the wearing time. It also gives helpful suggestions for the maintenance of the appliance.

HEADGEAR SCORE CARD

PRODUCT NUMBER	QUANTITIES
49-5042	100/pk



ORTHODONTIC DIPLOMA WITH ENVELOPE

PRODUCT NUMBER	QUANTITIES
49-5046	100/pk

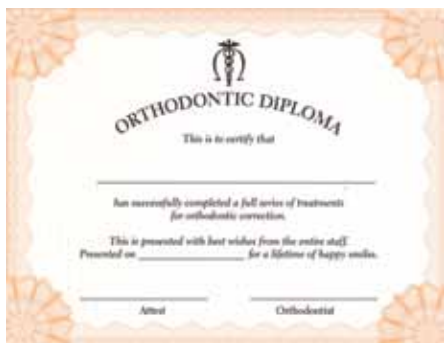

ORTHODONTIC SCHEDULE BOOK 8" X 14"

PRODUCT NUMBER	FEATURES	QUANTITIES
49-5036	Book with 250 Schedule Pages	1/pk
49-5038	Replacement Binder	1/pk
49-5040	250 Refill Pages	1/pk



ACCOUNT RECORD CARD

PRODUCT NUMBER	QUANTITIES
49-5044	100/pk

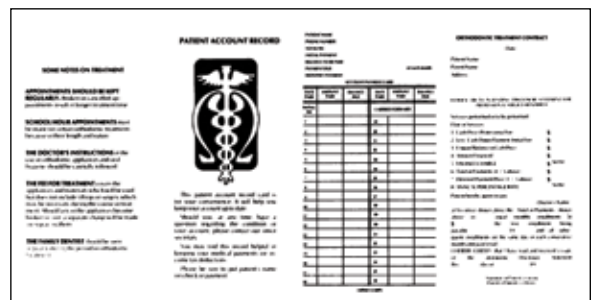

COUPON PAYMENT BOOK

PRODUCT NUMBER	FEATURES	QUANTITIES
49-5030	12 Months	100/pk
49-5032	24 Months	100/pk
49-5034	36 Months	100/pk

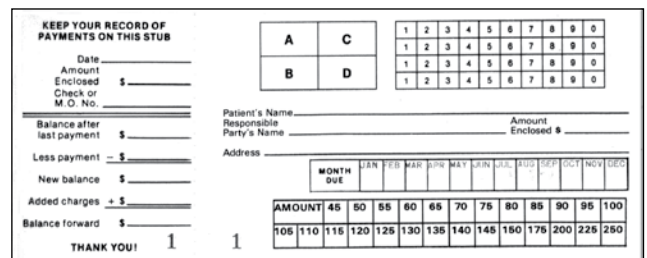

SCALPEL HANDLES

PRODUCT NUMBER	FEATURES
06-2910	#3 with metric scale



PRODUCT NUMBER	FEATURES
06-2903	#3 fits Blade #10, 11, 12, 15

06-2915	#3L
---------	-----



PRODUCT NUMBER	FEATURES
06-2904	#4 fits Blade #20, 21, 22, 23

06-2920	#4L
---------	-----



PRODUCT NUMBER	FEATURES
06-2907	#7 fits Blade #10, 11, 12, 15



PRODUCT NUMBER	FEATURES
06-2912	#8 fits Blade #60



PRODUCT NUMBER	FEATURES
06-2925	Large Lab Type Handle #3

06-2930	Large Lab Type Handle #4
---------	--------------------------

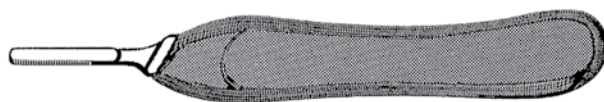

PRODUCT NUMBER	FEATURES
06-2908	Round Scalpel Handle, Straight #3R, fits Blade #10, 11, 12, 15



PRODUCT NUMBER	FEATURES
06-3090	Blade Remover



BLADES AND SCALPELS



BLADES, STAINLESS STEEL

STERILE

PRODUCT NUMBER	FEATURES	QUANTITIES
06-3100	#10	100/box
06-3101	#11	100/box
06-3102	#12	100/box
06-3103	#15	100/box
06-3108	#15C	100/box
06-3104	#20	100/box
06-3105	#21	100/box
06-3106	#22	100/box
06-3107	#23	100/box

BLADES, CARBON STEEL

STERILE

PRODUCT NUMBER	FEATURES	QUANTITIES
06-3010	#10	100/box
06-3011	#11	100/box
06-3012	#12	100/box
06-3013	#12D	100/box
06-3015	#15	100/box
06-3016	#15C	100/box
06-3020	#20	100/box
06-3021	#21	100/box
06-3022	#22	100/box
06-3023	#23	100/box

SCALPELS, DISPOSABLE

STERILE

PRODUCT NUMBER	FEATURES	QUANTITIES
06-3110	#10	10/box
06-3111	#11	10/box
06-3112	#12	10/box
06-3115	#15	10/box
06-3120	#20	10/box
06-3121	#21	10/box
06-3122	#22	10/box
06-3123	#23	10/box



SKLARSAFE™ SAFETY SCALPELS



LATEX-FREE

- Protective, transparent sheath can be opened, closed, and locked with a single hand.
- Precision stainless steel blade made in England.
- Sturdy, “Sure-Grip” handle.
- Audible “click” when sheath advanced to locked position.
- OSHA Compliant.
- Individually sealed in sturdy film and Tyvek® pack.

STERILE

PRODUCT NUMBER	FEATURES	QUANTITIES
06-3094	#10	10/box
06-3095	#11	10/box
06-3096	#15	10/box

NON-STERILE

06-3130	#10	500/cs
06-3132	#11	500/cs
06-3134	#15	500/cs

BLADES AND SCALPELS



MINI BLADES AND SCALPELS

STERILE

PRODUCT NUMBER	FEATURES	QUANTITIES
97-1822	#61	25/box
97-1721	#62	12/box
97-1821	#62	25/box
97-1820	#63	25/box
97-1826	#64	25/box
97-1825	#65	25/box
97-1824	#67	25/box
97-1823	#69	25/box



MINI PODIATRY HANDLE

NON-STERILE

PRODUCT NUMBER	FEATURES	QUANTITIES
97-1450	#3K	1 Each



SPECIALTY BLADES

NON-STERILE

PRODUCT NUMBER	FEATURES	QUANTITIES
97-1400	#318, Curved Edge	12/box
97-1405	#312, Curved Edge	12/box
97-1410	#313, Curved Edge	12/box
97-1415	#314, Curved Edge	12/box
97-1420	#316, Straight Edge	12/box
97-1425	#300, Straight Edge	12/box
97-1430	#361, Knife Edge	12/box

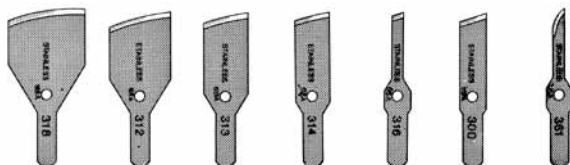

SELF-LOCKING HANDLE

NON-STERILE

PRODUCT NUMBER	FEATURES	QUANTITIES
97-1445	#6	1 Each



CARBON P-M BLADE

NON-STERILE

PRODUCT NUMBER	FEATURES	QUANTITIES
06-3024	#60	50/box

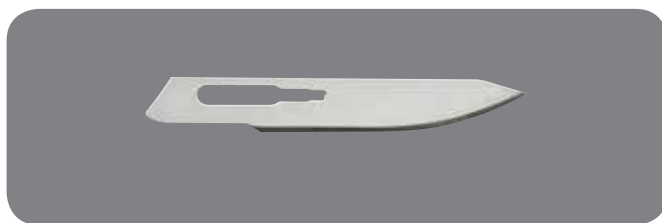

MINI THUMB SCALPEL

NON-STERILE

PRODUCT NUMBER	FEATURES	QUANTITIES
06-7052	#11	1500/cs



STITCH CUTTER

STERILE

PRODUCT NUMBER	FEATURES	QUANTITIES
06-3030	Stainless Steel	100/box



SKLAR DISPOSABLE FACE MASKS

The Sklar Disposable Face Mask is offered in the most popular style to meet clinical requirements in the operating room, general medicine, or any other areas requiring facial protection. Protecting against infectious pathogens, Sklar masks are $\geq 98\%$ BFE, non-woven, soft and breathable. Convenient ear loops and adjustable nose-bridge ensure a proper fit. Latex Free.

NON-STERILE

PRODUCT NUMBER	FEATURES	QUANTITIES
96-5557	Mask Earloop, Blue	50/bx
96-5557A	Mask Earloop, Blue	500/cs
96-5557BNS	Mask Earloop, Blue, Bulk	2000/cs



SKLAR SURGICAL GOWNS

- Low linting, lightweight and breathable SMS fabric.
- Generous cut provides comfort and freedom of movement during various procedures.
- Superior liquid barrier protection provides confidence against strikethrough.
- Velcro-style neck closure easily adjusts for a perfect fit.
- Meets safety standards for Class I Flame Resistance.
- Meets AAMI Level I requirements.
- Disposable, single use.

NON-STERILE

PRODUCT NUMBER	FEATURES	QUANTITIES
96-5329	Non-Reinforced, Large	40/cs
96-5331	Non-Reinforced, X-Large	40/cs
96-5333	Non-Reinforced, XX-Large	40/cs

BULK, NON-STERILE

96-5003B	Non-Reinforced, Large	160/cs
96-5005B	Non-Reinforced, X-Large	160/cs
96-5006B	Non-Reinforced, XX-Large	120/cs



All Sklar Stainless Steelware is produced according to the strictest standards to ensure superior performance and durability.

*All products are packaged individually. Select products are available in bulk. To order larger quantities, simply add the package quantity to the end of the product number when ordering, ie. 10-1670-12 for 12/cs or 10-1670-48 for 48/cs.

IODINE CUP*

PRODUCT NUMBER	DESCRIPTION	QUANTITIES
10-1670	6 oz., 3 ⁷ / ₁₆ " x 2"	1, 12, 24 or 48/cs
10-1671	14 oz., 4 ³ / ₈ " x 2 ⁵ / ₈ "	1, 12, 24 or 48/cs

MEDICINE CUP*

PRODUCT NUMBER	DESCRIPTION	QUANTITIES
10-1675	2 oz., 2 ¹ / ₈ " x 2" Graduated Measure	1, 12, 24 or 48/cs

TUMBLER*

PRODUCT NUMBER	DESCRIPTION	QUANTITIES
10-1536	2 ⁷ / ₈ " x 3 ¹ / ₈ "	1, 12/cs

PITCHER / BEAKER*

PRODUCT NUMBER	DESCRIPTION	QUANTITIES
10-1172	125ml, 2 ¹ / ₈ " x 2 ⁵ / ₈ " w/o Handle	1 Each
10-1173	250ml, 2 ⁵ / ₈ " x 3 ¹ / ₄ " w/o Handle	1 Each
10-1174	600ml, 3 ³ / ₈ " x 4 ⁵ / ₈ " w/o Handle	1 Each
10-1176	2000ml, 4 ⁷ / ₈ " x 7 ¹ / ₈ " w/o Handle	1 Each
10-1177	3000ml, 5 ¹ / ₂ " x 8 ¹ / ₄ " w/o Handle	1 Each
10-1178	4000ml, 6 ¹ / ₈ " x 8 ⁷ / ₈ " w/o Handle	1 Each
10-1175	1200ml, 4 ¹ / ₈ " x 6 ¹ / ₁₆ " with closed Handle	1 Each
10-1539	2000ml, 5 ¹ / ₁₆ " x 6 ⁵ / ₈ " with closed Handle	1, 6 or 12/cs
10-1180	3000ml, 6 ¹ / ₁₆ " x 7" with closed Handle	1 Each
10-1181	4000ml, 6 ⁷ / ₈ " x 8 ⁷ / ₈ " with closed Handle	1 Each



GRADUATED MEASURE*

PRODUCT NUMBER	DESCRIPTION	QUANTITIES
10-1552	16 oz., 3 $\frac{3}{4}$ " x 4 $\frac{5}{8}$ "	1, 6 or 12/cs
10-1510	32 oz., 4 $\frac{3}{4}$ " x 5 $\frac{1}{4}$ "	1, 6 or 12/cs
10-1674	64 oz., 5 $\frac{1}{2}$ " x 6 $\frac{1}{2}$ "	1, 6 or 12/cs

**MIXING/SOLUTION BOWLS***

PRODUCT NUMBER	DESCRIPTION	QUANTITIES
10-1488	$\frac{7}{8}$ qt., 6 $\frac{5}{8}$ " x 2 $\frac{1}{2}$ "	1 or 12/cs
10-1491	1 $\frac{1}{2}$ qt., 8 $\frac{1}{8}$ " x 3"	1 or 12/cs
10-1492	3 qt., 9 $\frac{3}{4}$ " x 4"	1 or 12/cs
10-1493	5 qt., 11 $\frac{7}{8}$ " x 4 $\frac{1}{2}$ "	1 or 12/cs
10-1494	6 $\frac{3}{4}$ qt., 12 $\frac{3}{4}$ " x 5 $\frac{1}{4}$ "	1, 6 or 12/cs
10-1495	8 qt., 13 $\frac{5}{16}$ " x 5 $\frac{7}{16}$ "	1, 6 or 12/cs

**SPONGE BOWLS***

PRODUCT NUMBER	DESCRIPTION	QUANTITIES
10-1496	12 oz., 4 $\frac{1}{4}$ " x 2"	1 or 12/cs
10-1498	22 oz., 5" x 2 $\frac{3}{8}$ "	1 or 12/cs
10-1484	29 oz., 5 $\frac{9}{16}$ " x 2 $\frac{9}{16}$ "	1 or 12/cs
10-1485	36 oz., 6 $\frac{1}{4}$ " x 2 $\frac{3}{4}$ "	1 or 12/cs
10-1483	48 oz., 7 $\frac{1}{8}$ " x 2 $\frac{3}{4}$ "	1 or 12/cs
10-1486	64 oz., 7 $\frac{9}{16}$ " x 3"	1 or 12/cs

**SOLUTION BASINS***

PRODUCT NUMBER	DESCRIPTION	QUANTITIES
10-1489	4 $\frac{1}{2}$ qt., 12" x 4 $\frac{1}{4}$ "	1 or 12/cs
10-1505	7 qt., 13 $\frac{5}{8}$ " x 4 $\frac{5}{8}$ "	1, 6 or 12/cs
10-1507	9 $\frac{1}{2}$ qt., 14 $\frac{1}{2}$ " x 5"	1, 6 or 12/cs



*All products are packaged individually. Select products are available in bulk. To order larger quantities, simply add the package quantity to the end of the product number when ordering, ie. 10-1670-12 for 12/cs or 10-1670-48 for 48/cs.

EMESIS BASINS*

PRODUCT NUMBER	DESCRIPTION	QUANTITIES
10-1497	10 oz., 6 ⁵ / ₈ " x 3 ¹ / ₂ " x 1 ¹ / ₂ "	1 or 12/cs
10-1698	12 oz., 8 ¹ / ₈ " x 3 ³ / ₈ " x 1 ⁵ / ₈ "	1 or 12/cs
10-1699	26 oz., 9 ⁷ / ₈ " x 4 ¹ / ₂ " x 2 ¹ / ₈ "	1 or 12/cs
10-1487	48 oz., 12 ¹ / ₂ " x 5 ³ / ₄ " x 2 ¹ / ₄ "	1 Each

HOSPITAL BUCKETS

PRODUCT NUMBER	DESCRIPTION	QUANTITIES
10-1182	13 qt., 11 ⁵ / ₈ " x 9 ¹ / ₄ " w/o lid	1 Each
10-1450	13 qt., 11 ⁵ / ₈ " x 9 ¹ / ₄ " with lid	1 Each
10-1183	16 qt., 11 ³ / ₄ " x 10 ⁵ / ₈ " w/o lid	1 Each
10-1451	16 qt., 11 ³ / ₄ " x 10 ⁵ / ₈ " with lid	1 Each
10-1184	20 qt., 13 ³ / ₄ " x 11 ¹ / ₁₆ " w/o lid	1 Each

HOSPITAL KICK BUCKET WITHOUT LID

PRODUCT NUMBER	DESCRIPTION	QUANTITIES
10-1551	13 qt., 11 ⁵ / ₈ " x 9 ¹ / ₄ "	1 Each

STORAGE CONTAINERS*

PRODUCT NUMBER	DESCRIPTION	QUANTITIES
10-1540	1/2 gal., 5 ⁷ / ₁₆ " x 6 ⁵ / ₈ " no handles	1, 6 or 12/cs
10-1186	3 gal., 10 ³ / ₁₆ " x 9"	1 Each
10-1188	4 gal., 13" x 9"	1 Each
10-1189	5 gal., 13" x 11"	1 Each
10-1190	6 gal., 13" x 13"	1 Each



*All products are packaged individually. Select products are available in bulk. To order larger quantities, simply add the package quantity to the end of the product number when ordering, ie. 10-1670-12 for 12/cs or 10-1670-48 for 48/cs.

DRESSING JAR WITH LID*

PRODUCT NUMBER	DESCRIPTION	QUANTITIES
10-1523	½ qt., 4½" x 2¼"	1 or 12/cs
10-1533	1¼ qt., 4" x 5"	1 or 12/cs
10-1538	1⅞ qt., 4⅞" x 6¼"	1 or 12/cs
10-1527	3 qt., 5⅞" x 6⅞"	1 or 12/cs
10-1543	4¾ qt., 6¾" x 7¾"	1 or 12/cs
10-1544	6 qt., 7¼" x 8⅜"	1, 6 or 12/cs
10-1547	8 qt., 8" x 9⅞"	1, 6 or 12/cs

**FORCEP / THERMOMETER JAR***

PRODUCT NUMBER	DESCRIPTION	QUANTITIES
10-1550	1½" x 3"	1, 6 or 12/cs
10-1541	2¼" x 4½"	1, 6 or 12/cs
10-1545	2¼" x 7"	1, 6 or 12/cs

**FUNNELS WITH HANGING HOOK**

PRODUCT NUMBER	DESCRIPTION	QUANTITIES
10-1157	2⅜ oz., 3" x 3¾"	1 Each
10-1158	6⅞ oz., 4⅞" x 4⅞"	1 Each
10-1159	13 oz., 5⅞" x 5⅞"	1 Each
10-1160	22¼ oz., 6¼" x 6⅞"	1 Each
10-1170	32 oz., 7" x 8⅜"	1 Each
10-1171	64 oz., 8⅞" x 9½"	1 Each

**LAB / UTILITY SCOOP**

PRODUCT NUMBER	DESCRIPTION	QUANTITIES
10-1192	5 oz., 5" x 2½" (Overall length 9½")	1 Each



*All products are packaged individually. Select products are available in bulk. To order larger quantities, simply add the package quantity to the end of the product number when ordering, ie. 10-1670-12 for 12/cs or 10-1670-48 for 48/cs.

OINTMENT JAR WITH LID*

PRODUCT NUMBER	DESCRIPTION	QUANTITIES
10-1525	9 oz., 3 1/8" x 2 3/4"	1 or 12/cs



MINI TRAY WITH LID

PRODUCT NUMBER	DESCRIPTION	QUANTITIES
10-1768	8 1/2" x 3" x 1 1/2"	1 Each



**SKLAR
DISINFECTANT™
SURFACE WIPES**

**READY-TO-USE, PRE-MOISTENED TOWELETTES
SAME EFFECTIVE FORMULA AS
SKLAR DISINFECTANT!**

- Ready to use, non-toxic formula.
- Specially formulated for the control of cross contamination.
- Effective against H1N1, MRSA, Salmonella, Parvo, Feline Leukemia, Herpes Simplex, Distemper, Ringworm, Strangles.
- Safe for all areas of the facility.
- Satisfies OSHA's Bloodborne Pathogen Standards.
- Destroys odor-causing bacteria.
- 7" x 10" non-woven, tear resistant towelette.
- Clean scent.
- EPA registered.

PRODUCT NUMBER	DESCRIPTION	QUANTITIES
10-1616	100 Towelettes/Canister	6/case
10-1617	100 Towelettes/Canister	12/case



**Convenient
Dispensing
Canister**

*All products are packaged individually. Instrument trays and covers are sold separately unless otherwise noted. Select products are available in bulk. To order larger quantities, simply add the package quantity to the end of the product number when ordering, ie. 10-1670-12 for 12/cs or 10-1670-48 for 48/cs.

MAYO TRAYS (SOLID)*

PRODUCT NUMBER	DESCRIPTION	QUANTITIES
10-1690	10" x 6½" x ¾"	1, 6 or 12/cs
10-1691	13⅛" x 9⅜" x ¾"	1, 6 or 12/cs
10-1692	15½" x 10⅝" x ¾"	1, 6 or 12/cs
10-1693	17" x 11⅝" x ¾"	1, 6 or 12/cs
10-1694	19 ⅞" x 12⅝" x ¾"	1, 6 or 12/cs
10-1695	21¼" x 16¼" x ⅞"	1, 6 or 12/cs



MAYO TRAYS (PERFORATED)*

PRODUCT NUMBER	DESCRIPTION	QUANTITIES
10-1684	10" x 6½" x ¾"	1, 6 or 12/cs
10-1685	13¾" x 9¾" x ¾"	1, 6 or 12/cs
10-1686	15½" x 10⅝" x ¾"	1, 6 or 12/cs
10-1687	17" x 11⅝" x ¾"	1, 6 or 12/cs
10-1688	19⅞" x 12⅝" x ¾"	1, 6 or 12/cs
10-1689	21¼" x 16¼" x ⅞"	1 or 6/cs



CATHETER INSTRUMENT TRAYS*

PRODUCT NUMBER	DESCRIPTION	COVERS	QUANTITIES
10-1955	8¾" x 3¼" x 1½"	10-1956 - Dome	1, 6 or 12/cs
10-1738	8⅞" x 5" x 2"	10-1722 - Dome	1, 6 or 12/cs
10-1760	8⅞" x 5" x 3"	10-1722 - Dome	1, 6 or 12/cs
10-1886	17¼" x 4½" x 2"	10-1887 - Flat	1, 6 or 12/cs



MESH CLEANING BASKETS*

PRODUCT NUMBER	DESCRIPTION	QUANTITIES
10-1731	6" x 9" x 3"	1 Each
10-1732	20" x 10½" x 3½"	1 Each
10-1733	9½" x 16" x 4"	1 Each
10-1734	12" x 21" x 5"	1 Each
10-1736	14" x 20" x 5"	1 or 12/cs

PERFORATED CLEANING BASKET

PRODUCT NUMBER	DESCRIPTION	QUANTITIES
10-1560	12¾" x 10¾" x 6"	1 Each

INSTRUMENT DRYING TRAYS*

PRODUCT NUMBER	DESCRIPTION	QUANTITIES
10-1876	10" x 6½" x ¾"	1, 6 or 12/cs
10-1883	13⅛" x 9⅜" x ¾"	1, 6 or 12/cs
10-1884	15⅞" x 10⅝" x ¾"	1, 6 or 12/cs
10-1683	17" x 11⅞" x ¾"	1, 6 or 12/cs
10-1888	19⅞" x 12⅝" x ¾"	1, 6 or 12/cs
10-1680	21¼" x 16¼" x ⅞"	1, 6 or 12/cs



*All products are packaged individually. Select products are available in bulk. To order larger quantities, simply add the package quantity to the end of the product number when ordering, ie. 10-1670-12 for 12/pk or 10-1670-48 for 48/pk.

INSTRUMENT TRAYS, PERFORATED BOTTOM

PRODUCT NUMBER	DESCRIPTION	QUANTITIES
10-1740	8 ⁷ / ₈ " x 5" x 2"	1 Each
10-1874	10" x 6 ¹ / ₂ " x 2"	1 Each
10-1892	12" x 7 ³ / ₄ " x 2"	1 Each
10-1879	12" x 7 ³ / ₄ " x 2 ¹ / ₂ "	1 Each
10-1758	12 ³ / ₄ " x 10 ¹ / ₂ " x 2 ¹ / ₂ "	1 Each
10-1862	12 ³ / ₄ " x 10 ¹ / ₂ " x 4"	1 Each
10-1894	16 ¹ / ₂ " x 10" x 2 ¹ / ₂ "	1 Each
10-1895	20 ³ / ₄ " x 12 ³ / ₄ " x 2 ¹ / ₂ "	1 Each



INSTRUMENT TRAYS, PERFORATED BOTTOM / SIDES*

PRODUCT NUMBER	DESCRIPTION	QUANTITIES
10-1757	12 ³ / ₄ " x 10 ¹ / ₂ " x 1 ¹ / ₄ "	1 Each
10-1697	12 ³ / ₄ " x 10 ¹ / ₂ " x 2 ¹ / ₂ "	1 Each
10-1943	12 ³ / ₄ " x 10 ¹ / ₂ " x 4"	1 Each
10-1944	12 ³ / ₄ " x 10 ¹ / ₂ " x 6"	1 Each
10-1941	20 ³ / ₄ " x 12 ³ / ₄ " x 1 ¹ / ₄ "	1 Each
10-1759	20 ³ / ₄ " x 12 ³ / ₄ " x 2 ¹ / ₂ "	1 Each
10-1949	20 ³ / ₄ " x 12 ³ / ₄ " x 4"	1, 6 or 12/cs
10-1942	20 ³ / ₄ " x 12 ³ / ₄ " x 6"	1 Each



INSTRUMENT TRAYS, SOLID*

PRODUCT NUMBER	DESCRIPTION	COVERS	QUANTITIES
10-1755	6 ⁷ / ₈ " x 4 ¹ / ₄ " x 2"	10-1737	1, 6 or 12/cs
10-1741	6 ⁷ / ₈ " x 6 ³ / ₈ " x 4" Heavyweight	10-1835	1 or 6/cs
10-1764	10" x 6 ¹ / ₂ " x 2"	10-1766	1 Each
10-1742	10 ³ / ₈ " x 6 ³ / ₈ " x 2 ¹ / ₂ "	10-1542	1, 6 or 12/cs
10-1877	12" x 7 ³ / ₄ " x 2 ¹ / ₄ "	10-1878	1, 6 or 12/cs
10-1744	12 ³ / ₄ " x 6 ⁷ / ₈ " x 2 ¹ / ₂ "	10-1724	1, 6 or 12/cs
10-1746	12 ³ / ₄ " x 10 ¹ / ₂ " x 2 ¹ / ₂ "	10-1882	1, 6 or 12/cs
10-1950	12 ³ / ₄ " x 10 ¹ / ₂ " x 2 ¹ / ₂ " Heavyweight	10-1882	1, 6 or 12/cs
10-1747	12 ³ / ₄ " x 10 ¹ / ₂ " x 4"	10-1882	1, 6 or 12/cs
10-1952	12 ³ / ₄ " x 10 ¹ / ₂ " x 4" Heavyweight	10-1882	1, 6 or 12/cs
10-1870	12 ³ / ₄ " x 10 ¹ / ₂ " x 6"	10-1882	1, 6 or 12/cs
10-1753	13 ⁷ / ₈ " x 12 ⁷ / ₈ " x 2 ¹ / ₂ "	10-1754	1, 6 or 12/cs
10-1748	16 ¹ / ₂ " x 10" x 2 ¹ / ₂ "	10-1756	1, 6 or 12/cs
10-1749	16 ¹ / ₂ " x 10" x 4"	10-1756	1 Each
10-1953	20 ³ / ₄ " x 12 ³ / ₄ " x 2 ¹ / ₂ " Heavyweight	10-1535	1, 6 or 12/cs
10-1954	20 ³ / ₄ " x 12 ³ / ₄ " x 4" Heavyweight	10-1535	1, 6 or 12/cs
10-1948	20 ³ / ₄ " x 12 ³ / ₄ " x 6"	10-1535	1, 6 or 12/cs



*All products are packaged individually. Instrument trays and covers are sold separately unless otherwise noted. Select products are available in bulk. To order larger quantities, simply add the package quantity to the end of the product number when ordering, ie. 10-1670-12 for 12/cs or 10-1670-48 for 48/cs.

STERILIZATION TRAY / BATH SETS

PRODUCT NUMBER	DESCRIPTION	QUANTITIES
10-1947	Large Set Includes:	
	Solid Tray 10-1948 20¾" x 12¾" x 6"	1
	Perforated Tray 10-1949 20¾" x 12¾" x 4"	1
	Cover 10-1535 20¾" x 12¾"	1
10-1679	Small Set Includes:	
	Solid Tray 10-1747 12¾" x 10½" x 4"	1
	Perforated Tray 10-1697 12¾" x 10½" x 2½"	1
	Cover 10-1882 12¾" x 10½"	1

STERILIZATION TRAYS*

PRODUCT NUMBER	DESCRIPTION	COVERS	QUANTITIES
10-1850	4 qt., 12¾" x 10½" x 2½"	10-1864	1 Each
10-1860	7 qt., 12¾" x 10½" x 4"	10-1864	1 Each
10-1750	5 ¼ qt., 20¾" x 6¾" x 4"	10-1854	1, 6 or 12/cs
10-1752	9 qt., 20¾" x 6¾" x 6"	10-1854	1, 6 or 12/cs
10-1953	8 ½ qt., 20¾" x 12¾" x 2½", Heavyweight	10-1535	1, 6 or 12/cs
10-1954	14 ½ qt., 20¾" x 12¾" x 4", Heavyweight	10-1535	1, 6 or 12/cs
10-1948	24 qt., 20¾" x 12¾" x 6"	10-1535	1, 6 or 12/cs

PERFORATED STERILIZATION TRAYS

PRODUCT NUMBER	DESCRIPTION	QUANTITIES
10-1710	10" x 6½" x 2½"	1 Each
10-1713	10" x 10½" x 3½"	1 Each
10-1714	15" x 10½" x 3½"	1 Each
10-1720	20" x 10½" x 3½"	1 Each
10-1957	20¾" x 12¾" x 4" Mesh bottom	1 Each



*All products are packaged individually. Instrument trays and covers are sold separately unless otherwise noted. Select products are available in bulk. To order larger quantities, simply add the package quantity to the end of the product number when ordering, ie. 10-1670-12 for 12/cs or 10-1670-48 for 48/cs



LIFTING HANDLES

PRODUCT NUMBER	DESCRIPTION	QUANTITIES
10-1725	For Sterilization Trays	1 Pair



FLASH STERILIZATION TRAY

PRODUCT NUMBER	DESCRIPTION	QUANTITIES
10-1711	10" x 6½" x 2"	1 Each
10-1712	Single Handle for Flash Sterilization Tray 10-1711	1 Each



DOUBLE DECKER MICRO TRAY

PRODUCT NUMBER	DESCRIPTION	QUANTITIES
10-1717	10" x 15" x 2¼"	1 Each



MICRO TRAY WITH HINGED LID

PRODUCT NUMBER	DESCRIPTION	QUANTITIES
10-1706	8½" x 8" x 1¼" with 2½" x 2½" Compartment	1 Each
10-1707	8½" x 12" x 1⅞"	1 Each
10-1708	8½" x 14" x 1⅞"	1 Each
10-1702	10½" x 10" x 1⅞"	1 Each
10-1716	10½" x 20" x 2½" with 10½" x 5" Compartment	1 Each

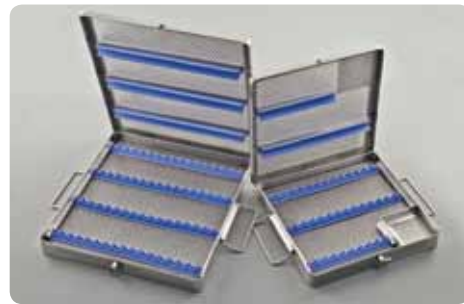

PRODUCT NUMBER	DESCRIPTION	QUANTITIES
10-1700	8½" x 8" x 1¼"	1 Each
10-1703	10½" x 15" x 1¼"	1 Each



MICRO TRAY WITH HINGED LID (Not pictured)

PRODUCT NUMBER	DESCRIPTION	QUANTITIES
10-1701	10" x 6½" x 7⁄8"	1 Each

STERILIZATION BOX (Not pictured)

PRODUCT NUMBER	DESCRIPTION	QUANTITIES
10-1705	6⅜" x 3⅜" x 1¼"	1 Each

WEINSTEIN INSTRUMENT STRINGERS

PRODUCT NUMBER	DESCRIPTION	QUANTITIES
10-1800	5½" x 3¼"	1 Each
10-1805	11¼" x 3¼"	1 Each



E-Z LOCK INSTRUMENT STRINGERS

PRODUCT NUMBER	DESCRIPTION	QUANTITIES
10-1806	2½" x 6"	1 Each
10-1808	2½" x 8"	1 Each
10-1810	2½" x 10"	1 Each
10-1812	2½" x 12"	1 Each
10-1814	2½" x 14"	1 Each
10-1816	2½" x 16"	1 Each
10-1818	2½" x 18"	1 Each
10-1826	5" x 6"	1 Each
10-1828	5" x 8"	1 Each
10-1830	5" x 10"	1 Each
10-1832	5" x 12"	1 Each
10-1834	5" x 14"	1 Each
10-1836	5" x 16"	1 Each
10-1838	5" x 18"	1 Each

INSTRUMENT STRINGERS

PRODUCT NUMBER	DESCRIPTION	QUANTITIES
10-1340	2½" x 6"	1 Each
10-1342	2½" x 8"	1 Each
10-1344	2½" x 10"	1 Each
10-1346	2½" x 12"	1 Each
10-1347	2½" x 14"	1 Each
10-1348	2½" x 16"	1 Each
10-1349	2½" x 18"	1 Each



WEISENBACH INSTRUMENT HOLDER

PRODUCT NUMBER	DESCRIPTION	QUANTITIES
10-1775	6"	1 Each
10-1776	12"	1 Each



BUNT INSTRUMENT STRINGER

PRODUCT NUMBER	DESCRIPTION	QUANTITIES
10-1770	5¼" x 1½"	1 Each

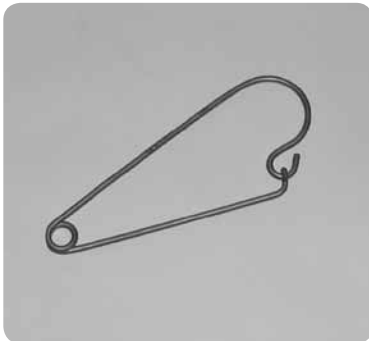

MAYO INSTRUMENT HOLDER

PRODUCT NUMBER	DESCRIPTION	QUANTITIES
10-1772	5½"	1 Each

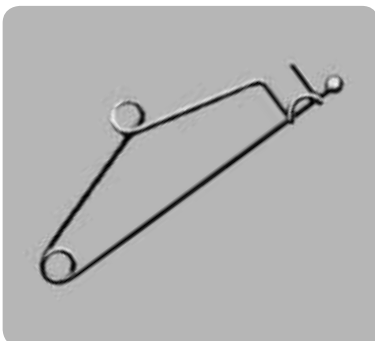

WORCESTER INSTRUMENT HOLDER

PRODUCT NUMBER	DESCRIPTION	QUANTITIES
10-1839	13" x 3"	1 Each

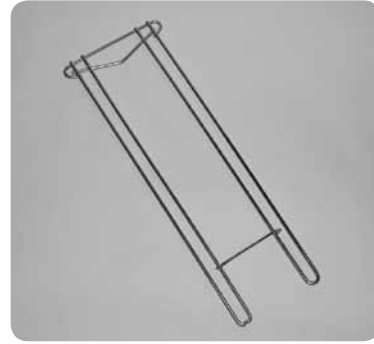

SAUNDERS INSTRUMENT RACK

PRODUCT NUMBER	DESCRIPTION	QUANTITIES
10-1780	6" x 4"	1 Each

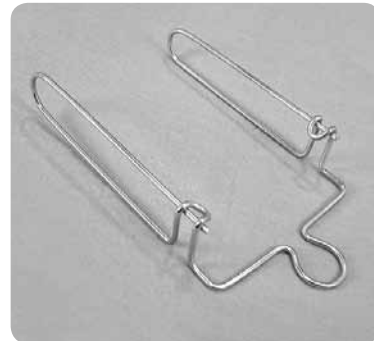

POSILOCK INSTRUMENT RACK

PRODUCT NUMBER	DESCRIPTION	QUANTITIES
10-1763		1 Each



SKLARLITE™

STERILIZATION CONTAINER SYSTEM

Pre-Vacuum Steam Sterilization

The SklarLite™ Rigid Sterilization Container System provides an organized, routine and secure approach to the sterilization of surgical instruments. Customize your SklarLite™ System by selecting colored lids and ID labels. Available in your choice of six vibrant colors for easy identification of instrument sets by procedure and/or department. Choose from various configurations to fit your surgery center needs.

- Anodized aluminum alloy is strong and durable yet lightweight and easy to handle.
- Stackable Containers maximizes space in the autoclave and storage shelf space; reduces cycle runs.
- Stackable Baskets provide ease of instrument transfer per procedure and maximizes space inside containers.
- Silicon mats secure delicate and laparoscopic instruments to minimize damage.
- Tamper evident seals prevent accidental sterile field breach.
- Long Lasting Sterilization.



STANDARD CONTAINERS



Consists of a body and perforated lid and used with Sklar's disposable filters and other compatible accessories for sterilization. Choose from either perforated or non-perforated bottoms. Lids available in six different colors for easy identification by procedure or department.

SAFE CONTAINERS



Consists of identical body and perforated lid, but features an additional solid cover that safeguards the perforation field and contents during transportation and storage. Choose from either perforated or non-perforated bottoms. Safety lids available in six different colors for easy identification by procedure or department.

SKLARLITE™ HALF-SIZE CONTAINERS

11¼" L X 11" W

STANDARD CONTAINERS			SAFE CONTAINERS	
Non-Perforated Bottom	Perforated Bottom	Size	Non-Perforated Bottom	Perforated Bottom
10-4500	10-4512	4"	10-4524	10-4536
10-4502	10-4514	4"	10-4526	10-4538
10-4504	10-4516	4"	10-4528	10-4540
10-4506	10-4518	4"	10-4530	10-4542
10-4508	10-4520	4"	10-4532	10-4544
10-4510	10-4522	4"	10-4534	10-4546
10-4548	10-4560	5"	10-4572	10-4584
10-4550	10-4562	5"	10-4574	10-4586
10-4552	10-4564	5"	10-4576	10-4588
10-4554	10-4566	5"	10-4578	10-4590
10-4556	10-4568	5"	10-4580	10-4592
10-4558	10-4570	5"	10-4582	10-4594
10-4596	10-4608	6"	10-4620	10-4632
10-4598	10-4610	6"	10-4622	10-4634
10-4600	10-4612	6"	10-4624	10-4636
10-4602	10-4614	6"	10-4626	10-4638
10-4604	10-4616	6"	10-4628	10-4640
10-4606	10-4618	6"	10-4630	10-4642
10-4644	10-4656	8"	10-4668	10-4680
10-4646	10-4658	8"	10-4670	10-4682
10-4648	10-4660	8"	10-4672	10-4684
10-4650	10-4662	8"	10-4674	10-4686
10-4652	10-4664	8"	10-4676	10-4688
10-4654	10-4666	8"	10-4678	10-4690
10-4692	10-4704	10"	10-4716	10-4728
10-4694	10-4706	10"	10-4718	10-4730
10-4696	10-4708	10"	10-4720	10-4732
10-4698	10-4710	10"	10-4722	10-4734
10-4700	10-4712	10"	10-4724	10-4736
10-4702	10-4714	10"	10-4726	10-4738



ACCESSORIES

PRODUCT NUMBER	MODEL	FEATURES
10-4784	Half Size Wire Basket	9½" x 10" x 1"
10-4786	Half Size Wire Basket	9½" x 10" x 2"
10-4788	Half Size Wire Basket	9½" x 10" x 3"
10-4790	Half Size Wire Basket	9½" x 10" x 4"
10-4970	Half Size Silicon Mat	8½" x 9"



SKLARLITE™ MID-SIZE CONTAINERS
18¼" L X 11" W

STANDARD CONTAINERS			SAFE CONTAINERS	
Non-Perforated Bottom	Perforated Bottom	Size	Non-Perforated Bottom	Perforated Bottom
10-4300	10-4312	4"	10-4324	10-4336
10-4302	10-4314	4"	10-4326	10-4338
10-4304	10-4316	4"	10-4328	10-4340
10-4306	10-4318	4"	10-4330	10-4342
10-4308	10-4320	4"	10-4332	10-4344
10-4310	10-4322	4"	10-4334	10-4346
10-4348	10-4360	5"	10-4370	10-4382
10-4350	10-4361	5"	10-4372	10-4384
10-4352	10-4362	5"	10-4374	10-4386
10-4354	10-4364	5"	10-4376	10-4388
10-4356	10-4366	5"	10-4378	10-4390
10-4358	10-4368	5"	10-4380	10-4392
10-4394	10-4406	6"	10-4418	10-4430
10-4396	10-4408	6"	10-4420	10-4432
10-4398	10-4410	6"	10-4422	10-4434
10-4400	10-4412	6"	10-4424	10-4436
10-4402	10-4414	6"	10-4426	10-4438
10-4404	10-4416	6"	10-4428	10-4440

ACCESSORIES

PRODUCT NUMBER	MODEL	FEATURES
10-4478	Mid Size Wire Basket	16" x 10" x 1"
10-4480	Mid Size Wire Basket	16" x 10" x 2"
10-4482	Mid Size Wire Basket	16" x 10" x 3"
10-4484	Mid Size Wire Basket	16" x 10" x 4"
10-4975	Mid Size Silicon Mat	15" x 9"

GENERAL ACCESSORIES

Complete any SklarLite™ Container System by selecting disposable filters, indicators and labels to maximize security in preparation and maintenance of surgical sets and sterile materials.

PRODUCT NUMBER	MODEL	FEATURES
10-4900	Process Indicator Cards	Steam, 250/Bx
10-4910	Disposable Filters	100/Pk
10-4925	Security Seals	100/Pk
10-4930	ID Labels*	Silver
10-4930ENG	ID Labels*	Silver Custom Engraved, Max. 16 Characters

*Choose from six vibrant colors including Silver, Yellow, Red, Blue, Green or Black. Contact your Sklar Account Manager for information on the complete product line.



SKLARLITE™ FULL-SIZE CONTAINERS

23" L X 11" W

STANDARD CONTAINERS			SAFE CONTAINERS	
Non-Perforated Bottom	Perforated Bottom	Size	Non-Perforated Bottom	Perforated Bottom
10-4000	10-4012	4"	10-4024	10-4036
10-4002	10-4014	4"	10-4026	10-4038
10-4004	10-4016	4"	10-4028	10-4040
10-4006	10-4018	4"	10-4030	10-4042
10-4008	10-4020	4"	10-4032	10-4044
10-4010	10-4022	4"	10-4034	10-4046
10-4048	10-4060	5"	10-4072	10-4084
10-4050	10-4062	5"	10-4074	10-4086
10-4052	10-4064	5"	10-4076	10-4088
10-4054	10-4066	5"	10-4078	10-4090
10-4056	10-4068	5"	10-4080	10-4092
10-4058	10-4070	5"	10-4082	10-4094
10-4096	10-4108	6"	10-4120	10-4132
10-4098	10-4110	6"	10-4122	10-4134
10-4100	10-4112	6"	10-4124	10-4136
10-4102	10-4114	6"	10-4126	10-4138
10-4104	10-4116	6"	10-4128	10-4140
10-4106	10-4118	6"	10-4130	10-4142
10-4144	10-4156	8"	10-4168	10-4180
10-4146	10-4158	8"	10-4170	10-4182
10-4148	10-4160	8"	10-4172	10-4184
10-4150	10-4162	8"	10-4174	10-4186
10-4152	10-4164	8"	10-4176	10-4188
10-4154	10-4166	8"	10-4178	10-4190
10-4192	10-4204	10"	10-4216	10-4228
10-4194	10-4206	10"	10-4218	10-4230
10-4196	10-4208	10"	10-4220	10-4232
10-4198	10-4210	10"	10-4222	10-4234
10-4200	10-4212	10"	10-4224	10-4236
10-4202	10-4214	10"	10-4226	10-4238



ACCESSORIES

PRODUCT NUMBER	MODEL	FEATURES
10-4284	Full Size Wire Basket	21¼" x 10" x 1"
10-4286	Full Size Wire Basket	21¼" x 10" x 2"
10-4288	Full Size Wire Basket	21¼" x 10" x 3"
10-4290	Full Size Wire Basket	21¼" x 10" x 4"
10-4985	Full Size Silicon Mat	20½" x 9"



INSTRUMENT CASSETTES

Organized Procedure Kits save time and improve safety! Sklar is pleased to introduce a new line of cassette trays to organize and protect instruments during handling and transportation. Removable, silicone instrument holders afford you the option of an open configuration in any cassette. Cassettes with detachable lids feature moveable instrument holders to customize instrument configuration. Choose from various cassette sizes and styles to fit your needs.

- High quality, heavy gauge stainless steel.
- Optimum slot position for effective cleaning and drainage.
- Easy open/closing latch system.
- Silicone Inserts for secure instrument placement.



SMALL CASSETTES

Typical Applications Include:

- Diagnostic Kit
- Root Planning Kit
- New Patient Kit
- Composite Kit

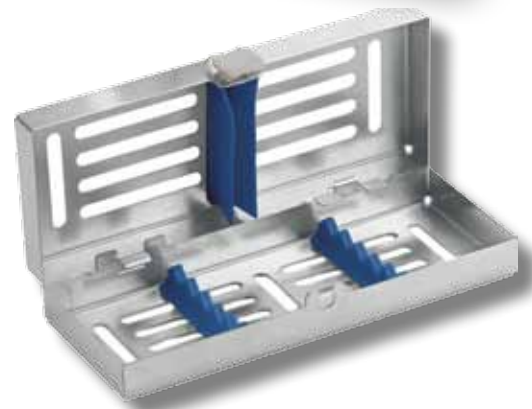

PRODUCT NUMBER	SIZE	CONFIGURATION	FEATURES
10-6500	7" x 2¾" x 1⅓"	5 Instruments	Detachable Lid/Instrument Holders
10-6501	7" x 2⅓" x 9⁄7"	5 Instruments	Fixed Lid/Instrument Holders

MEDIUM CASSETTES

Typical Applications Include:

- Hygiene Kit
- Restoration Kit
- Cavity Prep Kit
- Endo Kit
- Crown & Bridge Kit

PRODUCT NUMBER	SIZE	CONFIGURATION	FEATURES
10-6505	7" x 4⅓" x 1⅓"	7 Instruments	Detachable Lid/Instrument Holders
10-6506	7" x 3½" x 6⁄7"	7 Instruments	Fixed Lid/Instrument Holders



MEDIUM CASSETTES, CONTINUED

PRODUCT NUMBER	SIZE	CONFIGURATION	FEATURES
10-6510	7" x 5¾" x 1⅓"	10 Instruments	Detachable Lid/Instrument Holders
10-6511	7" x 5" x ⅞"	10 Instruments	Fixed Lid/Instrument Holders



LARGE CASSETTES

Typical Applications Include:

- Periodontal Surgery
- Restoration Kit
- Extraction

PRODUCT NUMBER	SIZE	CONFIGURATION	FEATURES
10-6515	11½" x 7" x 1⅓"	20 Instruments	Detachable Lid/Instrument Holders
10-6516	11" x 7¼" x 1"	20 Instruments	Fixed Lid/Instrument Holders



EXTRA LARGE CASSETTE

Available with specially designed silicone inserts to hold up to 12 extracting forceps. Or choose the open configuration recommended for large surgical instrument sets.

PRODUCT NUMBER	SIZE	CONFIGURATION	FEATURES
10-6520	15" x 8¼" x 1½"	12 Forceps	Detachable Lid/Instrument Holders
10-6521	15" x 8¼" x 1½"	Open	Detachable Lid



INSTRUMENT HOLDERS

UNIVERSAL

PRODUCT NUMBER	SIZE	CONFIGURATION	FEATURES
10-6531	5"	10 Instruments	3 pc Silicone Set, Blue
10-6536	10½"	20 Instruments	3 pc Silicone Set, Blue



CLIP IN CASSETTES

PRODUCT NUMBER	SIZE	CONFIGURATION	FEATURES
10-6525	7" x 2⅓" x ⅞"	5 Instruments	Open top and bottom

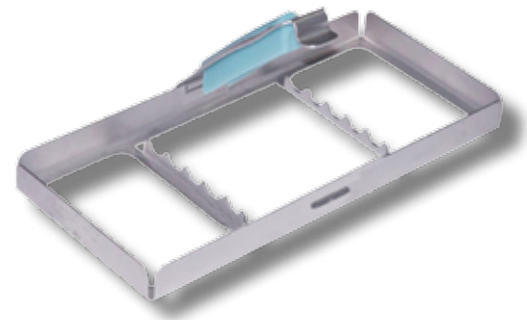

PRODUCT NUMBER	SIZE	CONFIGURATION	FEATURES
10-6526	7" x 3½" x 1"	10 Instruments	Open Top with Instrument Holders



Replacement instrument holders, in various colors are also available. Contact your Sklar Account Manager for more information.

MEDICINE CUPS

STERILE

PRODUCT NUMBER	FEATURES	QUANTITIES
96-7027	2 oz.	25/cs



PITCHERS*

STERILE

PRODUCT NUMBER	FEATURES	QUANTITIES
96-7268	Open Handle, 1200ml	5/cs

NON-STERILE

96-7270	Open Handle, 1200ml	35/cs
---------	---------------------	-------



NON-STERILE

PRODUCT NUMBER	FEATURES	QUANTITIES
10-1546	Graduated Measure, 16 oz., Reusable	1 or 6/cs



SPECIMEN TUBES

STERILE

PRODUCT NUMBER	FEATURES	QUANTITIES
96-7459	3½" x ½"	3/pk, 50pk/cs, 150/cs



PLASTIC BOWLS

STERILE

PRODUCT NUMBER	FEATURES	QUANTITIES
96-7028	8 oz.	25/cs
96-7020	16 oz.	10/cs
96-7174	32 oz.	20/cs
96-7451	48 oz.	5/cs



*Select products are available individually or in bulk packaging. To order large quantities, simply add the package quantity to the end of the product number when ordering, ie. 10-1670-12 for 12/pk or 10-1670-48 for 48/pk.

EMESIS BASINS

NON-STERILE

PRODUCT NUMBER	FEATURES	QUANTITIES
96-7543	700cc	25/cs



OR BASINS

STERILE

PRODUCT NUMBER	FEATURES	QUANTITIES
96-1679	Round, 7 qt., Blue	5/cs

NON-STERILE

08-1011	Round, 5 qt., Pink	50/cs
---------	--------------------	-------

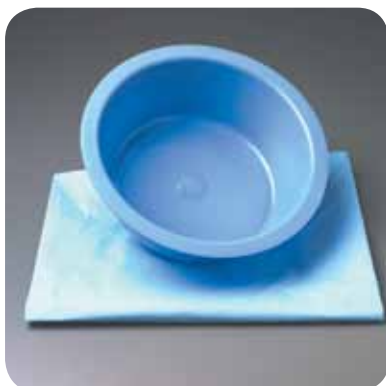

GUIDEWIRE BOWLS

STERILE

PRODUCT NUMBER	FEATURES	QUANTITIES
96-1630	8¼" x 3"	10/cs



UTILITY BOWLS*

NON-STERILE

PRODUCT NUMBER	FEATURES	QUANTITIES
10-1502	Sponge / Utility Bowl, Aqua, 1¼ qt.	1 or 12/cs



NON-STERILE

PRODUCT NUMBER	FEATURES	QUANTITIES
10-1504	Solution Bowl, Reusable, Lt Green, 7 qt.	1 or 12/cs



*Select products are available individually or in bulk packaging. To order large quantities, simply add the package quantity to the end of the product number when ordering, ie. 10-1670-12 for 12/pk or 10-1670-48 for 48/pk.

PLASTIC TRAYS

STERILE

PRODUCT NUMBER	FEATURES	QUANTITIES
96-7025	Small Shallow Prep	25/cs
96-7033	Half Shallow	25/cs
96-7024	Half Deep	25/cs
96-7175	Full Deep	25/cs
96-7177	2-Compartment	25/cs
96-7178	3-Compartment	25/cs



PROCEDURE TRAYS*

NON-STERILE

PRODUCT NUMBER	FEATURES	QUANTITIES
10-1960	Mini, Non-Perforated, Blue, 10 ¹ / ₈ " x 6 ⁵ / ₈ "	1 Each
10-1965	Mini, Perforated, Blue, 10 ¹ / ₈ " x 6 ⁵ / ₈ "	1, 6 or 12/cs
10-1961	Small, Non-Perforated, Blue, 10 ⁷ / ₁₆ " x 13 ⁹ / ₁₆ "	1 Each
10-1966	Small, Perforated, Blue, 10 ⁷ / ₁₆ " x 13 ⁹ / ₁₆ "	1, 6 or 12/cs
10-1962	Medium, Non-Perforated, Blue, 11 ³ / ₄ " x 16"	1 Each
10-1967	Medium, Perforated, Blue, 11 ³ / ₄ " x 16"	1, 6 or 12/cs
10-1964	Large, Heavy Duty, Non-Perforated, Blue, 15" x 20"	1 Each



SOAKING TRAYS WITH REMOVABLE BASKET

NON-STERILE

PRODUCT NUMBER	FEATURES	QUANTITIES
10-2555	Small Instrument Tray, 8" x 3 ¹ / ₂ " x 2"	1 Each
10-2556	Large Instrument Tray, 10" x 5" x 2 ¹ / ₂ "	1 Each
10-2557 (not pictured)	Round Cup Size Tray, 3" x 3", 4 oz.	1 Each



*Select products are available individually or in bulk packaging. To order large quantities, simply add the package quantity to the end of the product number when ordering, ie. 10-1670-12 for 12/pk or 10-1670-48 for 48/pk.

SKLARTIP™ INSTRUMENT PROTECTORS



Sklar Instrument Protectors provide a convenient, color-coded means of protecting surgical instrument tips and edges. Auto-clavable, steam and gas permeable, and available in a wide variety of shapes and sizes, SklarTip™ Instrument Protectors provide exceptional protection during handling and sterilization. Latex Free.

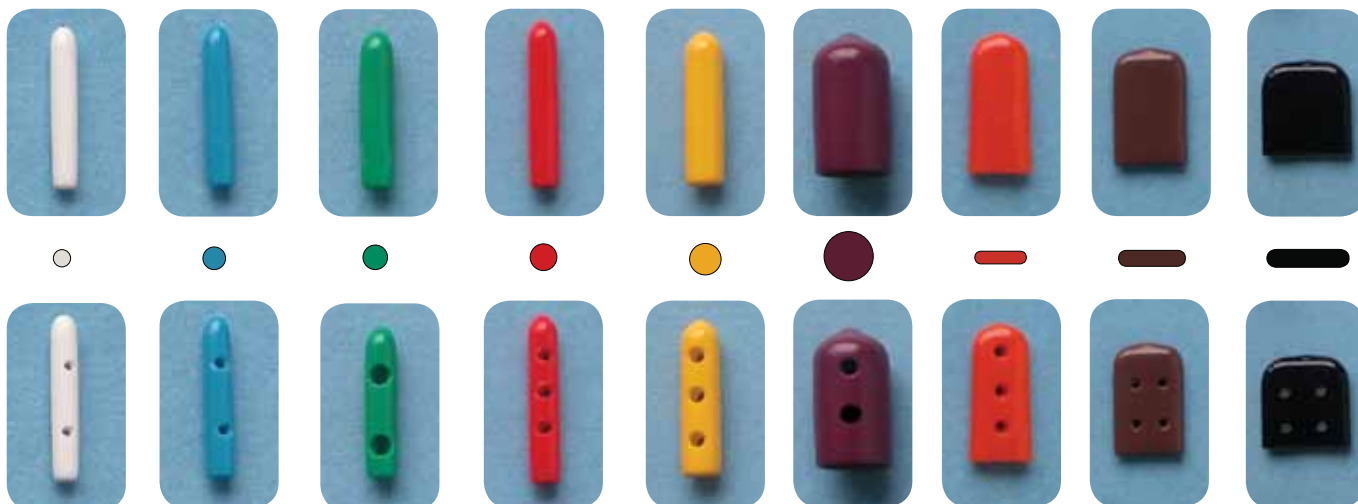

INSTRUMENT PROTECTORS - NON-VENTED

PRODUCT NUMBER	FEATURES	QUANTITIES
96-1510	19 x 1.5mm, 3/4" x 1/16"	White 100/pk
96-1508	19 x 2.0mm, 3/4" x 5/64"	Blue 100/pk
96-1506	19 x 3.0mm, 3/4" x 1/8"	Green 100/pk
96-1504	25 x 3.0mm, 1" x 1/8"	Red 100/pk
96-1502	25 x 5.0mm, 1" x 3/16"	Yellow 100/pk
96-1500	19 x 1.0mm, 3/4" x 3/64"	Maroon 100/pk
96-1516	25 x 1.5mm, 1" x 3/8" x 1/16"	Orange 100/pk
96-1514	25 x 2.0mm, 1" x 5/8" x 5/64"	Brown 100/pk
96-1512	25 x 3.0mm, 1" x 1" x 1/8"	Black 100/pk
96-1518	Assorted	100/pk

INSTRUMENT PROTECTORS - VENTED

PRODUCT NUMBER	FEATURES	QUANTITIES
96-1410	19 x 1.5mm, 3/4" x 1/16"	White 100/pk
96-1408	19 x 2.0mm, 3/4" x 5/64"	Blue 100/pk
96-1406	19 x 3.0mm, 3/4" x 1/8"	Green 100/pk
96-1404	25 x 3.0mm, 1" x 1/8"	Red 100/pk
96-1402	25 x 5.0mm, 1" x 3/16"	Yellow 100/pk
96-1400	19 x 1.0mm, 3/4" x 3/64"	Maroon 100/pk
96-1416	25 x 1.5mm, 1" x 3/8" x 1/16"	Orange 100/pk
96-1414	25 x 2.0mm, 1" x 5/8" x 5/64"	Brown 100/pk
96-1412	25 x 3.0mm, 1" x 1" x 1/8"	Black 100/pk
96-1418	Assorted	100/pk

OSTEOTOME GUARDS - VENTED

PRODUCT NUMBER	FEATURES	QUANTITIES
96-1440	3/4" x 1/4"	50/pk
96-1442	1" x 3/8"	50/pk
96-1444	1" x 1/2"	50/pk
96-1446	1 1/2" x 1 1/2"	50/pk

TIP GRIPS

PRODUCT NUMBER	FEATURES	QUANTITIES
96-1550	.062" Yellow	3pr/pk, 5pks
96-1552	.062" Yellow	5pr/pk, 5pks

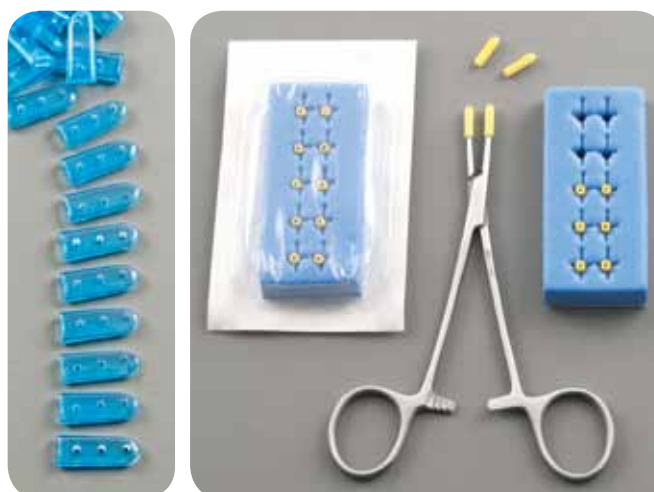

Instrument recognition is key to efficient processing in a busy clinical setting. SklarTip™ Instrument ID products offer a convenient color coded system for identifying instruments. Offered in various combinations including tape sheets, tape rolls and tags, products last through many autoclaving and gas sterilization processes. Latex Free.

ID SHEET TAPE

PRODUCT NUMBER	FEATURES	QUANTITIES
96-1845	Blue with White Stripes	1 Each
96-1846	Green with White Stripes	1 Each
96-1847	Red with White Stripes	1 Each
96-1848	Yellow with White Stripes	1 Each
96-1849	Orange with White Stripes	1 Each
96-1850	Brown with White Stripes	1 Each
96-1851	Lavender with White Stripes	1 Each
96-1852	Light Blue with White Stripes	1 Each
96-1853	Pink with White Stripes	1 Each



ID ROLL TAPE

PRODUCT NUMBER	FEATURES	QUANTITIES
96-1860	White 300" x 1/4"	1 Each
96-1862	Green 300" x 1/4"	1 Each
96-1864	Yellow 300" x 1/4"	1 Each
96-1866	Orange 300" x 1/4"	1 Each
96-1868	Black 300" x 1/4"	1 Each
96-1870	Purple 300" x 1/4"	1 Each
96-1872	Blue 300" x 1/4"	1 Each
96-1874	Red 300" x 1/4"	1 Each
96-1876	Brown 300" x 1/4"	1 Each



INSTRUMENT ID TAGS

PRODUCT NUMBER	FEATURES	QUANTITIES
96-1900	ID Repair Tags, Red	100/pk
96-1901	ID Repair Tags, Red	1000/pk
96-1903	Sklar Tags, White	100/pk
96-1905	ID Tags for Sharpen, Blue	100/pk
96-1906	ID Tags for Sharpen, Blue	1000/pk





CANNULA CLEANING BRUSHES

PRODUCT NUMBER	FEATURES		QUANTITIES
10-1350	12"	2mm Diameter	3/pk
10-1660	12"	3mm Diameter	3/pk
10-1661	12"	3mm Diameter	12/pk
10-1663	12"	3mm Diameter	24/pk
10-1352	12"	4mm Diameter	3/pk
10-1354	12"	5mm Diameter	3/pk
10-1356	12"	6mm Diameter	3/pk
10-1664	15"	9mm Diameter	3/pk
10-1665	15"	9mm Diameter	12/pk
10-1666	15"	9mm Diameter	24/pk
10-1668	15"	25mm Diameter	3/pk
10-1669	15"	25mm Diameter	12/pk
10-1672	15"	25mm Diameter	24/pk
10-1362	18"	5mm Diameter	3/pk
10-1364	18"	10mm Diameter	3/pk
10-1366	18"	15mm Diameter	3/pk
78-2824	19"	8mm Diameter	3/pk
10-1370	24"	2.5mm Diameter	3/pk
10-1372	24"	5mm Diameter	3/pk
10-1374	24"	7mm Diameter	3/pk
10-1376	24"	10mm Diameter	3/pk



TRACHEAL TUBE BRUSHES

PRODUCT NUMBER	FEATURES	QUANTITIES
78-2821	Small, 6" x 1/2" Diameter	6/pk
78-2822	Medium, 7" x 5/8" Diameter	6/pk



**INSTRUMENT CLEANING BRUSHES
(STAINLESS BRISTLES)**

PRODUCT NUMBER	FEATURES	QUANTITIES
10-1650	Stainless Steel Bristles	3/pk
10-1652	Stainless Steel Bristles	12/pk
10-1658	Stainless Steel Bristles	24/pk



**INSTRUMENT CLEANING BRUSHES
(NYLON BRISTLES)**

PRODUCT NUMBER	FEATURES	QUANTITIES
10-1651	Nylon Bristles	3/pk
10-1657	Nylon Bristles	12/pk
10-1659	Nylon Bristles	24/pk
10-1465	Nylon Bristles, Disposable	12/pk
10-1468	Nylon Bristles, Disposable	24/pk



**INSTRUMENT CLEANING BRUSHES
(DOUBLE ENDED)**

PRODUCT NUMBER	FEATURES	QUANTITIES
10-1444	Nylon Bristles	3/pk



**INSTRUMENT CLEANING BRUSHES
(DOUBLE TAPERED)**

PRODUCT NUMBER	FEATURES	QUANTITIES
10-1384	6", Double Tapered Brush	3/pk
10-1388	8", Double Tapered Brush	3/pk





SUCTION TUBE CLEANING BRUSHES (BARON & FRAZIER)

PRODUCT NUMBER	FEATURES		QUANTITIES
10-1396	6"	1.6mm	3/pk
10-1400	8"	2mm	3/pk
10-1401	8"	2.3mm	3/pk
10-1402	8"	2.6mm	3/pk
10-1403	8"	3mm	3/pk
10-1404	8"	3.3mm	3/pk
10-1405	8"	3.6mm	3/pk
10-1406	8"	4mm	3/pk



SURGICAL SCRUB BRUSHES

PRODUCT NUMBER	FEATURES	QUANTITIES
06-2880	With Channel Back	1 Each
06-2870	With Channel Back	12/pk
06-2882	With Nail Scrubber	1 Each
06-2873	With Nail Scrubber	12/pk
06-2881	Standard	1 Each
06-2872	Standard	12/pk



CANNULA INSTRUMENT CLEANERS

PRODUCT NUMBER	FEATURES		QUANTITIES
10-1470	12" Length	1/8" Diameter	3/pk
10-1472	12" Length	1/4" Diameter	3/pk



DOUBLE END VALVE BRUSHES

PRODUCT NUMBER	FEATURES	QUANTITIES
10-1398	5 3/4" Length 9mm and 5mm Diameter Nylon Tips	3/pk



SURFACE CLEANING BRUSH

FOR USE ON SINKS, AUTOCLAVES, ULTRASONIC CLEANERS, BOWLS, BASINS, ETC.

PRODUCT NUMBER	FEATURES	QUANTITIES
10-1418	3 1/4" L x 3" W Brush Head 4 1/2" Plastic handle 2" White medical grade Nylon bristles	3/pk



LARGE INSTRUMENT CLEANING BRUSH

FOR USE ON RETRACTORS, SPECULA, ETC.

PRODUCT NUMBER	FEATURES	QUANTITIES
10-1420	7" L x 1 1/4" W Brush Head 7 1/2" Plastic Handle Overall Length 14 1/2" 1" White medical grade Nylon bristles	3/pk



AUTOCLAVE CLEANING BRUSH

FOR USE ON AUTOCLAVE CHAMBERS AND DOORS, SINKS, CARTS, ETC.

PRODUCT NUMBER	FEATURES	QUANTITIES
10-1422	3 1/4" L x 3" W Brush Head 16" Plastic handle 2" White medical grade Nylon bristles	3/pk



INSTRUMENT SPOT REMOVER PAD

FOR USE ON O.R. GRADE SATIN FINISH INSTRUMENTS

PRODUCT NUMBER	FEATURES	QUANTITIES
10-1414	6" x 9"	1 Each
10-1415	6" x 9"	10/pk



BRUSH DRYING RACK & BRUSH HOLDER

PRODUCT NUMBER	FEATURES	QUANTITIES
10-1399	Brush Rack	1 Each
10-1545	Brush Holder	1 Each

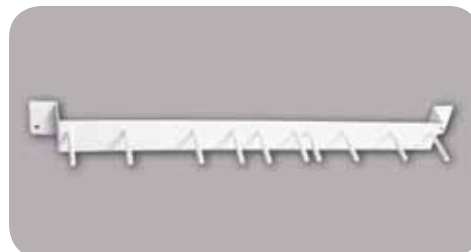



10-1426—INSTRUMENT CLEANING BRUSH SET

PRODUCT NUMBER	DESCRIPTION	QUANTITIES
10-1660	Cannula Cleaning Brush 12" 3mm, 3/pk	1 pk
10-1362	Cannula Cleaning Brush 18" 5mm, 3/pk	1 pk
10-1374	Cannula Cleaning Brush 24" 7mm, 3/pk	1 pk
10-1376	Cannula Cleaning Brush 24" 10mm, 3/pk	1 pk
10-1396	Suction Tube Brush 6" 1.6mm, 3/pk	1 pk
10-1400	Suction Tube Brush 8" 2mm, 3/pk	1 pk
10-1402	Suction Tube Brush 8" 2.6mm, 3/pk	1 pk
10-1404	Suction Tube Brush 8" 3.3mm, 3/pk	1 pk
10-1406	Suction Tube Brush 8" 4mm, 3/pk	1 pk
10-1418	Surface Cleaning Brush, 3/pk	1 pk
10-1444	Double End Brush Nylon, 3/pk	2 pks
10-1650	Brush Stainless Steel Bristle, 3/pk	1 pk
10-1651	Brush Nylon Bristle, 3/pk	2 pks



10-1428—ENDOSCOPIC BRUSH SET

PRODUCT NUMBER	DESCRIPTION	QUANTITIES
10-1350	Cannula Cleaning Brush 12" 2mm, 3/pk	1 pk
10-1660	Cannula Cleaning Brush 12" 3mm, 3/pk	1 pk
10-1354	Cannula Cleaning Brush 12" 5mm, 3/pk	1 pk
10-1362	Cannula Cleaning Brush 18" 5mm, 3/pk	1 pk
10-1364	Cannula Cleaning Brush 18" 10mm, 3/pk	1 pk
10-1370	Cannula Cleaning Brush 24" 2.5mm, 3/pk	1 pk
10-1372	Cannula Cleaning Brush 24" 5mm, 3/pk	1 pk
10-1376	Cannula Cleaning Brush 24" 10mm, 3/pk	1 pk
10-1398	Double End Valve Brush Nylon, 3/pk	2 pks
10-1444	Double End Brush Nylon, 3/pk	2 pks



10-1424—AUTOCLAVE CLEANING BRUSH SET

PRODUCT NUMBER	DESCRIPTION	QUANTITIES
10-1424HDL	Telescopic Handle extends from 24" to 48"	1 Each
10-1424PBR	Large Cleaning Brush 7½" L x 5½" W with round corner bristles	1 Each
10-1424BHD	Surface Cleaning Brush, 4½" handle	1 Each



10-1432—MICRO BRUSH SET

PRODUCT NUMBER	DESCRIPTION	QUANTITIES
10-1350	Cannula Cleaning Brush 12" 2mm, 3/pk	1 pk
10-1660	Cannula Cleaning Brush 12" 3mm, 3/pk	1 pk
10-1396	Suction Tube Brush 6" 1.6mm, 3/pk	1 pk
10-1400	Suction Tube Brush 8" 2mm, 3/pk	1 pk
10-1402	Suction Tube Brush 8" 2.6mm, 3/pk	1 pk
10-1404	Suction Tube Brush 8" 3.3mm, 3/pk	1 pk
10-1406	Suction Tube Brush 8" 4mm, 3/pk	1 pk
10-1444	Double End Brush Nylon, 3/pk	1 pk

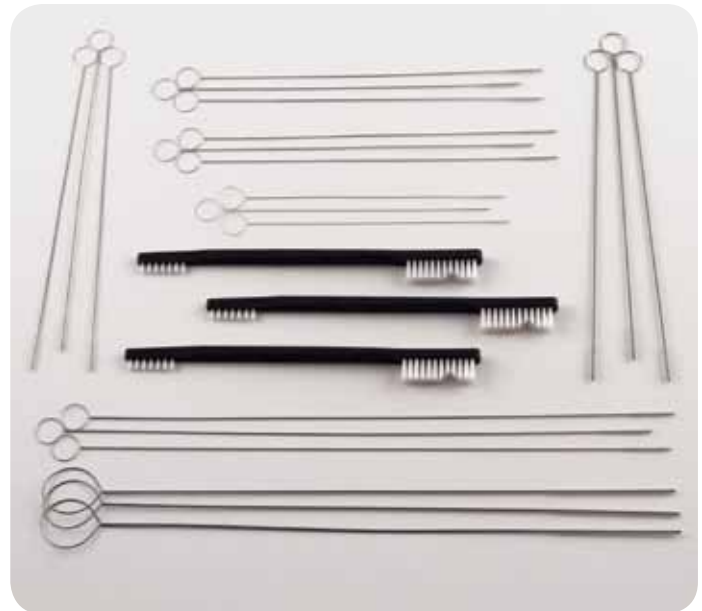

10-1434—ALL PURPOSE BRUSH SET

PRODUCT NUMBER	DESCRIPTION	QUANTITIES
10-1650	Brush Stainless Steel Bristle 3/pk	1 pk
10-1651	Brush Nylon Bristle 3/pk	1 pk
10-1420	Large Instrument Cleaning Brush 3/pk	1 pk
10-1418	Surface Cleaning Brush 3/pk	1 pk





Sklar is pleased to offer a full line of Care & Cleaning agents to disinfect, decontaminate, sterilize, lubricate and protect your stainless steel surgical instruments and equipment. For expert care of your surgical instruments at every stage of the cleaning process, trust Sklar to deliver the right cleaning agent for you.



3 EASY STEPS FOR THE CARE AND CLEANING OF YOUR INSTRUMENTS

1 DECONTAMINATION

Sklar Disinfectants are a pre-cleaner and disinfectant for the safe decontamination of soiled surgical instruments, medical and surgical equipment and inanimate surfaces including plastics, stainless steel, chrome, glass, Plexiglas and baked on painted surfaces.

Disinfectants are effective against a broad range of pathogens in as little as 2 minutes.



2 CLEANING

Sklar carries a complete line of effective detergents and enzymatics for cleaning, not only for your surgical instruments, but also metals, glassware, plastic and rubber. Available in your choice of powder, liquid concentrate or spray foams.



3 LUBRICATION

To guarantee extended life and performance of your surgical instruments, choose one of Sklar's lubricants or sprays as the final step in your instrument processing regimen. Specifically designed to protect against corrosion, rust and staining, Sklar offers several different types of lubricants to protect your investments.



SKLAR-CIDE™

HIGH LEVEL DISINFECTING/STERILIZING SOLUTION

Sporicidal • Bactericidal • Virucidal • Fungicidal

SKLAR-CIDE provides a safe and efficient means for the high-level disinfection or sterilization of medical, ophthalmic, dental and surgical devices including endoscopes and lensed instruments. It may be used as a standard soak solution or in automatic reprocessing units set at room temperature. Unlike other solutions, there is no need to increase the solution temperature to provide high-level disinfection in 25 minutes.

SKLAR-CIDE is a surfactant-free, activated glutaraldehyde liquid chemical sterilant and high-level disinfectant. Its active ingredient is glutaraldehyde in a nominal concentration of 3%. When the powdered activator is added, the solution turns green in color to indicate its readiness for use. In addition to the active ingredient, this ready-to-use solution contains buffers, wetting agents, and a rust and corrosion inhibitor and it has a pleasant fragrance.

SKLAR-CIDE produces high-level disinfection at room temperature in as little time as 25 minutes, and complete sterilization in 10 hours at room temperature.

- Reusable for 28 days instead of 14, safer and saves time and money.
- Surfactant free - Will not damage scope surfaces or cloud lenses.
- Can be used safely on all devices, including instruments and endoscopes. No need to stock several products.

PRODUCT NUMBER	FEATURES	QUANTITIES
10-1623	28 HLD 1 Gallon Bottles	4/case
10-1624	28 HLD 1 Gallon Bottle	1 bottle

GLUTARALDEHYDE STRIPS

PRODUCT NUMBER	FEATURES	QUANTITIES
96-4105	2.1% MEC 60 Strips / Bottle	2 bottles/case





SKLAR DISINFECTANT

2 MINUTE KILL TIME

READY-TO-USE SPRAY SURFACE DISINFECTANT

- Ready to use, non-toxic formula.
- Specially formulated for the control of cross contamination.
- Effective against a broad range of pathogens including H1N1, HIV-1, HPV, VRE, Norovirus, Hep B & C as well as TB, MRSA and A. Baumannii.
- Safe for all areas of the facility including the NICU, operating rooms, isolation rooms, patient care areas and laboratories.
- Satisfies OSHA's Bloodborne Pathogen Standards.
- Non-irritating formula.
- EPA registered.

PRODUCT NUMBER	FEATURES	QUANTITIES
10-1643	24 oz. Spray Bottles	6/case
10-1642	24 oz. Spray Bottle	1 bottle
10-1653	1 Gallon Bottles	4/case
10-1654	1 Gallon Bottle	1 bottle
10-1644	2.5 Gallon Bottles	2/case



SKLAR DISINFECTANT SURFACE WIPES

READY-TO-USE, PRE-MOISTENED TOWELETTES

**SAME EFFECTIVE FORMULA AS
SKLAR DISINFECTANT!**

- Ready to use, non-toxic formula.
- Specially formulated for the control of cross contamination.
- Effective against a broad range of pathogens including H1N1, HIV-1, HPV, VRE, Norovirus, Hep B & C as well as TB, MRSA and A. Baumannii.
- Safe for all areas of the facility.
- Satisfies OSHA's Bloodborne Pathogen Standards.
- Destroys odor-causing bacteria.
- 7" x 10" non-woven, tear resistant towelette.
- Clean scent.
- EPA registered.

PRODUCT NUMBER	FEATURES	QUANTITIES
10-1616	100 Towelettes / Canister	6/case
10-1617	100 Towelettes / Canister	12/case





SKLAR SPRAY-ZYME™

SURGICAL INSTRUMENT PRE-CLEANER

Multi-Enzyme Based Instrument Presoak & Cleaner Foam Spray Cleaner

The newest product from Sklar for expert care of your surgical instruments. This multi-enzymatic spray creates a heavy foam which lasts for hours, keeping soiled instruments moist to avoid encrustation while also pre-cleaning prior to processing.

- Prevents Organic Encrustation - enzyme foam stops blood and bodily fluids from drying onto surgical instruments.
- No More Spills - messy spills between the operating room and central cleaning / processing department are eliminated.
- Neutral pH - safe and effective for stainless steel, tungsten carbide, aluminum and brass instruments.
- Bacteriostatic - microbiological control agents inhibit bacterial growth in the ready-to-use foam solution.
- Long Lasting Foam - saves time, foam lasts many hours after application.
- Multi-Enzymatic - contains a synergistic blend of lipase and protease enzymes.

PRODUCT NUMBER	FEATURES	QUANTITIES
10-2722	22 oz. Refillable Spray Bottles	12/case
10-2724	1 Gallon Bottles	4/case



SKLAR SOAK™

INSTRUMENT PRE-SOAK & DECONTAMINANT RUST RESISTANT!

Immersing soiled instruments in SKLAR SOAK effectively pre-cleans and decontaminates, without fear of rusting!

SKLAR SOAK is an effective pre-cleaner that breaks down bio-burden, lifting blood and other organic debris from the surface, while penetrating box locks and crevices. The rust inhibitor protects the delicate chromium oxide layer of the instrument, thus defending against rust and corrosion. Using SKLAR SOAK™ as a pre-cleaner is the first line of defense against rust, prolonging the life of the instrument and therefore protecting your investment!

Soaking for only two minutes thoroughly decontaminates instruments, reducing the risk of exposure to pathogens such as H1N1, HIV-1, HPV, VRE, Norovirus, Hep B & C as well as TB, MRSA and A. Baumannii. However, because SKLAR SOAK™ contains a rust inhibitor, instruments may soak for several hours without fear of rusting! Employees are protected from cross contamination, and at the same time can enjoy the freedom to reprocess instruments when it's convenient!

SKLAR SOAK is ideal for use on all stainless steel instruments:

- PH balanced, designed specifically for stainless steel instruments.
- Intermediate level disinfectant with broad spectrum of efficacy.
- Rust resistant.
- Non-caustic.
- Ready to use.
- No special handling or disposal.
- Fragrant, no offensive odors.
- Non-glutaraldehyde.

PRODUCT NUMBER	FEATURES	QUANTITIES
10-1603	1 Gallon Bottles	4/case
10-1609	1 Gallon Bottle	1 bottle





SKLAR INSTRU-GUARD™ ONE STEP

A "ONE STEP" INSTRUMENT CLEANER AND LUBRICANT

EXTENDS INSTRUMENT LIFE!

SKLAR INSTRU-GUARD ONE STEP contains a penetrating lubricant that protects and helps extend the life of surgical instruments. The detergents and emulsifiers quickly break up and remove organic soils from box locks and other hard to reach places.

SKLAR INSTRU-GUARD ONE STEP contains four rust inhibitors to control corrosion and eliminate scaling and spotting. It does not contain phosphates and can reduce the time and cost involved in processing your instruments by cleaning and lubricating in one easy step.

PRODUCT NUMBER	FEATURES	QUANTITIES
10-2800	1 Gallon Bottles	4/case
10-2801	1 Gallon Bottle	1 bottle



SKLAR INSTRU-GUARD™ LUBE

SURGICAL INSTRUMENT LUBRICANT / RUST INHIBITOR

- Increase the Life of Instruments.
- Protects all Surgical Instruments.

SKLAR INSTRU-GUARD LUBE is an easy-to-use, water soluble, lubricant and rust inhibitor. When used daily as a rinse after every cleaning it keeps moving parts operating smoothly and remains effective after autoclaving, but without leaving an oily residue.

Regular lubrication is essential no matter which cleaning method is employed (including ultrasonic). SKLAR INSTRU-GUARD LUBE is ideal for maintaining instrument quality and performance.

PRODUCT NUMBER	FEATURES	QUANTITIES
10-1635	1 Gallon Containers Concentrated	4/case
10-1634	1 Gallon Container Concentrated	1 container
10-1636	8 oz. Spray Bottles	12/case
10-1637	8 oz. Spray Bottle	1 bottle





SKLAR KLEEN™

LOW FOAM, LIQUID DETERGENT AND POWDERED FORMULA

Regular Formula for Manual and Ultrasonic Cleaning

SKLAR KLEEN is non-corrosive, non aggressive, phosphate free and biodegradable. We have specifically developed SKLAR KLEEN for manual and ultrasonic cleaning. It is moderately alkaline, affording optimum cleaning without etching glassware or attacking instrument metal.

Low Foam Formula for Automatic Cleaning

The SKLAR KLEEN Low Foam Liquid is concentrated in order to provide a very cost-effective solution. It is especially formulated to maintain low foam, ensuring effective and trouble-free action in washer/sterilizers and tunnel washers. Dispersing quickly, the SKLAR KLEEN Low Foam formula is also well suited for automatic injection systems.

PRODUCT NUMBER	FEATURES	QUANTITIES
10-2701	Low Foam 1 Gallon Bottles	4/case
10-1608	Powdered 5 lb. Containers	4/case
10-1607	Powdered 5 lb. Container	1 container
10-1630	Powdered 3.5 lb. Pitchers	6/case
10-2765	Powdered 3.5 lb. Pitcher	1 pitcher
10-1612	Liquid 8 oz. Bottles	6/case
10-1614	Liquid 8 oz. Bottle	1 bottle
10-1613	Liquid 1 Gallon Bottles	4/case
10-1627	Liquid 1 Gallon Bottle	1 bottle



SKLAR-SHEEN™

AUTOCLAVE AND INSTRUMENT CLEANER AND CONDITIONER

With an efficacious phosphoric acid cleaning agent, Sklar Sheen is a robust spot, stain and rust remover. Ideal for dissolving hard water deposits, use in autoclaves to quickly cut through steam sterilizer scale and deposits.

Verstire and effective, SKLAR SHEEN couples powerful stain and rust removers with corrosion inhibitors, making it tough on stains but gentle on instruments. Recondition instruments to restore them to nearly brand new working condition.

Use to clean and recondition any stainless steel surface to its original luster, including carts, trays and basins.

- Conditions for lasting protection.
- Dissolves hard water deposits.
- Frees up frozen box locks.
- Restores and extends surgical instrument life.

PRODUCT NUMBER	FEATURES	QUANTITIES
10-2730	Stain & Rust Remover	1 gallon bottle
10-2732	Stain & Rust Remover	4/case
10-2736	Spray Foam Autoclave Cleaner & Conditioner	22oz. bottle
10-2738	Spray Foam Autoclave Cleaner & Conditioner	12/case





SKLAR ENZYMATIC™ DETERGENT

MULTI-ENZYME DETERGENT CONCENTRATE

100% Biodegradable

SKLAR ENZYMATIC Detergent is a low-foaming, fast acting detergent specifically designed for use when instruments and/or cloth materials become soiled with organic debris.

SKLAR ENZYMATIC Detergent may be used as a manual instrument cleaner as well as a pre-soak for blood-contaminated linens, clothing and instruments. It is also used in ultrasonic units and in washer/sterilizer/decontaminators. When used as directed, the enzymatic pH neutral formula is safe for use on rubber, plastic, stainless steel instruments, and surgical equipment as well as cloth.

PRODUCT NUMBER	FEATURES	QUANTITIES
10-2777	1 Gallon Bottles	4/case
10-2775	1 Gallon Bottles	2/case
10-2776	1 Gallon Bottle	1 bottle



3 EASY STEPS FOR THE CARE AND CLEANING OF YOUR INSTRUMENTS

DECONTAMINATION

1 SKLAR SPRAY DISINFECTANT™ Disinfectant / Decontaminant Cleaner

SKLAR DISINFECTANT is a pre-cleaner and disinfectant for the safe decontamination of soiled surgical instruments, medical and surgical equipment, and inanimate surfaces including plastics, stainless steel, chrome, glass, Plexiglas and baked on painted surfaces. The use of SKLAR DISINFECTANT for 2 minutes kills infectious organisms including H1N1, HIV-1, HPV, VRE, Norovirus, Hep B & C, as well as TB, MRSA, and A-Baumannii.



CLEANING

2 SKLAR KLEEN™ DETERGENTS AND ENZYMATICS

Sklar has an array of agents for effectively cleaning not only your surgical instruments, but for other metals, glassware, plastic, and rubber. SKLAR KLEEN detergent is available as a powder or liquid. Our enzymatic products, specially formulated for processing instruments heavily laden with organic debris, are concentrated and available in a variety of sizes. Sklar also offers SPRAY-ZYME™ a new foam spray pre-cleaner.



Choose The Cleaning Product Right For You!

LUBRICATION

3 SKLAR LUBRICANT AND SPRAY LUBE™

SKLAR LUBE should be a part of your instrument processing regimen to guarantee extending the life and performance of this very important investment. Sklar offers several different types of lubricant to suit your needs. All designed specifically for surgical instruments, they each contain rust inhibitors to protect against corrosion, rusting, and staining.



YOUR FINAL STEP IS AUTOCLAVE STERILIZATION Your Instruments Will Look And Work Like New!



SKLAR STAT™

INSTANT FOAM HAND SANITIZER

KILLS 99% OF GERMS IN LESS THAN 15 SECONDS!

SKLAR-STAT Instant Foam Hand Sanitizer, based on the active ingredient Benzalkonium Chloride, is a unique formulation featuring exceptional skin feel, conditioning and moisturizing properties. The efficacy of this product has been confirmed to reduce *S. Aureus* 99.999% and *S. Aureus* MRSA 99.9% in as little as 15 seconds. SKLAR-STAT Instant Foaming Hand Sanitizer produces a fast drying, non-sticky foam that contains unique conditioning and moisturizing ingredients, leaving the skin with a soft, silky after-feel.

PRODUCT NUMBER	FEATURES	QUANTITIES
10-2850	50 ml Pump Dispensers	24/case
10-2852	550 ml Pump Dispensers	12/case

SKLAR STAT™

AUTOMATIC FOAM DISPENSER

Motion activated, battery powered and wall-mounted, Sklar's AUTOMATIC FOAM DISPENSER allows for easy access and reduced risk of cross contamination. Ideal for use in hospitals, medical centers, offices, schools and any high-traffic public area with multiple users.



PRODUCT NUMBER	FEATURES	QUANTITIES
10-2856	Wall Mount Dispenser	1 Each
10-2854	1000ml Refill Bottles	6/case
10-2858	(2) Cases 1000ml Refill Bottles plus Free Wall Mount Dispenser	1 Set

- Alcohol-Free
- Non-Sticky
- Moisturizes and Conditions Hands

1. Pump a small amount into palm of hand.
2. Rub thoroughly over both surfaces of both hands.
3. Rub hands together briskly until dry.



SKLAR FRESH™

LIQUID SPRAY ODOR ABSORBER

SKLAR FRESH is an environmentally friendly blend of pure biodegradable organic essential oils and trace elements. It is a non-allergenic liquid spray that neutralizes odors at their source. Simply spray SKLAR FRESH directly in the air or on the source (i.e. bathrooms, refuse, soiled items from vomitus, incontinence odors, etc.)

PRODUCT NUMBER	FEATURES	QUANTITIES
10-2842	22 oz. Spray Bottles	12/case

SKLAR POLISH™

INSTRUMENT STAIN REMOVER

Non-Abrasive

SKLAR POLISH is an effective stain remover for use on all your metal surgical instruments, including stainless steel, chrome and brass. It will brighten instrument trays, basins and racks and may also be used on porcelain and tile surfaces.



PRODUCT NUMBER	FEATURES	QUANTITIES
10-1626	8 oz. Jars	12/case
10-1629	8 oz. Jars	6/case
10-1927	8 oz. Jar	1 jar





SKLAR INSTRUMENT CARE KIT

A Trio of Sklar's Care and Cleaning products to keep instruments in tiptop shape.

PRODUCT NUMBER	FEATURES	QUANTITIES
10-1625		
	Sklar Lube™ 8 oz. Spray Bottle	1 each
	Sklar Kleen™ Liquid 8 oz. Bottle	1 each
	Sklar Polish™ 8 oz. Jar	1 each
	Stainless Steel Bristle Cleaning Brush	1 each
	Nylon Bristle Cleaning Brush	1 each



TROUBLE SHOOTING

NO STEEL IS TRULY "STAINLESS"

It's a fact that so-called stainless steel is subject to both water-spotting and staining. However what many people identify as a "rust" problem usually turns out to be something else.

Most often the problem is actually a stain caused by a surface deposit. These deposits appear in a variety of colors depending upon the type of deposit involved. Once the cause is found and eliminated, most of the time the problem quickly diminishes or disappears completely.

As you probably know, stainless steel is ideally suited for the surgical suite because it is rust resistant, it can be honed to an extremely sharp edge or fine point,

and it can be hardened to maintain the delicate, yet precise, requirements of the surgeon. But it is this hardenable quality – the amount of carbon used during the manufacturing process – coupled with harsh chemicals and improper care that renders stainless steel susceptible to corrosion.

To protect your instrument investment, Sklar cleaning agents have been specifically formulated to provide cost effective instrument care solutions that help maintain the life and performance of your valuable stainless steel instruments.

TROUBLE SHOOTING

CORROSION

- Problem:** Debris and residue in box locks, serrations and ratchets.
- Solution:** Serrations, box locks and ratchets should be carefully cleaned and rinsed. A soft bristle brush is effective in these difficult areas.
- Problem:** Moisture remaining on the instruments within the sterile wrapped packs; excessive moisture in autoclave during sterilization and termination of cycle.
- Solution:** Preheat autoclave, drying time cannot be accelerated, open autoclave door slightly. Routinely inspect valves. Malfunctioning valves can precipitate corrosion.
- Problem:** Some local water supplies contain excessive quantities of alkali. This can manifest itself by depositing corrosive matter on the instruments.
- Solution:** It is generally accepted that cold distilled or demineralized water be used during sterilization. An alternative is to use the local water supply, while instituting a program of preventive maintenance. Carefully clean surfaces with SKLAR KLEEN™, using SKLAR POLISH™ to remove difficult stains and SKLAR LUBE™ for proper lubrication.

PITTING

- Problem:** Instruments are inevitably exposed to chemical compounds that initiate pitting. The most common are saline solutions and blood.
- Solution:** It is essential that instruments be rinsed with distilled or demineralized water and then cleaned routinely.
- Problem:** Some Non-Sklar detergents contain a chloride or have an acid base. If rinsing is not thorough, the residual detergent can precipitate pitting. Hydrochloric acid can be formed by the combination of chloride in the cleaner and steam, causing the instrument to pit.
- Solution:** Evaluate detergents without a chloride base. SKLAR KLEEN™ is recommended.
- Problem:** Instruments may be pitted when the detergent used has an excessively high pH. If instruments are not rinsed thoroughly and then autoclaved, the heat increases the effect of the solution on the instruments.
- Solution:** Use only detergents specifically developed for instrument cleaning. SKLAR KLEEN™ products are pH balanced.

BROWNISH STAIN

- Problem:** This stain is more obvious on dull finish instruments. Most likely, it is a deposit of chromium oxide. The thin hard layer protects stainless steel from corrosion precipitated by the atmosphere. The brownish film (sometimes dull blue) occurs naturally when stainless is heated. Occasionally this stain can be traced to the sterilizer. Improper cleaning compounds could contain poly phosphates that cause the copper components in the sterilizer to be deposited by electrolytic action on the stainless steel instruments.
- Solution:** Water supply to autoclave should be cold and demineralized. Use the correct amount of SKLAR KLEEN™ as recommended for best results.

BLUISH GRAY STAINS

- Problem:** Cold sterilizing solutions.
- Solution:** In the preparation of the solution make certain the manufacturer's directions are followed accurately. To minimize discoloration use distilled water and add a rust inhibitor. Using the solution beyond recommended time limitations will cause the solution to become corrosive.

RUST DEPOSIT

- Problem:** Sterilizing instruments of different metals in the same cycle will cause rusting. An electrolytic action carries the carbon particles from the exposed metal and deposits them on the stainless steel instruments. The rapid oxidation of molecules results in a surface film of rust.
- Solution:** The ideal technique would be to sterilize the two types of instruments separately. It is recommended that chrome plated instruments that indicate signs of peeling or flaking be replaced with stainless steel instruments.
- Problem:** The rust film on the surface of stainless steel instruments can be caused by chemicals in the detergent. Excess amounts of iron or other minerals from the local water supply may cause the rust deposits.
- Solution:** It is recommended that instruments be rinsed with distilled or demineralized water. Surface rust can be removed by light buffing or an application of SKLAR POLISH™.

LIGHT AND DARK COLORED SPOTS

- Problem:** Spotting caused by slow evaporation of water drops identified with the mineral content of the water.
- Solution:** Eliminate water droplets by adhering to autoclave manufacturer's operating instructions. Autoclave door should not be opened until steam has been completely vented.



06-2870.....223	10-1170.....200	10-1483.....198	10-1542.....204
06-2872.....223	10-1171.....200	10-1483-12.....198	10-1542-12.....204
06-2873.....223	10-1172.....197	10-1484.....198	10-1542-6.....204
06-2880.....223	10-1173.....197	10-1484-12.....198	10-1543.....200
06-2881.....223	10-1174.....197	10-1485.....198	10-1543-12.....200
06-2882.....223	10-1175.....197	10-1485-12.....198	10-1544.....200
06-2903.....159, 192	10-1176.....197	10-1486.....198	10-1544-12.....200
06-2904.....192	10-1177.....197	10-1486-12.....198	10-1544-6.....200
06-2907.....192	10-1178.....197	10-1487.....199	10-1545.....200, 224
06-2908.....192	10-1180.....197	10-1488.....198	10-1545-12.....200
06-2910.....192	10-1181.....197	10-1488-12.....198	10-1545-6.....200
06-2912.....192	10-1182.....199	10-1489.....198	10-1546.....216
06-2915.....192	10-1183.....199	10-1489-12.....198	10-1546-6.....216
06-2920.....192	10-1184.....199	10-1491.....198	10-1547.....200
06-2925.....192	10-1186.....199	10-1491-12.....198	10-1547-12.....200
06-2930.....192	10-1188.....199	10-1492.....198	10-1547-6.....200
06-3010.....193	10-1189.....199	10-1492-12.....198	10-1550.....200
06-3011.....159, 193	10-1190.....199	10-1493.....198	10-1550-12.....200
06-3012.....193	10-1192.....200	10-1493-12.....198	10-1550-6.....200
06-3013.....193	10-1211.....174	10-1494.....198	10-1551.....199
06-3015.....159, 193	10-1280.....125, 174	10-1494-12.....198	10-1552.....198
06-3016.....193	10-1340.....207	10-1494-6.....198	10-1552-12.....198
06-3020.....193	10-1342.....207	10-1495.....198	10-1552-6.....198
06-3021.....193	10-1344.....207	10-1495-12.....198	10-1560.....203
06-3022.....193	10-1346.....207	10-1495-6.....198	10-1603.....8, 232
06-3023.....193	10-1347.....207	10-1496.....198	10-1607.....11, 235
06-3024.....195	10-1348.....207	10-1496-12.....198	10-1608.....11, 235
06-3030.....195	10-1349.....207	10-1497.....199	10-1609.....8, 232
06-3090.....192	10-1350.....221	10-1497-12.....199	10-1612.....11, 235
06-3094.....194	10-1352.....221	10-1498.....198	10-1613.....11, 235
06-3095.....194	10-1354.....221	10-1498-12.....198	10-1614.....11, 235
06-3096.....194	10-1356.....221	10-1502.....217	10-1616.....6, 95, 201, 230
06-3100.....193	10-1362.....221	10-1502-12.....217	10-1617.....6, 95, 201, 230
06-3101.....193	10-1364.....221	10-1504.....217	10-1623.....4, 228
06-3102.....193	10-1366.....221	10-1504-12.....217	10-1624.....4, 228
06-3103.....193	10-1370.....221	10-1505.....198	10-1625.....17, 25, 241
06-3104.....193	10-1372.....221	10-1505-12.....198	10-1626.....16, 240
06-3105.....193	10-1374.....221	10-1505-6.....198	10-1627.....11, 235
06-3106.....193	10-1376.....221	10-1507.....198	10-1629.....16, 240
06-3107.....193	10-1384.....222	10-1507-12.....198	10-1630.....11, 235
06-3108.....193	10-1388.....222	10-1507-6.....198	10-1634.....10, 234
06-3110.....193	10-1396.....223	10-1510.....198	10-1635.....10, 234
06-3111.....193	10-1398.....223	10-1510-12.....198	10-1636.....10, 234
06-3112.....193	10-1399.....224	10-1510-6.....198	10-1637.....10, 234
06-3115.....193	10-1400.....223	10-1523.....200	10-1642.....5, 84, 229
06-3120.....193	10-1401.....223	10-1523-12.....200	10-1643.....5, 84, 229
06-3121.....193	10-1402.....223	10-1525.....201	10-1644.....5, 84, 229
06-3122.....193	10-1403.....223	10-1525-12.....201	10-1650.....222
06-3123.....193	10-1404.....223	10-1527.....200	10-1651.....222
06-3130.....194	10-1405.....223	10-1527-12.....200	10-1652.....222
06-3132.....194	10-1406.....223	10-1533.....200	10-1653.....5, 84, 229
06-3134.....194	10-1414.....224	10-1533-12.....200	10-1654.....5, 84, 229
06-7052.....195	10-1415.....224	10-1535.....204-205	10-1657.....222
07-1562.....125	10-1418.....224	10-1535-12.....204-205	10-1658.....222
07-1563.....125	10-1420.....224	10-1535-6.....204-205	10-1659.....222
07-1801.....154	10-1422.....224	10-1536.....197	10-1660.....221
07-1802.....154	10-1424.....226	10-1536-12.....197	10-1661.....221
07-1805.....154	10-1426.....225	10-1538.....200	10-1663.....221
07-1806.....154	10-1428.....225	10-1538-12.....200	10-1664.....221
08-1011.....217	10-1432.....226	10-1539.....197	10-1665.....221
10-1013.....174	10-1434.....226	10-1539-12.....197	10-1666.....221
10-1080.....125, 174	10-1444.....222	10-1539-6.....197	10-1668.....221
10-1081.....174	10-1450.....199	10-1540.....199	10-1669.....221
10-1111.....174	10-1451.....199	10-1540-12.....199	10-1670.....197
10-1157.....200	10-1465.....222	10-1540-6.....199	10-1670-12.....197
10-1158.....200	10-1468.....222	10-1541.....200	10-1670-24.....197
10-1159.....200	10-1470.....223	10-1541-12.....200	10-1670-48.....197
10-1160.....200	10-1472.....223	10-1541-6.....200	10-1671.....197

10-1671-12.....	197	10-1712.....	206	10-1763.....	208	10-1894.....	204
10-1671-24.....	197	10-1713.....	205	10-1764.....	204	10-1895.....	204
10-1671-48.....	197	10-1714.....	205	10-1766.....	204	10-1927.....	16, 240
10-1672.....	221	10-1716.....	206	10-1768.....	201	10-1941.....	204
10-1674.....	198	10-1717.....	206	10-1770.....	208	10-1942.....	204
10-1674-12.....	198	10-1720.....	205	10-1772.....	208	10-1943.....	204
10-1674-6.....	198	10-1722.....	202	10-1775.....	208	10-1944.....	204
10-1675.....	197	10-1722-12.....	202	10-1776.....	208	10-1947.....	205
10-1675-12.....	197	10-1722-6.....	202	10-1780.....	208	10-1948.....	204-205
10-1675-24.....	197	10-1724.....	204	10-1800.....	207	10-1948-12.....	204-205
10-1675-48.....	197	10-1724-12.....	204	10-1805.....	207	10-1948-6.....	204-205
10-1679.....	205	10-1724-6.....	204	10-1806.....	207	10-1949.....	204
10-1680.....	203	10-1725.....	206	10-1808.....	207	10-1949-12.....	204
10-1680-12.....	203	10-1731.....	203	10-1810.....	207	10-1949-6.....	204
10-1680-6.....	203	10-1732.....	203	10-1812.....	207	10-1950.....	204
10-1683.....	203	10-1733.....	203	10-1814.....	207	10-1950-12.....	204
10-1683-12.....	203	10-1734.....	203	10-1816.....	207	10-1950-6.....	204
10-1683-6.....	203	10-1736.....	203	10-1818.....	207	10-1952.....	204
10-1684.....	202	10-1736-12.....	203	10-1826.....	207	10-1952-12.....	204
10-1684-12.....	202	10-1737.....	204	10-1828.....	207	10-1952-6.....	204
10-1684-6.....	202	10-1737-12.....	204	10-1830.....	207	10-1953.....	204-205
10-1685.....	202	10-1737-6.....	204	10-1832.....	207	10-1953-12.....	204-205
10-1685-12.....	202	10-1738.....	202	10-1834.....	207	10-1953-6.....	204-205
10-1685-6.....	202	10-1738-12.....	202	10-1835.....	204	10-1954.....	204-205
10-1686.....	202	10-1738-6.....	202	10-1835-6.....	204	10-1954-12.....	204-205
10-1686-12.....	202	10-1740.....	204	10-1836.....	207	10-1954-6.....	204-205
10-1686-6.....	202	10-1741.....	204	10-1838.....	207	10-1955.....	202
10-1687.....	202	10-1741-6.....	204	10-1839.....	208	10-1955-12.....	202
10-1687-12.....	202	10-1742.....	204	10-1850.....	205	10-1955-6.....	202
10-1687-6.....	202	10-1742-12.....	204	10-1854.....	205	10-1956.....	202
10-1688.....	202	10-1742-6.....	204	10-1854-12.....	205	10-1956-12.....	202
10-1688-12.....	202	10-1744.....	204	10-1854-6.....	205	10-1956-6.....	202
10-1688-6.....	202	10-1744-12.....	204	10-1860.....	205	10-1957.....	205
10-1689.....	202	10-1744-6.....	204	10-1862.....	204	10-1960.....	218
10-1689-6.....	202	10-1746.....	204	10-1864.....	205	10-1961.....	218
10-1690.....	202	10-1746-12.....	204	10-1870.....	204	10-1962.....	218
10-1690-12.....	202	10-1746-6.....	204	10-1870-12.....	204	10-1964.....	218
10-1690-6.....	202	10-1747.....	204	10-1870-6.....	204	10-1965.....	218
10-1691.....	202	10-1747-12.....	204	10-1874.....	204	10-1965-12.....	218
10-1691-12.....	202	10-1747-6.....	204	10-1876.....	203	10-1965-6.....	218
10-1691-6.....	202	10-1748.....	204	10-1876-12.....	203	10-1966.....	218
10-1692.....	202	10-1748-12.....	204	10-1876-6.....	203	10-1966-12.....	218
10-1692-12.....	202	10-1748-6.....	204	10-1877.....	204	10-1966-6.....	218
10-1692-6.....	202	10-1749.....	204	10-1877-12.....	204	10-1967.....	218
10-1693.....	202	10-1750.....	205	10-1877-6.....	204	10-1967-12.....	218
10-1693-12.....	202	10-1750-12.....	205	10-1878.....	204	10-1967-6.....	218
10-1693-6.....	202	10-1750-6.....	205	10-1878-12.....	204	10-2555.....	218
10-1694.....	202	10-1752.....	205	10-1878-6.....	204	10-2556.....	218
10-1694-12.....	202	10-1752-12.....	205	10-1879.....	204	10-2557.....	218
10-1694-6.....	202	10-1752-6.....	205	10-1882.....	204	10-2701.....	11, 235
10-1695.....	202	10-1753.....	204	10-1882-12.....	204	10-2722.....	7, 231
10-1695-12.....	202	10-1753-12.....	204	10-1882-6.....	204	10-2724.....	7, 231
10-1695-6.....	202	10-1753-6.....	204	10-1883.....	203	10-2730.....	12, 236
10-1697.....	204	10-1754.....	204	10-1883-12.....	203	10-2732.....	12, 236
10-1698.....	199	10-1754-12.....	204	10-1883-6.....	203	10-2736.....	12, 236
10-1698-12.....	199	10-1754-6.....	204	10-1884.....	203	10-2738.....	12, 236
10-1699.....	199	10-1755.....	204	10-1884-12.....	203	10-2765.....	11, 235
10-1699-12.....	199	10-1755-12.....	204	10-1884-6.....	203	10-2775.....	13, 237
10-1700.....	206	10-1755-6.....	204	10-1886.....	202	10-2776.....	13, 237
10-1701.....	206	10-1756.....	204	10-1886-12.....	202	10-2777.....	13, 237
10-1702.....	206	10-1756-12.....	204	10-1886-6.....	202	10-2800.....	9, 233
10-1703.....	206	10-1756-6.....	204	10-1887.....	202	10-2801.....	9, 233
10-1705.....	206	10-1757.....	204	10-1887-12.....	202	10-2842.....	16, 240
10-1706.....	206	10-1758.....	204	10-1887-6.....	202	10-2850.....	15, 239
10-1707.....	206	10-1759.....	204	10-1888.....	203	10-2852.....	15, 239
10-1708.....	206	10-1760.....	202	10-1888-12.....	203	10-2854.....	15, 70, 102, 239
10-1710.....	205	10-1760-12.....	202	10-1888-6.....	203	10-2856.....	15, 70, 102, 239
10-1711.....	206	10-1760-6.....	202	10-1892.....	204	10-2858.....	15, 70, 102, 239

10-4646.....	210	10-6095.....	185	15-2060.....	145	16-2105.....	140
10-4648.....	210	10-6120.....	185	15-2065.....	145	16-2110.....	140
10-4650.....	210	10-6125.....	185	15-2555.....	146	16-2115.....	140
10-4652.....	210	10-6155.....	185	15-2567.....	146	16-2205.....	140
10-4654.....	210	10-6390.....	185	15-3150.....	151	16-2210.....	140
10-4656.....	210	10-6395.....	185	15-3305.....	143	16-2211.....	140
10-4658.....	210	10-6405.....	185	15-3306.....	143	16-2215.....	140
10-4660.....	210	10-6500.....	213	15-3310.....	143	16-2305.....	140
10-4662.....	210	10-6501.....	213	15-3311.....	143	16-2310.....	140
10-4664.....	210	10-6505.....	213	15-3315.....	143	16-2311.....	140
10-4666.....	210	10-6506.....	213	15-3325.....	144	16-2312.....	140
10-4668.....	210	10-6510.....	214	15-3326.....	144	16-2405.....	140
10-4670.....	210	10-6511.....	214	15-3330.....	144	16-2505.....	140
10-4672.....	210	10-6515.....	214	15-3331.....	144	16-2800.....	73, 141
10-4674.....	210	10-6516.....	214	15-3340.....	144	16-3503.....	142
10-4676.....	210	10-6520.....	214	15-3342.....	144	16-3504.....	142
10-4678.....	210	10-6521.....	214	15-3343.....	144	16-3505.....	142
10-4680.....	210	10-6525.....	215	15-3348.....	144	16-3506.....	142
10-4682.....	210	10-6526.....	215	15-3349.....	144	16-3507.....	142
10-4684.....	210	10-6531.....	215	15-3352.....	143	16-3508.....	142
10-4686.....	210	10-6536.....	215	15-3357.....	143	16-3509.....	142
10-4688.....	210	11-1035.....	152	15-3403.....	143	16-3510.....	142
10-4690.....	210	11-1045.....	152	15-3404.....	143	16-3511.....	142
10-4692.....	210	11-1055.....	152	15-3405.....	143	16-3513.....	142
10-4694.....	210	11-1060.....	152	15-3406.....	143	16-3514.....	142
10-4696.....	210	11-1072.....	152	15-3407.....	143	16-3515.....	142
10-4698.....	210	11-1080.....	152	15-3408.....	143	16-3526.....	142
10-4700.....	210	11-1255.....	152	15-3409.....	143	16-3527.....	142
10-4702.....	210	13-1045.....	145	15-3410.....	143	16-3528.....	142
10-4704.....	210	13-1050.....	145	15-3411.....	143	16-3545.....	142
10-4706.....	210	13-1055.....	145	15-3412.....	143	16-3546.....	142
10-4708.....	210	13-1060.....	145	15-3426.....	144	16-3614.....	140
10-4710.....	210	13-1065.....	145	15-3427.....	144	16-3615.....	140
10-4712.....	210	13-1072.....	145	15-3429.....	144	16-3620.....	140
10-4714.....	210	13-2045.....	145	15-3430.....	144	16-3621.....	140
10-4716.....	210	13-2050.....	145	15-3434.....	144	17-1230.....	121
10-4718.....	210	13-2055.....	145	15-3435.....	144	17-1232.....	121
10-4720.....	210	13-2060.....	145	15-3442.....	144	17-1235.....	121
10-4722.....	210	13-2065.....	145	15-3443.....	144	17-1335.....	121
10-4724.....	210	13-2072.....	145	15-3444.....	143	17-1450.....	57, 121
10-4726.....	210	14-1045.....	145	15-3448.....	144	17-1455.....	57, 121
10-4728.....	210	14-1050.....	145	15-3449.....	144	17-1550.....	57, 121
10-4730.....	210	14-1055.....	145	15-3452.....	143	17-1555.....	57, 121
10-4732.....	210	14-1060.....	145	15-3457.....	143	17-1650.....	57, 121
10-4734.....	210	14-1065.....	145	15-3507.....	143	17-1750.....	57, 121
10-4736.....	210	14-1072.....	145	15-3508.....	143	17-1850.....	57, 121
10-4738.....	210	14-2045.....	145	15-3509.....	143	17-2055.....	122
10-4784.....	210	14-2050.....	145	16-1055.....	141	17-2155.....	122
10-4786.....	210	14-2055.....	145	16-1056.....	141	18-1050.....	57, 121
10-4788.....	210	14-2060.....	145	16-1057.....	141	18-1150.....	57, 121
10-4790.....	210	14-2065.....	145	16-1155.....	141	18-1552.....	122
10-4900.....	211	14-2072.....	145	16-1156.....	141	18-1652.....	122
10-4910.....	211	15-1045.....	145	16-1157.....	141	18-2140.....	122
10-4925.....	211	15-1050.....	145	16-1505.....	141	18-2155.....	122
10-4930.....	211	15-1055.....	145	16-1510.....	141	18-2162.....	122
10-4930ENG.....	211	15-1060.....	145	16-1515.....	141	18-2164.....	122
10-4970.....	210	15-1065.....	145	16-1605.....	141	19-1040.....	122
10-4975.....	211	15-1242.....	143	16-1610.....	141	19-1045.....	122
10-4985.....	212	15-1243.....	143	16-1615.....	141	19-1050.....	122
10-6000.....	185	15-1342.....	143	16-1805.....	140	19-1055.....	122
10-6005.....	185	15-1343.....	143	16-1810.....	140	19-1060.....	122
10-6025.....	185	15-1355.....	150, 165	16-1815.....	140	19-1070.....	122
10-6045.....	185	15-1358.....	151	16-1905.....	140	19-1080.....	122
10-6055.....	185	15-1555.....	146	16-1910.....	140	19-1110.....	122
10-6060.....	185	15-1567.....	146	16-1915.....	140	19-1112.....	122
10-6080.....	185	15-2045.....	145	16-2005.....	140	19-1245.....	123
10-6085.....	185	15-2050.....	145	16-2010.....	140	19-1250.....	123
10-6090.....	185	15-2055.....	145	16-2015.....	140	19-1255.....	123



19-1260.....	123	21-8007.....	127	22-1455.....	145	23-2136.....	129
19-1270.....	123	21-8008.....	127	22-1545.....	145	23-2220.....	129
19-1280.....	123	21-8009.....	127	22-1550.....	145	23-2224.....	129
19-1310.....	123	21-8010.....	127	22-1555.....	145	23-2225.....	129
19-1312.....	123	21-8011.....	127	22-1556.....	146	23-2228.....	130
19-1445.....	123	21-8012.....	127	22-1567.....	146	23-2230.....	130
19-1450.....	123	21-8013.....	127	22-1645.....	145	23-2232.....	130
19-1455.....	123	21-8014.....	127	22-1650.....	145	23-2234.....	130
19-1460.....	123	21-8016.....	127	22-1655.....	145	23-2235.....	130
19-1480.....	123	21-8019.....	127	22-2450.....	146	23-2236.....	129
19-1510.....	123	21-8020.....	127	22-2460.....	146	23-2500.....	120
19-1512.....	123	21-8021.....	127	22-2520.....	149, 160	23-2501.....	120
19-1650.....	123	21-8022.....	127	22-2522.....	149	23-2505.....	120
19-1655.....	123	21-8023.....	127	22-2545.....	146	23-2506.....	120
19-1660.....	123	21-8024.....	127	22-2550.....	146	23-2507.....	120
19-1850.....	123	21-8025.....	126	22-2555.....	146	23-2508.....	120
19-1855.....	123	21-8026.....	126	22-2567.....	146	23-2600.....	119
19-1905.....	123	21-8027.....	126	22-2650.....	146	23-2602.....	119
19-1910.....	123	21-8028.....	126	22-2745.....	149, 159	23-2603.....	119
19-2260.....	124	21-8029.....	126	22-2750.....	149	23-2604.....	119
19-2280.....	124	21-8030.....	126	22-2751.....	149, 160	23-2606.....	119
19-2310.....	124	21-8031.....	126	22-2755.....	148	23-2608.....	119
19-2320.....	124	21-8032.....	126	22-2834.....	150	23-2811.....	119
19-2860.....	123	21-8033.....	126	22-2835.....	150	23-2819.....	119
19-2880.....	123	21-8034.....	126	22-2837.....	151	23-2824.....	119
19-2910.....	123	21-8035.....	126	22-2844.....	150	23-2826.....	119
19-3055.....	57	21-8040.....	87	22-2845.....	150	23-2828.....	119
19-3056.....	57	21-8041.....	127	22-2855.....	148	23-2830.....	119
19-3147.....	57	21-8043.....	87	22-2934.....	150	23-2834.....	119
19-3161.....	57	21-8046.....	87	22-2935.....	150	23-2836.....	119
20-1265.....	132, 160	21-8047.....	87	22-2947.....	150	23-2838.....	119
20-1270.....	132	21-8051.....	126	22-2950.....	151	23-2851.....	120
20-1280.....	132	21-8070.....	127	22-4150.....	123	23-2852.....	120
20-1290.....	132	21-8071.....	127	22-4152.....	123	23-2861.....	120
20-1295.....	132	21-8080.....	127	22-4154.....	123	23-2862.....	120
20-1350.....	131	21-9012.....	128	22-4156.....	123	23-2864.....	120
20-1352.....	131	21-9016.....	128	22-4350.....	123	23-2865.....	120
20-1450.....	131	21-9018.....	128	22-4352.....	123	24-1962.....	149
20-1547.....	131	21-9030.....	128	22-4354.....	123	24-2335.....	37, 150
20-1750.....	132	21-9035.....	128	22-4356.....	123	24-2337.....	37, 152
20-1751.....	132	21-9045.....	128	22-4550.....	123	24-2340.....	37, 73, 152
20-2052.....	131	21-9060.....	74	22-6157.....	122	24-2341.....	37, 73, 152
20-2060.....	131	21-9065.....	74	22-6585.....	154	24-2342.....	73, 150
20-2070.....	131	22-1054.....	152	22-6586.....	154	24-2345.....	37, 73, 152
20-2270.....	131	22-1057.....	146	22-6590.....	155	24-2346.....	37, 73, 152
20-2480.....	131	22-1061.....	123	22-6591.....	155	24-2347.....	150
20-2490.....	131	22-1062.....	123	22-8945.....	135	24-2355.....	152
20-2747.....	131	22-1063.....	123	22-8946.....	135	36-2060.....	122
20-2748.....	131	22-1064.....	123	22-9132.....	136	36-2160.....	122
20-2755.....	131	22-1072.....	152	22-9133.....	136	36-2162.....	122
20-2765.....	131	22-1135.....	147	22-9141.....	136	36-2260.....	122
20-2775.....	131	22-1145.....	145	22-9142.....	136	36-2262.....	122
20-2910.....	131	22-1150.....	145	22-9143.....	136	36-2275.....	122
20-2911.....	131	22-1155.....	145	22-9144.....	136	36-2295.....	122
20-3055.....	132	22-1161.....	123	23-2100.....	120	40-3186.....	89, 139
20-3070.....	132	22-1162.....	123	23-2101.....	120	40-3189.....	89, 139
20-3075.....	132	22-1163.....	123	23-2105.....	120	40-3190.....	138
20-3080.....	132	22-1164.....	123	23-2106.....	120	40-3191.....	89, 139
21-2240.....	127	22-1235.....	147	23-2107.....	120	40-3192.....	138
21-7012.....	126	22-1245.....	145	23-2108.....	120	40-3196.....	139
21-7013.....	126	22-1250.....	145	23-2120.....	129	40-3198.....	139
21-8000.....	126	22-1255.....	145	23-2124.....	129	40-3206.....	139
21-8001.....	126	22-1345.....	145	23-2125.....	129	40-3208.....	139
21-8002.....	127	22-1350.....	145	23-2128.....	130	40-3215.....	139
21-8003.....	127	22-1354.....	150	23-2130.....	130	40-3220.....	139
21-8004.....	126	22-1355.....	145	23-2132.....	130	40-3225.....	139
21-8005.....	126	22-1445.....	145	23-2134.....	130	40-4268.....	138
21-8006.....	127, 159, 164	22-1450.....	145	23-2135.....	130	40-4270.....	138



40-5765	95	48-105	55	48-768	125	49-0245	24
40-5870	95	48-109	113	48-774	135	49-0250	24, 163
40-5871	95	48-116	49	48-776	104	49-0255	25
40-5925	95, 164	48-128	48, 57	48-785	135	49-0260	25, 163
40-5926	95	48-130	29, 51	48-796	61	49-0265	25
40-7368	164	48-202	45	48-835	65	49-0270	25
41-1050	147	48-204	108	48-885	32, 54	49-0275	25
41-1054	147	48-226	106	48-904	104	49-0400	26, 58
41-1163	151	48-228	40	48-922	85	49-0405	26, 58
41-1339	96	48-236	36	48-965	57	49-0410	26, 58
46-4700	176	48-238	110	48-966	57	49-0415	26, 58
46-4705	176	48-252	110	48-967	57	49-0420	26, 58
47-1047	146	48-264	105	49-0001	19	49-0425	26, 58
47-1048	146	48-266	36	49-0002	19	49-0430	26, 58
47-1049	146	48-274	38	49-0003	19	49-0435	26, 58
47-1058	146	48-276	106	49-0004	19, 163	49-0440	26, 58
47-1059	146	48-278	38	49-0005	19	49-0445	26, 58
47-1060	146	48-282	38	49-0006	19	49-0450	26, 58
47-1068	146	48-288	38	49-0007	19	49-0455	27, 59
47-1069	146	48-289	105	49-0010	20	49-0460	27, 59
47-1070	146	48-296	38	49-0011	20	49-0465	27, 59
47-1071	146	48-301	111	49-0012	20	49-0470	27, 59
47-1072	146	48-309	61	49-0013	20	49-0475	27, 59
47-1075	146	48-315	48	49-0014	20	49-0480	27, 59, 162-164
47-1078	148	48-318	49	49-0015	20	49-0485	27, 59
47-1079	148	48-321	23	49-0016	20	49-0490	27, 59
47-1080	149	48-322	49	49-0017	20	49-0495	27, 59
47-1081	149	48-327	111	49-0018	20	49-0500	27, 59
47-1084	149	48-339	108	49-0019	20	49-0600	28, 50, 156
47-1085	149	48-350	49	49-0020	20	49-0605	28, 50, 156
47-1086	149	48-351	108	49-0021	20	49-0610	28, 50
47-1087	149	48-355	62	49-0026	21	49-0615	28, 50, 156, 158
47-1135	147	48-356	62	49-0027	21	49-0620	28, 50, 156
47-1140	147	48-358	62	49-0028	21	49-0625	28, 50, 156, 158-159
47-1143	147	48-363	116	49-0029	21	49-0630	28, 50
47-1144	147	48-368	48	49-0030	21	49-0635	28, 50, 156, 158-160, 165
47-1145	147	48-375	116	49-0031	21	49-0640	29, 51
47-1235	147	48-378	48, 57	49-0032	21	49-0645	29, 51, 156
47-1240	147	48-388	47	49-0034	21	49-0650	29, 51, 156
47-1243	147	48-389	62	49-0036	21, 163	49-0655	29, 51, 156
47-1244	147	48-422	42	49-0100	22	49-0660	29, 51, 156, 158, 161-165
47-1245	147, 162-164	48-424	42	49-0101	22	49-0665	29, 51
47-1246	147	48-425	62	49-0105	22	49-0670	29, 51
47-1248	147	48-428	42	49-0110	22	49-0675	29, 51
47-1340	147	48-434	28, 50	49-0115	22	49-0680	30, 52, 156, 159, 161
47-1360	146	48-462	63	49-0120	22	49-0685	30, 52, 156
47-1440	147	48-472	29, 51	49-0125	22, 163	49-0690	30, 52, 156
47-1441	147	48-489	137	49-0130	22, 163	49-0695	30, 52, 156
47-1442	147	48-498	63	49-0135	23	49-0700	30, 52, 156
47-1447	124	48-500	62	49-0140	23	49-0705	30, 52, 156
47-1450	124	48-507	63	49-0145	23	49-0800	31, 53, 158
47-2047	124	48-524	44	49-0150	23	49-0805	31, 53
47-2049	124	48-526	44	49-0155	23	49-0810	31, 53, 160
47-2147	124	48-533	64	49-0160	23	49-0815	31, 53
47-2148	124	48-538	44	49-0165	23	49-0820	31, 53, 160-161, 165
47-2380	102	48-561	29, 51	49-0170	23	49-0825	31, 53
47-2447	124	48-562	64	49-0175	23	49-0830	31, 53, 161, 164-165
47-2455	138	48-648	64	49-0180	23	49-0835	32, 54
47-2555	136	48-698	65	49-0185	23	49-0840	32, 54, 158-159, 161, 164
47-2556	136	48-708	37, 73, 152	49-0200	24	49-0845	32, 54
47-2670	136	48-721	37, 73, 152	49-0205	24	49-0850	32, 54
47-2837	125	48-729	37, 73, 152	49-0210	24		
47-2852	125	48-735	37, 73, 152	49-0215	24		
47-2925	125	48-738	65	49-0220	24		
47-2930	125	48-752	105	49-0225	24		
47-2935	125	48-756	107	49-0230	24		
47-2955	125	48-761	125	49-0235	24		
48-102	55	48-766	107	49-0240	24		



49-0855	32, 54	49-1475	46	49-1990	63	49-2415	71
49-0860	32, 54	49-1480	46	49-1995	64	49-2420	71
49-0865	33, 160, 163, 165	49-1485	46	49-2000	64	49-2425	71
49-0890	33, 162-164	49-1490	46	49-2005	64	49-2430	71
49-0895	33	49-1500	47	49-2010	64	49-2435	71
49-0900	34	49-1505	47	49-2015	64	49-2440	71
49-0905	33, 162-164	49-1510	47	49-2020	64	49-2445	71, 161-162
49-0910	34, 162-163	49-1515	47	49-2025	64	49-2450	71
49-0915	34	49-1520	47	49-2030	64	49-2455	71
49-0920	34	49-1525	47	49-2035	65	49-2460	72
49-0925	34	49-1530	47	49-2040	65	49-2465	72
49-0930	34	49-1535	47	49-2045	65	49-2470	72
49-0935	34	49-1540	47	49-2050	65	49-2475	72
49-0940	35	49-1545	47	49-2055	65	49-2480	72
49-0945	35	49-1550	47	49-2060	65	49-2500	74
49-0950	35	49-1555	47	49-2065	65	49-2505	74
49-0955	35	49-1560	47	49-2070	66	49-2510	74, 161
49-0960	35	49-1565	47	49-2075	66	49-2515	74
49-0965	35	49-1570	47	49-2080	67	49-2520	74
49-0970	35	49-1575	47	49-2085	67	49-2525	75, 162
49-1000	36	49-1580	47, 163	49-2090	67	49-2530	75
49-1005	36	49-1590	47, 160, 162-164	49-2095	67	49-2535	75
49-1015	36	49-1600	45	49-2100	67	49-2540	75, 161-162
49-1020	36	49-1605	45	49-2105	67	49-2545	75
49-1025	36	49-1700	48, 57, 156	49-2110	67	49-2550	75
49-1030	36	49-1705	48, 57, 156	49-2115	67	49-2600	78, 164
49-1050	38, 157	49-1710	48, 156	49-2120	67	49-2605	78, 164
49-1055	38, 157	49-1715	48, 156	49-2125	67	49-2610	78, 159-161, 165
49-1060	38, 157	49-1720	48, 156	49-2130	67	49-2615	78
49-1065	38, 157	49-1725	48	49-2135	67	49-2620	78
49-1070	38, 157	49-1730	48	49-2140	68	49-2625	78, 165
49-1200	39, 60	... 49, 156, 158-159, 161-165		49-2145	68	49-2630	78
49-1205	39, 60	49-1735	49, 156	49-2150	68	49-2635	78
49-1210	39, 60	49-1740	49, 156	49-2155	68 79, 157, 159, 161, 165	
49-1215	39, 60, 163 49, 156, 160-161, 165		49-2160	68	49-2640	79, 157
49-1220	39, 60	49-1745	49, 156, 158	49-2165	68	49-2645	79, 157, 161
49-1225	39, 60, 163	49-1750	49, 156	49-2170	68	49-2650	79, 157, 159, 161, 165
49-1230	39, 60	49-1755	49, 156	49-2175	68 79, 157, 159, 161, 165	
49-1235	39, 60	49-1760	49, 156	49-2180	68	49-2655	79, 157
49-1250	40, 161, 163	49-1765	49, 156	49-2185	68	49-2660	79, 157, 159, 161
49-1255	40, 161, 163	49-1770	49, 156	49-2190	68	49-2665	79, 157, 159, 161
49-1260	40, 161, 163	49-1800	44	49-2195	68	49-2670	79, 157
49-1270	41	49-1805	44	49-2200	68	49-2675	79, 157, 165
49-1271	41	49-1810	44	49-2205	69	49-2700	80, 160
49-1272	41	49-1815	44	49-2210	69	49-2705	80, 160
49-1273	41	49-1820	44, 162-164	49-2215	69, 162	49-2710	80, 160
49-1280	41	49-1825	44	49-2220	69	49-2715	80, 160
49-1285	41	49-1830	44	49-2225	69	49-2720	80, 160
49-1290	41	49-1835	44	49-2230	69	49-2725	80, 160
49-1295	41	49-1840	44	49-2235	69	49-2730	80, 160
49-1300	41	49-1900	61	49-2240	69	49-2750	80
49-1305	42, 162-164	49-1905	61	49-2245	69	49-2755	80
49-1310	42	49-1910	61	49-2250	69	49-2760	81
49-1315	42	49-1915	61	49-2255	69, 162	49-2765	81
49-1320	42	49-1920	61	49-2260	69	49-2770	81
49-1325	42	49-1925	61	49-2265	69	49-2775	81
49-1350	43	49-1930	62	49-2270	69	49-2800	81
49-1355	43	49-1935	62	49-2275	70, 161-162	49-2805	81
49-1360	43	49-1940	62	49-2280	70, 161-162	49-2810	81
49-1365	43	49-1945	62	49-2285	70	49-2815	81
49-1370	43	49-1950	62	49-2290	70	49-2820	81
49-1440	46	49-1955	62	49-2295	70	49-2825	81
49-1445	46	49-1960	62	49-2300	70	49-2830	81
49-1450	46	49-1965	63	49-2305	70	49-2835	81
49-1455	46	49-1970	63	49-2310	70	49-2840	81
49-1460	46	49-1975	63	49-2400	72, 162	49-2845	81
49-1465	46	49-1980	63	49-2405	71	49-2870	82
49-1470	46	49-1985	63	49-2410	71, 161-162	49-2875	82

49-2880.....	82	49-3405.....	96	49-3815.....	90	49-4320.....	113
49-2885.....	82	49-3410.....	96	49-3820.....	90	49-4325.....	113
49-2900.....	82	49-3415.....	96	49-3825.....	90	49-4350.....	113
49-2905.....	82	49-3420.....	96	49-3830.....	90	49-4355.....	113
49-2910.....	82	49-3425.....	96	49-4000.....	104	49-4360.....	113
49-2920.....	83	49-3430.....	96	49-4005.....	104, 157	49-4365.....	113
49-2925.....	83	49-3435.....	96	49-4010.....	104	49-4370.....	113
49-2930.....	83	49-3440.....	96	49-4015.....	104	49-4380.....	113
49-2940.....	83	49-3445.....	96	49-4020.....	104	49-4385.....	114
49-2945.....	83, 159-161, 165	49-3450.....	96	49-4025.....	104	49-4390.....	114
49-2950.....	83	49-3455.....	96	49-4030.....	104, 157	49-4395.....	114
49-2955.....	83, 159-161, 165	49-3460.....	96	49-4035.....	104	49-4400.....	115
49-2960.....	83	49-3465.....	96	49-4040.....	104	49-4405.....	115
49-2965.....	84, 160	49-3470.....	96	49-4045.....	105	49-4410.....	115
49-2970.....	84	49-3475.....	96	49-4050.....	105	49-4415.....	115
49-2975.....	84	49-3480.....	96	49-4055.....	105	49-4420.....	115
49-2980.....	84	49-3485.....	96	49-4060.....	105, 157	49-4425.....	115
49-3000.....	85, 160	49-3490.....	96	49-4065.....	105	49-4430.....	116, 157
49-3005.....	85, 160	49-3495.....	96	49-4070.....	105	49-4435.....	116
49-3010.....	85, 160	49-3500.....	97	49-4075.....	105	49-4440.....	116, 157
49-3015.....	85, 160	49-3505.....	97	49-4080.....	105	49-4445.....	116
49-3020.....	85, 160	49-3510.....	97	49-4085.....	105	49-4450.....	116
49-3025.....	85	49-3515.....	97	49-4090.....	106	49-4455.....	116
49-3050.....	85	49-3520.....	97	49-4095.....	106	49-4460.....	117
49-3055.....	85, 159	49-3525.....	97	49-4100.....	106	49-4465.....	117
49-3060.....	86	49-3530.....	97	49-4105.....	106	49-4470.....	117
49-3065.....	86	49-3535.....	97	49-4110.....	106	49-4475.....	117
49-3080.....	86	49-3540.....	97	49-4115.....	106	49-4500.....	137
49-3081.....	86	49-3545.....	97	49-4120.....	106	49-4505.....	137
49-3082.....	86	49-3550.....	97	49-4125.....	107	49-4600.....	176
49-3083.....	86	49-3600.....	98	49-4130.....	107	49-4605.....	176
49-3084.....	86	49-3605.....	98	49-4135.....	107	49-4610.....	176
49-3085.....	86	49-3610.....	98	49-4140.....	107, 157	49-4615.....	176
49-3086.....	86	49-3615.....	98	49-4145.....	107, 157	49-4620.....	176
49-3100.....	88	49-3620.....	98	49-4150.....	107	49-4625.....	176
49-3105.....	175	49-3625.....	98	49-4155.....	107	49-4630.....	176
49-3110.....	175	49-3630.....	98	49-4160.....	108	49-4635.....	176
49-3115.....	175	49-3635.....	98	49-4165.....	108	49-4640.....	176
49-3120.....	175	49-3640.....	99	49-4170.....	108	49-4645.....	176
49-3125.....	88, 160	49-3645.....	99	49-4175.....	108	49-4650.....	176
49-3130.....	88, 160	49-3650.....	99	49-4180.....	108	49-4655.....	176
49-3140.....	175	49-3655.....	99	49-4185.....	108	49-4660.....	176
49-3150.....	174	49-3660.....	99	49-4190.....	109	49-4665.....	176
49-3155.....	174	49-3665.....	99	49-4195.....	109	49-4670.....	176
49-3170.....	175	49-3670.....	99	49-4200.....	109	49-4675.....	176
49-3175.....	175	49-3675.....	99	49-4205.....	109	49-4680.....	176
49-3180.....	175	49-3680.....	99	49-4210.....	109	49-4685.....	176
49-3200.....	88	49-3685.....	100	49-4215.....	109	49-4690.....	176
49-3205.....	88	49-3690.....	100	49-4220.....	110	49-4695.....	176
49-3210.....	88	49-3695.....	100	49-4225.....	110	49-4710.....	176
49-3215.....	94	49-3700.....	100	49-4230.....	110	49-4715.....	176
49-3240.....	94, 159	49-3705.....	100	49-4235.....	110	49-4800.....	77, 175
49-3245.....	94	49-3710.....	100	49-4240.....	110	49-5000.....	190
49-3250.....	94	49-3715.....	100	49-4245.....	110	49-5002.....	189
49-3255.....	94	49-3720.....	100	49-4250.....	110	49-5004.....	190
49-3260.....	94	49-3725.....	100	49-4255.....	111, 157	49-5006.....	190
49-3265.....	94	49-3730.....	101	49-4260.....	111	49-5008.....	189
49-3300.....	91	49-3735.....	101	49-4265.....	111, 157	49-5010.....	191
49-3305.....	91	49-3740.....	101	49-4270.....	111	49-5012.....	190
49-3310.....	91, 159	49-3745.....	101	49-4275.....	111	49-5014.....	189
49-3315.....	91	49-3750.....	101	49-4280.....	111, 157	49-5016.....	189
49-3330.....	91	49-3755.....	101	49-4285.....	112	49-5018.....	189
49-3335.....	91	49-3760.....	101	49-4290.....	112	49-5018S.....	189
49-3340.....	91	49-3765.....	102	49-4295.....	112	49-5024.....	190
49-3345.....	91	49-3770.....	102	49-4300.....	112	49-5026.....	189
49-3350.....	91	49-3800.....	90	49-4305.....	112	49-5028.....	190
49-3355.....	91, 164	49-3805.....	90	49-4310.....	112	49-5030.....	191
49-3400.....	96	49-3810.....	90	49-4315.....	113, 157	49-5032.....	191



49-5034.....	191	65-4099.....	155	55, 158-159, 160-165	93-1750-2.....	134
49-5036.....	191	65-4100.....	155	73-1500.....	55	93-1750-3.....	134
49-5038.....	191	65-4101.....	155	73-1505.....	55, 159	93-1750-4.....	134
49-5040.....	191	65-4103.....	155	73-1510.....	55	93-1750-5.....	134
49-5042.....	191	65-4105.....	155	73-1515.....	55	93-1751-1.....	134
49-5044.....	191	65-4107.....	155	73-1520.....	55, 159	93-1751-2.....	134
49-5046.....	191	65-6265.....	87	73-1525.....	55	93-1751-3.....	134
50-1953.....	155	65-6357.....	87	73-1530.....	55	93-1751-4.....	134
50-1955.....	155	65-6358.....	87	73-1535.....	55	93-1751-5.....	134
50-1957.....	155	65-6550.....	131	73-1540.....	55	93-1760-1.....	133
50-1982.....	154	65-6554.....	87	73-1545.....	55	93-1760-10.....	133
50-1985.....	154	66-1035.....	125	73-1550.....	55	93-1760-12.....	133
50-2006.....	154	66-1036.....	125	73-1600.....	56	93-1760-14.....	133
50-2007.....	154	66-1038.....	125	73-1605.....	56	93-1760-16.....	133
50-2008.....	154	66-2734.....	124	73-1610.....	56	93-1760-2.....	133
50-2009.....	154	66-2736.....	124	73-1615.....	56	93-1760-4.....	133
50-2010.....	154	66-2738.....	124	73-1620.....	56	93-1760-6.....	133
50-2011.....	154	66-2740.....	124	73-1625.....	56	93-1760-8.....	133
50-2012.....	154	66-2840.....	124	74-3260.....	122	93-1762-1.....	133
50-2014.....	154	66-2940.....	124	74-3270.....	122	93-1762-10.....	133
50-2106.....	154	66-3140.....	124	75-1006.....	135	93-1762-11.....	133
50-2108.....	154	66-3240.....	124	75-1007.....	135	93-1762-12.....	133
50-2109.....	154	66-3340.....	124	75-1010.....	135	93-1762-13.....	133
50-2110.....	154	66-3341.....	124	75-1015.....	135	93-1762-14.....	133
50-2112.....	154	66-3540.....	124	75-1016.....	135	93-1762-16.....	133
50-2206.....	154	66-3541.....	124	75-1017.....	135	93-1762-18.....	133
50-2207.....	154	66-3740.....	124	75-1025.....	135	93-1762-2.....	133
50-2208.....	154	66-3741.....	124	75-1026.....	135	93-1762-20.....	133
50-2210.....	154	66-7447.....	174	75-1030.....	135	93-1762-3.....	133
50-2212.....	154	66-7642.....	174	75-1031.....	135	93-1762-4.....	133
50-2825.....	154	66-7644.....	174	75-1032.....	135	93-1762-5.....	133
50-3046.....	124	67-4620.....	96	75-1033.....	135	93-1762-6.....	133
50-3047.....	124, 159	67-4621.....	96	75-1034.....	135	93-1762-7.....	133
50-3147.....	124, 159	67-4622.....	96	75-1118.....	137	93-1762-8.....	133
50-4462.....	148	67-5175.....	138	75-1120.....	137, 159	93-1762-9.....	133
50-4465.....	148	67-5458.....	139	75-1122.....	137	93-1770-0.....	133
50-4562.....	147	67-5987.....	138	75-1124.....	137	93-1770-00.....	133
50-4563.....	147	67-5988.....	138	75-1140.....	136	93-1770-1.....	133
50-4662.....	148	67-5990.....	138	75-1141.....	136	93-1770-2.....	133
50-4664.....	148	67-5991.....	138	75-2155.....	137	93-1770-3.....	133
51-3447.....	118	67-5992.....	138	75-2160.....	137	93-1770-4.....	133
51-3448.....	118	67-5994.....	138	75-2161.....	137	93-1770-5.....	133
51-3460.....	118	73-1188.....	56	75-5267.....	148	93-1770-6.....	133
51-3480.....	118	73-1189.....	56	75-5460.....	146	93-1770-7.....	133
52-1277.....	164	73-1190.....	56	78-1001.....	136	93-1770-8.....	133
60-6162.....	136	73-1191.....	56	78-1002.....	136	93-1770-9.....	133
60-6164.....	136	73-1192.....	56	78-1003.....	136	93-1780-1.....	133
64-1160.....	148	73-1193.....	56	78-1101.....	136	93-1780-10.....	133
64-1161.....	148	73-1194.....	56	78-1102.....	136	93-1780-11.....	133
64-1345.....	151	73-1195.....	56	78-1103.....	136	93-1780-12.....	133
64-1348.....	151	73-1196.....	56	78-2821.....	222	93-1780-2.....	133
64-1445.....	151	73-1197.....	56	78-2822.....	222	93-1780-3.....	133
64-1942.....	89	73-1400.....	78-2824.....	221	93-1780-4.....	133
64-2042.....	147	55, 158-159, 160-165	90-1590.....	146	93-1780-5.....	133
64-2142.....	147	73-1405.....	55	90-1690.....	146	93-1780-6.....	133
64-2143.....	147	73-1410.....	55, 159	93-1740-1.....	133	93-1780-7.....	133
64-2242.....	153	73-1415.....	55	93-1740-2.....	133	93-1780-8.....	133
64-2342.....	153	73-1420.....	55	93-1740-3.....	133	93-1780-9.....	133
64-2440.....	89, 153	73-1450.....	55	93-1740-4.....	133	96-1161.....	188
64-2442.....	89, 153	73-1455.....	55	93-1741-1.....	133	96-1162.....	188
64-2535.....	153	73-1460.....	55	93-1741-2.....	133	96-1163.....	188
64-3210.....	153	73-1465.....	55	93-1741-3.....	133	96-1164.....	188
64-3211.....	153	73-1470.....	55	93-1741-4.....	133	96-1175.....	188
64-3212.....	153	73-1475.....	55	93-1742-1.....	134	96-1400.....	219
64-3215.....	153	73-1480.....	55	93-1742-2.....	134	96-1402.....	219
64-3294.....	153	73-1485.....	55	93-1742-3.....	134	96-1404.....	219
64-3296.....	153	73-1490.....	55	93-1742-4.....	134	96-1406.....	219
65-4098.....	155	73-1495.....	93-1750-1.....	134	96-1408.....	219

96-1410	219	96-2182	188	96-2558	170	96-2704	168
96-1412	219	96-2184	188	96-2559	170	96-2707	169
96-1414	219	96-2186	188	96-2560	169	96-2708	169
96-1416	219	96-2190	188	96-2561	169	96-2710	171
96-1418	219	96-2192	188	96-2562	169	96-2712	171
96-1440	219	96-2194	188	96-2563	169	96-2720	167
96-1442	219	96-2196	188	96-2564	171	96-2721	167
96-1444	219	96-2198	188	96-2565	171	96-2726	167
96-1446	219	96-2402	168	96-2566	169	96-2728	167
96-1500	219	96-2404	168	96-2567	169	96-2765	170
96-1502	219	96-2410	170	96-2568	170	96-2774	170
96-1504	219	96-2412	170	96-2569	170	96-2775	170
96-1506	219	96-2445	179	96-2570	170	96-2902	186
96-1508	219	96-2447	179	96-2571	170	96-2903	186
96-1510	219	96-2449	179	96-2572	170	96-2905	186
96-1512	219	96-2452	181	96-2573	170	96-2906	186
96-1514	219	96-2456	179	96-2574	170	96-2907	186
96-1516	219	96-2497	167	96-2575	170	96-2908	186
96-1518	219	96-2499	167	96-2576	170	96-2909	186
96-1550	219	96-2500	168	96-2577	170	96-2910	186
96-1552	219	96-2501	168	96-2578	170	96-2914	186
96-1621	182	96-2502	168	96-2579	170	96-2915	186
96-1630	217	96-2503	168	96-2580	171	96-2916	186
96-1662	182	96-2504	167	96-2581	171	96-2917	186
96-1665	183	96-2505	167	96-2582	172	96-2918	187
96-1669	183	96-2506	167	96-2583	172	96-2919	187
96-1670	183	96-2507	167	96-2584	172	96-2921	170
96-1679	217	96-2510	168	96-2585	172	96-2929	187
96-1845	220	96-2511	168	96-2586	172	96-2930	187
96-1846	220	96-2512	168	96-2587	172	96-2931	187
96-1847	220	96-2513	168	96-2590	172	96-3006	169
96-1848	220	96-2514	167	96-2591	172	96-3008	169
96-1849	220	96-2516	167	96-2592	167	96-3010	169
96-1850	220	96-2517	167	96-2593	167	96-3160	188
96-1851	220	96-2518	168	96-2594	171	96-3162	188
96-1852	220	96-2519	168	96-2595	171	96-3164	188
96-1853	220	96-2520	167	96-2596	168	96-3166	188
96-1860	220	96-2521	167	96-2597	167	96-3168	188
96-1862	220	96-2522	167	96-2598	168	96-3170	188
96-1864	220	96-2523	167	96-2599	171	96-3172	188
96-1866	220	96-2524	167	96-2630	171	96-3174	188
96-1868	220	96-2525	167	96-2632	171	96-3176	188
96-1870	220	96-2526	167	96-2634	171	96-3178	188
96-1872	220	96-2527	167	96-2636	171	96-3179	188
96-1874	220	96-2528	171	96-2649	167	96-3180	188
96-1876	220	96-2529	171	96-2650	167	96-3182	188
96-1900	220	96-2530	167	96-2651	167	96-3184	188
96-1901	220	96-2531	167	96-2652	169	96-3186	188
96-1903	220	96-2532	171	96-2653	169	96-3190	188
96-1905	220	96-2533	171	96-2654	168	96-3192	188
96-1906	220	96-2536	169	96-2655	170	96-3194	188
96-1940	182	96-2537	169	96-2656	170	96-3196	188
96-1942	182	96-2538	169	96-2657	169	96-3198	188
96-1944	182	96-2539	169	96-2658	169	96-3250	177
96-1946	182	96-2544	169	96-2659	172	96-3251	177
96-1949	182	96-2545	169	96-2660	170	96-3252	177
96-2160	188	96-2546	169	96-2661	170	96-3253	177
96-2162	188	96-2547	169	96-2662	168	96-3254	177
96-2164	188	96-2548	169	96-2663	168	96-3255	177
96-2166	188	96-2549	169	96-2664	169	96-3256	177
96-2168	188	96-2550	169	96-2670	170	96-3257	177
96-2170	188	96-2551	169	96-2672	168	96-3258	177
96-2172	188	96-2552	169	96-2680	167	96-3259	177
96-2174	188	96-2553	169	96-2682	167	96-3260	177
96-2176	188	96-2554	169	96-2688	170	96-3261	177
96-2178	188	96-2555	169	96-2701	168	96-3262	177
96-2180	188	96-2556	169	96-2702	168	96-3264	177
96-2181	188	96-2557	169	96-2703	168	96-3266	177



96-3270.....177	96-3422.....77, 177	96-8967.....173	97-1652.....155
96-3271.....177	96-4105.....4, 228	96-8968.....173	97-1654.....155
96-3272.....177	96-5003B.....196	96-8969.....173	97-1721.....195
96-3273.....177	96-5005B.....196	96-8970.....173	97-1820.....195
96-3274.....177	96-5006B.....196	96-8971.....173	97-1821.....195
96-3280.....178	96-5267.....184	96-8972.....173	97-1822.....195
96-3281.....178	96-5280.....184	96-8973.....173	97-1823.....195
96-3283.....178	96-5281.....184	96-8974.....173	97-1824.....195
96-3284.....178	96-5282.....184	96-8975.....173	97-1825.....195
96-3285.....178	96-5283.....184	96-8977.....173	97-1826.....195
96-3286.....178	96-5284.....184	97-231.....152	98-104.....147
96-3287.....178	96-5285.....184	97-241.....152	98-109.....147
96-3288.....178	96-5286.....184	97-247.....148	98-1476.....156
96-3289.....178	96-5296.....183	97-249.....149	98-1477.....156
96-3290.....178	96-5297.....183	97-272.....145	98-1478.....157
96-3291.....178	96-5298.....183	97-275.....145	98-1479.....157
96-3292.....178	96-5329.....196	97-308.....146	98-1480.....38, 157
96-3295.....178	96-5331.....196	97-312.....146	98-1481.....158
96-3296.....178	96-5333.....196	97-314.....148	98-1482.....158
96-3298.....76, 178	96-5557.....	97-316.....148	98-1483.....158
96-3299.....76, 17840, 66, 114, 184, 196	97-318.....148	98-1484.....159
96-3300.....76, 178	96-5557A.....	97-346.....150	98-1485.....159
96-3301.....17840, 66, 114, 184, 196	97-352.....150	98-1486.....160
96-3302.....178	96-5557BNS.....	97-358.....150	98-1487.....160
96-3303.....17840, 66, 114, 184, 196	97-364.....73	98-1488.....160
96-3304.....178	96-5627.....182	97-409.....121	98-1489.....161
96-3315.....179	96-5628.....184	97-421.....121	98-1490.....161
96-3316.....179	96-5629.....184	97-426.....57, 121	98-1491.....161
96-3321.....179	96-5658.....187	97-431.....57, 121	98-1492.....162
96-3322.....179	96-5659.....187	97-436.....122	98-1493.....162
96-3325.....179	96-5660.....187	97-442.....122	98-1494.....163
96-3326.....179	96-5661.....187	97-809.....131	98-1495.....163
96-3330.....180	96-5699.....183	97-826.....131	98-1496.....164
96-3331.....180	96-5700.....183	97-832.....131	98-1497.....164
96-3332.....180	96-7020.....216	97-838.....132	98-1498.....164
96-3333.....180	96-7024.....218	97-842.....131	98-1499.....165
96-3336.....180	96-7025.....218	97-847.....131	98-1500.....165
96-3340.....180	96-7027.....181, 216	97-872.....131	
96-3341.....180	96-7028.....216	97-877.....131	
96-3350.....43, 77, 180	96-7033.....218	97-883.....132	
96-3352.....43, 77, 180	96-7154.....181	97-0050.....103	
96-3354.....76, 90, 181	96-7174.....216	97-0511.....103	
96-3356.....76, 90, 181	96-7175.....218	97-0527.....103, 164	
96-3358.....45, 77, 181	96-7177.....218	97-0530.....103, 159, 164	
96-3360.....76, 181	96-7178.....218	97-0535.....103	
96-3362.....76, 181	96-7268.....216	97-1241.....89	
96-3370.....76	96-7270.....216	97-1243.....89	
96-3372.....76	96-7451.....216	97-1400.....195	
96-3374.....76	96-7459.....216	97-1405.....195	
96-3376.....76	96-7543.....217	97-1410.....195	
96-3380.....76	96-7548.....182	97-1415.....195	
96-3382.....76	96-7887.....181	97-1420.....195	
96-3384.....76	96-8923.....183	97-1425.....195	
96-3386.....76	96-8924.....183	97-1430.....195	
96-3388.....76	96-8936.....183	97-1445.....195	
96-3390.....76	96-8937.....183	97-1450.....195	
96-3392.....76	96-8938.....182	97-1533.....92	
96-3394.....76	96-8939.....182	97-1545.....92	
96-3396.....77	96-8940.....182	97-1564.....92	
96-3398.....77	96-8941.....182	97-1615.....92, 159	
96-3400.....77	96-8942.....182	97-1617.....92	
96-3402.....77	96-8948.....182	97-1620.....92	
96-3410.....77, 177	96-8951.....181	97-1625.....92	
96-3412.....77, 177	96-8962.....173	97-1635.....93	
96-3414.....77, 177	96-8963.....173	97-1640.....93	
96-3416.....77, 177	96-8964.....173	97-1642.....93	
96-3418.....77, 177	96-8965.....173	97-1645.....93	
96-3420.....77, 177	96-8966.....173	97-1650.....155	

A

A Three-Way Partnership Pamphlet	189
Abell Pliers	62
Abell Pliers, Mid Grade	62
Accessories, SklarLite™	211
Account Record Card	191
Acetate, Kno-Kurl™	45, 77, 181
Acorn Burnisher	24
Adams Pliers	68
Adhesive Kit, Super "C" Ortho	77
Adson (Ewald) Dressing Forcep	124, 159
Adson Dressing Forcep	124
Adson Dressing Forcep, Econo-Sterile™	170
Adson Dressing Forcep, Sklarlite™	119
Adson Dressing Forcep, Sklarlite™	119
Adson Dressing Forcep, TC	118
Adson Suction Tube	154
Adson Tissue Forcep	124, 159
Adson Tissue Forcep, Sklarlite XD™	119
Adson Tissue Forcep, Sklarlite™	119
Adson-Brown Tissue Forcep	124
Adson-Brown Tissue Forcep, Econo-Sterile™	170
Adson-Brown Tissue Forcep, Sklarlite XD™	119
Adson-Brown Tissue Forcep, Sklarlite™	119
Agathe Cement Spatula	44
Akers Knife	86
Akers Set	86
Akers Spoon	86
Akers/Evans Handle	86
Alginate, KromoPan™	76, 181
Alligator Napkin Clip	175
Allis Tissue Forcep	122
Allis Tissue Forcep, Econo-Sterile™	170
Allis Tissue Forcep, Sklarlite XD™	120
Allis Tissue Forcep, Sklarlite™	120
Amalgam Carrier	20-21
Amalgam Carrier, TC	19, 163
Amalgam Set	163
Amalgam Well	21, 163
An Orthodontic Milestone Pamphlet	190
Andrews Plugger	22
Andrews Tongue Depressor	137
Andrews-Pynchon Suction Tube	155
Anterior Pliers	65
Apical Elevator	99
Appliance Cases, Disposable	178
Applicators, Cotton-Tipped	183
Arch Pliers	68
Arrow Head Pliers	66
B	
Baade Pliers	65
Baade Pliers, Mid Grade	65
Back Action Plugger	22
Backhaus Towel Clamp	125
Backhaus Towel Clamp, Econo-Sterile™	171
Bag, Linen, Disposable	185
Bag, Reclosable, Disposable	185
Baker Crown Scissors	152
Ball, Cotton	183
Band Pliers	67
Band Plugger/Director	74
Band Pusher	74
Band Pusher/Director	74
Band Setter	74
Band Slitting Pliers	67
Band, Matrix	46-47
Baron Suction Tube	155
Basic Dental Set	158
Basic Dental Surgery Set	159
Basic Examination Set I	158
Basic Examination Set II	158
Basin, Emesis, Stainless Steel	199
Basin, Plastic Emesis	217
Basin, Plastic OR	217
Basin, Solution, Stainless Steel	198
Basket, Cleaning, Stainless Steel	203
Basket, Sterilization, SklarLite™	210-212
Baumgartner Needle Holder	131
Baumgartner Needle Holder, Econo-Sterile™	171
Baumgartner Needle Holder, Mid-Grade	131
Baumgartner Needle Holder, Sklarlite XD™	130
Baumgartner Needle Holder, Sklarlite™	130
Baumgartner Needle Holder, TC	126
Bayonet Elevator	100
Bayonet Pliers	69
Behrman Plugger	22
Bernard Pliers	68
Best Face Forward Pamphlet	189
Beyer Rongeur	138
Bib, Dental, Disposable	179
Bird Beak Pliers	69, 162
Bite Stick	75
Bite Tray, Disposable	177
Black Plugger	22-23, 163
Blade Remover	192
Blade, Carbon P-M	195
Blade, Disposable Surgical	159, 193
Blade, Scalpel	195
Blade, Surgical, Disposable	159, 193
Blower, Chip	155
Blumenthal Rongeur	138
Boley Gauge	45
Boley Gauge, Mid-Grade	45
Bond and Bracket Holder	75
Bond Bracket Holder	161-162
Bone File	92, 159
Bone Pusher	97
Bone Rongeur	138
Bone Tamper	164
Bone, Miller, File	92
Book, Coupon Payment	191
Book, Orthodontic Schedule	191
Bottle, Sklar-Stat™ Dispenser	15, 70, 102, 239
Bowl, Mixing/Solution, Stainless Steel	198
Bowl, Plastic Guidewire	217
Bowl, Plastic Multi-Purpose Utility	216
Bowl, Plastic Utility	217
Bowl, Sponge, Stainless Steel	198
Bowman Lachrymal Probe	155
Boxes, Model	43, 77, 180
Boynton Needle Holder	132
Boynton Needle Holder, TC	127
Bracket Holder, Bond	161-162
Bracket Pliers	67, 70
Bracket Positioning Gauge	75
Brewer Rubber Dam Forcep	36
Bright, Retainer	76, 90, 181
Brophy Scissors	148
Brown Tissue Forcep	123
Brush, Cleaning	223-224
Brush, Cleaning Set	225-226
Brush, Drying Rack	224
Brush, Instrument Cleaning	221-222
Brush, Suction Tube Cleaning	223
Brush, Surgical Scrub	223
Brush, Tracheal Tube Cleaning	222
Buchin Cephalometric Tracing Template	76, 181
Buck Knife	86
Bucket, Hospital Kick, Stainless Steel	199
Bucket, Hospital, Stainless Steel	199
Bulb, Chip Blower	155
Bur and Diamond Holder	174
BURNISHERS	
Burnishers	24-25, 163
Burnisher, Acorn	24
Burnisher, Ladmore	24
Burnisher, University of Michigan	25
C	
Calcium Hydroxide Placer	47, 163
Can Liner, Disposable	185
Carbon P-M Blade	195
Card, Account Record	191
Card, Headgear Score	191
Carrier, Amalgam	20-21
Carrier, Amalgam TC	19, 163
CARVERS	
Carver, Cleoid & Discoid	39, 60, 163
Carver, Hollenback	40, 161, 163
Carver, Hollenback, Mid-Grade	40
Carver, Interproximal	42, 162-164
Carver, Le Cron	42
Carver, Le Cron, Mid-Grade	42
Carver, Reeves	42
Carver, Roach	42
Carver, Roach, Mid-Grade	42
Carver, Tanner	41



Carver, Vehe.....	42
Carver, Vehe, Mid-Grade.....	42
Carver, Walls.....	41
Carver, Ward.....	41
---	---
Cases, Appliance, Disposable.....	178
Cassette, Sterilization.....	213-215
Castroviejo Corneal Scissors.....	89, 153
Castroviejo Needle Holder.....	87
Castroviejo Needle Holder, TC.....	87
Catheter Instrument Tray Cover, Stainless Steel.....	202
Catheter Instrument Tray, Stainless Steel.....	202
Catheter Instrument Tray, Stainless Steel, Miniature.....	201
Cement (Crown Seat) Set.....	164
Cement Spatula.....	44, 162-164
Cement Spatula, Agathe.....	44
Cement Spatula, Mid-Grade.....	44
Cephalometric, Buchin Tracing Template.....	76
Chalazion Forcep, Desmarres.....	125
Cheek Retractor.....	136-137
Cheek Retractor, Disposable.....	178
Cheek Retractor, University of Minnesota.....	137, 159
Children's Extracting Forcep.....	115-117, 157
Chip Blower.....	155
Chip Blower Bulb.....	155
Chip Blower Tip.....	155
Chisel, Coupland.....	94
Chisel, Gardner.....	94, 159
Chisel, Ochsenein.....	88
Chisel, Wakefield.....	94
Clamp, Backhaus Towel.....	125
Clamp, Backhaus Towel, Econo-Sterile™.....	171
Clamp, Hoff Towel, Econo-Sterile™.....	171
Clamp, Jones.....	125
Clamp, Lorna Edna Towel.....	125
Clamp, Lorna Edna Towel, Econo-Sterile™.....	171
Clamp, Towel, Hoff, Plastic.....	187
Clamp, Towel, Plastic.....	187
Clamp, Tube, Plastic.....	186
Clasp Adjusting Pliers.....	65
Clasp Adjusting Pliers, Mid-Grade.....	65
Cleaner, Sonic.....	77, 175
Cleaning Basket, Stainless Steel.....	203
Cleaning Brush.....	223-224
Cleaning Brush Set.....	225-226
Cleaning, Instrument Brush.....	221-223
Cleaning, Suction Tube Brush.....	223
Cleaning, Tracheal Tube Brush.....	222
Cleoid & Discoid Carver.....	39, 60, 163
Cleveland Rongeur.....	139
Coded Probe.....	32, 54, 158-159, 161, 164
Cogswell Elevator.....	100
College Pliers.....	48-49, 57, 156, 158-165
College Pliers, Mid-Grade.....	49
College Pliers Set.....	156
Collier Needle Holder.....	131

Columbia Curette.....	78, 159-161, 164-165
Columbia Lip Retractor.....	137
Composite/Crown Prep Set.....	162
Condenser, Hollenback.....	23
Cone Socket Pliers.....	61
Cone Socket Pliers, Mid-Grade.....	61
Container, Sterilization, SklarLite™.....	210-212
Container, Storage, Stainless Steel.....	199
Cord Packer, Retraction.....	33, 162-164
Cotton Balls.....	183
Cotton Roll Holder.....	137
Cotton Rolls.....	183
Cotton-Tipped Applicators.....	183
Coupland Chisel.....	94
Coupland Suction Tube.....	154
Coupon Payment Book.....	191
Covers, Disposable Headrest.....	179
Crane Kaplan Scaler.....	80, 160
Crane Pick Elevator.....	99
Crane-Kaplan Dissector.....	88
Crane-Kaplan Knife.....	85
Crane-Kaplan Pocket Marker.....	88, 160
Crile Forcep, Econo-Sterile™.....	169
Crile-Wood Needle Holder.....	132, 160
Crile-Wood Needle Holder, Econo-Sterile™.....	172
Crile-Wood Needle Holder, Mid-Grade.....	132
Crile-Wood Needle Holder, Sklarlite XD™.....	130
Crile-Wood Needle Holder, Sklarlite™.....	130
Crile-Wood Needle Holder, TC.....	127, 159, 164
Crile-Wood Needle Holder, TC, Left.....	128
Crown & Bridge Set.....	164
Crown Gauge.....	45
Crown Gripper, Wynman, TC.....	90
Crown Pliers.....	65
Crown Remover, Morrell.....	90
Crown Scissors.....	37, 73, 152,
Crown Scissors, Mid-Grade.....	37, 73, 152
Crown-Festooning Scissors, Pedro.....	37, 152
Cryer Elevator.....	100
Cup, Graduated Measure, Plastic.....	216
Cup, Graduated Measure, Stainless Steel.....	198
Cup, Iodine, Stainless Steel.....	197
Cup, Medicine, Stainless Steel.....	197
Cup, Disposable Plastic Medicine.....	181, 216

CURETTES

Curette, Columbia.....	78, 159-161, 164-165
Curette, Gracey.....	79, 157, 159, 161, 165
Curette, Lucas.....	91, 159
Curette, McCall's.....	78, 165
Curette, Molt.....	91, 164
---	---
Cushion, Mouth Gag, Doyen Jansen (Molt).....	135
Cutter, Stitch.....	195
Cutter, Wire, & Parallel Pliers.....	72

D

Dean Rongeur.....	138
Dean Scissors.....	148
Dean Scissors, Mid-Grade.....	148
Denhardt Mouth Gag.....	135
Dental Bib, Disposable.....	179
Dental Mirror, Disposable.....	181
Depressor, Tongue, Andrews.....	137
Depressor, Tongue, Disposable.....	180
Depressor, Tongue, Wieder.....	137
Depressors, Tongue.....	137
Derf Needle Holder.....	131
Derf Needle Holder, Econo-Sterile™.....	172
Derf Needle Holder, Mid-Grade.....	131
Derf Needle Holder, Sklarlite XD™.....	129
Derf Needle Holder, Sklarlite™.....	129
Derf Needle Holder, TC.....	126
Desmarres Chalazion Forcep.....	125
Detergent, Sklar Enzymatic™.....	13, 237
Detergent, Sklar Kleen™ Liquid.....	11, 235
Detergent, Sklar Kleen™ Low Foam.....	11, 235
Detergent, Sklar Kleen™ Powder.....	11, 235
Diagonal Wire Cutter.....	72
Diamond-Tipped Pliers.....	48
Diploma, Orthodontic.....	191
Director and Scaler, Ligature.....	75, 162
Disinfectant, Sklar.....	5, 84, 229
Disinfectant, Sklar Surface Wipes.....	6, 95, 201, 230
Dispenser, Sklar-Stat™ Bottle.....	15, 70, 102, 239
Dispenser, Sklar-Stat™ Foam.....	15, 70, 102, 239

DISPOSABLES

Disposable Appliance Cases.....	178
Disposable Aspirating Tips.....	180
Disposable Bite Tray.....	177
Disposable Can Liner.....	185
Disposable Cheek Retractor.....	178
Disposable Dental Bib.....	179
Disposable Dental Mirror.....	181
Disposable Ejectors.....	180
Disposable Evacuator Tips.....	180
Disposable Headrest Covers.....	179
Disposable Impression Trays.....	177
Disposable Linen Bag.....	185
Disposable Lip Retractor.....	76, 137, 178
Disposable Mouth Protector.....	178
Disposable Plastic Medicine Cup.....	181, 216
Disposable Reclosable Bag.....	185
Disposable Scalpel.....	193
Disposable Sklar OR Towel.....	182
Disposable Sklar Cotton OR Towel.....	182
Disposable Surgical Blade.....	159, 193
Disposable Tongue Depressor.....	180
Disposable Tongue Shield.....	179
Disposable Toothbrush.....	179
Disposable Tray Sleeves.....	179

Dissector, Crane-Kaplan.....	88
Distal End Cutter.....	71, 161-162
Doyen Jansen (Molt) Mouth Gag.....	135
Doyen Jansen (Molt) Mouth Gag Cushion.....	135
Dressing Eye Forcep.....	124
Dressing Forcep.....	122-123
Dressing Forcep, Adson.....	124
Dressing Forcep, Adson (Ewald).....	124
Dressing Forcep, Adson Sklarlite XD™.....	119
Dressing Forcep, Adson Sklarlite™.....	119
Dressing Forcep, Adson, TC.....	118
Dressing Forcep, Econo-Sterile™.....	170
Dressing Forcep, Plastic.....	186
Dressing Forcep, Semkin.....	123
Dressing Forcep, Sklarlite XD™.....	119
Dressing Forcep, Sklarlite™.....	119
Dressing Forcep, TC.....	118
Dressing Jar, Stainless Steel.....	200
Drying Rack Brush.....	224

E

ECONO-STERILE™

Econo-Sterile™ Adson Forcep.....	170
Econo-Sterile™ Adson-Brown Forcep.....	170
Econo-Sterile™ Allis Tissue Forcep.....	170
Econo-Sterile™ Backhaus Towel Clamp.....	171
Econo-Sterile™ Baumgartner Needle Holder.....	171
Econo-Sterile™ Crile Forcep.....	169
Econo-Sterile™ Crile-Wood Needle Holder.....	172
Econo-Sterile™ Derf Needle Holder.....	172
Econo-Sterile™ Dressing Forcep.....	170
Econo-Sterile™ Halsey Needle Holder.....	172
Econo-Sterile™ Halsted Mosquito Forcep.....	169
Econo-Sterile™ Hartmann Mosquito Forcep.....	169
Econo-Sterile™ Hoff Towel Clamp.....	171
Econo-Sterile™ Iris Scissors.....	167
Econo-Sterile™ Kelly Forcep.....	169
Econo-Sterile™ Knowles Bandage Scissors.....	168
Econo-Sterile™ Lister Bandage Scissors.....	168
Econo-Sterile™ Littauer Stitch Scissors.....	168
Econo-Sterile™ Lorna Edna Towel Clamp.....	171
Econo-Sterile™ Mayo Scissors.....	167
Econo-Sterile™ Mayo-Hegar Needle Holder.....	171
Econo-Sterile™ Metzbaum Scissors.....	167
Econo-Sterile™ Operating Scissors.....	167
Econo-Sterile™ Rochester Pean Forcep.....	169
Econo-Sterile™ Rochester-Ochsner Forcep.....	169
Econo-Sterile™ Spencer Stitch Scissors.....	168
Econo-Sterile™ Splinter Forcep.....	170
Econo-Sterile™ Sponge Forcep.....	171
Econo-Sterile™ Tissue Forcep.....	170
Econo-Sterile™ Utility Scissors.....	168
Econo-Sterile™ Webster Needle Holder.....	172
Econo-Sterile™ Wire Cutting Scissors.....	168
Econo-Sterile™ Wireform Halsted Mosquito Forcep.....	173

Econo-Sterile™ Wireform Kelly Forcep.....	173
Econo-Sterile™ Wireform Needle Holder.....	173
Econo-Sterile™ Wireform Scissors.....	173
Econo-Sterile™ Wireform Sponge Forcep.....	173
Econo-Sterile™ Wireform Stitch Scissors.....	173
Econo-Sterile™ Wireform Thumb Forcep.....	173
Econo-Sterile™ Wireform Towel Forcep.....	173

Ejectors, Disposable.....	180
Elastic Placing Instrument.....	75
Elastic Pliers.....	70
Elastics, Orthodontic.....	76
Elastomeric Pliers.....	70

ELEVATORS

Elevator 30.....	98
Elevator 31.....	98
Elevator 34.....	98
Elevator 34S.....	98
Elevator 46.....	98
Elevator 50.....	98
Elevator 77R.....	98
Elevator 81.....	98
Elevator, Apical.....	99
Elevator, Bayonet.....	100
Elevator, Cogswell.....	100
Elevator, Crane Pick.....	99
Elevator, Cryer.....	100
Elevator, Freer.....	102
Elevator, Molt.....	103, 159, 164
Elevator, OHL Periosteal.....	103
Elevator, Potts.....	102
Elevator, Prichard Periosteal.....	103
Elevator, Root Tip.....	101
Elevator, Seldin.....	99, 103, 164
Elevator, West Periosteal.....	103
Elevators.....	98-100

Emesis Basin, Plastic.....	217
Emesis Basin, Stainless Steel.....	199
End Cutter, Distal.....	71, 161-162
Evacuator Tips, Disposable.....	180
Evans Knife.....	86
Evans Set.....	86
Evans Spoon.....	86
Excavators.....	26-27, 58-59, 162-164
Explorer Set.....	156
Explorers.....	28-30, 50-52, 156, 158-165
Explorers, Mid-Grade.....	28-29, 50-51

EXTRACTING FORCEPS

Extracting Forceps.....	104-113, 157
Extracting Forceps, Mid-Grade.....	104-108, 110-111
Extracting Forcep Set.....	157
Extracting, Children's Forceps.....	115-117, 157
Extracting, Children's Forceps, Mid-Grade.....	116
Extracting, Henahan Forcep.....	113

Extracting, Mead Forcep.....	113
Extracting, Mead Forcep, Mid-Grade.....	113
Extracting, Standard Forcep.....	104
Extracting, Standard Forcep, Mid-Grade.....	104
Extracting, Witzel Forcep.....	114
Extracting, Woodward Forcep.....	114-115

Eye Dressing Forcep.....	124
Eye Needle.....	133-134

F

Face Masks, Sklar.....	40, 66, 114
Facebow Pliers.....	68
Fahnenstock Knife.....	175
Fiberglass Mirror.....	56
File, Bone.....	92, 159
File, Bone, Howard.....	92
File, Bone, Miller.....	92
File, Nail/Bone.....	93
Filling Instrument, Gregg.....	34
Filling Instrument, Ladmore.....	35
Filling Instrument, Plastic.....	34-35, 162-164
Filling Instrument, Woodson.....	35
Fischer Flat Nose Pliers.....	64
Fischer Flat Nose Pliers, Mid-Grade.....	64
Flat Nose Pliers.....	64
Foam Dispenser, Sklar-Stat™.....	15, 70, 102, 239
Foaming Hand Sanitizer, Sklar-Stat™.....	15, 239
Forcep Jar, Stainless Steel.....	200, 224

FORCEPS

Forcep, Adson (Ewald) Dressing.....	124, 159
Forcep, Adson Dressing.....	124
Forcep, Adson Dressing, Sklarlite XD™.....	119
Forcep, Adson Dressing, Sklarlite™.....	119
Forcep, Adson Dressing, TC.....	118
Forcep, Adson Tissue.....	124, 159
Forcep, Adson Tissue, Sklarlite XD™.....	119
Forcep, Adson Tissue, Sklarlite™.....	119
Forcep, Adson, Econo-Sterile™.....	170
Forcep, Adson-Brown Tissue.....	124
Forcep, Adson-Brown Tissue, Sklarlite XD™.....	119
Forcep, Adson-Brown Tissue, Sklarlite™.....	119
Forcep, Adson-Brown, Econo-Sterile™.....	170
Forcep, Allis Tissue.....	122
Forcep, Allis Tissue, Econo-Sterile™.....	170
Forcep, Allis Tissue, Sklarlite XD™.....	120
Forcep, Allis Tissue, Sklarlite™.....	120
Forcep, Brewer, Rubber Dam.....	36
Forcep, Brown Tissue.....	123
Forcep, Crile, Econo-Sterile™.....	169
Forcep, Desmarres Chalazion.....	125
Forcep, Dressing.....	122-123
Forcep, Dressing Eye.....	124
Forcep, Dressing, Econo-Sterile™.....	170
Forcep, Dressing, Plastic.....	186
Forcep, Dressing, Sklarlite XD™.....	119



Forcep, Dressing, Sklarlite™	119
Forcep, Dressing, TC	118
Forcep, Econo-Sterile™, Wireform,	
Halsted Mosquito	173
Forcep, Econo-Sterile™, Wireform, Kelly	173
Forcep, Econo-Sterile™, Wireform, Sponge	173
Forcep, Econo-Sterile™, Wireform, Thumb	173
Forcep, Econo-Sterile™, Wireform, Towel	173
Forcep, Extracting	104-113, 157
Forcep, Extracting, Children's	115-117, 157
Forcep, Extracting, Henahan	113
Forcep, Extracting, Mead	113
Forcep, Extracting, Mid-Grade	104-108, 110-111
Forcep, Extracting, Standard	104
Forcep, Extracting, Witzel	114
Forcep, Extracting, Woodward	114-115
Forcep, Grasping	174
Forcep, Halsted Mosquito	57, 121
Forcep, Halsted Mosquito, Mid-Grade	57, 121
Forcep, Halsted Mosquito, Sklarlite XD™	120
Forcep, Halsted Mosquito, Sklarlite™	120
Forcep, Halsted, Econo-Sterile™	169
Forcep, Hartmann Mosquito	121
Forcep, Hartmann Mosquito, Econo-Sterile™	169
Forcep, Hartmann Mosquito, Mid-Grade	121
Forcep, Hartmann Mosquito, Sklarlite XD™	120
Forcep, Hartmann Mosquito, Sklarlite™	120
Forcep, Hemostatic, Plastic	186
Forcep, Jeweler Style	174
Forcep, Kelly	122
Forcep, Kelly, Econo-Sterile™	169
Forcep, Kelly, Mid-Grade	122
Forcep, Kelly, Sklarlite XD™	120
Forcep, Kelly, Sklarlite™	120
Forcep, Miller Groovelok	47, 160, 162-164
Forcep, Miller Groovelok, Mid-Grade	47
Forcep, Peet Splinter	57
Forcep, Rochester Pean, Econo-Sterile™	169
Forcep, Rochester-Ochsner, Econo-Sterile™	169
Forcep, Rubber Dam	36
Forcep, Russian Tissue	124
Forcep, Semkin Dressing	123
Forcep, Semkin Tissue	123
Forcep, Splinter, Econo-Sterile™	170
Forcep, Sponge, Econo-Sterile™	171
Forcep, Sponge, Plastic	187
Forcep, Sterilizer	174
Forcep, Sterilizing	125
Forcep, Sterilizing, Mid-Grade	125
Forcep, Tissue	123-124
Forcep, Tissue, Econo-Sterile™	170
Forcep, Tissue, Sklarlite XD™	119
Forcep, Tissue, Sklarlite™	119
Forcep, University of Washington, Rubber Dam	36
Forcep, University of Washington, Rubber Dam, Mid-Grade	36
Forcep, Utility Sterilizer	125

Forcep, Utility Sterilizer, Mid-Grade	125
Forcep, Utility, Plastic	186
Forcep, Williams Splinter	57
Forcep, Williams Splinter, Mid-Grade	57
Forcep, Young Tongue Seizing	125
—	
Fox/Williams Probe	32, 54
Frazier Ferguson Suction Tube	154
Frazier Suction Tube	154
Frazier Tissue Hook	136
Freer Elevator	102
Friedman Rongeur	138
Friedman Rongeur, Micro	89, 139
Funnel, Stainless Steel	200

G

Gag, Mouth, Denhardt	135
Gag, Mouth, Doyen Jansen (Molt)	135
Gag, Mouth, Doyen Jansen (Molt), Mid-Grade	135
Gag, Mouth, Jennings	135
Gag, Mouth, Wesson	135
Gardner Chisel	94, 159
Gauge, Boley	45
Gauge, Boley, Mid-Grade	45
Gauge, Bracket	75
Gauge, Crown	45
Gauze Sponge	184
Gerzog Mallet	95
Gloves, Latex	188
Gloves, Nitrile	188
Gloves, Vinyl	188
Glutaraldehyde Strips	4, 228
Goldman-Fox Knife	85, 160
Goldman-Fox Knife, Mid-Grade	85
Goldman-Fox Probe	31-32, 53-54, 160
Goldman-Fox Probe/Explorer	32, 54
Goldman-Fox Scaler	80, 160
Goldman-Fox Scissors	149, 160
Goldman-Fox Scissors, Mid-Grade	149
Goldman-Fox Scissors, Sklar Edge™ TC	140
Goldman-Fox Scissors, Sklarhone™	144
Gordon Pliers	64
Gordon Pliers, Mid-Grade	64
Goslee Pliers	63
Goslee Pliers, Mid-Grade	63
Gown, Surgical	196
Gracey Curette	79, 157, 159, 161, 165
Gracey Curette Set	157
Gradle Scissors, Sklarhone™	143
Graduated Measure Cup, Plastic	216
Graduated Measure Cup, Stainless Steel	198
Grasping Forcep	174
Gregg Filling Instrument	34
Gritman Wax Spatula	43
Guard, Osteotome	219
Guard, TipGrips™ Instrument Guard	219
Guidewire Bowl, Plastic	217

H

Halsey Needle Holder	132
Halsey Needle Holder, Econo-Sterile™	172
Halsey Needle Holder, Sklarlite XD™	130
Halsey Needle Holder, Sklarlite™	130
Halsey Needle Holder, TC	126
Halsted Mosquito Forcep	57, 121
Halsted Mosquito Forcep, Econo-Sterile™	169
Halsted Mosquito Forcep, Econo-Sterile™ Wireform	173
Halsted Mosquito Forcep, Sklarlite XD™	120
Halsted Mosquito Forcep, Sklarlite™	120
Handle, Akers/Evans	86
Handle, Scalpel	159, 192, 195
Handle, Sterilization Tray, Stainless Steel	206
Handles, Lifting, Stainless Steel	206
Hard Wire Cutters	72, 162
Hartman Rongeur	139
Hartmann Mosquito Forcep	121
Hartmann Mosquito Forcep, Econo-Sterile™	169
Hartmann Mosquito Forcep, Sklarlite XD™	120
Hartmann Mosquito Forcep, Sklarlite™	120
Hawley Pliers	68
Headgear Score Card	191
Headrest Covers, Disposable	179
Heath Scissors	149
Heidbrink Root Tip Pick	101
Hemostatic Forcep, Plastic	186
Henahan Extracting Forcep	113
Hoff Towel Clamp, Econo-Sterile™	171
Holder, Bond and Bracket	75
Holder, Bond Bracket	161-162
Holder, Bur and Diamond	174
Holder, Rubber Dam	36
Hollenback Carver	40, 161, 163
Hollenback Carver, Mid-Grade	40
Hollenback Condenser	23
Hook, Frazier Tissue	136
Hook, Tissue Twist	136
Hospital Bucket, Stainless Steel	199
Hospital Kick Bucket, Stainless Steel	199
How Pliers	62
How Pliers, Mid-Grade	62
How Pliers, TC	61
Hydroxide Placer, Calcium	47, 163

I

ID Roll Tape, Sklar	220
ID Sheet Tape	220
ID Tags, Instrument	220
Impression Trays, Disposable	177
Impression Trays, Metal	176
Instrument Care Kit, Sklar	17, 25, 241
Instrument Drying Tray, Stainless Steel	203
Instrument Guard, TipGrips™	219
Instrument Holder Set	215

Instrument ID Tags	220	Knife, Murphy	175	Masks, Sklar Face	40, 66, 114	
Instrument Polish, Sklar.....	16, 240	Knife, Orban	85, 159	Mat, Silicon, SklarLite™	210-212	
Instrument Protectors, SklarTip™	219	Knife, Plaster and Compound.....	175	Mathieu Needle Holder	132	
Instrument Rack, Stainless Steel.....	208	Kno-Kurl™ Acetate	45, 77, 181	Mathieu Needle Holder, Mid-Grade.....	132	
Instrument Soaking Tray, Plastic	218	Knowles Bandage Scissors.....	152	Mathieu Needle Holder, TC	127	
Instrument Spot Remover Pad	224	Knowles Bandage Scissors, Econo-Sterile™	168	Mathieu Pliers.....	69-70, 161-162	
Instrument Stringer, Stainless Steel	207-208	KromoPan™ Alginate	76, 181	Matrix Band	46-47	
Instrument Tray Cover, Stainless Steel	204-205	L			Matrix Retainers	46, 146
Instrument Tray, Stainless Steel	204	Lab/Utility Scoop, Stainless Steel.....	200	Mayo Scissors	146	
Instrument, Cleaning Brush	221-222	Laboratory & Office Pliers.....	63	Mayo Scissors, Econo-Sterile™	167	
Instrument, Elastic Placing	75	Laboratory & Office Pliers, Mid-Grade.....	63	Mayo Scissors, Mid-Grade	146	
Interproximal Carver	42, 162-164	Lachrymal Probe, Bowman	155	Mayo Scissors, Sklar Edge™ TC	141	
Intraoral Photographic Mirrors	77, 177	Ladmore Burnisher.....	24	Mayo Scissors, Sklarhone™	144	
Iodine Cup, Stainless Steel	197	Ladmore Filling Instrument	35	Mayo Tray, Stainless Steel	202	
Iris Scissors	147, 162-164	Lagrange Scissors.....	159	Mayo-Hegar Needle Holder	131	
Iris Scissors, Econo-Sterile™	167	Lahey Retractor	164	Mayo-Hegar Needle Holder, Econo-Sterile™	171	
Iris Scissors, Mid-Grade	147	Lane Cleft Palate Needle.....	134	Mayo-Hegar Needle Holder, Mid-Grade.....	131	
Iris Scissors, Sklar Edge™ TC	140	Laryngeal Mirror	56	Mayo-Hegar Needle Holder, Sklarlite XD™	130	
Iris Scissors, Sklarhone™	143	Latex Gloves.....	188	Mayo-Hegar Needle Holder, Sklarlite™	130	
Iris Scissors, Sklarhone™ TC.....	142	Latex Orthodontic Elastics.....	76	Mayo-Hegar Needle Holder, TC	126	
J						
Jacquette Scaler	80-82	Le Cron Carver	42	Mayo-Hegar Needle Holder, TC, Left	128	
Jar, Dressing, Stainless Steel.....	200	Le Cron Carver, Mid-Grade	42	McCall's Curette	78	
Jar, Forcep, Stainless Steel.....	200, 224	Lifting Handles, Stainless Steel.....	206	McClure Iris Scissors.....	89	
Jar, Ointment, Stainless Steel	201	Ligature Director and Scaler.....	75, 162	McKellops Pliers.....	63	
Jarabak Pliers.....	68	Ligature Pliers.....	68	McKellops Pliers, Mid-Grade.....	63	
Jennings Mouth Gag	135	Ligature Tucker and Director	75	Mead Extracting Forcep	113	
Jeweler Style Forcep	174	Light Wire Pliers	68	Mead Rongeur.....	139	
Johnson Pliers	62	Linen Bag, Disposable.....	185	Medicine Cup, Disposable Plastic	181, 216	
Johnson Pliers, Mid-Grade	62	Liner, Can, Disposable	185	Medicine Cup, Stainless Steel.....	197	
Jones Clamp.....	125	Lingual Pliers	67	Meriam Pliers.....	48, 156	
Joseph Scissors	147	Lip Retractor, Columbia	137	Meriam Pliers, Mid-Grade.....	48	
Junior Toothbrush	179	Lip Retractor, Disposable	76, 137, 178	Metal Impression Trays	176	
K						
Kaye Dissecting Scissor	149	Liquid Detergent, Sklar Kleen™	11, 235	Metzenbaum Scissors	146	
Kaye Dissecting Scissors, Sklar Edge™ TC	140	Lister Bandage Scissors.....	152	Metzenbaum Scissors, Econo-Sterile™	167	
Kelly Forcep.....	122	Lister Bandage Scissors, Econo-Sterile™	168	Metzenbaum Scissors, Sklar Edge™ TC	140	
Kelly Forcep, Econo-Sterile™	169	Lister Bandage Scissors, Mid-Grade.....	152	Metzenbaum Scissors, Sklarhone™	143	
Kelly Forcep, Econo-Sterile™ Wireform.....	173	Littauer Stitch Scissors	150, 165	Metzenbaum Scissors, Sklarhone™ TC.....	142	
Kelly Forcep, Mid-Grade.....	122	Littauer Stitch Scissors, Econo-Sterile™	168	Michigan Probe.....	31, 53	
Kelly Forcep, Sklarlite XD™	120	Littauer Stitch Scissors, Mid-Grade	150	Micro Friedman Rongeur.....	89, 139	
Kelly Forcep, Sklarlite™	120	Locklin Scissors.....	148	Micro Sterilization Tray Cover, Stainless Steel.....	206	
Kelly-Adson Scissors.....	147-148	Long Stitch Scissors	151	Micro Sterilization Tray, Stainless Steel.....	206	
Kelly-Adson Scissors, Mid-Grade.....	148	Loop Pliers.....	68	MID-GRADE		
Kirkland Knife	86	Lorna Edna Towel Clamp	125	Mid-Grade Abell Pliers.....	62	
Kit, Sklar Instrument Care	17, 25, 241	Lorna Edna Towel Clamp, Econo-Sterile™	171	Mid-Grade Baade Pliers	65	
Kit, Super "C" Ortho Adhesive	77	Low Foam Detergent, Sklar Kleen™	11, 235	Mid-Grade Baumgartner Needle Holder.....	131	
Knife, Akers	86	Lube, Sklar Instru-Guard™	10, 234	Mid-Grade Black Plugger	23	
Knife, Buck	86	Lucas Curette	91, 159	Mid-Grade Boley Gauge.....	45	
Knife, Crane-Kaplan	85	M			Mid-Grade Cement Spatula.....	44
Knife, Evans	86	Mallet.....	95, 164	Mid-Grade Children's Extracting Forcep	116	
Knife, Fahnenstock.....	175	Mallet Ends.....	95	Mid-Grade Clasp Adjusting Pliers.....	65	
Knife, Goldman-Fox.....	85, 160	Mallet Ends, Sklar.....	95	Mid-Grade College Pliers	48-49, 57	
Knife, Goldman-Fox, Mid-Grade.....	85	Mallet, Gerzog.....	95	Mid-Grade Cone Socket Pliers.....	61	
Knife, Kirkland	86	Mallet, Sklar.....	95	Mid-Grade Crile-Wood Needle Holder.....	132	
		Markley Plugger.....	23	Mid-Grade Crown Scissors.....	37, 73, 152	
		Mask, Procedure	184, 196	Mid-Grade Dean Scissors	148	
				Mid-Grade Derf Needle Holder.....	131	



Mid-Grade Doyen Jansen (Molt) Mouth Gag.....	135
Mid-Grade Explorers	28-29, 50-51
Mid-Grade Extracting Forcep	104-108, 110-111
Mid-Grade Fischer Pliers.....	64
Mid-Grade Goldman-Fox Knife.....	85
Mid-Grade Goldman-Fox Scissors	149
Mid-Grade Gordon Pliers.....	64
Mid-Grade Goslee Pliers	63
Mid-Grade Halsted Mosquito Forcep.....	57, 121
Mid-Grade Hartmann Mosquito Forcep.....	121
Mid-Grade Hollenback Carver.....	40
Mid-Grade How Pliers	62
Mid-Grade Iris Scissors	147
Mid-Grade Johnson Pliers	62
Mid-Grade Kelly Forcep.....	122
Mid-Grade Kelly-Adson Scissors.....	148
Mid-Grade Laboratory & Office Pliers.....	63
Mid-Grade Le Cron Carver	42
Mid-Grade Lister Bandage Scissors.....	152
Mid-Grade Littauer Stitch Scissors	150
Mid-Grade Mathieu Needle Holder.....	132
Mid-Grade Mayo Scissors	146
Mid-Grade Mayo-Hegar Needle Holder.....	131
Mid-Grade McKellops Pliers.....	63
Mid-Grade Mead Extracting Forcep	113
Mid-Grade Meriam Pliers.....	48
Mid-Grade Miller Groovelok Forcep	47
Mid-Grade Mouth Mirror Handle.....	55
Mid-Grade Oliver Pliers	65
Mid-Grade Olsen-Hegar Needle Holder	131
Mid-Grade Operating Scissors	145
Mid-Grade P.K. Thomas Wax Placer.....	38
Mid-Grade Peeso Pliers	62
Mid-Grade Perry Pliers	48
Mid-Grade Probe and Seeker.....	32, 54
Mid-Grade Reynolds Pliers.....	62
Mid-Grade Roach Carver	42
Mid-Grade Rubber Dam Punch.....	36
Mid-Grade Spencer Stitch Scissors.....	150
Mid-Grade Standard Extracting Forcep.....	104
Mid-Grade Sterilizing Forcep.....	125
Mid-Grade University of Minnesota Cheek Retractor	137
Mid-Grade University of Washington Rubber Dam Forcep.....	36
Mid-Grade Utility Sterilizer Forcep.....	125
Mid-Grade Vehe Carver.....	42
Mid-Grade Webster Needle Holder	131
Mid-Grade Williams Splinter Forcep.....	57
Mid-Grade Wire Bending Pliers	61, 64
Mid-Grade Wire Cutting Scissors	73
---	---
Miller Bone File.....	92
Miller Groovelok Forcep	47, 160, 162-164
Miller Groovelok Forcep, Mid-Grade	47
Mini Thumb Scalpel.....	195
Miniature Catheter Instrument Tray, Stainless Steel.....	201

MIRRORS

Mirror Handle, Mouth.....	55, 158-165
Mirror Handle, Mouth, Mid-Grade.....	55
Mirror, Dental, Disposable	181
Mirror, Fiberglass.....	56
Mirror, Intraoral Photographic.....	77, 177
Mirror, Laryngeal.....	56
Mirror, Mouth	55, 158-165
---	---
Mixing/Solution Bowl, Stainless Steel.....	198
Model Boxes.....	43, 77, 180
Molt Curette.....	91, 164
Molt Elevator.....	103, 159, 164
Morrell Crown Remover.....	90
Mortonson Plugger	23
Mosquito Forcep, Halsted.....	57
Mosquito Forcep, Halsted, Mid-Grade.....	57, 121
Mosquito Forcep, Halsted, Sklarlite XD™	120
Mosquito Forcep, Halsted, Sklarlite™	120
Mosquito Forcep, Hartmann	121
Mosquito Forcep, Hartmann, Mid-Grade.....	121
Mosquito Forcep, Hartmann, Sklarlite XD™	120
Mosquito Forcep, Hartmann, Sklarlite™	120
Mouth Gag, Denhardt.....	135
Mouth Gag, Doyen Jansen (Molt).....	135
Mouth Gag, Doyen Jansen (Molt) Cushion	135
Mouth Gag, Doyen Jansen (Molt), Mid-Grade.....	135
Mouth Gag, Jennings	135
Mouth Gag, Wesson.....	135
Mouth Mirror	55, 158-165
Mouth Mirror Handle	55, 158-165
Mouth Protector, Disposable	178
Multi-Purpose Utility Bowl, Plastic	216
Murphy Knife	175

N

Nabers Probe	32, 54
Nail/Bone File	93
Napkin Clip, Alligator	175

NEEDLE HOLDERS

Needle Holder, Baumgartner.....	131
Needle Holder, Baumgartner, Econo-Sterile™	171
Needle Holder, Baumgartner, Mid-Grade	131
Needle Holder, Baumgartner, Sklarlite XD™	130
Needle Holder, Baumgartner, Sklarlite™	130
Needle Holder, Baumgartner, TC	126
Needle Holder, Boynton.....	132
Needle Holder, Boynton, TC.....	127
Needle Holder, Castroviejo.....	87
Needle Holder, Castroviejo, TC	87
Needle Holder, Collier.....	131
Needle Holder, Crile-Wood.....	132, 160
Needle Holder, Crile-Wood, Econo-Sterile™	172
Needle Holder, Crile-Wood, Mid-Grade.....	132
Needle Holder, Crile-Wood, Sklarlite XD™	130

Needle Holder, Crile-Wood, Sklarlite™	130
Needle Holder, Crile-Wood, TC	127, 159, 164
Needle Holder, Crile-Wood, TC, Left	128
Needle Holder, Derf.....	131
Needle Holder, Derf, Econo-Sterile™	172
Needle Holder, Derf, Mid-Grade	131
Needle Holder, Derf, Sklarlite XD™	129
Needle Holder, Derf, Sklarlite™	129
Needle Holder, Derf, TC	126
Needle Holder, Halsey.....	132
Needle Holder, Halsey, Econo-Sterile™	172
Needle Holder, Halsey, Sklarlite XD™	130
Needle Holder, Halsey, Sklarlite™	130
Needle Holder, Halsey, TC	126
Needle Holder, Mathieu.....	132
Needle Holder, Mathieu, Mid-Grade	132
Needle Holder, Mathieu, TC	127
Needle Holder, Mayo-Hegar	131
Needle Holder, Mayo-Hegar, Econo-Sterile™	171
Needle Holder, Mayo-Hegar, Mid-Grade	131
Needle Holder, Mayo-Hegar, Sklarlite XD™	130
Needle Holder, Mayo-Hegar, Sklarlite™	130
Needle Holder, Mayo-Hegar, TC	126
Needle Holder, Mayo-Hegar, TC, Left	128
Needle Holder, Olsen-Hegar	131
Needle Holder, Olsen-Hegar, Mid-Grade.....	131
Needle Holder, Olsen-Hegar, Sklarlite XD™	129
Needle Holder, Olsen-Hegar, Sklarlite™	129
Needle Holder, Olsen-Hegar, TC.....	126
Needle Holder, PAR, TC.....	126
Needle Holder, Ross.....	87
Needle Holder, Ryder, TC.....	127
Needle Holder, Ryder, TC, Left.....	128
Needle Holder, Sternal Wire Twister, TC	74
Needle Holder, Stevens.....	87
Needle Holder, Webster	131
Needle Holder, Webster, Econo-Sterile™	172
Needle Holder, Webster, Mid-Grade.....	131
Needle Holder, Webster, Sklarlite XD™	129
Needle Holder, Webster, Sklarlite™	129
Needle Holder, Webster, TC	127
Needle Holder, Webster, TC, Left.....	128
Needle Holders, Econo-Sterile™, Wireform	173

---	---
Needle, Eye.....	133-134
Needle, Lane Cleft Palate.....	134
Needle, Regular Surgeon.....	133
New's Suture Scissors.....	151
Nipper, Plaster.....	175
Nipper, Tissue.....	89
Nitrile Gloves	188
Non-Pinch College Pliers, Mid-Grade.....	49
Noyes Iris Scissors.....	153

O

O'Brien Stitch Scissors.....	151
Ochsenbein Chisel	88

Octagonal Mirror Handle, Mid-Grade	55	PAR Needle Holder, TC	126	Pliers, Bernard	68	
Odor Neutralizer Spray, Sklar Fresh™	16, 240	Parallel Pliers	72	Pliers, Bird Beak	69, 162	
OHL Periosteal Elevator	103	Parallel Pliers & Wire Cutter	72	Pliers, Bracket	67, 70	
Ointment Jar, Stainless Steel	201	Payment Book, Coupon	191	Pliers, Clasp Adjusting	65	
Oliver Band Removing Pliers, Mid-Grade	65	Pedo Crown-Festooning Scissors	37, 152	Pliers, Clasp Adjusting, Mid-Grade	65	
Oliver Pliers	65	Pedodontic Implant Set	160	Pliers, College	48-49, 156, 158-165	
Olsen-Hegar Needle Holder	131	Peeso Pliers	62	Pliers, College, Mid-Grade	48-49, 57	
Olsen-Hegar Needle Holder, Mid-Grade	131	Peeso Pliers, Mid-Grade	62	Pliers, Cone Socket	61	
Olsen-Hegar Needle Holder, Sklarlite XD™	129	Peet Splinter Forcep	57	Pliers, Cone Socket, Mid-Grade	61	
Olsen-Hegar Needle Holder, Sklarlite™	129	Periodontal Instrument Set I	159	Pliers, Crown	65	
Olsen-Hegar Needle Holder, TC	126	Periodontal Instrument Set II	160	Pliers, Diamond Tipped	48	
One Step, Sklar Instru-Guard™	9, 233	Periodontal Instrument Set III	160	Pliers, Elastic	70	
Operating Scissors	145	Periosteal, Elevator, OHL	103	Pliers, Elastomeric	70	
Operating Scissors, Econo-Sterile™	167	Periosteal, Elevator, Prichard	103	Pliers, Facebow	68	
Operating Scissors, Mid-Grade	145	Periosteal, Elevator, West	103	Pliers, Fischer	64	
Operating Scissors, Sklar Edge™ TC	141	Perry Pliers	48, 156	Pliers, Fischer, Mid-Grade	64	
Operating Scissors, Sklarhone™	144	Perry Pliers, Mid-Grade	48	Pliers, Flat Nose	64	
Optical Pliers	69	Photographic Mirror, Intraoral	77, 177	Pliers, Gordon	64	
OR Basin, Plastic	217	Pick, Root Tip	101	Pliers, Gordon, Mid-Grade	64	
OR Towel, Sklar Cotton, Disposable	182	Pin & Ligature Pliers	64	Pliers, Goslee	63	
OR Towel, Sklar, Disposable	182	Pin & Ligature Pliers, TC	61	Pliers, Goslee, Mid-Grade	63	
Oral Wedge	135	Pin & Ligature Wire Cutters	71, 161-162	Pliers, Hawley	68	
Orban Knife	85, 159	Pitcher, Plastic	216	Pliers, How	62	
Ortho, Super "C" Adhesive Kit	77	Pitcher/Beaker, Stainless Steel	197	Pliers, How, Mid-Grade	62	
Orthodontic Archwire Adjustment Set	162	Placer, Wax, P.K. Thomas	38, 157	Pliers, How, TC	61	
Orthodontic Banding/Bonding Set	161	Placer, Wax, P.K. Thomas, Mid-Grade	38	Pliers, Jarabak	68	
Orthodontic Diploma	191	Plaster and Compound Knife	175	Pliers, Johnson	62	
Orthodontic Pliers	61-70, 72, 161-162	Plaster Nipper	175	Pliers, Johnson, Mid-Grade	62	
Orthodontic Pliers, Mid-Grade	61-65	Plastic Emesis Basin	217	Pliers, Laboratory & Office	63	
Orthodontic Schedule Book	191	Plastic Filling Instrument	34-35, 162-164	Pliers, Laboratory & Office, Mid-Grade	63	
Osteotome Guard	219	Plastic Filling Instrument, Smith Special	35	Pliers, Ligature	68	
Osteotome Handle	97	Plastic Graduated Measure Cup	216	Pliers, Light Wire	68	
Osteotome Insert	96	Plastic Guidewire Bowl	217	Pliers, Lingual	67	
Osteotome, Sheehan	96	Plastic Instrument Soaking Tray	218	Pliers, Loop	68	
Osteotome, West	96	Plastic Medicine Cup, Disposable	181, 216	Pliers, Mathieu	69-70, 161-162	
P			Plastic Multi-Purpose Utility Bowl	216	Pliers, McKellops	63
P.K. Thomas Wax Placer	38, 157	Plastic OR Basin	217	Pliers, McKellops, Mid-Grade	63	
P.K. Thomas Wax Placer, Mid-Grade	38	Plastic Pitcher	216	Pliers, Meriam	48, 156	
P.K. Thomas Wax Placer Set	38, 157	Plastic Procedure Tray	218	Pliers, Meriam, Mid-Grade	48	
Pad, Instrument Spot Remover	224	Plastic Round Basin	217	Pliers, Oliver	65	
PAMPHLETS			Plastic Solution Basin	217	Pliers, Oliver, Mid-Grade	65
Pamphlet, A Three-Way Partnership	189	Plastic Specimen Tube	216	Pliers, Optical	69	
Pamphlet, Best Face Forward	189	Plastic Sponge/Utility Bowl	217	Pliers, Parallel	72	
Pamphlet, Orthodontic Milestone	190	Plastic Surgery Retractor	136	Pliers, Parallel & Wire Cutter	72	
Pamphlet, You and Your Appliances	190	Plastic Tray	218	Pliers, Peeso	62	
Pamphlet, You and Your Bandless Braces	190	PLIERS			Pliers, Peeso, Mid-Grade	62
Pamphlet, You and Your Elastics	190	Pliers, Abell	62	Pliers, Perry	48, 156	
Pamphlet, You and Your Headgear	191	Pliers, Abell, Mid-Grade	62	Pliers, Perry, Mid-Grade	48	
Pamphlet, You and Your Retainer	190	Pliers, Adams	68	Pliers, Pin & Ligature	64	
Pamphlet, You and Your Toothbrush	189	Pliers, Anterior	65	Pliers, Pin & Ligature, TC	61	
Pamphlet, Your Child and Orthodontics	189	Pliers, Arch	68	Pliers, Posterior	63, 67	
Pamphlet, Your Child's First Day	189	Pliers, Arrow Head	66	Pliers, Reynolds	62	
Pamphlet, Your Child's Palate Widening	190	Pliers, Baade	65	Pliers, Reynolds, Mid-Grade	62	
Pamphlet, Your First Days in Treatment	189	Pliers, Baade, Mid-Grade	65	Pliers, Ribbon Arch	64, 66	
--			Pliers, Band	67	Pliers, Robinson	63
		Pliers, Bayonet	69	Pliers, Round Nose	61	
				Pliers, Step	69	



Pliers, Stop.....	69
Pliers, Three Jaw.....	69, 162
Pliers, Three Prong.....	69
Pliers, Torquing.....	69
Pliers, Tweed & Helix.....	69
Pliers, Weingart.....	70, 161-162
Pliers, Wire Bending.....	61, 64
Pliers, Wire Bending, Mid-Grade.....	61, 64
Pliers, Young.....	61

Plugger, Andrews.....	22
Plugger, Back Action.....	22
Plugger, Behrman.....	22
Plugger, Black.....	22, 163
Plugger, Black, Mid-Grade.....	23
Plugger, Markley.....	23
Plugger, Mortonson.....	23
Plugger, Smith.....	23
Plugger, Tanner.....	23
Plugger/Director, Band.....	74
Pocket Marker, Crane-Kaplan.....	88, 160
Polish, Sklar Instrument.....	16, 240
Polokoff Rasp.....	93
Posterior Pliers.....	63, 67
Potts Elevator.....	102
Powder Detergent, Sklar Kleen™.....	11, 235
Prichard Periosteal Elevator.....	103

PROBES

Probes.....	31, 53, 158
Probe and Seeker, Mid-Grade.....	32, 54
Probe, Bowman Lachrymal.....	155
Probe, Coded.....	32, 54, 158-159, 161, 164
Probe, Fox/Williams.....	32, 54
Probe, Goldman-Fox.....	31-32, 53-54, 160
Probe, Michigan.....	31, 53
Probe, Nabers.....	32, 54
Probe, UNC.....	31, 53, 161, 164-165
Probe, WHO (PSR).....	31, 53, 160-161, 165
Probe, Williams.....	31, 53
Probe/Explorer.....	33, 160, 163, 165
Probe/Explorer, Goldman-Fox.....	32, 54
Procedure Mask.....	184, 196
Procedure Tray, Plastic.....	218
Prophy Set.....	161
Protector, Mouth, Disposable.....	178
Protectors, SklarTip™ Instrument.....	219
Punch, Rubber Dam.....	36
Punch, Rubber Dam, Mid-Grade.....	36
Pusher, Band.....	74
Pusher, Bone.....	97
Pusher/Director, Band.....	74, 161

Q

Quimby Scissors.....	149, 160
----------------------	----------

R

RA Matrix Scissors.....	37, 150
Rack, Instrument, Stainless Steel.....	208
Rasp, Polokoff.....	93
Reclosable Bag, Disposable.....	185
Reconditioner, Sklar Sheen™.....	12, 236
Record Card, Account.....	191
Reeh Stitch Scissors.....	151
Reeves Carver.....	42
Regular Surgeon Needle.....	133
Remover, Blade.....	192
Restorative Set.....	163
Retainer Bright.....	76, 90, 181
Retainers, Matrix.....	46
Retraction Cord Packer.....	33
Retractor, Cheek.....	136-137, 159
Retractor, Cheek, Mid-Grade.....	137
Retractor, Cheek, University of Minnesota.....	137, 159
Retractor, Cheek, University of Minnesota, Mid-Grade.....	137
Retractor, Disposable Cheek.....	178
Retractor, Lahey.....	164
Retractor, Lip, Columbia.....	137
Retractor, Lip, Disposable.....	76, 137, 178
Retractor, Plastic Surgery.....	136
Retractor, Senn.....	136
Retractor, Tracheal.....	136
Reynolds Pliers.....	62
Reynolds Pliers, Mid-Grade.....	62
Ribbon Arch Pliers.....	64, 66
Ribbon Stitch Scissors.....	151
Roach Carver.....	42
Roach Carver, Mid-Grade.....	42
Robinson Pliers.....	63
Rochester Ochsner Forcep, Econo-Sterile™.....	169
Rochester Pean Forcep, Econo-Sterile™.....	169
Roll Holder, Cotton.....	137
Rolls, Cotton.....	183
Rongeur.....	139
Rongeur, Beyer.....	138
Rongeur, Blumenthal.....	138
Rongeur, Bone.....	138
Rongeur, Cleveland.....	139
Rongeur, Dean.....	138
Rongeur, Friedman.....	138
Rongeur, Friedman, Micro.....	89, 139
Rongeur, Hartman.....	139
Rongeur, Mead.....	139
Root Planing Set.....	165
Root Tip Elevator.....	101
Ross Needle Holder.....	87
Round Mirror Handle, Mid-Grade.....	55
Round Nose Pliers.....	61
Rubber Dam Forcep.....	36
Rubber Dam Forcep, Brewer.....	36
Rubber Dam Forcep, University of Washington.....	36

Rubber Dam Forcep, University of Washington, Mid-Grade.....	36
Rubber Dam Holder.....	36
Rubber Dam Punch.....	36
Rubber Dam Punch, Mid-Grade.....	36
Russian Tissue Forcep.....	124
Ryder Needle Holder, TC.....	127
Ryder Needle Holder, TC, Left.....	128

S

Safety Scalpel, SklarSafe™.....	194
Sanitizer, Sklar-Stat™ Foaming Hand.....	15, 239

SCALERS

Scaler, Crane Kaplan.....	80, 160
Scaler, Goldman-Fox.....	80, 160
Scaler, Jacqueline.....	80-82
Scaler, Taylor.....	82
Scaler, Towner.....	82
Scaler, Towner/Jacquette.....	82
Scaler, Universal.....	83-84, 159-161, 165
Scaler, Whiteside.....	83
Scaler, Younger Good.....	83

Scalpel Blade.....	195
Scalpel Handle.....	159, 192, 195
Scalpel, Disposable.....	193
Scalpel, Mini Thumb.....	195
Scalpel, SklarSafe™ Safety.....	33, 194
Schedule Book, Orthodontic.....	191

SCISSORS

Scissors, Baker Crown.....	152
Scissors, Brophy.....	148
Scissors, Castroviejo Corneal.....	89, 153
Scissors, Crown.....	37, 73, 152
Scissors, Crown, Mid-Grade.....	37, 73, 152
Scissors, Dean.....	148
Scissors, Dean, Mid-Grade.....	148
Scissors, Econo-Sterile™, Wireform.....	173
Scissors, Goldman-Fox.....	149, 160
Scissors, Goldman-Fox, Mid-Grade.....	149
Scissors, Goldman-Fox, Sklar Edge™ TC.....	140
Scissors, Goldman-Fox, Sklarhone™.....	144
Scissors, Gradle, Sklarhone™.....	143
Scissors, Heath.....	149
Scissors, Iris.....	147, 162-164
Scissors, Iris, Econo-Sterile™.....	167
Scissors, Iris, Mid-Grade.....	147
Scissors, Iris, Sklar Edge™ TC.....	140
Scissors, Iris, Sklarhone™.....	143
Scissors, Iris, Sklarhone™ TC.....	142
Scissors, Joseph.....	147
Scissors, Kaye Dissecting.....	149
Scissors, Kaye Dissecting, Sklar Edge™ TC.....	140
Scissors, Kelly-Adson.....	147-148
Scissors, Kelly-Adson, Mid-Grade.....	148

Scissors, Knowles Bandage.....	152
Scissors, Knowles Bandage, Econo-Sterile™.....	168
Scissors, Lagrange.....	149, 159
Scissors, Lister Bandage.....	152
Scissors, Lister Bandage, Econo-Sterile™.....	168
Scissors, Lister Bandage, Mid-Grade.....	152
Scissors, Littauer Stitch.....	150, 165
Scissors, Littauer Stitch, Econo-Sterile™.....	168
Scissors, Littauer Stitch, Mid-Grade.....	150
Scissors, Locklin.....	148
Scissors, Mayo.....	146
Scissors, Mayo, Econo-Sterile™.....	167
Scissors, Mayo, Mid-Grade.....	146
Scissors, Mayo, Sklar Edge™ TC.....	141
Scissors, Mayo, Sklarhone™.....	144
Scissors, McClure Iris.....	89
Scissors, Metzenbaum.....	146
Scissors, Metzenbaum, Econo-Sterile™.....	167
Scissors, Metzenbaum, Sklar Edge™ TC.....	140
Scissors, Metzenbaum, Sklarhone™.....	143
Scissors, Metzenbaum, Sklarhone™ TC.....	142
Scissors, Noyes Iris.....	153
Scissors, Operating.....	145
Scissors, Operating, Econo-Sterile™.....	167
Scissors, Operating, Mid-Grade.....	145
Scissors, Operating, Sklar Edge™ TC.....	141
Scissors, Operating, Sklarhone™.....	144
Scissors, Pedo Crown-Festooning.....	37, 152
Scissors, Quimby.....	149, 160
Scissors, RA Matrix.....	37, 150
Scissors, Ribbon Stitch.....	151
Scissors, Sklar.....	149
Scissors, Spencer Stitch.....	150
Scissors, Spencer Stitch, Econo-Sterile™.....	168
Scissors, Spencer Stitch, Mid-Grade.....	150
Scissors, Stevens, Sklarhone™.....	143
Scissors, Stitch.....	151
Scissors, Stitch, Littauer, Plastic.....	186
Scissors, Stitch, Long.....	151
Scissors, Stitch, O'Brien.....	151
Scissors, Stitch, Reeh.....	151
Scissors, Suture.....	150
Scissors, Suture, New's.....	151
Scissors, Utility, Econo-Sterile™.....	168
Scissors, Wagner.....	146
Scissors, Wire Cutting.....	73
Scissors, Wire Cutting, Econo-Sterile™.....	168
Scissors, Wire Cutting, Mid-Grade.....	73
Scissors, Wire Cutting, Sklar Edge™ TC.....	73, 141
-	
Scoop, Lab/Utility, Stainless Steel.....	200
Score Card, Headgear.....	191
Seldin Elevator.....	99, 103, 164
Self-Locking College Pliers, Mid-Grade.....	48, 57
Semkin Dressing Forcep.....	123
Semkin Tissue Forcep.....	123
Senn Retractor.....	136

SETS

Set, Akers.....	86
Set, Amalgam.....	163
Set, Basic Dental.....	158
Set, Basic Dental Surgery.....	159
Set, Basic Examination I.....	158
Set, Basic Examination II.....	158
Set, Brush, Cleaning.....	225-226
Set, Cement (Crown Seat).....	164
Set, College Pliers.....	156
Set, Composite/Crown Prep.....	162
Set, Crown & Bridge.....	164
Set, Evans.....	86
Set, Explorer.....	156
Set, Extracting Forcep.....	157
Set, Gracey Curette.....	157
Set, Instrument Holder.....	215
Set, Orthodontic Archwire Adjustment.....	162
Set, Orthodontic Banding/Bonding.....	161
Set, P.K. Thomas Wax Placer.....	38, 157
Set, Pedodontic Implant.....	160
Set, Periodontal Instrument I.....	159
Set, Periodontal Instrument II.....	160
Set, Periodontal Instrument III.....	160
Set, Prophy.....	161
Set, Restorative.....	163
Set, Root Planing.....	165
Set, Sinus Lift.....	164
Set, Suture Removal.....	165
-	
Setter, Band.....	74
Sheehan Osteotome.....	96
Shield, Tongue, Disposable.....	178
Silicon Mat, SklarLite™.....	210-212
Sinus Lift Set.....	164
Sklar Disinfectant.....	5, 84, 229

SKLAR EDGE™

Sklar Edge™ TC Goldman-Fox Scissors.....	140
Sklar Edge™ TC Iris Scissors.....	140
Sklar Edge™ TC Kaye Dissecting Scissors.....	140
Sklar Edge™ TC Mayo Scissors.....	141
Sklar Edge™ TC Metzenbaum Scissors.....	140
Sklar Edge™ TC Operating Scissors.....	141
Sklar Edge™ TC Wire Cutting Scissors.....	73, 141
-	
Sklar Enzymatic™ Detergent.....	13, 237
Sklar Fresh™ Odor Neutralizer Spray.....	16, 240
Sklar ID Roll Tape.....	220
Sklar Instru-Guard™ Lube.....	10, 234
Sklar Instru-Guard™ One Step.....	9, 233
Sklar Instrument Care Kit.....	17, 241
Sklar Instrument Polish.....	16, 240
Sklar Kleen™ Liquid Detergent.....	11, 235
Sklar Kleen™ Low Foam Detergent.....	11, 235
Sklar Kleen™ Powder Detergent.....	11, 235

Sklar Mallet.....	95
Sklar Scissors.....	149
Sklar Sheen™ Foam Spray.....	12, 236
Sklar Sheen™ Reconditioner.....	12, 236
Sklar Soak™.....	8, 232
Sklar Spray-Zyme™.....	7, 231
Sklar Surface Wipes Disinfectant.....	6, 95, 201, 230
Sklar-Cide™.....	4, 228

SKLARHONE™

Sklarhone™ Goldman-Fox Scissors.....	144
Sklarhone™ Gradle Scissors.....	143
Sklarhone™ Iris Scissors.....	143
Sklarhone™ Mayo Scissors.....	144
Sklarhone™ Metzenbaum Scissors.....	143
Sklarhone™ Operating Scissors.....	144
Sklarhone™ Stevens Scissors.....	143
Sklarhone™ TC Iris Scissors.....	142
Sklarhone™ TC Metzenbaum Scissors.....	142

SKLARLITE XD™

Sklarlite XD™ Adson Dressing Forcep.....	119
Sklarlite XD™ Adson Tissue Forcep.....	119
Sklarlite XD™ Adson-Brown Tissue Forcep.....	119
Sklarlite XD™ Allis Tissue Forcep.....	120
Sklarlite XD™ Baumgartner Needle Holder.....	130
Sklarlite XD™ Crile-Wood Needle Holder.....	130
Sklarlite XD™ Derf Needle Holder.....	129
Sklarlite XD™ Dressing Forcep.....	119
Sklarlite XD™ Halsey Needle Holder.....	130
Sklarlite XD™ Halsted Mosquito Forcep.....	120
Sklarlite XD™ Hartmann Mosquito Forcep.....	120
Sklarlite XD™ Kelly Forcep.....	120
Sklarlite XD™ Mayo-Hegar Needle Holder.....	130
Sklarlite XD™ Olsen-Hegar Needle Holder.....	129
Sklarlite XD™ Tissue Forcep.....	119
Sklarlite XD™ Webster Needle Holder.....	129

SKLARLITE™

Sklarlite™ Accessories.....	211
Sklarlite™ Adson Dressing Forcep.....	119
Sklarlite™ Adson Tissue Forcep.....	119
Sklarlite™ Adson-Brown Tissue Forcep.....	119
Sklarlite™ Allis Tissue Forcep.....	120
Sklarlite™ Baumgartner Needle Holder.....	130
Sklarlite™ Crile-Wood Needle Holder.....	130
Sklarlite™ Derf Needle Holder.....	129
Sklarlite™ Dressing Forcep.....	119
Sklarlite™ Halsey Needle Holder.....	130
Sklarlite™ Halsted Mosquito Forcep.....	120
Sklarlite™ Hartmann Mosquito Forcep.....	120
Sklarlite™ Kelly Forcep.....	120
Sklarlite™ Mayo-Hegar Needle Holder.....	130
Sklarlite™ Olsen-Hegar Needle Holder.....	129
Sklarlite™ Silicon Mat.....	210-212
Sklarlite™ Sterilization Basket.....	210-212
Sklarlite™ Sterilization Container.....	210-212



SklarLite™ Tissue Forcep.....	119
SklarLite™ Webster Needle Holder.....	129
--	
SklarSafe™ Safety Scalpel	194
Sklar-Stat™ Dispenser Bottle.....	15, 70, 102, 239
Sklar-Stat™ Foam Dispenser.....	15, 70, 102, 239
Sklar-Stat™ Foaming Hand Sanitizer.....	15, 239
SklarTip™ Instrument Protectors	219
Sleeves, Tray, Disposable	179
Smith Plugger.....	23
Smith Special Plastic Filling Instrument.....	35
Solution Basin, Stainless Steel.....	198
Sonic Cleaner.....	77, 175
Spatula, Cement.....	44, 162-164
Spatula, Cement, Agathe.....	44
Spatula, Cement, Mid-Grade.....	44
Spatula, Wax	43
Spatula, Wax, Gritman.....	43
Specimen Tube, Plastic.....	216
Spencer Stitch Scissors.....	150
Spencer Stitch Scissors, Econo-Sterile™	168
Spencer Stitch Scissors, Mid-Grade.....	150
Spiral Toothbrush.....	179
Splinter Forcep, Econo-Sterile™	170
Splinter Forcep, Peet.....	57
Splinter Forcep, Williams.....	57
Splinter Forcep, Williams, Mid-Grade.....	57
Sponge Bowl, Stainless Steel.....	198
Sponge Forcep, Econo-Sterile™	171
Sponge Forcep, Econo-Sterile™ Wireform.....	173
Sponge Forcep, Plastic	187
Sponge, Gauze.....	184
Spoon, Akers	86
Spoon, Evans	86
Spray, Foam, Sklar Sheen™	12, 236
Spray, Sklar Fresh™ Odor Neutralizer	16, 240

STAINLESS STEEL

Stainless Steel Catheter Instrument Tray.....	202
Stainless Steel Catheter Instrument Tray Cover	202
Stainless Steel Catheter Instrument Tray, Miniature	201
Stainless Steel Cleaning Basket.....	203
Stainless Steel Dressing Jar.....	200
Stainless Steel Emesis Basin.....	199
Stainless Steel Forcep Jar.....	200, 224
Stainless Steel Funnel.....	200
Stainless Steel Graduated Measure Cup	198
Stainless Steel Hospital Bucket.....	199
Stainless Steel Hospital Kick Bucket.....	199
Stainless Steel Instrument Drying Tray	203
Stainless Steel Instrument Rack.....	208
Stainless Steel Instrument Stringer	207-208
Stainless Steel Instrument Tray.....	204
Stainless Steel Instrument Tray Cover	204-205
Stainless Steel Iodine Cup.....	197
Stainless Steel Lab/Utility Scoop.....	200

Stainless Steel Lifting Handles	206
Stainless Steel Mayo Tray	202
Stainless Steel Medicine Cup.....	197
Stainless Steel Micro Sterilization Tray	206
Stainless Steel Micro Sterilization Tray Cover.....	206
Stainless Steel Mixing/Solution Bowl.....	198
Stainless Steel Ointment Jar	201
Stainless Steel Pitcher/Beaker	197
Stainless Steel Solution Basin.....	198
Stainless Steel Sponge Bowl.....	198
Stainless Steel Sterilization Tray	205-206
Stainless Steel Sterilization Tray Cover.....	205
Stainless Steel Sterilization Tray Handle	206
Stainless Steel Sterilization/Bath Set Tray	205
Stainless Steel Sterilizing Tray	204-205
Stainless Steel Storage Container.....	199
Stainless Steel Tumbler.....	197
--	

Standard Extracting Forcep.....	104
Step Pliers	69
Sterilization Basket, SklarLite™	210-212
Sterilization Cassette.....	213-215
Sterilization Container, SklarLite™	210-212
Sterilization Tray Cover, Stainless Steel.....	205
Sterilization Tray Handle, Stainless Steel.....	206
Sterilization Tray, Stainless Steel	205-206
Sterilization/Bath Set Tray, Stainless Steel.....	205
Sterilizer Forcep	174
Sterilizer Forcep, Utility.....	125
Sterilizer Forcep, Utility, Mid-Grade.....	125
Sterilizing Forcep.....	125
Sterilizing Forcep, Mid-Grade.....	125
Sterilizing Tray, Stainless Steel	204-205
Sternal Wire Twister Needle Holder, TC	74
Stevens Needle Holder.....	87
Stevens Scissors, Sklarhone™	143
Stick, Bite.....	75
Stitch Cutter.....	195
Stitch Scissors.....	151
Stitch Scissors, Econo-Sterile™, Wireform	173
Stitch Scissors, Littauer, Plastic.....	186
Stitch Scissors, Long.....	151
Stitch Scissors, O'Brien.....	151
Stitch Scissors, Reeh	151
Stitch Scissors, Ribbon.....	151
Stop Pliers	69
Storage Container, Stainless Steel.....	199
Stringer, Instrument, Stainless Steel	207-208
Strips, Gluteraldehyde	4, 228
Suction Tube, Adson.....	154
Suction Tube, Andrews-Pynchon.....	155
Suction Tube, Baron.....	155
Suction Tube, Cleaning Brush.....	223
Suction Tube, Coupland	154
Suction Tube, Frazier	154
Suction Tube, Frazier Ferguson	154
Suction Tube, Yankauer	154

Super "C" Ortho Adhesive Kit	77
Surgical Gown	196
Surgical Scrub Brush.....	223
Suture Removal Set	165
Suture Scissors	150
Suture Scissors, New's.....	151

T

Tags, Instrument ID	220
Tamper, Bone	164
Tanner Carver.....	41
Tanner Plugger	23
Tape, ID Roll, Sklar.....	220
Tape, ID Sheet.....	220
Taylor Scaler.....	82

TUNGSTEN CARBIDE

TC Adson Dressing Forcep	118
TC Amalgam Carrier.....	19, 163
TC Baumgartner Needle Holder	126
TC Boynton Needle Holder.....	127
TC Castroviejo Needle Holder.....	87
TC Crile-Wood Needle Holder.....	127, 159, 164
TC Crile-Wood Needle Holder, Left.....	128
TC Derf Needle Holder	126
TC Dressing Forcep	118
TC Goldman-Fox Scissors, Sklar Edge™	140
TC Halsey Needle Holder.....	126
TC How Pliers.....	61
TC Iris Scissors, Sklar Edge™	140
TC Iris Scissors, Sklarhone™	142
TC Kaye Dissecting Scissors, Sklar Edge™	140
TC Mathieu Needle Holder.....	127
TC Mayo Scissors, Sklar Edge™	141
TC Mayo-Hegar Needle Holder	126
TC Mayo-Hegar Needle Holder, Left.....	128
TC Metzenbaum Scissors, Sklar Edge™	140
TC Metzenbaum Scissors, Sklarhone™	142
TC Olsen-Hegar Needle Holder	126
TC Operating Scissors, Sklar Edge™	141
TC PAR Needle Holder.....	126
TC Pin & Ligature Pliers	61
TC Ryder Needle Holder	127
TC Ryder Needle Holder, Left	128
TC Sternal Wire Twister Needle Holder.....	74
TC Webster Needle Holder	127
TC Webster Needle Holder, Left.....	128
TC Wire Cutting Scissors, Sklar Edge™	73, 141
TC Wynman Crown Gripper	90
--	
Template, Buchin Tracing	76, 181
Three Jaw Pliers.....	69, 162
Three Prong Pliers.....	69
Thumb Forcep, Econo-Sterile™ Wireform	173
Tip, Chip Blower	155
TipGrips™ Instrument Guard	219
Tips, Disposable Aspirating	180

Tips, Disposable Evacuator.....	180
Tissue Forcep.....	123-124
Tissue Forcep, Adson.....	124
Tissue Forcep, Adson Sklarlite XD™.....	119
Tissue Forcep, Adson Sklarlite™.....	119
Tissue Forcep, Adson-Brown.....	124
Tissue Forcep, Adson-Brown Sklarlite XD™.....	119
Tissue Forcep, Adson-Brown Sklarlite™.....	119
Tissue Forcep, Allis.....	122
Tissue Forcep, Brown.....	123
Tissue Forcep, Econo-Sterile™.....	170
Tissue Forcep, Russian.....	124
Tissue Forcep, Semkin.....	123
Tissue Forcep, Sklarlite XD™.....	119
Tissue Forcep, Sklarlite™.....	119
Tissue Nipper.....	89
Tissue Twist Hook.....	136
Tongue Depressor, Andrews.....	137
Tongue Depressor, Disposable.....	180
Tongue Depressor, Wieder.....	137
Tongue Depressors.....	137
Tongue Seizing, Young, Forcep.....	125
Tongue Shield, Disposable.....	178
Toothbrush, Disposable.....	179
Torquing Pliers.....	69
Towel Clamp, Backhaus.....	125
Towel Clamp, Backhaus, Econo-Sterile™.....	171
Towel Clamp, Hoff, Econo-Sterile™.....	171
Towel Clamp, Hoff, Plastic.....	187
Towel Clamp, Lorna Edna.....	125
Towel Clamp, Lorna Edna, Econo-Sterile™.....	171
Towel Clamp, Plastic.....	187
Towel Forcep, Econo-Sterile™ Wireform.....	173
Towel, OR, Sklar Cotton, Disposable.....	182
Towel, OR, Sklar, Disposable.....	182
Towner Scaler.....	82
Towner/Jacquette Scaler.....	82
Tracheal Retractor.....	136
Tracheal Tube, Cleaning Brush.....	222
Tracing Template, Buchin.....	76, 181
Travel Toothbrush.....	179
TRAYS	
Tray Cover, Catheter Instrument, Stainless Steel.....	202
Tray Cover, Instrument, Stainless Steel.....	204-205
Tray Cover, Micro Sterilization, Stainless Steel.....	206
Tray Cover, Sterilization, Stainless Steel.....	205
Tray, Catheter Instrument, Stainless Steel.....	202
Tray, Catheter Instrument, Stainless Steel, Miniature.....	201
Tray, Instrument Drying, Stainless Steel.....	203
Tray, Instrument, Stainless Steel.....	204
Tray, Mayo, Stainless Steel.....	202
Tray, Micro Sterilization, Stainless Steel.....	206
Tray, Plastic.....	218
Tray, Plastic Instrument Soaking.....	218
Tray, Plastic Procedure.....	218
Tray, Sterilization, Stainless Steel.....	205-206
Tray, Sterilization/Bath Set, Stainless Steel.....	205
Tray, Sterilizing, Stainless Steel.....	204-205
—	
Tray Sleeves, Disposable.....	179
Tube Clamp, Plastic.....	186
Tube, Plastic Specimen.....	216
Tucker and Director, Ligature.....	75
Tumbler, Stainless Steel.....	197
Tweed & Helix Pliers.....	69
U	
UNC Probe.....	31, 53, 161, 164-165
Universal Scaler.....	83-84, 159-161, 165
University of Michigan Burnisher.....	25
University of Minnesota Cheek Retractor.....	137, 159
University of Washington Rubber Dam Forcep.....	36
University of Washington Rubber Dam Forcep, Mid-Grade.....	36
Utility Bowl, Plastic.....	217
Utility Forcep, Plastic.....	186
Utility Scissors, Econo-Sterile™.....	168
Utility Sterilizer Forcep.....	125
Utility Sterilizer Forcep, Mid-Grade.....	125
V	
Vehe Carver.....	42
Vehe Carver, Mid-Grade.....	42
Vinyl Gloves.....	188
W	
Wagner Scissors.....	146
Wakefield Chisel.....	94
Walls Carver.....	41
Ward Carver.....	41
Wax Carver, Hollenback.....	40, 161, 163
Wax Carver, Hollenback, Mid-Grade.....	40
Wax Carver, Interproximal.....	42, 162-164
Wax Carver, Le Cron.....	42
Wax Carver, Le Cron, Mid-Grade.....	42
Wax Carver, P.K. Thomas.....	38, 157
Wax Carver, P.K. Thomas Set.....	38
Wax Carver, P.K. Thomas, Mid-Grade.....	38
Wax Carver, Reeves.....	42
Wax Carver, Roach.....	42
Wax Carver, Roach, Mid-Grade.....	42
Wax Carver, Tanner.....	41
Wax Carver, Vehe.....	42
Wax Carver, Vehe, Mid-Grade.....	42
Wax Carver, Walls.....	41
Wax Carver, Ward.....	41
Wax Placer, P.K. Thomas.....	157
Wax Spatula.....	43
Webster Needle Holder.....	131
Webster Needle Holder, Econo-Sterile™.....	172
Webster Needle Holder, Mid-Grade.....	131
Webster Needle Holder, Sklarlite XD™.....	129
Webster Needle Holder, Sklarlite™.....	129
Webster Needle Holder, TC.....	127
Webster Needle Holder, TC, Left.....	128
Wedge, Oral.....	135
Weingart Pliers.....	70, 161-162
Well, Amalgam.....	21, 163
Wesson Mouth Gag.....	135
West Osteotome.....	96
West Periosteal Elevator.....	103
Whiteside Scaler.....	83
WHO (PSR) Probe.....	31, 53, 160-161, 165
Wieder Tongue Depressor.....	137
Williams Probe.....	31, 53
Williams (Stieglitz) Splinter Forcep.....	57
Williams (Stieglitz) Splinter Forcep, Mid-Grade.....	57
Wipes, Surface Disinfectant, Sklar.....	6, 95, 201, 230
Wire Bending Pliers.....	61, 64
Wire Bending Pliers, Mid-Grade.....	61, 64
Wire Cutter & Parallel Pliers.....	72
Wire Cutter, Diagonal.....	72
Wire Cutter, Hard.....	72, 162
Wire Cutter, Pin & Ligature.....	71, 161-162
Wire Cutting Scissors.....	73
Wire Cutting Scissors, Econo-Sterile™.....	168
Wire Cutting Scissors, Mid-Grade.....	73
Wire Cutting Scissors, Sklar Edge™ TC.....	73, 141
Wire Cutting Scissors, Suture.....	150
Wireform Halsted Mosquito Forcep, Econo-Sterile™.....	173
Wireform Kelly Forcep, Econo-Sterile™.....	173
Wireform Needle Holder, Econo-Sterile™.....	173
Wireform Scissors, Econo-Sterile™.....	173
Wireform Sponge Forcep, Econo-Sterile™.....	173
Wireform Stitch Scissors, Econo-Sterile™.....	173
Wireform Thumb Forcep, Econo-Sterile™.....	173
Wireform Towel Forcep, Econo-Sterile™.....	173
Witzel Extracting Forcep.....	114
Woodson Filling Instrument.....	35
Woodward Extracting Forcep.....	114-115
Wynman Crown Gripper, TC.....	90
Y	
Yankauer Suction Tube.....	154
You and Your Appliances Pamphlet.....	190
You and Your Bandless Braces Pamphlet.....	190
You and Your Elastics Pamphlet.....	190
You and Your Headgear Pamphlet.....	191
You And Your Retainer Pamphlet.....	190
You and Your Toothbrush Pamphlet.....	189
Young Pliers.....	61
Young Tongue Seizing Forcep.....	125
Younger Good Scaler.....	83
Your Child and Orthodontics Pamphlet.....	189
Your Child's First Day Pamphlet.....	189
Your Child's Palate Widening Appliance Pamphlet.....	190
Your First Days In Treatment Pamphlet.....	189

SKLAR DISINFECTANT

2 MINUTE KILL TIME

READY-TO-USE SPRAY SURFACE DISINFECTANT

- Ready to use, non-toxic formula.
- Specially formulated for the control of cross contamination.
- Effective against a broad range of pathogens including H1N1, HIV-1, HPV, VRE, Norovirus, Hep B & C as well as TB, MRSA and A. Baumannii.
- Safe for all areas of the facility including the NICU, operating rooms, isolation rooms, patient care areas and laboratories.
- Satisfies OSHA's Bloodborne Pathogen Standards.
- Non-irritating formula.
- EPA registered.



PRODUCT NUMBER	FEATURES	QUANTITIES
10-1643	24 oz. Spray Bottles	6/case
10-1642	24 oz. Spray Bottle	1 bottle
10-1653	1 Gallon Bottles	4/case
10-1654	1 Gallon Bottle	1 bottle
10-1644	2.5 Gallon Bottles	2/case



The Tradition Continues

SKLAR DISINFECTANT SURFACE WIPES

READY-TO-USE, PRE-MOISTENED TOWELETTES

SAME EFFECTIVE FORMULA AS SKLAR DISINFECTANT!

- Ready to use, non-toxic formula.
- Specially formulated for the control of cross contamination.
- Effective against a broad range of pathogens including H1N1, HIV-1, HPV, VRE, Norovirus, Hep B & C as well as TB, MRSA and A. Baumannii.
- Safe for all areas of the facility.
- Satisfies OSHA's Bloodborne Pathogen Standards.
- Destroys odor-causing bacteria.
- 7" x 10" non-woven, tear resistant towelette.
- Clean scent.
- EPA registered.



889 South Matlack Street
West Chester, PA 19382

800.221.2166

610.430.3200

Fax: 610.696.9007

International Phone: 610.430.3200

International Fax: 610.430.3941

surgi@sklarcorp.com

international@sklarcorp.com

www.sklarcorp.com

DISTRIBUTED BY:

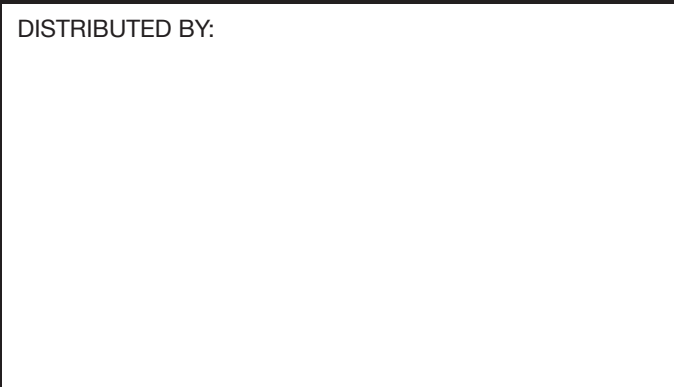

©Copyright 2013. Sklar Corporation, West Chester, PA. All rights reserved. No portion of this catalog may be reproduced without written permission of Sklar.