



# OB/GYN

MEDICAL/SURGICAL PRODUCTS  
FOR CARE OF THE FEMALE PATIENT

**IN-OFFICE SURGERY**

**LAPAROSCOPY**

**SURGICAL DISPOSABLES/DIAGNOSTICS**

**INSTRUMENT CARE AND CLEANING**





- 3-14 ..... Specula
- 15-20 ..... Retractors
- 21-23 ..... Endocervical Specula
- 24-28 ..... Hooks
- 29-30 ..... Sounds
- 31-33 ..... Dilators/Punches
- 34-36 ..... Curettes
- 37 ..... Hysterectomy/Parametrium
- 38-42 ..... Obstetrical Forceps
- 43-50 ..... Biopsy Forceps
- 51 ..... Colposcopy Sets
- 52-77 ..... Scissors
- 78-106 ..... Forceps
- 107-120 ..... Needle Holders
- 121-142 ..... Laparoscopic Instruments
- 143-161 ..... Electrosurgery
- 162-172 ..... Laser Instruments (Sklar Black™)
- 173-179 ..... Instrument Sets
- 180-188 ..... Disposable Products
- 189-195 ..... Procedure Trays
- 196-205 ..... Surgi-OR™
- 206-215 ..... Merit™
- 216-225 ..... Econo™ Sterile
- 226 ..... Suction Tubes
- 227-232 ..... Stethoscopes
- 233 ..... Protective Apparel
- 234-237 ..... Blades & Scalpels
- 238-251 ..... Stainless Steel
- 252-254 ..... Plasticware
- 255-256 ..... Instrument Protectors & ID
- 257-262 ..... Brushes
- 263-276 ..... Care & Cleaning
- 277-304 ..... Index

©Copyright 2012  
Sklar Corporation  
889 S. Matlack Street  
West Chester, PA 19382

Phone: 800.221.2166  
Fax: 610.696.9007  
Email: Surgi@sklarcorp.com

International  
Phone: 610.430.3200  
Fax: 610.430.3941  
Email: International@sklarcorp.com

#### DISCLAIMERS:

Sklar offers a full line of quality surgical products and services to meet your needs.

Product information within this catalog is intended to provide general information about Sklar, its products and services and makes no representation either expressed or implied to the contrary. It is not meant to provide specialist advice or instructions concerning the products available from Sklar. For additional information and special inquiries concerning our products and services, please contact Sklar directly.

Accurate and up-to-date information is our goal. However, in an effort to continually improve our product line, illustrations and content within this catalog are subject to change without notice. Contact your sales representative to verify availability.

In no event is Sklar liable for any incidental, special or exemplary damages or loss of profits in connection with the use of a Sklar Instrument or Product.

Convenience Kits (FDA recognized term) illustrated in this catalog are representative of Sklar's assembly capability. The final design and approval of the kit is the responsibility of the customer and will be managed in accordance with the Sklar Design and Development process.

©Copyright 2012. Sklar Corporation, West Chester, PA. All rights reserved. No portion of this catalog may be reproduced without written permission of Sklar.

#### ORDERS

- Sklar's full line of Instrument Products are available through any authorized Sklar Distributor. Contact our Customer Service Department at 800.221.2166 to locate a Sales Representative in your area.
- Customers with established accounts and in good standing are subject to Net 30 days from date of invoice. Poor credit conditions can result in denial, delay or cancellation of orders.

#### SHIPMENTS

- Pricing is FOB West Chester PA unless otherwise noted and may be subject to change. Shipping schedules are approximate and subject to change without notice. Same day shipping is available. Standard orders will be shipped via the carrier of Sklar's choice. Special shipping requests will be accepted but additional handling charges are applicable.
- All Sklar instruments and product are carefully inspected prior to shipment. Customers shall inspect all items upon receipt and file a claim within (10) days of receipt of shipment.

#### WARRANTY

- Instruments and Products are recommended for their intended use only, and require continuous and proper care. Misuse can damage instruments and products and void the warranty.
- All Sklar instruments are guaranteed to be free from defect in material and workmanship. Defective instruments may be returned for repair or replacement at no charge. Repair or replacement is at the discretion of Sklar. Warranty is void on any instrument serviced by any company other than Sklar Instrument Repair Services.
- Sklar offers a variety of supplementary surgical products. These products are held to high standards for material and craftsmanship and some are subject to a limited warranty (vary by product).
- Standard sterile kits may be returned within 30 days, provided sterility of the inner packs have not been compromised, package is unopened and resalable.
- Most cleaning products are non-returnable.

#### RETURNS

- A Returned Goods Authorization (RGA) number must be obtained prior to returning products to Sklar. Contact our Customer Service Department at 800.221.2166 for authorization and complete return instructions. Following an investigation, any credit, repair or replacement will be issued at Sklar's discretion.

# Speculums

## **Sklar Blue™ Electrosurgical Speculums** ..... Page 4

Designed to provide an effective, non-conductive, patient-safe surface, Sklar's line of electrosurgical instruments features our exclusive Sklar Blue™ insulated coating that prevents transmission of RF current through the instrument. Manufactured of the highest quality stainless steel, these instruments are fully autoclavable. All Sklar Blue™ electrosurgical coatings are guaranteed for one year against manufacturing defects.

## **Sklar Black™ Laser Speculums** ..... Page 7

Sklar Black™ Laser instruments use an improved black polymer coating developed specifically for Laser surgery. Testing demonstrates that the Sklar Black™ coating over a sandblasted surface reduced reflective laser energy to less than one-tenth of one percent. The durable coating improves patient safety and provides a reliable instrument you can use with confidence for years of service. All Sklar Laser coatings are guaranteed for one year against manufacturing defects.

## **General Surgery Instruments** ..... Page 10

Our very best operating room, high quality instruments incorporating optimum grades of German grade surgical steel, finely detailed craftsmanship and exacting standards of manufacturing. Choose from a full line of the most popular patterns.

## **Surgi-OR™ Instruments** ..... Page 13

Hand-crafted and forged from Japanese surgical grade stainless steel, Surgi-OR™ instruments are built to last. Precision engineering and stringent quality control guidelines ensure superior performance. Available in the most popular patterns, this cost-effective solution doesn't sacrifice quality for value and convenience in the Operating Room and other important surgical settings.

## **Econo™ Sterile Instruments** ..... Page 14

Econo™ Sterile instruments are suitable in a number of surgical venues where economical choice with reliable performance is most important. Convenient, ready-to-use sterile instruments provide the very best value with the greatest utility of any surgical instrument.



**GRAVES VAGINAL SPECULUMS**

**WITH LOOPS FOR DISPOSABLE SMOKE EVACUATION TUBING**

91-5015	3" x 1/2"	Extra Small
91-5010	3" x 3/4"	Small
91-5012	4" x 1 1/4"	Medium
91-5014	4 1/2" x 1 3/8"	Large
91-5018	4 3/4" x 1 1/2"	Extra Large



**GRAVES VAGINAL SPECULUMS**

**WITH PERMANENT SMOKE EVACUATION TUBE**

91-5020	3" x 3/4"	Small
91-5022	4" x 1 1/4"	Medium
91-5024	4 1/2" x 1 3/8"	Large
91-5028	4 3/4" x 1 1/2"	Extra Large



**GRAVES VAGINAL SPECULUMS**

**WITHOUT TUBE OR LOOPS**

91-5066	3" x 1/2"	Extra Small
91-5060	3" x 3/4"	Small
91-5062	4" x 1 1/4"	Medium
91-5064	4 1/2" x 1 3/8"	Large
91-5068	4 3/4" x 1 1/2"	Extra Large



**PEDERSON VAGINAL SPECULUMS**

**WITH LOOPS FOR DISPOSABLE SMOKE EVACUATION TUBING**

91-5038	2 3/4" x 1/2"	Extra Small
91-5032	3" x 1/2"	Small
91-5040	4" x 5/8"	Slender
91-5034	4" x 7/8"	Medium
91-5036	4 3/4" x 1"	Large



**PEDERSON VAGINAL SPECULUMS**

**WITH PERMANENT SMOKE EVACUATION TUBE**

91-5042	3" x 1/2"	Small
91-5050	4" x 5/8"	Slender
91-5044	4" x 7/8"	Medium
91-5046	4 3/4" x 1"	Large
91-5047	4 3/4" x 1 5/8"	Extra Large



**PEDERSON VAGINAL SPECULUMS**

**WITHOUT TUBE OR LOOPS**

91-5088	2 3/4" x 1/2"	Extra Small
91-5082	3" x 1/2"	Small
91-5092	4" x 5/8"	Slender
91-5084	4" x 7/8"	Medium
91-5086	4 3/4" x 1"	Large



Autoclavable



**GRAVES VAGINAL SPECULUM  
WIDE VIEW PATTERN**

**WITH LARGE PROXIMAL OPENING FOR  
INSTRUMENTATION**

91-5080 4" x 1¼" Medium, with loops to hold and direct disposable Smoke Evacuation Tubing



**GRAVES OB-VIEW VAGINAL  
SPECULUMS**

**WITH PERMANENT SMOKE EVACUATION TUBE  
(NOT ILLUSTRATED)**

91-3740 4" x 1½" Medium  
91-3741 4¾" x 1½" Large

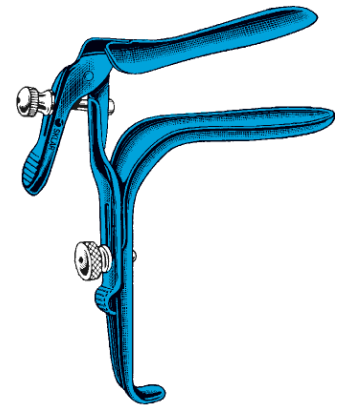

**FREEWAY GRAVES VAGINAL  
SPECULUMS**

**OPEN SIDE, 90° ANGLE**

91-5160 4" x 1¼" Medium, with permanent Smoke Evacuation Tube (not illustrated)  
  
91-5161 4" x 1¼" Medium, without permanent Smoke Evacuation Tube

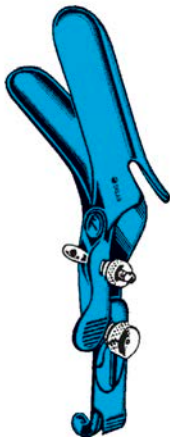

**FREEWAY GRAVES VAGINAL  
SPECULUM**

**OPEN SIDE, 45° ANGLE**

91-5162 4" x 1¼" Medium, with permanent Smoke Evacuation Tube (not illustrated)



**CUSCO VAGINAL SPECULUMS**

**WITH PERMANENT SMOKE EVACUATION TUBE**

91-5150 3" x 1¼" Small  
91-5152 3⅓" x 1⅓" Medium  
91-5154 3¾" x 1⅜" Large

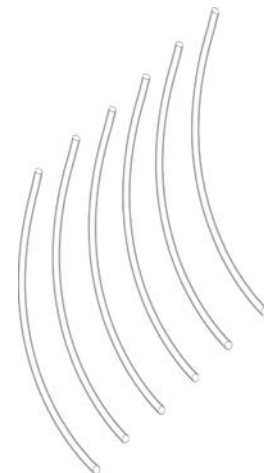

**DISPOSABLE SMOKE  
EVACUATION TUBING**

93-2160 10" Precut  
⅜" Inside Diameter  
¼" Outside Diameter 50/cs





**COLLIN VAGINAL SPECULUMS**

- 91-5180 4¼" x 1¼" Medium, with permanent Smoke Evacuation Tube (not illustrated)
- 91-5185 4¼" x 1¼" Medium, with loops to hold and direct disposable Smoke Evacuation Tubing



**AUVARD VAGINAL SPECULUMS**

- MEDIUM**
- 91-5120 2¾" x 1½" 2½ lbs. with permanent Smoke Evacuation Tube (not illustrated)
  - 91-5122 2¾" x 1½" 2½ lbs. with loop to hold and direct disposable Smoke Evacuation Tubing



**AUVARD VAGINAL SPECULUMS**

- MEDIUM LONG BLADE**
- 91-5130 4" x 1¾" 2½ lbs. without loop
  - 91-5132 4" x 1¾" 2½ lbs. with loop to hold and direct disposable Smoke Evacuation Tubing



**STEINER-AUVARD VAGINAL SPECULUMS**

- MEDIUM, EXTRA LONG BLADE**
- 91-5140 5½" x 1¼" 2½ lbs. without loop
  - 91-5142 5½" x 1¼" 2½ lbs. with loop to hold and direct disposable Smoke Evacuation Tubing



Autoclavable



**GRAVES VAGINAL SPECULUMS**  
WITH LOOPS FOR DISPOSABLE SMOKE EVACUATION TUBING

90-9005	3" x 1/2"	Extra Small
90-9000	3" x 3/4"	Small
90-9002	4" x 1 1/4"	Medium
90-9004	4 1/2" x 1 3/8"	Large
90-9006	4 3/4" x 1 1/2"	Extra Large

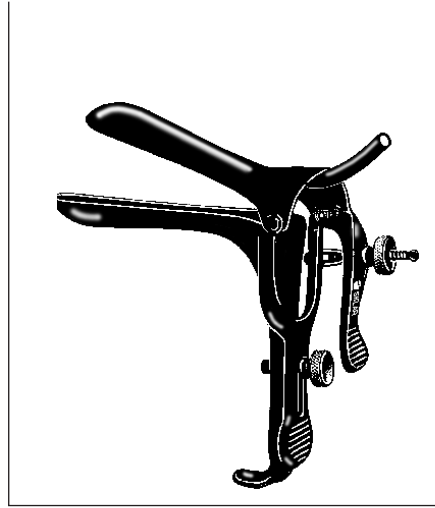

**GRAVES VAGINAL SPECULUMS**  
WITH PERMANENT SMOKE EVACUATION TUBE

90-9015	3" x 3/4"	Small
90-9016	4" x 1 1/4"	Medium
90-9018	4 1/2" x 1 3/8"	Large
90-9020	4 3/4" x 1 1/2"	Extra Large

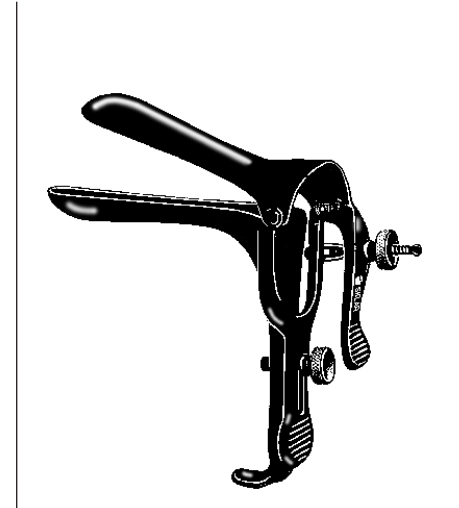

**GRAVES VAGINAL SPECULUMS**  
WITHOUT TUBE OR LOOPS

90-3812	3" x 1/2"	Extra Small
90-3804	3" x 3/4"	Small
90-3806	4" x 1 1/4"	Medium
90-3808	4 1/2" x 1 3/8"	Large
90-3810	4 3/4" x 1 1/2"	Extra Large



**PEDERSON VAGINAL SPECULUMS**  
WITH LOOPS FOR DISPOSABLE SMOKE EVACUATION TUBING

90-9035	2 3/4" x 1/2"	Extra Small
90-9030	3" x 1/2"	Small
90-9038	4" x 5/8"	Slender
90-9032	4" x 7/8"	Medium
90-9034	4 3/4" x 1"	Large

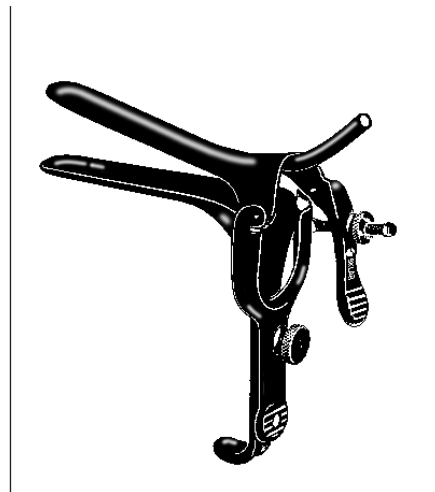

**PEDERSON VAGINAL SPECULUMS**  
WITH PERMANENT SMOKE EVACUATION TUBE

90-9040	3" x 1/2"	Small
90-9050	4" x 5/8"	Slender
90-9042	4" x 7/8"	Medium
90-9044	4 3/4" x 1"	Large
90-9048	4 3/4" x 1 5/8"	Extra Large



**PEDERSON VAGINAL SPECULUMS**  
WITHOUT TUBE OR LOOPS

90-3841	2 3/4" x 1/2"	Extra Small
90-3833	3" x 1/2"	Small
90-3837	4" x 5/8"	Slender
90-3839	4" x 7/8"	Medium
90-3835	4 3/4" x 1"	Large



Autoclavable



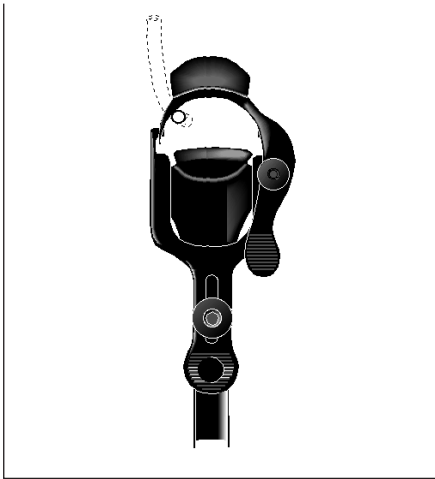

**GRAVES VAGINAL SPECULUMS  
WIDE VIEW PATTERN**

**WITH LARGE PROXIMAL OPENING FOR  
INSTRUMENTATION**

- 90-9054 4" x 1¼" Medium, with permanent Smoke Evacuation Tube
- 90-9055 4" x 1¼" Medium, with loops to hold and direct Smoke Evacuation Tubing



**FREEWAY GRAVES VAGINAL  
SPECULUMS**

**OPEN SIDE, 90° ANGLE**

- 90-3754 4" x 1¼" Medium, with permanent Smoke Evacuation Tube (not illustrated)
- 90-3755 4" x 1¼" Medium, with loop to hold and direct disposable Smoke Evacuation Tubing (not illustrated)

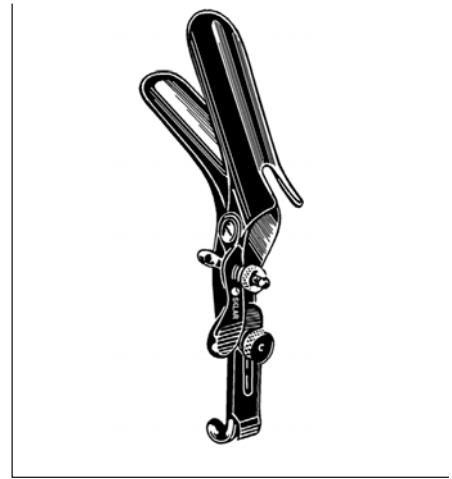

**FREEWAY GRAVES VAGINAL  
SPECULUMS**

**OPEN SIDE, 45° ANGLE**

- 90-3814 4" x 1¼" With permanent Smoke Evacuation Tube (not illustrated)
- 90-3815 4" x 1¼" With loop to hold and direct disposable Smoke Evacuation Tubing (not illustrated)

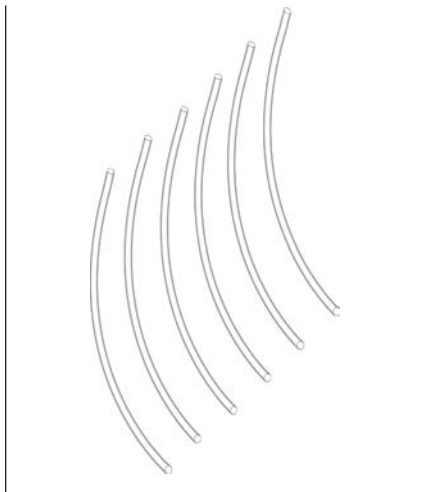

**DISPOSABLE SMOKE  
EVACUATION TUBING**

- 93-2160 10" Precut  
3/16" Inside Diameter  
1/4" Outside Diameter 50/cs

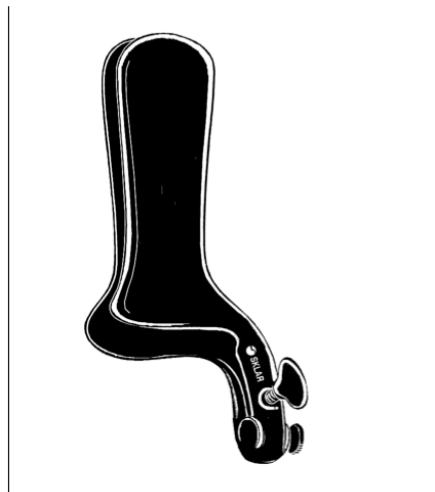

**COLLIN VAGINAL SPECULUM**

- 90-3946 4¼" x 1¼" Medium, with permanent Smoke Evacuation Tube (not illustrated)

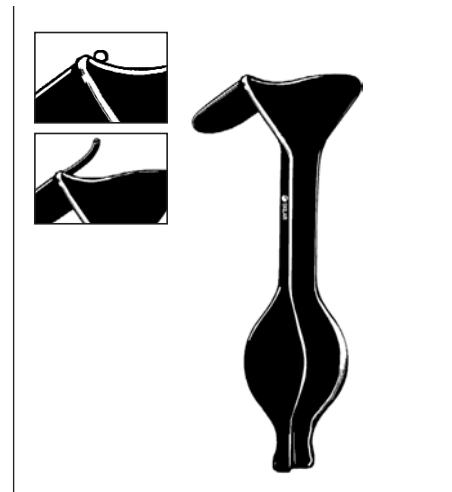

**AUWARD VAGINAL SPECULUMS**

- MEDIUM**
- 90-9100 2¾" x 1½" 2½ lbs. without loop
  - 90-9102 2¾" x 1½" 2½ lbs. with loop to hold and direct disposable Smoke Evacuation Tubing
  - 90-9103 2¾" x 1½" 2½ lbs. with permanent Smoke Evacuation Tube

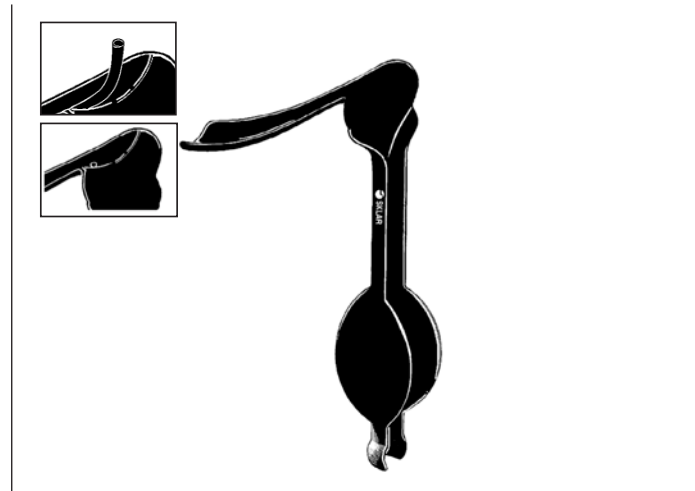
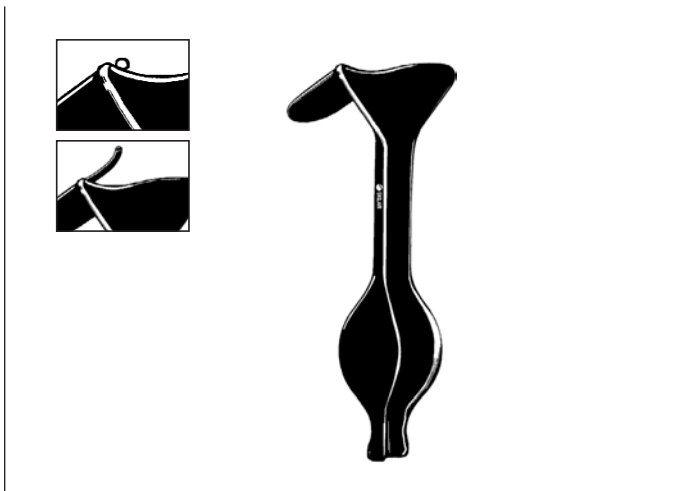

Autoclavable

**AUVARD VAGINAL SPECULUMS**
**MEDIUM, LONG BLADES**

- 90-9106 4" x 1 3/4" 2 1/2 lbs. without loop
- 90-9108 4" x 1 3/4" 2 1/2 lbs. with loop to hold and direct disposable Smoke Evacuation Tubing
- 90-9109 4" x 1 3/4" 2 1/2 lbs. with permanent Smoke Evacuation Tube

**STEINER-AUVARD VAGINAL SPECULUMS**
**MEDIUM, EXTRA LONG BLADE**

- 90-3560 5 1/2" x 1 1/4" 2 1/2 lbs. without loop
- 90-3561 5 1/2" x 1 1/4" 2 1/2 lbs. with loop to hold and direct disposable Smoke Evacuation Tubing
- 90-3562 5 1/2" x 1 1/4" 2 1/2 lbs. with permanent Smoke Evacuation Tube

**SKLAR MONSEL'S**
**FERRIC SUBSULFATE PASTE**

A ONE-TIME USE pre-mixed paste packaged in convenient ready-to-use bottles.

Also includes 12 rayon tip applicators.

Product Number

96-1200

**SKLAR LUGOL'S**
**STRONG IODINE SOLUTION USP**

A ONE-TIME USE pre-mixed iodine solution packaged in convenient ready-to-use bottles.

Also includes 12 rayon tip applicators.

Product Number

96-1210



Autoclavable



**GRAVES VAGINAL SPECULUMS**

90-3800	3" x 1/2"	Extra Small
90-3700	3" x 3/4"	Small
90-3701	4" x 1 1/4"	Medium
90-3702	4 1/2" x 1 3/8"	Large
90-3802	4 3/4" x 1 1/2"	Extra Large
90-3803	6" x 1 1/2"	Extra Long



**PEDERSON VAGINAL SPECULUMS**

90-3849	2 3/4" x 1/2"	Extra Small
90-3710	3" x 1/2"	Small
90-3712	4" x 5/8"	Slender
90-3713	4" x 7/8"	Medium
90-3711	4 3/4" x 1"	Large
90-3851	4 3/4" x 1 5/8"	Extra Large



**PEDERSON OPEN-SIDED VAGINAL SPECULUM**

**OPEN ON RIGHT SIDE**  
90-3751 4" x 1"



**GRAVES VAGINAL SPECULUMS**

**GOLD SCREWS**

90-3720	3/4" x 3"	Small
90-3721	1 1/4" x 4"	Medium
90-3722	1 3/8" x 4 1/4"	Large



**PEDERSON VAGINAL SPECULUMS**

**GOLD SCREWS**

90-3730	1/2" x 3"	Small
90-3731	7/8" x 4"	Medium
90-3732	1" x 4 3/4"	Large

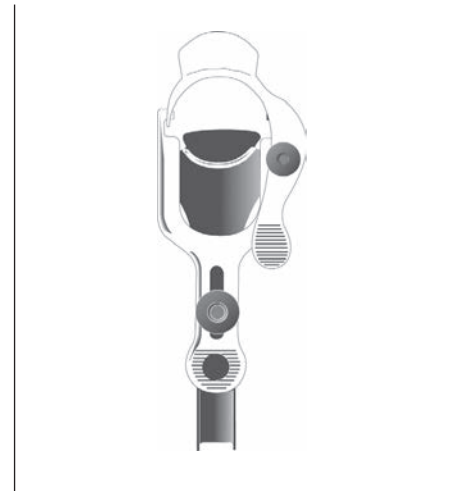

**GRAVES VAGINAL SPECULUM WIDE VIEW PATTERN**

**WITH LARGE PROXIMAL OPENING FOR INSTRUMENTATION**  
90-3705 4" x 1 1/4" Medium

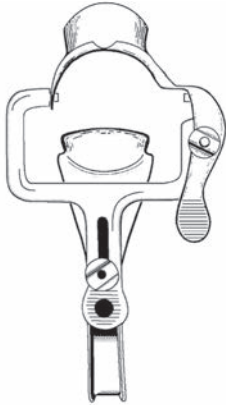

**GRAVES OB-VIEW VAGINAL SPECULUMS**

- 90-3740 4" x 1¼" Medium
- 90-3741 4¾" x 1½" Large

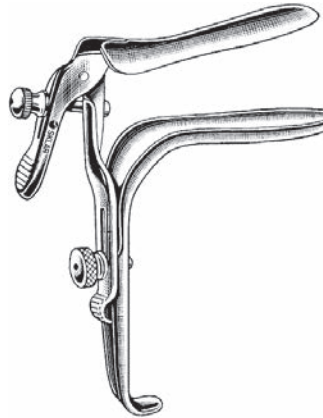

**FREEWAY GRAVES VAGINAL SPECULUM**

- OPEN SIDE, 90° ANGLE**  
90-3750 4" x 1¼" Medium

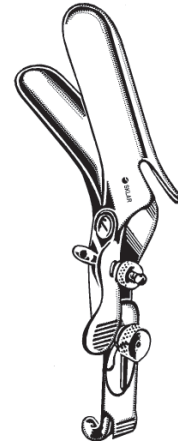

**FREEWAY GRAVES VAGINAL SPECULUM**

- OPEN SIDE, 45° ANGLE**  
90-3752 4" x 1¼" Medium



**SIDE SCREW**

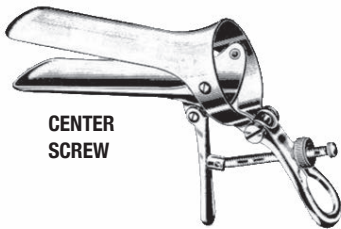

**CENTER SCREW**

**CUSCO VAGINAL SPECULUMS**

**WITH SIDE SCREW**

- 90-3957 3" x 1¼" Small
- 90-3959 3¼" x 1¼" Medium
- 90-3960 3¾" x 1½" Large

**WITH CENTER SCREW**

- 90-3952 3" x 1¼" Small
- 90-3953 3¼" x 1¼" Medium
- 90-3954 3¾" x 1½" Large



**COLLIN VAGINAL SPECULUMS**

- 90-3943 3½" x 1¼" Small
- 90-3945 4¼" x 1¼" Medium
- 90-3944 4½" x 1½" Large

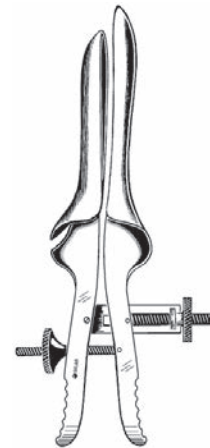

**DEVILBISS VAGINAL SPECULUM**

- PARALLEL OPENING, CHROME**  
90-3865 4" x 1¼"

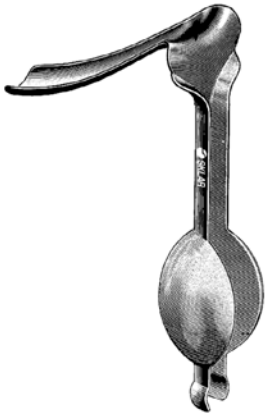

**AUVARD WEIGHTED VAGINAL SPECULUMS**

- 90-3525 2¾" x 1½" 2 lbs. Light
- 90-3526 2¾" x 1½" 2½ lbs. Medium
- 90-3527 2¾" x 1½" 3 lbs. Heavy
- 90-3530 4" x 1¾" 2½ lbs. Medium, Long Blade



**GARRIGUE WEIGHTED VAGINAL SPECULUMS**

- 90-3535 3" x 1½" 2 lbs. Light
- 90-3536 3" x 1½" 2½ lbs. Medium
- 90-3537 3" x 1½" 3 lbs. Heavy



**STEINER-AUVARD VAGINAL SPECULUM**

- 90-3559 5½" x 1¼" 2½ lbs. Medium



**HENROTIN WEIGHTED VAGINAL SPECULUM**

- 90-3555 3¼" x 1¼" 3 lbs. Heavy

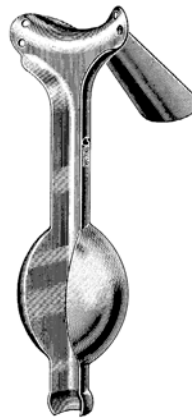

**BERLIND-AUVARD WEIGHTED VAGINAL SPECULUM**

- 90-3558 4¼" x 1⅝" 2½ lbs. Medium

# SURGI-OR

Hand-crafted and forged from Japanese surgical grade stainless steel, Surgi-OR™ instruments are built to last. Precision engineering and stringent quality control guidelines ensure superior performance. Available in the most popular patterns, this cost effective solution doesn't sacrifice quality for value and convenience in the Operating Room and other important clinical settings.

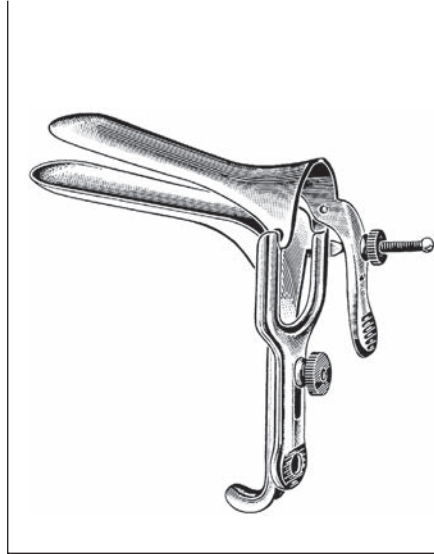

**GRAVES VAGINAL SPECULUMS**

95-304	3" x 1/2"	X-Small
95-303	3" x 3/4"	Small
95-312	4" x 1 1/4"	Medium
95-324	4 1/2" x 1 3/8"	Large
95-322	4 3/4" x 1 1/2"	X-Large



**PEDERSON VAGINAL SPECULUMS**

95-334	2 3/4" x 1/2"	X-Small
95-347	3" x 1/2"	Small
95-348	4" x 7/8"	Medium
95-362	4 3/4" x 1"	Large
95-368	4 3/4" x 1 5/8"	X-Large

## SKLAR SOAK™

### SURGICAL INSTRUMENT SOAK

Immersing soiled instruments in SKLAR SOAK™ for two minutes substantially reduces the risk of exposure to many infectious organisms.

- Effective Against: H1N1, HIV-1, HPV, VRE, Norovirus, Hep B & C as well as TB, MRSA, A. baumannii, and C. difficile in its vegetative form.
- Non-Glutaraldehyde.
- PH Neutral Formula designed for safe use on all surgical instruments & stainless steelware.
- Non-Caustic Formula allows for use as a manual cleaner or in ultrasonic units.
- EPA Registered.
- Meets all OSHA standards on blood borne pathogen destruction.
- Ready to use.



PRODUCT NUMBER	FEATURES	QUANTITIES
10-1603	1 Gallon Bottles	4/case
10-1609	1 Gallon Bottle	1 bottle

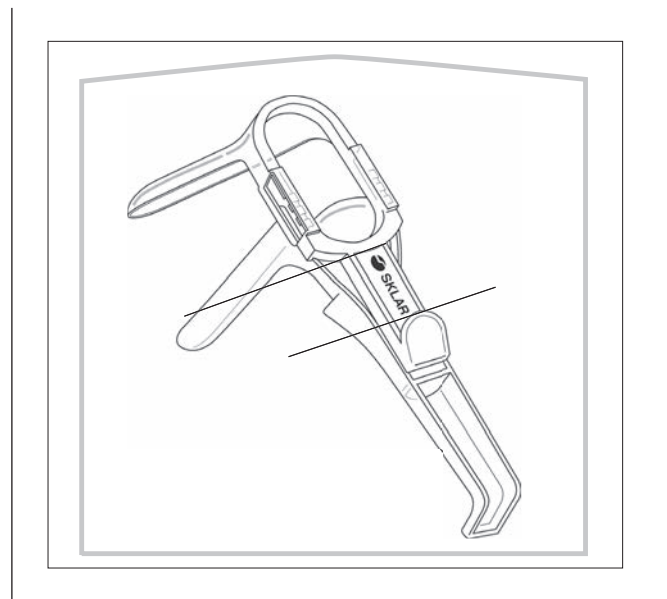
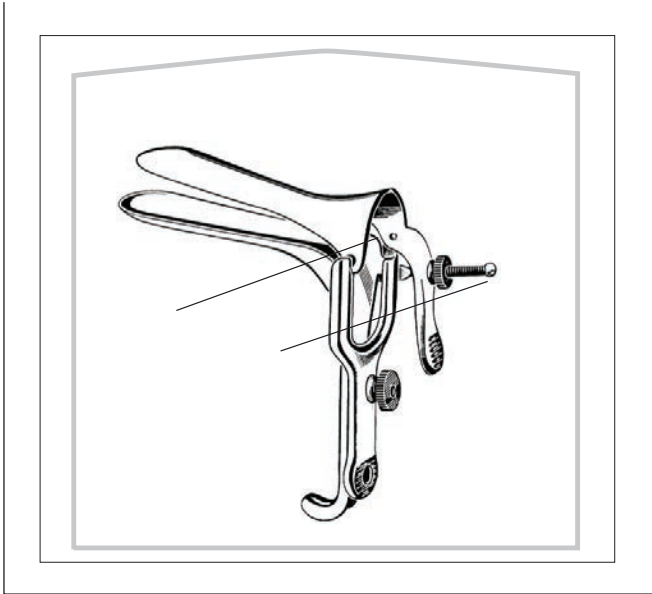

**GRAVES SPECULUMS**

96-2603	Small	25/cs
96-2605	Medium	25/cs
96-2607	Large	25/cs

**DISPOSABLE GRAVES SPECULUMS**

**PLASTIC**

96-2602	Small	50/cs
96-2604	Medium	50/cs
96-2606	Large	50/cs

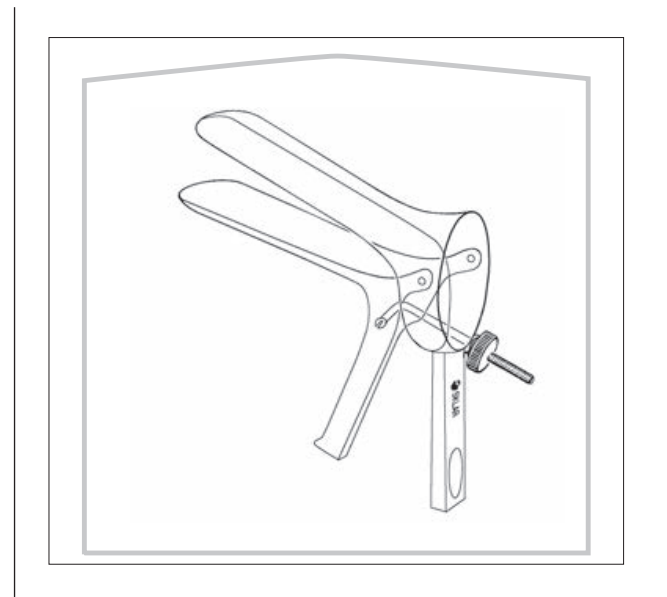
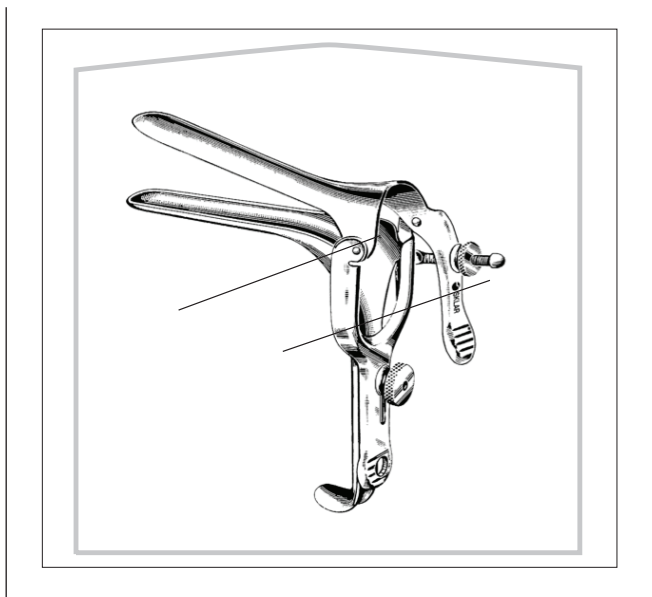

**PEDERSON SPECULUMS**

96-2613	Small	25/cs
96-2615	Medium	25/cs
96-2617	Large	25/cs

**DISPOSABLE CUSCO SPECULUMS**

**PLASTIC**

96-2642	Small	50/cs
96-2644	Medium	50/cs
96-2648	Large	50/cs



## **r retractors**

Sklar offers a full line of Retractors in a variety of the most popular styles and sizes to meet the surgeon's need in any situation. Specifically designed to actively separate incisions or safely hold back underlying organs and tissue for optimal access and exposure of the site. Avoid unintended injury to surrounding tissue by selecting blunt retractors or opt for a more secure grip that sharp retractors can afford. Both styles allow for optimum flexibility and precision while working.

### **Sklar Blue™ Electrosurgical Retractors** ..... Page 16

Designed to provide an effective, non-conductive, patient-safe surface, Electrosurgical Retractors feature our exclusive Sklar Blue™ insulated coating that prevents transmission of RF current through the instrument. Manufactured of the highest quality stainless steel, these instruments are fully autoclavable. All Sklar Blue™ electrosurgical coatings are guaranteed for one year against manufacturing defects.

### **Sklar Black™ Laser Retractors** ..... Page 17

Sklar Black™ Laser Retractors use an improved black polymer coating developed specifically for Laser surgery. Testing demonstrates that the Sklar Black™ coating over a sandblasted surface reduced reflective laser energy to less than one-tenth of one percent. The durable coating improves patient safety and provides a reliable instrument you can use with confidence. All Sklar Laser coatings are guaranteed for one year against manufacturing defects.

### **General Surgery Retractors** ..... Page 18

Our very best operating room, high quality instruments incorporating optimum grades of German grade surgical steel, finely detailed craftsmanship and exacting standards of manufacturing. Choose from a full line of the most popular patterns.



**RETRACTORS**

**Sklar Blue™ ElectroSurgical**



**LATERAL VAGINAL RETRACTOR**

**RATCHET HANDLE**

91-5190 Blade fits inside Vaginal Speculum



**SIMS VAGINAL RETRACTORS**

**SINGLE END**

91-5200 Medium  
91-5202 Medium, with loop to hold and direct Disposable Smoke Evacuation Tubing



**SIMS VAGINAL RETRACTORS**

**DOUBLE END**

91-5210 Medium  
91-5212 Medium, with loop to hold and direct Disposable Smoke Evacuation Tubing



**JACKSON VAGINAL RETRACTORS**

**SINGLE END**

91-5215 3" x 1½" Small  
91-5218 3½" x 1½" Medium  
91-5220 4" x 1½" Large



**TAUBER VAGINAL SPATULA**

91-5176 10" Blade 3½" x 1⅜"



**SEGOND VAGINAL SPATULA**

91-5178 10½" Blade 4¾" x 1⅜"



Autoclavable



**LATERAL VAGINAL RETRACTOR**

**RATCHET HANDLE**

90-8845 Blade fits inside Vaginal Speculum



**JACKSON RETRACTORS**

**SINGLE END**

- 90-9064 3" x 1½" Small with Permanent Smoke Evacuation Tube
- 90-9065 3½" x 1½" Medium without Tube or Loops
- 90-9066 3½" x 1½" Medium with Loop to hold and direct disposable Smoke Evacuation Tubing
- 90-9069 3½" x 1½" Medium with Permanent Smoke Evacuation Tube
- 90-9067 4" x 1½" Large without Tube or Loops
- 90-9068 4" x 1½" Large with Loop to hold and direct disposable Smoke Evacuation Tubing
- 90-9070 4" x 1½" Large with Permanent Smoke Evacuation Tube

# SKLAR INSTRUMENT CARE KIT

**A TRIO OF SKLAR'S CARE AND CLEANING PRODUCTS TO KEEP INSTRUMENTS IN TIPTOP SHAPE.**

Each Kit Contains:

- 1 Sklar Lube™ 8 oz. Spray Bottle
- 1 Sklar Kleen™ Liquid 8 oz. Bottle
- 1 Sklar Polish™ 8 oz. Jar
- 1 Stainless Steel Bristle Cleaning Brush
- 1 Nylon Bristle Cleaning Brush

PRODUCT NUMBER  
10-1625



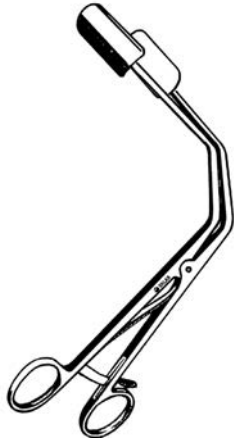

**LATERAL VAGINAL RETRACTOR**

**RATCHET HANDLE**

90-3980 Blade fits inside Vaginal Speculum



**SIMS VAGINAL RETRACTORS**

**DOUBLE END**

90-3150	7/8" x 2 1/2"	1" x 3"	#1
90-3151	1" x 2 1/2"	1 1/8" x 3"	#2
90-3152	1" x 3"	1 1/4" x 3 1/4"	#3
90-3153	1 1/4" x 3"	1 1/2" x 3 1/4"	#4
90-3154	1 1/4" x 3 1/4"	1 1/2" x 4"	#5
90-3155	1 1/4" x 3 1/4"	1 3/4" x 4"	#6

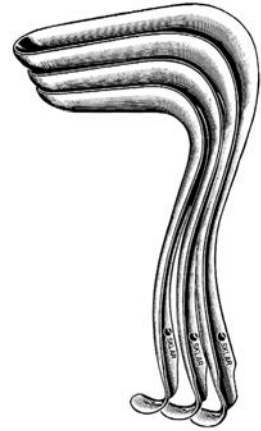

**SIMS VAGINAL RETRACTORS**

**SINGLE END**

90-3225	2 1/2" x 1"	Small
90-3230	3" x 1 1/4"	Medium
90-3235	3 1/2" x 1 1/2"	Large



**JACKSON VAGINAL RETRACTORS**

**SINGLE END**

90-3130	3" x 1 1/2"	Small
90-3135	3 1/2" x 1 1/2"	Medium
90-3140	4" x 1 1/2"	Large

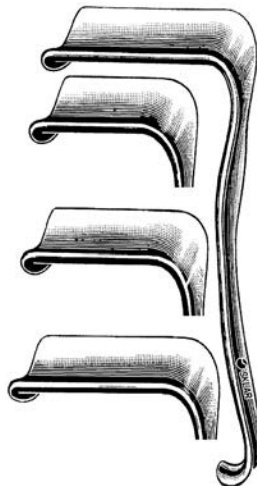

**EASTMAN RETRACTORS**

90-3030	3" x 1 1/2"	Small
90-3035	3 1/2" x 1 1/2"	Medium
90-3040	4" x 1 1/2"	Large



**SIMS-KELLY VAGINAL RETRACTORS**

**SKLAR-GRIP HANDLE**

90-3422	2 1/4" x 1"	Small
90-3427	2 3/4" x 1 1/4"	Medium
90-3430	3" x 1 1/2"	Large

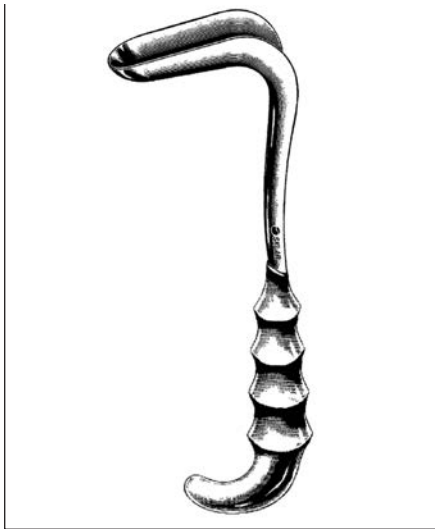

**SIMS VAGINAL RETRACTORS**

**SKLAR-GRIP HANDLE**

90-3327	2¼" x 1"	Small
90-3330	3" x 1¼"	Medium
90-3335	3½" x 1½"	Large

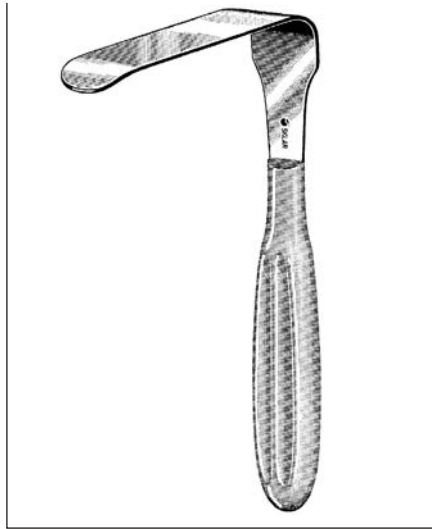

**BRANTLEY-TURNER RETRACTOR**

90-3470 7" Blade 4" x 1¼"

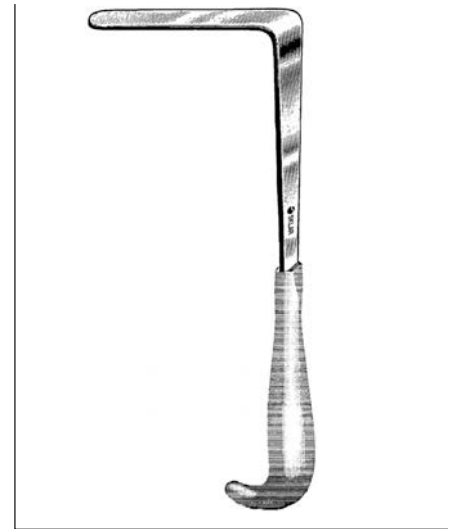

**PRYOR-PEAN RETRACTOR**

90-3510 10¼" Blade 4¼" x 1"

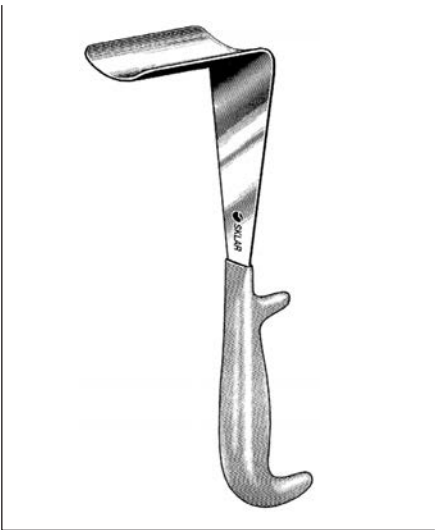

**DOYEN RETRACTORS**

60-2185	9"	Blade 1¾" x 2⅛"	Small
60-2190	9"	Blade 1¾" x 3¼"	Medium
60-2195	9"	Blade 2¼" x 3¼"	Large

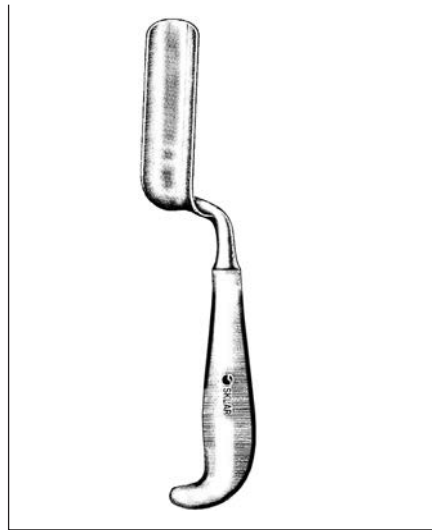

**TAUBER VAGINAL SPATULA**

90-3692 10" Blade 3½" x 1⅝"

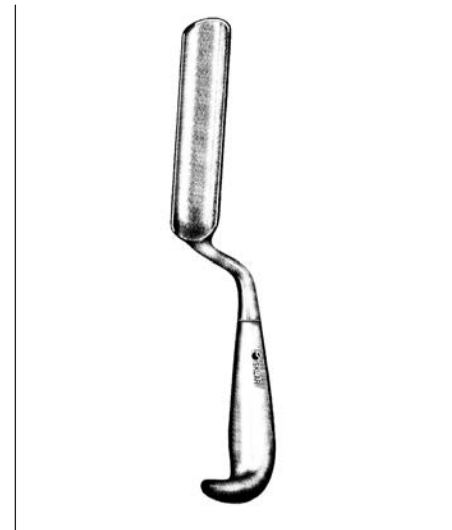

**SEGOND VAGINAL SPATULA**

90-3610 10½" Blade 4¾" x 1⅝"



**BREISKY RETRACTORS**

90-3520	100mm x 20mm
90-3521	100mm x 25mm
90-3522	100mm x 30mm
90-3528	130mm x 40mm
90-3529	156mm x 40mm

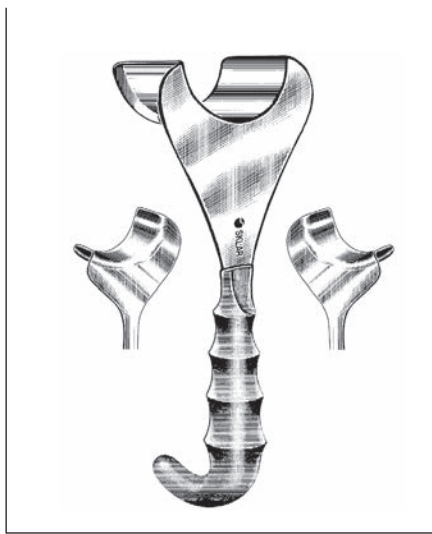

**DELEE RETRACTOR**

90-3452	9½"	2¾" x 2"	Universal
---------	-----	----------	-----------



**HEANEY RETRACTORS**

60-1616	10½"	Blade 1¾" x 1"
60-1617	10½"	Blade 3" x 1"
60-1618	10½"	Blade 3¼" x 1⅛"



**GELPI RETRACTORS**

22-8850	3½"
22-8853	5½"
22-8855	6¼"
60-6570	7"
60-6580	7½" With Stops



**RIGBY RETRACTORS**

**TRU-GRIP RATCHET HANDLE**

60-6370	7"
---------	----

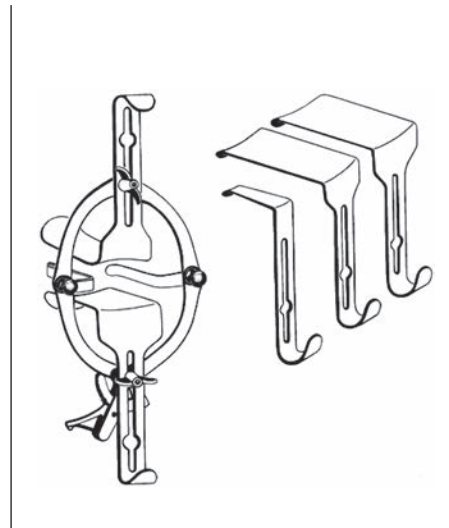

**O'SULLIVAN-O'CONNOR VAGINAL RETRACTORS**

**SMALL WITH THREE INTERCHANGEABLE BLADES**

90-3045	1½" x ¾"	Small
	3" x 1½"	Medium
	3½" x 1¾"	Large



**KOGAN ENDOCERVICAL SPECULUM**

WITH GAUGE AND SCREW

91-5230 Narrow Wire Blades



**KOGAN ENDOCERVICAL SPECULUM**

WITH SPRING HANDLE

91-5228 Narrow Wire Blades



**KOGAN ENDOCERVICAL SPECULUM**

WITH RATCHET HANDLE

91-5235 Narrow Wire Blades



**KOGAN ENDOCERVICAL SPECULUM**

WITH GAUGE AND SCREW

91-5232 Wide Wire Blades

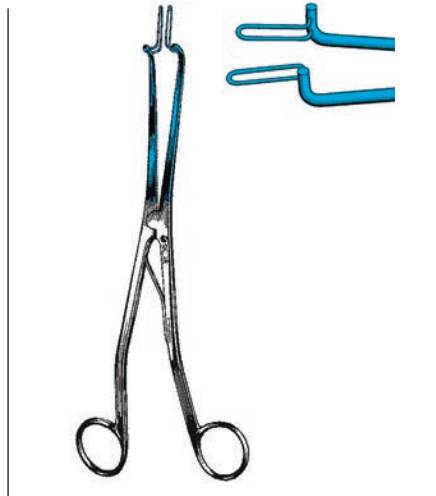

**KOGAN ENDOCERVICAL SPECULUM**

WITH SPRING HANDLE

91-5226 Wide Wire Blades



**KOGAN ENDOCERVICAL SPECULUM**

WITH RATCHET HANDLE

91-5234 Wide Wire Blades



Autoclavable

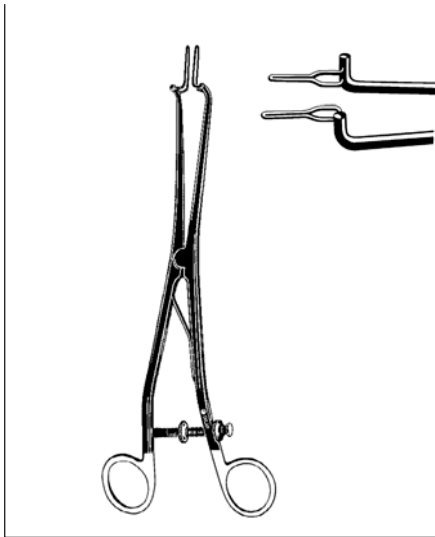

**KOGAN ENDOCERVICAL SPECULUM**

WITH GAUGE AND SCREW

90-8855 Narrow Wire Blades

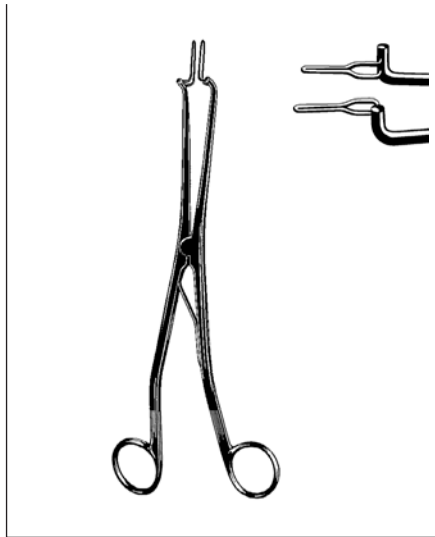

**KOGAN ENDOCERVICAL SPECULUM**

WITH SPRING HANDLE

90-8865 Narrow Wire Blades



**KOGAN ENDOCERVICAL SPECULUM**

WITH RATCHET HANDLE

90-8862 Narrow Wire Blades

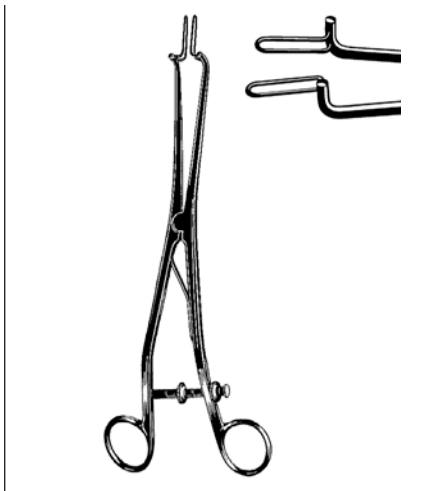

**KOGAN ENDOCERVICAL SPECULUM**

WITH GAUGE AND SCREW

90-8858 Wide Wire Blades

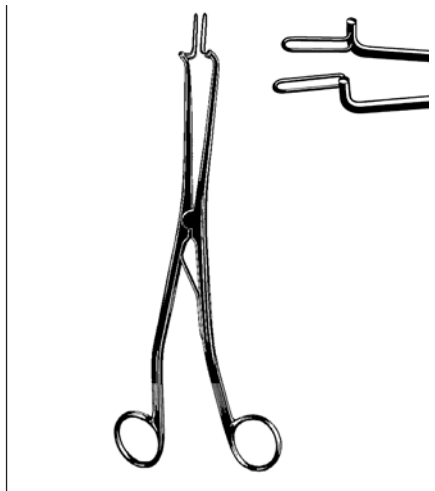

**KOGAN ENDOCERVICAL SPECULUM**

WITH SPRING HANDLE

90-8850 Wide Wire Blades



**KOGAN ENDOCERVICAL SPECULUM**

WITH RATCHET HANDLE

90-8860 Wide Wire Blades



Autoclavable



**KOGAN ENDOCERVICAL SPECULUM**

**WITH GAUGE AND SCREW**

90-3990 Narrow Wire Blades

**KOGAN ENDOCERVICAL SPECULUM**

**WITH SPRING HANDLE**

90-3996 Narrow Wire Blades

**KOGAN ENDOCERVICAL SPECULUM**

**WITH RATCHET HANDLE**

90-3997 Narrow Wire Blades

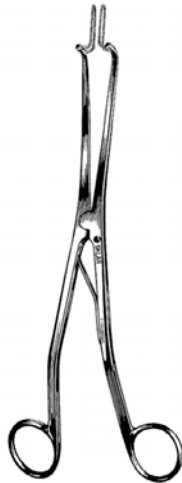
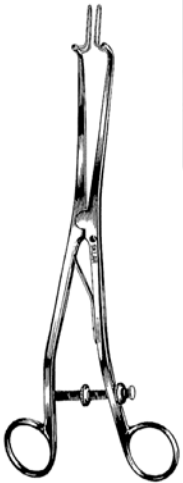

**KOGAN ENDOCERVICAL SPECULUM**

**WITH GAUGE AND SCREW**

90-3995 Wide Wire Blades

**KOGAN ENDOCERVICAL SPECULUM**

**WITH SPRING HANDLE**

90-3994 Wide Wire Blades

**KOGAN ENDOCERVICAL SPECULUM**

**WITH RATCHET HANDLE**

90-3998 Wide Wire Blades



HOOKS

Sklar Blue™ Electrosurgical

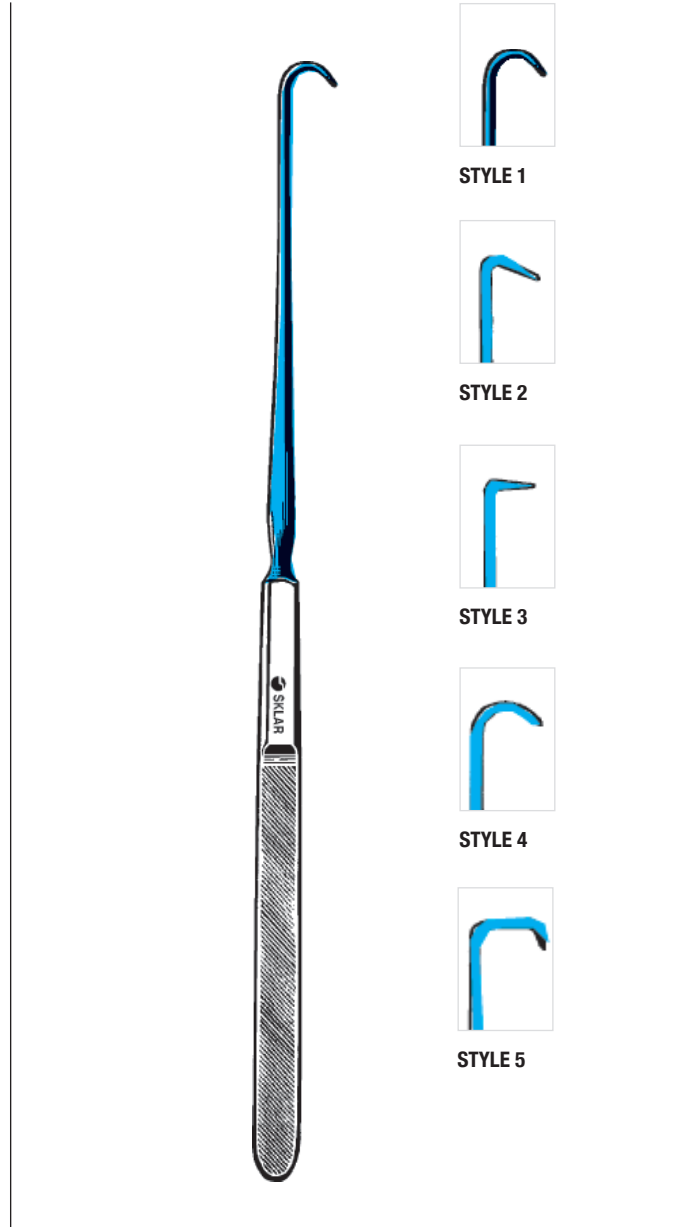
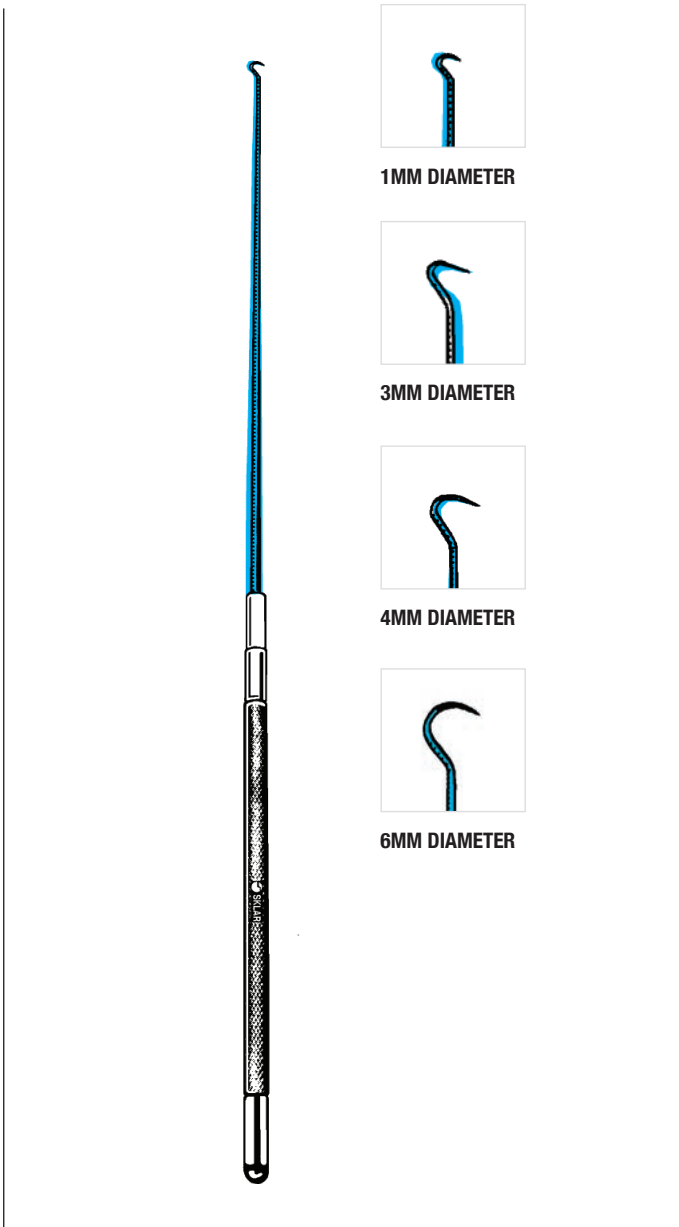

IRIS HOOKS

QUICK RELEASE

91-5244	9"	1mm	91-5248	12"	1mm
91-5243	9"	3mm	91-5247	12"	3mm
91-5242	9"	4mm	91-5246	12"	4mm
91-5241	9"	6mm	91-5245	12"	6mm
91-5236	9"	Set of 4	91-5238	12"	Set of 4

EMMETT HOOKS

91-5251	9"	Style 1
91-5252	9"	Style 2
91-5253	9"	Style 3
91-5254	9"	Style 4
91-5255	9"	Style 5
91-5250	9"	Set of 5



Autoclavable

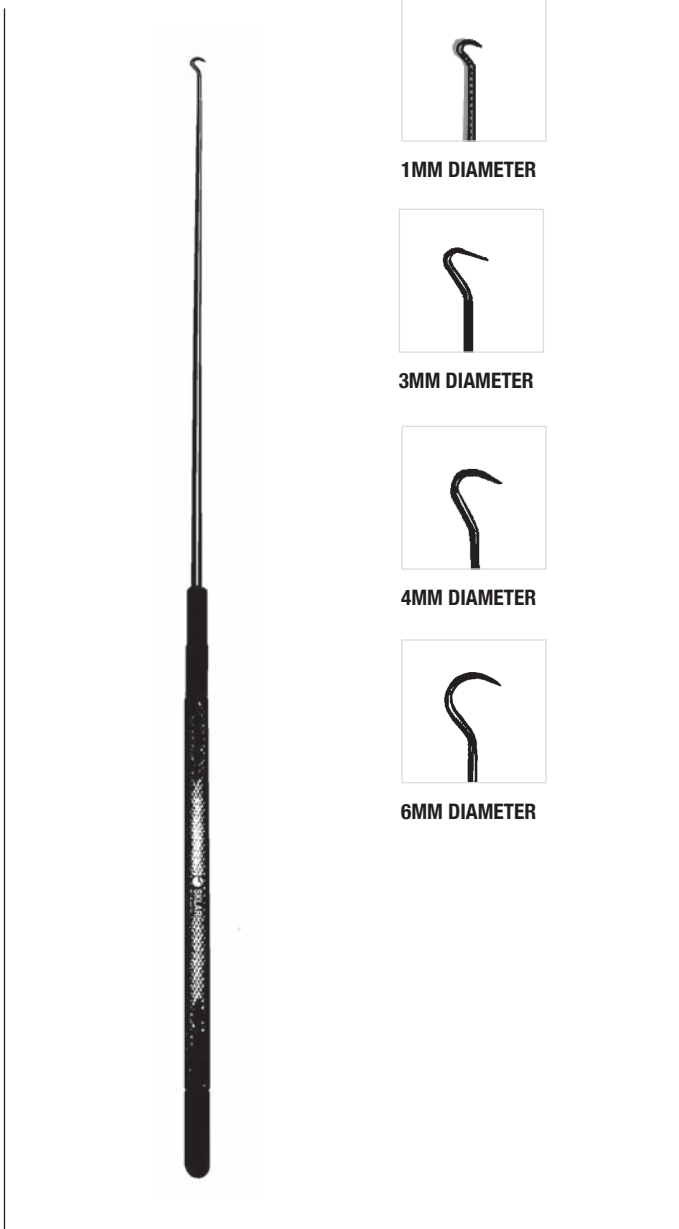

**1MM DIAMETER**



**3MM DIAMETER**



**4MM DIAMETER**



**6MM DIAMETER**



**STYLE 1**



**STYLE 2**



**STYLE 3**



**STYLE 4**



**STYLE 5**

**IRIS HOOKS**

**QUICK RELEASE**

90-2126	9"	1mm	90-2128	12"	1mm
90-2122	9"	3mm	90-2124	12"	3mm
90-2118	9"	4mm	90-2120	12"	4mm
90-2114	9"	6mm	90-2116	12"	6mm
90-2160	9"	Set of 4	90-2131	12"	Set of 4

**EMMETT TENACULUM HOOKS**

90-2171	9"	Style 1
90-2172	9"	Style 2
90-2173	9"	Style 3
90-2174	9"	Style 4
90-2175	9"	Style 5
90-2170	9"	Set of 5



Autoclavable



**TYRELL IRIS HOOKS**

90-1056	5"	3mm	Blunt
90-1058	5"	3mm	Sharp

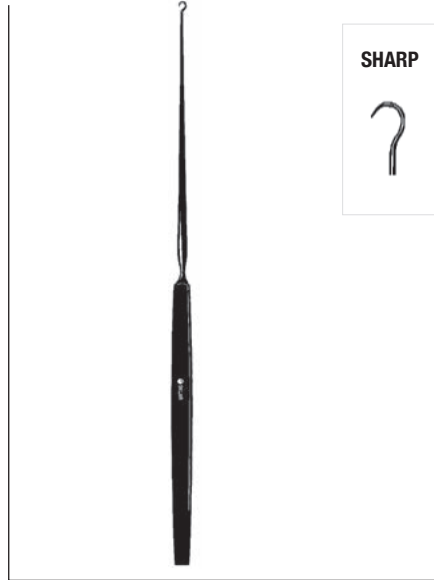

**GILLIES SKIN HOOKS**

90-1045	7"	3mm	Sharp
90-1047	7"	4mm	Sharp



**FRAZIER TISSUE HOOKS**

90-1048	5"	Sharp	Extra Delicate
90-1049	5"	Blunt	Extra Delicate



**GUTHRIE DOUBLE HOOKS**

**SHARP**

90-1046	5"	3mm	2 Small Prongs
90-1044	5"	5mm	2 Large Prongs

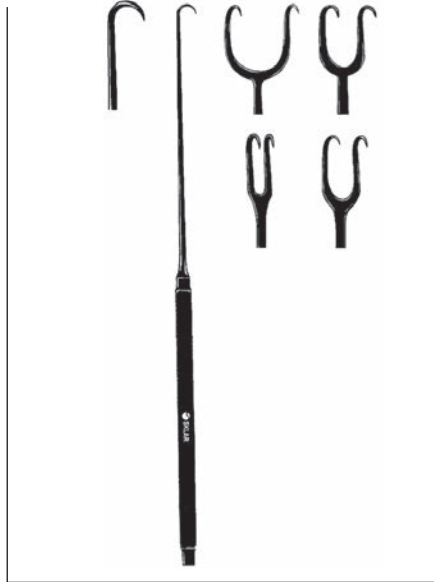

**JOSEPH SKIN HOOKS**

**SHARP**

90-1050	6¼"	-	1 Prong
90-1051	6¼"	2mm	2 Prongs
90-1052	6¼"	5mm	2 Prongs
90-1053	6¼"	7mm	2 Prongs
90-1054	6¼"	10mm	2 Prongs
90-1055	6¼"	12mm	2 Prongs



Autoclavable



1MM DIAMETER

3MM DIAMETER

4MM DIAMETER

6MM DIAMETER

**IRIS HOOKS**

**QUICK RELEASE**

90-8336	9"	1mm	90-8348	12"	1mm
90-8335	9"	3mm	90-8346	12"	3mm
90-8334	9"	4mm	90-8344	12"	4mm
90-8333	9"	6mm	90-8342	12"	6mm
90-8332	9"	Set of 4	90-8341	12"	Set of 4

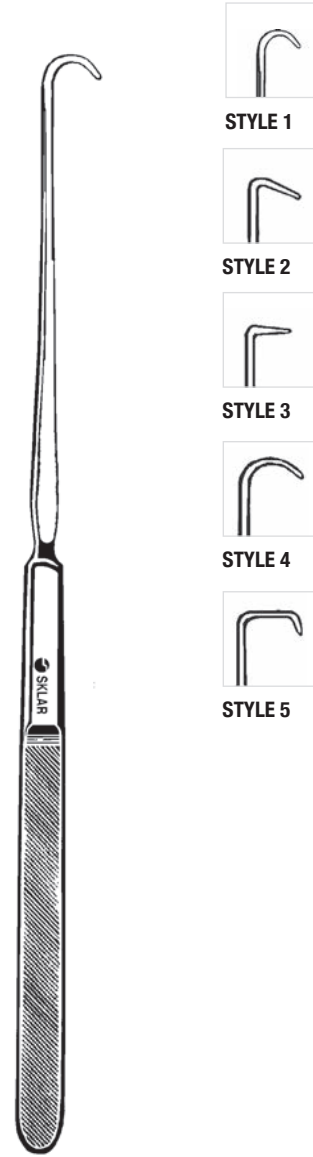

STYLE 1

STYLE 2

STYLE 3

STYLE 4

STYLE 5

**EMMETT HOOKS**

90-8301	9"	Style 1
90-8302	9"	Style 2
90-8303	9"	Style 3
90-8304	9"	Style 4
90-8305	9"	Style 5
90-8306	9"	Set of 5

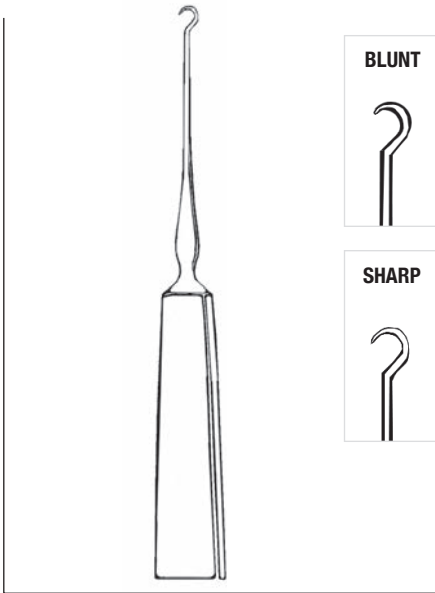

**TYRELL IRIS HOOKS**

65-3205	5"	3mm	Blunt
65-3206	5"	3mm	Sharp

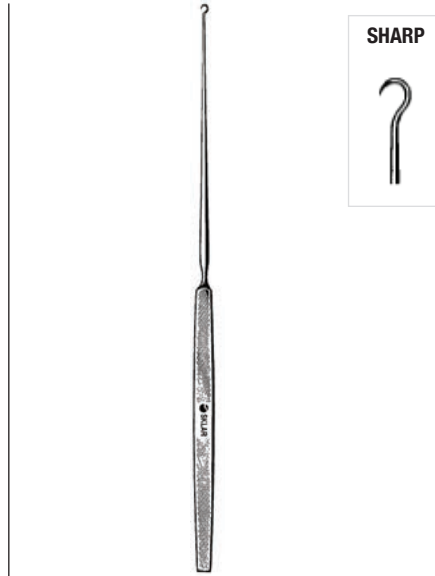

**GILLIES SKIN HOOKS**

47-2570	7"	3mm	Sharp
47-2572	7"	4mm	Sharp

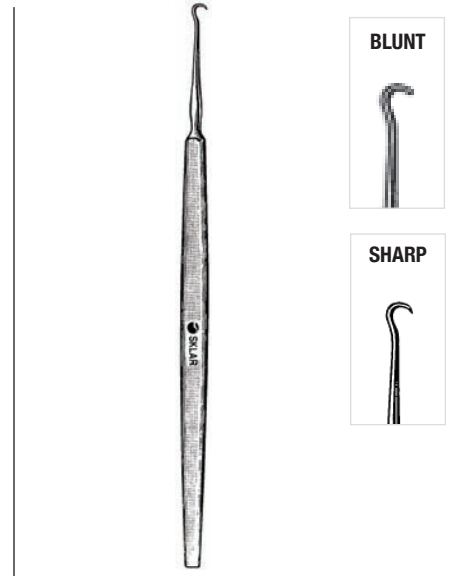

**FRAZIER TISSUE HOOKS**

47-2555	5"	Sharp	Extra Delicate
47-2556	5"	Blunt	Extra Delicate

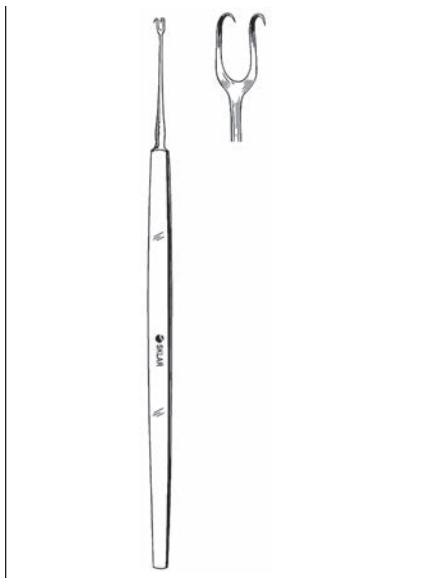

**GUTHRIE DOUBLE HOOKS**

**SHARP**

47-2651	5"	3mm	2 Small Prongs
47-2650	5"	5mm	2 Large Prongs

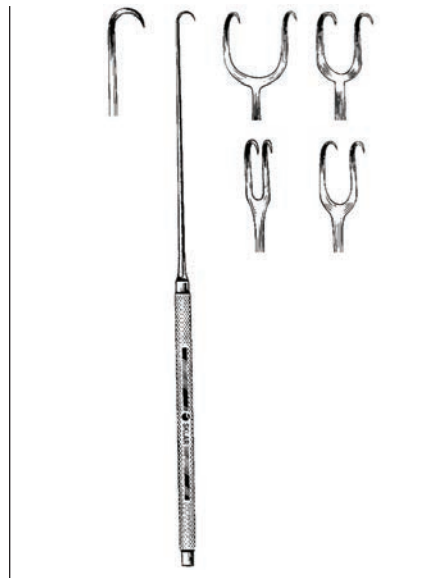

**JOSEPH SKIN HOOKS**

**SHARP**

47-2500	6¼"	-	1 Prong
47-2502	6¼"	2mm	2 Prongs
47-2505	6¼"	5mm	2 Prongs
47-2507	6¼"	7mm	2 Prongs
47-2510	6¼"	10mm	2 Prongs
47-2512	6¼"	12mm	2 Prongs

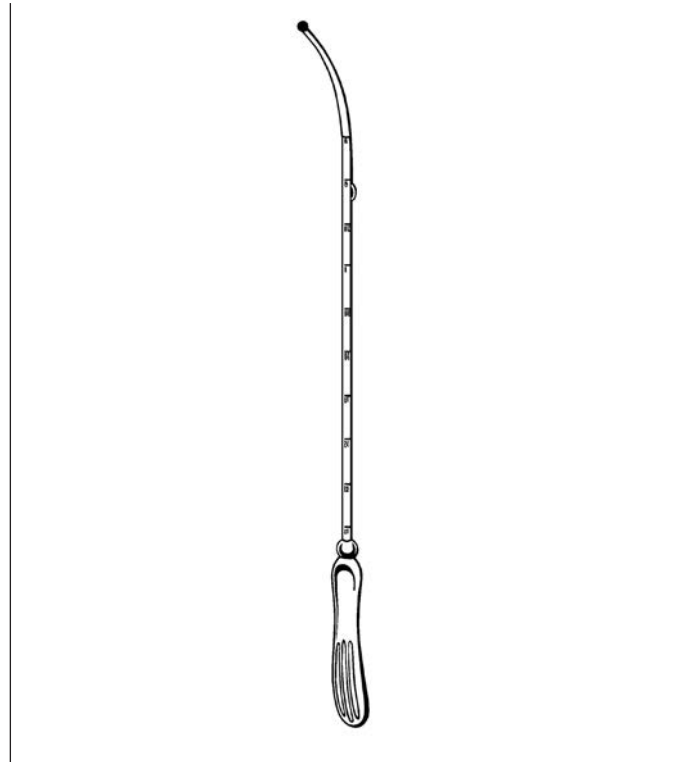
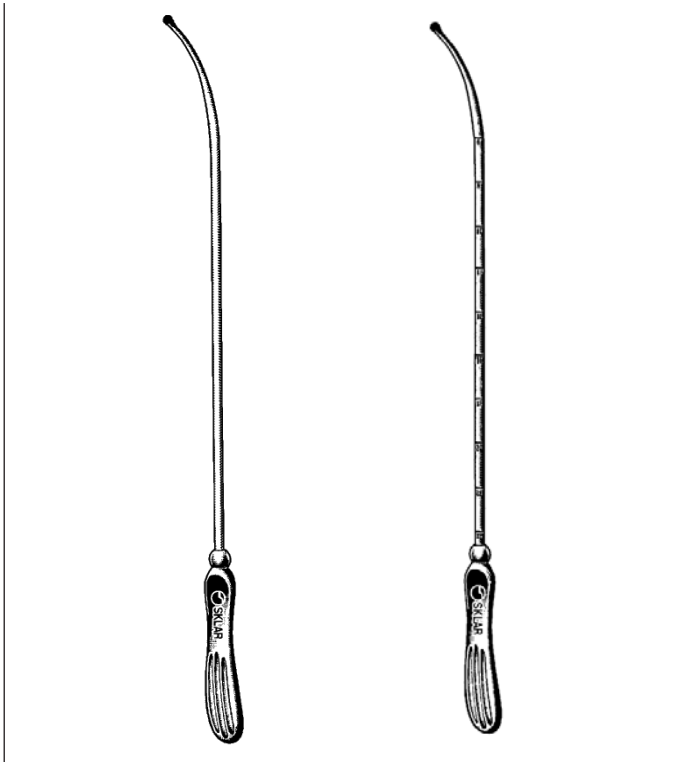

**SIMS UTERINE SOUNDS**

**MALLEABLE**

- |         |      |                                     |
|---------|------|-------------------------------------|
| 90-5312 | 12½" | Non-Graduated, Silver Plated        |
| 90-5314 | 12½" | Centimeter Graduated, Silver Plated |

**SIMPSON UTERINE SOUNDS**

**MALLEABLE WITH NODULE JUST BELOW CURVE**

- |         |      |                                     |
|---------|------|-------------------------------------|
| 90-5412 | 12½" | Inch Graduated, Silver Plated       |
| 90-5413 | 12½" | Centimeter Graduated, Silver Plated |
| 90-5415 | 12½" | Centimeter Graduated, Silver Plated |
- Straight

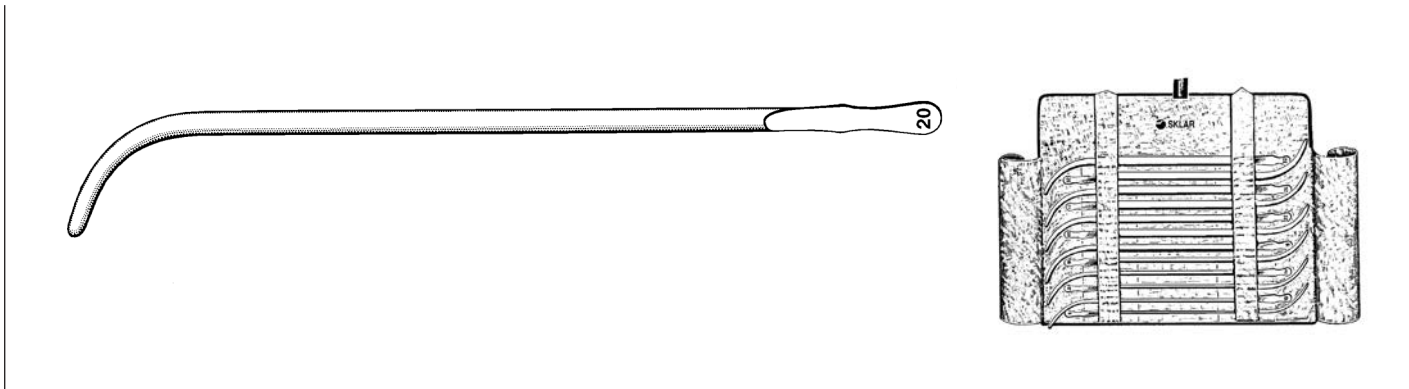

**VAN BUREN URETHRAL SOUNDS**

- |         |           |         |           |
|---------|-----------|---------|-----------|
| 85-1008 | 8 French  | 85-1026 | 26 French |
| 85-1010 | 10 French | 85-1028 | 28 French |
| 85-1012 | 12 French | 85-1030 | 30 French |
| 85-1014 | 14 French | 85-1032 | 32 French |
| 85-1016 | 16 French | 85-1034 | 34 French |
| 85-1018 | 18 French | 85-1036 | 36 French |
| 85-1020 | 20 French | 85-1038 | 38 French |
| 85-1022 | 22 French | 85-1040 | 40 French |
| 85-1024 | 24 French |         |           |

**SETS IN KHAKI ROLL**

- |         |            |                       |
|---------|------------|-----------------------|
| 85-1065 | Set of 17  | Sizes 8-40 French     |
| 85-1070 | Set of 6   | Sizes 14-24 French    |
| 85-1075 | Set of 12  | Sizes 8-30 French     |
| 85-1076 | Khaki Roll | Holds up to 12 Sounds |

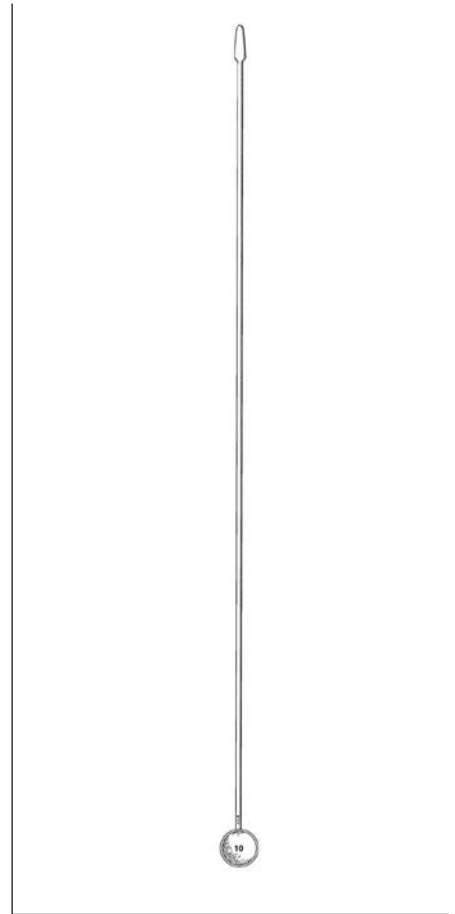
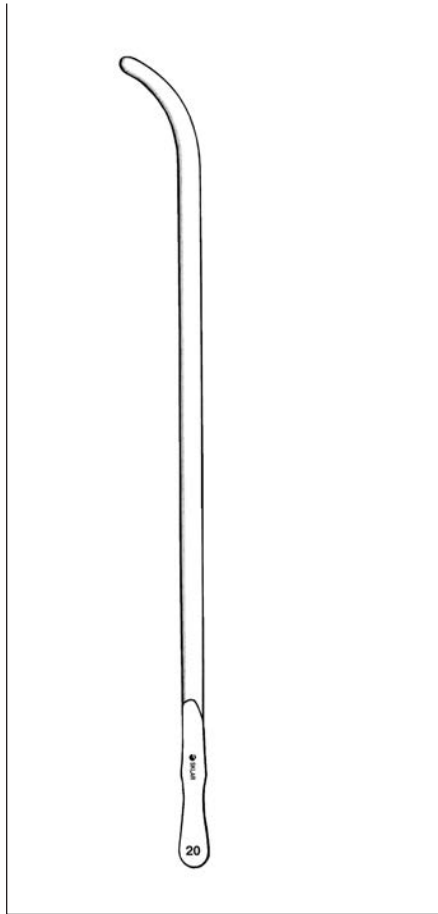
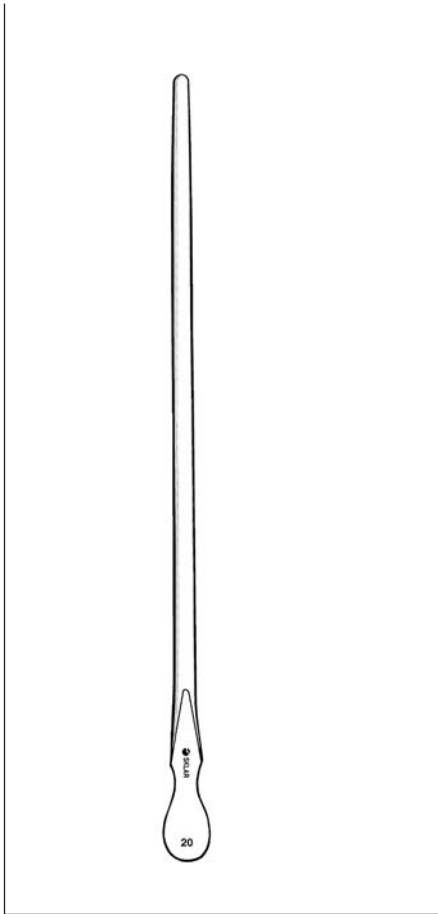

**DITTEL URETHRAL SOUNDS**

**STRAIGHT, 11½"**

- 85-1308 8 French
- 85-1310 10 French
- 85-1312 12 French
- 85-1314 14 French
- 85-1316 16 French
- 85-1318 18 French
- 85-1320 20 French
- 85-1322 22 French
- 85-1324 24 French
- 85-1326 26 French
- 85-1328 28 French
- 85-1330 30 French
- 85-1332 32 French
- 85-1334 34 French
- 85-1336 36 French
- 85-1338 38 French
- 85-1340 40 French

**SETS IN KHAKI ROLL**

- 85-1342 Set of 6 8, 12, 16, 20, 24, 30FR
- 85-1345 Set of 17 8-40 French

**OTIS DITTEL URETHRAL SOUNDS**

**CURVED, 11½"**

- 85-1408 8 French
- 85-1410 10 French
- 85-1412 12 French
- 85-1414 14 French
- 85-1416 16 French
- 85-1418 18 French
- 85-1420 20 French
- 85-1422 22 French
- 85-1424 24 French
- 85-1426 26 French
- 85-1428 28 French
- 85-1430 30 French
- 85-1432 32 French
- 85-1434 34 French
- 85-1436 36 French
- 85-1438 38 French
- 85-1440 40 French

**SETS IN KHAKI ROLL**

- 85-1442 Set of 8 16-30 French
- 85-1446 Set of 17 8-40 French

**OTIS BOUGIE A BOULE**

**STRAIGHT, 9¾"**

- 85-1608 8 French
- 85-1610 10 French
- 85-1612 12 French
- 85-1614 14 French
- 85-1616 16 French
- 85-1618 18 French
- 85-1620 20 French
- 85-1622 22 French
- 85-1624 24 French
- 85-1626 26 French
- 85-1628 28 French
- 85-1630 30 French
- 85-1632 32 French

**SETS IN KHAKI ROLL**

- 85-1635 Set of 8 16-30 French
- 85-1636 Set of 13 8-32 French

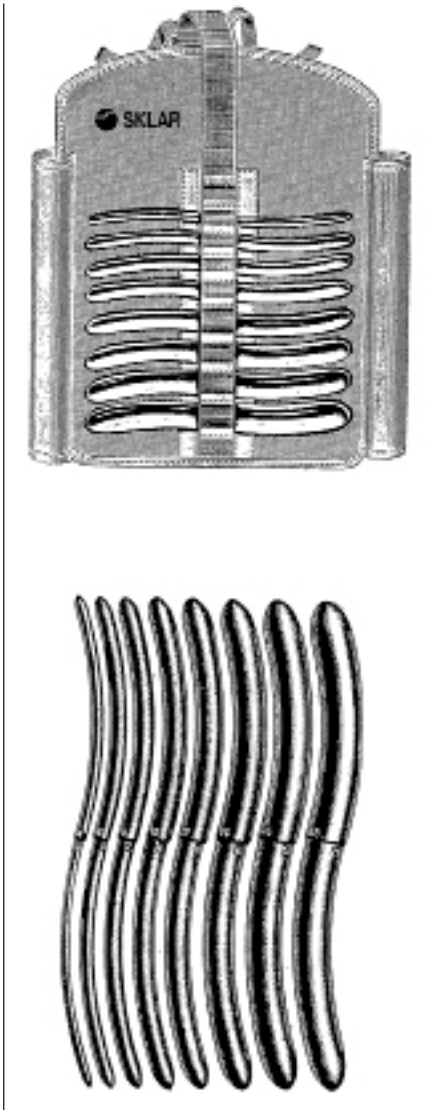

**HEGAR UTERINE DILATOR**  
**DOUBLE END, 7"**

- 90-4802 1/2 mm
- 90-4804 3/4 mm
- 90-4806 5/6 mm
- 90-4808 7/8 mm
- 90-4810 9/10 mm
- 90-4812 11/12 mm
- 90-4814 13/14 mm
- 90-4816 15/16 mm
- 90-4818 17/18 mm
- 90-4828 27/28 mm
- 90-4832 31/32 mm
- 90-4825 Set of 8, 3/4mm thru 17/18mm  
without Khaki Roll
- 90-4826 Set of 8, 3/4mm thru 17/18mm  
with Khaki Roll

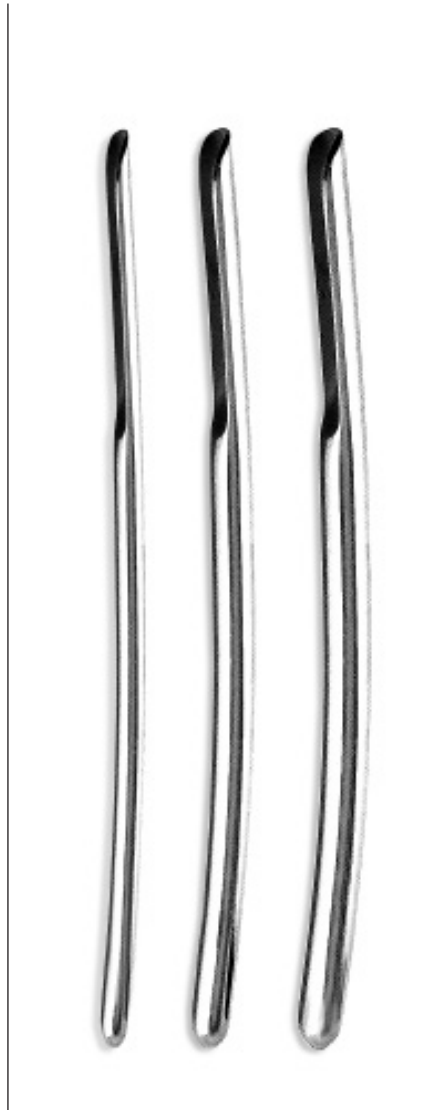

**HEGAR UTERINE DILATOR**  
**SINGLE END, 7"**

- 90-4784 1.0 mm
- 90-4785 1.5 mm
- 90-4786 2.0 mm
- 90-4787 2.5 mm
- 90-4788 3.0 mm
- 90-4789 3.5 mm
- 90-4790 4.0 mm
- 90-4791 4.5 mm
- 90-4792 5.0 mm
- 90-4793 5.5 mm
- 90-4794 6.0 mm
- 90-4795 6.5 mm
- 90-4796 7.0 mm
- 90-4797 7.5 mm
- 90-4798 8.0 mm
- 90-4799 9.0 mm

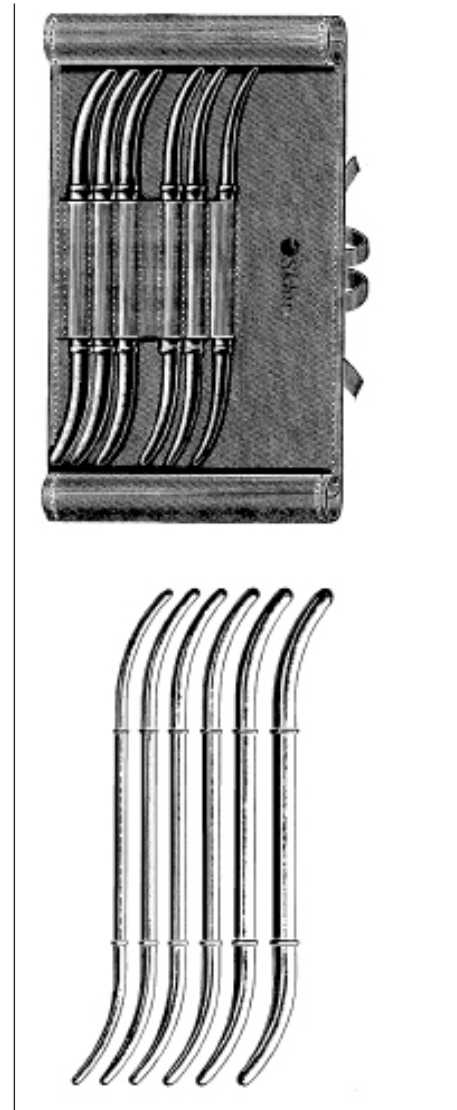

**HANK UTERINE DILATOR**  
**AMERICAN SCALE**

- 90-4908 7/8
- 90-4910 9/10
- 90-4912 11/12
- 90-4914 13/14
- 90-4916 15/16
- 90-4918 17/18
- 90-4920 19/20
- 90-4928 27/28
- 90-4925 Set of 6, 9/10 thru 19/20  
without Khaki Roll
- 90-4926 Set of 6, 9/10 thru 19/20  
with Khaki Roll
- 90-4927 Khaki Roll



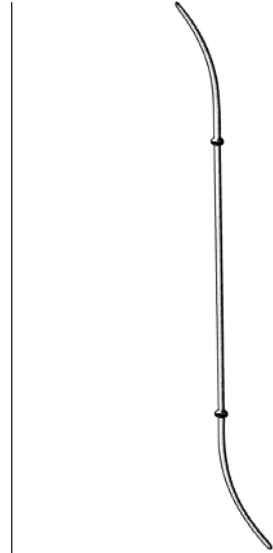
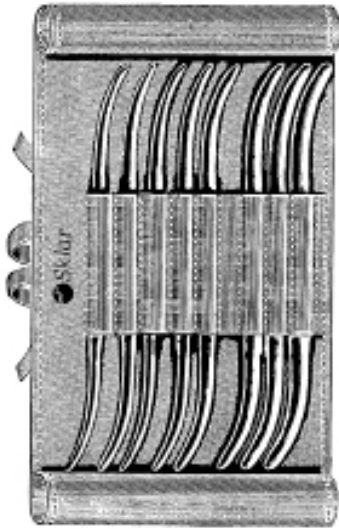
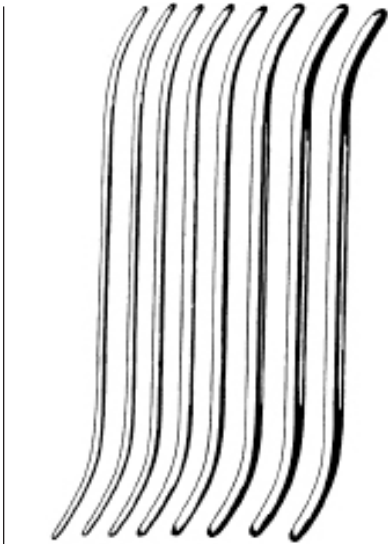

**PRATT UTERINE DILATOR**

- 90-5215 13/15 French
- 90-5219 17/19 French
- 90-5223 21/23 French
- 90-5227 25/27 French
- 90-5231 29/31 French
- 90-5235 33/35 French

- 90-5239 37/39 French
- 90-5243 41/43 French
- 90-5245 45/47 French
- 90-5249 49/51 French
- 90-5253 53/55 French
- 90-5250 Set of 8, 13/15 thru 41/43 with Kahki Roll

**KLEEGMAN DILATOR**

- NARROW**  
90-4902 10½"

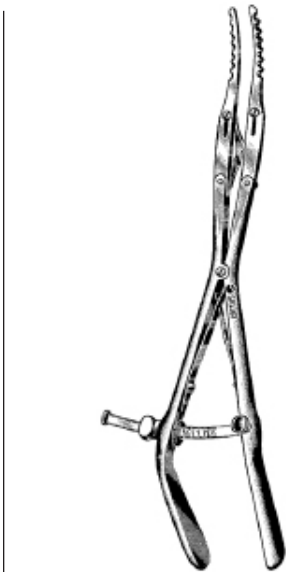

**GOODELL UTERINE DILATOR**

- 90-4713 13"

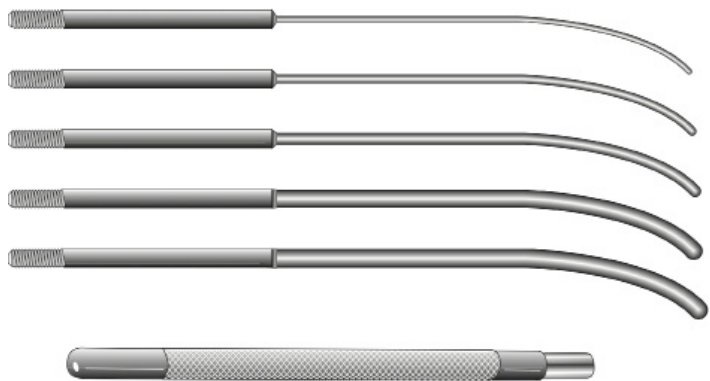

**MINI DILATORS**

**SET WITH HANDLE**

- 90-6280 Set Includes: 1.0mm  
1.5mm  
2.0mm  
2.5mm  
3.0mm

- 90-6281 Handle for Mini Dilator Set



### WALTHER DILATOR

#### CHROME

85-2012	12 French	85-2028	28 French
85-2014	14 French	85-2030	30 French
85-2016	16 French	85-2032	32 French
85-2018	18 French	85-2034	34 French
85-2020	20 French	85-2036	36 French
85-2022	22 French	85-2038	38 French
85-2024	24 French	85-2010	Set of 14
85-2026	26 French		

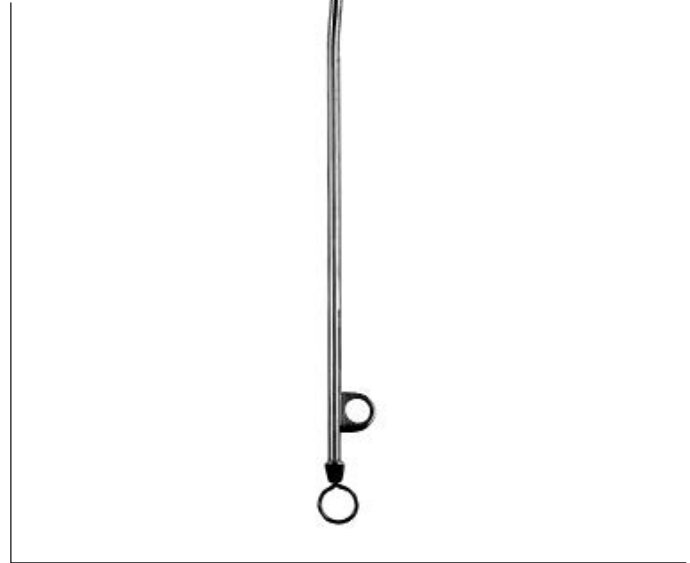

### FEMALE CATHETER

#### CHROME

85-2210	10 French
85-2212	12 French
85-2214	14 French
85-2216	16 French
85-2218	18 French
85-2220	20 French

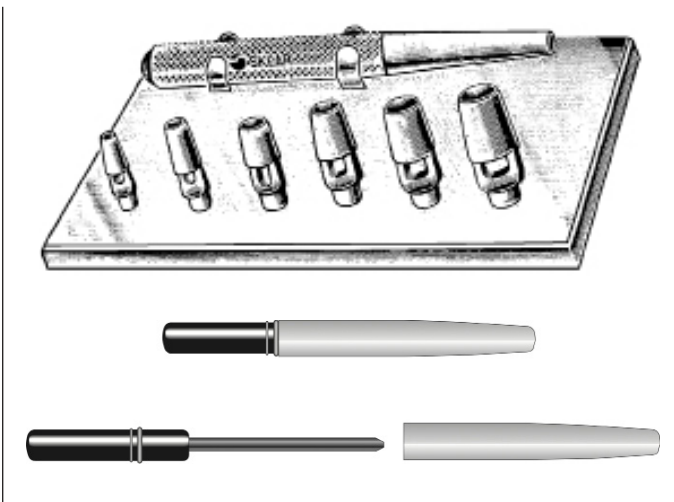

### KEYES VULVAR/DERMAL PUNCH

06-4100	Set of 6, 2mm thru 7mm with Universal Handle and Sterilizable Base
06-4110	KEYES Sharpening Stone



### KEYES CUTANEOUS PUNCH

#### ROUND

06-4142	2mm	06-4146	6mm
06-4143	3mm	06-4147	7mm
06-4144	4mm	06-4148	8mm
06-4145	5mm	06-4110	KEYES Sharpening Stone

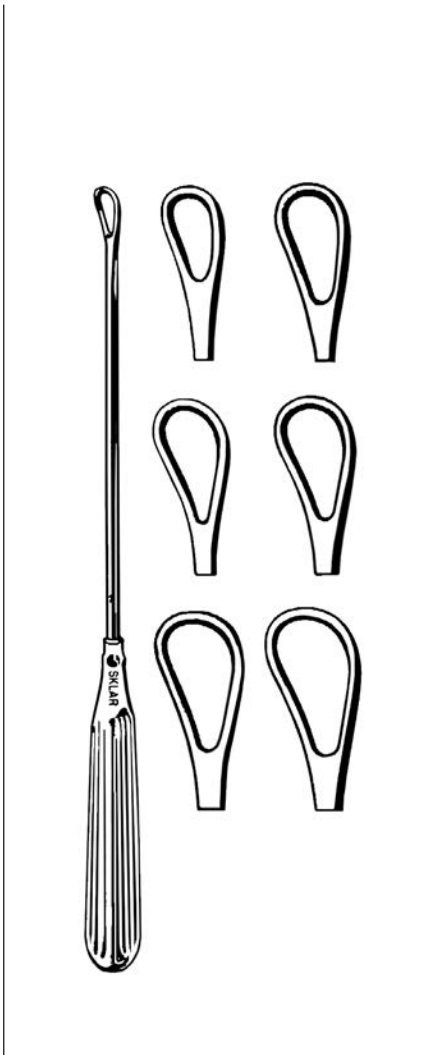

**THOMAS UTERINE CURETTES**

BLUNT, 11"

- |            |                  |
|------------|------------------|
| 90-5431 #1 | 90-5435 #5       |
| 90-5432 #2 | 90-5436 #6       |
| 90-5433 #3 | 90-5438 Set of 6 |

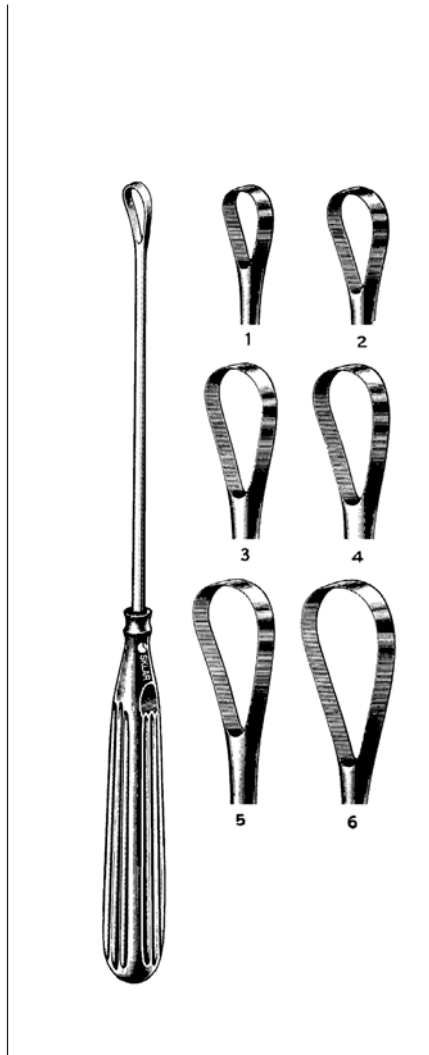

**SIMS UTERINE CURETTES**

SHARP, 11"

- |             |                  |
|-------------|------------------|
| 90-5499 #00 | 90-5424 #4       |
| 90-5500 #0  | 90-5425 #5       |
| 90-5421 #1  | 90-5426 #6       |
| 90-5422 #2  | 90-5428 Set of 6 |
| 90-5423 #3  |                  |

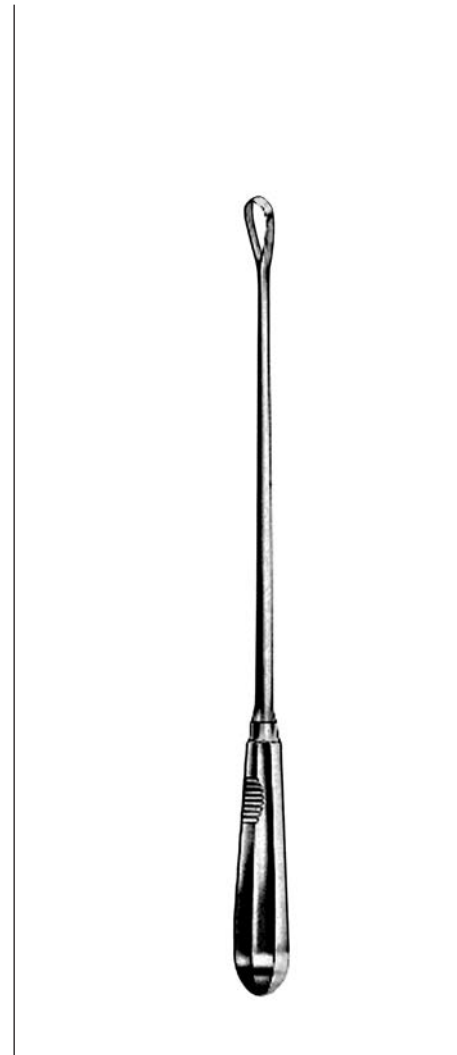

**RECAMIER UTERINE CURETTES**

SHARP, 12½", WITH MALLEABLE SHAFTS

- |             |             |
|-------------|-------------|
| 90-5610 #00 | 90-5616 #5  |
| 90-5611 #0  | 90-5617 #6  |
| 90-5612 #1  | 90-5618 #7  |
| 90-5613 #2  | 90-5619 #8  |
| 90-5614 #3  | 90-5620 #9  |
| 90-5615 #4  | 90-5621 #10 |

BLUNT, 12½", WITH MALLEABLE SHAFTS

- |             |             |
|-------------|-------------|
| 90-5622 #00 | 90-5628 #5  |
| 90-5623 #0  | 90-5629 #6  |
| 90-5624 #1  | 90-5630 #7  |
| 90-5625 #2  | 90-5631 #8  |
| 90-5626 #3  | 90-5632 #9  |
| 90-5627 #4  | 90-5633 #10 |



**BUMM UTERINE CURETTES**

13½", WITH MALLEABLE SHAFTS

<b>SHARP</b>		<b>BLUNT</b>	
90-5602	#14	90-5605	#14
90-5603	#15	90-5606	#15
90-5604	#16	90-5607	#16

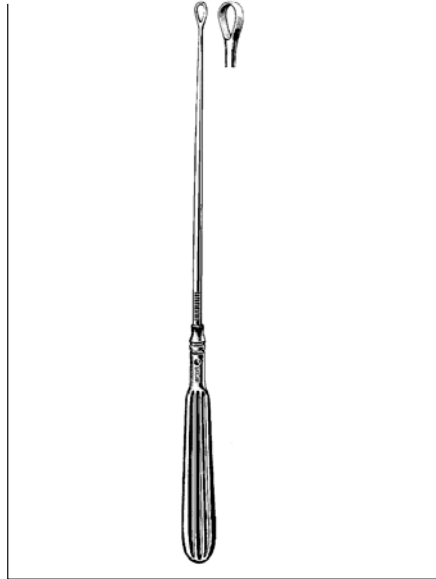

**HOLDEN UTERINE CURETTE**

**SEMI-SHARP**  
90-5710 10¾" Extra Small

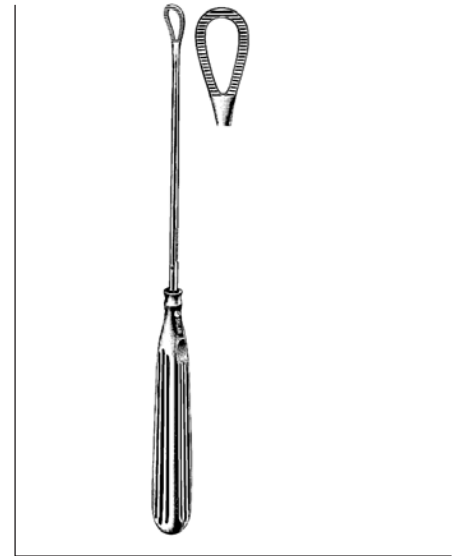

**GREENE UTERINE CURETTE**

**SERRATED**  
90-5566 11"

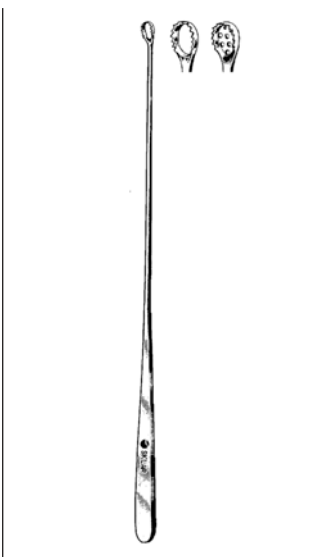

**HEANEY UTERINE CURETTES**

**SERRATED**

90-6095	9½"	Open Curette
90-6195	9½"	With Basket



**KELLY-GRAY UTERINE CURETTE**

**MALLEABLE**

90-6081	9½"	#1
90-6082	9½"	#2
90-6083	9½"	#3
90-6084	9½"	#4

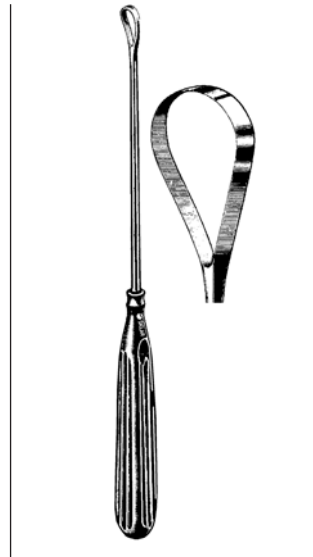

**LOUNSBURY PLACENTA CURETTE**

90-5713 13" ¾" Wide

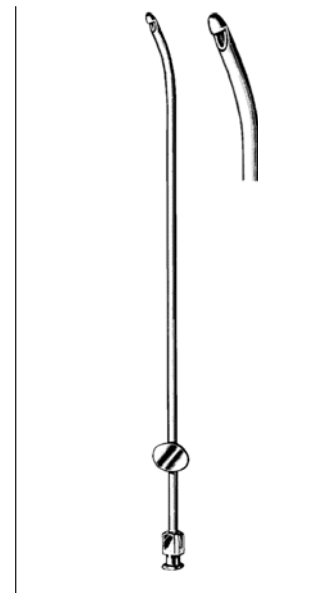

**NOVAK ENDOMETRIAL CURETTES**

90-6289	9½"	1mm
90-6290	9½"	2mm
90-6291	9½"	3mm
90-6292	9½"	4mm

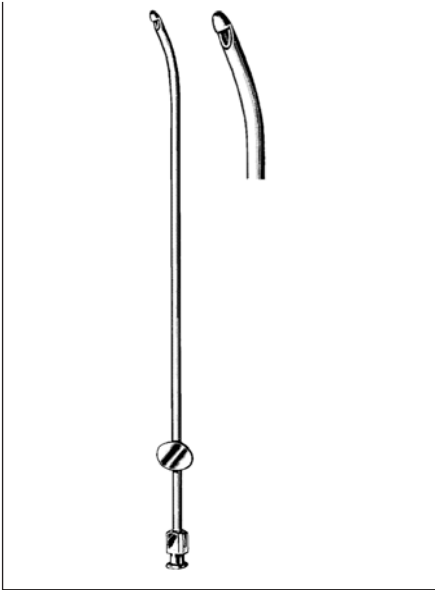

**RANDALL ENDOMETRIAL CURETTE**

90-6295 9½" 4mm



**SKLAR MINI ENDOCERVICAL CURETTE**

90-6285 Small rounded tip for easier entry into stenosed cervix

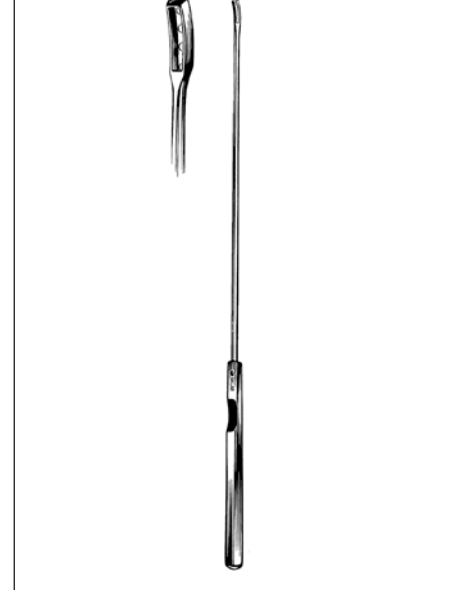

**KEVORKIAN – YOUNGE ENDOCERVICAL CURETTES**

**NARROW TIP**  
 90-6611 12" Without Basket  
 90-6612 12" With Basket

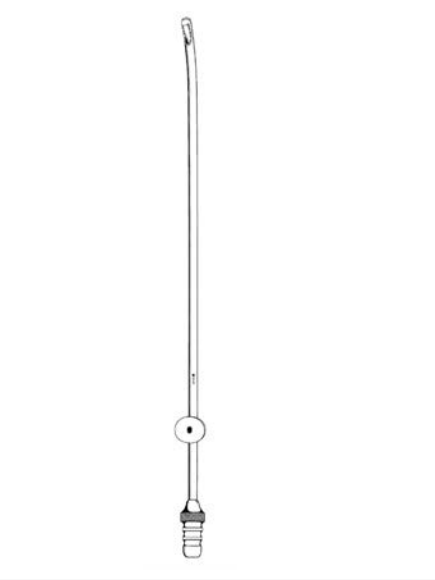

**LAUFE – NOVAK DIAGNOSTIC CURETTE**

WITH SUCTION FINGER CONTROL

90-5834 Small

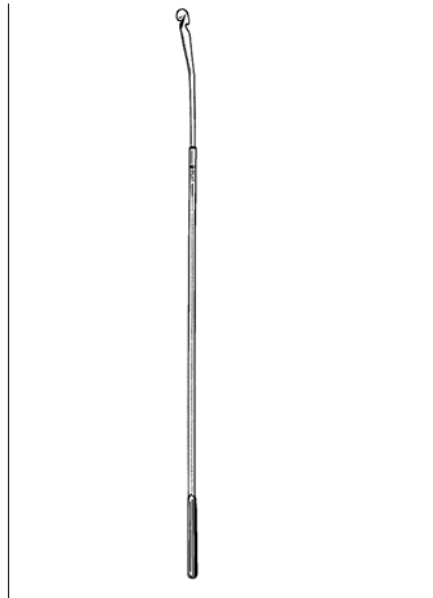

**IUD EXTRACTOR**

90-8210 10½"

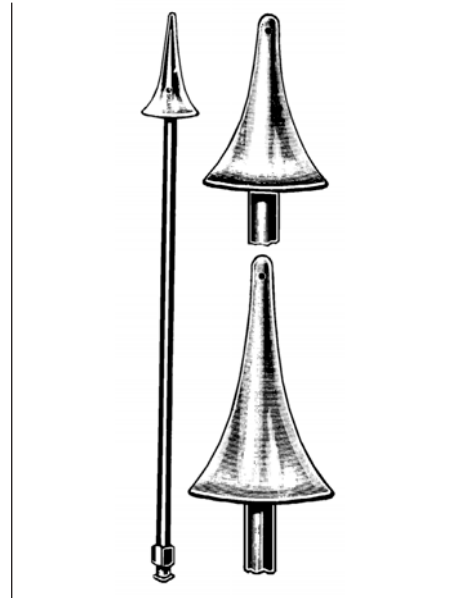

**HOLMAN – MATHIEU CANNULA FOR HYSTEOSALPINGOGRAPHY**

90-6582 Small 8¼" (21cm) with Luer-Lock Chrome Plated  
 90-6590 Large 9" (22.9cm) with Luer-Lock Chrome Plated

## Z-Type Scissors & Forceps

Sklar's Z-Type Hysterectomy/Parametrium Scissors and Forceps are specifically designed to ideally meet the surgeon's needs during vaginal and abdominal hysterectomy procedures. Manufactured from German grade stainless steel and under the highest quality standards, these specialized instruments provide uncompromised balance, feel and performance.

### Z-TYPE SCISSORS

With solid Tungsten Carbide inserts, Z-Type Scissors have extremely sharp, strong and precise cutting edges with lasting durability, and are specifically formed to cut tissue laterally. They are designed to complement the curvature of Z-Type Forceps for optimal access, visibility and control.

PRODUCT NUMBER		DESCRIPTION
16-4000	9"	Z-Type Parametrium Scissors, Slight Curve
16-4001	9"	Z-Type Parametrium Scissors, Curved
16-4002	9"	Z-Type Parametrium Scissors, Full Curve
16-4004	10½"	Z-Type Parametrium Scissors, Slight Curve
16-4005	10½"	Z-Type Parametrium Scissors, Curved
16-4006	10½"	Z-Type Parametrium Scissors, Full Curve
16-4008	12"	Z-Type Parametrium Scissors, Slight Curve
16-4009	12"	Z-Type Parametrium Scissors, Curved
16-4010	12"	Z-Type Parametrium Scissors, Full Curve
16-4012	14"	Z-Type Parametrium Scissors, Slight Curve
16-4013	14"	Z-Type Parametrium Scissors, Curved
16-4014	14"	Z-Type Parametrium Scissors, Full Curve



### Z-TYPE FORCEPS

Longitudinal grooves with tip serrations on Z-Type Forceps ensure an atraumatic yet firm grip on tissue, minimizing slippage and tissue trauma. Longer instrument design and off-set handles ensure superior manipulation and exposure especially for deep pelvic surgery or obese patients.

PRODUCT NUMBER		DESCRIPTION
90-2785	8¼"	Z-Type Hysterectomy Forceps, Straight
90-2786	8¼"	Z-Type Hysterectomy Forceps, Slight Curve
90-2787	8¼"	Z-Type Hysterectomy Forceps, Full Curve
90-2788	8¼"	Z-Type Hysterectomy Forceps, Angled
90-2790	9½"	Z-Type Hysterectomy Forceps, Straight
90-2792	9½"	Z-Type Hysterectomy Forceps, Slight Curve
90-2793	9½"	Z-Type Hysterectomy Forceps, Full Curve
90-2794	9½"	Z-Type Hysterectomy Forceps, Angled
90-2796	12"	Z-Type Hysterectomy Forceps, Straight
90-2797	12"	Z-Type Hysterectomy Forceps, Slight Curve
90-2798	12"	Z-Type Hysterectomy Forceps, Full Curve
90-2799	12"	Z-Type Hysterectomy Forceps, Angled
90-2801	14"	Z-Type Hysterectomy Forceps, Straight
90-2802	14"	Z-Type Hysterectomy Forceps, Slight Curve
90-2803	14"	Z-Type Hysterectomy Forceps, Full Curve
90-2804	14"	Z-Type Hysterectomy Forceps, Angled





**ELLIOT OBSTETRICAL FORCEPS**

92-1712 12½"  
92-1715 15"



**PIPER OBSTETRICAL FORCEP  
FOR BREECH PRESENTATION**

92-2717 17½"

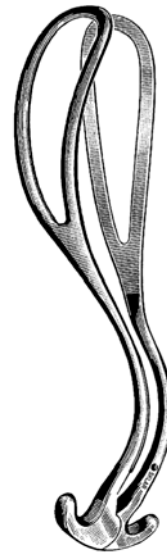

**LAUFE-PIPER OBSTETRICAL  
FORCEP**

92-2812 12"



**KIELLAND OBSTETRICAL FORCEP**

92-1915 15¾"



**LUIKART OBSTETRICAL FORCEP**

92-2015 15¾"

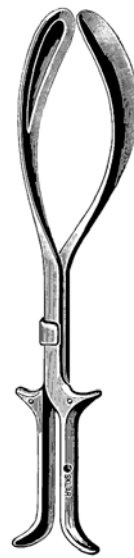

**KIELLAND-LUIKART  
OBSTETRICAL FORCEP**

92-2115 15¾"

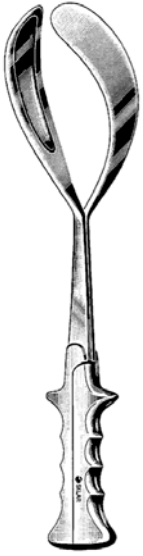

**MCLANE-TUCKER-LUIKART  
OBSTETRICAL FORCEP**

92-2215 15½"



**SIMPSON-LUIKART  
OBSTETRICAL FORCEP**

92-2314 14"

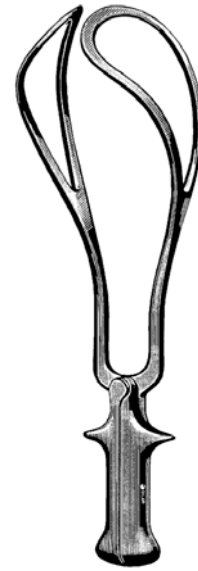

**DE LEE OBSTETRICAL  
FORCEPS**

92-1012	12"	Short for Caesareans
92-1014	14"	Standard
92-1015	15¼"	Long

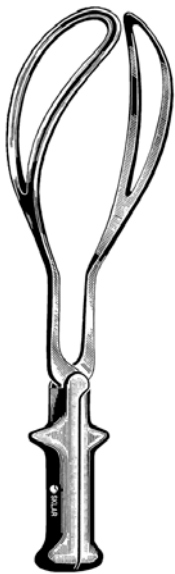

**SIMPSON OBSTETRICAL  
FORCEPS**

92-1112	12"	Short
92-1114	14¼"	Long



**MCLANE-TUCKER OBSTETRICAL  
FORCEP**

92-1415 15¼"



**HALE OBSTETRICAL FORCEP**

92-1610 10¼"



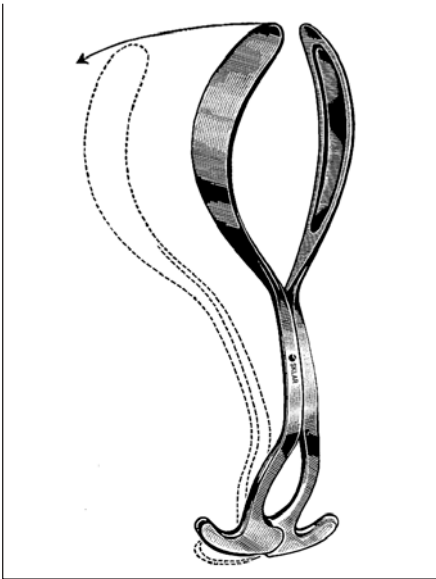

**LAUFE DIVERGENT  
OBSTETRICAL FORCEP**

92-2912 12½"

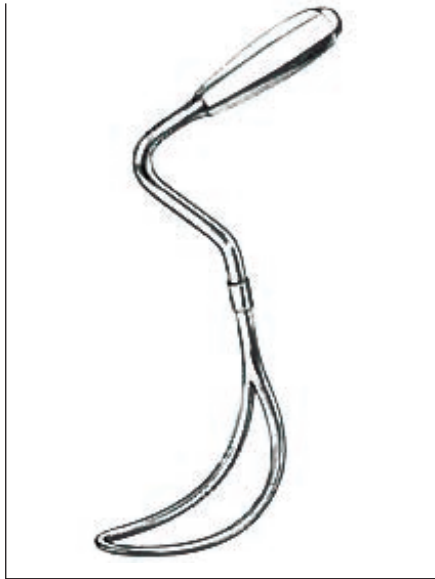

**MURLESS  
HEAD EXTRACTOR**

92-2915 10½"

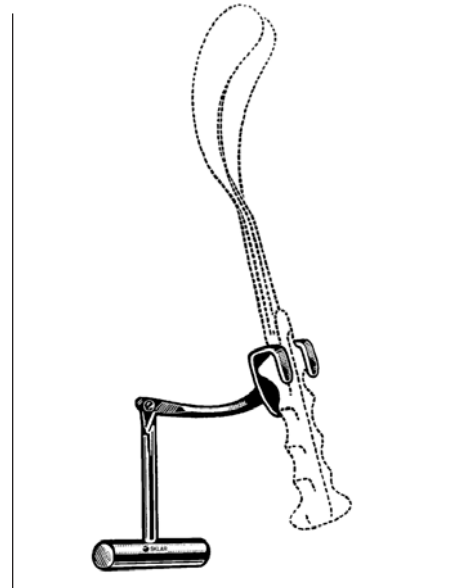

**BILL TRACTION HANDLE  
FOR USE ON STANDARD OBSTETRICAL  
FORCEPS**

92-3350

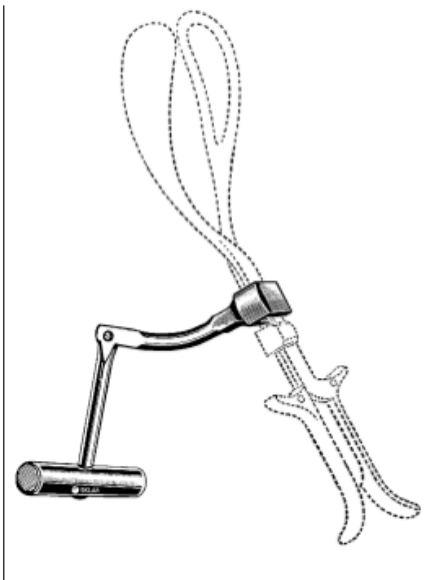

**LUIKART-BILL TRACTION  
HANDLE**

92-3360

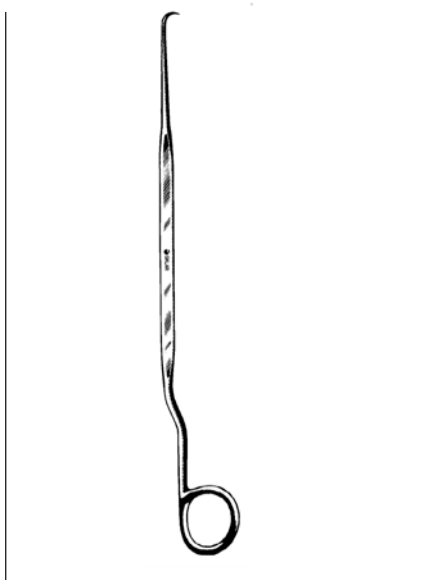

**BEACHAM AMNIOTOME**

91-4210 10¼"

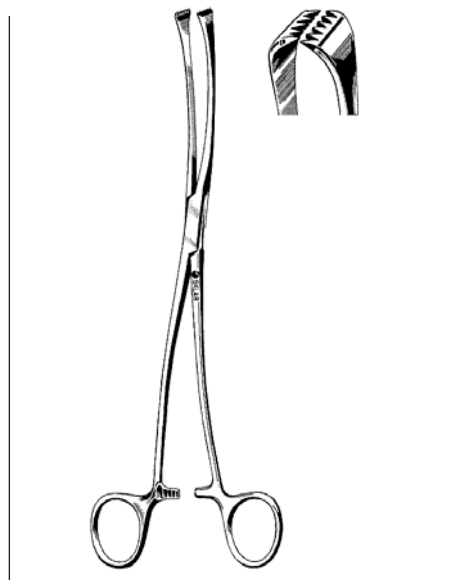

**IOWA MEMBRANE FORCEP**

**S-CURVE**

91-4310 10"

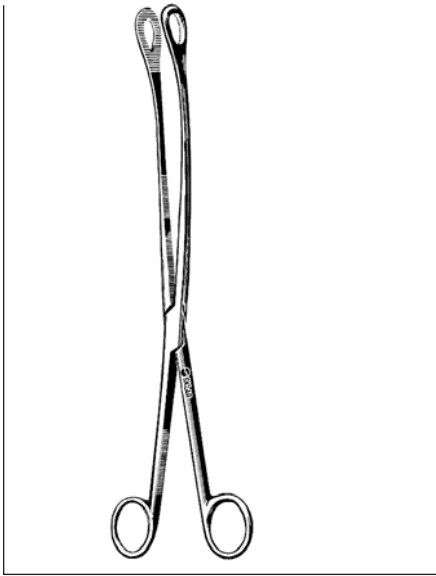

**KELLY PLACENTA FORCEP**

**CURVED**

92-5012 12"

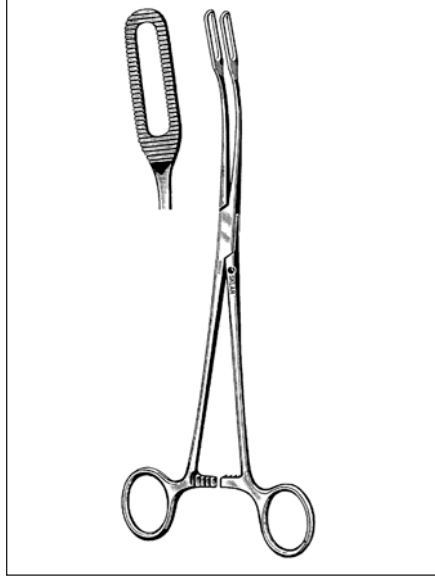

**JAVERTS PLACENTA FORCEPS**

92-5095 9½" Serrated Jaws

92-5195 9½" Smooth Jaws

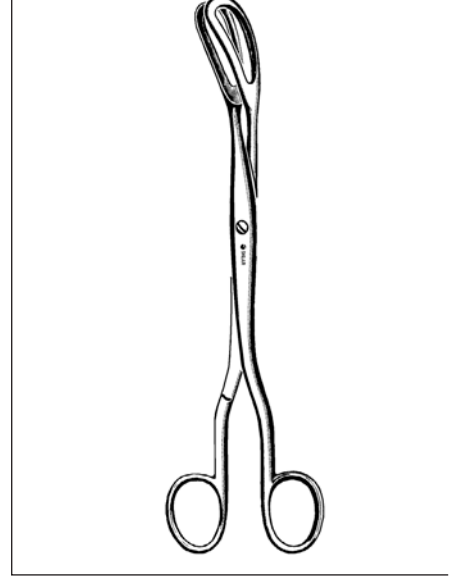

**COREY OVUM FORCEP**

92-5295 9½"

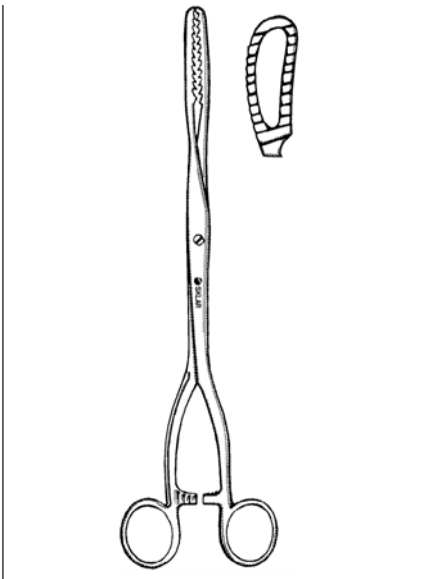

**BIERER OVUM FORCEPS**

**WITH RATCHET**

92-5298 11" Serrated Jaw

**WITHOUT RATCHET**

91-3822 11" Serrated Jaw

91-3823 12½" Serrated Jaw

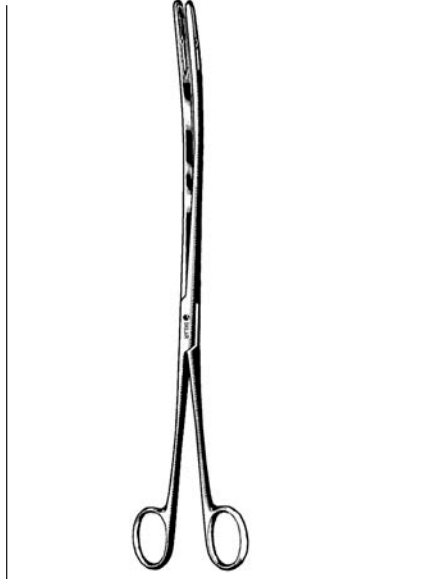

**BOND PLACENTA FORCEP**

92-5412 12"

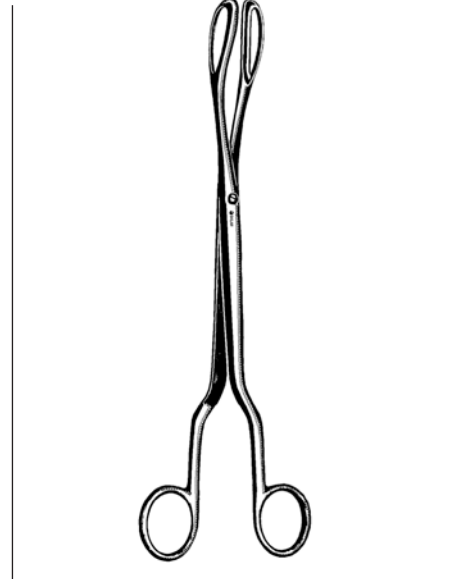

**BARRETT PLACENTA FORCEP**

92-5310 10"

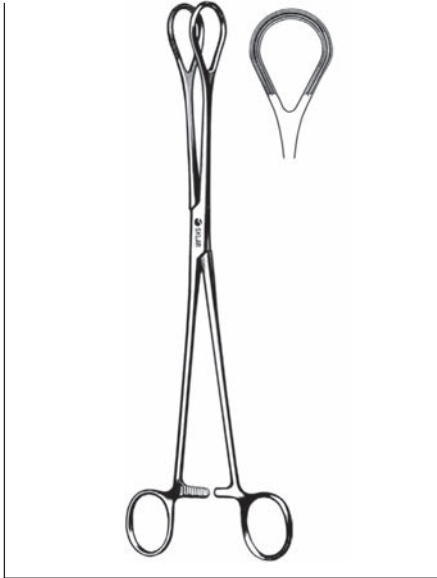

**ATRAUMATIC OVUM FORCEP**  
92-5280 10" Straight

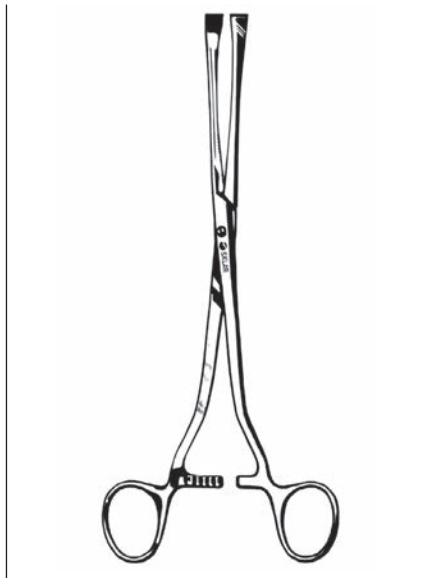

**GREEN ARMYTAGE FORCEP**  
90-5420 8 1/4"



**COLLYER PELVIMETER**  
92-4100



**MARTIN PELVIMETER**  
92-4130

## SKLAR SURGICAL GOWNS

- Low linting, lightweight and breathable SMS fabric.
- Generous cut provides comfort and freedom of movement during various procedures.
- Superior liquid barrier protection provides confidence against strikethrough.
- Velcro-style neck closure easily adjusts for a perfect fit.
- Meets safety standards for Class I Flame Resistance.
- Meets AAMI Level I requirements.
- Disposable, single use.

AVAILABLE IN NON-STERILE AND BULK, NON-STERILE. SEE PAGE 233 FOR ORDERING INFORMATION.



**PRECISION ENGINEERED**, hand-crafted and imported from Germany, Sklar Biopsy Punches have a reputation for being the best in the industry. A complete selection of forcep tips combined with three specific handle configurations provide the flexibility, comfort and control required by the most selective physicians.

### MICRO-CUT

Micro-Cut Premium Grade Biopsy Punches feature a knife honed edge on the upper jaw for a cleaner, more precise cut. Precisely balanced and superior workmanship delivers the finest value in quality gynecological instruments. Micro-Cut Forceps are easily identified by their dual gold handles.

#### MICRO-CUT TISCHLER KEVORKIAN BIOPSY PUNCH

PRODUCT NUMBER	DESCRIPTION
90-8920	3mm x 9.5mm Bite



#### MICRO-CUT MINI-TISCHLER PUNCH

PRODUCT NUMBER	DESCRIPTION
90-8945	2.3mm x 4.2mm Bite



#### MICRO-CUT TISCHLER OVAL BIOPSY PUNCH

PRODUCT NUMBER	DESCRIPTION
90-8940	3mm x 7mm Bite



#### MICRO-CUT KEVORKIAN BIOPSY PUNCH

PRODUCT NUMBER	DESCRIPTION
90-8952	3mm x 8mm Bite

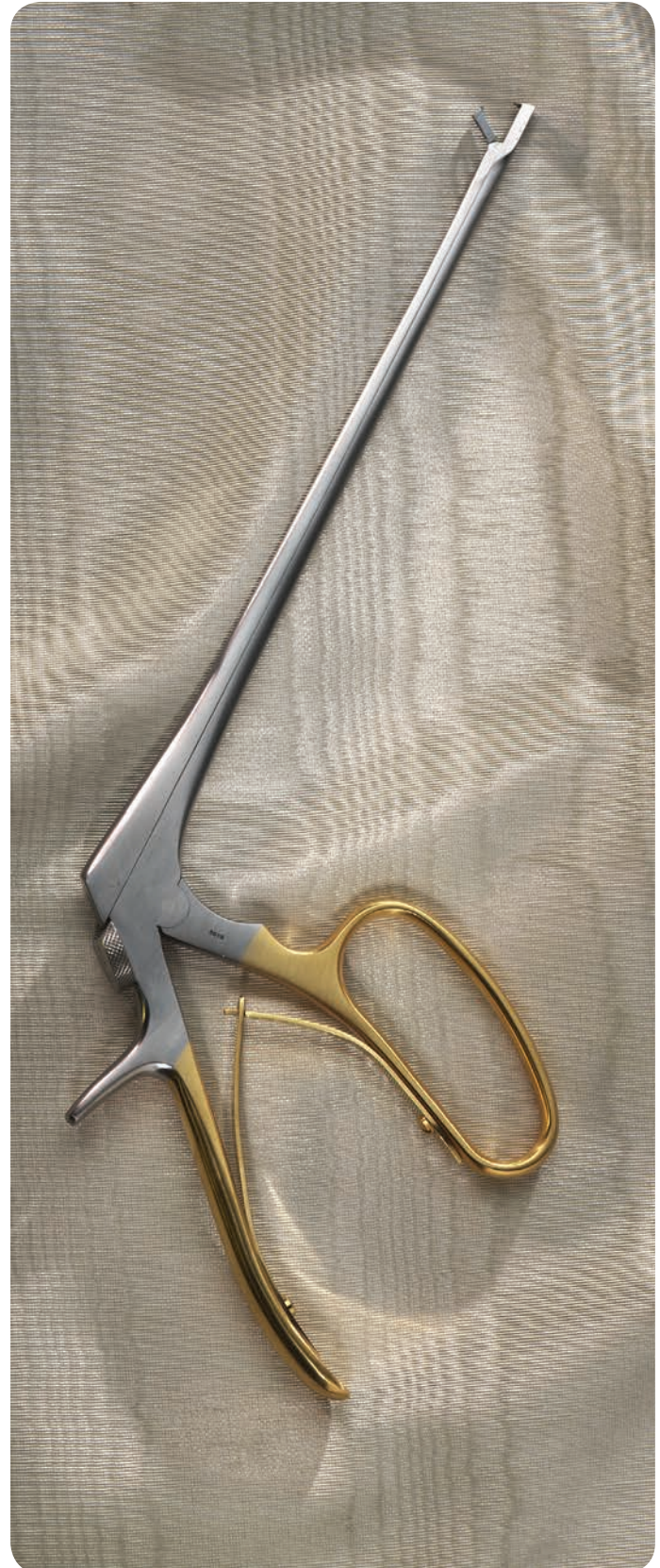

**MICRO-CUT OVAL BIOPSY PUNCH**

PRODUCT NUMBER	DESCRIPTION
90-8948	3mm x 5mm Bite



**MICRO-CUT KEVORKIAN-YOUNGE BIOPSY PUNCH**

PRODUCT NUMBER	DESCRIPTION
90-8905	3mm x 9.7mm Bite



**MICRO-CUT EPPENDORFER BIOPSY PUNCH**

PRODUCT NUMBER	DESCRIPTION
90-8010	4mm x 8mm Bite



**MICRO-CUT WITTNER UTERINE BIOPSY PUNCH**

PRODUCT NUMBER	DESCRIPTION
90-8900	4mm x 8mm Bite, Straight



### SKLAR FULLY ROTATIONAL BIOPSY FORCEPS

**MICRO-CUT** Premium Grade Biopsy Forceps rotate a full 360° and are designed to obtain a perfect sample without obstruction of the biopsy site. Combining fine craftsmanship with the added benefit of a knife honed edge on the upper jaw, Micro-Cut Forceps allow for a cleaner, more precise cut. A full assortment of tip-shaft combinations provide flexible configurations to compliment the most difficult gynecological procedure. Micro-Cut Forceps are easily identifiable by their dual gold handles.

#### COMPLETE INSTRUMENT

##### MICRO-CUT TISCHLER OVAL BIOPSY PUNCH

PRODUCT NUMBER	DESCRIPTION
90-8960	3mm x 7mm Bite 7" Shaft Length
90-8981	3mm x 7mm Bite 12" Shaft Length



##### MICRO-CUT OVAL BIOPSY PUNCH

PRODUCT NUMBER	DESCRIPTION
90-8962	3mm x 5mm Bite 7" Shaft Length
90-8982	3mm x 5mm Bite 12" Shaft Length



##### MICRO-CUT MINI TISCHLER BIOPSY PUNCH

PRODUCT NUMBER	DESCRIPTION
90-8964	2.3mm x 4.2mm Bite 7" Shaft Length
90-8983	2.3mm x 4.2mm Bite 12" Shaft Length



##### MICRO-CUT KEVORKIAN BIOPSY PUNCH

PRODUCT NUMBER	DESCRIPTION
90-8966	3mm x 8mm Bite 7" Shaft Length
90-8984	3mm x 8mm Bite 12" Shaft Length

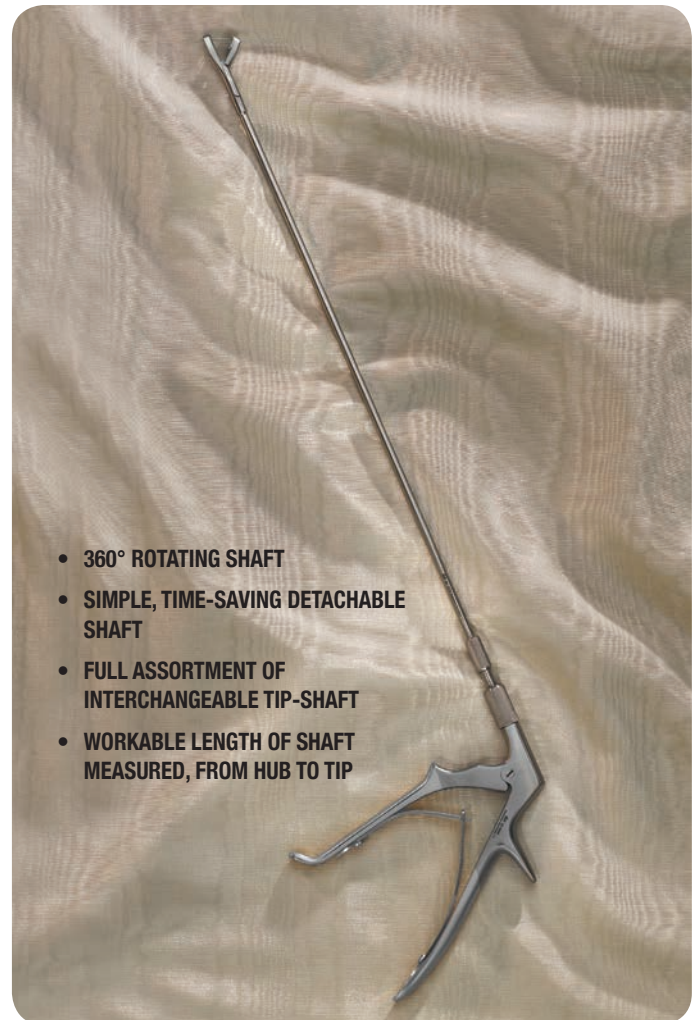

- 360° ROTATING SHAFT
- SIMPLE, TIME-SAVING DETACHABLE SHAFT
- FULL ASSORTMENT OF INTERCHANGEABLE TIP-SHAFT
- WORKABLE LENGTH OF SHAFT MEASURED, FROM HUB TO TIP

#### CANNULA WITH TIP ONLY

PRODUCT NUMBER	DESCRIPTION
90-8970	7" Tischler Oval
90-8972	7" Oval
90-8974	7" Mini Tischler
90-8976	7" Kevorkian
90-8986	12" Tischler Oval
90-8987	12" Oval
90-8988	12" Mini Tischler
90-8989	12" Kevorkian

#### HANDLE ONLY

PRODUCT NUMBER	DESCRIPTION
90-8980	Handle for use with 7" Cannula
90-8985	Handle for use with 12" Cannula

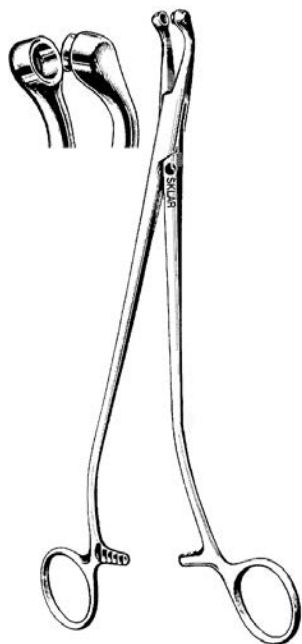

**MICRO-CUT GAYLOR BIOPSY PUNCH**

90-8925 9½"



**MICRO-CUT GELHORN BIOPSY PUNCH**

90-8930 9½"

# SKLAR DISINFECTANT™

SPRAY SURFACE DISINFECTANT

**2 MINUTE KILL TIME**

- Ready to use, non-toxic formula.
- Specially formulated for the control of cross contamination.
- Effective against C. Diff, TB, HBV, HCV, Hydrophilic and Lipophilic viruses including HIV-1 (AIDS Virus), bacteria and fungi on inanimate objects.
- Safe for all areas of the facility including the NICU, operating rooms, isolation rooms, patient care areas and laboratories.
- Satisfies OSHA's Bloodborne Pathogen Standards.
- Non-irritating formula.
- EPA registered.



PRODUCT NUMBER	DESCRIPTION	Quantities
10-1643	24 oz. Spray Bottles	6/cs
10-1653	1 Gallon Bottles	4/cs

**PRECISION**, balance and control are the key features of Sklar's line of OR Grade Biopsy Punches and ensures the highest level of hand-crafted workmanship. A variety of tip-handle combinations provide the flexibility, comfort and control required by the most selective physicians. Select forcep tips are available with a 60° Wide Bite mouth for easy removal of biopsy and safer cleaning and are easily identified by their Dual Gold handles. Guaranteed for a lifetime against manufacturing defects.

### TISCHLER KEVORKIAN BIOPSY PUNCH

PRODUCT NUMBER	DESCRIPTION
90-6887	3mm x 9.5mm Bite
90-9570	3mm x 9.5mm Bite, 60° Opening



### MINI TISCHLER BIOPSY PUNCH

PRODUCT NUMBER	DESCRIPTION
90-7530	2.3mm x 4.2mm Bite
90-9555	2.3mm x 4.2mm, 60° Opening

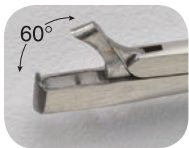

### TISCHLER OVAL BIOPSY PUNCH

PRODUCT NUMBER	DESCRIPTION
90-7520	3mm x 7mm Bite
90-9560	3mm x 7mm Bite, 60° Opening



### KEVORKIAN BIOPSY PUNCH

PRODUCT NUMBER	DESCRIPTION
90-7540	3mm x 8mm Bite
90-9575	3mm x 8mm Bite, 60° Opening





**OVAL BIOPSY PUNCH**

PRODUCT NUMBER	DESCRIPTION
90-7525	3mm x 5mm Bite
90-9565	3mm x 5mm Bite, 60° Opening



**KEVORKIAN-YOUNGE BIOPSY PUNCH**

PRODUCT NUMBER	DESCRIPTION
90-6610	3mm x 9.7mm Bite



**EPPENDORFER BIOPSY PUNCH**

PRODUCT NUMBER	DESCRIPTION
90-6820	4mm x 8mm Bite



**WITTNER UTERINE BIOPSY PUNCH**

PRODUCT NUMBER	DESCRIPTION
90-6600	4mm x 8mm Bite, Straight
90-6602	4mm x 8mm Bite, Angular



### SKLAR FULLY ROTATIONAL BIOPSY FORCEPS

**FULLY ROTATIONAL**, Sklar's line of 360° OR Grade Rotating Biopsy Forceps are designed to obtain a perfect sample without obstructing the biopsy site. The shaft is detachable from the handle allowing for a full assortment of tip-shaft combinations to compliment the most difficult gynecological procedure. Flexible configurations, high-quality and precision craftsmanship are backed by a lifetime guarantee against manufacturing defects.

#### COMPLETE INSTRUMENT

##### TISCHLER OVAL BIOPSY PUNCH

PRODUCT NUMBER	DESCRIPTION
90-7551	3mm x 7mm Bite 7" Shaft Length
90-7571	3mm x 7mm Bite 12" Shaft Length



##### MINI TISCHLER BIOPSY PUNCH

PRODUCT NUMBER	DESCRIPTION
90-7553	2.3mm x 4.2mm Bite 7" Shaft Length
90-7573	2.3mm x 4.2mm Bite 12" Shaft Length



##### OVAL BIOPSY PUNCH

PRODUCT NUMBER	DESCRIPTION
90-7552	3mm x 5mm Bite 7" Shaft Length
90-7572	3mm x 5mm Bite 12" Shaft Length



##### KEVORKIAN BIOPSY PUNCH

PRODUCT NUMBER	DESCRIPTION
90-7554	3mm x 8mm Bite 7" Shaft Length
90-7574	3mm x 8mm Bite 12" Shaft Length

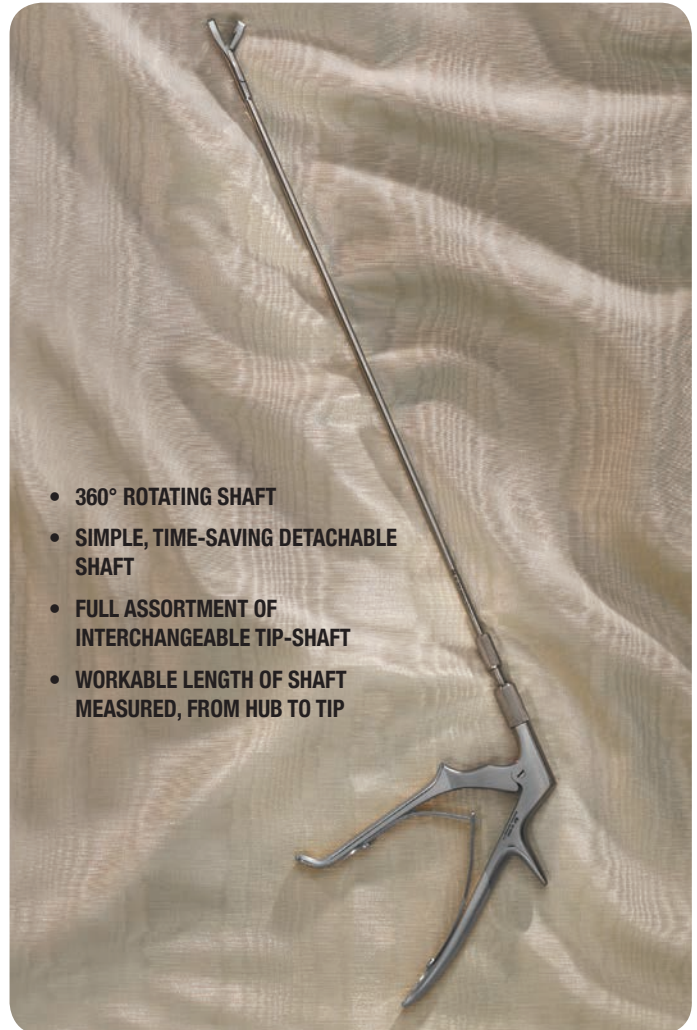

- 360° ROTATING SHAFT
- SIMPLE, TIME-SAVING DETACHABLE SHAFT
- FULL ASSORTMENT OF INTERCHANGEABLE TIP-SHAFT
- WORKABLE LENGTH OF SHAFT MEASURED, FROM HUB TO TIP

#### CANNULA WITH TIP ONLY

PRODUCT NUMBER	DESCRIPTION
90-7555	7" Tischler Oval
90-7556	7" Oval
90-7557	7" Mini Tischler
90-7558	7" Kevorkian
90-7576	12" Tischler Oval
90-7577	12" Oval
90-7578	12" Mini Tischler
90-7579	12" Kevorkian

#### HANDLE ONLY

PRODUCT NUMBER	DESCRIPTION
90-7560	Handle for use with 7" Cannula
90-7575	Handle for use with 12" Cannula



**GAYLOR BIOPSY PUNCH**

IMPROVED JAWS

90-7385 9½"



**GELHORN BIOPSY PUNCH**

90-7492 9½"



**SCHUBERT-VAN DOREN BIOPSY PUNCH**

90-7511 10" Angular Tip and Shanks

**SKLAR DISINFECTANT™  
SURFACE WIPES**

**CONVENIENT DISPENSING CANISTER  
READY-TO-USE**

PRODUCT NUMBER	DESCRIPTION	QUANTITIES
10-1616	100 Towelettes/Canister	6/CS
10-1617	100 Towelettes/Canister	12/CS



**90-8555 – MINI COLPOSCOPY SET**

PRODUCT NUMBER	DESCRIPTION	FEATURES	QUANTITIES
90-3990	Kogan Endocervical Speculum	With Gauge and Screw, Narrow Wire Blades	1
90-8336	Iris Hook	Quick Release, 1mm 9"	1
90-6285	Mini Endocervical Curette		1
90-7530	Mini Tischler Biopsy Forcep	2.3mm x 4.2mm Bite	1



**90-8557 – STANDARD COLPOSCOPY SET**

PRODUCT NUMBER	DESCRIPTION	FEATURES	QUANTITIES
90-3995	Kogan Endocervical Speculum	With Gauge and Screw, Wide Wire Blades	1
90-8334	Iris Hook	Quick Release, 4mm 9"	1
90-6612	Kevorkian-Younger Endocervical Curette	With Basket, Narrow Tip, 12"	1
90-7520	Tischler Oval Biopsy Forcep	3mm x 7mm Bite	1



# Scissors

## **SklarEdge™** ..... Page 53

SklarEdge™ scissors are manufactured using a Sklar Exclusive edging process that permanently bonds Tungsten Carbide to the scissor blades. Tungsten Carbide is an extremely hard alloy that provides an exceptionally strong and sharper edge while maintaining a Sklar 5-year guarantee of durability. These perfectly balanced scissors are readily identified by the dual gold finger rings.

## **Premium** ..... Page 55

Sklar is proud to offer a full line of Premium instruments that have been modified to meet the needs of clinicians for specific procedures. Choose from a wide variety of the most popular patterns.

### **SklarCut™**

SklarCut™ improves the design and function of your most frequently used surgical instruments with the addition of ultra-fine serrations on one blade. This premium feature provides additional surgical control by holding the tissue while cutting more cleanly and with greater precision. SklarCut™ scissors are easily identified by the gold finger ring on the serrated blade handle.

### **SklarHone™**

SklarHone™ scissors combine the cutting edge of a surgical knife with that of a standard scissor. With either smooth or a finely serrated edge, these superior instruments employ the most sophisticated technology to create a smooth, clean cutting action; ideal for delicate surgery or when thick coarse tissue is encountered. SklarHone™ scissors are distinctly identified by their dual black handles.

### **SklarLite™/SklarLite X™**

SklarLite™ premium scissors provide the clinician a lighter pattern, minimizing fatigue during prolonged procedures. A comfortable instrument that withstands the rigors of frequent use while retaining its structural integrity. SklarLite X™ extra delicate scissors provide the most sensitive surgical tool as well as our lightest pattern with surprising strength. SklarLite™ and SklarLite X™ are fully guaranteed for a lifetime of dependable use.

## **General Surgery Instruments** ..... Page 62

Our very best operating room, high quality instruments incorporating optimum grades of German grade surgical steel, finely detailed craftsmanship and exacting standards of manufacturing. Choose from a full line of the most popular patterns.

## **Surgi-OR™ Instruments** ..... Page 72

A Mid-Grade line of high-quality OR instruments, hand-crafted and forged from Japanese surgical grade stainless steel. This cost-effective line of instruments offers significant value to the Operating Room as well as other important surgical settings.

## **Econo™ Sterile Instruments** ..... Page 75

Econo™ Sterile instruments are suitable in a number of surgical venues where economical choice with reliable performance is most important. Convenient, ready-to-use sterile instruments provide the very best value with the greatest utility of any surgical instrument.



### SKLAR EDGE™ TC OPERATING SCISSORS

#### STRAIGHT

16-1055	5½"	Sharp/Sharp
16-1056	5½"	Sharp/Blunt
16-1057	5½"	Blunt/Blunt



### SKLAR EDGE™ TC OPERATING SCISSORS

#### CURVED

16-1155	5½"	Sharp/Sharp
16-1156	5½"	Sharp/Blunt
16-1157	5½"	Blunt/Blunt



### SKLAR EDGE™ TC IRIS SCISSORS

16-2405	4½"	Straight
16-2505	4½"	Curved



### SKLAR EDGE™ TC MAYO DISSECTING SCISSORS

16-1505	5½"	Straight
16-1605	5½"	Curved
16-1510	6¾"	Straight
16-1610	6¾"	Curved
16-1515	9"	Straight
16-1615	9"	Curved

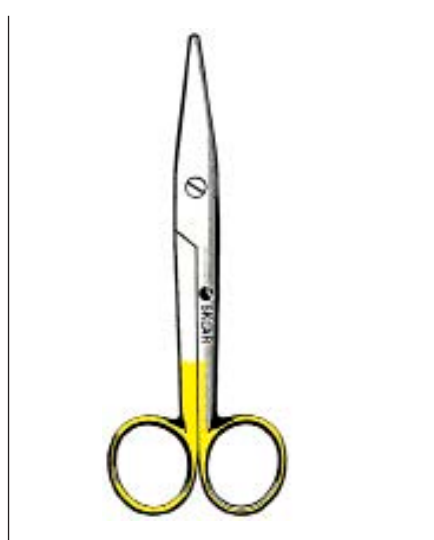

### SKLAR EDGE™ TC MAYO-STILLE DISSECTING SCISSORS

16-3552	5½"	Straight
16-3562	5½"	Curved
16-3557	6¾"	Straight
16-3567	6¾"	Curved

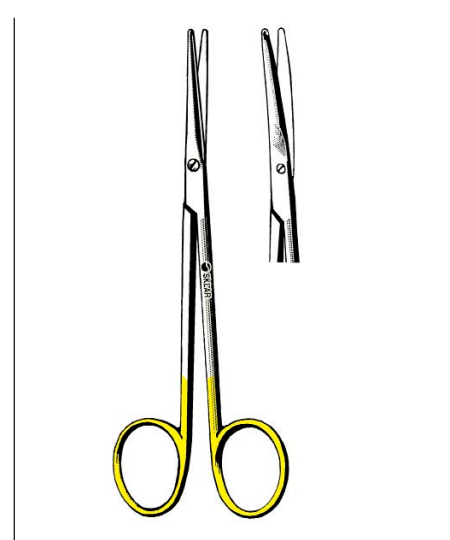

### SKLAR EDGE™ TC METZENBAUM (LAHEY) SCISSORS

16-1805	5¾"	Straight	Delicate
16-1905	5¾"	Curved	Delicate
16-1810	5¾"	Straight	Standard
16-1910	5¾"	Curved	Standard



**SKLAR EDGE™ TC METZENBAUM SCISSORS**

**STRAIGHT**

16-2010	7"	Standard	
16-2210	9"	Standard	
16-2005	7"	Delicate	
16-2205	9"	Delicate	
16-2015	7"	Delicate	Sharp/Sharp

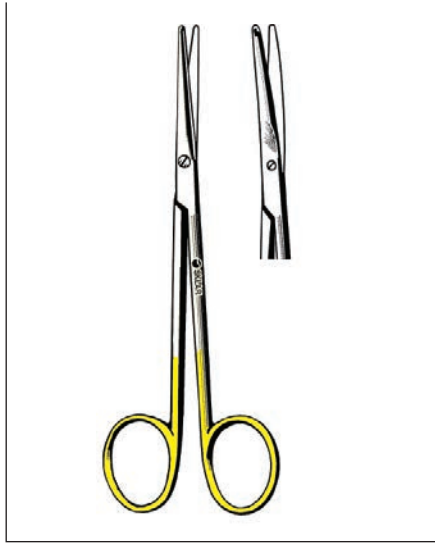

**SKLAR EDGE™ TC METZENBAUM SCISSORS**

**CURVED**

16-2110	7"	Standard	
16-2310	9"	Standard	
16-2311	11"	Standard	
16-2105	7"	Delicate	
16-2305	9"	Delicate	
16-2115	7"	Delicate	Sharp/Sharp



**SKLAR EDGE™ TC STRABISMUS SCISSORS**

16-2605	4½"	Straight
16-2705	4½"	Curved



**SKLAR EDGE™ TC DISSECTING SCISSOR**

16-2610	5"	Curved
---------	----	--------

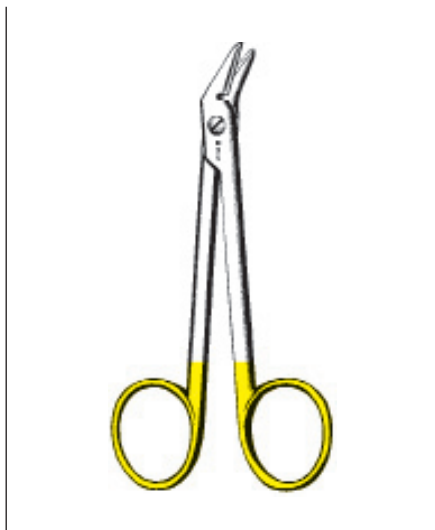

**SKLAR EDGE™ TC WIRE CUTTING SCISSOR**

16-2800	4¾"	Angled	Serrated
---------	-----	--------	----------



**SKLAR EDGE™ TC BLEPHAROPLASTY SCISSOR**

47-1148	4½"	Curved
---------	-----	--------

SKLAR EDGE  
TUNGSTEN CARBIDE

**SKLARCUT™ OPERATING SCISSORS**

15-3500	5½"	Straight	Sharp/Sharp
15-3505	5½"	Straight	Sharp/Blunt
15-3510	5½"	Curved	Sharp/Sharp
15-3515	5½"	Curved	Sharp/Blunt

**SKLARLITE™ SKLARCUT™ OPERATING SCISSORS**

23-1260	5½"	Straight	Sharp/Sharp
23-1262	5½"	Straight	Sharp/Blunt
23-1264	5½"	Curved	Sharp/Sharp
23-1266	5½"	Curved	Sharp/Blunt

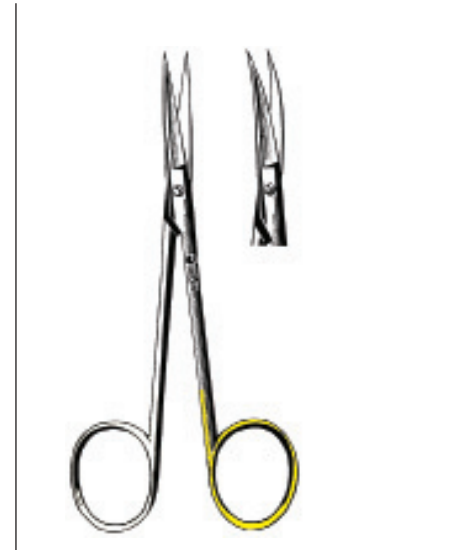
**SKLARCUT™ IRIS SCISSORS**

15-3585	4½"	Straight
15-3590	4½"	Curved

**SKLARLITE™ SKLARCUT™ IRIS SCISSORS**

23-1268	4½"	Straight
23-1270	4½"	Curved

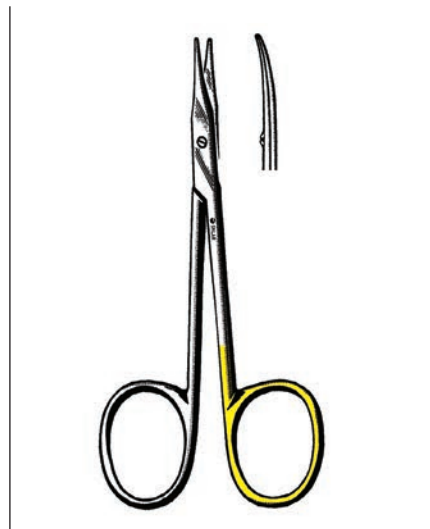
**SKLARCUT™ STEVENS TENOTOMY SCISSORS**

15-3372	4½"	Straight	Blunt/Blunt
15-3370	4½"	Curved	Blunt/Blunt

**SKLARCUT™ MAYO SCISSORS**

15-3550	5½"	Straight
15-3560	5½"	Curved
15-3555	6¾"	Straight
15-3565	6¾"	Curved
15-3566	9"	Straight
15-3568	9"	Curved







**SKLARLITE™ SKLARCUT™ MAYO SCISSORS**

23-1274 6¾" Straight  
23-1278 6¾" Curved

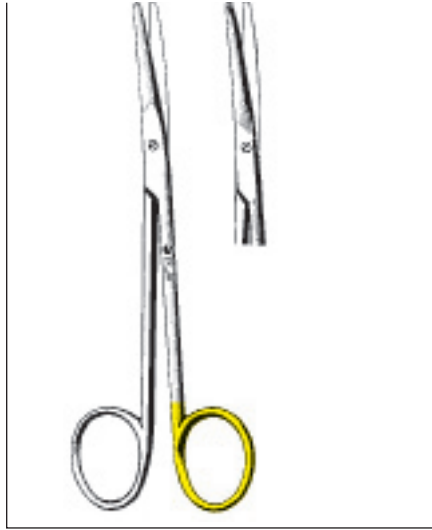

**SKLARCUT™ METZENBAUM (LAHEY) SCISSORS**

15-3569 4½" Straight  
15-3571 4½" Curved  
15-3570 5¾" Curved  
15-3575 7" Curved  
15-3574 9" Curved

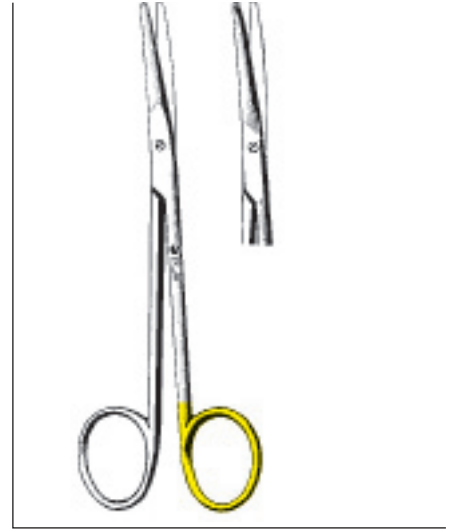

**SKLARLITE™ SKLARCUT™ METZENBAUM (LAHEY) SCISSORS**

23-1280 5¾" Curved  
23-1267 7" Curved

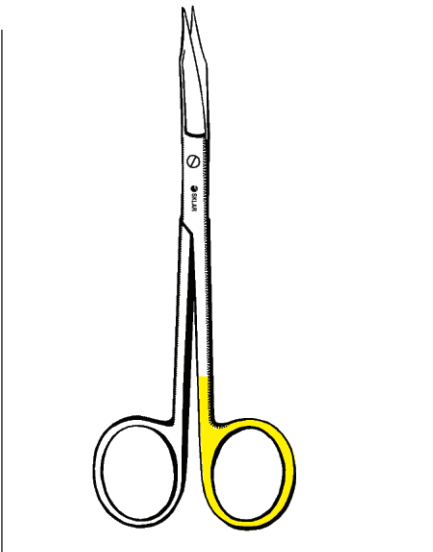

**SKLARCUT™ GOLDMAN-FOX SCISSOR**

15-3536 5" Delicate

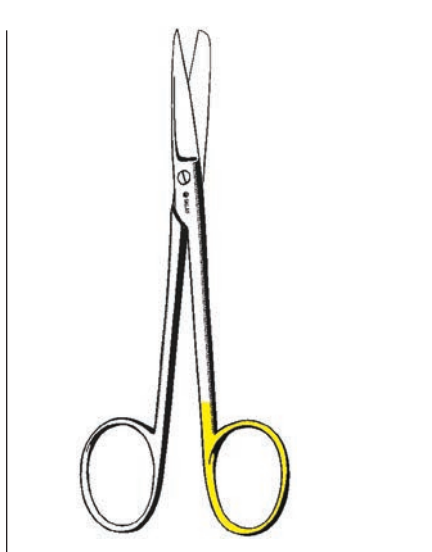

**SKLARCUT™ WAGNER SCISSOR**

15-3542 4½" Straight Sharp/Blunt

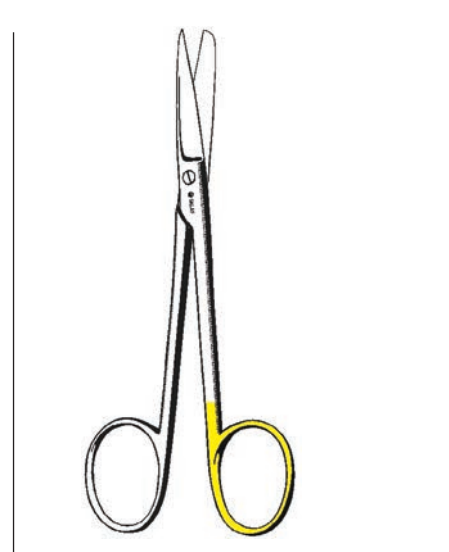

**SKLARLITE™ SKLARCUT™ WAGNER SCISSOR**

23-1254 4½" Straight Sharp/Blunt



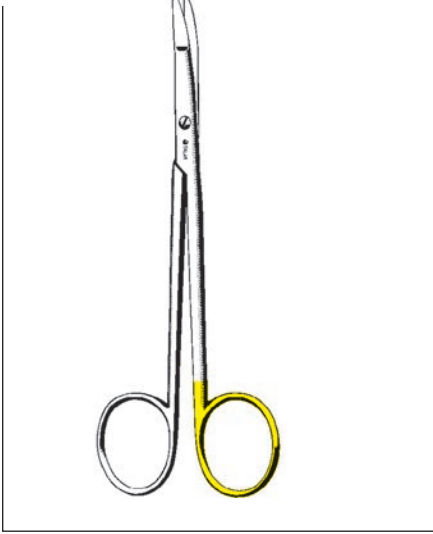

**SKLARCUT™ RAGNELL SCISSORS**

15-3320 5" Curved



**SKLARLITE™ SKLARCUT™ RAGNELL SCISSORS**

23-1250 5" Curved

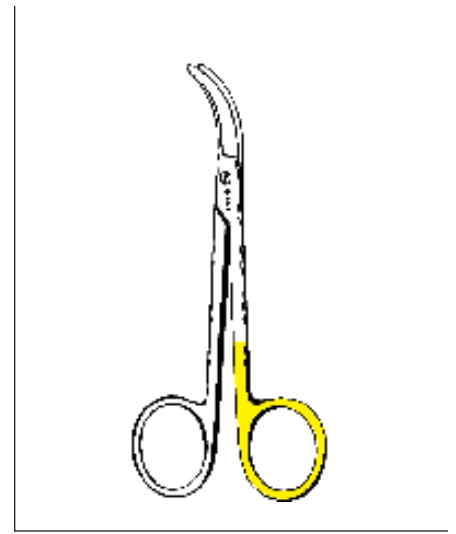

**SKLARCUT™ FOMON LATERAL SCISSORS**

15-3548 5" Curved



**SKLARCUT™ PLASTIC SURGERY SCISSORS**

15-3520 4½" Straight  
15-3525 4½" Curved  
15-3535 4½" Curved Delicate

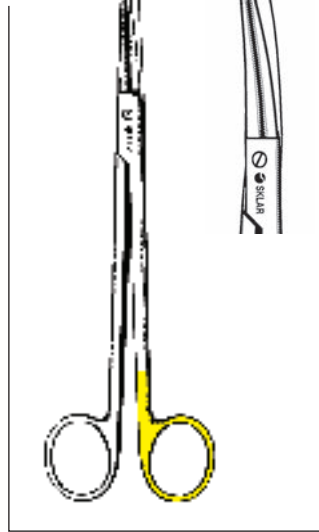

**SKLARCUT™ GORNEY PLASTIC SCISSORS**

15-3577 7¼" Straight  
15-3578 7¼" Curved

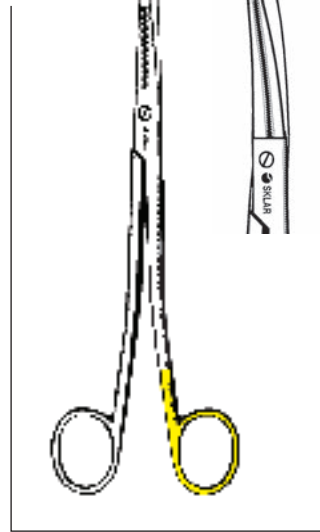

**SKLARCUT™ GORNEY FACE LIFT SCISSORS**

15-3583 7½" Straight  
15-3584 7½" Curved

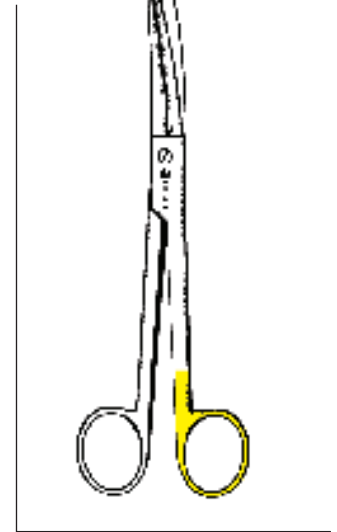

**SKLARCUT™ KAYE FACE LIFT SCISSORS**

15-3579 6" Curved  
15-3580 7½" Curved



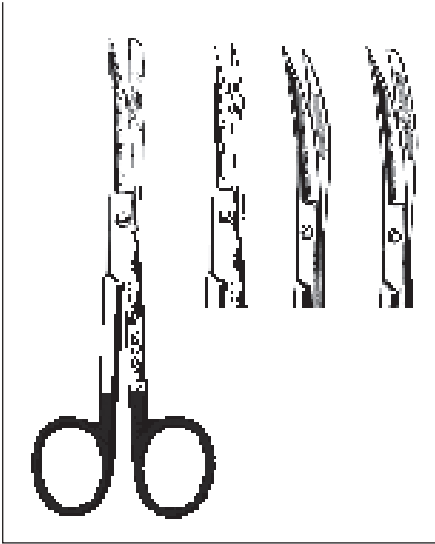

**SKLARHONE™ OPERATING SCISSORS**

**STRAIGHT**

15-3342	5½"	Smooth	Sharp/Sharp
15-3343	5½"	Smooth	Sharp/Blunt
15-3442	5½"	Serrated	Sharp/Sharp
15-3443	5½"	Serrated	Sharp/Blunt

**CURVED**

15-3348	5½"	Smooth	Sharp/Sharp
15-3349	5½"	Smooth	Sharp/Blunt
15-3448	5½"	Serrated	Sharp/Sharp
15-3449	5½"	Serrated	Sharp/Blunt



**SKLARHONE™ MAYO SCISSORS**

15-3325	5½"	Straight	Smooth
15-3330	5½"	Curved	Smooth
15-3430	5½"	Curved	Serrated
15-3326	6¾"	Straight	Smooth
15-3426	6¾"	Straight	Serrated
15-3331	6¾"	Curved	Smooth

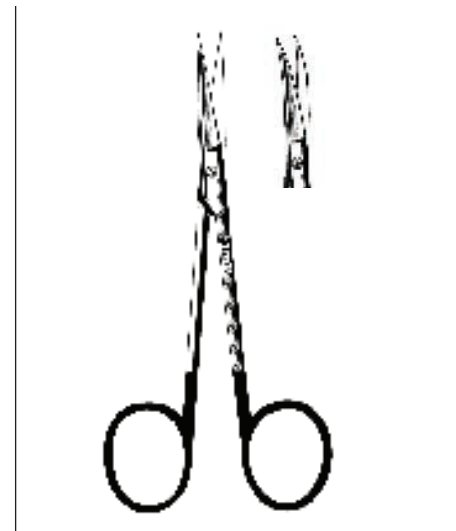

**SKLARHONE™ IRIS SCISSORS**

15-3352	4½"	Straight	Smooth
15-3452	4½"	Straight	Serrated
15-3357	4½"	Curved	Smooth
15-3457	4½"	Curved	Serrated



**SKLARHONE™ METZENBAUM (LAHEY) SCISSORS**

15-3306	5¾"	Curved	Smooth
15-3406	5¾"	Curved	Serrated
15-3310	7"	Curved	Smooth
15-3410	7"	Curved	Serrated
15-3311	8"	Curved	Smooth
15-3315	9"	Curved	Smooth
15-3412	9"	Curved	Serrated

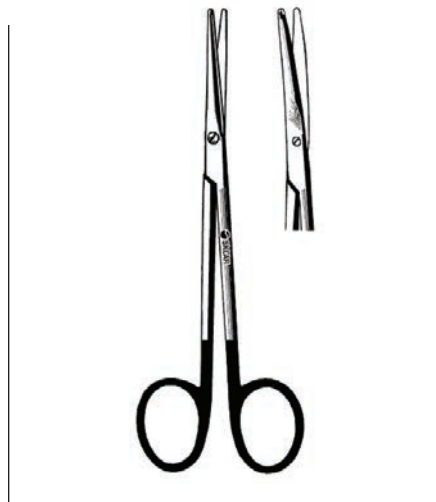

**SKLARHONE™ SKLARLITE™ METZENBAUM (LAHEY) SCISSORS**

15-9107	7"	Straight	
15-9117	7"	Curved	
15-9108	8"	Straight	
15-9118	8"	Curved	
15-9109	9"	Straight	
15-9119	9"	Curved	

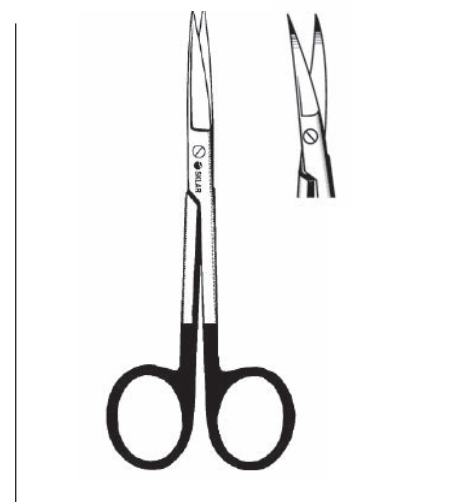

**SKLARHONE™ PLASTIC SURGERY SCISSORS**

15-3460	4¾"	Straight	
15-3461	4¾"	Curved	

SKLARLITE  
THE LIGHT TOUCH  
SKLARHONE™  
MICRO-CUT

**SKLARLITE**  
THE LIGHT TOUCH

**SKLARLITE™ OPERATING SCISSORS**

23-1100	4½"	Straight	Sharp/Sharp
23-1104	4½"	Straight	Sharp/Blunt
23-1101	5"	Straight	Sharp/Sharp
23-1105	5"	Straight	Sharp/Blunt
23-1102	5½"	Straight	Sharp/Sharp
23-1106	5½"	Straight	Sharp/Blunt



**SKLARLITE XD**  
EXTRA \* DELICATE

**SKLARLITE XD™ OPERATING SCISSORS**

23-1112	4½"	Straight	Sharp/Sharp
23-1116	4½"	Straight	Sharp/Blunt
23-1113	5"	Straight	Sharp/Sharp
23-1117	5"	Straight	Sharp/Blunt
23-1114	5½"	Straight	Sharp/Sharp
23-1118	5½"	Straight	Sharp/Blunt



**SKLARLITE**  
THE LIGHT TOUCH

**SKLARLITE™ OPERATING SCISSORS**

23-1124	4½"	Curved	Sharp/Sharp
23-1128	4½"	Curved	Sharp/Blunt
23-1126	5½"	Curved	Sharp/Sharp
23-1130	5½"	Curved	Sharp/Blunt

**SKLARLITE XD**  
EXTRA \* DELICATE

**SKLARLITE XD™ OPERATING SCISSORS**

23-1136	4½"	Curved	Sharp/Sharp
23-1140	4½"	Curved	Sharp/Blunt
23-1138	5½"	Curved	Sharp/Sharp
23-1142	5½"	Curved	Sharp/Blunt

**SKLARLITE**  
THE LIGHT TOUCH

**SKLARLITE™ MAYO DISSECTING SCISSORS**

23-1164	5½"	Straight
23-1166	5½"	Curved
23-1165	6¾"	Straight
23-1167	6¾"	Curved



**SKLARLITE XD**  
EXTRA \* DELICATE

**SKLARLITE XD™ MAYO DISSECTING SCISSORS**

23-1168	5½"	Straight
23-1170	5½"	Curved
23-1169	6¾"	Straight
23-1171	6¾"	Curved

**SKLARLITE**  
THE LIGHT TOUCH

**SKLARLITE™ METZENBAUM (LAHEY) SCISSORS**

23-1172	4½"	Straight
23-1174	4½"	Curved
23-1173	5¾"	Straight
23-1175	5¾"	Curved

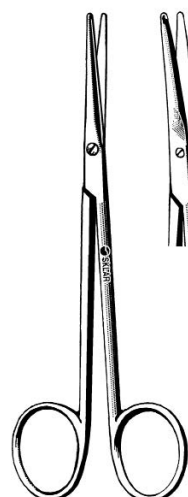

**SKLARLITE XD**  
EXTRA \* DELICATE

**SKLARLITE XD™ METZENBAUM (LAHEY) SCISSORS**

23-1176	4½"	Straight
23-1178	4½"	Curved
23-1177	5¾"	Straight
23-1179	5¾"	Curved

SKLARLITE  
THE LIGHT TOUCH

**SKLARLITE™ METZENBAUM  
SCISSORS**

23-1180	7"	Straight
23-1182	7"	Curved



SKLARLITE XD  
EXTRA \* DELICATE

**SKLARLITE XD™ METZENBAUM  
SCISSORS**

23-1184	7"	Straight
23-1186	7"	Curved

SKLARLITE  
THE LIGHT TOUCH

**SKLARLITE™ IRIS SCISSORS**

23-1148	3½"	Straight
23-1150	3½"	Curved
23-1149	4½"	Straight
23-1151	4½"	Curved



SKLARLITE XD  
EXTRA \* DELICATE

**SKLARLITE™ XD IRIS SCISSORS**

23-1152	3½"	Straight
23-1154	3½"	Curved
23-1153	4½"	Straight
23-1155	4½"	Curved

SKLARLITE  
THE LIGHT TOUCH

**SKLARLITE™ STEVENS  
SCISSORS**

23-1156	4½"	Straight	Blunt/Blunt
23-1157	4½"	Curved	Blunt/Blunt

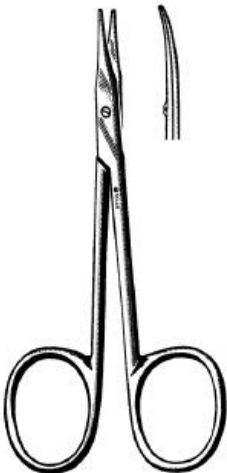

SKLARLITE XD  
EXTRA \* DELICATE

**SKLARLITE XD™ STEVENS  
SCISSORS**

23-1160	4½"	Straight	Blunt/Blunt
23-1161	4½"	Curved	Blunt/Blunt

SKLARLITE  
THE LIGHT TOUCH

**SKLARLITE™ STRABISMUS  
SCISSORS**

23-1158	4½"	Straight
23-1159	4½"	Curved

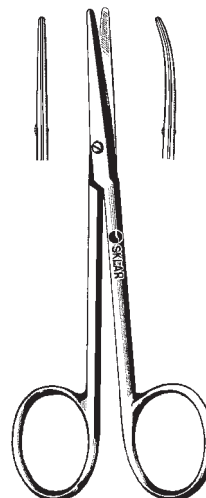

SKLARLITE XD  
EXTRA \* DELICATE

**SKLARLITE XD™ STRABISMUS  
SCISSORS**

23-1162	4½"	Straight
23-1163	4½"	Curved

**SKLARLITE**  
THE LIGHT TOUCH

**SKLARLITE™ SPENCER STITCH SCISSORS**

- 23-1188 3½"
- 23-1189 4½"
- 23-1190 5½" Littauer

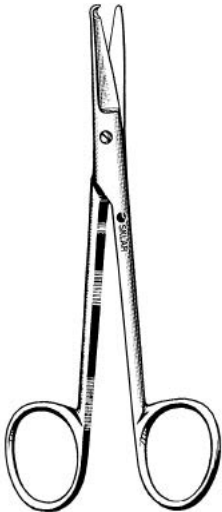

**SKLARLITE XD**  
EXTRA \* DELICATE

**SKLARLITE XD™ SPENCER STITCH SCISSORS**

- 23-1193 3½"
- 23-1194 4½"
- 23-1195 5½" Littauer

**SKLARLITE**  
THE LIGHT TOUCH

**SKLARLITE™ SHORTBENT SUTURE SCISSORS**

- 23-1191 3½"



**SKLARLITE XD**  
EXTRA \* DELICATE

**SKLARLITE XD™ SHORTBENT SUTURE SCISSORS**

- 23-1196 3½"

**SKLARLITE**  
THE LIGHT TOUCH

**SKLARLITE™ PRECISION SUTURE SCISSORS**

- 23-1290 3½" Straight
- 23-1292 3½" Curved
- 23-1294 4½" Straight
- 23-1296 4½" Curved



**SKLARLITE XD**  
EXTRA \* DELICATE

**SKLARLITE XD™ PRECISION SUTURE SCISSORS**

- 23-1300 3½" Straight
- 23-1302 3½" Curved
- 23-1304 4½" Straight
- 23-1306 4½" Curved

**SKLARLITE**  
THE LIGHT TOUCH

**SKLARLITE™ LISTER BANDAGE SCISSORS**

- 23-1199 5½"
- 23-1200 7¼"



**SKLARLITE XD**  
EXTRA \* DELICATE

**SKLARLITE XD™ LISTER BANDAGE SCISSORS**

- 23-1202 5½"
- 23-1203 7¼"



**OPERATING SCISSORS**

**STRAIGHT**

13-1045	4½"	Sharp/Sharp
14-1045	4½"	Sharp/Blunt
15-1045	4½"	Blunt/Blunt
13-1050	5"	Sharp/Sharp
14-1050	5"	Sharp/Blunt
15-1050	5"	Blunt/Blunt
13-1055	5½"	Sharp/Sharp
14-1055	5½"	Sharp/Blunt
15-1055	5½"	Blunt/Blunt
13-1060	6"	Sharp/Sharp
14-1060	6"	Sharp/Blunt
15-1060	6"	Blunt/Blunt
13-1065	6½"	Sharp/Sharp
14-1065	6½"	Sharp/Blunt
15-1065	6½"	Blunt/Blunt
13-1072	7¼"	Sharp/Sharp
14-1072	7¼"	Sharp/Blunt

**DELICATE**

22-1145	4½"	Sharp/Sharp
22-1245	4½"	Sharp/Blunt
22-1345	4½"	Blunt/Blunt
22-1150	5"	Sharp/Sharp
22-1250	5"	Sharp/Blunt
22-1350	5"	Blunt/Blunt
22-1155	5½"	Sharp/Sharp
22-1255	5½"	Sharp/Blunt
22-1355	5½"	Blunt/Blunt

**OPERATING SCISSORS**

**CURVED**

13-2045	4½"	Sharp/Sharp
14-2045	4½"	Sharp/Blunt
15-2045	4½"	Blunt/Blunt
13-2050	5"	Sharp/Sharp
14-2050	5"	Sharp/Blunt
15-2050	5"	Blunt/Blunt
13-2055	5½"	Sharp/Sharp
14-2055	5½"	Sharp/Blunt
15-2055	5½"	Blunt/Blunt
13-2060	6"	Sharp/Sharp
14-2060	6"	Sharp/Blunt
15-2060	6"	Blunt/Blunt
13-2065	6½"	Sharp/Sharp
14-2065	6½"	Sharp/Blunt
15-2065	6½"	Blunt/Blunt
13-2072	7¼"	Sharp/Sharp
14-2072	7¼"	Sharp/Blunt

**DELICATE**

22-1445	4½"	Sharp/Sharp
22-1545	4½"	Sharp/Blunt
22-1645	4½"	Blunt/Blunt
22-1450	5"	Sharp/Sharp
22-1550	5"	Sharp/Blunt
22-1650	5"	Blunt/Blunt
22-1455	5½"	Sharp/Sharp
22-1555	5½"	Sharp/Blunt
22-1655	5½"	Blunt/Blunt

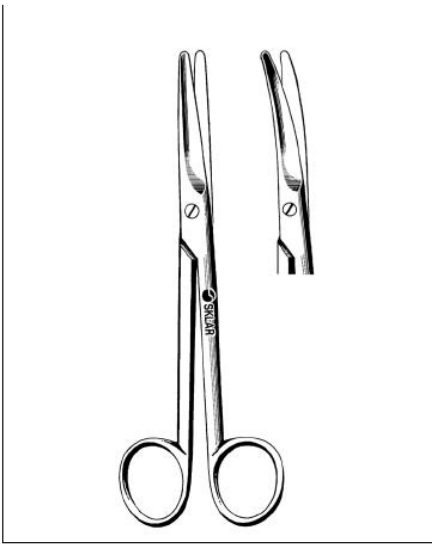

**MAYO DISSECTING SCISSORS**

**STRAIGHT**

15-1555	5½"	
15-1567	6¾"	
90-1590	9"	
55-8711	11"	Harrington

**CURVED**

15-2555	5½"	
15-2567	6¾"	
90-1690	9"	
55-8611	11"	Harrington

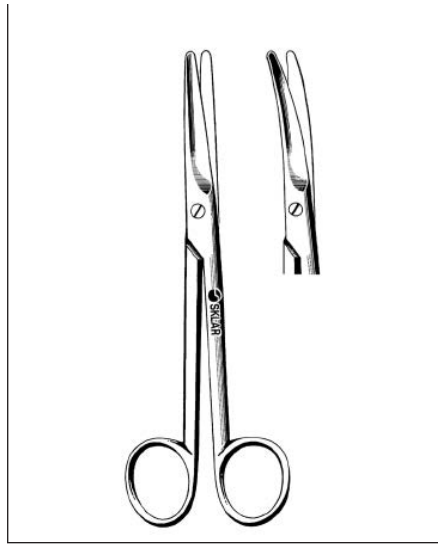

**MAYO DISSECTING SCISSORS**

**DELICATE**

22-1556	5½"	Straight
22-2555	5½"	Curved
22-1567	6¾"	Straight
22-2567	6¾"	Curved

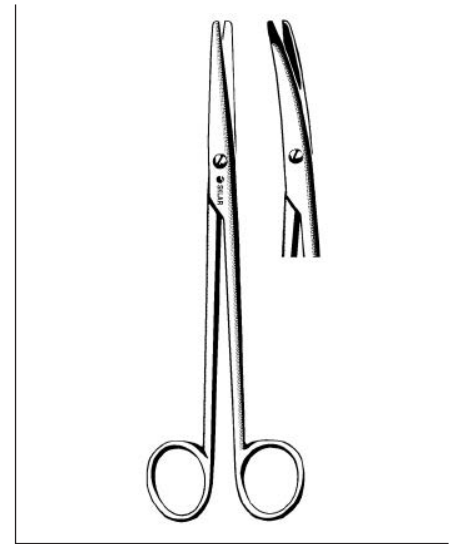

**MAYO-STILLE DISSECTING SCISSORS**

15-1655	5½"	Straight
15-2655	5½"	Curved
15-1667	6¾"	Straight
15-2667	6¾"	Curved

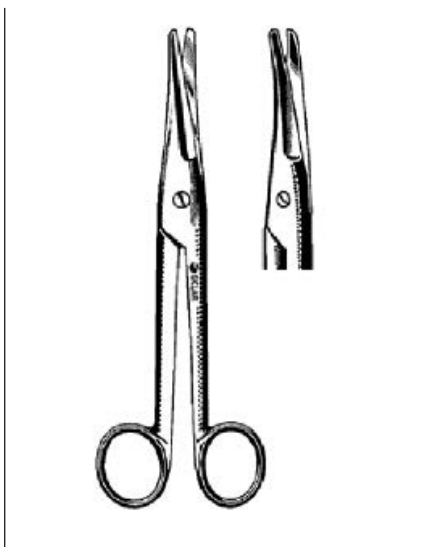

**MAYO NOBLE DISSECTING SCISSORS**

15-1762	6½"	Straight
15-2762	6½"	Curved



**MAYO-NOBLE STILLE DISSECTING SCISSORS**

15-1862	6"	Straight
15-2862	6"	Curved

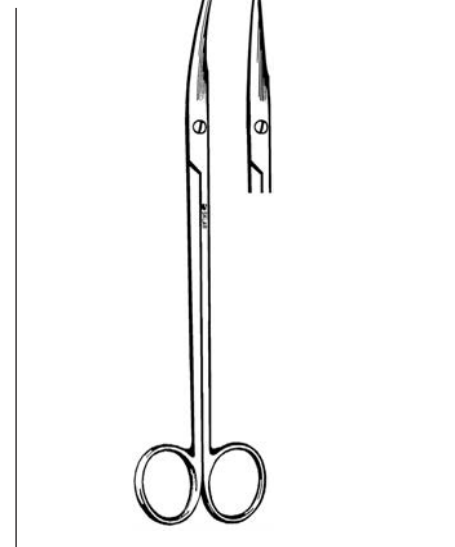

**ADA DISSECTING SCISSORS**

52-3170	7"	Curved
52-3080	8"	Straight





**METZENBAUM SCISSORS**

**STRAIGHT**

75-5570	7"	
55-9180	8"	Nelson
55-9190	9"	Nelson
55-9310	10"	Nelson
55-9311	11"	Nelson



**METZENBAUM SCISSORS**

**CURVED**

75-5670	7"	
55-9080	8"	Nelson
55-9090	9"	Nelson
55-9210	10"	Nelson
55-9411	11"	Nelson
55-9612	12"	Nelson
55-9614	14"	Nelson

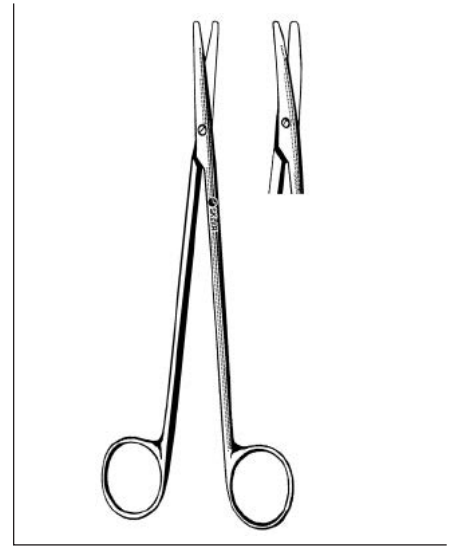

**METZENBAUM SCISSORS**

**DELICATE**

22-1071	7"	Straight	
22-1070	7"	Curved	
55-9184	8"	Straight	Nelson
55-9084	8"	Curved	Nelson
55-9194	9"	Straight	Nelson
55-9094	9"	Curved	Nelson

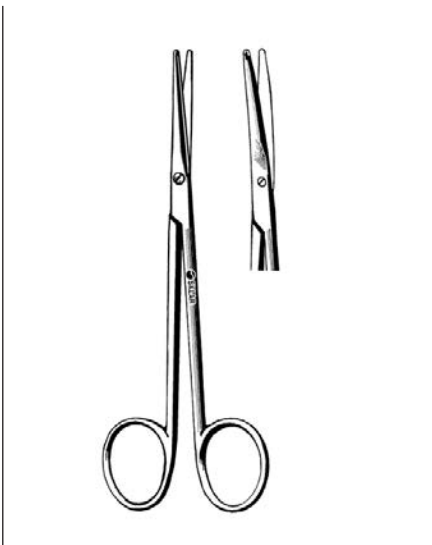

**METZENBAUM (LAHEY) SCISSORS**

22-2550	4½"	Straight
22-2545	4½"	Curved
75-5460	5¾"	Straight
47-1360	5¾"	Curved

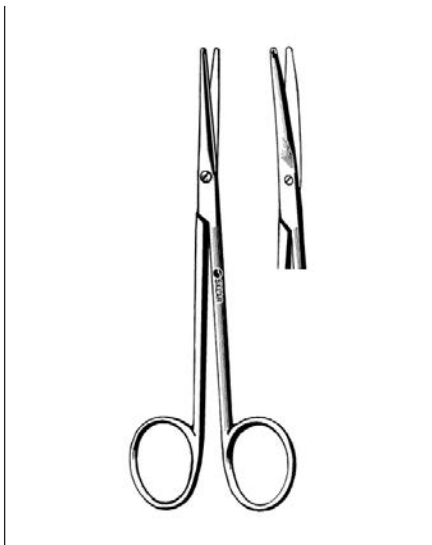

**METZENBAUM (LAHEY) SCISSORS**

<b>DELICATE</b>		
22-2450	4½"	Straight
22-2650	4½"	Curved
22-2460	5¾"	Straight
22-1057	5¾"	Curved

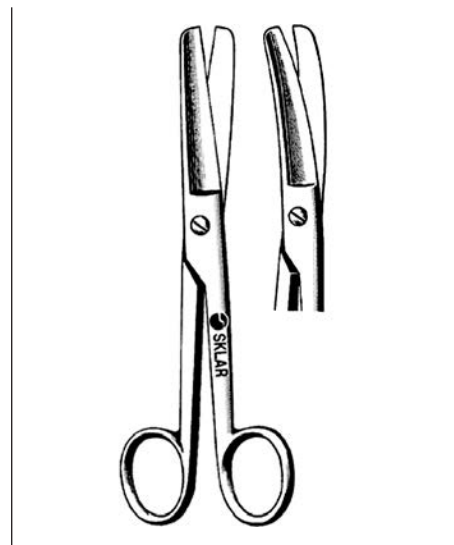

**DOYEN SCISSORS**

15-1307	7"	Straight Smooth
15-1308	7"	Straight Serrated
15-2307	7"	Curved Smooth
15-2308	7"	Curved Serrated



**KELLY-ADSON SCISSORS**

50-4562 6¼" Straight Smooth  
50-4563 6¼" Straight Serrated



**KELLY-ADSON SCISSOR**

50-4662 6¼" Curved Smooth

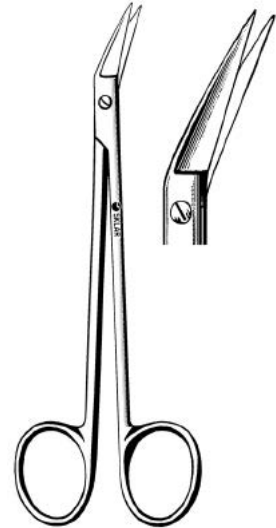

**KELLY-ADSON SCISSOR**

50-4462 6¼" Angled Smooth

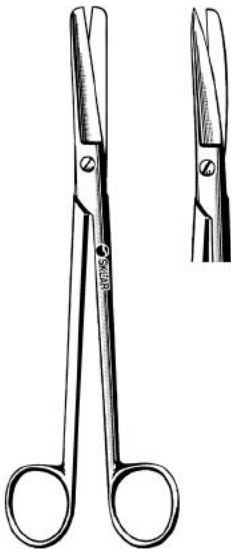

**SIMS SCISSORS**

90-1280 8" Straight Sharp/Sharp  
90-1180 8" Straight Sharp/Blunt  
90-1080 8" Straight Blunt/Blunt  
90-1580 8" Curved Sharp/Sharp  
90-1480 8" Curved Sharp/Blunt  
90-1380 8" Curved Blunt/Blunt



**PLASTIC SURGERY SCISSOR**

47-1345 4½" Curved Sharp/Sharp

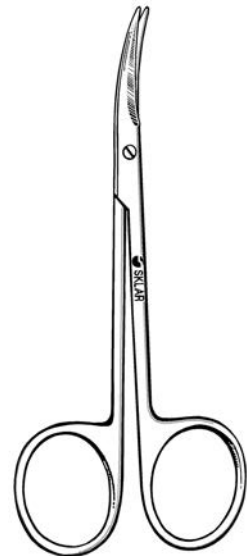

**DURA SCISSOR**

22-2742 4¼" Curved Semi-Sharp



**IRIS SCISSORS**

**STRAIGHT**

- 47-1135 3½" Sharp/Sharp
- 47-1140 3½" Blunt/Blunt
- 47-1441 4" Sharp/Sharp Heavy
- 47-1145 4½" Sharp/Sharp
- 47-1144 4½" Blunt/Blunt

**CURVED**

- 47-1235 3½" Sharp/Sharp
- 47-1240 3½" Blunt/Blunt
- 47-1442 4" Sharp/Sharp Heavy
- 47-1245 4½" Sharp/Sharp
- 47-1244 4½" Blunt/Blunt

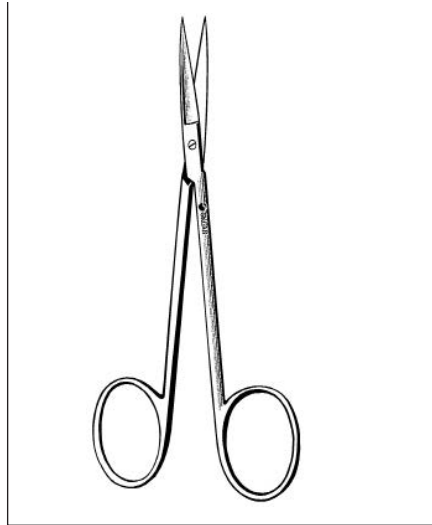

**IRIS SCISSORS**

**DELICATE**

- 22-1135 3½" Straight
- 22-1235 3½" Curved
- 47-1440 4" Straight
- 47-1246 4½" Straight
- 47-1248 4½" Curved



**IRIS SCISSORS**

- 64-2042 4¼" Angled Probe Point
- 64-2142 4½" Angled Sharp/Sharp

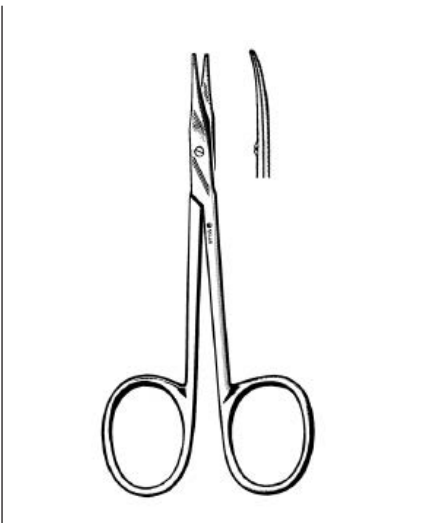

**STEVENS TENOTOMY SCISSORS**

- 64-1242 4½" Straight Blunt/Blunt
- 64-1343 4½" Curved Sharp/Sharp
- 64-1342 4½" Curved Blunt/Blunt

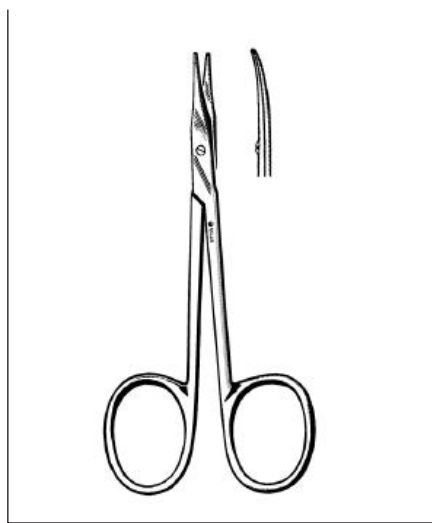

**STEVENS TENOTOMY SCISSORS**

- DELICATE**
- 22-1240 4½" Straight Sharp/Sharp
  - 22-1241 4½" Curved Sharp/Sharp
  - 22-1242 4½" Straight Blunt/Blunt
  - 22-1342 4½" Curved Blunt/Blunt

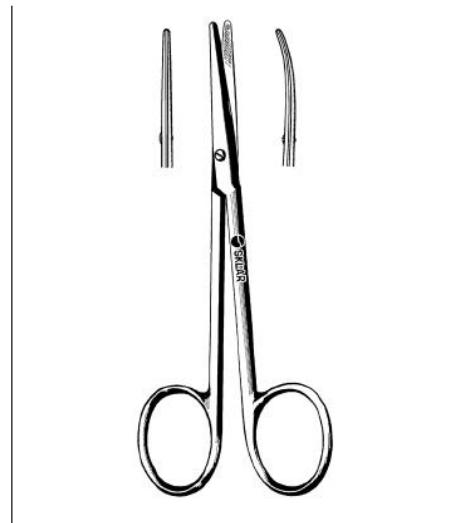

**STRABISMUS SCISSORS**

- 64-1442 4½" Straight
  - 64-1542 4½" Curved
- DELICATE**
- 22-1442 4½" Straight
  - 22-1542 4½" Curved



**RIBBON IRIS SCISSORS**

47-1250 4" Straight  
47-1255 4" Curved

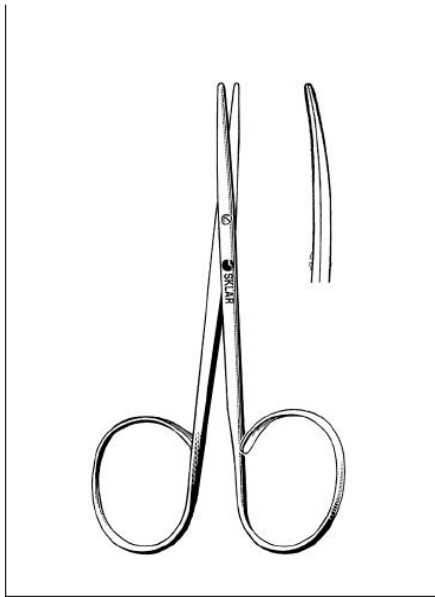

**RIBBON STRABISMUS SCISSORS**

64-1240 4" Straight  
64-1340 4" Curved



**RIBBON STEVENS TENOTOMY SCISSORS**

64-1241 4" Straight  
64-1341 4" Curved

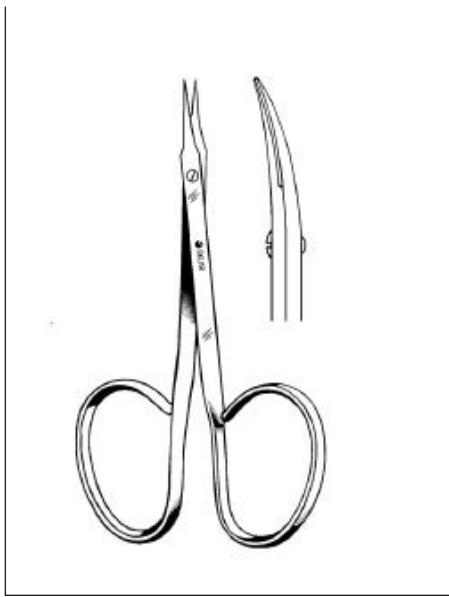

**RIBBON STITCH SCISSORS**

64-1345 4" Straight  
64-1445 4" Curved

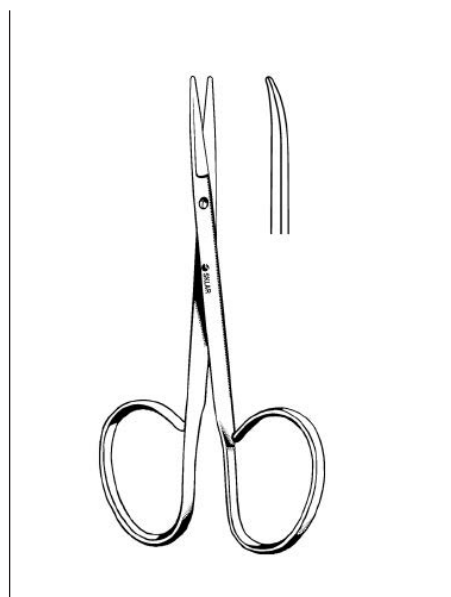

**UTILITY RIBBON SCISSORS**

47-1146 4" Straight Blunt/Blunt  
47-1247 4" Curved Blunt/Blunt



**SPENCER STITCH SCISSORS**

22-2835 3½" Spencer  
22-2834 3½" Spencer Delicate  
22-2845 4½" Spencer  
22-2844 4½" Spencer Delicate  
15-1355 5½" Littauer  
22-1354 5½" Littauer Delicate



**SUTURE SCISSOR**

24-2347 4¾" Straight Serrated Heavy

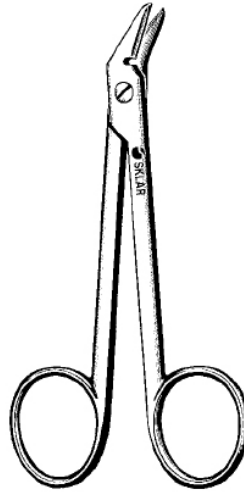

**SUTURE WIRE CUTTING SCISSO**

24-2342 4¾" Angled Serrated



**SUTURE WIRE SCISSOR**

24-1965 4½" Delicate

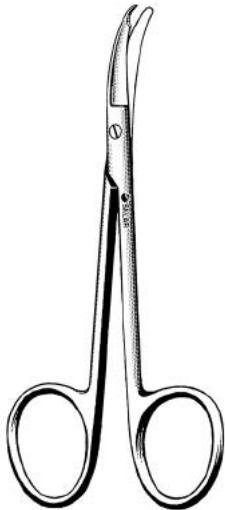

**SUTURE SCISSORS**

22-2935 3½" Shortbent  
22-2934 3½" Shortbent Delicate  
22-2947 4¾" Northbent



**SKLAR STITCH SCISSORS**

15-3150 4½" Angled  
22-2950 5" Curved Sideways

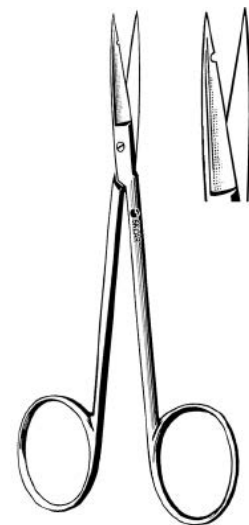

**SKLAR PRECISION SUTURE SCISSORS**

22-2820 3½" Straight  
22-2822 3½" Curved  
22-2824 4½" Straight  
22-2825 4½" Curved



**LISTER BANDAGE SCISSORS**

- 11-1035 3½"
- 11-1045 4½"
- 11-1055 5½"
- 11-1072 7¼"
- 11-1080 8"
- 11-1060 8" Large Ring



**LISTER BANDAGE SCISSORS**

- DELICATE**
- 22-1054 5½"
  - 22-1072 7¼"

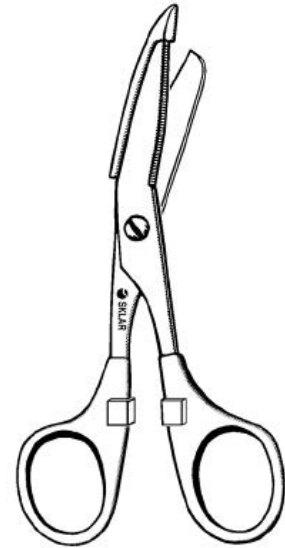

**NURSES BANDAGE SCISSORS**

- 11-1495 5½" Pink
- 11-1496 5½" Blue

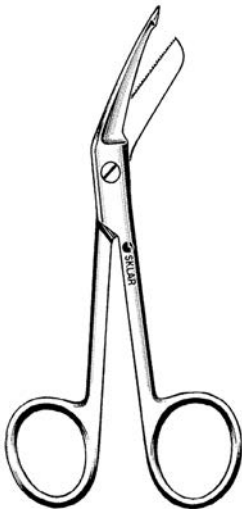

**BANTAM BANDAGE SCISSOR**

- 11-1257 5¼" Serrated

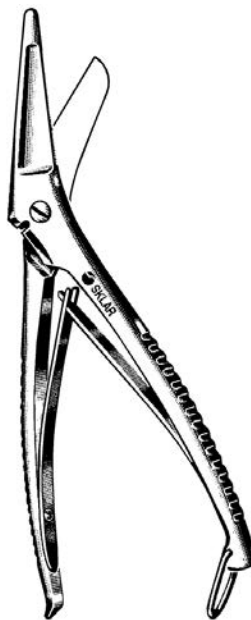

**COMMANDER UTILITY SHEAR**

- 11-1298 8½" Serrated

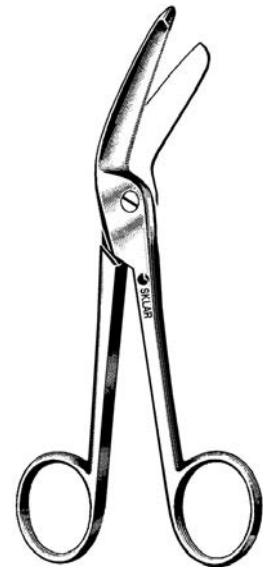

**HERCULES UTILITY SCISSOR**

- 11-1297 7½" Serrated



**ESMARCH HEAVY PLASTER SHEARS**

11-1380 8"  
11-1390 9"

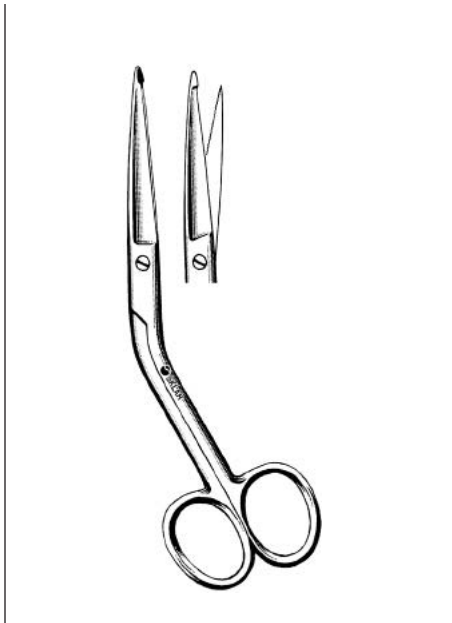

**SKLAR HIGH LEVEL BANDAGE SCISSOR**

11-1252 5½" Serrated

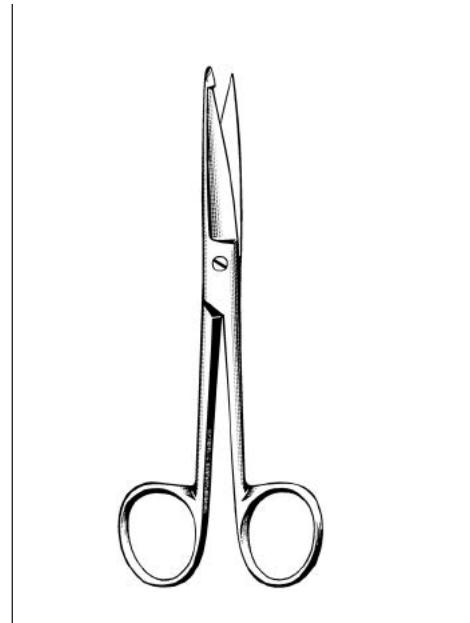

**KNOWLES BANDAGE SCISSOR**

11-1255 5½"



**MOLESKIN SCISSORS**

97-1350 7½" Straight Serrated  
97-1351 7½" Curved Serrated

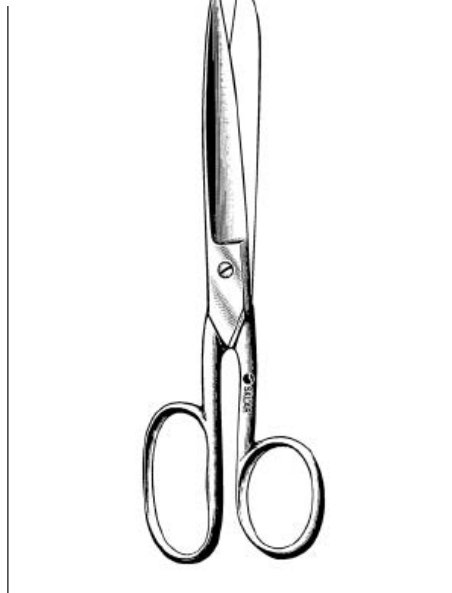

**USA GAUZE SCISSOR**

11-1180 8"

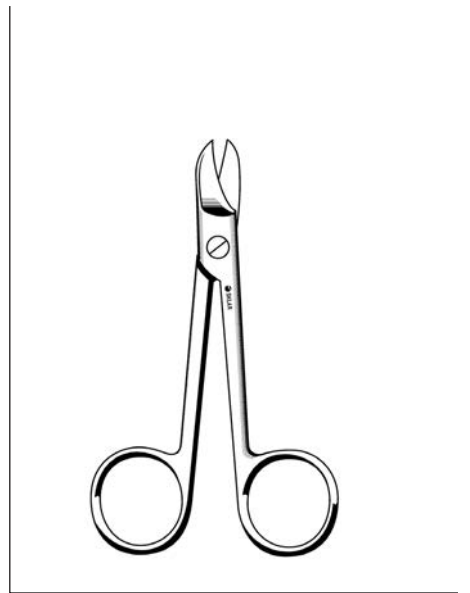

**CROWN SCISSORS**

24-2345 4" Straight Smooth  
24-2340 4" Straight Serrated  
24-2346 4" Curved Smooth  
24-2341 4" Curved Serrated

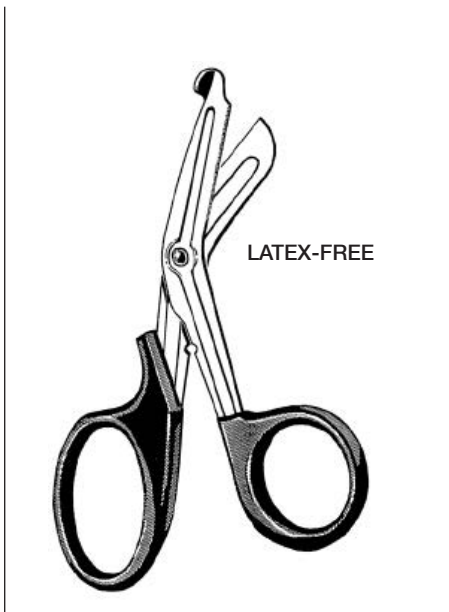

**UTILITY SCISSORS**

**SERRATED**

11-1278	6"	Blue
11-1280	7½"	Blue
11-1281	7½"	Black
11-1282	7½"	Green
11-1283	7½"	Red
11-1284	7½"	White
11-1285	7½"	Purple
11-1286	7½"	Orange
11-1287	7½"	Yellow



**BRAUN EPISIOTOMY SCISSORS**

**ANGLED**

90-1755	5½"
90-1785	8½"

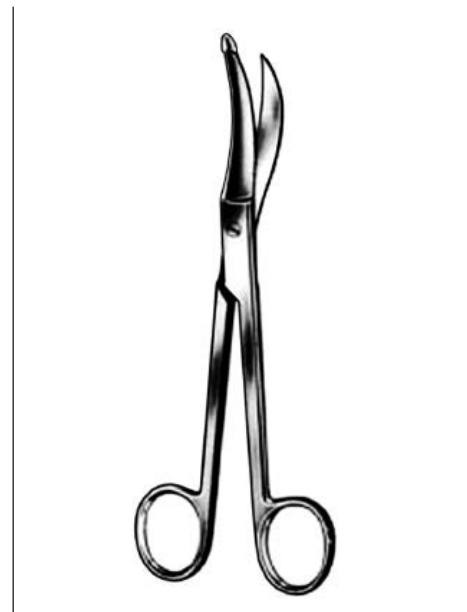

**WALDMANN EPISIOT SCISSOR**

**SERRATED**

90-1770	7"
---------	----

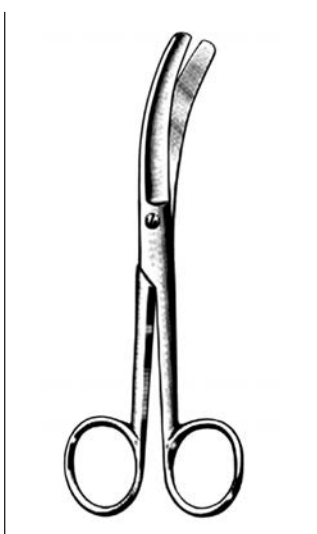

**BUSCH UMBILICAL SCISSOR**

92-5565	6½"
---------	-----

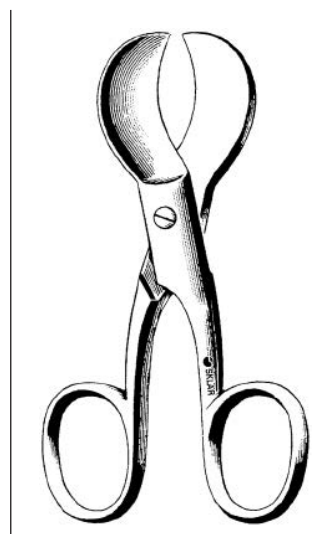

**UMBILICAL SCISSOR**

92-5540	4"
---------	----

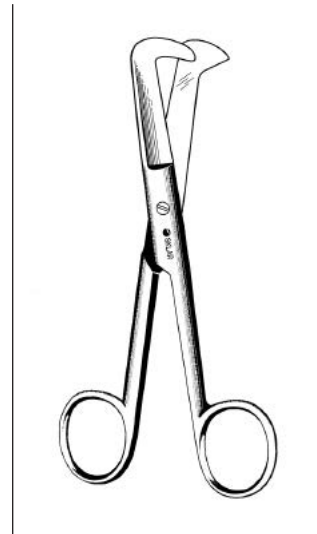

**SCHUMACHER UMBILICAL SCISSOR**

92-5560	6¼"
---------	-----

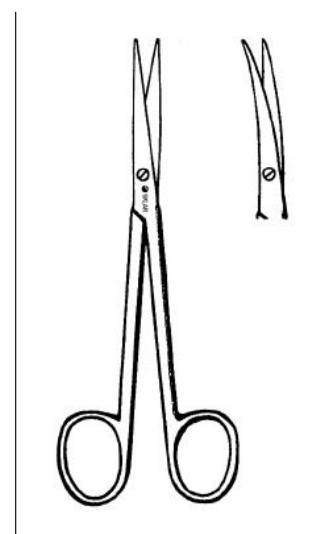

**BROPHY SULLIVAN SCISSORS**

**SERRATED**

22-2855	5¾"	Straight
22-2755	5¾"	Curved





**TC OPERATING SCISSORS**

95-110	5½"	Straight	Sharp/Blunt
95-111	5½"	Curved	Sharp/Blunt



**TC IRIS SCISSORS**

95-124	4½"	Straight	
95-125	4½"	Curved	



**TC MAYO DISSECTING SCISSORS**

95-112	6¾"	Straight	
95-113	6¾"	Curved	



**TC MAYO METZENBAUM SCISSORS**

95-119	5¾"	Straight	Standard
95-122	5¾"	Curved	Standard
95-115	7"	Straight	Standard
95-117	7"	Curved	Standard
95-118	5¾"	Straight	Delicate
95-120	5¾"	Curved	Delicate
95-114	7"	Straight	Delicate
95-116	7"	Curved	Delicate

**OPERATING SCISSORS**
**STRAIGHT**

95-265	4½"	Sharp/Blunt
95-266	4½"	Sharp/Sharp
95-290	5"	Sharp/Sharp
95-278	5½"	Blunt/Blunt
95-272	5½"	Sharp/Blunt
95-275	5½"	Sharp/Sharp
95-281	6½"	Sharp/Blunt
95-284	6½"	Sharp/Sharp

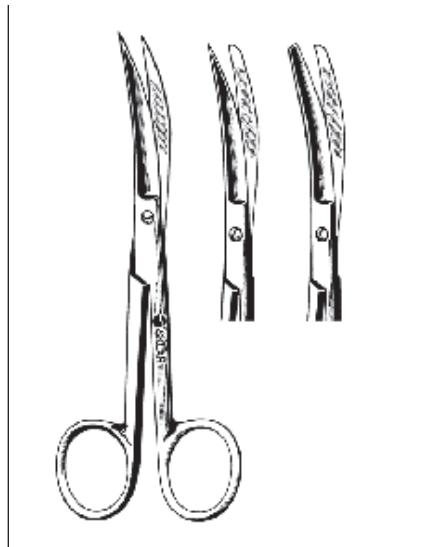
**OPERATING SCISSORS**
**CURVED**

95-294	4½"	Sharp/Sharp
95-292	5½"	Sharp/Blunt
95-295	5½"	Sharp/Sharp
95-299	5½"	Blunt/Blunt

**IRIS SCISSORS**

95-103	3½"	Straight
95-107	3½"	Curved
95-104	4½"	Straight
95-109	4½"	Curved

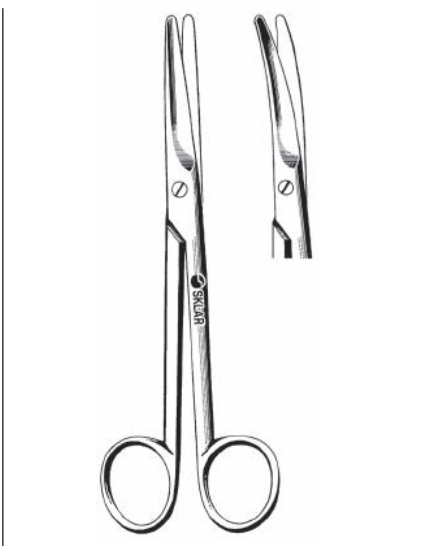
**MAYO DISSECTING SCISSORS**

95-308	5½"	Straight	
95-330	5½"	Curved	
95-321	6¾"	Straight	
95-325	6¾"	Curved	
95-329	6¾"	Straight	Serrated
95-332	6¾"	Curved	Serrated
95-327	9"	Straight	
95-328	9"	Curved	

**METZENBAUM DISSECTING SCISSORS**

95-335	5¾"	Straight	Lahey
95-336	5¾"	Curved	Lahey
95-339	7"	Straight	
95-340	7"	Curved	

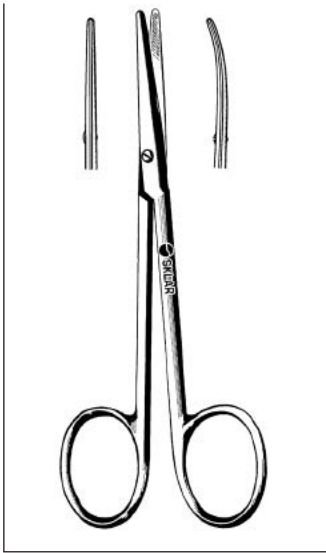

**STEVENS TENOTOMY SCISSORS**

95-160	4½"	Straight	Blunt/Blunt
95-161	4½"	Curved	Blunt/Blunt

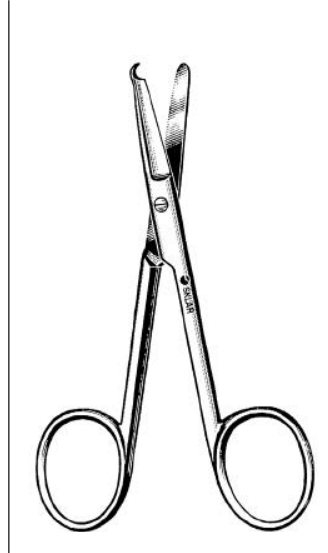

**STRABISMUS SCISSORS**

95-360 4½" Straight  
95-361 4½" Curved



**SPENCER STITCH SCISSORS**

95-346 3½"  
95-352 4½"



**LITTAUER STITCH SCISSOR**

95-358 5½"

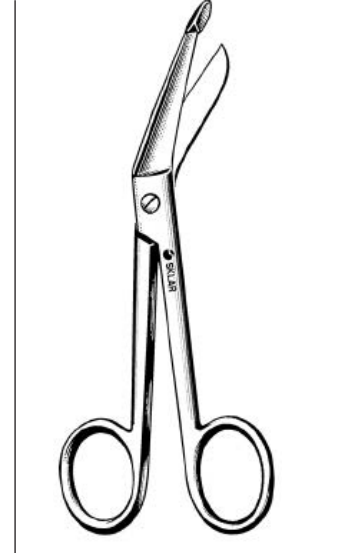

**LISTER BANDAGE SCISSORS**

95-222 3½"  
95-226 4½"  
95-231 5½"  
95-241 7¼"  
95-243 8"  
95-245 8" Large Ring



**LISTER BANDAGE SCISSORS**

WITH POCKET CLIP

95-232 5½"  
95-232B 5½" Blue Ring Handle  
95-232P 5½" Pink Ring Handle

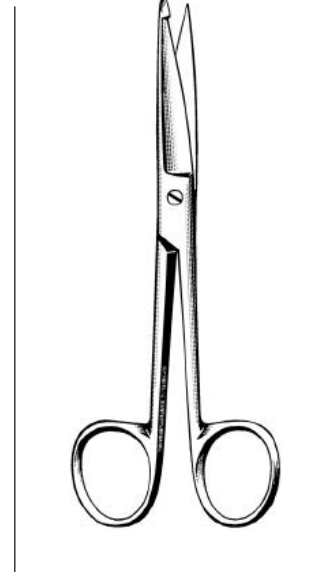

**KNOWLES BANDAGE SCISSOR**

95-254 5½"

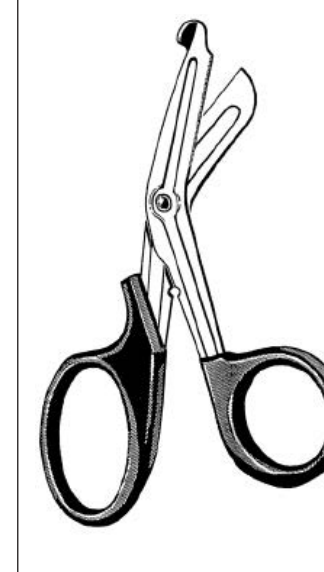

**MULTI-CUT UTILITY SHEARS**

SERRATED

95-100 6" Black Handle  
95-105 7½" Black Handle

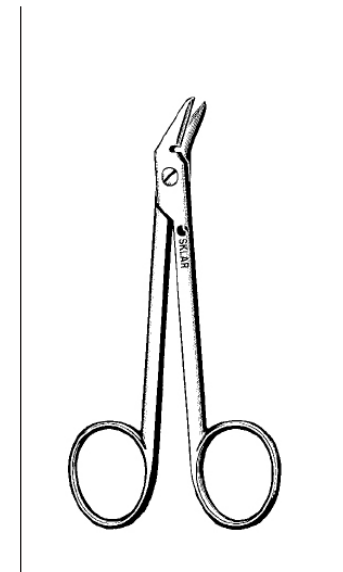

**WIRE CUTTING SCISSOR**

SERRATED

95-364 4¾" Angled



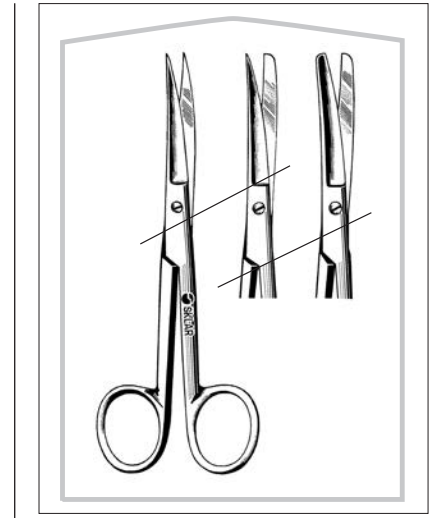

**OPERATING SCISSORS**

**STRAIGHT**

- 96-2597 4½" Sharp/Blunt 25/cs
- 96-2592 4½" Sharp/Sharp 25/cs
- 96-2521 5½" Sharp/Blunt 25/cs
- 96-2523 5½" Sharp/Sharp 25/cs
- 96-2728 4½" Sharp/Blunt 50/cs
- 96-2593 4½" Sharp/Sharp 50/cs

- 96-2514 5½" Blunt/Blunt 50/cs
- 96-2520 5½" Sharp/Blunt 50/cs
- 96-2522 5½" Sharp/Sharp 50/cs
- 96-2726 6½" Sharp/Blunt 50/cs
- 96-2649 5½" Sharp/Blunt 100/cs

**OPERATING SCISSORS**

**CURVED**

- 96-2526 5½" Sharp/Blunt 25/cs
- 96-2527 5½" Sharp/Sharp 25/cs
- 96-2524 5½" Sharp/Blunt 50/cs
- 96-2525 5½" Sharp/Sharp 50/cs

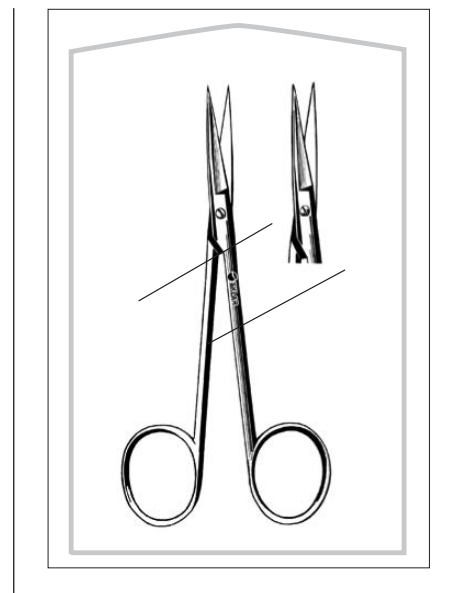
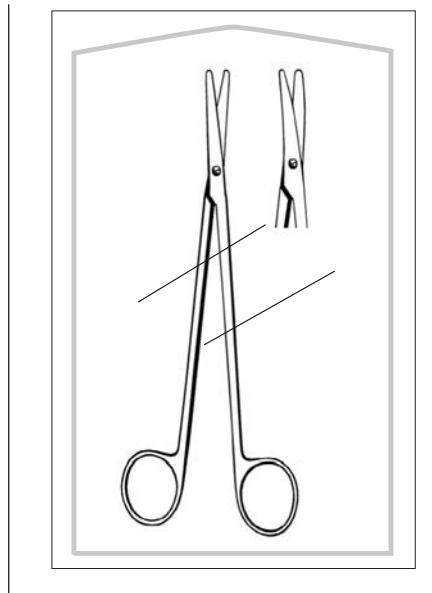
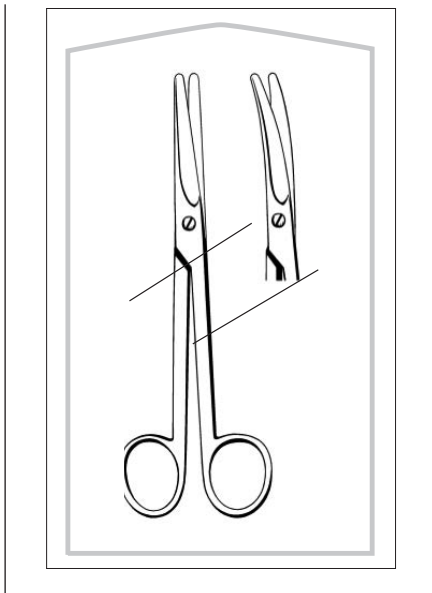

**MAYO SCISSORS**

- 96-2531 5½" Straight 25/cs
- 96-2530 5½" Straight 50/cs

**METZENBAUM SCISSORS**

- 96-2517 5½" Straight 25/cs
- 96-2720 5½" Curved 25/cs
- 96-2682 7" Curved 25/cs
- 96-2516 5½" Straight 50/cs
- 96-2721 5½" Curved 50/cs
- 96-2680 7" Curved 50/cs

**IRIS SCISSORS**

- 96-2505 4½" Straight 25/cs
- 96-2507 4½" Curved 25/cs
- 96-2497 3½" Straight 50/cs
- 96-2499 3½" Curved 50/cs
- 96-2504 4½" Straight 50/cs
- 96-2506 4½" Curved 50/cs
- 96-2650 4½" Straight 100/cs
- 96-2651 4½" Curved 100/cs

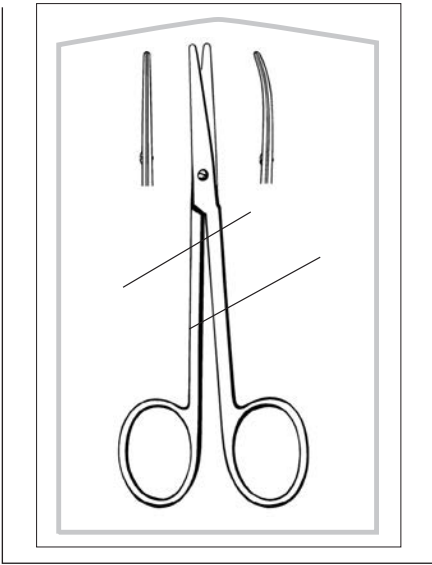

**STRABISMUS SCISSORS**

- 96-2542 4½" Straight 25/cs
- 96-2543 4½" Curved 25/cs
- 96-2540 4½" Straight 50/cs
- 96-2541 4½" Curved 50/cs

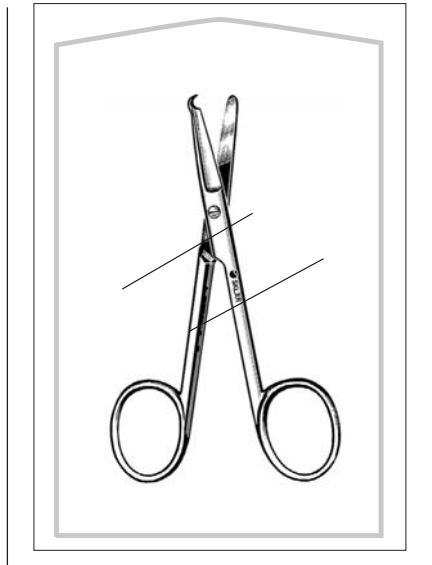

**SPENCER STITCH SCISSORS**

- 96-2598 4½" 25/cs
- 96-2672 3½" 50/cs
- 96-2596 4½" 50/cs

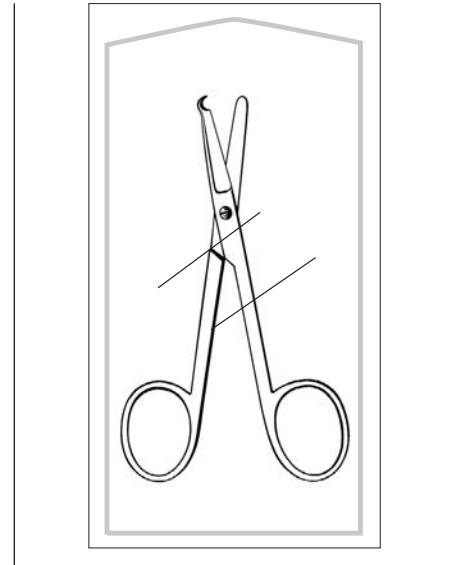

**LITTAUER STITCH SCISSORS**

- 96-2511 3½" 25/cs
- 96-2513 5½" 25/cs
- 96-2510 3½" 50/cs
- 96-2512 5½" 50/cs
- 96-2663 3½" 100/cs
- 96-2662 5½" 100/cs

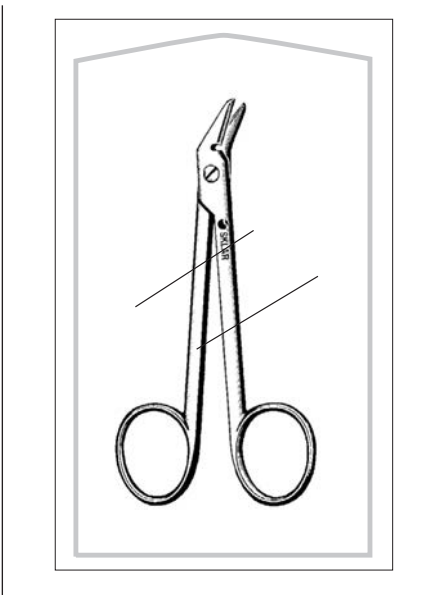

**WIRE CUTTING SCISSORS**

- 96-2519 4¾" Angled 25/cs
- 96-2518 4¾" Angled 50/cs

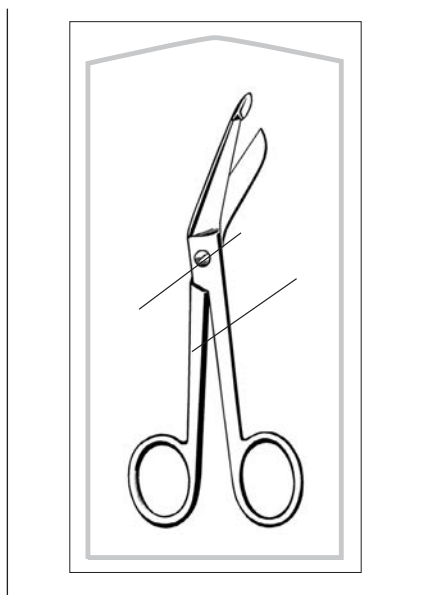

**LISTER BANDAGE SCISSORS**

- 96-2503 5½" 25/cs
- 96-2501 4½" 50/cs
- 96-2502 5½" 50/cs
- 96-2654 5½" 100/cs

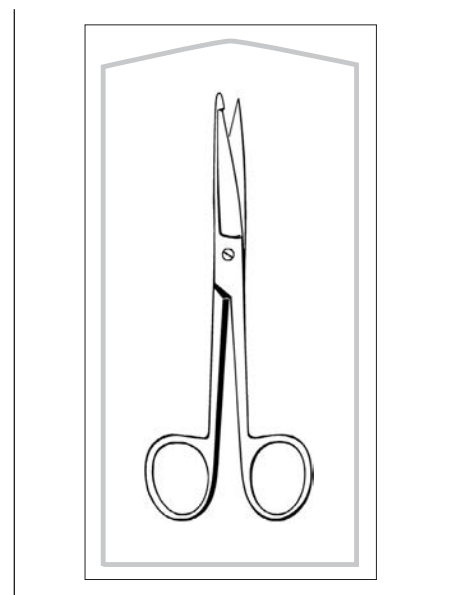

**KNOWLES BANDAGE SCISSORS**

- 96-2404 5½" 25/cs
- 96-2402 5½" 50/cs



**UTILITY SCISSORS**

96-2701	5½"	Black	25/cs	96-1223	7"	Burgundy	25/cs	96-1228	7"	Lime Green	25/cs
96-2703	7"	Black	25/cs	96-1224	7"	Magenta	25/cs	96-1229	7"	Hunter Green	25/cs
96-1220	7"	Yellow	25/cs	96-1225	7"	Navy Blue	25/cs	96-2702	5½"	Black	50/cs
96-1221	7"	Orange	25/cs	96-1226	7"	Royal	25/cs	96-2704	7"	Black	50/cs
96-1222	7"	Purple	25/cs	96-1227	7"	Teal Blue	25/cs				

# STETHOSCOPES

**SKLAR OFFERS A COMPLETE LINE OF HIGH QUALITY STETHOSCOPES**

For a complete listing of Sklar's extensive Stethoscope product line, contact your Sklar Account Manager or Distributor Sales Representative.



# forceps

## Sklar Blue™ Electrosurgical Forceps..... Page 79

Designed to provide an effective, non-conductive, patient-safe surface, Sklar's line of electrosurgical forceps feature our exclusive Sklar Blue™ insulated coating that prevents transmission of RF current through the instrument. Manufactured of the highest quality stainless steel, these instruments are fully autoclavable. All Sklar Blue™ electrosurgical coatings are guaranteed for one year against manufacturing defects.

## Sklar Black™ Laser Forceps..... Page 81

Sklar Black™ Laser Forceps use an improved black polymer coating developed specifically for Laser surgery. Testing demonstrates that the Sklar Black™ coating over a sandblasted surface reduced reflective laser energy to less than one-tenth of one percent. The durable coating improves patient safety and provides a reliable instrument you can use with confidence for years of service. All Sklar Laser coatings are guaranteed for one year against manufacturing defects.

## Tungsten Carbide Forceps..... Page 85

Sklar TC™ Forceps utilize solid tungsten carbide insert jaws for long-lasting, positive holding power beyond that of any standard instrument. Sklar TC™ Forceps use this special non-slip tissue gripping profile to enable the user to apply exact pressure for proper tissue handling and suture tying, with exceptional control that reduces trauma. These precisely ground forceps are readily identified by the gold handles.

## Premium Forceps..... Page 86

### Sklarlite™

Premium Forceps have been reduced in their overall pattern weight while maintaining the strength and durability of a standard pattern. The result is a noticeably lighter, extremely sensitive instrument that can withstand the daily rigors of surgery.

### Sklarlite XD™

Extra Delicate Forceps mill scant microns off the delicate pattern to produce one of the lightest general surgery forceps on the market today, without compromising instrument integrity and reliability. Sklarlite™ and Sklarlite XD™ are covered under the same warranty that guarantees all Sklar instruments for a lifetime of dependable use.

### Sklar LiteGrip™

Forceps offer fenestrated handles to allow for a firm secure grip in a lighter pattern.

## General Surgery Instruments..... Page 89

Our very best operating room, high quality instruments incorporating optimum grades of German grade surgical steel, finely detailed craftsmanship and exacting standards of manufacturing. Choose from a full line of the most popular patterns.

## Surgi-OR™ Instruments..... Page 100

Hand-crafted and forged from Japanese surgical grade stainless steel, Surgi-OR™ instruments are built to last. Precision engineering and stringent quality control guidelines ensure superior performance. Available in the most popular patterns, this cost-effective solution doesn't sacrifice quality for value and convenience in the Operating Room and other important surgical settings.

## Econo™ Sterile Instruments..... Page 104

Econo™ Sterile instruments are suitable in a number of surgical venues where economical performance is most important. Convenient, ready-to-use sterile instruments provide the very best value with the greatest utility of any surgical instrument.



**BOZEMAN FORCEP**  
**ONE LARGE RING**  
 91-5310 10¼" S-Curve



**BOZEMAN FORCEPS**  
 91-5307 10½" Straight  
 91-5308 10¼" S-Curve



**SCHWEIZER FORCEP**  
 91-5404 9½" Straight



**CLEMETSON FORCEPS**  
**NON-RATCHETED**  
 91-5400 9½" Straight



**LAUFE UTERINE POLYP FORCEP**  
 91-5408 7¾" Curved



**SCHROEDER TENACULUM FORCEPS**  
 91-5452 10" Pozzi (Round Tips)  
 91-5455 10" Braun (Flat Tips)



**BABCOCK FORCEPS**  
 91-5268 8"  
 91-5270 9½"



**ALLIS TISSUE FORCEPS**  
 91-5278 7½" 5x6 Teeth  
 91-5440 9½" 5x6 Teeth



Autoclavable



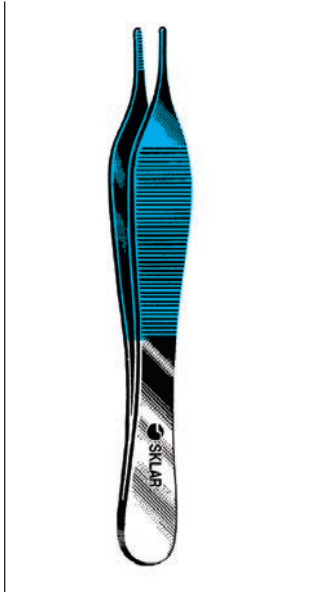

**ADSON FORCEP**

SERRATED

91-5428 4 3/4"

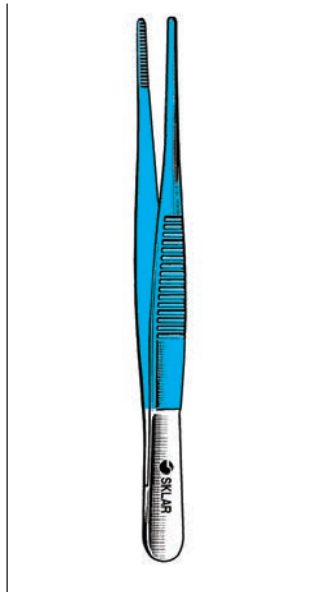

**DRESSING FORCEPS**

SERRATED

91-5420 8"  
91-5422 10"  
91-5424 12"

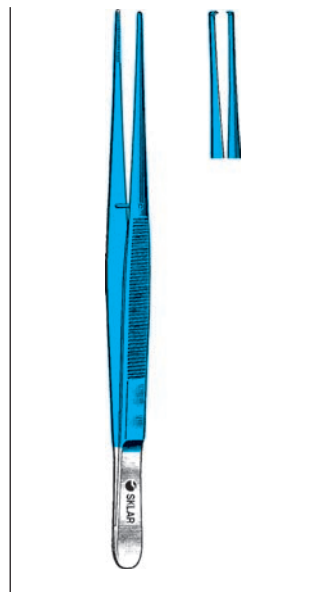

**POTTS-SMITH FORCEPS**

91-5411 7" Serrated  
91-5412 10" Serrated  
91-5413 8 1/4" 1x2 Teeth  
91-5414 10" 1x2 Teeth

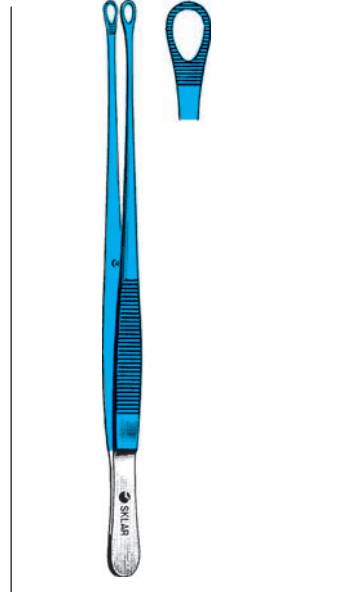

**TUTTLE/SINGLEY FORCEPS**

91-5300 7" Tuttle  
91-5302 9" Singley

# SKLAR FACE MASKS

The Sklar Disposable Face Mask is offered in the most popular style to meet clinical requirements in the operating room, general medicine, or any other areas requiring facial protection. Protecting against infectious pathogens, Sklar masks are ≥98% BFE, non-woven, soft and breathable. Convenient ear loops and adjustable nose-bridge ensures a proper fit. Latex Free.

**NON-STERILE**

PRODUCT NUMBER	FEATURES	QUANTITIES
96-5557	Mask Earloop, Blue	50/bx
96-5557A	Mask Earloop, Blue	500/cs
96-5557BNS	Mask Earloop, Blue Bulk	2000/cs



Autoclavable



**BOZEMAN FORCEPS**  
**ONE LARGE RING**  
 90-2342 10¼" S-Curve



**BOZEMAN FORCEPS**  
 90-2340 10¼" S-Curve



**CAMPION GRASPING FORCEPS**  
 90-2298 9¼" Curved



**DELEE UTERINE FORCEP**  
 90-7111 11" Heavy



**SCHWEIZER FORCEPS**  
 90-2350 9½"



**CLEMETSON FORCEPS**  
**NOT RATCHETED**  
 90-2348 9½" Straight



**LAUFE UTERINE POLYP FORCEPS**  
 90-2345 7¾" Curved



Autoclavable

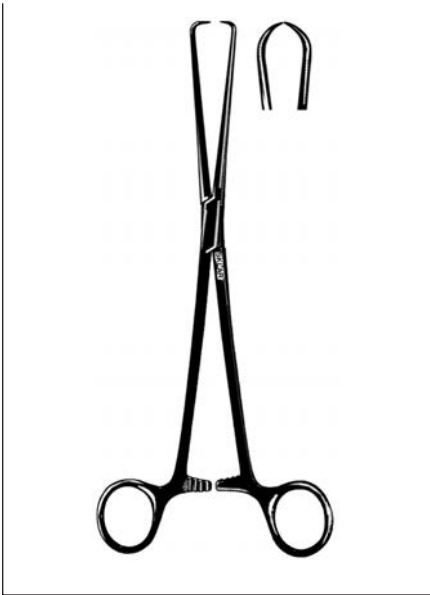

**SCHROEDER TENACULUM FORCEPS**

90-2325	10"	Braun (Flat Tips)
90-2326	10"	Pozzi (Round Tips)

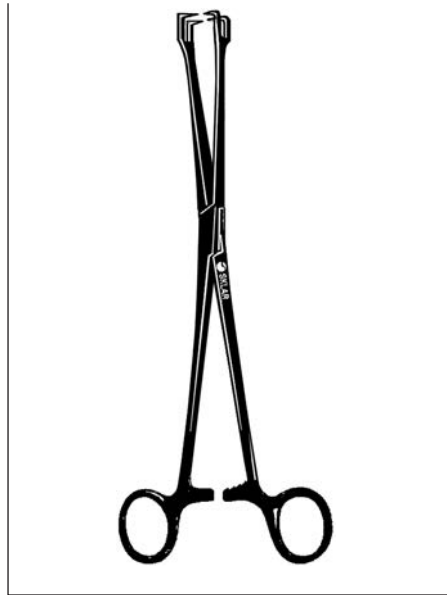

**SCHROEDER VULSELLUM FORCEPS**

90-1790	9½"	Straight
90-1890	9½"	Curved



**BABCOCK FORCEPS**

90-2278	8"
90-2295	9½"

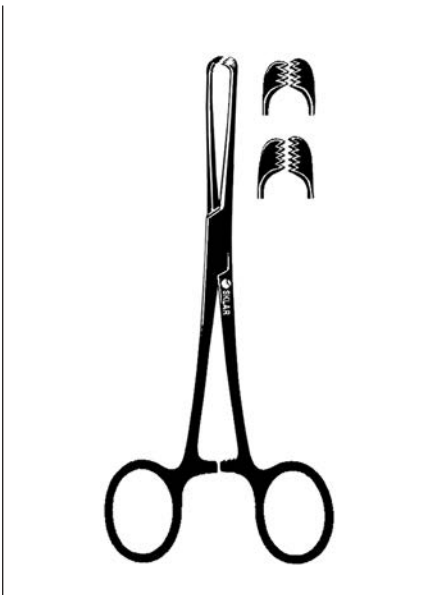

**ALLIS TISSUE FORCEPS**

90-2276	7½"	5x6 Teeth
90-2279	9½"	5x6 Teeth



**ROCHESTER-PEAN FORCEP**

90-2292	7¼"	Curved
---------	-----	--------

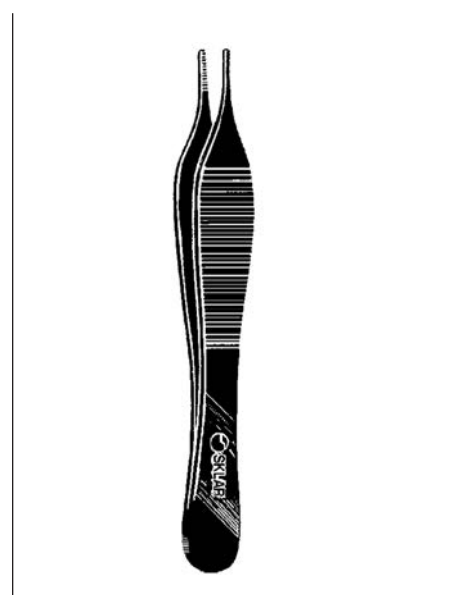

**ADSON FORCEP**

90-2261	4¾"	Serrated
---------	-----	----------

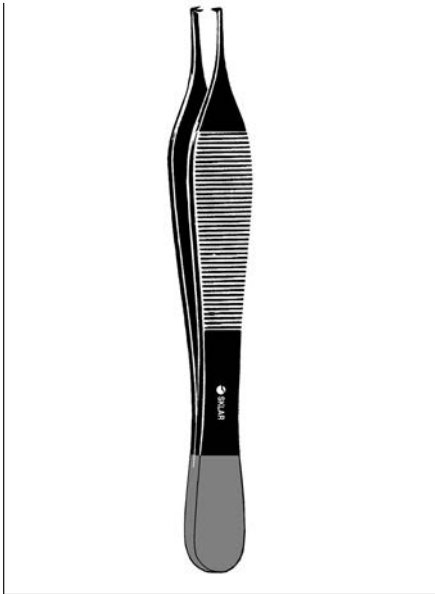

Autoclavable

**ADSON TISSUE FORCEPS**

90-2262	4¾"	1x2 Teeth
90-1060	4¾"	1x2 Teeth
90-1061	4¾"	2x3 Teeth

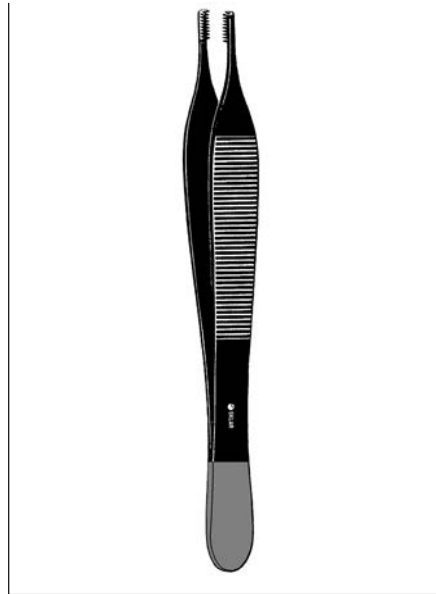
**ADSON-BROWN TISSUE FORCEP**

90-1062	4¾"	Side Grasping	7x7 Teeth
---------	-----	---------------	-----------

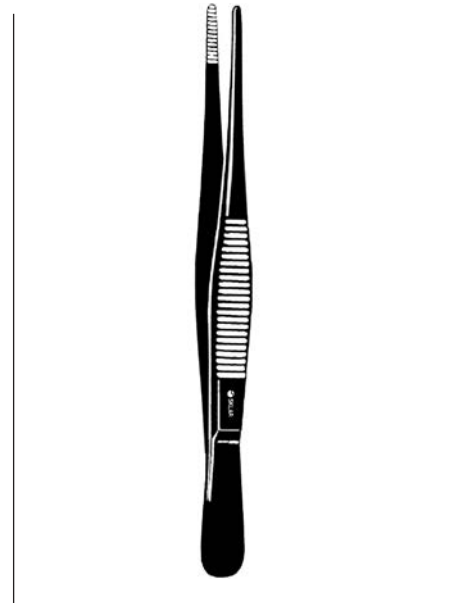
**DRESSING FORCEPS**

<b>SERRATED</b>	
90-1063	4½"
90-1064	5"
90-1065	5½"
90-1066	6"

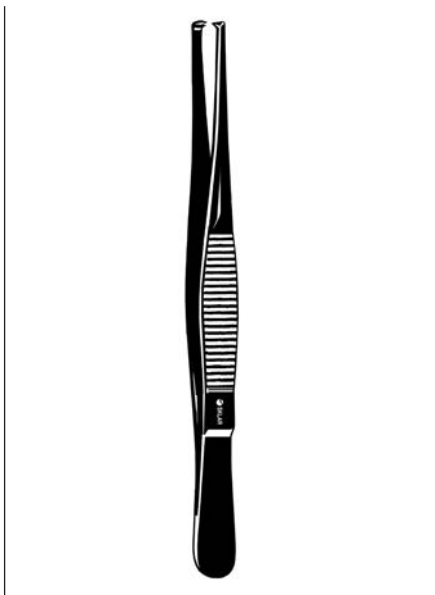
**TISSUE FORCEPS**

90-1020	4½"	1x2 Teeth
90-1021	5"	1x2 Teeth
90-1022	5½"	1x2 Teeth
90-1023	6"	1x2 Teeth

**DEBAKEY ATRAUMATIC TISSUE FORCEPS**

<b>2.0 MM JAWS</b>	
90-2310	7¾"
90-2312	9½"

**POTTS-SMITH FORCEPS**

90-2304	7"	Serrated
90-2306	10"	Serrated



Autoclavable

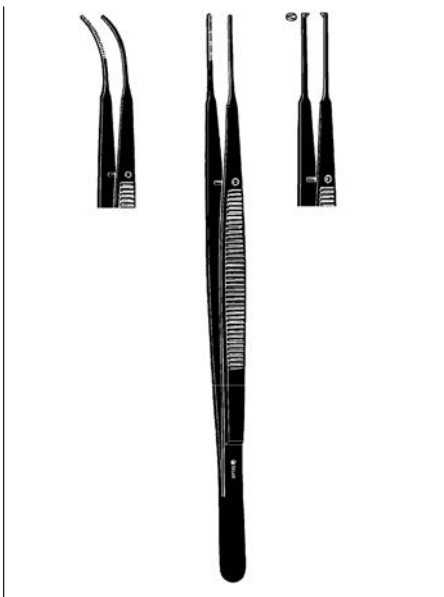

**GERALD FORCEPS**

90-1025	7"	Straight	Serrated
90-1026	7"	Curved	Serrated
90-1027	7"	Straight	1x2 Teeth

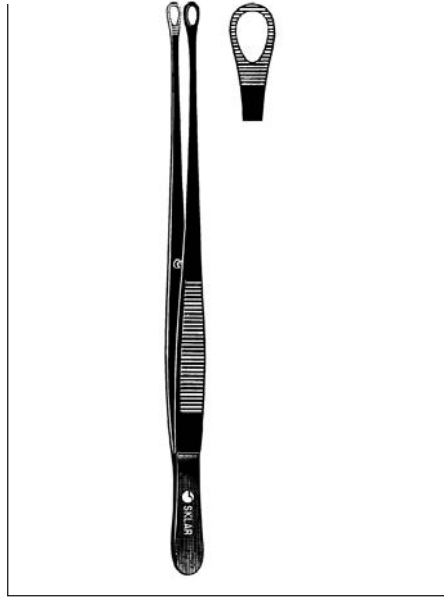

**TUTTLE/SINGLEY FORCEPS**

90-2270	7"	Tuttle
90-2272	9"	Singley



**CASTROVIEJO FORCEP**

90-2313	4 1/4"	.5mm Teeth
---------	--------	------------

# SKLAR DISPOSABLE SCALPELS

**STERILE**

PRODUCT NUMBER	FEATURES	QUANTITIES
06-3110	#10	10/box
06-3111	#11	10/box
06-3112	#12	10/box
06-3115	#15	10/box
06-3120	#20	10/box
06-3121	#21	10/box
06-3122	#22	10/box
06-3123	#23	10/box

ALL SKLAR PRECISION PRODUCTS ARE LATEX FREE

BOXES ARE MARKED WITH LOT NUMBER AND EXPIRATION DATES FOR TRACEABILITY



Autoclavable

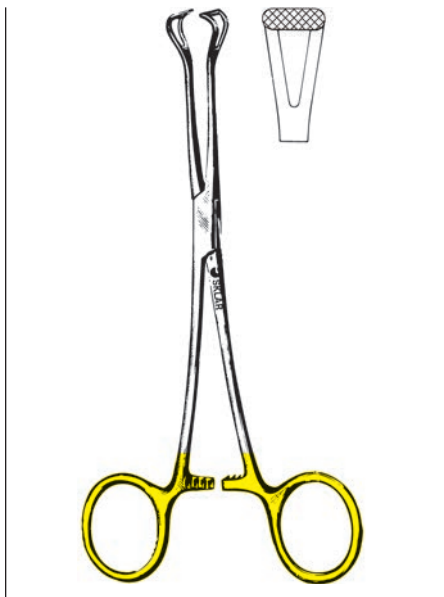

**TC BABCOCK FORCEPS**

97-1565 6¼"  
97-1570 8"

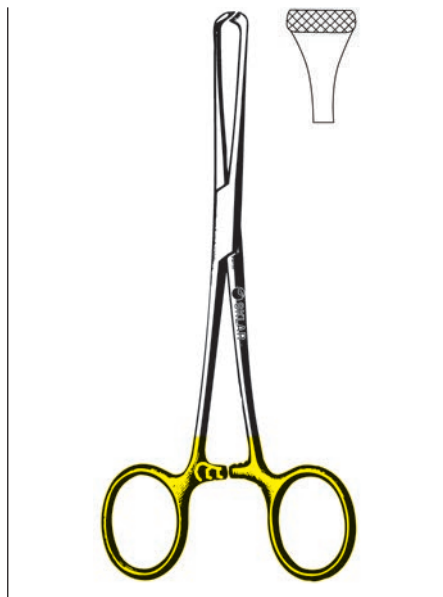

**TC ALLIS TISSUE FORCEPS**

97-1555 6"  
97-1560 7½"

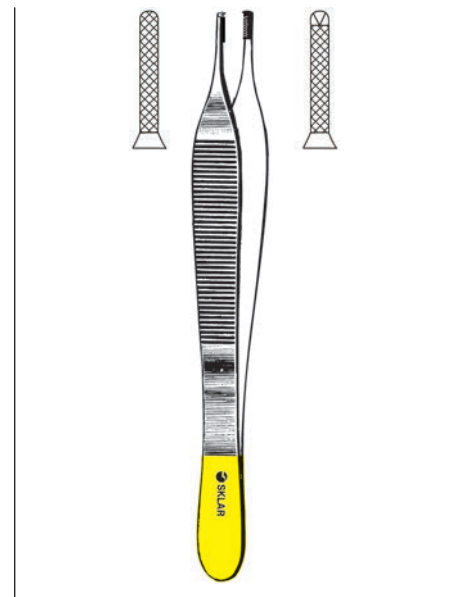

**TC ADSON DRESSING FORCEPS**

51-3447 4¾" Serrated  
51-3049 4¾" 1x2 Teeth with platform

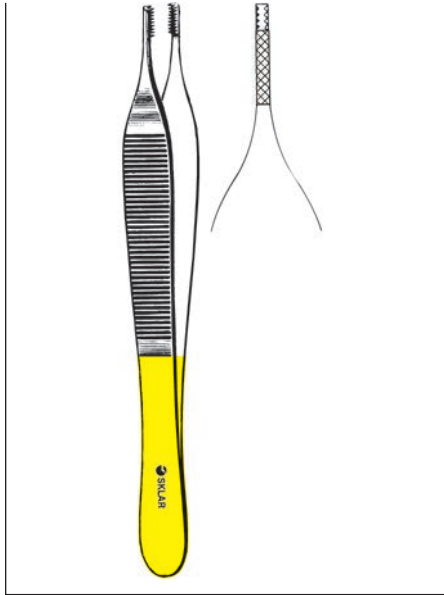

**TC ADSON-BROWN FORCEPS**

51-1447 4¾" Side Grasping

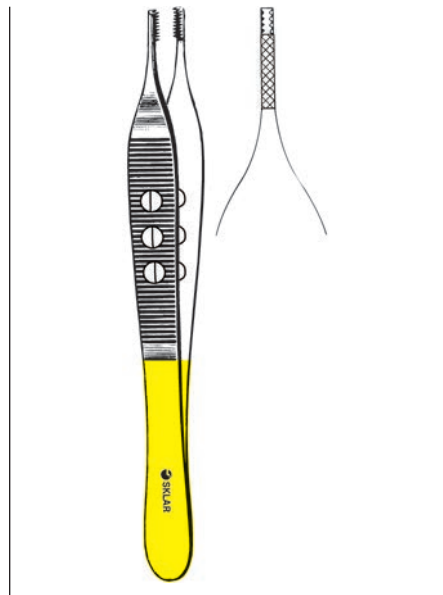

**TC LITEGRIP™ ADSON-BROWN FORCEPS**

51-1448 4¾" Side Grasping

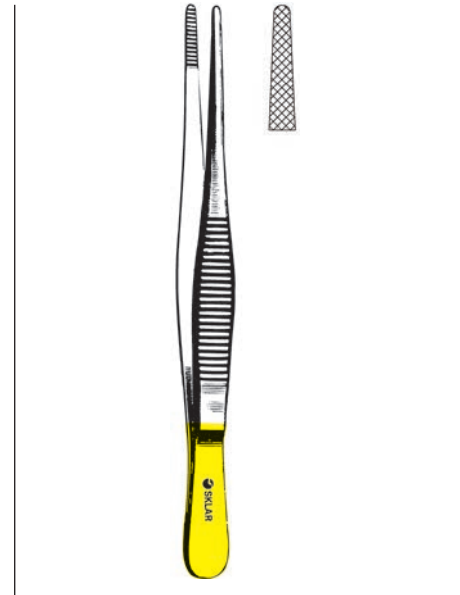

**TC DRESSING FORCEPS**

51-3460 6" Serrated  
51-3480 8" Serrated

**SKLARLITE**  
THE LIGHT TOUCH

**SKLARLITE™ HALSTED MOSQUITO FORCEPS**

- 23-2105 5" Straight
- 23-2106 5" Curved

**SKLARLITE XD**  
EXTRA DELICATE

**SKLARLITE™ EXTRA DELICATE HALSTED MOSQUITO FORCEPS**

- 23-2505 5" Straight
- 23-2506 5" Curved

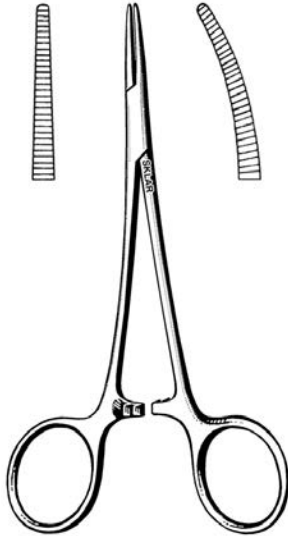

**SKLARLITE**  
THE LIGHT TOUCH

**SKLARLITE™ CRILE HEMOSTATIC FORCEPS**

- 23-2110 5½" Straight
- 23-2113 5½" Curved

**SKLARLITE XD**  
EXTRA DELICATE

**SKLARLITE™ EXTRA DELICATE CRILE HEMOSTATIC FORCEPS**

- 23-2510 5½" Straight
- 23-2513 5½" Curved

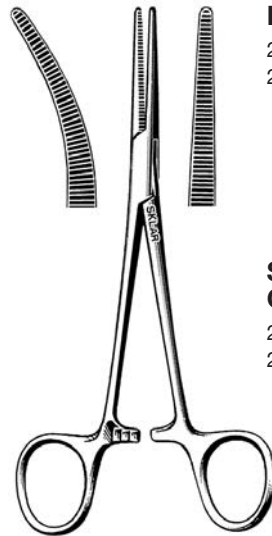

**SKLARLITE**  
THE LIGHT TOUCH

**SKLARLITE™ KELLY HEMOSTATIC FORCEPS**

- 23-2107 5½" Straight
- 23-2108 5½" Curved

**SKLARLITE XD**  
EXTRA DELICATE

**SKLARLITE™ EXTRA DELICATE KELLY HEMOSTATIC FORCEPS**

- 23-2507 5½" Straight
- 23-2508 5½" Curved

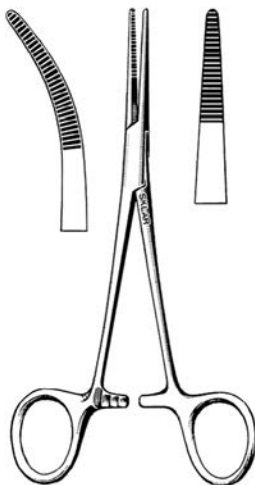

**SKLARLITE**  
THE LIGHT TOUCH

**SKLARLITE™ HARTMANN MOSQUITO FORCEPS**

- 23-2100 3½" Straight
- 23-2101 3½" Curved

**SKLARLITE XD**  
EXTRA DELICATE

**SKLARLITE™ EXTRA DELICATE HARTMANN MOSQUITO FORCEPS**

- 23-2500 3½" Straight
- 23-2501 3½" Curved

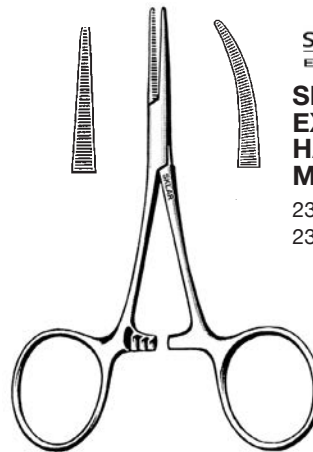

**SKLARLITE**  
THE LIGHT TOUCH
**SKLARLITE™ ROCHESTER-PEAN FORCEPS**

23-2532	6¼"	Straight
23-2538	6¼"	Curved
23-2542	7¼"	Curved

**SKLARLITE XD**  
EXTRA DELICATE
**SKLARLITE™ EXTRA DELICATE ROCHESTER-PEAN FORCEPS**

23-2552	6¼"	Straight
23-2561	6¼"	Curved
23-2563	7¼"	Curved

**SKLARLITE**  
THE LIGHT TOUCH
**SKLARLITE™ ROCHESTER-OCHSNER FORCEPS**

23-2560	6¼"	1x2 Teeth	Straight
23-2568	6¼"	1x2 Teeth	Curved

**SKLARLITE XD**  
EXTRA DELICATE
**SKLARLITE™ EXTRA DELCATE ROCHESTER-OCHSNER FORCEPS**

23-2577	6¼"	1x2 Teeth	Straight
23-2585	6¼"	1x2 Teeth	Curved

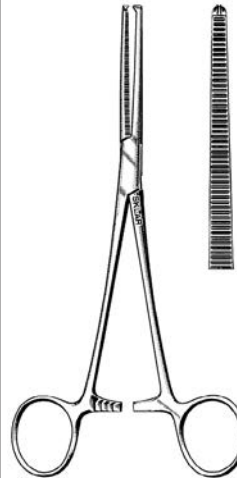
**SKLARLITE**  
THE LIGHT TOUCH
**SKLARLITE™ ALLIS TISSUE FORCEPS**

23-2851	6"	4x5 Teeth
23-2852	6"	5x6 Teeth

**SKLARLITE XD**  
EXTRA DELICATE
**SKLARLITE™ EXTRA DELICATE ALLIS TISSUE FORCEPS**

23-2861	5"	4x5 Teeth
23-2864	6"	4x5 Teeth
23-2865	6"	5x6 Teeth

**SKLARLITE**  
THE LIGHT TOUCH
**SKLARLITE™ ADSON FORCEPS**
**DRESSING**

23-2600	4¾"	Serrated
---------	-----	----------

**TISSUE**

23-2602	4¾"	1x2 Teeth
---------	-----	-----------

**ADSON-BROWN**

23-2603	4¾"	Side Grasping
---------	-----	---------------

**SKLARLITE XD**  
EXTRA DELICATE
**SKLARLITE™ EXTRA DELICATE ADSON FORCEPS**
**DRESSING**

23-2604	4¾"	Serrated
---------	-----	----------

**TISSUE**

23-2606	4¾"	1x2 Teeth
---------	-----	-----------

**ADSON-BROWN**

23-2608	4¾"	Side Grasping
---------	-----	---------------







**SKLARLITE**  
THE LIGHT TOUCH

**SKLAR LITEGRIP™ ADSON FORCEPS**

- 50-3148 4¾" Serrated
- 50-3050 4¾" 1x2 Teeth



**SKLARLITE XD**  
EXTRA \* DELICATE

**SKLAR LITEGRIP™ ADSON-BROWN FORCEPS**

- 47-1448 4¾" 7x7 Teeth  
Side Grasping

**SKLARLITE**  
THE LIGHT TOUCH

**SKLARLITE™ DRESSING FORCEPS**

- SERRATED**
- 23-2824 4½"
  - 23-2826 5"
  - 23-2828 5½"
  - 23-2830 6"



**SKLARLITE XD**  
EXTRA \* DELICATE

**SKLARLITE™ EXTRA DELICATE DRESSING FORCEPS**

- 23-2834 4½"
- 23-2836 5"
- 23-2838 5½"

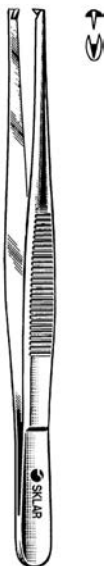

**SKLARLITE**  
THE LIGHT TOUCH

**SKLARLITE™ TISSUE FORCEPS**

- 23-2809 4½" 1x2 Teeth
- 23-2811 5½" 1x2 Teeth



**SKLARLITE XD**  
EXTRA \* DELICATE

**SKLARLITE™ EXTRA DELICATE TISSUE FORCEPS**

- 23-2819 5½" 1x2 Teeth

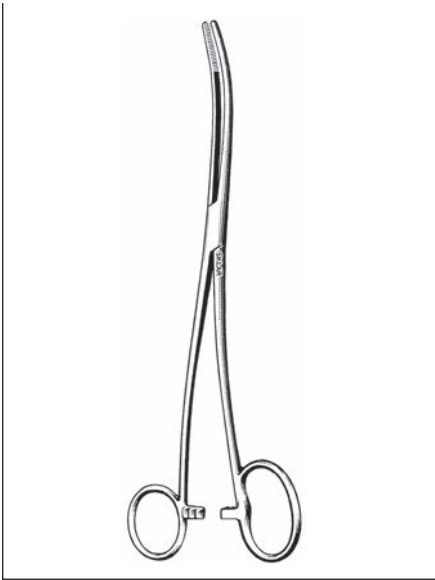

**BOZEMAN FORCEP**  
**ONE LARGE RING**  
90-7710 10¼" S-Curve

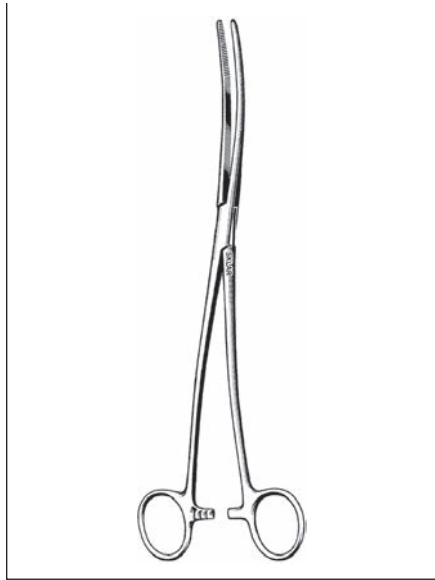

**BOZEMAN FORCEPS**  
90-7610 10½" Straight  
80-1410 10¼" S-Curve

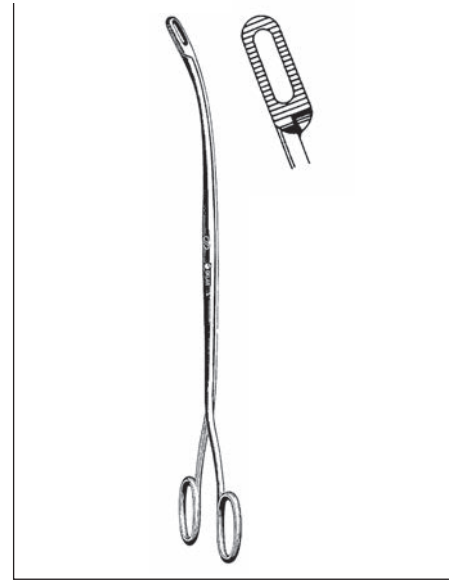

**CAMPION UTERINE FORCEP**  
90-7898 9¼" Curved

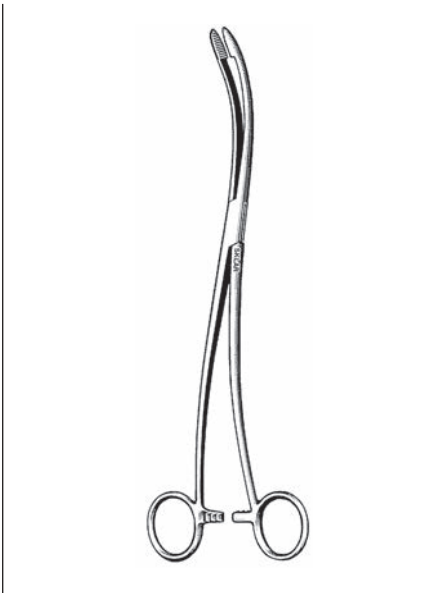

**DELEE UTERINE FORCEP**  
90-8111 11" S-Curve



**CHERON UTERINE DRESSING FORCEP**  
90-7910 10½"

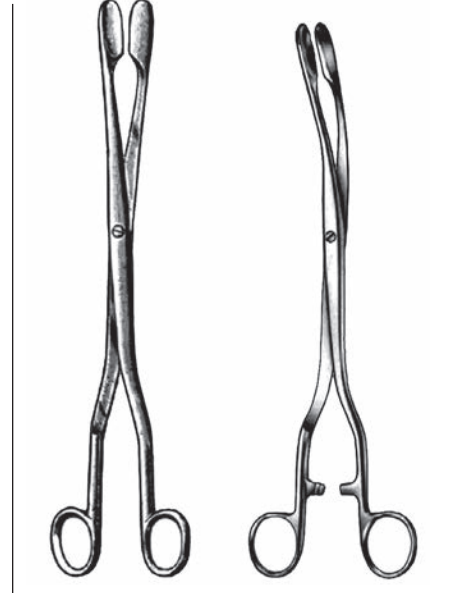

**WINTER PLACENTA & OVUM FORCEPS**  
90-5292 11" Straight  
90-5293 11" Curved

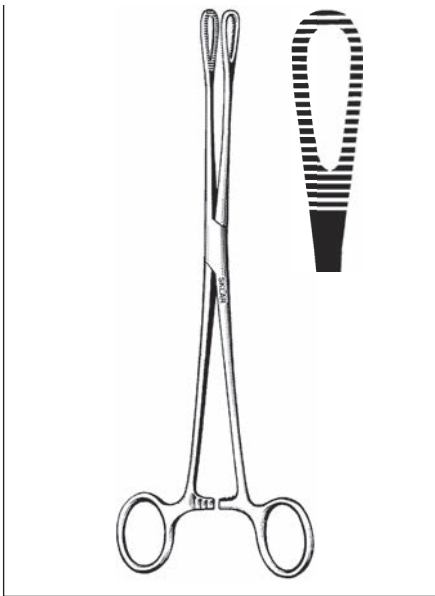

**SCHWEIZER UTERINE FORCEP**  
90-7995 9½" Straight

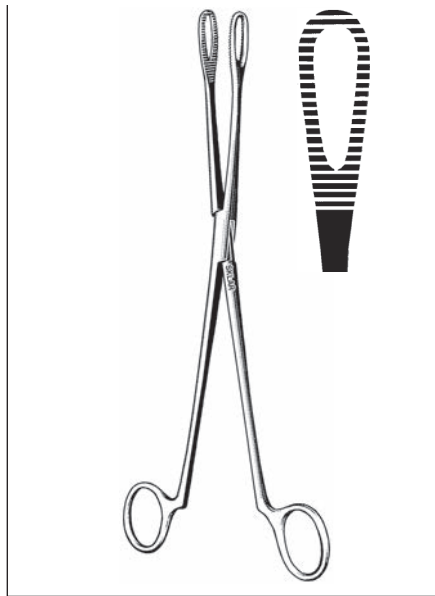

**CLEMETSON UTERINE FORCEP**  
NON-RATCHETED  
90-7895 9½" Straight

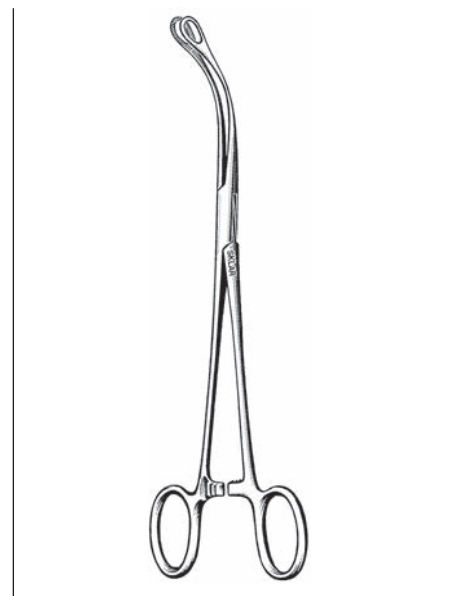

**LAUFE UTERINE POLYP FORCEP**  
90-7977 7¾" Curved

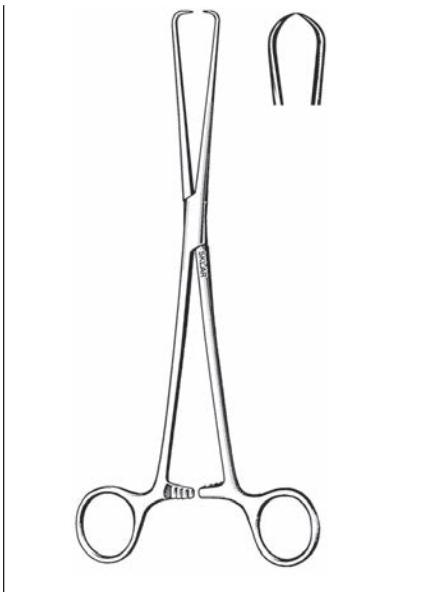

**SCHROEDER TENACULUM FORCEPS**  
91-1290 10" Braun (Flat Tips)  
91-1298 10" Pozzi (Round Tips)

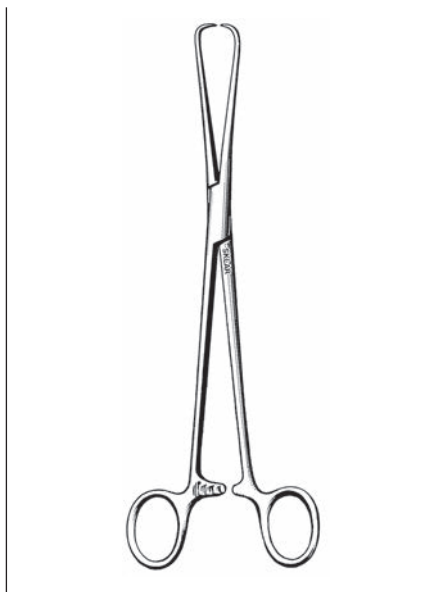

**BARRETT TENACULUM FORCEPS**  
18-2257 6½" Delicate  
91-1070 7" Straight

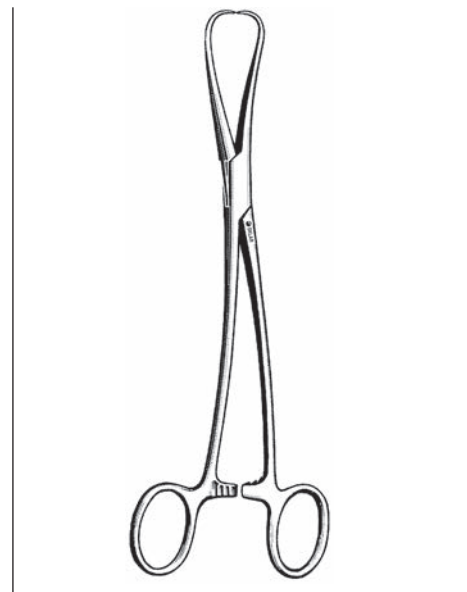

**JARCHO TENACULUM FORCEP**  
91-1275 7½" S-Curved

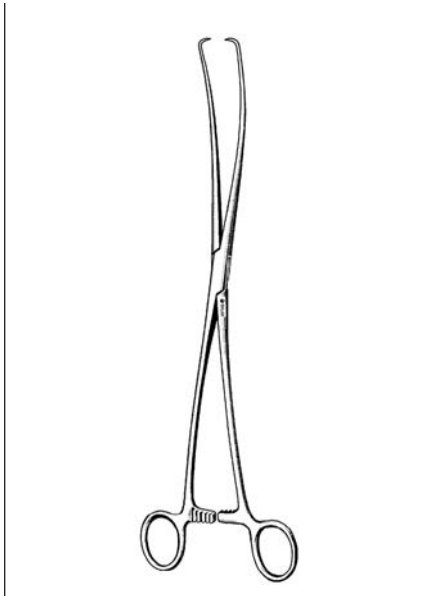

**DUPLAY TENACULUM FORCEP**  
91-1111 11" S-Curve

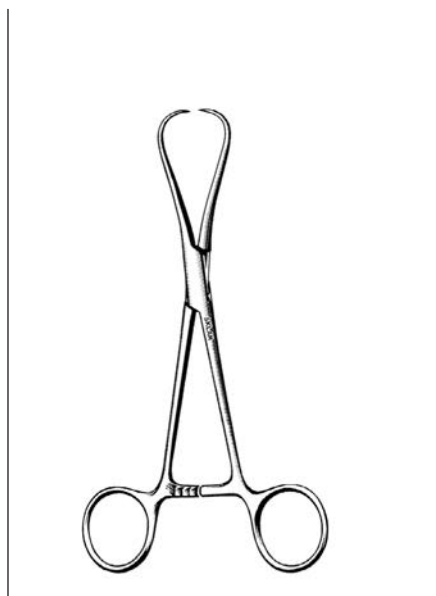

**STAUDE-MOORE TENACULUM FORCEPS**  
91-1455 5½" Straight  
91-1465 6½" Straight

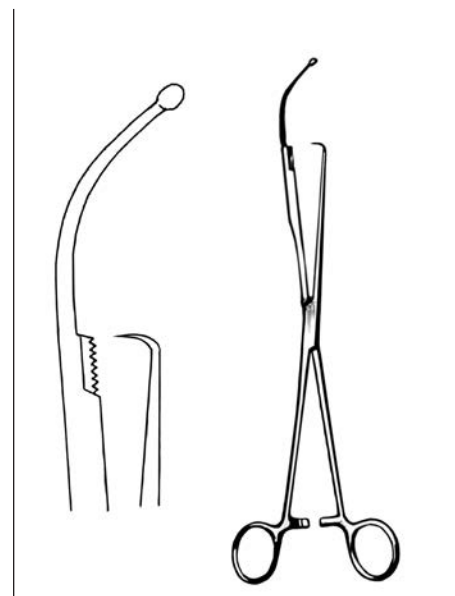

**HULKA TENACULUM FORCEP**  
91-1280 11½"

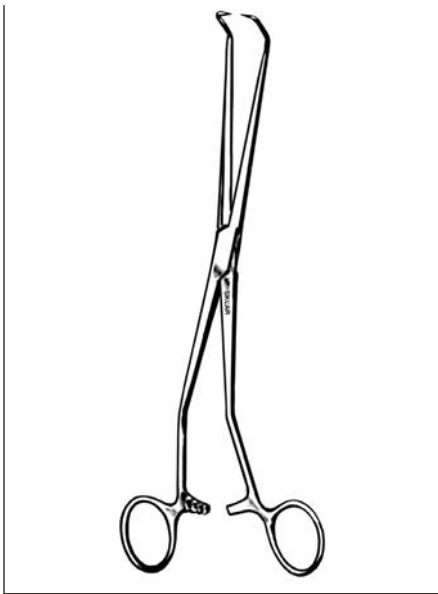

**KAHN TENACULUM FORCEP**  
91-1125 9½"

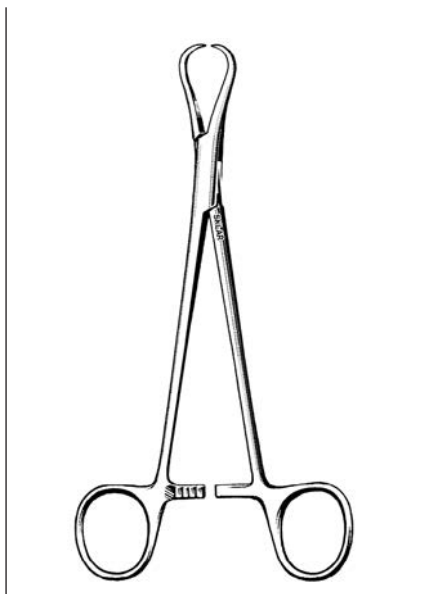

**ADAIR BREAST TENACULUM FORCEP**  
36-1865 6½"

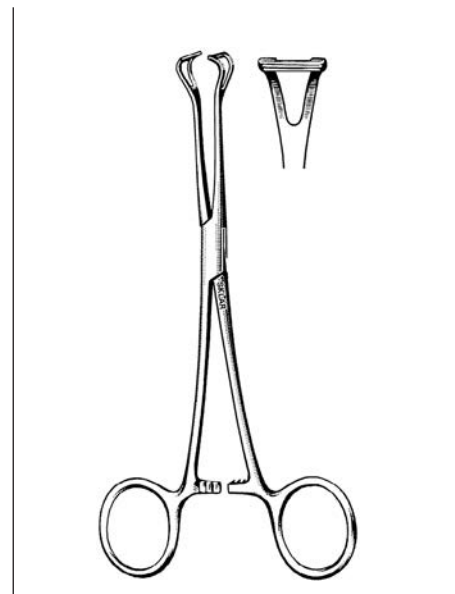

**BABCOCK FORCEPS**  
22-6155 5½"  
36-1662 6¼"  
36-1677 8"  
36-1692 9½"

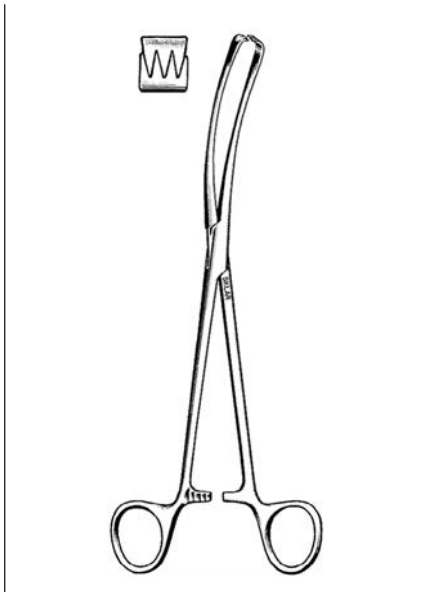

**TEALE VULSELLUM FORCEP**  
**CURVED SIDEWAYS**  
 91-2695 9" 3x4 Teeth

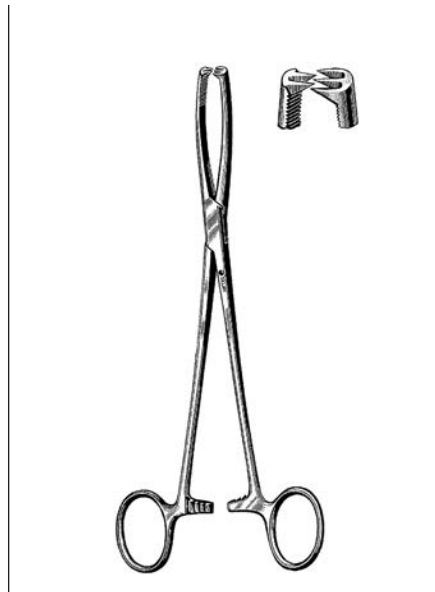

**HENROTIN VULSELLUM FORCEP**  
 91-2585 8½" 2x3 Teeth

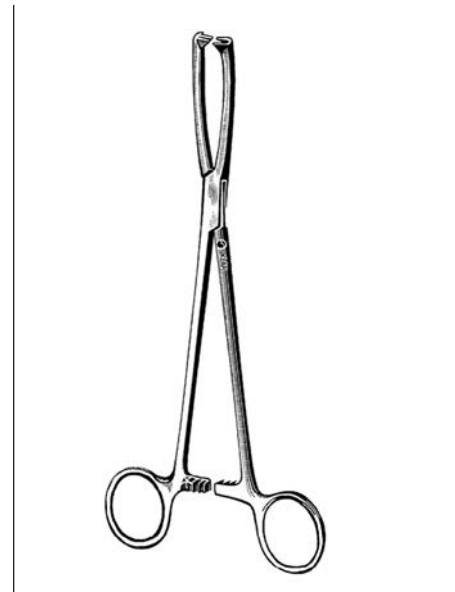

**DOYEN VULSELLUM FORCEP**  
 91-2482 8¼"

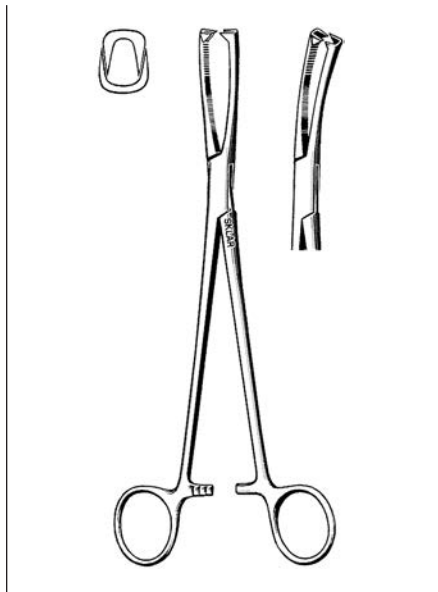

**JACOBS VULSELLUM FORCEPS**  
**SERRATED**  
 91-2282 8¼" Straight  
 91-2382 8¼" Angled

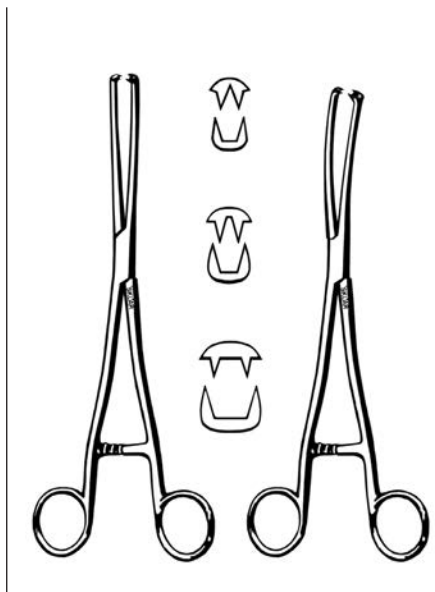

**MUSEUX VULSELLUM FORCEPS**  
**2X2 TEETH**  
 91-2906 9½" 6mm Straight  
 91-3006 9½" 6mm Curved  
 91-2908 9½" 8mm Straight  
 91-3008 9½" 8mm Curved  
 91-2910 9½" 10mm Straight  
 91-3010 9½" 10mm Curved

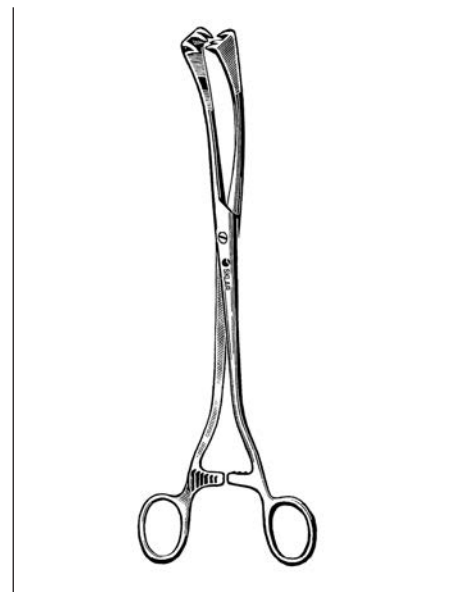

**SECOND (COLLIN) FORCEPS**  
**4X4 TEETH**  
 91-3795 9½" Curved on flat  
**3X3 TEETH**  
 91-3095 9½" Straight  
 91-3195 9½" Curved sideways

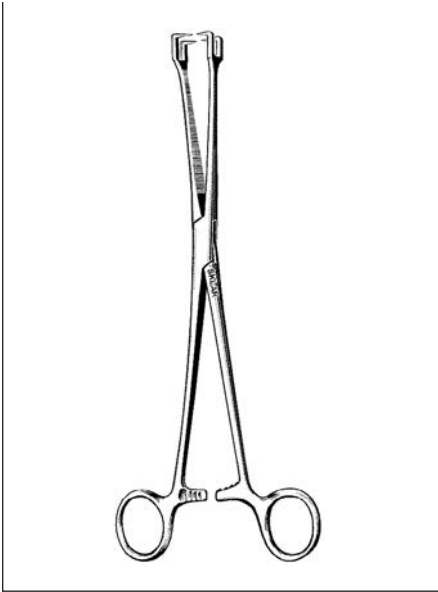

**SCHROEDER VULSELLUM FORCEP**

91-1590 9½" Straight

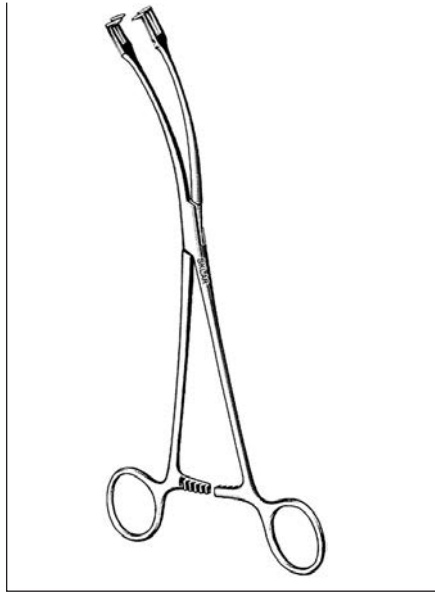

**SCHROEDER VULSELLUM FORCEPS**

91-1690 9" Curved on Flat  
91-1890 9½" Curved Sideways

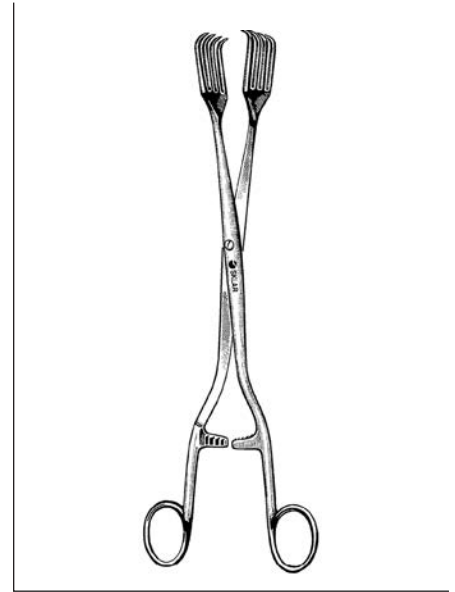

**BILLROTH FORCEP**

91-3810 10¾" 4x4 Teeth

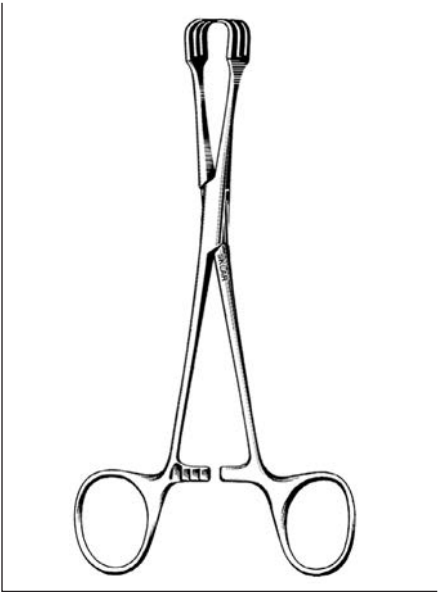

**LAHEY TRACTION FORCEPS**

17-3562 6¼"  
91-2080 8" (MGH)

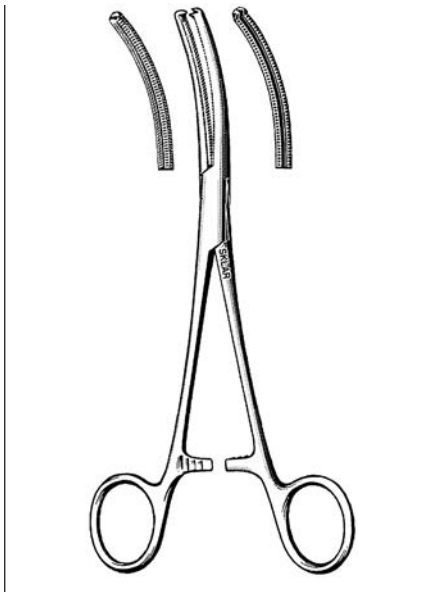

**GELPI-LOWRIE FORCEP**

90-1885 8½"

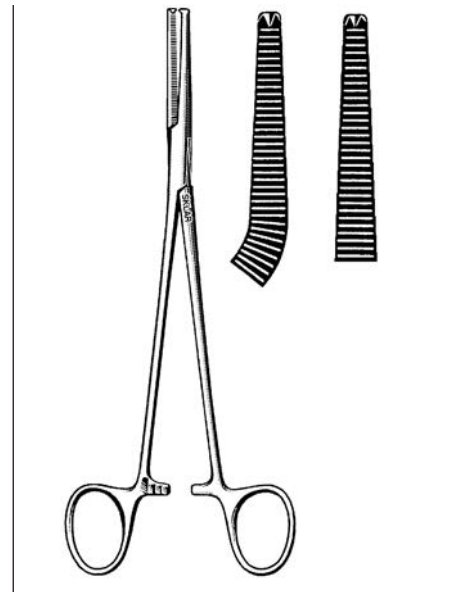

**PHANEUF FORCEPS**

90-2682 8¼" Straight  
90-2680 8¼" Curved

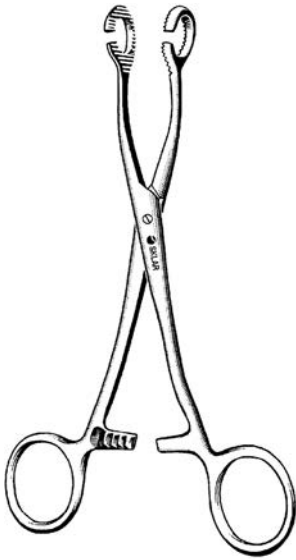

**HILDEBRANDT UTERINE HEMOSTATIC FORCEP**

90-8065 6½"

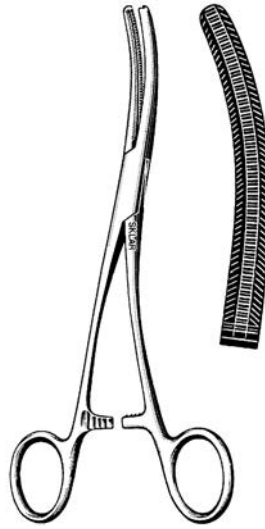

**DE ALVAREZ FORCEP**

90-2782 7¾" S-Curve

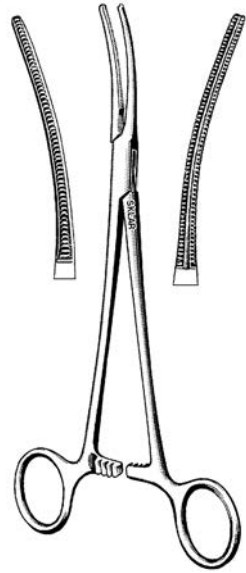

**GUSBERG HYSTERECTOMY FORCEP**

90-2780 8" Curved

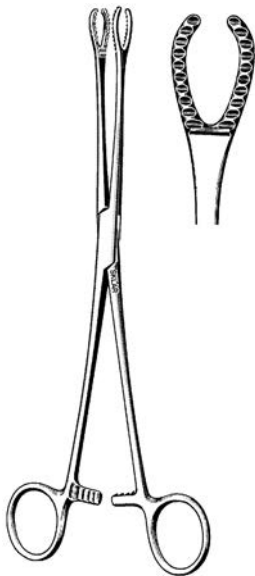

**GUTGLASS CERVIX FORCEP**

90-8090 9½"



**MAIER-GROSS UTERINE DRESSING FORCEPS**

**WITH RATCHET**

90-8070	7"	Straight
90-8072	7"	Curved
90-8080	8"	Straight
90-8082	8"	Curved
90-8110	10"	Straight
90-8112	10"	Curved

**WITHOUT RATCHET**

90-8120	7"	Straight
90-8122	7"	Curved
90-8130	8"	Straight
90-8132	8"	Curved
90-8140	10"	Straight
90-8142	10"	Curved

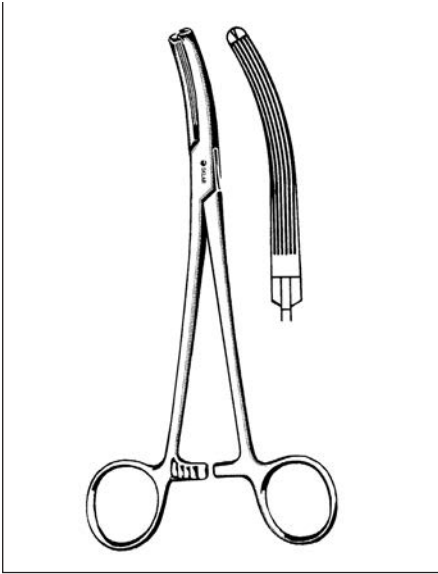

**LONG FORCEP**  
90-2690 7½"

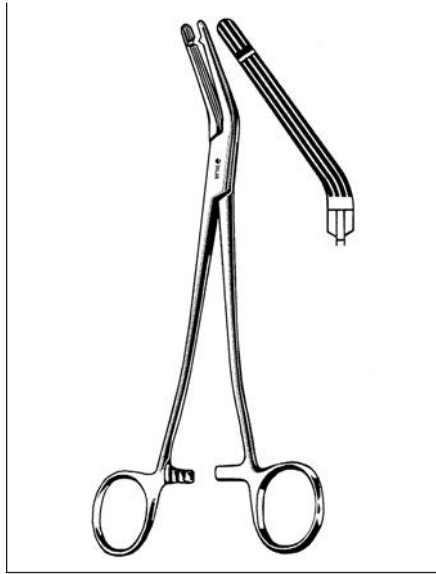

**LAWTON FORCEP**  
90-2180 8¼"

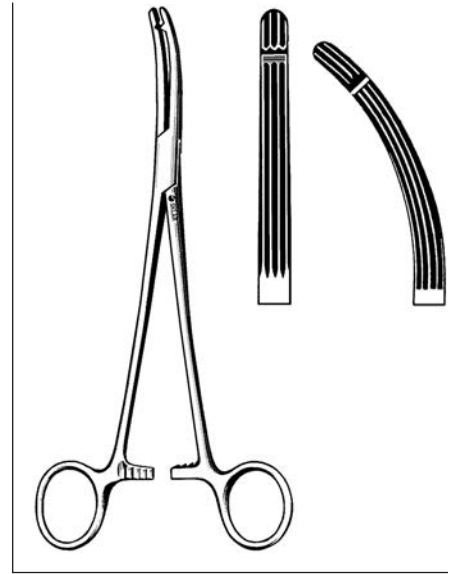

**HEANEY-BALLENTINE FORCEPS**  
**LONGITUDINAL SERRATIONS**  
90-2480 8" Straight  
90-2580 8" Curved

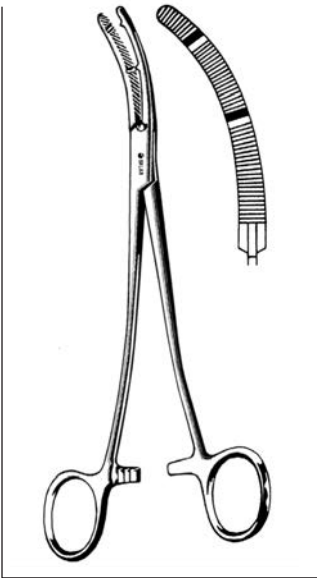

**HEANEY-KANTER FORCEP**  
90-2379

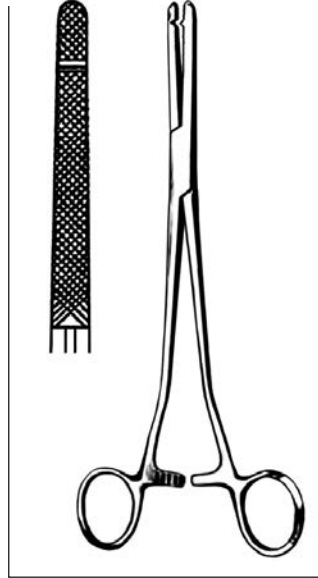

**HEANEY REZAK FORCEP**  
90-1877 8¼"

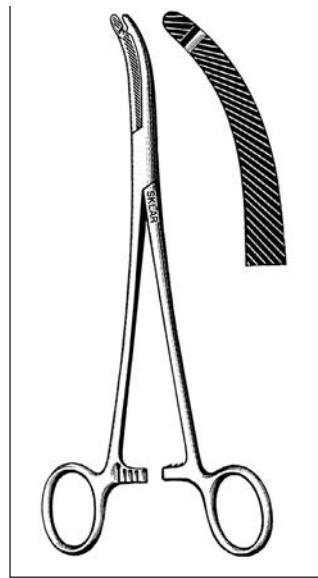

**HEANEY FORCEPS**  
**SINGLE TOOTH**  
90-1977 7¾" Light  
90-2177 8¼" Heavy

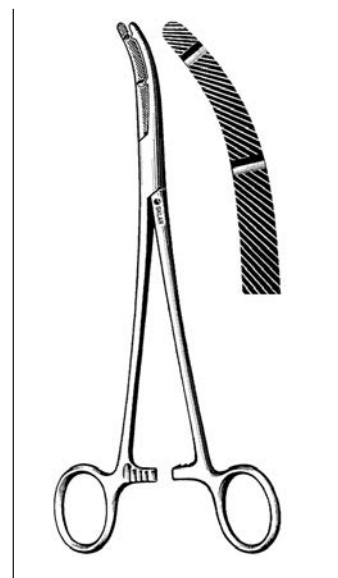

**HEANEY FORCEPS**  
**HEAVY DOUBLE TOOTH**  
90-2280 8"  
90-2387 8¾"





**Z-TYPE HYSTERECTOMY FORCEPS**

LONGITUDINAL GROOVES WITH TIP SERRATIONS

90-2785	8¼"	Straight	90-2796	12"	Straight
90-2786	8¼"	Slight Curve	90-2797	12"	Slight Curve
90-2787	8¼"	Full Curve	90-2798	12"	Full Curve
90-2788	8¼"	Angled	90-2799	12"	Angled
90-2790	9½"	Straight	90-2801	14"	Straight
90-2792	9½"	Slight Curve	90-2802	14"	Slight Curve
90-2793	9½"	Full Curve	90-2803	14"	Full Curve
90-2794	9½"	Angled	90-2804	14"	Angled



**WERTHEIM-CULLEN CLAMP**

33-1375	8½"	Pediatric
---------	-----	-----------



**SOMMER UTERINE ELEVATING FORCEP**

90-5297	9"
---------	----

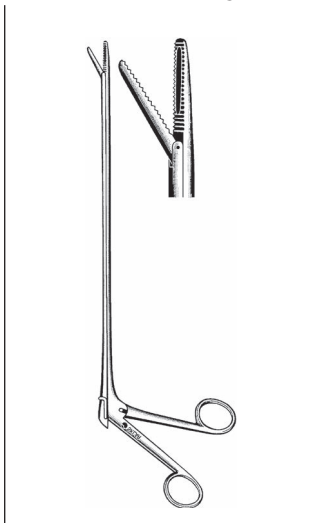

**MATHIEU FOREIGN BODY FORCEP**

79-3228	7¾"
79-3230	11"

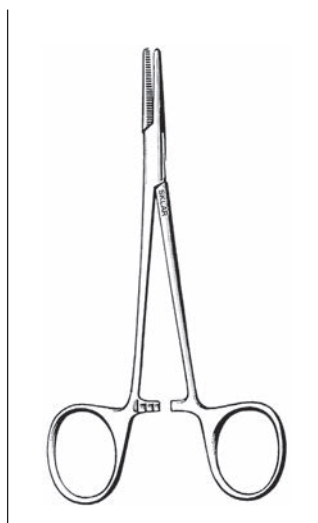

**HALSTED MOSQUITO HEMOSTATS**

17-1450	5"	Straight
17-1650	5"	Straight, 1x2
17-1550	5"	Curved
17-1750	5"	Curved, 1x2

**DELICATE**

18-1050	5"	Straight
18-1150	5"	Curved

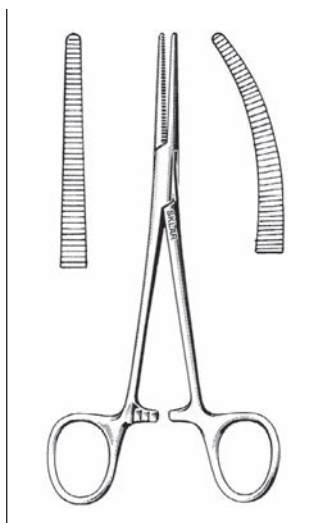

**CRILE HEMOSTATIC FORCEPS**

17-3055	5½"	Straight
17-3155	5½"	Curved
17-3062	6¼"	Straight
17-3162	6¼"	Curved
17-3075	7½"	Straight
17-3175	7½"	Curved

**DELICATE**

18-1952	5½"	Straight
18-2052	5½"	Curved

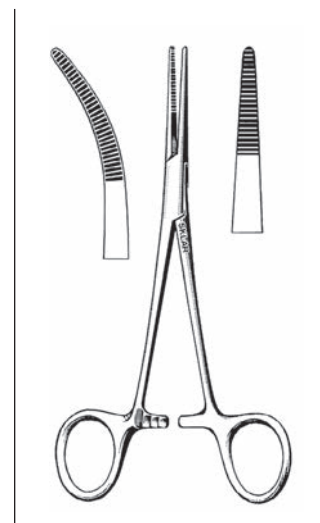

**KELLY HEMOSTATIC FORCEPS**

17-2055	5½"	Straight
17-2155	5½"	Curved
74-3270	7"	Straight, Extra Heavy

**DELICATE**

18-1552	5½"	Straight
18-1652	5½"	Curved

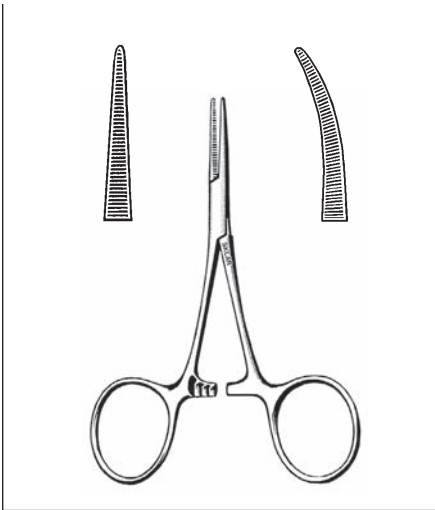
**HARTMANN MOSQUITO FORCEPS**
**SERRATED**

17-1235	3½"	Straight
17-1335	3½"	Curved

**DELICATE**

17-1230	3½"	Straight
17-1232	3½"	Curved

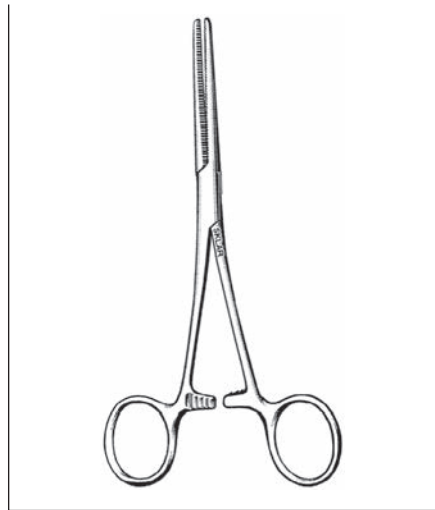
**ROCHESTER-PEAN FORCEPS**
**STRAIGHT**

17-2455	5½"
17-2462	6¼"
17-2467	6¾" Heavy
17-2472	7¼"
17-2480	8"
36-2690	9"
36-2710	10¼"

**CURVED**

17-2255	5½"
17-2262	6¼"
17-2267	6¾" Heavy
17-2272	7¼"
17-2280	8"
36-2790	9"
36-2810	10¼"

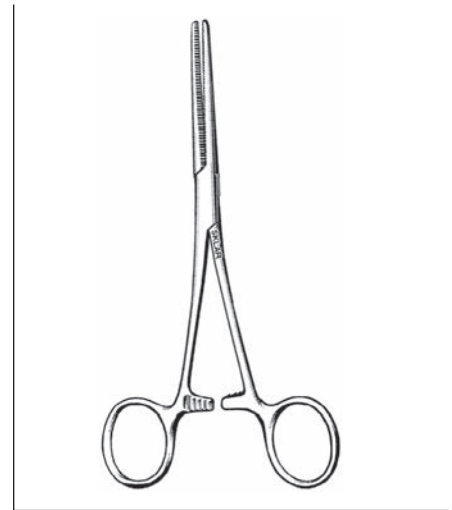
**ROCHESTER-PEAN FORCEPS**
**DELICATE**

22-3555	5½"	Straight
22-3655	5½"	Curved
17-2362	6¼"	Curved
22-2272	7¼"	Curved
22-2280	8"	Curved

**ROCHESTER-OGHSNER FORCEPS**
**1x2 TEETH**
**STRAIGHT**

17-2855	5½"
17-2862	6¼"
17-2872	7¼"
17-2880	8"

**CURVED**

17-2655	5½"
17-2662	6¼"
17-2672	7¼"
17-2680	8"

**ROCHESTER-OGHSNER FORCEPS**
**DELICATE, 1x2 TEETH**
**STRAIGHT**

18-1752	5¼"
22-3755	5½"
17-2962	6¼"

**CURVED**

18-1852	5¼"
22-3855	5½"
17-2762	6¼"

**ALLIS TISSUE FORCEPS**

36-2060	6"	3x4 Teeth
36-2160	6"	4x5 Teeth
36-2260	6"	5x6 Teeth
36-2275	7½"	5x6 Teeth

**DELICATE**

18-2140	4"	4x5 Teeth
18-2155	5"	4x5 Teeth
18-2162	6"	4x5 Teeth
18-2164	6"	5x6 Teeth
36-2295	9½"	5x6 Teeth



**ALLIS FORCEPS**

**ATRAUMATIC JAWS**

36-2298	6"	Straight
36-2280	8"	Straight
36-2385	10"	Straight

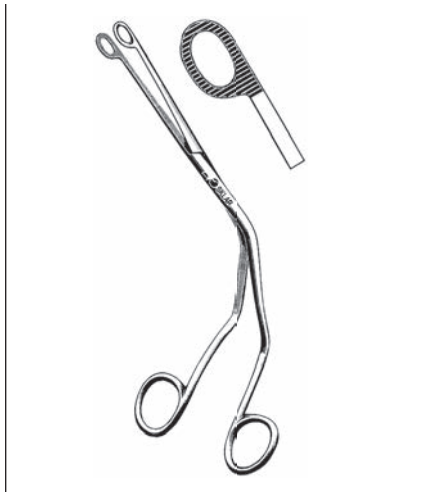

**MAGILL CATHETER FORCEPS**

07-1777	6½"	Infant
07-1780	8"	Child
07-1797	10"	Adult



**ADSON FORCEPS DRESSING**

**DRESSING**

50-3147	4¾"	Serrated
47-2147	4¾"	Serrated, Delicate

**TISSUE**

50-3047	4¾"	1x2 Teeth
47-2047	4¾"	1x2 Teeth, Delicate
47-2049	4¾"	2x3 Teeth, Delicate

**ADSON-BROWN**

47-1447	4¾"	Side Grasping
47-2447	4¾"	Side Grasping, Delicate



**ADSON FORCEPS**

50-3048	4¾"	Serrated, 1x2 Teeth
50-3049	4¾"	1x2 Teeth with Platform

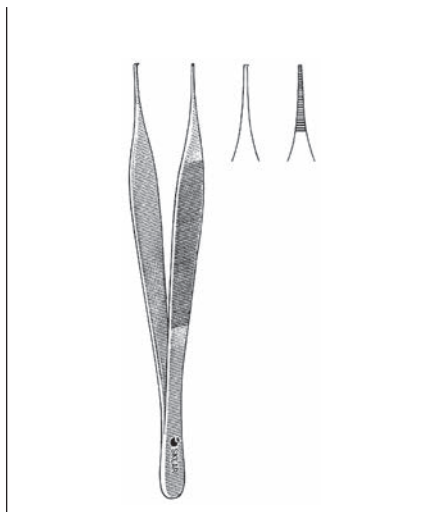

**MICRO ADSON FORCEPS**

98-2047	4¾"	1x2 Teeth
98-2048	4¾"	Serrated



**DRESSING FORCEPS**

**SERRATED**

19-1040	4"	19-1060	6"
19-1045	4½"	19-1080	8"
19-1050	5"	19-1110	10"
19-1055	5½"	19-1112	12"



**DRESSING FORCEPS**

**SERRATED, DELICATE**

22-1161	4½"
22-1162	5"
22-1163	5½"
22-1164	6"



**TISSUE FORCEPS**

**1 X 2 TEETH**

19-1245	4½"	19-1280	8"
19-1250	5"	19-1310	10"
19-1255	5½"	19-1312	12"
19-1260	6"		

**1 X 2 TEETH, DELICATE**

22-1063	5½"
---------	-----



**TISSUE FORCEPS**

**2 X 3 TEETH**

19-1450	5"
19-1455	5½"
19-1460	6"
19-1480	8"
19-1510	10"
19-1512	12"

**3 X 4 TEETH**

19-1655	5½"
19-1660	6"

**4 X 5 TEETH**

19-1855	5½"
19-1910	10"

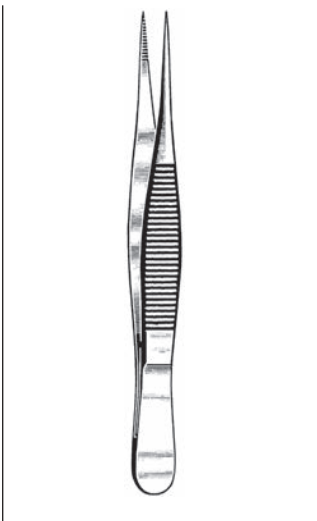

**FINE POINT SPLINTER FORCEPS**

19-3035	3½"
19-3040	4"
19-3045	4½"

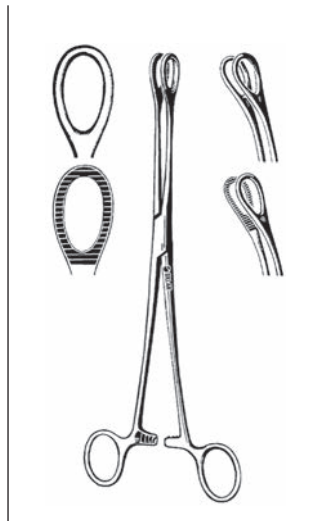

**FOERSTER SPONGE FORCEPS**

**STRAIGHT**

87-2095	9½"	Smooth
87-2195	9½"	Serrated

**CURVED**

87-2295	9½"	Smooth
87-2395	9½"	Serrated



**BACKHAUS TOWEL CLAMPS**

47-2935	3½"
47-2955	5¼"

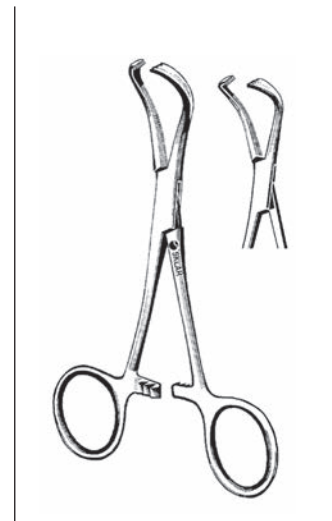

**LORNA EDNA TOWEL CLAMP**

**NON-PERFORATING**

47-2837	4"
47-2852	5¼"



**BOZEMAN UTERINE DRESSING FORCEP**

95-374 10¼" S-curved

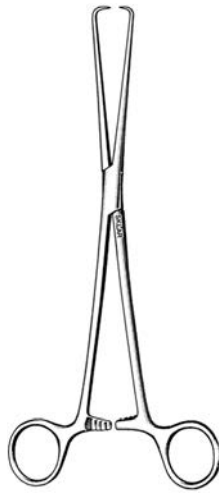

**SCHROEDER TENACULUM FORCEP**

95-386 9½"



**BABCOCK FORCEP**

95-952 6¼"  
95-441 8"

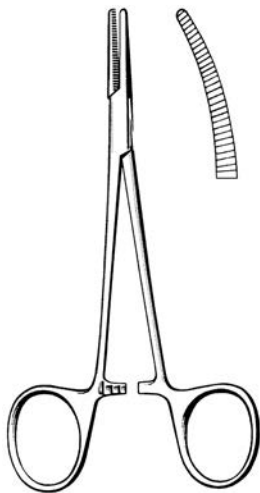

**HALSTED MOSQUITO FORCEPS**

95-426 5" Straight  
95-431 5" Curved

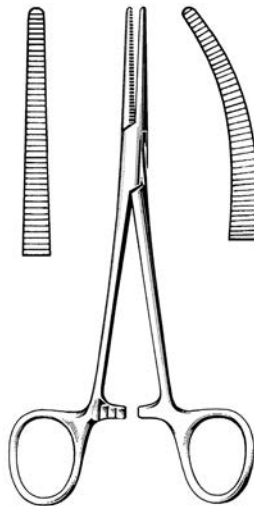

**CRILE FORCEPS**

95-447 5½" Straight  
95-458 6¼" Straight  
95-452 5½" Curved  
95-463 6¼" Curved

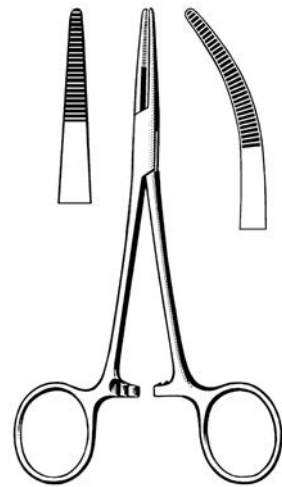

**KELLY FORCEPS**

95-436 5½" Straight  
95-442 5½" Curved

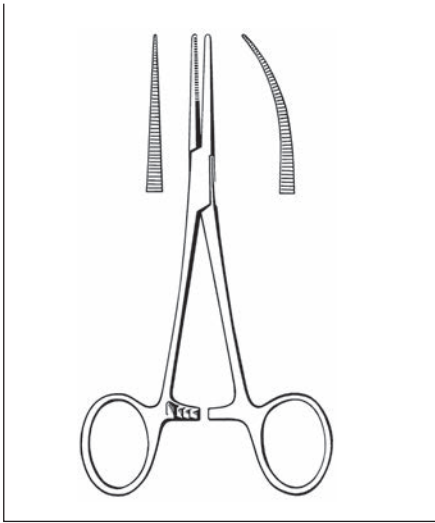
**RANKIN-KELLY FORCEPS**

95-465	6¾"	Straight
95-469	6¾"	Curved

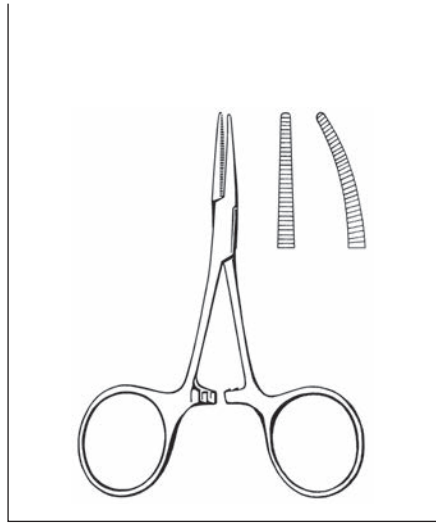
**HARTMANN MOSQUITO FORCEPS**

95-409	3½"	Straight
95-421	3½"	Curved

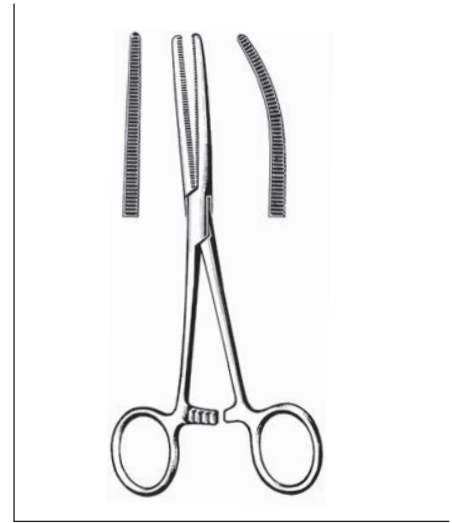
**ROCHESTER-PEAN FORCEPS**

STRAIGHT		CURVED	
95-470	5½"	95-471	5½"
95-473	6¼"	95-477	6¼"
95-481	7¼"	95-485	7¼"
95-492	8"	95-498	8"
95-483	9"	95-487	9"
95-494	10¼"		

**ROCHESTER-OGHSNER FORCEPS**

STRAIGHT 1x2 TEETH		CURVED 1x2 TEETH	
95-500	5½"	95-501	5½"
95-504	6¼"	95-512	6¼"
95-521	7¼"	95-525	7¼"
95-513	8"	95-514	8"
95-515	9"	95-516	9"
95-517	10"	95-518	10"

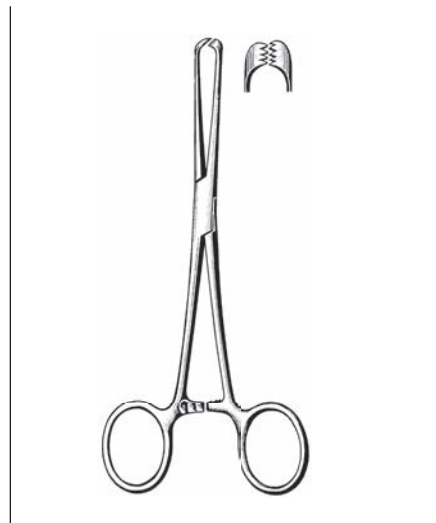
**ALLIS TISSUE FORCEPS**

95-934	6"	5x6 Teeth
95-938	7½"	5x6 Teeth



**ADSON DRESSING FORCEPS**

- 95-771 4¾" Serrated
- DELICATE**
- 95-772 4¾" Serrated



**ADSON TISSUE FORCEPS**

- 95-775 4¾" 1x2 Teeth
- DELICATE**
- 95-776 4¾" 1x2 Teeth



**ADSON-BROWN TISSUE FORCEP**

- 95-778 4¾" Side-Grasping



**DRESSING FORCEPS**

- 95-705 4½" Serrated
- 95-710 5" Serrated
- 95-727 5½" Serrated
- 95-731 6" Serrated
- 95-736 8" Serrated
- 95-742 10" Serrated



**TISSUE FORCEPS**

- 95-753 4½" 1x2 Teeth
- 95-757 5" 1x2 Teeth
- 95-762 5½" 1x2 Teeth
- 95-766 6" 1x2 Teeth
- 95-770 8" 1x2 Teeth



**SPLINTER FORCEPS**

- 95-777 3½"
- 95-781 4½"

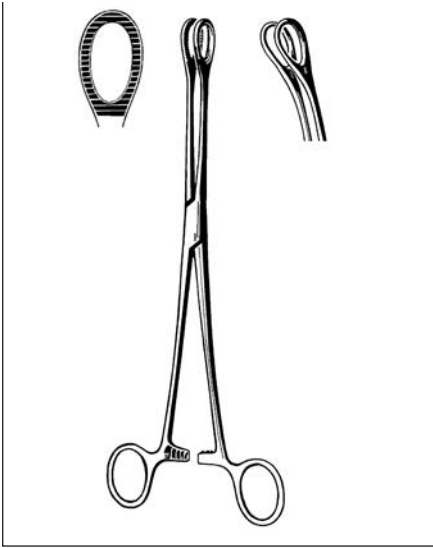

**FOERSTER SPONGE FORCEPS**

95-571	7"	Straight	Serrated
95-577	9½"	Straight	Serrated
95-586	9½"	Curved	Serrated

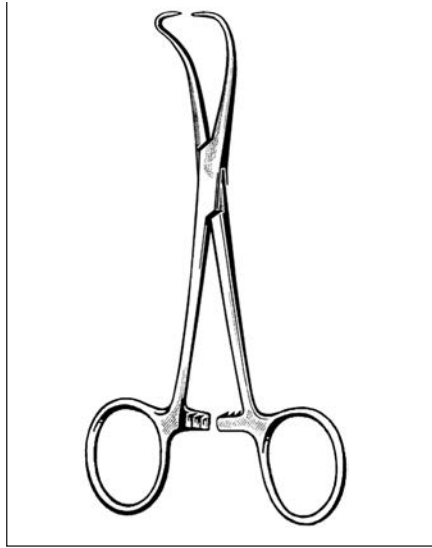

**BACKHAUS TOWEL CLAMPS**

95-606	3½"
95-611	5¼"

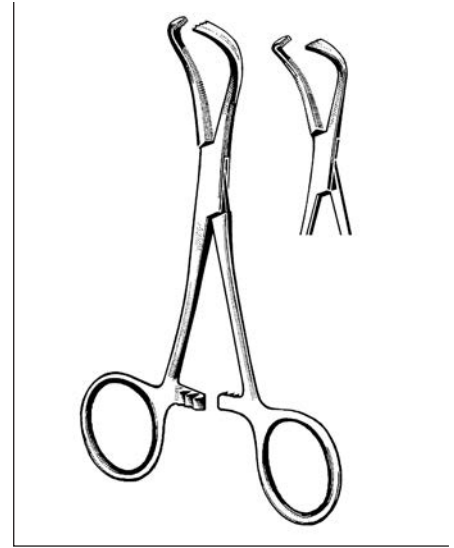

**LORNA EDNA TOWEL CLAMPS**

95-629	3½"
95-635	5¼"

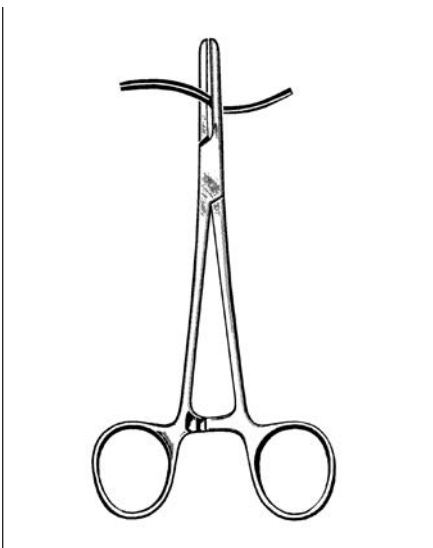

**PRESBYTERIAN TUBE  
OCCLUDING FORCEP**

95-592	7"	Straight, Smooth
--------	----	------------------

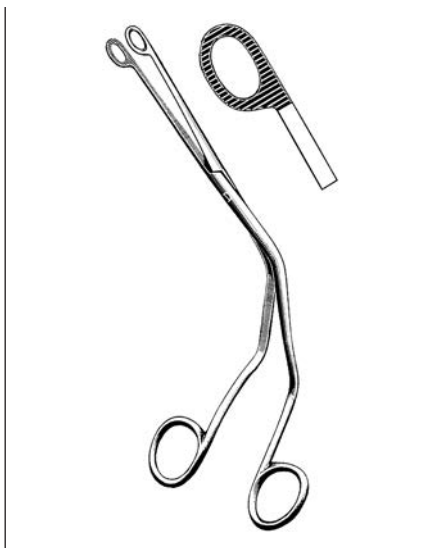

**MAGILL CATHETER FORCEP**

95-285	Child
95-289	Adult



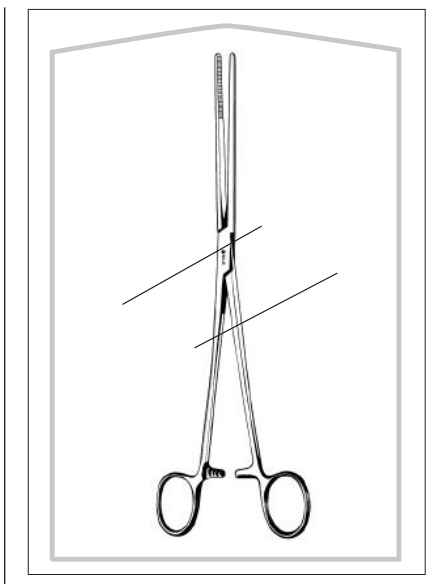

**BOZEMAN FORCEPS**

- 96-2622 10¼" S-Curve Case/25
- 96-2620 10¼" S-Curve Case/50

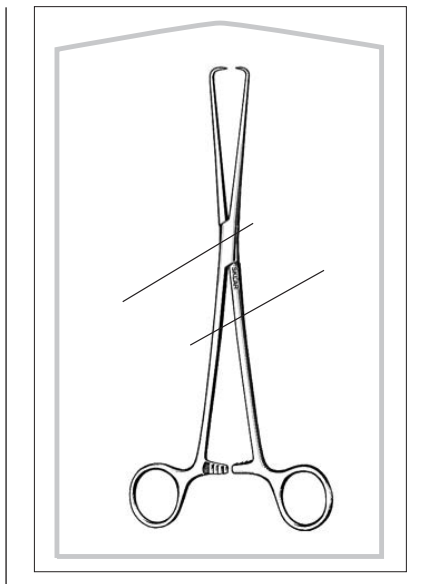

**SCHROEDER TENACULUM FORCEPS**

- 96-2624 9½" Case/25
- 96-2626 9½" Case/50

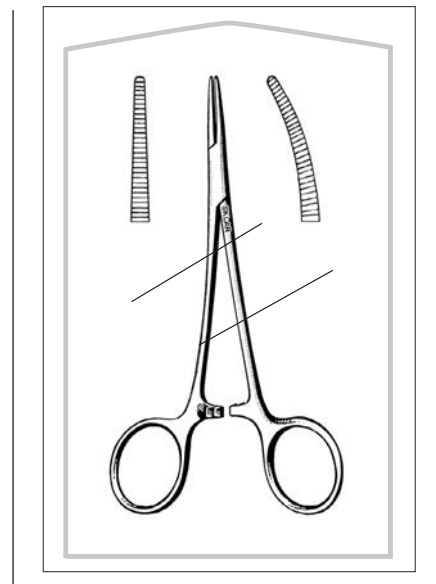

**HALSTED MOSQUITO FORCEPS**

- 96-2537 5" Straight Case/25
- 96-2539 5" Curved Case/25
- 96-2536 5" Straight Case/50
- 96-2538 5" Curved Case/50
- 96-2657 5" Straight Case/100
- 96-2658 5" Curved Case/100

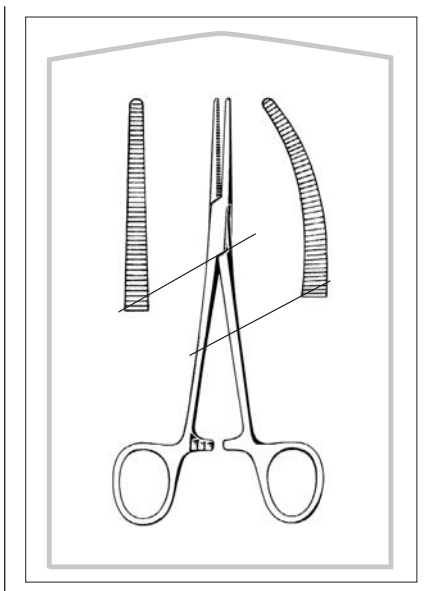

**CRILE FORCEPS**

- 96-2551 5½" Straight Case/25
- 96-2553 5½" Curved Case/25
- 96-2550 5½" Straight Case/50
- 96-2552 5½" Curved Case/50

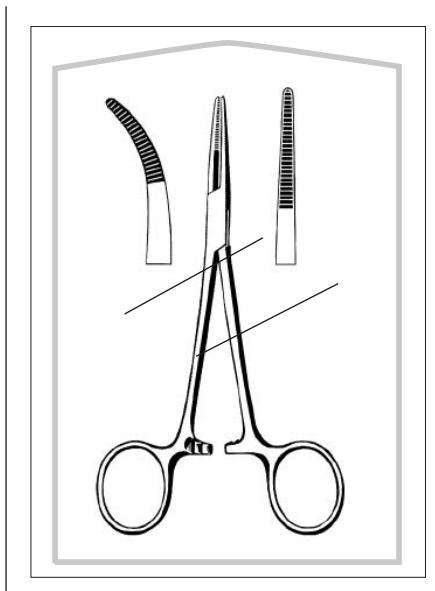

**KELLY FORCEPS**

- 96-2561 5½" Straight Case/25
- 96-2563 5½" Curved Case/25
- 96-2560 5½" Straight Case/50
- 96-2562 5½" Curved Case/50
- 96-2652 5½" Straight Case/100
- 96-2653 5½" Curved Case/100

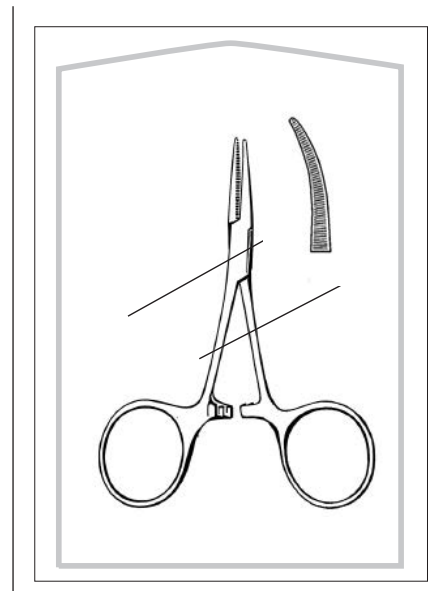

**HARTMANN FORCEPS**

- 96-2556 3½" Straight Case/25
- 96-2557 3½" Curved Case/25
- 96-2554 3½" Straight Case/50
- 96-2555 3½" Curved Case/50

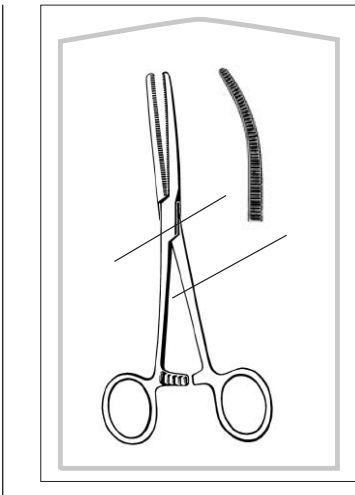

**ROCHESTER-PEAN FORCEPS**

96-2545	6¼"	Straight	Case/25
96-2547	6¼"	Curved	Case/25
96-3006	7¼"	Straight	Case/25
96-3008	7¼"	Straight	Case/25
96-2548	8½"	Curved	Case/25
96-2544	6¼"	Straight	Case/50
96-2546	6¼"	Curved	Case/50
96-2549	8½"	Curved	Case/100
96-2664	8½"	Curved	Case/100

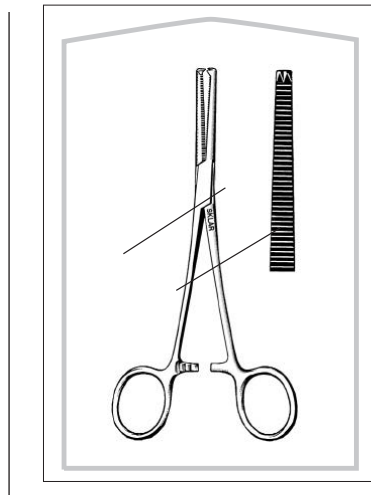

**ROCHESTER-OCHSNER FORCEPS**

96-2566	6¼"	Straight	Case/25
96-2567	6¼"	Curved	Case/25
96-2707	6¼"	Straight	Case/50
96-2708	6¼"	Curved	Case/50

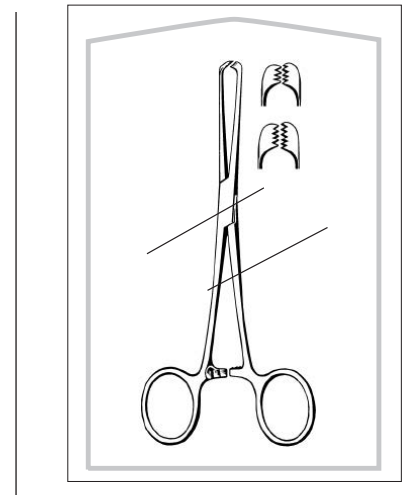

**ALLIS TISSUE FORCEPS**

96-2575	6"	4x5 Teeth	Case/25
96-2576	6"	4x5 Teeth	Case/50
96-2774	7¼"	6x7 Teeth	Case/50

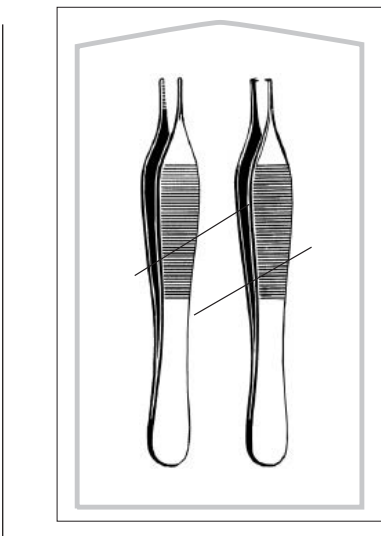

**ADSON FORCEPS**

96-2571	4¾"	Dressing	Serrated	Case/25
96-2573	4¾"	Tissue	1x2 Teeth	Case/25
96-2570	4¾"	Dressing	Serrated	Case/50
96-2572	4¾"	Tissue	1x2 Teeth	Case/50
96-2577	4¾"	Dressing	Serrated, Delicate	Case/50
96-2775	4¾"	Tissue	1x2 Teeth Delicate	Case/50
96-2655	4¾"	Dressing	Serrated	Case/100
96-2656	4¾"	Tissue	1x2 Teeth	Case/100

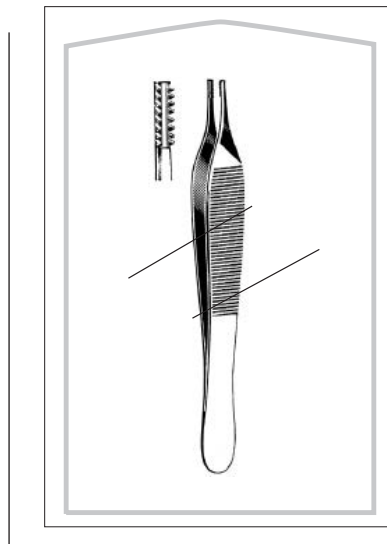

**ADSON BROWN FORCEPS**

<b>SIDE GRASPING</b>				
96-2559	4¾"			Case/25
96-2558	4¾"			Case/50

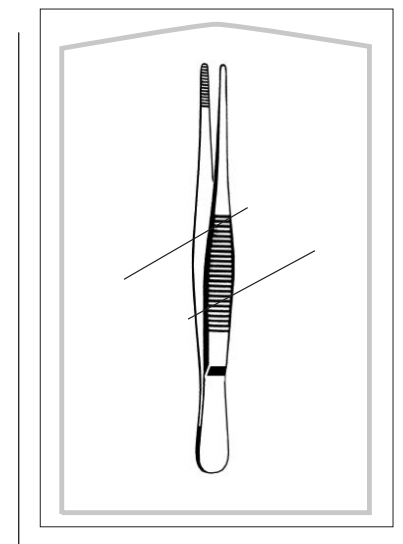

**DRESSING FORCEPS**

<b>SERRATED</b>				
96-2569	5"			Case/25
96-2921	8"			Case/25
96-2688	4½"			Case/50
96-2568	5"			Case/50
96-2660	5"			Case/100

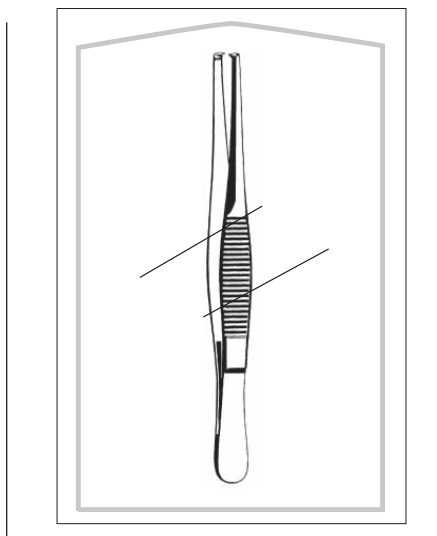

**TISSUE FORCEPS**

96-2579	5"	1x2 Teeth	Case/25
96-2578	5"	1x2 Teeth	Case/50
96-2661	5"	1x2 Teeth	Case/100

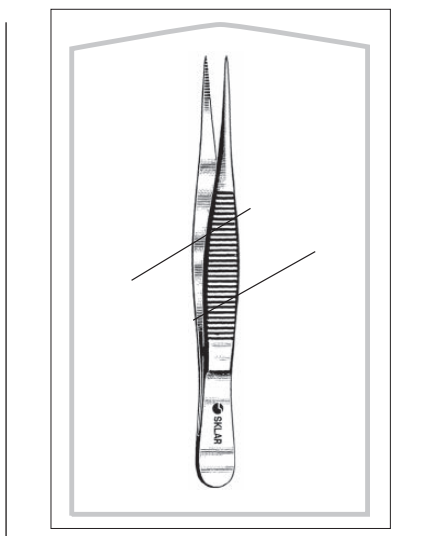

**FINE POINT SPLINTER FORCEPS**

96-2412	4½"	Case/25
96-2410	4½"	Case/50

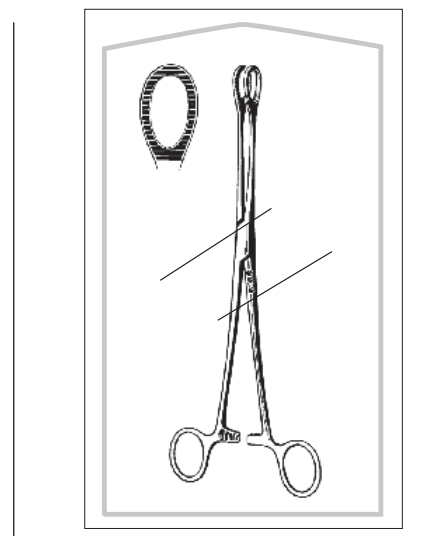

**SPONGE FORCEPS**

<b>SERRATED</b>			
96-2533	9"	Straight	Case/25
96-2532	9"	Straight	Case/50

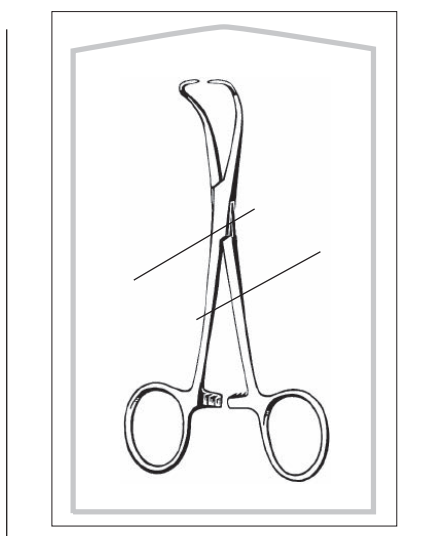

**BACKHAUS TOWEL CLAMPS**

96-2632	3½"	Straight	Case/25
96-2636	5¼"	Curved	Case/25
96-2630	3½"	Straight	Case/50
96-2634	5¼"	Curved	Case/50

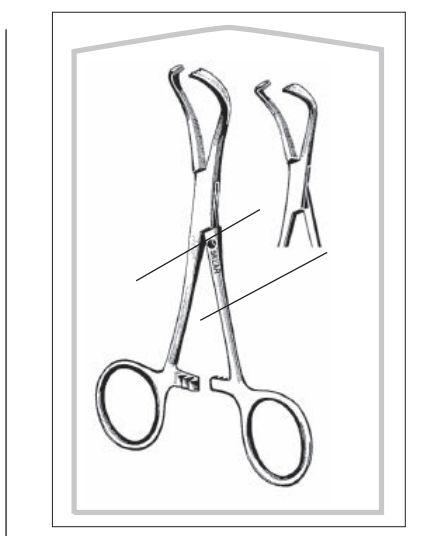

**LORNA EDNA TOWEL CLAMPS**

96-2529	3½"	Case/25
96-2528	3½"	Case/50

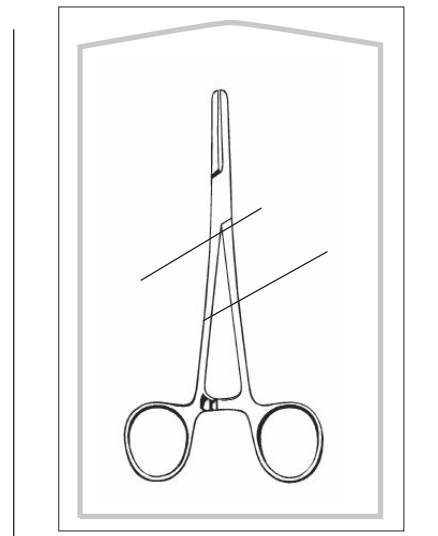

**PRESBYTERIAN TUBE OCCLUDING FORCEP**

<b>SMOOTH</b>			
96-2408	7"	Straight	Case/25
96-2406	7"	Straight	Case/50

## *needle Holders*

### **Tungsten Carbide Needle Holders** ..... Page 108

Sklar TC™ needle holders utilize solid tungsten carbide insert jaws with a Sklar pyramid profile to hold suture needles far more securely than any standard instrument. All TC inserts are virtually indestructible with an extremely hard alloy that provides exceptional control, eliminating needle rotation and slippage. These precisely ground needle holders are readily identified by the dual gold finger rings.

### **Premium Needle Holders** ..... Page 112

Sklar offers Premium instruments that have been modified to meet the needs of clinicians for specific procedures and fully guaranteed for a lifetime of dependable use.

#### **Skarlite™**

Premium Needle Holders have been reduced in their overall pattern weight to produce a lighter instrument for improved comfort that minimizes fatigue to clinicians during prolonged procedures.

#### **Skarlite Ø™**

Extra Delicate Needle Holders provide the most sensitive surgical tool as well as our lightest possible pattern while retaining its needle grasping capability and strength.

### **General Surgery Instruments** ..... Page 114

Our very best operating room, high quality needle holders are forged and finished from optimum grades of German surgical steel with finely detailed craftsmanship and exacting standards of manufacturing, including our exceptional line of Microsurgery instruments.

### **Surgi-OR™ Tungsten Carbide Instruments** ..... Page 118

A Mid-Grade line of high-quality OR instruments, hand-crafted and forged from Japanese surgical grade stainless steel, that features solid tungsten carbide insert jaws for exceptional control and unbeatable strength. Designed to give you maximum performance at affordable cost, Surgi-OR™ TC needle holders offer significant value to the Operating Room and other important surgical settings. Surgi-OR™ TC needle holders are easily identified by the dual gold finger rings.

### **Surgi-OR™ Instruments** ..... Page 119

A Mid-Grade line of high-quality OR instruments, hand-crafted and forged from Japanese surgical grade stainless steel. This cost-effective line of instruments offers significant value to the Operating Room as well as other important surgical settings.

### **Econo™ Sterile Instruments** ..... Page 120

Econo™ Sterile instruments are suitable in a number of surgical venues where economical performance is most important. Convenient, ready-to-use sterile instruments provide the very best value with the greatest utility of any surgical instrument.



**TC DERF  
NEEDLE HOLDER**

**SERRATED**

21-8004 4¾"

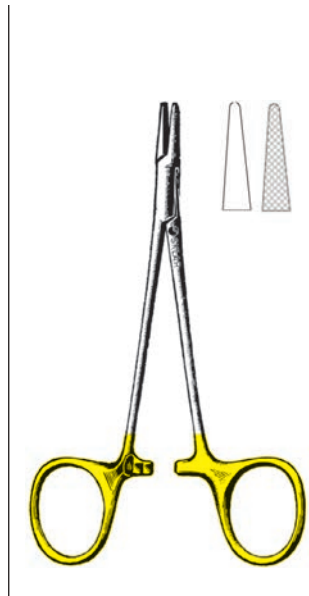

**TC WEBSTER  
NEEDLE HOLDERS**

21-8002 5¼" Smooth

21-8080 5¼" Serrated

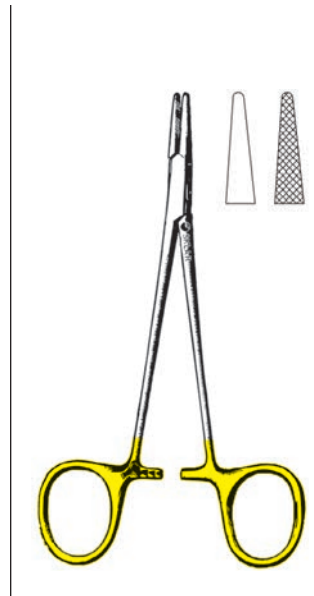

**TC HALSEY  
NEEDLE HOLDERS**

21-8000 5¼" Smooth

21-8001 5¼" Serrated



**TC OLSEN-HEGAR  
NEEDLE HOLDERS**

21-8025 4¾" Serrated, Delicate

21-8026 4¾" Smooth, Delicate

21-8027 5½" Serrated

21-8028 6½" Serrated

21-8029 7½" Serrated



**TC MATHIEU  
NEEDLE HOLDERS**

21-8070 5½"

21-8071 6¾" Narrow Jaw

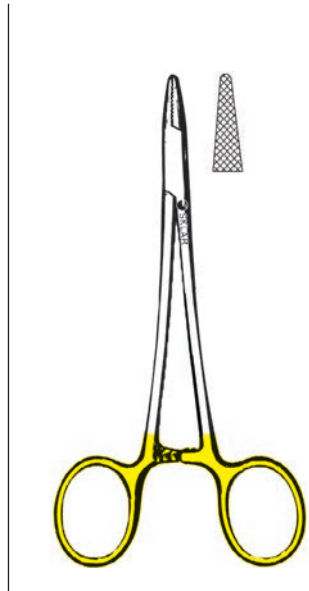

**TC BAUMGARTNER  
NEEDLE HOLDER**

**SERRATED**

21-8005 5¼"



**TC MAYO-HEGAR  
NEEDLE HOLDERS**

**SERRATED**

21-8030 5½"

21-8031 6"

21-8032 7"

21-8033 8"

21-8051 9½"

21-8034 10½"

21-8035 12"

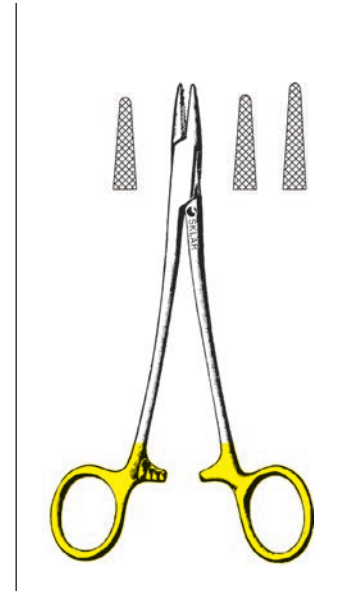

**TC CRILE-WOOD  
NEEDLE HOLDERS**

**SERRATED**

21-8006 6" Narrow

21-8007 7" DeBakey

21-8008 8" DeBakey

21-8009 9" DeBakey

21-8010 10½" DeBakey

21-8011 12" DeBakey

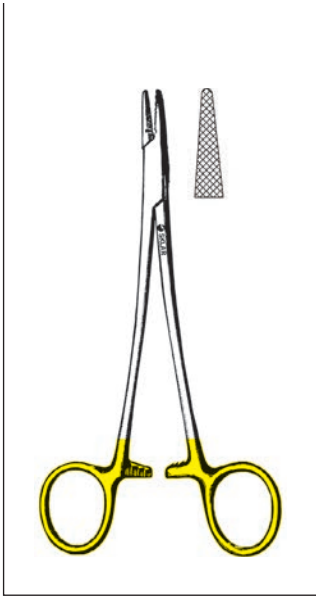

**TC CRILE-MURRAY  
NEEDLE HOLDER**

**SERRATED**

21-8075 6"

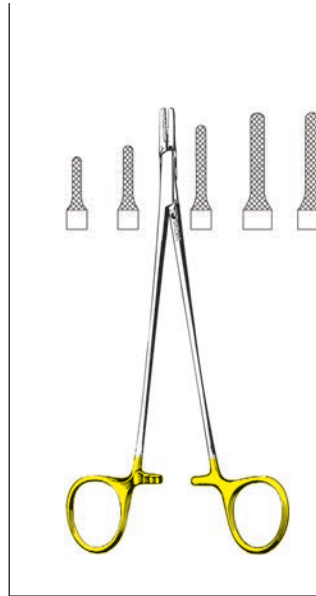

**TC RYDER  
NEEDLE HOLDERS**

**SERRATED**

21-8019 5"  
21-8020 6"  
21-8021 7"  
21-8022 8"  
21-8023 9"

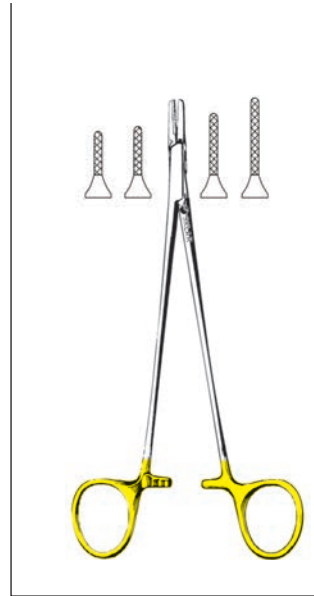

**TC RYDER  
NEEDLE HOLDERS**

**MICRO SERRATED**

21-8012 5"  
21-8013 6"  
21-8014 7"  
21-8016 9"

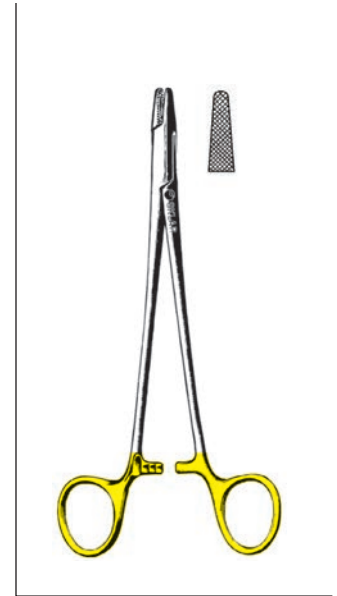

**TC NEW ORLEANS  
NEEDLE HOLDER**

**SERRATED**

21-8082 7"

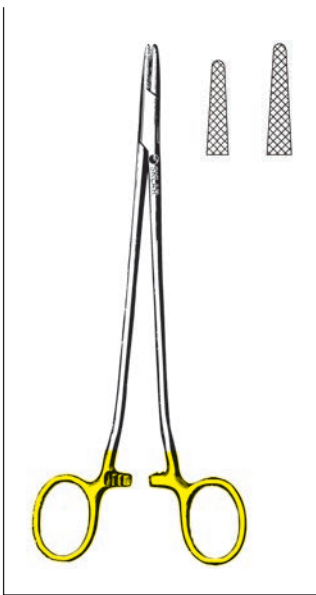

**TC SAROT  
NEEDLE HOLDERS**

21-8036 7 1/8" Serrated  
21-8037 10 1/2" Serrated

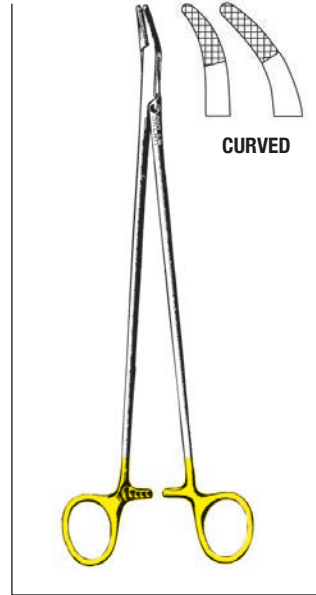

**TC HEANEY  
NEEDLE HOLDERS**

21-8060 8 1/4" Serrated, Curved  
21-8061 10" Serrated, Curved

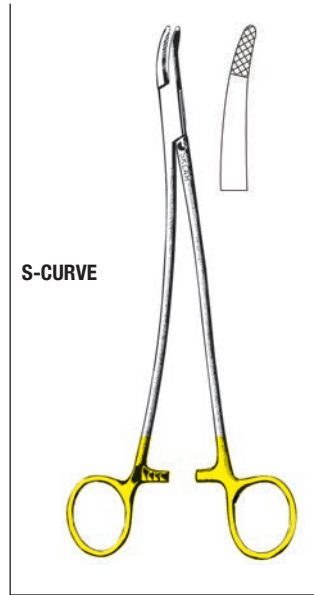

**TC STRATTE  
NEEDLE HOLDER**

21-8065 9" Serrated,  
S-Curve

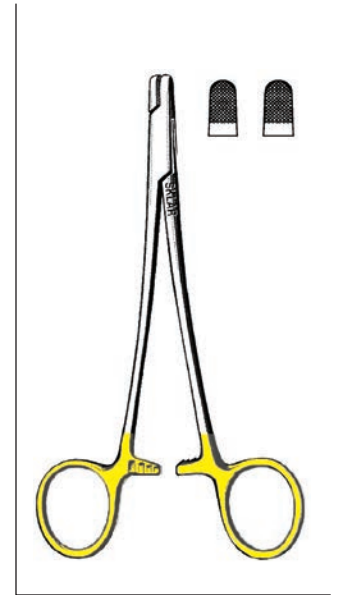

**TC STERNAL WIRE  
TWISTERS**

21-9060 5"  
21-9065 7"

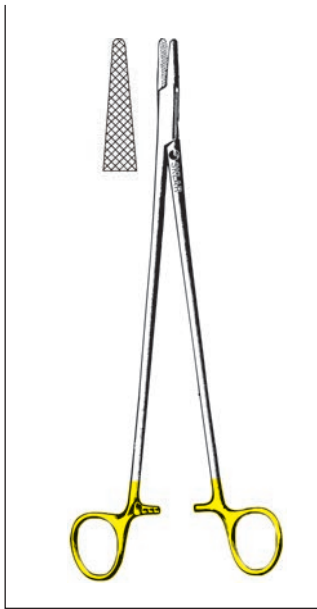

**TC WANGENSTEEN  
NEEDLE HOLDER**

**SERRATED**  
21-3510 10½"

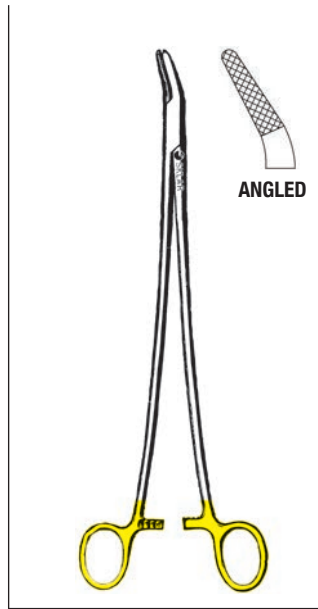

**TC FINOCHIETTO  
NEEDLE HOLDER**

**SERRATED**  
21-8039 10½"



**TC NEIVERT  
NEEDLE HOLDER**

**SERRATED**  
21-8086 5" One Offset Ring



**TC GILLIES  
NEEDLE HOLDER**

**SERRATED**  
21-2662 6"



**TC CASTROVIEJO  
NEEDLE HOLDERS**

21-8040 5½" Smooth, Straight  
21-8046 5½" Serrated, Straight  
21-8047 5½" Serrated, Curved

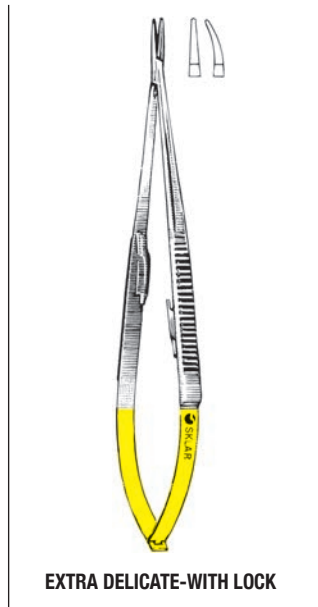

**TC CASTROVIEJO  
NEEDLE HOLDERS**

21-8042 5½" Smooth, Straight  
21-8043 5½" Smooth, Curved

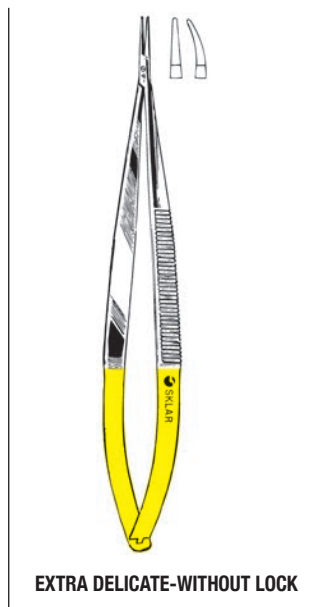

**TC CASTROVIEJO  
NEEDLE HOLDERS**

21-8044 5½" Smooth, Straight  
21-8045 5½" Smooth, Curved

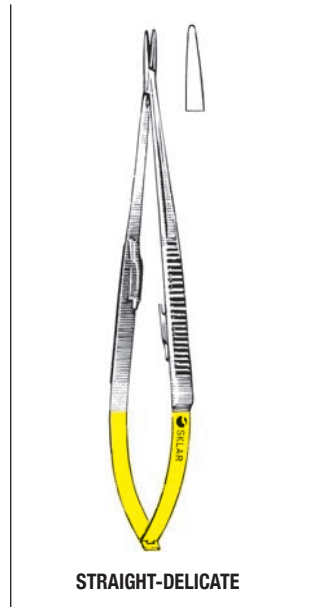

**TC JACOBSON  
NEEDLE HOLDERS**

21-8055 8¼" Smooth w/Lock  
21-8058 8¼" Smooth w/o Lock  
21-8059 9¼" Smooth w/Lock

## ***Sklar's Left-Handed needle Holder S***

Now there's a ring-handled needle holder created for the needs of left-handed surgeons.

Sklar's left-handed needle holder features a unique ratchet design that makes it possible for surgeons to easily control the needle holder with their left hand. As a result surgeons experience less fatigue and hand strain than ever before.

***Suitable for Left Hand use***

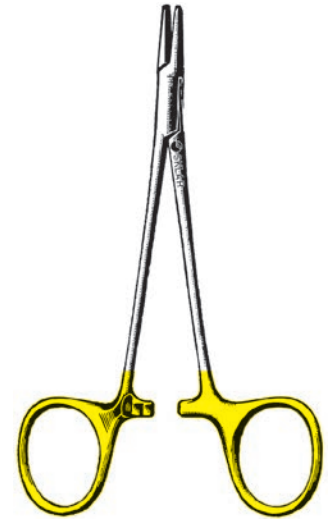

**TC WEBSTER NEEDLE HOLDER**

**SMOOTH**

21-9012 5" Left Handed



**TC MAYO-HEGAR  
NEEDLE HOLDERS**

**SERRATED**

21-9016 6" Left Handed

21-9018 7" Left Handed



**TC CRILE-WOOD  
NEEDLE HOLDERS**

**SERRATED**

21-9030 6" Left Handed

21-9035 7" Left Handed



**TC RYDER NEEDLE HOLDER**

**SERRATED**

21-9045 6" Left Handed



SKLARLITE  
THE LIGHT TOUCH

**SKLARLITE™  
DERF NEEDLE HOLDER**

23-2124 4¾" Serrated



SKLARLITE XD  
EXTRA DELICATE

**SKLARLITE  
EXTRA DELICATE™  
DERF NEEDLE HOLDER**

23-2224 4¾" Serrated

SKLARLITE  
THE LIGHT TOUCH

**SKLARLITE™  
WEBSTER  
NEEDLE HOLDER**

23-2125 5¼" Smooth  
23-2120 5¼" Serrated

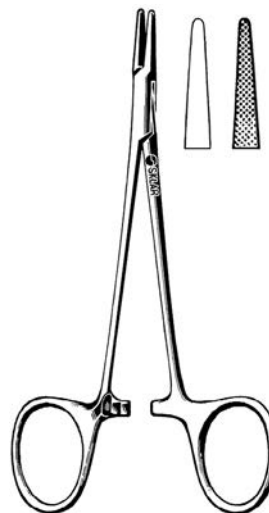

SKLARLITE XD  
EXTRA DELICATE

**SKLARLITE  
EXTRA DELICATE™  
WEBSTER  
NEEDLE HOLDER**

23-2225 5¼" Smooth  
23-2220 5¼" Serrated

SKLARLITE  
THE LIGHT TOUCH

**SKLARLITE™  
HALSEY  
NEEDLE HOLDER**

23-2135 5¼" Smooth  
23-2130 5¼" Serrated

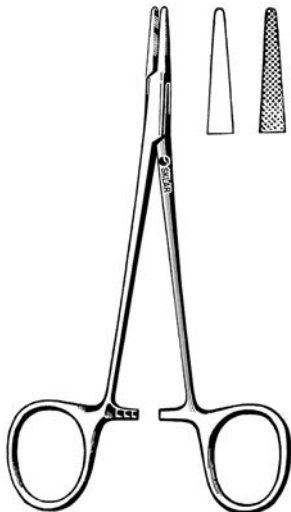
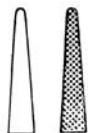

SKLARLITE XD  
EXTRA DELICATE

**SKLARLITE  
EXTRA DELICATE™  
HALSEY  
NEEDLE HOLDER**

23-2235 5¼" Smooth  
23-2230 5¼" Serrated

SKLARLITE  
THE LIGHT TOUCH

**SKLARLITE™  
OLSEN-HEGAR  
NEEDLE HOLDER**

23-2136 5½" Serrated



SKLARLITE XD  
EXTRA DELICATE

**SKLARLITE™  
EXTRA DELICATE  
OLSEN-HEGAR  
NEEDLE HOLDER**

23-2236 5½" Serrated



SKLARLITE  
THE LIGHT TOUCH

**SKLARLITE™  
CRILE-WOOD  
NEEDLE HOLDER**

23-2134 6" Serrated

SKLARLITE XD  
EXTRA DELICATE

**SKLARLITE  
EXTRA DELICATE™  
CRILE-WOOD  
NEEDLE HOLDER**

23-2234 6" Serrated

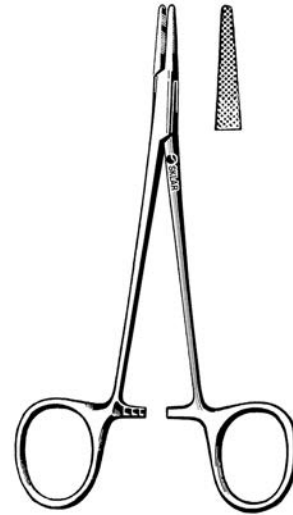

SKLARLITE  
THE LIGHT TOUCH

**SKLARLITE™  
BAUMGARTNER  
NEEDLE HOLDER**

23-2132 5½" Serrated

SKLARLITE XD  
EXTRA DELICATE

**SKLARLITE™  
EXTRA DELICATE  
BAUMGARTNER  
NEEDLE HOLDER**

23-2232 5½" Serrated

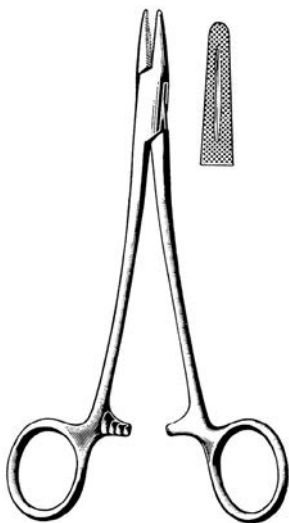

SKLARLITE  
THE LIGHT TOUCH

**SKLARLITE™  
MAYO-HEGAR  
NEEDLE HOLDER**

23-2128 7" Serrated

SKLARLITE XD  
EXTRA DELICATE

**SKLARLITE  
EXTRA DELICATE™  
MAYO-HEGAR  
NEEDLE HOLDER**

23-2228 7" Serrated

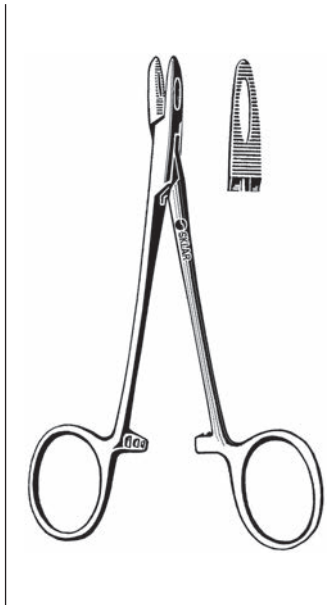

**COLLIER  
NEEDLE HOLDER**  
65-6550 5¼" Serrated,  
Fenestrated Jaw



**DERF NEEDLE HOLDER**  
20-1547 4¾" Serrated

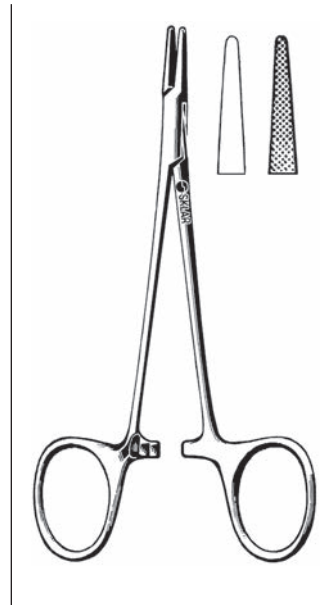

**WEBSTER  
NEEDLE HOLDER**  
20-1350 5¼" Smooth  
20-1352 5¼" Serrated  
20-3090 5¼" Smooth, Heavy

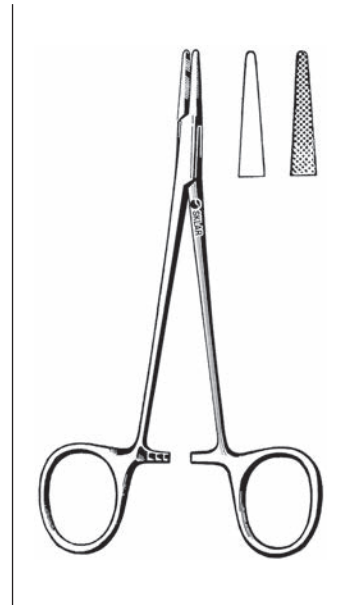

**HALSEY NEEDLE HOLDER**  
20-1750 5¼" Smooth  
20-1751 5¼" Serrated

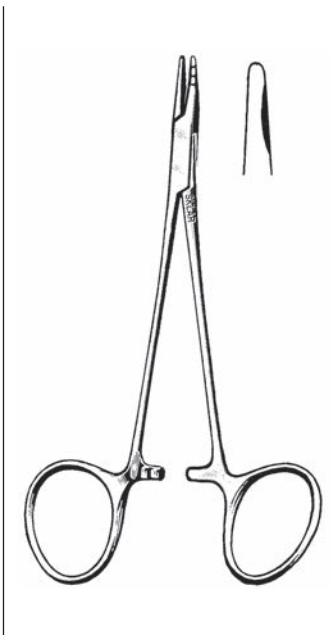

**NEIVERT  
NEEDLE HOLDER**  
20-1760 5" 1 Offset Ring

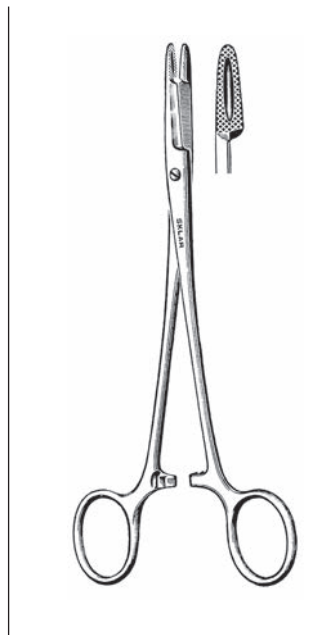

**OLSEN-HEGAR  
NEEDLE HOLDER**  
20-2747 4¾" Serrated, Delicate  
20-2748 4¾" Smooth, Delicate  
20-2755 5½" Serrated  
20-2765 6½" Serrated  
20-2775 7" Serrated



**CONVERSE  
NEEDLE HOLDER**  
20-3350 5" Serrated,  
Longitudinal



**BROWN NEEDLE HOLDER  
HORIZONTAL SERRATIONS**  
20-4852 5¼" Rounded Jaws  
20-4867 6¾" Rounded Jaws



**MATHIEU  
NEEDLE HOLDER**

20-3055 5½" Serrated  
20-3075 7½" Serrated

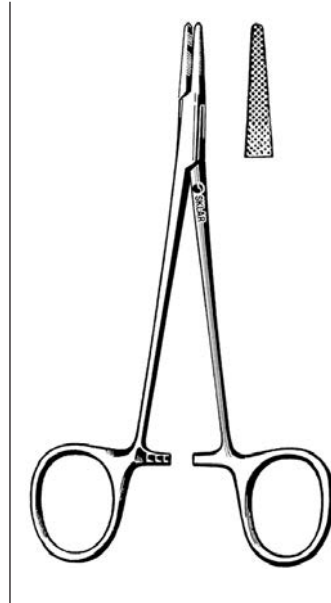

**BAUMGARTNER  
NEEDLE HOLDER**

20-1450 5¼" Serrated

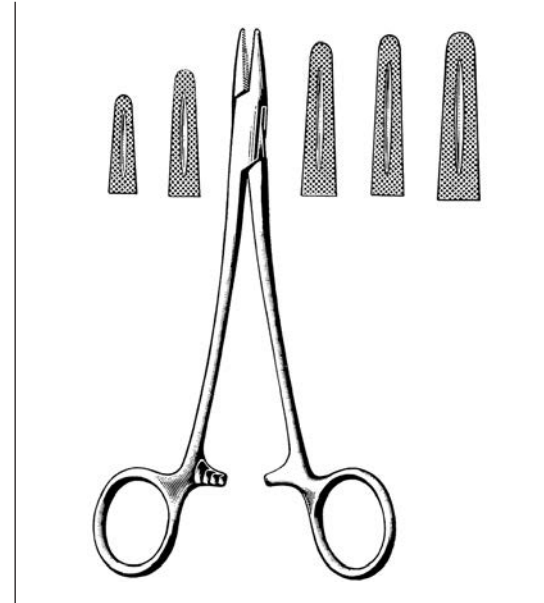

**MAYO-HEGAR NEEDLE HOLDER**

**SERRATED**

20-2052 5¼"	20-2480 8"
20-2060 6"	20-2490 9½"
20-2070 7"	20-2910 10½" Masson
20-2270 7" Broad Jaw	20-2911 11½" Masson



**CRILE-WOOD NEEDLE HOLDER**

**SERRATED**

20-1265 6" Narrow Jaws  
20-1270 7"  
20-1280 8"  
20-1290 9"  
20-1295 10½"

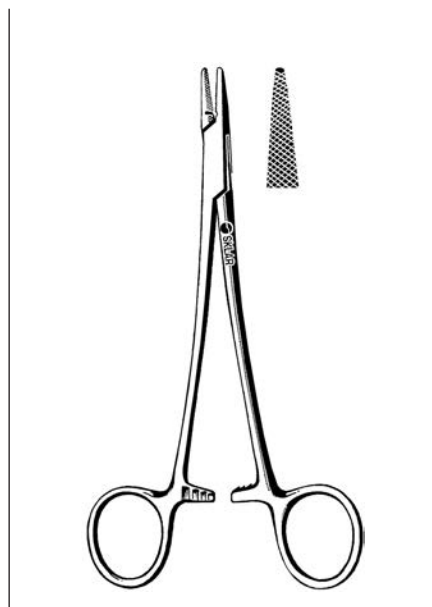

**CRILE-MURRAY NEEDLE HOLDER**

20-1260 6" Serrated

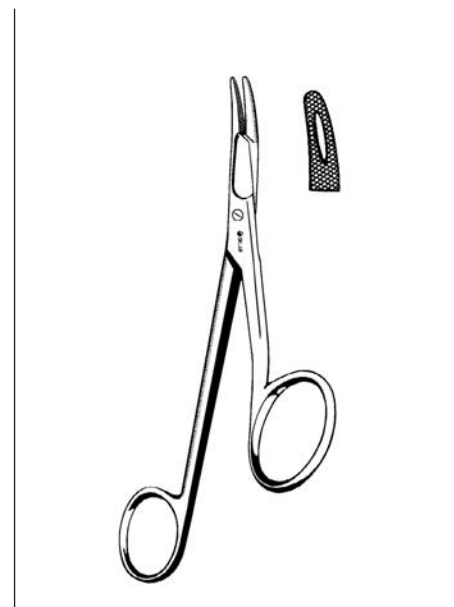

**GILLIES NEEDLE HOLDER**

20-2662 6" Serrated

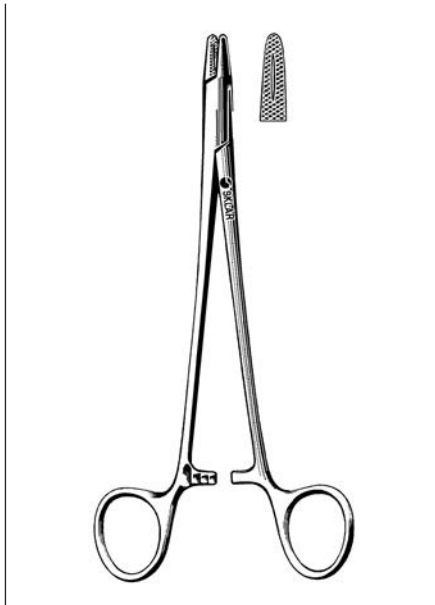

**NEW ORLEANS NEEDLE HOLDER**

20-1870 7" Serrated

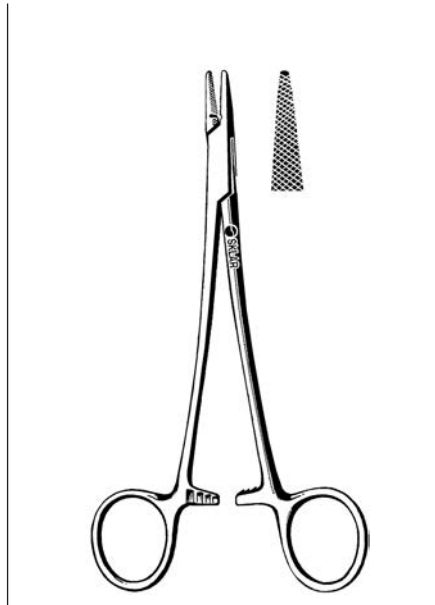

**CRILE NEEDLE HOLDER**

20-1160 6" Serrated

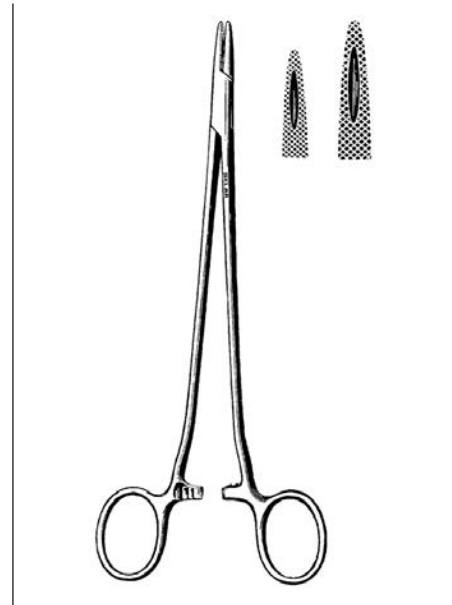

**SAROT NEEDLE HOLDER**

22-5050 5" Serrated  
20-4170 7 1/8" Serrated  
20-3910 10 1/4" Serrated

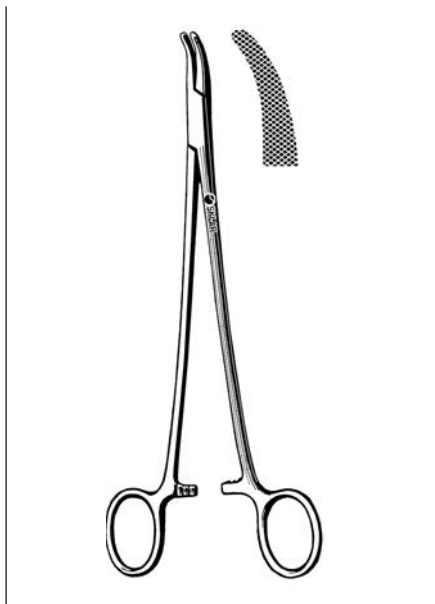

**HEANEY NEEDLE HOLDER**

20-4682 8 1/4" Serrated, Curved

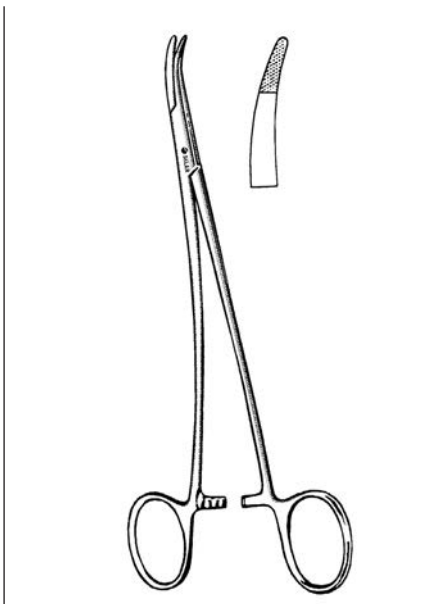

**STRATTE NEEDLE HOLDER**

20-4795 9" Serrated, S-Curve

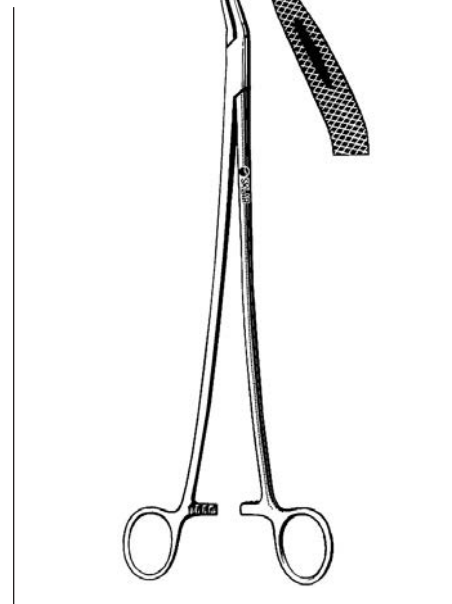

**FINOCHIETTO NEEDLE HOLDER**

20-4510 10 1/4" Serrated, Angular

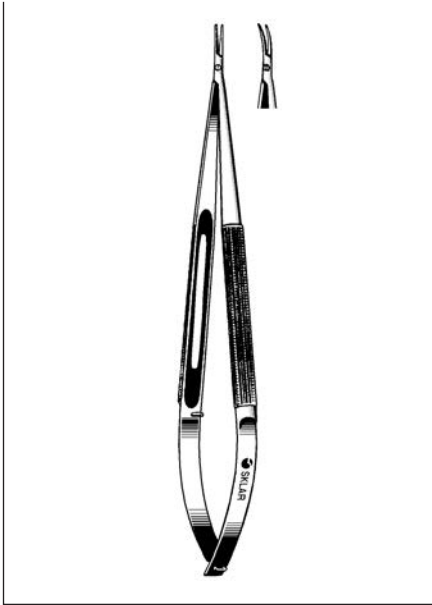

**MICRO SURGERY  
NEEDLE HOLDERS**  
ROUND HANDLE WITHOUT LOCK

98-3180	5¼"	Curved
98-3186	7⅞"	Straight
98-3188	7⅞"	Curved



**MICRO SURGERY  
NEEDLE HOLDERS**  
ROUND HANDLE WITH LOCK

98-3190	7⅞"	Straight
98-3192	7⅞"	Curved

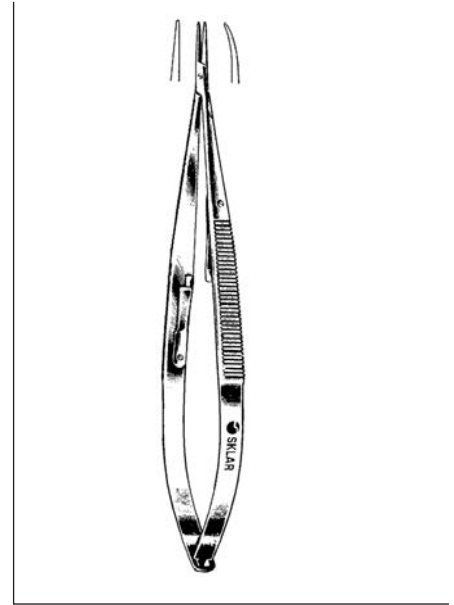

**CASTROVIEJO  
NEEDLE HOLDERS**

65-6350	5¼"	Straight w/o Lock
65-6352	5¼"	Straight w/Lock
65-6354	5¼"	Curved w/Lock

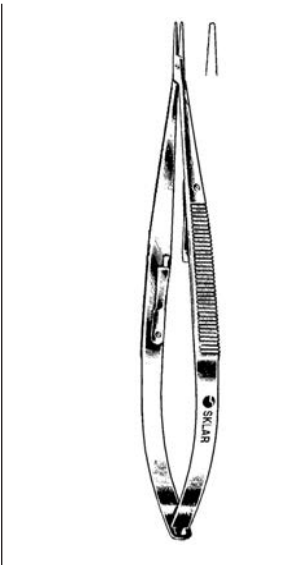

**CASTROVIEJO  
NEEDLE HOLDERS**  
WITH LOCK

65-6357	5½"	Straight
65-6358	5½"	Curved

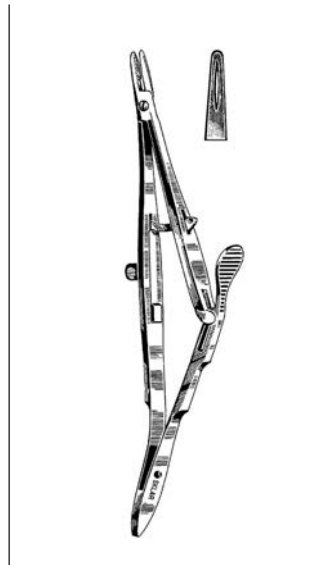

**CASTROVIEJO KALT  
NEEDLE HOLDERS**

65-6055	5½"	Serrated
---------	-----	----------



**BARRAQUER  
NEEDLE HOLDERS**  
WITHOUT CATCH

65-6452	5¼"	Curved, Delicate
---------	-----	------------------

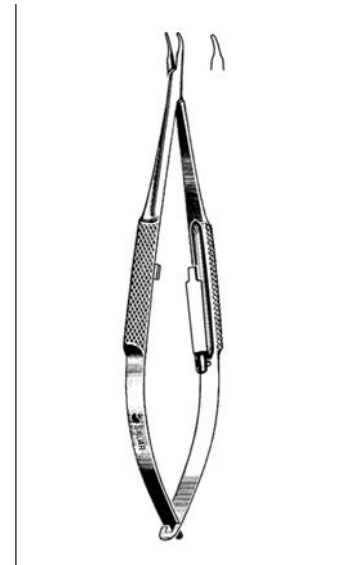

**BARRAQUER  
NEEDLE HOLDERS**  
WITH CATCH

65-6448	5¼"	Curved, Delicate
65-6446	5½"	Curved, Delicate

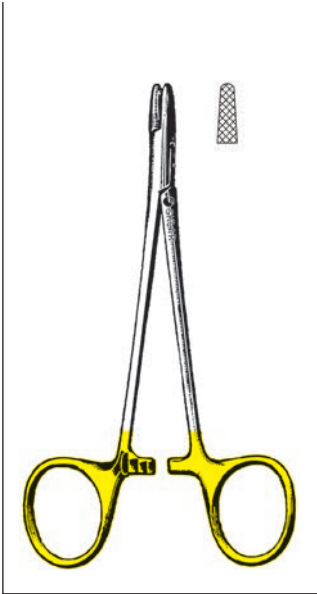

**TC DERF NEEDLE HOLDER**  
95-136 4¾" Serrated

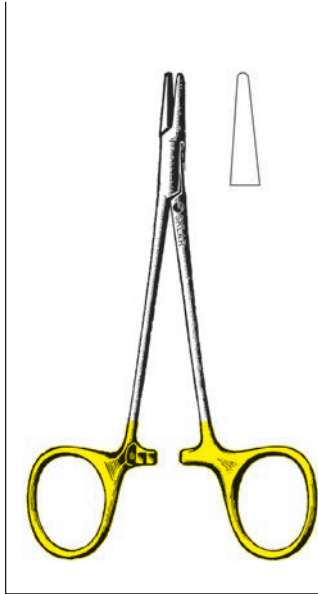

**TC WEBSTER NEEDLE HOLDER**  
95-130 5¼" Smooth

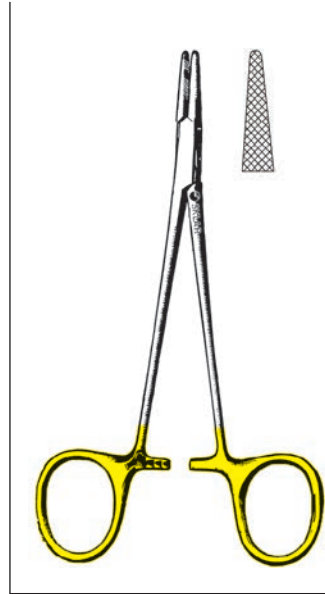

**TC HALSEY NEEDLE HOLDER**  
95-132 5¼" Smooth  
95-133 5¼" Serrated

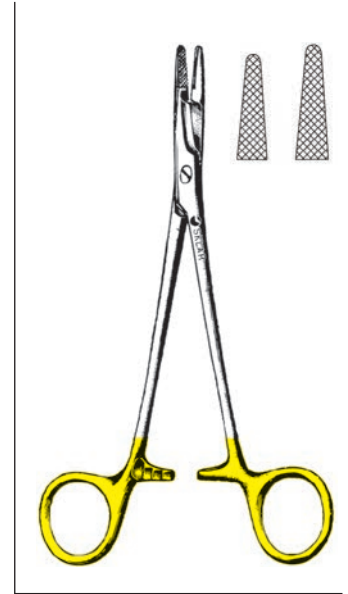

**TC OLSEN-HEGAR NEEDLE HOLDERS**  
95-146 4¾" Serrated, Delicate  
95-147 5½" Serrated  
95-148 6½" Serrated, Delicate  
95-149 7½" Serrated

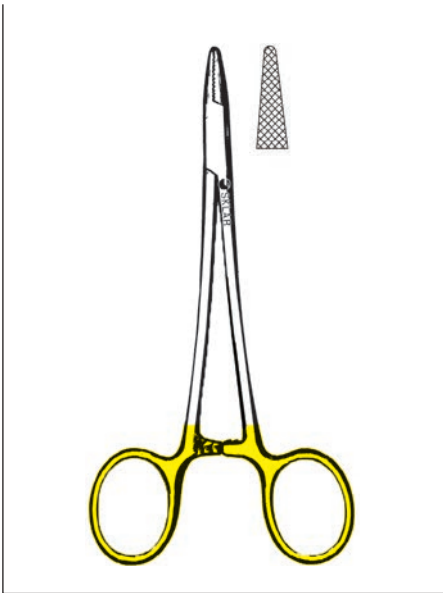

**TC BAUMGARTNER NEEDLE HOLDER**  
95-135 5¼" Serrated

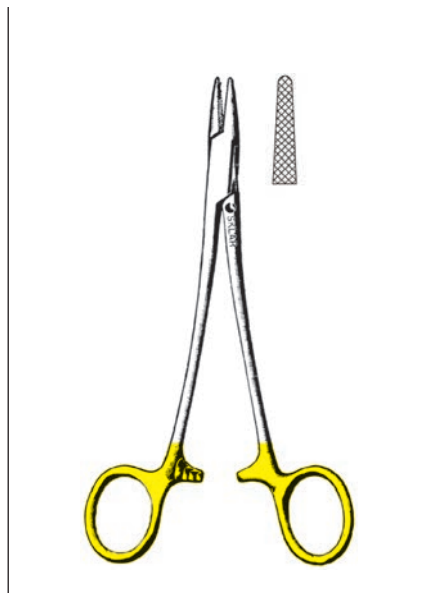

**TC MAYO-HEGAR NEEDLE HOLDERS**  
**SERRATED**  
95-140 5¼"  
95-141 6"  
95-142 7"  
95-143 8"

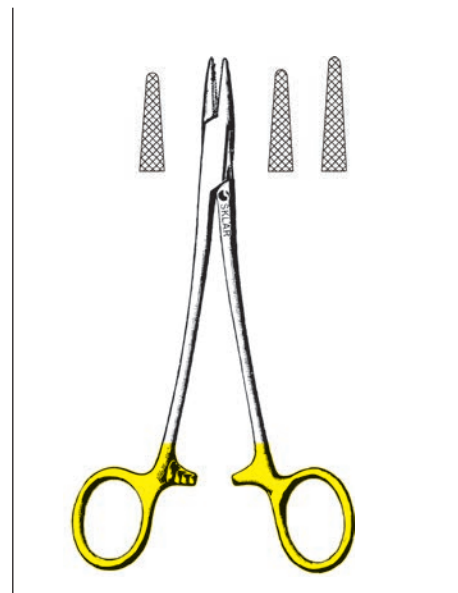

**TC CRILE-WOOD NEEDLE HOLDERS**  
**SERRATED**  
95-137 6" Narrow  
95-138 7" DeBaKey  
95-139 8" DeBaKey



**DERF NEEDLE HOLDER**

95-826 4¾" Serrated

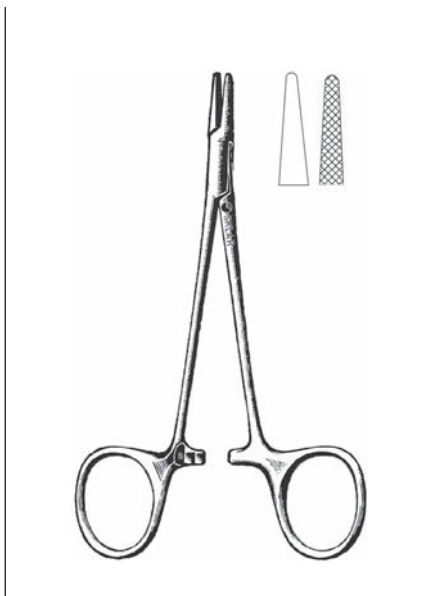

**WEBSTER NEEDLE HOLDERS**

95-809 5¼" Smooth  
95-813 5¼" Serrated

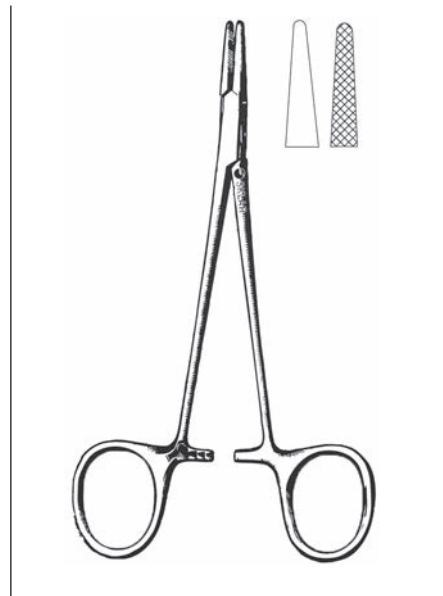

**HALSEY NEEDLE HOLDERS**

95-810 5¼" Smooth  
95-812 5¼" Serrated

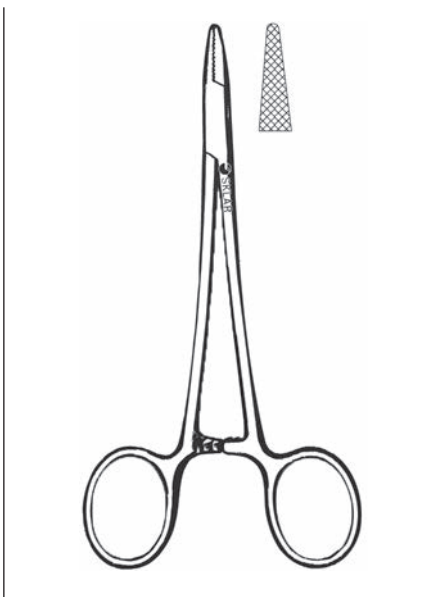

**BAUMGARTNER NEEDLE HOLDER**

95-832 5¼" Serrated

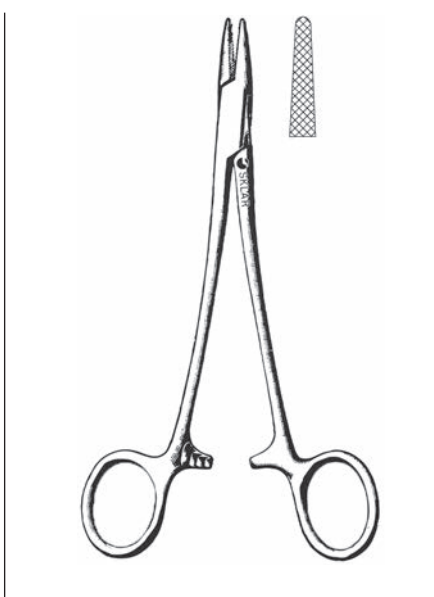

**MAYO-HEGAR NEEDLE HOLDERS**

**SERRATED**  
95-842 5¼"  
95-847 6"  
95-853 7"  
95-869 8"



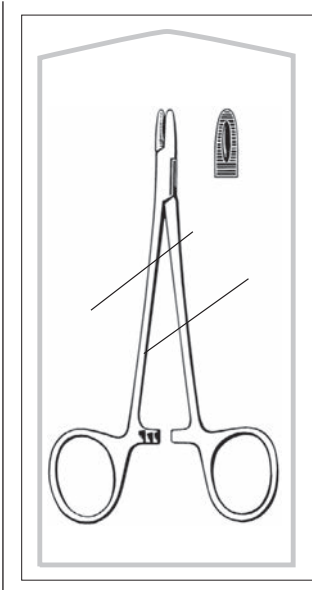

**DERF NEEDLE HOLDERS**

- 96-2583 4¾" Serrated 25/cs
- 96-2582 4¾" Serrated 50/cs

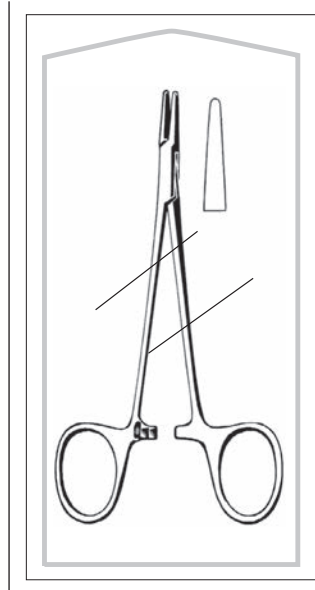

**WEBSTER NEEDLE HOLDERS**

- 96-2587 5¼" Smooth 25/cs
- 96-2586 5¼" Smooth 50/cs
- 96-2659 5¼" Smooth 100/cs

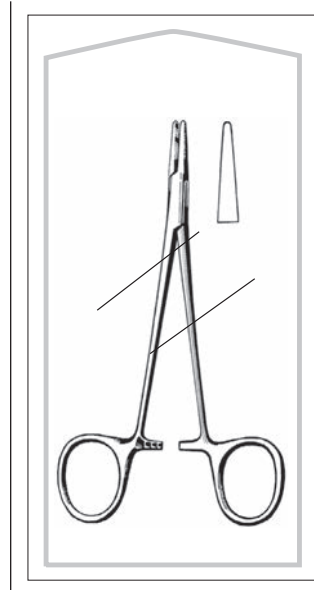

**HALSEY NEEDLE HOLDERS**

- 96-2585 5" Smooth 25/cs
- 96-2584 5" Smooth 50/cs

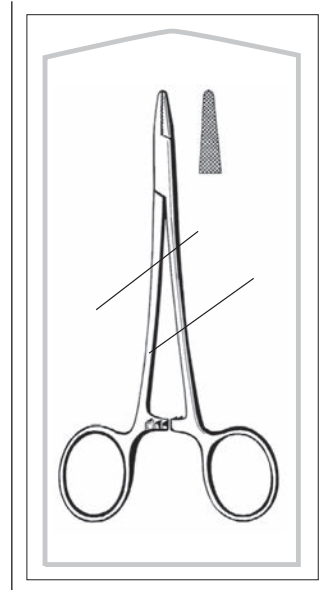

**BAUMGARTNER NEEDLE HOLDERS**

- 96-2581 5½" Serrated 25/cs
- 96-2580 5½" Serrated 50/cs

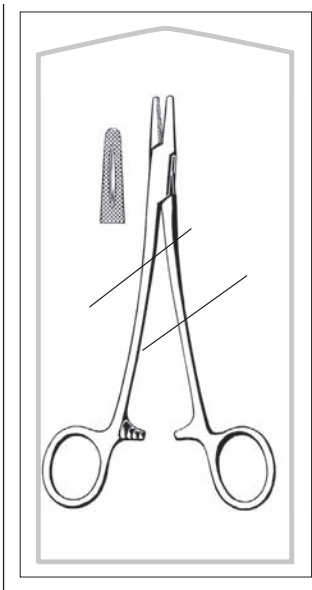

**MAYO-HEGAR NEEDLE HOLDERS**

- 96-2595 6" Serrated 25/cs
- 96-2594 6" Serrated 50/cs

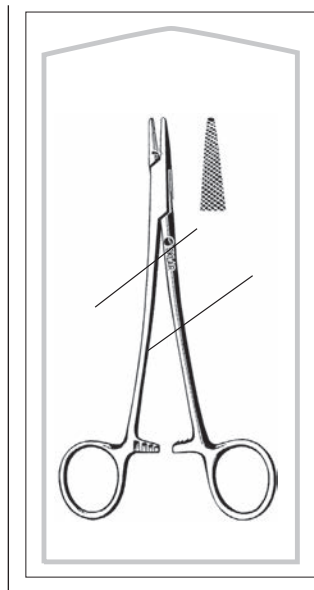

**CRILE-WOOD NEEDLE HOLDERS**

- 96-2591 6" Serrated 25/cs
- 96-2590 6" Serrated 50/cs

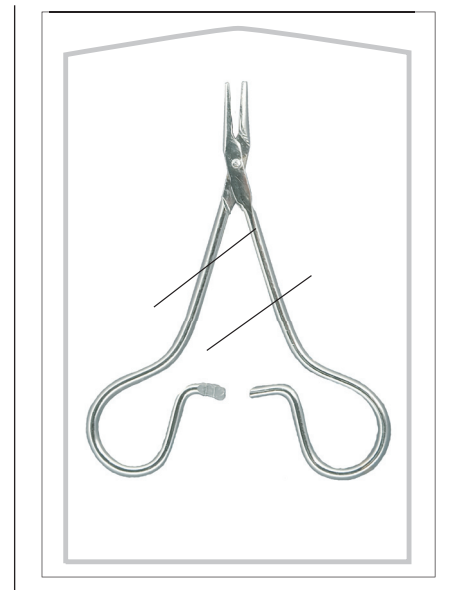

**WIREFORM NEEDLE HOLDERS**

- 96-8968 5¼" Smooth 50/cs
- 96-8974 5¼" Serrated 50/cs

**SKLARTECH 5000**

The Sklartech 5000 Laparoscopic Instrument line provides a full range of the most popular patterns. Instruments can be purchased as a complete set or individually. When purchased as a complete instrument, Sklartech Laparoscopic Scissors, Dissectors and Forceps include the insert with tip, insulated cannula and carbon fiber handle with locking collar.

**SKLARTECH 5000****INSULATED SHAFT**

Vital protection against electro-surgical transfer.

**INSERT WITH TIP**

Easily separated from cannula for cleaning and reprocessing with convenient screw design.

**HANDLE**

Comfortable carbon fiber ring construction allows for precise hold of tissue. Choose from ratchet (YC) or non-ratcheted (XC) designs.

**LOCKING COLLAR**

Features 360° rotation for ideal jaw position. Activate lock to provide tension and prevent accidental movement.

As with all Sklar complete Laparoscopic instruments, the handles and replacement inserts are easily interchangeable to perform as intended and required by the surgeon. Each Sklartech 5000 scope is constructed of the highest quality German grade stainless steel to provide reliable durability and ease of use.

**PERITONEAL SCISSORS**

COMPLETE INSTRUMENT	REPLACEMENT	DIAMETER	LENGTH	FEATURES
31-9026XC	31-9026	5mm	33cm	Straight, Blunt Tips, XC Handle



**OPERATING SCISSORS**

COMPLETE INSTRUMENT	REPLACEMENT INSERT	DIAMETER	LENGTH	FEATURES
31-9027XC	31-9027	10mm	33cm	Straight, XC Handle



**METZENBAUM SCISSORS**

COMPLETE INSTRUMENT	REPLACEMENT INSERT	DIAMETER	LENGTH	FEATURES
31-9005XC	31-9005	5mm	33cm	Straight, XC Handle
31-9005YC	31-9005	5mm	33cm	Straight, YC Handle



COMPLETE INSTRUMENT	REPLACEMENT INSERT	DIAMETER	LENGTH	FEATURES
31-9010XC	31-9010	5mm	33cm	Curved, XC Handle
31-9010XC-45	31-9010-45	5mm	45cm	Curved, XC Handle



COMPLETE INSTRUMENT	REPLACEMENT INSERT	DIAMETER	LENGTH	FEATURES
31-9012XC	31-9012	5mm	33cm	Curved, Serrated, XC Handle
31-9012XC-45	31-9012-45	5mm	45cm	Curved, Serrated, XC Handle



**HOOK SCISSORS**

COMPLETE INSTRUMENT	REPLACEMENT INSERT	DIAMETER	LENGTH	FEATURES
31-9016XC	31-9016	5mm	33cm	Standard, Flush Tips, XC Handle



COMPLETE INSTRUMENT	REPLACEMENT INSERT	DIAMETER	LENGTH	FEATURES
31-9015XC	31-9015	5mm	33cm	Sharp Cutting Edge, Overlapping Tips, XC Handle
31-9015XC-45	31-9015-45	5mm	45cm	Sharp Cutting Edge, Overlapping Tips, XC Handle



**MICRO SCISSORS**

COMPLETE INSTRUMENT	REPLACEMENT INSERT	DIAMETER	LENGTH	FEATURES
31-9020XC	31-9020	5mm	33cm	Straight, Extremely Delicate, XC Handle



COMPLETE INSTRUMENT	REPLACEMENT INSERT	DIAMETER	LENGTH	FEATURES
31-9025XC	31-9025	5mm	33cm	Curved, Extremely Delicate, XC Handle



**MARYLAND DISSECTORS**

COMPLETE INSTRUMENT	REPLACEMENT INSERT	DIAMETER	LENGTH	FEATURES
31-9030XC	31-9030	5mm	33cm	Cross Serration, XC Handle
31-9030XC-45	31-9030-45	5mm	45cm	Cross Serration, XC Handle



COMPLETE INSTRUMENT	REPLACEMENT INSERT	DIAMETER	LENGTH	FEATURES
31-9031XC	31-9031	5mm	33cm	Diamond Serration, XC Handle
31-9120XC	31-9120	10mm	33cm	Diamond Serration, XC Handle

**MIXTER FORCEPS**

COMPLETE INSTRUMENT	REPLACEMENT INSERT	DIAMETER	LENGTH	FEATURES
31-9033XC	31-9033	5mm	33cm	90° Angle, Cross Serration, XC Handle



COMPLETE INSTRUMENT	REPLACEMENT INSERT	DIAMETER	LENGTH	FEATURES
31-9035XC	31-9035	5mm	33cm	90° Angle, Diamond Serration, XC Handle
31-9125XC	31-9125	10mm	33cm	90° Angle, Diamond Serration, XC Handle
31-9125XC-45	31-9125-45	10mm	45cm	90° Angle, Diamond Serration, XC Handle

**DISSECTING FORCEPS**

COMPLETE INSTRUMENT	REPLACEMENT INSERT	DIAMETER	LENGTH	FEATURES
31-9036XC	31-9036	5mm	33cm	Curved, Serrated, XC Handle

**DOLPHIN FORCEPS**

COMPLETE INSTRUMENT	REPLACEMENT INSERT	DIAMETER	LENGTH	FEATURES
31-9040XC	31-9040	5mm	33cm	Short, XC Handle



**KELLY FORCEP**

COMPLETE INSTRUMENT	REPLACEMENT INSERT	DIAMETER	LENGTH	FEATURES
31-9043XC	31-9043	5mm	33cm	Double Action, XC Handle



**GLASSMANN FORCEP**

COMPLETE INSTRUMENT	REPLACEMENT INSERT	DIAMETER	LENGTH	FEATURES
31-9096YC	31-9096	5mm	33cm	Atraumatic Clamp, YC Handle



**TENACULUM FORCEP**

COMPLETE INSTRUMENT	REPLACEMENT INSERT	DIAMETER	LENGTH	FEATURES
31-9111YC	31-9111	5mm	33cm	1x1 Sharp Teeth, YC Handle
31-9113YC	31-9113	10mm	33cm	1x1 Sharp Teeth, YC Handle



**KOCHER FORCEP**

COMPLETE INSTRUMENT	REPLACEMENT INSERT	DIAMETER	LENGTH	FEATURES
31-9128XC	31-9128	10mm	33cm	60mm Jaws, Axial Serration, XC Handle



**SPOON FORCEPS**

COMPLETE INSTRUMENT	REPLACEMENT INSERT	DIAMETER	LENGTH	FEATURES
31-9135XC	31-9135	10mm	33cm	XC Handle



**CLAW FORCEPS**

COMPLETE INSTRUMENT	REPLACEMENT INSERT	DIAMETER	LENGTH	FEATURES
31-9045XC	31-9045	5mm	33cm	Traumatic Jaws, XC Handle
31-9045YC	31-9045	5mm	33cm	Traumatic Jaws, YC Handle



COMPLETE INSTRUMENT	REPLACEMENT INSERT	DIAMETER	LENGTH	FEATURES
31-9130XC	31-9130	10mm	33cm	Traumatic Jaws, XC Handle



**BABCOCK FORCEPS**

COMPLETE INSTRUMENT	REPLACEMENT INSERT	DIAMETER	LENGTH	FEATURES
31-9105YC	31-9105	5mm	33cm	YC Handle



COMPLETE INSTRUMENT	REPLACEMENT INSERT	DIAMETER	LENGTH	FEATURES
31-9140XC	31-9140	10mm	33cm	XC Handle
31-9140YC	31-9140	10mm	33cm	YC Handle
31-9140YC-45	31-9140-45	10mm	45cm	YC Handle



**ALLIS FORCEPS**

COMPLETE INSTRUMENT	REPLACEMENT INSERT	DIAMETER	LENGTH	FEATURES
31-9067YC	31-9067	5mm	33cm	TC Inserted Jaws, Atraumatic Clamp, YC Handle



COMPLETE INSTRUMENT	REPLACEMENT INSERT	DIAMETER	LENGTH	FEATURES
31-9144YC	31-9144	10mm	33cm	TC Inserted Jaws, Diamond Serrations, YC Handle



**STRONG ATRAUMATIC CLAMP**

COMPLETE INSTRUMENT	REPLACEMENT INSERT	DIAMETER	LENGTH	FEATURES
31-9145YC	31-9145	10mm	33cm	40mm Jaws, Straight, YC Handle



**NEEDLE HOLDER**

COMPLETE INSTRUMENT	REPLACEMENT INSERT	DIAMETER	LENGTH	FEATURES
31-9112YC	31-9112	5mm	33cm	10mm Jaws, Pointed, YC Handle



**Laparoscopic Grasping Forceps**
**GRASPING FORCEPS**

COMPLETE INSTRUMENT	REPLACEMENT INSERT	DIAMETER	LENGTH	FEATURES
31-9050XC	31-9050	5mm	33cm	Standard, Cross Serrations, XC Handle
31-9050YC	31-9050	5mm	33cm	Standard, Cross Serrations, YC Handle
31-9050YC-45	31-9050-45	5mm	45cm	Standard, Cross Serrations, YC Handle



COMPLETE INSTRUMENT	REPLACEMENT INSERT	DIAMETER	LENGTH	FEATURES
31-9051YC	31-9051	5mm	33cm	Tapered, Rounded Jaws, YC Handle



COMPLETE INSTRUMENT	REPLACEMENT INSERT	DIAMETER	LENGTH	FEATURES
31-9055YC	31-9055	5mm	33cm	Endo Clinch, Extremely Atraumatic Serrations, YC Handle



COMPLETE INSTRUMENT	REPLACEMENT INSERT	DIAMETER	LENGTH	FEATURES
31-9080YC	31-9080	5mm	33mm	With Spoon, YC Handle
31-9080XC	31-9080	5mm	33mm	With Spoon, XC Handle



COMPLETE INSTRUMENT	REPLACEMENT INSERT	DIAMETER	LENGTH	FEATURES
31-9085YC	31-9085	5mm	33mm	Pointed with Spoon, YC Handle



COMPLETE INSTRUMENT	REPLACEMENT INSERT	DIAMETER	LENGTH	FEATURES
31-9100YC	31-9100	5mm	33mm	Maxi (Fundus), YC Handle





**WAVE FORCEPS**

COMPLETE INSTRUMENT	REPLACEMENT INSERT	DIAMETER	LENGTH	FEATURES
31-9060YC	31-9060	5mm	33cm	Atraumatic Wavelike Serrations, Single Action, YC Handle
31-9060YC-45	31-9060-45	5mm	45cm	Atraumatic Wavelike Serrations, Single Action, YC Handle
31-9061YC	31-9061	5mm	33cm	Atraumatic Wavelike Serrations, Double Action, YC Handle



**DEBAKEY FORCEPS**

COMPLETE INSTRUMENT	REPLACEMENT INSERT	DIAMETER	LENGTH	FEATURES
31-9065YC	31-9065	5mm	33cm	40mm Jaws, YC Handle
31-9065XC	31-9065	5mm	33mm	40mm Jaws, XC Handle
31-9065YC-45	31-9065-45	5mm	45mm	40mm Jaws, YC Handle
31-9065XC-45	31-9065-45	5mm	45mm	40mm Jaws, XC Handle



**BABCOCK/DEBAKEY FORCEP**

COMPLETE INSTRUMENT	REPLACEMENT INSERT	DIAMETER	LENGTH	FEATURES
31-9142XC	31-9142	10mm	33cm	Atraumatic Serrations, XC Handle



**COBRA FORCEP**

COMPLETE INSTRUMENT	REPLACEMENT INSERT	DIAMETER	LENGTH	FEATURES
31-9075YC	31-9075	5mm	33cm	2x3 Teeth, Double Action, YC Handle



**ALLIGATOR FORCEP**

COMPLETE INSTRUMENT	REPLACEMENT INSERT	DIAMETER	LENGTH	FEATURES
31-9070YC	31-9070	5mm	33cm	Double Action, YC Handle



**ATRAUMATIC GRASPERS**

COMPLETE INSTRUMENT	REPLACEMENT INSERT	DIAMETER	LENGTH	FEATURES
31-9098XC	31-9098	5mm	33cm	Single Action, YC Handle



COMPLETE INSTRUMENT	REPLACEMENT INSERT	DIAMETER	LENGTH	FEATURES
31-9097XC	31-9097	5mm	33cm	Diamond Serrations, XC Handle
31-9097YC	31-9097	5mm	33cm	Diamond Serrations, YC Handle



**FENESTRATED GRASPING DISSECTOR**

COMPLETE INSTRUMENT	REPLACEMENT INSERT	DIAMETER	LENGTH	FEATURES
31-9042XC	31-9042	5mm	33cm	16mm Double Action Jaw, XC Handle



**FENESTRATED GRASPING FORCEPS**

COMPLETE INSTRUMENT	REPLACEMENT INSERT	DIAMETER	LENGTH	FEATURES
31-9090YC	31-9090	5mm	33cm	22mm Double Action Jaw, YC Handle
31-9090XC-45	31-9090-45	5mm	45cm	22mm Double Action Jaw, XC Handle



COMPLETE INSTRUMENT	REPLACEMENT INSERT	DIAMETER	LENGTH	FEATURES
31-9095XC	31-9095	5mm	33cm	40mm Double Action Jaw, XC Handle
31-9095YC	31-9095	5mm	33mm	40mm Double Action Jaw, YC Handle
31-9095XC-45	31-9095-45	5mm	45mm	40mm Double Action Jaw, XC Handle
31-9095YC-45	31-9095-45	5mm	45mm	40mm Double Action Jaw, YC Handle



**PUNCH**

COMPLETE INSTRUMENT	REPLACEMENT INSERT	DIAMETER	LENGTH	FEATURES
31-9046XC	31-9046	5mm	33cm	Probe Excision



**BIOPSY PUNCH**

COMPLETE INSTRUMENT	REPLACEMENT INSERT	DIAMETER	LENGTH	FEATURES
31-9047XC	31-9047	5mm	33cm	No Tooth, XC Handle



COMPLETE INSTRUMENT	REPLACEMENT INSERT	DIAMETER	LENGTH	FEATURES
31-9110YC	31-9110	5mm	33cm	With Tooth, YC Handle
31-9110YC-45	31-9110-45	5mm	45cm	With Tooth, YC Handle



COMPLETE INSTRUMENT	REPLACEMENT INSERT	DIAMETER	LENGTH	FEATURES
31-9115XC	31-9115	5mm	33cm	Spoon with Teeth, XC Handle
31-9115YC	31-9115	5mm	33cm	Spoon with Teeth, YC Handle
31-9115YC-45	31-9115-45	5mm	45cm	Spoon with Teeth, YC Handle



**SKLAR “XC” CARBON HANDLE**

INSTRUMENT	FEATURES
31-9001XC	Standard, non-ratchet, lightweight, carbon fiber reinforced non-conductive safety handle with locking collar handle. Fully rotating with a proximally positioned high-frequency connector.

**SKLAR “YC” CARBON HANDLE**

INSTRUMENT	FEATURES
31-9002YC	Standard, ratchet, lightweight, carbon fiber reinforced non-conductive safety handle with locking collar handle. Fully rotating with a proximally positioned high-frequency connector.

**REPLACEMENT LOCKING COLLAR**

INSTRUMENT	FEATURES
31-9160	For Sklar Standard Handles



Instruments may be ordered as complete sets or assembled from components ordered separately. Optional handles for customizing instruments - interchangeable for 3mm, 5mm or 10mm - are available for special order. Contact your Sklar Sales Representative for details.

**CANNULAS**

INSTRUMENT	DIAMETER	LENGTH	FEATURES
31-9155	5mm	33cm	Insulated
31-9155-45	5mm	45cm	Insulated



31-9150	10mm	33mm	Insulated With Permanent Locking Collar Attached
31-9150-45	10mm	45mm	Insulated With Permanent Locking Collar Attached



### HASSON TROCAR WITH TRUMPET VALVE

COMPLETE INSTRUMENT	REPLACEMENT OBTURATOR	LENGTH	FEATURES
31-1002	31-0004	11mm	Hasson Trumpet Valve Cannula with 11mm Blunt Tip Obturator



### STANDARD TROCAR WITH TRUMPET VALVE

COMPLETE INSTRUMENT	REPLACEMENT OBTURATOR	LENGTH	FEATURES
31-1007	31-1010	5.5mm	Trumpet Valve Cannula With 5.5mm Sharp Obturator



### STANDARD TROCAR WITH TRAP DOOR

COMPLETE INSTRUMENT	REPLACEMENT OBTURATOR	LENGTH	FEATURES
31-1004	31-1011	11mm	Trap Door Cannula With 11mm Sharp Obturator



### STANDARD TROCAR WITH AUTOMATIC VALVE

COMPLETE INSTRUMENT	REPLACEMENT INSERT	LENGTH	FEATURES
31-1015	31-1010	5.5mm	Automatic Valve Cannula with 5.5mm Sharp Obturator, Dismountable
31-1016	31-1011	11mm	Automatic Valve Cannula with 11mm Sharp Obturator, Dismountable



### STANDARD TROCAR WITH SILICON VALVE

COMPLETE INSTRUMENT	REPLACEMENT INSERT	LENGTH	FEATURES
31-1017	31-1010	5.5mm	Silicon Valve Cannula with LL Stopcock & 5.5mm Sharp Obturator, Dismountable
31-1018	31-1011	11mm	Silicon Valve Cannula with LL Stopcock & 11mm Sharp Obturator, Dismountable



**OBTURATORS**

INSTRUMENT	LENGTH	FEATURES
31-0004	11mm	Blunt Tip Obturator for 11mm Hasson Cannula
31-1011	11mm	Extremely Sharp Pyramidal Tip Obturator for Standard Trocar
31-1010	5.5mm	Extremely Sharp Pyramidal Tip Obturator for Standard Trocar



**THREADED CANNULA SLEEVE**

INSTRUMENT	LENGTH	FEATURES
31-1020	5.5mm	Interchangeable with Standard Smooth Cannulas



**SNAP ON FLIP REDUCER**

INSTRUMENT	LENGTH	FEATURES
31-1042		Reduces from 11mm to 5.5mm



**S-RETRACTOR**

INSTRUMENT	LENGTH	FEATURES
60-6130	6 1/4"	Set of 2



**TROCAR CANNULA PARTS**

FOR USE WITH STANDARD & HASSON VALVE CANNULAS				
<b>EXTERNAL SEALS</b>	5.5mm	11mm	11mm (Hasson)	11mm (Hasson)
	RED	BLUE	BLUE	GRAY
	31-0003	31-0001	31-0001	31-0002
FOR USE WITH TRAP DOOR CANNULAS				
<b>INTERNAL SEAL</b>	5.5mm		11mm	
	GRAY		YELLOW	
	31-4323		31-4324	
FOR USE WITH SILICON VALVE CANNULAS				
<b>SILICON VALVE</b>	5.5mm		11mm	
	31-4328		31-4329	



### VERRES NEEDLE WITH STOPCOCK

INSTRUMENT	DIAMETER	LENGTH	FEATURES
31-2327	2.3mm	100mm	Stopcock
31-2350	2.3mm	120mm	Stopcock
31-2352	2.3mm	150mm	Stopcock



### NEEDLE FOR INJECTION AND IRRIGATION

INSTRUMENT	DIAMETER	LENGTH	FEATURES
31-2355	5mm	33cm	Luer Lock, 2mm Hollow Needle
31-2355-45	5mm	45cm	Luer Lock, 2mm Hollow Needle



### GRADUATED PROBE

INSTRUMENT	DIAMETER	LENGTH	FEATURES
31-2365	5.5mm	33cm	Graduated



**ESOPHAGUS RETRACTOR**

INSTRUMENT	DIAMETER	LENGTH	FEATURES
31-4565	5.5mm	33cm	For Gastric Band Application



**FAN RETRACTOR**

INSTRUMENT	DIAMETER	LENGTH	FEATURES
31-4562	5.5mm	33cm	3 Finger Articulating Fan, Slightly Bent



**FAN RETRACTOR**

INSTRUMENT	DIAMETER	LENGTH	FEATURES
31-4563	10mm	33cm	5 Finger Articulating Fan, Slightly Bent



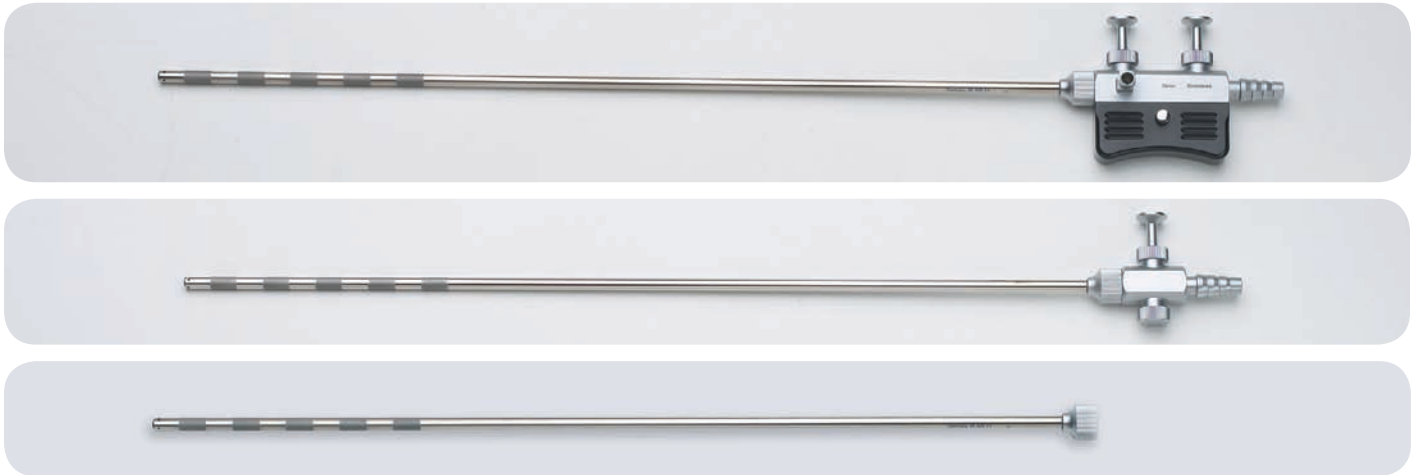

### SUCTION IRRIGATION SYSTEM

COMPLETE INSTRUMENT	DIAMETER	LENGTH	FEATURES
31-2238	5mm	33cm	Dual Trumpet Valve (also fits 10mm Sheath)
31-2238-45	5mm	45cm	Dual Trumpet Valve (also fits 10mm Sheath)
31-2258	5mm	33cm	Single Trumpet Valve (also fits 10mm Sheath)
31-4003	5mm	33cm	Sheath Only
31-4004	10mm	33cm	Sheath Only
31-2205	5mm	33cm	Tube Channel, for Laser-Fiber
31-2238OR	-	-	O-Ring, Replacement Pk/10



### HIGH-VOLUME SUCTION IRRIGATION SYSTEM

COMPLETE INSTRUMENT	DIAMETER	LENGTH	FEATURES
31-2239	5mm 10mm	33cm	Dual Trumpet Valve (includes both 5mm and 10mm Sheaths)
31-2347	5mm	33cm	Sheath Only
31-2349	10mm	33cm	Sheath Only



**TC NEEDLE HOLDERS**  
**NON-INSULATED WITH TUNGSTEN CARBIDE JAW INSERTS AND AXIAL HANDLE**

COMPLETE INSTRUMENT	DIAMETER	LENGTH	FEATURES
31-2550	5mm	33cm	Standard, Straight, Flushable Shaft, 10mm Jaw, Axial Handle
31-2550-45	5mm	45cm	Standard, Straight, Flushable Shaft, 10mm Jaw, Axial Handle
31-2551	5mm	33cm	Standard, Curved Right, Flushable Shaft, 10mm Jaw, Axial Handle
31-2552	5mm	33cm	Standard, Curved Left, Flushable Shaft, 10mm Jaw, Axial Handle
31-2552-45	5mm	45cm	Standard, Curved Left, Flushable Shaft, 10mm Jaw, Axial Handle
31-2553	5mm	33cm	Standard, Straight, Solid Shaft, 8mm Jaw, Axial Handle

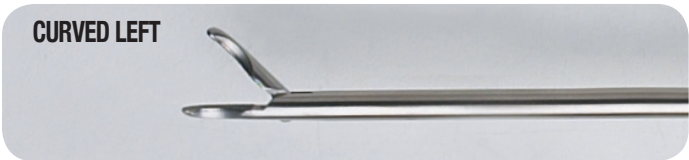

Each coagulating Electrode is able to connect to the suction control valve of your choice (Listed below). Insulated Electrodes and Control Valves sold separately.

### INSULATED ELECTRODES, WITH SUCTION

INSTRUMENT	DIAMETER	FEATURES
31-2235 (A)	5mm	Spatula
31-2237 (B)	5mm	L-Hook
31-2241 (C)	5mm	Knife
31-2243 (D)	5mm	J-Hook
31-2244 (E)	5mm	Blunt

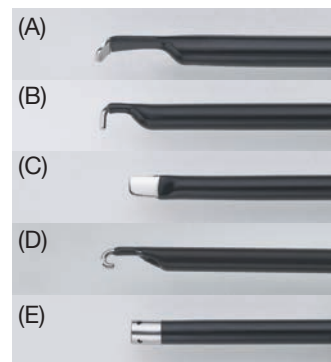

### HIGH FREQUENCY SUCTION CONTROL VALVES

INSTRUMENT	DIAMETER	FEATURES
31-2227 (A)	5mm	Insulated Suction Control with Single Trumpet Valve
31-2233 (B)	5mm	Insulated Suction Control with Double Trumpet Valve
31-2229 (C)	5mm	Insulated Suction Control with Double Trumpet Valve and Handle

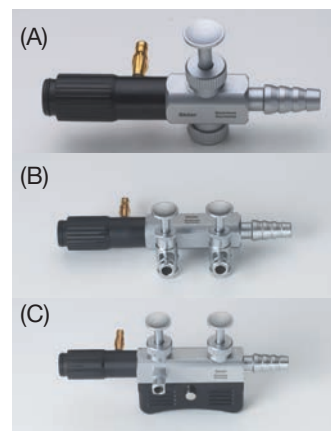

### INSULATED ELECTRODES, WITHOUT SUCTION

Each Electrode has a permanently fitted adapter for connecting to the Electrosurgical Cable. Insulated Electrodes and Cables sold separately.

INSTRUMENT	DIAMETER	FEATURES
31-2435 (A)	5mm	Spatula
31-2437 (B)	5mm	L-Hook
31-2443 (C)	5mm	J-Hook
31-2445 (D)	5mm	Button
31-2447 (E)	5mm	Cone

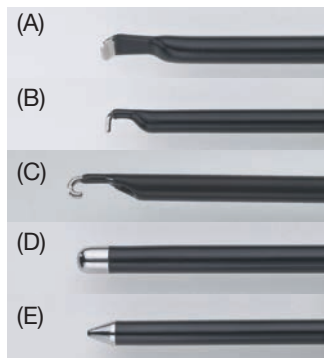

### ELECTROSURGICAL CABLE

INSTRUMENT	LENGTH	FEATURES
31-2242	277cm	Monopolar



**METZENBAUM SCISSORS**

COMPLETE INSTRUMENT	REPLACEMENT INSERT	DIAMETER	LENGTH	FEATURES
31-4306XC	31-4306	3mm	33cm	Mini, Straight, XC Handle
31-4303XC	31-4303	3mm	33cm	Mini, Curved, XC Handle
31-4307XC	31-4307	3mm	33cm	Mini, Curved, Serrated, XC Handle

**HOOK SCISSORS**

COMPLETE INSTRUMENT	REPLACEMENT INSERT	DIAMETER	LENGTH	FEATURES
31-4304XC	31-4304	3mm	33cm	Mini, Delicate, Straight, XC Handle

**MARYLAND DISSECTOR**

COMPLETE INSTRUMENT	REPLACEMENT INSERT	DIAMETER	LENGTH	FEATURES
31-4310XC	31-4310	3mm	33cm	Mini, Cross Serrations, Curved, XC Handle



**FORCEPS**

COMPLETE INSTRUMENT	REPLACEMENT INSERT	DIAMETER	LENGTH	FEATURES
31-4314YC	31-4314	3mm	33cm	Mini Duck Nose, Cross Serrations, Straight, YC Handle
31-4309XC	31-4309	3mm	33cm	Mini Kelly, Double Action Delicate Jaws, XC Handle
31-4315XC	31-4315	3mm	33cm	Mini Spoon, XC Handle
31-4316XC	31-4316	3mm	33cm	Mini Spoon, Serrated, XC Handle

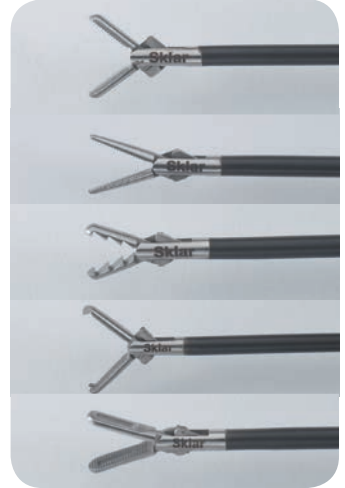

**GRASPING FORCEPS**

COMPLETE INSTRUMENT	REPLACEMENT INSERT	DIAMETER	LENGTH	FEATURES
31-4308YC	31-4308	3mm	33cm	Mini Grasping Forcep, YC Handle
31-4311XC	31-4311	3mm	33cm	Mini Atraumatic, Dissector, Straight, XC Handle
31-4312YC	31-4312	3mm	33cm	Mini Grasping Forcep, Heavy Serrations, YC Handle
31-4313YC	31-4313	3mm	33cm	Mini Cobra, Heavy Serrations, YC Handle
31-4317YC	31-4317	3mm	33cm	Mini Fenestrated, 8mm Double Action Jaws, YC Handle



**PUNCH**

COMPLETE INSTRUMENT	REPLACEMENT INSERT	DIAMETER	LENGTH	FEATURES
31-4305XC	31-4305	3mm	33cm	Mini Punch, Delicate



**NEEDLE HOLDER**

**NON-INSULATED WITH TUNGSTEN CARBIDE JAW INSERTS AND AXIAL HANDLE**

COMPLETE INSTRUMENT	DIAMETER	LENGTH	FEATURES
31-9360AX	3mm	33cm	Mini, Straight, Axial Ring Handle
31-9362AX	3mm	33cm	Mini, Curved Right, Axial Ring Handle
31-9364AX	3mm	33cm	Mini, Curved Left, Axial Ring Handle

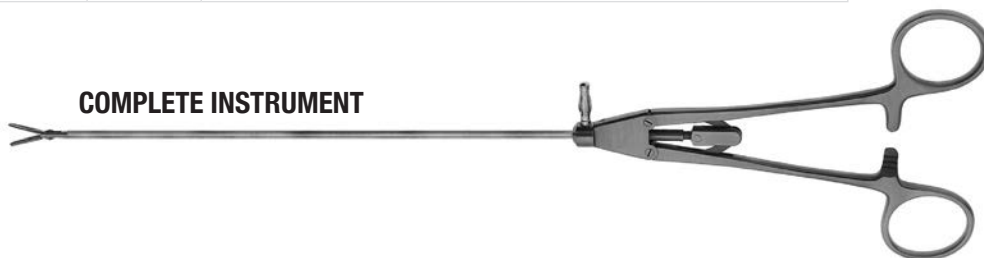

**Miniature Laparoscopic Accessories**
**MINIATURE ENDOSCOPE**

COMPLETE INSTRUMENT	DIAMETER	LENGTH	FEATURES
31-4301	2.7mm	30cm	Miniature, Autoclavable



**MINIATURE TROCAR**

COMPLETE INSTRUMENT	REPLACEMENT OBTURATOR	DIAMETER	FEATURES
31-4302	31-4318	3mm	Mini, with Trap Door Cannula, Resusable, Includes 3mm Obturator
31-4320	-	3mm	External Seal, Red For use with Standard and Hasson Cannulas
31-4321	-	3mm	Internal Seal, Gray For use with Trap Door Cannulas only

**ELECTROSURGERY**
**INSULATED ELECTRODES WITHOUT SUCTION**

Each Electrode has a permanently fitted adapter for connecting to the Electrosurgical Cable. Insulated Electrodes and Cables sold separately.

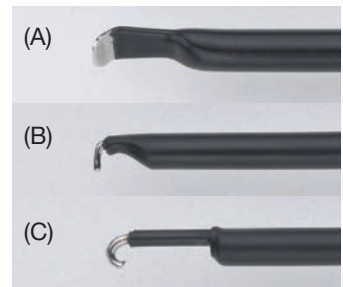
INSTRUMENT	DIAMETER	FEATURES
31-4325 (A)	3mm	Mini, Spatula
31-4326 (B)	3mm	Mini, L-Hook
31-4327 (C)	3mm	Mini, J-Hook

**ELECTROSURGICAL CABLE**

INSTRUMENT	LENGTH	FEATURES
31-2242	277cm	Monopolar



**98-1354 - BAND SET**

PRODUCT NUMBER	DESCRIPTION	QUANTITY
31-2238-45	Suction/Irrigation System with 45mm Cannula Dual Trumpet Valve	1
31-9012XC-45	Metzenaum Scissors, Curved - 5mm, 45cm	1
31-9030XC-45	Maryland Dissector - 5mm, 45cm	1
31-9090XC-45	Fenestrated Grasper, 22mm Jaw - 5mm, 45cm	1
31-9095XC-45	Fenestrated Grasper, 40mm Jaw - 5mm, 45cm	1
31-4565	Esophagus Retractor - 5mm	1

**98-1355 - CHOLECYSTECTOMY SET**

PRODUCT NUMBER	DESCRIPTION	QUANTITY
31-2227	Suction Control Handle for Spatula Electrode	2
31-2235	Spatula Electrode with Suction - 5mm	1
31-2237	L Hook Electrode with Suction - 5mm	1
31-2239	High Volume Suction Irrigation System	1
31-2355	Needle for Injection and Irrigation - 5mm	1
31-9005XC	Metzenbaum Scissors, Straight - 5mm, 33cm	1
31-9010XC	Metzenbaum Scissors, Curved - 5mm, 33cm	1
31-9015XC	Hook Scissors - 5mm, 33cm	1
31-9025XC	Micro Scissors, Curved - 5mm, 33cm	1
31-9030XC	Maryland Dissector - 5mm, 33cm	1
31-9035XC	Mixer Forceps, Diamond Serrations - 5mm, 33cm	1
31-9040XC	Dolphin Forceps with Spoon - 5mm, 33cm	1
31-9050YC	Standard Grasping Forceps - 5cm, 33cm	1
31-9060YC	Wave Grasper - 5mm, 33cm	1
31-9100YC	Maxi (Fundus) Grasper - 5mm, 33cm	1
31-9125XC	Mixer Forceps - 10mm, 33cm	1
31-9130XC	Claw Forceps - 10mm, 33cm	1
31-9135XC	Spoon Forceps - 10mm, 33cm	1

**98-1356 - APPENDECTOMY SET**

PRODUCT NUMBER	DESCRIPTION	QUANTITY
31-2239	High Volume Suction Irrigation System	1
31-2552	TC Needle Holder, Curved Left - 5mm, 33cm	1
31-9010XC	Metzenbaum Scissors, Curved - 5mm, 33cm	1
31-9025XC	Micro Scissors, Curved - 5mm, 33cm	1
31-9050YC	Standard Grasping Forceps - 5mm, 33cm	1
31-9085YC	Pointed Grasping Forceps with Spoon - 5mm, 33cm	1
31-9125XC	Mixer Forceps - 10mm, 33cm	1
31-9130XC	Claw Forceps - 10mm, 33cm	1

**98-1357 - BOWEL RESECTION SET**

PRODUCT NUMBER	DESCRIPTION	QUANTITY
31-2552	TC Needle Holder, Curved Left - 5mm, 33cm	1
31-2235	Spatula Electrode with Suction - 5mm	1
31-2227	Suction Control Valve for Spatula Electrode	1
31-9067YC	Allis Forceps TC - 5mm, 33cm	1
31-9080YC	Grasping Forcep with Spoon - 5mm, 33cm	1
31-9051YC	Tapering Grasping Forcep - 5mm, 33cm	1
31-9040XC	Dolphin Forcep with Spoon - 5mm, 33cm	1
31-9140YC	Babcock Forcep - 10mm, 33cm	1
31-9095YC	Fenestrated Grasper, 40mm Jaws - 5mm, 33cm	1
31-9010XC	Metzenbaum Scissors, Curved - 5mm 33cm	1
31-9025XC	Micro Scissors, Curved - 5mm, 33cm	1



# electrosurgery

## Sklar Blue™ Electrosurgical Instruments

Sklar Blue™ Electrosurgery Instruments are designed to provide an effective, non-conductive, patient-safe surface. Sklar's line of electrosurgical instruments features our exclusive Sklar Blue™ insulated coating that prevents transmission of RF current through the instrument. Manufactured of the highest quality stainless steel, these instruments are fully autoclavable. All Sklar Blue™ electrosurgical coatings are guaranteed for one year against manufacturing defects.

Speculums .....	Page 144
Retractors .....	Page 147
Endocervical Speculums .....	Page 148
Forceps .....	Page 149
Hooks .....	Page 151

## Electrosurgical Accessories

Sklar's long held tradition of providing quality surgical instruments is carried through with the establishment of the Sklar line of electrosurgical pencils, grounding pads, active electrodes and accessories. Offering unsurpassed performance and design features, Sklar Electrosurgical products delivery quality you can feel, see and trust for any challenging surgical procedure.

Electrosurgical Pencils .....	Page 152
Electrodes .....	Page 153
Accessories .....	Page 158
Bipolar Forceps .....	Page 160





**GRAVES VAGINAL SPECULUMS  
WITH LOOPS FOR DISPOSABLE SMOKE EVACUATION  
TUBING**

91-5015	3" x 1/2"	Extra Small
91-5010	3" x 3/4"	Small
91-5012	4" x 1 1/4"	Medium
91-5014	4 1/2" x 1 3/8"	Large
91-5018	4 3/4" x 1 1/2"	Extra Large



**GRAVES VAGINAL SPECULUMS  
WITH PERMANENT SMOKE EVACUATION TUBE**

91-5020	3" x 3/4"	Small
91-5022	4" x 1 1/4"	Medium
91-5024	4 1/2" x 1 3/8"	Large
91-5028	4 3/4" x 1 1/2"	Extra Large



**GRAVES VAGINAL SPECULUMS  
WITHOUT TUBE OR LOOPS**

91-5066	3" x 1/2"	Extra Small
91-5060	3" x 3/4"	Small
91-5062	4" x 1 1/4"	Medium
91-5064	4 1/2" x 1 3/8"	Large
91-5068	4 3/4" x 1 1/2"	Extra Large



**PEDERSON VAGINAL SPECULUMS  
WITH LOOPS FOR DISPOSABLE SMOKE EVACUATION  
TUBING**

91-5038	2 3/4" x 1/2"	Extra Small
91-5032	3" x 1/2"	Small
91-5040	4" x 5/8"	Slender
91-5034	4" x 7/8"	Medium
91-5036	4 3/4" x 1"	Large



**PEDERSON VAGINAL SPECULUMS  
WITH PERMANENT SMOKE EVACUATION TUBE**

91-5042	3" x 1/2"	Small
91-5050	4" x 5/8"	Slender
91-5044	4" x 7/8"	Medium
91-5046	4 3/4" x 1"	Large
91-5047	4 3/4" x 1 5/8"	Extra Large

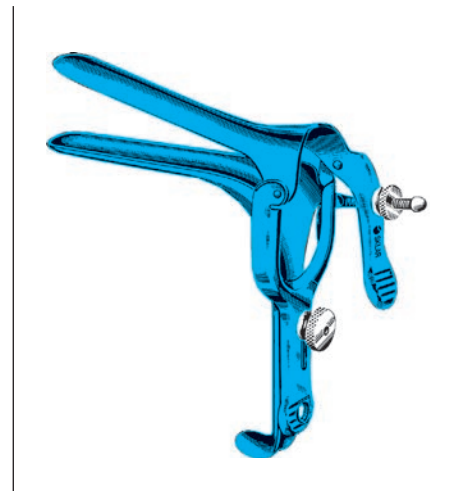

**PEDERSON VAGINAL SPECULUMS  
WITHOUT TUBE OR LOOPS**

91-5088	2 3/4" x 1/2"	Extra Small
91-5082	3" x 1/2"	Small
91-5092	4" x 5/8"	Slender
91-5084	4" x 7/8"	Medium
91-5086	4 3/4" x 1"	Large



Autoclavable



**GRAVES VAGINAL SPECULUM  
 WIDE VIEW PATTERN**  
 WITH LARGE PROXIMAL OPENING FOR  
 INSTRUMENTATION

91-5080 4" x 1¼" Medium, with loops  
 to hold and direct  
 disposable Smoke  
 Evacuation Tubing



**GRAVES OB-VIEW VAGINAL  
 SPECULUMS**  
 WITH PERMANENT SMOKE EVACUATION TUBE  
 (NOT ILLUSTRATED)

91-3740 4" x 1½" Medium  
 91-3741 4¾" x 1½" Large

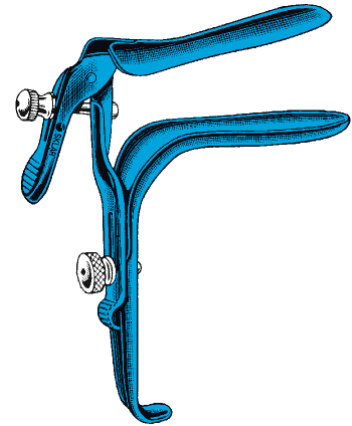

**FREEWAY GRAVES VAGINAL  
 SPECULUMS**

**OPEN SIDE, 90° ANGLE**  
 91-5160 4" x 1¼" Medium, with permanent  
 Smoke Evacuation Tube  
 (not illustrated)  
 91-5161 4" x 1¼" Medium, without  
 permanent Smoke  
 Evacuation Tube

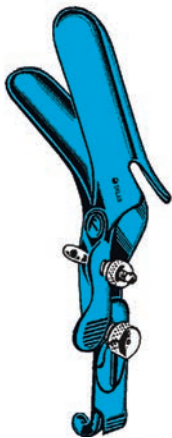

**FREEWAY GRAVES VAGINAL  
 SPECULUM**  
**OPEN SIDE, 45° ANGLE**

91-5162 4" x 1¼" Medium, with  
 permanent Smoke  
 Evacuation Tube  
 (not illustrated)



**CUSCO VAGINAL SPECULUMS**  
 WITH PERMANENT SMOKE EVACUATION TUBE

91-5150 3" x 1¼" Small  
 91-5152 3⅓" x 1⅓" Medium  
 91-5154 3¾" x 1⅜" Large

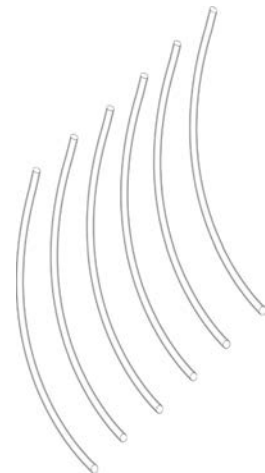

**DISPOSABLE SMOKE  
 EVACUATION TUBING**

93-2160 10" Precut  
 ⅜" Inside Diameter  
 ¼" Outside Diameter 50/cs





**AUWARD VAGINAL SPECULUMS**

**MEDIUM**

- 91-5120 2¾" x 1½" 2½ lbs. with permanent Smoke Evacuation Tube (not illustrated)
- 91-5122 2¾" x 1½" 2½ lbs. with loop to hold and direct disposable Smoke Evacuation Tubing



**AUWARD VAGINAL SPECULUMS**

**MEDIUM LONG BLADE**

- 91-5130 4" x 1¾" 2½ lbs. without loop
- 91-5132 4" x 1¾" 2½ lbs. with loop to hold and direct disposable Smoke Evacuation Tubing



**STEINER-AUWARD VAGINAL SPECULUMS**

**MEDIUM EXTRA LONG BLADE**

- 91-5140 5½" x 1¼" 2½ lbs. without loop
- 91-5142 5½" x 1¼" 2½ lbs. with loop to hold and direct disposable Smoke Evacuation Tubing



**COLLIN VAGINAL SPECULUMS**

- 91-5180 4¼" x 1¼" Medium, with permanent Smoke Evacuation Tube (not illustrated)
- 91-5185 4¼" x 1¼" Medium, with loops to hold and direct disposable Smoke Evacuation Tubing

## MONSEL'S & LUGOL'S

MONSEL'S PASTE Item #96-1200  
LUGOL'S SOLUTION Item #96-1210  
8ml Ready to use bottles

**IN-OFFICE  
GYNECOLOGICAL  
ELECTROSURGERY**



Autoclavable



**LATERAL VAGINAL RETRACTOR  
 WITH RATCHET**

91-5190 Fits Inside Speculum



**SIMS VAGINAL RETRACTORS  
 SINGLE END**

91-5200 Medium  
 91-5202 Medium with loop to hold and direct disposable Smoke Evacuation Tubing (not illustrated)



**SIMS VAGINAL RETRACTORS  
 DOUBLE END**

91-5210 Medium  
 91-5212 Medium with loop to hold and direct disposable Smoke Evacuation Tubing (not illustrated)



**JACKSON VAGINAL RETRACTORS  
 SINGLE END**

91-5215 3" x 1½" Small  
 91-5218 3½" x 1½" Medium  
 91-5220 4" x 1½" Large



**TAUBER VAGINAL SPATULA**

91-5176 3½"



**SEGOND VAGINAL SPATULA**

91-5178 4¾"





**KOGAN ENDOCERVICAL SPECULUM**

WITH GAUGE AND SCREW

91-5230 Narrow Wire Blades



**KOGAN ENDOCERVICAL SPECULUM**

WITH SPRING HANDLE

91-5228 Narrow Wire Blades



**KOGAN ENDOCERVICAL SPECULUM**

WITH RATCHET HANDLE

91-5235 Narrow Wire Blades

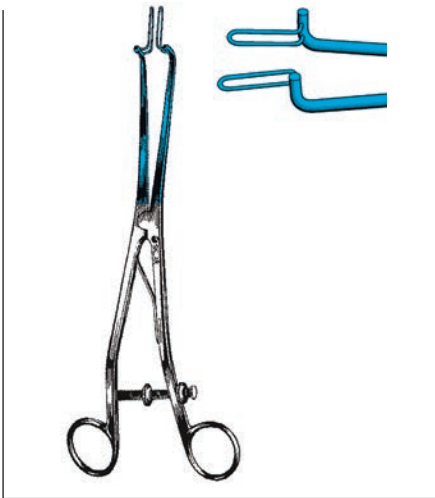

**KOGAN ENDOCERVICAL SPECULUM**

WITH GAUGE AND SCREW

91-5232 Wide Wire Blades

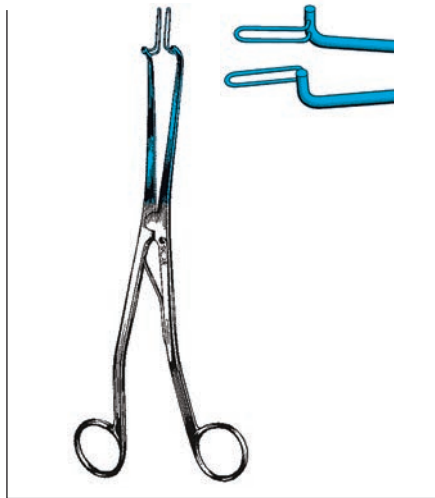

**KOGAN ENDOCERVICAL SPECULUM**

WITH SPRING HANDLE

91-5226 Wide Wire Blades



**KOGAN ENDOCERVICAL SPECULUM**

WITH RATCHET HANDLE

91-5234 Wide Wire Blades



Autoclavable



**SCHWEIZER FORCEP**

91-5404 9½" Straight



**CLEMETSON FORCEP**

**WITHOUT RATCHET**

91-5400 9½" Straight

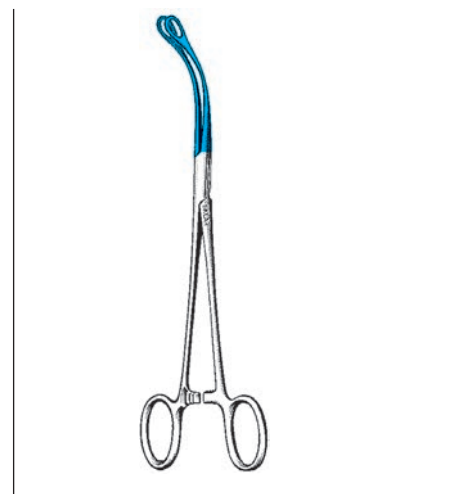

**LAUFE UTERINE POLYP FORCEP**

91-5408 7¾"



**SCHROEDER TENACULUM FORCEPS**

91-5450 10" Braun Flat Tips  
91-5452 10" Pozzi Round Tips



**BABCOCK FORCEPS**

91-5268 8"  
91-5270 9½"



**ALLIS TISSUE FORCEPS**

91-5278 7½" 5x6 Teeth  
91-5440 9½" 5x6 Teeth



Autoclavable

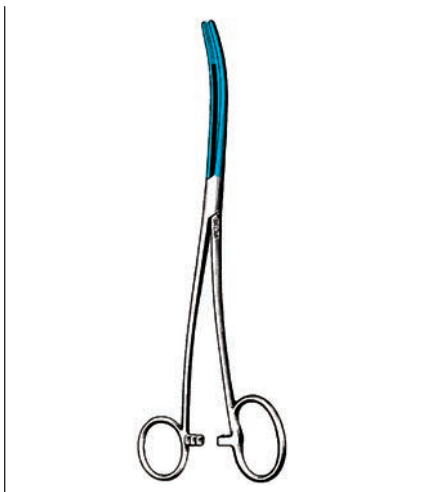

**BOZEMAN FORCEP**

91-5310 10¼" S-Curve, One Large Ring



**BOZEMAN FORCEPS**

91-5307 10½" Straight  
91-5308 10¼" S-Curve

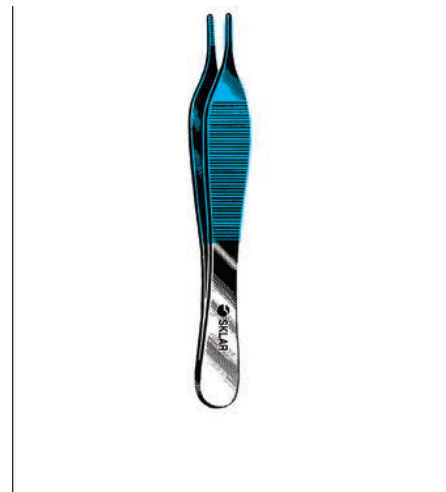

**ADSON FORCEPS**

91-5428 4¾" Serrated



**DRESSING FORCEPS**

91-5420 8" Serrated  
91-5422 10" Serrated  
91-5424 12" Serrated



**POTTS-SMITH FORCEPS**

91-5411 7" Serrated  
91-5412 10" Serrated  
91-5413 8¼" 1x2 Teeth  
91-5414 10" 1x2 Teeth



**TUTTLE/ SINGLEY FORCEPS**

91-5300 7" Tuttle  
91-5302 9" Singley



Autoclavable



Sklar Blue™ Hooks



**IRIS HOOKS**

**QUICK RELEASE**

91-5244	9"	1mm	91-5248	12"	1mm
91-5243	9"	3mm	91-5247	12"	3mm
91-5242	9"	4mm	91-5246	12"	4mm
91-5241	9"	6mm	91-5245	12"	6mm
91-5236	9"	Set of 4	91-5238	12"	Set of 4

**EMMETT HOOKS**

91-5251	9"	Style 1
91-5252	9"	Style 2
91-5253	9"	Style 3
91-5254	9"	Style 4
91-5255	9"	Style 5
91-5250	9"	Set of 5



Autoclavable



**Sklar Premium**

Electrosurgical Pencils are available in a push button, foot switch or rocker switch configuration. Sklar pencils are ergonomically designed to provide maximum balance and comfort for the surgeon. Each pencil features a removable 2.75" stainless steel blade electrode, with hex locking feature to provide stability during difficult surgical procedures.

Unsurpassed performance and design features, like sealed switching components, make the Sklar Premium Electrosurgical Pencil the right choice. Pencil tips are interchangeable with any of Sklar's electrodes and most other manufacturer's electrodes. Sklar Pencils come standard with a pre-attached 3 meter cord with a standard three prong plug. All Electrosurgical Pencils are provided in a single use, sterile pouch.

**PUSH BUTTON SWITCH**

PRODUCT NUMBER	FEATURES	ACCESSORIES	QUANTITIES
96-9601	2.75" Blade Electrode	-	50/Box
96-9602	2.75" Blade Electrode	-	50/bx, 2bx/cs, 100/cs
96-9603	2.75" Blade Electrode	Holster	50/Box
96-9604	2.75" Blade Electrode	Holster	50/bx, 2bx/cs, 100/cs
96-9605	2.75" Blade Electrode	Holster, Tip Cleaner	50/Box
96-9606	2.75" Blade Electrode	Holster, Tip Cleaner	50/bx, 2bx/cs, 100/cs
96-9607	2.75" Coated Blade Electrode	-	50/Box
96-9608	2.75" Coated Blade Electrode	-	50/bx, 2bx/cs, 100/cs
96-9609	2.75" Coated Blade Electrode	Holster	50/Box
96-9610	2.75" Coated Blade Electrode	Holster	50/bx, 2bx/cs, 100/cs



**ROCKER SWITCH**

PRODUCT NUMBER	FEATURES	ACCESSORIES	QUANTITIES
96-9611	2.75" Blade Electrode	-	50/Box
96-9612	2.75" Blade Electrode	-	50/bx, 2bx/cs, 100/cs
96-9613	2.75" Blade Electrode	Holster	50/Box
96-9614	2.75" Blade Electrode	Holster	50/bx, 2bx/cs, 100/cs
96-9615	2.75" Blade Electrode	Holster, Tip Cleaner	50/Box
96-9616	2.75" Blade Electrode	Holster, Tip Cleaner	50/bx, 2bx/cs, 100/cs
96-9617	2.75" Coated Blade Electrode	-	50/Box
96-9618	2.75" Coated Blade Electrode	-	50/bx, 2bx/cs, 100/cs
96-9619	2.75" Coated Blade Electrode	Holster	50/Box
96-9620	2.75" Coated Blade Electrode	Holster	50/bx, 2bx/cs, 100/cs



**FOOT SWITCH**

PRODUCT NUMBER	FEATURES	ACCESSORIES	QUANTITIES
96-9621	2.75" Blade Electrode	-	50/Box
96-9622	2.75" Blade Electrode	-	50/bx, 2bx/cs, 100/cs
96-9623	2.75" Blade Electrode	Holster	50/Box
96-9624	2.75" Blade Electrode	Holster	50/bx, 2bx/cs, 100/cs
96-9625	2.75" Blade Electrode	Holster, Tip Cleaner	50/Box
96-9626	2.75" Blade Electrode	Holster, Tip Cleaner	50/bx, 2bx/cs, 100/cs
96-9627	2.75" Coated Blade Electrode	-	50/Box
96-9628	2.75" Coated Blade Electrode	-	50/bx, 2bx/cs, 100/cs
96-9629	2.75" Coated Blade Electrode	Holster	50/Box
96-9630	2.75" Coated Blade Electrode	Holster	50/bx, 2bx/cs, 100/cs





Electrodes | Single Use | Sterile

Sklar Premium Blade Electrodes feature a ribbed molded insulator, which allows the surgeon or technician easy removal of the electrode during procedures. They are available with a hex lock feature that assures stability and prohibits rotation of the blade during difficult procedures. They are also available coated with an anti-stick material that allows easy clean up of accumulated debris.

**BLADE ELECTRODES**

PRODUCT NUMBER	FEATURES	QUANTITIES
96-9632	Flex Tip Blade, 2.4"	10/Box
96-9633	Flex Tip Blade, 2.4"	10/bx, 10bx/cs, 100/cs
96-9634	Flex Tip Blade, Hex Lock Hub, 2.4"	10/Box
96-9635	Flex Tip Blade, Hex Lock Hub, 2.4"	10/bx, 10bx/cs, 100/cs
96-9636	Solid Steel Blade, 2.75"	10/Box
96-9637	Solid Steel Blade, 2.75"	10/bx, 10bx/cs, 100/cs
96-9638	Solid Steel Coated Blade, 2.75"	10/Box
96-9639	Solid Steel Coated Blade 2.75"	10/bx, 10bx/cs, 100/cs
96-9640	Solid Steel Blade, Hex Lock Hub, 2.75"	10/Box
96-9641	Solid Steel Blade, Hex Lock Hub, 2.75"	10/bx, 10bx/cs, 100/cs
96-9642	Solid Steel Coated Blade, Hex Lock Hub, 2.75"	10/Box
96-9643	Solid Steel Coated Blade, Hex Lock Hub, 2.75"	10/bx, 10bx/cs, 100/cs



PRODUCT NUMBER	FEATURES	QUANTITIES
96-9644	Solid Steel Blade, 6"	10/Box
96-9645	Solid Steel Blade, 6"	10/bx, 10bx/cs, 100/cs



PRODUCT NUMBER	FEATURES	QUANTITIES
96-9646	Solid Steel Coated Blade, 6"	10/Box
96-9647	Solid Steel Coated Blade, 6"	10/bx, 10bx/cs, 100/cs



PRODUCT NUMBER	FEATURES	QUANTITIES
96-9648	Solid Steel Blade, 10"	10/Box
96-9649	Solid Steel Blade, 10"	10/bx, 10bx/cs, 100/cs



PRODUCT NUMBER	FEATURES	QUANTITIES
96-9650	Solid Steel Coated Blade, 10"	10/Box
96-9651	Solid Steel Coated Blade, 10"	10/bx, 10bx/cs, 100/cs



Sklar Premium Loop Electrodes feature a strong and durable tungsten steel loop incorporated into a reinforced T-molded head for added stability during difficult and delicate surgical procedures. All electrodes are a standard five inches in length and feature an extended insulation covering to protect the surgeon and patient.

**LOOP ELECTRODES**

PRODUCT NUMBER	FEATURES	QUANTITIES
96-9652	Tungsten Loop, 10 MM x 5 MM, 5"	5/Box

96-9653	Tungsten Loop, 10 MM x 5 MM, 5"	5/bx, 10bx/cs, 50/cs
---------	---------------------------------	----------------------



96-9654	Tungsten Loop, 10 MM x 10 MM, 5"	5/Box
---------	----------------------------------	-------

96-9655	Tungsten Loop, 10 MM x 10 MM, 5"	5/bx, 10bx/cs, 50/cs
---------	----------------------------------	----------------------



96-9656	Tungsten Loop, 15 MM x 10 MM, 5"	5/Box
---------	----------------------------------	-------

96-9657	Tungsten Loop, 15 MM x 10 MM, 5"	5/bx, 10bx/cs, 50/cs
---------	----------------------------------	----------------------



96-9658	Tungsten Loop, 15 MM x 15 MM, 5"	5/Box
---------	----------------------------------	-------

96-9659	Tungsten Loop, 15 MM x 15 MM, 5"	5/bx, 10bx/cs, 50/cs
---------	----------------------------------	----------------------



96-9660	Tungsten Loop, 20 MM x 10 MM, 5"	5/Box
---------	----------------------------------	-------

96-9661	Tungsten Loop, 20 MM x 10 MM, 5"	5/bx, 10bx/cs, 50/cs
---------	----------------------------------	----------------------



96-9662	Tungsten Loop, 20 MM x 15 MM, 5"	5/Box
---------	----------------------------------	-------

96-9663	Tungsten Loop, 20 MM x 15 MM, 5"	5/bx, 10bx/cs, 50/cs
---------	----------------------------------	----------------------



**LLETZ BALL ELECTRODES**

PRODUCT NUMBER	FEATURES	QUANTITIES
96-1040	3 MM / 0.3 CM	5/Box

**LLETZ SQUARE ELECTRODES**

PRODUCT NUMBER	FEATURES	QUANTITIES
96-1099	10 x 8 MM / 1.0 x 0.8 CM	5/Box

**LLETZ LOOP ELECTRODES**

PRODUCT NUMBER	FEATURES	QUANTITIES
96-1060	15 x 8 MM / 1.5 x 0.8 CM	5/Box
96-1075	20 x 8 MM / 2.0 x 0.8 CM	5/Box
96-1085	20 x 20 MM / 2.0 x 2.0 CM	5/Box



Sklar Premium Needle Electrodes feature a durable and ultra fine needle point for precise locations during the surgical procedure. All electrodes feature a ribbed molded insulation for easy removal and extended insulation to protect the surgeon and patient.

**STRAIGHT NEEDLE ELECTRODES**

PRODUCT NUMBER	FEATURES	QUANTITIES
96-9664	Solid Stainless Steel Needle, 2.8"	10/Box
96-9665	Solid Stainless Steel Needle, 2.8"	10/bx, 10bx/cs, 100/cs
96-9666	Solid Stainless Steel Coated Needle, 2.8"	10/Box
96-9667	Solid Stainless Steel Coated Needle, 2.8"	10/bx, 10bx/cs, 100/cs



96-9668	Solid Stainless Steel Needle, 6"	10/Box
96-9669	Solid Stainless Steel Needle, 6"	10/bx, 10bx/cs, 100/cs



96-9670	Solid Stainless Steel Coated Needle, 6"	10/Box
96-9671	Solid Stainless Steel Coated Needle, 6"	10/bx, 10bx/cs, 100/cs



96-9672	Solid Stainless Steel Needle, 10"	10/Box
96-9673	Solid Stainless Steel Needle, 10"	10/bx, 10bx/cs, 100/cs



96-9674	Solid Stainless Steel Coated Needle, 10"	10/Box
96-9675	Solid Stainless Steel Coated Needle, 10"	10/bx, 10bx/cs, 100/cs



Sklar Premium Straight Ball Electrodes feature our Hex Locking system to assure stability during difficult procedures. They also have our Ribbed Molded insulation for easy removal and extended insulation for protection of the surgeon and patient.

### STRAIGHT BALL ELECTRODES

PRODUCT NUMBER	FEATURES	QUANTITIES
96-9676	Stainless Steel 4mm Ball, 2"	10/Box
96-9677	Stainless Steel 4mm Ball, 2"	10/bx, 10bx/cs, 100/cs
96-9678	Stainless Steel 4mm Coated Ball, 2"	10/Box
96-9679	Stainless Steel 4mm Coated Ball, 2"	10/bx, 10bx/cs, 100/cs
96-9680	Stainless Steel 5mm Ball, 2"	10/Box
96-9681	Stainless Steel 5mm Ball, 2"	10/bx, 10bx/cs, 100/cs
96-9682	Stainless Steel 5mm Coated Ball, 2"	10/Box
96-9683	Stainless Steel 5mm Coated Ball, 2"	10/bx, 10bx/cs, 100/cs



96-9684	Stainless Steel 5mm Ball, 5.3"	10/Box
96-9685	Stainless Steel 5mm Ball, 5.3"	10/bx, 10bx/cs, 100/cs



96-9686	Stainless Steel 5mm Coated Ball, 5.3"	10/Box
96-9687	Stainless Steel 5mm Coated Ball, 5.3"	10/bx, 10bx/cs, 100/cs



Sklar Premium Patient Return Pads are manufactured using an advanced design hydro-gel adhesive that, incorporated with a gel overlay system, provide a much safer return pad for both the patient and surgeon. Sklar offers Patient Return Pads in five different configurations.

**RETURN ELECTRODES / GROUNDING PADS**

PRODUCT NUMBER	FEATURES	QUANTITIES
96-9688	Dual Element, 9' Cord Attached, Standard	50/Box
96-9690	Dual Element, Non-Corded, Standard	5/pk, 40pk/cs, 200/bx

96-9688 and 96-9690 are dual element return pads designed to be used with electrosurgical units that are equipped with REM or Neutral Electrode safety systems that continually monitor impedance levels. The 96-9688 comes with a pre-attached 9 foot cord with standard plug. The 96-9690 requires the use of a reusable cable, 96-9698.

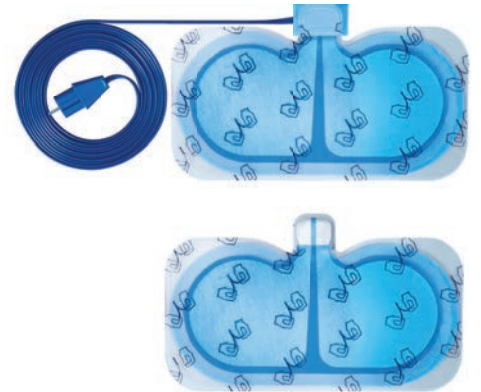

PRODUCT NUMBER	FEATURES	QUANTITIES
96-9692	Single Element, 9' Cord Attached, Standard	50/Box
96-9694	Single Element, Non-Corded, Standard	5/pk, 40pk/cs, 200/bx

96-9692 and 96-9694 are traditional single element return pads manufactured using the same hydro-gel technology. Both are designed for use with all electrosurgical generators. The 96-9692 comes with a pre-attached 9 foot cord, with standard connector and the 96-9694 requires the use of a reusable cable, 96-9698.

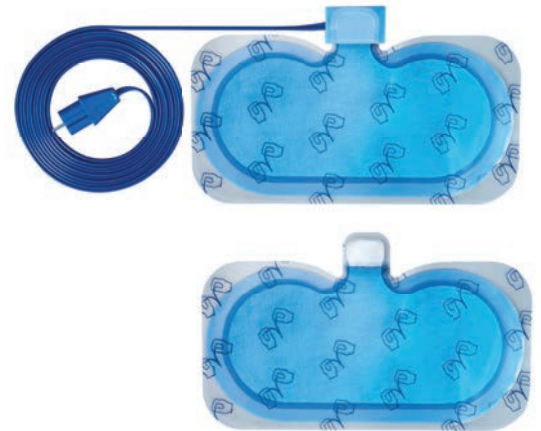

PRODUCT NUMBER	FEATURES	QUANTITIES
96-9696	Dual Element, 9' Cord Attached, Pediatric / Infant	50/Box



**CORDS AND CABLES**

PRODUCT NUMBER	FEATURES	QUANTITIES
96-9698	Reusable Return Pad Cable For Use With Non-Corded Pads, 15' Non-Sterile	10/Box



PRODUCT NUMBER	FEATURES	QUANTITIES
96-9700	Single Use, Sterile, Bipolar Forceps Cord, Flying Lead, 12'	10/Box
96-9701	Single Use, Sterile, Bipolar Forceps Cord, Flying Lead, 12'	10/bx, 5bx/cs, 50/cs



PRODUCT NUMBER	FEATURES	QUANTITIES
96-9702	Single Use, Sterile, Bipolar Forceps Cord, Solid Connector, 12'	10/Box
96-9703	Single Use, Sterile, Bipolar Forceps Cord, Solid Connector, 12'	10/bx, 5bx/cs, 50/cs



**TIP CLEANERS-DISPOSABLE**

PRODUCT NUMBER	FEATURES	QUANTITIES
96-9704	Sterile	50/Box
96-9706	Non-Sterile	500/Box

42.5 MM X 42.5 MM  
(1.7" X 1.7")



**HOLSTERS-DISPOSABLE**

PRODUCT NUMBER	FEATURES	QUANTITIES
96-9708	Sterile	100/Box
96-9710	Non-Sterile	500/Box





**ADSON FORCEPE**

PRODUCT NUMBER	FEATURES
91-6100	1 MM, 4¾"

**COAPTATION FORCEPE**

PRODUCT NUMBER	FEATURES
91-6101	.5 MM, 4"

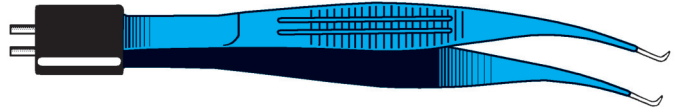
**CUSHING FORCEPE**

PRODUCT NUMBER	FEATURES
91-6102	1 MM, 6"

**GERALD BAYONET FORCEPE**

PRODUCT NUMBER	FEATURES
91-6103	1 MM, 7"

**GERALD FORCEPE**

PRODUCT NUMBER	FEATURES
91-6104	1 MM, 7"

**HARDY BAYONET FORCEPE**

PRODUCT NUMBER	FEATURES
91-6105	1 MM, 8½"

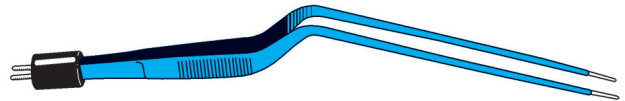
**WARNING: STERILIZATION GUIDELINES**

Follow manufacturer's recommendations and AAMI standards for sterilization.

STEAM: steam autoclave at 250°F / 121°C for 20 minutes.

FLASH: steam autoclave at 275°F / 134°C for 10 minutes.

GAS (ETO): follow manufacturer's guide for the unit which you are using.

**JANSEN BAYONET FORCEP**

PRODUCT NUMBER	FEATURES
91-6106	1 MM, 6"



**JEWELER #5 FORCEP**

PRODUCT NUMBER	FEATURES
91-6107	.5 MM 4½"



**MALIS FORCEP**

PRODUCT NUMBER	FEATURES
91-6108	1 MM, 7"



**MCPHERSON FORCEP**

PRODUCT NUMBER	FEATURES
91-6109	.5 MM, 3½" Curved



**MCPHERSON FORCEP**

PRODUCT NUMBER	FEATURES
91-6110	.5 MM, 3½" Straight



**SEMKIN FORCEP**

PRODUCT NUMBER	FEATURES
91-6111	.5 MM, 5½"



**TENZEL FORCEP**

PRODUCT NUMBER	FEATURES
91-6112	.5 MM, 4"



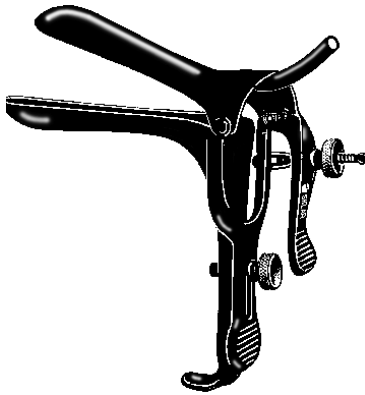

**GRAVES VAGINAL SPECULUMS  
WITH PERMANENT SMOKE EVACUATION TUBE**

90-9015	3" x ¾"	Small
90-9016	4" x 1¼"	Medium
90-9018	4½" x 1⅜"	Large
90-9020	4¾" x 1½"	Extra Large



**GRAVES VAGINAL SPECULUMS  
WITH LOOPS FOR DISPOSABLE SMOKE EVACUATION TUBING**

90-9005	3" x ½"	Extra Small
90-9000	3" x ¾"	Small
90-9002	4" x 1¼"	Medium
90-9004	4½" x 1⅜"	Large
90-9006	4¾" x 1½"	Extra Large



**GRAVES VAGINAL SPECULUMS  
WITHOUT TUBE OR LOOPS**

90-3812	3" x ½"	Extra Small
90-3804	3" x ¾"	Small
90-3806	4" x 1¼"	Medium
90-3808	4½" x 1⅜"	Large
90-3810	4¾" x 1 ½"	Extra Large



**PEDERSON VAGINAL SPECULUMS  
WITH PERMANENT SMOKE EVACUATION TUBE**

90-9040	3" x ½"	Small
90-9050	4" x ⅝"	Slender
90-9042	4" x ⅞"	Medium
90-9044	4¾" x 1"	Large
90-9048	4¾" x 1⅝"	Extra Large



**PEDERSON VAGINAL SPECULUMS  
WITH LOOPS FOR DISPOSABLE SMOKE EVACUATION TUBING**

90-9035	2¾" x ½"	Extra Small
90-9030	3" x ½"	Small
90-9038	4" x ⅝"	Slender
90-9032	4" x ⅞"	Medium
90-9034	4¾" x 1"	Large



**PEDERSON VAGINAL SPECULUMS  
WITHOUT TUBE OR LOOPS**

90-3841	2¾" x ½"	Extra Small
90-3833	3" x ½"	Small
90-3837	4" x ⅝"	Slender
90-3839	4" x ⅞"	Medium
90-3835	4¾" x 1"	Large



Autoclavable



Specula

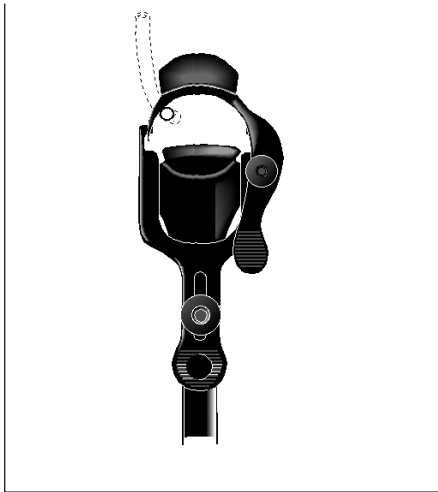

**GRAVES VAGINAL SPECULUMS  
WIDE VIEW PATTERN**

**WITH LARGE PROXIMAL OPENING FOR INSTRUMENTATION**

- 90-9054 4" x 1¼" With permanent Smoke Evacuation Tube
- 90-9055 4" x 1¼" Medium, with loops to hold and direct Smoke Evacuation Tubing



**FREEWAY GRAVES VAGINAL SPECULUMS**

**OPEN SIDE, 90° ANGLE**

- 90-3754 4" x 1¼" With permanent Smoke Evacuation Tube (not illustrated)
- 90-3755 4" x 1¼" With loop to hold and direct Disposable Smoke Evacuation Tubing (not illustrated)



**FREEWAY GRAVES VAGINAL SPECULUMS**

**OPEN SIDE, 45° ANGLE**

- 90-3814 4" x 1¼" With permanent Smoke Evacuation Tube (not illustrated)
- 90-3815 4" x 1¼" With loop to hold and direct Disposable Smoke Evacuation Tubing (not illustrated)

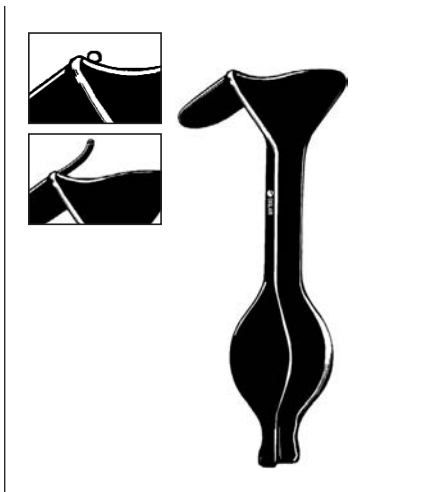

**AUVARD VAGINAL SPECULUMS**

**MEDIUM**

- 90-9100 2¾" x 1½" 2½ lbs. without loop
- 90-9102 2¾" x 1½" 2½ lbs. with loop to hold and direct Disposable Evacuation Tubing
- 90-9103 2¾" x 1½" 2½ lbs. with Permanent Smoke Evacuation Tube

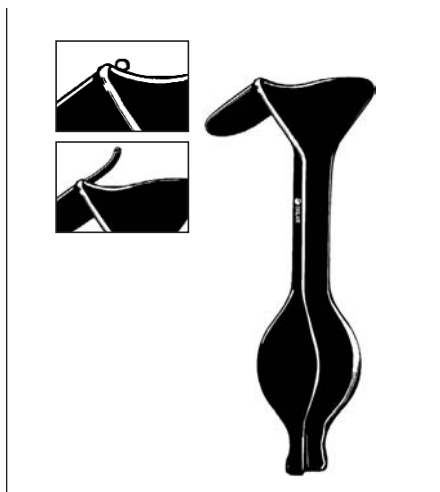

**AUVARD VAGINAL SPECULUMS**

**MEDIUM, LONG BLADES**

- 90-9106 4" x 1¼" 2½ lbs. Without loop
- 90-9108 4" x 1¼" 2½ lbs. With loop to hold and direct Disposable Evacuation Tubing
- 90-9109 4" x 1¼" With permanent Smoke Evacuation Tube

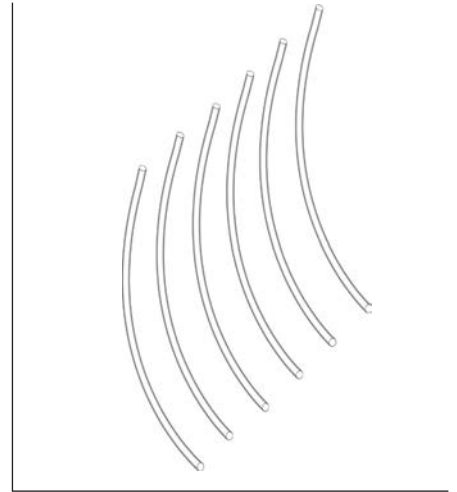

**DISPOSABLE SMOKE EVACUATION TUBING**

- 93-2160 10" precut 3/16" ID, 1/4" OD 50/cs



Autoclavable



**STEINER-AUVARD VAGINAL SPECULUMS**

**MEDIUM, EXTRA LONG BLADE**

- 90-3560 5½" x 1¼" 2½ lbs. without loop
- 90-3561 5½" x 1¼" 2½ lbs. with loop to hold and direct Disposable Evacuation Tubing
- 90-3562 5½" x 1¼" 2½ lbs. with Permanent Smoke Evacuation Tube



**COLLIN VAGINAL SPECULUM**

- 90-3946 4¼" x 1¼" With permanent Smoke Evacuation Tube (not illustrated)



**LATERAL VAGINAL RETRACTOR**

**RATCHET WITH HANDLE**

- 90-8845 Blade fits inside Vaginal Speculum



**JACKSON RETRACTORS SE**

**SINGLE END**

- 90-9064 3" x 1½" Small with permanent Smoke Evacuation Tube
- 90-9069 3½" x 1½" Medium without Tube or Loops
- 90-9065 3½" x 1½" Medium with permanent Smoke Evacuation Tube
- 90-9066 3½" x 1½" Medium with loop to hold and direct disposable Smoke Evacuation Tubing
- 90-9067 4" x 1½" Large without Tube or Loops
- 90-9068 4" x 1½" Large with loop to hold and direct disposable Smoke Evacuation Tubing
- 90-9070 4" x 1½" Large with permanent Smoke Evacuation Tube



Autoclavable



**KOGAN ENDOCERVICAL SPECULUM**

**WITH GAUGE AND SCREWS**

90-8855 Narrow Wire Blades



**KOGAN ENDOCERVICAL SPECULUM**

**WITH SPRING HANDLE**

90-8865 Narrow Wire Blades



**KOGAN ENDOCERVICAL SPECULUM**

**WITH RATCHET HANDLE**

90-8862 Narrow Wire Blades



**KOGAN ENDOCERVICAL SPECULUM**

**WITH GAUGE AND SCREW**

90-8858 Wide Wire Blades



**KOGAN ENDOCERVICAL SPECULUM**

**WITH SPRING HANDLE**

90-8850 Wide Wire Blades



**KOGAN ENDOCERVICAL SPECULUM**

**WITH RATCHET HANDLE**

90-8860 Wide Wire Blades



Autoclavable



1MM DIAMETER

4MM DIAMETER

3MM DIAMETER

6MM DIAMETER

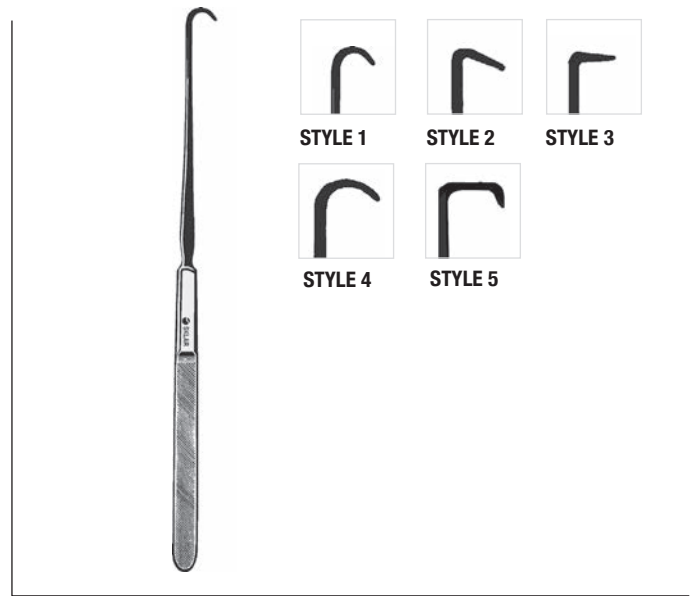

STYLE 1

STYLE 2

STYLE 3

STYLE 4

STYLE 5

**IRIS HOOKS**

**QUICK RELEASE**

90-2126	9"	1mm	90-2128	12"	1mm
90-2122	9"	3mm	90-2124	12"	3mm
90-2118	9"	4mm	90-2120	12"	4mm
90-2114	9"	6mm	90-2116	12"	6mm
90-2160	9"	Set of 4	90-2131	12"	Set of 4

**EMMETT TENACULUM HOOKS**

90-2171	9"	Style 1
90-2172	9"	Style 2
90-2173	9"	Style 3
90-2174	9"	Style 4
90-2175	9"	Style 5
90-2170	9"	Set of 5

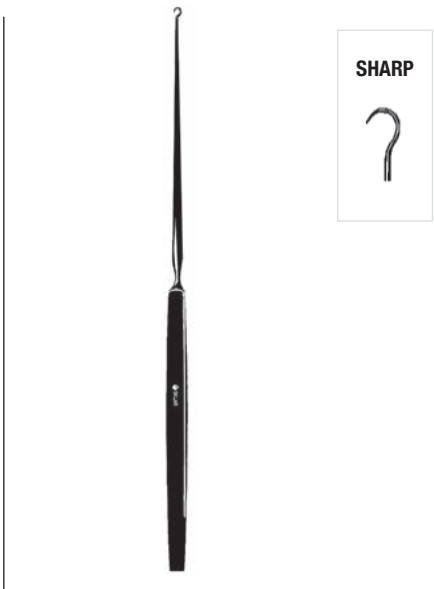

SHARP

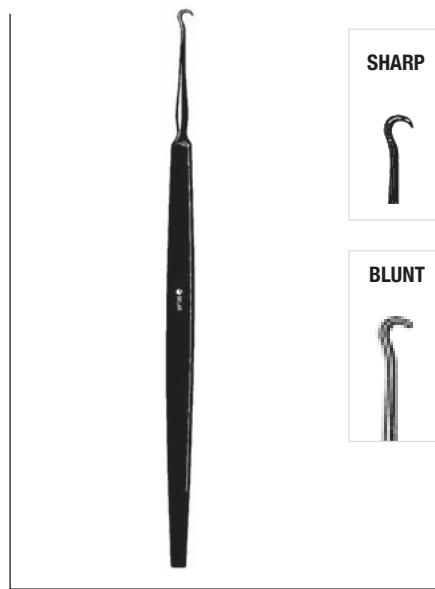

SHARP

BLUNT



BLUNT

SHARP

**GILLIES SKIN HOOKS**

90-1045	7"	3mm	Sharp
90-1047	7"	4mm	Sharp

**FRAZIER TISSUE HOOKS**

90-1048	5"	Sharp	Extra Delicate
90-1049	5"	Blunt	Extra Delicate

**TYRELL IRIS HOOKS**

90-1056	5"	3mm	Blunt
90-1058	5"	3mm	Sharp



Autoclavable



Hooks



**GUTHRIE DOUBLE HOOKS**

SHARP

- 90-1046 5" 3mm 2 Small Prongs
- 90-1044 5" 5mm 2 Large Prongs

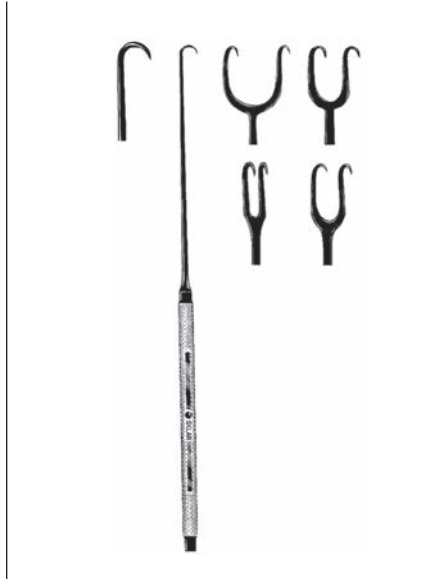

**JOSEPH SKIN HOOKS**

SHARP

- 90-1050 6¼" 1 Sharp Prong
- 90-1051 6¼" 2mm 2 Prong
- 90-1052 6¼" 5mm 2 Prong
- 90-1053 6¼" 7mm 2 Prong
- 90-1054 6¼" 10mm 2 Prong
- 90-1055 6¼" 12mm 2 Prong



**DERMAL RETRACTOR**

- 90-1040 5¼" Sharp
- 90-1042 5¼" Blunt



**SENN RETRACTOR**

DOUBLE END

- 90-1057 6" Sharp
- 90-1059 6" Blunt



**DESMARRES LID RETRACTORS**

- 90-1038 12mm
- 90-1036 16mm
- 90-1035 18mm

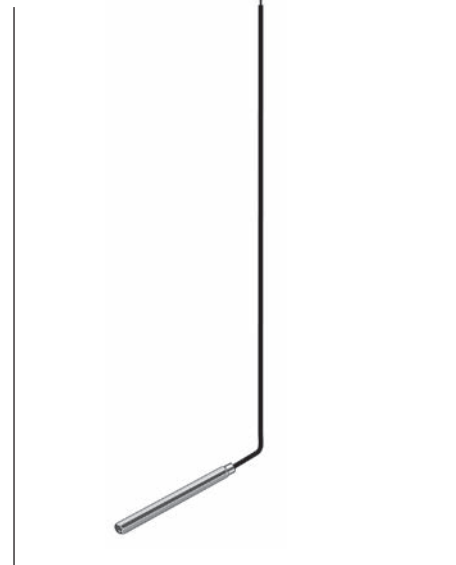

**DEPTH RULER IN MM**

- 90-2242 12"



Autoclavable





**BOZEMAN FORCEP**  
90-2342 10 1/4" S-Curve, One Large Ring



**BOZEMAN FORCEP**  
90-2340 10 1/4" S-Curve



**CAMPION GRASPING FORCEP**  
90-2298 9 1/4" Curved

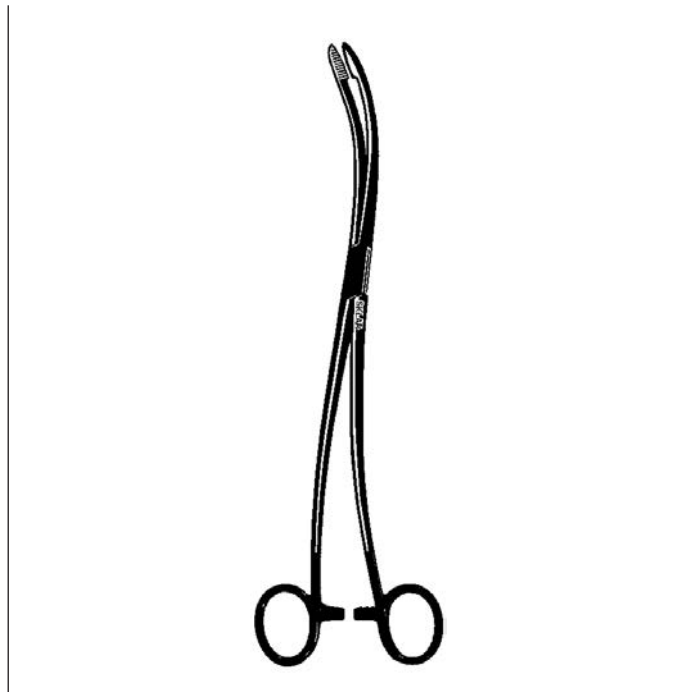

**DELEE UTERINE FORCEP**  
90-7111 11" Heavy S-Curve



Autoclavable



**SCHWEIZER FORCEP**  
90-2350 9½" Straight



**CLEMETSON FORCEP**  
NON RATCHETED  
90-2348 9½" Straight



**LAUFE UTERINE POLYP FORCEP**  
90-2345 7¾" Curved



**SCHROEDER TENACULUM FORCEPS**  
90-2325 10" Braun Flat Tips  
90-2326 10" Pozzi Round Tips



**SCHROEDER VULSELLUM FORCEPS**  
90-1790 9½" Straight  
90-1890 9½" Curved Sideways



**BABCOCK FORCEPS**  
90-2278 8"  
90-2295 9½"



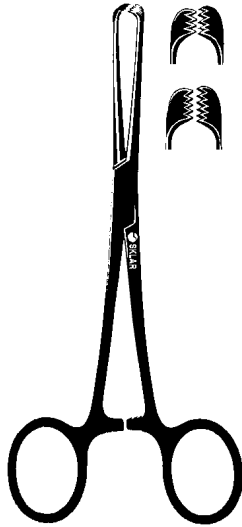

**ALLIS TISSUE FORCEPS**

90-2276 7½" 5x6 Teeth  
 90-2279 9½" 5x6 Teeth



**PEAN FORCEP**

90-2292 7¼" Curved



**ADSON FORCEPS**

90-2261 4¾" Serrated  
 90-2262 4¾" 1x2 Teeth  
 90-1060 4¾" 1x2 Teeth  
 90-1061 4¾" 2x3 Teeth  
 90-1062 4¾" 7x7 Teeth



**DRESSING FORCEPS**

**SERRATED**  
 90-1063 4½"  
 90-1064 5"  
 90-1065 5½"  
 90-1066 6"



Autoclavable



Forceps



**TISSUE FORCEPS**

**1X2 TEETH**

- 90-1020 4½"
- 90-1021 5"
- 90-1022 5½"
- 90-1023 6"



**DEBAKEY FORCEPS**

- 90-2310 7¾" 2mm
- 90-2312 9½" 2mm



**POTTS-SMITH FORCEPS**

- 90-2304 7" Serrated
- 90-2306 10" Serrated

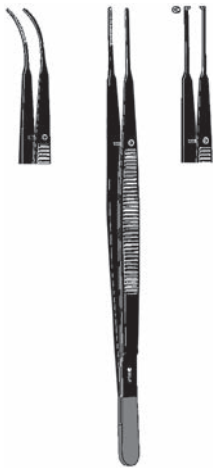

**GERALD FORCEPS**

- 90-1025 7" Straight Serrated
- 90-1026 7" Curved Serrated
- 90-1027 7" Straight 1x2 Teeth

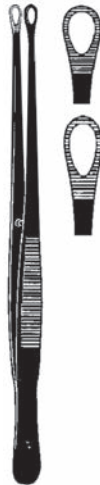

**TUTTLE/SINGLEY FORCEPS**

- 90-2270 7" Tuttle
- 90-2272 9" Singley



**CASTROVIEJO FORCEPS**

- 90-2313 4 ¼" .5mm Teeth



Autoclavable



**MAYO-HEGAR NEEDLE HOLDERS**

90-2287 7"

90-2288 8"



**HEANEY NEEDLE HOLDER**

90-2330 8¼" 2mm Curved



**NEWPORT PROBE**

45° ANGLE

90-9132 12"



**CASTRO CALIPER**

90-2264 3¼"



Autoclavable



**98-1000 – MAJOR BASIC SURGERY SET**

PRODUCT NUMBER	DESCRIPTION	FEATURES	QUANTITIES
47-1447	Adson Brown Tissue Forceps	4¾"	2
47-2147	Adson Forcep	Delicate, Serrated, 4¾"	1
36-2160	Allis Tissue Forceps	4x5 Teeth, 6"	3
36-2275	Allis Tissue Forceps	5x6 Teeth, 7½"	6
36-1662	Babcock Intestinal Forceps	6¼"	2
36-1677	Babcock Intestinal Forceps	8"	2
47-2955	Backhaus Towel Clamps	5¼"	12
60-6670	Balfour Abdominal Retractor	7"	1
17-3055	Crile Forceps	Straight, 5½"	12
17-3155	Crile Forceps	Curved, 5½"	12
60-3090	Deaver Retractors	#0, 1" x 9"	2
60-2713	Deaver Retractors	#2, 1" x 13"	2
60-3212	Deaver Retractors	#3, 1½" x 12"	2
60-3312	Deaver Retractor	#4, 2" x 12"	1
19-1055	Dressing Forceps	Serrated, 5½"	2
19-1080	Dressing Forceps	Serrated, 8"	2
87-2195	Foerster Sponge Forceps	Straight, Serrated, 9½"	2
87-2395	Foerster Sponge Forceps	Curved, Serrated, 9½"	2
17-1450	Halsted Mosquito Forceps	Straight, 5"	6
17-1550	Halsted Mosquito Forceps	Curved, 5"	6
17-1235	Hartmann Mosquito Forceps	Straight, Serrated, 3½"	3
17-1335	Hartmann Mosquito Forceps	Curved, Serrated, 3½"	3
15-1555	Mayo Dissecting Scissor	Straight, 5½"	1
15-2567	Mayo Dissecting Scissor	Curved, 6¾"	1
75-5670	Metzenbaum Scissors	Curved, 7"	2
55-9090	Metz-Nelson Scissor	Curved, 9"	1
30-1560	Probes	Double End, 6"	2
30-1960	Probes	With Eye, 6"	2
60-1681	Richardson Retractor	With Sklar-Grip Handle, Medium, 9½", 1" x 1¼"	1
60-1691	Richardson Retractor	With Sklar-Grip Handle, X-Large, 9½", ¾" x 2"	1
60-1695	Richardson-Eastman Retractor	Set of 2	1
17-2862	Rochester-Ochsner Forceps	Straight, 1x2 Teeth, 6¼"	2
17-2662	Rochester-Ochsner Forceps	Curved, 1x2 Teeth, 6¼"	2
17-2880	Rochester-Ochsner Forceps	Straight, 1x2 Teeth, 8"	2
17-2462	Rochester-Pean Forceps	Straight, 6¼"	6
17-2262	Rochester-Pean Forceps	Curved, 6¼"	6
17-2480	Rochester-Pean Forceps	Straight, 8"	3
17-2280	Rochester-Pean Forceps	Curved, 8"	3
06-2860	Ruler	Steel, 6"	1
19-2280	Russian Tissue Forceps	8"	2
06-2903	Scalpel Handles	#3	2
06-2904	Scalpel Handles	#4	2
74-3075	Schmidt Hemostat Forceps	Half Curved Jaws, 7½"	2
60-6164	Senn Retractors	Double End, Blunt, 6¼"	2
60-6162	Senn Retractors	Double End, Sharp, 6¼"	2
23-1106	Sklarlite Operating Scissors	Straight, Sharp/Blunt, 5½"	2
23-1130	Sklarlite Operating Scissors	Curved, Sharp/Blunt, 5½"	2
23-1157	Sklarlite Stevens Tenotomy Scissor	Curved, Blunt/Blunt, 4½"	1
21-8031	TC Mayo-Hegar Needle Holders	Serrated, 6"	2

**98-1000 — MAJOR BASIC SURGERY SET (CONTINUED)**

PRODUCT NUMBER	DESCRIPTION	FEATURES	QUANTITIES
19-1255	Tissue Forceps	1x2 Teeth, 5½"	3
19-1280	Tissue Forcep	1x2 Teeth, 8"	1
60-1085	US Army Retractor	Set of 2, Double End, 8¼"	2
10-1805	Weinstein Sterilizing Racks	11¼" x 3¼"	3
07-1805	Yankauer Suction Tubes	Stainless Steel	2
60-3598	Zalkind Ribbon Retractors	Malleable, ¾" x 7¾"	2
60-3610	Zalkind Ribbon Retractors	Malleable, 1" x 13"	2
60-3615	Zalkind Ribbon Retractors	Malleable, 1½" x 13"	2

**98-1014 — D AND C SET**

PRODUCT NUMBER	DESCRIPTION	FEATURES	QUANTITIES
90-3526	Auvar Weighted Speculum	Medium, 2½ lbs., 2¾" x 1½"	1
47-2955	Backhaus Towel Clamps	5¼"	6
80-1410	Bozeman Forcep	Double Curved, 10¼"	1
17-3062	Crile Forceps	Straight, 6¼"	6
17-3162	Crile Forceps	Curved, 6¼"	6
19-1080	Dressing Forcep	Serrated, 8"	1
87-2395	Foerster Sponge Forceps	Curved, Serrated, 9½"	2
90-4713	Goodell Dilator	Large, 13"	1
90-3701	Graves Vaginal Speculum	Medium, 1¼" x 4"	1
90-3702	Graves Vaginal Speculum	Large, 1⅜" x 4½"	1
90-4826	Hegar Dilators	Set of 8	1
90-3130	Jackson Retractor	Small Blade, 3" x 1½"	1
90-3135	Jackson Retractor	Medium Blade, 3½" x 1½"	1
92-5095	Javerts Forcep	Serrated, 9½"	1
90-6612	Kevorkian-Young Endocervical Curette	With Basket, 12"	1
90-3995	Kogan Endocervical Speculum	Wide Wire Blades, With Gauge	1
90-3710	Pederson Vaginal Speculum	Small, ½" x 3"	1
06-2903	Scalpel Handle	#3	1
06-2915	Scalpel Handle	#3L	1
06-2907	Scalpel Handle	#7	1
91-1290	Schroeder Braun Tenaculum Forcep	10"	1
90-5422	Sims Curette	#2, Sharp, 11"	1
90-5423	Sims Curette	#3, Sharp, 11"	1
90-5424	Sims Curette	#4, Sharp, 11"	1
90-5425	Sims Curette	#5, Sharp, 11"	1
90-5312	Sims Sound	Plain, 12½"	1
21-1260	TC Crile-Murray Needle Holder	Serrated, 6"	1
21-8032	TC Mayo-Hegar Needle Holder	Serrated, 7"	1
19-1280	Tissue Forcep	1x2 Teeth, 8"	1



**98-1016 — GYNECOLOGICAL SURGERY SET**

PRODUCT NUMBER	DESCRIPTION	FEATURES	QUANTITIES
36-2275	Allis Tissue Forceps	5x6 Teeth, 7½"	2
36-2295	Allis Tissue Forceps	5x6 Teeth, 9½"	2
90-3526	Auvarad Weighted Speculum	Medium, 2½ lbs., 2¾" x 1½"	1
47-2955	Backhaus Towel Clamps	5¼"	8
80-1410	Bozeman Forceps	Double Curved, 10"	2
17-3062	Crile Forceps	Straight, 6¼"	6
17-3162	Crile Forceps	Curved, 6¼"	6
90-2782	DeAlvarez Forceps	Double Curved, 8¼"	2
19-1080	Dressing Forcep	Serrated, 8"	1
90-3030	Eastman Retractor	Small Blade, 3" x 1½"	1
90-3035	Eastman Retractor	Medium Blade, 3½" x 1½"	1
90-3040	Eastman Retractor	Large Blade, 4" x 1½"	1
87-2195	Foerster Sponge Forceps	Straight, Serrated, 9½"	2
90-3700	Graves Vaginal Speculum	Small, ¾" x 3"	1
90-3701	Graves Vaginal Speculum	Medium, 1¼" x 4"	1
90-3702	Graves Vaginal Speculum	Large, 1⅜" x 4½"	1
90-4926	Hank Dilators	Set of 6	1
90-1977	Heaney Forceps	Light, Single Tooth, 7¾"	2
90-2177	Heaney Forceps	Heavy, Single Tooth, 8¼"	2
20-4682	Heaney Needle Holders	8¼"	2
90-1590	Mayo Dissecting Scissor	Straight, 9"	1
90-1690	Mayo Dissecting Scissor	Curved, 9"	1
20-2480	Mayo-Hegar Needle Holder	Serrated, 8"	1
55-9190	Metz-Nelson Scissor	Straight, 9"	1
55-9090	Metz-Nelson Scissor	Curved, 9"	1
14-2065	Operating Scissor	Curved, Sharp/Blunt, 6½"	1
90-2680	Phaneuf Forceps	Angled, 8¼"	2
34-2023	Poole Suction Tubes	23 French, Slip on End	2
17-1055	Pratt T-Shaped Clamps	Straight, 6"	2
17-2880	Rochester-Ochsner Forceps	Straight, 1x2 Teeth, 8"	3
17-2680	Rochester-Ochsner Forceps	Curved, 1x2 Teeth, 8"	3
17-2480	Rochester-Pean Forceps	Straight, 8"	3
17-2280	Rochester-Pean Forceps	Curved, 8"	3
19-2280	Russian Tissue Forcep	8"	1
19-2310	Russian Tissue Forcep	10"	1
06-2903	Scalpel Handle	#3	1
06-2915	Scalpel Handle	#3L	1
06-2904	Scalpel Handle	#4	1
06-2920	Scalpel Handle	#4L	1
91-1290	Schroeder Braun Tenaculum Forceps	10"	2
90-7995	Schweizer Uterine Forcep	Straight, 9½"	1
90-5413	Simpson Uterine Sound	CM Graduation	1
23-1106	Skarlite Operating Scissor	Straight, Sharp/Blunt, 5½"	1
23-1102	Skarlite Operating Scissor	Straight, Sharp/Sharp, 5½"	1
97-1560	TC Allis Grasping Forceps	7½"	2
21-8032	TC Mayo-Hegar Needle Holders	Serrated, 7"	2
21-8033	TC Mayo-Hegar Needle Holders	Serrated, 8"	2
51-4382	TC Potts-Smith Dressing Forcep	8¼"	1
19-1280	Tissue Forceps	1x2 Teeth, 8"	2
07-1805	Yankauer Suction Tube	Stainless Steel	1



**98-1018 — GYNECOLOGICAL BIOPSY SET**

PRODUCT NUMBER	DESCRIPTION	FEATURES	QUANTITIES
90-3526	Auvard Weighted Speculum	Medium, 2½ lbs., 2¾" x 1 ½"	1
80-1410	Bozeman Forcep	Double Curved, 10¼"	1
90-7710	Bozeman Forcep	Double Curved (One Large Ring), 10¼"	1
87-2195	Foerster Sponge Forceps	Straight, Serrated, 9½"	2
87-2395	Foerster Sponge Forceps	Curved, Serrated, 9½"	2
90-7492	Gelhorn Biopsy Forceps	9½"	1
90-3700	Graves Vaginal Speculum	Small, ¾" x 3"	1
90-3701	Graves Vaginal Speculum	Medium, 1¼" x 4"	1
90-3702	Graves Vaginal Speculum	Large, 1⅜" x 4½"	1
90-6612	Kevorkian-Younger Endocervical Curette	With Basket, 12"	1
90-3995	Kogan Endocervical Speculum	Wide Wire Blades, With Gauge	1
90-6292	Novak Endometrial Curette	4mm, 9½"	1
91-1290	Schroeder Braun Tenaculum Forcep	10"	1
90-5413	Simpson Uterine Sound	CM Graduation	1
90-5423	Sims Curette	#3, Sharp, 11"	1
90-6887	Tischler Cervical Biopsy Forcep	3 x 9.5mm, 8½"	1

**98-1020 — OBSTETRICAL SET**

PRODUCT NUMBER	DESCRIPTION	FEATURES	QUANTITIES
36-2380	Allis-Thoms Forcep	6x7 Teeth, 8"	1
47-2955	Backhaus Towel Clamps	5¼"	12
90-1755	Braun Episiotomy Scissor	Angled, 5½"	1
17-3062	Crile Forceps	Straight, 6¼"	3
17-3162	Crile Forceps	Curved, 6¼"	6
19-1060	Dressing Forceps	Serrated, 6"	2
90-3035	Eastman Retractor	Medium Blade, 3½" x 1½"	1
90-3040	Eastman Retractor	Large Blade, 4" x 1½"	1
87-2395	Foerster Sponge Forceps	Curved, Serrated, 9½"	2
91-4310	Iowa Puncturing Forcep	10"	1
92-2912	Laufe Divergent OB Forcep	12½"	1
15-1567	Mayo Dissecting Scissors	Straight, 6¾"	1
92-2215	McLane-Tucker-Luikart OB Forcep	15½"	1
14-1060	Operating Scissors	Straight, Sharp/Blunt, 6"	1
14-2060	Operating Scissors	Curved, Sharp/Blunt, 6"	1
17-2880	Rochester-Ochsner Forcep	Straight, 1x2 Teeth, 8"	1
17-2472	Rochester-Pean Forceps	Straight, 7¼"	3
17-2272	Rochester-Pean Forceps	Curved, 7¼"	3
19-2280	Russian Tissue Forceps	8"	2
92-1114	Simpson OB Forcep	Long, 14¼"	1
92-2314	Simpson-Luikart OB Forcep	14"	1
16-1610	Sklar Edge Mayo Dissecting Scissor	Tungsten Carbide, Curved, 6¾"	1
21-8032	TC Mayo-Hegar Needle Holders	Serrated, 7"	2
21-8033	TC Mayo-Hegar Needle Holder	Serrated, 8"	1
19-1260	Tissue Forceps	1x2 Teeth, 6"	2



**98-1024 – HYSTERECTOMY SET**

(FOR USE WITH MAJOR BASIC SET)

PRODUCT NUMBER	DESCRIPTION	FEATURES	QUANTITIES
36-2295	Allis Tissue Forceps	5x6 Teeth, 9½"	2
60-3090	Deaver Retractor	#0, 1" x 9"	1
60-3112	Deaver Retractor	#1, 1" x 12"	1
60-3212	Deaver Retractor	#3, 1½" x 12"	1
52-5195	DeBakey Tissue Forceps	Straight, 2mm, 9½"	1
87-2195	Foerster Sponge Forceps	Straight, Serrated, 9½"	2
90-2280	Heaney Clamps	Double Tooth, 8"	6
20-4682	Heaney Needle Holders	8¼"	2
90-2480	Heaney-Ballantine Clamps	Straight, Longitudinal Serrations, 8"	2
90-2580	Heaney-Ballantine Clamp	Curved, Longitudinal Serrations, 8"	1
15-2567	Mayo Dissecting Scissors	Curved, 6¾"	1
55-9080	Metz-Nelson Scissors	Curved, 8"	1
55-2894	Mixer Right Angle Forceps	Longitudinal Serrations, 10½"	2
17-2680	Rochester-Ochsner Forceps	Curved, 1x2 Teeth, 8"	4
17-2880	Rochester-Ochsner Forceps	Straight, 1x2 Teeth, 8"	8
19-2280	Russian Tissue Forcep	8"	1
06-2915	Scalpel Handle	#3L	1
74-3075	Schmidt Hemostat Forceps	Half Curved Jaws, 7½"	2

**98-1026 – SMALL GYN BIOPSY SET**

PRODUCT NUMBER	DESCRIPTION	FEATURES	QUANTITIES
90-8335	Iris Hook	Quick Release, 3mm, 9"	1
90-6612	Kevorkian-Young Endocervical Curette	With Basket, 12"	1
90-3990	Kogan Endocervical Speculum	Narrow Wire Blades, With Gauge	1
90-7525	Sklar Oval Biopsy Forceps	3mm x 5mm	1
91-1290	Schroeder Braun Tenaculum Forcep	10"	1

**98-1028 – CESAREAN SECTION SET**

(FOR USE WITH MAJOR BASIC SET)

PRODUCT NUMBER	DESCRIPTION	FEATURES	QUANTITIES
92-1012	DeLee OB Forcep	12"	1
87-2195	Foerster Sponge Forcep	Straight, Serrated, 9½"	1
90-3135	Jackson Vaginal Retractor	Medium Blade, 3½" x 1½"	1
20-2910	Masson Needle Holder	Serrated, 10½"	1
90-1590	Mayo Dissecting Scissor	Straight, 9"	1
90-1690	Mayo Dissecting Scissor	Curved, 9"	1
90-2680	Phaneuf Forceps	Angular, 8¼"	2
21-8060	TC Heaney Needle Holder	Curved, Serrated, 8¼"	1

**90-8557 — COLPOSCOPY SET**

PRODUCT NUMBER	DESCRIPTION	FEATURES	QUANTITIES
90-8334	Iris Hook	Quick Release, 4mm, 9"	1
90-6612	Kevorkian-Younger Endocervical Curette	With Basket, 12"	1
90-3995	Kogan Endocervical Speculum	Wide Wire Blades, With Gauge	1
90-7520	Tischler Oval Biopsy Forcep	3mm x 7mm	1

**98-1400 — GYNECOLOGICAL ABDOMINAL SET**

PRODUCT NUMBER	DESCRIPTION	FEATURES	QUANTITIES
36-2275	Allis Tissue Forceps	5x6 Teeth, 7½"	8
91-1070	Barrett Tenaculum Forceps	Straight, 7"	2
10-1808	E-Z Lock Instrument Stringer	8" x 2½"	1
91-2282	Jacobs Vulsellum Forceps	Straight, 8¼"	2
52-2970	Jorgenson Scissor	Strong Curve, 9"	1
34-1414	Ochsner Trocar	14 French, 10 Fr Catheter	1
90-3025	O'Sullivan O'Connor Abdominal Retractor	With 3 Interchangeable Blades, 2 Small / 1 Large	1
90-2680	Phaneuf Forceps	Angled, 8¼"	4
19-2280	Russian Tissue Forceps	8"	2
91-1298	Schroeder Tenaculum Forceps	Rounded Tips, 10"	2
90-5500	Sims Curettes	#0, Sharp	2
16-1615	Sklar Edge Mayo Dissecting Scissor	Tungsten Carbide, Curved, 9"	1
10-4394	SklarLite Mid-Size Container	18¼" x 11" x 6" Non-Perforated Bottom	1
10-4484	SklarLite Mid-Size Wire Basket	16" x 10" x 4"	1
91-1465	Staud-Moore Tenaculum Forceps	6½"	2



**98-1401 – RADICAL VULVECTOMY SET**

PRODUCT NUMBER	DESCRIPTION	FEATURES	QUANTITIES
50-1472	Adson Forceps	Curved, 7¼"	4
50-3047	Adson Tissue Forceps	1x2 Teeth, 4¾"	2
36-2160	Allis Tissue Forceps	4x5 Teeth, 6"	10
47-2955	Backhaus Towel Clamps	5¼"	2
91-1070	Barrett Tenaculum Forceps	Straight, 7"	2
17-3055	Crile Forceps	Straight, 5½"	4
17-3155	Crile Forceps	Curved, 5½"	18
50-1290	Cushing Nerve/Vein Retractors	9"	2
52-5177	DeBakey Atraumatic Forceps	2mm, 7¾"	2
19-1060	Dressing Forceps	Serrated, 6"	2
19-1080	Dressing Forceps	Serrated, 8"	2
10-1810	E-Z Lock Instrument Stringers	10" x 2½"	2
87-2195	Foerster Sponge Forceps	Straight, Serrated, 9½"	4
55-2880	Gemini Clamps	Delicate, Angled, 8"	4
17-1550	Halsted Mosquito Forceps	Curved, 5"	4
60-1661	Kelly Retractors	9½", 2" x 2½"	2
47-2852	Lorna-Edna Towel Clamps	5¼"	2
60-1676	Richardson Retractors	With SklarGrip™ Handle, Small, 9½", ¾" x 1"	2
60-1681	Richardson Retractors	With SklarGrip™ Handle, Medium, 9½", 1" x 1¼"	2
17-2862	Rochester-Ochsner Forceps	Straight, 1x2 Teeth, 6¼"	8
17-2880	Rochester-Ochsner Forceps	Straight, 1x2 Teeth, 8"	10
17-2262	Rochester-Pean Forceps	Curved, 6¼"	16
06-2903	Scalpel Handles	#3	2
06-2907	Scalpel Handle	#7	1
91-1298	Schroeder Tenaculum Forceps	Rounded Tips, 10"	2
16-1510	Sklar Edge Mayo Dissecting Scissor	Tungsten Carbide, Straight, 6¾"	1
16-1610	Sklar Edge Mayo Dissecting Scissor	Tungsten Carbide, Curved, 6¾"	1
16-1905	Sklar Edge Metzenbaum Lahey Scissor	Tungsten Carbide, Delicate, Curved, 5¾"	1
16-2110	Sklar Edge Metzenbaum Scissor	Tungsten Carbide, Curved, 7"	1
10-4096	SklarLite Full Size Container	23" x 11" x 6" Non-Perforated Bottom	1
10-4290	SklarLite Full Size Wire Basket	21¼" x 10" x 4"	1
91-1465	Stauder-Moore Tenaculum Forceps	6½"	2
21-8031	TC Mayo Hegar Needle Holders	Tungsten Carbide, Serrated, 6"	2
21-8032	TC Mayo Hegar Needle Holders	Tungsten Carbide, Serrated, 7"	2
19-1260	Tissue Forceps	1x2 Teeth, 6"	2
19-1280	Tissue Forceps	1x2 Teeth, 8"	2
60-1085	US Army Retractor	Set of 2, Double End, 8¼"	1
42-1865	Weitlaner Retractors	3x4 Teeth, Blunt, 6½"	2



## SKLARSPEC™

### DISPOSABLE GRAVES VAGINAL SPECULA

SKLARSPEC plastic specula are clear, disposable, and comfortable. Plastic material allows 360 degree visibility and reduces thermal shock. Provides protection of the doctor, the nurse and the patient from cross contamination. Clean up is eliminated by single-use only. Plastic material avoids unpleasant temperature shock associated with metal. One hand operation with wide range adjustment.

### PLASTIC VAGINAL SPECULUMS, GRAVES STYLE

#### STERILE

PRODUCT NUMBER	DESCRIPTION	QUANTITIES
96-2602	Small	50/cs
96-2604	Medium	50/cs
96-2606	Large	50/cs
96-1857	Small	100/cs
96-1867	Medium	100/cs
96-1877	Large	100/cs

#### NON-STERILE

PRODUCT NUMBER	DESCRIPTION	QUANTITIES
96-0857	Small	100/cs
96-0867	Medium	100/cs
96-0877	Large	100/cs



**PLASTIC VAGINAL SPECULUMS, LIGHT SOURCE STYLE**

**NON-STERILE**

PRODUCT NUMBER	DESCRIPTION	QUANTITIES
96-0827	Small, Blue	100/cs
96-0837	Medium, Green	100/cs
96-0847	Large, White	100/cs



**PLASTIC VAGINAL SPECULUMS, CUSCO STYLE**

**STERILE**

PRODUCT NUMBER	DESCRIPTION	QUANTITIES
96-2642	Small	50/cs
96-2644	Medium	50/cs
96-2648	Large	50/cs

**NON-STERILE**

PRODUCT NUMBER	DESCRIPTION	QUANTITIES
96-0557	Small	10/pk, 10pk/cs, 100/cs
96-0567	Medium	10/pk, 10pk/cs, 100/cs
96-0577	Large	10/pk, 10pk/cs, 100/cs



**SKLAR MONSEL'S FERRIC SUBSULFATE PASTE**

A ONE-TIME USE pre-mixed paste packaged in convenient ready-to-use bottles. Also includes 12 rayon tip applicators.

Sklar has converted Monsel's solution (ferric subsulfate) into an efficacious and conveniently packaged paste. As a hemostatic agent it is ideal to apply to cervical tissue following colposcopic biopsy, electrosurgical excision (LLETZ or LEEP) and ablative (LASER) surgery. Sklar Monsel's is fabricated to relieve office personnel from the inexact and messy task of mixing their own compound for post-surgical treatment of their female patients.

PRODUCT NUMBER	DESCRIPTION	QUANTITIES
96-1200	8ml Bottle & Swab	12 Each

**SKLAR LUGOL'S STRONG IODINE SOLUTION USP**

A ONE-TIME USE pre-mixed iodine solution packaged in convenient ready-to-use bottles. Also includes 12 rayon tip applicators.

This iodine contrast medium is also sealed in airtight bottles which assist in mitigating waste associated with the use of this product. The Lugol's works quickly to assist the Colposcopist to identify potentially diseased cervical tissue (CIN) by changing suspect tissue in the cervical transformation zone into a white "target" for excision or biopsy. Healthy tissue will remain unchanged by the application of Lugol's.

PRODUCT NUMBER	DESCRIPTION	QUANTITIES
96-1210	8ml Bottle & Swab	12 Each



## SKLAR SILICONE VAGINAL DILATORS

Sklar Silicone Vaginal Dilators are used to enlarge the vagina for the purposes of examination, a surgical procedure or for the relief of vaginismus. This is accomplished by supporting or distending the vaginal canal. They are contraindicated in acute genital tract or pelvic infections or with non-compliant patients.

### VAGINAL DILATOR SETS

#### NON-STERILE

PRODUCT NUMBER	DESCRIPTION	QUANTITIES			
90-5260	Small Family	Length	Small OD	Large OD	Set of 4
	XL	75.0mm	13.5mm	18.0mm	
	L	65.0mm	12mm	16.0mm	
	M	60.0mm	10.5mm	14.0mm	
	S	50.0mm	9.5mm	13.0mm	
90-5262	Medium Family	Length	Small OD	Large OD	Set of 4
	XL	95.0mm	26.0mm	33.0mm	
	L	86.0mm	22.5mm	28.0mm	
	M	78.0mm	19.5mm	23.0mm	
	S	75.0mm	12.5mm	17.0mm	
90-5264	Large Family	Length	Small OD	Large OD	Set of 4
	XL	150.0mm	30.0mm	38.0mm	
	L	138.0mm	25.5mm	32.0mm	
	M	118.0mm	19.5mm	28.0mm	
	S	120.0mm	19.5mm	24.0mm	



#### Normal Anatomy

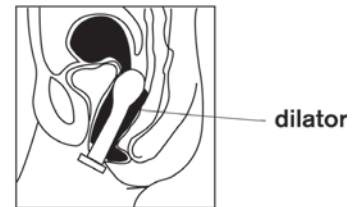

Dilator in Position





**SKLAR STERILE DISPOSABLE ENDOCERVICAL CURETTE**

**SINGLE PEEL POUCHES, SINGLE USE ONLY**

PRODUCT NUMBER	QUANTITIES
96-4143	25/bx

Federal law restricts the sale of this device by or on the order of a physician. Contents sterile unless package has been opened or damaged.

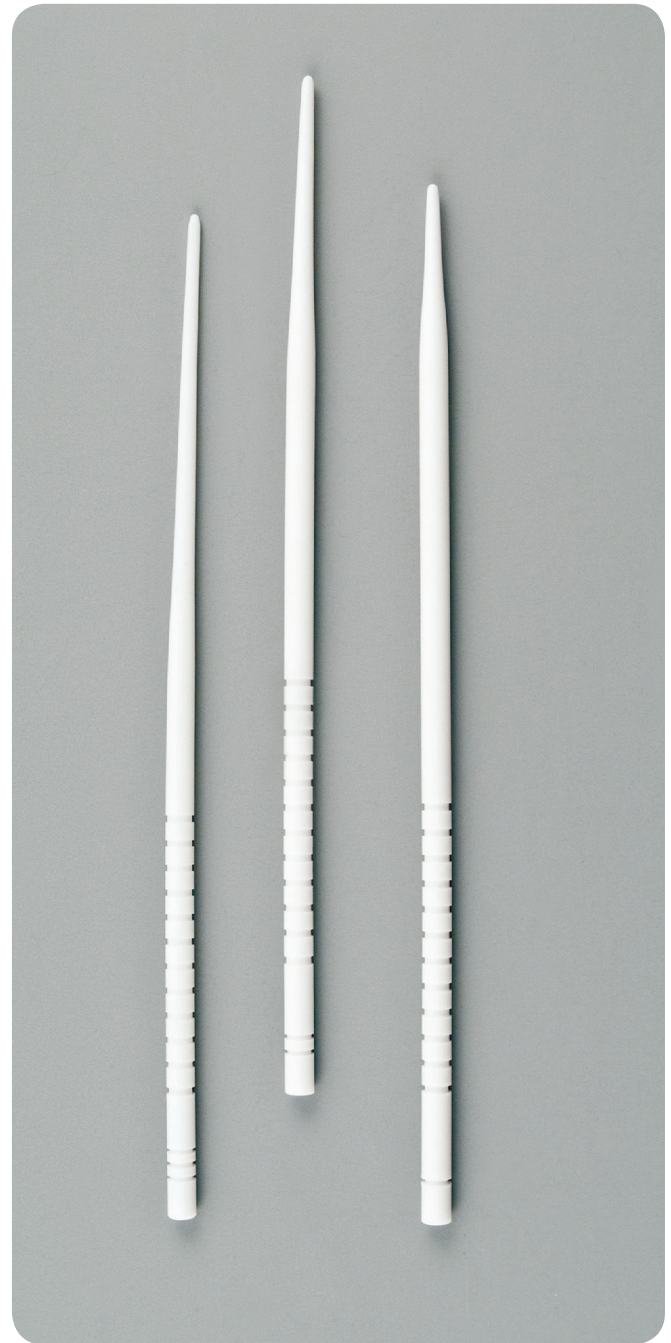

**SKLAR OS DILATOR SET**

**NON-STERILE**

PRODUCT NUMBER	DESCRIPTION	QUANTITIES
96-4150	Teflon Reusable Set Includes Os Locator, Canal Finder, Fundus Dilator	Set of 3



**SKLAR OS DILATORS, DISPOSABLE**

**STERILE**

PRODUCT NUMBER	QUANTITIES
96-4155	50/bx



## PESSARIES

Sklar offers a full line of soft, silicone Pessaries for effective vaginal support and relief of incontinence. Pessaries are uniquely designed for ease of insertion and removal. Properly fitted, Pessaries can be successfully used to treat a variety of gynecologic conditions and abnormalities. Choose from the most popular patterns, available in a variety of shapes and sizes. Latex Free.



### RING WITH SUPPORT

For Mild Uterine Prolapse or a Cystocele

PRODUCT NUMBER	DESCRIPTION	QUANTITIES
90-5291	#1 2"	1 Each
90-5292	#2 2¼"	1 Each
90-5293	#3 2½"	1 Each
90-5294	#4 2¾"	1 Each
90-5295	#5 3"	1 Each
90-5296	#6 3¼"	1 Each
90-5297	#7 3½"	1 Each



### GELHORN PESSARY WITH DRAIN

For a Mild Cystocele or Moderate Uterine Prolapse

PRODUCT NUMBER	DESCRIPTION	QUANTITIES
90-5282	#2 2"	1 Each
90-5283	#3 2¼"	1 Each
90-5284	#4 2½"	1 Each
90-5285	#5 2¾"	1 Each
90-5286	#6 3"	1 Each



### DONUT

For Moderate Uterine Prolapse or a Mild Cystocele or Rectocele

PRODUCT NUMBER	DESCRIPTION	QUANTITIES
90-5271	#1 2¼"	1 Each
90-5272	#2 2½"	1 Each
90-5273	#3 2¾"	1 Each
90-5274	#4 3"	1 Each
90-5275	#5 3¼"	1 Each
90-5276	#6 3½"	1 Each



### CUBE WITH DRAIN

For Moderate to Severe Uterine Prolapse or a Mild Cystocele or Rectocele

PRODUCT NUMBER	DESCRIPTION	QUANTITIES
90-5301	#1 29mm	1 Each
90-5302	#2 33mm	1 Each
90-5303	#3 37mm	1 Each
90-5304	#4 41mm	1 Each
90-5305	#5 45mm	1 Each

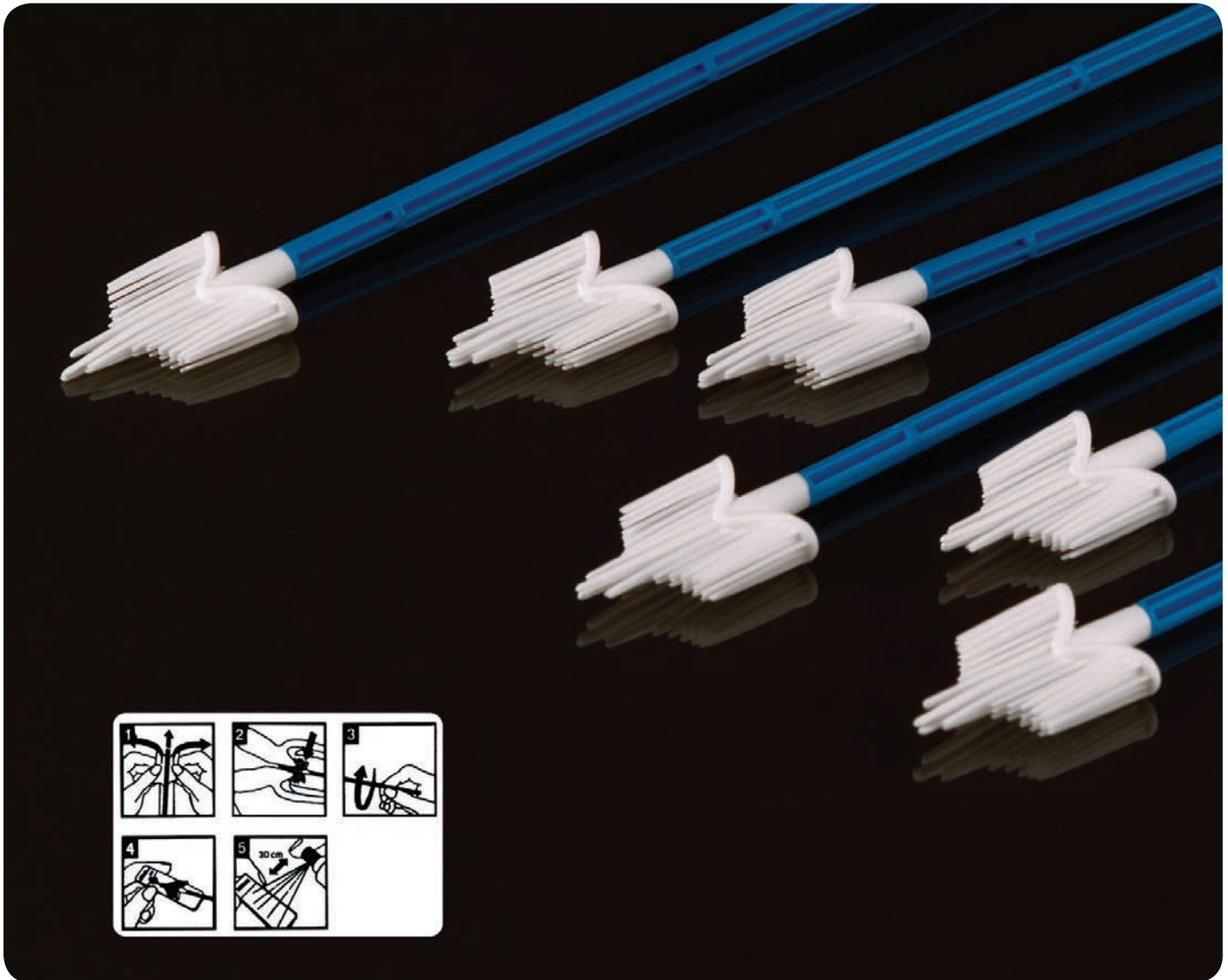

### SKLAR CERVIX BRUSH CERVICAL CELL SAMPLER

Sklar's Cervix Brush is made of polyethylene and has a total length of 20 centimeters. The top portion uses a soft flexible brush to obtain cell samples. The brush consists of 57 semi-circular plastic bristles of various lengths. The shape is such that the top edges of the brush follow the contours of the cervix. The longer middle bristles reach deep into the endocervical canal. The shorter bristles touch both the ectocervical area and transformation zone at the same time.

#### SKLAR CERVIX BRUSH

##### STERILE

PRODUCT NUMBER	QUANTITIES
96-4140	100/bx

##### NON-STERILE

PRODUCT NUMBER	QUANTITIES
96-4140NS	100/bx



**UTERINE MANIPULATOR/  
INJECTOR, DISPOSABLE**

STERILE

PRODUCT NUMBER	DESCRIPTION	QUANTITIES
96-4120	4.5mm O.D. -33cm Length	12/cs



**ENDOMETRIAL BIOPSY CANNULA**

STERILE

PRODUCT NUMBER	DESCRIPTION	QUANTITIES
96-4100	For Aspiration Biopsy	25/cs



**ENDOMETRIAL SAMPLING SET**

STERILE

PRODUCT NUMBER	DESCRIPTION	QUANTITIES
96-4160	3mm	10/bx



**NEEDLE EXTENDERS, DISPOSABLE**

PLASTIC LUER LOCK ADAPTER

STERILE

PRODUCT NUMBER	DESCRIPTION	QUANTITIES
96-5190	3"	10/bx
96-5192	4"	10/bx
96-5194	5"	10/bx
96-5196	6"	10/bx



**NEEDLE EXTENDERS, REUSABLE**

PRODUCT NUMBER	DESCRIPTION	QUANTITIES
96-4190	3"	1
96-4192	4"	1
96-4194	5"	1
96-4196	6"	1





## SKLAR TRU-PUNCH™ DISPOSABLE VULVAR BIOPSY PUNCH

The SKLAR Tru-punch has a seamless steel tip carefully honed for a razor sharp incision and perfect sample. The ribbed and hollow handle permits tissue to be easily dislodged.

### STERILE DISPOSABLE BIOPSY PUNCH

PRODUCT NUMBER	DESCRIPTION	QUANTITY	PRODUCT NUMBER	DESCRIPTION	QUANTITY
96-0192	1mm	25/bx	96-1092	1mm	50/bx
96-0197	1.5mm	25/bx	96-1098	1.5mm	50/bx
96-1140	2mm	25/bx	96-1100	2mm	50/bx
96-0102	2.5mm	25/bx	96-1102	2.5mm	50/bx
96-1142	3mm	25/bx	96-1105	3mm	50/bx
96-1144	3.5mm	25/bx	96-1110	3.5mm	50/bx
96-1146	4mm	25/bx	96-1115	4mm	50/bx
96-1148	5mm	25/bx	96-1120	5mm	50/bx
96-1150	6mm	25/bx	96-1125	6mm	50/bx
96-1152	8mm	25/bx	96-1130	8mm	50/bx
96-1160	Assorted - 5 of each: 2, 3, 3.5, 4 & 5mm	25/bx	96-0160	Assorted - 5 of each: 2, 3, 3.5, 4 & 5mm	50/bx



Sterile

**96-1721 — HYSTEROSALPINGOGRAM BASIC TRAY 10/CASE**

DESCRIPTION	QUANTITIES
Drape, 18" x 26" Fenestrated	1
20" Extension Set, L/L	1
Gauze, 4" x 4"	6
Gloves, Pair/Walleted, Powder Free	1
Graves Vaginal Speculum, Disposable	1
Half Drape Sheet	1
Lubricating Jelly	1
Needle, 18GA x 1½"	1
PVP Ointment Packet, 1 gram	1
PVP Solution .75 oz	1
8" Rayon Swab	2
Stopcock, 1-Way LP w/Rot	1
Syringe, 10cc, L/L	1
Syringe, 10cc, Control, L/L	1
Tray, Half Deep	1
Tray, Large Foam	1
Uterine Injector, 2.0	1
Uterine Sound	1
Ziplock Bag, 6" x 6"	1



**96-1722 — AMNIOCENTESIS TRAY 10/CASE**

DESCRIPTION	QUANTITIES
Adhesive Bandage	1
Drape, 24" x 36" Fenestrated	1
Filter Straw, 5 Micron	1
Gauze, 4" x 4"	8
Lidocaine 1%, 5ml Ampule	1
Needle, 22GA x 1½"	1
Needle, 22GA x 3½" Spinal	1
Needle, 25GA x ½"	1
6" Plastic Ruler	1
PVP Swabsticks 3's	1
Specimen Tube, Clear	3
Syringe, 5cc, L/L	1
Syringe, 10cc, L/L	1
Syringe, 20cc, L/L	1
Towel Absorbent	1
Ultrasound Gel Pak	1



**96-1723 — STANDARD CT BIOPSY TRAY 10/CASE**

DESCRIPTION	QUANTITIES
Adhesive Bandage	1
Alcohol Prep Pad	1
Ampule Holder 5ml	1
Drape, 24" x 36" Fenestrated	1
Gauze, 4" x 4"	10
Lidocaine 1%, 5ml Ampule	2
Mini Scalpel	1
Needle, 22GA x 1½"	1
Needle, 25GA x ½", Safety Glide	1
6" Paper Ruler	1
PVP Swabsticks 3's	1
Syringe, 10cc, L/L	4
Towel, Absorbent	2
Tray, Half Shallow	1



**96-1801 — ULTRASOUND TRAY****10/CASE**

DESCRIPTION	QUANTITIES
Adhesive Bandage	1
6" Applicator Prep Stick	3
Drape, 18" x 26"	3
Drape, 24" x 36" Fenestrated	1
Gauze, 3" x 3"	12
Lidocaine 1%, 5ml Ampule	1
Needle, 20GA x 1½"	1
Needle, 25GA x 1½"	1
6" Paper Ruler	1
Procedure Tray	1
Syringe, 10cc, L/L	3
Tray, Prep Shallow	1

**96-1803 — CYST / FNA / CORE TRAY****10/CASE**

DESCRIPTION	QUANTITIES
Alcohol Swabsticks Triple	1
Ampule Holder, 5ml	1
Bowl, 16 oz.	1
Drape, 24" x 36" Fenestrated	1
Gauze, 4" x 4"	6
Lidocaine 1%, 5ml Ampule	1
Needle, 18GA x 1½"	1
Needle, 21GA x 1½"	1
Needle, 22GA x 1½"	1
Needle, 25GA x ½"	1
Probe Cover	1
PVP Swabsticks 3's	1
Scalpel, #11, Disposable	1
Syringe, 5cc, L/L	1
Syringe, 10cc, L/L	1
Tray, Half Deep	1
Ziplock Bag, 8" x 10"	1

**96-1807 — CYST ASPIRATION TRAY****25/CASE**

DESCRIPTION	QUANTITIES
Gauze, 4" x 4"	5
Needle, 21GA x 1½"	1
PVP Swabsticks 3's	1
Syringe, 10cc, L/L	1
Tray, Small Deep Prep	1





Sterile

**96-1916 – LLETZ ELECTROSURGERY TRAY 10/CASE**

DESCRIPTION	QUANTITIES
Alcohol Prep Pad	1
Ampule Holder, 5ml	1
Lidocaine 2%, 10ml	1
Lidocaine 2%, 30ml w/Epi	1
Lugol's PVP Solution	1
Monsel's Hemostatic Paste	1
Needle, 27GA x 3¼"	1
Needle, 30GA x 1"	1
Panty Liner	1
8" Rayon Swab	6
Tray, Half Shallow	1
Underpad, 17" x 24"	1
Ziplock Bag, 4" x 7"	1



**96-1917 – PAP SMEAR TRAY 50/CASE**

DESCRIPTION	QUANTITIES
Alcohol Swabstick Single	1
Ampule Holder, 5ml	1
Cervix Brush	1
6" Cotton Tip Applicator	2
Glass Slides Frosted	1
Gloves, Pair/Walleted LF	1
Graves Vaginal Speculum, Disposable	1



**96-4319 – D & C / GYN PACK 4/CASE**

DESCRIPTION	QUANTITIES
6" Applicator Prep Stick	3
Back Table Cover	1
Catheter, Rob-Nel, 14 Fr	1
6" Cotton Tip Applicator	2
Gauze, 4" x 4"	10
Gloves, Pair/Walleted, Powder Free	1
Gown, XL	1
Lap Drape	1
Leggings, Lithotomy, 31" x 43"	2
Lubricating Jelly, Foil Pack 5gram	2
OB Pads	1
OR Towel, Blue	7
PVP Paint Bottle, 4 oz.	1
PVP Scrub Bottle, 4 oz.	1
Specimen Cup w/Lid, 4 oz.	1
Sponge, Wing Small	6
Telfa Pad, 8" x 3"	1
Towel Absorbent	2
Tray, 2 Compartment	1
Tray, 3 Compartment	1
Under Buttocks Drape w/Pouch	1





**96-3171 — LABOR AND DELIVERY TRAY 5/CASE**

DESCRIPTION	QUANTITIES
Back Table Cover	1
Bowl, 80 oz.	1
Bowl, Lid	1
Drape, Vaginal Delivery	1
Gauze, 4" x 4" X-Ray	1
Half Drape Sheet	1
Lap Sponges, Pk/5	1
Maternity Pad	2
Needle, 21GA x 1½"	1
OR Towel, Blue	4
Specimen Tube 8ml w/Screw Cap	1
Syringe, Bulb 3 oz.	1
Syringe, 10cc, Control, L/L	1
Umbilical Clip	1

**96-4305 — L & D PACK 3/CASE**

DESCRIPTION	QUANTITIES
Abdominal Drape	1
Baby Receiving Blanket	1
Back Table Cover	1
Bowl, 16 oz.	1
Bowl, 80 oz.	1
Sponge Bowl, 32 oz.	1
Gauze, 4" x 4" X-Ray	30
Gown, XL	1
Gown, XL Microcool	1
Half Drape Sheet	1
Leggings, 31" x 48"	2
Needle, 22GA x 1½"	1
OB Pads	2
OR Basin, 7 qt.	1
OR Towel, Blue	4
Syringe, 10cc, L/L	1
Syringe, Ear/Ulcer 2 oz.	1
Towel Absorbent	2
Tray, Half Deep	1
Umbilical Clip	1
Under Buttocks Drape w/Pouch	1
Vaginal Packing Gauze, 4" x 36"	1

**96-3181 — C-SECTION TRAY 5/CASE**

DESCRIPTION	QUANTITIES
Abdominal Pad	1
6" Applicator Prep Stick	3
Back Table Cover	1
Band Bag	1
Drape, Vaginal Delivery	1
Gloves, Pair/Walleted, Latex	1
Gown, Large	1
Lap Sponges	10
Maternity Pad	1
Mayo Stand Cover	1
Needle Counter	1
OR Towel, Blue	4
PVP Prep Bottle, 2 oz.	1
Specimen Tube 8ml w/Screw Cap	1
Suction Tubing, ¼" x 12'	1
Syringe, Bulb, 3 oz.	1
Tray, Half Shallow	1
Tray, Large Foam	1
Tray, Prep Shallow	1





Sterile

**96-4306— C-SECTION PACK**

**1/CASE**



DESCRIPTION	QUANTITIES
Baby Receiving Blanket	1
Back Table Cover	1
Bowl, 80 oz.	1
Sponge Bowl, 32 oz.	1
#10 Carbon Scalpel Blade	2
#20 Carbon Scalpel Blade	1
Drape, 24" x 36" Fenestrated	1
Drape, C-Section w/Pouch & Fenestration	1
Gown, XL	1
Gown, XL Reinforced	2
Lap Sponges	15
Mayo Stand Cover	1
Medicine Cup, 2 oz.	1
OB Pads	2
OR Basin, 7 qt.	2
OR Towel, Blue	6
Suction Tubing, ¼" x 12'	1
Suture Bag	1
Syringe, Ear/Ulcer, 2 oz.	1
Umbilical Clip	1
Yankauer Suction Tube, Non-Vented	1

**96-4307— C-SECTION TRAY**

**2/CASE**



DESCRIPTION	QUANTITIES
Baby Cap	1
Baby Receiving Blanket	1
Back Table Cover	1
#10 Carbon Scalpel Blade	2
#20 Carbon Scalpel Blade	1
Drape, C-Section w/Pouch & Fenestration	1
Emesis Basin, 700cc	1
Gauze, 4" x 4"	10
Gauze, 4" x 4" X-Ray	10
Gloves, Pair, Devon Light LF	2
Gown, XL	2
Gown, XL Reinforced	1
Lap Sponges	20
Mayo Stand Cover	1
Medicine Cup, 2 oz.	1
Needle, 18GA x 1½"	1
Needle Counter	1
Non Adherent Dressing, 3" x 4"	1
OB Pads	2
OR Basin, 7 qt.	2
OR Towel, Blue	5
Pitcher, 1200ml	1
Placenta Basin	1
Skin Marker	1
Specimen Cup w/ Lid, 4 oz.	1
Sponge Bowl, 32 oz.	1
Suction Tubing ¼" x 12'	1
Suture Bag	1
Syringe, 10cc, L/L	1
Syringe, 20cc, L/L	1
Syringe, Ear/Ulcer, 2 oz.	1
Towel Absorbent	2
Tray, Large Foam	1
Umbilical Clip	1
Utility Drape w/Tape	4
Venous Blood Collection Tube, 7ml	1
Venous Blood Collection Tube, 10ml	1
Yankauer Suction Tube, Non-Vented	1

**96-2309 — ECONOMY MATERNITY PACK 50/CASE**

DESCRIPTION	QUANTITIES
Draw String Bag	1
OB Pads	5
Ziplock Bag, 10" x 12"	1



**96-2310 — MATERNITY PACK 50/CASE**

DESCRIPTION	QUANTITIES
Draw String Bag	1
Peri Cold Packs	3
Stretch Briefs	1



**96-2311 — DELUXE MATERNITY PACK 20/CASE**

DESCRIPTION	QUANTITIES
Draw String Bag	1
OB Pads	10
OB Pads Maxi	9
Peri Bottle	1
Peri Cold Packs	3
Sani-Bag	12
Stretch Briefs	2
Underpad, 23" x 24"	5





Non-Sterile

**96-2312 — ECONOMY BABY CARE PACK 50/CASE**

DESCRIPTION	QUANTITIES
Aloetouch Wipes, 12/cs	1
Baby Comb	1
Draw String Bag	1
Ivory Soap, 3 oz.	1
Syringe, Bulb Irrigation, 60cc	1
Tape Measure	1



**96-2313 — BABY CARE PACK 50/CASE**

DESCRIPTION	QUANTITIES
Aloetouch Wipes, 12/cs	1
Baby Comb	1
Digital Thermometer	1
Draw String Bag	1
Ivory Soap, 3 oz.	1
Lubricating Jelly	1
Syringe, Bulb Irrigation, 60cc	1
Tape Measure	1



**96-2314 — DELUXE BABY CARE PACK 20/CASE**

DESCRIPTION	QUANTITIES
Aloetouch Wipes, 12/cs	1
Baby Comb	1
Diapers	15
Digital Thermometer	1
Draw String Bag	1
Hand/Body Lotion, 2 oz.	1
Ivory Soap, 3 oz.	1
Lubricating Jelly	1
Syringe, Bulb Irrigation, 60cc	1
Tape Measure	1



Surgi-OR™ is a full line of high-quality, Mid-Grade OR instruments, hand-crafted and forged from Japanese surgical grade stainless steel. This cost-effective line of instruments are designed to give you maximum performance at affordable cost and offers significant value to the Operating Room as well as other important surgical settings.

Sklar is pleased to offer Surgi-OR™ Tungsten Carbide Instruments that feature this extremely hard alloy resulting in a superior instrument.

Surgi-OR™ Needle Holders feature solid Tungsten Carbide insert jaws for exceptional control and unbeatable strength. These perfectly balanced instruments are readily identified by the dual gold finger rings and afford quality and performance you can trust in a variety of surgical settings.

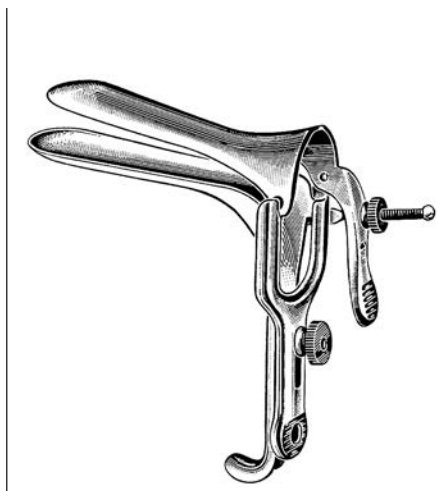

**GRAVES VAGINAL SPECULUMS**

95-304	3" x 1/2"	X-small
95-303	3" x 3/4"	Small
95-312	4" x 1 1/4"	Medium
95-324	4 1/2" x 1 3/8"	Large
95-322	4 3/4" x 1 1/2"	X-Large

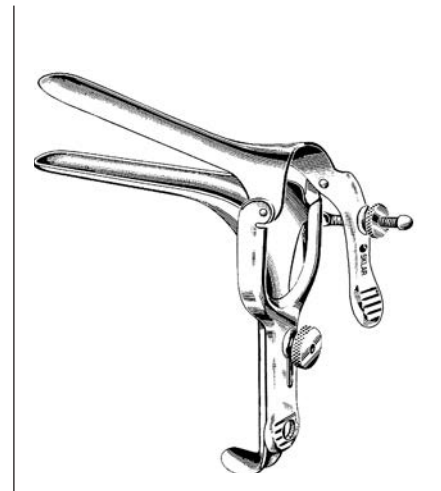

**PEDERSON VAGINAL SPECULUMS**

95-334	2 3/4" x 1/2"	X-Small
95-347	3" x 1/2"	Small
95-348	4" x 7/8"	Medium
95-362	4 3/4" x 1"	Large
95-368	4 3/4" x 1 5/8"	X-Large



**TC OPERATING SCISSORS**

95-110	5 1/2"	Straight	Sharp/Blunt
95-111	5 1/2"	Curved	Sharp/Blunt



**TC IRIS SCISSORS**

95-124	4 1/2"	Straight	Sharp/Sharp
95-125	4 1/2"	Curved	Sharp/Sharp



**TC MAYO DISSECTING SCISSORS**

95-112 6¾" Straight  
95-113 6¾" Curved



**TC MAYO METZENBAUM SCISSORS**

95-119	5¾"	Straight	Standard
95-122	5¾"	Curved	Standard
95-115	7"	Straight	Standard
95-117	7"	Curved	Standard
95-118	5¾"	Straight	Delicate
95-120	5¾"	Curved	Delicate
95-114	7"	Straight	Delicate
95-116	7"	Curved	Delicate

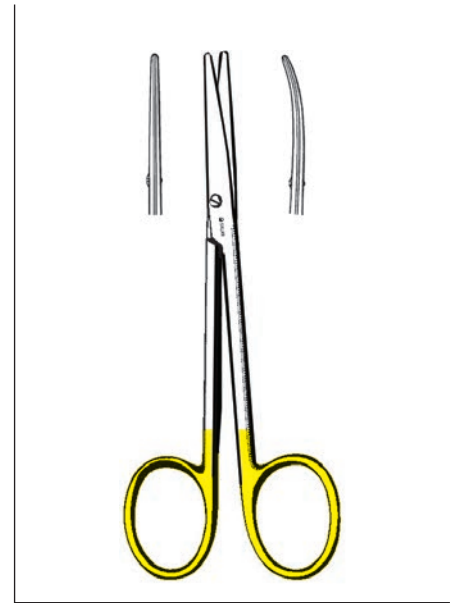

**TC STRABISMUS SCISSORS**

95-126	4½"	Straight	Blunt/Blunt
95-127	4½"	Curved	Blunt/Blunt

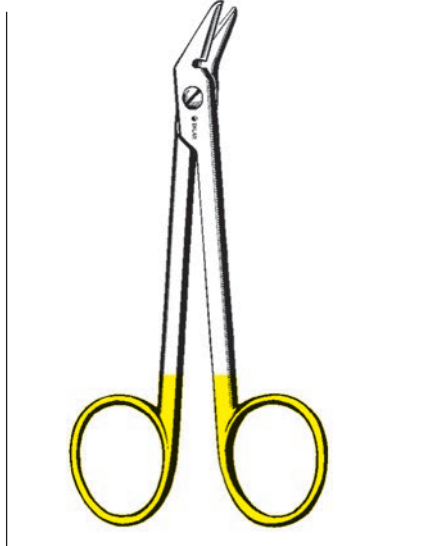

**TC WIRE CUTTING SCISSOR**

95-128 4¾" Angled Serrated



**TC DERF NEEDLE HOLDER**

95-136 4¾" Serrated



**TC WEBSTER NEEDLE HOLDER**

95-130 5¼" Smooth



**TC HALSEY NEEDLE HOLDERS**

- 95-132 5¼" Smooth
- 95-133 5¼" Serrated



**TC OLSEN-HEGAR NEEDLE HOLDERS**

- 95-146 4¾" Serrated, Delicate
- 95-147 5½" Serrated
- 95-148 6½" Serrated
- 95-149 7½" Serrated

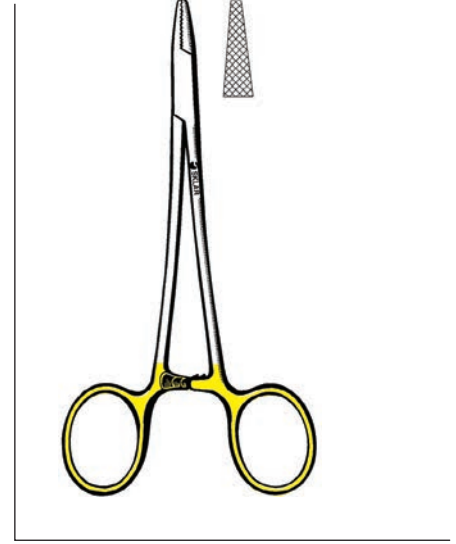

**TC BAUMGARTNER NEEDLE HOLDER**

- 95-135 5¼" Serrated



**TC MAYO-HEGAR NEEDLE HOLDERS**

- SERRATED**
- 95-140 5¼"
  - 95-141 6"
  - 95-142 7"
  - 95-143 8"

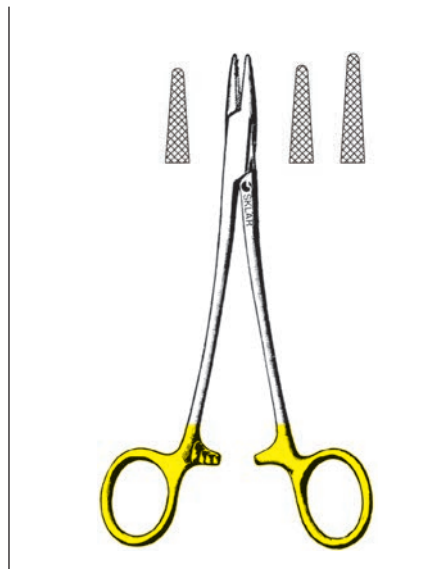

**TC CRILE-WOOD NEEDLE HOLDERS**

- SERRATED**
- 95-137 6"
  - 95-138 7"
  - 95-139 8"

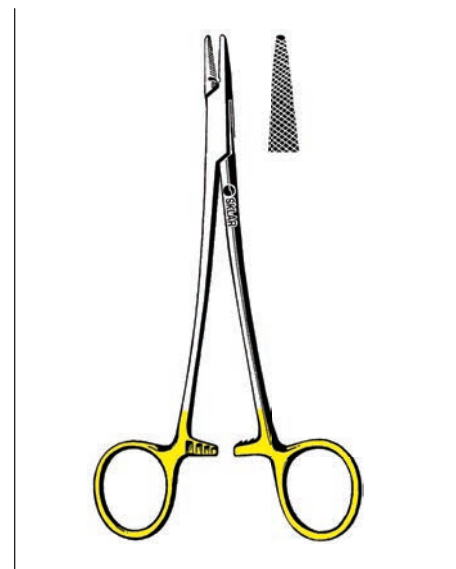

**TC CRILE-MURRAY NEEDLE HOLDER**

- 95-134 6" Serrated

**OPERATING SCISSORS**
**STRAIGHT**

95-266	4½"	Sharp/Sharp
95-265	4½"	Sharp/Blunt
95-290	5"	Sharp/Sharp
95-275	5½"	Sharp/Sharp
95-272	5½"	Sharp/Blunt
95-278	5½"	Blunt/Blunt
95-284	6½"	Sharp/Sharp
95-281	6½"	Sharp/Blunt

**OPERATING SCISSORS**
**CURVED**

95-294	4½"	Curved	Sharp/Sharp
95-295	5½"	Curved	Sharp/Sharp
95-292	5½"	Curved	Sharp/Blunt
95-299	5½"	Curved	Blunt/Blunt

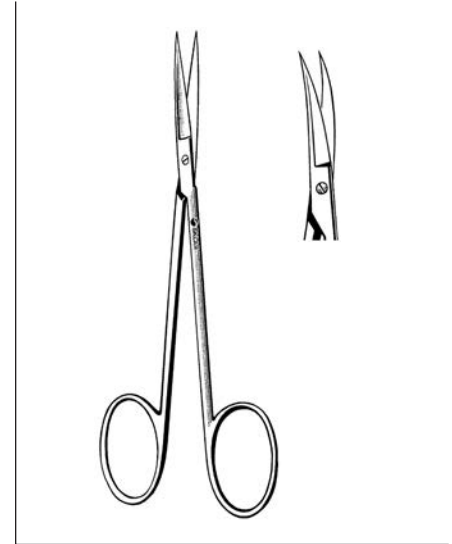
**IRIS SCISSORS**

95-103	3½"	Straight
95-107	3½"	Curved
95-104	4½"	Straight
95-109	4½"	Curved

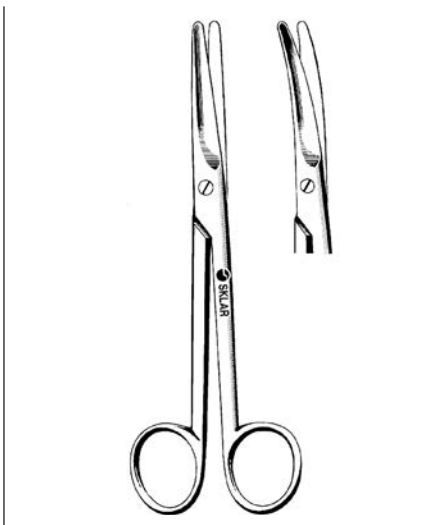
**MAYO DISSECTING SCISSORS**

95-308	5½"	Straight	
95-330	5½"	Curved	
95-321	6¾"	Straight	
95-325	6¾"	Curved	
95-329	6¾"	Straight	Serrated
95-332	6¾"	Curved	Serrated
95-327	9"	Straight	
95-328	9"	Curved	

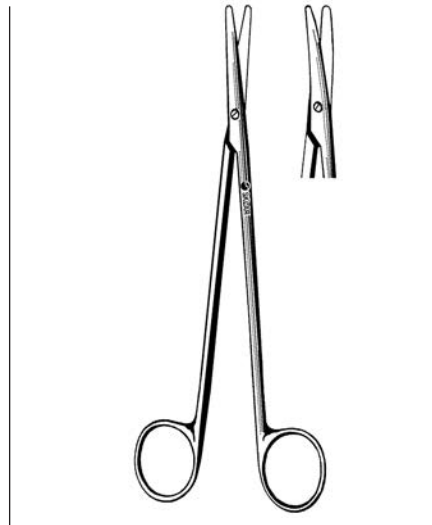

**METZENBAUM DISSECTING SCISSORS**

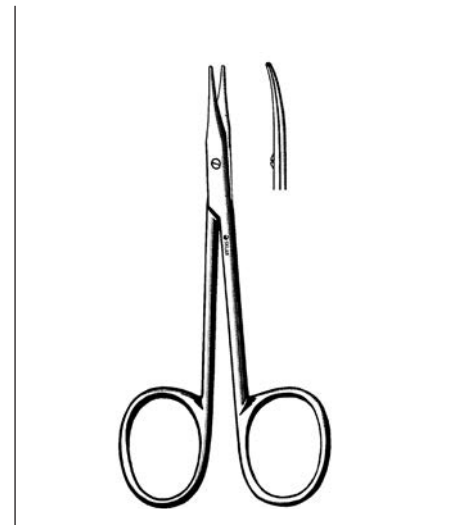
95-335	5¾"	Straight
95-336	5¾"	Curved
95-339	7"	Straight
95-340	7"	Curved

**STEVENS DISSECTING SCISSORS**

95-160	4⅛"	Straight	Blunt/Blunt
95-161	4⅛"	Curved	Blunt/Blunt

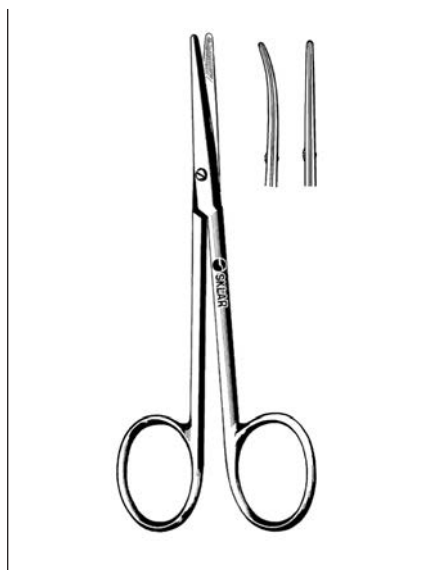



**STRABISMUS SCISSORS**

95-360 4½" Straight  
95-361 4½" Curved

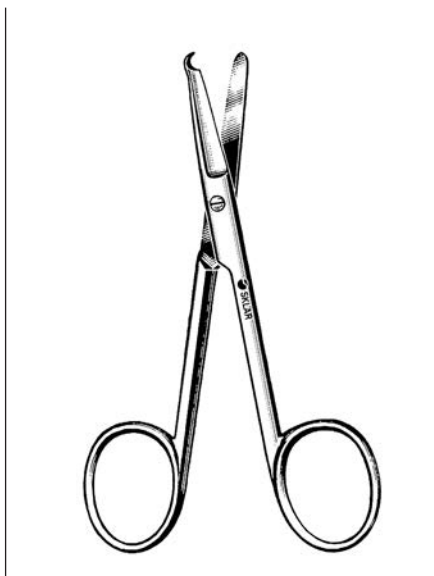

**STITCH SCISSORS**

95-346 3½" Spencer  
95-352 4½" Spencer  
95-358 5½" Littauer

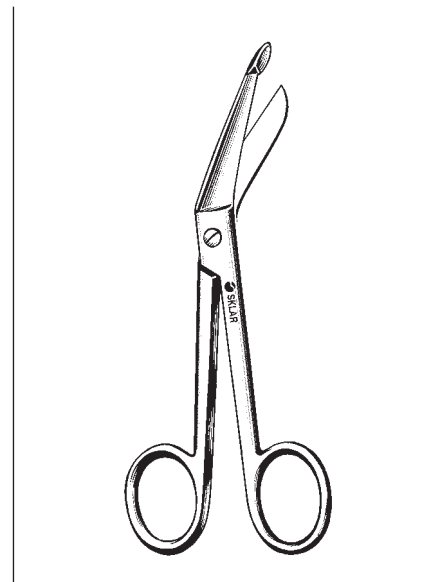

**LISTER BANDAGE SCISSORS**

95-222 3½"  
95-226 4½"  
95-231 5½"  
95-241 7¼"  
95-243 8"  
95-245 8" With Large Finger Ring

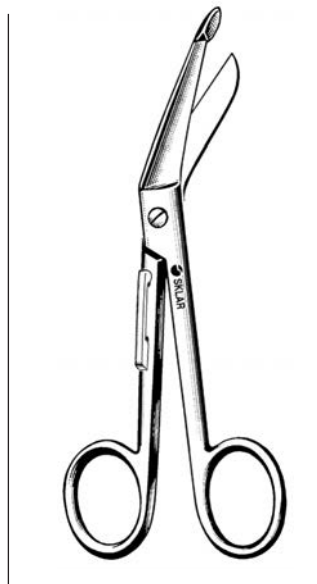

**LISTER BANDAGE SCISSORS WITH POCKET CLIP**

95-232 5½"  
95-232B 5½" Blue Ring Handle  
95-232P 5½" Pink Ring Handle

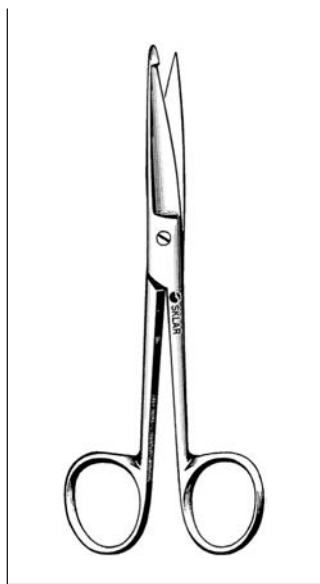

**KNOWLES BANDAGE SCISSOR**

95-254 5½"



**MULTI-CUT UTILITY SCISSORS**

**BLACK HANDLE**  
95-100 6" Serrated  
95-105 7½" Serrated

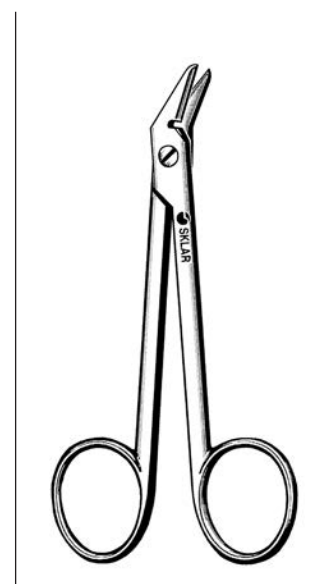

**WIRE CUTTING SCISSOR**

**ANGLED**  
95-364 4¾" Serrated

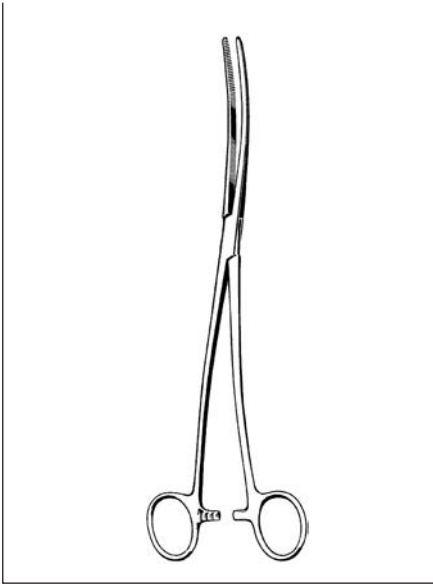

**BOZEMAN UTERINE DRESSING FORCEP**

95-374 10¼" S-Curve

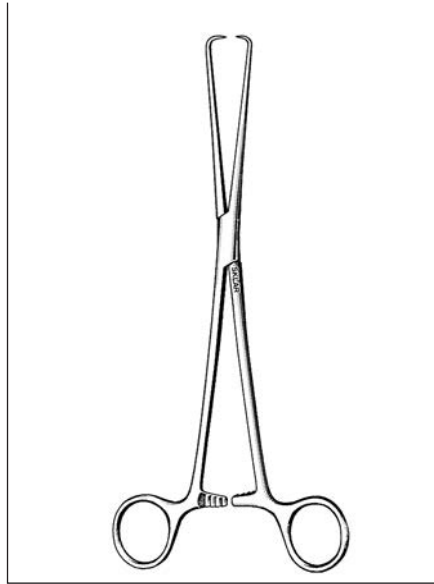

**SCHROEDER TENACULUM FORCEP**

95-386 9½" Straight

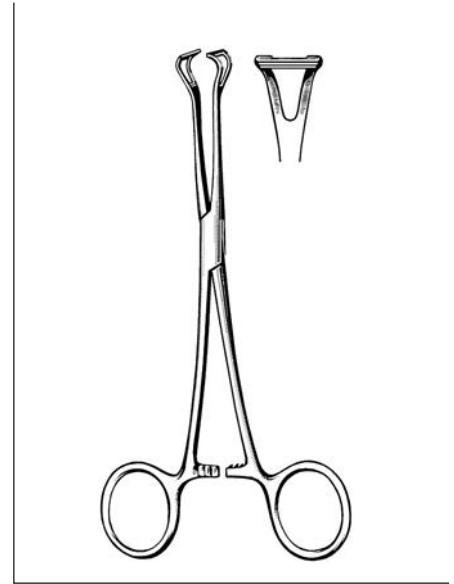

**BABCOCK FORCEPS**

95-952 6¼"  
95-441 8"

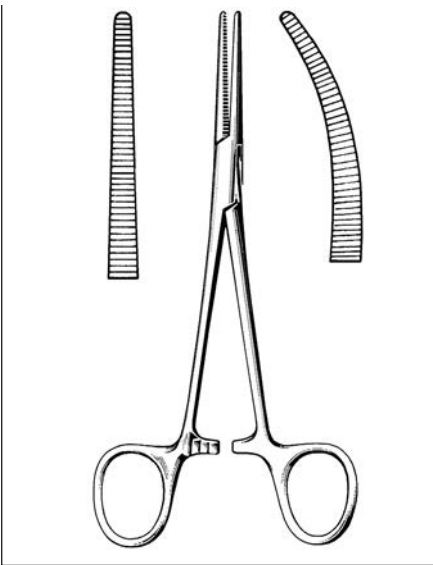

**CRILE FORCEPS**

95-447 5½" Straight  
95-452 5½" Curved  
95-458 6¼" Straight  
95-463 6¼" Curved

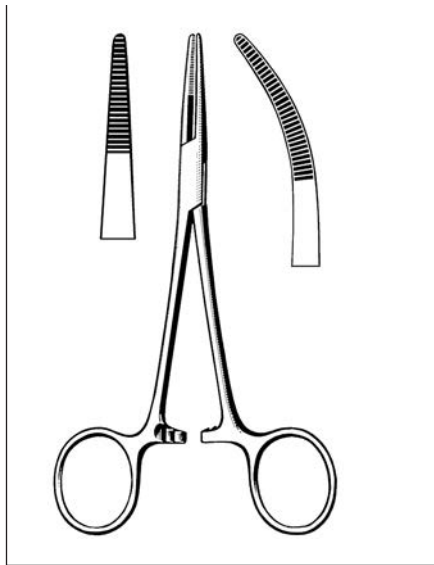

**KELLY FORCEPS**

95-436 5½" Straight  
95-442 5½" Curved

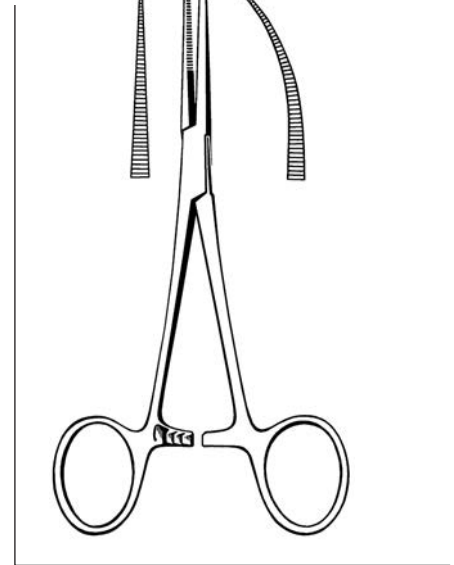

**RANKIN-KELLY FORCEPS**

95-465 6¼" Straight  
95-469 6¼" Curved

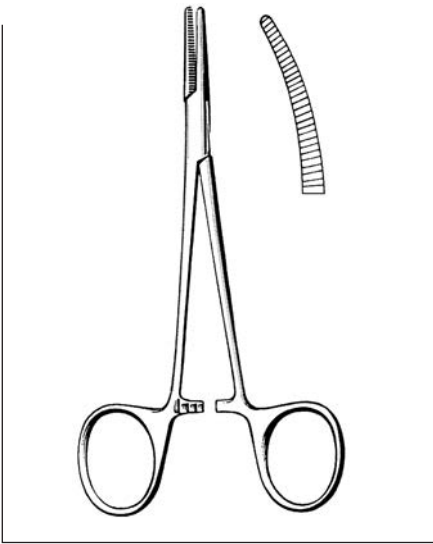

**HALSTED MOSQUITO FORCEPS**

- 95-426 5" Straight
- 95-431 5" Curved

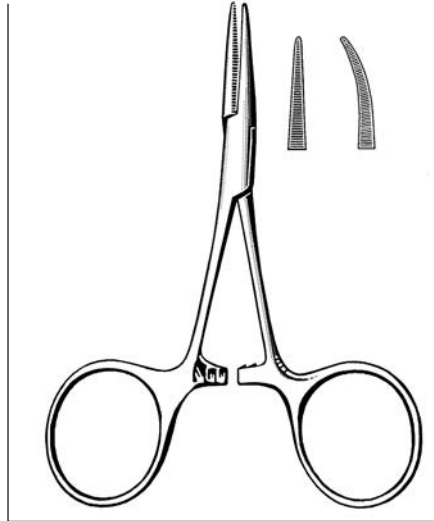

**HARTMANN MOSQUITO FORCEPS**

- 95-409 3½" Straight
- 95-421 3½" Curved

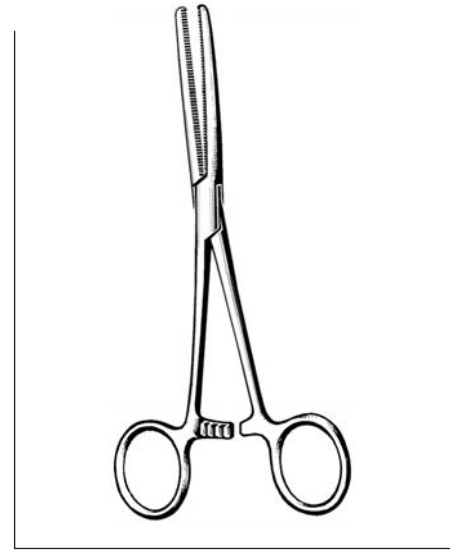

**ROCHESTER-PEAN FORCEPS**

- 95-470 5½" Straight
- 95-471 5½" Curved
- 95-473 6¼" Straight
- 95-477 6¼" Curved
- 95-481 7¼" Straight
- 95-485 7¼" Curved
- 95-492 8" Straight
- 95-498 8" Curved
- 95-483 9" Straight
- 95-487 9" Curved
- 95-494 10¼" Straight

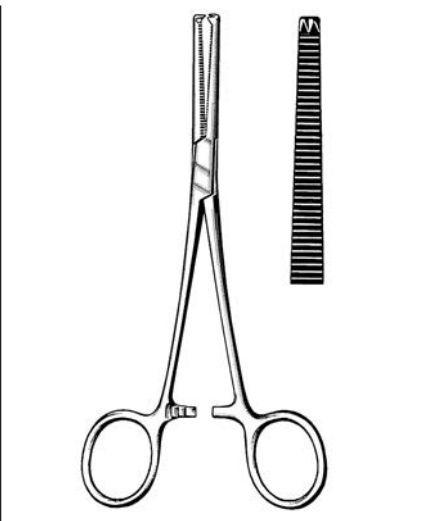

**ROCHESTER-OGHSNER FORCEPS**

- | STRAIGHT, 1x2 TEETH | CURVED, 1x2 TEETH |
|---------------------|-------------------|
| 95-500 5½"          | 95-501 5½"        |
| 95-504 6¼"          | 95-512 6¼"        |
| 95-521 7¼"          | 95-525 7¼"        |
| 95-513 8"           | 95-514 8"         |
| 95-515 9"           | 95-516 9"         |
| 95-517 10"          | 95-518 10"        |

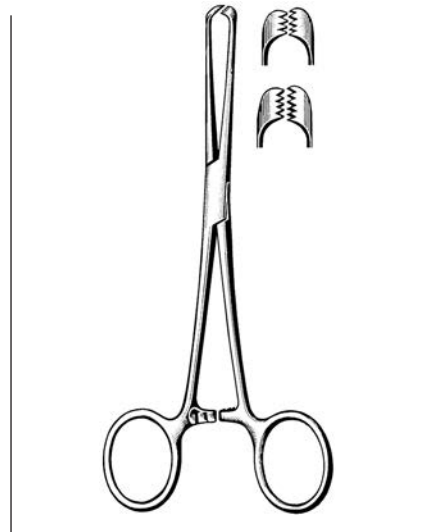

**ALLIS TISSUE FORCEPS**

- 95-934 6" 5x6 Teeth
- 95-938 7½" 5x6 Teeth

**ADSON FORCEPS**
**DRESSING**

- 95-771 4¾" Serrated
- 95-772 4¾" Serrated, Delicate

**ADSON FORCEPS**
**TISSUE**

- 95-775 4¾" 1x2 Teeth
- 95-776 4¾" 1x2 Teeth, Delicate

**ADSON FORCEPS**
**ADSON-BROWN**

- 95-778 4¾" Side-Grasping

**DRESSING FORCEPS**
**SERRATED**

- 95-705 4½"
- 95-710 5"
- 95-727 5½"
- 95-731 6"
- 95-736 8"
- 95-742 10"

**TISSUE FORCEPS**
**1X2 TEETH**

- 95-753 4½"
- 95-757 5"
- 95-762 5½"
- 95-766 6"
- 95-770 8"

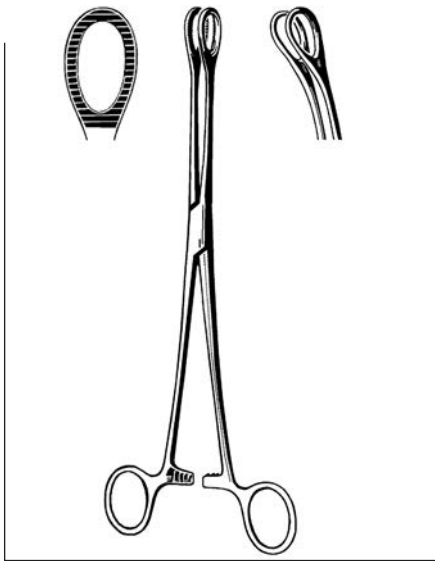

**SPLINTER FORCEPS**

- 95-777 3½"
- 95-781 4½"

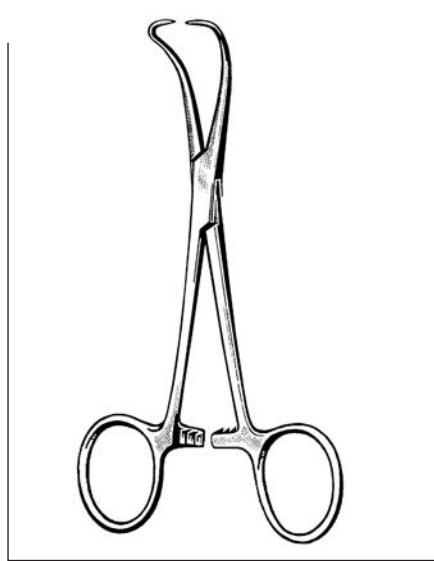

**FOERSTER SPONGE FORCEPS**

95-571	7"	Straight	Serrated
95-577	9½"	Straight	Serrated
95-586	9½"	Curved	Serrated



**BACKHAUS TOWEL CLAMPS**

95-606	3½"
95-611	5¼"



**LORNA EDNA TOWEL CLAMPS**

95-629	3½"
95-635	5¼"

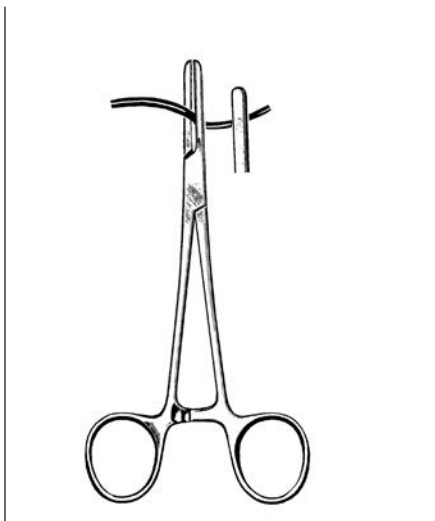

**PRESBYTERIAN TUBE  
OCCLUDING FORCEP**

95-592	7"	Straight, Smooth
--------	----	------------------

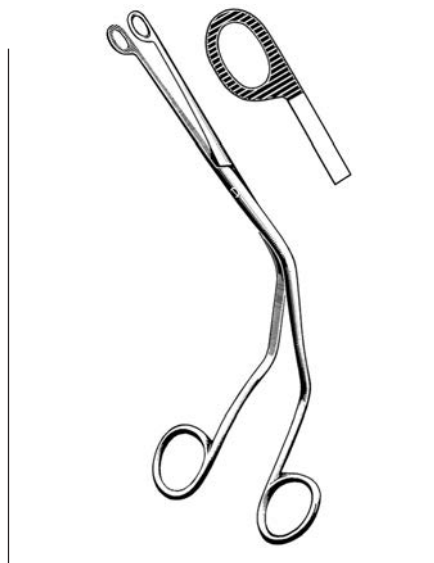

**MAGILL CATHETER FORCEPS**

95-285	8"	Child
95-289	10"	Adult



**DERF NEEDLE HOLDER**

95-826 4¾" Serrated

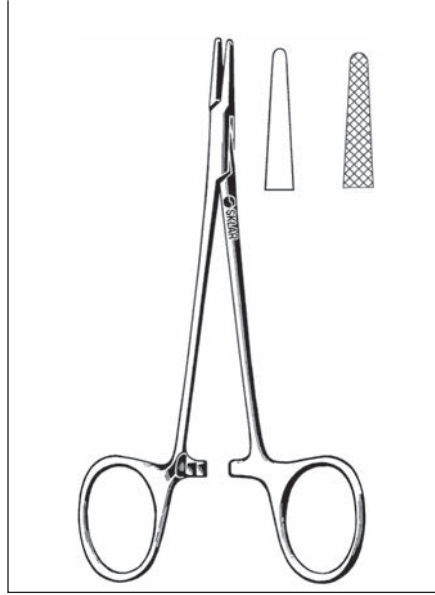

**WEBSTER NEEDLE HOLDERS**

95-809 5¼" Smooth  
95-813 5¼" Serrated

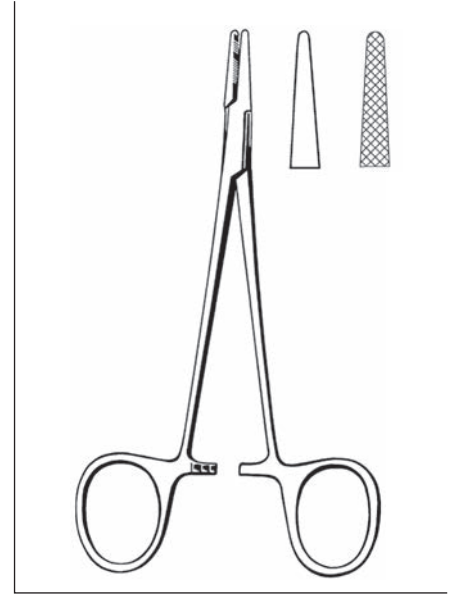

**HALSEY NEEDLE HOLDERS**

95-810 5¼" Smooth  
95-812 5¼" Serrated

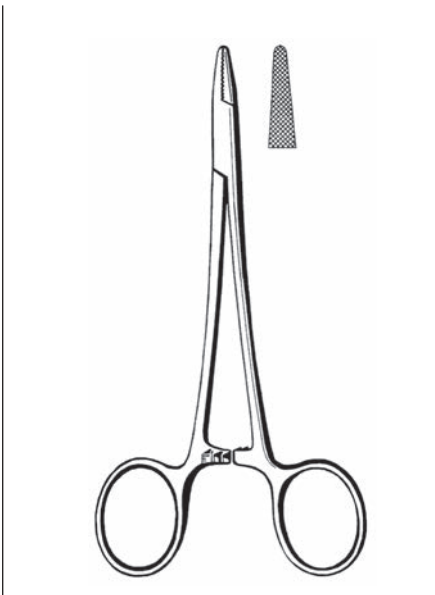

**BAUMGARTNER NEEDLE HOLDER**

95-832 5¼" Serrated

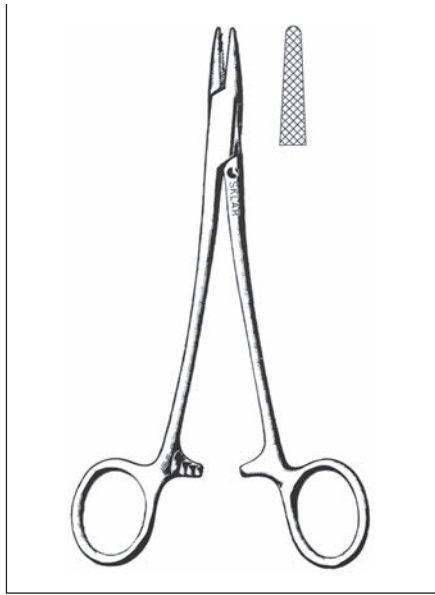

**MAYO-HEGAR NEEDLE HOLDERS**

**SERRATED**  
95-842 5¼"  
95-847 6"  
95-853 7"  
95-869 8"

# MERIT

Quality

Service

Price

The most cost-effective line of quality instruments from Pakistan designed for routine surgical use.

- All instruments are forged from surgical grade stainless steel
- Crafted in FDA registered manufacturing facilities by skilled instrument makers
- Designed to meet OR tolerances for surgical quality
- 10 year guarantee
- Same day shipment on orders received by 3:00 PM
- No charge for drop shipments
- Available and invoiced by your distributor
- Backed by Sklar Instruments for value pricing
- Custom pricing available in minutes for volume orders
- Ask about our "Bid Pricing"



**GRAVES VAGINAL SPECULUMS**

98-303	3" x ¾"	Small
98-312	4" x 1¼"	Medium
98-324	4½" x 1⅜"	Large
98-325	4¾" x 1½"	Extra Large



**PEDERSON VAGINAL SPECULUMS**

98-336	3" x ½"	Small
98-364	4" x ⅝"	Slender
98-348	4" x ⅞"	Medium
98-362	4¾" x 1"	Large
98-366	6½" x 1½"	Extra Large



**SIMPSON UTERINE SOUND**

**MALLEABLE WITH NODULE JUST BELOW CURVE**

98-382	12½"	Centimeter Graduated, Silver Plated
--------	------	-------------------------------------



**SIMS UTERINE SOUND**

**MALLEABLE**

98-384	12½"	Non-Graduated, Silver Plated
--------	------	------------------------------



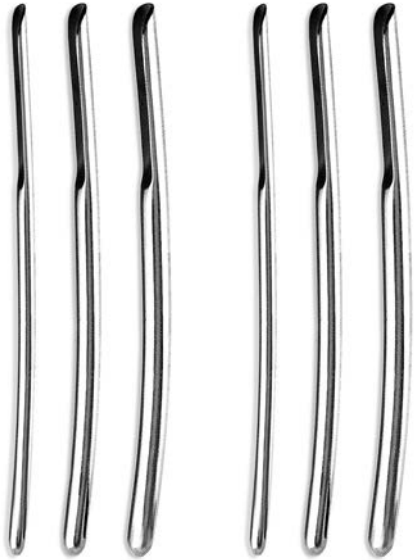

**HEGAR UTERINE DILATOR**

SET OF 6  
98-370

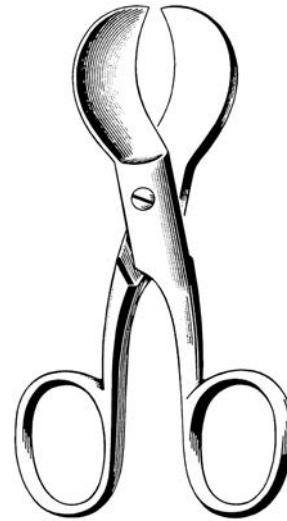

**UMBILICAL SCISSOR**

98-367 4"



**BOZEMAN UTERINE DRESSING FORCEP**

98-374 10¼"

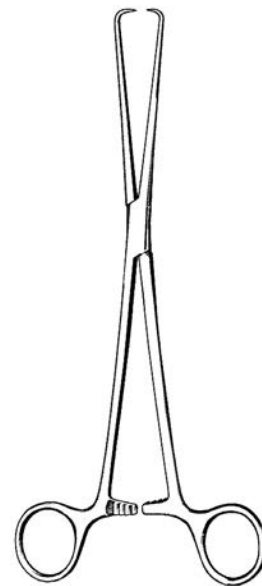

**SCHROEDER TENACULUM FORCEP**

98-386 9½"

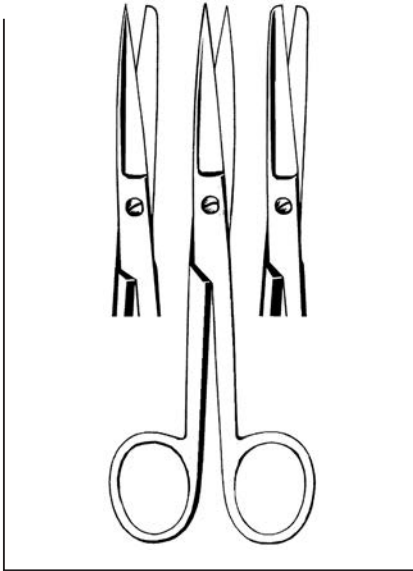

**OPERATING SCISSORS**

**STRAIGHT**

97-263	4½"	Sharp/Blunt
97-272	5½"	Sharp/Blunt
97-281	6½"	Sharp/Blunt
97-266	4½"	Sharp/Sharp
97-275	5½"	Sharp/Sharp
97-284	6½"	Sharp/Sharp
97-269	4½"	Blunt/Blunt
97-278	5½"	Blunt/Blunt
97-288	6½"	Blunt/Blunt

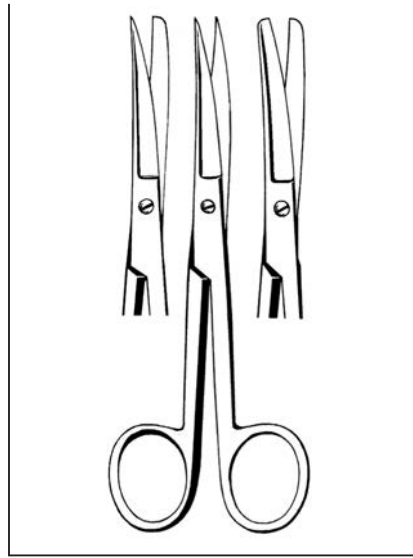

**OPERATING SCISSORS**

**CURVED**

97-292	5½"	Sharp/Blunt
97-293	6½"	Sharp/Blunt
97-295	5½"	Sharp/Sharp
97-297	6½"	Sharp/Sharp
97-270	4½"	Blunt/Blunt
97-299	5½"	Blunt/Blunt
97-300	5½"	Sharp/Sharp

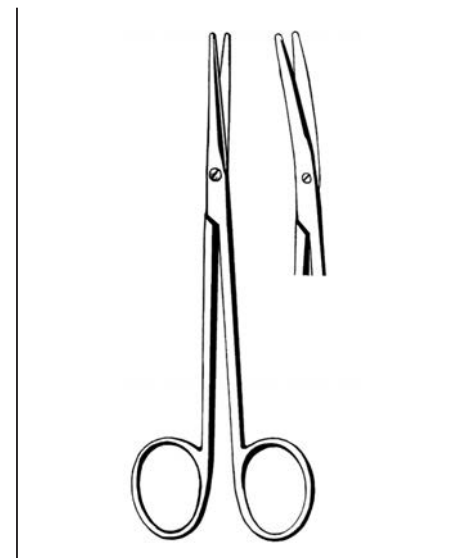

**METZENBAUM SCISSORS**

**STRAIGHT**

97-335	5¾"
97-339	7"

**CURVED**

97-336	5¾"	Sharp/Blunt
97-340	7"	Sharp/Blunt

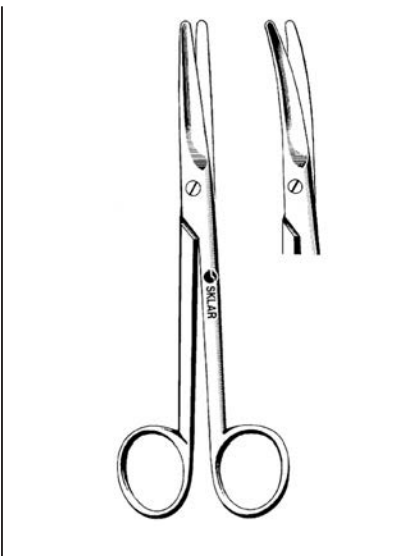

**MAYO DISSECTING SCISSORS**

**STRAIGHT**

97-308	5½"
97-321	6¾"

**CURVED**

97-312	5½"
97-325	6¾"

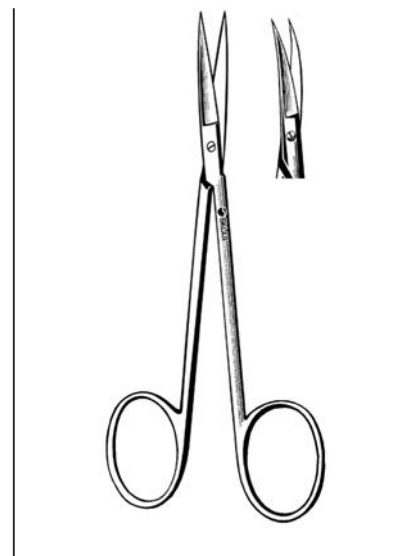

**IRIS SCISSORS**

**STRAIGHT**

98-103	3½"
98-104	4½"

**CURVED**

98-107	3½"
98-109	4½"

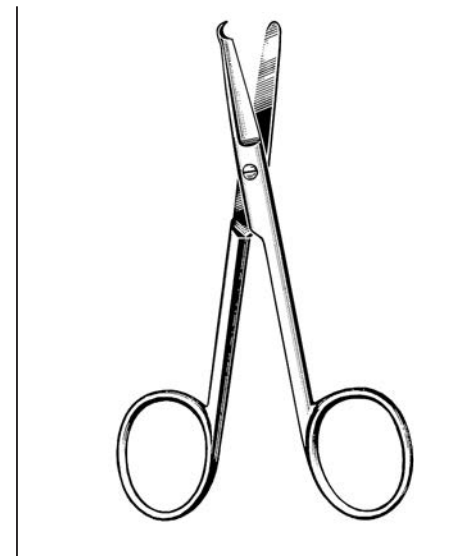

**SPENCER STITCH SCISSORS**

97-346	3½"
97-352	4¾"

**LITTAUR STITCH SCISSORS**

97-358	5½"
--------	-----



**MULTI-CUT UTILITY SCISSORS**

**SERRATED**

97-105	7½"	Black
97-107	7½"	Blue
97-108	7½"	Purple
97-109	7½"	Green

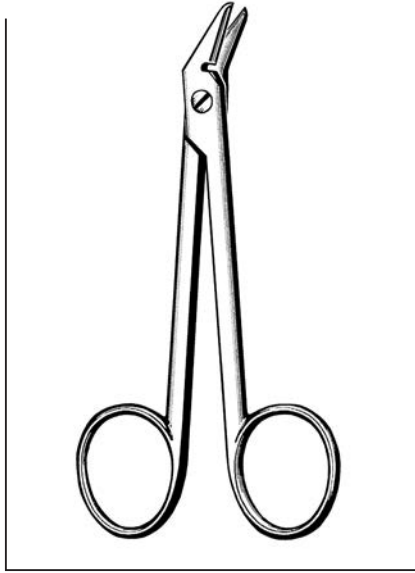

**WIRE CUTTING SCISSORS**

97-364	4¾"
--------	-----

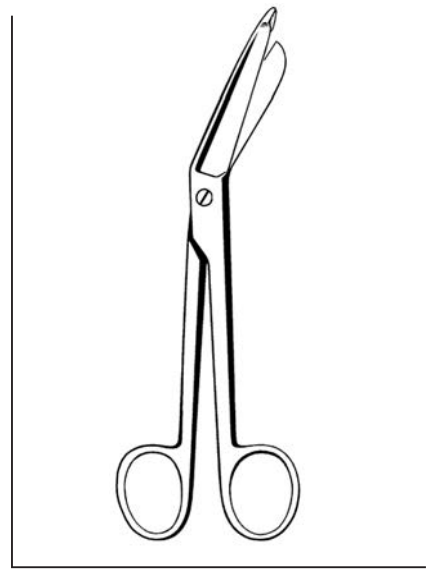

**LISTER BANDAGE SCISSORS**

97-222	3½"	
97-226	4½"	
97-231	5½"	
97-237	5½"	With Clip
97-241	7¼"	

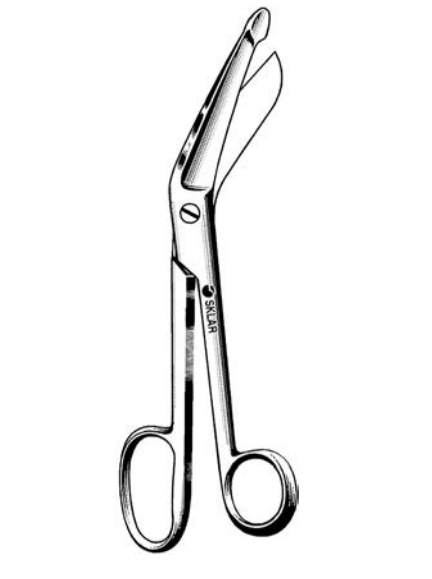

**LISTER BAND SCISSORS**

97-245	8"	Large Ring
--------	----	------------

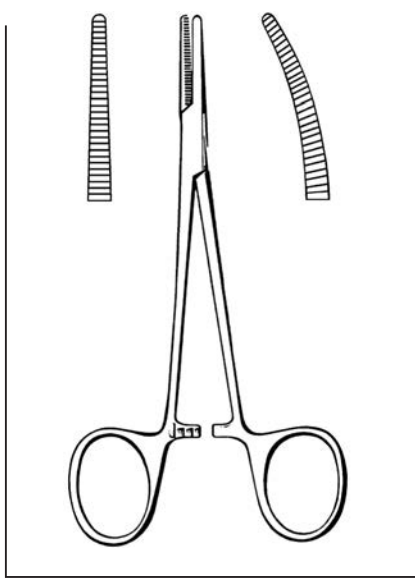

**HALSTEAD MOSQUITO FORCEPS**

<b>STRAIGHT</b>		<b>CURVED</b>	
97-426	5"	97-431	5"

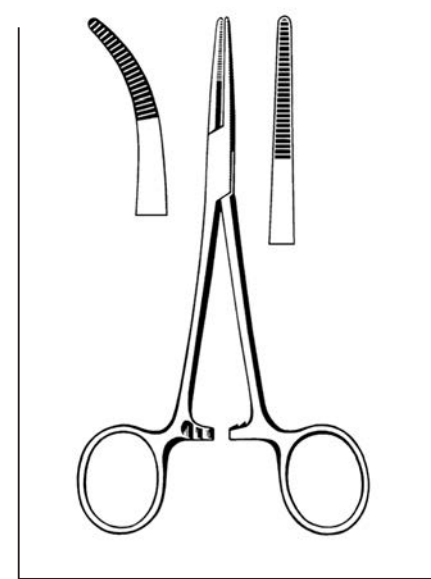

**KELLY FORCEPS**

<b>STRAIGHT</b>		<b>CURVED</b>	
97-436	5½"	97-442	5½"

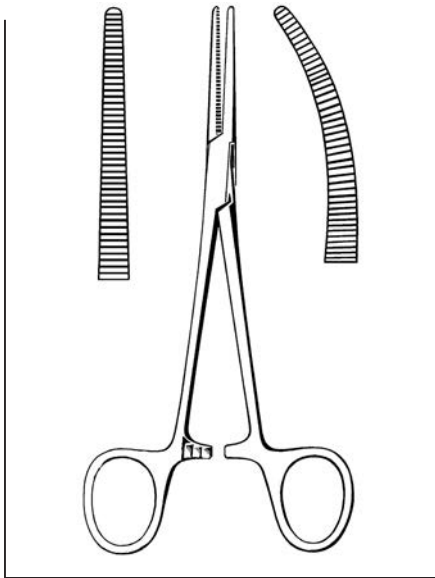

**CRILE FORCEPS**

STRAIGHT		CURVED	
97-447	5½"	97-452	5½"
97-458	6¼"	97-463	6¼"

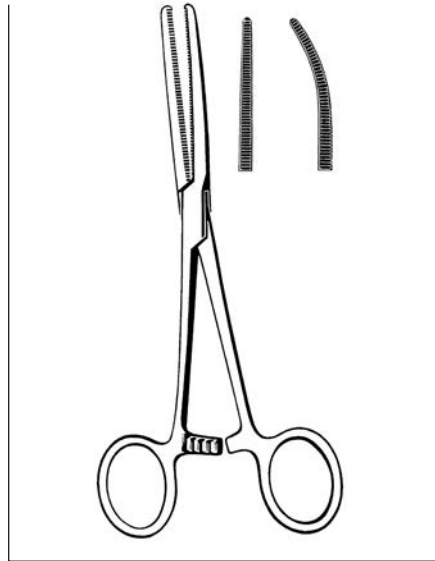

**ROCHESTER-PEAN FORCEPS**

STRAIGHT		CURVED	
97-470	5½"	97-471	5½"
97-473	6¼"	97-477	6¼"
97-481	7¼"	97-485	7¼"
97-492	8"	97-498	8"
97-483	9"	97-487	9"
97-494	10¼"	97-496	10¼"

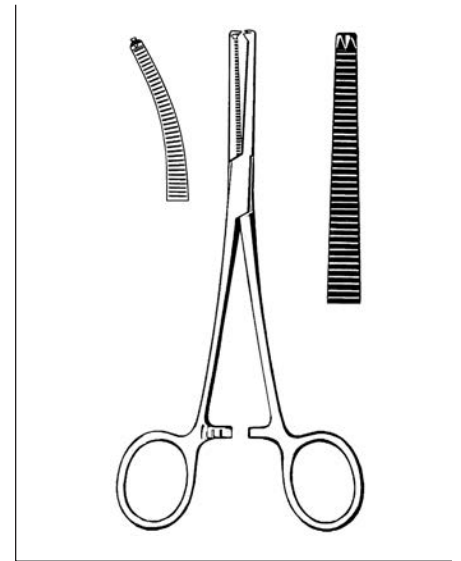

**ROCHESTER-OSHSNER FORCEPS**

STRAIGHT		CURVED	
97-500	5½"	97-501	5½"
97-504	6¼"	97-512	6¼"
97-521	7¼"	97-525	7¼"
97-513	8"		
97-517	10"		

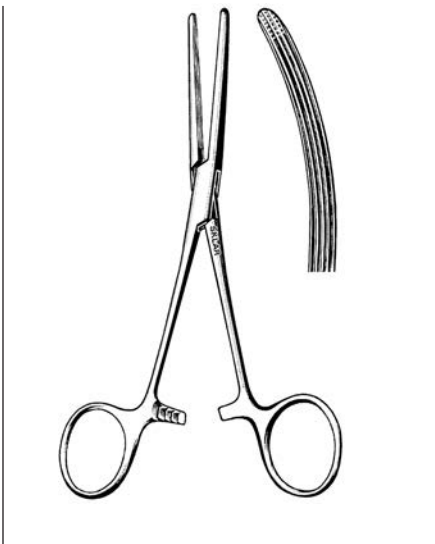

**ROCHESTER-CARMALT FORCEPS**

STRAIGHT		CURVED	
97-528	6¼"	97-534	6¼"
97-537	8"	97-542	8"

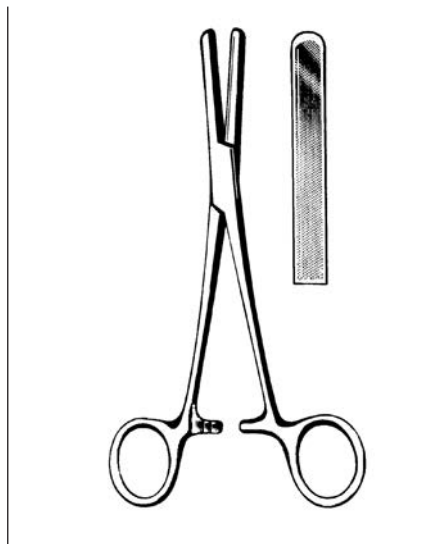

**PRESBYTERIAN TUBE OCCLUDING FORCEP**

97-592	6½"
--------	-----

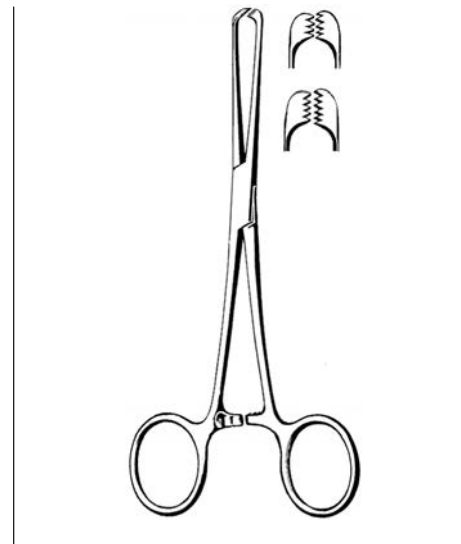

**ALLIS TISSUE FORCEPS**

97-930	6"	4x5 Teeth
97-934	6"	5x6 Teeth
97-938	7½"	5x6 Teeth

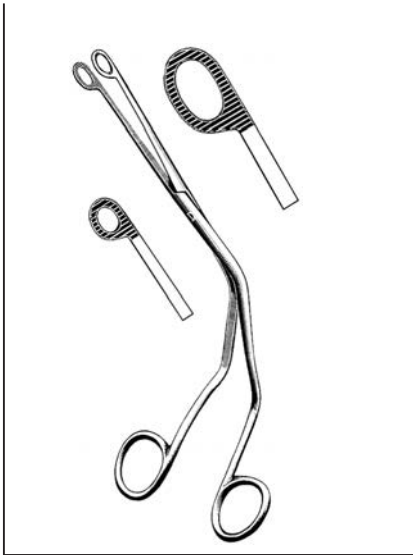

**MAGILL CATHETER FORCEPS**

- 97-285 Child
- 97-289 Adult

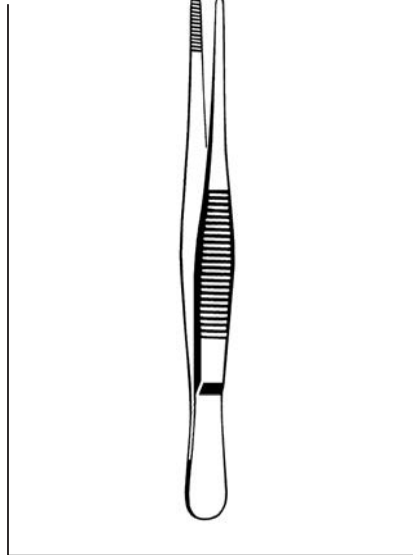

**DRESSING FORCEPS**

- 97-705 4½"
- 97-710 5"
- 97-727 5½"
- 97-731 6"
- 97-736 8"
- 97-742 10"
- 97-748 12"

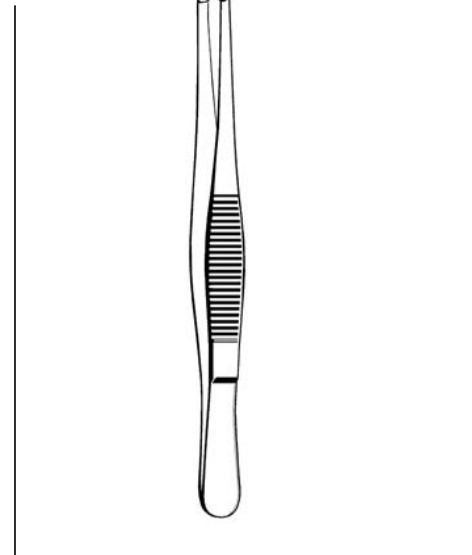

**TISSUE FORCEPS**

- 97-753 4½" 1x2 Teeth
- 97-757 5½" 1x2 Teeth
- 97-762 5½" 1x2 Teeth
- 97-769 5½" 2x3 Teeth

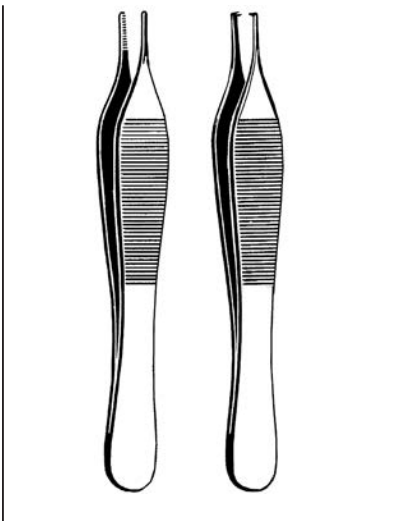

**ADSON DRESSING/ TISSUE FORCEPS**

**DRESSING-SERRATED**

- 97-771 4¾"
- 97-772 4¾" Delicate

**TISSUE-1X2 TEETH**

- 97-775 4¾"
- 97-776 4¾" Delicate

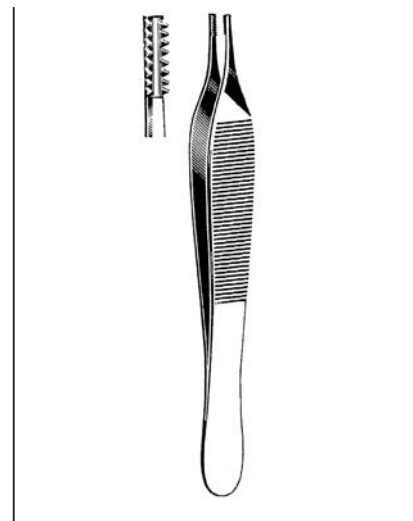

**ADSON-BROWN TISSUE FORCEP**

**STRAIGHT**

- 97-778 4¾" Side Grasping

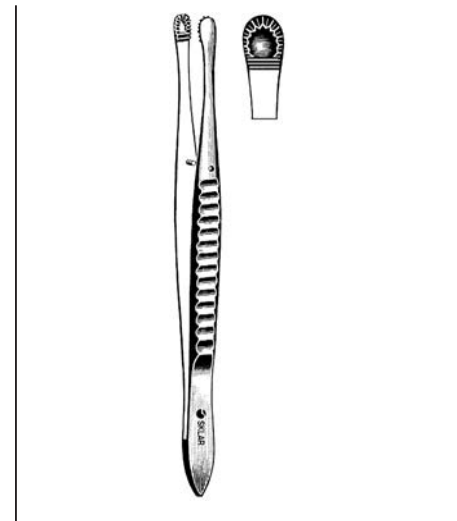

**RUSSIAN TISSUE FORCEP**

- 97-604 6"

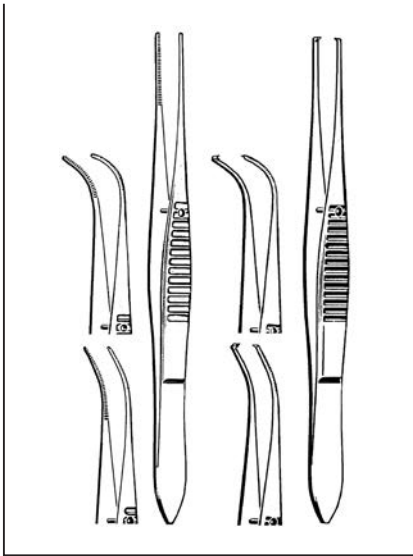

**IRIS DRESSING/ TISSUE FORCEPS**

**DRESSING-SERRATED**

98-123	4"	Straight
98-129	4"	Half Curved
98-135	4"	Full Curved

**TISSUE-1X2 TEETH**

98-142	4"	Straight
97-146	4"	Half Curved
97-151	4"	Full Curved

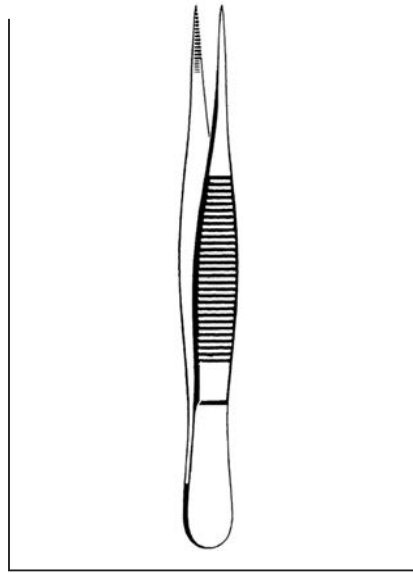

**PLAIN SPLINTER FORCEPS**

97-777	3½"
97-781	4½"

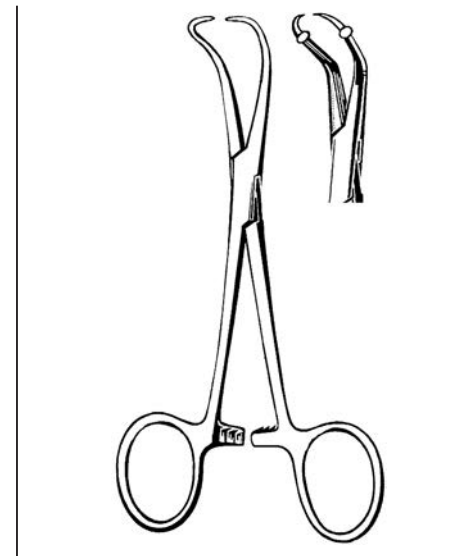

**BACKHAUS TOWEL CLAMPS**

97-606	3½"	1x2 Teeth
97-611	5¼"	1x2 Teeth
97-623	5¼"	Roeder With Ball Stops

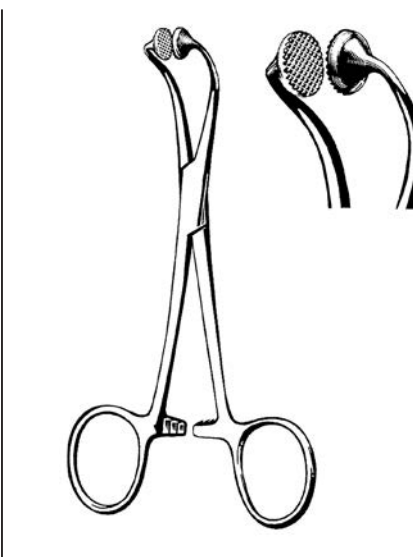

**VESSELS NON-PERFORATING TOWEL FORCEPS**

97-645	4½"
97-655	5½"

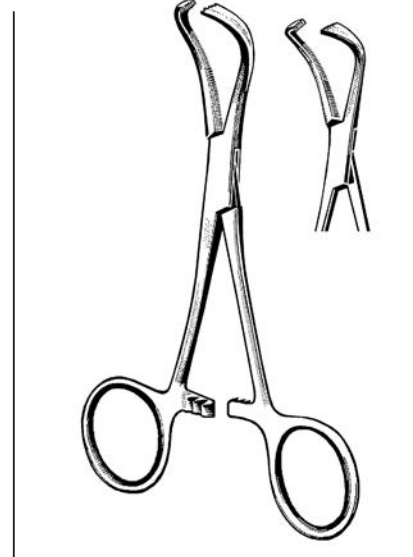

**LORNA (EDNA) TOWEL CLAMPS**

97-629	3½"
97-635	5¼"

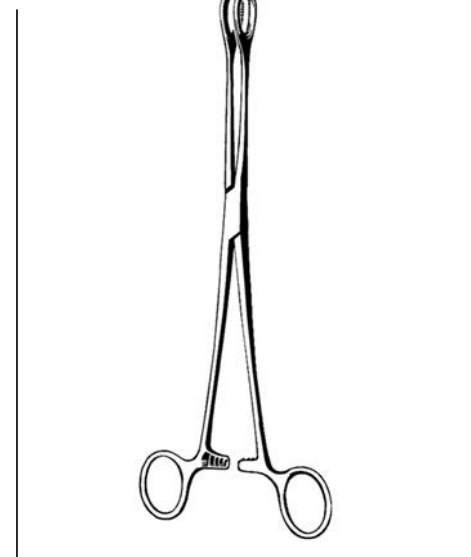

**FORESTER SPONGE FORCEPS**

<b>SERRATED</b>		
97-571	7"	Straight
97-577	9½"	Straight
97-586	9½"	Curved

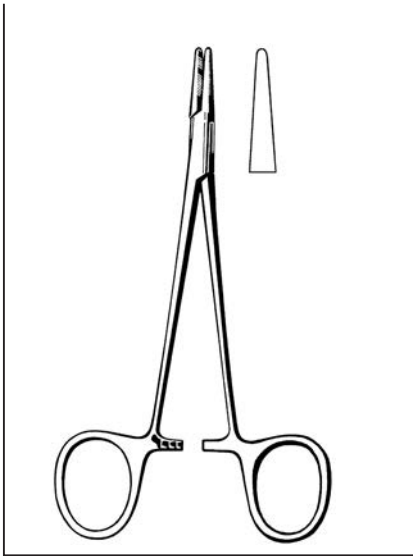

**HALSEY NEEDLE HOLDER**

97-810 5" Smooth



**OLSEN-HEGAR NEEDLE HOLDERS**

97-872 5½"  
97-877 6½"  
97-881 7½"



**CRILE-WOOD NEEDLE HOLDER**

97-838 6"

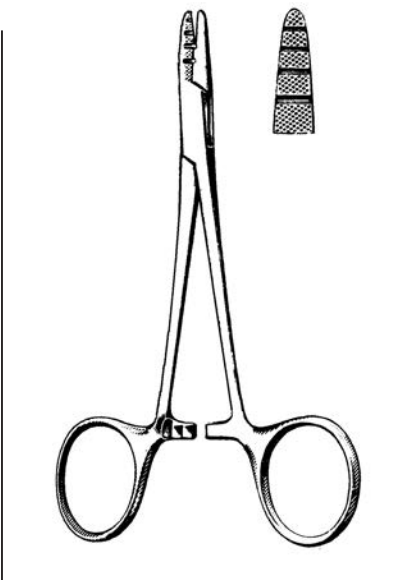

**ABBY NEEDLE HOLDER**

97-894 5"

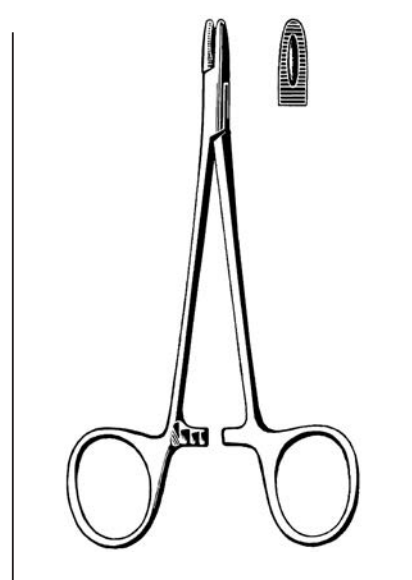

**DERF NEEDLE HOLDER**

97-826 4¾"

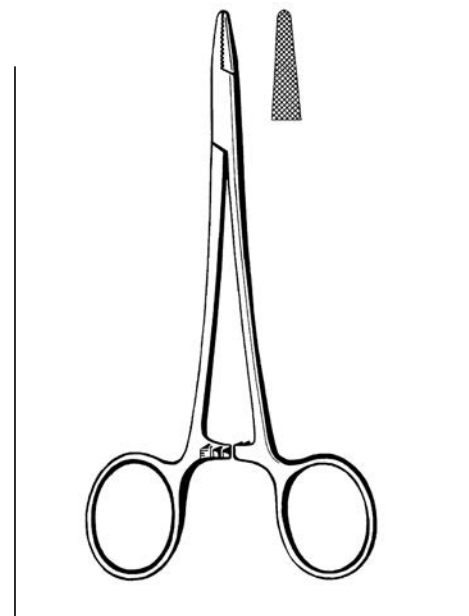

**BAUMGARTNER NEEDLE HOLDER**

97-832 5½"

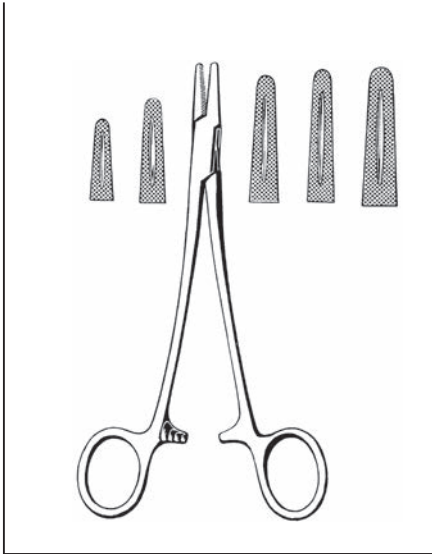

**MAYO-HEGAR NEEDLE HOLDERS**

97-842	5¼"
97-847	6"
97-853	7"
97-869	8"

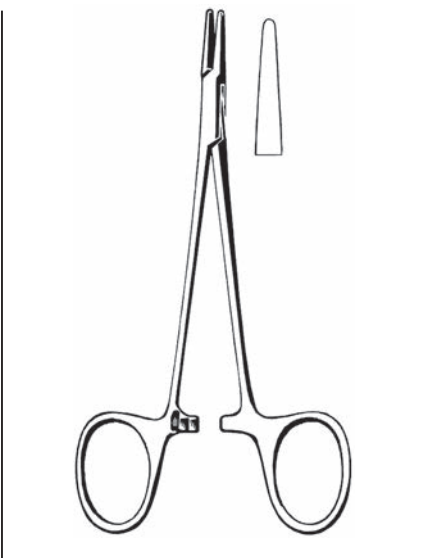

**WEBSTER NEEDLE HOLDER**

97-809	5"	Smooth
--------	----	--------

**SKLAR CERVIX BRUSH  
CERVICAL CELL SAMPLER**

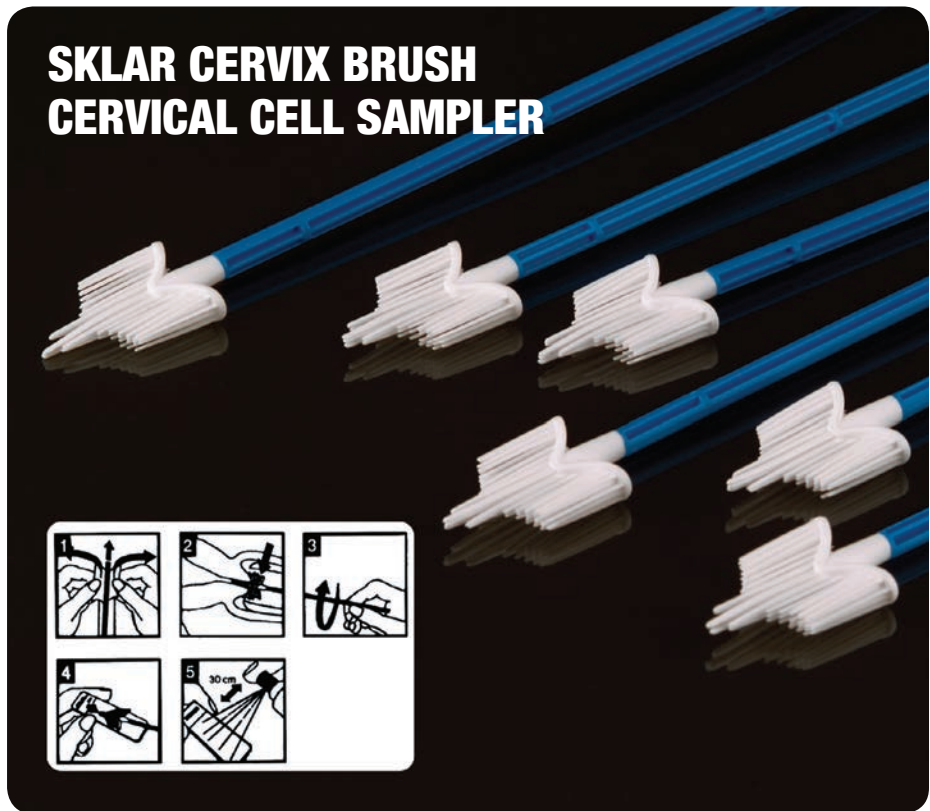

**SKLAR CERVIX BRUSH**

**NON-STERILE**

PRODUCT NUMBER	QUANTITIES
96-4140NS	100/bx

**STERILE**

PRODUCT NUMBER	QUANTITIES
96-4140	100/bx

Sklar's Cervix Brush is made of polyethylene and has a total length of 20 centimeters. The top portion uses a soft flexible brush to obtain cell samples. The brush consists of 57 semi-circular plastic bristles of various lengths. The shape is such that the top edges of the brush follow the contours of the cervix. The longer middle bristles reach deep into the endocervical canal. The shorter bristles touch both the ectocervical area and transformation zone at the same time.





## Econo™ Sterile Instruments

- FACTORY IS-ISO 9000 CERTIFIED AND CGMP COMPLIANT
- CHROMIUM CONTENT OF 11.5% TO 12.5% TO PREVENT RUSTING
- COMBINES HIGH QUALITY WITH LOW COST
- SAVES LABOR COSTS
- CONVENIENT & SAFE
- ELIMINATES COSTLY CLEANING, PROCESSING AND STERILIZATION
- MANUFACTURED IN PAKISTAN IN A FAMILY-OWNED FACTORY
- PACKAGED AND ETO STERILIZED IN OUR OWN US FACILITY
- STERILE ONE-TIME USE
- 101 PATTERNS

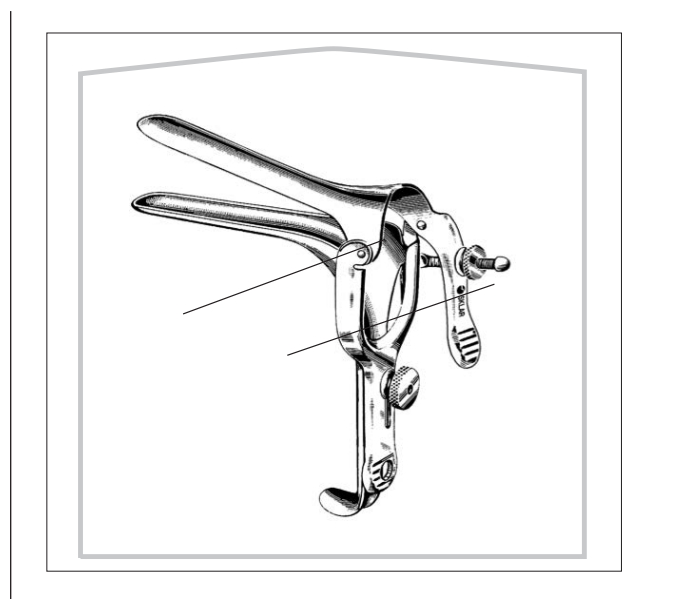
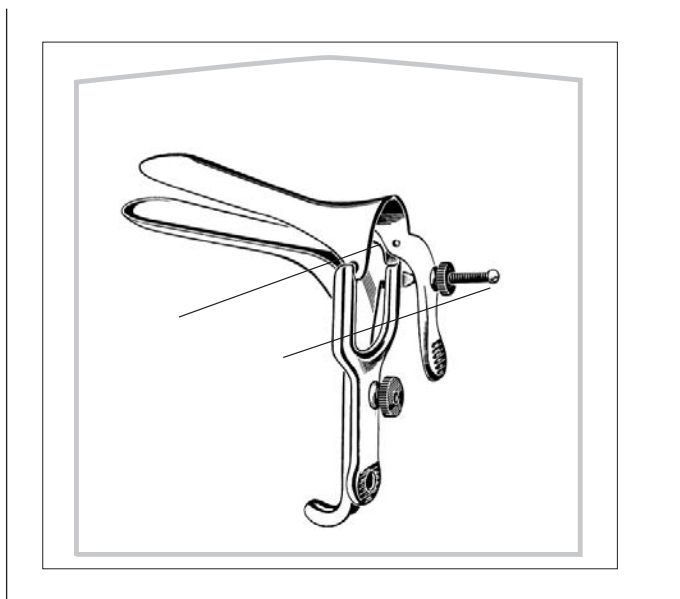

**GRAVES SPECULUMS**

96-2603	Small	25/cs	96-3000	Small	50/cs
96-2605	Medium	25/cs	96-3001	Medium	50/cs
96-2607	Large	25/cs	96-3002	Large	50/cs

**PEDERSON SPECULUMS**

96-2613	Small	25/cs	96-2612	Small	50/cs
96-2615	Medium	25/cs	96-2614	Medium	50/cs
96-2617	Large	25/cs	96-2616	Large	50/cs

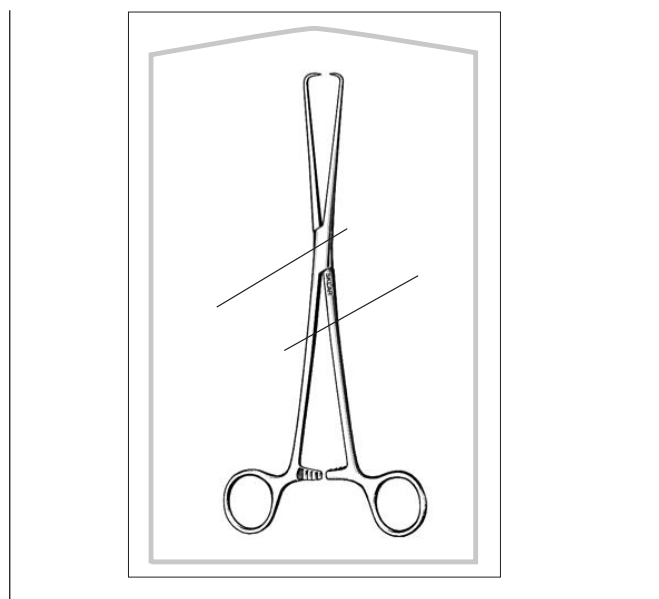

**BOZEMAN FORCEPS**

96-2622	10¼" S-Curve	25/cs
96-2620	10¼" S-Curve	50/cs

**SCHROEDER TENACULUM FORCEPS**

96-2624	9½"	25/cs
96-2626	9½"	50/cs



**OPERATING SCISSORS**

**STRAIGHT**

96-2597	4½"	Sharp/Blunt	25/cs	96-2514	5½"	Blunt/Blunt	50/cs
96-2592	4½"	Sharp/Sharp	25/cs	96-2520	5½"	Sharp/Blunt	50/cs
96-2521	5½"	Sharp/Blunt	25/cs	96-2522	5½"	Sharp/Sharp	50/cs
96-2523	5½"	Sharp/Sharp	25/cs	96-2726	6½"	Sharp/Blunt	50/cs
96-2728	4½"	Sharp/Blunt	50/cs	96-2649	5½"	Sharp/Blunt	100/cs
96-2593	4½"	Sharp/Sharp	50/cs				

**OPERATING SCISSORS**

**CURVED**

96-2526	5½"	Sharp/Blunt	25/cs
96-2527	5½"	Sharp/Sharp	25/cs
96-2524	5½"	Sharp/Blunt	50/cs
96-2525	5½"	Sharp/Sharp	50/cs

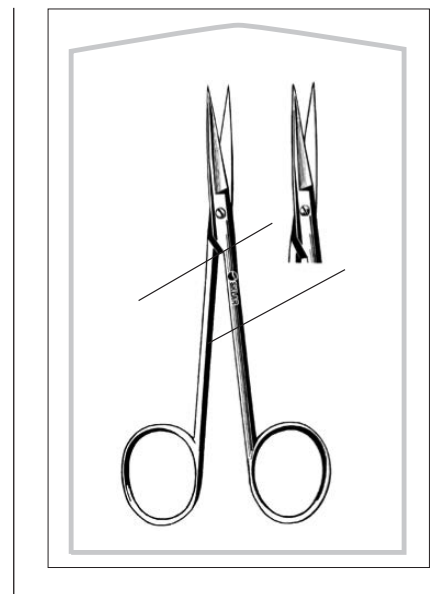
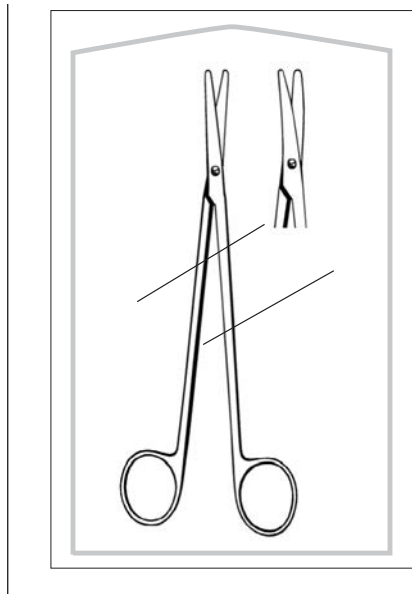
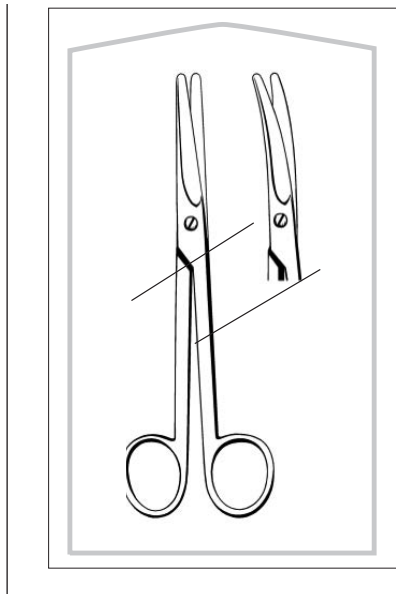

**MAYO SCISSORS**

96-2531	5½"	Straight	25/cs
96-2530	5½"	Straight	50/cs

**METZENBAUM SCISSORS**

96-2517	5½"	Straight	25/cs
96-2720	5½"	Curved	25/cs
96-2682	7"	Curved	25/cs
96-2516	5½"	Straight	50/cs
96-2721	5½"	Curved	50/cs
96-2680	7"	Curved	50/cs

**IRIS SCISSORS**

96-2505	4½"	Straight	25/cs
96-2507	4½"	Curved	25/cs
96-2497	3½"	Straight	50/cs
96-2499	3½"	Curved	50/cs
96-2504	4½"	Straight	50/cs
96-2506	4½"	Curved	50/cs
96-2650	4½"	Straight	100/cs
96-2651	4½"	Curved	100/cs

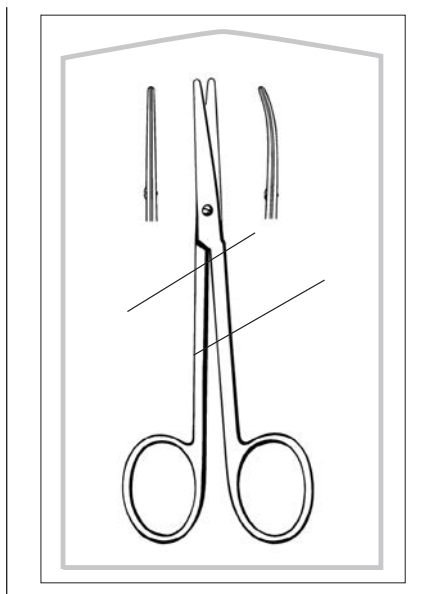

**STRABISMUS SCISSORS**

- 96-2542 4½" Straight 25/cs
- 96-2543 4½" Curved 25/cs
- 96-2540 4½" Straight 50/cs
- 96-2541 4½" Curved 50/cs

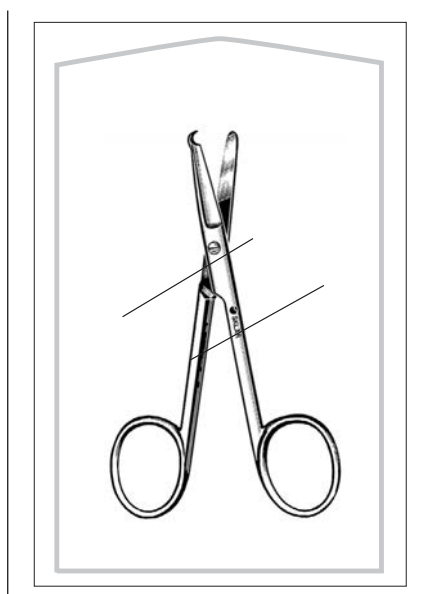

**SPENCER STITCH SCISSORS**

- 96-2598 4½" 25/cs
- 96-2672 3½" 50/cs
- 96-2596 4½" 50/cs

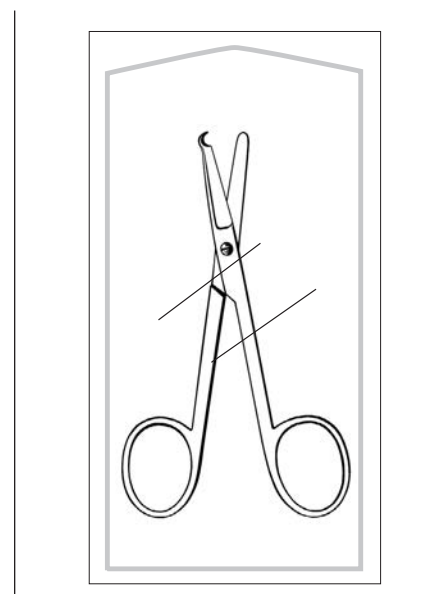

**LITTAUER STITCH SCISSORS**

- 96-2511 3½" 25/cs
- 96-2513 5½" 25/cs
- 96-2510 3½" 50/cs
- 96-2512 5½" 50/cs
- 96-2663 3½" 100/cs
- 96-2662 5½" 100/cs

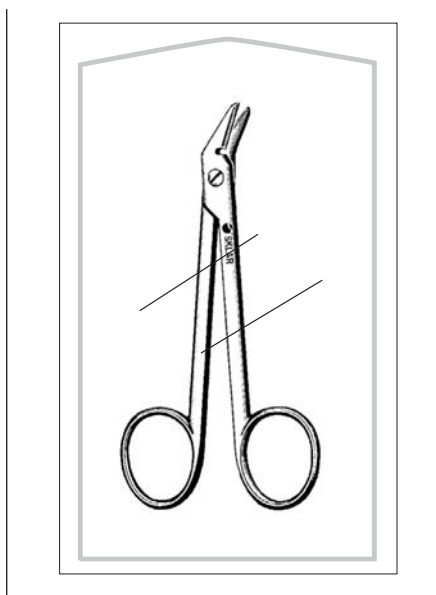

**WIRE CUTTING SCISSORS**

- 96-2519 4¾" Angled 25/cs
- 96-2518 4¾" Angled 50/cs

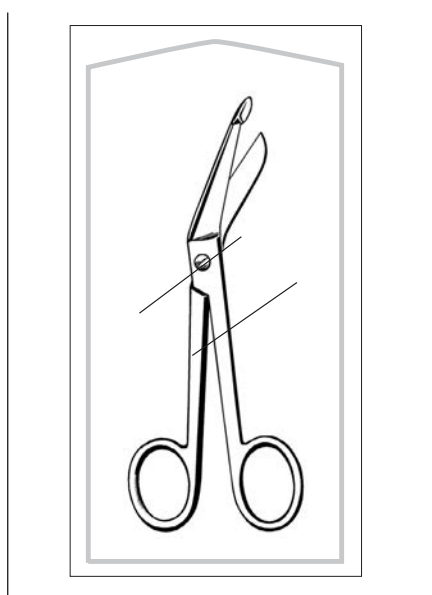

**LISTER BANDAGE SCISSORS**

- 96-2503 5½" 25/cs
- 96-2501 4½" 50/cs
- 96-2502 5½" 50/cs
- 96-2654 5½" 100/cs

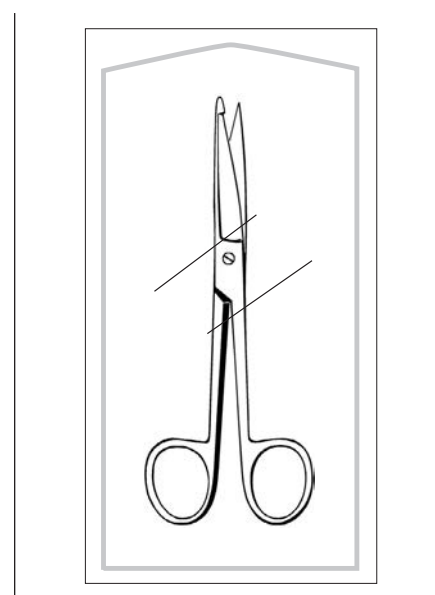

**KNOWLES BANDAGE SCISSORS**

- 96-2404 5½" 25/cs
- 96-2402 5½" 50/cs



**UTILITY SCISSORS**

96-2701	5½"	Black	25/cs	96-1223	7"	Burgundy	25/cs	96-1228	7"	Lime Green	25/cs
96-2703	7"	Black	25/cs	96-1224	7"	Magenta	25/cs	96-1229	7"	Hunter Green	25/cs
96-1220	7"	Yellow	25/cs	96-1225	7"	Navy Blue	25/cs	96-2702	5½"	Black	50/cs
96-1221	7"	Orange	25/cs	96-1226	7"	Royal	25/cs	96-2704	7"	Black	50/cs
96-1222	7"	Purple	25/cs	96-1227	7"	Teal Blue	25/cs				

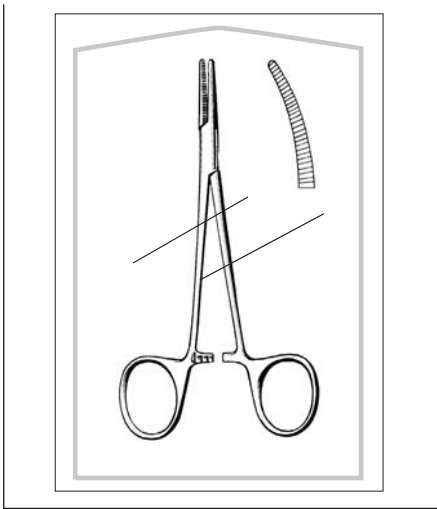

**HALSTEAD MOSQUITO FORCEPS**

96-2537	5"	Straight	25/cs
96-2539	5"	Curved	25/cs
96-2536	5"	Straight	50/cs
96-2538	5"	Curved	50/cs
96-2657	5"	Straight	100/cs
96-2658	5"	Curved	100/cs

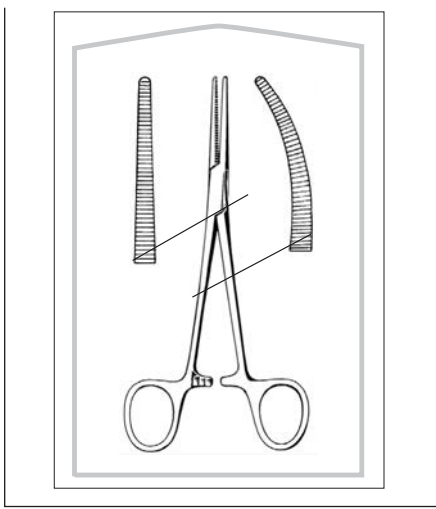

**CRILE FORCEPS**

96-2551	5½"	Straight	25/cs
96-2553	5½"	Curved	25/cs
96-2550	5½"	Straight	50/cs
96-2552	5½"	Curved	50/cs

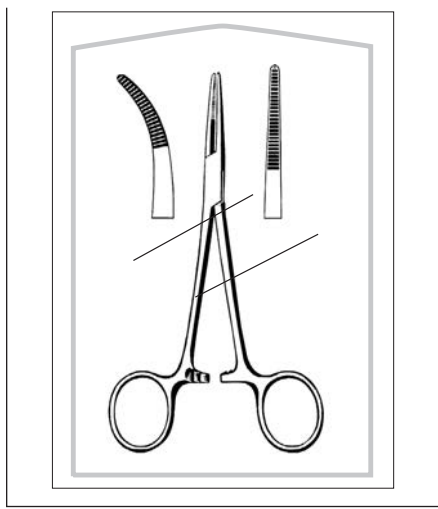

**KELLY FORCEPS**

96-2561	5½"	Straight	25/cs
96-2563	5½"	Curved	25/cs
96-2560	5½"	Straight	50/cs
96-2562	5½"	Curved	50/cs
96-2652	5½"	Straight	100/cs
96-2653	5½"	Curved	100/cs

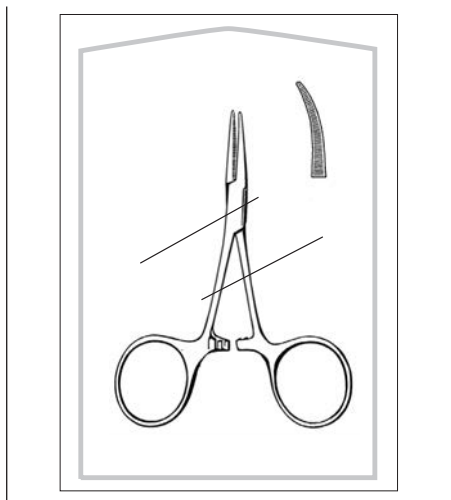

**HARTMANN FORCEPS**

96-2556	3½" Straight	25/cs
96-2557	3½" Curved	25/cs
96-2554	3½" Straight	50/cs
96-2555	3½" Curved	50/cs

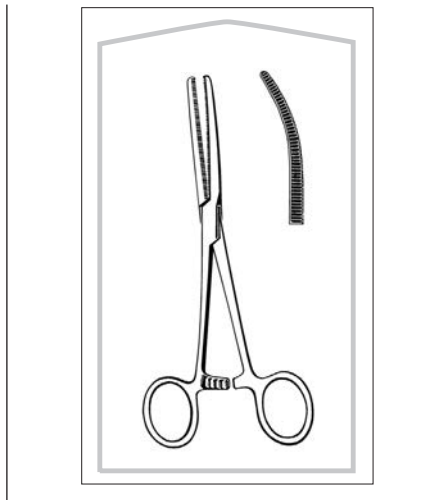

**ROCHESTER PEAN FORCEPS**

96-2545	6¼" Straight	25/cs
96-2547	6¼" Curved	25/cs
96-3006	7¼" Straight	25/cs
96-3008	7¼" Curved	25/cs
96-2548	8½" Curved	25/cs
96-2544	6¼" Straight	50/cs
96-2546	6¼" Curved	50/cs
96-2549	8½" Curved	50/cs
96-2664	8½" Curved	100/cs

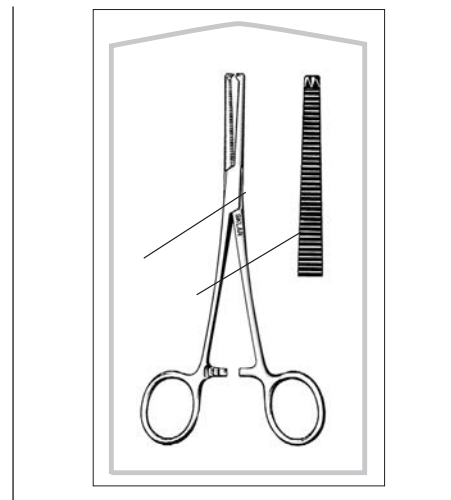

**ROCHESTER-OSHSNER FORCEPS**

96-2566	6¼" Straight	25/cs
96-2567	6¼" Curved	25/cs
96-2707	6¼" Straight	50/cs
96-2708	6¼" Curved	50/cs

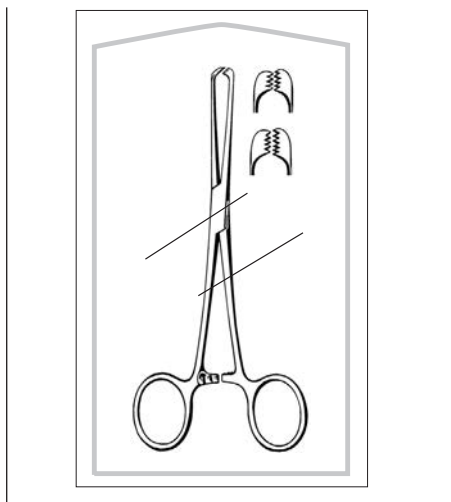

**ALLIS TISSUE FORCEPS**

96-2575	6"	4x5 Teeth	25/cs
96-2576	6"	4x5 Teeth	50/cs
96-2774	7¼"	6x7 Teeth	50/cs

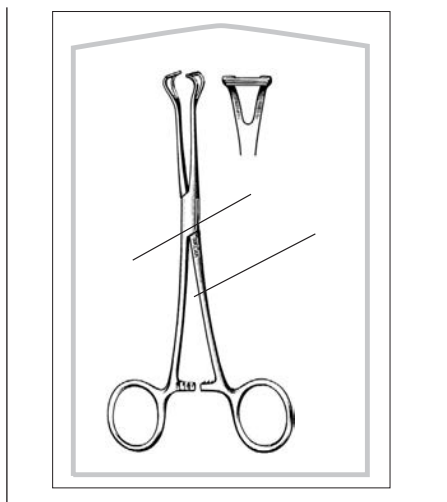

**BABCOCK FORCEPS**

96-2706	6¼" Straight	25/cs
96-2705	6¼" Straight	50/cs

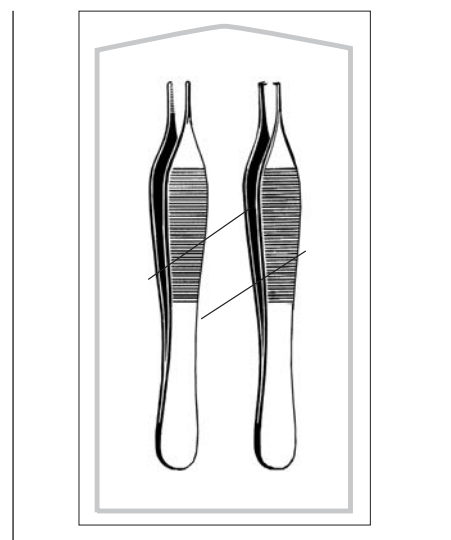

**ADSON FORCEPS**

96-2571	4¾"	Serrated	25/cs
96-2573	4¾"	1x2 Teeth	25/cs
96-2570	4¾"	Serrated	50/cs
96-2572	4¾"	1x2 Teeth	50/cs
96-2577	4¾"	Serrated Delicate	50/cs
96-2775	4¾"	1x2 Teeth Delicate	50/cs
96-2655	4¾"	Serrated	100/cs
96-2656	4¾"	1x2 Teeth	100/cs

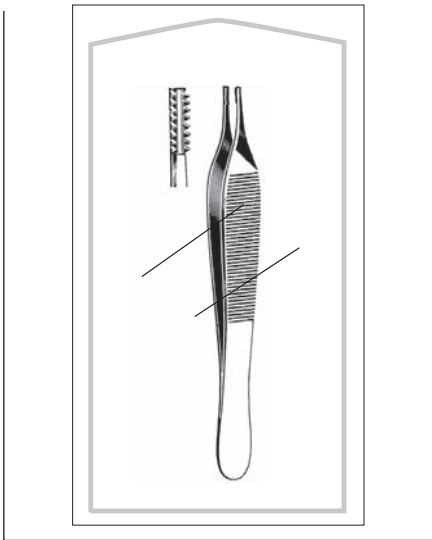

**ADSON BROWN FORCEPS**

96-2559 4¾" Side Grasping 25/cs  
 96-2558 4¾" Side Grasping 50/cs

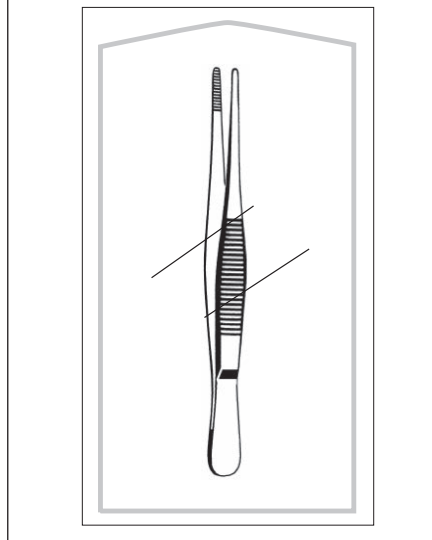

**DRESSING FORCEPS**

96-2569 5" Serrated 25/cs  
 96-2921 8" Serrated 25/cs  
 96-2688 4½" Serrated 50/cs  
 96-2568 5" Serrated 50/cs  
 96-2660 5" Serrated 100/cs

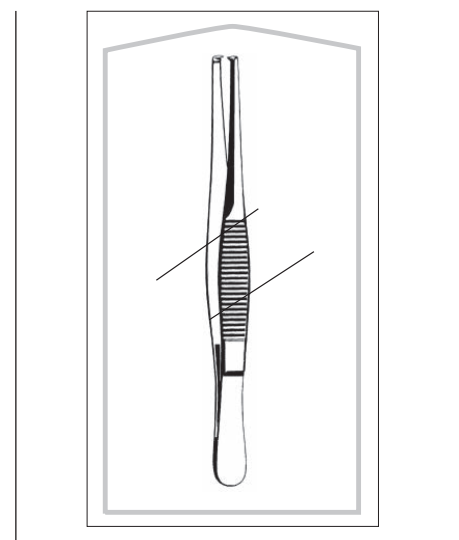

**TISSUE FORCEPS**

96-2579 5" 1x2 Teeth 25/cs  
 96-2578 5" 1x2 Teeth 50/cs  
 96-2661 5" 1x2 Teeth 100/cs

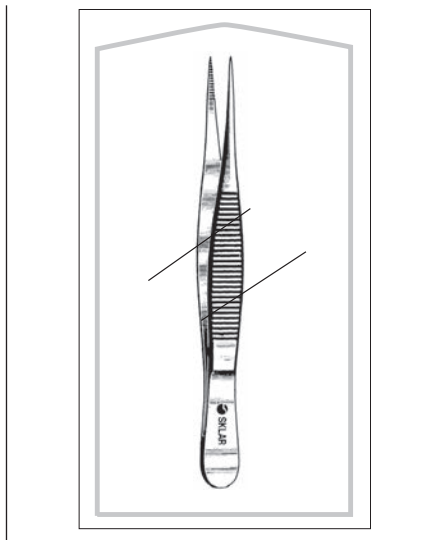

**FINE POINT SPLINTER FORCEPS**

96-2412 4½" 25/cs  
 96-2410 4½" 50/cs

**SKLAR-STAT™**  
**INSTANT FOAM HAND SANITIZER**

- Alcohol-Free
- Non-Sticky
- Moisturizes and Conditions Hands

**PRODUCT NUMBER**  
 10-2850 50ml Pump Dispensers 24/case  
 10-2852 550ml Pump Dispensers 12/case

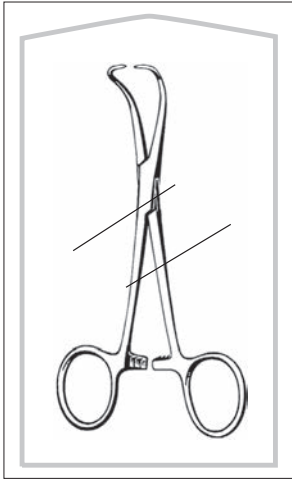
**BACKHAUS TOWEL CLAMPS**

96-2632	3½"	25/cs
96-2636	5¼"	25/cs
96-2630	3½"	50/cs
96-2634	5¼"	50/cs

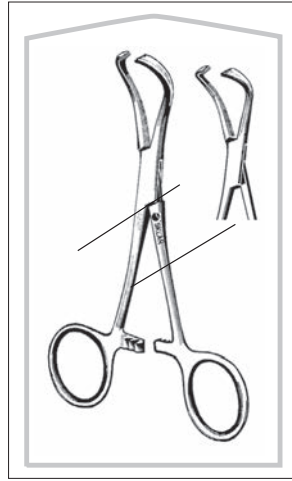
**LORNA EDNA TOWEL CLAMPS**

96-2529	3½"	25/cs
96-2528	3½"	50/cs

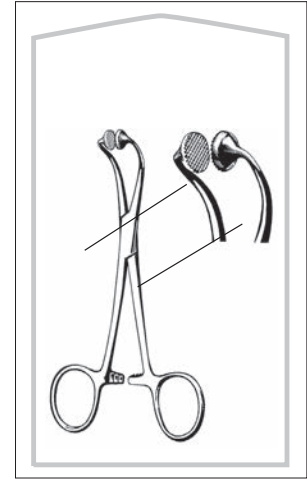
**HOFF TOWEL CLAMPS**

96-2565	5¼"	25/cs
96-2564	5¼"	50/cs

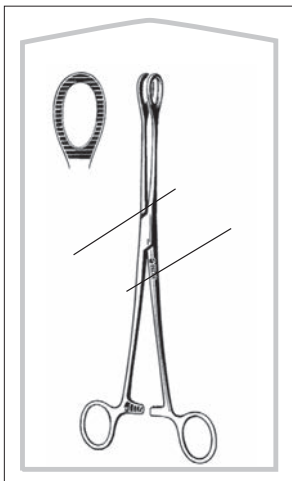

**SPONGE FORCEPS**

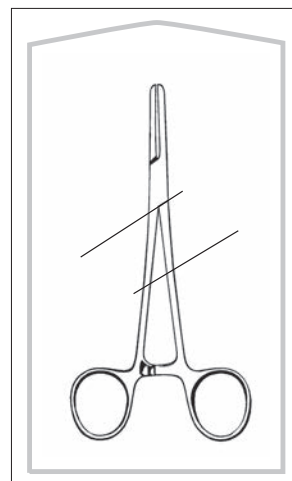
96-2533	9½"	Straight, Serrated	25/cs
96-2532	9½"	Straight, Serrated	50/cs

**PRESBYTERIAN TUBE  
OCCLUDING FORCEPS**

96-2408	7"	Smooth	25/cs
96-2406	7"	Smooth	50/cs

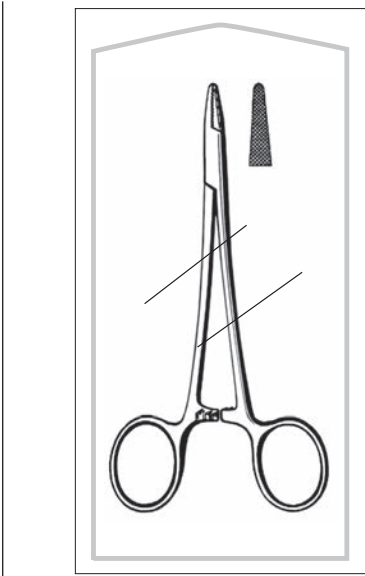



**BAUMGARTNER NEEDLE HOLDERS**

- 96-2581 5½" Serrated 25/cs
- 96-2580 5½" Serrated 50/cs

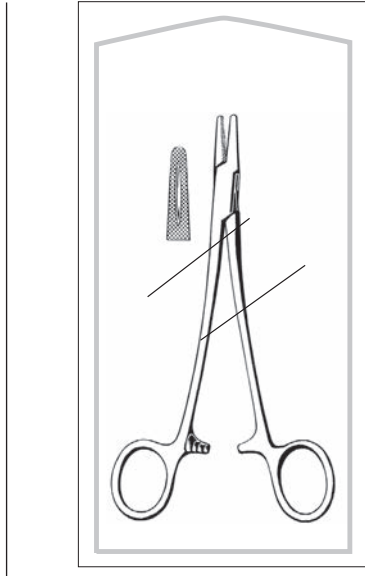

**MAYO-HEGAR NEEDLE HOLDERS**

- 96-2599 5" Serrated 25/cs
- 96-2595 6" Serrated 25/cs
- 96-2594 6" Serrated 50/cs
- 96-2710 7" Serrated 50/cs
- 96-2712 8" Serrated 50/cs

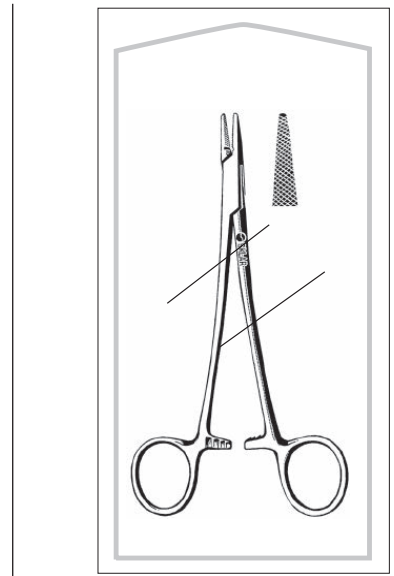

**CRILE-WOOD NEEDLE HOLDERS**

- 96-2591 6" Serrated 25/cs
- 96-2590 6" Serrated 50/cs

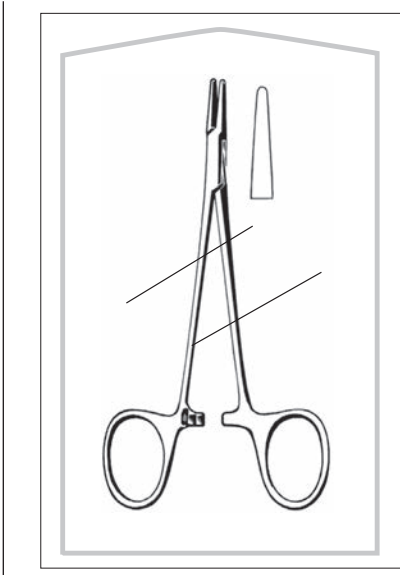

**WEBSTER NEEDLE HOLDERS**

- 96-2587 5¼" Smooth 25/cs
- 96-2586 5¼" Smooth 50/cs
- 96-2659 5¼" Smooth 100/cs

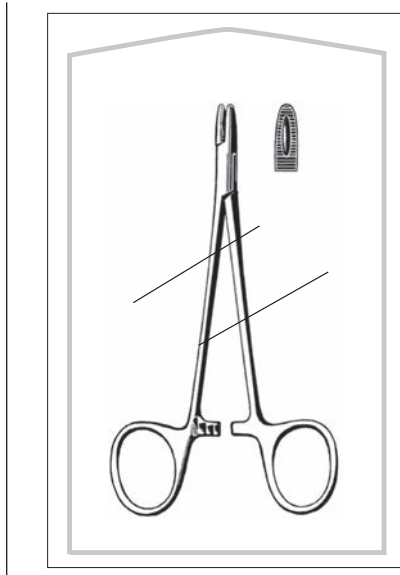

**DERF NEEDLE HOLDERS**

- 96-2583 4¾" Serrated 25/cs
- 96-2582 4¾" Serrated 50/cs

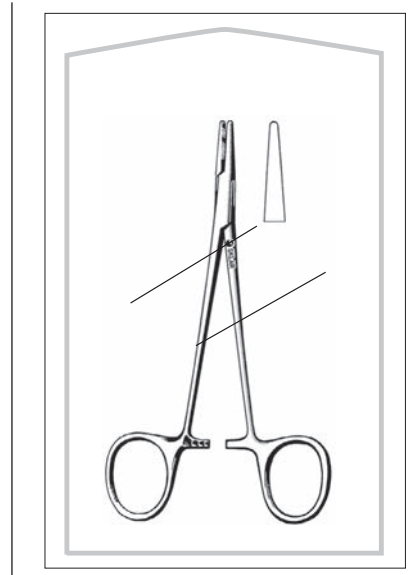

**HALSEY NEEDLE HOLDERS**

- 96-2585 5" Smooth 25/cs
- 96-2584 5" Smooth 50/cs

**STITCH SCISSORS**

- 96-8971 4½" Littauer 50/cs
- 96-8973 4½" Sharp/Blunt 50/cs
- 96-8972 5¼" Sharp/Blunt 50/cs
- 96-8975 5¼" Sharp/Sharp 50/cs

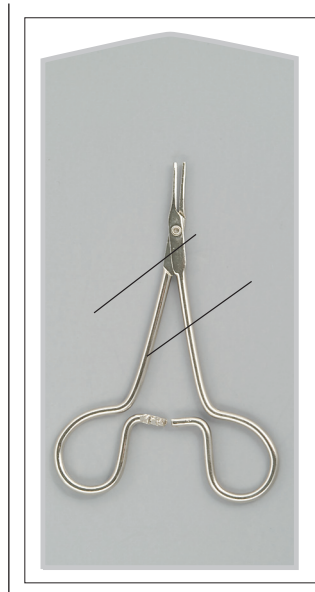
**HALSTED FORCEPS**

- 96-8964 5" Straight 50/cs
- 96-8965 5" Curved 50/cs

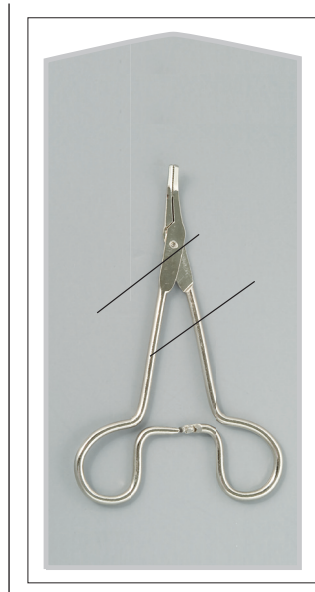
**KELLY FORCEPS**

- 96-8967 5½" Straight 50/cs
- 96-8966 5½" Curved 50/cs

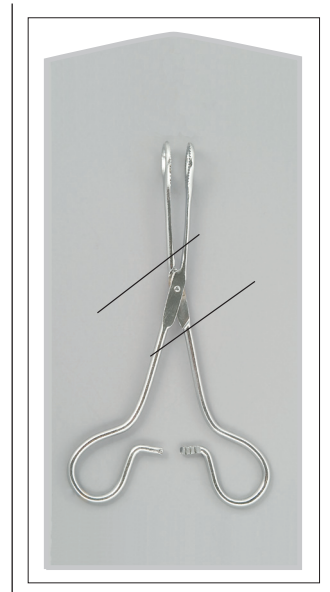
**SPONGE FORCEPS**

- 96-8969 7" Serrated 50/cs
- 96-8970 9½" Serrated 50/cs

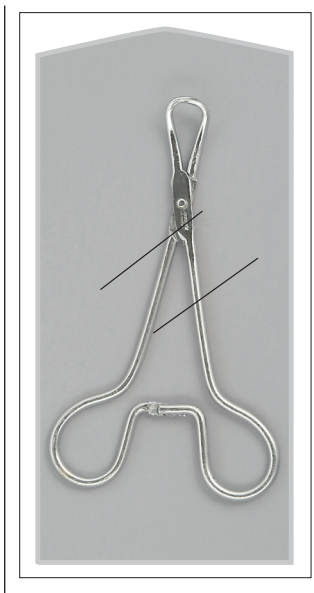
**TOWEL FORCEP**

- 96-8962 5¼" 50/cs

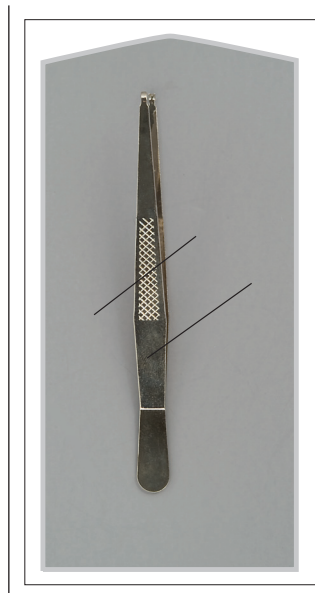
**THUMB FORCEP**

- 96-8963 4½" 1x2 Teeth 50/cs

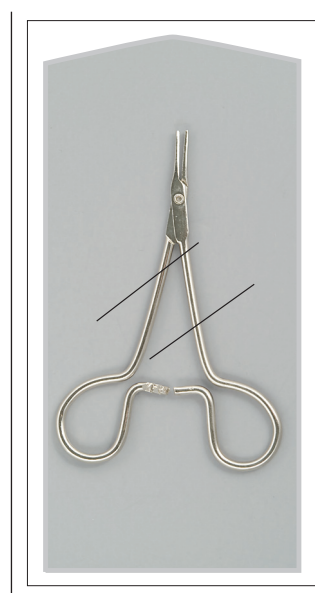
**TISSUE FORCEP**

- 96-8976 5" 50/cs

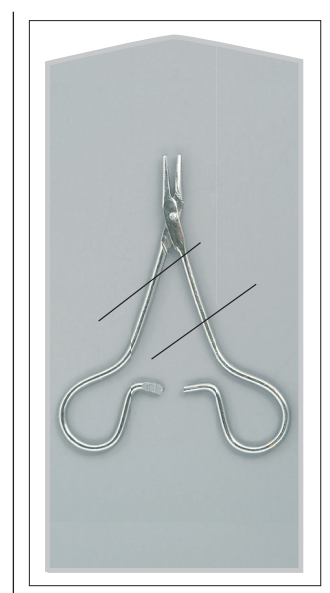

**NEEDLE HOLDERS**

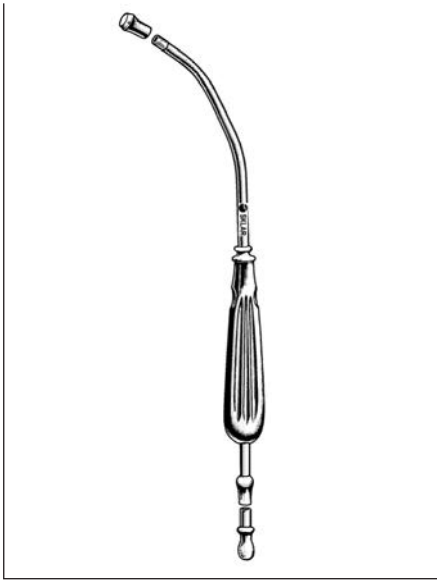
- 96-8968 5¼" Smooth 50/cs
- 96-8974 5¼" Serrated 50/cs

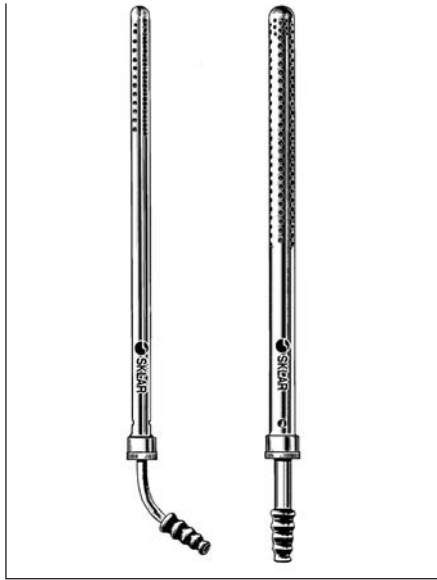

**YANKAUER SUCTION TUBE**

- 07-1801 11" Chrome Plated
- 07-1805 11" Stainless Steel
- 22-6585 8½" Stainless Steel, Pediatric
- 07-1802 Tip For use with 07-1801
- 07-1806 Tip For use with 07-1805
- 22-6586 Tip For use with 22-6585



**POOLE SUCTION TUBE**

- 22-6577 16 French Curved Pediatric
- 34-2023 23 French Curved
- 34-2230 30 French Straight Slip on End



**BARON SUCTION TUBE**

- 50-1953 3 French
- 50-1955 5 French
- 50-1957 7 French

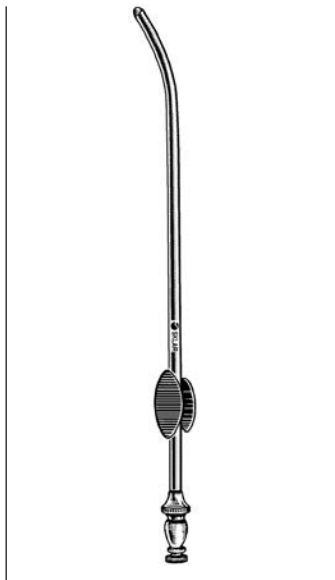

**ADSON SUCTION TUBE**

- 50-1982 6" 12 French
- 50-1985 7½" 15 French

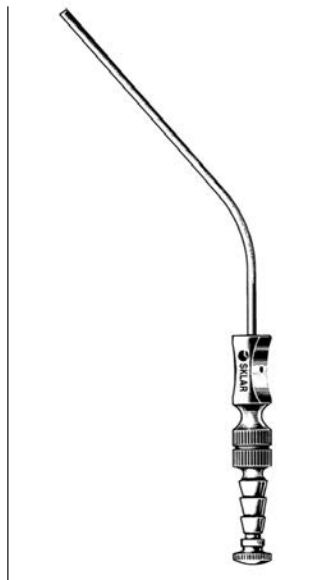

**FRAZIER SUCTION TUBE**

- 50-2006 6 French
- 50-2007 7 French
- 50-2008 8 French
- 50-2009 9 French
- 50-2010 10 French
- 50-2011 11 French
- 50-2012 12 French
- 50-2014 14 French



**FRAZIER SUCTION TUBE 90 DEGREE**

- 50-2206 7½" 6 French
- 50-2207 7½" 7 French
- 50-2208 7½" 8 French
- 50-2210 7½" 10 French
- 50-2212 7½" 12 French

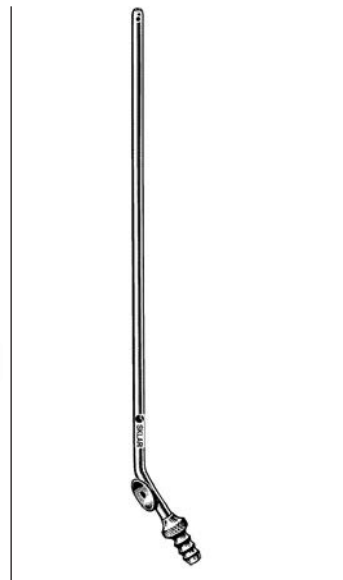

**BUIE SUCTION TUBE**

- 80-2715 15 French With Valve
- 80-2815 15 French Without Valve

Designed to meet the exacting standards of health care professionals who demand precise acoustic response in various settings, Sklar offers a full range of Stethoscopes that feature superb craftsmanship and performance.

### SPRAGUE RAPPAPORT STETHOSCOPES

- The most popular stethoscope style on the market, worldwide.
- Includes five easily interchangeable chest pieces: 3 Bells (Adult, Medium and Infant) and 2 Diaphragms (Small and Large) allowing for a full range of diagnostic capabilities. Also includes 3 different size ear tips.
- Superior high and low frequency sensitivity; designed to detect the entire range of heart and chest sounds. Clinically proven to deliver more faint heart sounds and murmurs than other stethoscopes.
- Chest piece is equipped with a full rotational dual-output acoustic valve mechanism that ensures smooth rotation and accurate acoustic transmission.
- All components are individually machined and precisely assembled to deliver the choice stethoscope of medical professionals.
- Comfortably angled, anatomically correct headset with patented soft ear tips and excellent acoustic seal.
- Latex Free.

### SPRAGUE RAPPAPORT STETHOSCOPES

#### DUAL HEAD

PRODUCT NUMBER	FEATURES
06-1625	28" Gray
06-1627	28" Black
06-2304	28" Blue



## CARDIOLOGY STETHOSCOPES

- Superb craftsmanship, construction and materials to offer the ultimate performance and sound transmission.
- Available in single-sided or dual-sided design with very high acoustic response.
- Offered as a double-lumen tube design in a variety of color choices to meet individual preferences.
- Comfortably angled, anatomically correct headset with patented soft ear tips and excellent acoustic seal.
- Latex Free.

### SINGLE SIDED

PRODUCT NUMBER      FEATURES

06-2750      27"      Black

06-2800      28"      Black

06-2802      28"      Blue

06-2803      28"      Green

### DUAL HEAD

Deluxe, two-sided traditional combination chest piece with patented turnable diaphragm to allow for high, medium and low frequency sounds to be heard.

PRODUCT NUMBER      FEATURES

06-1670      28"      Black

06-1671      28"      Burgundy

06-1672      28"      Navy Blue

06-1673      28"      Green

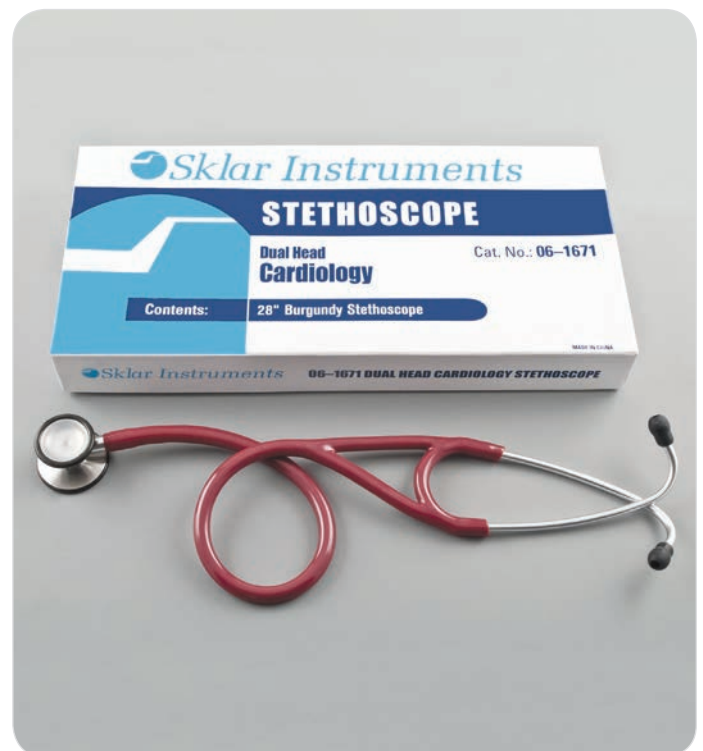

### ADULT STETHOSCOPES

- Unsurpassed quality and value.
- Available in single-sided or dual-sided design, in a variety of color choices, with very high acoustic response.
- Specifically designed, sized and acoustically precisioned for adults.
- Patient friendly non-chill rim and diaphragm, excellent acoustic seal and comfortable fit with patented soft ear tips and a comfortably angled, anatomically correct headset.
- Unlimited flexibility and portable convenience.
- Latex Free.

#### SINGLE SIDED

PRODUCT NUMBER	FEATURES
06-2760	30" Black



#### DUAL HEAD

Deluxe, stainless steel, two-sided traditional combination chest piece with high and low frequency capabilities.

PRODUCT NUMBER	FEATURES
06-1601	30" Gray
06-2298	30" Purple
06-2299	30" Hunter Green
06-2300	30" Black
06-2302	30" Blue



### LIGHT ADULT STETHOSCOPES

#### DUAL HEAD

Lighter construction reduces fatigue while maintaining performance.

PRODUCT NUMBER	FEATURES
06-1630	30" Black
06-1632	30" Gray



## PEDIATRIC AND INFANT STETHOSCOPES

- Traditional bell/diaphragm chest pieces are specifically designed, sized and acoustically precise for children and infants.
- Solid Stainless Steel chest piece features a 1" Traditional Bell for Pediatric and ¾" Bell for Infant.
- Easy rotation between diaphragm or open bell side of stethoscope and sensitive to both high and low frequencies.
- Available as a dual-sided design, in a variety of attractive colors for use with children and infants.
- Excellent acoustic seal and comfortable fit with patented soft ear tips and a comfortably angled, anatomically correct headset.
- Latex Free.



### PEDIATRIC STETHOSCOPES

#### DUAL HEAD

PRODUCT NUMBER	FEATURES
06-1640	30" Gray
06-2415	30" Pink
06-2417	30" Black
06-2418	30" Burgundy
06-2422	30" Blue



### INFANT STETHOSCOPES

#### DUAL HEAD

PRODUCT NUMBER	FEATURES
06-1642	30" Gray
06-2426	30" Pink
06-2427	30" Light Blue
06-2428	30" Black

### FETAL STETHOSCOPE

#### CHROME-PLATED INNER SPRING BINAURAL AND VINYL COATED HEADREST

PRODUCT NUMBER	FEATURES
06-1662	22" Y-Tubing Black



### NURSES STETHOSCOPES

#### SINGLE SIDED

- Economic solution for situations that require a quality listening device.
- Latex Free.

PRODUCT NUMBER	FEATURES
06-1004	30" Blue
06-1635	30" Black
06-1638	30" Gray



### TEACHING TRAINING STETHOSCOPE

#### SINGLE SIDED

- Specifically designed for multi-function teaching applications.
- Elongated tubing for comfortable two-person use.
- Latex Free.

PRODUCT NUMBER	FEATURES
06-1668	40" Black



### DISPOSABLE STETHOSCOPES

#### SINGLE SIDED

- Designed for single use to prevent cross contamination in infectious situations.
- Plastic, ultra sensitive chest piece with remarkable acoustic performance.
- Latex Free.

PRODUCT NUMBER	FEATURES
96-1201	30" Blue
96-1202	30" Yellow





**BOWLES STETHOSCOPE**

PRODUCT NUMBER

06-1000

**PERRELL FETOSCOPE**

PRODUCT NUMBER

06-1701

FEATURES

With Slip on Tubing Adaptor

**PINARD FETOSCOPE**

PRODUCT NUMBER

06-1101

FEATURES

Aluminum





### SKLAR DISPOSABLE FACE MASKS

The Sklar Disposable Face Mask is offered in the most popular style to meet clinical requirements in the operating room, general medicine, or any other areas requiring facial protection. Protecting against infectious pathogens, Sklar masks are ≥98% BFE, non-woven, soft and breathable. Convenient ear loops and adjustable nose-bridge ensures a proper fit. Latex Free.

**NON-STERILE**

PRODUCT NUMBER	FEATURES	QUANTITIES
96-5557	Mask Earloop, Blue	50/bx
96-5557A	Mask Earloop, Blue	500/cs
96-5557BNS	Mask Earloop, Blue, Bulk	2000/cs



### SKLAR SURGICAL GOWNS

- Low linting, lightweight and breathable SMS fabric.
- Generous cut provides comfort and freedom of movement during various procedures.
- Superior liquid barrier protection provides confidence against strikethrough.
- Velcro-style neck closure easily adjusts for a perfect fit.
- Meets safety standards for Class I Flame Resistance.
- Meets AAMI Level I requirements.
- Disposable, single use.

**NON-STERILE**

PRODUCT NUMBER	FEATURES	QUANTITIES
96-5329	Non-Reinforced, Large	40/cs
96-5331	Non-Reinforced, X-Large	40/cs
96-5333	Non-Reinforced, XX-Large	40/cs

**BULK, NON-STERILE**

96-5003B	Non-Reinforced, Large	160/cs
96-5005B	Non-Reinforced, X-Large	160/cs
96-5006B	Non-Reinforced, XX-Large	120/cs



**SCALPEL HANDLES**

PRODUCT NUMBER	FEATURES
06-2910	#3 with metric scale

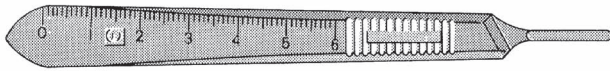

PRODUCT NUMBER	FEATURES
06-2903	#3 fits Blade #10, 11, 12, 15
06-2915	#3L



PRODUCT NUMBER	FEATURES
06-2904	#4 fits Blade #20, 21, 22, 23
06-2920	#4L



PRODUCT NUMBER	FEATURES
06-2907	#7 fits Blade #10, 11, 12, 15



PRODUCT NUMBER	FEATURES
06-2912	#8 fits Blade #60



PRODUCT NUMBER	FEATURES
06-2925	Large Lab Type Handle #3
06-2930	Large Lab Type Handle #4

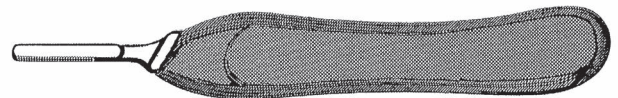

PRODUCT NUMBER	FEATURES
06-2908	Round Scalpel Handle, Straight #3R, fits Blade #10, 11, 12, 15



PRODUCT NUMBER	FEATURES
06-3090	Blade Remover

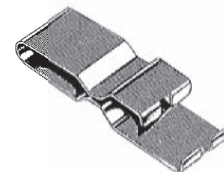

**BLADES, STAINLESS STEEL**
**STERILE**

PRODUCT NUMBER	FEATURES	QUANTITIES
06-3100	#10	100/box
06-3101	#11	100/box
06-3102	#12	100/box
06-3103	#15	100/box
06-3108	#15C	100/box
06-3104	#20	100/box
06-3105	#21	100/box
06-3106	#22	100/box
06-3107	#23	100/box

**BLADES, CARBON STEEL**
**STERILE**

PRODUCT NUMBER	FEATURES	QUANTITIES
06-3010	#10	100/box
06-3011	#11	100/box
06-3012	#12	100/box
06-3013	#12D	100/box
06-3015	#15	100/box
06-3016	#15C	100/box
06-3020	#20	100/box
06-3021	#21	100/box
06-3022	#22	100/box
06-3023	#23	100/box

**SCALPELS, DISPOSABLE**
**STERILE**

PRODUCT NUMBER	FEATURES	QUANTITIES
06-3110	#10	10/box
06-3111	#11	10/box
06-3112	#12	10/box
06-3115	#15	10/box
06-3120	#20	10/box
06-3121	#21	10/box
06-3122	#22	10/box
06-3123	#23	10/box





**LATEX-FREE**

**SKLARSABA FETYS ALPE S**

- Protective, transparent sheath can be opened, closed, and locked with a single hand.
- Precision stainless steel blade made in England.
- Sturdy, “Sure-Grip” handle.
- Audible “click” when sheath advanced to locked position.
- OSHA Compliant.
- Individually sealed in sturdy film and Tyvek® pack.

**STERILE**

PRODUCT NUMBER	FEATURES	QUANTITIES
----------------	----------	------------

06-3094	#10	10/box
---------	-----	--------

06-3095	#11	10/box
---------	-----	--------

06-3096	#15	10/box
---------	-----	--------

**NON-STERILE**

06-3130	#10	500/cs
---------	-----	--------

06-3132	#11	500/cs
---------	-----	--------

06-3134	#15	500/cs
---------	-----	--------

### MINI BLADES AND SCALPELS

STERILE

PRODUCT NUMBER	FEATURES	QUANTITIES
97-1822	#61	25/box
97-1721	#62	12/box
97-1821	#62	25/box
97-1820	#63	25/box
97-1826	#64	25/box
97-1825	#65	25/box
97-1824	#67	25/box
97-1823	#69	25/box



### MINI PODIATRY HANDLE

NON-STERILE

PRODUCT NUMBER	FEATURES	QUANTITIES
97-1450	#3K	1 Each



### SPECIALTY BLADES

NON-STERILE

PRODUCT NUMBER	FEATURES	QUANTITIES
97-1400	#318, Curved Edge	12/box
97-1405	#312, Curved Edge	12/box
97-1410	#313, Curved Edge	12/box
97-1415	#314, Curved Edge	12/box
97-1420	#316, Straight Edge	12/box
97-1425	#300, Straight Edge	12/box
97-1430	#361, Knife Edge	12/box

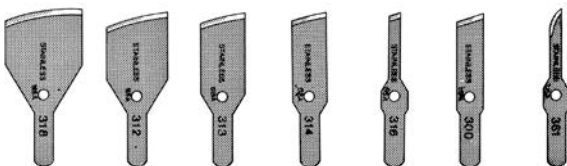

### SELF-LOCKING HANDLE

NON-STERILE

PRODUCT NUMBER	FEATURES	QUANTITIES
97-1445	#6	1 Each



### CARBON P-M BLADE

NON-STERILE

PRODUCT NUMBER	FEATURES	QUANTITIES
06-3024	#60	50/box

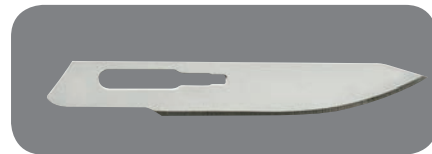

### MINI THUMB SCALPEL

NON-STERILE

PRODUCT NUMBER	FEATURES	QUANTITIES
06-7052	#11	1500/cs



### STITCH CUTTER

STERILE

PRODUCT NUMBER	FEATURES	QUANTITIES
06-3030	Stainless Steel	100/box



All Sklar Stainless Steelware is produced according to the strictest standards to ensure superior performance and durability.

\*All products are packaged individually. Select products are available in bulk. To order larger quantities, simply add the package quantity to the end of the product number when ordering, ie. 10-1670-12 for 12/pk or 10-1670-48 for 48/pk.

**IODINE CUP\***

PRODUCT NUMBER	DESCRIPTION	QUANTITIES
10-1670	6 oz., 3 <sup>7</sup> / <sub>16</sub> " x 2"	1, 12, 24 or 48/box
10-1671	14 oz., 4 <sup>3</sup> / <sub>8</sub> " x 2 <sup>5</sup> / <sub>8</sub> "	1, 12, 24 or 48/box



**MEDICINE CUP\***

PRODUCT NUMBER	DESCRIPTION	QUANTITIES
10-1675	2 oz., 2 <sup>1</sup> / <sub>8</sub> " x 2" Graduated Measure	1, 12, 24 or 48/box



**TUMBLER\***

PRODUCT NUMBER	DESCRIPTION	QUANTITIES
10-1536	7 oz., 2 <sup>7</sup> / <sub>8</sub> " x 3 <sup>1</sup> / <sub>8</sub> "	1, 12/box



**PITCHER / BEAKER\***

PRODUCT NUMBER	DESCRIPTION	QUANTITIES
10-1172	125ml, 2 <sup>1</sup> / <sub>8</sub> " x 2 <sup>5</sup> / <sub>8</sub> " w/o Handle	1 Each
10-1173	250ml, 2 <sup>5</sup> / <sub>8</sub> " x 3 <sup>1</sup> / <sub>4</sub> " w/o Handle	1 Each
10-1174	600ml, 3 <sup>3</sup> / <sub>8</sub> " x 4 <sup>5</sup> / <sub>8</sub> " w/o Handle	1 Each
10-1176	2000ml, 4 <sup>7</sup> / <sub>8</sub> " x 7 <sup>1</sup> / <sub>8</sub> " w/o Handle	1 Each
10-1177	3000ml, 5 <sup>1</sup> / <sub>2</sub> " x 8 <sup>1</sup> / <sub>4</sub> " w/o Handle	1 Each
10-1178	4000ml, 6 <sup>1</sup> / <sub>8</sub> " x 8 <sup>7</sup> / <sub>8</sub> " w/o Handle	1 Each
10-1175	1200ml, 4 <sup>1</sup> / <sub>8</sub> " x 6 <sup>1</sup> / <sub>8</sub> " with closed Handle	1 Each
10-1539	2000ml, 5 <sup>1</sup> / <sub>16</sub> " x 6 <sup>3</sup> / <sub>8</sub> " with closed Handle	1, 6 or 12/box
10-1180	3000ml, 6 <sup>1</sup> / <sub>16</sub> " x 7" with closed Handle	1 Each
10-1181	4000ml, 6 <sup>7</sup> / <sub>8</sub> " x 8 <sup>7</sup> / <sub>8</sub> " with closed Handle	1 Each



**GRADUATED MEASURE\***

PRODUCT NUMBER	DESCRIPTION	QUANTITIES
10-1552	16 oz., 3¾" x 4⅝"	1, 6 or 12/box
10-1510	32 oz., 4¾" x 5¼"	1, 6 or 12/box
10-1674	64 oz., 5½" x 6½"	1, 6 or 12/box

**SPONGE BOWLS\***

PRODUCT NUMBER	DESCRIPTION	QUANTITIES
10-1496	12 oz., 4¼" x 2"	1 or 12/box
10-1498	22 oz., 5" x 2⅜"	1 or 12/box
10-1484	29 oz., 5⅝" x 2⅞"	1 or 12/box
10-1485	36 oz., 6¼" x 2¾"	1 or 12/box
10-1483	48 oz., 7⅞" x 2¾"	1 or 12/box
10-1486	64 oz., 7⅞" x 3"	1 or 12/box

**MIXING/SOLUTION BOWLS\***

PRODUCT NUMBER	DESCRIPTION	QUANTITIES
10-1488	⅞ qt., 6⅝" x 2½"	1 or 12/box
10-1491	1⅞ qt., 8⅞" x 3"	1 or 12/box
10-1492	3 qt., 9¾" x 4"	1 or 12/box
10-1493	5 qt., 11⅞" x 4½"	1 or 12/box
10-1494	6¾ qt., 12¾" x 5¼"	1, 6 or 12/box
10-1495	8 qt., 13⅝" x 5⅞"	1, 6 or 12/box

**SOLUTION BASINS\***

PRODUCT NUMBER	DESCRIPTION	QUANTITIES
10-1489	4½ qt., 12" x 4¼"	1 or 12/box
10-1505	7 qt., 13⅝" x 4⅝"	1, 6 or 12/box
10-1507	9½ qt., 14½" x 5"	1, 6 or 12/box





**EMESIS BASINS\***

PRODUCT NUMBER	DESCRIPTION	QUANTITIES
10-1497	10 oz., 6 $\frac{5}{8}$ " x 3 $\frac{1}{2}$ " x 1 $\frac{1}{2}$ "	1 or 12/box
10-1698	12 oz., 8 $\frac{1}{8}$ " x 3 $\frac{5}{8}$ " x 1 $\frac{5}{8}$ "	1 or 12/box
10-1699	26 oz., 9 $\frac{7}{8}$ " x 4 $\frac{1}{2}$ " x 2 $\frac{1}{8}$ "	1 or 12/box
10-1487	48 oz., 12 $\frac{1}{8}$ " x 5 $\frac{3}{4}$ " x 2 $\frac{1}{4}$ "	1 Each

**HOSPITAL BUCKETS**

PRODUCT NUMBER	DESCRIPTION	QUANTITIES
10-1182	13 qt., 11 $\frac{1}{8}$ " x 9 $\frac{1}{4}$ " w/o lid	1 Each
10-1450	13 qt., 11 $\frac{1}{8}$ " x 9 $\frac{1}{4}$ " with lid	1 Each
10-1183	16 qt., 11 $\frac{3}{4}$ " x 10 $\frac{1}{8}$ " w/o lid	1 Each
10-1451	16 qt., 11 $\frac{3}{4}$ " x 10 $\frac{1}{8}$ " with lid	1 Each
10-1184	20 qt., 13 $\frac{3}{4}$ " x 11 $\frac{13}{16}$ " w/o lid	1 Each

**HOSPITAL KICK BUCKET WITHOUT LID**

PRODUCT NUMBER	DESCRIPTION	QUANTITIES
10-1551	13 qt., 11 $\frac{1}{8}$ " x 9 $\frac{1}{4}$ "	1 Each

**STORAGE CONTAINERS\***

PRODUCT NUMBER	DESCRIPTION	QUANTITIES
10-1540	1/2 gal., 5 $\frac{7}{8}$ " x 6 $\frac{5}{8}$ " no handles	1, 6 or 12/box
10-1186	3 gal., 10 $\frac{3}{8}$ " x 9"	1 Each
10-1188	4 gal., 13" x 9"	1 Each
10-1189	5 gal., 13" x 11"	1 Each
10-1190	6 gal., 13" x 13"	1 Each



\*All products are packaged individually. Select products are available in bulk. To order larger quantities, simply add the package quantity to the end of the product number when ordering, ie. 10-1670-12 for 12/pk or 10-1670-48 for 48/pk.

**DRESSING JAR WITH LID\***

PRODUCT NUMBER	DESCRIPTION	QUANTITIES
10-1523	½ qt., 4⅞" x 2¼"	1 or 12/box
10-1533	1 ¼ qt., 4" x 5"	1 or 12/box
10-1538	1 ⅞ qt., 4⅞" x 6 ¼"	1 or 12/box
10-1527	3 qt., 5⅞" x 6¾"	1 or 12/box
10-1543	4¾ qt., 6¾" x 7¾"	1 or 12/box
10-1544	6 qt., 7¼" x 8⅞"	1, 6 or 12/box
10-1547	8 qt., 8" x 9⅞"	1, 6 or 12/box

**FORCEP/THERMOMETER JAR\***

PRODUCT NUMBER	DESCRIPTION	QUANTITIES
10-1550	1½" x 3"	1, 6 or 12/box
10-1541	2¼" x 4½"	1, 6 or 12/box
10-1545	2¼" x 7"	1, 6 or 12/box

**FUNNELS WITH HANGING HOOK**

PRODUCT NUMBER	DESCRIPTION	QUANTITIES
10-1157	2⅞ oz., 3" x 3¾"	1 Each
10-1158	6⅜ oz., 4⅞" x 4⅞"	1 Each
10-1159	13 oz., 5⅞" x 5⅞"	1 Each
10-1160	22¼ oz., 6¼" x 6⅞"	1 Each
10-1170	32 oz., 7" x 8⅞"	1 Each
10-1171	64 oz., 8⅞" x 9½"	1 Each

**LAB / UTILITY SCOOP**

PRODUCT NUMBER	DESCRIPTION	QUANTITIES
10-1192	5 oz., 5" x 2½" (Overall length 9½")	1 Each



**OINTMENT JAR WITH LID\***

PRODUCT NUMBER	DESCRIPTION	QUANTITIES
10-1525	9 oz., 3 1/8" x 2 3/4"	1 or 12/box



**MINI TRAY WITH LID**

PRODUCT NUMBER	DESCRIPTION	QUANTITIES
10-1768	8 1/2" x 3" x 1 1/2"	1 Each



CONVENIENT  
DISPENSING  
CANISTER

SEE PAGE 265 FOR  
ORDERING DETAILS

# SKLAR DISINFECTANT™ SURFACE WIPES

BACTERICIDAL • VIRUCIDAL • FUNGICIDAL • TUBERCULOCIDAL

**3 MINUTE KILL TIME!**

- READY TO USE, NON-TOXIC, NON-IRRITATING FORMULA
- SPECIALLY FORMULATED FOR THE CONTROL OF CROSS CONTAMINATION
- EFFECTIVE AGAINST C.DIFF, TB, HBV, HCV, VRE, HYDROPHILIC AND LIPOPHILIC VIRUSES INCLUDING HIV-1 (AIDS VIRUS), BACTERIA AND FUNGI ON INANIMATE OBJECTS
- SAFE FOR ALL AREAS OF THE FACILITY INCLUDING THE NICU, OPERATING ROOMS, ISOLATION ROOMS, PATIENT CARE AREAS, LABORATORIES AND DIALYSIS
- SATISFIES OSHA'S BLOODBORNE PATHOGEN STANDARDS
- DESTROYS ODOR-CAUSING BACTERIA
- 7" X 10" NON-WOVEN, TEAR RESISTANT TOWELETTE
- CLEAN SCENT
- EPA REGISTERED

\*All products are packaged individually. Instrument trays and covers are sold separately unless otherwise noted. Select products are available in bulk. To order larger quantities, simply add the package quantity to the end of the product number when ordering, ie. 10-1670-12 for 12/pk or 10-1670-48 for 48/pk.

**MAYO TRAYS (SOLID)\***

PRODUCT NUMBER	DESCRIPTION	QUANTITIES
10-1690	10" x 6½" x ¾"	1, 6 or 12/box
10-1691	13⅛" x 9⅜" x ¾"	1, 6 or 12/box
10-1692	15⅞" x 10⅝" x ¾"	1, 6 or 12/box
10-1693	17" x 11⅝" x ¾"	1, 6 or 12/box
10-1694	19 ⅞" x 12⅝" x ¾"	1, 6 or 12/box
10-1695	21¼" x 16¼" x ⅞"	1, 6 or 12/box



**MAYO TRAYS (PERFORATED)\***

PRODUCT NUMBER	DESCRIPTION	QUANTITIES
10-1684	10" x 6½" x ¾"	1, 6 or 12/box
10-1685	13¾" x 9¾" x ¾"	1, 6 or 12/box
10-1686	15⅞" x 10⅝" x ¾"	1, 6 or 12/box
10-1687	17" x 11⅝" x ¾"	1, 6 or 12/box
10-1688	19⅞" x 12⅝" x ¾"	1, 6 or 12/box
10-1689	21¼" x 16¼" x ⅞"	1 or 6/box



**CATHETER INSTRUMENT TRAYS\***

PRODUCT NUMBER	DESCRIPTION	COVERS	QUANTITIES
10-1955	8¾" x 3¼" x 1½"	10-1956 - Dome	1, 6 or 12/box
10-1738	8⅞" x 5" x 2"	10-1722 - Dome	1, 6 or 12/box
10-1760	8⅞" x 5" x 3"	10-1722 - Dome	1, 6 or 12/box
10-1886	17¼" x 4½" x 2"	10-1887 - Flat	1, 6 or 12/box



### MESH CLEANING BASKET\*

PRODUCT NUMBER	DESCRIPTION	QUANTITIES
10-1729	4¼" x 7¼" x 2"	1 Each
10-1731	6" x 9" x 3"	1 Each
10-1732	8½" x 12½" x 3½"	1 Each
10-1733	9½" x 16" x 4"	1 Each
10-1734	12" x 21" x 5"	1 Each
10-1736	14" x 20" x 5"	1 or 12/box



### PERFORATED CLEANING BASKET

PRODUCT NUMBER	DESCRIPTION	QUANTITIES
10-1560	12¾" x 10¾" x 6"	1 Each



### INSTRUMENT DRYING TRAYS\*

PRODUCT NUMBER	DESCRIPTION	QUANTITIES
10-1876	10" x 6½" x ¾"	1, 6 or 12/box
10-1883	13 <sup>1</sup> / <sub>16</sub> " x 9 <sup>13</sup> / <sub>16</sub> " x ¾"	1, 6 or 12/box
10-1884	15½" x 10½" x ¾"	1, 6 or 12/box
10-1683	17" x 11½" x ¾"	1, 6 or 12/box
10-1888	19½" x 12½" x ¾"	1, 6 or 12/box
10-1680	21¼" x 16¼" x 7/8"	1, 6 or 12/box



### INSTRUMENT TRAYS, PERFORATED BOTTOM

PRODUCT NUMBER	DESCRIPTION	QUANTITIES
10-1740	8 <sup>7</sup> / <sub>8</sub> " x 5" x 2"	1 Each
10-1874	10" x 6 <sup>1</sup> / <sub>2</sub> " x 2"	1 Each
10-1892	12" x 7 <sup>3</sup> / <sub>4</sub> " x 2"	1 Each
10-1879	12" x 7 <sup>3</sup> / <sub>4</sub> " x 2 <sup>1</sup> / <sub>2</sub> "	1 Each
10-1758	12 <sup>3</sup> / <sub>4</sub> " x 10 <sup>1</sup> / <sub>2</sub> " x 2 <sup>1</sup> / <sub>2</sub> "	1 Each
10-1862	12 <sup>3</sup> / <sub>4</sub> " x 10 <sup>1</sup> / <sub>2</sub> " x 4"	1 Each
10-1894	16 <sup>1</sup> / <sub>2</sub> " x 10" x 2 <sup>1</sup> / <sub>2</sub> "	1 Each
10-1895	20 <sup>3</sup> / <sub>4</sub> " x 12 <sup>3</sup> / <sub>4</sub> " x 2 <sup>1</sup> / <sub>2</sub> "	1 Each

### INSTRUMENT TRAYS , PERFORATED BOTTOM / SIDES\*

PRODUCT NUMBER	DESCRIPTION	QUANTITIES
10-1757	12 <sup>3</sup> / <sub>4</sub> " x 10 <sup>1</sup> / <sub>2</sub> " x 1 <sup>1</sup> / <sub>4</sub> "	1 Each
10-1697	12 <sup>3</sup> / <sub>4</sub> " x 10 <sup>1</sup> / <sub>2</sub> " x 2 <sup>1</sup> / <sub>2</sub> "	1 Each
10-1943	12 <sup>3</sup> / <sub>4</sub> " x 10 <sup>1</sup> / <sub>2</sub> " x 4"	1 Each
10-1944	12 <sup>3</sup> / <sub>4</sub> " x 10 <sup>1</sup> / <sub>2</sub> " x 6"	1 Each
10-1941	20 <sup>3</sup> / <sub>4</sub> " x 12 <sup>3</sup> / <sub>4</sub> " x 1 <sup>1</sup> / <sub>4</sub> "	1 Each
10-1759	20 <sup>3</sup> / <sub>4</sub> " x 12 <sup>3</sup> / <sub>4</sub> " x 2 <sup>1</sup> / <sub>2</sub> "	1 Each
10-1949	20 <sup>3</sup> / <sub>4</sub> " x 12 <sup>3</sup> / <sub>4</sub> " x 4"	1, 6 or 12/box
10-1942	20 <sup>3</sup> / <sub>4</sub> " x 12 <sup>3</sup> / <sub>4</sub> " x 6"	1 Each

### INSTRUMENT TRAYS, SOLID\*

PRODUCT NUMBER	DESCRIPTION	COVERS	QUANTITIES
10-1755	6 <sup>7</sup> / <sub>8</sub> " x 4 <sup>1</sup> / <sub>4</sub> " x 2"	10-1737	1, 6 or 12/box
10-1741	6 <sup>7</sup> / <sub>8</sub> " x 6 <sup>3</sup> / <sub>8</sub> " x 4" Heavyweight	10-1835	1 or 6/box
10-1764	10" x 6 <sup>1</sup> / <sub>2</sub> " x 2"	10-1766	1 Each
10-1742	10 <sup>3</sup> / <sub>8</sub> " x 6 <sup>3</sup> / <sub>8</sub> " x 2 <sup>1</sup> / <sub>2</sub> "	10-1542	1, 6 or 12/box
10-1877	12" x 7 <sup>3</sup> / <sub>4</sub> " x 2 <sup>1</sup> / <sub>4</sub> "	10-1878	1, 6 or 12/box
10-1744	12 <sup>3</sup> / <sub>4</sub> " x 6 <sup>7</sup> / <sub>8</sub> " x 2 <sup>1</sup> / <sub>2</sub> "	10-1724	1, 6 or 12/box
10-1746	12 <sup>3</sup> / <sub>4</sub> " x 10 <sup>1</sup> / <sub>2</sub> " x 2 <sup>1</sup> / <sub>2</sub> "	10-1882	1, 6 or 12/box
10-1950	12 <sup>3</sup> / <sub>4</sub> " x 10 <sup>1</sup> / <sub>2</sub> " x 2 <sup>1</sup> / <sub>2</sub> " Heavyweight	10-1882	1, 6 or 12/box
10-1747	12 <sup>3</sup> / <sub>4</sub> " x 10 <sup>1</sup> / <sub>2</sub> " x 4"	10-1882	1, 6 or 12/box
10-1952	12 <sup>3</sup> / <sub>4</sub> " x 10 <sup>1</sup> / <sub>2</sub> " x 4" Heavyweight	10-1882	1, 6 or 12/box
10-1870	12 <sup>3</sup> / <sub>4</sub> " x 10 <sup>1</sup> / <sub>2</sub> " x 6"	10-1882	1, 6 or 12/box
10-1753	13 <sup>7</sup> / <sub>8</sub> " x 12 <sup>7</sup> / <sub>8</sub> " x 2 <sup>1</sup> / <sub>2</sub> "	10-1754	1, 6 or 12/box
10-1748	16 <sup>1</sup> / <sub>2</sub> " x 10" x 2 <sup>1</sup> / <sub>2</sub> "	10-1756	1, 6 or 12/box
10-1749	16 <sup>1</sup> / <sub>2</sub> " x 10" x 4"	10-1756	1 Each
10-1953	20 <sup>3</sup> / <sub>4</sub> " x 12 <sup>3</sup> / <sub>4</sub> " x 2 <sup>1</sup> / <sub>2</sub> " Heavyweight	10-1535	1, 6 or 12/box
10-1954	20 <sup>3</sup> / <sub>4</sub> " x 12 <sup>3</sup> / <sub>4</sub> " x 4" Heavyweight	10-1535	1, 6 or 12/box
10-1948	20 <sup>3</sup> / <sub>4</sub> " x 12 <sup>3</sup> / <sub>4</sub> " x 6"	10-1535	1, 6 or 12/box



\*All products are packaged individually. Instrument trays and covers are sold separately unless otherwise noted. Select products are available in bulk. To order larger quantities, simply add the package quantity to the end of the product number when ordering, ie. 10-1670-12 for 12/pk or 10-1670-48 for 48/pk.

### STERILIZATION TRAY / BATH SETS

PRODUCT NUMBER	DESCRIPTION	QUANTITIES
10-1947	Large Set Includes:	
	Solid Tray 10-1948 20¾" x 12¾" x 6"	1
	Perforated Tray 10-1949 20¾" x 12¾" x 4"	1
	Cover 10-1535 20¾" x 12¾"	1
10-1679	Small Set Includes:	
	Solid Tray 10-1747 12¾" x 10½" x 4"	1
	Perforated Tray 10-1697 12¾" x 10½" x 2½"	1
	Cover 10-1882 12¾" x 10½"	1



### STERILIZATION TRAYS\*

PRODUCT NUMBER	DESCRIPTION	COVERS	QUANTITIES
10-1850	4 qt., 12¾" x 10½" x 2½"	10-1864	1 Each
10-1860	7 qt., 12¾" x 10½" x 4"	10-1864	1 Each
10-1750	5 ¼ qt., 20¾" x 6¾" x 4"	10-1854	1, 6 or 12/box
10-1752	9 qt., 20¾" x 6¾" x 6"	10-1854	1, 6 or 12/box
10-1953	8 ½ qt., 20¾" x 12¾" x 2½", Heavyweight	10-1535	1, 6 or 12/box
10-1954	14 ½ qt., 20¾" x 12¾" x 4", Heavyweight	10-1535	1, 6 or 12/box
10-1948	24 qt., 20¾" x 12¾" x 6"	10-1535	1, 6 or 12/box



### PERFORATED STERILIZATION TRAYS

PRODUCT NUMBER	DESCRIPTION	QUANTITIES
10-1710	10" x 6½" x 2½"	1 Each
10-1713	10" x 10½" x 3½"	1 Each
10-1714	15" x 10½" x 3½"	1 Each
10-1720	20" x 10½" x 3½"	1 Each
10-1957	20¾" x 12¾" x 4" Mesh bottom	1 Each



\*All products are packaged individually. Instrument trays and covers are sold separately unless otherwise noted. Select products are available in bulk. To order larger quantities, simply add the package quantity to the end of the product number when ordering, ie. 10-1670-12 for 12/pk or 10-1670-48 for 48/pk.



**LIFTING HANDLES**

PRODUCT NUMBER	DESCRIPTION	QUANTITIES
10-1725	For Sterilization Trays	1 Pair



**FLASH STERILIZATION TRAY**

PRODUCT NUMBER	DESCRIPTION	QUANTITIES
10-1711	10" x 6½" x 2"	1 Each
10-1712	Single Handle for Flash Sterilization Tray 10-1711	1 Each



**DOUBLE DECKER MICRO TRAY**

PRODUCT NUMBER	DESCRIPTION	QUANTITIES
10-1717	10" x 15" x 2¼"	1 Each

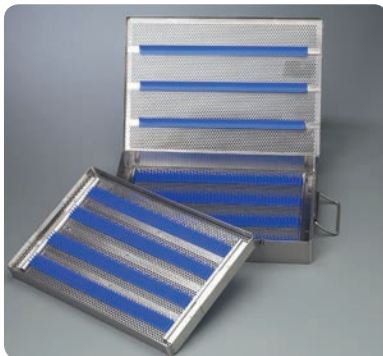

**MICRO TRAY WITH HINGED LID**

PRODUCT NUMBER	DESCRIPTION	Quantities
10-1706	8½" x 8" x 1⅛" with 2½" x 2½" Compartment	1 Each
10-1707	8½" x 12" x 1⅛"	1 Each
10-1708	8½" x 14" x 1⅛"	1 Each
10-1702	10½" x 10" x 1⅛"	1 Each
10-1716	10½" x 20" x 2½" with 10½" x 5" Compartment	1 Each

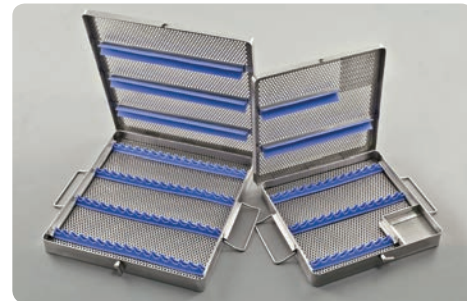

PRODUCT NUMBER	DESCRIPTION	QUANTITIES
10-1700	8½" x 8" x 1¼"	1 Each
10-1703	10½" x 15" x 1¼"	1 Each



**MICRO TRAY WITH HINGED LID** (Not pictured)

PRODUCT NUMBER	DESCRIPTION	QUANTITIES
10-1701	10" x 6½" x ⅞"	1 Each

**STERILIZATION BOX** (Not pictured)

PRODUCT NUMBER	DESCRIPTION	QUANTITIES
10-1705	6¾" x 3¾" x 1¾"	1 Each



### WEINSTEIN INSTRUMENT STRINGERS

PRODUCT NUMBER	DESCRIPTION	QUANTITIES
10-1800	5½" x 3¼"	1 Each
10-1805	11¼" x 3¼"	1 Each

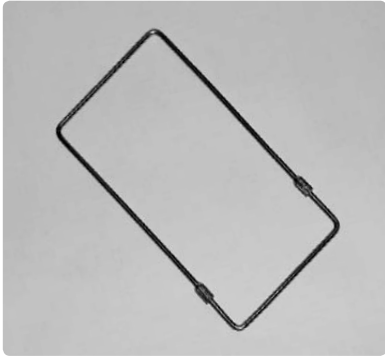

### INSTRUMENT STRINGERS

PRODUCT NUMBER	DESCRIPTION	QUANTITIES
10-1340	2½" x 6"	1 Each
10-1342	2½" x 8"	1 Each
10-1344	2½" x 10"	1 Each
10-1346	2½" x 12"	1 Each
10-1347	2½" x 14"	1 Each
10-1348	2½" x 16"	1 Each
10-1349	2½" x 18"	1 Each



### E-Z LOCK INSTRUMENT STRINGERS

PRODUCT NUMBER	DESCRIPTION	QUANTITIES
10-1806	2½" x 6"	1 Each
10-1808	2½" x 8"	1 Each
10-1810	2½" x 10"	1 Each
10-1812	2½" x 12"	1 Each
10-1814	2½" x 14"	1 Each
10-1816	2½" x 16"	1 Each
10-1818	2½" x 18"	1 Each
10-1826	5" x 6"	1 Each
10-1828	5" x 8"	1 Each
10-1830	5" x 10"	1 Each
10-1832	5" x 12"	1 Each
10-1834	5" x 14"	1 Each
10-1836	5" x 16"	1 Each
10-1838	5" x 18"	1 Each



**Instrument Stringers**
**WEISENBACH INSTRUMENT HOLDER**

PRODUCT NUMBER	DESCRIPTION	QUANTITIES
10-1775	6"	1 Each
10-1776	12"	1 Each

**WORCESTER INSTRUMENT HOLDER**

PRODUCT NUMBER	DESCRIPTION	QUANTITIES
10-1839	13" x 3"	1 Each

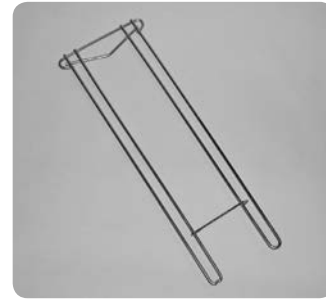
**BUNT INSTRUMENT STRINGER**

PRODUCT NUMBER	DESCRIPTION	QUANTITIES
10-1770		1 Each

**SAUNDERS INSTRUMENT RACK**

PRODUCT NUMBER	DESCRIPTION	QUANTITIES
10-1780		1 Each

**MAYO INSTRUMENT HOLDER**

PRODUCT NUMBER	DESCRIPTION	QUANTITIES
10-1772		1 Each

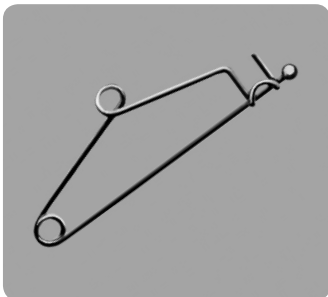
**POSILOCK INSTRUMENT RACK**

PRODUCT NUMBER	DESCRIPTION	QUANTITIES
10-1763		1 Each



## SKLARLITE™

### Sterilization Container System

#### HALF SIZE

NON-PERFORATED BOTTOM	PERFORATED BOTTOM	MODEL	FEATURES
10-4500	10-4512	Standard	11¼" x 11" x 4"
10-4548	10-4560	Standard	11¼" x 11" x 5"
10-4596	10-4608	Standard	11¼" x 11" x 6"
10-4644	10-4656	Standard	11¼" x 11" x 8"
10-4692	10-4704	Standard	11¼" x 11" x 10"
10-4524	10-4536	Safe	11¼" x 11" x 4"
10-4572	10-4584	Safe	11¼" x 11" x 5"
10-4620	10-4632	Safe	11¼" x 11" x 6"
10-4668	10-4680	Safe	11¼" x 11" x 8"
10-4716	10-4728	Safe	11¼" x 11" x 10"

#### MID SIZE

NON-PERFORATED BOTTOM	PERFORATED BOTTOM	MODEL	FEATURES
10-4300	10-4312	Standard	18¼" x 11" x 4"
10-4348	10-4360	Standard	18¼" x 11" x 5"
10-4394	10-4406	Standard	18¼" x 11" x 6"
10-4324	10-4336	Safe	18¼" x 11" x 4"
10-4370	10-4382	Safe	18¼" x 11" x 5"
10-4418	10-4430	Safe	18¼" x 11" x 6"

#### FULL SIZE

NON-PERFORATED BOTTOM	PERFORATED BOTTOM	MODEL	FEATURES
10-4000	10-4012	Standard	23" x 11" x 4"
10-4048	10-4060	Standard	23" x 11" x 5"
10-4096	10-4108	Standard	23" x 11" x 6"
10-4144	10-4156	Standard	23" x 11" x 8"
10-4192	10-4204	Standard	23" x 11" x 10"
10-4024	10-4036	Safe	23" x 11" x 4"
10-4072	10-4084	Safe	23" x 11" x 5"
10-4120	10-4132	Safe	23" x 11" x 6"
10-4168	10-4180	Safe	23" x 11" x 8"
10-4216	10-4228	Safe	23" x 11" x 10"

Containers and accessories for the SklarLite™ Sterilization Container System are available in a variety of sizes and colors. Contact your Sklar Account Manager for information on the complete product line.

## SKLARLITE™ Sterilization Container System

The SklarLite™ Rigid Sterilization Container System is a reusable rigid container made from anodized aluminum alloy, designed to be strong and durable yet lightweight and easy to handle.

- Stackable Containers
- Stackable Baskets
- 6 Month Shelf Life
- Load Limit 25lbs.



#### TWO MODELS TO CHOOSE FROM:

##### STANDARD

Consists of a body and perforated lid and used with Sklar's disposable filters and other compatible accessories for sterilization. Choose from either perforated or non-perforated bottoms.

##### SAFE

Consists of identical body and lid, but features an additional solid cover that safeguards the perforation field and contents during transportation and storage.

# SKLARLITE™

## Sterilization Container System

The SklarLite™ Rigid Sterilization Container System provides instruments an organized, routine and secure approach to the sterilization of surgical instruments. Customize your SklarLite™ System by selecting colored perforated container lids, solid safety lids and ID labels. Available in your choice of six vibrant colors for easy identification of instrument sets by procedure and/or department. Choose from Silver, Yellow, Green, Blue, Black and Red.

### BASKETS

SklarLite™ features stackable inner baskets to optimize internal space while silicone mats securely protect delicate and laparoscopic instruments during sterilization, transport and storage.

PRODUCT NUMBER	MODEL	FEATURES
10-4784	Half Size	10" x 9½" x 1"
10-4786	Half Size	10" x 9½" x 2"
10-4788	Half Size	10" x 9½" x 3"
10-4790	Half Size	10" x 9½" x 4"
10-4478	Mid Size	16" x 10" x 1"
10-4480	Mid Size	16" x 10" x 2"
10-4482	Mid Size	16" x 10" x 3"
10-4484	Mid Size	16" x 10" x 4"
10-4284	Full Size	21¼" x 10" x 1"
10-4286	Full Size	21¼" x 10" x 2"
10-4288	Full Size	21¼" x 10" x 3"
10-4290	Full Size	21¼" x 10" x 4"

### SILICONE MATS

PRODUCT NUMBER	MODEL	FEATURES
10-4970	Half Size	8½" x 9"
10-4975	Mid Size	15" x 9"
10-4985	Full Size	20½" x 9"

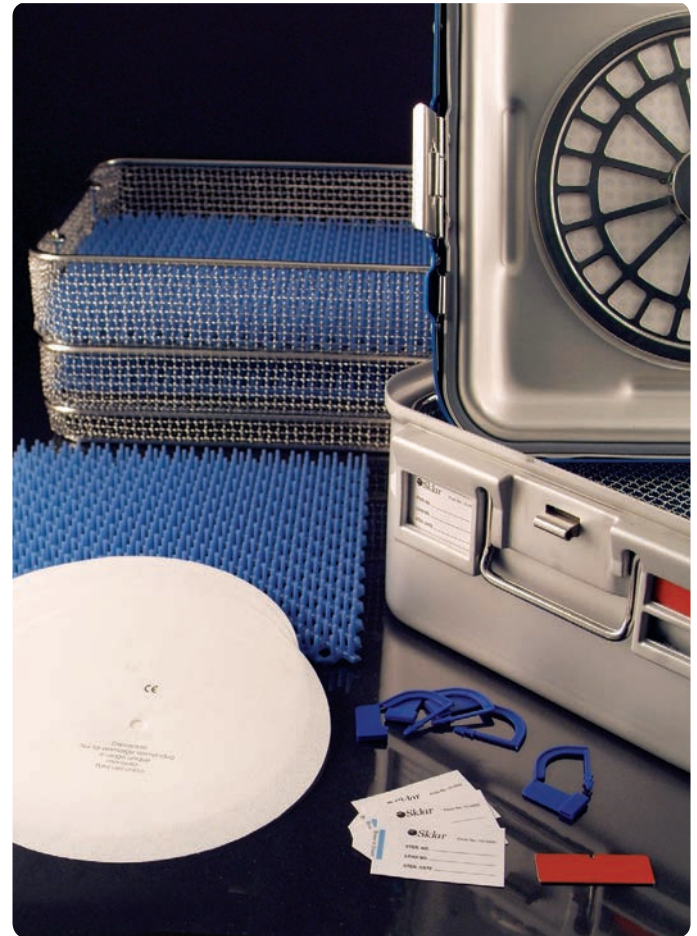

### ACCESSORIES

PRODUCT NUMBER	MODEL	FEATURES
10-4900	Process Indicator Cards	Steam, 250/box
10-4910	Filters	Disposable, 100/pack
10-4925	Security Seals	100/pack
10-4930	ID Labels	Silver
10-4930ENG	ID Labels	Silver Custom Engraved, Maximum 16 Characters



**MEDICINE CUPS**

STERILE

PRODUCT NUMBER	FEATURES	QUANTITIES
96-7027	2 oz.	25/cs

**PITCHERS\***

STERILE

PRODUCT NUMBER	FEATURES	QUANTITIES
96-7268	Open Handle, 1200ml	5/cs

NON-STERILE

96-7270	Open Handle, 1200ml	35/cs
---------	---------------------	-------



NON-STERILE

PRODUCT NUMBER	FEATURES	QUANTITIES
10-1546	Graduated Measure, 16 oz., Reusable	1 or 6/cs

**SPECIMEN TUBES**

STERILE

PRODUCT NUMBER	FEATURES	QUANTITIES
96-7459	3½" x ½"	3/pk, 50pk/cs, 150/cs

**PLASTIC BOWLS**

STERILE

PRODUCT NUMBER	FEATURES	QUANTITIES
96-7028	8 oz.	25/cs
96-7020	16 oz.	10/cs
96-7174	32 oz.	20/cs
96-7451	48 oz.	5/cs



\*Select products are available individually or in bulk packaging. To order large quantities, simply add the package quantity to the end of the product number when ordering, ie. 10-1670-12 for 12/pk or 10-1670-48 for 48/pk.

**EMESIS BASINS**

STERILE

PRODUCT NUMBER	FEATURES	QUANTITIES
96-7543	700cc	25/cs



**OR BASINS**

STERILE

PRODUCT NUMBER	FEATURES	QUANTITIES
96-1679	Round, 7 qt., Blue	5/cs

NON-STERILE

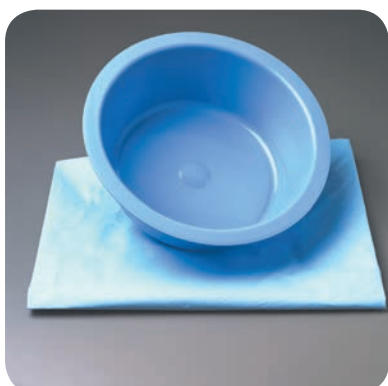
08-1011	Round, 5 qt., Pink	50/cs
---------	--------------------	-------



\*Select products are available individually or in bulk packaging. To order large quantities, simply add the package quantity to the end of the product number when ordering, ie. 10-1670-12 for 12/pk or 10-1670-48 for 48/pk.

**GUIDEWIRE BOWLS**

STERILE

PRODUCT NUMBER	FEATURES	QUANTITIES
96-1630	8¼" x 3"	10/cs

**UTILITY BOWLS\***

NON-STERILE

PRODUCT NUMBER	FEATURES	QUANTITIES
10-1502	Sponge/Utility Bowl, Aqua, 1¼ qt.	1 or 12/cs



NON-STERILE

PRODUCT NUMBER	FEATURES	QUANTITIES
10-1504	Solution Bowl, Reusable, Lt Green, 7 qt.	1 or 12/cs



### PLASTIC TRAYS

#### STERILE

PRODUCT NUMBER	FEATURES	QUANTITIES
96-7025	Small Shallow Prep	25/cs
96-7033	Half Shallow	25/cs
96-7024	Half Deep	25/cs
96-7175	Full Deep	25/cs
96-7177	2-Compartment	25/cs
96-7178	3-Compartment	25/cs



### PROCEDURE TRAYS\*

#### NON-STERILE

PRODUCT NUMBER	FEATURES	QUANTITIES
10-1960	Mini, Non-Perforated, Blue, 10 <sup>1</sup> / <sub>8</sub> " x 6 <sup>5</sup> / <sub>8</sub> "	1 Each
10-1965	Mini, Perforated, Blue, 10 <sup>1</sup> / <sub>8</sub> " x 6 <sup>5</sup> / <sub>8</sub> "	1, 6 or 12/cs
10-1961	Small, Non-Perforated, Blue, 10 <sup>7</sup> / <sub>16</sub> " x 13 <sup>9</sup> / <sub>16</sub> "	1 Each
10-1966	Small, Perforated, Blue, 10 <sup>7</sup> / <sub>16</sub> " x 13 <sup>9</sup> / <sub>16</sub> "	1, 6 or 12/cs
10-1962	Medium, Non-Perforated, Blue, 11 <sup>3</sup> / <sub>4</sub> " x 16"	1 Each
10-1967	Medium, Perforated, Blue, 11 <sup>3</sup> / <sub>4</sub> " x 16"	1, 6 or 12/cs
10-1964	Large, Heavy Duty, Non-Perforated, Blue, 15" x 20"	1 Each



### SOAKING TRAYS WITH REMOVABLE BASKET

#### NON-STERILE

PRODUCT NUMBER	FEATURES	QUANTITIES
10-2555	Small Instrument Tray, 8" x 3 <sup>1</sup> / <sub>2</sub> " x 2"	1 Each
10-2556	Large Instrument Tray, 10" x 5" x 2 <sup>1</sup> / <sub>2</sub> "	1 Each
10-2557 (not pictured)	Round Cup Size Tray, 3" x 3", 4 oz.	1 Each



\*Select products are available individually or in bulk packaging. To order large quantities, simply add the package quantity to the end of the product number when ordering, ie. 10-1670-12 for 12/pk or 10-1670-48 for 48/pk.



## SklarTip™ Instrument Protectors

Sklar Instrument Protectors provide a convenient, color-coded means of protecting surgical instrument tips and edges. Autoclavable, steam and gas permeable, and available in a wide variety of shapes and sizes, SklarTip™ Instrument Protectors provide exceptional protection during handling and sterilization. Latex Free.



### INSTRUMENT PROTECTORS - NON-VENTED

PRODUCT NUMBER	FEATURES	QUANTITIES
96-1510	19 x 1.5mm, 3/4" x 1/16"	White 100/pk
96-1508	19 x 2.0mm, 3/4" x 5/64"	Blue 100/pk
96-1506	19 x 3.0mm, 3/4" x 1/8"	Green 100/pk
96-1504	25 x 3.0mm, 1" x 1/8"	Red 100/pk
96-1502	25 x 5.0mm, 1" x 3/16"	Yellow 100/pk
96-1500	19 x 1.0mm, 3/4" x 3/64"	Maroon 100/pk
96-1516	25 x 1.5mm, 1" x 3/8" x 1/16"	Orange 100/pk
96-1514	25 x 2.0mm, 1" x 5/8" x 5/64"	Brown 100/pk
96-1512	25 x 3.0mm, 1" x 1" x 1/8"	Black 100/pk
96-1518	Assorted	100/pk

### INSTRUMENT PROTECTORS - VENTED

PRODUCT NUMBER	FEATURES	QUANTITIES
96-1410	19 x 1.5mm, 3/4" x 1/16"	White 100/pk
96-1408	19 x 2.0mm, 3/4" x 5/64"	Blue 100/pk
96-1406	19 x 3.0mm, 3/4" x 1/8"	Green 100/pk
96-1404	25 x 3.0mm, 1" x 1/8"	Red 100/pk
96-1402	25 x 5.0mm, 1" x 3/16"	Yellow 100/pk
96-1400	19 x 1.0mm, 3/4" x 3/64"	Maroon 100/pk
96-1416	25 x 1.5mm, 1" x 3/8" x 1/16"	Orange 100/pk
96-1414	25 x 2.0mm, 1" x 5/8" x 5/64"	Brown 100/pk
96-1412	25 x 3.0mm, 1" x 1" x 1/8"	Black 100/pk
96-1418	Assorted	100/pk

### OSTEOTOME GUARDS - VENTED

PRODUCT NUMBER	FEATURES	QUANTITIES
96-1440	3/4" x 1/4"	50/pk
96-1442	1" x 3/8"	50/pk
96-1444	1" x 1/2"	50/pk
96-1446	1 1/2" x 1 1/2"	50/pk

### TIP GRIPS

PRODUCT NUMBER	FEATURES	QUANTITIES
96-1550	.062" Yellow	3pr/pk, 5pks
96-1552	.062" Yellow	5pr/pk, 5pks





Instrument recognition is key to efficient processing in a busy clinical setting. SklarTip™ Instrument ID products offer a convenient color coded system for identifying instruments. Offered in various combinations including tape sheets, tape rolls and tags, products last through many autoclaving and gas sterilization processes. Latex Free.

**ID SHEET TAPE**

PRODUCT NUMBER	FEATURES	QUANTITIES
96-1845	Blue with White Stripes	1 Each
96-1846	Green with White Stripes	1 Each
96-1847	Red with White Stripes	1 Each
96-1848	Yellow with White Stripes	1 Each
96-1849	Orange with White Stripes	1 Each
96-1850	Brown with White Stripes	1 Each
96-1851	Lavender with White Stripes	1 Each
96-1852	Light Blue with White Stripes	1 Each
96-1853	Pink with White Stripes	1 Each

**ID ROLL TAPE**

PRODUCT NUMBER	FEATURES	QUANTITIES
96-1860	White 300" x 1/4"	1 Each
96-1862	Green 300" x 1/4"	1 Each
96-1864	Yellow 300" x 1/4"	1 Each
96-1866	Orange 300" x 1/4"	1 Each
96-1868	Black 300" x 1/4"	1 Each
96-1870	Purple 300" x 1/4"	1 Each
96-1872	Blue 300" x 1/4"	1 Each
96-1874	Red 300" x 1/4"	1 Each
96-1876	Brown 300" x 1/4"	1 Each

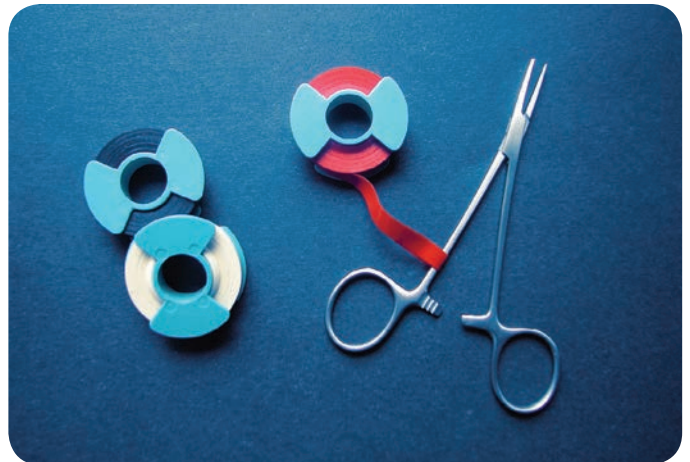
**INSTRUMENT ID TAGS**

PRODUCT NUMBER	FEATURES	QUANTITIES
96-1900	ID Repair Tags, Red	100/pk
96-1901	ID Repair Tags, Red	1000/pk
96-1903	Sklar Tags, White	100/pk
96-1905	ID Tags for Sharpen, Blue	100/pk
96-1906	ID Tags for Sharpen, Blue	1000/pk



**CANNULA CLEANING BRUSHES**

PRODUCT NUMBER	FEATURES	QUANTITIES
10-1350	12" 2mm Diameter	3/pk
10-1660	12" 3mm Diameter	3/pk
10-1661	12" 3mm Diameter	12/pk
10-1663	12" 3mm Diameter	24/pk
10-1352	12" 4mm Diameter	3/pk
10-1354	12" 5mm Diameter	3/pk
10-1356	12" 6mm Diameter	3/pk
10-1664	15" 9mm Diameter	3/pk
10-1665	15" 9mm Diameter	12/pk
10-1666	15" 9mm Diameter	24/pk
10-1668	15" 25mm Diameter	3/pk
10-1669	15" 25mm Diameter	12/pk
10-1672	15" 25mm Diameter	24/pk
10-1362	18" 5mm Diameter	3/pk
10-1364	18" 10mm Diameter	3/pk
10-1366	18" 15mm Diameter	3/pk
78-2824	19" 8mm Diameter	3/pk
10-1370	24" 2.5mm Diameter	3/pk
10-1372	24" 5mm Diameter	3/pk
10-1374	24" 7mm Diameter	3/pk
10-1376	24" 10mm Diameter	3/pk



**TRACHEAL TUBE BRUSHES**

PRODUCT NUMBER	FEATURES	QUANTITIES
78-2821	Small, 6" x 1/2" Diameter	6/pk
78-2822	Medium, 7" x 5/8" Diameter	6/pk



**INSTRUMENT CLEANING BRUSHES (STAINLESS BRISTLES)**

PRODUCT NUMBER	FEATURES	QUANTITIES
10-1650	Stainless Steel Bristles	3/pk
10-1652	Stainless Steel Bristles	12/pk
10-1658	Stainless Steel Bristles	24/pk



**INSTRUMENT CLEANING BRUSHES (NYLON BRISTLES)**

PRODUCT NUMBER	FEATURES	QUANTITIES
10-1651	Nylon Bristles	3/pk
10-1657	Nylon Bristles	12/pk
10-1659	Nylon Bristles	24/pk
10-1465	Nylon Bristles, Disposable	12/pk
10-1468	Nylon Bristles, Disposable	24/pk



**INSTRUMENT CLEANING BRUSHES (DOUBLE ENDED)**

PRODUCT NUMBER	FEATURES	QUANTITIES
10-1444	Nylon Bristles	3/pk



**INSTRUMENT CLEANING BRUSHES (DOUBLE TAPERED)**

PRODUCT NUMBER	FEATURES	QUANTITIES
10-1384	6", Double Tapered Brush	3/pk
10-1388	8", Double Tapered Brush	3/pk



**SUCTION TUBE CLEANING BRUSHES  
(BARON & FRAZIER)**

PRODUCT NUMBER	FEATURES	QUANTITIES
10-1396	6" 1.6mm	3/pk
10-1400	8" 2mm	3/pk
10-1401	8" 2.3mm	3/pk
10-1402	8" 2.6mm	3/pk
10-1403	8" 3mm	3/pk
10-1404	8" 3.3mm	3/pk
10-1405	8" 3.6mm	3/pk
10-1406	8" 4mm	3/pk

**SURGICAL SCRUB BRUSHES**

PRODUCT NUMBER	FEATURES	QUANTITIES
06-2880	With Channel Back	1 Each
06-2870	With Channel Back	12/pk
06-2882	With Nail Scrubber	1 Each
06-2873	With Nail Scrubber	12/pk
06-2881	Standard	1 Each
06-2872	Standard	12/pk

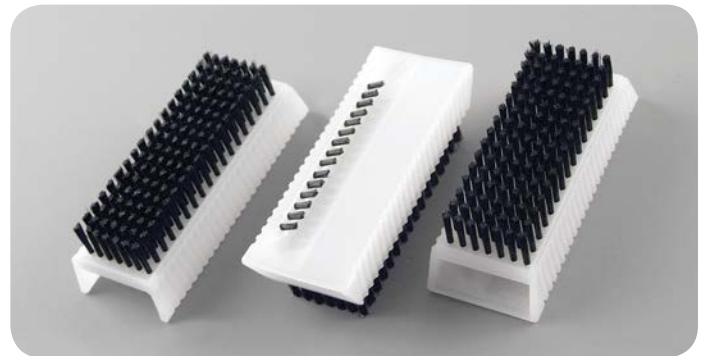
**CANNULA INSTRUMENT (PIPE) CLEANERS**

PRODUCT NUMBER	FEATURES	QUANTITIES
10-1470	12" Length 1/8" Diameter	3/pk
10-1472	12" Length 1/4" Diameter	3/pk

**DOUBLE END VALVE BRUSHES**

PRODUCT NUMBER	FEATURES	QUANTITIES
10-1398	5 3/4" Length 9mm and 5mm Diameter Nylon Tips	3/pk



**SURFACE CLEANING BRUSH**

FOR USE ON SINKS, AUTOCLAVES, ULTRASONIC CLEANERS, BOWLS, BASINS, ETC.

PRODUCT NUMBER	FEATURES	QUANTITIES
10-1418	3 1/4" L x 3" W Brush Head 4 1/2" Plastic handle 2" White medical grade Nylon bristles	3/pk



**LARGE INSTRUMENT CLEANING BRUSH**

FOR USE ON RETRACTORS, SPECULA, ETC.

PRODUCT NUMBER	FEATURES	QUANTITIES
10-1420	5" L x 1" W Brush Head 5" Plastic handle 1" White medical grade Nylon bristles	3/pk



**AUTOCLAVE CLEANING BRUSH**

FOR USE ON AUTOCLAVE CHAMBERS AND DOORS, SINKS, CARTS, ETC.

PRODUCT NUMBER	FEATURES	QUANTITIES
10-1422	3 1/4" L x 3" W Brush Head 16" Plastic handle 2" White medical grade Nylon bristles	3/pk



**INSTRUMENT SPOT REMOVER PAD**

FOR USE ON O.R. GRADE SATIN FINISH INSTRUMENTS

PRODUCT NUMBER	FEATURES	QUANTITIES
10-1414	6" x 9"	1 Each
10-1415	6" x 9"	10/pk

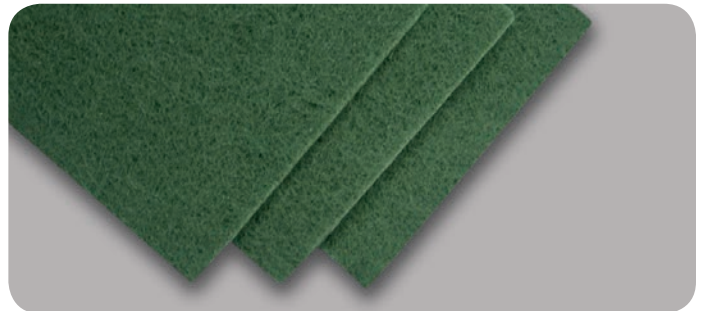

**BRUSH DRYING RACK & BRUSH HOLDER**

PRODUCT NUMBER	FEATURES	QUANTITIES
10-1399	Brush Rack	1 Each
10-1545	Brush Holder	1 Each

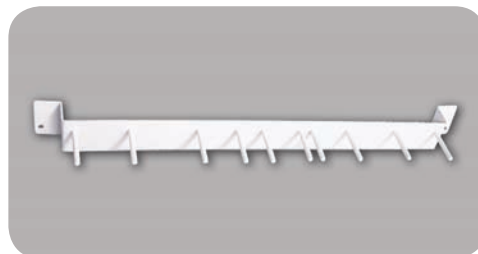

**10-1426 INSTRUMENT CLEANING BRUSH SET**

PRODUCT NUMBER	DESCRIPTION	QUANTITIES
10-1660	Cannula Cleaning Brush 12" 3mm, 3/pk	1 pk
10-1362	Cannula Cleaning Brush 18" 5mm, 3/pk	1 pk
10-1374	Cannula Cleaning Brush 24" 7mm, 3/pk	1 pk
10-1376	Cannula Cleaning Brush 24" 10mm, 3/pk	1 pk
10-1396	Suction Tube Brush 6" 1.6mm, 3/pk	1 pk
10-1400	Suction Tube Brush 8" 2mm, 3/pk	1 pk
10-1402	Suction Tube Brush 8" 2.6mm, 3/pk	1 pk
10-1404	Suction Tube Brush 8" 3.3mm, 3/pk	1 pk
10-1406	Suction Tube Brush 8" 4mm, 3/pk	1 pk
10-1418	Surface Cleaning Brush, 3/pk	1 pk
10-1444	Double End Brush Nylon, 3/pk	2 pks
10-1650	Brush Stainless Steel Bristle, 3/pk	1 pk
10-1651	Brush Nylon Bristle, 3/pk	2 pks

**10-1428 ENDOSCOPIC BRUSH SET**

PRODUCT NUMBER	DESCRIPTION	QUANTITIES
10-1350	Cannula Cleaning Brush 12" 2mm, 3/pk	1 pk
10-1660	Cannula Cleaning Brush 12" 3mm, 3/pk	1 pk
10-1354	Cannula Cleaning Brush 12" 5mm, 3/pk	1 pk
10-1362	Cannula Cleaning Brush 18" 5mm, 3/pk	1 pk
10-1364	Cannula Cleaning Brush 18" 10mm, 3/pk	1 pk
10-1370	Cannula Cleaning Brush 24" 2.5mm, 3/pk	1 pk
10-1372	Cannula Cleaning Brush 24" 5mm, 3/pk	1 pk
10-1376	Cannula Cleaning Brush 24" 10mm, 3/pk	1 pk
10-1398	Double End Valve Brush Nylon, 3/pk	2 pks
10-1444	Double End Brush Nylon, 3/pk	2 pks

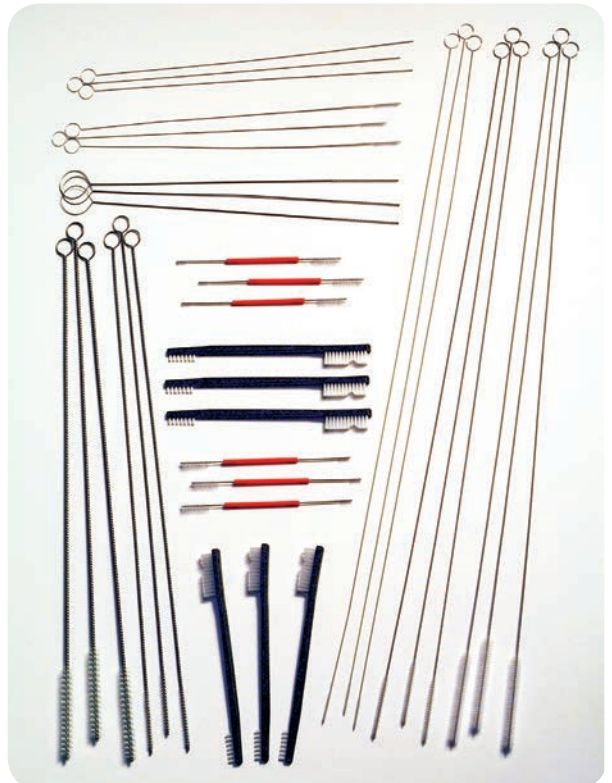

### 10-1424 AUTOCLAVE CLEANING BRUSH SET

PRODUCT NUMBER	DESCRIPTION	QUANTITIES
10-1424HDL	Telescopic Handle extends from 24" to 48"	1 Each
10-1424PBR	Large Cleaning Brush 7½" L x 5½" W with round corner bristles	1 Each
10-1424BHD	Surface Cleaning Brush, 4½" handle	1 Each



### 10-1432 MICRO-OPTHALMIC BRUSH SET

PRODUCT NUMBER	DESCRIPTION	QUANTITIES
10-1350	Cannula Cleaning Brush 12" 2mm, 3/pk	1 pk
10-1660	Cannula Cleaning Brush 12" 3mm, 3/pk	1 pk
10-1396	Suction Tube Brush 6" 1.6mm, 3/pk	1 pk
10-1400	Suction Tube Brush 8" 2mm, 3/pk	1 pk
10-1402	Suction Tube Brush 8" 2.6mm, 3/pk	1 pk
10-1404	Suction Tube Brush 8" 3.3mm, 3/pk	1 pk
10-1406	Suction Tube Brush 8" 4mm, 3/pk	1 pk
10-1444	Double End Brush Nylon, 3/pk	1 pk

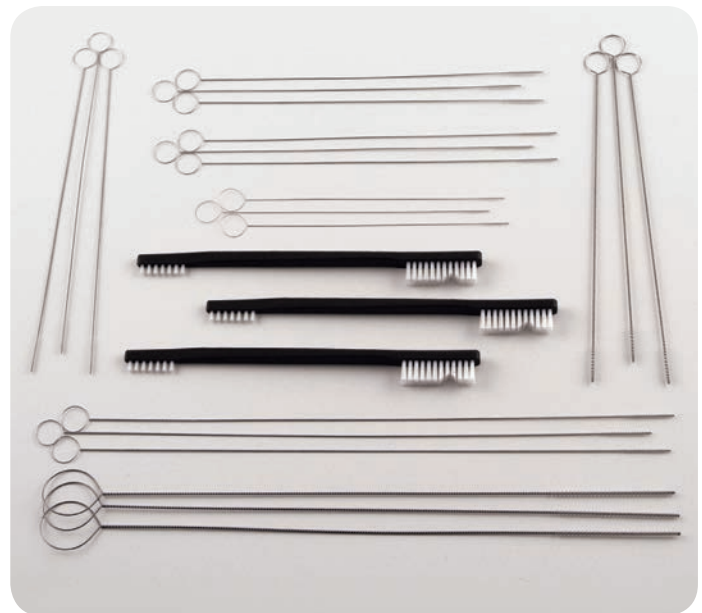

### 10-1434 ALL PURPOSE BRUSH SET

PRODUCT NUMBER	DESCRIPTION	QUANTITIES
10-1650	Brush Stainless Steel Bristle 3/pk	1 pk
10-1651	Brush Nylon Bristle 3/pk	1 pk
10-1420	Large Instrument Cleaning Brush 3/pk	1 pk
10-1418	Surface Cleaning Brush 3/pk	1 pk





# SKLAR-CIDE™

**SPORICIDAL • BACTERICIDAL  
VIRUCIDAL • FUNGICIDAL**

SKLAR-CIDE provides a safe and efficient means for the high-level disinfection or sterilization of medical, ophthalmic, dental and surgical devices including endoscopes and lensed instruments. It may be used as a standard soak solution or in automatic reprocessing units set at room temperature. Unlike other solutions, there is no need to increase the solution temperature to provide high-level disinfection in 25 minutes.

SKLAR-CIDE is a surfactant-free, activated glutaraldehyde liquid chemical sterilant and high-level disinfectant. Its active ingredient is glutaraldehyde in a nominal concentration of 3%. When the powdered activator is added, the solution turns green in color to indicate its readiness for use. In addition to the active ingredient, this ready-to-use solution contains buffers, wetting agents, and a rust and corrosion inhibitor and it has a pleasant fragrance.

SKLAR-CIDE produces high-level disinfection at room temperature in as little time as 25 minutes, and complete sterilization in 10 hours at room temperature.

- Reusable for 28 days instead of 14, safer and saves time and money.
- Surfactant free - Will not damage scope surfaces or cloud lenses.
- Can be used safely on all devices, including instruments and endoscopes. No need to stock several products.

PRODUCT NUMBER	FEATURES	QUANTITIES
10-1623	28 HLD 1 Gallon Bottles	4/case
10-1624	28 HLD 1 Gallon Bottle	1 bottle

## GLUTARALDEHYDE STRIPS

PRODUCT NUMBER	FEATURES	QUANTITIES
96-4105	2.1% MEC 60 Strips / Bottle	2 bottles/case



HIGH LEVEL DISINFECTING / STERILIZING SOLUTION

# SKLAR-CIDE™

**Sklar Instruments**  
**Sklar-Cide<sup>28</sup> HLD**  
Reusable Sterilizing and High Level Disinfecting Solution  
**3% Glutaraldehyde**  
ACTIVE INGREDIENTS: Glutaraldehyde 3.0%  
INERT INGREDIENTS: 97.0%  
TOTAL: 100.0%  
KEEP OUT OF REACH OF CHILDREN  
**DANGER**  
See side panel for additional precautionary statements  
Cat. No. 10-1623 Contents: 1 U.S. Gallon / 3.785  
Sklar Instruments • 888 S. Matlack Street • West Chester, PA 19382  
800.221.2166 • 610.430.3200 • 610.206.9007  
e-mail: surg@sklarcorp.com • international@sklarcorp.com  
www.sklarcorp.com • Made in the U.S.A.



# SKLAR DISINFECTANT™

READY-TO-USE SPRAY  
SURFACE DISINFECTANT

**2 Minute Kill Time!**

- Ready to use, non-toxic formula.
- Specially formulated for the control of cross contamination.
- Effective against a broad range of pathogens including H1N1, HIV-1, HPV, VRE, Norovirus, Hep B & C as well as TB, MRSA, A. Baumannii, and C. Diff in its vegetative form. Safe for all areas of the facility including the NICU, operating rooms, isolation rooms, patient care areas and laboratories.
- Satisfies OSHA's Bloodborne Pathogen Standards.
- Non-irritating formula.
- EPA registered.

PRODUCT NUMBER	FEATURES	QUANTITIES
10-1643	24 oz. Spray Bottles	6/case
10-1642	24 oz. Spray Bottle	1 bottle
10-1653	1 Gallon Bottles	4/case
10-1654	1 Gallon Bottle	1 bottle
10-1644	2.5 Gallon Bottles	2/case





# SKLAR DISINFECTANT™ SURFACE WIPES

**2 Minute Kill Time!**

**SAME EFFECTIVE FORMULA AS  
SKLAR DISINFECTANT!**

- Ready to use, non-toxic formula.
- Specially formulated for the control of cross contamination.
- Effective against a broad range of pathogens including H1N1, HIV-1, HPV, VRE, Norovirus, Hep B & C as well as TB, MRSA, A. Baumannii, and C. Diff in its vegetative form.
- Safe for all areas of the facility including the NICU, operating rooms, isolation rooms, patient care areas and laboratories.
- Satisfies OSHA's Bloodborne Pathogen Standards.
- Destroys odor-causing bacteria.
- 7" x 10" non-woven, tear resistant towelette.
- Clean scent.
- EPA registered.

PRODUCT NUMBER	FEATURES	QUANTITIES
10-1616	100 Towelettes / Canister	6/case
10-1617	100 Towelettes / Canister	12/case



**KILLS MRSA AND H1N1 VIRUS  
3 MINUTE KILL TIME!**

# SKLAR SPRAY-ZYME™

## MULTI-ENZYME BASED INSTRUMENT PRESOAK & CLEANER

### FOAM SPRAY CLEANER

The newest product from Sklar for expert care of your surgical instruments. This multi-enzymatic spray creates a heavy foam which lasts for hours, keeping soiled instruments moist to avoid encrustation while also pre-cleaning prior to processing.

- Prevents Organic Encrustation - enzyme foam stops blood and bodily fluids from drying onto surgical instruments.
- No More Spills - messy spills between the operating room and central cleaning /processing department are eliminated.
- Neutral pH - safe and effective for stainless steel, tungsten carbide, aluminum and brass instruments.
- Bacteriostatic - microbiological control agents inhibit bacterial growth in the ready-to-use foam solution.
- Long Lasting Foam - saves time, foam lasts many hours after application.
- Multi-Enzymatic - contains a synergistic blend of lipase and protease enzymes.

PRODUCT NUMBER	FEATURES	QUANTITIES
10-2722	22 oz. Refillable Spray Bottles	12/case
10-2724	1 Gallon Bottles	4/case

## SKLAR-ZYME™ POUCHES

### CONVENIENT VALUE

Each pouch of SKLAR-ZYME produces one gallon of enzymatic detergent. This convenient, easy to use product guarantees very little waste and is ideal for the office or smaller surgical setting.

PRODUCT NUMBER	FEATURES	QUANTITIES
10-2774	½ oz. Pouches	32/box





## SKLAR SOAK™

### INSTRUMENT PRE-SOAK & DECONTAMINANT

#### RUST RESISTANT!

Immersing soiled instruments in SKLAR SOAK effectively pre-cleans and decontaminates, without fear of rusting!

SKLAR SOAK is an effective pre-cleaner that breaks down bio-burden, lifting blood and other organic debris from the surface, while penetrating box locks and crevices. The rust inhibitor protects the delicate chromium oxide layer of the instrument, thus defending against rust and corrosion. Using SKLAR SOAK™ as a pre-cleaner is the first line of defense against rust, prolonging the life of the instrument and therefore protecting your investment!

Soaking for only two minutes thoroughly decontaminates instruments, reducing the risk of exposure to pathogens such as H1N1, HIV-1, HPV, VRE, Norovirus, Hep B & C as well as TB, MRSA, A. Baumannii, and C. Diff in its vegetative form. However, because SKLAR SOAK™ contains a rust inhibitor, instruments may soak for several hours without fear of rusting! Employees are protected from cross contamination, and at the same time can enjoy the freedom to reprocess instruments when it's convenient!

SKLAR SOAK is ideal for use on all stainless steel instruments:

- PH balanced, designed specifically for stainless steel instruments.
- Intermediate level disinfectant with broad spectrum of efficacy.
- Rust resistant.
- Non-caustic.
- Ready to use.
- No special handling or disposal.
- Fragrant, no offensive odors.
- Non-glutaraldehyde.

PRODUCT NUMBER	FEATURES	QUANTITIES
10-1603	1 Gallon Bottles	4/case
10-1609	1 Gallon Bottle	1 bottle

SURGICAL INSTRUMENT SOAK

## SKLAR SOAK™



# SKLAR INSTRU-GUARD™ ONE STEP

A “ONE STEP” INSTRUMENT  
CLEANER AND LUBRICANT

**EXTENDS INSTRUMENT LIFE!**

SKLAR INSTRU-GUARD ONE STEP contains a penetrating lubricant that protects and helps extend the life of surgical instruments. The detergents and emulsifiers quickly break up and remove organic soils from box locks and other hard to reach places.

SKLAR INSTRU-GUARD ONE STEP contains four rust inhibitors to control corrosion and eliminate scaling and spotting. It does not contain phosphates and can reduce the time and cost involved in processing your instruments by cleaning and lubricating in one easy step.

PRODUCT NUMBER	FEATURES	QUANTITIES
10-2800	1 Gallon Bottles	4/case
10-2801	1 Gallon Bottle	1 bottle





# SKLAR INSTRU-GUARD™ LUBE

## SURGICAL INSTRUMENT LUBRICANT / RUST INHIBITOR

- Increase the Life of Instruments.
- Protects all Surgical Instruments.

SKLAR INSTRU-GUARD LUBE is an easy-to-use, water soluble, lubricant and rust inhibitor. When used daily as a rinse after every cleaning it keeps moving parts operating smoothly and remains effective after autoclaving, but without leaving an oily residue.

Regular lubrication is essential no matter which cleaning method is employed (including ultrasonic). SKLAR INSTRU-GUARD LUBE is ideal for maintaining instrument quality and performance.

PRODUCT NUMBER	FEATURES	QUANTITIES
10-1635	1 Gallon Containers Concentrated	4/case
10-1634	1 Gallon Container Concentrated	1 container
10-1636	8 oz. Spray Bottles	12/case
10-1637	8 oz. Spray Bottle	1 bottle



## SKLAR KLEEN™

### REGULAR FORMULA FOR MANUAL AND ULTRASONIC CLEANING

SKLAR KLEEN is non-corrosive, non aggressive, phosphate free and biodegradable. We have specifically developed SKLAR KLEEN for manual and ultrasonic cleaning. It is moderately alkaline, affording optimum cleaning without etching glassware or attacking instrument metal.

### LOW FOAM FORMULA FOR AUTOMATIC CLEANING

The SKLAR KLEEN Low Foam Liquid is concentrated in order to provide a very cost-effective solution. It is especially formulated to maintain low foam, ensuring effective and trouble-free action in washer / sterilizers and tunnel washers. Dispersing quickly, the SKLAR KLEEN Low Foam formula is also well suited for automatic injection systems.

PRODUCT NUMBER	FEATURES	QUANTITIES
10-2701	Low Foam 1 Gallon Bottles	4/case
10-1608	Powdered 5 lb. Containers	4/case
10-1607	Powdered 5 lb. Container	1 container
10-1630	Powdered 3.5 lb. Pitchers	6/case
10-2765	Powdered 3.5 lb. Pitcher	1 pitcher
10-1612	Liquid 8 oz. Bottles	6/case
10-1614	Liquid 8 oz. Bottle	1 bottle
10-1613	Liquid 1 Gallon Bottles	4/case
10-1627	Liquid 1 Gallon Bottle	1 bottle



LOW FOAM, LIQUID DETERGENT AND POWDERED FORMULA

## SKLAR KLEEN™





# SKLAR ENZYMATIC™ DETERGENT

## 100% Biodegradable

SKLAR ENZYMATIC Detergent is a low-foaming, fast acting detergent specifically designed for use when instruments and/or cloth materials become soiled with organic debris.

SKLAR ENZYMATIC Detergent may be used as a manual instrument cleaner as well as a pre-soak for blood-contaminated linens, clothing and instruments. It is also used in ultrasonic units and in washer/sterilizer/decontaminators. When used as directed, the enzymatic pH neutral formula is safe for use on rubber, plastic, stainless steel instruments, and surgical equipment as well as cloth.

PRODUCT NUMBER	FEATURES	QUANTITIES
10-2777	1 Gallon Bottles	4/case
10-2775	1 Gallon Bottles	2/case
10-2776	1 Gallon Bottle	1 bottle





## 3 EASY STEPS FOR THE CARE AND CLEANING OF YOUR INSTRUMENTS

### DECONTAMINATION

#### 1 SKLAR SPRAY DISINFECTANT™ Disinfectant / Decontaminant Cleaner

SKLAR DISINFECTANT is a pre-cleaner and disinfectant for the safe decontamination of soiled surgical instruments, medical and surgical equipment, and inanimate surfaces including plastics, stainless steel, chrome, glass, Plexiglas and baked on painted surfaces. The use of SKLAR DISINFECTANT for 2 minutes kills infectious organisms including H1N1, HIV-1, HPV, VRE, Norovirus, Hepatitis B & C, as well as TB, MRSA, A-Baumannii, and C-Diff in its vegetative form.



### CLEANING

#### 2 SKLAR KLEEN™ DETERGENTS AND ENZYMATICS

Sklar has an array of agents for effectively cleaning not only your surgical instruments, but for other metals, glassware, plastic, and rubber. SKLAR KLEEN detergent is available as a powder or liquid. Our enzymatic products, specially formulated for processing instruments heavily laden with organic debris, are concentrated and available in a variety of sizes. Sklar also offers SPRAY-ZYME™ a new foam spray pre-cleaner.



*Choose The Cleaning Product Right For You!*

### LUBRICATION

#### 3 SKLAR LUBRICANT AND SPRAY LUBE

SKLAR LUBE should be a part of your instrument processing regimen to guarantee extending the life and performance of this very important investment. Sklar offers several different types of lubricant to suit your needs. All designed specifically for surgical instruments, they each contain rust inhibitors to protect against corrosion, rusting, and staining.



**YOUR FINAL STEP IS AUTOCLAVE STERILIZATION** Your Instruments Will Look And Work Like New!



# SKLAR STAT™

## INSTANT FOAM HAND SANITIZER

**KILLS 99% OF GERMS IN LESS THAN 15 SECONDS!**

SKLAR-STAT Instant Foam Hand Sanitizer, based on the active ingredient Benzalkonium Chloride, is a unique formulation featuring exceptional skin feel, conditioning and moisturizing properties. The efficacy of this product has been confirmed to reduce *S. Aureus* 99.9999% and *S. Aureus* MRSA 99.9% in as little as 15 seconds. SKLAR-STAT Instant Foaming Hand Sanitizer produces a fast drying, non-sticky foam that contains unique conditioning and moisturizing ingredients, leaving the skin with a soft, silky after-feel.

PRODUCT NUMBER	FEATURES	QUANTITIES
10-2850	50ml Pump Dispensers	24/case
10-2852	550ml Pump Dispensers	12/case

# SKLAR STAT™

## AUTOMATIC FOAM DISPENSER

Motion activated, battery powered and wall-mounted, Sklars AUTOMATIC FOAM DISPENSER allows for easy access and reduced risk of cross contamination. Ideal for use in hospitals, medical centers, offices, schools and any high-traffic public area with multiple users.



PRODUCT NUMBER	FEATURES	QUANTITIES
10-2856	Wall Mount Dispenser	1 Each
10-2854	1000ml Refill Bottles	6/case

INSTANT FOAM HAND SANITIZER

# SKLAR-STAT™

- **Alcohol-Free**
- **Non-Sticky**
- **Moisturizes and Conditions Hands**

1. Pump a small amount into palm of hand.
2. Rub thoroughly over both surfaces of both hands.
3. Rub hands together briskly until dry.

## SKLAR FRESH™

### LIQUID SPRAY ODOR ABSORBER

SKLAR FRESH is an environmentally friendly blend of pure biodegradable organic essential oils and trace elements. It is a non-allergenic liquid spray that neutralizes odors at their source. Simply spray SKLAR FRESH directly in the air or on the source (i.e. bathrooms, refuse, soiled items from vomitus, incontinence odors, etc.)

PRODUCT NUMBER	FEATURES	QUANTITIES
10-2842	22 oz. Spray Bottles	12/case

## SKLAR POLISH™

### INSTRUMENT STAIN REMOVER

#### Non-Abrasive

SKLAR POLISH is an effective stain remover for use on all your metal surgical instruments, including stainless steel, chrome and brass. It will brighten instrument trays, basins and racks and may also be used on porcelain and tile surfaces.



PRODUCT NUMBER	FEATURES	QUANTITIES
10-1626	8 oz. Jars	12/case
10-1629	8 oz. Jars	6/case
10-1927	8 oz. Jar	1 jar

ODOR ABSORBER / LIQUID SPRAY

## SKLAR FRESH™





## SKLAR INSTRUMENT CARE KIT

A Trio of Sklar's Care and Cleaning products to keep instruments in tiptop shape.

PRODUCT NUMBER	FEATURES	QUANTITIES
10-1625		
	Sklar Lube™ 8 oz. Spray Bottle	1 each
	Sklar Kleen™ Liquid 8 oz. Bottle	1 each
	Sklar Polish™ 8 oz. Jar	1 each
	Stainless Steel Bristle Cleaning Brush	1 each
	Nylon Bristle Cleaning Brush	1 each



## TROUBLE SHOOTING

### NO STEEL IS TRULY “STAINLESS”

It's a fact that so-called stainless steel is subject to both water-spotting and staining. However what many people identify as a “rust” problem usually turns out to be something else.

Most often the problem is actually a stain caused by a surface deposit. These deposits appear in a variety of colors depending upon the type of deposit involved. Once the cause is found and eliminated, most of the time the problem quickly diminishes or disappears completely.

As you probably know, stainless steel is ideally suited for the surgical suite because it is rust resistant, it can be honed to an extremely sharp edge or fine point,

and it can be hardened to maintain the delicate, yet precise, requirements of the surgeon. But it is this hardenable quality – the amount of carbon used during the manufacturing process – coupled with harsh chemicals and improper care that renders stainless steel susceptible to corrosion.

To protect your instrument investment, Sklar cleaning agents have been specifically formulated to provide cost effective instrument care solutions that help maintain the life and performance of your valuable stainless steel instruments.

## TROUBLE SHOOTING

### CORROSION

**Problem:** Debris and residue in box locks, serrations and ratchets.

**Solution:** Serrations, box locks and ratchets should be carefully cleaned and rinsed. A soft bristle brush is effective in these difficult areas.

**Problem:** Moisture remaining on the instruments within the sterile wrapped packs; excessive moisture in autoclave during sterilization and termination of cycle.

**Solution:** Preheat autoclave, drying time cannot be accelerated, open autoclave door slightly. Routinely inspect valves. Malfunctioning valves can precipitate corrosion.

**Problem:** Some local water supplies contain excessive quantities of alkali. This can manifest itself by depositing corrosive matter on the instruments.

**Solution:** It is generally accepted that cold distilled or demineralized water be used during sterilization. An alternative is to use the local water supply, while instituting a program of preventive maintenance. Carefully clean surfaces with SKLAR KLEEN™, using SKLAR POLISH™ to remove difficult stains and SKLAR LUBE™ for proper lubrication.

### PITTING

**Problem:** Instruments are inevitably exposed to chemical compounds that initiate pitting. The most common are saline solutions and blood.

**Solution:** It is essential that instruments be rinsed with distilled or demineralized water and then cleaned routinely.

**Problem:** Some Non-Sklar detergents contain a chloride or have an acid base. If rinsing is not thorough, the residual detergent can precipitate pitting. Hydrochloric acid can be formed by the combination of chloride in the cleaner and steam, causing the instrument to pit.

**Solution:** Evaluate detergents without a chloride base. SKLAR KLEEN™ is recommended.

**Problem:** Instruments may be pitted when the detergent used has an excessively high pH. If instruments are not rinsed thoroughly and then autoclaved, the heat increases the effect of the solution on the instruments.

**Solution:** Use only detergents specifically developed for instrument cleaning. SKLAR KLEEN™ products are pH balanced.

### BROWNISH STAIN

**Problem:** This stain is more obvious on dull finish instruments. Most likely, it is a deposit of chromium oxide. The thin hard layer protects stainless steel from corrosion precipitated by the atmosphere. The brownish film (sometimes dull blue) occurs naturally when stainless is heated. Occasionally this stain can be traced to the sterilizer. Improper cleaning compounds could contain poly phosphates that cause the copper components in the sterilizer to be deposited by electrolytic action on the stainless steel instruments.

**Solution:** Water supply to autoclave should be cold and demineralized. Use the correct amount of SKLAR KLEEN™ as recommended for best results.

### BLUISH GRAY STAINS

**Problem:** Cold sterilizing solutions.

**Solution:** In the preparation of the solution make certain the manufacturer's directions are followed accurately. To minimize discoloration use distilled water and add a rust inhibitor. Using the solution beyond recommended time limitations will cause the solution to become corrosive.

### RUST DEPOSIT

**Problem:** Sterilizing instruments of different metals in the same cycle will cause rusting. An electrolytic action carries the carbon particles from the exposed metal and deposits them on the stainless steel instruments. The rapid oxidation of molecules results in a surface film of rust.

**Solution:** The ideal technique would be to sterilize the two types of instruments separately. It is recommended that chrome plated instruments that indicate signs of peeling or flaking be replaced with stainless steel instruments.

**Problem:** The rust film on the surface of stainless steel instruments can be caused by chemicals in the detergent. Excess amounts of iron or other minerals from the local water supply may cause the rust deposits.

**Solution:** It is recommended that instruments be rinsed with distilled or demineralized water. Surface rust can be removed by light buffing or an application of SKLAR POLISH™.

### LIGHT AND DARK COLORED SPOTS

**Problem:** Spotting caused by slow evaporation of water drops identified with the mineral content of the water.

**Solution:** Eliminate water droplets by adhering to autoclave manufacturer's operating instructions. Autoclave door should not be opened until steam has been completely vented.

06-1000 .....	232	06-3030 .....	237	10-1189 .....	240	10-1491 .....	239
06-1004 .....	231	06-3090 .....	234	10-1190 .....	240	10-1491-12 .....	239
06-1101 .....	232	06-3094 .....	236	10-1192 .....	241	10-1492 .....	239
06-1601 .....	229	06-3095 .....	236	10-1340 .....	248	10-1492-12 .....	239
06-1625 .....	227	06-3096 .....	236	10-1342 .....	248	10-1493 .....	239
06-1627 .....	227	06-3100 .....	235	10-1344 .....	248	10-1493-12 .....	239
06-1630 .....	229	06-3101 .....	235	10-1346 .....	248	10-1494 .....	239
06-1632 .....	229	06-3102 .....	235	10-1347 .....	248	10-1494-12 .....	239
06-1635 .....	231	06-3103 .....	235	10-1348 .....	248	10-1494-6 .....	239
06-1638 .....	231	06-3104 .....	235	10-1349 .....	248	10-1495 .....	239
06-1640 .....	230	06-3105 .....	235	10-1350 .....	257	10-1495-12 .....	239
06-1642 .....	230	06-3106 .....	235	10-1352 .....	257	10-1495-6 .....	239
06-1662 .....	230	06-3107 .....	235	10-1354 .....	257	10-1496 .....	239
06-1668 .....	231	06-3108 .....	235	10-1356 .....	257	10-1496-12 .....	239
06-1670 .....	228	06-3110 .....	84, 235	10-1362 .....	257	10-1497 .....	240
06-1671 .....	228	06-3111 .....	84, 235	10-1364 .....	257	10-1497-12 .....	240
06-1672 .....	228	06-3112 .....	84, 235	10-1366 .....	257	10-1498 .....	239
06-1673 .....	228	06-3115 .....	84, 235	10-1370 .....	257	10-1498-12 .....	239
06-1701 .....	232	06-3120 .....	84, 235	10-1372 .....	257	10-1502 .....	253
06-2298 .....	229	06-3121 .....	84, 235	10-1374 .....	257	10-1502-12 .....	253
06-2299 .....	229	06-3122 .....	84, 235	10-1376 .....	257	10-1504 .....	253
06-2300 .....	229	06-3123 .....	84, 235	10-1384 .....	258	10-1504-12 .....	253
06-2302 .....	229	06-3130 .....	236	10-1388 .....	258	10-1505 .....	239
06-2304 .....	227	06-3132 .....	236	10-1396 .....	259	10-1505-12 .....	239
06-2415 .....	230	06-3134 .....	236	10-1398 .....	259	10-1505-6 .....	239
06-2417 .....	230	06-4100 .....	33	10-1399 .....	260	10-1507 .....	239
06-2418 .....	230	06-4110 .....	33	10-1400 .....	259	10-1507-12 .....	239
06-2422 .....	230	06-4142 .....	33	10-1401 .....	259	10-1507-6 .....	239
06-2426 .....	230	06-4143 .....	33	10-1402 .....	259	10-1510 .....	239
06-2427 .....	230	06-4144 .....	33	10-1403 .....	259	10-1510-12 .....	239
06-2428 .....	230	06-4145 .....	33	10-1404 .....	259	10-1510-6 .....	239
06-2750 .....	228	06-4146 .....	33	10-1405 .....	259	10-1523 .....	241
06-2760 .....	229	06-4147 .....	33	10-1406 .....	259	10-1523-12 .....	241
06-2800 .....	228	06-4148 .....	33	10-1414 .....	260	10-1525 .....	242
06-2802 .....	228	06-7052 .....	237	10-1415 .....	260	10-1525-12 .....	242
06-2803 .....	228	07-1777 .....	98	10-1418 .....	260	10-1527 .....	241
06-2870 .....	259	07-1780 .....	98	10-1420 .....	260	10-1527-12 .....	241
06-2872 .....	259	07-1797 .....	98	10-1422 .....	260	10-1533 .....	241
06-2873 .....	259	07-1801 .....	226	10-1424 .....	262	10-1533-12 .....	241
06-2880 .....	259	07-1802 .....	226	10-1426 .....	261	10-1535 .....	245, 246
06-2881 .....	259	07-1805 .....	226	10-1428 .....	261	10-1535-12 .....	245, 246
06-2882 .....	259	07-1806 .....	226	10-1432 .....	262	10-1535-6 .....	245, 246
06-2903 .....	234	08-1011 .....	253	10-1434 .....	262	10-1536 .....	238
06-2904 .....	234	10-1157 .....	241	10-1444 .....	258	10-1536-12 .....	238
06-2907 .....	234	10-1158 .....	241	10-1450 .....	240	10-1538 .....	241
06-2908 .....	234	10-1159 .....	241	10-1451 .....	240	10-1538-12 .....	241
06-2910 .....	234	10-1160 .....	241	10-1465 .....	258	10-1539 .....	238
06-2912 .....	234	10-1170 .....	241	10-1468 .....	258	10-1539-12 .....	238
06-2915 .....	234	10-1171 .....	241	10-1470 .....	259	10-1539-6 .....	238
06-2920 .....	234	10-1172 .....	238	10-1472 .....	259	10-1540 .....	240
06-2925 .....	234	10-1173 .....	238	10-1483 .....	239	10-1540-12 .....	240
06-2930 .....	234	10-1174 .....	238	10-1483-12 .....	239	10-1540-6 .....	240
06-3010 .....	235	10-1175 .....	238	10-1484 .....	239	10-1541 .....	241
06-3011 .....	235	10-1176 .....	238	10-1484-12 .....	239	10-1541-12 .....	241
06-3012 .....	235	10-1177 .....	238	10-1485 .....	239	10-1541-6 .....	241
06-3013 .....	235	10-1178 .....	238	10-1485-12 .....	239	10-1542 .....	245
06-3015 .....	235	10-1180 .....	238	10-1486 .....	239	10-1542-12 .....	245
06-3016 .....	235	10-1181 .....	238	10-1486-12 .....	239	10-1542-6 .....	245
06-3020 .....	235	10-1182 .....	240	10-1487 .....	240	10-1543 .....	241
06-3021 .....	235	10-1183 .....	240	10-1488 .....	239	10-1543-12 .....	241
06-3022 .....	235	10-1184 .....	240	10-1488-12 .....	239	10-1544 .....	241
06-3023 .....	235	10-1186 .....	240	10-1489 .....	239	10-1544-12 .....	241
06-3024 .....	237	10-1188 .....	240	10-1489-12 .....	239	10-1544-6 .....	241

10-1545.....241, 260	10-1672.....257	10-1710.....246	10-1756-12.....245
10-1545-12.....241	10-1674.....239	10-1711.....247	10-1756-6.....245
10-1545-6.....241	10-1674-12.....239	10-1712.....247	10-1757.....245
10-1546.....252	10-1674-6.....239	10-1713.....246	10-1758.....245
10-1546-6.....252	10-1675.....238	10-1714.....246	10-1759.....245
10-1547.....241	10-1675-12.....238	10-1716.....247	10-1760.....243
10-1547-12.....241	10-1675-24.....238	10-1717.....247	10-1760-12.....243
10-1547-6.....241	10-1675-48.....238	10-1720.....246	10-1760-6.....243
10-1550.....241	10-1679.....246	10-1722.....243	10-1763.....249
10-1550-12.....241	10-1680.....244	10-1722-12.....243	10-1764.....245
10-1550-6.....241	10-1680-12.....244	10-1722-6.....243	10-1766.....245
10-1551.....240	10-1680-6.....244	10-1724.....245	10-1768.....242
10-1552.....239	10-1683.....244	10-1724-12.....245	10-1770.....249
10-1552-12.....239	10-1683-12.....244	10-1724-6.....245	10-1772.....249
10-1552-6.....239	10-1683-6.....244	10-1725.....247	10-1775.....249
10-1560.....244	10-1684.....243	10-1729.....244	10-1776.....249
10-1603.....13, 267	10-1684-12.....243	10-1731.....244	10-1780.....249
10-1607.....270	10-1684-6.....243	10-1732.....244	10-1800.....248
10-1608.....270	10-1685.....243	10-1733.....244	10-1805.....248
10-1609.....13, 267	10-1685-12.....243	10-1734.....244	10-1806.....248
10-1612.....270	10-1685-6.....243	10-1736.....244	10-1808.....248
10-1613.....270	10-1686.....243	10-1736-12.....244	10-1810.....248
10-1614.....270	10-1686-12.....243	10-1737.....245	10-1812.....248
10-1616.....50, 265	10-1686-6.....243	10-1737-12.....245	10-1814.....248
10-1617.....50, 265	10-1687.....243	10-1737-6.....245	10-1816.....248
10-1623.....263	10-1687-12.....243	10-1738.....243	10-1818.....248
10-1624.....263	10-1687-6.....243	10-1738-12.....243	10-1826.....248
10-1625.....17, 275	10-1688.....243	10-1738-6.....243	10-1828.....248
10-1626.....274	10-1688-12.....243	10-1740.....245	10-1830.....248
10-1627.....270	10-1688-6.....243	10-1741.....245	10-1832.....248
10-1629.....274	10-1689.....243	10-1741-6.....245	10-1834.....248
10-1630.....270	10-1689-6.....243	10-1742.....245	10-1835.....245
10-1634.....269	10-1690.....243	10-1742-12.....245	10-1835-6.....245
10-1635.....269	10-1690-12.....243	10-1742-6.....245	10-1836.....248
10-1636.....269	10-1690-6.....243	10-1744.....245	10-1838.....248
10-1637.....269	10-1691.....243	10-1744-12.....245	10-1839.....249
10-1642.....264	10-1691-12.....243	10-1744-6.....245	10-1850.....246
10-1643.....46, 264	10-1691-6.....243	10-1746.....245	10-1854.....246
10-1644.....264	10-1692.....243	10-1746-12.....245	10-1854-12.....246
10-1650.....258	10-1692-12.....243	10-1746-6.....245	10-1854-6.....246
10-1651.....258	10-1692-6.....243	10-1747.....245	10-1860.....246
10-1652.....258	10-1693.....243	10-1747-12.....245	10-1862.....245
10-1653.....46, 264	10-1693-12.....243	10-1747-6.....245	10-1864.....246
10-1654.....264	10-1693-6.....243	10-1748.....245	10-1870.....245
10-1657.....258	10-1694.....243	10-1748-12.....245	10-1870-12.....245
10-1658.....258	10-1694-12.....243	10-1748-6.....245	10-1870-6.....245
10-1659.....258	10-1694-6.....243	10-1749.....245	10-1874.....245
10-1660.....257	10-1695.....243	10-1750.....246	10-1876.....244
10-1661.....257	10-1695-12.....243	10-1750-12.....246	10-1876-12.....244
10-1663.....257	10-1695-6.....243	10-1750-6.....246	10-1876-6.....244
10-1664.....257	10-1697.....245	10-1752.....246	10-1877.....245
10-1665.....257	10-1698.....240	10-1752-12.....246	10-1877-12.....245
10-1666.....257	10-1698-12.....240	10-1752-6.....246	10-1877-6.....245
10-1668.....257	10-1699.....240	10-1753.....245	10-1878.....245
10-1669.....257	10-1699-12.....240	10-1753-12.....245	10-1878-12.....245
10-1670.....238	10-1700.....247	10-1753-6.....245	10-1878-6.....245
10-1670-12.....238	10-1701.....247	10-1754.....245	10-1879.....245
10-1670-24.....238	10-1702.....247	10-1754-12.....245	10-1882.....245
10-1670-48.....238	10-1703.....247	10-1754-6.....245	10-1882-12.....245
10-1671.....238	10-1705.....247	10-1755.....245	10-1882-6.....245
10-1671-12.....238	10-1706.....247	10-1755-12.....245	10-1883.....244
10-1671-24.....238	10-1707.....247	10-1755-6.....245	10-1883-12.....244
10-1671-48.....238	10-1708.....247	10-1756.....245	10-1883-6.....244

10-1884	244	10-2722	266	10-4608	250	14-1060	62
10-1884-12	244	10-2724	266	10-4620	250	14-1065	62
10-1884-6	244	10-2765	270	10-4632	250	14-1072	62
10-1886	243	10-2774	266	10-4644	250	14-2045	62
10-1886-12	243	10-2775	271	10-4656	250	14-2050	62
10-1886-6	243	10-2776	271	10-4668	250	14-2055	62
10-1887	243	10-2777	271	10-4680	250	14-2060	62
10-1887-12	243	10-2800	268	10-4692	250	14-2065	62
10-1887-6	243	10-2801	268	10-4704	250	14-2072	62
10-1888	244	10-2842	274	10-4716	250	15-1045	62
10-1888-12	244	10-2850	273	10-4728	250	15-1050	62
10-1888-6	244	10-2852	273	10-4784	251	15-1055	62
10-1892	245	10-2854	273	10-4786	251	15-1060	62
10-1894	245	10-2856	273	10-4788	251	15-1065	62
10-1895	245	10-4000	250	10-4790	251	15-1307	64
10-1927	274	10-4012	250	10-4900	251	15-1308	64
10-1941	245	10-4024	250	10-4910	251	15-1355	67
10-1942	245	10-4036	250	10-4925	251	15-1555	63
10-1943	245	10-4048	250	10-4930	251	15-1567	63
10-1944	245	10-4060	250	10-4930ENG	251	15-1655	63
10-1947	246	10-4072	250	10-4970	251	15-1667	63
10-1948	245, 246	10-4084	250	10-4975	251	15-1762	63
10-1948-12	245, 246	10-4096	250	10-4985	251	15-1862	63
10-1948-6	245, 246	10-4108	250	11-1035	69	15-2045	62
10-1949	245	10-4120	250	11-1045	69	15-2050	62
10-1949-12	245	10-4132	250	11-1055	69	15-2055	62
10-1949-6	245	10-4144	250	11-1060	69	15-2060	62
10-1950	245	10-4156	250	11-1072	69	15-2065	62
10-1950-12	245	10-4168	250	11-1080	69	15-2307	64
10-1950-6	245	10-4180	250	11-1180	70	15-2308	64
10-1952	245	10-4192	250	11-1252	70	15-2567	63
10-1952-12	245	10-4204	250	11-1255	70	15-2655	63
10-1952-6	245	10-4216	250	11-1257	69	15-2667	63
10-1953	245, 246	10-4228	250	11-1278	71	15-2762	63
10-1953-12	245, 246	10-4284	251	11-1280	71	15-2862	63
10-1953-6	245, 246	10-4286	251	11-1281	71	15-3150	68
10-1954	245, 246	10-4288	251	11-1282	71	15-3306	58
10-1954-12	245, 246	10-4290	251	11-1283	71	15-3310	58
10-1954-6	245, 246	10-4300	250	11-1284	71	15-3311	58
10-1955	243	10-4312	250	11-1285	71	15-3315	58
10-1955-12	243	10-4324	250	11-1286	71	15-3320	57
10-1955-6	243	10-4336	250	11-1287	71	15-3325	58
10-1956	243	10-4348	250	11-1297	69	15-3326	58
10-1956-12	243	10-4360	250	11-1298	69	15-3330	58
10-1956-6	243	10-4370	250	11-1380	70	15-3331	58
10-1957	246	10-4382	250	11-1390	70	15-3342	58
10-1960	254	10-4394	250	11-1495	69	15-3343	58
10-1961	254	10-4406	250	11-1496	69	15-3348	58
10-1962	254	10-4418	250	13-1045	62	15-3349	58
10-1964	254	10-4430	250	13-1050	62	15-3352	58
10-1965	254	10-4478	251	13-1055	62	15-3357	58
10-1965-12	254	10-4480	251	13-1060	62	15-3370	55
10-1965-6	254	10-4482	251	13-1065	62	15-3372	55
10-1966	254	10-4484	251	13-1072	62	15-3406	58
10-1966-12	254	10-4500	250	13-2045	62	15-3410	58
10-1966-6	254	10-4512	250	13-2050	62	15-3412	58
10-1967	254	10-4524	250	13-2055	62	15-3426	58
10-1967-12	254	10-4536	250	13-2060	62	15-3430	58
10-1967-6	254	10-4548	250	13-2065	62	15-3442	58
10-2555	254	10-4560	250	13-2072	62	15-3443	58
10-2556	254	10-4572	250	14-1045	62	15-3448	58
10-2557	254	10-4584	250	14-1050	62	15-3449	58
10-2701	270	10-4596	250	14-1055	62	15-3452	58





15-3457 ..... 58

15-3460 ..... 58

15-3461 ..... 58

15-3500 ..... 55

15-3505 ..... 55

15-3510 ..... 55

15-3515 ..... 55

15-3520 ..... 57

15-3525 ..... 57

15-3535 ..... 57

15-3536 ..... 56

15-3542 ..... 56

15-3548 ..... 57

15-3550 ..... 55

15-3555 ..... 55

15-3560 ..... 55

15-3565 ..... 55

15-3566 ..... 55

15-3568 ..... 55

15-3569 ..... 56

15-3570 ..... 56

15-3571 ..... 56

15-3574 ..... 56

15-3575 ..... 56

15-3577 ..... 57

15-3578 ..... 57

15-3579 ..... 57

15-3580 ..... 57

15-3583 ..... 57

15-3584 ..... 57

15-3585 ..... 55

15-3590 ..... 55

15-9107 ..... 58

15-9108 ..... 58

15-9109 ..... 58

15-9117 ..... 58

15-9118 ..... 58

15-9119 ..... 58

16-1055 ..... 53

16-1056 ..... 53

16-1057 ..... 53

16-1155 ..... 53

16-1156 ..... 53

16-1157 ..... 53

16-1505 ..... 53

16-1510 ..... 53

16-1515 ..... 53

16-1605 ..... 53

16-1610 ..... 53

16-1615 ..... 53

16-1805 ..... 53

16-1810 ..... 53

16-1905 ..... 53

16-1910 ..... 53

16-2005 ..... 54

16-2010 ..... 54

16-2015 ..... 54

16-2105 ..... 54

16-2110 ..... 54

16-2115 ..... 54

16-2205 ..... 54

16-2210 ..... 54

16-2305 ..... 54

16-2310 ..... 54

16-2311 ..... 54

16-2405 ..... 53

16-2505 ..... 53

16-2605 ..... 54

16-2610 ..... 54

16-2705 ..... 54

16-2800 ..... 54

16-3552 ..... 53

16-3557 ..... 53

16-3562 ..... 53

16-3567 ..... 53

16-4000 ..... 37

16-4001 ..... 37

16-4002 ..... 37

16-4004 ..... 37

16-4005 ..... 37

16-4006 ..... 37

16-4008 ..... 37

16-4009 ..... 37

16-4010 ..... 37

16-4012 ..... 37

16-4013 ..... 37

16-4014 ..... 37

17-1230 ..... 97

17-1232 ..... 97

17-1235 ..... 97

17-1335 ..... 97

17-1450 ..... 96

17-1550 ..... 96

17-1650 ..... 96

17-1750 ..... 96

17-2055 ..... 96

17-2155 ..... 96

17-2255 ..... 97

17-2262 ..... 97

17-2267 ..... 97

17-2272 ..... 97

17-2280 ..... 97

17-2362 ..... 97

17-2455 ..... 97

17-2462 ..... 97

17-2467 ..... 97

17-2472 ..... 97

17-2480 ..... 97

17-2655 ..... 97

17-2662 ..... 97

17-2672 ..... 97

17-2680 ..... 97

17-2762 ..... 97

17-2855 ..... 97

17-2862 ..... 97

17-2872 ..... 97

17-2880 ..... 97

17-2962 ..... 97

17-3055 ..... 96

17-3062 ..... 96

17-3075 ..... 96

17-3155 ..... 96

17-3162 ..... 96

17-3175 ..... 96

17-3562 ..... 93

18-1050 ..... 96

18-1150 ..... 96

18-1552 ..... 96

18-1652 ..... 96

18-1752 ..... 97

18-1852 ..... 97

18-1952 ..... 96

18-2052 ..... 96

18-2140 ..... 97

18-2155 ..... 97

18-2162 ..... 97

18-2164 ..... 97

18-2257 ..... 90

19-1040 ..... 98

19-1045 ..... 98

19-1050 ..... 98

19-1055 ..... 98

19-1060 ..... 98

19-1080 ..... 98

19-1110 ..... 98

19-1112 ..... 98

19-1245 ..... 99

19-1250 ..... 99

19-1255 ..... 99

19-1260 ..... 99

19-1280 ..... 99

19-1310 ..... 99

19-1312 ..... 99

19-1450 ..... 99

19-1455 ..... 99

19-1460 ..... 99

19-1480 ..... 99

19-1510 ..... 99

19-1512 ..... 99

19-1655 ..... 99

19-1660 ..... 99

19-1855 ..... 99

19-1910 ..... 99

19-3035 ..... 99

19-3040 ..... 99

19-3045 ..... 99

20-1160 ..... 116

20-1260 ..... 115

20-1265 ..... 115

20-1270 ..... 115

20-1280 ..... 115

20-1290 ..... 115

20-1295 ..... 115

20-1350 ..... 114

20-1352 ..... 114

20-1450 ..... 115

20-1547 ..... 114

20-1750 ..... 114

20-1751 ..... 114

20-1760 ..... 114

20-1870 ..... 116

20-2052 ..... 115

20-2060 ..... 115

20-2070 ..... 115

20-2270 ..... 115

20-2480 ..... 115

20-2490 ..... 115

20-2662 ..... 115

20-2747 ..... 114

20-2748 ..... 114

20-2755 ..... 114

20-2765 ..... 114

20-2775 ..... 114

20-2910 ..... 115

20-2911 ..... 115

20-3055 ..... 115

20-3075 ..... 115

20-3090 ..... 114

20-3350 ..... 114

20-3910 ..... 116

20-4170 ..... 116

20-4510 ..... 116

20-4682 ..... 116

20-4795 ..... 116

20-4852 ..... 114

20-4867 ..... 114

21-2662 ..... 110

21-3510 ..... 110

21-8000 ..... 108

21-8001 ..... 108

21-8002 ..... 108

21-8004 ..... 108

21-8005 ..... 108

21-8006 ..... 108

21-8007 ..... 108

21-8008 ..... 108

21-8009 ..... 108

21-8010 ..... 108

21-8011 ..... 108

21-8012 ..... 109

21-8013 ..... 109

21-8014 ..... 109

21-8016 ..... 109

21-8019 ..... 109

21-8020 ..... 109

21-8021 ..... 109

21-8022 ..... 109

21-8023 ..... 109

21-8025 ..... 108

21-8026 ..... 108

21-8027 ..... 108

21-8028 ..... 108

21-8029 ..... 108

21-8030 ..... 108

21-8031 ..... 108

21-8032 ..... 108

21-8033 ..... 108

21-8034 ..... 108

21-8035 ..... 108

21-8036 ..... 109

21-8037 ..... 109

21-8039 ..... 110

21-8040 ..... 110

21-8042 ..... 110

21-8043 ..... 110

21-8044 ..... 110

21-8045 ..... 110

21-8046 ..... 110

21-8047 ..... 110

21-8051 ..... 108

21-8055 ..... 110

21-8058 ..... 110

21-8059 ..... 110	22-2555 ..... 63	23-1161 ..... 60	23-2120 ..... 112
21-8060 ..... 109	22-2567 ..... 63	23-1162 ..... 60	23-2124 ..... 112
21-8061 ..... 109	22-2650 ..... 64	23-1163 ..... 60	23-2125 ..... 112
21-8065 ..... 109	22-2742 ..... 65	23-1164 ..... 59	23-2128 ..... 113
21-8070 ..... 108	22-2755 ..... 71	23-1165 ..... 59	23-2130 ..... 112
21-8071 ..... 108	22-2820 ..... 68	23-1166 ..... 59	23-2132 ..... 113
21-8075 ..... 109	22-2822 ..... 68	23-1167 ..... 59	23-2134 ..... 113
21-8080 ..... 108	22-2824 ..... 68	23-1168 ..... 59	23-2135 ..... 112
21-8082 ..... 109	22-2825 ..... 68	23-1169 ..... 59	23-2136 ..... 112
21-8086 ..... 110	22-2834 ..... 67	23-1170 ..... 59	23-2220 ..... 112
21-9012 ..... 111	22-2835 ..... 67	23-1171 ..... 59	23-2224 ..... 112
21-9016 ..... 111	22-2844 ..... 67	23-1172 ..... 59	23-2225 ..... 112
21-9018 ..... 111	22-2845 ..... 67	23-1173 ..... 59	23-2228 ..... 113
21-9030 ..... 111	22-2855 ..... 71	23-1174 ..... 59	23-2230 ..... 112
21-9035 ..... 111	22-2934 ..... 68	23-1175 ..... 59	23-2232 ..... 113
21-9045 ..... 111	22-2935 ..... 68	23-1176 ..... 59	23-2234 ..... 113
21-9060 ..... 109	22-2947 ..... 68	23-1177 ..... 59	23-2235 ..... 112
21-9065 ..... 109	22-2950 ..... 68	23-1178 ..... 59	23-2236 ..... 112
22-1054 ..... 69	22-3555 ..... 97	23-1179 ..... 59	23-2500 ..... 86
22-1057 ..... 64	22-3655 ..... 97	23-1180 ..... 60	23-2501 ..... 86
22-1063 ..... 99	22-3755 ..... 97	23-1182 ..... 60	23-2505 ..... 86
22-1070 ..... 64	22-3855 ..... 97	23-1184 ..... 60	23-2506 ..... 86
22-1071 ..... 64	22-5050 ..... 116	23-1186 ..... 60	23-2507 ..... 86
22-1072 ..... 69	22-6155 ..... 91	23-1188 ..... 61	23-2508 ..... 86
22-1135 ..... 66	22-6577 ..... 226	23-1189 ..... 61	23-2510 ..... 86
22-1145 ..... 62	22-6585 ..... 226	23-1190 ..... 61	23-2513 ..... 86
22-1150 ..... 62	22-6586 ..... 226	23-1191 ..... 61	23-2532 ..... 87
22-1155 ..... 62	22-8850 ..... 20	23-1193 ..... 61	23-2538 ..... 87
22-1161 ..... 99	22-8853 ..... 20	23-1194 ..... 61	23-2542 ..... 87
22-1162 ..... 99	22-8855 ..... 20	23-1195 ..... 61	23-2552 ..... 87
22-1163 ..... 99	23-1100 ..... 59	23-1196 ..... 61	23-2560 ..... 87
22-1164 ..... 99	23-1101 ..... 59	23-1199 ..... 61	23-2561 ..... 87
22-1235 ..... 66	23-1102 ..... 59	23-1200 ..... 61	23-2563 ..... 87
22-1240 ..... 66	23-1104 ..... 59	23-1202 ..... 61	23-2568 ..... 87
22-1241 ..... 66	23-1105 ..... 59	23-1203 ..... 61	23-2577 ..... 87
22-1242 ..... 66	23-1106 ..... 59	23-1250 ..... 57	23-2585 ..... 87
22-1245 ..... 62	23-1112 ..... 59	23-1254 ..... 56	23-2600 ..... 87
22-1250 ..... 62	23-1113 ..... 59	23-1260 ..... 55	23-2602 ..... 87
22-1255 ..... 62	23-1114 ..... 59	23-1262 ..... 55	23-2603 ..... 87
22-1342 ..... 66	23-1116 ..... 59	23-1264 ..... 55	23-2604 ..... 87
22-1345 ..... 62	23-1117 ..... 59	23-1266 ..... 55	23-2606 ..... 87
22-1350 ..... 62	23-1118 ..... 59	23-1267 ..... 56	23-2608 ..... 87
22-1354 ..... 67	23-1124 ..... 59	23-1268 ..... 55	23-2809 ..... 88
22-1355 ..... 62	23-1126 ..... 59	23-1270 ..... 55	23-2811 ..... 88
22-1442 ..... 66	23-1128 ..... 59	23-1274 ..... 56	23-2819 ..... 88
22-1445 ..... 62	23-1130 ..... 59	23-1278 ..... 56	23-2824 ..... 88
22-1450 ..... 62	23-1136 ..... 59	23-1280 ..... 56	23-2826 ..... 88
22-1455 ..... 62	23-1138 ..... 59	23-1290 ..... 61	23-2828 ..... 88
22-1542 ..... 66	23-1140 ..... 59	23-1292 ..... 61	23-2830 ..... 88
22-1545 ..... 62	23-1142 ..... 59	23-1294 ..... 61	23-2834 ..... 88
22-1550 ..... 62	23-1148 ..... 60	23-1296 ..... 61	23-2836 ..... 88
22-1555 ..... 62	23-1149 ..... 60	23-1300 ..... 61	23-2838 ..... 88
22-1556 ..... 63	23-1150 ..... 60	23-1302 ..... 61	23-2851 ..... 87
22-1567 ..... 63	23-1151 ..... 60	23-1304 ..... 61	23-2852 ..... 87
22-1645 ..... 62	23-1152 ..... 60	23-1306 ..... 61	23-2861 ..... 87
22-1650 ..... 62	23-1153 ..... 60	23-2100 ..... 86	23-2864 ..... 87
22-1655 ..... 62	23-1154 ..... 60	23-2101 ..... 86	23-2865 ..... 87
22-2272 ..... 97	23-1155 ..... 60	23-2105 ..... 86	24-1965 ..... 68
22-2280 ..... 97	23-1156 ..... 60	23-2106 ..... 86	24-2340 ..... 70
22-2450 ..... 64	23-1157 ..... 60	23-2107 ..... 86	24-2341 ..... 70
22-2460 ..... 64	23-1158 ..... 60	23-2108 ..... 86	24-2342 ..... 68
22-2545 ..... 64	23-1159 ..... 60	23-2110 ..... 86	24-2345 ..... 70
22-2550 ..... 64	23-1160 ..... 60	23-2113 ..... 86	24-2346 ..... 70

24-2347 .....	68	31-4307XC .....	139	31-9030XC .....	124	31-9095YC-45 .....	129
31-0001 .....	133	31-4308 .....	140	31-9030XC-45 .....	124	31-9096 .....	125
31-0002 .....	133	31-4308YC .....	140	31-9031 .....	124	31-9096YC .....	125
31-0003 .....	133	31-4309 .....	139	31-9031XC .....	124	31-9097 .....	129
31-0004 .....	133	31-4309XC .....	139	31-9033 .....	124	31-9097XC .....	129
31-1002 .....	132	31-4310 .....	139	31-9033XC .....	124	31-9097YC .....	129
31-1004 .....	132	31-4310XC .....	139	31-9035 .....	124	31-9098 .....	129
31-1007 .....	132	31-4311 .....	140	31-9035XC .....	124	31-9098YC .....	129
31-1010 .....	133	31-4311XC .....	140	31-9036 .....	124	31-9100 .....	127
31-1011 .....	133	31-4312 .....	140	31-9036XC .....	124	31-9100YC .....	127
31-1015 .....	132	31-4312YC .....	140	31-9040 .....	124	31-9105 .....	126
31-1016 .....	132	31-4313 .....	140	31-9040XC .....	124	31-9105YC .....	126
31-1017 .....	132	31-4313YC .....	140	31-9042 .....	129	31-9110 .....	130
31-1018 .....	132	31-4314 .....	139	31-9042XC .....	129	31-9110-45 .....	130
31-1020 .....	133	31-4314YC .....	139	31-9043 .....	125	31-9110YC .....	130
31-1042 .....	133	31-4315 .....	139	31-9043XC .....	125	31-9110YC-45 .....	130
31-2205 .....	136	31-4315XC .....	139	31-9045 .....	125	31-9111 .....	125
31-2227 .....	138	31-4316 .....	139	31-9045XC .....	125	31-9111YC .....	125
31-2229 .....	138	31-4316XC .....	139	31-9045YC .....	125	31-9112 .....	126
31-2233 .....	138	31-4317 .....	140	31-9046 .....	130	31-9112YC .....	126
31-2235 .....	138	31-4317YC .....	140	31-9046XC .....	130	31-9113 .....	125
31-2237 .....	138	31-4318 .....	141	31-9047 .....	130	31-9113YC .....	125
31-2238 .....	136	31-4320 .....	141	31-9047XC .....	130	31-9115 .....	130
31-2238-45 .....	136	31-4321 .....	141	31-9050-45 .....	127	31-9115-45 .....	130
31-2238OR .....	136	31-4323 .....	133	31-9050XC .....	127	31-9115XC .....	130
31-2239 .....	136	31-4324 .....	133	31-9050YC .....	127	31-9115YC .....	130
31-2241 .....	138	31-4325 .....	141	31-9050YC-45 .....	127	31-9115YC-45 .....	130
31-2242 .....	138, 141	31-4326 .....	141	31-9051 .....	127	31-9120 .....	124
31-2243 .....	138	31-4327 .....	141	31-9051YC .....	127	31-9120XC .....	124
31-2244 .....	138	31-4328 .....	133	31-9055 .....	127	31-9125 .....	124
31-2258 .....	136	31-4329 .....	133	31-9055YC .....	127	31-9125-45 .....	124
31-2327 .....	134	31-4562 .....	135	31-9060 .....	128	31-9125XC .....	124
31-2347 .....	136	31-4563 .....	135	31-9060-45 .....	128	31-9125XC-45 .....	124
31-2349 .....	136	31-4565 .....	135	31-9060YC .....	128	31-9128 .....	125
31-2350 .....	134	31-9001XC .....	131	31-9060YC-45 .....	128	31-9128XC .....	125
31-2352 .....	134	31-9002YC .....	131	31-9061 .....	128	31-9130 .....	125
31-2355 .....	134	31-9005 .....	122	31-9061YC .....	128	31-9130XC .....	125
31-2355-45 .....	134	31-9005XC .....	122	31-9065 .....	128	31-9135 .....	125
31-2365 .....	134	31-9005YC .....	122	31-9065-45 .....	128	31-9135XC .....	125
31-2435 .....	138	31-9010 .....	122	31-9065XC .....	128	31-9140 .....	126
31-2437 .....	138	31-9010-45 .....	122	31-9065XC-45 .....	128	31-9140-45 .....	126
31-2443 .....	138	31-9010XC .....	122	31-9065YC .....	128	31-9140XC .....	126
31-2445 .....	138	31-9010XC-45 .....	122	31-9065YC-45 .....	128	31-9140YC .....	126
31-2447 .....	138	31-9012 .....	122	31-9067 .....	126	31-9140YC-45 .....	126
31-2550 .....	137	31-9012-45 .....	122	31-9067YC .....	126	31-9142 .....	128
31-2550-45 .....	137	31-9012XC .....	122	31-9070 .....	128	31-9142XC .....	128
31-2551 .....	137	31-9012XC-45 .....	122	31-9070YC .....	128	31-9144 .....	126
31-2552 .....	137	31-9015 .....	123	31-9075 .....	128	31-9144YC .....	126
31-2552-45 .....	137	31-9015-45 .....	123	31-9075YC .....	128	31-9145 .....	126
31-2553 .....	137	31-9015XC .....	123	31-9080 .....	127	31-9145YC .....	126
31-4003 .....	136	31-9015XC-45 .....	123	31-9080XC .....	127	31-9150 .....	131
31-4004 .....	136	31-9016 .....	123	31-9080YC .....	127	31-9150-45 .....	131
31-4301 .....	141	31-9016XC .....	123	31-9085 .....	127	31-9155 .....	131
31-4302 .....	141	31-9020 .....	123	31-9085YC .....	127	31-9155-45 .....	131
31-4303 .....	139	31-9020XC .....	123	31-9090 .....	129	31-9160 .....	131
31-4303XC .....	139	31-9025 .....	123	31-9090-45 .....	129	31-9180 .....	127
31-4304 .....	139	31-9025XC .....	123	31-9090XC-45 .....	129	31-9360AX .....	140
31-4304XC .....	139	31-9026 .....	122	31-9090YC .....	129	31-9362AX .....	140
31-4305 .....	140	31-9026XC .....	122	31-9095 .....	129	31-9364AX .....	140
31-4305XC .....	140	31-9027 .....	122	31-9095-45 .....	129	33-1375 .....	96
31-4306 .....	139	31-9027XC .....	122	31-9095XC .....	129	34-2023 .....	226
31-4306XC .....	139	31-9030 .....	124	31-9095XC-45 .....	129	34-2230 .....	226
31-4307 .....	139	31-9030-45 .....	124	31-9095YC .....	129	36-1662 .....	91

36-1677	91	50-2007	226	64-1345	67	85-1332	30
36-1692	91	50-2008	226	64-1442	66	85-1334	30
36-1865	91	50-2009	226	64-1445	67	85-1336	30
36-2060	97	50-2010	226	64-1542	66	85-1338	30
36-2160	97	50-2011	226	64-2042	66	85-1340	30
36-2260	97	50-2012	226	64-2142	66	85-1342	30
36-2275	97	50-2014	226	65-3205	28	85-1345	30
36-2280	98	50-2206	226	65-3206	28	85-1408	30
36-2295	97	50-2207	226	65-6055	117	85-1410	30
36-2298	98	50-2208	226	65-6350	117	85-1412	30
36-2385	98	50-2210	226	65-6352	117	85-1414	30
36-2690	97	50-2212	226	65-6354	117	85-1416	30
36-2710	97	50-3047	98	65-6357	117	85-1418	30
36-2790	97	50-3048	98	65-6358	117	85-1420	30
36-2810	97	50-3049	98	65-6446	117	85-1422	30
47-1135	66	50-3050	88	65-6448	117	85-1424	30
47-1140	66	50-3147	98	65-6452	117	85-1426	30
47-1144	66	50-3148	88	65-6550	114	85-1428	30
47-1145	66	50-4462	65	74-3270	96	85-1430	30
47-1146	67	50-4562	65	75-5460	64	85-1432	30
47-1148	54	50-4563	65	75-5570	64	85-1434	30
47-1235	66	50-4662	65	75-5670	64	85-1436	30
47-1240	66	51-1447	85	78-2821	258	85-1438	30
47-1244	66	51-1448	85	78-2822	258	85-1440	30
47-1245	66	51-3049	85	78-2824	257	85-1442	30
47-1246	66	51-3447	85	79-3228	96	85-1446	30
47-1247	67	51-3460	85	79-3230	96	85-1608	30
47-1248	66	51-3480	85	80-1410	89	85-1610	30
47-1250	67	52-3080	63	80-2715	226	85-1612	30
47-1255	67	52-3170	63	80-2815	226	85-1614	30
47-1345	65	55-8611	63	85-1008	29	85-1616	30
47-1360	64	55-8711	63	85-1010	29	85-1618	30
47-1440	66	55-9080	64	85-1012	29	85-1620	30
47-1441	66	55-9084	64	85-1014	29	85-1622	30
47-1442	66	55-9090	64	85-1016	29	85-1624	30
47-1447	98	55-9094	64	85-1018	29	85-1626	30
47-1448	88	55-9180	64	85-1020	29	85-1628	30
47-2047	98	55-9184	64	85-1022	29	85-1630	30
47-2049	98	55-9190	64	85-1024	29	85-1632	30
47-2147	98	55-9194	64	85-1026	29	85-1635	30
47-2447	98	55-9210	64	85-1028	29	85-1636	30
47-2500	28	55-9310	64	85-1030	29	85-2010	33
47-2502	28	55-9311	64	85-1032	29	85-2012	33
47-2505	28	55-9411	64	85-1034	29	85-2014	33
47-2507	28	55-9612	64	85-1036	29	85-2016	33
47-2510	28	55-9614	64	85-1038	29	85-2018	33
47-2512	28	60-1616	20	85-1040	29	85-2020	33
47-2555	28	60-1617	20	85-1065	29	85-2022	33
47-2556	28	60-1618	20	85-1070	29	85-2024	33
47-2570	28	60-2185	19	85-1075	29	85-2026	33
47-2572	28	60-2190	19	85-1076	29	85-2028	33
47-2650	28	60-2195	19	85-1308	30	85-2030	33
47-2651	28	60-6130	133	85-1310	30	85-2032	33
47-2837	99	60-6370	20	85-1312	30	85-2034	33
47-2852	99	60-6570	20	85-1314	30	85-2036	33
47-2935	99	60-6580	20	85-1316	30	85-2038	33
47-2955	99	64-1240	67	85-1318	30	85-2210	33
50-1953	226	64-1241	67	85-1320	30	85-2212	33
50-1955	226	64-1242	66	85-1322	30	85-2214	33
50-1957	226	64-1340	67	85-1324	30	85-2216	33
50-1982	226	64-1341	67	85-1326	30	85-2218	33
50-1985	226	64-1342	66	85-1328	30	85-2220	33
50-2006	226	64-1343	66	85-1330	30	87-2095	99



87-2195 .....	99	90-2160 .....	25, 166	90-3035 .....	18	90-3754 .....	8, 163
87-2295 .....	99	90-2170 .....	25, 166	90-3040 .....	18	90-3755 .....	8, 163
87-2395 .....	99	90-2171 .....	25, 166	90-3045 .....	20	90-3800 .....	10
90-1020 .....	83, 171	90-2172 .....	25, 166	90-3130 .....	18	90-3802 .....	10
90-1021 .....	83, 171	90-2173 .....	25, 166	90-3135 .....	18	90-3803 .....	10
90-1022 .....	83, 171	90-2174 .....	25, 166	90-3140 .....	18	90-3804 .....	7, 162
90-1023 .....	83, 171	90-2175 .....	25, 166	90-3150 .....	18	90-3806 .....	7, 162
90-1025 .....	84, 171	90-2177 .....	95	90-3151 .....	18	90-3808 .....	7, 162
90-1026 .....	84, 171	90-2180 .....	95	90-3152 .....	18	90-3810 .....	7, 162
90-1027 .....	84, 171	90-2242 .....	167	90-3153 .....	18	90-3812 .....	7, 162
90-1035 .....	167	90-2261 .....	82, 170	90-3154 .....	18	90-3814 .....	8, 163
90-1036 .....	167	90-2262 .....	83, 170	90-3155 .....	18	90-3815 .....	8, 163
90-1038 .....	167	90-2264 .....	172	90-3225 .....	18	90-3833 .....	7, 162
90-1040 .....	167	90-2270 .....	84, 171	90-3230 .....	18	90-3835 .....	7, 162
90-1042 .....	167	90-2272 .....	84, 171	90-3235 .....	18	90-3837 .....	7, 162
90-1044 .....	26, 167	90-2276 .....	82, 170	90-3327 .....	19	90-3839 .....	7, 162
90-1045 .....	26, 166	90-2278 .....	82, 169	90-3330 .....	19	90-3841 .....	7, 162
90-1046 .....	26, 167	90-2279 .....	82, 170	90-3335 .....	19	90-3849 .....	10
90-1047 .....	26, 166	90-2280 .....	95	90-3422 .....	18	90-3851 .....	10
90-1048 .....	26, 166	90-2287 .....	172	90-3427 .....	18	90-3865 .....	11
90-1049 .....	26, 166	90-2288 .....	172	90-3430 .....	18	90-3943 .....	11
90-1050 .....	26, 167	90-2292 .....	82, 170	90-3452 .....	20	90-3944 .....	11
90-1051 .....	26, 167	90-2295 .....	82, 169	90-3470 .....	19	90-3945 .....	11
90-1052 .....	26, 167	90-2298 .....	81, 168	90-3510 .....	19	90-3946 .....	8, 164
90-1053 .....	26, 167	90-2304 .....	83, 171	90-3520 .....	20	90-3952 .....	11
90-1054 .....	26, 167	90-2306 .....	83, 171	90-3521 .....	20	90-3953 .....	11
90-1055 .....	26, 167	90-2310 .....	83, 171	90-3522 .....	20	90-3954 .....	11
90-1056 .....	26, 166	90-2312 .....	83, 171	90-3525 .....	12	90-3957 .....	11
90-1057 .....	167	90-2313 .....	84, 171	90-3526 .....	12	90-3959 .....	11
90-1058 .....	26, 166	90-2325 .....	82, 169	90-3527 .....	12	90-3960 .....	11
90-1059 .....	167	90-2326 .....	82, 169	90-3528 .....	20	90-3980 .....	18
90-1060 .....	83, 170	90-2330 .....	172	90-3529 .....	20	90-3990 .....	23
90-1061 .....	83, 170	90-2340 .....	81, 168	90-3530 .....	12	90-3994 .....	23
90-1062 .....	83, 170	90-2342 .....	81, 168	90-3535 .....	12	90-3995 .....	23
90-1063 .....	83, 170	90-2345 .....	81, 169	90-3536 .....	12	90-3996 .....	23
90-1064 .....	83, 170	90-2348 .....	81, 169	90-3537 .....	12	90-3997 .....	23
90-1065 .....	83, 170	90-2350 .....	81, 169	90-3555 .....	12	90-3998 .....	23
90-1066 .....	83, 170	90-2379 .....	95	90-3558 .....	12	90-4713 .....	32
90-1080 .....	65	90-2387 .....	95	90-3559 .....	12	90-4784 .....	31
90-1180 .....	65	90-2480 .....	95	90-3560 .....	9, 164	90-4785 .....	31
90-1280 .....	65	90-2580 .....	95	90-3561 .....	9, 164	90-4786 .....	31
90-1380 .....	65	90-2680 .....	93	90-3562 .....	9, 164	90-4787 .....	31
90-1480 .....	65	90-2682 .....	93	90-3610 .....	19	90-4788 .....	31
90-1580 .....	65	90-2690 .....	95	90-3692 .....	19	90-4789 .....	31
90-1590 .....	63	90-2780 .....	94	90-3700 .....	10	90-4790 .....	31
90-1690 .....	63	90-2782 .....	94	90-3701 .....	10	90-4791 .....	31
90-1755 .....	71	90-2785 .....	37, 96	90-3702 .....	10	90-4792 .....	31
90-1770 .....	71	90-2786 .....	37, 96	90-3705 .....	10	90-4793 .....	31
90-1785 .....	71	90-2787 .....	37, 96	90-3710 .....	10	90-4794 .....	31
90-1790 .....	82, 169	90-2788 .....	37, 96	90-3711 .....	10	90-4795 .....	31
90-1877 .....	95	90-2790 .....	37, 96	90-3712 .....	10	90-4796 .....	31
90-1885 .....	93	90-2792 .....	37, 96	90-3713 .....	10	90-4797 .....	31
90-1890 .....	82, 169	90-2793 .....	37, 96	90-3720 .....	10	90-4798 .....	31
90-1977 .....	95	90-2794 .....	37, 96	90-3721 .....	10	90-4799 .....	31
90-2114 .....	25, 166	90-2796 .....	37, 96	90-3722 .....	10	90-4802 .....	31
90-2116 .....	25, 166	90-2797 .....	37, 96	90-3730 .....	10	90-4804 .....	31
90-2118 .....	25, 166	90-2798 .....	37, 96	90-3731 .....	10	90-4806 .....	31
90-2120 .....	25, 166	90-2799 .....	37, 96	90-3732 .....	10	90-4808 .....	31
90-2122 .....	25, 166	90-2801 .....	37, 96	90-3740 .....	11	90-4810 .....	31
90-2124 .....	25, 166	90-2802 .....	37, 96	90-3741 .....	11	90-4812 .....	31
90-2126 .....	25, 166	90-2803 .....	37, 96	90-3750 .....	11	90-4814 .....	31
90-2128 .....	25, 166	90-2804 .....	37, 96	90-3751 .....	10	90-4816 .....	31
90-2131 .....	25, 166	90-3030 .....	18	90-3752 .....	11	90-4818 .....	31



90-4825	31	90-5424	34	90-6600	48	90-8332	27
90-4826	31	90-5425	34	90-6602	48	90-8333	27
90-4828	31	90-5426	34	90-6610	48	90-8334	27
90-4832	31	90-5428	34	90-6611	36	90-8335	27
90-4902	32	90-5431	34	90-6612	36	90-8336	27
90-4908	31	90-5432	34	90-6820	48	90-8341	27
90-4910	31	90-5433	34	90-6887	47	90-8342	27
90-4912	31	90-5434	34	90-7111	81, 168	90-8344	27
90-4914	31	90-5435	34	90-7385	50	90-8346	27
90-4916	31	90-5436	34	90-7492	50	90-8348	27
90-4918	31	90-5438	34	90-7511	50	90-8555	51
90-4920	31	90-5499	34	90-7520	47	90-8557	51, 178
90-4925	31	90-5500	34	90-7525	48	90-8845	17, 164
90-4926	31	90-5566	35	90-7530	47	90-8850	22, 165
90-4927	31	90-5602	35	90-7540	47	90-8855	22, 165
90-4928	31	90-5603	35	90-7551	49	90-8858	22, 165
90-5215	32	90-5604	35	90-7552	49	90-8860	22, 165
90-5219	32	90-5605	35	90-7553	49	90-8862	22, 165
90-5223	32	90-5606	35	90-7554	49	90-8865	22, 165
90-5227	32	90-5607	35	90-7555	49	90-8900	44
90-5231	32	90-5610	34	90-7556	49	90-8905	44
90-5235	32	90-5611	34	90-7557	49	90-8920	43
90-5239	32	90-5612	34	90-7558	49	90-8925	46
90-5243	32	90-5613	34	90-7560	49	90-8930	46
90-5245	32	90-5614	34	90-7571	49	90-8940	43
90-5249	32	90-5615	34	90-7572	49	90-8945	43
90-5250	32	90-5616	34	90-7573	49	90-8948	44
90-5253	32	90-5617	34	90-7574	49	90-8952	43
90-5260	183	90-5618	34	90-7575	49	90-8960	45
90-5262	183	90-5619	34	90-7576	49	90-8962	45
90-5264	183	90-5620	34	90-7577	49	90-8964	45
90-5271	185	90-5621	34	90-7578	49	90-8966	45
90-5272	185	90-5622	34	90-7579	49	90-8970	45
90-5273	185	90-5623	34	90-7610	89	90-8972	45
90-5274	185	90-5624	34	90-7710	89	90-8974	45
90-5275	185	90-5625	34	90-7895	90	90-8976	45
90-5276	185	90-5626	34	90-7898	89	90-8980	45
90-5282	185	90-5627	34	90-7910	89	90-8981	45
90-5283	185	90-5628	34	90-7977	90	90-8982	45
90-5284	185	90-5629	34	90-7995	90	90-8983	45
90-5285	185	90-5630	34	90-8010	44	90-8984	45
90-5286	185	90-5631	34	90-8065	94	90-8985	45
90-5291	185	90-5632	34	90-8070	94	90-8986	45
90-5292	89, 185	90-5633	34	90-8072	94	90-8987	45
90-5293	89, 185	90-5710	35	90-8080	94	90-8988	45
90-5294	185	90-5713	35	90-8082	94	90-8989	45
90-5295	185	90-5834	36	90-8090	94	90-9000	7, 162
90-5296	185	90-6081	35	90-8110	94	90-9002	7, 162
90-5297	96, 185	90-6082	35	90-8111	89	90-9004	7, 162
90-5301	185	90-6083	35	90-8112	94	90-9005	7, 162
90-5302	185	90-6084	35	90-8120	94	90-9006	7, 162
90-5303	185	90-6095	35	90-8122	94	90-9015	7, 162
90-5304	185	90-6195	35	90-8130	94	90-9016	7, 162
90-5305	185	90-6280	32	90-8132	94	90-9018	7, 162
90-5312	29	90-6281	32	90-8140	94	90-9020	7, 162
90-5314	29	90-6285	36	90-8142	94	90-9030	7, 162
90-5412	29	90-6289	35	90-8210	36	90-9032	7, 162
90-5413	29	90-6290	35	90-8301	27	90-9034	7, 162
90-5415	29	90-6291	35	90-8302	27	90-9035	7, 162
90-5420	42	90-6292	35	90-8303	27	90-9038	7, 162
90-5421	34	90-6295	36	90-8304	27	90-9040	7, 162
90-5422	34	90-6582	36	90-8305	27	90-9042	7, 162
90-5423	34	90-6590	36	90-8306	27	90-9044	7, 162



90-9048	7, 162	91-5022	4, 144	91-5248	24, 151	92-4100	42
90-9050	7, 162	91-5024	4, 144	91-5250	24, 151	92-4130	42
90-9054	8, 163	91-5028	4, 144	91-5251	24, 151	92-5012	41
90-9055	8, 163	91-5032	4, 144	91-5252	24, 151	92-5095	41
90-9064	17, 164	91-5034	4, 144	91-5253	24, 151	92-5195	41
90-9065	17, 164	91-5036	4, 144	91-5254	24, 151	92-5280	42
90-9066	17, 164	91-5038	4, 144	91-5255	24, 151	92-5295	41
90-9067	17, 164	91-5040	4, 144	91-5268	79, 149	92-5298	41
90-9068	17, 164	91-5042	4, 144	91-5270	79, 149	92-5310	41
90-9069	17, 164	91-5044	4, 144	91-5278	79, 149	92-5412	41
90-9070	17, 164	91-5046	4, 144	91-5300	80, 150	92-5540	71
90-9100	8, 163	91-5047	4, 144	91-5302	80, 150	92-5560	71
90-9102	8, 163	91-5050	4, 144	91-5307	79, 150	92-5565	71
90-9103	8, 163	91-5060	4, 144	91-5308	79, 150	93-2160	5, 8, 145, 163
90-9106	9, 163	91-5062	4, 144	91-5310	79, 150	95-100	74, 200
90-9108	9, 163	91-5064	4, 144	91-5400	79, 149	95-103	73, 199
90-9109	9, 163	91-5066	4, 144	91-5404	79, 149	95-104	73, 199
90-9132	172	91-5068	4, 144	91-5408	79, 149	95-105	74, 200
90-9555	47	91-5080	5, 145	91-5411	80, 150	95-107	73, 199
90-9560	47	91-5082	4, 144	91-5412	80, 150	95-109	73, 199
90-9565	48	91-5084	4, 144	91-5413	80, 150	95-110	72, 196
90-9570	47	91-5086	4, 144	91-5414	80, 150	95-111	72, 196
90-9575	47	91-5088	4, 144	91-5420	80, 150	95-112	72, 197
91-1070	90	91-5092	4, 144	91-5422	80, 150	95-113	72, 197
91-1111	91	91-5120	6, 146	91-5424	80, 150	95-114	72, 197
91-1125	91	91-5122	6, 146	91-5428	80, 150	95-115	72, 197
91-1275	90	91-5130	6, 146	91-5440	79, 149	95-116	72, 197
91-1280	91	91-5132	6, 146	91-5450	149	95-117	72, 197
91-1290	90	91-5140	6, 146	91-5452	79, 149	95-118	72, 197
91-1298	90	91-5142	6, 146	91-5455	79	95-119	72, 197
91-1455	91	91-5150	5, 145	91-6100	160	95-120	72, 197
91-1465	91	91-5152	5, 145	91-6101	160	95-122	72, 197
91-1590	93	91-5154	5, 145	91-6102	160	95-124	72, 196
91-1690	93	91-5160	5, 145	91-6103	160	95-125	72, 196
91-1890	93	91-5161	5, 145	91-6104	160	95-126	197
91-2080	93	91-5162	5, 145	91-6105	160	95-127	197
91-2282	92	91-5176	16, 147	91-6106	161	95-128	197
91-2382	92	91-5178	16, 147	91-6107	161	95-130	118, 197
91-2482	92	91-5180	6, 146	91-6108	161	95-132	118, 198
91-2585	92	91-5185	6, 146	91-6109	161	95-133	118, 198
91-2695	92	91-5190	16, 147	91-6110	161	95-134	198
91-2906	92	91-5200	16, 147	91-6111	161	95-135	118, 198
91-2908	92	91-5202	16, 147	91-6112	161	95-136	118, 197
91-2910	92	91-5210	16, 147	92-1012	39	95-137	118, 198
91-3006	92	91-5212	16, 147	92-1014	39	95-138	118, 198
91-3008	92	91-5215	16, 147	92-1015	39	95-139	118, 198
91-3010	92	91-5218	16, 147	92-1112	39	95-140	118, 198
91-3095	92	91-5220	16, 147	92-1114	39	95-141	118, 198
91-3195	92	91-5226	21, 148	92-1415	39	95-142	118, 198
91-3740	5, 145	91-5228	21, 148	92-1610	39	95-143	118, 198
91-3741	5, 145	91-5230	21, 148	92-1712	38	95-146	118, 198
91-3795	92	91-5232	21, 148	92-1715	38	95-147	118, 198
91-3810	93	91-5234	21, 148	92-1915	38	95-148	118, 198
91-3822	41	91-5235	21, 148	92-2015	38	95-149	118, 198
91-3823	41	91-5236	24, 151	92-2115	38	95-160	73, 199
91-4210	40	91-5238	24, 151	92-2215	39	95-161	73, 199
91-4310	40	91-5241	24, 151	92-2314	39	95-222	74, 200
91-5010	4, 144	91-5242	24, 151	92-2717	38	95-226	74, 200
91-5012	4, 144	91-5243	24, 151	92-2812	38	95-231	74, 200
91-5014	4, 144	91-5244	24, 151	92-2912	40	95-232	74, 200
91-5015	4, 144	91-5245	24, 151	92-2915	40	95-232B	74, 200
91-5018	4, 144	91-5246	24, 151	92-3350	40	95-232P	74, 200
91-5020	4, 144	91-5247	24, 151	92-3360	40	95-241	74, 200

95-243.....	74, 200	95-477.....	101, 202	96-0567.....	181	96-1506.....	255
95-245.....	74, 200	95-481.....	101, 202	96-0577.....	181	96-1508.....	255
95-254.....	74, 200	95-483.....	101, 202	96-0827.....	181	96-1510.....	255
95-265.....	73, 199	95-485.....	101, 202	96-0837.....	181	96-1512.....	255
95-266.....	73, 199	95-487.....	101, 202	96-0847.....	181	96-1514.....	255
95-272.....	73, 199	95-492.....	101, 202	96-0857.....	180	96-1516.....	255
95-275.....	73, 199	95-494.....	101, 202	96-0867.....	180	96-1518.....	255
95-278.....	73, 199	95-498.....	101, 202	96-0877.....	180	96-1550.....	255
95-281.....	73, 199	95-500.....	101, 202	96-1040.....	155	96-1630.....	253
95-284.....	73, 199	95-501.....	101, 202	96-1060.....	155	96-1679.....	253
95-285.....	103, 204	95-504.....	101, 202	96-1075.....	155	96-1721.....	189
95-289.....	103, 204	95-512.....	101, 202	96-1085.....	155	96-1722.....	189
95-290.....	73, 199	95-513.....	101, 202	96-1092.....	188	96-1723.....	189
95-292.....	73, 199	95-514.....	101, 202	96-1097.....	188	96-1801.....	190
95-294.....	73, 199	95-515.....	101, 202	96-1098.....	188	96-1803.....	190
95-295.....	73, 199	95-516.....	101, 202	96-1099.....	155	96-1807.....	190
95-299.....	73, 199	95-517.....	101, 202	96-1100.....	188	96-1845.....	256
95-303.....	13, 196	95-518.....	101, 202	96-1102.....	188	96-1846.....	256
95-304.....	13, 196	95-521.....	101, 202	96-1105.....	188	96-1847.....	256
95-308.....	73, 199	95-525.....	101, 202	96-1110.....	188	96-1848.....	256
95-312.....	13, 196	95-571.....	103, 204	96-1115.....	188	96-1849.....	256
95-321.....	73, 199	95-577.....	103, 204	96-1120.....	188	96-1850.....	256
95-322.....	13, 196	95-586.....	103, 204	96-1125.....	188	96-1851.....	256
95-324.....	13, 196	95-592.....	103, 204	96-1130.....	188	96-1852.....	256
95-325.....	73, 199	95-606.....	103, 204	96-1140.....	188	96-1853.....	256
95-327.....	73, 199	95-611.....	103, 204	96-1142.....	188	96-1857.....	180
95-328.....	73, 199	95-629.....	103, 204	96-1144.....	188	96-1860.....	256
95-329.....	73, 199	95-635.....	103, 204	96-1146.....	188	96-1862.....	256
95-330.....	73, 199	95-705.....	102, 203	96-1148.....	188	96-1864.....	256
95-332.....	73, 199	95-710.....	102, 203	96-1150.....	188	96-1866.....	256
95-334.....	13, 196	95-727.....	102, 203	96-1152.....	188, 255	96-1867.....	180
95-335.....	73, 199	95-731.....	102, 203	96-1160.....	188	96-1868.....	256
95-336.....	73, 199	95-736.....	102, 203	96-1200.....	9, 146, 182	96-1870.....	256
95-339.....	73, 199	95-742.....	102, 203	96-1201.....	231	96-1872.....	256
95-340.....	73, 199	95-753.....	102, 203	96-1202.....	231	96-1874.....	256
95-346.....	74, 200	95-757.....	102, 203	96-1210.....	9, 146, 182	96-1876.....	256
95-347.....	13, 196	95-762.....	102, 203	96-1220.....	77, 220	96-1877.....	180
95-348.....	13, 196	95-766.....	102, 203	96-1221.....	77, 220	96-1900.....	256
95-352.....	74, 200	95-770.....	102, 203	96-1222.....	77, 220	96-1901.....	256
95-358.....	74, 200	95-771.....	102, 203	96-1223.....	77, 220	96-1903.....	256
95-360.....	74, 200	95-772.....	102, 203	96-1224.....	77, 220	96-1905.....	256
95-361.....	74, 200	95-775.....	102, 203	96-1225.....	77, 220	96-1906.....	256
95-362.....	13, 196	95-776.....	102, 203	96-1226.....	77, 220	96-1916.....	191
95-364.....	74, 200	95-777.....	102, 203	96-1227.....	77, 220	96-1917.....	191
95-368.....	13, 196	95-778.....	102, 203	96-1228.....	77, 220	96-2309.....	194
95-374.....	100, 201	95-781.....	102, 203	96-1229.....	77, 220	96-2310.....	194
95-386.....	100, 201	95-809.....	119, 205	96-1400.....	255	96-2311.....	194
95-409.....	101, 202	95-810.....	119, 205	96-1402.....	255	96-2312.....	195
95-421.....	101, 202	95-812.....	119, 205	96-1404.....	255	96-2313.....	195
95-426.....	100, 202	95-813.....	119, 205	96-1406.....	255	96-2314.....	195
95-431.....	100, 202	95-826.....	119, 205	96-1408.....	255	96-2402.....	76, 219
95-436.....	100, 201	95-832.....	119, 205	96-1410.....	255	96-2404.....	76, 219
95-441.....	100, 201	95-842.....	119, 205	96-1412.....	255	96-2406.....	106, 223
95-442.....	100, 201	95-847.....	119, 205	96-1414.....	255	96-2408.....	106, 223
95-447.....	100, 201	95-853.....	119, 205	96-1416.....	255	96-2410.....	106, 222
95-452.....	100, 201	95-869.....	119, 205	96-1418.....	255	96-2412.....	106, 222
95-458.....	100, 201	95-934.....	101, 202	96-1440.....	255	96-2497.....	75, 218
95-463.....	100, 201	95-938.....	101, 202	96-1442.....	255	96-2499.....	75, 218
95-465.....	101, 201	95-952.....	100, 201	96-1444.....	255	96-2501.....	76, 219
95-469.....	101, 201	96-0102.....	188	96-1446.....	255	96-2502.....	76, 219
95-470.....	101, 202	96-0160.....	188	96-1500.....	255	96-2503.....	76, 219
95-471.....	101, 202	96-0192.....	188	96-1502.....	255	96-2504.....	75, 218
95-473.....	101, 202	96-0557.....	181	96-1504.....	255	96-2505.....	75, 218



96-2506	75, 218	96-2575	105, 221	96-2680	75, 218	96-7174	252
96-2507	75, 218	96-2576	105, 221	96-2682	75, 218	96-7175	254
96-2510	76, 219	96-2577	105, 221	96-2688	105, 222	96-7177	254
96-2511	76, 219	96-2578	106, 222	96-2701	77, 220	96-7178	254
96-2512	76, 219	96-2579	106, 222	96-2702	77, 220	96-7268	252
96-2513	76, 219	96-2580	120, 224	96-2703	77, 220	96-7270	252
96-2514	75, 218	96-2581	120, 224	96-2704	77, 220	96-7451	252
96-2516	75, 218	96-2582	120, 224	96-2705	221	96-7459	252
96-2517	75, 218	96-2583	120, 224	96-2706	221	96-7543	253
96-2518	76, 219	96-2584	120, 224	96-2707	105, 221	96-8962	225
96-2519	76, 219	96-2585	120, 224	96-2708	105, 221	96-8963	225
96-2520	75, 218	96-2586	120, 224	96-2710	224	96-8964	225
96-2521	75, 218	96-2587	120, 224	96-2712	224	96-8965	225
96-2522	75, 218	96-2590	120, 224	96-2720	75, 218	96-8966	225
96-2523	75, 218	96-2591	120, 224	96-2721	75, 218	96-8967	225
96-2524	75, 218	96-2592	75, 218	96-2726	75, 218	96-8968	120, 225
96-2525	75, 218	96-2593	75, 218	96-2728	75, 218	96-8969	225
96-2526	75, 218	96-2594	120, 224	96-2774	105, 221	96-8970	225
96-2527	75, 218	96-2595	120, 224	96-2775	105, 221	96-8971	225
96-2528	106, 223	96-2596	76, 219	96-2921	105, 222	96-8972	225
96-2529	106, 223	96-2597	75, 218	96-3000	217	96-8973	225
96-2530	75, 218	96-2598	76, 219	96-3001	217	96-8974	120, 225
96-2531	75, 218	96-2599	224	96-3002	217	96-8975	225
96-2532	106, 223	96-2602	14, 180	96-3006	105, 221	96-8976	225
96-2533	106, 223	96-2603	14, 217	96-3008	105, 221	96-9602	152
96-2536	104, 220	96-2604	14, 180	96-3171	192	96-9604	152
96-2537	104, 220	96-2605	14, 217	96-3181	192	96-9606	152
96-2538	104, 220	96-2606	14, 180	96-4100	187	96-9608	152
96-2539	104, 220	96-2607	14, 217	96-4105	263	96-9610	152
96-2540	76, 219	96-2612	217	96-4120	187	96-9612	152
96-2541	76, 219	96-2613	14, 217	96-4140	186, 215	96-9614	152
96-2542	76, 219	96-2614	217	96-4140NS	186, 215	96-9616	152
96-2543	76, 219	96-2615	14, 217	96-4143	184	96-9618	152
96-2544	105, 221	96-2616	217	96-4150	184	96-9620	152
96-2545	105, 221	96-2617	14, 217	96-4155	184	96-9622	152
96-2546	105, 221	96-2620	104, 217	96-4160	187	96-9624	152
96-2547	105, 221	96-2622	104, 217	96-4190	187	96-9626	152
96-2548	105, 221	96-2624	104, 217	96-4192	187	96-9628	152
96-2549	105, 221	96-2626	104, 217	96-4194	187	96-9630	152
96-2550	104, 220	96-2630	106, 223	96-4196	187	96-9632	153
96-2551	104, 220	96-2632	106, 223	96-4305	192	96-9634	153
96-2552	104, 220	96-2634	106, 223	96-4306	193	96-9636	153
96-2553	104, 220	96-2636	106, 223	96-4307	193	96-9638	153
96-2554	104, 221	96-2642	14, 181	96-4319	191	96-9640	153
96-2555	104, 221	96-2644	14, 181	96-5003B	233	96-9642	153
96-2556	104, 221	96-2648	14, 181	96-5005B	233	96-9644	153
96-2557	104, 221	96-2649	75, 218	96-5006B	233	96-9646	153
96-2558	105, 222	96-2650	75, 218	96-5190	187	96-9648	153
96-2559	105, 222	96-2651	75, 218	96-5192	187	96-9650	153
96-2560	104, 220	96-2652	104, 220	96-5194	187	96-9652	154
96-2561	104, 220	96-2653	104, 220	96-5196	187	96-9654	154
96-2562	104, 220	96-2654	76, 219	96-5329	233	96-9656	154
96-2563	104, 220	96-2655	105, 221	96-5331	233	96-9658	154
96-2564	223	96-2656	105, 221	96-5333	233	96-9660	154
96-2565	223	96-2657	104, 220	96-5557	80, 233	96-9662	154
96-2566	105, 221	96-2658	104, 220	96-5557A	80, 233	96-9664	156
96-2567	105, 221	96-2659	120, 224	96-5557BNS	80, 233	96-9666	156
96-2568	105, 222	96-2660	105, 222	96-7020	252	96-9668	156
96-2569	105, 222	96-2661	106, 222	96-7024	254	96-9670	156
96-2570	105, 221	96-2662	76, 219	96-7025	254	96-9672	156
96-2571	105, 221	96-2663	76, 219	96-7027	252	96-9674	156
96-2572	105, 221	96-2664	105, 221	96-7028	252	96-9676	157
96-2573	105, 221	96-2672	76, 219	96-7033	254	96-9678	157



96-9680 .....	157	97-299 .....	209	97-742 .....	212	98-3192 .....	117
96-9682 .....	157	97-300 .....	209	97-748 .....	212	98-324 .....	207
96-9684 .....	157	97-308 .....	209	97-753 .....	212	98-325 .....	207
96-9686 .....	157	97-312 .....	209	97-757 .....	212	98-336 .....	207
96-9688 .....	158	97-321 .....	209	97-762 .....	212	98-348 .....	207
96-9690 .....	158	97-325 .....	209	97-769 .....	212	98-362 .....	207
96-9692 .....	158	97-335 .....	209	97-771 .....	212	98-364 .....	207
96-9694 .....	158	97-336 .....	209	97-772 .....	212	98-366 .....	207
96-9696 .....	158	97-339 .....	209	97-775 .....	212	98-367 .....	208
96-9698 .....	159	97-340 .....	209	97-776 .....	212	98-370 .....	208
96-9700 .....	159	97-346 .....	209	97-777 .....	213	98-374 .....	208
96-9702 .....	159	97-352 .....	209	97-778 .....	212	98-382 .....	207
96-9704 .....	159	97-358 .....	209	97-781 .....	213	98-384 .....	207
96-9706 .....	159	97-364 .....	210	97-809 .....	215	98-386 .....	208
96-9708 .....	159	97-426 .....	210	97-810 .....	214		
96-9710 .....	159	97-431 .....	210	97-826 .....	214		
97-105 .....	210	97-436 .....	210	97-832 .....	214		
97-107 .....	210	97-442 .....	210	97-838 .....	214		
97-108 .....	210	97-447 .....	211	97-842 .....	215		
97-109 .....	210	97-452 .....	211	97-847 .....	215		
97-1350 .....	70	97-458 .....	211	97-853 .....	215		
97-1351 .....	70	97-463 .....	211	97-869 .....	215		
97-1400 .....	237	97-470 .....	211	97-872 .....	214		
97-1405 .....	237	97-471 .....	211	97-877 .....	214		
97-1410 .....	237	97-473 .....	211	97-881 .....	214		
97-1415 .....	237	97-477 .....	211	97-894 .....	214		
97-1420 .....	237	97-481 .....	211	97-930 .....	211		
97-1425 .....	237	97-483 .....	211	97-934 .....	211		
97-1430 .....	237	97-485 .....	211	97-938 .....	211		
97-1445 .....	237	97-487 .....	211	98-1000 .....	173-174		
97-1450 .....	237	97-492 .....	211	98-1014 .....	174		
97-1555 .....	85	97-494 .....	211	98-1016 .....	175		
97-1560 .....	85	97-496 .....	211	98-1018 .....	176		
97-1565 .....	85	97-498 .....	211	98-1020 .....	176		
97-1570 .....	85	97-500 .....	211	98-1024 .....	177		
97-1721 .....	237	97-501 .....	211	98-1026 .....	177		
97-1820 .....	237	97-504 .....	211	98-1028 .....	177		
97-1821 .....	237	97-512 .....	211	98-103 .....	209		
97-1822 .....	237	97-513 .....	211	98-104 .....	209		
97-1823 .....	237	97-517 .....	211	98-107 .....	209		
97-1824 .....	237	97-521 .....	211	98-109 .....	209		
97-1825 .....	237	97-525 .....	211	98-123 .....	213		
97-1826 .....	237	97-528 .....	211	98-129 .....	213		
97-222 .....	210	97-534 .....	211	98-135 .....	213		
97-226 .....	210	97-537 .....	211	98-1354 .....	142		
97-231 .....	210	97-542 .....	211	98-1355 .....	142		
97-237 .....	210	97-571 .....	213	98-1356 .....	142		
97-241 .....	210	97-577 .....	213	98-1357 .....	142		
97-245 .....	210	97-586 .....	213	98-1400 .....	178		
97-263 .....	209	97-592 .....	211	98-1401 .....	179		
97-266 .....	209	97-604 .....	212	98-142 .....	213		
97-269 .....	209	97-606 .....	213	98-146 .....	213		
97-270 .....	209	97-611 .....	213	98-151 .....	213		
97-272 .....	209	97-623 .....	213	98-2047 .....	98		
97-275 .....	209	97-629 .....	213	98-2048 .....	98		
97-278 .....	209	97-635 .....	213	98-285 .....	212		
97-281 .....	209	97-645 .....	213	98-289 .....	212		
97-284 .....	209	97-655 .....	213	98-303 .....	207		
97-288 .....	209	97-705 .....	212	98-312 .....	207		
97-292 .....	209	97-710 .....	212	98-3180 .....	117		
97-293 .....	209	97-727 .....	212	98-3186 .....	117		
97-295 .....	209	97-731 .....	212	98-3188 .....	117		
97-297 .....	209	97-736 .....	212	98-3190 .....	117		

## A

Abbey Needle Holder, Merit™	214
Accessories, Disposable, Electrosurgical	159
Accessories, SklarLite™	251
Ada Dissecting Scissors	63
Adair Breast Tenaculum Forcep	91
Adson (Ewald) Dressing Forcep	98
Adson Bipolar Forcep, Electrosurgical	160
Adson Dressing Forcep	98
Adson Dressing Forcep, Econo-Sterile™	105
Adson Dressing Forcep, Merit™	212
Adson Dressing Forcep, Sklar Black™	82, 170
Adson Dressing Forcep, Sklar Blue™	80, 150
Adson Dressing Forcep, Sklarlite™	87
Adson Dressing Forcep, Sklarlite™	87-88
Adson Dressing Forcep, Surgi-OR™	102, 203
Adson Dressing Forcep, TC	85
Adson Forcep, Econo-Sterile™	221
Adson Suction Tube	226
Adson Tissue Forcep	98
Adson Tissue Forcep, Econo-Sterile™	105
Adson Tissue Forcep, Merit™	212
Adson Tissue Forcep, Sklar Black™	170
Adson Tissue Forcep, Sklarlite™	87
Adson Tissue Forcep, Sklarlite™	87-88
Adson Tissue Forcep, Surgi-OR™	102, 203
Adson Tissue Forcep, TC	85
Adson-Brown Tissue Forcep	98
Adson-Brown Tissue Forcep, Econo-Sterile™	105, 222
Adson-Brown Tissue Forcep, Merit™	212
Adson-Brown Tissue Forcep, Sklar Black™	83, 170
Adson-Brown Tissue Forcep, Sklarlite™	87-88
Adson-Brown Tissue Forcep, Sklarlite™	87
Adson-Brown Tissue Forcep, Surgi-OR™	102, 203
Adson-Brown Tissue Forcep, TC	85
Adult Stethoscope	229
Allis Forcep	98
Allis Forcep, Laparoscopic	126
Allis Tissue Forcep	97
Allis Tissue Forcep, Econo-Sterile™	105, 221
Allis Tissue Forcep, Merit™	211
Allis Tissue Forcep, Sklar Black™	82, 170
Allis Tissue Forcep, Sklar Blue™	79, 149
Allis Tissue Forcep, Sklarlite™	87
Allis Tissue Forcep, Sklarlite™	87
Allis Tissue Forcep, Surgi-OR™	101, 202
Allis Tissue Forcep, TC	85
Amniocentesis Tray	189
Amniotome, Beacham	40
Armytage Forceps	42
Auvarad Vaginal Speculum	12
Auvarad Vaginal Speculum, Sklar Black™	8-9, 163
Auvarad Vaginal Speculum, Sklar Blue™	6, 146

## B

Babcock Forcep	91
Babcock Forcep, Econo-Sterile™	221
Babcock Forcep, Laparoscopic	126
Babcock Forcep, Sklar Black™	82, 169
Babcock Forcep, Sklar Blue™	79, 149
Babcock Forcep, Surgi-OR™	100, 201
Babcock Forcep, TC	85
Babcock/DeBakey Forcep, Laparoscopic	128
Baby Care Tray	195
Baby Care Tray, Deluxe	195
Baby Care Tray, Economy	195
Backhaus Towel Forcep	99
Backhaus Towel Forcep, Econo-Sterile™	106, 223
Backhaus Towel Forcep, Merit™	213
Backhaus Towel Forcep, Surgi-OR™	103, 204
Bantam Bandage Scissors	69
Baron Suction Tube	226
Barraquer Needle Holder	117
Barrett Placenta Forceps	41
Barrett Tenaculum Forcep	90
Basin, Emesis, Stainless Steel	240
Basin, Plastic Emesis	253
Basin, Plastic Round	253
Basin, Plastic Solution	253
Basin, Solution, Stainless Steel	239
Basket, Cleaning, Stainless Steel	244
Basket, Sterilization, SklarLite™	251
Baumgartner Needle Holder	115
Baumgartner Needle Holder, Econo-Sterile™	120, 224
Baumgartner Needle Holder, Merit™	214
Baumgartner Needle Holder, Sklarlite™	113
Baumgartner Needle Holder, Sklarlite™	113
Baumgartner Needle Holder, Surgi-OR™	119, 205
Baumgartner Needle Holder, Surgi-OR™ TC	118, 198
Baumgartner Needle Holder, TC	108
Beacham Amniotome	40
Berlind-Auvarad Vaginal Speculum	12
Bierer Ovum Forceps	41
Bill Traction Handle	40
Billroth Forcep	93

## BIOPSY

Biopsy Forceps	43-50
Biopsy Punch, Cannula	49
Biopsy Punch, Eppendorfer	48
Biopsy Punch, Gaylor	50
Biopsy Punch, Gelhorn	50
Biopsy Punch, Handle	49
Biopsy Punch, Kevorkian	47
Biopsy Punch, Kevorkian-Young	48
Biopsy Punch, Keyes Cutaneous	33
Biopsy Punch, Laparoscopic	130
Biopsy Punch, Micro-Cut Cannula	45
Biopsy Punch, Micro-Cut Eppendorfer	44

Biopsy Punch, Micro-Cut Gaylor	46
Biopsy Punch, Micro-Cut Gelhorn	46
Biopsy Punch, Micro-Cut Handle	45
Biopsy Punch, Micro-Cut Kevorkain	43
Biopsy Punch, Micro-Cut Kevorkian-Young	44
Biopsy Punch, Micro-Cut Oval	44
Biopsy Punch, Micro-Cut Tischler Mini	43
Biopsy Punch, Micro-Cut Tischler Oval	43
Biopsy Punch, Micro-Cut Tischler-Kevorkian	43
Biopsy Punch, Micro-Cut Universal	45
Biopsy Punch, Micro-Cut Wittner Uterine	44
Biopsy Punch, Oval	48
Biopsy Punch, Schubert	50
Biopsy Punch, Sharpening Stone	33
Biopsy Punch, Sharpening Stone	33
Biopsy Punch, Tischler Mini	47
Biopsy Punch, Tischler Oval	47
Biopsy Punch, Tischler-Kevorkian	47
Biopsy Punch, Tru-Punch™, Disposable	188
Biopsy Punch, Universal	49
Biopsy Punch, Wittner Uterine	48

--

Bipolar Forcep, Electrosurgical Adson	160
Bipolar Forcep, Electrosurgical Coaptation	160
Bipolar Forcep, Electrosurgical Cord	159
Bipolar Forcep, Electrosurgical Cushing	160
Bipolar Forcep, Electrosurgical Gerald	160
Bipolar Forcep, Electrosurgical Gerald Bayonet	160
Bipolar Forcep, Electrosurgical Hardy Bayonet	160
Bipolar Forcep, Electrosurgical Jansen Bayonet	161
Bipolar Forcep, Electrosurgical Jeweler	161
Bipolar Forcep, Electrosurgical Malis	161
Bipolar Forcep, Electrosurgical McPherson	161
Bipolar Forcep, Electrosurgical Semkin	161
Bipolar Forcep, Electrosurgical Tenzel	161
Blade Electrode Disposable, Electrosurgical	153
Blade, Carbon P-M	237
Blade, Disposable Surgical	235
Blade, Remover	234
Blade, Scalpel	237
Blade, Surgical, Disposable	235
Blades & Scalpels	234-237
Blepharoplasty Scissors, Sklar Edge™ TC	54
Bond Placenta Forceps	41
Bottle, Sklar-Stat™ Dispenser	273
Bowl, Mixing/Solution, Stainless Steel	239
Bowl, Plastic Guidewire	253
Bowl, Plastic Multi-Purpose Utility	252
Bowl, Plastic Sponge/Utility	253
Bowl, Sponge, Stainless Steel	239
Bowles Stethoscope	232
Bozeman Forcep	89
Bozeman Forcep, Econo-Sterile™	104, 217
Bozeman Forcep, Merit™	208
Bozeman Forcep, Sklar Black™	81, 168
Bozeman Forcep, Sklar Blue™	79
Bozeman Forcep, Surgi-OR™	100, 201

Brantley-Turner Vaginal Retractor.....	19
Braun Episiotomy Scissors.....	71
Breisky Retractor.....	20
Brophy Sullivan Scissors.....	71
Brown Needle Holder.....	114
Brush, Cleaning.....	259-260
Brush, Cleaning Set.....	261-262
Brush, Drying Rack.....	260
Brush, Instrument Cleaning.....	257-258
Brush, Suction Tube Cleaning.....	259
Brush, Surgical Scrub.....	259
Brush, Tracheal Tube Cleaning.....	258
Brushes.....	257-262
Bucket, Hospital Kick, Stainless Steel.....	240
Bucket, Hospital, Stainless Steel.....	240
Buie Suction Tube.....	226
Bumm Uterine Curette.....	35
Busch Umbilical Scissors.....	71

## C

Cable, Disposable, Electrosurgical.....	159
Caliper, Sklar Black™ Castro.....	172
Campion Forcep, Sklar Black™.....	81, 168
Campion Uterine Forcep.....	89
Cannula Biopsy Punch, Micro-Cut.....	45
Cannula, Biopsy Punch.....	49
Cannula, Endometrial, Disposable.....	187
Cannula, Holman-Mathieu.....	36
Cannula, Laparoscopic.....	131
Carbon P-M Blade.....	237
Cardiology Stethoscope.....	228
Care & Cleaning Solutions.....	263-276
Castro Caliper, Sklar Black™.....	172
Castroviejo Forcep, Sklar Black™.....	84, 171
Castroviejo Needle Holder.....	117
Castroviejo Needle Holder, TC.....	110
Castroviejo-Kalt Needle Holder.....	117
Catheter Instrument Tray Cover, Stainless Steel.....	243
Catheter Instrument Tray, Stainless Steel.....	243
Catheter Instrument Tray, Stainless Steel, Miniature.....	242
Cervex Brush, Disposable.....	186, 215
Cesarean Section Set.....	177
Cheron Dressing Forcep.....	89
Claw Forcep, Laparoscopic.....	125
Cleaning Basket, Stainless Steel.....	244
Cleaning Brush.....	259-260
Cleaning Brush Set.....	261-262
Cleaning, Instrument Brush.....	257-258
Cleaning, Suction Tube Brush.....	259
Cleaning, Tracheal Tube Brush.....	258
Clemetson Forcep.....	90
Clemetson Forcep, Sklar Black™.....	81, 169
Clemetson Forcep, Sklar Blue™.....	79, 149
Coaptation Bipolar Forcep, Electrosurgical.....	160
Collar, Laparoscopic.....	131
Collier Needle Holder.....	114

Collin Vaginal Speculum.....	11
Collin Vaginal Speculum, Sklar Black™.....	8, 164
Collin Vaginal Speculum, Sklar Blue™.....	6, 146
Collyer Pelvimeter Forceps.....	42
Colposcopy Set.....	51
Commander Utility Scissors.....	69
Container, Sterilization, SklarLite™.....	250
Container, Storage, Stainless Steel.....	240
Converse Needle Holder.....	114
Cord Bipolar Forcep, Electrosurgical.....	159
Corey Ovum Forceps.....	41
Crile Forcep.....	96
Crile Forcep, Econo-Sterile™.....	104, 220
Crile Forcep, Merit™.....	211
Crile Forcep, Sklarlite XD™.....	86
Crile Forcep, Sklarlite™.....	86
Crile Forcep, Surgi-OR™.....	100, 201
Crile Needle Holder.....	116
Crile-Murray Needle Holder.....	115
Crile-Murray Needle Holder, Surgi-OR™ TC.....	198
Crile-Murray Needle Holder, TC.....	109
Crile-Wood Needle Holder.....	115
Crile-Wood Needle Holder Left, TC.....	111
Crile-Wood Needle Holder, Econo-Sterile™.....	120, 224
Crile-Wood Needle Holder, Merit™.....	214
Crile-Wood Needle Holder, Sklarlite XD™.....	113
Crile-Wood Needle Holder, Sklarlite™.....	113
Crile-Wood Needle Holder, Surgi-OR™ TC.....	118, 198
Crile-Wood Needle Holder, TC.....	108
Crown Scissors.....	70
C-Section Tray.....	192
Cube Pessary.....	185
Cup, Graduated Measure, Plastic.....	252
Cup, Graduated Measure, Stainless Steel.....	239
Cup, Iodine, Stainless Steel.....	238
Cup, Medicine, Stainless Steel.....	238
Cup, Plastic Medicine.....	252
Curette, Bumm Uterine.....	35
Curette, Endocervical.....	36
Curette, Greene Uterine.....	35
Curette, Heaney Uterine.....	35
Curette, Holden Uterine.....	35
Curette, Kelly-Gray Uterine.....	35
Curette, Kevorkian-Young Endocervical.....	36
Curette, Laufe-Nov.....	36
Curette, Lounsbury Placenta.....	35
Curette, Novak Endometrial.....	35
Curette, Randall Endometrial Biopsy.....	36
Curette, Recamier Uterine.....	34
Curette, Sims Uterine.....	34
Curette, Thomas Uterine.....	34
Curettes.....	34-36
Curette, Endocervical, Disposable.....	184
Cusco Vaginal Speculum.....	11
Cusco Vaginal Speculum, Disposable.....	181
Cusco Vaginal Speculum, Econo-Sterile™.....	14
Cusco Vaginal Speculum, Sklar Blue™.....	5, 145

Cushing Bipolar Forcep, Electrosurgical.....	160
Cutter, Stitch.....	237
Cyst Aspiration Tray.....	190
Cyst/FNA/CORE Tray.....	190

## D

D&C Gynecology Tray.....	191
D&C Set.....	174
De Alvarez Forcep.....	94
DeBakey Forcep, Laparoscopic.....	128
DeBakey Forcep, Sklar Black™.....	83, 171
Delee Obstetrical Forceps.....	39
Delee Retractor.....	20
Delee Uterine Forcep.....	89
Delee Uterine Forcep, Sklar Black™.....	81, 168
Deluxe Baby Care Tray.....	195
Deluxe Maternity Tray.....	194
Depth Ruler, Sklar Black™.....	167
Derf Needle Holder.....	114
Derf Needle Holder, Econo-Sterile™.....	120, 224
Derf Needle Holder, Merit™.....	214
Derf Needle Holder, Sklarlite XD™.....	112
Derf Needle Holder, Sklarlite™.....	112
Derf Needle Holder, Surgi-OR™.....	119, 205
Derf Needle Holder, Surgi-OR™ TC.....	118, 197
Derf Needle Holder, TC.....	108
Dermal Retractor, Sklar Black™.....	167
Desmarres Lid Retractor, Sklar Black™.....	167
Detergent, Sklar Enzymatic™.....	271
Detergent, Sklar Kleen™ Liquid.....	270
Detergent, Sklar Kleen™ Low Foam.....	270
Detergent, Sklar Kleen™ Powder.....	270
Devilbiss Vaginal Speculum.....	11
Dilator Handle.....	32
Dilator Set.....	32
Dilator, Female Catheter.....	33
Dilator, Goodell.....	32
Dilator, Hank Uterine.....	31
Dilator, Hegar Uterine.....	31
Dilator, Hegar Uterine, Merit™.....	208
Dilator, Kleegman.....	32
Dilator, Pratt Uterine.....	32
Dilator, Walther.....	33
Dilators.....	31-33
Disinfectant, Sklar.....	46, 264
Disinfectant, Sklar Surface Wipes.....	50, 265
Dispenser, Sklar-Stat™ Bottle.....	273
Dispenser, Sklar-Stat™ Foam.....	273

## DISPOSABLES

Disposable Biopsy Punch, Tru-Punch™.....	188
Disposable Cervex Brush.....	186, 215
Disposable Cusco Vaginal Speculum, Econo-Sterile™.....	14
Disposable Electrosurgical Blade Electrode.....	153
Disposable Electrosurgical Cable.....	159

Disposable Electrosurgical Grouding Pad .....	158
Disposable Electrosurgical Holster .....	159
Disposable Electrosurgical Lietz Electrode .....	155
Disposable Electrosurgical Loop Electrode .....	154
Disposable Electrosurgical Pencil .....	152
Disposable Electrosurgical Straight Electrode ..	156-157
Disposable Electrosurgical Tip Cleaner .....	159
Disposable Endocervical, Currette .....	184
Disposable Endometrial Sampling Set .....	187
Disposable Endometrial, Cannula .....	187
Disposable Graves Vaginal Speculum Lighted, SklarSpec™ .....	181
Disposable Graves Vaginal Speculum, Econo-Sterile™ .....	14, 217
Disposable Graves Vaginal Speculum, SklarSpec™ .....	180
Disposable Lugols .....	9, 146, 182
Disposable Monsels .....	9, 146, 182
Disposable Needle Extender .....	187
Disposable Os Dilator .....	184
Disposable Os Dilator Set .....	184
Disposable Pederson Vaginal Speculum, Econo-Sterile™ .....	14, 217
Disposable Scalpel .....	84, 235
Disposable Smoke Evacuation Tubing ...	5, 8, 145, 163
Disposable Stethoscope .....	231
Disposable Surgical Blade .....	235
Disposable Uterine Manipulator/Injector .....	187
Disposable Vaginal Dilators .....	183
Disposable Vaginal Speculum, Cusco .....	181
Disposables .....	180-188

--

Dissecting Forcep, Laparoscopic .....	124
Dissecting Scissors, Sklar Edge™ TC .....	54
Dittel Urethral Sound .....	30
Dolphin Forcep, Laparoscopic .....	124
Donut Pessary .....	185
Doyen Abdominal Retractor .....	19
Doyen Scissors .....	64
Doyen Vulsellum Forcep .....	92
Dressing Forcep .....	98-99
Dressing Forcep, Econo-Sterile™ .....	105, 222
Dressing Forcep, Merit™ .....	212
Dressing Forcep, Sklar Black™ .....	83, 170
Dressing Forcep, Sklar Blue™ .....	80, 150
Dressing Forcep, Sklarlite XD™ .....	88
Dressing Forcep, Sklarlite™ .....	88
Dressing Forcep, Surgi-OR™ .....	102, 203
Dressing Forcep, TC .....	85
Dressing Jar, Stainless Steel .....	241
Drying Rack Brush .....	260
Duplay Tenaculum Forcep .....	91
Dura Scissors .....	65

## E

Eastman Retractor .....	18
Economy Baby Care Tray .....	195
Economy Maternity Tray .....	194

## ECONO-STERILE™

Econo-Sterile™ Adson Dressing Forcep .....	105
Econo-Sterile™ Adson Forcep .....	221
Econo-Sterile™ Adson Tissue Forcep .....	105
Econo-Sterile™ Adson-Brown Forcep .....	105, 222
Econo-Sterile™ Allis Tissue Forcep .....	105, 221
Econo-Sterile™ Babcock Forcep .....	221
Econo-Sterile™ Backhaus Towel Forcep .....	106, 223
Econo-Sterile™ Baumgartner Needle Holder ..	120, 224
Econo-Sterile™ Bozeman Forcep .....	104, 217
Econo-Sterile™ Crile Forcep .....	104, 220
Econo-Sterile™ Crile-Wood Needle Holder ..	120, 224
Econo-Sterile™ Cusco Vaginal Speculum .....	14
Econo-Sterile™ Derf Needle Holder .....	120, 224
Econo-Sterile™ Dressing Forcep .....	105, 222
Econo-Sterile™ Fine Point Splinter Forcep ..	106, 222
Econo-Sterile™ Foerster Sponge Forcep .....	106, 223
Econo-Sterile™ Graves Vaginal Speculum ..	14, 217
Econo-Sterile™ Halsey Needle Holder .....	120, 224
Econo-Sterile™ Halsted Mosquito Forcep ..	104, 220
Econo-Sterile™ Hartmann Mosquito Forcep ..	104, 221
Econo-Sterile™ Hoff Towel Forcep .....	223
Econo-Sterile™ Instruments .....	216-225
Econo-Sterile™ Iris Scissors .....	75, 218
Econo-Sterile™ Kelly Forcep .....	104, 220
Econo-Sterile™ Knowles Bandage Scissors ..	76, 219
Econo-Sterile™ Lister Bandage Scissors ..	76, 219
Econo-Sterile™ Littauer Stitch Scissors ..	76, 219
Econo-Sterile™ Lorna Edna Towel Forcep ..	106, 223
Econo-Sterile™ Mayo Scissors .....	75, 218
Econo-Sterile™ Mayo-Hegar Needle Holder ..	120, 224
Econo-Sterile™ Metzenbaum Scissors .....	75, 218
Econo-Sterile™ Operating Scissors .....	75, 218
Econo-Sterile™ Pederson Vaginal Speculum ..	14, 217
Econo-Sterile™ Presbyterian Tube Occluding Forcep .....	106, 223
Econo-Sterile™ Rochester-Ochsner Forcep ..	105, 221
Econo-Sterile™ Rochester-Pean Forcep .....	105, 221
Econo-Sterile™ Schroeder Tenaculum Forcep .....	104, 217
Econo-Sterile™ Spencer Stitch Scissors ..	76, 219
Econo-Sterile™ Strabismus Scissors .....	76, 219
Econo-Sterile™ Tissue Forcep .....	106, 222
Econo-Sterile™ Utility Scissors .....	77, 220
Econo-Sterile™ Webster Needle Holder .....	120, 224
Econo-Sterile™ Wire Cutting Scissors .....	76, 219
Econo-Sterile™ Wireform Halsted Forcep ..	225
Econo-Sterile™ Wireform Kelly Forcep .....	225

Econo-Sterile™ Wireform Needle Holder .....	120, 225
Econo-Sterile™ Wireform Scissors .....	225
Econo-Sterile™ Wireform Sponge Forcep .....	225
Econo-Sterile™ Wireform Thumb Forcep .....	225
Econo-Sterile™ Wireform Tissue Forcep .....	225
Econo-Sterile™ Wireform Towel Forcep .....	225

--

Electrode, Disposable, Electrosurgical .....	153-157
Electrode, Laparoscopic .....	138
Electrode, Laparoscopic, Miniature .....	141
Electrosurgical Blade Electrode, Disposable ..	153
Electrosurgical Cable, Disposable .....	159
Electrosurgical Cable, Laparoscopic .....	138, 141
Electrosurgical Cord, Bipolar Forcep .....	159
Electrosurgical Forcep, Bipolar .....	160-161
Electrosurgical Grouding Pad, Disposable ..	158
Electrosurgical Holster, Disposable .....	159
Electrosurgical Lietz Electrode, Disposable ..	155
Electrosurgical Loop Electrode, Disposable ..	154
Electrosurgical Pencil, Disposable .....	152
Electrosurgical Straight Electrode, Disposable	156-157
Electrosurgical Tip Cleaner, Disposable .....	159
Elliot Obstetrical Forceps .....	38
Emesis Basin, Plastic .....	253
Emesis Basin, Stainless Steel .....	240
Emmett Hook .....	27
Emmett Hook, Sklar Black™ .....	25, 166
Emmett Hook, Sklar Blue™ .....	24, 151
Endocervical Curette .....	36
Endocervical Curette, Disposable .....	184
Endocervical Speculum, Kogan .....	23
Endocervical Speculum, Kogan, Sklar Black™	22, 165
Endocervical Speculum, Kogan, Sklar Blue™	21, 148
Endocervical Speculums .....	21-23
Endometrial Sampling Set, Disposable .....	187
Endometrial, Cannula, Disposable .....	187
Endoscope, Laparoscopic, Miniature .....	141
Eppendorfer Biopsy Punch .....	48
Eppendorfer Biopsy Punch, Micro-Cut .....	44
Esmarch Plaster Scissors .....	70
Esophagus Retractor, Laparoscopic .....	135
Extractor, IUD .....	36
Extractor, Murless Head .....	40

## F

Fan Retractor, Laparoscopic .....	135
Female Catheter Dilator .....	33
Fetal Stethoscope .....	230
Fetoscope, Perrell .....	232
Fetoscope, Pinard .....	232
Fine Point Splinter Forcep, Econo-Sterile™	106, 222
Fine Splinter Forcep .....	99
Finocchio Needle Holder .....	116
Finocchio Needle Holder, TC .....	110

Foam Dispenser, Sklar-Stat™	273
Foaming Hand Sanitizer, Sklar-Stat®	273
Foerster Sponge Forcep	99
Foerster Sponge Forcep, Econo-Sterile™	106, 223
Foerster Sponge Forcep, Merit™	213
Foerster Sponge Forcep, Surgi-OR™	103, 204
Fomon Lateral Scissors, Sklarcut™	57

**FORCEPS**

Forcep Jar, Stainless Steel	241, 260
Forcep, Adson Dressing, TC	85
Forcep, Adair Breast Tenaculum	91
Forcep, Adson (Ewald) Dressing	98
Forcep, Adson Dressing	98
Forcep, Adson Dressing, Econo-Sterile™	105
Forcep, Adson Dressing, Merit™	212
Forcep, Adson Dressing, Sklar Black™	82, 170
Forcep, Adson Dressing, Sklar Blue™	80, 150
Forcep, Adson Dressing, Sklarlite XD™	87
Forcep, Adson Dressing, Sklarlite™	87-88
Forcep, Adson Dressing, Surgi-OR™	102, 203
Forcep, Adson Dressing, TC	85
Forcep, Adson Tissue	98
Forcep, Adson Tissue, Econo-Sterile™	105
Forcep, Adson Tissue, Merit™	212
Forcep, Adson Tissue, Sklar Black™	170
Forcep, Adson Tissue, Sklarlite XD™	87
Forcep, Adson Tissue, Sklarlite™	87-88
Forcep, Adson Tissue, Surgi-OR™	102, 203
Forcep, Adson Tissue, TC	85
Forcep, Adson, Econo-Sterile™	221
Forcep, Adson-Brown Tissue	98
Forcep, Adson-Brown Tissue, Merit™	212
Forcep, Adson-Brown Tissue, Sklarlite XD™	87-88
Forcep, Adson-Brown Tissue, Sklarlite™	87
Forcep, Adson-Brown Tissue, Surgi-OR™	102, 203
Forcep, Adson-Brown Tissue, TC	85
Forcep, Adson-Brown, Econo-Sterile™	105, 222
Forcep, Adson-Brown, Sklar Black™	83, 170
Forcep, Allis	98
Forcep, Allis Tissue	97
Forcep, Allis Tissue, Econo-Sterile™	105, 221
Forcep, Allis Tissue, Merit™	211
Forcep, Allis Tissue, Sklar Black™	82, 170
Forcep, Allis Tissue, Sklar Blue™	79, 149
Forcep, Allis Tissue, Sklarlite XD™	87
Forcep, Allis Tissue, Sklarlite™	87
Forcep, Allis Tissue, Surgi-OR™	101, 202
Forcep, Allis Tissue, TC	85
Forcep, Armytage	42
Forcep, Babcock	91
Forcep, Babcock, Econo-Sterile™	221
Forcep, Babcock, Sklar Black™	82, 169
Forcep, Babcock, Sklar Blue™	79, 149
Forcep, Babcock, Surgi-OR™	100, 201
Forcep, Backhaus Towel	99
Forcep, Backhaus Towel, Econo-Sterile™	106, 223
Forcep, Backhaus Towel, Merit™	213
Forcep, Backhaus Towel, Surgi-OR™	103, 204
Forcep, Barrett Placenta	41
Forcep, Barrett Tenaculum	90
Forcep, Bierer Ovum	41
Forcep, Billroth	93
Forcep, Bond Placenta	41
Forcep, Bozeman	89
Forcep, Bozeman, Econo-Sterile™	104, 217
Forcep, Bozeman, Merit™	208
Forcep, Bozeman, Sklar Black™	81, 168
Forcep, Bozeman, Sklar Blue™	79
Forcep, Bozeman, Surgi-OR™	100, 201
Forcep, Champion Uterine	89
Forcep, Champion, Sklar Black™	81, 168
Forcep, Castroviejo, Sklar Black™	84, 171
Forcep, Cheron Dressing	89
Forcep, Clemetson	90
Forcep, Clemetson, Sklar Black™	81, 169
Forcep, Clemetson, Sklar Blue™	79, 149
Forcep, Collyer Pelvimeter	42
Forcep, Corey Ovum	41
Forcep, Crile	96
Forcep, Crile, Econo-Sterile™	104, 220
Forcep, Crile, Merit™	211
Forcep, Crile, Sklarlite XD™	86
Forcep, Crile, Sklarlite™	86
Forcep, Crile, Surgi-OR™	100, 201
Forcep, De Alvarez	94
Forcep, DeBaKey, Sklar Black™	83, 171
Forcep, Delee Uterine	89
Forcep, Delee Uterine, Sklar Black™	81, 168
Forcep, Doyen Vulsellum	92
Forcep, Dressing	98-99
Forcep, Dressing, Econo-Sterile™	105, 222
Forcep, Dressing, Merit™	212
Forcep, Dressing, Sklar Black™	83, 170
Forcep, Dressing, Sklar Blue™	80, 150
Forcep, Dressing, Sklarlite XD™	88
Forcep, Dressing, Sklarlite™	88
Forcep, Dressing, Surgi-OR™	102, 203
Forcep, Dressing, TC	85
Forcep, Duplay Tenaculum	91
Forcep, Electrosurgical	160-161
Forcep, Fine Point Splinter, Econo-Sterile™	106, 222
Forcep, Fine Splinter	99
Forcep, Foerster Sponge	99
Forcep, Foerster Sponge, Econo-Sterile™	106, 223
Forcep, Foerster Sponge, Merit™	213
Forcep, Foerster Sponge, Surgi-OR™	103, 204
Forcep, Gelpi-Lowrie	93
Forcep, Gerald, Sklar Black™	84, 171
Forcep, Gusberg Hysterectomy	94
Forcep, Gutglass Cervix	94
Forcep, Halsted Mosquito	96
Forcep, Halsted Mosquito, Econo-Sterile™	104, 220
Forcep, Halsted Mosquito, Sklarlite XD™	86
Forcep, Halsted Mosquito, Sklarlite™	86
Forcep, Halsted Mosquito, Surgi-OR™	100, 202
Forcep, Hartmann Mosquito	97
Forcep, Hartmann Mosquito, Econo-Sterile™	104, 221
Forcep, Hartmann Mosquito, Merit™	210
Forcep, Hartmann Mosquito, Sklarlite XD™	86
Forcep, Hartmann Mosquito, Sklarlite™	86
Forcep, Hartmann Mosquito, Surgi-OR™	101, 202
Forcep, Heaney	95
Forcep, Heaney-Ballentine	95
Forcep, Heaney-Kanter	95
Forcep, Heaney-Rezek	95
Forcep, Henrotin Vulsellum	92
Forcep, Hildebrandt	94
Forcep, Hoff Towel, Econo-Sterile™	223
Forcep, Hulka Tenaculum	91
Forcep, Iowa Puncturing	40
Forcep, Iris Dressing, Merit™	213
Forcep, Iris Tissue, Merit™	213
Forcep, Jacobs Vulsellum	92
Forcep, Jarcho Tenaculum	90
Forcep, Javerts Placenta	41
Forcep, Kahn Tenaculum	91
Forcep, Kelly	96
Forcep, Kelly Placenta	41
Forcep, Kelly, Econo-Sterile™	104, 220
Forcep, Kelly, Merit™	210
Forcep, Kelly, Sklarlite XD™	86
Forcep, Kelly, Sklarlite™	86
Forcep, Kelly, Surgi-OR™	100, 201
Forcep, Lahey Traction	93
Forcep, Laparoscopic	124-129
Forcep, Laufe Uterine Polyp	90
Forcep, Laufe Uterine Polyp, Sklar Black™	81, 169
Forcep, Laufe Uterine Polyp, Sklar Blue™	79, 149
Forcep, Lawton	95
Forcep, Long	95
Forcep, Lorna Edna Towel	99
Forcep, Lorna Edna Towel, Econo-Sterile™	106, 223
Forcep, Lorna Edna Towel, Merit™	213
Forcep, Lorna Edna Towel, Surgi-OR™	103, 204
Forcep, Magill Catheter	98
Forcep, Magill Catheter, Merit™	212
Forcep, Magill Catheter, Surgi-OR™	103, 204
Forcep, Maier Gross Uterine Dressing	94
Forcep, Martin Pelvimeter	42
Forcep, Mathieu Foreign Body Forcep	96
Forcep, Micro Adson Dressing	98
Forcep, Micro Adson Tissue	98
Forcep, Museux Vulsellum	92
Forcep, Ovum	42

Forcep, Phaneuf Uterine Artery .....	93
Forcep, Plain Splinter, Merit™ .....	213
Forcep, Plain Splinter, Surgi-OR™ .....	102, 203
Forcep, Potts-Smith, Sklar Black™ .....	83, 171
Forcep, Potts-Smith, Sklar Blue™ .....	80, 150
Forcep, Presbyterian Tube Occluding , Surgi-OR™ .....	103, 204
Forcep, Presbyterian Tube Occluding, Econo-Sterile™ .....	106, 223
Forcep, Presbyterian Tube Occluding, Merit™ .....	211
Forcep, Rankin Kelly, Surgi-OR™ .....	101, 201
Forcep, Rochester-Carmalt, Merit™ .....	211
Forcep, Rochester-Ochsner.....	97
Forcep, Rochester-Ochsner, Econo-Sterile™ ..	105, 221
Forcep, Rochester-Ochsner, Merit™ .....	211
Forcep, Rochester-Ochsner, Sklarlite XD™ .....	87
Forcep, Rochester-Ochsner, Sklarlite™ .....	87
Forcep, Rochester-Ochsner, Surgi-OR™ .....	101, 202
Forcep, Rochester-Pean .....	97
Forcep, Rochester-Pean, Econo-Sterile™ .....	105, 221
Forcep, Rochester-Pean, Merit™ .....	211
Forcep, Rochester-Pean, Sklar Black™ .....	82, 170
Forcep, Rochester-Pean, Sklarlite XD™ .....	87
Forcep, Rochester-Pean, Sklarlite™ .....	87
Forcep, Rochester-Pean, Surgi-OR™ .....	101, 202
Forcep, Russian Tissue, Merit™ .....	212
Forcep, Schroeder Tenaculum .....	90
Forcep, Schroeder Tenaculum, Econo-Sterile™ .....	104, 217
Forcep, Schroeder Tenaculum, Merit™ .....	208
Forcep, Schroeder Tenaculum, Sklar Black™ ..	82, 169
Forcep, Schroeder Tenaculum, Sklar Blue™ ..	79, 149
Forcep, Schroeder Tenaculum, Surgi-OR™ ..	100, 201
Forcep, Schroeder Vulsellum .....	93
Forcep, Schroeder Vulsellum, Sklar Black™ ..	82
Forcep, Schweizer .....	90
Forcep, Schweizer, Sklar Black™ .....	81, 169
Forcep, Schweizer, Sklar Blue™ .....	79, 149
Forcep, Segond (Collin) .....	92
Forcep, Singley, Sklar Black™ .....	84, 171
Forcep, Singley, Sklar Blue™ .....	80, 150
Forcep, Somer Uterine.....	96
Forcep, Staude-Moore Tenaculum.....	91
Forcep, Teale Vulsellum .....	92
Forcep, Tissue .....	99
Forcep, Tissue, Econo-Sterile™ .....	106, 222
Forcep, Tissue, Merit™ .....	212
Forcep, Tissue, Sklar Black™ .....	83, 171
Forcep, Tissue, Sklarlite XD™ .....	88
Forcep, Tissue, Sklarlite™ .....	88
Forcep, Tissue, Surgi-OR™ .....	102, 203
Forcep, Tuttle, Sklar Black™ .....	84, 171
Forcep, Tuttle, Sklar Blue™ .....	80, 150
Forcep, Vessells Towel, Merit™ .....	213
Forcep, Wertheim-Cullen Pedicle .....	96
Forcep, Winter Placenta and Ovum.....	89
Forcep, Wireform Halsted, Econo-Sterile™ .....	225

Forcep, Wireform Kelly, Econo-Sterile™ .....	225
Forcep, Wireform Sponge, Econo-Sterile™ .....	225
Forcep, Wireform Thumb, Econo-Sterile™ .....	225
Forcep, Wireform Tissue, Econo-Sterile™ .....	225
Forcep, Wireform Towel, Econo-Sterile™ .....	225
Forcep, Z-Type Hysterectomy.....	37, 96
Forceps .....	78-106

--

Frazier Suction Tube .....	226
Frazier Tissue Hook .....	28
Frazier Tissue Hook, Sklar Black™ .....	26, 166
Freeway Graves Vaginal Speculum.....	11
Freeway Graves Vaginal Speculum, Sklar Black™ .....	8, 163
Freeway Graves Vaginal Speculum, Sklar Blue™ ..	5, 145
Funnel, Stainless Steel .....	241

## G

Garrigue Vaginal Speculum .....	12
Gaylor Biopsy Punch .....	50
Gaylor Biopsy Punch, Micro-Cut.....	46
Gelhorn Biopsy Punch .....	50
Gelhorn Biopsy Punch, Micro-Cut.....	46
Gelhorn Pessary .....	185
Gelpi Retractor .....	20
Gelpi-Lowrie Forcep.....	93
Gerald Bayonet Bipolar Forcep, Electrosurgical ..	160
Gerald Bipolar Forcep, Electrosurgical .....	160
Gerald Forcep, Sklar Black™ .....	84, 171
Gillies Hook.....	28
Gillies Hook, Sklar Black™ .....	26, 166
Gillies Needle Holder .....	115
Gillies Needle Holder, TC.....	110
Glassman Forcep, Laparoscopic .....	125
Gluteraldehyde Strips .....	263
Goldman-Fox Scissors, Sklarcut™ .....	56
Goodell Dilator .....	32
Gorney Face Lift Scissors, Sklarcut™ .....	57
Gorney Plastic Surgery Scissors, Sklarcut™ .....	57
Gown, Surgical.....	233
Graduated Measure Cup, Plastic.....	252
Graduated Measure Cup, Stainless Steel.....	239
Graduated Probe, Laparoscopic.....	134
Grasping Forcep, Laparoscopic.....	127-129
Graves Vaginal Speculum.....	10-11
Graves Vaginal Speculum Lighted, SklarSpec™ Disposable .....	181
Graves Vaginal Speculum, Econo-Sterile™ .....	14, 217
Graves Vaginal Speculum, Merit™ .....	207
Graves Vaginal Speculum, Sklar Black™ .....	7-8, 162-163
Graves Vaginal Speculum, Sklar Blue™ .....	4-5, 144-145
Graves Vaginal Speculum, SklarSpec™ Disposable ..	180
Graves Vaginal Speculum, Surgi-OR™ .....	13, 196
Greene Uterine Curette.....	35
Grouding Pad Disposable, Electrosurgical .....	158
Guard, Osteotome .....	255

Guard, TipGrips™ Instrument Guard .....	255
Guidewire Bowl, Plastic .....	253
Gusberg Hysterectomy Forcep .....	94
Gutglass Cervix Forcep .....	94
Guthrie Double Hook .....	28
Guthrie Double Hook, Sklar Black™ .....	26, 167
GYN Abdominal Set.....	178
Gynecological Biopsy Set .....	176, 177
Gynecological Surgery Set .....	175

## H

Hale Obstetrical Forceps .....	39
Halsey Needle Holder .....	114
Halsey Needle Holder, Econo-Sterile™ .....	120, 224
Halsey Needle Holder, Merit™ .....	214
Halsey Needle Holder, Sklarlite XD™ .....	112
Halsey Needle Holder, Sklarlite™ .....	112
Halsey Needle Holder, Surgi-OR™ .....	119, 205
Halsey Needle Holder, Surgi-OR™ TC.....	118, 198
Halsey Needle Holder, TC .....	108
Halsted Forcep, Wireform Econo-Sterile™ .....	225
Halsted Mosquito Forcep .....	96
Halsted Mosquito Forcep, Econo-Sterile™ .....	104, 220
Halsted Mosquito Forcep, Sklarlite XD™ .....	86
Halsted Mosquito Forcep, Sklarlite™ .....	86
Halsted Mosquito Forcep, Surgi-OR™ .....	100, 202
Handle, Bill Traction.....	40
Handle, Biopsy Punch.....	49
Handle, Biopsy Punch, Micro-Cut .....	45
Handle, Dilator .....	32
Handle, Laparoscopic .....	131
Handle, Luikart-Bill Traction .....	40
Handle, Scalpel.....	234, 237
Handle, Sterilization Tray, Stainless Steel .....	247
Handles, Lifting, Stainless Steel .....	247
Hank Uterine Dilator.....	31
Hardy Bayonet Bipolar Forcep, Electrosurgical .....	160
Harrington-Mayo Scissors.....	63
Hartmann Mosquito Forcep .....	97
Hartmann Mosquito Forcep, Econo-Sterile™ ..	104, 221
Hartmann Mosquito Forcep, Merit™ .....	210
Hartmann Mosquito Forcep, Sklarlite XD™ .....	86
Hartmann Mosquito Forcep, Sklarlite™ .....	86
Hartmann Mosquito Forcep, Surgi-OR™ .....	101, 202
Heaney Forcep .....	95
Heaney Needle Holder.....	116
Heaney Needle Holder, Sklar Black™ .....	172
Heaney Needle Holder, TC .....	109
Heaney Retractor .....	20
Heaney Uterine Curette .....	35
Heaney-Ballentine Forcep .....	95
Heaney-Kanter Forcep.....	95
Heaney-Rezek Forcep .....	95
Hegar Uterine Dilator .....	31
Hegar Uterine Dilator, Merit™ .....	208
Henrovin Vaginal Speculum.....	12

Henrotin Vulsellum Forcep.....	92
Hercules Utility Scissors .....	69
Hildebrandt Forcep .....	94
Hi-Level Scissors .....	70
Hoff Towel Forcep, Econo-Sterile™.....	223
Holden Uterine Curette .....	35
Holman-Mathieu Cannula .....	36
Holster Disposable, Electrosurgical .....	159
Hook Scissors, Laparoscopic.....	123
Hook, Emmett .....	27
Hook, Emmett, Sklar Black™.....	25, 166
Hook, Emmett, Sklar Blue™ .....	24, 151
Hook, Frazier Tissue.....	28
Hook, Frazier Tissue, Sklar Black™ .....	26, 166
Hook, Gillies.....	28
Hook, Gillies, Sklar Black™ .....	26, 166
Hook, Guthrie Double .....	28
Hook, Guthrie Double, Sklar Black™.....	26, 167
Hook, Iris.....	27
Hook, Iris, Sklar Black™ .....	25, 166
Hook, Iris, Sklar Blue™ .....	24, 151
Hook, Joseph.....	28
Hook, Joseph, Sklar Black™ .....	26, 167
Hook, Tyrell Iris .....	28
Hook, Tyrell Iris, Sklar Black™.....	26, 166
Hooks.....	24-28
Hospital Bucket, Stainless Steel .....	240
Hospital Kick Bucket, Stainless Steel .....	240
Hulka Tenaculum Forcep .....	91
Hysterectomy Forcep, Z-Type.....	37, 96
Hysterectomy Instruments .....	37
Hysterectomy Set.....	177
Hysterosalpingogram Basic Tray .....	189

## I

ID Sheet Tape .....	256
Infant Stethoscope .....	230
Instrument Drying Tray, Stainless Steel .....	244
Instrument Guard Guard, TipGrips™ .....	255
Instrument ID & Protectors.....	255-256
Instrument ID Tags .....	256
Instrument Polish, Sklar .....	274
Instrument Protectors, SklarTip™.....	255
Instrument Rack, Stainless Steel .....	249
Instrument Soaking Tray, Plastic.....	254
Instrument Spot Remover Pad.....	260
Instrument Stringer, Stainless Steel.....	248-249
Instrument Tray Cover, Stainless Steel.....	245
Instrument Tray, Stainless Steel .....	245
Instrument, Cleaning Brush .....	257-258
Iodine Cup, Stainless Steel.....	238
Iowa Puncturing Forceps .....	40
Iris Dressing Forcep, Merit™ .....	213
Iris Hook.....	27
Iris Hook, Sklar Black™ .....	25, 166
Iris Hook, Sklar Blue™.....	24, 151

Iris Scissors.....	66
Iris Scissors, Econo-Sterile™ .....	75, 218
Iris Scissors, Merit™ .....	209
Iris Scissors, Sklar Edge™ TC.....	53
Iris Scissors, Sklarcut™.....	55
Iris Scissors, Sklarhone™.....	58
Iris Scissors, Sklarlite XD™ .....	60
Iris Scissors, Sklarlite™ .....	60
Iris Scissors, Sklarlite™ Sklarcut™ .....	55
Iris Scissors, Surgi-OR™ .....	73, 199
Iris Scissors, Surgi-OR™ TC .....	72, 196
Iris Tissue Forcep, Merit™ .....	213
IUD Extractor .....	36

## J

Jackson Vaginal Retractor .....	18
Jackson Vaginal Retractor, Sklar Black™ .....	17, 164
Jackson Vaginal Retractor, Sklar Blue™.....	16, 147
Jacobs Vulsellum Forcep .....	92
Jacobson Needle Holder, TC .....	110
Jansen Bayonet Bipolar Forcep, Electrosurgical .....	160
Jar, Dressing, Stainless Steel .....	241
Jar, Forcep, Stainless Steel .....	241, 260
Jar, Ointment, Stainless Steel.....	242
Jarcho Tenaculum Forcep .....	90
Javerts Placenta Forceps .....	41
Jeweler Bipolar Forcep, Electrosurgical.....	160
Joseph Hook .....	28
Joseph Hook, Sklar Black™ .....	26, 167

## K

Kahn Tenaculum Forcep .....	91
Kaye Face Lift Scissors, Sklarcut™ .....	57
Kelly Forcep.....	96
Kelly Forcep, Econo-Sterile™ .....	104, 220
Kelly Forcep, Laparoscopic.....	125
Kelly Forcep, Merit™ .....	210
Kelly Forcep, Sklarlite XD™ .....	86
Kelly Forcep, Sklarlite™.....	86
Kelly Forcep, Surgi-OR™ .....	100, 201
Kelly Forcep, Wireform Econo-Sterile™ .....	225
Kelly Placenta Forceps .....	41
Kelly-Adson Scissors .....	65
Kelly-Gray Uterine Curette.....	35
Kevorkain Biopsy Punch, Micro-Cut .....	43
Kevorkian Biopsy Punch .....	47
Kevorkian-Young Biopsy Punch.....	48
Kevorkian-Young Biopsy Punch, Micro-Cut .....	44
Kevorkian-Young Endocervical Curette .....	36
Keyes Cutaneous Biopsy Punch.....	33
Keyes Skin Biopsy Set.....	33
Khaki Roll .....	29, 31
Kieland Obstetrical Forceps.....	38
Kieland-Luikart Obstetrical Forceps.....	38
Kit, Sklar Instrument Care.....	17, 275

Kleegman Dilator .....	32
Knowles Bandage Scissors .....	70
Knowles Bandage Scissors, Econo-Sterile™ .....	76, 219
Knowles Bandage Scissors, Surgi-OR™ .....	74, 200
Kocher Forcep, Laparoscopic.....	125
Kogan Endocervical Speculum .....	23
Kogan Endocervical Speculum, Sklar Black™ .....	22, 165
Kogan Endocervical Speculum, Sklar Blue™ .....	21, 148

## L

Lab/Utility Scoop, Stainless Steel .....	241
Labor and Delivery Tray.....	192
Lahey Traction Forcep .....	93

## LAPAROSCOPY

Laparoscopic Biopsy Punch.....	130
Laparoscopic Cannula .....	131
Laparoscopic Collar .....	131
Laparoscopic Electrode .....	138
Laparoscopic Electrode, Miniature.....	141
Laparoscopic Electrosurgical Cable.....	138, 141
Laparoscopic Endoscope, Miniature .....	141
Laparoscopic Forcep .....	124-129
Laparoscopic Handle .....	131
Laparoscopic Needle .....	134
Laparoscopic Needle Holder.....	126
Laparoscopic Needle Holder, TC .....	137
Laparoscopic Obturator .....	133, 141
Laparoscopic Punch, Miniature.....	140
Laparoscopic Reducer .....	133
Laparoscopic Retractor Esophagus.....	135
Laparoscopic Retractor Fan.....	135
Laparoscopic Retractor Graduated.....	134
Laparoscopic Scissors .....	122-123
Laparoscopic Scissors, Miniature .....	139-140
Laparoscopic Set .....	142
Laparoscopic S-Retractor .....	133
Laparoscopic Suction Irrigation System.....	136
Laparoscopic TC Needle Holder, Miniature .....	140
Laparoscopic Trocar .....	132-133
Laparoscopic Trocar Miniature .....	141
Laparoscopic Trocar Set, Miniature .....	141
Laparoscopic Valve.....	133

--

Lateral Vaginal Retractor .....	18
Lateral Vaginal Retractor, Sklar Black™ .....	17, 164
Lateral Vaginal Retractor, Sklar Blue™ .....	16, 147
Laufe Divergent Obstetrical Forceps .....	40
Laufe Uterine Polyp Forcep .....	90
Laufe Uterine Polyp Forcep, Sklar Black™ .....	81, 169
Laufe Uterine Polyp Forcep, Sklar Blue™ .....	79, 149
Laufe-Nov Curette.....	36
Laufe-Piper Obstetrical Forceps .....	38
Lawton Forcep .....	95
Lifting Handles, Stainless Steel .....	247





Liquid Detergent, Sklar Kleen™ .....270

Lister Bandage Scissors .....69

Lister Bandage Scissors, Econo-Sterile™ .....76, 219

Lister Bandage Scissors, Merit™ .....210

Lister Bandage Scissors, Sklarlite XD™ .....61

Lister Bandage Scissors, Sklarlite™ .....61

Lister Bandage Scissors, Surgi-OR™ .....74, 200

Littauer Stitch Scissors, Econo-Sterile™ .....76, 219

Littauer Stitch Scissors, Merit™ .....209

Littauer Stitch Scissors, Surgi-OR™ .....74, 200

Lietz Electrode Disposable, Electrosurgical .....155

Lietz Electrosurgery Tray .....191

Long Forcep .....95

Loop Electrode Disposable, Electrosurgical .....154

Lorna Edna Towel Forcep .....99

Lorna Edna Towel Forcep, Econo-Sterile™ .....106, 223

Lorna Edna Towel Forcep, Merit™ .....213

Lorna Edna Towel Forcep, Surgi-OR™ .....103, 204

Lounsbury Placenta Curette .....35

Low Foam Detergent, Sklar Kleen™ .....270

Lube, Sklar Instru-Guard™ .....269

Lugols, Disposable .....9, 146, 182

Luikart Obstetrical Forceps .....38

Luikart-Bill Traction Handle .....40

Mayo-Hegar Needle Holder, Econo-Sterile™ ..120, 224

Mayo-Hegar Needle Holder, Merit™ .....215

Mayo-Hegar Needle Holder, Sklar Black™ .....172

Mayo-Hegar Needle Holder, Sklarlite XD™ .....113

Mayo-Hegar Needle Holder, Sklarlite™ .....113

Mayo-Hegar Needle Holder, Surgi-OR™ .....119, 205

Mayo-Hegar Needle Holder, Surgi-OR™ TC ..118, 198

Mayo-Hegar Needle Holder, TC.....108

Mayo-Hegar Needle Holder, TC, Left.....111

Mayo-Noble Scissors .....63

Mayo-Noble-Stillie Scissors .....63

Mayo-Stillie Scissors.....63

Mayo-Stillie Scissors, Sklar Edge™ TC.....53

McLane-Tucker Obstetrical Forceps .....39

McPherson Bipolar Forcep, Electrosurgical .....160

Medicine Cup, Plastic .....252

Medicine Cup, Stainless Steel .....238

Merit™ Russian Tissue Forcep.....212

Merit™ Schroeder Tenaculum Forcep .....208

Merit™ Sims Uterine Sound .....207

Merit™ Spencer Stitch Scissors .....209

Merit™ Tissue Forcep.....212

Merit™ Umbilical Scissors .....208

Merit™ Utility Scissors .....210

Merit™ Vessells Towel Forcep.....213

Merit™ Webster Needle Holder .....215

Merit™ Wire Cutting Scissors .....210

Metzenbaum Scissors.....64

Metzenbaum Scissors, Econo-Sterile™ .....75, 218

Metzenbaum Scissors, Laparoscopic .....122

Metzenbaum Scissors, Merit™ .....209

Metzenbaum Scissors, Sklar Edge™ TC.....54

Metzenbaum Scissors, Sklarcut™ .....56

Metzenbaum Scissors, Sklarhone™ .....58

Metzenbaum Scissors, Sklarhone™ Sklarlite™ .....58

Metzenbaum Scissors, Sklarlite XD™ .....59-60

Metzenbaum Scissors, Sklarlite™ .....59-60

Metzenbaum Scissors, Sklarlite™ Sklarcut™ .....56

Metzenbaum Scissors, Surgi-OR™ .....73, 199

Metzenbaum Scissors, Surgi-OR™ TC .....72, 197

Micro Adson Dressing Forcep .....98

Micro Adson Tissue Forcep.....98

Micro Scissors, Laparoscopic .....123

Micro Sterilization Tray Cover, Stainless Steel .....247

Micro Sterilization Tray, Stainless Steel .....247

Micro Surgery Needle Holder.....117

Micro-Cut Biopsy Punch Handle .....45

Micro-Cut Cannula Biopsy Punch .....45

Micro-Cut Eppendorfer Biopsy Punch.....44

Micro-Cut Gaylor Biopsy Punch .....46

Micro-Cut Gelhorn Biopsy Punch.....46

Micro-Cut Kevorkain Biopsy Punch .....43

Micro-Cut Kevorkian-Youngie Biopsy Punch .....44

Micro-Cut Oval Biopsy Punch .....44

Micro-Cut Tischler Mini Biopsy Punch .....43

Micro-Cut Tischler Oval Biopsy Punch.....43

Micro-Cut Tischler-Kevorkian Biopsy Punch.....43

Micro-Cut Universal Biopsy Punch .....45

Micro-Cut Wittner Uterine Biopsy Punch .....44

Mini Thumb Scalpel .....237

Miniature Catheter Instrument Tray,  
Stainless Steel .....242

Miniature Electrode, Laparoscopic.....141

Miniature Endoscope, Laparoscopic.....141

Miniature Needle Holder, Laparoscopic TC .....140

Miniature Obturator, Laparoscopic.....141

Miniature Punch, Laparoscopic.....140

Miniature Scissors, Laparoscopic .....139-140

Miniature Trocar Set, Laparoscopic .....141

Miniature Trocar, Laparoscopic.....141

Mixing/Solution Bowl, Stainless Steel .....239

Mixer Forcep, Laparoscopic.....124

Moleskin Scissors .....70

**MERIT™**

Merit™ Abbey Needle Holder .....214

Merit™ Adson Dressing Forcep .....212

Merit™ Adson Tissue Forcep.....212

Merit™ Adson-Brown Tissue Forcep .....212

Merit™ Allis Tissue Forcep .....211

Merit™ Backhaus Towel Forcep .....213

Merit™ Baumgartner Needle Holder.....214

Merit™ Bozeman Forcep .....208

Merit™ Crile Forcep.....211

Merit™ Crile-Wood Needle Holder.....214

Merit™ Derf Needle Holder.....214

Merit™ Dressing Forcep .....212

Merit™ Foerster Sponge Forcep .....213

Merit™ Graves Vaginal Speculum .....207

Merit™ Halsey Needle Holder .....214

Merit™ Hartmann Mosquito Forcep.....210

Merit™ Hegar Uterine Dilator.....208

Merit™ Iris Dressing Forcep .....213

Merit™ Iris Scissors .....209

Merit™ Iris Tissue Forcep.....213

Merit™ Kelly Forcep .....210

Merit™ Lister Bandage Scissors.....210

Merit™ Littauer Stitch Scissors.....209

Merit™ Lorna Edna Towel Forcep.....213

Merit™ Magill Catheter Forcep .....212

Merit™ Mayo Scissors .....209

Merit™ Mayo-Hegar Needle Holder.....215

Merit™ Metzenbaum Scissors .....209

Merit™ Olsen-Hegar Needle Holder .....214

Merit™ Operating Scissors .....209

Merit™ Pederson Vaginal Speculum .....207

Merit™ Plain Splinter Forcep.....213

Merit™ Presbyterian Tube Occluding Forcep .....211

Merit™ Rochester-Carmalt Forcep .....211

Merit™ Rochester-Ochsner Forcep.....211

Merit™ Rochester-Pean Forcep .....211

**M**

Magill Catheter Forcep .....98

Magill Catheter Forcep, Merit™ .....212

Magill Catheter Forcep, Surgi-OR™ .....103, 204

Maier Gross Uterine Dressing Forcep .....94

Major Basic Surgery Set .....173-174

Malis Bipolar Forcep, Electrosurgical.....160

Martin Pelvimeter Forceps .....42

Maryland Dissector, Laparoscopic .....124

Maryland Scissors, Laparoscopic .....122

Mask, Procedure .....80, 233

Mat, Silicon, SklarLite™ .....251

Maternity Tray .....194

Maternity Tray, Deluxe .....194

Maternity Tray, Economy .....194

Mathieu Foreign Body Forcep.....96

Mathieu Needle Holder .....115

Mathieu Needle Holder, TC.....108

Mayo Scissors.....63

Mayo Scissors, Econo-Sterile™ .....75, 218

Mayo Scissors, Merit™ .....209

Mayo Scissors, Sklar Edge™ TC.....53

Mayo Scissors, Sklarcut™ .....55

Mayo Scissors, Sklarhone™ .....58

Mayo Scissors, Sklarlite XD™ .....59

Mayo Scissors, Sklarlite™ .....59

Mayo Scissors, Sklarlite™ Sklarcut™ .....56

Mayo Scissors, Surgi-OR™ .....73, 199

Mayo Scissors, Surgi-OR™ TC .....72, 197

Mayo Tray, Stainless Steel.....243

Mayo-Hegar Needle Holder .....115

Monsels, Disposable ..... 9, 146, 182  
 Mosquito Forcep, Halsted, Econo-Sterile™ ..... 104, 220  
 Mosquito Forcep, Halsted, Sklarlite XD™ ..... 86  
 Mosquito Forcep, Halsted, Sklarlite™ ..... 86  
 Mosquito Forcep, Halsted, Surgi-OR™ ..... 100, 202  
 Mosquito Forcep, Hartmann, Econo-Sterile™ ..... 104, 221  
 Mosquito Forcep, Hartmann, Merit™ ..... 210  
 Mosquito Forcep, Hartmann, Sklarlite XD™ ..... 86  
 Mosquito Forcep, Hartmann, Sklarlite™ ..... 86  
 Mosquito Forcep, Hartmann, Surgi-OR™ ..... 101, 202  
 Multi-Purpose Utility Bowl, Plastic ..... 252  
 Murless Head Extractor ..... 40  
 Museux Vulsellum Forcep ..... 92

## N

Needle Extender ..... 187  
 Needle Extender, Disposable ..... 187

## NEEDLE HOLDERS

Needle Holder, Abbey, Merit™ ..... 214  
 Needle Holder, Barraquer ..... 117  
 Needle Holder, Baumgartner ..... 115  
 Needle Holder, Baumgartner, Econo-Sterile™ ..... 120, 224  
 Needle Holder, Baumgartner, Merit™ ..... 214  
 Needle Holder, Baumgartner, Sklarlite XD™ ..... 113  
 Needle Holder, Baumgartner, Sklarlite™ ..... 113  
 Needle Holder, Baumgartner, Surgi-OR™ ..... 119, 205  
 Needle Holder, Baumgartner, Surgi-OR™ TC ..... 118, 198  
 Needle Holder, Baumgartner, TC ..... 108  
 Needle Holder, Brown ..... 114  
 Needle Holder, Castroviejo ..... 117  
 Needle Holder, Castroviejo, TC ..... 110  
 Needle Holder, Castroviejo-Kalt ..... 117  
 Needle Holder, Collier ..... 114  
 Needle Holder, Converse ..... 114  
 Needle Holder, Crile ..... 116  
 Needle Holder, Crile-Murray ..... 115  
 Needle Holder, Crile-Murray, Surgi-OR™ TC ..... 198  
 Needle Holder, Crile-Murray, TC ..... 109  
 Needle Holder, Crile-Wood ..... 115  
 Needle Holder, Crile-Wood Left, TC ..... 111  
 Needle Holder, Crile-Wood, Econo-Sterile™ ..... 120, 224  
 Needle Holder, Crile-Wood, Merit™ ..... 214  
 Needle Holder, Crile-Wood, Sklarlite XD™ ..... 113  
 Needle Holder, Crile-Wood, Sklarlite™ ..... 113  
 Needle Holder, Crile-Wood, Surgi-OR™ TC ..... 118, 198  
 Needle Holder, Crile-Wood, TC ..... 108  
 Needle Holder, Derf ..... 114  
 Needle Holder, Derf, Econo-Sterile™ ..... 120, 224  
 Needle Holder, Derf, Merit™ ..... 214  
 Needle Holder, Derf, Sklarlite XD™ ..... 112  
 Needle Holder, Derf, Sklarlite™ ..... 112  
 Needle Holder, Derf, Surgi-OR™ ..... 119, 205  
 Needle Holder, Derf, Surgi-OR™ TC ..... 118, 197  
 Needle Holder, Derf, TC ..... 108

Needle Holder, Finocchio ..... 116  
 Needle Holder, Finocchio, TC ..... 110  
 Needle Holder, Gillies ..... 115  
 Needle Holder, Gillies, TC ..... 110  
 Needle Holder, Halsey ..... 114  
 Needle Holder, Halsey, Econo-Sterile™ ..... 120, 224  
 Needle Holder, Halsey, Merit™ ..... 214  
 Needle Holder, Halsey, Sklarlite XD™ ..... 112  
 Needle Holder, Halsey, Sklarlite™ ..... 112  
 Needle Holder, Halsey, Surgi-OR™ ..... 119, 205  
 Needle Holder, Halsey, Surgi-OR™ TC ..... 118, 198  
 Needle Holder, Halsey, TC ..... 108  
 Needle Holder, Heaney ..... 116  
 Needle Holder, Heaney, Sklar Black™ ..... 172  
 Needle Holder, Heaney, TC ..... 109  
 Needle Holder, Jacobson, TC ..... 110  
 Needle Holder, Laparoscopic ..... 126  
 Needle Holder, Laparoscopic TC ..... 137  
 Needle Holder, Laparoscopic, Miniature TC ..... 140  
 Needle Holder, Mathieu ..... 115  
 Needle Holder, Mathieu, TC ..... 108  
 Needle Holder, Mayo-Hegar ..... 115  
 Needle Holder, Mayo-Hegar Left, TC ..... 111  
 Needle Holder, Mayo-Hegar, Econo-Sterile™ ..... 120, 224  
 Needle Holder, Mayo-Hegar, Merit™ ..... 215  
 Needle Holder, Mayo-Hegar, Sklar Black™ ..... 172  
 Needle Holder, Mayo-Hegar, Sklarlite XD™ ..... 113  
 Needle Holder, Mayo-Hegar, Sklarlite™ ..... 113  
 Needle Holder, Mayo-Hegar, Surgi-OR™ ..... 119, 205  
 Needle Holder, Mayo-Hegar, Surgi-OR™ TC ..... 118, 198  
 Needle Holder, Mayo-Hegar, TC ..... 108  
 Needle Holder, Micro Surgery ..... 117  
 Needle Holder, Neivert ..... 114  
 Needle Holder, Neivert, TC ..... 110  
 Needle Holder, New Orleans ..... 116  
 Needle Holder, New Orleans, TC ..... 109  
 Needle Holder, Olsen-Hegar ..... 114  
 Needle Holder, Olsen-Hegar, Merit™ ..... 214  
 Needle Holder, Olsen-Hegar, Sklarlite XD™ ..... 112  
 Needle Holder, Olsen-Hegar, Sklarlite™ ..... 112  
 Needle Holder, Olsen-Hegar, Surgi-OR™ TC ..... 118, 198  
 Needle Holder, Olsen-Hegar, TC ..... 108  
 Needle Holder, Olsen-Hegar, TC ..... 111  
 Needle Holder, Ryder, TC ..... 109  
 Needle Holder, Sarot ..... 116  
 Needle Holder, Sarot, TC ..... 109  
 Needle Holder, Sternal Wire Twister, TC ..... 109  
 Needle Holder, Stratte ..... 116  
 Needle Holder, Stratte, TC ..... 109  
 Needle Holder, Wangenstein, TC ..... 110  
 Needle Holder, Webster ..... 114  
 Needle Holder, Webster, Econo-Sterile™ ..... 120, 224  
 Needle Holder, Webster, Merit™ ..... 215  
 Needle Holder, Webster, Sklarlite XD™ ..... 112  
 Needle Holder, Webster, Sklarlite™ ..... 112  
 Needle Holder, Webster, Surgi-OR™ ..... 119, 205  
 Needle Holder, Webster, Surgi-OR™ TC ..... 118, 197

Needle Holder, Webster, TC ..... 108, 111  
 Needle Holder, Wireform, Econo-Sterile™ ..... 120, 225  
 ---  
 Needle, Laparoscopic ..... 134  
 Neivert Needle Holder ..... 114  
 Neivert Needle Holder, TC ..... 110  
 New Orleans Needle Holder ..... 116  
 New Orleans Needle Holder, TC ..... 109  
 Newport Probe, Sklar Black™ ..... 172  
 Novak Endometrial Curette ..... 35  
 Nurse's Bandage Scissors ..... 69  
 Nurse's Bandage Scissors, Surgi-OR™ ..... 74, 200  
 Nurses Stethoscope ..... 231

## O

Obstetrical Forceps ..... 38-42  
 Obstetrical Forceps, Delee ..... 39  
 Obstetrical Forceps, Elliot ..... 38  
 Obstetrical Forceps, Hale ..... 39  
 Obstetrical Forceps, Kieland ..... 38  
 Obstetrical Forceps, Kieland-Luikart ..... 38  
 Obstetrical Forceps, Laufe Divergent ..... 40  
 Obstetrical Forceps, Laufe-Piper ..... 38  
 Obstetrical Forceps, Luikart ..... 38  
 Obstetrical Forceps, McLane-Tucker ..... 39  
 Obstetrical Forceps, McLane-Tucker-Luikart ..... 39  
 Obstetrical Forceps, Piper ..... 38  
 Obstetrical Forceps, Simpson ..... 39  
 Obstetrical Forceps, Simpson-Luikart ..... 39  
 Obstetrical Set ..... 176  
 Obturator, Laparoscopic ..... 133  
 Obturator, Laparoscopic Miniature ..... 141  
 Odor Neutralizer Spray, Sklar Fresh™ ..... 274  
 Ointment Jar, Stainless Steel ..... 242  
 Olsen-Hegar Needle Holder ..... 114  
 Olsen-Hegar Needle Holder, Merit™ ..... 214  
 Olsen-Hegar Needle Holder, Sklarlite XD™ ..... 112  
 Olsen-Hegar Needle Holder, Sklarlite™ ..... 112  
 Olsen-Hegar Needle Holder, Surgi-OR™ TC ..... 118, 198  
 Olsen-Hegar Needle Holder, TC ..... 108  
 One Step, Sklar Instru-Guard™ ..... 268  
 Operating Scissors ..... 62  
 Operating Scissors, Econo-Sterile™ ..... 75, 218  
 Operating Scissors, Laparoscopic ..... 122  
 Operating Scissors, Merit™ ..... 209  
 Operating Scissors, Sklar Edge™ TC ..... 53  
 Operating Scissors, Sklarcut™ ..... 55  
 Operating Scissors, Sklarhone™ ..... 58  
 Operating Scissors, Sklarlite XD™ ..... 59  
 Operating Scissors, Sklarlite™ ..... 59  
 Operating Scissors, Sklarlite™ Sklarcut™ ..... 55  
 Operating Scissors, Surgi-OR™ ..... 73, 199  
 Operating Scissors, Surgi-OR™ TC ..... 72, 196  
 Os Dilator Set, Disposable ..... 184  
 Os Dilator, Disposable ..... 184  
 Osteotome Guard ..... 255



O'Sullivan-O'Conner Vaginal Retractor.....	20
Otis Bougie A Boule.....	30
Otis Dittel Urethral Sound.....	30
Oval Biopsy Punch.....	48
Oval Biopsy Punch, Micro-Cut.....	44
Ovum Forceps.....	42

## P

Pad, Instrument Spot Remover.....	260
Pap Smear Tray.....	191
Parametrium Scissors, TC Z-Type.....	37
Pederson Vaginal Speculum.....	10
Pederson Vaginal Speculum, Econo-Sterile™.....	14, 217
Pederson Vaginal Speculum, Merit™.....	207
Pederson Vaginal Speculum, Sklar Black™.....	7, 162
Pederson Vaginal Speculum, Sklar Blue™.....	4, 144
Pederson Vaginal Speculum, Surgi-OR™.....	13, 196
Pediatric Stethoscope.....	230
Pencil Disposable, Electrosurgical.....	152
Peritoneal Scissors, Laparoscopic.....	122
Perrell Fetoscope.....	232
Pessaries.....	185
Phaneuf Uterine Artery Forcep.....	93
Pinard Fetoscope.....	232
Piper Obstetrical Forceps.....	38
Pitcher, Plastic.....	252
Pitcher/Beaker, Stainless Steel.....	238
Plain Splinter Forcep, Merit™.....	213
Plain Splinter Forcep, Surgi-OR™.....	102, 203
Plastic Emesis Basin.....	253
Plastic Graduated Measure Cup.....	252
Plastic Guidewire Bowl.....	253
Plastic Instrument Soaking Tray.....	254
Plastic Medicine Cup.....	252
Plastic Multi-Purpose Utility Bowl.....	252
Plastic Pitcher.....	252
Plastic Procedure Tray.....	254
Plastic Round Basin.....	253
Plastic Solution Basin.....	253
Plastic Specimen Tube.....	252
Plastic Sponge/Utility Bowl.....	253
Plastic Surgery Scissors.....	65
Plastic Surgery Scissors, Sklarcut™.....	57
Plastic Surgery Scissors, Sklarcut™ Gorney.....	57
Plastic Surgery Scissors, Sklarhone™.....	58
Plastic Tray.....	254
Plasticware.....	252-254
Polish, Sklar Instrument.....	274
Poole Suction Tube.....	226
Potts-Smith Forcep, Sklar Black™.....	83, 171
Potts-Smith Forcep, Sklar Blue™.....	80, 150
Powder Detergent, Sklar Kleen™.....	270
Pratt Uterine Dilator.....	32
Precision Suture Scissors.....	68
Precision Suture Scissors, Sklarlite XD™.....	61
Precision Suture Scissors, Sklarlite™.....	61

Presbyterian Tube Occluding Forcep, Econo-Sterile™.....	106, 223
Presbyterian Tube Occluding Forcep, Merit™.....	211
Presbyterian Tube Occluding Forcep, Surgi-OR™.....	103, 204
Probe, Graduated Laparoscopic.....	134
Probe, Sklar Black™ Newport.....	172
Procedure Mask.....	80, 233
Procedure Tray, Plastic.....	254
Procedure Trays.....	189-195
Protective Apparel.....	233
Protectors, SklarTip™ Instrument.....	255
Pryor-Pean Retractor.....	19
Punch, Biopsy, Laparoscopic.....	130
Punch, Laparoscopic, Miniature.....	140
Punch, Tru-Punch™ Disposable Biopsy.....	188
Punches.....	33

## R

Rack, Instrument, Stainless Steel.....	249
Radical Vulvectomy Set.....	179
Ragnell Scissors, Sklarcut™.....	57
Ragnell Scissors, Sklarlite™ Sklarcut™.....	57
Randall Endometrial Biopsy Curette.....	36
Rankin Kelly Forcep, Surgi-OR™.....	101, 201
Recamier Uterine Curette.....	34
Reducer, Laparoscopic.....	133
Remover, Blade.....	234

## RETRACTORS

Retractor, Brantley-Turner Vaginal.....	19
Retractor, Breisky.....	20
Retractor, Delee.....	20
Retractor, Dermal, Sklar Black™.....	167
Retractor, Desmarres Lid, Sklar Black™.....	167
Retractor, Doyen Abdominal.....	19
Retractor, Eastman.....	18
Retractor, Esophagus Laparoscopic.....	135
Retractor, Fan Laparoscopic.....	135
Retractor, Gelpi.....	20
Retractor, Heaney.....	20
Retractor, Jackson Vaginal.....	18
Retractor, Jackson Vaginal, Sklar Black™.....	17, 164
Retractor, Jackson Vaginal, Sklar Blue™.....	16, 147
Retractor, Lateral Vaginal.....	18
Retractor, Lateral Vaginal, Sklar Black™.....	17, 164
Retractor, Lateral Vaginal, Sklar Blue™.....	16, 147
Retractor, O'Sullivan-O'Conner Vaginal.....	20
Retractor, Pryor-Pean.....	19
Retractor, Rigby.....	20
Retractor, Senn, Sklar Black™.....	167
Retractor, Sims Vaginal.....	18-19
Retractor, Sims Vaginal, Sklar Blue™.....	16, 147
Retractor, Sims-Kelly.....	18

--

Ribbon Iris Scissors.....	67
Ribbon Stevens Tenotomy Scissors.....	67
Ribbon Stitch Scissors.....	67
Ribbon Strabismus Scissors.....	67
Ribbon Utility Scissors.....	67
Rigby Retractor.....	20
Ring Pessary.....	185
Rochester-Carmalt Forcep, Merit™.....	211
Rochester-Ochsner Forcep.....	97
Rochester-Ochsner Forcep, Econo-Sterile™.....	105, 221
Rochester-Ochsner Forcep, Merit™.....	211
Rochester-Ochsner Forcep, Sklarlite XD™.....	87
Rochester-Ochsner Forcep, Sklarlite™.....	87
Rochester-Ochsner Forcep, Surgi-OR™.....	101, 202
Rochester-Pean Forcep.....	97
Rochester-Pean Forcep, Econo-Sterile™.....	105, 221
Rochester-Pean Forcep, Merit™.....	211
Rochester-Pean Forcep, Sklar Black™.....	82, 170
Rochester-Pean Forcep, Sklarlite XD™.....	87
Rochester-Pean Forcep, Sklarlite™.....	87
Rochester-Pean Forcep, Surgi-OR™.....	101, 202
Round Basin, Plastic.....	253
Ruler, Sklar Black™ Depth.....	167
Russian Tissue Forcep, Merit™.....	212
Ryder Needle Holder, TC.....	109
Ryder Needle Holder, TC, Left.....	111

## S

Safety Scalpel, SklarSafe™.....	236
Sanitizer, Sklar-Stat™ Foaming Hand.....	273
Sarot Needle Holder.....	116
Sarot Needle Holder, TC.....	109
Scalpel Blade.....	237
Scalpel Handle.....	237
Scalpel, Disposable.....	84, 235
Scalpel, Handle.....	234, 237
Scalpel, Mini Thumb.....	237
Scalpel, SklarSafe™ Safety.....	236
Schroeder Tenaculum Forcep.....	90
Schroeder Tenaculum Forcep, Econo-Sterile™.....	104, 217
Schroeder Tenaculum Forcep, Merit™.....	208
Schroeder Tenaculum Forcep, Sklar Black™.....	82, 169
Schroeder Tenaculum Forcep, Sklar Blue™.....	79, 149
Schroeder Tenaculum Forcep, Surgi-OR™.....	100, 201
Schroeder Vulsellum Forcep.....	93
Schroeder Vulsellum Forcep, Sklar Black™.....	82
Schubert Biopsy Punch.....	50
Schumache Scissors.....	71
Schweizer Forcep.....	90
Schweizer Forcep, Sklar Black™.....	81, 169
Schweizer Forcep, Sklar Blue™.....	79, 149

## SCISSORS

Scissors, Ada Dissecting.....	63
Scissors, Bantam Bandage.....	69



Scissors, Blepharoplasty, Sklar Edge™ TC.....54	Scissors, Mayo-Noble-Stille.....63	Scissors, Stevens, Surgi-OR™.....73, 199
Scissors, Braun Episiotomy.....71	Scissors, Mayo-Stille.....63	Scissors, Stitch.....68
Scissors, Brophy Sullivan.....71	Scissors, Mayo-Stille, Sklar Edge™ TC.....53	Scissors, Strabismus.....66
Scissors, Busch Umbilical.....71	Scissors, Metzenbaum.....64	Scissors, Strabismus, Econo-Sterile™.....76, 219
Scissors, Commander Utility.....69	Scissors, Metzenbaum, Econo-Sterile™.....75, 218	Scissors, Strabismus, Sklar Edge™ TC.....54
Scissors, Crown.....70	Scissors, Metzenbaum, Merit™.....209	Scissors, Strabismus, Sklarlite XD™.....60
Scissors, Dissecting, Sklar Edge™ TC.....54	Scissors, Metzenbaum, Sklar Edge™ TC.....54	Scissors, Strabismus, Sklarlite™.....60
Scissors, Doyen.....64	Scissors, Metzenbaum, Sklarcut™.....56	Scissors, Strabismus, Surgi-OR™.....74, 200
Scissors, Dura.....65	Scissors, Metzenbaum, Sklarhone™.....58	Scissors, Strabismus, Surgi-OR™ TC.....197
Scissors, Esmarch Plaster.....70	Scissors, Metzenbaum, Sklarhone™ Sklarlite™.....58	Scissors, Suture.....68
Scissors, Fomon Lateral, Sklarcut™.....57	Scissors, Metzenbaum, Sklarlite XD™.....59-60	Scissors, Suture Wire Cutting.....68
Scissors, Goldman-Fox, Sklarcut™.....56	Scissors, Metzenbaum, Sklarite™.....59-60	Scissors, TC Z-Type Parametrium.....37
Scissors, Gorney Face Lift, Sklarcut™.....57	Scissors, Metzenbaum, Sklarite™ Sklarcut™.....56	Scissors, Umbilical.....71
Scissors, Gorney Plastic Surgery, Sklarcut™.....57	Scissors, Metzenbaum, Surgi-OR™.....73, 199	Scissors, Umbilical, Merit™.....208
Scissors, Harrington-Mayo.....63	Scissors, Metzenbaum, Surgi-OR™ TC.....72, 197	Scissors, US Army.....70
Scissors, Hercules Utility.....69	Scissors, Moleskin.....70	Scissors, Utility.....67, 71
Scissors, Hi-Level.....70	Scissors, Nurse's Bandage.....69	Scissors, Utility, Econo-Sterile™.....77, 220
Scissors, Iris.....66	Scissors, Nurse's Bandage, Surgi-OR™.....74, 200	Scissors, Utility, Merit™.....210
Scissors, Iris, Econo-Sterile™.....75, 218	Scissors, Operating.....62	Scissors, Utility, Surgi-OR™.....74, 200
Scissors, Iris, Merit™.....209	Scissors, Operating, Econo-Sterile™.....75, 218	Scissors, Wagner, Sklarcut™.....56
Scissors, Iris, Sklar Edge™ TC.....53	Scissors, Operating, Merit™.....209	Scissors, Wagner, Sklarlite™ Sklarcut™.....56
Scissors, Iris, Sklarcut™.....55	Scissors, Operating, Sklar Edge™ TC.....53	Scissors, Waldmann Episiot.....71
Scissors, Iris, Sklarhone™.....58	Scissors, Operating, Sklarcut™.....55	Scissors, Wire Cutting, Econo-Sterile™.....76, 219
Scissors, Iris, Sklarlite XD™.....60	Scissors, Operating, Sklarhone™.....58	Scissors, Wire Cutting, Merit™.....210
Scissors, Iris, Sklarlite™.....60	Scissors, Operating, Sklarlite XD™.....59	Scissors, Wire Cutting, Sklar Edge™ TC.....54
Scissors, Iris, Sklarlite™ Sklarcut™.....55	Scissors, Operating, Sklarlite™.....59	Scissors, Wire Cutting, Surgi-OR™.....74, 200
Scissors, Iris, Surgi-OR™.....73, 199	Scissors, Operating, Sklarlite™ Sklarcut™.....55	Scissors, Wire Cutting, Surgi-OR™ TC.....197
Scissors, Iris, Surgi-OR™ TC.....72, 196	Scissors, Operating, Surgi-OR™.....73, 199	Scissors, Wire Suture.....68
Scissors, Kaye Face Lift, Sklarcut™.....57	Scissors, Operating, Surgi-OR™ TC.....72, 196	Scissors, Wireform Econo-Sterile™.....225
Scissors, Kelly-Adson.....65	Scissors, Plastic Surgery.....65	Scoop, Lab/Utility, Stainless Steel.....241
Scissors, Knowles Bandage.....70	Scissors, Plastic Surgery, Sklarcut™.....57	---
Scissors, Knowles Bandage, Econo-Sterile™.....76, 219	Scissors, Plastic Surgery, Sklarhone™.....58	Segond (Collin) Forcep.....92
Scissors, Knowles Bandage, Surgi-OR™.....74, 200	Scissors, Precision Suture.....68	Segond Vaginal Spatula.....19
Scissors, Laparoscopic.....122-123	Scissors, Precision Suture, Sklarlite XD™.....61	Segund Vaginal Spatula, Sklar Blue™.....16, 147
Scissors, Laparoscopic, Miniature.....139-140	Scissors, Precision Suture, Sklarlite™.....61	Semkin Bipolar Forcep, Electrosurgical.....160
Scissors, Lister Bandage.....69	Scissors, Ragnell, Sklarcut™.....57	Senn Retractor, Sklar Black™.....167
Scissors, Lister Bandage, Econo-Sterile™.....76, 219	Scissors, Ragnell, Sklarlite™ Sklarcut™.....57	
Scissors, Lister Bandage, Merit™.....210	Scissors, Ribbon Utility.....67	
Scissors, Lister Bandage, Sklarlite XD™.....61	Scissors, Ribbon Iris.....67	
Scissors, Lister Bandage, Sklarlite™.....61	Scissors, Ribbon Stevens Tenotomy.....67	
Scissors, Lister Bandage, Surgi-OR™.....74, 200	Scissors, Ribbon Stitch.....67	
Scissors, Littauer Stitch, Econo-Sterile™.....76, 219	Scissors, Ribbon Strabismus.....67	
Scissors, Littauer Stitch, Merit™.....209	Scissors, Schumache.....71	
Scissors, Littauer Stitch, Surgi-OR™.....74, 200	Scissors, Shortbent Suture.....68	
Scissors, Mayo.....63	Scissors, Shortbent Suture, Sklarlite XD™.....61	
Scissors, Mayo, Econo-Sterile™.....75, 218	Scissors, Shortbent Suture, Sklarite™.....61	
Scissors, Mayo, Merit™.....209	Scissors, Sims.....65	
Scissors, Mayo, Sklar Edge™ TC.....53	Scissors, Spencer Stitch.....67	
Scissors, Mayo, Sklarcut™.....55	Scissors, Spencer Stitch, Econo-Sterile™.....76, 219	
Scissors, Mayo, Sklarhone™.....58	Scissors, Spencer Stitch, Merit™.....209	
Scissors, Mayo, Sklarlite XD™.....59	Scissors, Spencer Stitch, Sklarlite XD™.....61	
Scissors, Mayo, Sklarlite™.....59	Scissors, Spencer Stitch, Sklarlite™.....61	
Scissors, Mayo, Sklarlite™ Sklarcut™.....56	Scissors, Spencer Stitch, Surgi-OR™.....74, 200	
Scissors, Mayo, Surgi-OR™.....73, 199	Scissors, Stevens.....66	
Scissors, Mayo, Surgi-OR™ TC.....72, 197	Scissors, Stevens, Sklarcut™.....55	
Scissors, Mayo-Noble.....63	Scissors, Stevens, Sklarlite XD™.....60	
Scissors, Mayo-Noble.....63	Scissors, Stevens, Sklarlite™.....60	

## SETS

Set, Brush, Cleaning.....261-262
Set, Cesarean Section.....177
Set, Colposcopy.....51
Set, D&C.....174
Set, Dilator.....32
Set, Dittel Urethral Sound.....30
Set, Emmett Hook.....27
Set, Emmett Hook, Sklar Black™.....25, 166
Set, Emmett Hook, Sklar Blue™.....24, 151
Set, Endometrial Sampling, Disposable.....187
Set, GYN Abdominal.....178
Set, Gynecological Biopsy.....176, 177
Set, Gynecological Surgery.....175
Set, Hank Uterine Dilator.....31
Set, Hegar Uterine Dilator.....31
Set, Hegar Uterine Dilator, Merit™.....208
Set, Hysterectomy.....177
Set, Iris Hook.....177

Set, Iris Hook, Sklar Black™	25, 166
Set, Iris Hook, Sklar Blue™	24, 151
Set, Keyes Skin Biopsy	33
Set, Laparoscopic	142
Set, Laparoscopic Trocar, Miniature	141
Set, Major Basic Surgery	173-174
Set, Obstetrical	176
Set, Os Dilator, Disposable	184
Set, Otis Bougie A Boule	30
Set, Otis Dittel Urethral Sound	30
Set, Pratt Uterine Dilator	32
Set, Radical Vulvectomy	179
Set, Sims Uterine Curette	34
Set, Thomas Uterine Curette	34
Set, Van Buren Urethral Sound	29
Set, Walther Dilator	33

--

Sharpening Stone, Biopsy Punch	33
Shortbent Suture Scissors	68
Shortbent Suture Scissors, Sklarlite XD™	61
Shortbent Suture Scissors, Sklarlite™	61
Silicon Mat, SklarLite™	251
Simpson Obstetrical Forceps	39
Simpson Uterine Sound	29
Simpson-Luikart Obstetrical Forceps	39
Sims Scissors	65
Sims Uterine Curette	34
Sims Uterine Sound	29
Sims Uterine Sound, Merit™	207
Sims Vaginal Retractor	18-19
Sims Vaginal Retractor, Sklar Blue™	16, 147
Sims-Kelly Retractor	18
Singley Forcep, Sklar Black™	84, 171
Singley Forcep, Sklar Blue™	80, 150

### SKLAR BLACK™

Sklar Black™ Adson Dressing Forcep	82, 170
Sklar Black™ Adson Tissue Forcep	170
Sklar Black™ Adson-Brown Forcep	83, 170
Sklar Black™ Allis Tissue Forcep	82, 170
Sklar Black™ Auvard Vaginal Speculum	8-9, 163
Sklar Black™ Babcock Forcep	82, 169
Sklar Black™ Bozeman Forcep	81, 168
Sklar Black™ Champion Forcep	81, 168
Sklar Black™ Castro Caliper	172
Sklar Black™ Castroviejo Forcep	84, 171
Sklar Black™ Clemetson Forcep	81, 169
Sklar Black™ Collin Vaginal Speculum	8, 164
Sklar Black™ DeBaKey Forcep	83, 171
Sklar Black™ Delee Uterine Forcep	81, 168
Sklar Black™ Depth Ruler	167
Sklar Black™ Dermal Retractor	167
Sklar Black™ Desmarres Lid Retractor	167
Sklar Black™ Dressing Forcep	83, 170
Sklar Black™ Emmett Hook	25, 166
Sklar Black™ Frazier Tissue Hook	26, 166

Sklar Black™ Freeway Graves Vaginal Speculum	8, 163
Sklar Black™ Gerald Forcep	84, 171
Sklar Black™ Gillies Hook	26, 166
Sklar Black™ Graves Vaginal Speculum	7-8, 162-163
Sklar Black™ Guthrie Double Hook	26, 167
Sklar Black™ Heaney Needle Holder	172
Sklar Black™ Iris Hook	25, 166
Sklar Black™ Jackson Vaginal Retractor	17, 164
Sklar Black™ Joseph Hook	26, 167
Sklar Black™ Kogan Endocervical Speculum	22, 165
Sklar Black™ Laser Instruments	162-172
Sklar Black™ Lateral Vaginal Retractor	17, 164
Sklar Black™ Laufe Uterine Polyp Forcep	81, 169
Sklar Black™ Mayo-Hegar Needle Holder	172
Sklar Black™ Newport Probe	172
Sklar Black™ Pederson Vaginal Speculum	7, 162
Sklar Black™ Potts-Smith Forcep	83, 171
Sklar Black™ Rochester-Pean Forcep	82, 170
Sklar Black™ Schroeder Tenaculum Forcep	82, 169
Sklar Black™ Schroeder Vulsellum Forcep	82
Sklar Black™ Schweizer Forcep	81, 169
Sklar Black™ Senn Retractor	167
Sklar Black™ Singley Forcep	84, 171
Sklar Black™ Steiner-Auvard Vaginal Speculum	9, 164
Sklar Black™ Tissue Forcep	83, 171
Sklar Black™ Tuttle Forcep	84, 171
Sklar Black™ Tyrell Iris Hook	26, 166

### SKLAR BLUE™

Sklar Blue™ Adson Dressing Forcep	80, 150
Sklar Blue™ Allis Tissue Forcep	79, 149
Sklar Blue™ Auvard Vaginal Speculum	6, 146
Sklar Blue™ Babcock Forcep	79, 149
Sklar Blue™ Bozeman Forcep	79
Sklar Blue™ Clemetson Forcep	79, 149
Sklar Blue™ Collin Vaginal Speculum	6, 146
Sklar Blue™ Cusco Vaginal Speculum	5, 145
Sklar Blue™ Dressing Forcep	80, 150
Sklar Blue™ Emmett Hook	24, 151
Sklar Blue™ Freeway Graves Vaginal Speculum	5, 145
Sklar Blue™ Graves Vaginal Speculum	4-5, 144-145
Sklar Blue™ Iris Hook	24, 151
Sklar Blue™ Jackson Vaginal Retractor	16, 147
Sklar Blue™ Kogan Endocervical Speculum	21, 148
Sklar Blue™ Lateral Vaginal Retractor	16, 147
Sklar Blue™ Laufe Uterine Polyp Forcep	79, 149
Sklar Blue™ Pederson Vaginal Speculum	4, 144
Sklar Blue™ Potts-Smith Forcep	80, 150
Sklar Blue™ Schroeder Tenaculum Forcep	79, 149
Sklar Blue™ Schweizer Forcep	79, 149
Sklar Blue™ Segund Vaginal Spatula	16, 147
Sklar Blue™ Sims Vaginal Retractor	16, 147
Sklar Blue™ Singley Forcep	80, 150
Sklar Blue™ Steiner-Auvard Vaginal Speculum	6, 146
Sklar Blue™ Tauber Vaginal Spatula	16, 147

Sklar Blue™ Tuttle Forcep	80, 150
Sklar Disinfectant	46, 264

### SKLAR EDGE™

Sklar Edge™ TC Blepharoplasty Scissors	54
Sklar Edge™ TC Dissecting Scissors	54
Sklar Edge™ TC Iris Scissors	53
Sklar Edge™ TC Mayo Scissors	53
Sklar Edge™ TC Mayo-Stille Scissors	53
Sklar Edge™ TC Metzenbaum Scissors	54
Sklar Edge™ TC Operating Scissors	53
Sklar Edge™ TC Strabismus Scissors	54
Sklar Edge™ TC Wire Cutting Scissors	54

--

Sklar Enzymatic™ Detergent	271
Sklar Fresh™ Odor Neutralizer Spray	274
Sklar ID Roll Tape	256
Sklar Instru-Guard™ Lube	269
Sklar Instru-Guard™ One Step	268
Sklar Instrument Care Kit	17, 275
Sklar Instrument Polish	274
Sklar Kleen™ Liquid Detergent	270
Sklar Kleen™ Low Foam Detergent	270
Sklar Kleen™ Powder Detergent	270
Sklar Soak™	13, 267
Sklar Spray-Zyme™	266
Sklar Surface Wipes Disinfectant	50, 265
Sklar-Cide™	263

### SKLAR CUT™

Sklarcut™ Fomon Lateral Scissors	57
Sklarcut™ Goldman-Fox Scissors	56
Sklarcut™ Gorney Face Lift Scissors	57
Sklarcut™ Gorney Plastic Surgery Scissors	57
Sklarcut™ Iris Scissors	55
Sklarcut™ Iris Scissors, Sklarlite™	55
Sklarcut™ Kaye Face Lift Scissors	57
Sklarcut™ Mayo Scissors	55
Sklarcut™ Mayo Scissors, Sklarlite™	56
Sklarcut™ Metzenbaum Scissors	56
Sklarcut™ Metzenbaum Scissors, Sklarlite™	56
Sklarcut™ Operating Scissors	55
Sklarcut™ Operating Scissors, Sklarlite™	55
Sklarcut™ Plastic Surgery Scissors	57
Sklarcut™ Ragnell Scissors	57
Sklarcut™ Ragnell Scissors, Sklarlite™	57
Sklarcut™ Stevens Scissors	55
Sklarcut™ Wagner Scissors	56
Sklarcut™ Wagner Scissors, Sklarlite™	56

### SKLARHONE™

Sklarhone™ Iris Scissors	58
Sklarhone™ Mayo Scissors	58



Sklarhone™ Metzenbaum Scissors .....	58
Sklarhone™ Operating Scissors .....	58
Sklarhone™ Plastic Surgery Scissors .....	58
Sklarhone™ Sklarlite™ Metzenbaum Scissors .....	58

## SKLARLITE XD™

Sklarlite XD™ Adson Dressing Forcep .....	87
Sklarlite XD™ Adson Tissue Forcep .....	87
Sklarlite XD™ Adson-Brown Tissue Forcep .....	87-88
Sklarlite XD™ Allis Tissue Forcep .....	87
Sklarlite XD™ Baumgartner Needle Holder .....	113
Sklarlite XD™ Crile Forcep .....	86
Sklarlite XD™ Crile-Wood Needle Holder .....	113
Sklarlite XD™ Derf Needle Holder .....	112
Sklarlite XD™ Dressing Forcep .....	88
Sklarlite XD™ Halsey Needle Holder .....	112
Sklarlite XD™ Halsted Mosquito Forcep .....	86
Sklarlite XD™ Hartmann Mosquito Forcep .....	86
Sklarlite XD™ Iris Scissors .....	60
Sklarlite XD™ Kelly Forcep .....	86
Sklarlite XD™ Lister Bandage Scissors .....	61
Sklarlite XD™ Mayo Scissors .....	59
Sklarlite XD™ Mayo-Hegar Needle Holder .....	113
Sklarlite XD™ Metzenbaum Scissors .....	59-60
Sklarlite XD™ Olsen-Hegar Needle Holder .....	112
Sklarlite XD™ Operating Scissors .....	59
Sklarlite XD™ Precision Suture Scissors .....	61
Sklarlite XD™ Rochester-Ochsner Forcep .....	87
Sklarlite XD™ Rochester-Pean Forcep .....	87
Sklarlite XD™ Shortbent Suture Scissors .....	61
Sklarlite XD™ Spencer Stitch Scissors .....	61
Sklarlite XD™ Stevens Scissors .....	60
Sklarlite XD™ Strabismus Scissors .....	60
Sklarlite XD™ Tissue Forcep .....	88
Sklarlite XD™ Webster Needle Holder .....	112

## SKLARLITE™

SklarLite™ Accessories .....	251
Sklarlite™ Adson Dressing Forcep .....	87-88
Sklarlite™ Adson Tissue Forcep .....	87-88
Sklarlite™ Adson-Brown Tissue Forcep .....	87
Sklarlite™ Allis Tissue Forcep .....	87
Sklarlite™ Baumgartner Needle Holder .....	113
Sklarlite™ Crile Forcep .....	86
Sklarlite™ Crile-Wood Needle Holder .....	113
Sklarlite™ Derf Needle Holder .....	112
Sklarlite™ Dressing Forcep .....	88
Sklarlite™ Halsey Needle Holder .....	112
Sklarlite™ Halsted Mosquito Forcep .....	86
Sklarlite™ Hartmann Mosquito Forcep .....	86
Sklarlite™ Iris Scissors .....	60
Sklarlite™ Kelly Forcep .....	86
Sklarlite™ Lister Bandage Scissors .....	61
Sklarlite™ Mayo Scissors .....	59
Sklarlite™ Mayo-Hegar Needle Holder .....	113

Sklarlite™ Metzenbaum Scissors .....	59-60
Sklarlite™ Metzenbaum Scissors, Sklarhone™ .....	58
Sklarlite™ Olsen-Hegar Needle Holder .....	112
Sklarlite™ Operating Scissors .....	59
Sklarlite™ Precision Suture Scissors .....	61
Sklarlite™ Rochester-Ochsner Forcep .....	87
Sklarlite™ Rochester-Pean Forcep .....	87
Sklarlite™ Shortbent Suture Scissors .....	61
SklarLite™ Silicon Mat .....	251
Sklarlite™ Sklarcut™ Iris Scissors .....	55
Sklarlite™ Sklarcut™ Mayo Scissors .....	56
Sklarlite™ Sklarcut™ Metzenbaum Scissors .....	56
Sklarlite™ Sklarcut™ Operating Scissors .....	55
Sklarlite™ Sklarcut™ Ragnell Scissors .....	57
Sklarlite™ Sklarcut™ Wagner Scissors .....	56
Sklarlite™ Spencer Stitch Scissors .....	61
SklarLite™ Sterilization Basket .....	251
SklarLite™ Sterilization Container .....	250
Sklarlite™ Stevens Scissors .....	60
Sklarlite™ Strabismus Scissors .....	60
Sklarlite™ Tissue Forcep .....	88
Sklarlite™ Webster Needle Holder .....	112

---	---
SklarSafe™ Safety Scalpel .....	236
SklarSpec™ Graves Vaginal Speculum Lighted, Disposable .....	181
SklarSpec™ Graves Vaginal Speculum, Disposable .....	180
Sklar-Stat™ Dispenser Bottle .....	273
Sklar-Stat™ Foam Dispenser .....	273
Sklar-Stat™ Foaming Hand Sanitizer .....	273
SklarTech 5000™ Laparoscopic Instruments .....	121-142
SklarTip™ Instrument Protectors .....	255
Smoke Evacuation Tubing, Disposable .....	5, 8, 145, 163
Solution Basin, Plastic .....	253
Solution Basin, Stainless Steel .....	239
Somer Uterine Forcep .....	96
Sound, Dittel Urethral .....	30
Sound, Merit™ Sims Uterine .....	207
Sound, Otis Dittel Urethral .....	30
Sound, Simpson Uterine .....	29
Sound, Sims Uterine .....	29
Sound, Van Buren Urethral .....	29
Sounds .....	29-30
Spatula, Segond Vaginal .....	19
Spatula, Segund Vaginal, Sklar Blue™ .....	16, 147
Spatula, Tauber Vaginal .....	19
Spatula, Tauber Vaginal, Sklar Blue™ .....	16, 147
Specimen Tube, Plastic .....	252

## SPECULA

Speculum, Auvard Vaginal .....	12
Speculum, Berlind-Auvard Vaginal .....	12
Speculum, Collin Vaginal .....	11
Speculum, Cusco Vaginal .....	11
Speculum, Devilbiss Vaginal .....	11
Speculum, Disposable Cusco Vaginal .....	181

Speculum, Econo-Sterile™ Cusco Vaginal .....	14
Speculum, Econo-Sterile™ Graves Vaginal .....	14, 217
Speculum, Econo-Sterile™ Pederson Vaginal .....	14, 217
Speculum, Freeway Graves Vaginal .....	11
Speculum, Garrigue Vaginal .....	12
Speculum, Graves Vaginal .....	10-11
Speculum, Henrotin Vaginal .....	12
Speculum, Kogan Endocervical .....	23
Speculum, Merit™ Graves Vaginal .....	207
Speculum, Merit™ Pederson Vaginal .....	207
Speculum, Pederson Vaginal .....	10
Speculum, Sklar Black™ Auvard Vaginal .....	8-9, 163
Speculum, Sklar Black™ Collin Vaginal .....	8, 164
Speculum, Sklar Black™ Freeway Graves Vaginal .....	8, 163
Speculum, Sklar Black™ Graves Vaginal .....	7-8, 162-163
Speculum, Sklar Black™ Kogan Endocervical .....	22, 165
Speculum, Sklar Black™ Pederson Vaginal .....	7, 162
Speculum, Sklar Black™ Steiner-Auvard Vaginal .....	9
Speculum, Sklar Blue™ Auvard Vaginal .....	6, 146
Speculum, Sklar Blue™ Collin Vaginal .....	6, 146
Speculum, Sklar Blue™ Cusco Vaginal .....	5, 145
Speculum, Sklar Blue™ Freeway Graves Vaginal .....	5, 145
Speculum, Sklar Blue™ Graves Vaginal .....	4-5, 144-145
Speculum, Sklar Blue™ Kogan Endocervical .....	21, 148
Speculum, Sklar Blue™ Pederson Vaginal .....	4, 144
Speculum, Sklar Blue™ Steiner-Auvard Vaginal .....	6, 146
Speculum, SklarSpec™ Disposable Graves Vaginal .....	180
Speculum, SklarSpec™ Disposable Graves Vaginal Lighted .....	181
Speculum, Steiner Auvard Vaginal .....	12
Speculum, Surgi-OR™ Graves Vaginal .....	13, 196
Speculum, Surgi-OR™ Pederson Vaginal .....	13, 196

---	---
Spencer Stitch Scissors .....	67
Spencer Stitch Scissors, Econo-Sterile™ .....	76, 219
Spencer Stitch Scissors, Merit™ .....	209
Spencer Stitch Scissors, Sklarlite XD™ .....	61
Spencer Stitch Scissors, Sklarlite™ .....	61
Spencer Stitch Scissors, Surgi-OR™ .....	74, 200
Sponge Bowl, Stainless Steel .....	239
Sponge Forcep, Wireform Econo-Sterile™ .....	225
Sponge/Utility Bowl, Plastic .....	253
Spoon Forcep, Laparoscopic .....	125
Sprague Rappaport Stethoscope .....	227
Spray, Sklar Fresh™ Odor Neutralizer .....	274
S-Retractor, Laparoscopic .....	133

## STAINLESS STEEL

Stainless Steel Catheter Instrument Tray .....	243
Stainless Steel Catheter Instrument Tray Cover .....	243
Stainless Steel Catheter Instrument Tray, Miniature .....	242
Stainless Steel Cleaning Basket .....	244
Stainless Steel Dressing Jar .....	241
Stainless Steel Emesis Basin .....	240
Stainless Steel Forcep Jar .....	241, 260

Stainless Steel Funnel .....	241
Stainless Steel Graduated Measure Cup.....	239
Stainless Steel Hospital Bucket .....	240
Stainless Steel Hospital Kick Bucket .....	240
Stainless Steel Instrument Drying Tray.....	244
Stainless Steel Instrument Rack .....	249
Stainless Steel Instrument Stringer.....	248-249
Stainless Steel Instrument Tray .....	245
Stainless Steel Instrument Tray Cover.....	245
Stainless Steel Iodine Cup .....	238
Stainless Steel Lab/Utility Scoop .....	241
Stainless Steel Lifting Handles .....	247
Stainless Steel Mayo Tray .....	243
Stainless Steel Medicine Cup.....	238
Stainless Steel Micro Sterilization Tray.....	247
Stainless Steel Micro Sterilization Tray Cover .....	247
Stainless Steel Mixing/Solution Bowl.....	239
Stainless Steel Ointment Jar.....	242
Stainless Steel Pitcher/Beaker.....	238
Stainless Steel Solution Basin .....	239
Stainless Steel Sponge Bowl.....	239
Stainless Steel Sterilization Tray.....	246-247
Stainless Steel Sterilization Tray Cover .....	246
Stainless Steel Sterilization Tray Handle .....	247
Stainless Steel Sterilization/Bath Set Tray .....	246
Stainless Steel Sterilizing Tray.....	245
Stainless Steel Storage Container .....	240
Stainless Steel Tumbler .....	238
Stainless Steelware .....	238-251
--	
Standard CT Biopsy Tray .....	189
Staude-Moore Tenaculum Forcep.....	91
Steiner Auvard Vaginal Speculum.....	12
Steiner-Auvard Vaginal Speculum, Sklar Black™ 9, 164	
Steiner-Auvard Vaginal Speculum, Sklar Blue™ .6, 146	
Sterilization Basket, SklarLite™.....	251
Sterilization Container, SklarLite™ .....	250
Sterilization Tray Cover, Stainless Steel .....	246
Sterilization Tray Handle, Stainless Steel .....	247
Sterilization Tray, Stainless Steel.....	246-247
Sterilization/Bath Set Tray, Stainless Steel .....	246
Sterilizing Tray, Stainless Steel.....	245
Sternal Wire Twister Needle Holder, TC .....	109
Stethoscope, Adult .....	229
Stethoscope, Bowles .....	232
Stethoscope, Cardiology.....	228
Stethoscope, Disposable .....	231
Stethoscope, Fetal .....	230
Stethoscope, Infant.....	230
Stethoscope, Nurses.....	231
Stethoscope, Pediatric.....	230
Stethoscope, Sprague Rappaport.....	227
Stethoscope, Teaching/Training.....	231
Stethoscopes .....	227-232
Stevens Scissors .....	66
Stevens Scissors, Sklarcut™ .....	55
Stevens Scissors, Sklarlite XD™ .....	60
Stevens Scissors, Sklarlite™ .....	60
Stevens Scissors, Surgi-OR™ .....	73, 199
Stitch Cutter .....	237
Stitch Scissors .....	68
Storage Container, Stainless Steel .....	240
Strabismus Scissors .....	66
Strabismus Scissors, Econo-Sterile™ .....	76, 219
Strabismus Scissors, Sklar Edge™ TC.....	54
Strabismus Scissors, Sklarite XD™ .....	60
Strabismus Scissors, Sklarite™ .....	60
Strabismus Scissors, Surgi-OR™ .....	74, 200
Strabismus Scissors, Surgi-OR™ TC .....	197
Straight Electrode Disposable, Electrosurgical. 156-157	
Stratte Needle Holder .....	116
Stratte Needle Holder, TC.....	109
Stringer, Instrument, Stainless Steel.....	248-249
Strips, Glutaraldehyde .....	263
Suction Irrigation System, Laparoscopic.....	136
Suction Tube, Adson.....	226
Suction Tube, Baron .....	226
Suction Tube, Buie.....	226
Suction Tube, Cleaning Brush .....	259
Suction Tube, Frazier.....	226
Suction Tube, Poole.....	226
Suction Tube, Yankauer.....	226
Suction Tubes .....	226
Surface Wipes Disinfectant, Sklar .....	50, 265
Surgical Gown.....	233
Surgical Scrub Brush .....	259
<b>SURGI-OR™</b>	
Surgi-OR™ Adson Dressing Forcep.....	102, 203
Surgi-OR™ Adson Tissue Forcep.....	102, 203
Surgi-OR™ Adson-Brown Tissue Forcep .....	102, 203
Surgi-OR™ Allis Tissue Forcep .....	101, 202
Surgi-OR™ Babcock Forcep .....	100, 201
Surgi-OR™ Backhaus Towel Forcep .....	103, 204
Surgi-OR™ Baumgartner Needle Holder.....	119, 205
Surgi-OR™ Bozeman Forcep .....	100, 201
Surgi-OR™ Crile Forcep.....	100, 201
Surgi-OR™ Derf Needle Holder.....	119, 205
Surgi-OR™ Dressing Forcep.....	102, 203
Surgi-OR™ Foerster Sponge Forcep .....	103, 204
Surgi-OR™ Graves Vaginal Speculum .....	13, 196
Surgi-OR™ Halsey Needle Holder .....	119, 205
Surgi-OR™ Halsted Mosquito Forcep .....	100, 202
Surgi-OR™ Hartmann Mosquito Forcep.....	101, 202
Surgi-OR™ Instruments.....	186-205
Surgi-OR™ Iris Scissors .....	73, 199
Surgi-OR™ Kelly Forcep .....	100, 201
Surgi-OR™ Knowles Bandage Scissors.....	74, 200
Surgi-OR™ Lister Bandage Scissors.....	74, 200
Surgi-OR™ Littauer Stitch Scissors.....	74, 200
Surgi-OR™ Lorna Edna Towel Forcep.....	103, 204
Surgi-OR™ Magill Catheter Forcep.....	103, 204
Surgi-OR™ Mayo Scissors .....	73, 199
Surgi-OR™ Mayo-Hegar Needle Holder.....	119, 205
Surgi-OR™ Metzenbaum Scissors .....	73, 199
Surgi-OR™ Nurse's Bandage Scissors .....	74, 200
Surgi-OR™ Operating Scissors .....	73, 199
Surgi-OR™ Pederson Vaginal Speculum .....	13, 196
Surgi-OR™ Plain Splinter Forcep .....	102, 203
Surgi-OR™ Presbyterian Tube Occluding Forcep.....	103, 204
Surgi-OR™ Rankin Kelly Forcep .....	101, 201
Surgi-OR™ Rochester-Ochsner Forcep .....	101, 202
Surgi-OR™ Rochester-Pean Forcep .....	101, 202
Surgi-OR™ Schroeder Tenaculum Forcep .....	100, 201
Surgi-OR™ Spencer Stitch Scissors .....	74, 200
Surgi-OR™ Stevens Scissors.....	73, 199
Surgi-OR™ Strabismus Scissors.....	74, 200
Surgi-OR™ TC Baumgartner Needle Holder... ..	118, 198
Surgi-OR™ TC Crile-Murray Needle Holder .....	198
Surgi-OR™ TC Crile-Wood Needle Holder.....	118, 198
Surgi-OR™ TC Derf Needle Holder .....	118, 197
Surgi-OR™ TC Halsey Needle Holder.....	118, 198
Surgi-OR™ TC Iris Scissors .....	72, 196
Surgi-OR™ TC Mayo Scissors .....	72, 197
Surgi-OR™ TC Mayo-Hegar Needle Holder... ..	118, 198
Surgi-OR™ TC Metzenbaum Scissors .....	72, 197
Surgi-OR™ TC Olsen-Hegar Needle Holder ...	118, 198
Surgi-OR™ TC Operating Scissors .....	72, 196
Surgi-OR™ TC Strabismus Scissors.....	197
Surgi-OR™ TC Webster Needle Holder .....	118, 197
Surgi-OR™ TC Wire Cutting Scissors .....	197
Surgi-OR™ Tissue Forcep.....	102, 203
Surgi-OR™ Utility Scissors .....	74, 200
Surgi-OR™ Webster Needle Holder .....	119, 205
Surgi-OR™ Wire Cutting Scissors .....	74, 200
--	
Suture Scissors.....	68
Suture Wire Cutting Scissors .....	68
<b>T</b>	
Tags, Instrument ID.....	256
Tape, ID Sheet .....	256
Tape, Sklar ID Roll .....	256
Tauber Vaginal Spatula .....	19
Tauber Vaginal Spatula, Sklar Blue™ .....	16, 147
<b>TUNGSTEN CARBIDE</b>	
TC Adson Dressing Forcep.....	85
TC Adson Tissue Forcep.....	85
TC Adson-Brown Tissue Forcep .....	85
TC Allis Tissue Forcep .....	85
TC Babcock Forcep .....	85
TC Baumgartner Needle Holder .....	108
TC Baumgartner Needle Holder, Surgi-OR™ ..	118, 198
TC Blepharoplasty Scissors, Sklar Edge™ ..	54
TC Castroviejo Needle Holder .....	110
TC Crile-Murray Needle Holder .....	109

TC Crile-Murray Needle Holder, Surgi-OR™ ..... 198  
 TC Crile-Wood Needle Holder ..... 108  
 TC Crile-Wood Needle Holder, Left..... 111  
 TC Crile-Wood Needle Holder, Surgi-OR™ ..... 118, 198  
 TC Derf Needle Holder ..... 108  
 TC Derf Needle Holder, Surgi-OR™ ..... 118, 197  
 TC Dissecting Scissors, Sklar Edge™ ..... 54  
 TC Dressing Forcep ..... 85  
 TC Finochietto Needle Holder..... 110  
 TC Gillies Needle Holder ..... 110  
 TC Halsey Needle Holder ..... 108  
 TC Halsey Needle Holder, Surgi-OR™ ..... 118, 198  
 TC Heaney Needle Holder..... 109  
 TC Iris Scissors, Sklar Edge™ ..... 53  
 TC Iris Scissors, Surgi-OR™ ..... 72, 196  
 TC Jacobson Needle Holder..... 110  
 TC Mathieu Needle Holder ..... 108  
 TC Mayo Scissors, Sklar Edge™ ..... 53  
 TC Mayo Scissors, Surgi-OR™ ..... 72, 197  
 TC Mayo-Hegar Needle Holder ..... 108  
 TC Mayo-Hegar Needle Holder, Left..... 111  
 TC Mayo-Hegar Needle Holder, Surgi-OR™ ..... 118, 198  
 TC Mayo-Stille Scissors, Sklar Edge™ ..... 53  
 TC Metzbaum Scissors, Sklar Edge™ ..... 53-54  
 TC Metzbaum Scissors, Surgi-OR™ ..... 72, 197  
 TC Needle Holder, Laparoscopic ..... 137  
 TC Needle Holder, Laparoscopic, Miniature ..... 140  
 TC Neivert Needle Holder..... 110  
 TC New Orleans Needle Holder ..... 109  
 TC Olsen-Hegar Needle Holder..... 108  
 TC Olsen-Hegar Needle Holder, Surgi-OR™ ..... 118, 198  
 TC Operating Scissors, Sklar Edge™ ..... 53  
 TC Operating Scissors, Surgi-OR™ ..... 72, 196  
 TC Ryder Needle Holder..... 109  
 TC Ryder Needle Holder, Left..... 111  
 TC Sarot Needle Holder..... 109  
 TC Sternal Wire Twister Needle Holder ..... 109  
 TC Strabismus Scissors, Sklar Edge™ ..... 54  
 TC Strabismus Scissors, Surgi-OR™ ..... 197  
 TC Stratte Needle Holder..... 109  
 TC Wangenstein Needle Holder ..... 110  
 TC Webster Needle Holder ..... 108, 111  
 TC Webster Needle Holder, Surgi-OR™ ..... 118, 197  
 TC Wire Cutting Scissors, Sklar Edge™ ..... 54  
 TC Wire Cutting Scissors, Surgi-OR™ ..... 197  
 TC, Z-Type Parametrium Scissors..... 37  
 --  
 Teaching/Training Stethoscope ..... 231  
 Teale Vulsellum Forcep..... 92  
 Tenaculum Forcep, Laparoscopic ..... 125  
 Tenzel Bipolar Forcep, Electrosurgical..... 160  
 Thomas Uterine Curette..... 34  
 Thumb Forcep, Wireform Econo-Sterile™ ..... 225  
 Tip Cleaner Disposable, Electrosurgical ..... 159  
 TipGrips™ Instrument Guard Guard..... 255  
 Tischler Mini Biopsy Punch..... 47  
 Tischler Mini Biopsy Punch, Micro-Cut ..... 43

Tischler Oval Biopsy Punch ..... 47  
 Tischler Oval Biopsy Punch, Micro-Cut..... 43  
 Tischler-Kevorkian Biopsy Punch ..... 47  
 Tischler-Kevorkian Biopsy Punch, Micro-Cut..... 43  
 Tissue Forcep ..... 99  
 Tissue Forcep, Econo-Sterile™ ..... 106, 222  
 Tissue Forcep, Merit™ ..... 212  
 Tissue Forcep, Sklar Black™ ..... 83, 171  
 Tissue Forcep, Sklarlite XD™ ..... 88  
 Tissue Forcep, Sklarlite™ ..... 88  
 Tissue Forcep, Surgi-OR™ ..... 102, 203  
 Tissue Forcep, Wireform Econo-Sterile™ ..... 225  
 Towel Forcep, Wireform Econo-Sterile™ ..... 225  
 Tracheal Tube, Cleaning Brush..... 258  
 Tray Cover, Catheter Instrument, Stainless Steel ..... 243  
 Tray Cover, Instrument, Stainless Steel..... 245  
 Tray Cover, Micro Sterilization, Stainless Steel ..... 247  
 Tray Cover, Sterilization, Stainless Steel ..... 246  
 Tray, Amniocentesis ..... 189  
 Tray, Baby Care ..... 195  
 Tray, Catheter Instrument, Stainless Steel..... 243  
 Tray, Catheter Instrument, Stainless Steel, Miniature ..... 242  
 Tray, C-Section ..... 192  
 Tray, Cyst Aspiration ..... 190  
 Tray, Cyst/FNA/CORE ..... 190  
 Tray, D&C Gynecology..... 191  
 Tray, Deluxe Baby Care ..... 195  
 Tray, Deluxe Maternity ..... 194  
 Tray, Economy Baby Care ..... 195  
 Tray, Economy Maternity ..... 194  
 Tray, Hysterosalpingogram Basic ..... 189  
 Tray, Instrument Drying, Stainless Steel..... 244  
 Tray, Instrument, Stainless Steel ..... 245  
 Tray, Labor and Delivery ..... 192  
 Tray, Lietz Electrosurgery ..... 191  
 Tray, Maternity ..... 194  
 Tray, Mayo, Stainless Steel..... 243  
 Tray, Micro Sterilization, Stainless Steel ..... 247  
 Tray, Pap Smear ..... 191  
 Tray, Plastic..... 254  
 Tray, Plastic Instrument Soaking..... 254  
 Tray, Plastic Procedure ..... 254  
 Tray, Standard CT Biopsy ..... 189  
 Tray, Sterilization, Stainless Steel..... 246-247  
 Tray, Sterilization/Bath Set, Stainless Steel ..... 246  
 Tray, Sterilizing, Stainless Steel..... 245  
 Tray, Ultrasound..... 190  
 Trocar, Laparoscopic..... 132-133  
 Trocar, Laparoscopic, Miniature..... 141  
 Trocar, Set, Laparoscopic, Miniature ..... 141  
 Tru-Punch™ Biopsy Punch, Disposable ..... 188  
 Tube Occluding Forcep, Presbyterian,  
 Econo-Sterile™ ..... 106, 223  
 Tube Occluding Forcep, Presbyterian, Merit™ ..... 211  
 Tube Occluding Forcep, Presbyterian,  
 Surgi-OR™ ..... 103, 204  
 Tube, Adson Suction..... 226

Tube, Baron Suction ..... 226  
 Tube, Buie Suction..... 226  
 Tube, Frazier Suction..... 226  
 Tube, Plastic Specimen ..... 252  
 Tube, Poole Suction..... 226  
 Tube, Yankauer Suction..... 226  
 Tubing, Disposable Smoke Evacuation ... 5, 8, 145, 163  
 Tumbler, Stainless Steel ..... 238  
 Tuttle Forcep, Sklar Black™ ..... 84, 171  
 Tuttle Forcep, Sklar Blue™ ..... 80, 150  
 Tyrell Iris Hook ..... 28  
 Tyrell Iris Hook, Sklar Black™ ..... 26, 166

**U**

Ultrasound Tray..... 190  
 Umbilical Scissors..... 71  
 Umbilical Scissors, Merit™ ..... 208  
 Universal Biopsy Punch..... 49  
 Universal Biopsy Punch, Micro-Cut ..... 45  
 US Army Scissors ..... 70  
 Uterine Manipulator/Injector, Disposable ..... 187  
 Utility Scissors..... 67, 71  
 Utility Scissors, Commander..... 69  
 Utility Scissors, Econo-Sterile™ ..... 77, 220  
 Utility Scissors, Hercules ..... 69  
 Utility Scissors, Merit™ ..... 210  
 Utility Scissors, Ribbon ..... 67  
 Utility Scissors, Surgi-OR™ ..... 74, 200

**V**

Vaginal Dilators, Disposable ..... 183  
 Vaginal Retractor, Jackson ..... 18  
 Vaginal Retractor, Jackson, Sklar Black™ ..... 17, 164  
 Vaginal Retractor, Jackson, Sklar Blue™ ..... 16, 147  
 Vaginal Retractor, Lateral..... 18  
 Vaginal Retractor, Lateral, Sklar Black™ ..... 17, 164  
 Vaginal Retractor, Lateral, Sklar Blue™ ..... 16, 147  
 Vaginal Speculum, Auvarad ..... 12  
 Vaginal Speculum, Auvarad, Sklar Black™ ..... 8-9, 163  
 Vaginal Speculum, Auvarad, Sklar Blue™ ..... 6, 146  
 Vaginal Speculum, Berlind-Auvarad ..... 12  
 Vaginal Speculum, Collin, Sklar Black™ ..... 8, 164  
 Vaginal Speculum, Collin, Sklar Blue™ ..... 6, 146  
 Vaginal Speculum, Cusco ..... 11  
 Vaginal Speculum, Cusco, Disposable ..... 181  
 Vaginal Speculum, Cusco, Econo-Sterile™ ..... 14  
 Vaginal Speculum, Cusco, Sklar Blue™ ..... 5, 145  
 Vaginal Speculum, Devilbiss ..... 11  
 Vaginal Speculum, Freeway Graves ..... 11  
 Vaginal Speculum, Freeway Graves,  
 Sklar Black™ ..... 8, 163  
 Vaginal Speculum, Freeway Graves,  
 Sklar Blue™ ..... 5, 145  
 Vaginal Speculum, Garrigue ..... 12  
 Vaginal Speculum, Graves..... 10-11



Vaginal Speculum, Graves, Econo-Sterile™ ..... 14, 217  
 Vaginal Speculum, Graves, Merit™ ..... 207  
 Vaginal Speculum, Graves, Sklar Black™ ..... 7-8, 162-163  
 Vaginal Speculum, Graves, Sklar Blue™ .. 4-5, 144-145  
 Vaginal Speculum, Graves, SklarSpec™ Disposable,  
 Lighted ..... 181  
 Vaginal Speculum, Graves, Surgi-OR™ ..... 13, 196  
 Vaginal Speculum, Pederson ..... 10  
 Vaginal Speculum, Pederson, Econo-Sterile™ .. 14, 217  
 Vaginal Speculum, Pederson, Merit™ ..... 207  
 Vaginal Speculum, Pederson, Sklar Black™ ..... 7, 162  
 Vaginal Speculum, Pederson, Sklar Blue™ ..... 4, 144  
 Vaginal Speculum, Pederson, Surgi-OR™ ..... 13, 196  
 Vaginal Speculum, Steiner-Auvard ..... 12  
 Vaginal Speculum, Steiner-Auvard, Sklar Black™ ..... 9, 164  
 Vaginal Speculum, Steiner-Auvard, Sklar Blue™ ..... 6, 146  
 Vaginal, O'Sullivan-O'Conner Retractor ..... 20  
 Vaginal, Segond Spatula ..... 19  
 Vaginal, Segond Spatula, Sklar Blue™ ..... 16, 147  
 Vaginal, Sims Retractor ..... 18-19  
 Vaginal, Sims Retractor, Sklar Blue™ ..... 16, 147  
 Vaginal, Tauber Spatula ..... 19  
 Vaginal, Tauber Spatula, Sklar Blue™ ..... 16, 147  
 Valve, Laparoscopic ..... 133  
 Van Buren Urethral Sound ..... 29  
 Vessells Towel Forcep, Merit™ ..... 213

## W

Wagner Scissors, Sklarcut™ ..... 56  
 Wagner Scissors, Sklarlite™ Sklarcut™ ..... 56  
 Waldmann Episiot Scissors ..... 71  
 Walther Dilator ..... 33  
 Wangenstein Needle Holder, TC ..... 110  
 Webster Needle Holder ..... 114  
 Webster Needle Holder, Econo-Sterile™ ..... 120, 224  
 Webster Needle Holder, Merit™ ..... 215  
 Webster Needle Holder, Sklarlite XD™ ..... 112  
 Webster Needle Holder, Sklarlite™ ..... 112  
 Webster Needle Holder, Surgi-OR™ ..... 119, 205  
 Webster Needle Holder, Surgi-OR™ TC ..... 118, 197  
 Webster Needle Holder, TC ..... 108, 111  
 Wertheim-Cullen Pedicle Forcep ..... 96  
 Winter Placenta and Ovum Forcep ..... 89  
 Wire Cutting Scissors, Econo-Sterile™ ..... 76, 219  
 Wire Cutting Scissors, Merit™ ..... 210  
 Wire Cutting Scissors, Sklar Edge™ TC ..... 54  
 Wire Cutting Scissors, Surgi-OR™ ..... 74, 200  
 Wire Cutting Scissors, Surgi-OR™ TC ..... 197  
 Wire Cutting Scissors, Suture ..... 68  
 Wire Suture Scissors ..... 68  
 Wireform Halsted Forcep, Econo-Sterile™ ..... 225  
 Wireform Kelly Forcep, Econo-Sterile™ ..... 225  
 Wireform Needle Holder, Econo-Sterile™ ..... 120, 225  
 Wireform Scissors, Econo-Sterile™ ..... 225  
 Wireform Sponge Forcep, Econo-Sterile™ ..... 225  
 Wireform Thumb Forcep, Econo-Sterile™ ..... 225

Wireform Tissue Forcep, Econo-Sterile™ ..... 225  
 Wireform Towel Forcep, Econo-Sterile™ ..... 225  
 Wittner Uterine Biopsy Punch ..... 48  
 Wittner Uterine Biopsy Punch, Micro-Cut ..... 44

## Y

Yankauer Suction Tube ..... 226

## Z

Z-Type Hysterectomy Forcep ..... 37, 96  
 Z-Type Parametrium Scissors, TC ..... 37



The Tradition Continues

# SKLAR SOAK™

## INSTRUMENT PRE-SOAK & DECONTAMINANT

### RUST RESISTANT!

Ideal for use on all stainless steel instruments.

- PH balanced, designed specifically for stainless steel instruments.
- Intermediate level disinfectant with broad spectrum of efficacy.
- No special handling or disposal.
- Fragrant, no offensive odors.
- Non-glutaraldehyde.
- Non-caustic.
- Ready to use.



PRODUCT NUMBER	FEATURES	QUANTITIES
10-1603	1 Gal. Bottles	4/case
10-1609	1 Gal. Bottle	1 bottle



889 South Matlack Street  
West Chester, PA 19382

800.221.2166

610.430.3200

Fax: 610.696.9007

International Phone: 610.430.3200

International Fax: 610.430.3941

[surgi@sklarcorp.com](mailto:surgi@sklarcorp.com)

[international@sklarcorp.com](mailto:international@sklarcorp.com)

[www.sklarcorp.com](http://www.sklarcorp.com)

DISTRIBUTED BY:



©Copyright 2012. Sklar Corporation, West Chester, PA. All rights reserved. No portion of this catalog may be reproduced without written permission of Sklar.