



SKLAR PHYSICIAN CATALOG

Surgery Center Products

INSTRUMENTS AND SURGICAL DISPOSABLES

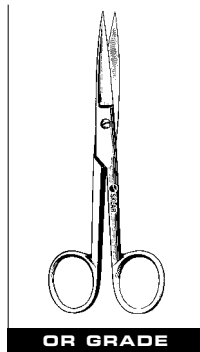


See Our 2001 Price List

*In-Office Care of Surgical Instruments
See Pages 477 - 491*

Sklar has 5 choices of quality surgical instruments... more than any other company!

For the first time ever in one surgical instrument catalog we offer you Sklar Operating Room quality, Mid-Grade value, Merit office instrumentation, the convenience of Floor Grade sterile instruments and Sklar Premium, our very best.



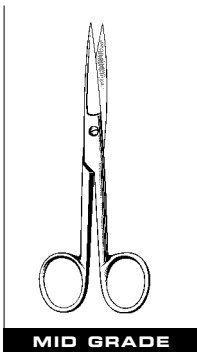
Sklar OR Quality Instruments

Our best operating room quality instruments incorporating the highest grades of surgical steel, finely detailed craftsmanship and exacting standards of manufacturing. These instruments are imported from Germany.



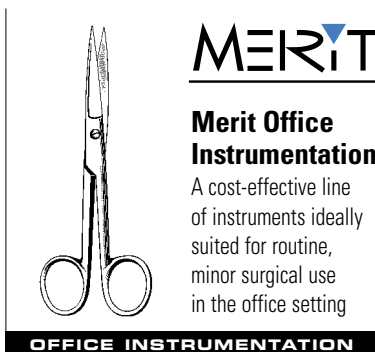
Sklar Premium™ Instruments

Our finest OR grade instruments with the addition of a unique Sklar performance feature to meet the specific surgical needs of the clinician.



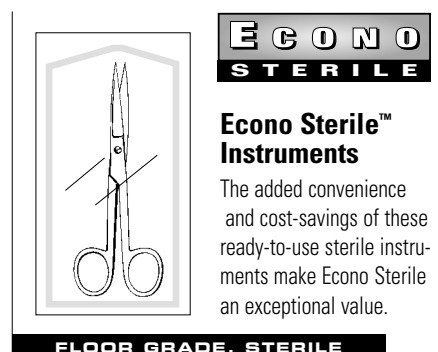
Surgi-OR™ Mid-Grade Quality Instruments

These mid-grade instruments are forged from surgical grade stainless steel and crafted to offer significant value at reduced costs for the operating room as well as other important surgical settings.



Merit Office Instrumentation

A cost-effective line of instruments ideally suited for routine, minor surgical use in the office setting.



Econo Sterile™ Instruments

The added convenience and cost-savings of these ready-to-use sterile instruments make Econo Sterile an exceptional value.

We invite you to take a closer look at Sklar and our many brands of surgical instruments, sterile disposables, diagnostics and thousands of new products for our physician customers.



CLICK HERE TO SEE THIS WEEK'S SPECIALS - www.sklarcorp.com

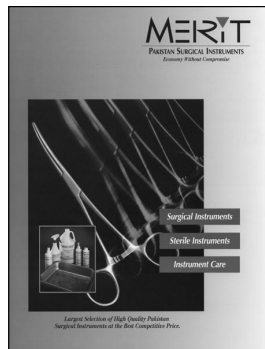


Sklar Instruments ***and Surgical Products***

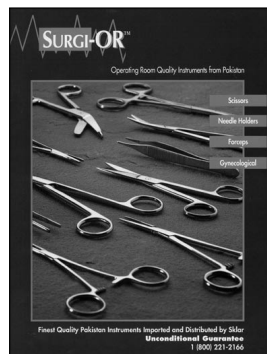
Physician And Surgery Center Products



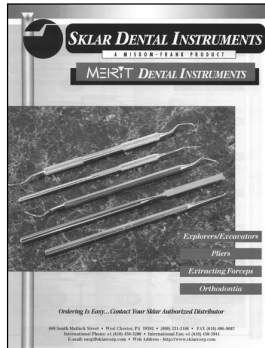
Sterile Instruments



MERIT™ Instruments



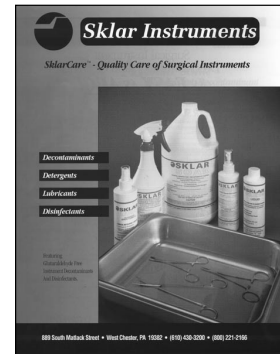
Surgi-OR™ Instruments



Dental/Orthodontia



Laparoscopic Instruments



**Care And Cleaning
Of Instruments**

SKLAR INSTRUMENTS **Quality you can feel...see...and trust!**

889 South Matlack Street • West Chester, PA 19382 • (800) 221-2166

For Fast FAX Quote (610) 696-9007

International Phone: USA Country Code + 610-430-3200

International Fax: USA Country Code + 610-430-3941

E-mail: surgis@sklarcorp.com • Web Address: <http://www.sklarcorp.com>

©COPYRIGHT 2000. SKLAR INSTRUMENTS, WEST CHESTER, PA. ALL RIGHTS RESERVED. NO PORTION OF THIS CATALOG MAY BE REPRODUCED WITHOUT THE WRITTEN PERMISSION OF SKLAR INSTRUMENTS. THIS CATALOG SUPERSEDES ALL PREVIOUS VERSIONS.

CLICK HERE TO SEE THIS WEEK'S SPECIALS - www.sklarcorp.com



Sklar Instruments

Instrument Care And Cleaning

Sklar has a family of exclusively formulated products which we recommend for the care of your surgical instruments and to preserve the value of this important investment.

SKLAR SOAK™

Non-Glutaraldehyde Decontaminant/Cleaner Disinfectant

Preclean and decontaminate soiled instruments for safe handling by staff members.

10-1603 Case of 4 Gallons



Step 1

SKLAR KLEEN™

Cleaning Detergent

A Sklar Kleen product is available for whatever method you choose to thoroughly clean your surgical instruments.

Liquid

10-1612 Case of 6 8oz.

10-1613 Case of 4 Gallons

Powder

10-1630 Case of 6 3-1/4 lb pitchers

10-1607 5 lb. Pail

10-1608 Case of 4 - 5 lb. Pails



Step 2

SKLAR INSTRU-GUARD LUBE™

Instrument Lubricant

A necessary step prior to sterilization which ensures a perfectly functioning instrument for life.

10-1635 Case of 4 Gallons, Concentrated

10-1636 Case of 12 8oz. Ready To Use Spray Bottles



Step 3



Sklar Instruments

Instrument Care And Cleaning

In recent years, Enzymatic detergents have become increasingly popular as soaking agents as well as detergents for removing organic debris.

SKLAR-ZYME™

ENZYMATIC

DETERGENT

10-2774
Box of 32, 1/2 oz. Pouches



SKLAR

ENZYMATIC™

10-2777
Case of 4 Gallons



SKLAR Instru-Guard™ One Step

A One Step Instrument Cleaner/Lubricant

A very popular and convenient product from Sklar which combines the effectiveness of an instrument detergent with the performance value of a lubricant.

10-2800 Case of 4 Gallons
10-2801 1 Gallon



SKLAR Disinfectant™

Non-Glutaraldehyde

Designed for instruments and medical surfaces. It is available in either gallon or spray bottles.




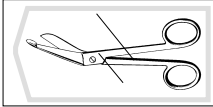

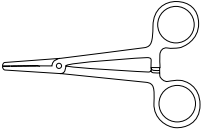
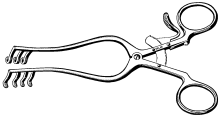

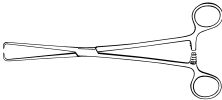


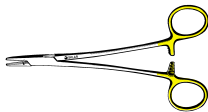



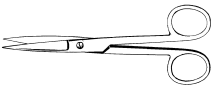

10-1653 Case of 4 Gallons
10-2762 Case of 12 24 oz. Spray Bottles
10-1643 Case of 6 24 oz. Spray Bottles

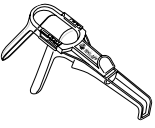



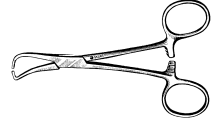




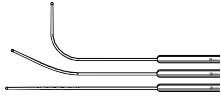
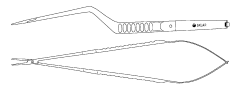

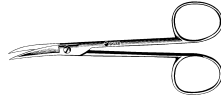
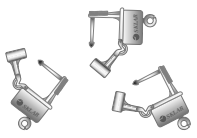
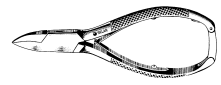
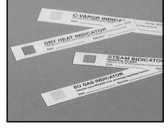
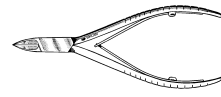



TABLE OF CONTENTS



INSTRUMENTS

<p>SCISSORS 10-33</p>		<p>MERIT 110-116</p>	
<p>HEMOSTATS/FORCEPS 34-59</p>		<p>ECONO STERILE 117-121</p>	
<p>NEEDLEHOLDERS 60-69</p>		<p>PLASTIC INSTRUMENTS STERILE & NON-STERILE 122-123</p>	
<p>RETRACTORS 70-75</p>		<p>DISPOSABLE PROCEDURE TRAYS/ STERILE PUT-UPS/COMPONENTS 124-141</p>	
<p>PREMIUM GRADE SKLARLITE & SKLARLITE XD 76-87</p>		<p>ECONO NON-STERILE 142</p>	
<p>PREMIUM GRADE SCISSORS SKLARCUT/EDGE/HONE 88-93</p>		<p>GYNECOLOGY INSTRUMENTS 143-198</p>	
<p>PREMIUM GRADE NEEDLEHOLDERS 94-97</p>		<p>SKLAR BLUE ELECTROSURGERY 199-209</p>	
<p>PREMIUM GRADE FORCEPS 98-99</p>		<p>SKLAR BLACK LASER 210-217</p>	
<p>SURGI-OR™ MID-GRADE 100-109</p>		<p>GYNECOLOGY/ LAPAROSCOPIC 218-233</p>	

<p>GYNECOLOGY DISPOSABLES 234-242</p>		<p>DENTAL SKLAR/MID-GRADE 407-427</p>	
<p>RECTAL 243-252</p>		<p>LARYNGOSCOPES LAMPS 428-432</p>	
<p>UROLOGY 253-259</p>		<p>STETHOSCOPES/ DIAGNOSTICS 433-438</p>	
<p>ENT/PLASTIC LIPOSUCTION 260-322</p>		<p>STAINLESS STEELWARE TRAYS, STERILIZATION POUCHES 439-443</p>	
<p>OPHTHALMOLOGY 323-345</p>		<p>SURGICAL DISPOSABLES 444-476</p>	
<p>MICROSURGERY 346-351</p>		<p>NEEDLES/SYRINGES 444-449</p>	
<p>DERMATOLOGY 352-379</p>		<p>TIP PROTECTORS/ INSTRUMENT ID 472-475</p>	
<p>PODIATRY 380-391</p>		<p>STERILE PROCESSING 476</p>	
<p>ORTHOPEDIC 392-406</p>		<p>CARE AND CLEANING 477-488</p>	



Sklar OR Quality Instruments

Our Best Operating Room quality instruments incorporating the highest grades of surgical steel, finely detailed craftsmanship and exacting standards of manufacturing. These instruments are imported from Germany.

Surgi-OR™ Mid-Grade Quality Instruments

These mid-grade instruments are forged from surgical grade stainless steel and crafted to offer significant value at reduced costs for the Operating Room as well as other important surgical settings.



Merit™ Physician Office Quality Instruments

A broad selection of Pakistan manufactured instruments crafted for routine surgical use and reliable performance. Utilized in a variety of clinical environments.

Econo™ Floor Grade Instruments

These economically manufactured floor grade instruments offer the greatest utility and the lowest cost.



Econo Sterile™ Instruments

The added convenience and cost-savings of these ready-to-use sterile instruments make Econo Sterile™ an exceptional value.

Sklar Premium™ Instruments

Our finest OR grade instruments with the addition of a unique Sklar performance feature to meet the specific surgical needs of the clinician.



• SKLARLITE™

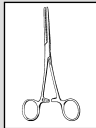
SKLARLITE
THE LIGHT TOUCH



Our premium Operating Room quality instruments provide a lighter version from the standard pattern without sacrifice to strength and durability.

• SKLARLITE XD™

SKLARLITE XD
EXTRA DELICATE



These instruments retain their structural integrity while providing the most delicate and sensitive instruments available.

• SKLARHONE™ Scissors

MICRO-CUT



Scissors are constructed with one knife blade and a standard scissor edge, either smooth or serrated for additional surgical control.

• SKLARCUT™ Scissors

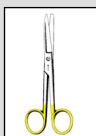
SKLARCUT
SERRATED BLADE



Cut cleanly and precisely due to ultra-fine serrations for improved grip throughout the entire cut.

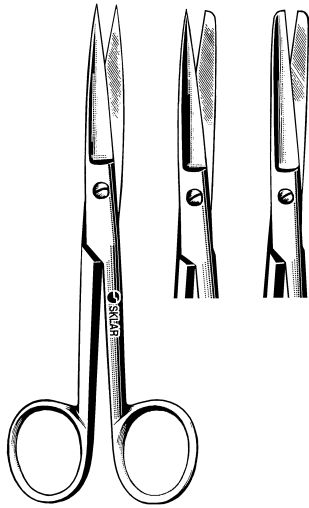
• SKLAR EDGE™

SKLAR EDGE
TUNGSTEN CARBIDE



Tungsten Carbide scissors are the standard for performance and quality as well as durability. Sklar Edge blades have a 5 year warranty.

OPERATING SCISSORS/STRAIGHT

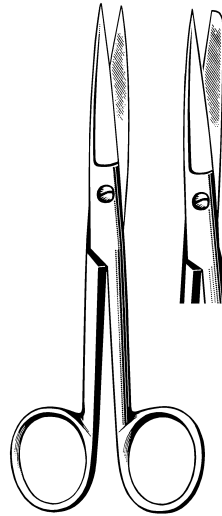


OR GRADE

OPERATING SCISSORS

Straight

S/S	S/B	B/B
13-1045 4½"	14-1045 4½"	15-1045 4½"
13-1050 5"	14-1050 5"	15-1050 5"
13-1055 5½"	14-1055 5½"	15-1055 5½"
13-1060 6"	14-1060 6"	15-1060 6"
13-1065 6½"	14-1065 6½"	15-1065 6½"
14-1058 5½"	S/B, Heavy Pattern	

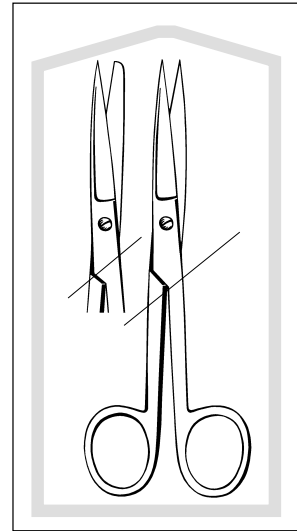


MID-GRADE

MID-GRADE OPERATING SCISSORS

Straight

S/S	S/B
95-275 5½"	95-265 4½"
95-284 6½"	95-272 5½"
	95-281 6½"



FLOOR-GRADE, STERILE

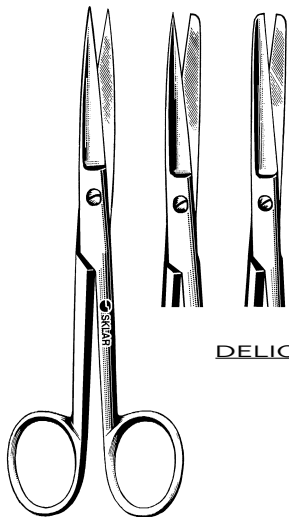
OPERATING SCISSORS, STERILE

Box/50

96-2520 5½"	Str.	S/B
96-2522 5½"	Str.	S/S

Box/25

96-2521 5½"	Str.	S/B
96-2523 5½"	Str.	S/S



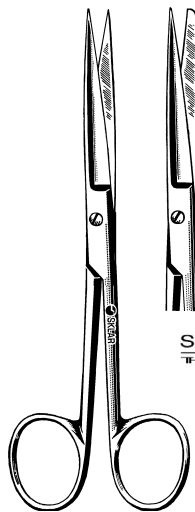
DELICATE

PREMIUM GRADE

OPERATING SCISSORS DELICATE

Straight

S/S	S/B	B/B
22-1145 4½"	22-1245 4½"	22-1345 4½"
22-1150 5"	22-1250 5"	22-1350 5"
22-1155 5½"	22-1255 5½"	22-1355 5½"



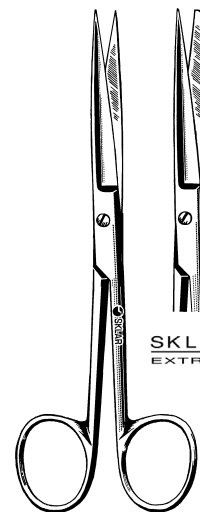
**SKLARLITE™
THE LIGHT TOUCH**

PREMIUM GRADE

SKLARLITE™ OPERATING SCISSORS

Straight

S/S	S/B
23-1100 4½"	23-1104 4½"
23-1101 5"	23-1105 5"
23-1102 5½"	23-1106 5½"



**SKLARLITE XD™
EXTRA DELICATE**

PREMIUM GRADE

SKLARLITE EXTRA DELICATE™ OPERATING SCISSORS

Straight

S/S	S/B
23-1112 4½"	23-1116 4½"
23-1113 5"	23-1117 5"
23-1114 5½"	23-1118 5½"



**SKLAR EDGE™ T-C
OPERATING SCISSORS**

Straight
S/S S/B B/B
16-1055 5/2" 16-1056 5/2" 16-1057 5/2"



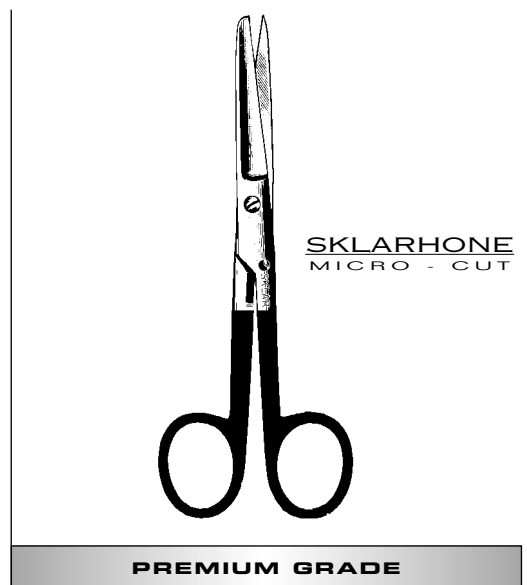
**SKLARCUT™
OPERATING SCISSORS**

Straight
S/S S/B
15-3500 5/2" 15-3505 5/2"



**SKLARLITE SKLARCUT™
OPERATING SCISSORS**

Straight
S/S S/B
23-1260 5/2" 23-1262 5/2"



**SKLARHONE™
OPERATING SCISSORS**

Straight, Smooth	Straight, Serrated
S/S	S/S
15-3342 5/2"	15-3442 5/2"
S/B	S/B
15-3343 5/2"	15-3443 5/2"

OPERATING SCISSORS/CURVED

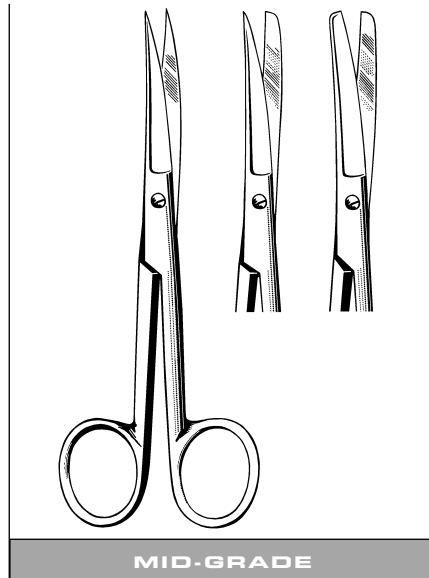


OR GRADE

OPERATING SCISSORS

Curved

S/S	S/B	B/B
13-2045 4½"	14-2045 4½"	15-2045 4½"
13-2050 5"	14-2050 5"	15-2050 5"
13-2055 5½"	14-2055 5½"	15-2055 5½"
13-2060 6"	14-2060 6"	15-2060 6"
13-2065 6½"	14-2065 6½"	15-2065 6½"

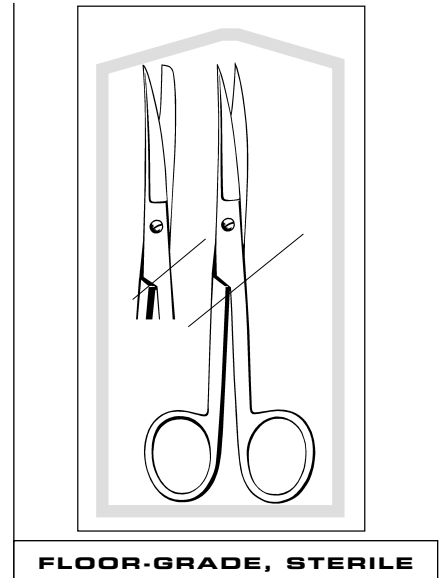


MID-GRADE

MID-GRADE OPERATING SCISSORS

Curved

S/S	S/B	B/B
95-295 5½"	95-292 5½"	95-299 5½"



FLOOR-GRADE, STERILE

OPERATING SCISSORS, STERILE

Box/50

96-2524 5½"	Cvd.	S/B
96-2525 5½"	Cvd.	S/S

Box/25

96-2526 5½"	Cvd.	S/B
96-2527 5½"	Cvd.	S/S



DELICATE

PREMIUM GRADE

OPERATING SCISSORS DELICATE

Curved

S/S	S/B	B/B
22-1445 4½"	22-1545 4½"	22-1645 4½"
22-1450 5"	22-1550 5"	22-1650 5"
22-1455 5½"	22-1555 5½"	22-1655 5½"



**SKLARLITE
THE LIGHT TOUCH**

PREMIUM GRADE

SKLARLITE™ OPERATING SCISSORS

Curved

S/S	S/B
23-1124 4½"	23-1128 4½"
23-1126 5½"	23-1130 5½"



**SKLARLITE XD
EXTRA DELICATE**

PREMIUM GRADE

SKLARLITE EXTRA DELICATE™ OPERATING SCISSORS

Curved

S/S	S/B
23-1136 4½"	23-1140 4½"
23-1138 5½"	23-1142 5½"



SKLAR EDGE
TUNGSTEN CARBIDE

PREMIUM GRADE

SKLAR EDGE™ T-C OPERATING SCISSORS

Curved

S/B

16-1156 5½"

S/S

16-1155 5½"



SKLARCUT
SERRATED BLADE

PREMIUM GRADE

SKLARCUT™ OPERATING SCISSORS

Curved

S/S

15-3510 5½"

S/B

15-3515 5½"



SKLARLITE
TUNGSTEN CARBIDE

SKLARCUT
SERRATED BLADE

PREMIUM GRADE

SKLARLITE SKLARCUT™ OPERATING SCISSORS

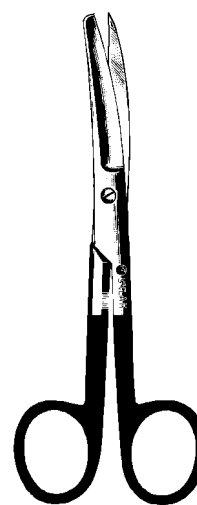
Curved

S/S

23-1264 5½"

S/B

23-1266 5½"



SKLARHONE
MICRO - CUT

PREMIUM GRADE

SKLARHONE™ OPERATING SCISSORS

Curved, Smooth

S/S

15-3348 5½"

Curved, Serrated

S/S

15-3448 5½"

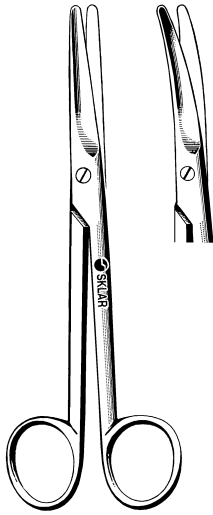
S/B

15-3349 5½"

S/B

15-3449 5½"

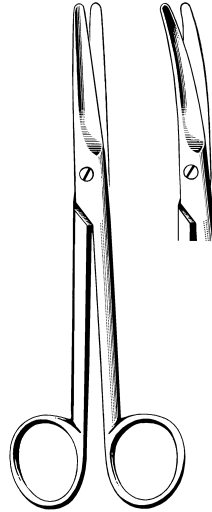
MAYO DISSECTING SCISSORS



OR GRADE

MAYO DISSECTING SCISSORS

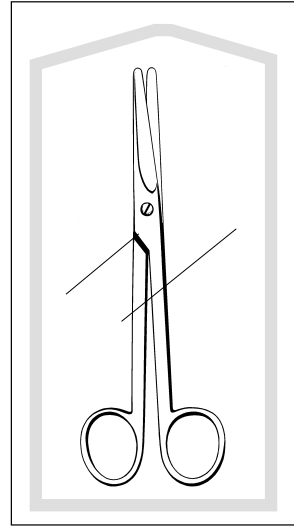
Straight		Curved	
15-1555	5½"	15-2555	5½"
15-1567	6¾"	15-2567	6¾"
90-1590	9"	90-1690	9"
15-2569	6¾" Curved, Heavy Pattern		



MID-GRADE

MID-GRADE MAYO DISSECTING SCISSORS

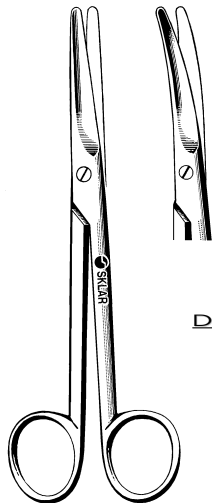
Straight		Curved	
95-308	5½"	95-330	5½"
95-321	6¾"	95-325	6¾"



FLOOR-GRADE, STERILE

MAYO DISSECTING SCISSORS, STERILE

Box/50		
96-2530	5½"	Str.
Box/25		
96-2531	5½"	Str.

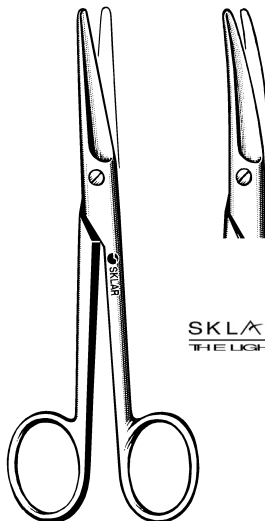


DELICATE

PREMIUM GRADE

MAYO DISSECTING SCISSORS DELICATE

Straight		Curved	
22-1556	5½"	22-2555	5½"
22-1567	6¾"	22-2567	6¾"

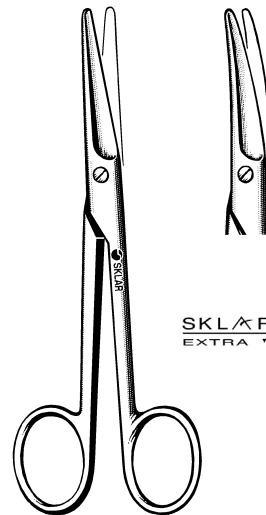


**SKLARLITE
THE LIGHT TOUCH**

PREMIUM GRADE

SKLARLITE™ MAYO DISSECTING SCISSORS

Straight		Curved	
23-1164	5½"	23-1166	5½"
23-1165	6¾"	23-1167	6¾"



**SKLARLITE XD
EXTRA DELICATE**

PREMIUM GRADE

SKLARLITE EXTRA DELICATE™ MAYO DISSECTING SCISSORS

Straight		Curved	
23-1168	5½"	23-1170	5½"
23-1169	6¾"	23-1171	6¾"



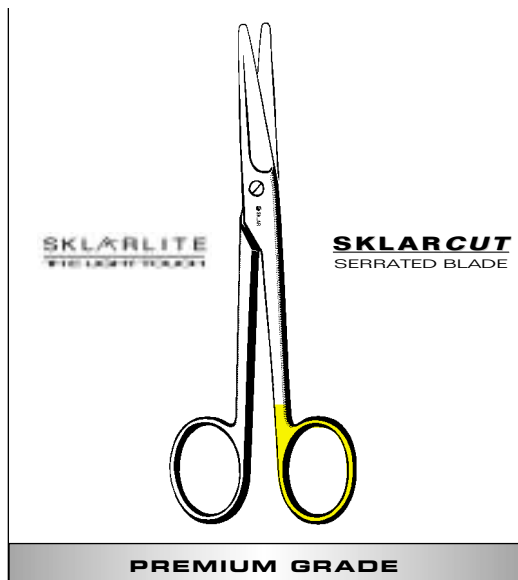
**SKLAR EDGE™ T-C
MAYO DISSECTING SCISSORS**

Straight		Curved	
16-1505	5½"	16-1605	5½"
16-1510	6¾"	16-1610	6¾"
16-1515	9"	16-1615	9"



**SKLARCUT™
MAYO DISSECTING SCISSORS**

Straight		Curved	
15-3550	5½"	15-3560	5½"
15-3555	6¾"	15-3565	6¾"



**SKLARLITE SKLARCUT™
MAYO DISSECTING SCISSORS**

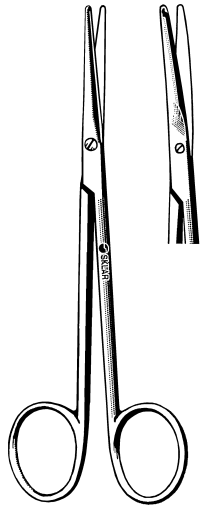
Straight		Curved	
23-1274	6¾"	23-1278	6¾"



**SKLARHONE™
MAYO DISSECTING SCISSORS**

Straight, Smooth		Curved, Smooth	
15-3325	5½"	15-3330	5½"
15-3326	6¾"	15-3331	6¾"

METZENBAUM (LAHEY) SCISSORS



OR GRADE

METZENBAUM (LAHEY) SCISSORS

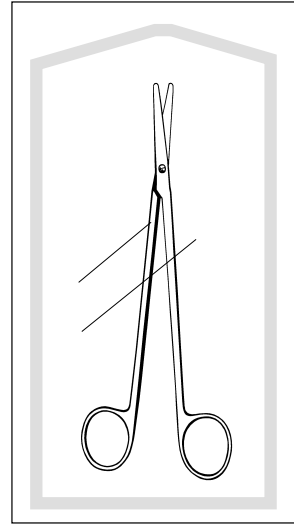
Straight		Curved	
22-2550	4½"	22-2545	4½"
75-5460	5¾"	47-1360	5¾"



MID-GRADE

MID-GRADE METZENBAUM (LAHEY) SCISSORS

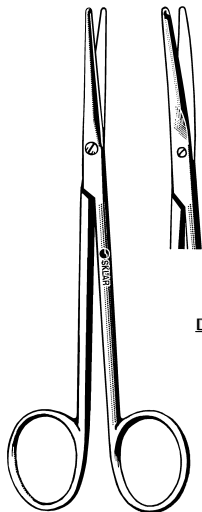
Straight		Curved	
95-335	5¾"	95-336	5¾"



FLOOR-GRADE, STERILE

METZENBAUM (LAHEY) SCISSORS, STERILE

Box/50		
96-2516	5¾"	Str.
Box/25		
96-2517	5¾"	Str.

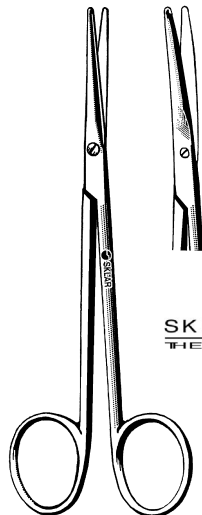


DELICATE

PREMIUM GRADE

METZENBAUM (LAHEY) SCISSORS DELICATE

Straight		Curved	
22-2450	4½"	22-2650	4½"
22-2460	5¾"	22-1057	5¾"



**SKLARLITE
THE LIGHT TOUCH**

PREMIUM GRADE

SKLARLITE™ METZENBAUM (LAHEY) SCISSORS

Straight		Curved	
23-1172	4½"	23-1174	4½"
23-1173	5¾"	23-1175	5¾"



**SKLARLITE XD
EXTRA DELICATE**

PREMIUM GRADE

SKLARLITE EXTRA DELICATE™ METZENBAUM (LAHEY) SCISSORS

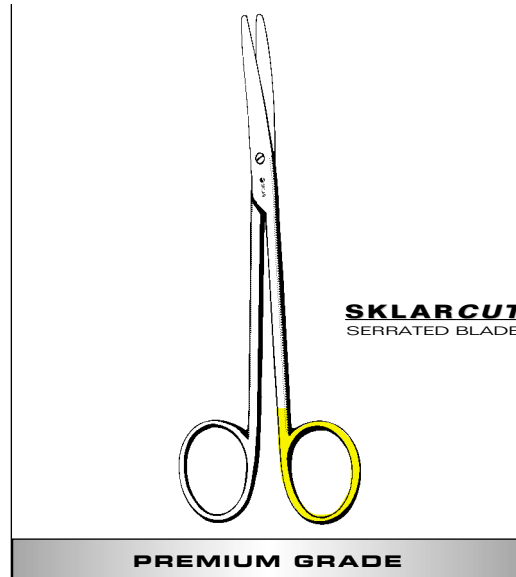
Straight		Curved	
23-1176	4½"	23-1178	4½"
23-1177	5¾"	23-1179	5¾"



PREMIUM GRADE

**SKLAR EDGE™ T-C
METZENBAUM (LAHEY)
SCISSORS**

Straight			Curved		
16-1805	5/8"	Delicate	16-1905	5/8"	Delicate
16-1810	5/8"	Standard	16-1910	5/8"	Standard



PREMIUM GRADE

**SKLARCUT™
METZENBAUM (LAHEY)
SCISSORS**

Curved	15-3570	5/8"
--------	---------	------



PREMIUM GRADE

**SKLARLITE SKLARCUT™
METZENBAUM (LAHEY)
SCISSORS**

Curved	23-1280	5/8"
--------	---------	------



PREMIUM GRADE

**SKLARHONE™
METZENBAUM (LAHEY)
SCISSORS**

Curved	15-3306	5/8"
--------	---------	------

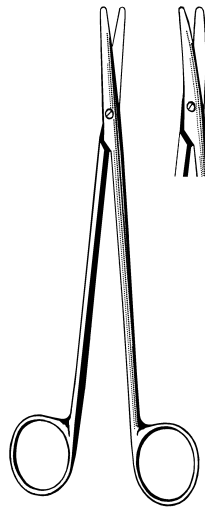
METZENBAUM DISSECTING SCISSORS



OR GRADE

METZENBAUM DISSECTING SCISSORS

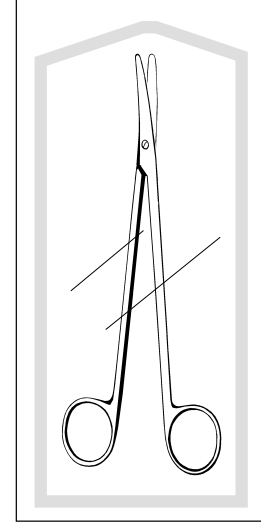
Straight		Curved	
75-5570	7"	75-5670	7"
55-9180	8"	55-9080	8"
55-9190	9" Nelson	55-9090	9" Nelson
55-9310	10" Nelson	55-9210	10" Nelson
55-9311	11" Nelson	55-9411	11" Nelson
		55-9612	12" Nelson
		55-9614	14" Nelson



MID-GRADE

MID-GRADE METZENBAUM DISSECTING SCISSORS

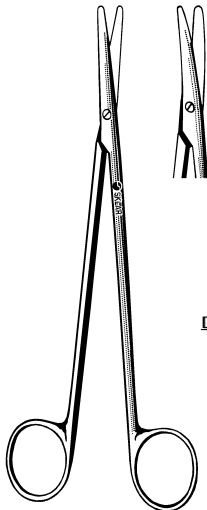
Straight		Curved	
95-339	7"	95-340	7"



FLOOR-GRADE, STERILE

METZENBAUM DISSECTING SCISSORS, STERILE

Box/50		
96-2680	7"	Cvd.
Box/25		
96-2682	7"	Cvd.

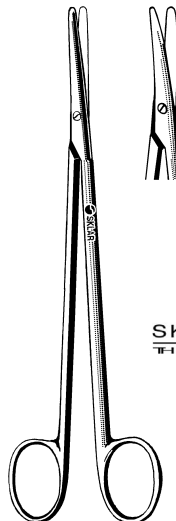


DELICATE

PREMIUM GRADE

METZENBAUM DISSECTING SCISSORS DELICATE

Straight		Curved	
22-1071	7"	22-1070	7"
55-9184	8"	55-9084	8"



SKLARLITE
THE LIGHT TOUCH

PREMIUM GRADE

SKLARLITE™ METZENBAUM DISSECTING SCISSORS

Straight		Curved	
23-1180	7"	23-1182	7"

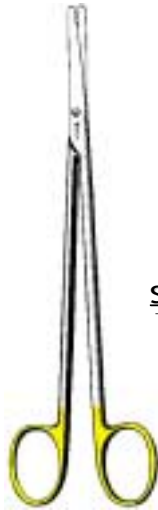


SKLARLITE XD
EXTRA DELICATE

PREMIUM GRADE

SKLARLITE EXTRA DELICATE™ METZENBAUM DISSECTING SCISSORS

Straight		Curved	
23-1184	7"	23-1186	7"



SKLAR EDGE
TUNGSTEN CARBIDE

PREMIUM GRADE

SKLAR EDGE™ T-C METZENBAUM DISSECTING SCISSORS

Straight			Curved		
16-2005	7"	Delicate	16-2105	7"	Delicate
16-2010	7"	Standard	16-2110	7"	Standard
16-2210	9"	Standard Nelson	16-2310	9"	Standard Nelson
			16-2311	11"	Standard Nelson



SKLARCUT
SERRATED BLADE

PREMIUM GRADE

SKLARCUT™ METZENBAUM DISSECTING SCISSORS

Curved	
15-3575	7"



SKLARLITE
SERRATED BLADE

SKLARCUT
SERRATED BLADE

PREMIUM GRADE

SKLARLITE SKLARCUT™ METZENBAUM DISSECTING SCISSORS

Curved	
23-1267	7"



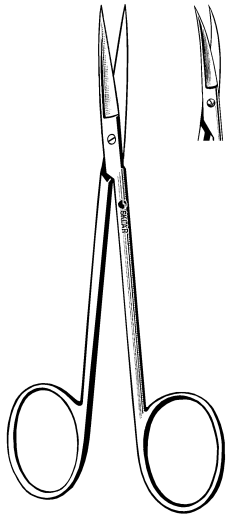
SKLARHONE
MICRO - CUT

PREMIUM GRADE

SKLARHONE™ METZENBAUM DISSECTING SCISSORS

Curved, Smooth	Curved, Serrated
15-3310	7"
15-3311	8"
15-3315	9"

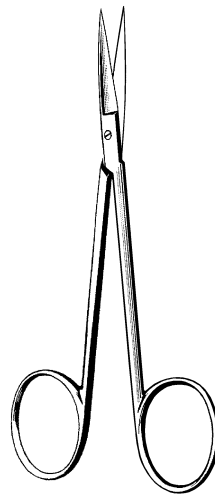
IRIS SCISSORS



OR GRADE

IRIS SCISSORS

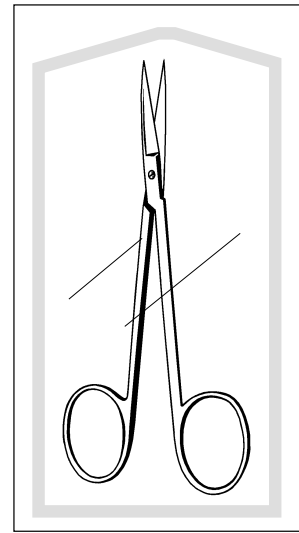
Straight S/S	Curved S/S	Angular S/S
47-1135 3 1/2"	47-1235 3 1/2"	64-2142 4 1/2"
47-1145 4 1/2"	47-1245 4 1/2"	



MID-GRADE

MID-GRADE IRIS SCISSORS

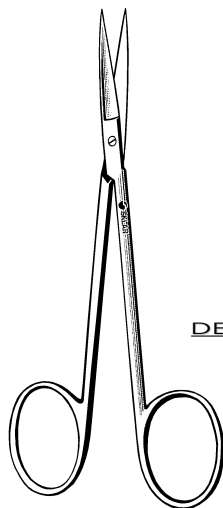
Straight	Curved
95-103 3 1/2"	95-107 3 1/2"
95-104 4 1/2"	95-109 4 1/2"



FLOOR-GRADE, STERILE

IRIS SCISSORS, STERILE

Box/50		
96-2504	4 1/2"	Str.
96-2506	4 1/2"	Cvd.
Box/25		
96-2505	4 1/2"	Str.
96-2507	4 1/2"	Cvd.

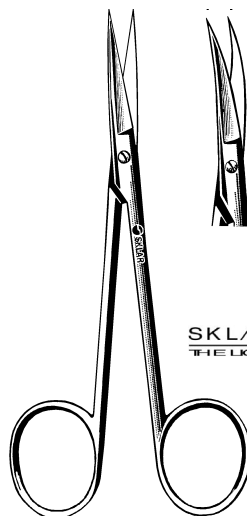


DELICATE

PREMIUM GRADE

IRIS SCISSORS DELICATE

Straight S/S	Curved S/S
22-1135 3 1/2"	22-1235 3 1/2"
47-1246 4 1/2"	47-1248 4 1/2"

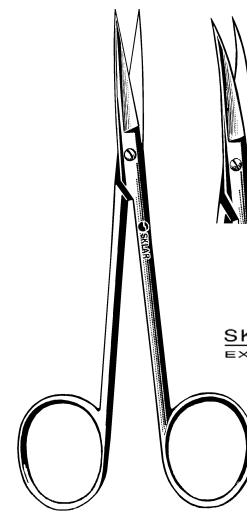


SKLARLITE
THE LIGHT TOUCH

PREMIUM GRADE

SKLARLITE™ IRIS SCISSORS

Straight S/S	Curved S/S
23-1148 3 1/2"	23-1150 3 1/2"
23-1149 4 1/2"	23-1151 4 1/2"



SKLARLITE XD
EXTRA DELICATE

PREMIUM GRADE

SKLARLITE EXTRA DELICATE™ IRIS SCISSORS

Straight S/S	Curved S/S
23-1152 3 1/2"	23-1154 3 1/2"
23-1153 4 1/2"	23-1155 4 1/2"



SKLAR EDGE™ T-C IRIS SCISSORS

Straight	Curved
16-2405 4 1/2"	16-2505 4 1/2"



SKLARCUT™ IRIS SCISSORS

Straight	Curved
15-3585 4 1/2"	15-3590 4 1/2"



SKLARLITE SKLARCUT™ IRIS SCISSORS

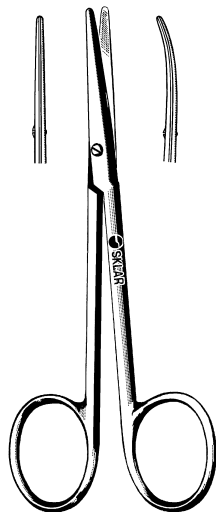
Straight	Curved
23-1268 4 1/2"	23-1270 4 1/2"



SKLARHONE™ IRIS SCISSORS

Straight, Smooth	Straight, Serrated
15-3352 4 1/2"	15-3452 4 1/2"
Curved, Smooth	Curved, Serrated
15-3357 4 1/2"	15-3457 4 1/2"

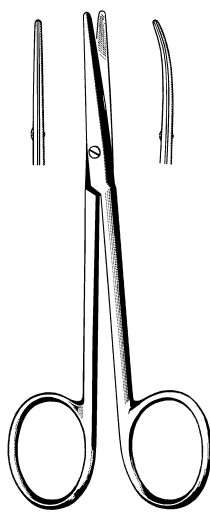
STRABISMUS SCISSORS



OR GRADE

STRABISMUS SCISSORS

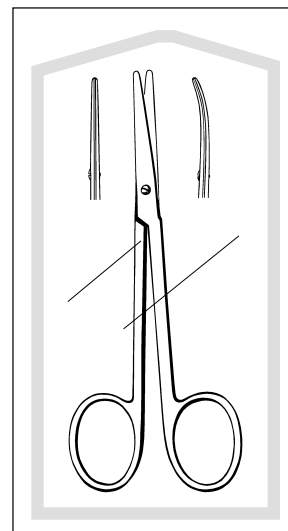
Straight	Curved
64-1442 4 1/2"	64-1542 4 1/2"



MID-GRADE

MID-GRADE STRABISMUS SCISSORS

Straight	Curved
95-360 4 1/2"	95-361 4 1/2"



FLOOR-GRADE, STERILE

STRABISMUS SCISSORS, STERILE

Box/50		
96-2540	4 1/2"	Str.
96-2541	4 1/2"	Cvd.
Box/25		
96-2542	4 1/2"	Str.
96-2543	4 1/2"	Cvd.



SKLAR EDGE
TUNGSTEN CARBIDE

PREMIUM GRADE

SKLAR EDGE™ T-C STRABISMUS SCISSORS

Straight	Curved
16-2605 4 1/2"	16-2705 4 1/2"

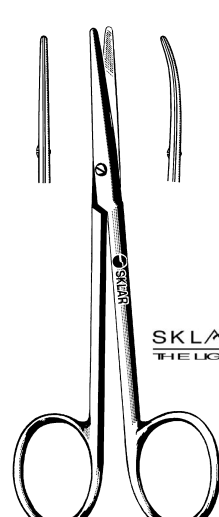


DELICATE

PREMIUM GRADE

STRABISMUS SCISSORS DELICATE

Straight	Curved
22-1442 4 1/2"	22-1542 4 1/2"

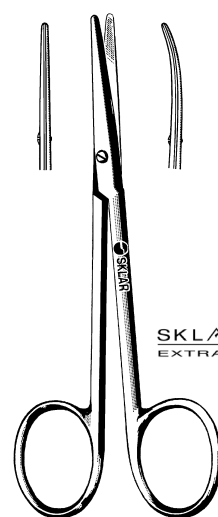


SKLARLITE
THEUGHTTOUGH

PREMIUM GRADE

SKLARLITE™ STRABISMUS SCISSORS

Straight	Curved
23-1158 4 1/2"	23-1159 4 1/2"

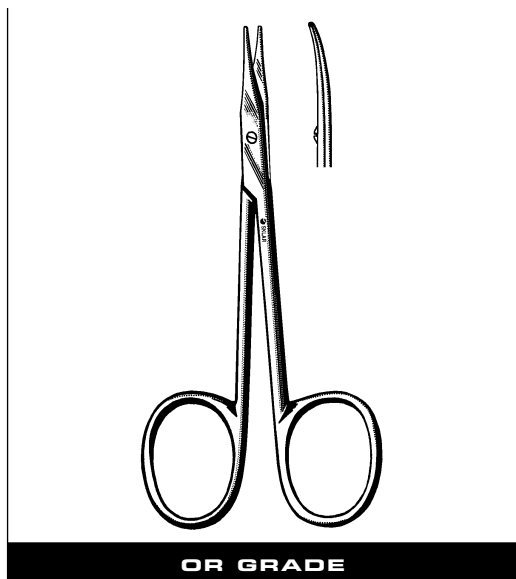


SKLARLITE XD
EXTRA DELICATE

PREMIUM GRADE

SKLARLITE EXTRA DELICATE™ STRABISMUS SCISSORS

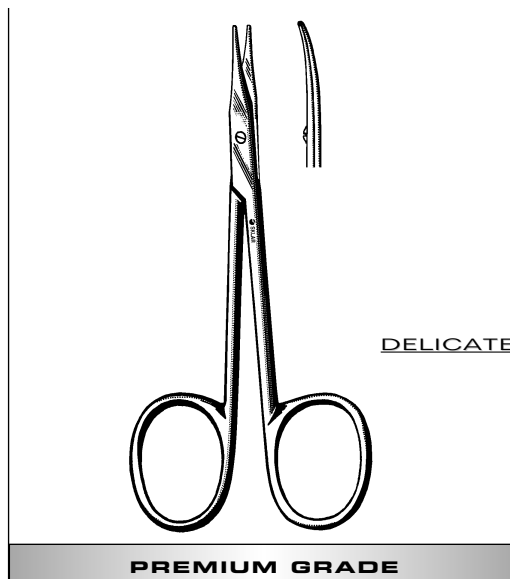
Straight	Curved
23-1162 4 1/2"	23-1163 4 1/2"



OR GRADE

STEVENS TENOTOMY SCISSORS

Straight	Curved
B/B	B/B
64-1242 4½"	64-1342 4½"

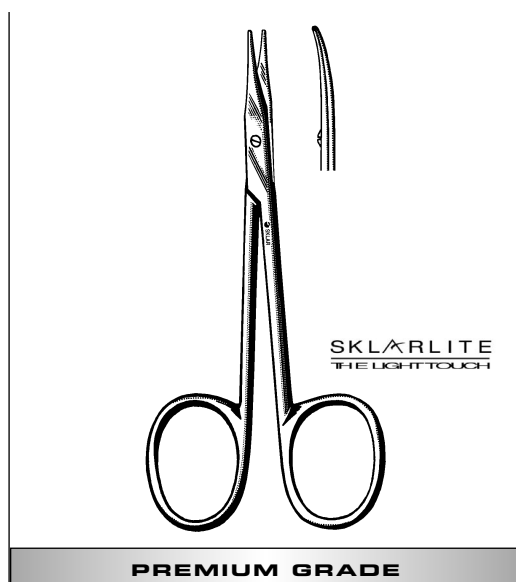


DELICATE

PREMIUM GRADE

STEVENS TENOTOMY SCISSORS DELICATE

Straight	Curved
22-1242 4½" B/B	22-1342 4½" B/B
22-1240 4½" S/S	22-1241 4½" S/S

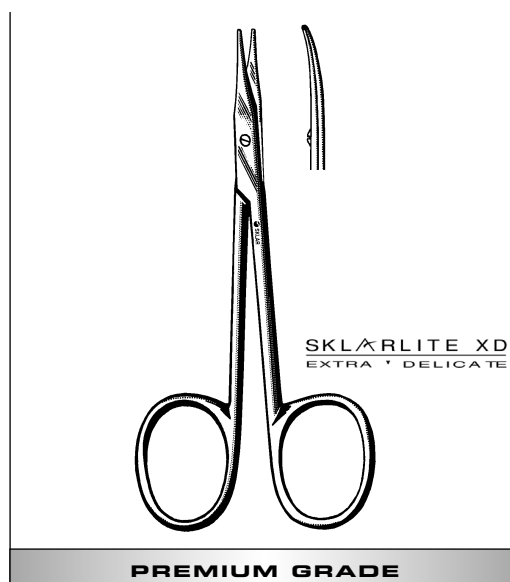


SKLARLITE
THE LIGHT TOUCH

PREMIUM GRADE

SKLARLITE™ STEVENS TENOTOMY SCISSORS

Straight	Curved
B/B	B/B
23-1156 4½"	23-1157 4½"



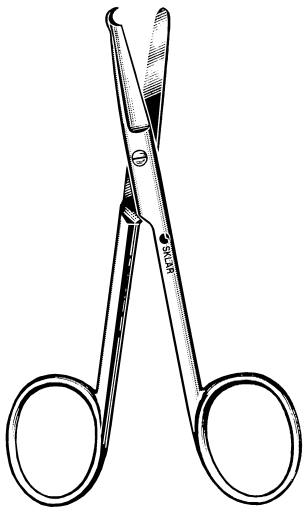
SKLARLITE XD
EXTRA DELICATE

PREMIUM GRADE

SKLARLITE EXTRA DELICATE™ STEVENS TENOTOMY SCISSORS

Straight	Curved
B/B	B/B
23-1160 4½"	23-1161 4½"

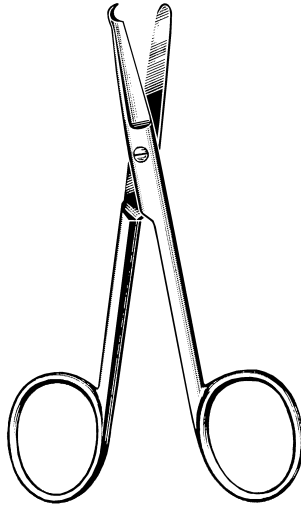
SPENCER STITCH SCISSORS



OR GRADE

SPENCER STITCH SCISSORS

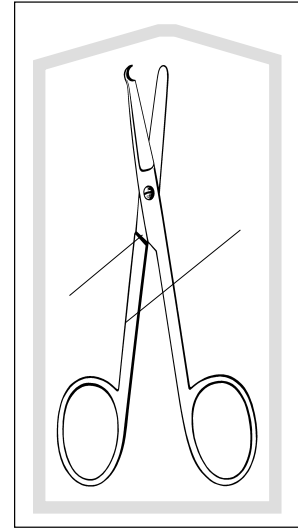
22-2835 3½"
22-2845 4½"



MID-GRADE

MID-GRADE SPENCER STITCH SCISSORS

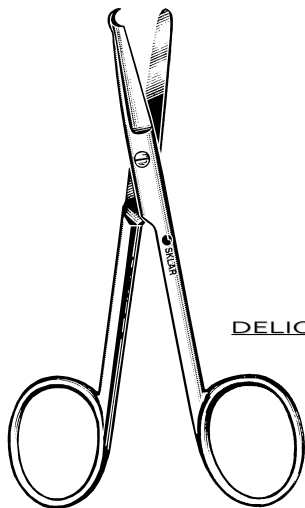
95-346 3½"
95-352 4½"



FLOOR-GRADE, STERILE

SPENCER STITCH SCISSORS, STERILE

Box/50
96-2508 4½"
Box/25
96-2509 4½"

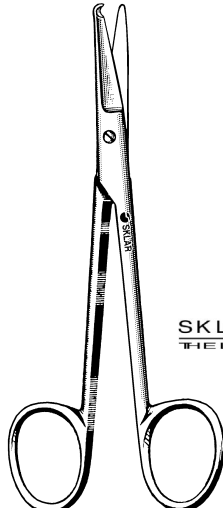


DELICATE

PREMIUM GRADE

SPENCER STITCH SCISSORS DELICATE

22-2834 3½"
22-2844 4½"



**SKLARLITE
"LIGHT TOUCH"**

PREMIUM GRADE

SKLARLITE™ SPENCER STITCH SCISSORS

23-1188 3½"
23-1189 4½"

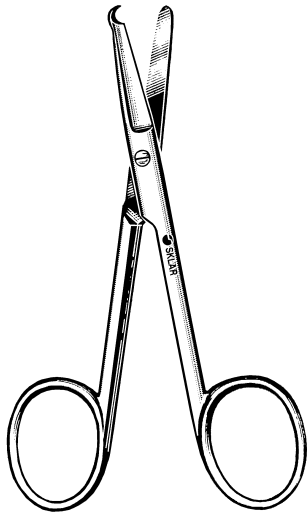


**SKLARLITE XD
EXTRA * DELICATE**

PREMIUM GRADE

SKLARLITE EXTRA DELICATE™ SPENCER STITCH SCISSORS

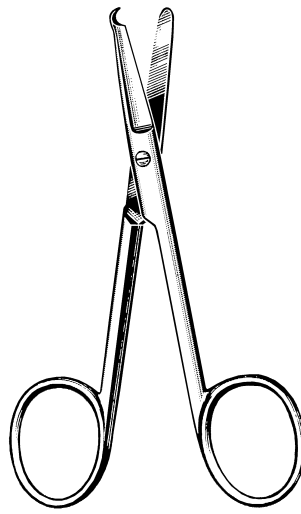
23-1193 3½"
23-1194 4½"



OR GRADE

LITTAUER STITCH SCISSORS

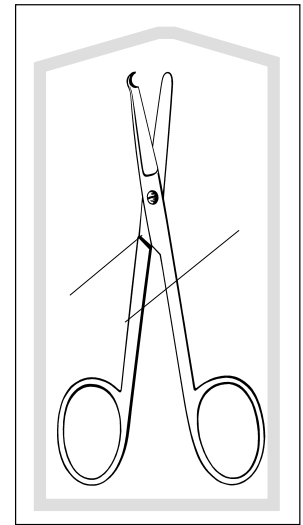
15-1355 5½"



MID-GRADE

**MID-GRADE
LITTAUER STITCH SCISSORS**

95-358 5½"

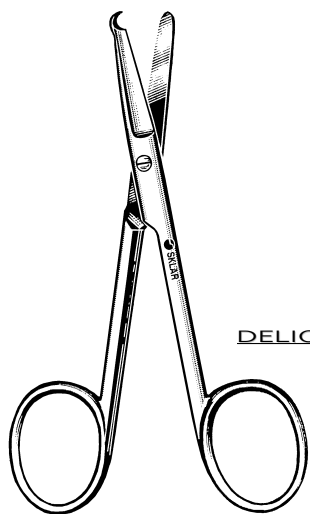


FLOOR-GRADE, STERILE

LITTAUER STITCH SCISSORS, STERILE

Box/50
96-2512 5½"

Box/25
96-2513 5½"



DELICATE

PREMIUM GRADE

**LITTAUER STITCH SCISSORS
DELICATE**

22-1354 5½"



**SKLARLITE
THE LIGHT TOUCH**

PREMIUM GRADE

**SKLARLITE™
LITTAUER STITCH SCISSORS**

23-1190 5½"



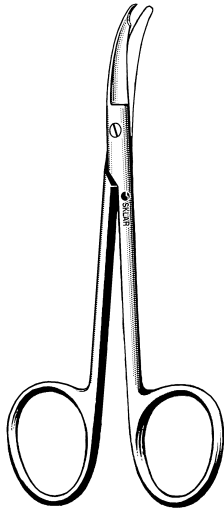
**SKLARLITE XD
EXTRA DELICATE**

PREMIUM GRADE

**SKLARLITE EXTRA DELICATE™
LITTAUER STITCH SCISSORS**

23-1195 5½"

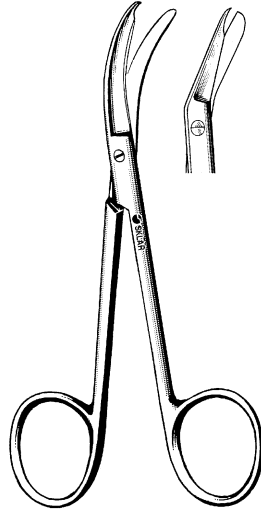
SUTURE & STITCH SCISSORS



OR GRADE

SUTURE SCISSORS

22-2935 3½" Shortbent
22-2947 4¾" Northbent



OR GRADE

SKLAR STITCH SCISSORS

22-2950 5" Curved Sideways
15-3150 5" Angular

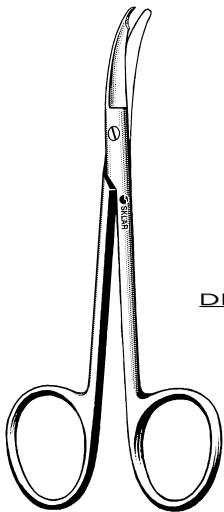


SKLARLITE
THE LIGHT TOUCH

PREMIUM GRADE

SKLARLITE™ SUTURE SCISSORS

23-1191 3½" Shortbent



DELICATE

PREMIUM GRADE

SUTURE SCISSORS DELICATE

22-2934 3½" Shortbent

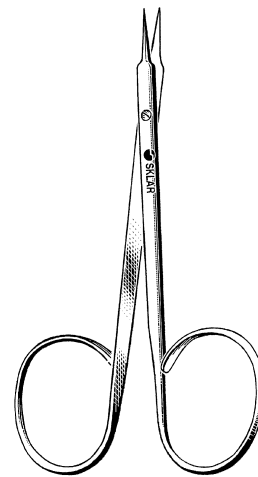


SKLARLITE XD
EXTRA DELICATE

PREMIUM GRADE

SKLARLITE EXTRA DELICATE™ SUTURE SCISSORS

23-1196 3½" Shortbent



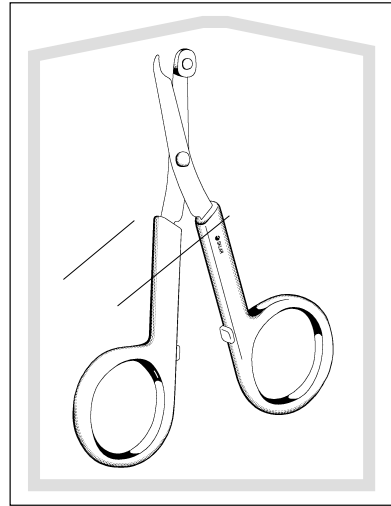
OR GRADE

RIBBON STITCH SCISSORS

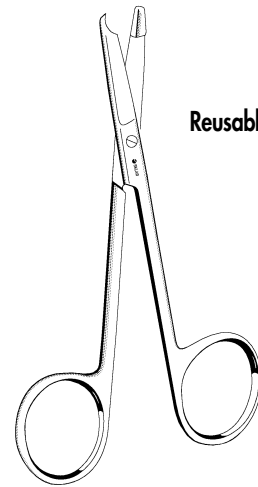
Straight 64-1345 4"
Curved 64-1445 4"

NEW!

SklarClip



FLOOR-GRADE (PLASTIC), STERILE



Reusable

SUTURE REMOVAL INSTRUMENT

Sterile, Plastic - 70/Box
96-2640 4 1/2"

Reusable, Stainless Steel
24-2253 3 1/2"
24-2254 4 1/2"
24-2255 5 1/2"

Removing sutures is now easier and faster with the NEW SklarClip Instrument. SklarClip holds the suture in the jaws as it cuts, allowing it to be withdrawn in one motion. Using SklarClip allows a free hand to stabilize the patient or hold gauze for wound cleansing. SklarClip is truly two instruments in one; suture scissors with the grasping ability of forceps. One instrument to lift, cut and remove stitches reducing instrument costs. Easy to use. Available as a disposable or reusable.

NEW!

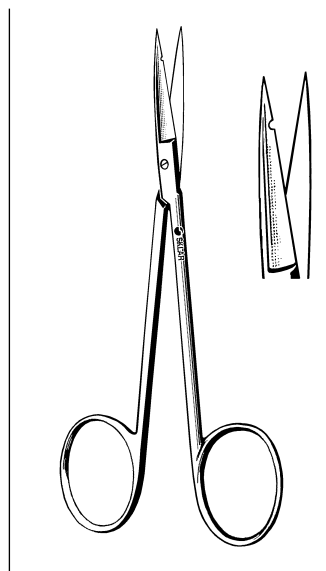
IRIS-SUTURE PRECISION SCISSORS

Sklar Iris and Suture scissors are combined to add convenience and practicality to our most popular patterns.

A suture cutting notch is part of the cutting blade of these finely honed and extremely sharp Iris scissors.

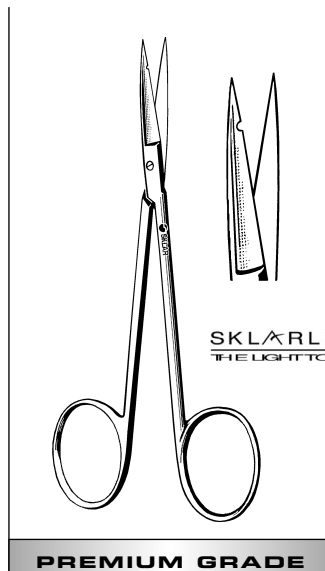
This unique Sklar instrument is ideal for very close, delicate surgery and suture removal.

SKLAR EXCLUSIVE



SKLAR PRECISION SCISSORS

22-2820 3 1/2" Straight
22-2822 3 1/2" Curved
22-2824 4 1/2" Straight
22-2825 4 1/2" Curved

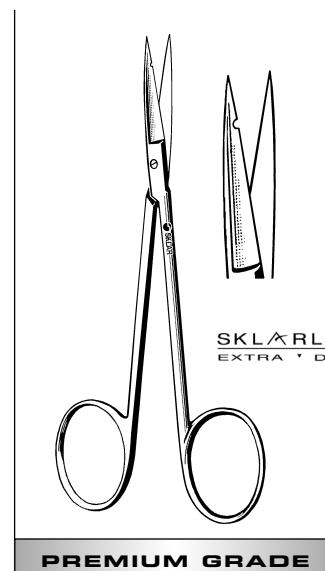


SKLARLITE
THE LIGHT TOUCH

PREMIUM GRADE

SKLARLITE™ PRECISION SCISSORS

23-1290 3 1/2" Straight
23-1292 3 1/2" Curved
23-1294 4 1/2" Straight
23-1296 4 1/2" Curved

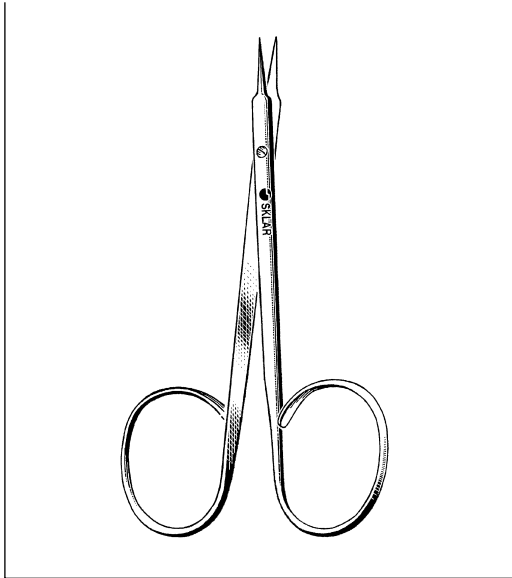


SKLARLITE XD
EXTRA DELICATE

PREMIUM GRADE

SKLARLITE EXTRA DELICATE™ PRECISION SCISSORS

23-1300 3 1/2" Straight
23-1302 3 1/2" Curved
23-1304 4 1/2" Straight
23-1306 4 1/2" Curved



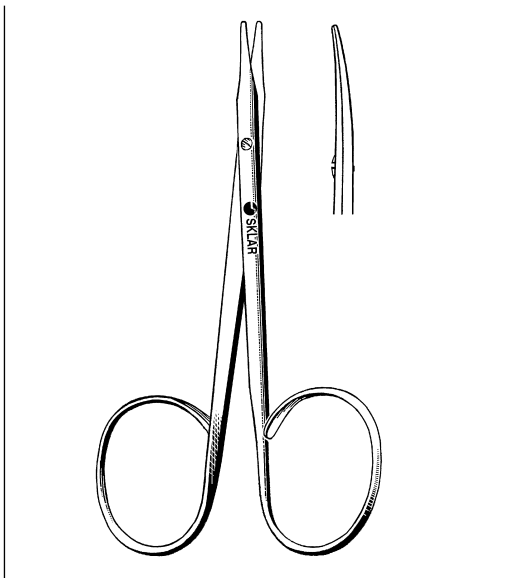
RIBBON STITCH SCISSORS

Straight	Curved
64-1345 4"	64-1445 4"



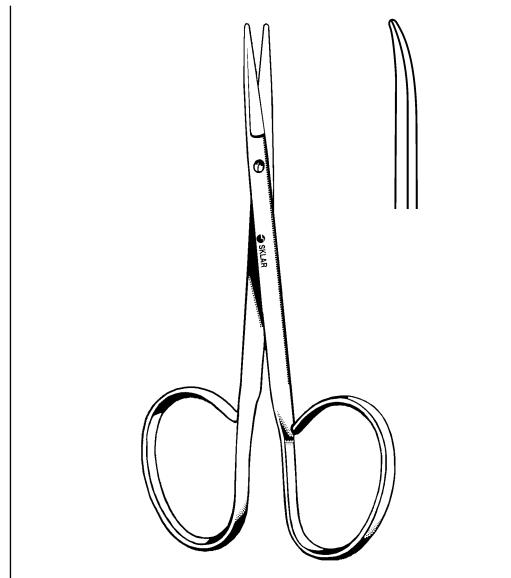
RIBBON STRABISMUS SCISSORS

Straight	Curved
64-1240 4"	64-1340 4"



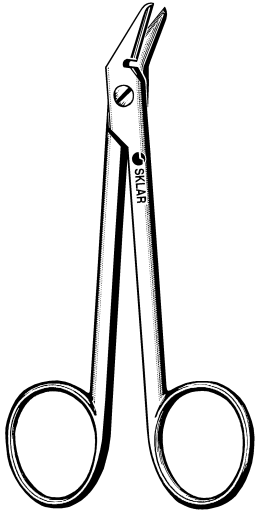
RIBBON STEVENS TENOTOMY SCISSORS

Straight	Curved
64-1241 4"	64-1341 4"



RIBBON UTILITY SCISSORS

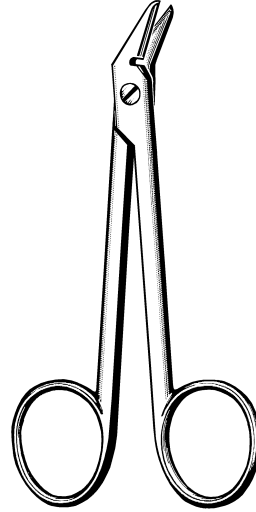
Straight	Curved
47-1146 4"	47-1247 4"



OR GRADE

WIRE CUTTING SCISSORS

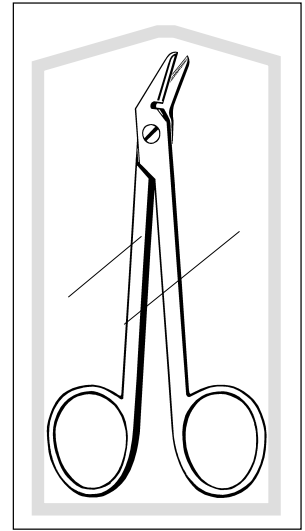
24-2342 4 3/4" Angular Serrated
 24-2349 4 3/4" Angular Serrated, Heavy Pattern



MID-GRADE

MID-GRADE WIRE CUTTING SCISSORS

95-364 4 3/4" Angular Serrated



FLOOR-GRADE, STERILE

WIRE CUTTING SCISSORS, STERILE

Box/50
 96-2518 4 3/4"

Box/25
 96-2519 4 3/4"

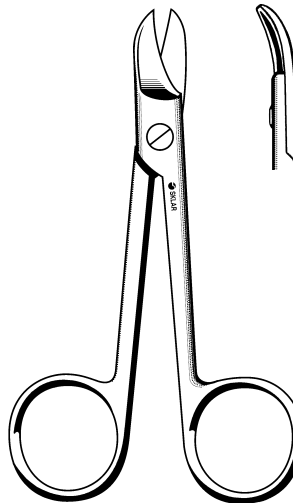


SKLAR EDGE
 TUNGSTEN CARBIDE

PREMIUM GRADE

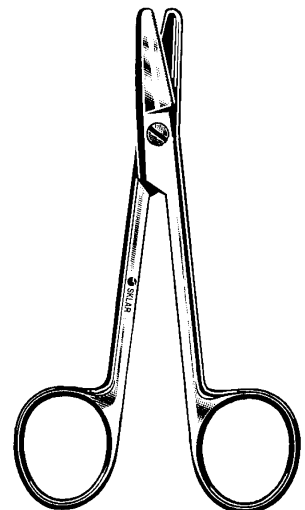
SKLAR EDGE™ T-C WIRE CUTTING SCISSORS

16-2800 4 3/4" Tungsten Carbide
 Angular Serrated



CROWN & COLLAR CUTTING SCISSORS

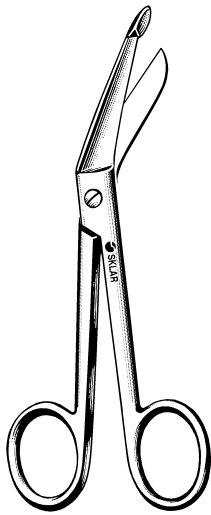
Straight	Curved
24-2345 4"	24-2346 4"
24-2340 4" Serr	24-2341 4" Serr



SUTURE WIRE CUTTING SCISSORS

24-2347 4 3/4" Straight
 Serrated Edges

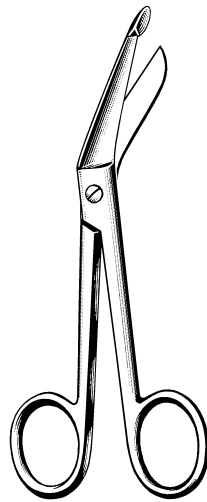
BANDAGE SCISSORS



OR GRADE

LISTER BANDAGE SCISSORS

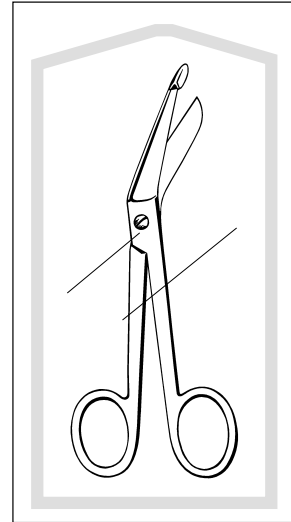
- 11-1035 3½"
- 11-1045 4½"
- 11-1055 5½"
- 11-1072 7¼"
- 11-1080 8"
- 11-1060 8" Large Ring
- 11-1078 7¼" Heavy Pattern



MID-GRADE

MID-GRADE LISTER BANDAGE SCISSORS

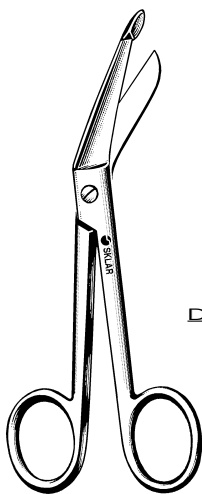
- 95-222 3½"
- 95-226 4½"
- 95-231 5½"
- 95-241 7¼"



FLOOR-GRADE, STERILE

LISTER BANDAGE SCISSORS STERILE

- Box/50
- 96-2502 5½"
- Box/25
- 96-2503 5½"

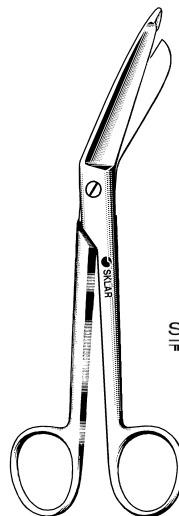


DELICATE

PREMIUM GRADE

LISTER BANDAGE SCISSORS DELICATE

- 22-1054 5½"
- 22-1072 7¼"

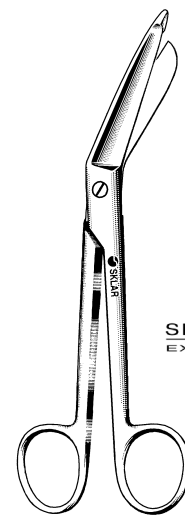


**SKLARLITE
THE LIGHT-TOUGH**

PREMIUM GRADE

SKLARLITE™ LISTER BANDAGE SCISSORS

- 23-1199 5½"
- 23-1200 7¼"

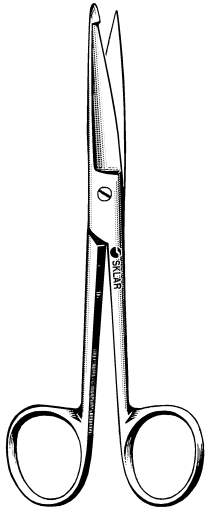


**SKLARLITE XD
EXTRA DELICATE**

PREMIUM GRADE

SKLARLITE EXTRA DELICATE™ LISTER BANDAGE SCISSORS

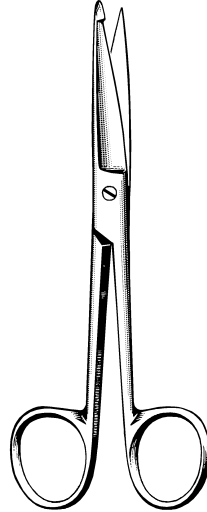
- 23-1202 5½"
- 23-1203 7¼"



OR GRADE

KNOWLES BANDAGE SCISSORS

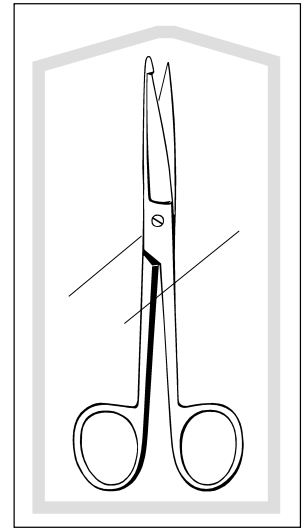
11-1255 5½"



MID-GRADE

**MID-GRADE
KNOWLES BANDAGE SCISSORS**

95-254 5¼"

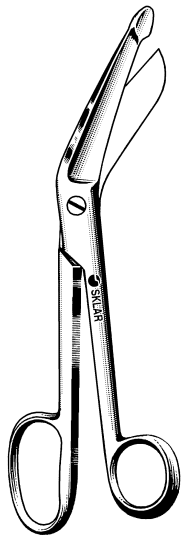


FLOOR-GRADE, STERILE

**KNOWLES BANDAGE SCISSORS,
STERILE**

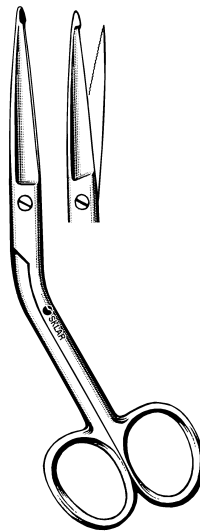
Box/50
96-2402 5½"

Box/25
96-2404 5½"



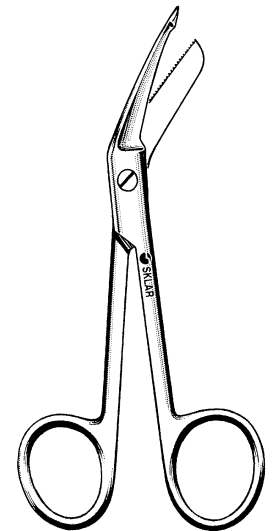
LISTER BANDAGE SCISSORS

Large Ring
11-1060 8"



**SKLAR HI LEVEL BANDAGE
SCISSORS**

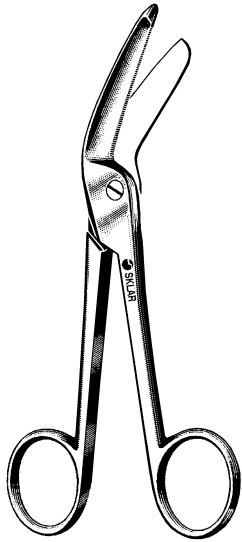
11-1252 5¼"



BANTAM BANDAGE SCISSORS

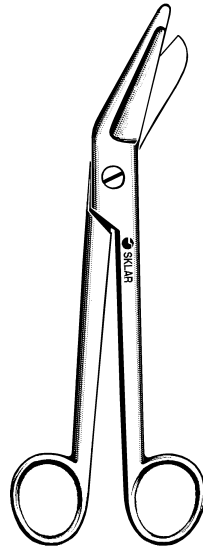
Serrated
11-1257 5¼"

UTILITY SCISSORS



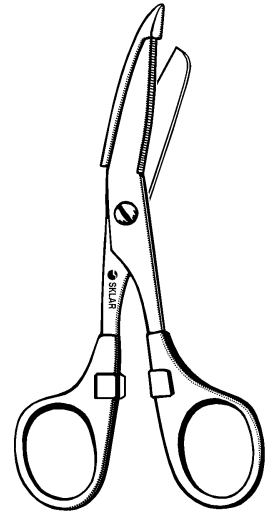
HERCULES UTILITY SCISSORS

11-1297 7½" Serrated



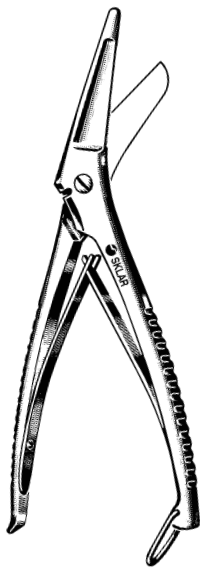
ESMARCH PLASTER SHEARS

Heavy Pattern
11-1380 8"
11-1390 9"



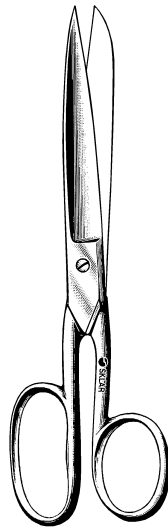
NURSES' BANDAGE SCISSORS

11-1495 5½" Pink finger rings with safety guards
11-1496 5½" Blue finger rings with safety guards



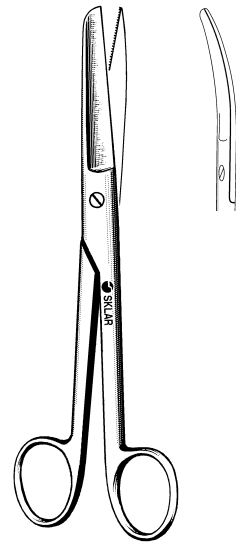
COMMANDER UTILITY SHEARS

Heavy Duty with Wire Cutting Notch
11-1298 8½"



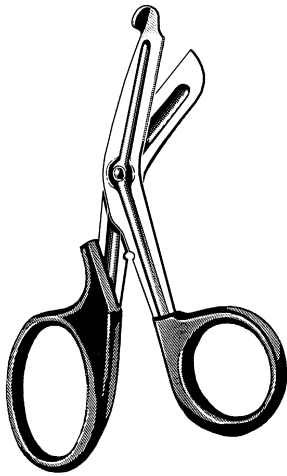
USA PATTERN GAUZE SCISSORS

11-1180 8"



MATERIAL/BANDAGE (MOLESKIN) SCISSORS

Serrated
97-1350 7½" Straight
97-1351 7½" Curved

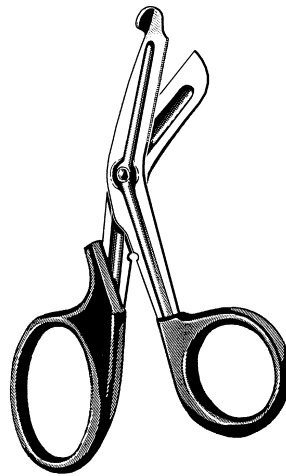


OR GRADE

MULTI-CUT UTILITY SCISSORS

Serrated

11-1278	6"	Standard
11-1280	7½"	Standard
11-1281	7½"	Blue
11-1282	7½"	Green
11-1283	7½"	Red
11-1284	7½"	White

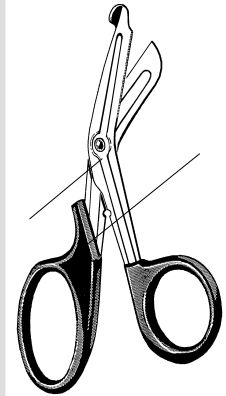


MID-GRADE

MID-GRADE MULTI-CUT UTILITY SCISSORS

Serrated

95-105	7½"	Standard
--------	-----	----------



FLOOR-GRADE, STERILE

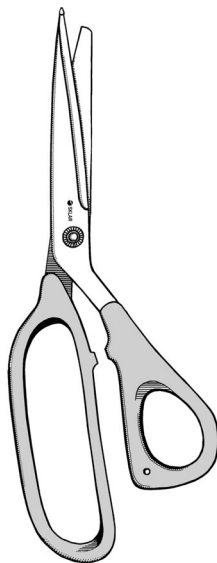
MULTI-CUT UTILITY SCISSORS, STERILE

Box/50

96-2702	5½"
96-2704	7"

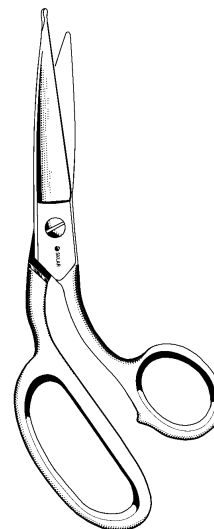
Box/25

96-2701	5½"
96-2703	7"



ELLEN'S UTILITY SCISSORS

11-1303	8½"	Plastic Handle
---------	-----	----------------



HEAVY DUTY EMERGENCY SCISSORS

11-1300	9"
---------	----



Sklar OR Quality Instruments

Our Best Operating Room quality instruments incorporating the highest grades of surgical steel, finely detailed craftsmanship and exacting standards of manufacturing. These instruments are imported from Germany.

Surgi-OR™ Mid-Grade Quality Instruments

These mid-grade instruments are forged from surgical grade stainless steel and crafted to offer significant value at reduced costs for the Operating Room as well as other important surgical settings.



MERIT

Merit™ Physician Office Quality Instruments

A broad selection of Pakistan manufactured instruments crafted for routine surgical use and reliable performance. Utilized in a variety of clinical environments.

Econo™ Floor Grade Instruments

These economically manufactured floor grade instruments offer the greatest utility and the lowest cost.



Econo Sterile™ Instruments

The added convenience and cost-savings of these ready-to-use sterile instruments make Econo Sterile™ an exceptional value.

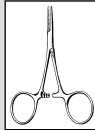
Sklar Premium™ Instruments

Our finest OR grade instruments with the addition of a unique Sklar performance feature to meet the specific surgical needs of the clinician.

PREMIUM INSTRUMENTS

• SKLARLITE™

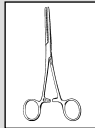
SKLARLITE
THE LIGHT TOUCH



Our premium Operating Room quality instruments provide a lighter version from the standard pattern without sacrifice to strength and durability.

• SKLARLITE XD™

SKLARLITE XD
EXTRA DELICATE



These instruments retain their structural integrity while providing the most delicate and sensitive instruments available.

• SKLARHONE™ Scissors

MICRO-CUT



Scissors are constructed with one knife blade and a standard scissor edge, either smooth or serrated for additional surgical control.

• SKLARCUT™ Scissors

SKLARCUT
SERRATED BLADE



Cut cleanly and precisely due to ultra-fine serrations for improved grip throughout the entire cut.

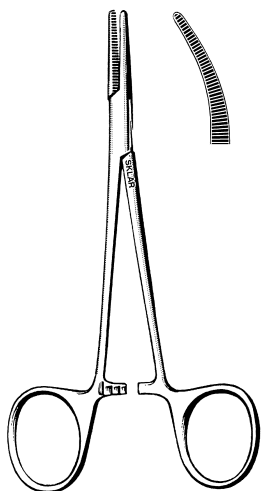
• SKLAR EDGE™

SKLAR EDGE
TUNGSTEN CARBIDE



Tungsten Carbide scissors are the standard for performance and quality as well as durability. Sklar Edge blades have a 5 year warranty.

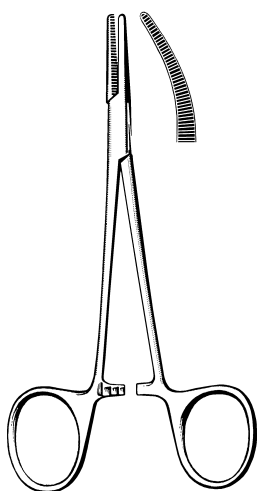
HALSTED MOSQUITO FORCEPS



OR GRADE

HALSTED MOSQUITO FORCEPS

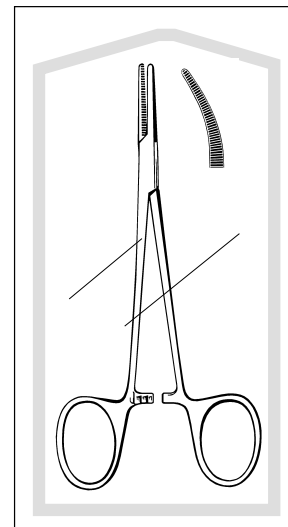
Straight		Curved	
17-1450	5"	17-1550	5"
17-1650	1x2 5"	17-1750	1x2 5"
17-1459	5" Heavy Pattern	17-1559	5" Heavy Pattern



MID-GRADE

MID-GRADE HALSTED MOSQUITO FORCEPS

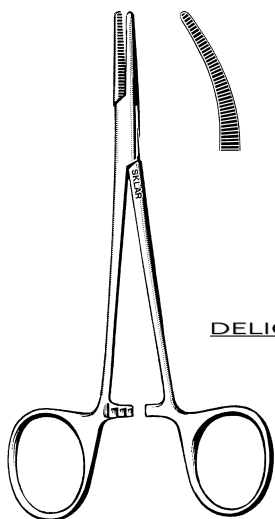
Straight		Curved	
95-426	5"	95-431	5"



FLOOR-GRADE, STERILE

HALSTED MOSQUITO FORCEPS, STERILE

Box/50		
96-2536	5"	Str.
96-2538	5"	Cvd.
Box/25		
96-2537	5"	Str.
96-2539	5"	Cvd.

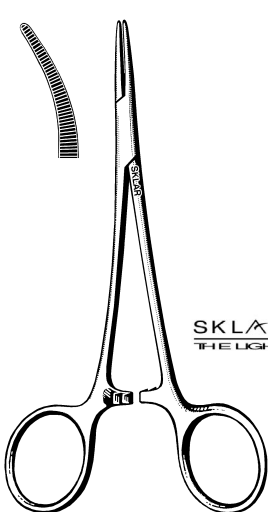


DELICATE

PREMIUM GRADE

HALSTED MOSQUITO FORCEPS DELICATE

Straight		Curved	
18-1050	5"	18-1150	5"

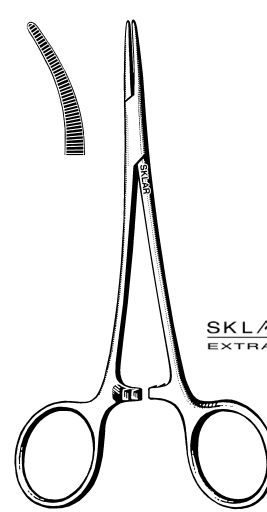


**SKLARLITE
THE LIGHT TOUCH**

PREMIUM GRADE

SKLARLITE™ HALSTED MOSQUITO FORCEPS

Straight		Curved	
23-2105	5"	23-2106	5"

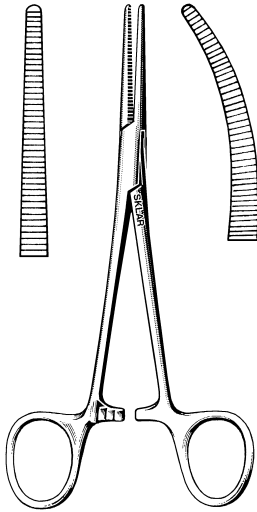


**SKLARLITE XD
EXTRA DELICATE**

PREMIUM GRADE

SKLARLITE EXTRA DELICATE™ HALSTED MOSQUITO FORCEPS

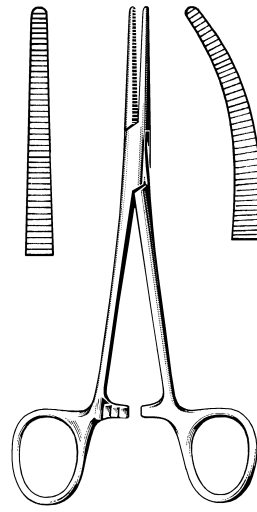
Straight		Curved	
23-2505	5"	23-2506	5"



OR GRADE

CRILE HEMOSTATIC FORCEPS

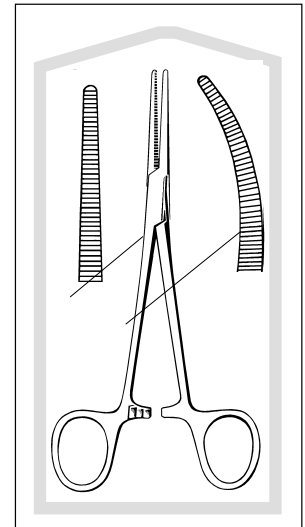
Straight		Curved	
17-3055	5½"	17-3155	5½"
17-3062	6¼"	17-3162	6¼"
17-3075	7½"	17-3175	7½"
17-3068	6¼" Heavy Pattern	17-3168	6¼" Heavy Pattern



MID-GRADE

MID-GRADE CRILE HEMOSTATIC FORCEPS

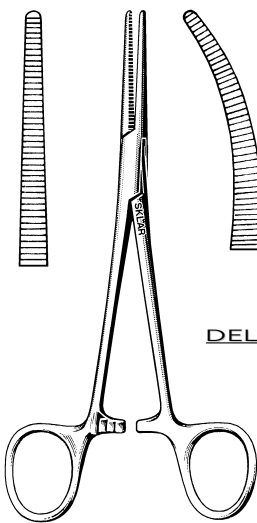
Straight		Curved	
95-447	5½"	95-452	5½"
95-458	6¼"	95-463	6¼"



FLOOR-GRADE, STERILE

CRILE HEMOSTATIC FORCEPS, STERILE

Box/50		
96-2550	5½"	Str.
96-2552	5½"	Cvd.
Box/25		
96-2551	5½"	Str.
96-2553	5½"	Cvd.

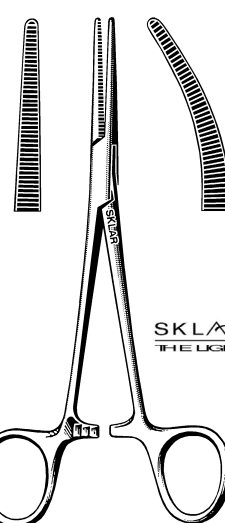


DELICATE

PREMIUM GRADE

CRILE HEMOSTATIC FORCEPS DELICATE

Straight		Curved	
18-1952	5½"	18-2052	5½"

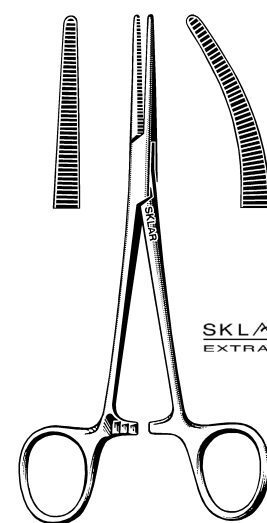


**SKLARLITE
THE LIGHT TOUCH**

PREMIUM GRADE

SKLARLITE™ CRILE HEMOSTATIC FORCEPS

Straight		Curved	
23-2110	5½"	23-2113	5½"



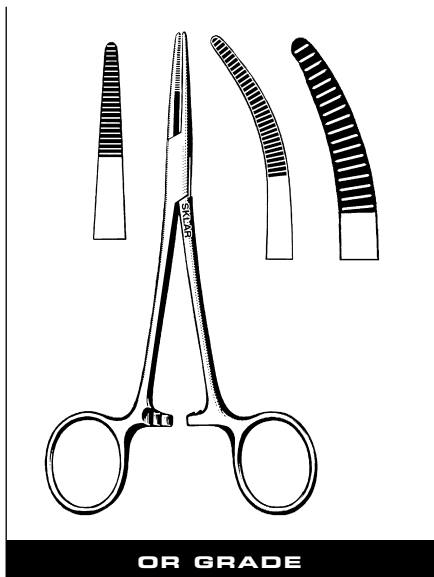
**SKLARLITE XD
EXTRA DELICATE**

PREMIUM GRADE

SKLARLITE EXTRA DELICATE™ CRILE HEMOSTATIC FORCEPS

Straight		Curved	
23-2510	5½"	23-2513	5½"

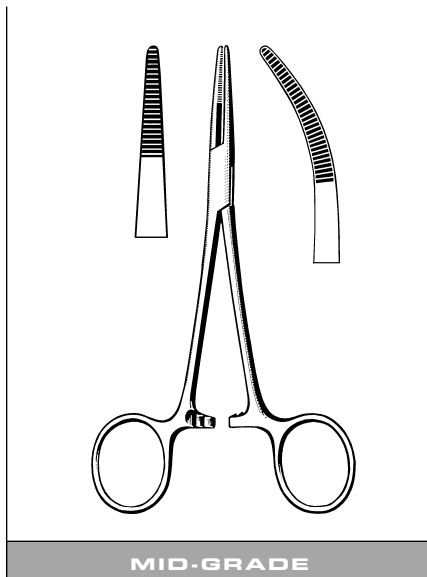
KELLY HEMOSTATIC FORCEPS



OR GRADE

KELLY HEMOSTATIC FORCEPS

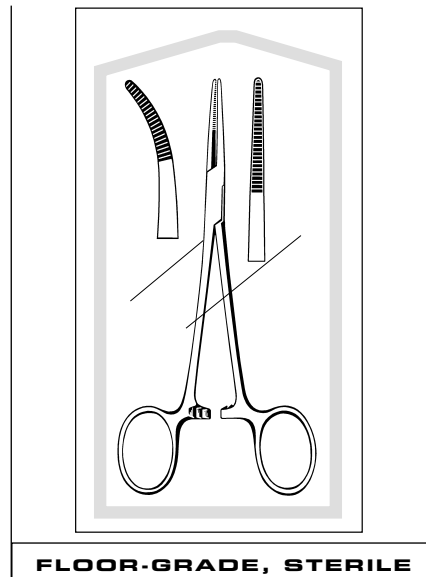
Straight		Curved	
17-2055	5½"	17-2155	5½"
74-3260	7" Heavy Pattern	74-3270	7" Heavy Pattern



MID-GRADE

MID-GRADE KELLY HEMOSTATIC FORCEPS

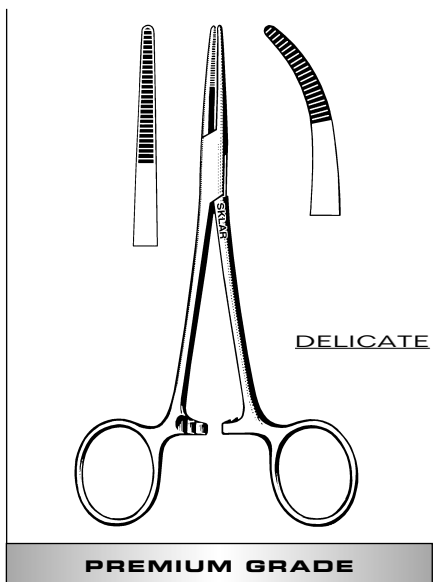
Straight		Curved	
95-436	5½"	95-442	5½"



FLOOR-GRADE, STERILE

KELLY HEMOSTATIC FORCEPS, STERILE

Box/50		
96-2560	5½"	Str.
96-2562	5½"	Cvd.
Box/25		
96-2561	5½"	Str.
96-2563	5½"	Cvd.

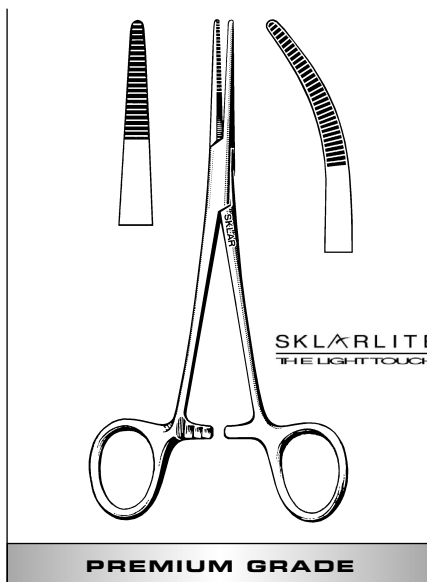


DELICATE

PREMIUM GRADE

KELLY HEMOSTATIC FORCEPS DELICATE

Straight		Curved	
18-1552	5½"	18-1652	5½"

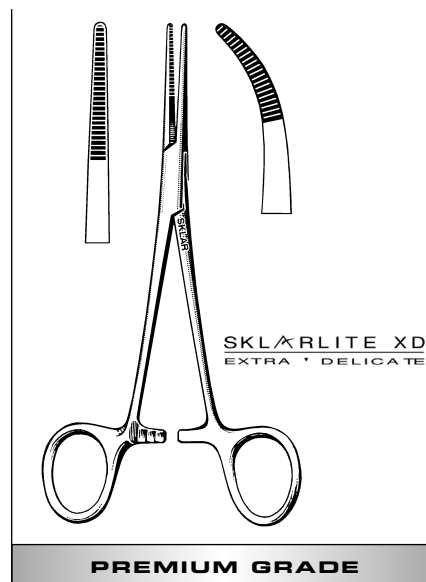


**SKLARLITE
THE LIGHT TOUCH**

PREMIUM GRADE

SKLARLITE™ KELLY HEMOSTATIC FORCEPS

Straight		Curved	
23-2107	5½"	23-2108	5½"

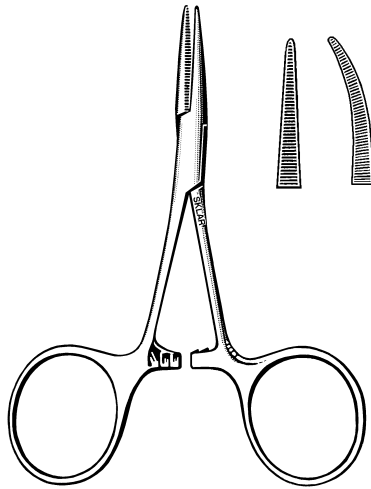


**SKLARLITE XD
EXTRA DELICATE**

PREMIUM GRADE

SKLARLITE EXTRA DELICATE™ KELLY HEMOSTATIC FORCEPS

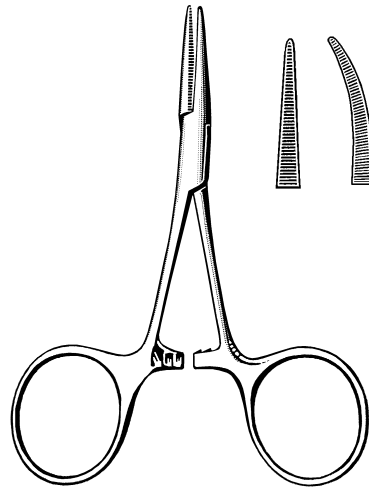
Straight		Curved	
23-2507	5½"	23-2508	5½"



OR GRADE

HARTMANN MOSQUITO HEMOSTATS

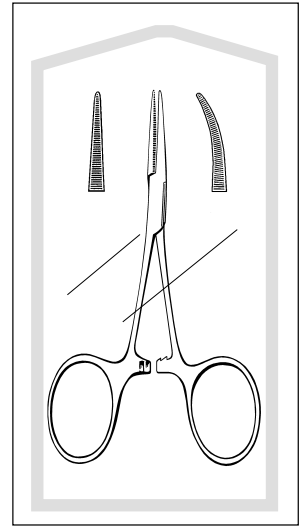
Straight	Curved
17-1235 3/2" Serrated	17-1335 3/2" Serrated



MID-GRADE

MID-GRADE HARTMANN MOSQUITO HEMOSTATS

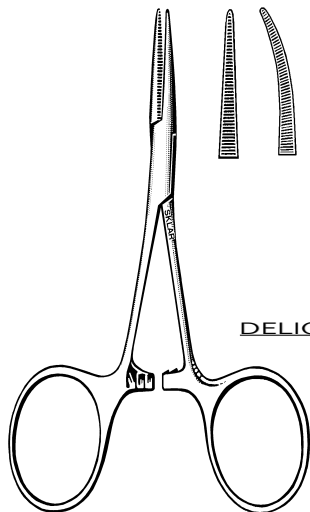
Straight	Curved
95-409 3/2"	95-421 3/2"



FLOOR-GRADE, STERILE

HARTMANN MOSQUITO HEMOSTATS, STERILE

Box/50		
96-2554 3/2"	Str.	
96-2555 3/2"	Cvd.	
Box/25		
96-2556 3/2"	Str.	
96-2557 3/2"	Cvd.	



DELICATE

PREMIUM GRADE

HARTMANN MOSQUITO HEMOSTATS DELICATE

Straight	Curved
17-1230 3/2"	17-1232 3/2"

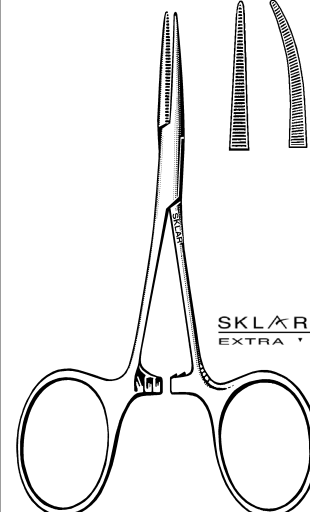


**SKLARLITE
THE LIGHT TOUCH**

PREMIUM GRADE

SKLARLITE™ HARTMANN MOSQUITO HEMOSTATS

Straight	Curved
23-2100 3/2"	23-2101 3/2"



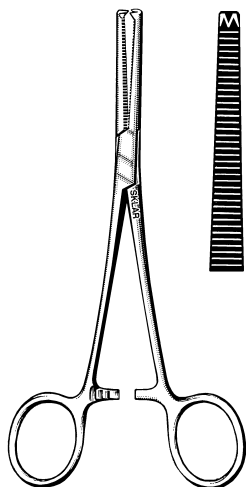
**SKLARLITE XD
EXTRA DELICATE**

PREMIUM GRADE

SKLARLITE EXTRA DELICATE™ HARTMANN MOSQUITO HEMOSTATS

Straight	Curved
23-2500 3/2"	23-2501 3/2"

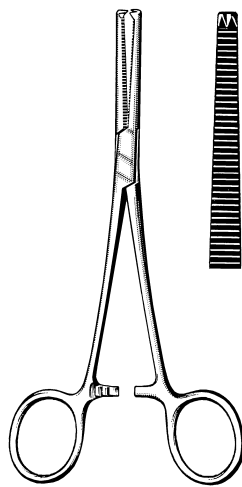
ROCHESTER-OSHSNER FORCEPS



OR GRADE

ROCHESTER-OSHSNER FORCEPS

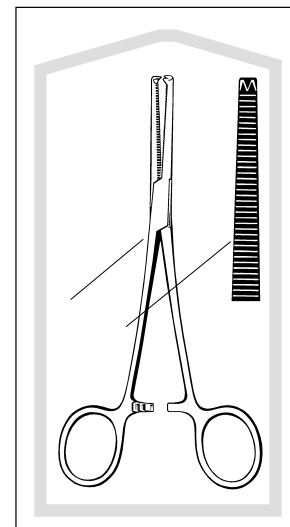
Straight 1x2 Teeth		Curved 1x2 Teeth	
17-2855	5 1/2" Kocher	17-2655	5 1/2" Kocher
17-2862	6 1/4"	17-2662	6 1/4"
17-2872	7 1/4"	17-2672	7 1/4"
17-2880	8"	17-2680	8"
17-2890	10"	17-2690	10"
17-2878	7 1/4" Heavy Pattern		



MID-GRADE

MID-GRADE ROCHESTER-OSHSNER FORCEPS

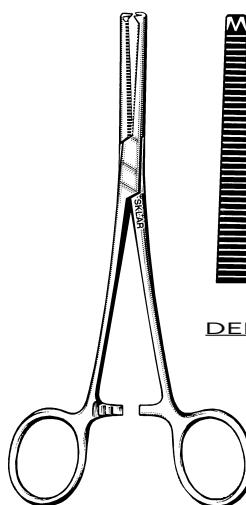
Straight 1x2 Teeth		Curved 1x2 Teeth	
95-500	5 1/2" Kocher	95-501	5 1/2" Kocher
95-504	6 1/4"	95-512	6 1/4"
95-521	7 1/4"	95-525	7 1/4"
95-513	8"	95-514	8"
95-515	9"	95-516	9"
95-517	10"	95-518	10"



FLOOR-GRADE, STERILE

ROCHESTER-OSHSNER FORCEPS, STERILE

Box/50		
96-2707	6 1/4"	Str.
96-2708	6 1/4"	Cvd.
Box/25		
96-2566	6 1/4"	Str.
96-2567	6 1/4"	Cvd.

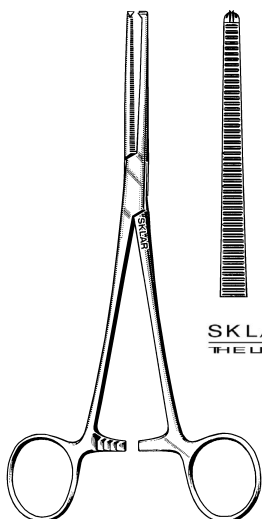


DELICATE

PREMIUM GRADE

ROCHESTER-OSHSNER FORCEPS DELICATE

Straight 1x2 Teeth		Curved 1x2 Teeth	
22-3755	5 1/2" Kocher	22-3855	5 1/2" Kocher
17-2962	6 1/4"	17-2762	6 1/4"

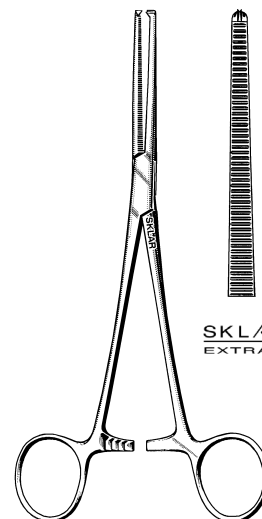


**SKLARLITE
THE LIGHT TOUGH**

PREMIUM GRADE

SKLARLITE™ ROCHESTER-OSHSNER FORCEPS

Straight 1x2 Teeth		Curved 1x2 Teeth	
23-2560	6 1/4"	23-2568	6 1/4"

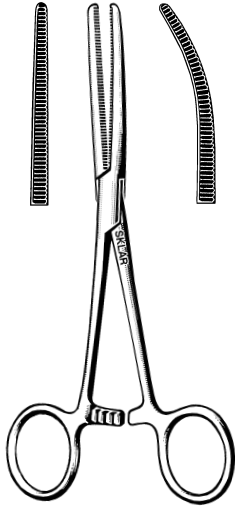


**SKLARLITE XD
EXTRA DELICATE**

PREMIUM GRADE

SKLARLITE EXTRA DELICATE™ ROCHESTER-OSHSNER FORCEPS

Straight 1x2 Teeth		Curved 1x2 Teeth	
23-2577	6 1/4"	23-2585	6 1/4"

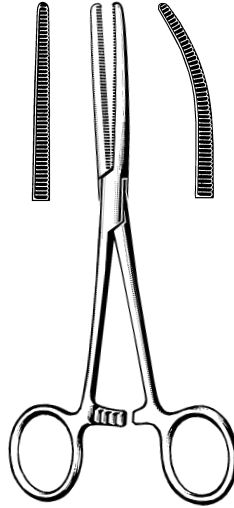


OR GRADE

ROCHESTER-PEAN FORCEPS

Straight		Curved	
17-2455	5½"	17-2255	5½"
17-2462	6¼"	17-2262	6¼"
17-2467	6¾"	17-2267	6¾"
17-2472	7¼"	17-2272	7¼"
17-2480	8"	17-2280	8"
36-2690	9"	36-2790	9"
36-2710	10½"	36-2810	10½"

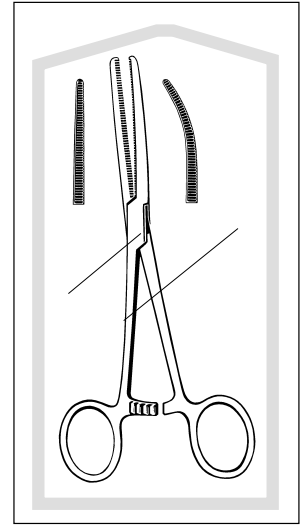
Heavy



MID-GRADE

MID-GRADE ROCHESTER-PEAN FORCEPS

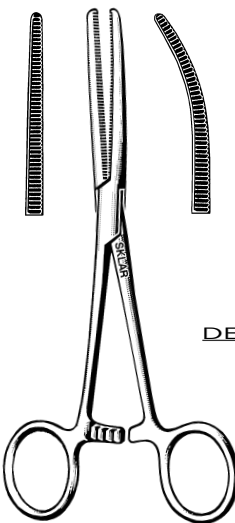
Straight		Curved	
95-470	5½"	95-471	5½"
95-473	6¼"	95-477	6¼"
95-481	7¼"	95-485	7¼"
95-492	8"		
95-483	9"		
95-494	10½"		



FLOOR-GRADE, STERILE

ROCHESTER-PEAN FORCEPS, STERILE

Box/50		
96-2544	6¼"	Str.
96-2546	6¼"	Cvd.
Box/25		
96-2545	6¼"	Str.
96-2547	6¼"	Cvd.

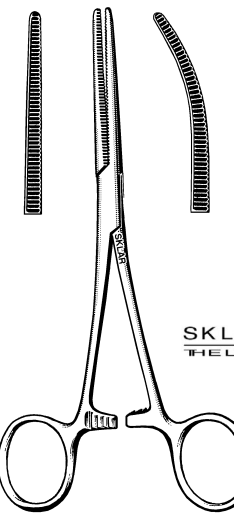


DELICATE

PREMIUM GRADE

ROCHESTER-PEAN FORCEPS DELICATE

Straight		Curved	
22-3555	5½"	22-3655	5½"
		17-2362	6¼"
		22-2280	8"

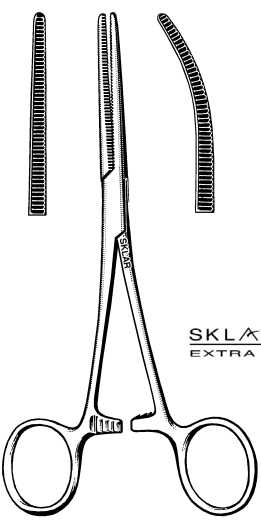


**SKLARLITE
THE LIGHT TOUCH**

PREMIUM GRADE

SKLARLITE™ ROCHESTER-PEAN FORCEPS

Straight		Curved	
23-2532	6¼"	23-2538	6¼"
		23-2542	7¼"



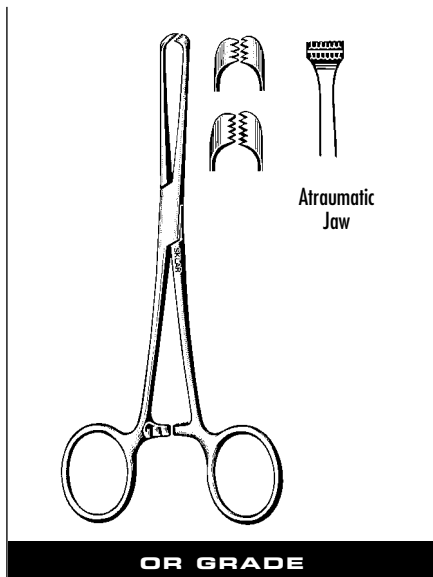
**SKLARLITE XD
EXTRA DELICATE**

PREMIUM GRADE

SKLARLITE EXTRA DELICATE™ ROCHESTER-PEAN FORCEPS

Straight		Curved	
23-2552	6¼"	23-2561	6¼"
		23-2563	7¼"

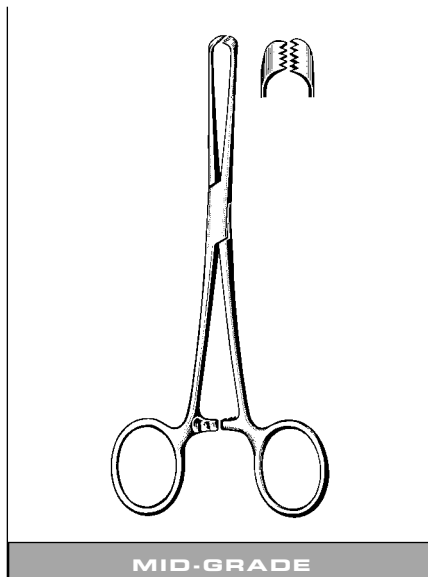
ALLIS FORCEPS



OR GRADE

ALLIS TISSUE FORCEPS

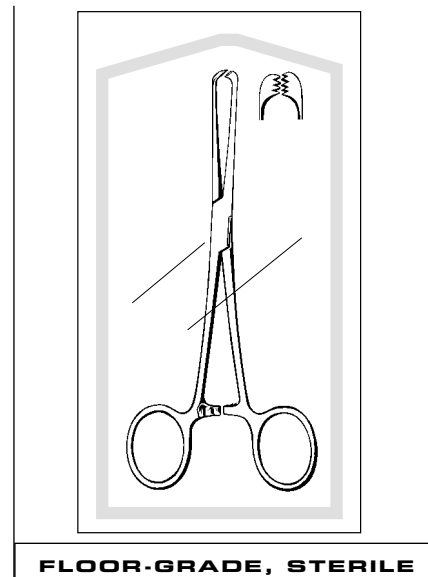
- | | | | | | |
|---------|--------|-------------------|---------|-----|--------|
| 36-2060 | 6" | 3x4 | 36-2298 | 6" | AT Jaw |
| 36-2160 | 6" | 4x5 | 36-2280 | 8" | AT Jaw |
| 36-2260 | 6" | 5x6 | 36-2385 | 10" | AT Jaw |
| 36-2275 | 7 1/2" | 5x6 | | | |
| 36-2295 | 9 1/2" | 5x6 | | | |
| 36-2278 | 7 1/2" | 5x6 Heavy Pattern | | | |



MID-GRADE

MID-GRADE ALLIS TISSUE FORCEPS

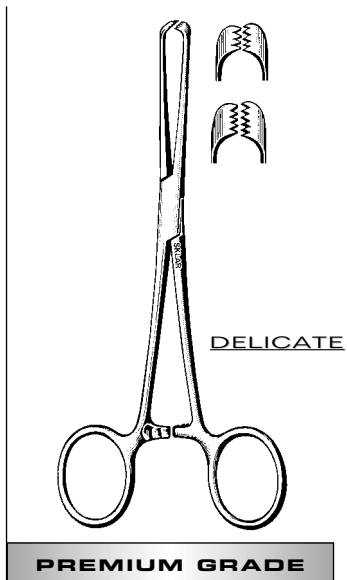
- | | | |
|--------|--------|-----|
| 95-934 | 6" | 5x6 |
| 95-938 | 7 1/2" | 5x6 |



FLOOR-GRADE, STERILE

ALLIS TISSUE FORCEPS, STERILE

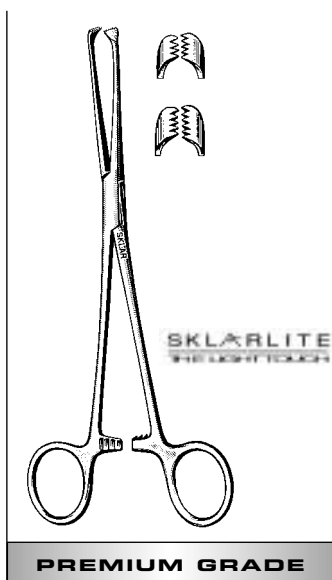
- | | |
|---------|----|
| Box/50 | |
| 96-2576 | 6" |
| Box/25 | |
| 96-2575 | 6" |



PREMIUM GRADE

ALLIS TISSUE FORCEPS DELICATE

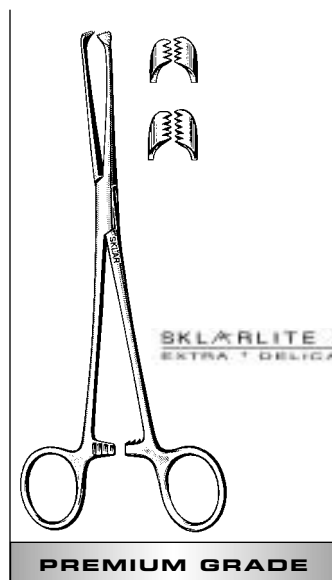
- | | | |
|---------|--------|-----|
| 18-2140 | 4" | 4x5 |
| 18-2155 | 5" | 4x5 |
| 22-6157 | 5 1/2" | 4x5 |
| 18-2162 | 6" | 4x5 |
| 18-2164 | 6" | 5x6 |



PREMIUM GRADE

SKLARLITE™ ALLIS TISSUE FORCEPS

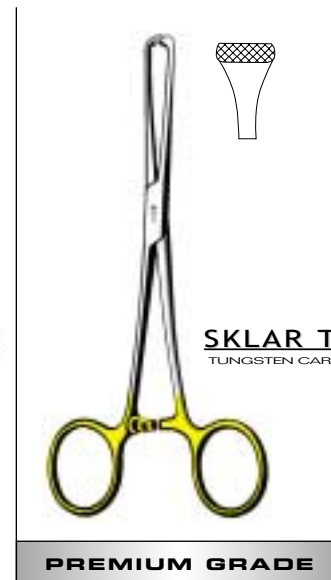
- | | | |
|---------|----|-----|
| 23-2851 | 6" | 4x5 |
| 23-2852 | 6" | 5x6 |



PREMIUM GRADE

SKLARLITE EXTRA DELICATE™ ALLIS TISSUE FORCEPS

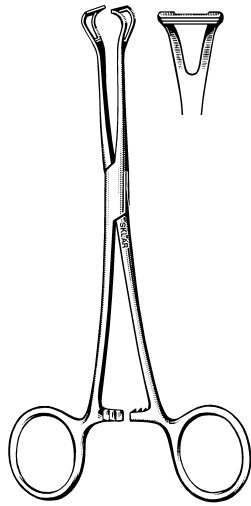
- | | | |
|---------|--------|-----|
| 23-2861 | 5" | 4x5 |
| 23-2862 | 5 1/2" | 4x5 |
| 23-2864 | 6" | 4x5 |
| 23-2865 | 6" | 5x6 |



PREMIUM GRADE

T-C ALLIS FORCEPS

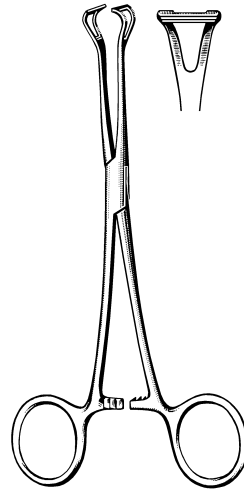
- | | |
|---------|--------|
| 97-1555 | 6" |
| 97-1560 | 7 1/2" |



OR GRADE

BABCOCK FORCEPS

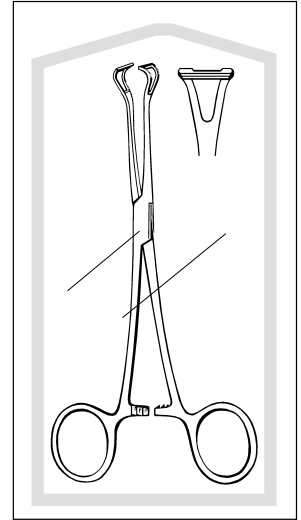
- 22-6155 5 1/4"
- 36-1662 6 1/4"
- 36-1677 8"
- 36-1692 9 1/2"



MID-GRADE

**MID-GRADE
BABCOCK FORCEPS**

- 95-952 6 1/4"



FLOOR-GRADE, STERILE

BABCOCK FORCEPS, STERILE

- Box/50
- 96-2705 6 1/4"
- Box/25
- 96-2706 6 1/4"

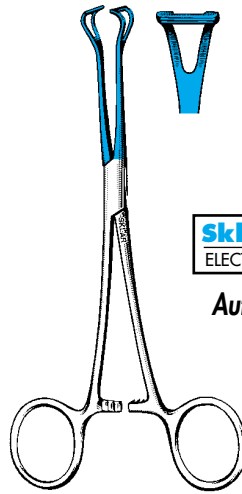


SKLAR T-C
TUNGSTEN CARBIDE

PREMIUM GRADE

T-C BABCOCK FORCEPS

- 97-1565 6 1/4"
- 97-1570 8"



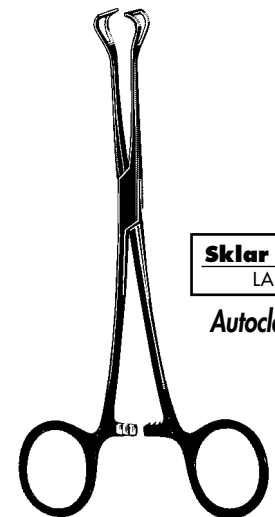
Sklar Blue™
ELECTROSURGICAL

Autoclavable

PREMIUM GRADE

SKLAR BLUE™ BABCOCK FORCEPS

- 91-5268 8"
- 91-5270 9 1/2"



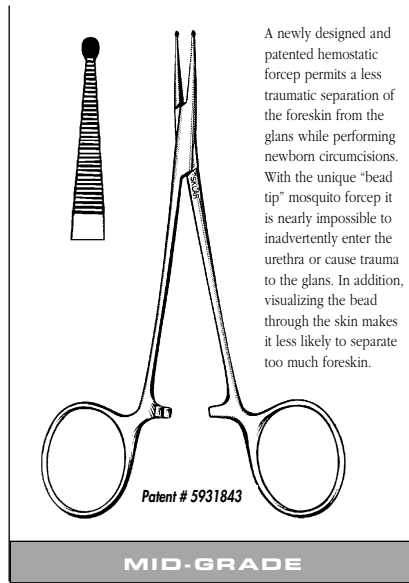
Sklar Black™
LASER

Autoclavable

PREMIUM GRADE

LASER BABCOCK FORCEPS

- 90-2278 8"
- 90-2295 9 1/2"

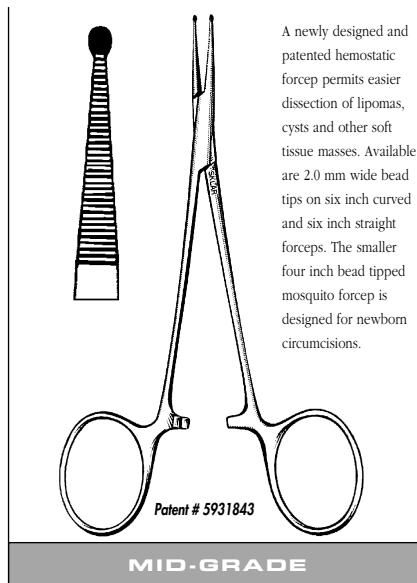


A newly designed and patented hemostatic forcep permits a less traumatic separation of the foreskin from the glans while performing newborn circumcisions. With the unique "bead tip" mosquito forcep it is nearly impossible to inadvertently enter the urethra or cause trauma to the glans. In addition, visualizing the bead through the skin makes it less likely to separate too much foreskin.

MID-GRADE

DUNAWAY CIRCUMCISION FORCEPS

95-456 4" With Bead Tip

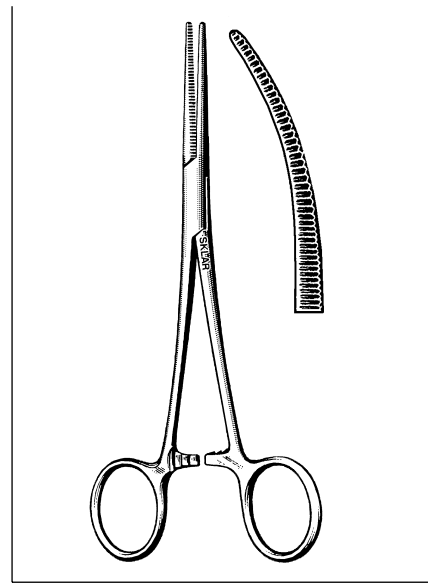


A newly designed and patented hemostatic forcep permits easier dissection of lipomas, cysts and other soft tissue masses. Available are 2.0 mm wide bead tips on six inch curved and six inch straight forceps. The smaller four inch bead tipped mosquito forcep is designed for newborn circumcisions.

MID-GRADE

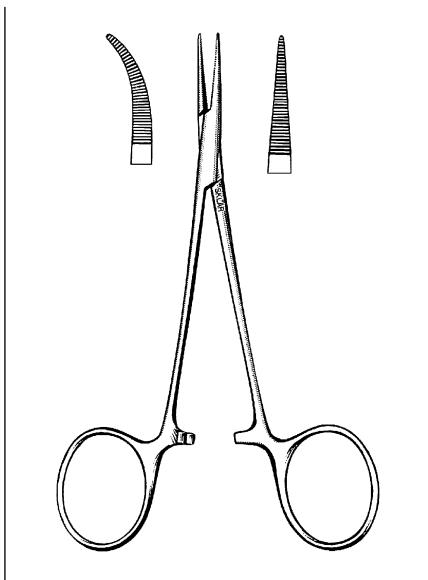
DUNAWAY DISSECTING FORCEPS

95-466 6" With Bead Tip Straight
95-467 6" With Bead Tip Curved



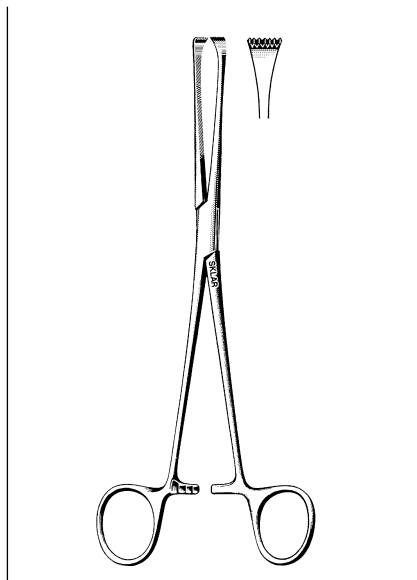
COLLER HEMOSTATIC FORCEPS

Straight		Curved	
17-3455	5½"	17-3555	5½"
17-3265	6¼"	17-3365	6¼"
17-3275	7½"	17-3375	7½"



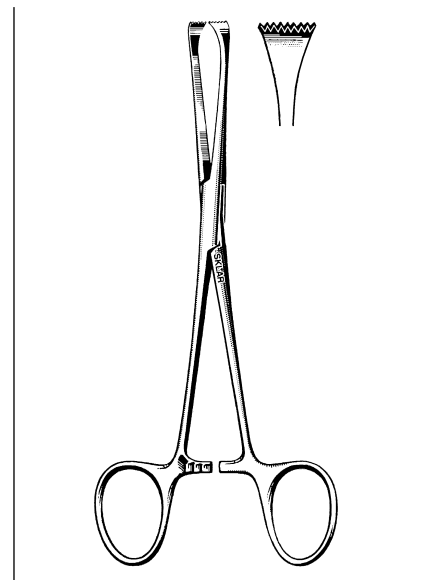
JACOBSON MOSQUITO FORCEPS

Straight		Curved	
98-2050	5"	98-2051	5"



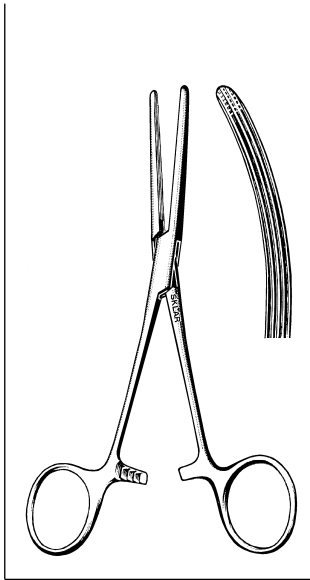
ALLIS-THOMS FORCEPS

36-2380 8" 6 x 7



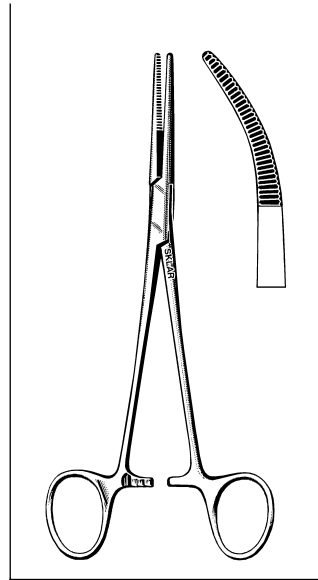
ALLIS-ADAIR FORCEPS

36-1765 6½" 9x10



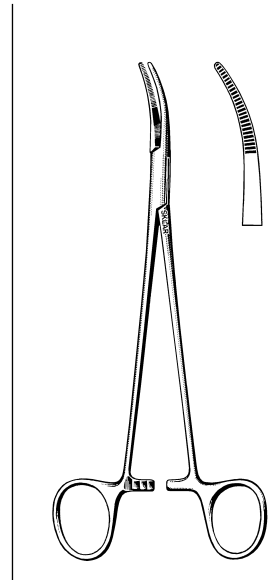
ROCHESTER-CARMALT FORCEPS

Straight		Curved	
17-1062	6 1/4"	17-1162	6 1/4"
17-1080	8"	17-1180	8"



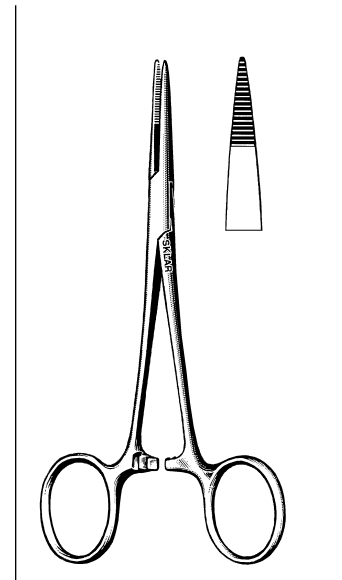
RANKIN HEMOSTATIC FORCEPS

17-1262	6 1/4"	Straight
17-1362	6 1/4"	Curved



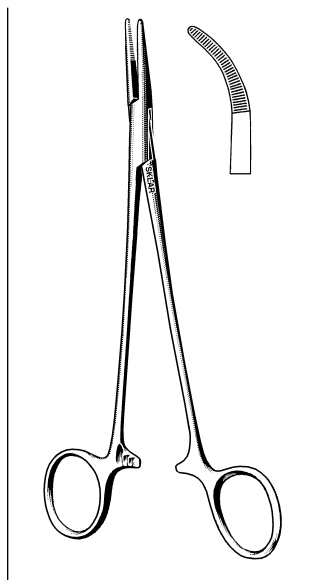
SCHNIDT FORCEPS

74-3075 7 1/4" Half Curved



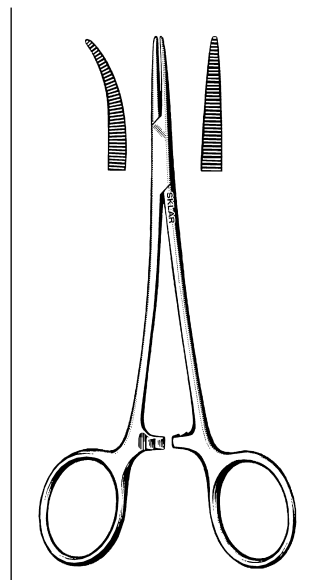
JOHNS HOPKINS MOSQUITO FORCEPS

17-1155 5 1/2" Straight



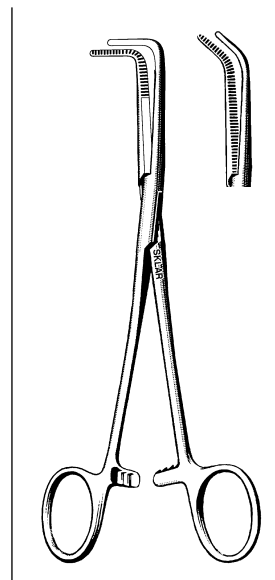
ADSON FORCEPS

50-1372	7 1/4"	Straight
50-1472	7 1/4"	Curved



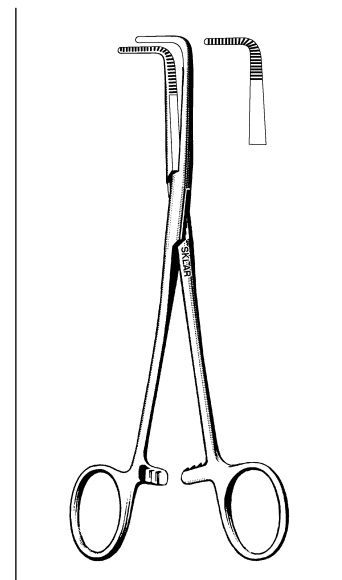
THOMSON MOSQUITO FORCEPS

22-3047	5"	Straight
22-3147	5"	Curved



MIXTER FORCEPS

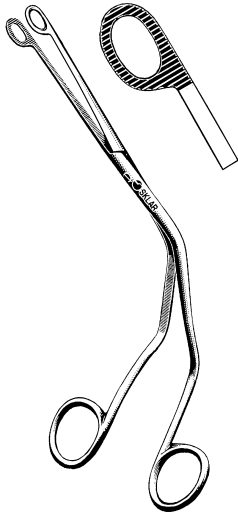
Right Angle		
18-1250	5 1/2"	
17-1762	6 1/4"	
17-1772	7 1/2"	
55-2892	9 1/4"	Slightly Curved



MIXTER FORCEPS DELICATE

Right Angle		
22-3255	5 1/2"	
22-3270	7 1/2"	

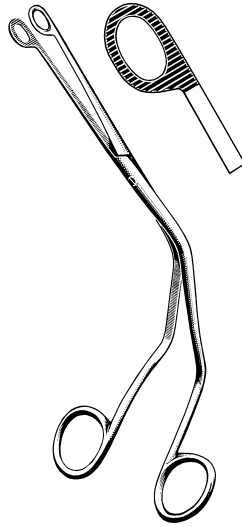
FORCEPS



OR GRADE

MAGILL CATHETER FORCEPS

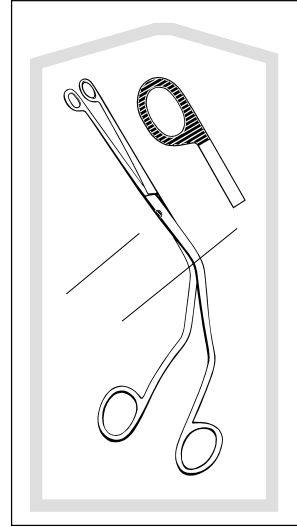
07-1777 Infant 6½"
 07-1780 Child 8"
 07-1797 Adult 10"



MID-GRADE

MID-GRADE MAGILL CATHETER FORCEPS

95-289 Adult
 95-285 Child

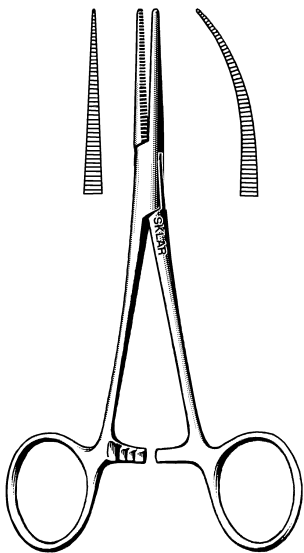


FLOOR-GRADE, STERILE

MAGILL CATHETER FORCEPS, STERILE

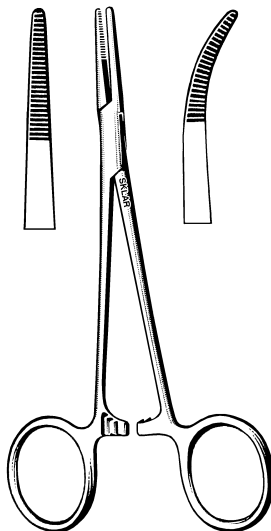
Box/50
 96-2684 Adult

Box/25
 96-2685 Adult



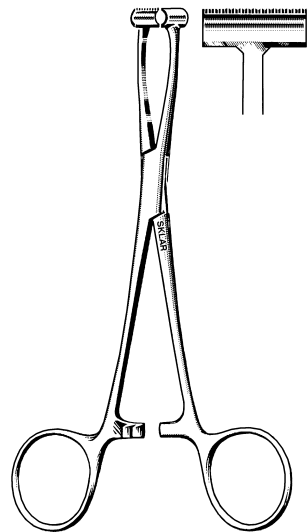
MICRO MOSQUITO FORCEPS

17-1220 5" Straight
 17-1225 5" Curved



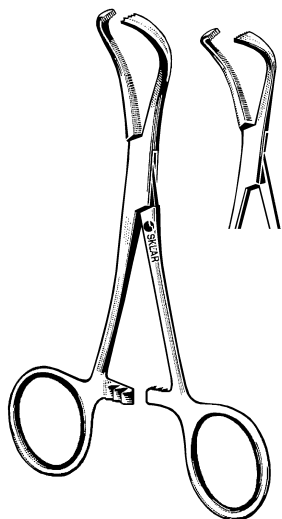
PROVIDENCE HOSPITAL FORCEPS

Straight Curved
 17-1855 5½" 17-1955 5½"
 18-1352 5½" Delicate 18-1452 5½" Delicate



PRATT FORCEPS

T-Shape
 17-1055 6"



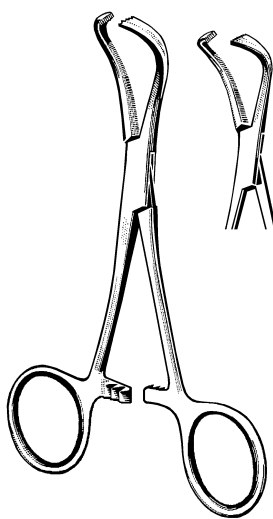
OR GRADE

LORNA (EDNA) TOWEL CLAMP

Non-Perforating

47-2837 3 1/2"

47-2852 5 1/4"

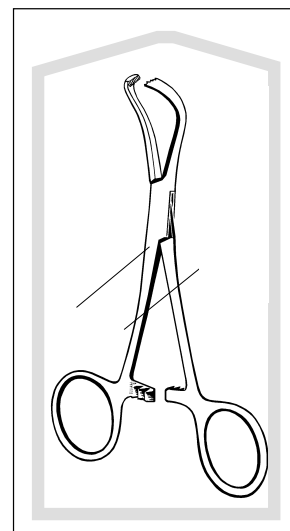


MID-GRADE

MID-GRADE LORNA (EDNA) TOWEL CLAMP

95-629 3 1/2"

95-635 5 1/4"



FLOOR-GRADE, STERILE

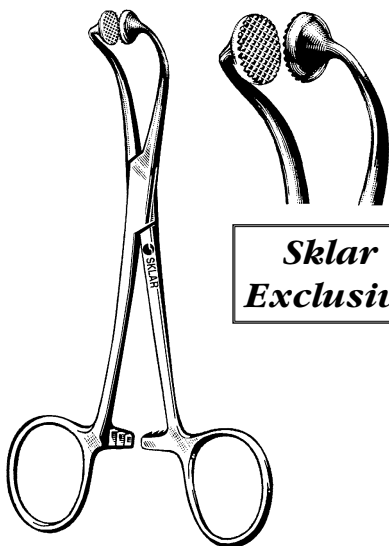
LORNA (EDNA) TOWEL CLAMP, STERILE

Box/50

96-2528 3 1/2"

Box/25

96-2529 3 1/2"



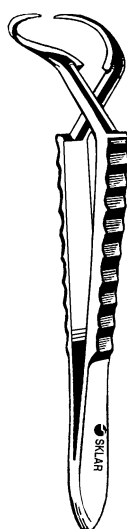
*Sklar
Exclusive*

HOFF TOWEL CLAMP

47-3040 4"

47-3057 5 1/4"

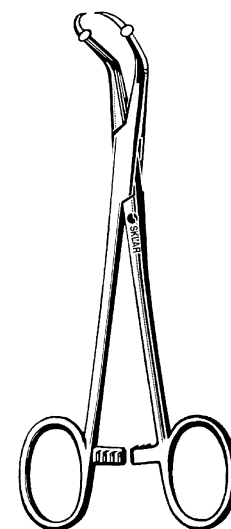
Serrated disc jaws effectively clamp—but will not tear or penetrate cloth or disposable drapes and towels. Can be removed and reapplied without contamination of the field. Also useful to secure cord and tubing to drapes.



JONES CROSS ACTION TOWEL CLAMP

47-2925 2 1/4" Delicate

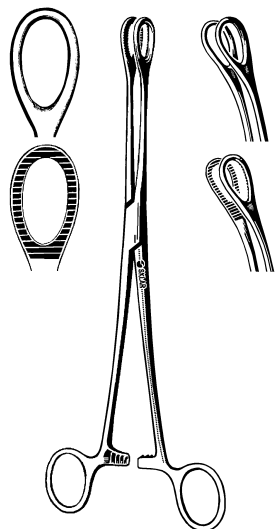
47-2930 3 1/2"



ROEDER TOWEL CLAMP

87-1052 5 1/4" With Ball Stops

SPONGE FORCEPS & TOWEL CLAMPS



OR GRADE

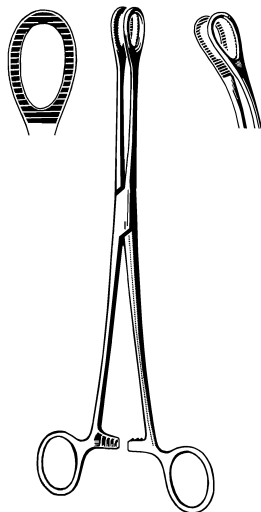
FOERSTER SPONGE FORCEPS

Straight

- 87-2095 9½" Smooth
- 87-2195 9½" Serrated
- 87-2199 9½" Serrated, Heavy Pattern

Curved

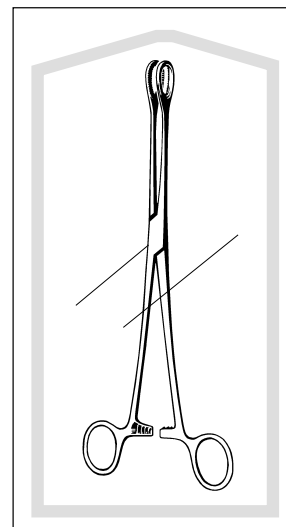
- 87-2295 9½" Smooth
- 87-2395 9½" Serrated



MID-GRADE

MID-GRADE FOERSTER SPONGE FORCEPS

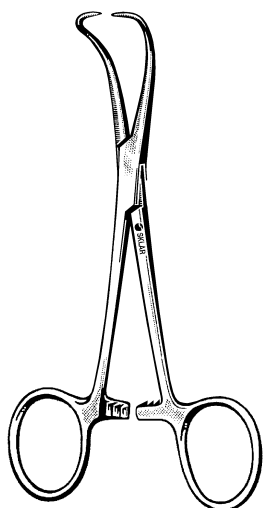
- 95-571 7" Straight Serrated
- 95-577 9½" Straight Serrated
- 95-586 9½" Curved Serrated



FLOOR-GRADE, STERILE

FOERSTER SPONGE FORCEPS, STERILE

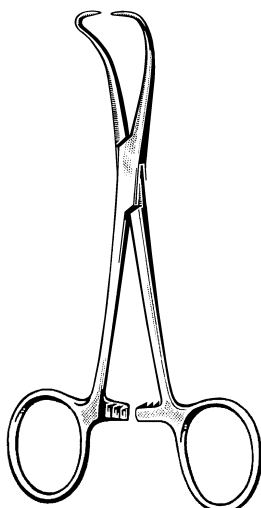
- Box/50, Straight
- 96-2532 9½" Serrated
- Box/25, Straight
- 96-2533 9½" Serrated



OR GRADE

BACKHAUS TOWEL CLAMP

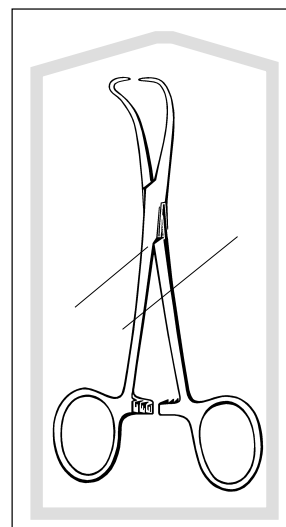
- 47-2935 3½"
- 47-2945 4½"
- 47-2955 5¼"
- 47-2960 6"
- 47-2959 5¼" Heavy Pattern



MID-GRADE

MID-GRADE BACKHAUS TOWEL CLAMP

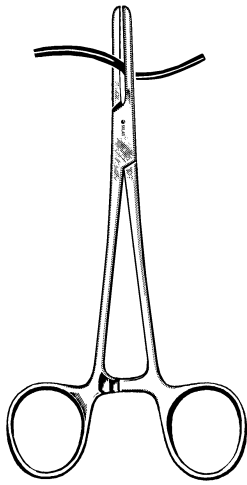
- 95-606 3½"
- 95-611 5¼"



FLOOR-GRADE, STERILE

BACKHAUS TOWEL CLAMP, STERILE

- Box/50
- 96-2534 3½"
- Box/25
- 96-2535 3½"

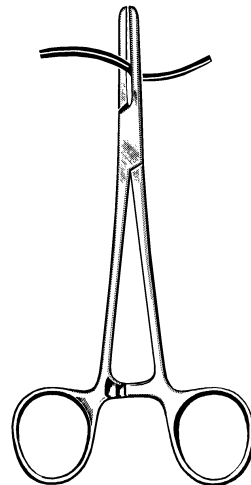


OR GRADE

TUBE OCCLUDING FORCEPS

Smooth Jaw, Straight

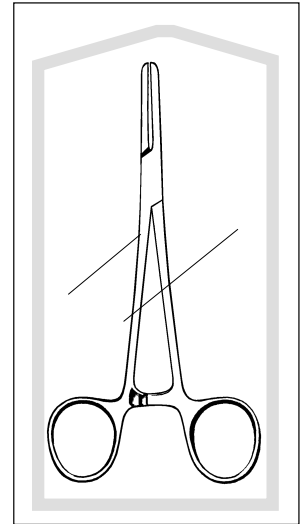
17-3995 5½"
17-3996 6½"
17-3997 7"



MID-GRADE

MID-GRADE TUBE OCCLUDING FORCEPS

Smooth Jaw, Straight
95-592 7"



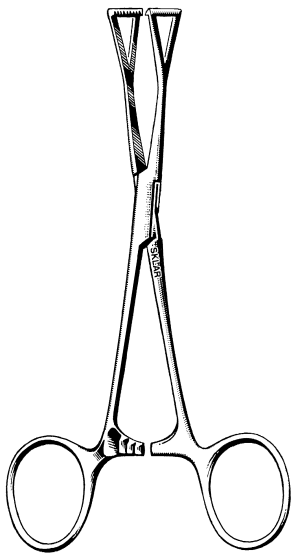
FLOOR-GRADE, STERILE

TUBE OCCLUDING FORCEPS, STERILE

Smooth Jaw, Straight

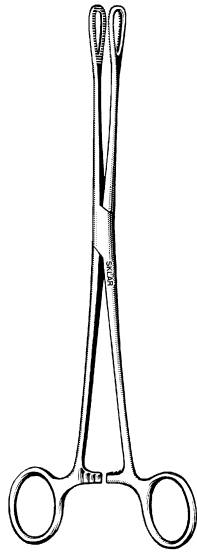
Box/50
96-2406 7"

Box/25
96-2408 7"



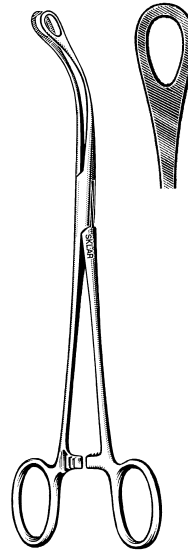
COLLIN (DUVAL) LUNG FORCEPS

36-2577 8" 1" Jaw
36-2595 9½" 1" Jaw
17-2958 8" Pennington ½" Jaw



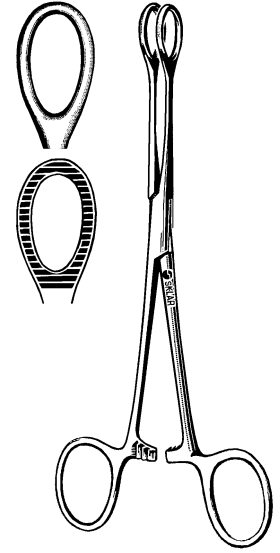
SCHWEIZER FORCEPS

90-7995 9½" Straight



PEANUT SPONGE FORCEPS

22-9380 8" Smooth Straight
22-9480 8" Serrated Curved



BALLENGER SPONGE FORCEPS

Straight
74-1370 7" Smooth
74-1470 7" Serrated
Curved
74-1570 7" Smooth
74-1670 7" Serrated

DRESSING FORCEPS



OR GRADE

DRESSING FORCEPS

Serrated

19-1045	4½"	19-1070	7"
19-1050	5"	19-1080	8"
19-1055	5½"	19-1110	10"
19-1060	6"	19-1112	12"
19-1058	6" Heavy Pattern		

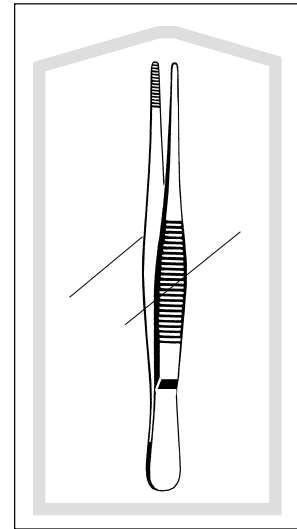


MID-GRADE

MID-GRADE DRESSING FORCEPS

Serrated

95-705	4½"	95-731	6"
95-710	5"	95-736	8"
95-727	5½"		



FLOOR-GRADE, STERILE

DRESSING FORCEPS, STERILE

Box/50

96-2568 5" Serrated

Box/25

96-2569 5" Serrated



DELICATE

PREMIUM GRADE

DRESSING FORCEPS DELICATE

Serrated

22-1161	4½"	22-1163	5½"
22-1162	5"	22-1164	6"



**SKLARLITE™
THE LIGHT TOUCH**

PREMIUM GRADE

SKLARLITE™ DRESSING FORCEPS

Serrated

23-2824	4½"	23-2828	5½"
23-2826	5"	23-2830	6"



**SKLARLITE XD™
EXTRA DELICATE**

PREMIUM GRADE

SKLARLITE EXTRA DELICATE™ DRESSING FORCEPS

Serrated

23-2834	4½"	23-2838	5½"
23-2836	5"		



**SKLAR T-C™
TUNGSTEN CARBIDE**

PREMIUM GRADE

T-C DRESSING FORCEPS

51-3460	6"	Serrated
51-3480	8"	Serrated



OR GRADE

TISSUE FORCEPS

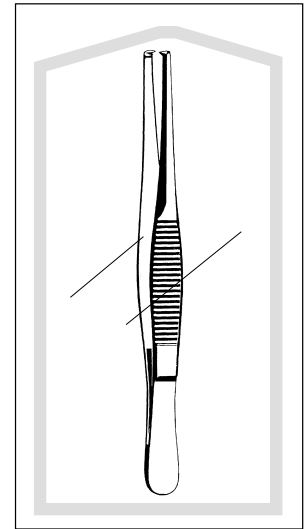
1x2 Teeth			
19-1245	4½"	19-1270	7"
19-1250	5"	19-1280	8"
19-1255	5½"	19-1310	10"
19-1260	6"	19-1312	12"
19-1258	6" Heavy Pattern		



MID-GRADE

MID-GRADE TISSUE FORCEPS

1x2 Teeth			
95-753	4½"	95-762	5½"
95-757	5"	95-766	6"



FLOOR-GRADE, STERILE

TISSUE FORCEPS, STERILE

Box/50		
96-2578	5"	1x2 Teeth
Box/25		
96-2579	5"	1x2 Teeth

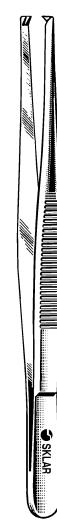


DELICATE

PREMIUM GRADE

TISSUE FORCEPS DELICATE

1x2 Teeth	
22-1063	5½"



**SKLARLITE™
THE LIGHT TOUCH**

PREMIUM GRADE

SKLARLITE™ TISSUE FORCEPS

1x2 Teeth	
23-2811	5½"



**SKLARLITE XD™
EXTRA DELICATE**

PREMIUM GRADE

SKLARLITE EXTRA DELICATE™ TISSUE FORCEPS

1x2 Teeth	
23-2819	5½"

ADSON FORCEPS



OR GRADE

ADSON (EWALD) FORCEPS

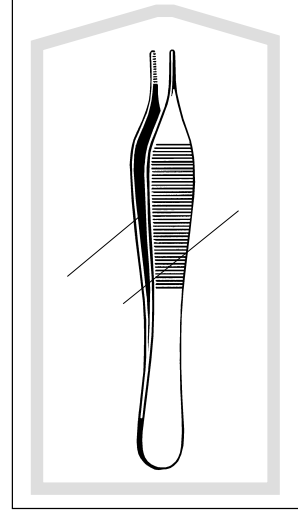
Dressing
 50-3147 4 3/4" Serrated
 50-3145 4 3/4" Serrated, Heavy Pattern



MID-GRADE

MID-GRADE ADSON FORCEPS

Dressing 95-771 4 3/4" Serrated
 Dressing-Delicate 95-772 4 3/4" Serrated



FLOOR-GRADE, STERILE

ADSON FORCEPS, STERILE

Box/50
 96-2570 4 3/4" Dressing, Serrated
 Box/25
 96-2571 4 3/4" Dressing, Serrated



DELICATE

PREMIUM GRADE

ADSON FORCEPS DELICATE

Dressing
 47-2147 4 3/4" Serrated



**SKLARLITE™
THE LIGHT TOUCH**

PREMIUM GRADE

SKLARLITE™ ADSON FORCEPS

Dressing
 23-2600 4 3/4" Serrated



**SKLARLITE XD
EXTRA DELICATE**

PREMIUM GRADE

SKLARLITE EXTRA DELICATE™ ADSON FORCEPS

Dressing
 23-2604 4 3/4" Serrated



OR GRADE

ADSON FORCEPS

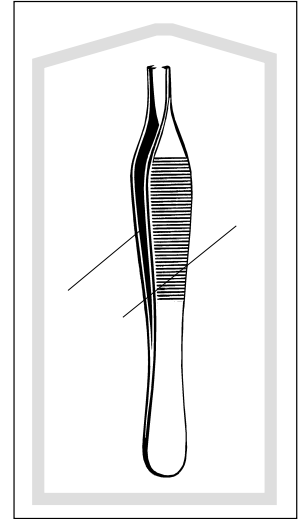
Tissue
 50-3047 4 3/4" 1x2 Teeth
 50-3045 4 3/4" 1x2 Teeth, Heavy Pattern



MID-GRADE

MID-GRADE ADSON FORCEPS

Tissue
 95-775 4 3/4" 1x2 Teeth
 Tissue-Delicate
 95-776 4 3/4" 1x2 Teeth



FLOOR-GRADE, STERILE

ADSON FORCEPS, STERILE

Box/50
 96-2572 4 3/4" Tissue, 1x2 Teeth
 Box/25
 96-2573 4 3/4" Tissue, 1x2 Teeth



DELICATE

PREMIUM GRADE

ADSON FORCEPS DELICATE

Tissue
 47-2047 4 3/4" 1x2 Teeth
 47-2049 4 3/4" 2x3 Teeth



**SKLARLITE
THE LIGHT TOUCH**

PREMIUM GRADE

SKLARLITE™ ADSON FORCEPS

Tissue
 23-2602 4 3/4" 1x2 Teeth



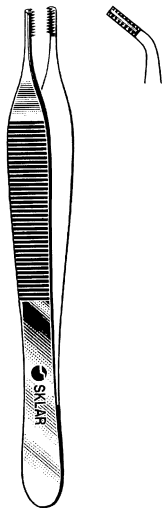
**SKLARLITE XD
EXTRA DELICATE**

PREMIUM GRADE

SKLARLITE EXTRA DELICATE™ ADSON FORCEPS

Tissue
 23-2606 4 3/4" 1x2 Teeth

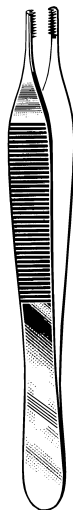
ADSON-BROWN FORCEPS



OR GRADE

ADSON-BROWN FORCEPS

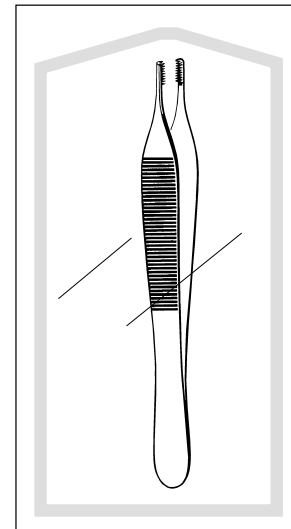
47-1447 4 3/4" Side Grasping
47-1450 4 3/4" Adson Brown Angled



MID-GRADE

MID-GRADE ADSON-BROWN FORCEPS

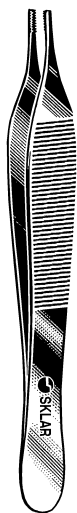
95-778 4 3/4" Side Grasping



FLOOR-GRADE, STERILE

ADSON-BROWN FORCEPS, STERILE

Box/50
96-2558 4 3/4" Side Grasping
Box/25
96-2559 4 3/4" Side Grasping



DELICATE

PREMIUM GRADE

ADSON-BROWN FORCEPS DELICATE

47-2447 4 3/4" Side Grasping



SKLARLITE
THE LIGHT TOUCH

PREMIUM GRADE

SKLARLITE™ ADSON-BROWN FORCEPS

23-2603 4 3/4" Side Grasping

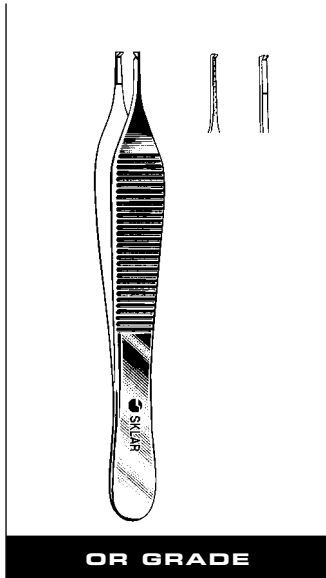


SKLARLITE XD
EXTRA DELICATE

PREMIUM GRADE

SKLARLITE EXTRA DELICATE™ ADSON-BROWN FORCEPS

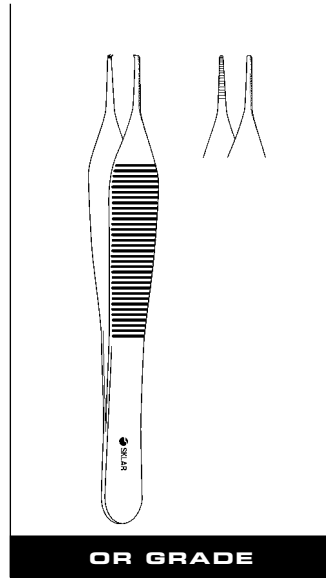
23-2608 4 3/4" Side Grasping



OR GRADE

ADSON FORCEPS

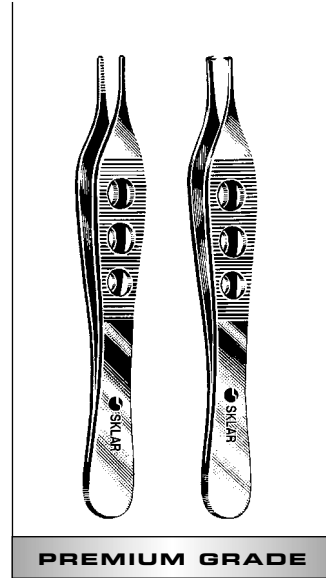
- 50-3048 4 3/4" Serrated, 1x2 Teeth
- 50-3049 4 3/4" 1x2 Teeth w/Platform



OR GRADE

MICRO ADSON FORCEPS

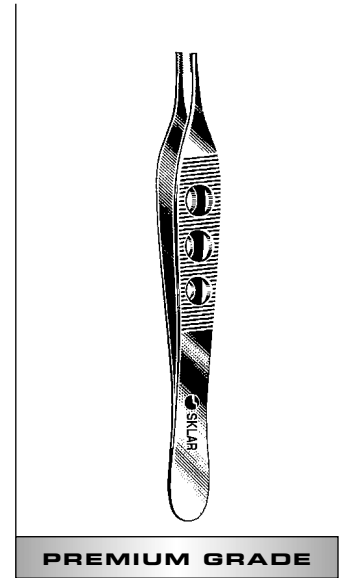
- 98-2047 4 3/4" 1x2 Teeth
- 98-2048 4 3/4" Serrated



PREMIUM GRADE

LITEGRIP™ ADSON FORCEPS

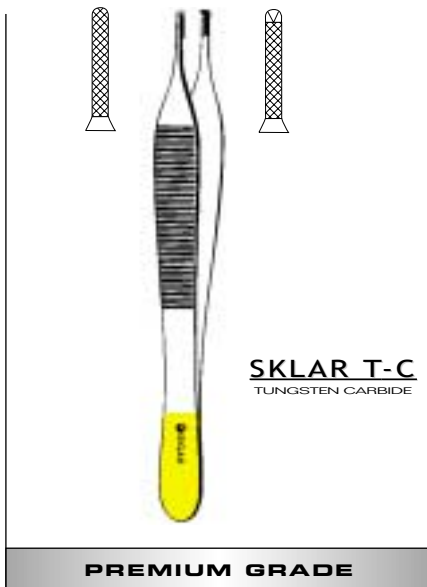
- Dressing and Tissue
- 50-3148 4 3/4" Serrated
- 50-3050 4 3/4" 1x2 Teeth



PREMIUM GRADE

LITEGRIP™ ADSON-BROWN FORCEPS

- 47-1448 4 3/4" Side Grasping

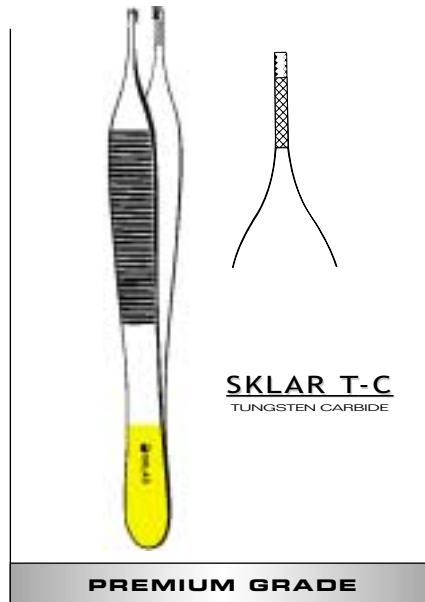


SKLAR T-C
TUNGSTEN CARBIDE

PREMIUM GRADE

T-C ADSON FORCEPS

- 51-3447 4 3/4" Serrated, Tungsten Carbide Insert
- 51-3049 4 3/4" 1x2 Teeth With Platform Tungsten Carbide Insert

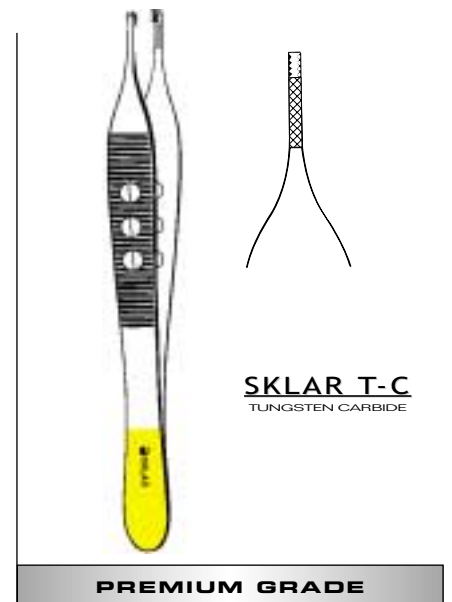


SKLAR T-C
TUNGSTEN CARBIDE

PREMIUM GRADE

T-C ADSON-BROWN FORCEPS

- 51-1447 4 3/4" Side Grasping With Tungsten Carbide Insert

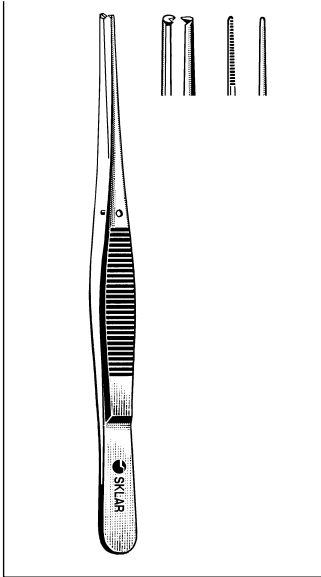


SKLAR T-C
TUNGSTEN CARBIDE

PREMIUM GRADE

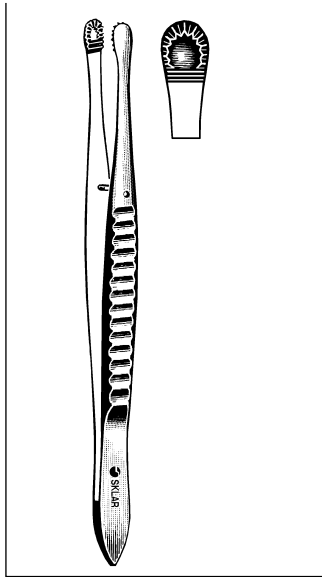
LITEGRIP™ T-C ADSON-BROWN FORCEPS

- 51-1448 4 3/4" Side Grasping With Tungsten Carbide Insert



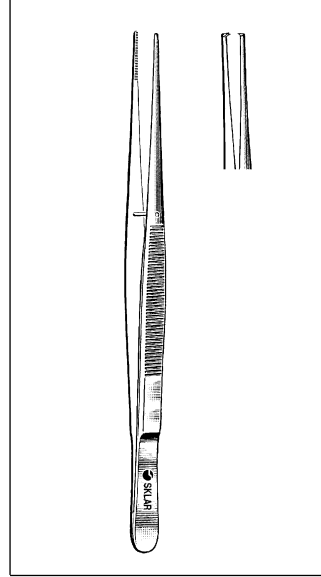
SEMKIN DRESSING/TISSUE FORCEPS

- 22-4150 5" Narrow Serrated
- 22-4250 5" Delicate Serrated
- 22-4350 5" Narrow 1x2 Teeth
- 22-4450 5" Delicate 1x2 Teeth



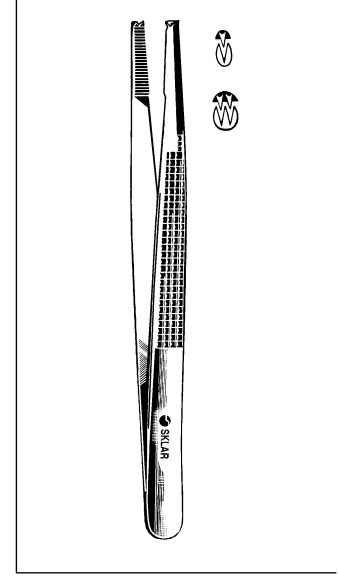
RUSSIAN TISSUE FORCEPS

- 19-2260 6"
- 19-2280 8"
- 19-2310 10"



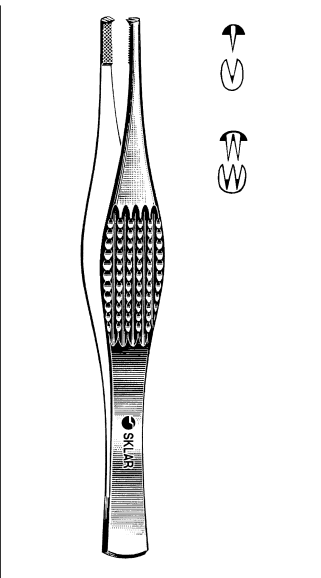
POTTS-SMITH FORCEPS

- 52-3270 7" Serrated
- 52-3282 8 1/4" Serrated
- 52-3370 7" 1x2 Teeth
- 52-3382 8 1/4" 1x2 Teeth
- 52-3310 10" Serrated
- 52-3410 10" 1x2 Teeth



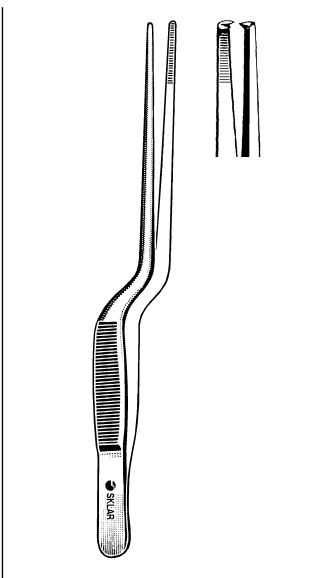
BONNEY TISSUE FORCEPS

- 19-2170 7" 1x2 Teeth
- 19-2172 7" 2x3 Teeth



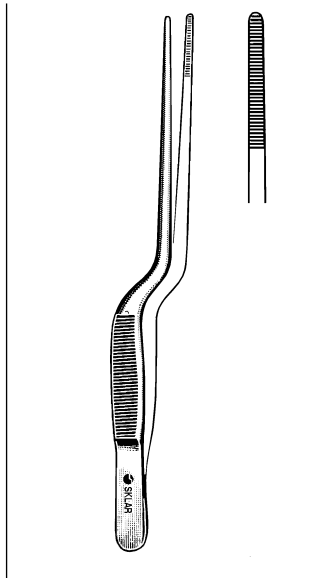
FERRIS-SMITH FORCEPS

- 47-1470 7" 1x2 Teeth With Platform
- 52-3970 7" 2x3 Teeth With Platform



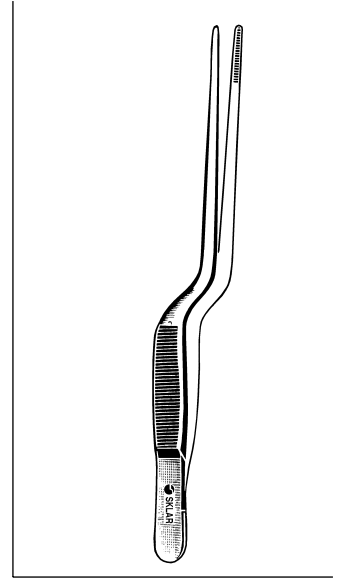
LUCAE BAYONET FORCEPS

- 67-1455 5 1/2" Serrated
- 67-1555 5 1/2" w/1x2 Teeth



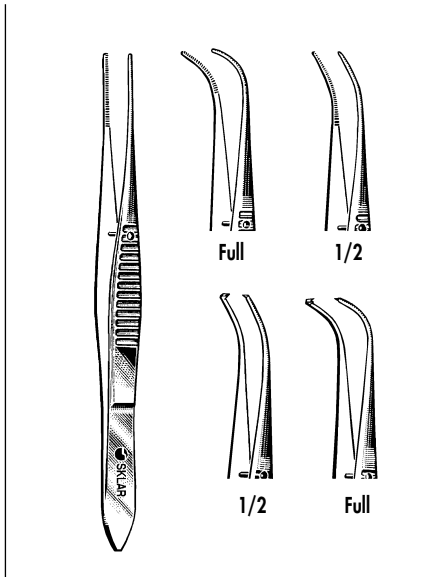
JANSEN BAYONET NASAL FORCEPS

- 67-1465 6 1/2"
- 70-4375 7 1/2"
- 70-4385 8 1/2"



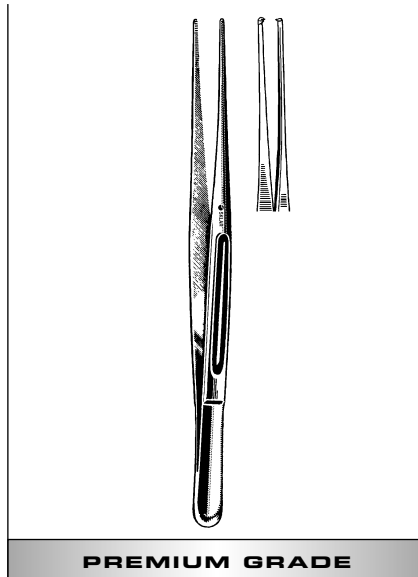
ADSON BAYONET FORCEPS

- 50-3371 7 1/2" Delicate



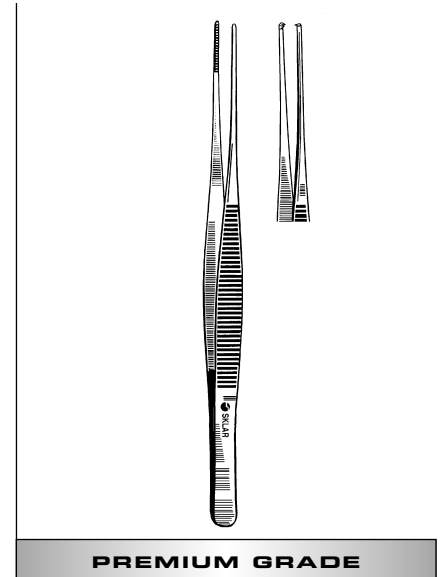
EYE FORCEPS

Serrated		1x2 Teeth	
66-2740	4" Straight	66-3340	4" Straight
66-2940	4" Half Curve	66-3540	4" Half Curve
66-3140	4" Full Curve	66-3740	4" Full Curve
Non-Magnetic		Non-Magnetic	
66-2840	4" Straight	66-3240	4" Straight



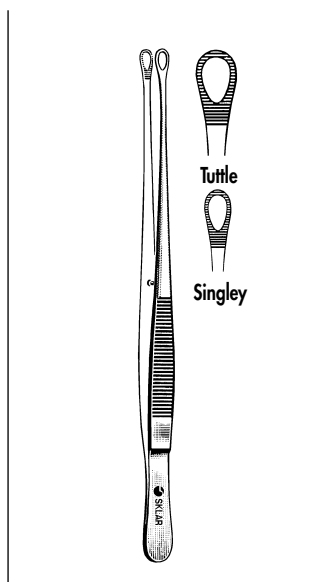
CUSHING BRAIN FORCEPS DELICATE

50-2670	7"	Serrated Jaw Gutch Handle
50-2870	7"	1x2 Teeth Gutch Handle



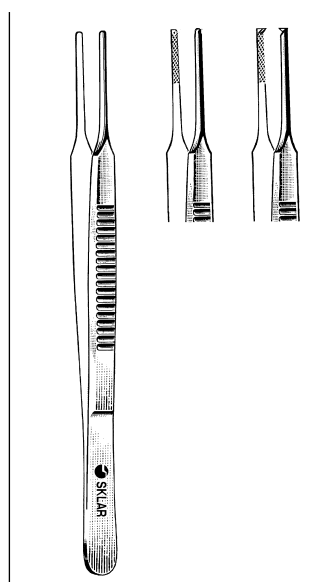
CUSHING BRAIN FORCEPS DELICATE

50-2770	7"	Serrated Jaw Serrated Handle
50-2970	7"	1x2 Teeth Serrated Handle



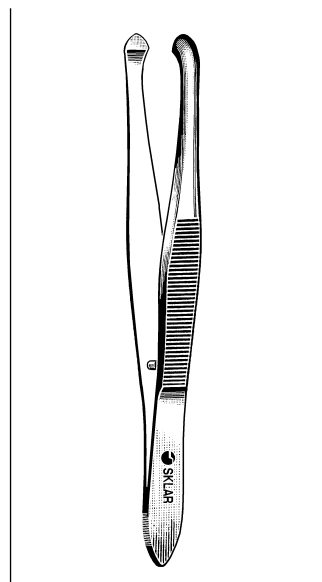
TUTTLE/SINGLEY FORCEPS

22-7470	7"	Tuttle
36-1290	9"	Singley



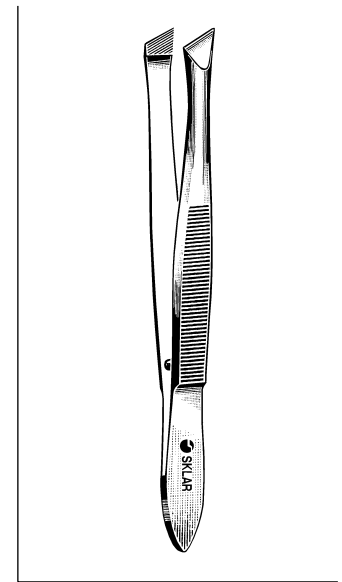
MCCULLOUGH UTILITY FORCEPS

66-6110	4"	Serrated
66-6112	4"	Smooth
66-6114	4"	Serrated w/1x2 Teeth



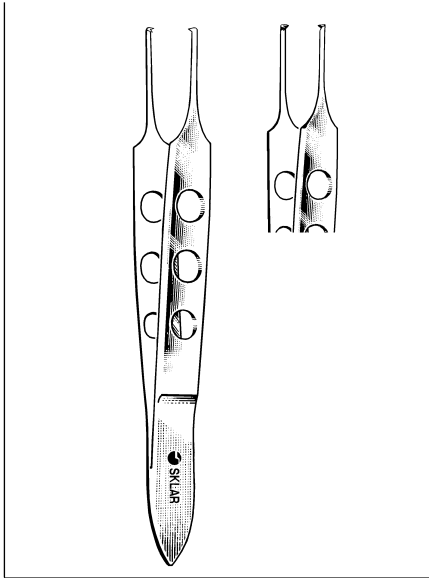
ZIEGLER CILIA FORCEPS

66-1535	3 1/2"
---------	--------



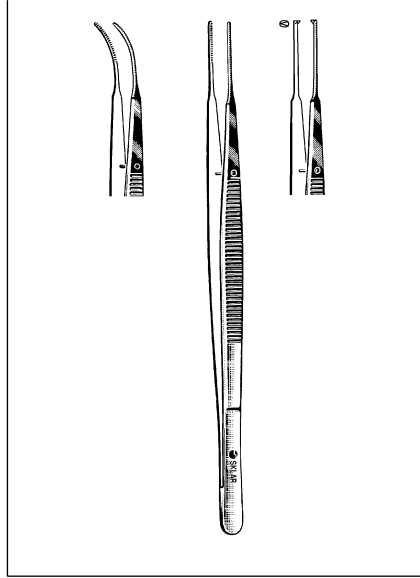
BERGH CILIA FORCEPS

66-1635	3 1/2"
---------	--------



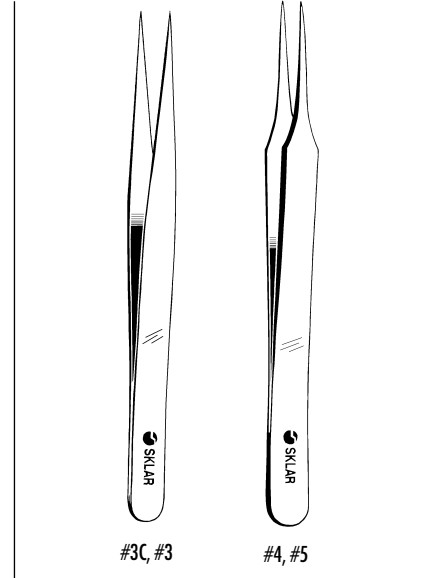
BISHOP-HARMON FORCEPS

- 66-4032 3 1/2" Serrated
- 66-4132 3 1/2" 1 x 2
- 66-4232 3 1/2" 1 x 2 Micro



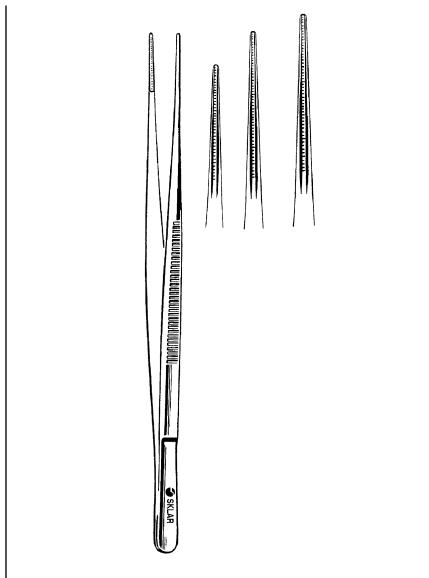
GERALD FORCEPS

- Serrated
- 47-1180 7" Straight
 - 47-1175 7" Curved
 - 1 x 2
 - 47-1173 7" Straight
 - 47-1186 7" Curved



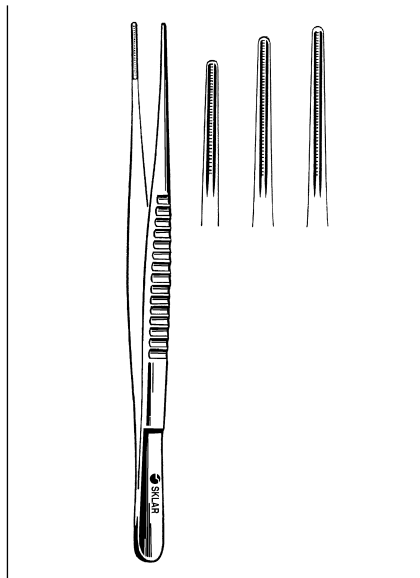
JEWELERS STYLE FORCEPS

- 66-7442 #3C Straight Delicate
- 66-7447 #3 Straight
- 66-7542 #4 Straight Delicate
- 66-7642 #5 Straight



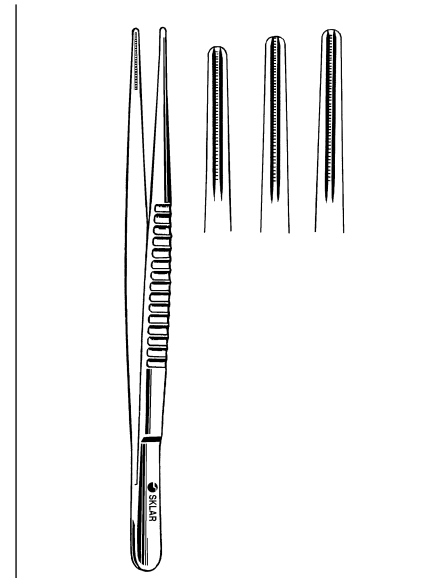
DEBAKEY ATRAUMATIC TISSUE FORCEPS

- 1.5 mm Jaw
- 52-5062 6 1/4"
 - 52-5077 7 1/4"
 - 52-5095 9 1/2"



DEBAKEY ATRAUMATIC TISSUE FORCEPS

- 2.0 mm Jaw
- 52-5162 6 1/4"
 - 52-5177 7 1/4"
 - 52-5195 9 1/2"



DEBAKEY ATRAUMATIC TISSUE FORCEPS

- 3.5mm Jaw
- 52-5262 6 1/4"
 - 52-5277 7 1/4"
 - 52-5295 9 1/2"



OR GRADE

FINE POINT SPLINTER FORCEPS

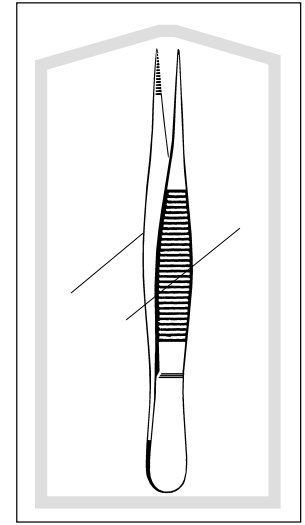
19-3035 3½"
 19-3040 4"
 19-3045 4½"



MID-GRADE

MID-GRADE FINE POINT SPLINTER FORCEPS

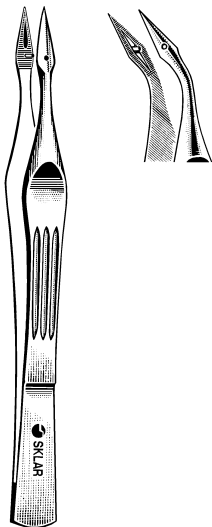
95-777 3½"
 95-781 4½"



FLOOR-GRADE, STERILE

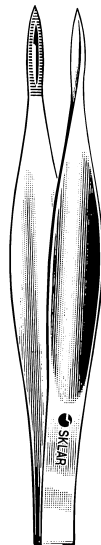
FINE POINT SPLINTER FORCEPS, STERILE

Box/50
 96-2410 4½"
 Box/25
 96-2412 4½"



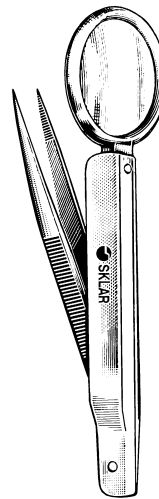
CARMALT SPLINTER FORCEPS

19-3240 4¼" Straight
 19-3340 4¼" Curved



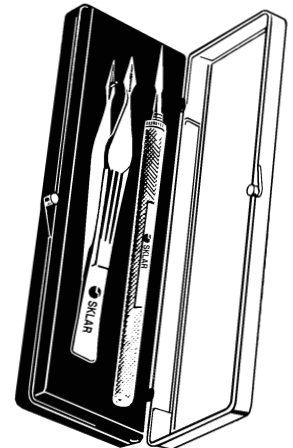
FEILCHENFELD SPLINTER FORCEPS

19-2930 3"
 19-2945 4½"



PLAIN SPLINTER FORCEPS WITH MAGNIFIER

19-3030 3" Chrome
 Non-Autoclavable



SKLAR SPLINTER REMOVAL KIT

19-3360 containing one 19-3240 and one 19-3350 in a convenient storage case.



Sklar OR Quality Instruments

Our Best Operating Room quality instruments incorporating the highest grades of surgical steel, finely detailed craftsmanship and exacting standards of manufacturing. These instruments are imported from Germany.

Surgi-OR™ Mid-Grade Quality Instruments

These mid-grade instruments are forged from surgical grade stainless steel and crafted to offer significant value at reduced costs for the Operating Room as well as other important surgical settings.



Merit™ Physician Office Quality Instruments

A broad selection of Pakistan manufactured instruments crafted for routine surgical use and reliable performance. Utilized in a variety of clinical environments.

Econo™ Floor Grade Instruments

These economically manufactured floor grade instruments offer the greatest utility and the lowest cost.



Econo Sterile™ Instruments

The added convenience and cost-savings of these ready-to-use sterile instruments make Econo Sterile™ an exceptional value.

Sklar Premium™ Instruments

Our finest OR grade instruments with the addition of a unique Sklar performance feature to meet the specific surgical needs of the clinician.



• SKLARLITE™

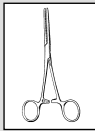
SKLARLITE
THE LIGHT TOUCH



Our premium Operating Room quality instruments provide a lighter version from the standard pattern without sacrifice to strength and durability.

• SKLARLITE XD™

SKLARLITE XD
EXTRA * DELICATE



These instruments retain their structural integrity while providing the most delicate and sensitive instruments available.

• SKLARHONE™ Scissors

MICRO-CUT



Scissors are constructed with one knife blade and a standard scissor edge, either smooth or serrated for additional surgical control.

• SKLARCUT™ Scissors

SKLARCUT
SERRATED BLADE



Cut cleanly and precisely due to ultra-fine serrations for improved grip throughout the entire cut.

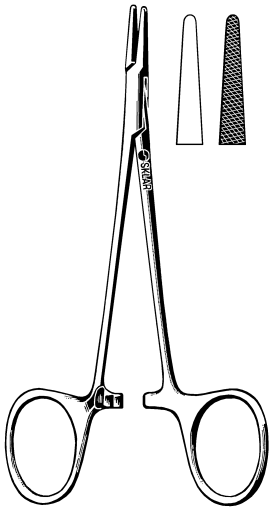
• SKLAR EDGE™

SKLAR EDGE
TUNGSTEN CARBIDE



Tungsten Carbide scissors are the standard for performance and quality as well as durability. Sklar Edge blades have a 5 year warranty.

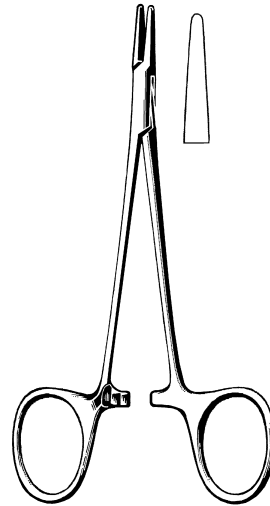
WEBSTER NEEDLE HOLDERS



OR GRADE

WEBSTER NEEDLE HOLDER

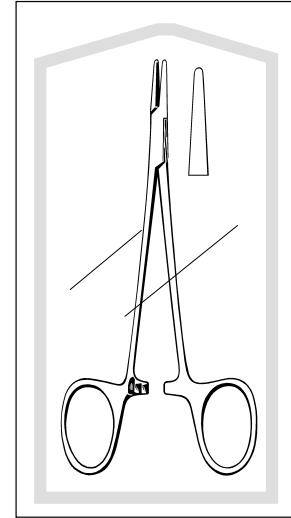
- 20-1350 5/4" Smooth
- 20-1352 5/4" Serrated
- 20-3090 5/4" Smooth, Heavy Pattern



MID-GRADE

MID-GRADE WEBSTER NEEDLE HOLDER

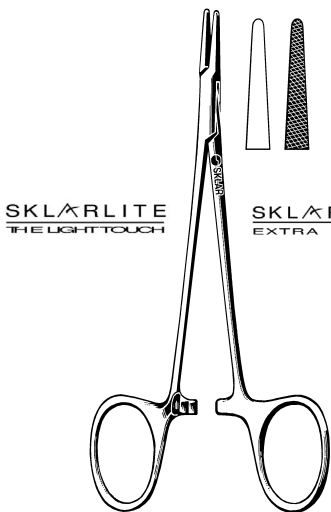
- 95-809 5/4" Smooth



FLOOR-GRADE, STERILE

WEBSTER NEEDLE HOLDER, STERILE

- Box/50
- 96-2586 5/4" Smooth
- Box/25
- 96-2587 5/4" Smooth



SKLARLITE
THE LIGHT TOUCH

SKLARLITE XD
EXTRA DELICATE

PREMIUM GRADE

SKLARLITE™ WEBSTER NEEDLE HOLDER

- 23-2125 5/4" Smooth
- 23-2120 5/4" Serrated

SKLARLITE EXTRA DELICATE™ WEBSTER NEEDLE HOLDER

- 23-2225 5/4" Smooth
- 23-2220 5/4" Serrated

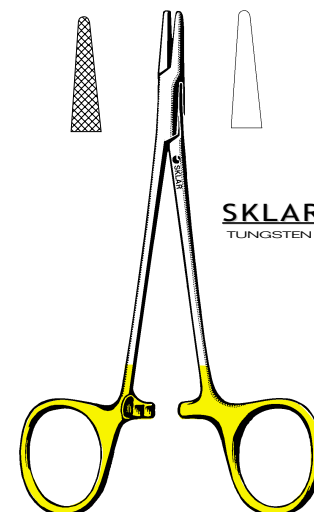


SKLARGRIP
CARBIDE COATING

PREMIUM GRADE

SKLARGRIP™ CARBIDE, WEBSTER NEEDLE HOLDER

- 21-1650 5/4" Smooth, Carbide Coating
- 21-1652 5/4" Serrated, Carbide Coating

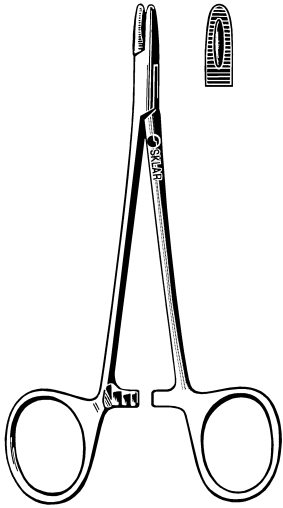


SKLAR T-C
TUNGSTEN CARBIDE

PREMIUM GRADE

T-C WEBSTER NEEDLE HOLDER

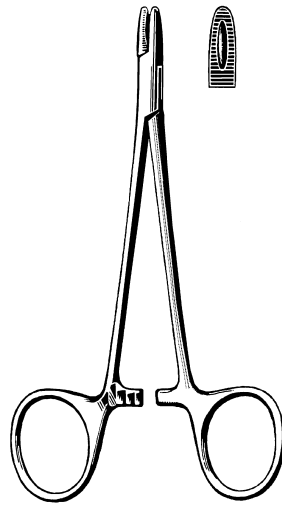
- 21-8002 5/4" Smooth Insert
- 21-8080 5/4" Serrated Insert



OR GRADE

DERF NEEDLE HOLDER

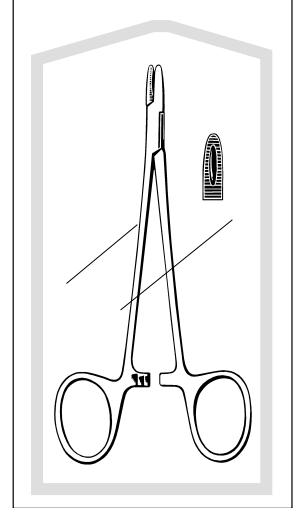
20-1547 4 3/4" Serrated



MID-GRADE

MID-GRADE DERF NEEDLE HOLDER

95-826 4 3/4" Serrated



FLOOR-GRADE, STERILE

DERF NEEDLE HOLDER, STERILE

Box/50

96-2582 4 3/4" Serrated

Box/25

96-2583 4 3/4" Serrated



SKLARLITE
THE LIGHT TOUCH

SKLARLITE XD
EXTRA DELICATE

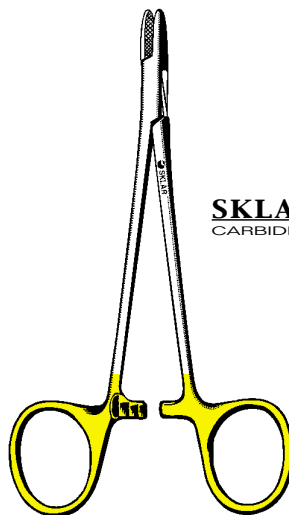
PREMIUM GRADE

SKLARLITE™ DERF NEEDLE HOLDER

23-2124 4 3/4" Serrated

SKLARLITE EXTRA DELICATE™ DERF NEEDLE HOLDER

23-2224 4 3/4" Serrated

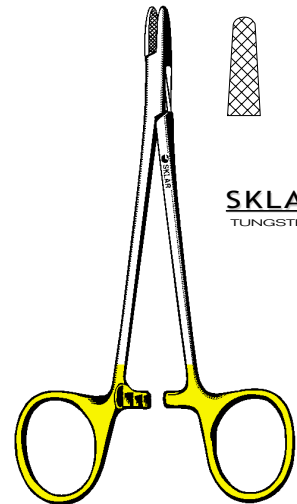


SKLARGRIP
CARBIDE COATING

PREMIUM GRADE

SKLARGRIP™ CARBIDE, DERF NEEDLE HOLDER

21-1547 4 3/4" Serrated, Carbide Coating



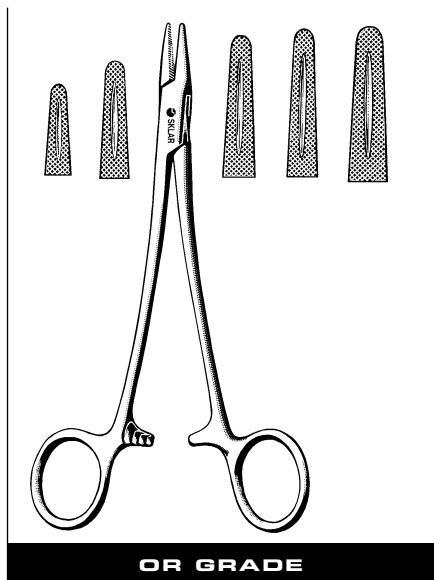
SKLAR T-C
TUNGSTEN CARBIDE

PREMIUM GRADE

T-C DERF NEEDLE HOLDER

21-8004 4 3/4" Serrated, Tungsten Carbide Insert

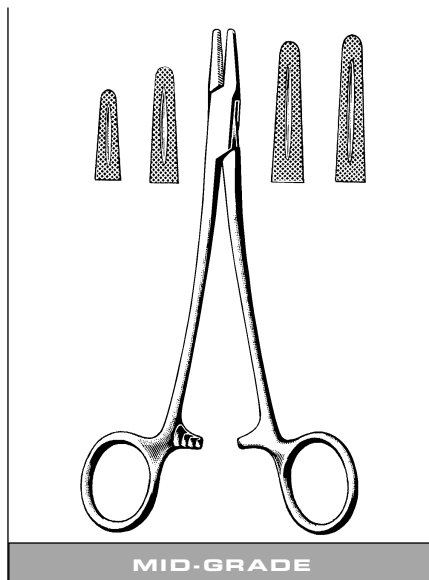
MAYO-HEGAR NEEDLE HOLDERS



OR GRADE

MAYO-HEGAR NEEDLE HOLDER

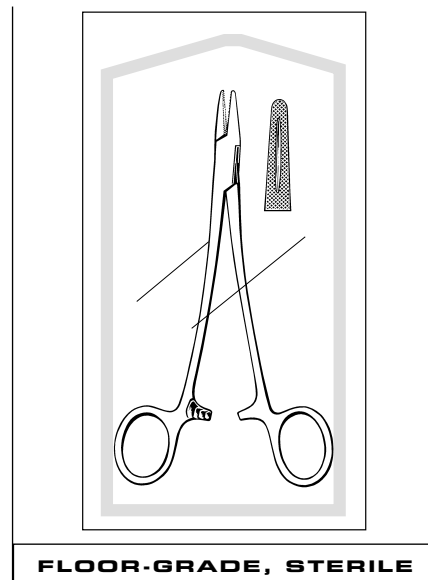
Serrated			
20-2052	5 1/4"	20-2480	8"
20-2060	6"	20-2490	9"
20-2070	7"	20-2910	10 1/2" Masson
20-2270	7" Broad Jaw	20-2911	11 1/2" Masson



MID-GRADE

MID-GRADE MAYO-HEGAR NEEDLE HOLDER

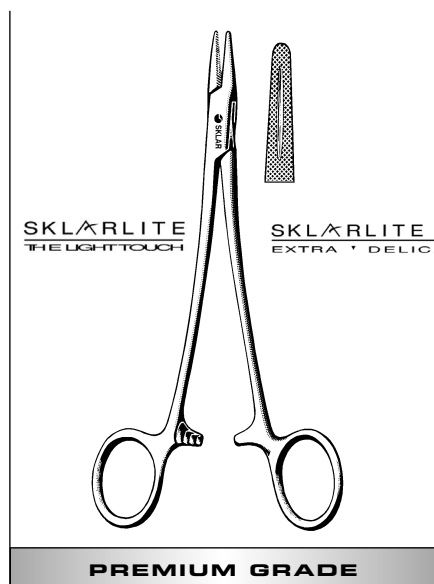
Serrated	
95-842	5 1/4"
95-847	6"
95-853	7"
95-869	8"



FLOOR-GRADE, STERILE

MAYO-HEGAR NEEDLE HOLDER, STERILE

Box/50	
96-2594	6"
Box/25	
96-2595	6"



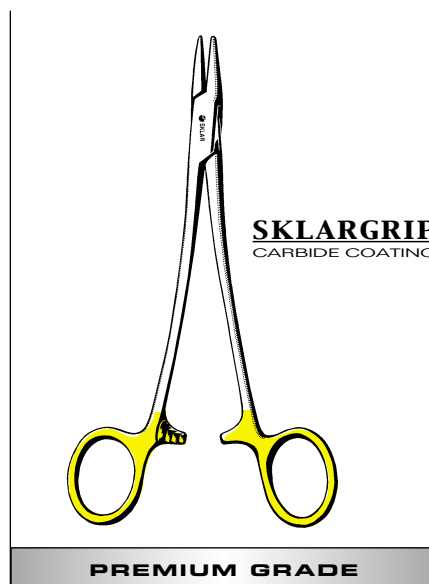
PREMIUM GRADE

SKLARLITE™ MAYO-HEGAR NEEDLE HOLDER

23-2128 7" Serrated

SKLARLITE EXTRA DELICATE™ MAYO-HEGAR NEEDLE HOLDER

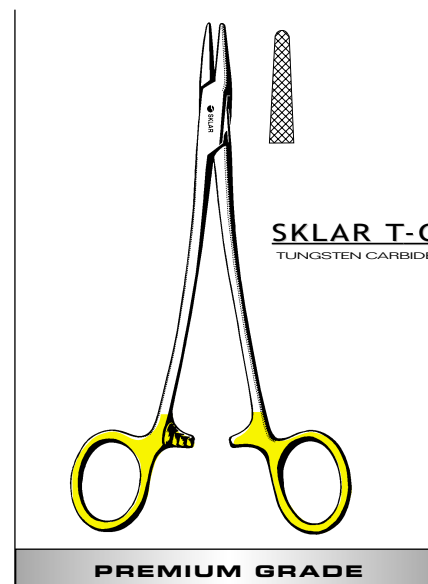
23-2228 7" Serrated



PREMIUM GRADE

SKLARGRIP™ CARBIDE, MAYO-HEGAR NEEDLE HOLDER

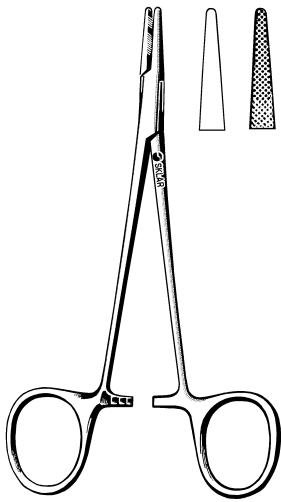
Serrated, Carbide Coating	
21-2060	6"
21-2070	7"
21-2480	8"
21-2910	10 1/2" Masson



PREMIUM GRADE

T-C MAYO-HEGAR NEEDLE HOLDER

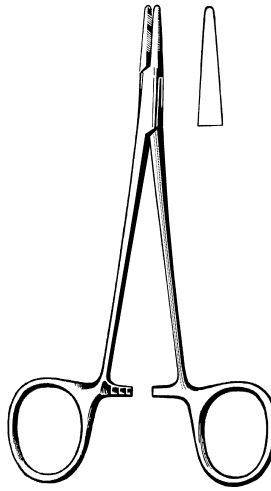
Serrated, Tungsten Carbide Insert	
21-8031	6"
21-8032	7"
21-8033	8"
21-8034	10 1/2"
21-8035	12"



OR GRADE

HALSEY NEEDLE HOLDER

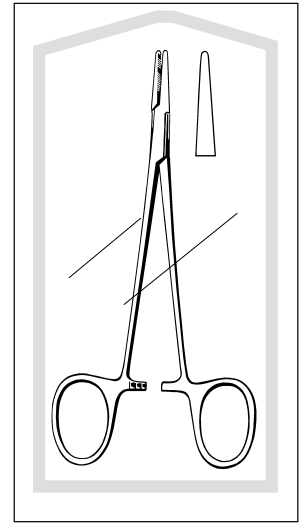
20-1750 5/4" Smooth
20-1751 5/4" Serrated



MID-GRADE

MID-GRADE HALSEY NEEDLE HOLDER

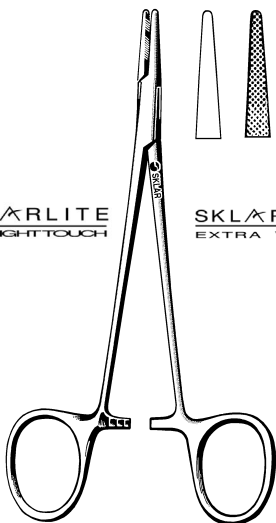
95-810 5/4" Smooth



FLOOR-GRADE, STERILE

HALSEY NEEDLE HOLDER, STERILE

Box/50
96-2584 5/4" Smooth
Box/25
96-2585 5/4" Smooth



SKLARLITE
THE LIGHT TOUCH

SKLARLITE XD
EXTRA DELICATE

PREMIUM GRADE

SKLARLITE™ HALSEY NEEDLE HOLDER

23-2135 5/4" Smooth 23-2130 5/4" Serrated

SKLARLITE EXTRA DELICATE™ HALSEY NEEDLE HOLDER

23-2235 5/4" Smooth 23-2230 5/4" Serrated

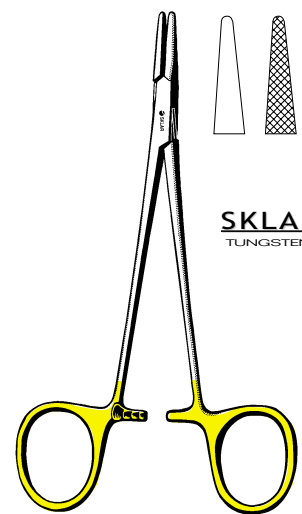


SKLARGRIP
CARBIDE COATING

PREMIUM GRADE

SKLARGRIP™ CARBIDE, HALSEY NEEDLE HOLDER

Light Model
21-1750 5/4" Smooth, Carbide Coating
21-1850 5/4" Serrated, Carbide Coating



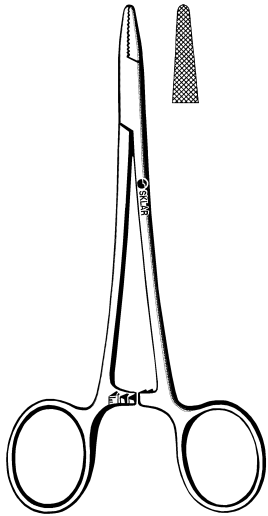
SKLAR T-C
TUNGSTEN CARBIDE

PREMIUM GRADE

T-C HALSEY NEEDLE HOLDER

21-8000 5/4" Smooth Insert
21-8001 5/4" Serrated Insert

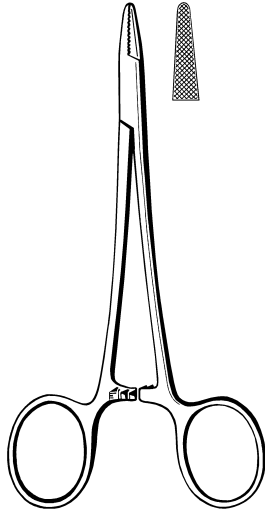
BAUMGARTNER NEEDLE HOLDERS



OR GRADE

BAUMGARTNER NEEDLE HOLDER

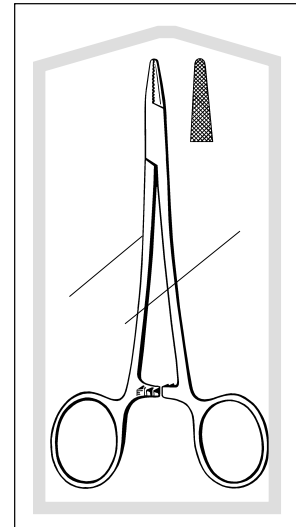
20-1450 5½" Serrated



MID-GRADE

MID-GRADE BAUMGARTNER NEEDLE HOLDER

95-832 5½"

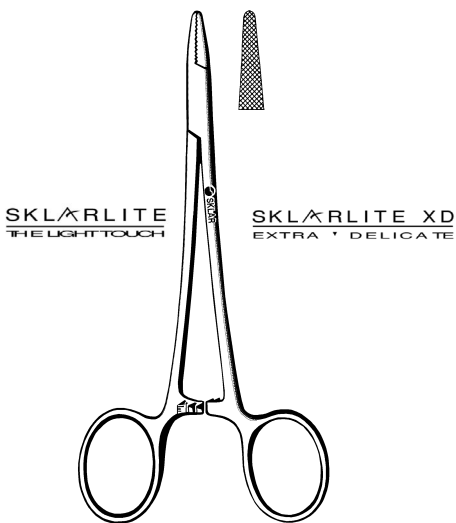


FLOOR-GRADE, STERILE

BAUMGARTNER NEEDLE HOLDER, STERILE

Box/50
96-2580 5½"

Box/25
96-2581 5½"



PREMIUM GRADE

SKLARLITE™ BAUMGARTNER NEEDLE HOLDER

23-2132 5½" Serrated

SKLARLITE EXTRA DELICATE™ BAUMGARTNER NEEDLE HOLDER

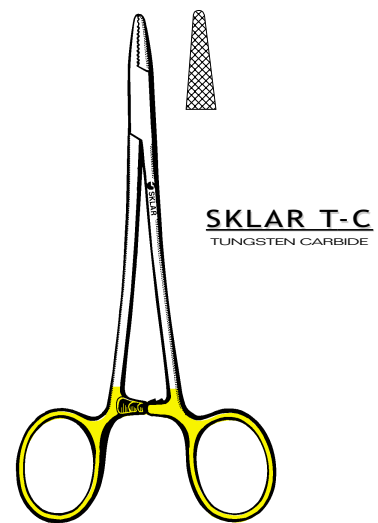
23-2232 5½" Serrated



PREMIUM GRADE

SKLARGRIP™ CARBIDE, BAUMGARTNER NEEDLE HOLDER

21-1450 5½" Serrated, Carbide Coating

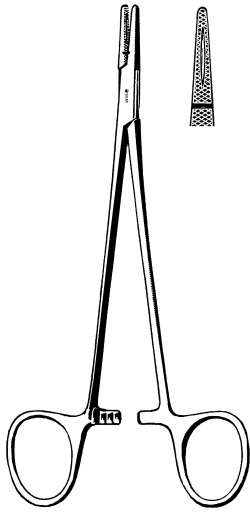


PREMIUM GRADE

T-C BAUMGARTNER NEEDLE HOLDER

21-8005 5½" Serrated, Tungsten Carbide Insert

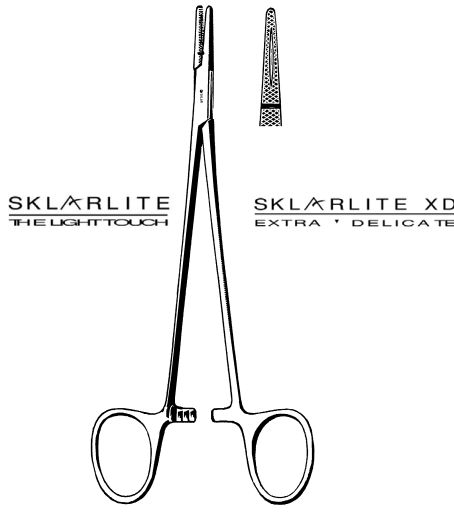
CRILE-WOOD NEEDLE HOLDERS CRILE-MURRAY NEEDLE HOLDERS



OR GRADE

CRILE-WOOD NEEDLE HOLDER

Serrated
 20-1265 6" Narrow Jaw
 20-1270 7"
 20-1280 8"
 20-1290 9"
 20-1295 10½"



SKLARLITE
THE LIGHT TOUCH

SKLARLITE XD
EXTRA DELICATE

PREMIUM GRADE

SKLARLITE™ CRILE-WOOD NEEDLE HOLDER

23-2134 6" Serrated

SKLARLITE EXTRA DELICATE™ CRILE-WOOD NEEDLE HOLDER

23-2234 6" Serrated

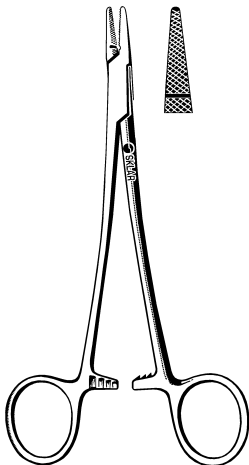


SKLAR T-C
TUNGSTEN CARBIDE

PREMIUM GRADE

T-C CRILE-WOOD NEEDLE HOLDER

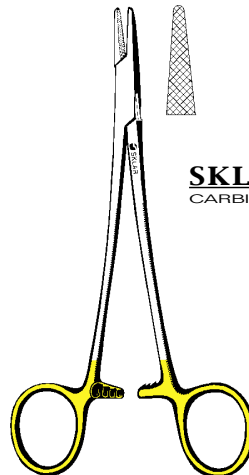
Serrated
 21-8006 6" Narrow Jaw
 21-8007 7"
 21-8008 8"
 21-8009 9"
 21-8010 10½"
 21-8011 12"



OR GRADE

CRILE-MURRAY NEEDLE HOLDER

20-1260 6" Serrated

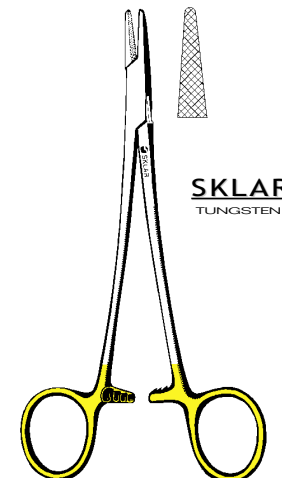


SKLARGRIP
CARBIDE COATING

PREMIUM GRADE

SKLARGRIP™ CARBIDE, CRILE-MURRAY NEEDLE HOLDER

21-1260 6" Serrated, Carbide Coating



SKLAR T-C
TUNGSTEN CARBIDE

PREMIUM GRADE

T-C CRILE-MURRAY NEEDLE HOLDER

21-8075 6" Tungsten Carbide Insert

OLSEN-HEGAR NEEDLE HOLDERS CASTROVIEJO NEEDLE HOLDERS



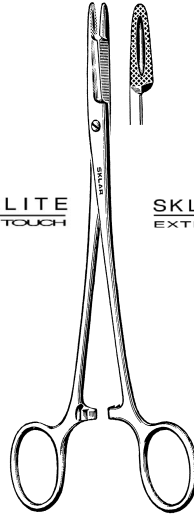
OR GRADE

OLSEN-HEGAR NEEDLE HOLDER

Scissors Combination

20-2747	4 1/2"	Delicate
20-2755	5 1/2"	
20-2765	6 1/2"	
20-2775	7"	

SKLARLITE
THE LIGHT TOUCH



SKLARLITE XD
EXTRA DELICATE

PREMIUM GRADE

SKLARLITE™ OLSEN-HEGAR NEEDLE HOLDER

Scissors Combination

23-2136	5 1/2"	Serrated
---------	--------	----------

SKLARLITE EXTRA DELICATE™ OLSEN-HEGAR NEEDLE HOLDER

Scissors Combination

23-2236	5 1/2"	Serrated
---------	--------	----------



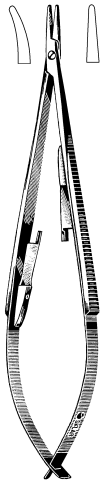
SKLAR T-C
TUNGSTEN CARBIDE

PREMIUM GRADE

T-C OLSEN-HEGAR NEEDLE HOLDER

Scissors Combination

21-8025	4 3/4"	Serrated	Delicate
21-8027	5 1/2"	Serrated	
21-8028	6 1/2"	Serrated	
21-8029	7 1/2"	Serrated	
21-8026	4 3/4"	Smooth	Delicate



OR GRADE

CASTROVIEJO NEEDLE HOLDER

With Lock

65-6357	5 1/2"	Straight, Smooth
65-6358	5 1/2"	Curved, Smooth

SKLAR T-C
TUNGSTEN CARBIDE



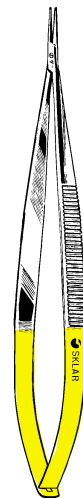
PREMIUM GRADE

T-C CASTROVIEJO NEEDLE HOLDER

Straight-Standard With Lock

21-8040	5 1/2"	Smooth
21-8046	5 1/2"	Serrated

SKLAR T-C
TUNGSTEN CARBIDE

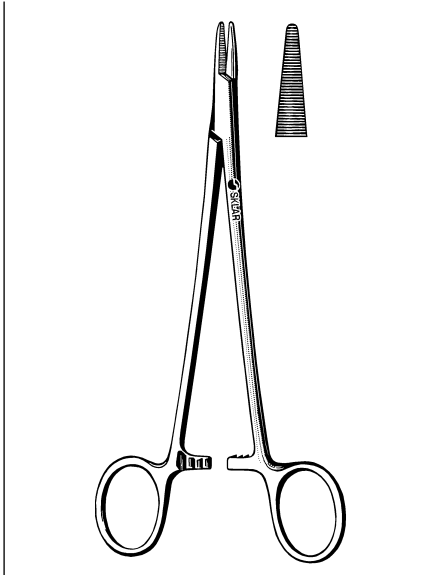


PREMIUM GRADE

T-C CASTROVIEJO NEEDLE HOLDER

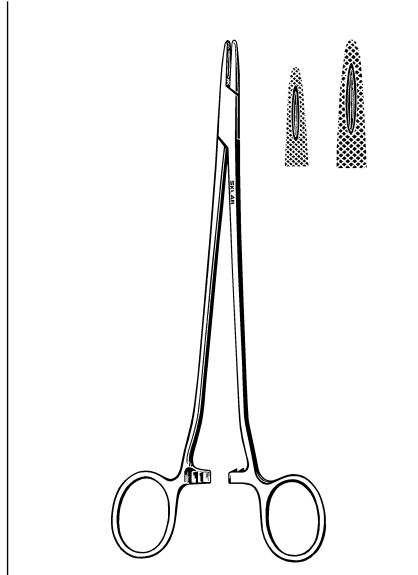
Delicate-Without Lock

21-8044	5 1/2"	Straight
21-8045	5 1/2"	Curved



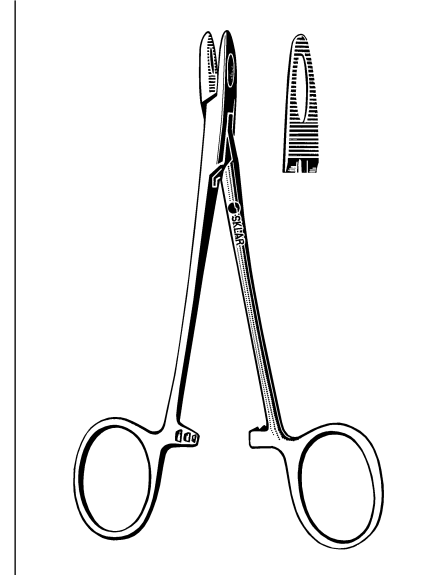
BROWN NEEDLE HOLDER

Rounded Jaws
 20-4852 5 1/4"
 20-4867 6 3/4"



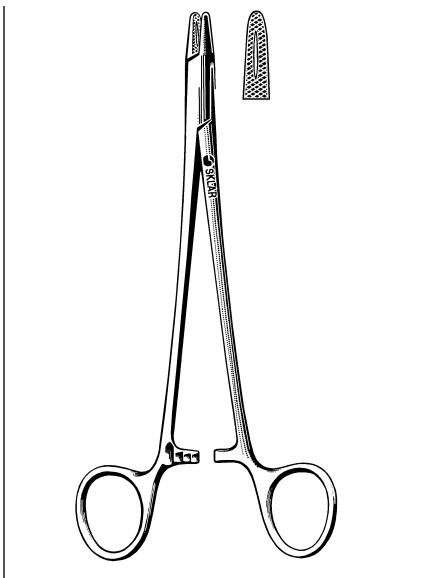
SAROT NEEDLE HOLDER

Serrated
 22-5050 5"
 20-4170 7 1/4"
 20-3910 10 1/4"



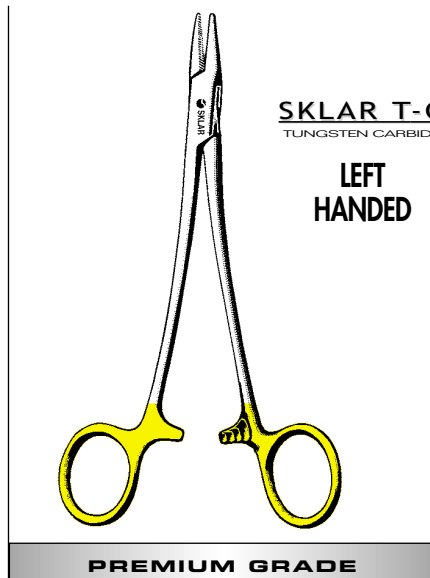
COLLIER NEEDLE HOLDER

Fenestrated Jaw
 65-6550 5 1/4" Serrated



NEW ORLEANS NEEDLE HOLDER

20-1870 7" Serrated



T-C INSERT MAYO-HEGAR NEEDLE HOLDER

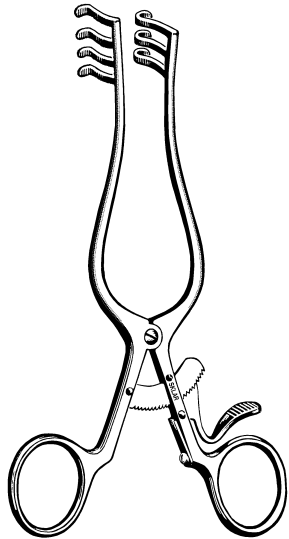
Serrated (Left Handed)
 21-9016 6"
 21-9018 7"



T-C INSERT CRILE-WOOD NEEDLE HOLDER

Serrated (Left Handed)
 21-9030 6"
 21-9035 7"

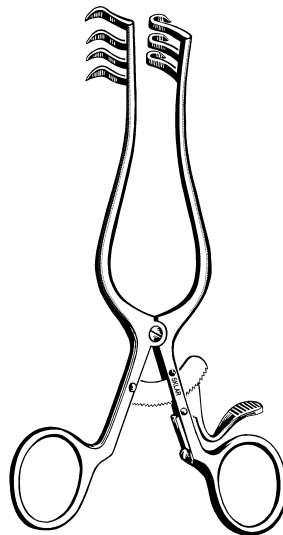
RETRACTORS / SELF-RETAINING



WEITLANER RETRACTOR

Tru-Grip Ratchet
Blunt

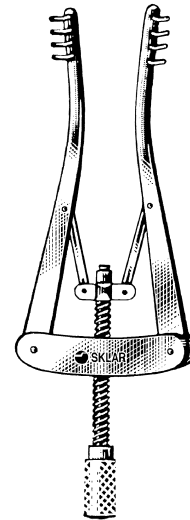
22-8345	4"	2 x 3 Teeth
22-8355	5"	3 x 4 Teeth
42-1865	6"	3 x 4 Teeth
42-1875	8"	3 x 4 Teeth
42-1895	9"	3 x 4 Teeth



WEITLANER RETRACTOR

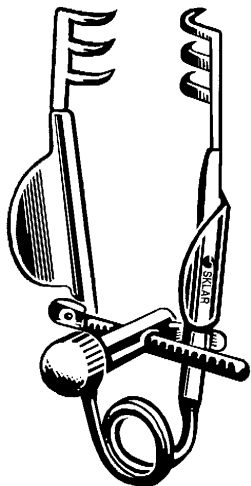
Tru-Grip Ratchet
Sharp

22-8245	4"	2 x 3 Teeth
22-8255	5"	3 x 4 Teeth
42-1965	6"	3 x 4 Teeth
42-1975	8"	3 x 4 Teeth
42-1995	9"	3 x 4 Teeth



ALM RETRACTOR

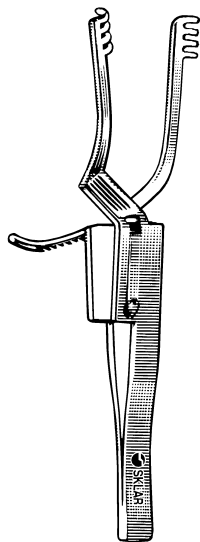
22-9027	2 3/4"	4 x 4 Teeth Blunt
60-6340	4"	4 x 4 Teeth Blunt
22-9029	2 3/4"	4 x 4 Teeth Sharp
60-6342	4"	4 x 4 Teeth Sharp



MELLER RETRACTOR

Delicate

65-1815	1 1/2"	3 x 3 Sharp Prongs
---------	--------	--------------------



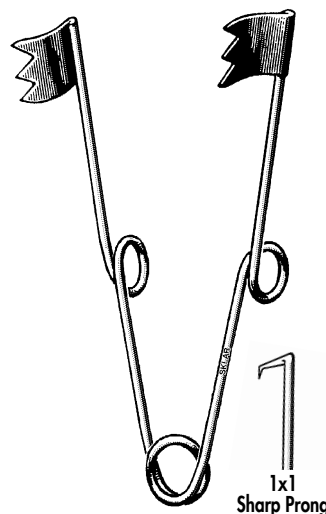
HOLZHEIMER X-ACTION RETRACTOR

Sharp

22-8920	4"	4x4 Teeth
---------	----	-----------

Blunt

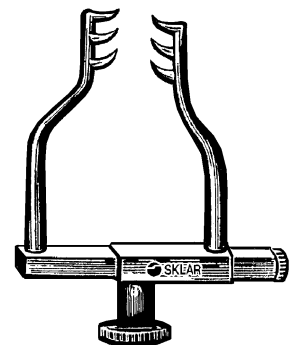
22-8940	4"	4x4 Teeth
---------	----	-----------



WIRE RETAINING RETRACTOR

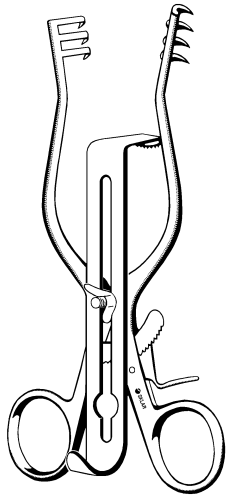
Small

22-8832	3/4"	3x3 Blade
22-8834	3/4"	1x1 Sharp Prong



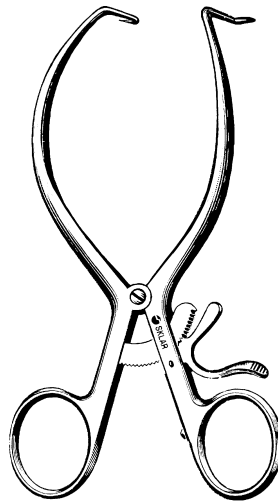
GOLDSTEIN RETRACTOR

47-2913	1 1/2"	3 x 3 Sharp Prongs
---------	--------	--------------------



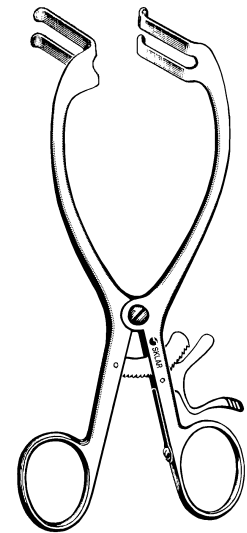
HENLY VASCULAR SURGERY RETRACTOR

Tru-Grip Ratchet
with adjustable center blade
55-7340 6½" 3x4 Sharp
55-7341 6½" 3x4 Blunt



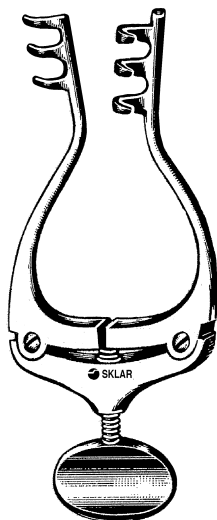
GELPI RETRACTOR

Tru-Grip Ratchet
22-8850 3½"
22-8853 5½"
22-8855 6½"
60-6570 7"



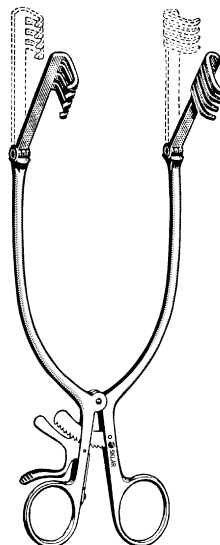
MAYO-ADAMS RETRACTOR

Tru-Grip Ratchet
60-6467 6¼" 2 Blades



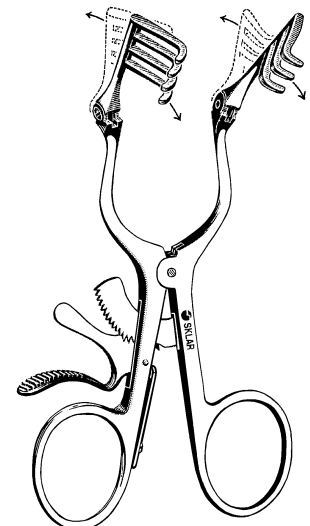
JANSEN RETRACTOR

3 x 3 Blades
47-2832 4" Blunt
47-2834 4" Sharp



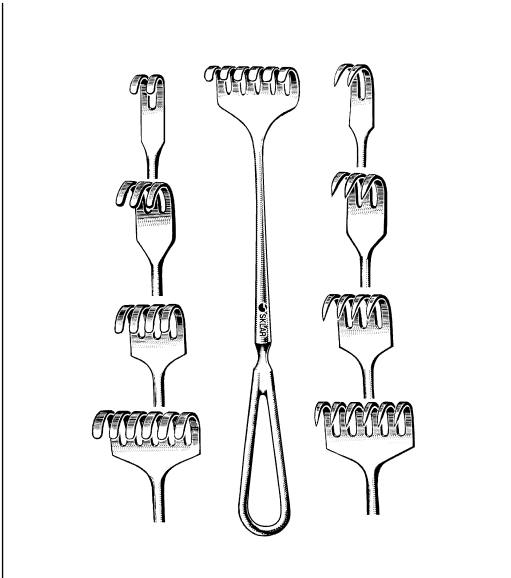
ADSON (BECKMAN) RETRACTOR

Tru-Grip Ratchet
42-1511 12" Blunt
42-1611 12" Sharp



WEITLANER-BECKMAN RETRACTOR

Tru-Grip Ratchet
Hinged Blades
42-1655 6" Blunt 3x4
42-1765 6" Sharp 3x4



VOLKMAN RETRACTOR (USA)

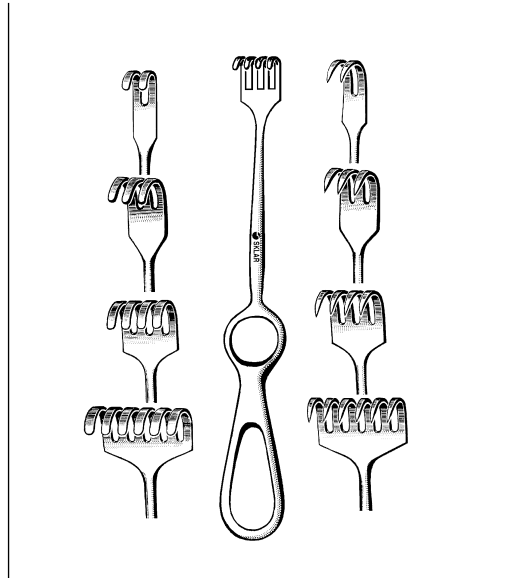
8½" Length

Blunt

60-5502 2 pr
60-5503 3 pr
60-5504 4 pr
60-5506 6 pr

Sharp

60-5602 2 pr
60-5603 3 pr
60-5604 4 pr
60-5606 6 pr



VOLKMAN RETRACTOR (RING HANDLE)

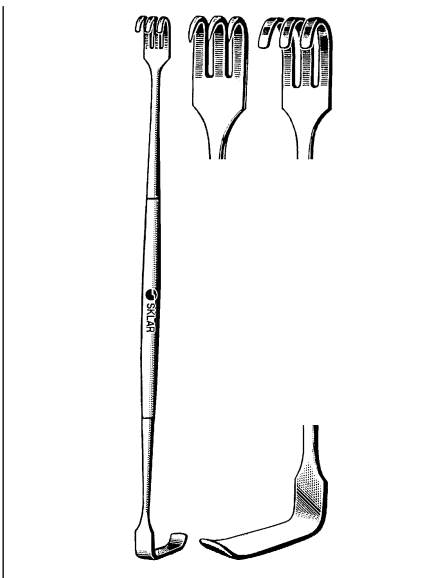
8½" Length

Blunt

60-5812 2 pr
60-5813 3 pr
60-5814 4 pr
60-5816 6 pr

Sharp

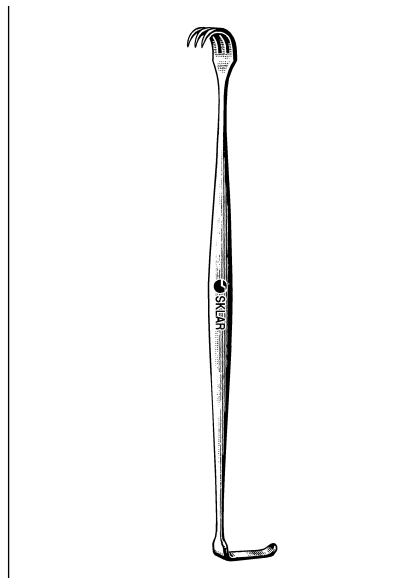
60-5822 2 pr
60-5823 3 pr
60-5824 4 pr
60-5826 6 pr



SENN RETRACTOR

Double Ended

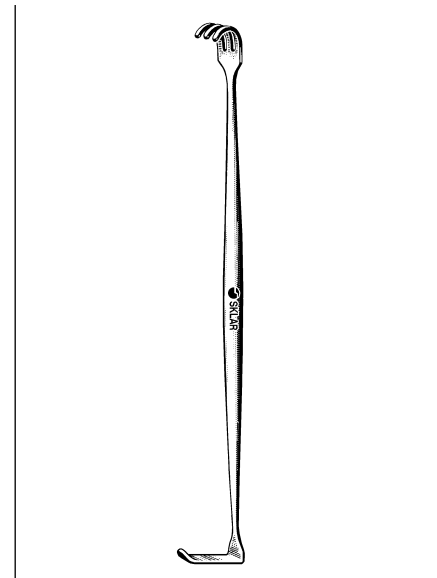
60-6162 6" Sharp
60-6164 6" Blunt



MILLER-SENN RETRACTOR

Double Ended

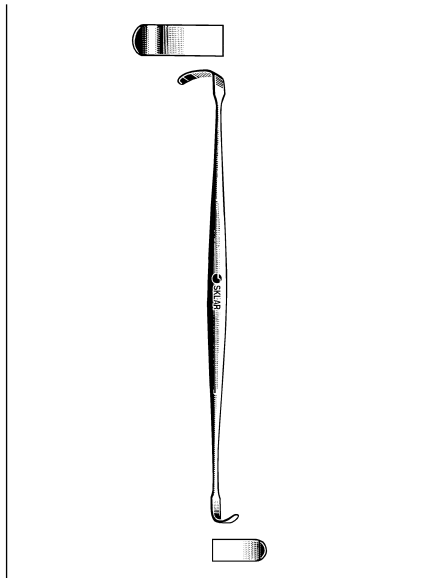
22-8360 6" Sharp
Solid End 5 mm x 18 mm
22-8460 6" Blunt
Solid End 5 mm x 18 mm



MATHIEU RETRACTOR

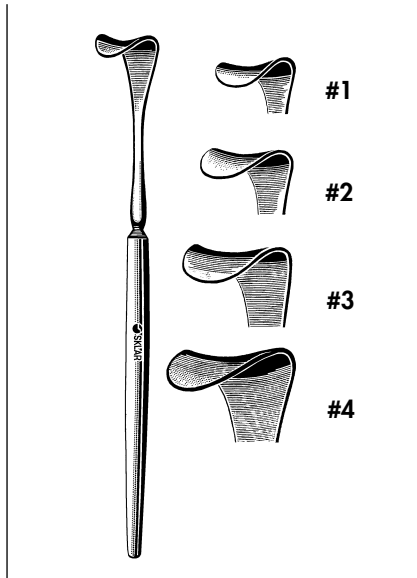
Double Ended

60-6062 6¼" Blunt



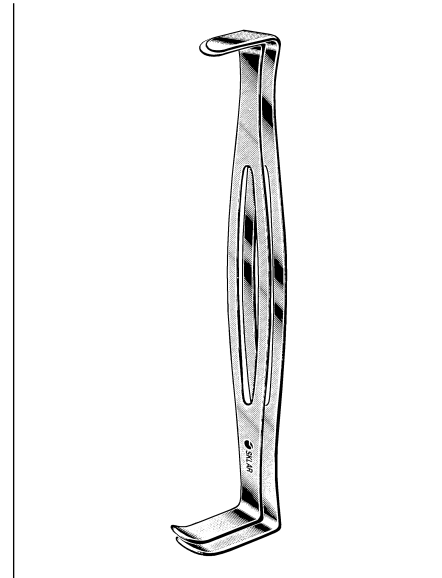
RAGNELL RETRACTOR

Double End
22-8560 6"



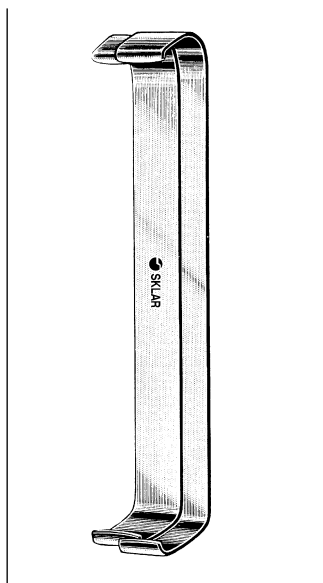
DESMARRES LID RETRACTOR

65-1841 #1 5 1/2" with 12mm Blade
65-1842 #2 5 1/2" with 14mm Blade
65-1843 #3 5 1/2" with 16mm Blade
65-1844 #4 5 1/2" with 18mm Blade



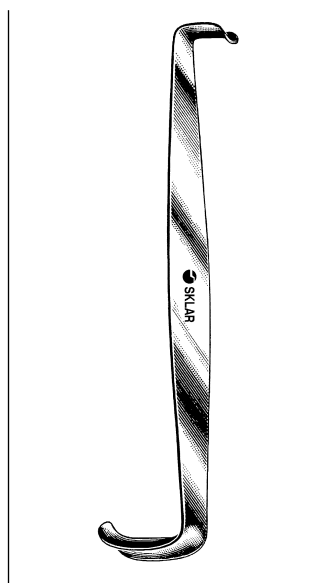
U.S. ARMY PATTERN RETRACTOR

Set of 2
60-1085 8 1/4"



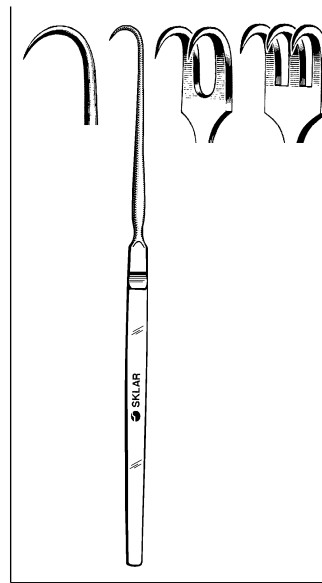
FARABEUF RETRACTOR

Double End Set of 2
60-1460 6" 5/8" x 1/8"
3/8" x 1"



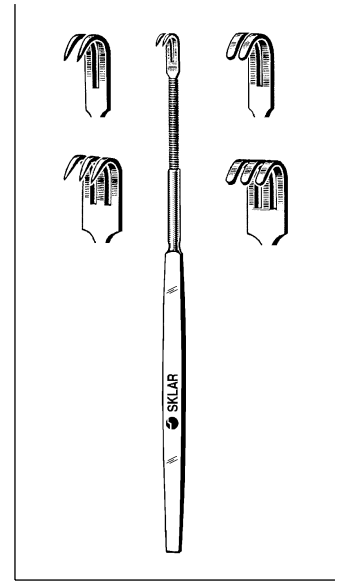
CRILE RETRACTOR

Double End
57-1445 4 1/2"



TRACHEAL RETRACTOR

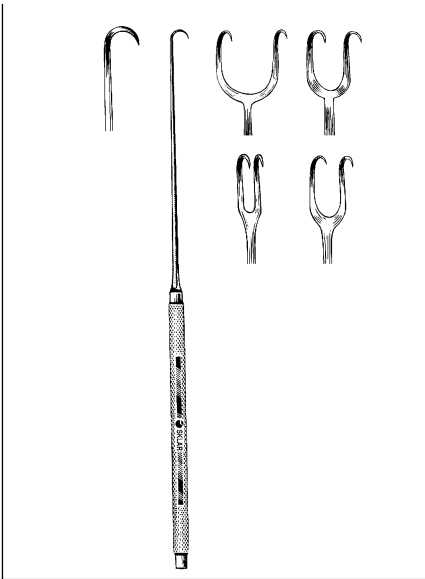
6 1/2"
78-1001 Sharp 1 prong
78-1002 Sharp 2 prong
78-1003 Sharp 3 prong
78-1101 Blunt 1 prong
78-1102 Blunt 2 prong
78-1103 Blunt 3 prong



PLASTIC SURGERY RETRACTOR

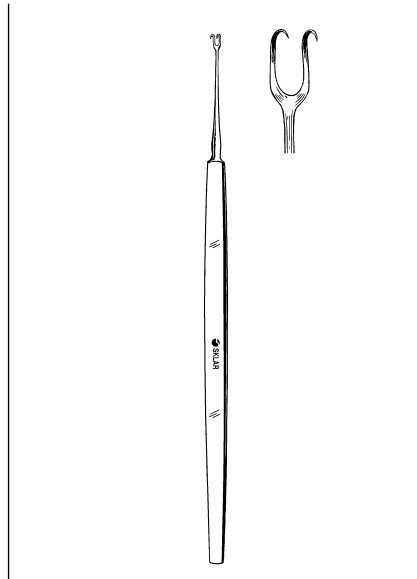
6" - Flexible Shank
22-9132 Sharp 2 Prong
22-9133 Sharp 3 Prong
22-9142 Blunt 2 Prong
22-9143 Blunt 3 Prong

RETRACTORS/HOOK



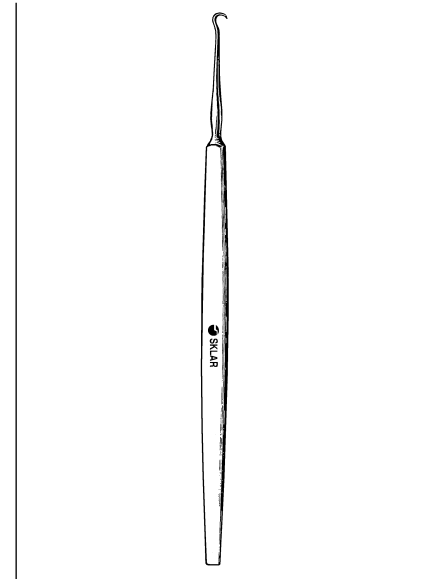
JOSEPH SKIN HOOK

- Sharp
- | | | |
|---------|--------|--------------|
| 47-2500 | 6 1/4" | 1 Prong |
| 47-2502 | 6 1/4" | 2 Prong 2mm |
| 47-2505 | 6 1/4" | 2 Prong 5mm |
| 47-2507 | 6 1/4" | 2 Prong 7mm |
| 47-2510 | 6 1/4" | 2 Prong 10mm |



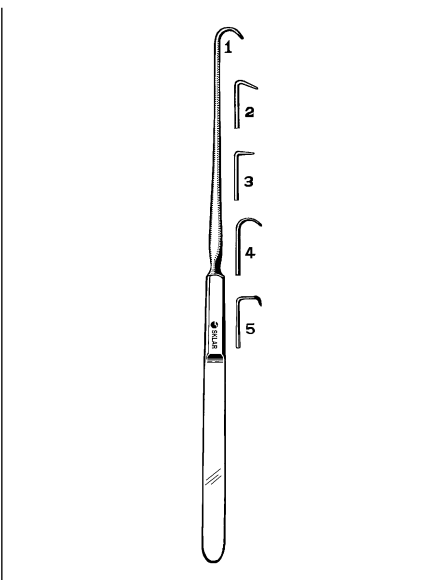
GUTHRIE DOUBLE HOOK

- | | | | |
|---------|----|-------|-------|
| 47-2650 | 5" | Large | Sharp |
| 47-2651 | 5" | Small | Sharp |



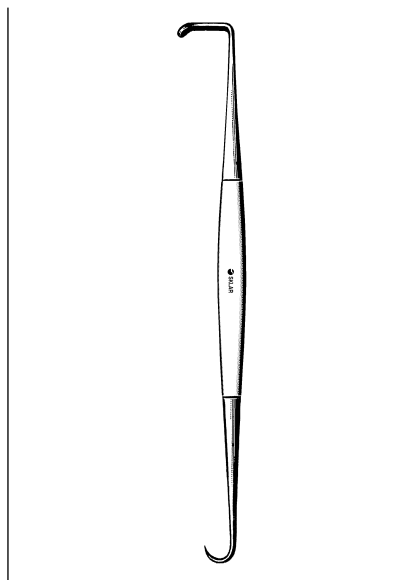
FRAZIER TISSUE HOOK

- | | | |
|---------|----|-------|
| 47-2555 | 5" | Sharp |
| 47-2556 | 5" | Blunt |



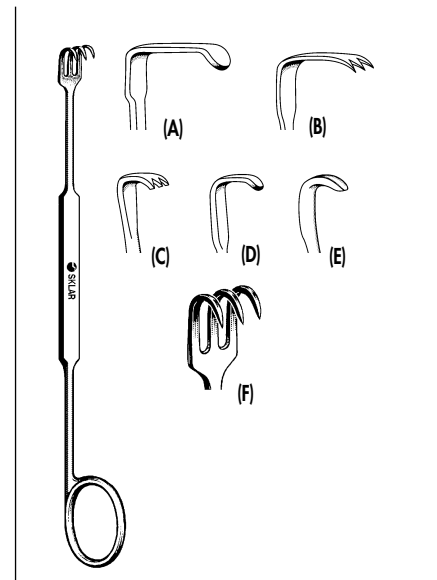
EMMETT HOOK 9"

- | | |
|---------|---------|
| 90-8301 | Style 1 |
| 90-8302 | Style 2 |
| 90-8303 | Style 3 |
| 90-8304 | Style 4 |
| 90-8305 | Style 5 |



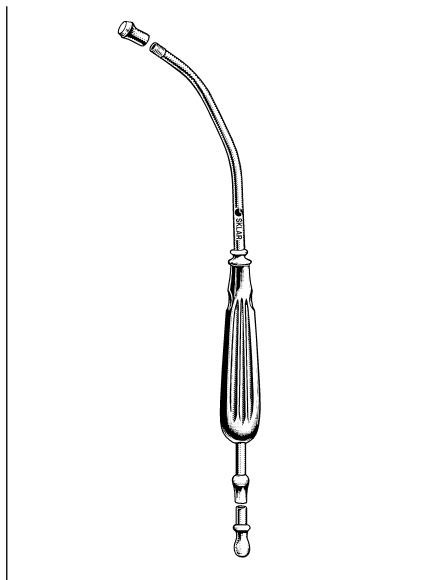
MEYERDING SKIN HOOK AND RETRACTOR

- Double End
47-2462 6 1/4"



MEYERDING RETRACTOR

- 7"
- | | | |
|---------|---|----------------|
| 22-8210 | A | 1/4" deep |
| 22-8211 | B | 3/8" deep |
| 22-8212 | C | 1/2" deep |
| 22-8213 | D | 3/4" deep |
| 22-8214 | E | 1" deep |
| 22-8215 | F | 3 prongs sharp |



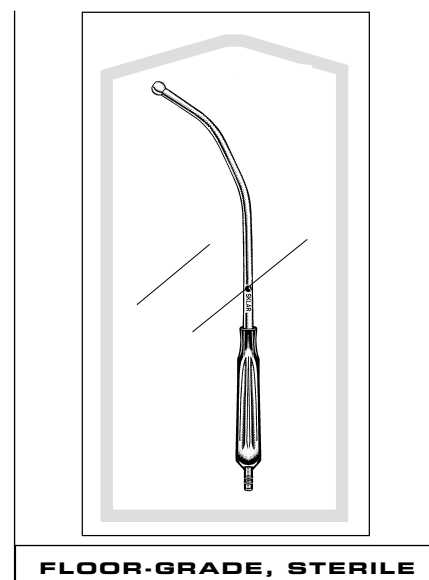
YANKAUER SUCTION TUBE

- 07-1801 Standard size, Chrome
- 07-1802 Tip Only For 07-1801
- 22-6585 Pediatric size
- 07-1805 Standard size, Stainless Steel
- 07-1806 Tip Only For 07-1805



PLASTIC YANKAUER SUCTION TUBE

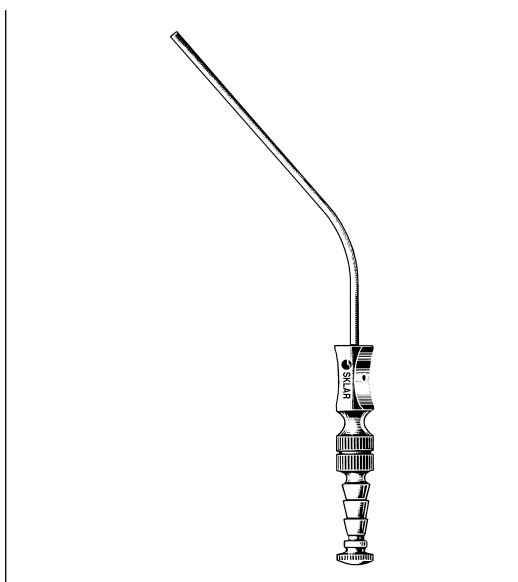
- Box/50
- 96-4171 Vented
- 96-4172 Non-Vented



FLOOR-GRADE, STERILE

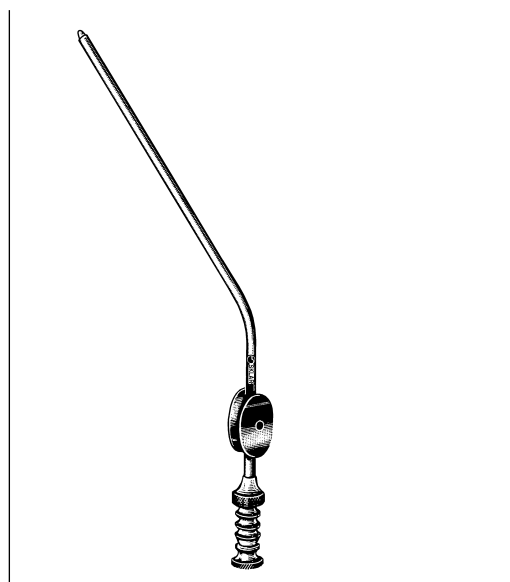
YANKAUER SUCTION TUBE, DISPOSABLE

- Box/10 Sterile
- 96-4174 Vented
- 96-4175 Non-Vented



FRAZIER SUCTION TUBE

- 50-2006 6 French
- 50-2007 7 French
- 50-2008 8 French
- 50-2010 10 French
- 50-2012 12 French



BARON SUCTION TUBE

- 50-1953 3 French
- 50-1955 5 French
- 50-1957 7 French

NEW!

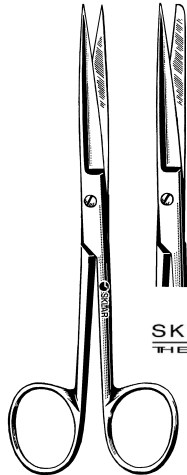
SKLARLITE™ PREMIUM SCISSORS

Skarlite™ provides the clinician a lighter pattern from the standard scissor while retaining it's structural integrity.

A comfortable instrument, which withstands the rigors of frequent use but minimizes fatigue from prolonged surgery.

Skarlite scissors are covered under the same warranty that guarantees all Sklar instruments for a lifetime of dependable use.

SKLAR EXCLUSIVE



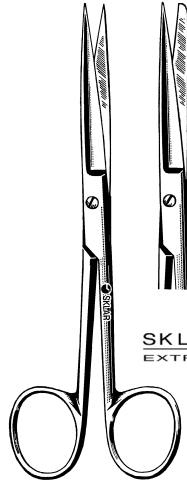
SKLARLITE
THE LIGHT TOUCH

PREMIUM GRADE

SKLARLITE™ OPERATING SCISSORS

Straight

S/S		S/B	
23-1100	4 1/2"	23-1104	4 1/2"
23-1101	5"	23-1105	5"
23-1102	5 1/2"	23-1106	5 1/2"



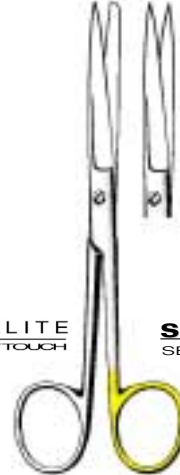
SKLARLITE XD
EXTRA DELICATE

PREMIUM GRADE

SKLARLITE EXTRA DELICATE™ OPERATING SCISSORS

Straight

S/S		S/B	
23-1112	4 1/2"	23-1116	4 1/2"
23-1113	5"	23-1117	5"
23-1114	5 1/2"	23-1118	5 1/2"



SKLARLITE
THE LIGHT TOUCH

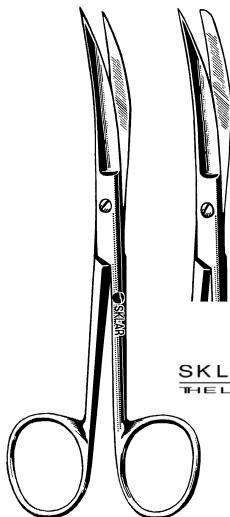
SKLARCUT
SERRATED BLADE

PREMIUM GRADE

SKLARLITE SKLARCUT™ OPERATING SCISSORS

Straight

S/S		S/B	
23-1260	5 1/2"	23-1262	5 1/2"



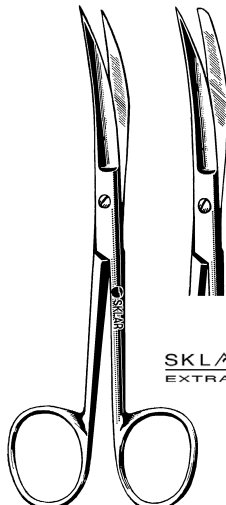
SKLARLITE
THE LIGHT TOUCH

PREMIUM GRADE

SKLARLITE™ OPERATING SCISSORS

Curved

S/S		S/B	
23-1124	4 1/2"	23-1128	4 1/2"
23-1126	5 1/2"	23-1130	5 1/2"



SKLARLITE XD
EXTRA DELICATE

PREMIUM GRADE

SKLARLITE EXTRA DELICATE™ OPERATING SCISSORS

Curved

S/S		S/B	
23-1136	4 1/2"	23-1140	4 1/2"
23-1138	5 1/2"	23-1142	5 1/2"



SKLARLITE
THE LIGHT TOUCH

SKLARCUT
SERRATED BLADE

PREMIUM GRADE

SKLARLITE SKLARCUT™ OPERATING SCISSORS

Curved

S/S		S/B	
23-1264	5 1/2"	23-1266	5 1/2"

NEW!

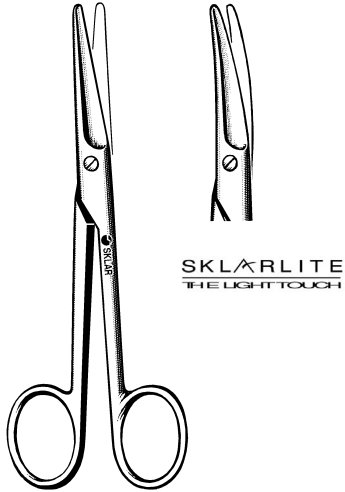
SKLARLITE XD™ PREMIUM SCISSORS

Sklarlite XD™ scissors are manufactured from our standard delicate pattern but with the addition of our unique Sklarlite instrument technology.

These extra delicate scissors provide the most sensitive surgical tool as well as our lightest pattern and with surprising strength.

Sklarlite XD™ scissors afford the same everyday reliability that you expect from all Sklar instruments.

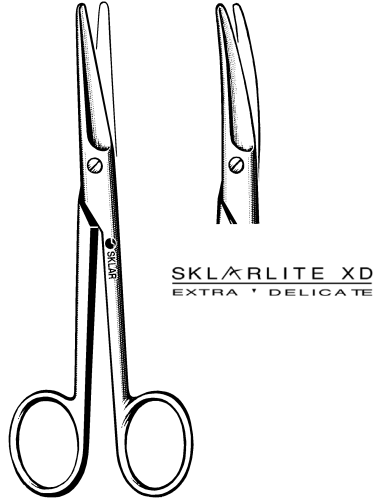
SKLAR EXCLUSIVE



PREMIUM GRADE

SKLARLITE™ MAYO DISSECTING SCISSORS

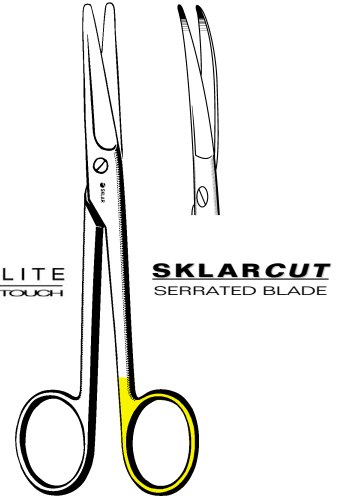
Straight		Curved	
23-1164	5½"	23-1166	5½"
23-1165	6¾"	23-1167	6¾"



PREMIUM GRADE

SKLARLITE EXTRA DELICATE™ MAYO DISSECTING SCISSORS

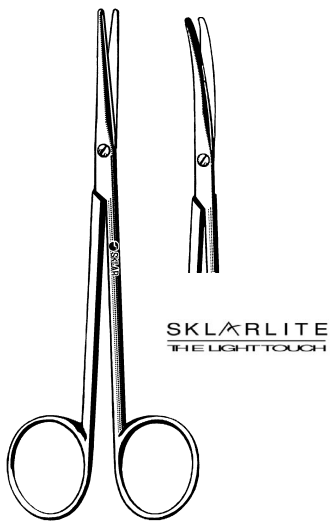
Straight		Curved	
23-1168	5½"	23-1170	5½"
23-1169	6¾"	23-1171	6¾"



PREMIUM GRADE

SKLARLITE SKLARCUT™ MAYO DISSECTING SCISSORS

Straight		Curved	
23-1274	6¾"	23-1278	6¾"



PREMIUM GRADE

SKLARLITE™ METZENBAUM (LAHEY) SCISSORS

Straight		Curved	
23-1172	4½"	23-1174	4½"
23-1173	5¾"	23-1175	5¾"



PREMIUM GRADE

SKLARLITE EXTRA DELICATE™ METZENBAUM (LAHEY) SCISSORS

Straight		Curved	
23-1176	4½"	23-1178	4½"
23-1177	5¾"	23-1179	5¾"



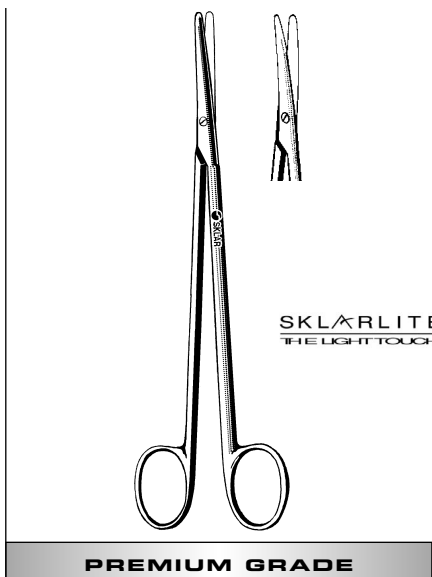
PREMIUM GRADE

SKLARLITE SKLARCUT™ METZENBAUM (LAHEY) SCISSORS

Curved, Blunt	
23-1280	5¾"

CLICK HERE TO SEE THIS WEEK'S SPECIALS - www.sklarcorp.com

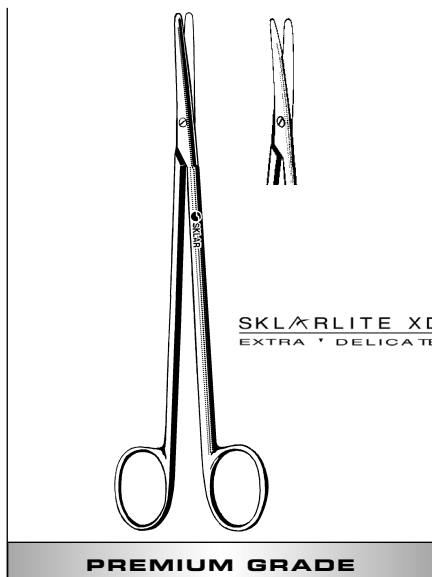
PREMIUM SKLARLITE™ & SKLARLITE XD™ SCISSORS



PREMIUM GRADE

SKLARLITE™ METZENBAUM DISSECTING SCISSORS

Straight	Curved
23-1180 7"	23-1182 7"



PREMIUM GRADE

SKLARLITE EXTRA DELICATE™ METZENBAUM DISSECTING SCISSORS

Straight	Curved
23-1184 7"	23-1186 7"



PREMIUM GRADE

SKLARLITE SKLARCUT™ METZENBAUM DISSECTING SCISSORS

Curved
23-1267 7"



PREMIUM GRADE

SKLARLITE™ IRIS SCISSORS

Straight	Curved
23-1148 3½"	23-1150 3½"
23-1149 4½"	23-1151 4½"



PREMIUM GRADE

SKLARLITE EXTRA DELICATE™ IRIS SCISSORS

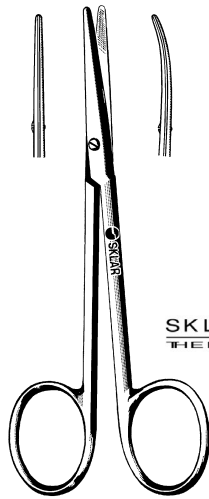
Straight	Curved
23-1152 3½"	23-1154 3½"
23-1153 4½"	23-1155 4½"



PREMIUM GRADE

SKLARLITE SKLARCUT™ IRIS SCISSORS

Straight	Curved
23-1268 4½"	23-1270 4½"



SKLARLITE
THE LIGHT TOUCH

PREMIUM GRADE

SKLARLITE™ STRABISMUS SCISSORS

Straight	Curved
23-1158 4½"	23-1159 4½"

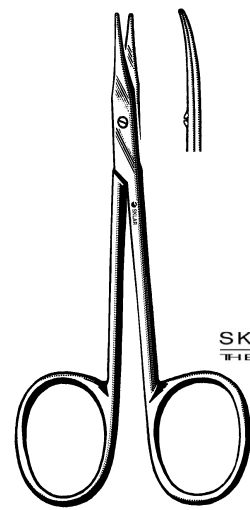


SKLARLITE XD
EXTRA DELICATE

PREMIUM GRADE

SKLARLITE™ EXTRA DELICATE STRABISMUS SCISSORS

Straight	Curved
23-1162 4½"	23-1163 4½"

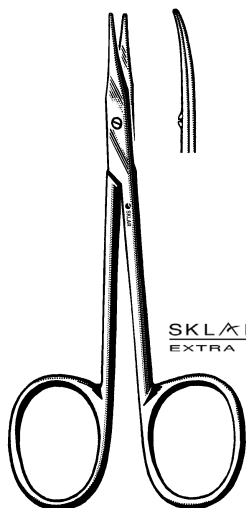


SKLARLITE
THE LIGHT TOUCH

PREMIUM GRADE

SKLARLITE™ STEVENS TENOTOMY SCISSORS

Straight	Curved
B/B	B/B
23-1156 4½"	23-1157 4½"

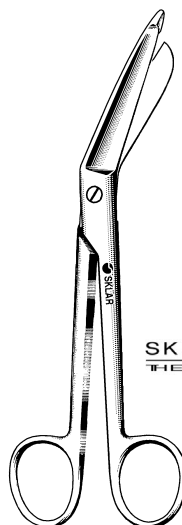


SKLARLITE XD
EXTRA DELICATE

PREMIUM GRADE

SKLARLITE™ EXTRA DELICATE STEVENS TENOTOMY SCISSORS

Straight	Curved
B/B	B/B
23-1160 4½"	23-1161 4½"



SKLARLITE
THE LIGHT TOUCH

PREMIUM GRADE

SKLARLITE™ LISTER BANDAGE SCISSORS

23-1199 5½"
23-1200 7¼"



SKLARLITE XD
EXTRA DELICATE

PREMIUM GRADE

SKLARLITE EXTRA DELICATE™ LISTER BANDAGE SCISSORS

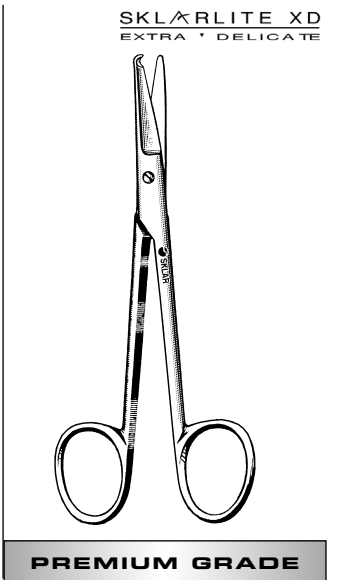
23-1202 5½"
23-1203 7¼"

PREMIUM SKLARLITE™ & SKLARLITE XD™ SCISSORS



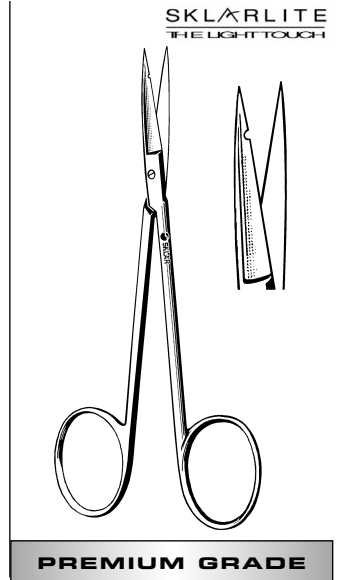
SKLARLITE™ SPENCER STITCH SCISSORS

23-1188 3½" Littauer
23-1189 4½"
23-1190 5½"



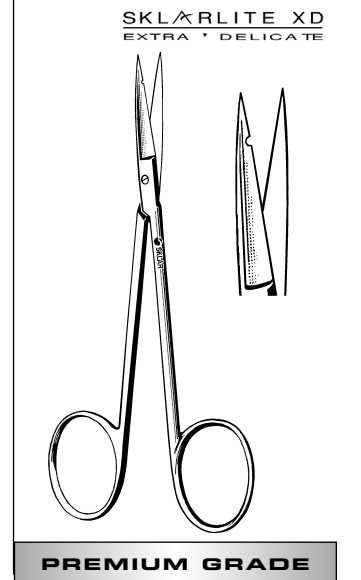
SKLARLITE EXTRA DELICATE™ SPENCER STITCH SCISSORS

23-1193 3½" Littauer
23-1194 4½"
23-1195 5½"



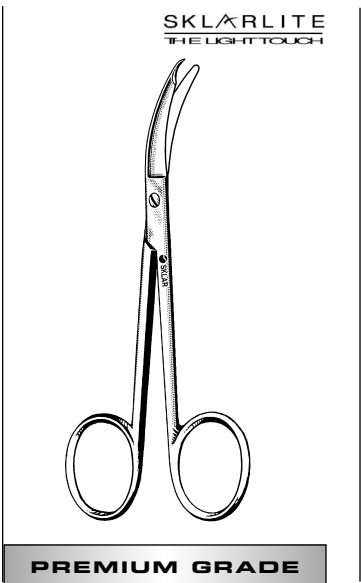
SKLARLITE™ PRECISION SCISSORS

23-1290 3½" Straight
23-1292 3½" Curved
23-1294 4½" Straight
23-1296 4½" Curved



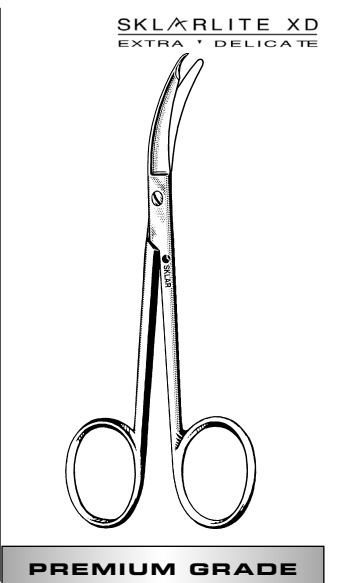
SKLARLITE XD™ PRECISION SCISSORS

23-1300 3½" Straight
23-1302 3½" Curved
23-1304 4½" Straight
23-1306 4½" Curved



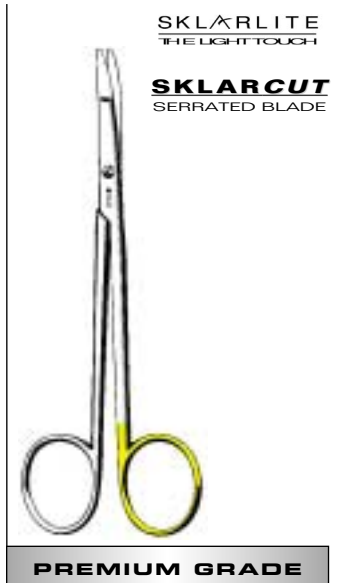
SKLARLITE™ SUTURE SCISSORS

23-1191 3½" Shortbent



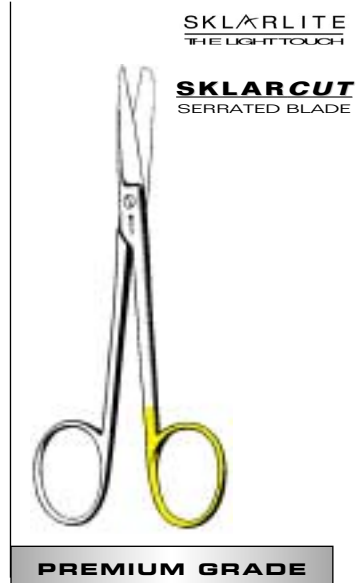
SKLARLITE EXTRA DELICATE™ SUTURE SCISSORS

23-1196 3½" Shortbent



SKLARLITE SKLARCUT™ RAGNELL DISSECTING SCISSORS

Curved
23-1250 5"



SKLARLITE SKLARCUT™ WAGNER SCISSORS

Straight
23-1254 4½" S/B

NEW!

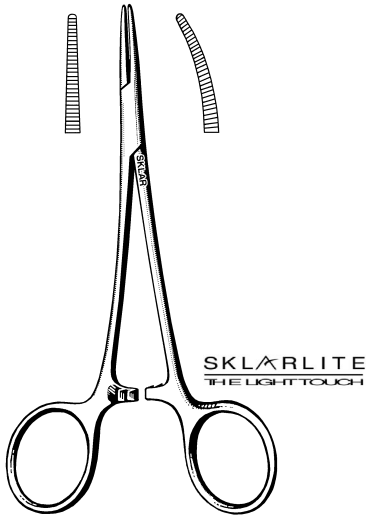
SKLARLITE™ PREMIUM FORCEPS

Sklarlite™ provides the clinician a lighter pattern from the standard forcep while retaining it's structural integrity.

A comfortable instrument, which withstands the rigors of frequent use but minimizes fatigue from prolonged surgery.

Sklarlite™ forceps are covered under the same warranty that guarantees all Sklar instruments for a lifetime of dependable use.

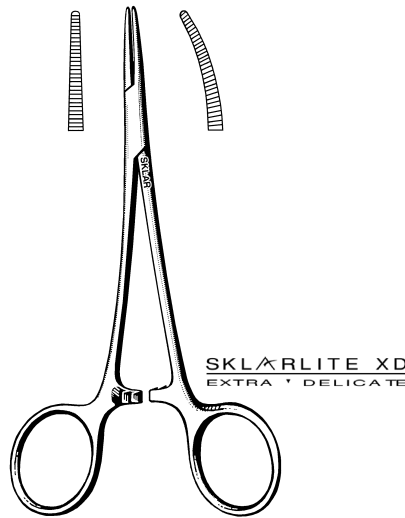
SKLAR EXCLUSIVE



PREMIUM GRADE

SKLARLITE™ HALSTED MOSQUITO FORCEPS

Straight 23-2105 5" Curved 23-2106 5"



PREMIUM GRADE

SKLARLITE EXTRA DELICATE™ HALSTED MOSQUITO FORCEPS

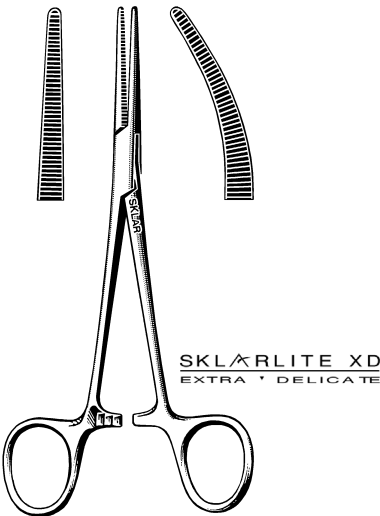
Straight 23-2505 5" Curved 23-2506 5"



PREMIUM GRADE

SKLARLITE™ CRILE HEMOSTATIC FORCEPS

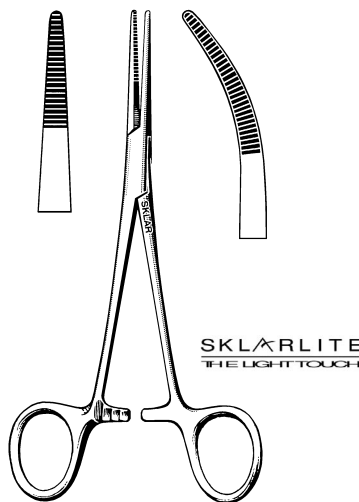
Straight 23-2110 5½" Curved 23-2113 5½"



PREMIUM GRADE

SKLARLITE EXTRA DELICATE™ CRILE HEMOSTATIC FORCEPS

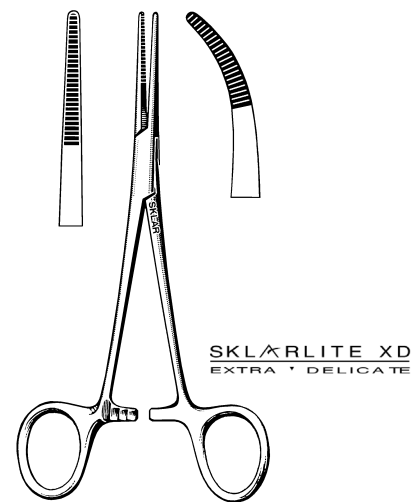
Straight 23-2510 5½" Curved 23-2513 5½"



PREMIUM GRADE

SKLARLITE™ KELLY HEMOSTATIC FORCEPS

Straight 23-2107 5½" Curved 23-2108 5½"



PREMIUM GRADE

SKLARLITE EXTRA DELICATE™ KELLY HEMOSTATIC FORCEPS

Straight 23-2507 5½" Curved 23-2508 5½"

NEW!

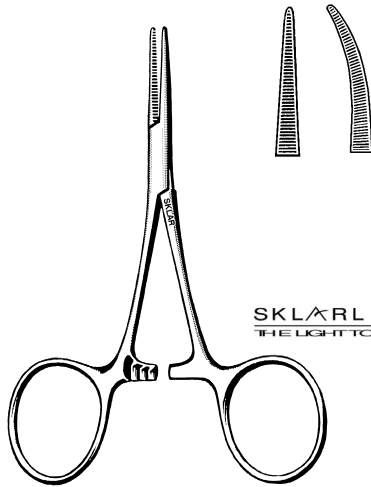
SKLARLITE XD™ PREMIUM FORCEPS

Sklarlite XD™ forceps are manufactured from our standard delicate pattern but with the addition of our unique Sklarlite™ instrument technology.

These extra delicate forceps provide the most sensitive surgical tools as well as our lightest pattern and with surprising strength.

Sklarlite XD™ forceps afford the same everyday reliability that you expect from all Sklar instruments

SKLAR EXCLUSIVE

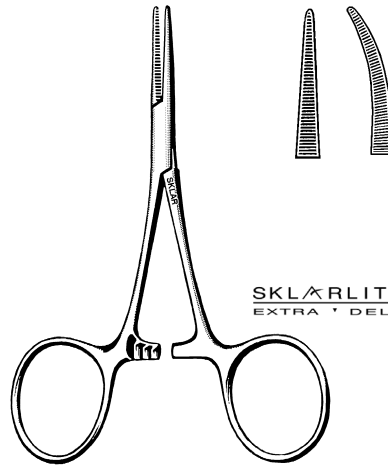


SKLARLITE
THE LIGHT TOUCH

PREMIUM GRADE

SKLARLITE™ HARTMANN MOSQUITO HEMOSTATS

Straight	Curved
23-2100 3 1/2"	23-2101 3 1/2"

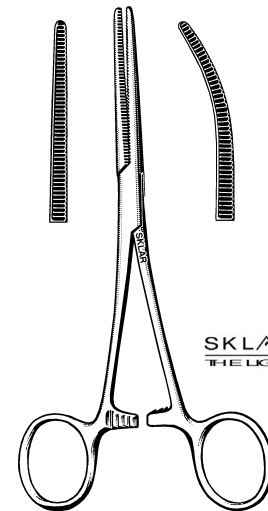


SKLARLITE XD
EXTRA DELICATE

PREMIUM GRADE

SKLARLITE EXTRA DELICATE™ HARTMANN MOSQUITO HEMOSTATS

Straight	Curved
23-2500 3 1/2"	23-2501 3 1/2"

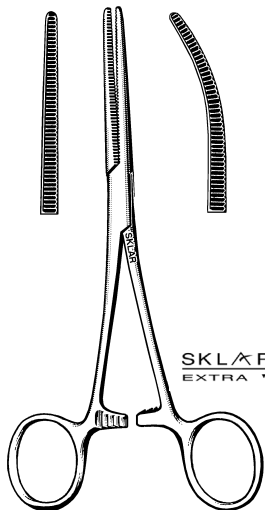


SKLARLITE
THE LIGHT TOUCH

PREMIUM GRADE

SKLARLITE™ ROCHESTER-PEAN FORCEPS

Straight	Curved
23-2532 6 1/4"	23-2538 6 1/4"
23-2534 7 1/4"	23-2542 7 1/4"

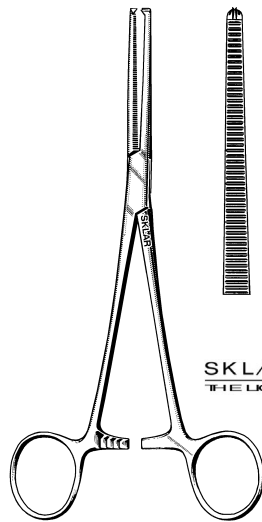


SKLARLITE XD
EXTRA DELICATE

PREMIUM GRADE

SKLARLITE EXTRA DELICATE™ ROCHESTER-PEAN FORCEPS

Straight	Curved
23-2552 6 1/4"	23-2561 6 1/4"
23-2554 7 1/4"	23-2563 7 1/4"

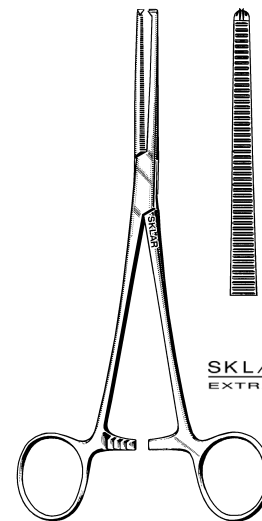


SKLARLITE
THE LIGHT TOUCH

PREMIUM GRADE

SKLARLITE™ ROCHESTER-OCHSNER FORCEPS

Straight 1x2 Teeth	Curved 1x2 Teeth
23-2560 6 1/4"	23-2568 6 1/4"

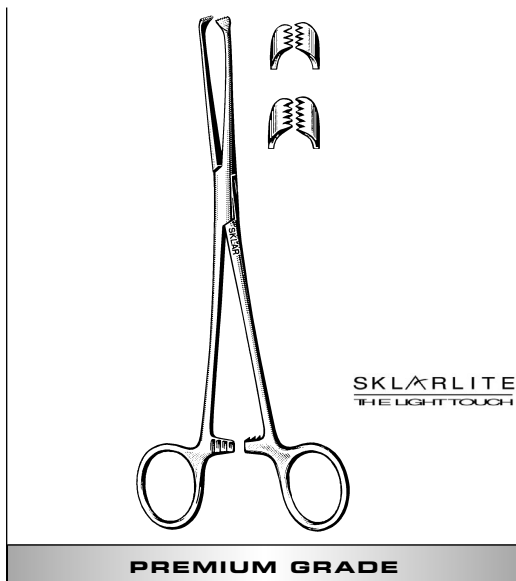


SKLARLITE XD
EXTRA DELICATE

PREMIUM GRADE

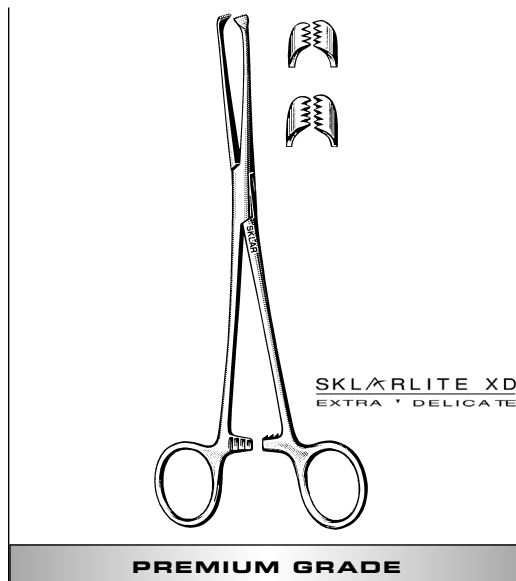
SKLARLITE EXTRA DELICATE™ ROCHESTER-OCHSNER FORCEPS

Straight	Curved
23-2577 6 1/4"	23-2585 6 1/4"



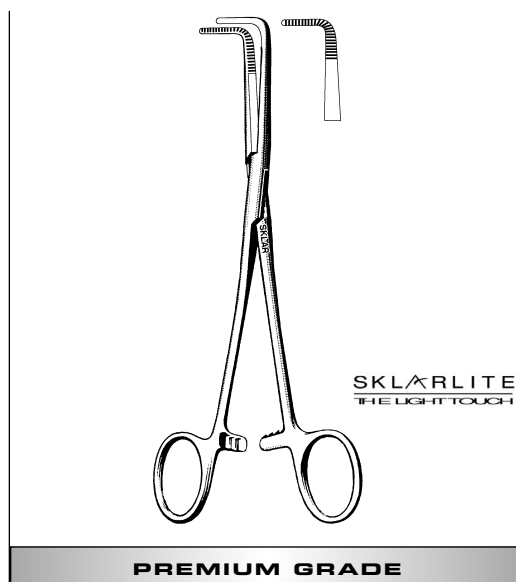
SKLARLITE™ ALLIS TISSUE FORCEPS

23-2851 6" 4x5
23-2852 6" 5x6



SKLARLITE EXTRA DELICATE™ ALLIS TISSUE FORCEPS

23-2861 5" 4x5
23-2862 5½" 4x5
23-2864 6" 4x5
23-2865 6" 5x6



SKLARLITE™ MIXTER FORCEPS

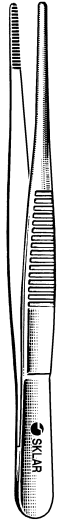
Right Angle
23-2516 5½"
23-2520 7¼"



SKLARLITE EXTRA DELICATE™ MIXTER FORCEPS

Right Angle
23-2521 5½"
23-2525 7¼"

SKLARLITE™ & SKLARLITE XD™ FORCEPS

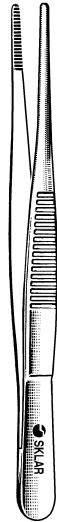


SKLARLITE
THE LIGHT TOUCH

PREMIUM GRADE

SKLARLITE™ DRESSING FORCEPS

Serrated
23-2824 4 1/2" 23-2828 5 1/2"
23-2826 5" 23-2830 6"

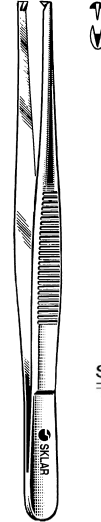


SKLARLITE XD
EXTRA DELICATE

PREMIUM GRADE

SKLARLITE EXTRA DELICATE™ DRESSING FORCEPS

Serrated
23-2834 4 1/2" 23-2838 5 1/2"
23-2836 5" 23-2840 6"

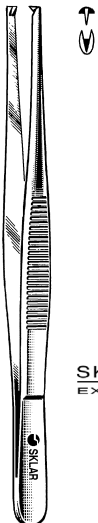


SKLARLITE
THE LIGHT TOUCH

PREMIUM GRADE

SKLARLITE™ TISSUE FORCEPS

1x2 Teeth
23-2809 4 1/2"
23-2811 5 1/2"



SKLARLITE XD
EXTRA DELICATE

PREMIUM GRADE

SKLARLITE EXTRA DELICATE™ TISSUE FORCEPS

1x2 Teeth
23-2819 5 1/2"



SKLARLITE
THE LIGHT TOUCH

PREMIUM GRADE

SKLARLITE™ ADSON FORCEPS

Dressing
23-2600 4 1/4" Serrated

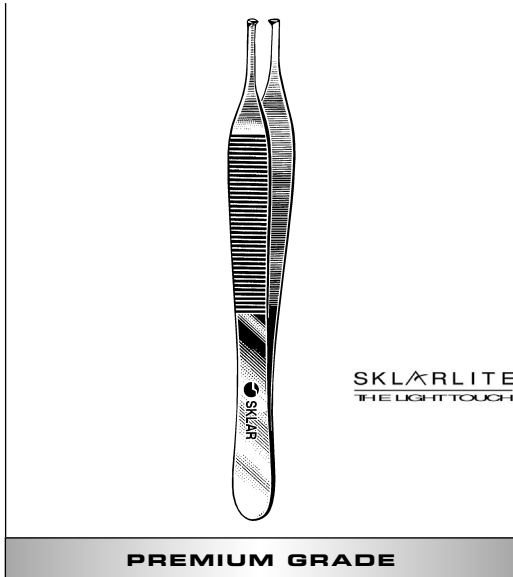


SKLARLITE XD
EXTRA DELICATE

PREMIUM GRADE

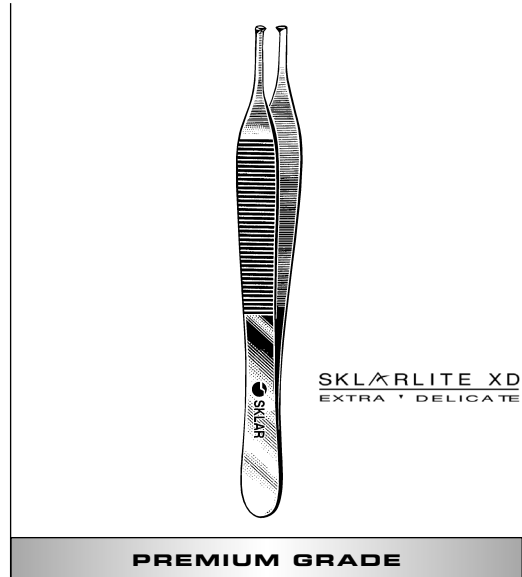
SKLARLITE EXTRA DELICATE™ ADSON FORCEPS

Dressing
23-2604 4 1/4" Serrated



**SKLARLITE™
ADSON FORCEPS**

Tissue
23-2602 4 3/4" 1x2 Teeth



**SKLARLITE
EXTRA DELICATE™
ADSON FORCEPS**

Tissue
23-2606 4 3/4" 1x2 Teeth



**SKLARLITE™
ADSON-BROWN FORCEPS**

23-2603 4 3/4" Side Grasping



**SKLARLITE
EXTRA DELICATE™
ADSON-BROWN FORCEPS**

23-2608 4 3/4" Side Grasping

NEW!

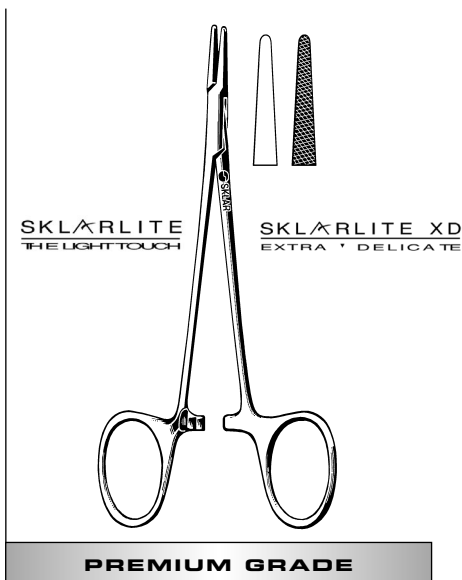
SKLARLITE XD™ PREMIUM NEEDLE HOLDERS

The Sklarlite™ technology is ideally suited to create a comfortable instrument for prolonged suturing.

The most common needle holders have been reduced in their overall pattern weight to produce a lighter instrument but one which also retains it's needle grasping capability.

Sklarlite™ and Sklarlite XD™ needle holders are fully guaranteed.

SKLAR EXCLUSIVE

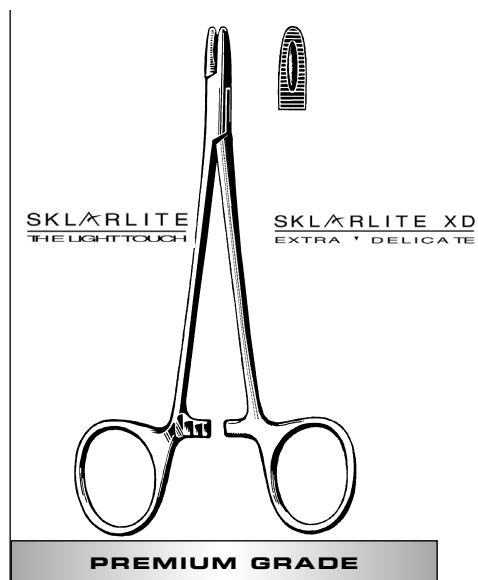


PREMIUM GRADE
SKLARLITE™ WEBSTER NEEDLE HOLDER

23-2125 5 1/4" Smooth 23-2120 5 1/4" Serrated

SKLARLITE EXTRA DELICATE™ WEBSTER NEEDLE HOLDER

23-2225 5 1/4" Smooth 23-2220 5 1/4" Serrated

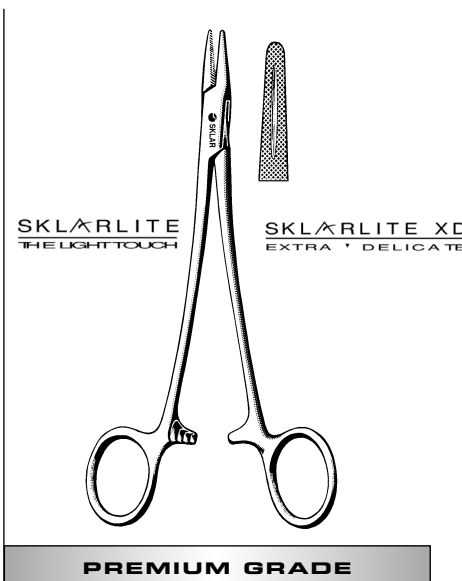


PREMIUM GRADE
SKLARLITE™ DERF NEEDLE HOLDER

23-2124 4 1/4" Serrated

SKLARLITE EXTRA DELICATE™ DERF NEEDLE HOLDER

23-2224 4 1/4" Serrated

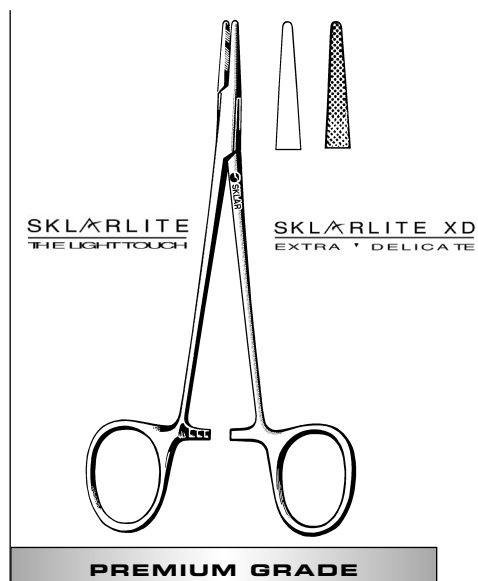


PREMIUM GRADE
SKLARLITE™ MAYO-HEGAR NEEDLE HOLDER

23-2128 7" Serrated

SKLARLITE EXTRA DELICATE™ MAYO-HEGAR NEEDLE HOLDER

23-2228 7" Serrated

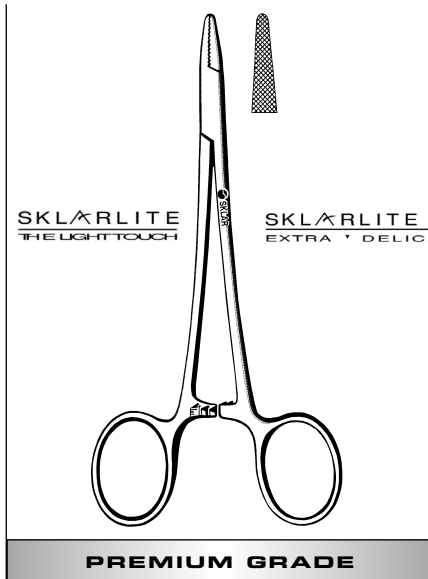


PREMIUM GRADE
SKLARLITE™ HALSEY NEEDLE HOLDER

23-2135 5 1/4" Smooth 23-2130 5 1/4" Serrated

SKLARLITE EXTRA DELICATE™ HALSEY NEEDLE HOLDER

23-2235 5 1/4" Smooth 23-2230 5 1/4" Serrated



**SKLARLITE™
BAUMGARTNER NEEDLE HOLDER**

23-2132 5½" Serrated

**SKLARLITE EXTRA DELICATE™
BAUMGARTNER NEEDLE HOLDER**

23-2232 5½" Serrated

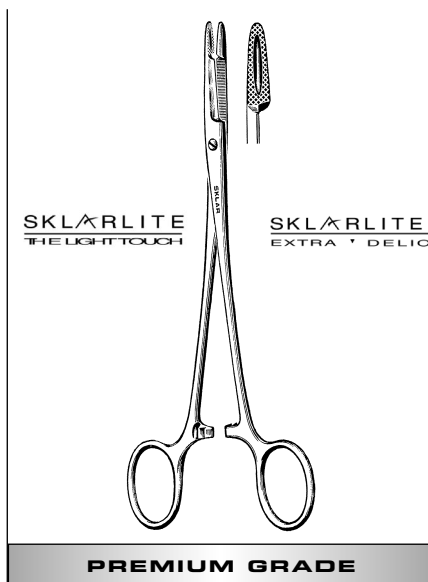


**SKLARLITE™
CRILE-WOOD NEEDLE HOLDER**

23-2134 6" Serrated

**SKLARLITE EXTRA DELICATE™
CRILE-WOOD NEEDLE HOLDER**

23-2234 6" Serrated

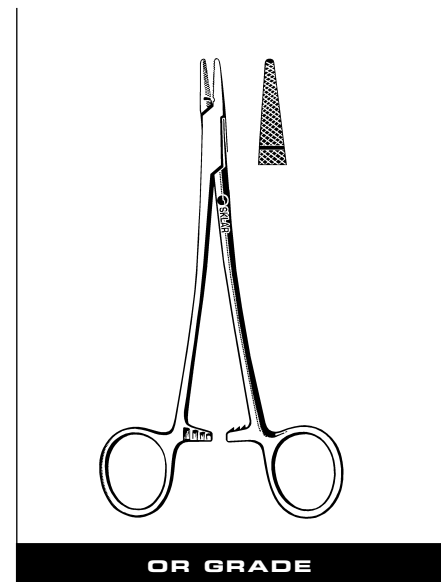


**SKLARLITE™
OLSEN-HEGAR NEEDLE HOLDER**

Scissors Combination
23-2136 5½" Serrated

**SKLARLITE EXTRA DELICATE™
OLSEN-HEGAR NEEDLE HOLDER**

Scissors Combination
23-2236 5½" Serrated



**CRILE-MURRAY
NEEDLE HOLDER**

20-1260 6" Serrated

NEW!

SKLARCUT™ PREMIUM SCISSORS

Skларcut™ improves the design and function of your most frequently used surgical instrument by the addition of ultra-fine serrations on one blade.

This premium feature provides additional surgical control by holding the tissue while cutting more cleanly and with greater precision.

Skларcut™ scissors are easily identified by the gold finger ring of the serrated blade.

SKLAR EXCLUSIVE



SKLARCUT
SERRATED BLADE

PREMIUM GRADE

SKLARCUT™ OPERATING SCISSORS

Straight
S/S 15-3500 5/2" S/B 15-3505 5/2"



SKLARLITE THE LIGHT TOUCH **SKLARCUT**
SERRATED BLADE

PREMIUM GRADE

SKLARLITE SKLARCUT™ OPERATING SCISSORS

Straight
S/S 23-1260 5/2" S/B 23-1262 5/2"



SKLARCUT
SERRATED BLADE

PREMIUM GRADE

SKLARCUT™ OPERATING SCISSORS

Curved
S/S 15-3510 5/2" S/B 15-3515 5/2"

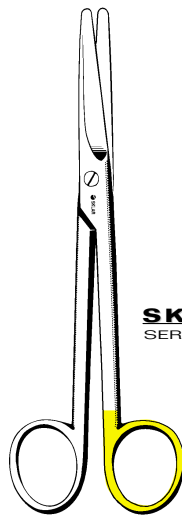


SKLARLITE THE LIGHT TOUCH **SKLARCUT**
SERRATED BLADE

PREMIUM GRADE

SKLARLITE SKLARCUT™ OPERATING SCISSORS

Curved
S/B 23-1266 5/2"

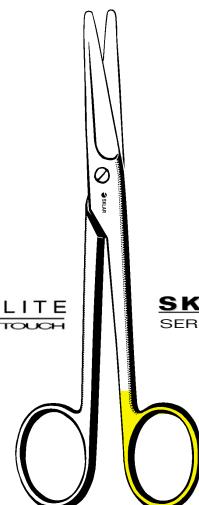


SKLARCUT
SERRATED BLADE

PREMIUM GRADE

SKLARCUT™ MAYO DISSECTING SCISSORS

Straight Curved
15-3550 5/2" 15-3560 5/2"
15-3555 6/4" 15-3565 6/4"

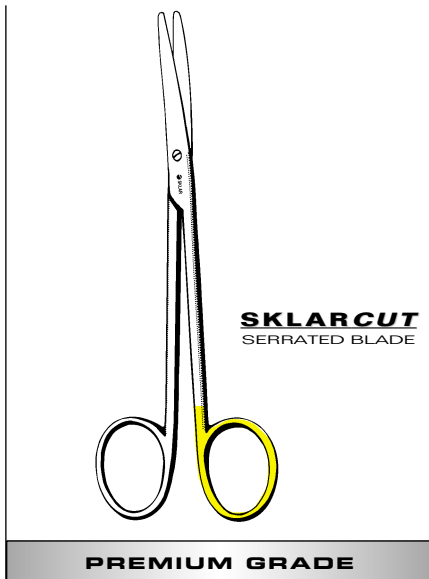


SKLARLITE THE LIGHT TOUCH **SKLARCUT**
SERRATED BLADE

PREMIUM GRADE

SKLARLITE SKLARCUT™ MAYO DISSECTING SCISSORS

Straight Curved
23-1274 6/4" 23-1278 6/4"



SKLARCUT™ METZENBAUM (LAHEY) SCISSORS

Curved
15-3570 5 1/4"



SKLARLITE SKLARCUT™ METZENBAUM (LAHEY) SCISSORS

Curved
23-1280 5 1/4"



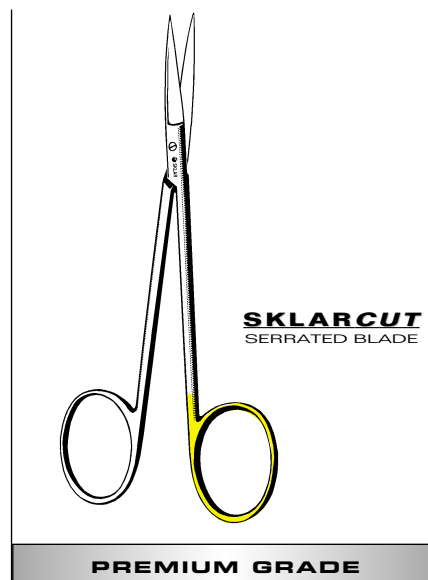
SKLARCUT™ METZENBAUM DISSECTING SCISSORS

Curved
15-3575 7"



SKLARLITE SKLARCUT™ METZENBAUM DISSECTING SCISSORS

Curved, Blunt
23-1267 7"



SKLARCUT™ IRIS SCISSORS

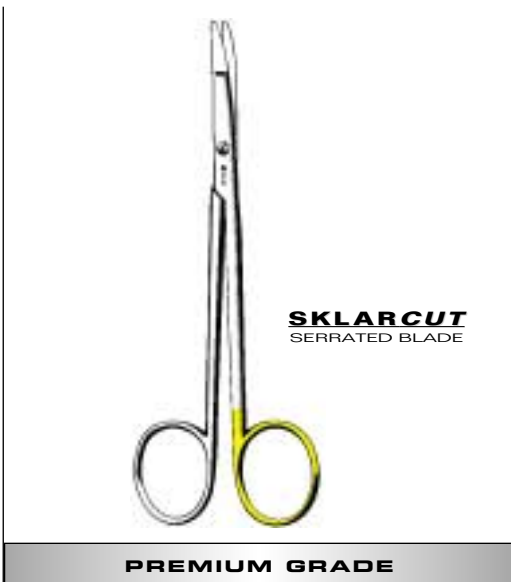
Straight 15-3585 4 1/2" Curved 15-3590 4 1/2"



SKLARLITE SKLARCUT™ IRIS SCISSORS

Straight 23-1268 4 1/2" Curved 23-1270 4 1/2"

PREMIUM SKLARCUT™ SCISSORS



SKLARCUT™ RAGNELL DISSECTING SCISSORS

Curved
15-3320 5"



SKLARLITE SKLARCUT™ RAGNELL DISSECTING SCISSORS

Curved
23-1250 5"



SKLARCUT™ WAGNER SCISSORS

Straight
15-3542 4½" S/B



SKLARLITE SKLARCUT™ WAGNER SCISSORS

Straight
23-1254 4½" S/B

NEW!

SKLAR EDGE™ PREMIUM SCISSORS

Sklar Edge™ scissors are manufactured using a Sklar exclusive edging process which permanently bonds tungsten carbide to the scissor blades.

Tungsten carbide is an extremely hard alloy providing an exceptionally strong and sharper edge while maintaining a Sklar 5 year guarantee of durability.

These perfectly balanced scissors are readily identified by the gold finger rings

SKLAR EXCLUSIVE



SKLAR EDGE
TUNGSTEN CARBIDE

PREMIUM GRADE

SKLAR EDGE™ T-C OPERATING SCISSORS

Straight

S/S	S/B	B/B
16-1055 5½"	16-1056 5½"	16-1057 5½"



SKLAR EDGE
TUNGSTEN CARBIDE

PREMIUM GRADE

SKLAR EDGE™ T-C OPERATING SCISSORS

Curved

S/B
16-1156 5½"



SKLAR EDGE
TUNGSTEN CARBIDE

PREMIUM GRADE

SKLAR EDGE™ T-C MAYO DISSECTING SCISSORS

Straight

16-1505 5½"	16-1605 5½"
16-1510 6¾"	16-1610 6¾"
16-1515 9"	16-1615 9"

Curved



SKLAR EDGE
TUNGSTEN CARBIDE

PREMIUM GRADE

SKLAR EDGE™ T-C METZENBAUM (LAHEY) SCISSORS

Straight

16-1805 5¼"	Delicate
16-1810 5¼"	Standard

Curved

16-1905 5¼"	Delicate
16-1910 5¼"	Standard



SKLAR EDGE
TUNGSTEN CARBIDE

PREMIUM GRADE

SKLAR EDGE™ T-C METZENBAUM DISSECTING SCISSORS

16-2005 7"	Delicate, Straight
16-2010 7"	Standard, Straight
16-2210 9"	Standard Nelson, Straight
16-2105 7"	Delicate, Curved
16-2110 7"	Standard, Curved
16-2310 9"	Standard Nelson, Curved
16-2311 11"	Standard Nelson, Curved



SKLAR EDGE
TUNGSTEN CARBIDE

PREMIUM GRADE

SKLAR EDGE™ T-C IRIS SCISSORS

Straight

16-2405 4¼"	16-2505 4¼"
-------------	-------------

Curved

PREMIUM SKLAR EDGE™ SCISSORS



SKLAR EDGE™ T-C STRABISMUS SCISSORS

Straight	Curved
B/B	B/B
16-2605 4½"	16-2705 4½"



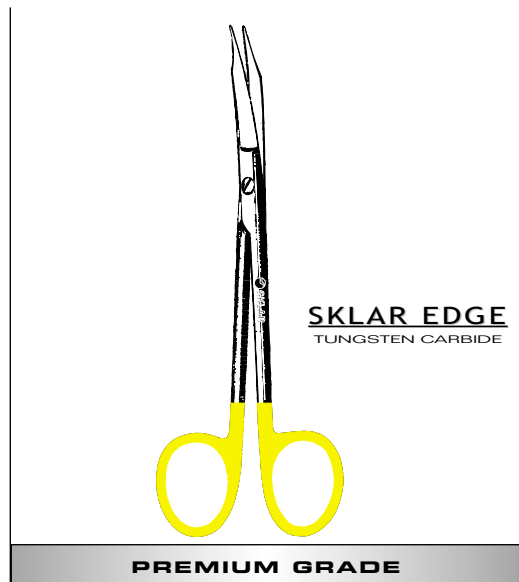
SKLAR EDGE™ T-C WIRE CUTTING SCISSORS

16-2800 4¾"	Tungsten Carbide
	Angular Serrated



SKLAR EDGE™ T-C MAYO-STILLE DISSECTING SCISSORS ROUNDED BLADES

Straight	Curved
16-3552 5½"	16-3562 5½"
16-3557 6¾"	16-3567 6¾"



SKLAR EDGE™ T-C DISSECTING SCISSORS

Curved
16-2610 5"

NEW!

SKLARHONE™ PREMIUM SCISSORS

Sklarhone™ scissors combine the cutting edge of a surgical knife with that of a standard scissor, either smooth or with a finely serrated edge.

These superior instruments employ the most sophisticated technology to create a smooth and clean cutting action whether for delicate surgery or when thick, coarse tissue is encountered.

Sklarhone™ scissors are distinctly identified by their black handles.

SKLAR EXCLUSIVE



SKLARHONE
MICRO - CUT

PREMIUM GRADE

SKLARHONE™ OPERATING SCISSORS

Straight, Smooth

S/S S/B
15-3342 5½" 15-3343 5½"

Straight, Serrated

S/S S/B
15-3442 5½" 15-3443 5½"



SKLARHONE
MICRO - CUT

PREMIUM GRADE

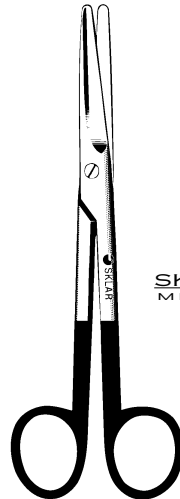
SKLARHONE™ OPERATING SCISSORS

Curved, Smooth

S/B
15-3349 5½"

Curved, Serrated

S/S S/B
15-3448 5½" 15-3449 5½"



SKLARHONE
MICRO - CUT

PREMIUM GRADE

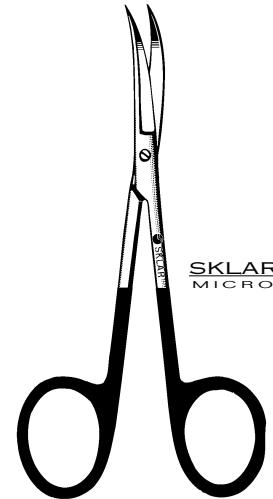
SKLARHONE™ MAYO DISSECTING SCISSORS

Straight, Smooth

15-3325 5½"
15-3326 6¾"

Curved, Smooth

15-3330 5½"
15-3331 6¾"



SKLARHONE
MICRO - CUT

PREMIUM GRADE

SKLARHONE™ IRIS SCISSORS

Straight, Smooth

15-3352 4½"

Curved, Smooth

15-3357 4½"

Serrated

15-3452 4½"

Serrated

15-3457 4½"



SKLARHONE
MICRO - CUT

PREMIUM GRADE

SKLARHONE™ METZENBAUM (LAHEY) SCISSORS

Curved

15-3306 5½"



SKLARHONE
MICRO - CUT

PREMIUM GRADE

SKLARHONE™ METZENBAUM DISSECTING SCISSORS

Curved, Smooth

15-3310 7"
15-3311 8"
15-3315 9"

Serrated

15-3410 7"



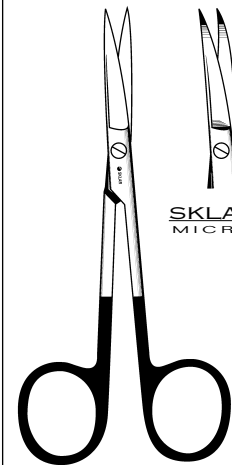
SKLARHONE
MICRO - CUT

PREMIUM GRADE

SKLARHONE™ JAMESON SCISSORS

Curved

15-7032 7"



SKLARHONE
MICRO - CUT

PREMIUM GRADE

SKLARHONE™ PLASTIC SURGERY SCISSORS

15-3460 4½" Straight

15-3461 4½" Curved

CLICK HERE TO SEE THIS WEEK'S SPECIALS - www.sklarcorp.com

NEW!

SKLAR TC™ PREMIUM NEEDLE HOLDERS

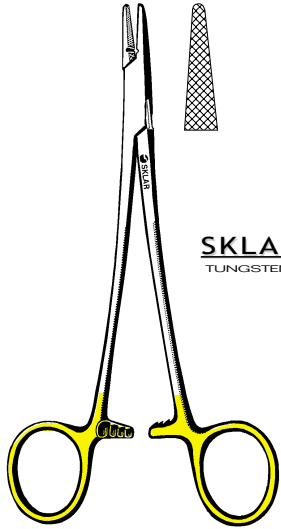
SKLAR TC™ needle holders utilize solid tungsten carbide insert jaws with a Sklar pyramid profile to hold suture needles far more securely than standard Needle Holders from any manufacturer.

All TC inserts are precisely ground and virtually indestructible and harder than any needle, eliminating needle rotation or slippage

Finely cut and evenly distributed ratchets on our handles further ensure exacting control over the suturing process.

TC INSERTS ARE GUARANTEED FOR 5 YEARS!

SKLAR EXCLUSIVE

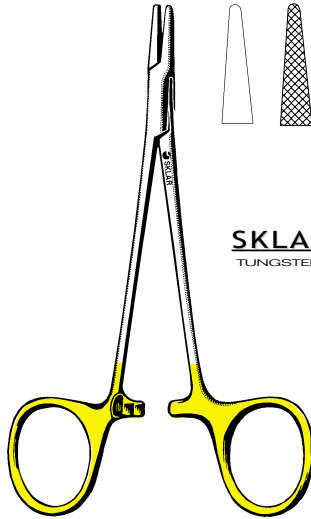


SKLAR T-C
TUNGSTEN CARBIDE

PREMIUM GRADE

T-C CRILE-MURRAY NEEDLE HOLDER

21-8075 6" Serrated

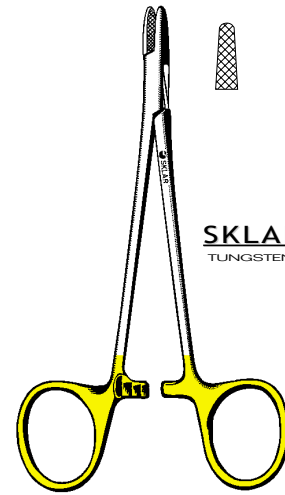


SKLAR T-C
TUNGSTEN CARBIDE

PREMIUM GRADE

T-C WEBSTER NEEDLE HOLDER

21-8002 5/4" Smooth
21-8080 5/4" Serrated

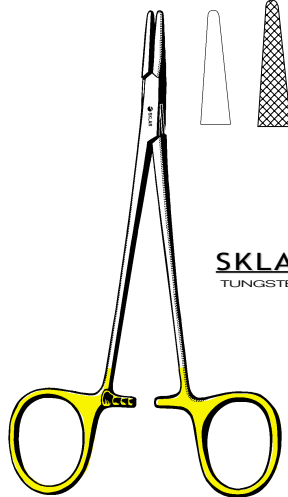


SKLAR T-C
TUNGSTEN CARBIDE

PREMIUM GRADE

T-C DERF NEEDLE HOLDER

21-8004 4 3/4" Serrated

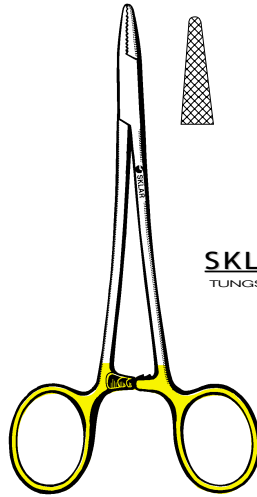


SKLAR T-C
TUNGSTEN CARBIDE

PREMIUM GRADE

T-C HALSEY NEEDLE HOLDER

21-8000 5/4" Smooth
21-8001 5/4" Serrated



SKLAR T-C
TUNGSTEN CARBIDE

PREMIUM GRADE

T-C BAUMGARTNER NEEDLE HOLDER

21-8005 5/4" Serrated

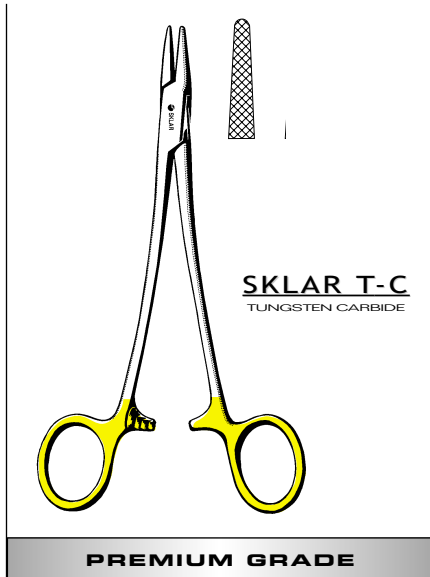


SKLAR T-C
TUNGSTEN CARBIDE

PREMIUM GRADE

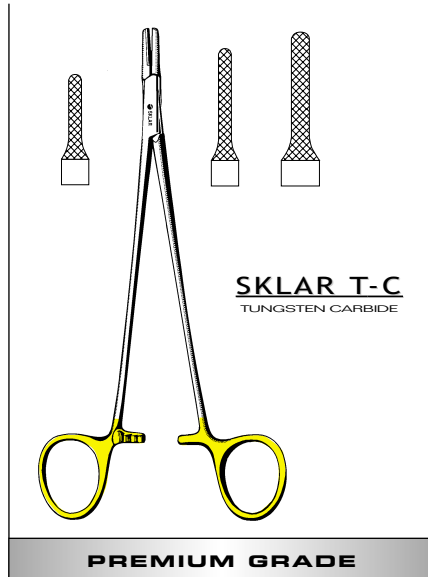
T-C CRILE-WOOD NEEDLE HOLDER

Serrated
21-8006 6" Narrow
21-8007 7"
21-8008 8"
21-8009 9"
21-8010 10 1/2"
21-8011 12"



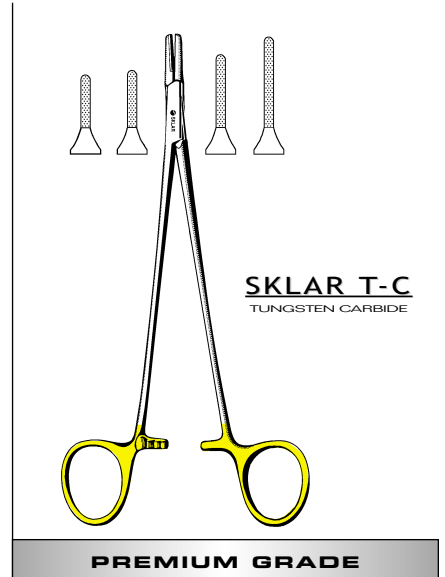
T-C MAYO-HEGAR NEEDLE HOLDER

- Serrated
- 21-8030 5¼"
 - 21-8031 6"
 - 21-8032 7"
 - 21-8033 8"
 - 21-8034 10½"
 - 21-8035 12"



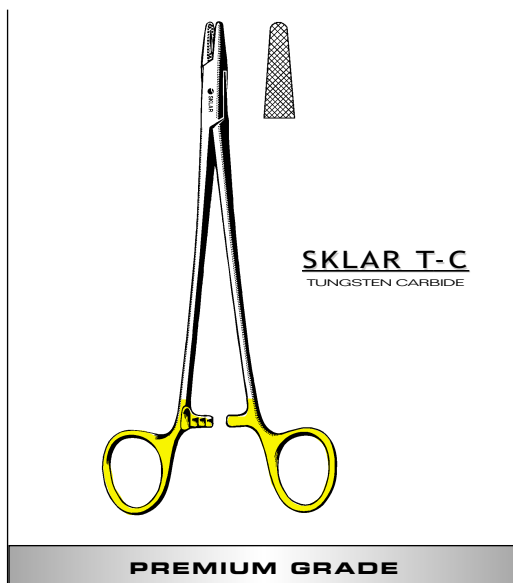
T-C RYDER NEEDLE HOLDER

- Serrated
- 21-8020 6"
 - 21-8022 8"
 - 21-8023 9"



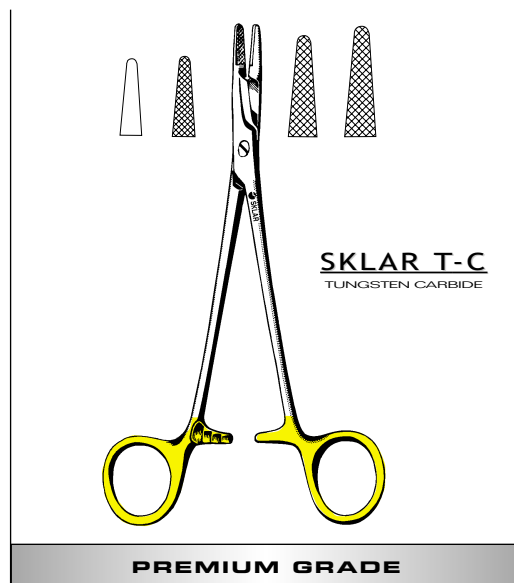
T-C RYDER NEEDLE HOLDER

- Micro-Serrated
- 21-8012 5"
 - 21-8013 6"
 - 21-8014 7"
 - 21-8016 9"



T-C NEW ORLEANS NEEDLE HOLDER

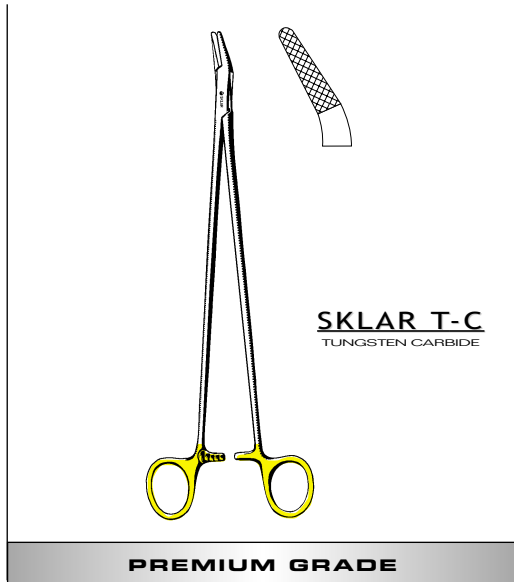
- 21-8082 7" Serrated



T-C OLSEN-HEGAR NEEDLE HOLDER

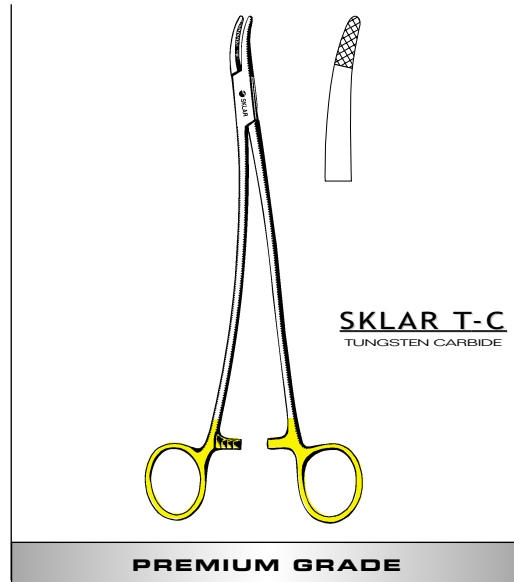
- Scissor Combination
- 21-8025 4¾" Serrated Delicate
 - 21-8027 5½" Serrated
 - 21-8028 6½" Serrated
 - 21-8029 7½" Serrated
 - 21-8026 4¾" Smooth Delicate

PREMIUM SKLAR T-C™ NEEDLE HOLDERS



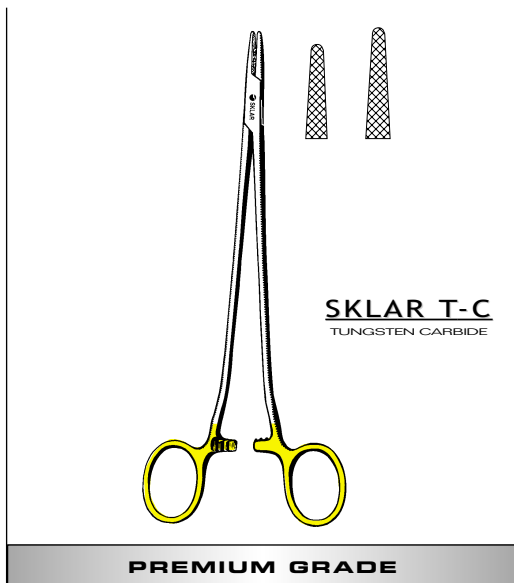
T-C FINOCHIETTO NEEDLE HOLDER

Angular
21-8039 10½" Serrated



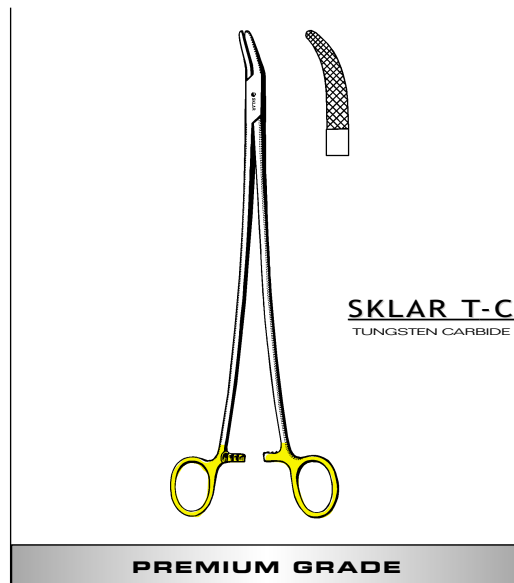
T-C STRATTE NEEDLE HOLDER

"S" Shaped
21-8065 9" Serrated



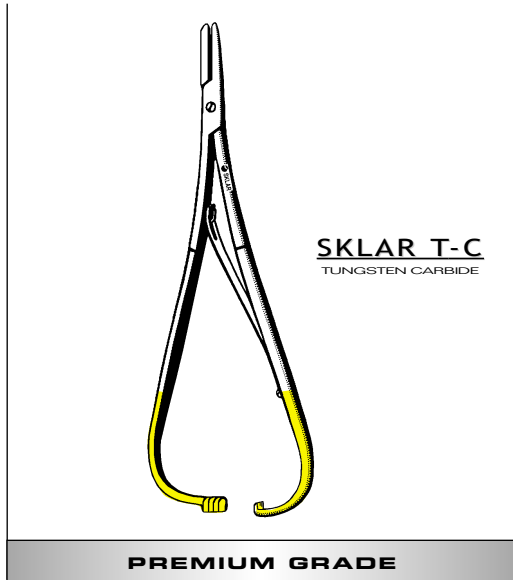
T-C SAROT NEEDLE HOLDER

21-8036 7½" Serrated
21-8037 10½" Serrated



T-C HEANEY NEEDLE HOLDER

Curved
21-8060 8½" Serrated
21-8061 10" Serrated



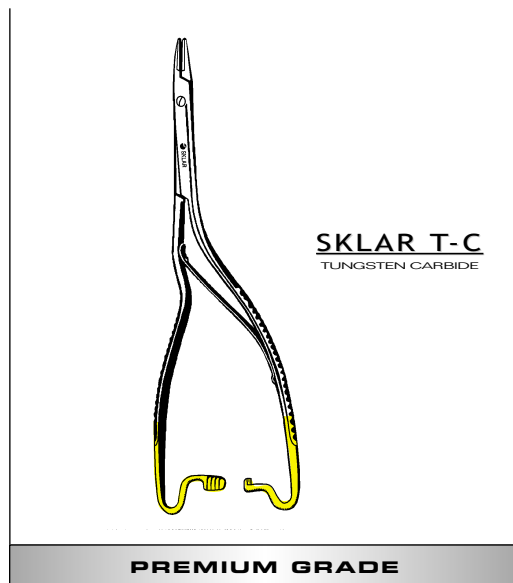
T-C MATHIEU NEEDLE HOLDER

21-8070 5½"
21-8071 6¾" Narrow Jaw



T-C BOZEMAN-HEANEY NEEDLE HOLDER

21-8062 10½" Curved



T-C LUETHY BECK NEEDLE HOLDER

21-8064 8"



T-C NEIVERT NEEDLE HOLDER

21-8086 5" Serrated, One Offset Finger Ring

NEW!

SKLAR TC™ PREMIUM FORCEPS

Sklar TC™ Premium Forceps, which are manufactured with a tungsten carbide insert, are designed to provide a very positive grasping jaw surface.

This non-slip profile allows the user to apply the precise pressure necessary for handling tissue, dressings or tying sutures quickly and efficiently.

Our five-year guarantee applies to the tungsten carbide inserts on these gold handle instruments.

SKLAR EXCLUSIVE



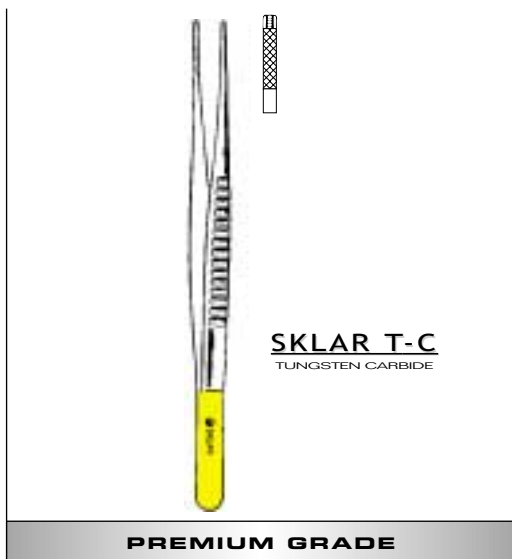
T-C ALLIS FORCEPS

- 97-1555 6"
- 97-1560 7½"



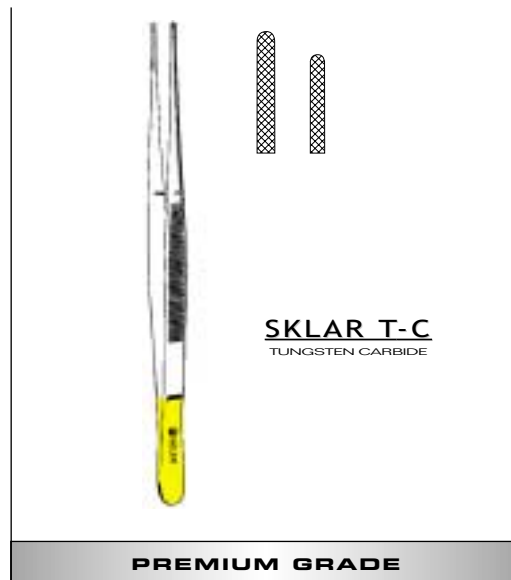
T-C BABCOCK FORCEPS

- 97-1565 6¼"
- 97-1570 8"



T-C DEBAKEY ATRAUMATIC FORCEPS

- 97-1530 6" 2.0 mm Tips
- 97-1531 6" 2.7mm Tips
- 97-1540 8" 2.0 mm Tips
- 97-1541 8" 2.7mm Tips



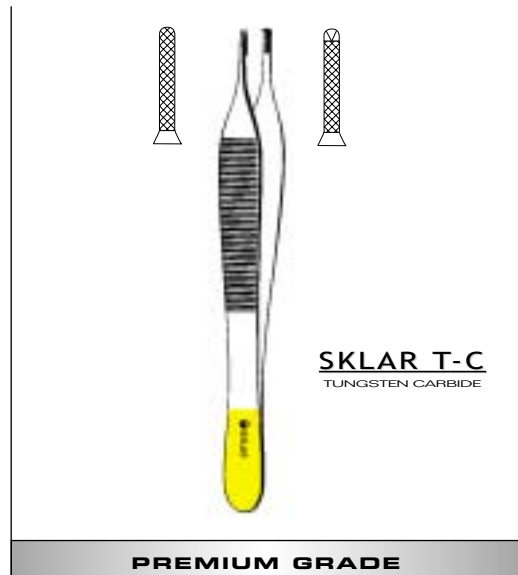
T-C POTTS-SMITH DRESSING FORCEPS

- 51-4360 6" Serrated
- 51-4370 7" Serrated
- 51-4382 8¼" Serrated



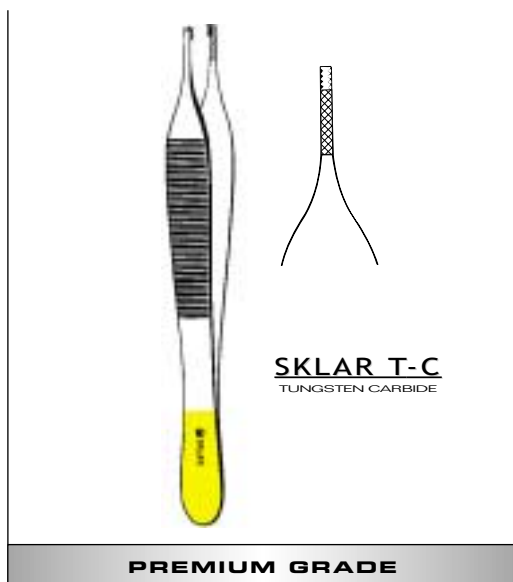
T-C DRESSING FORCEPS

51-3460 6" Serrated
51-3480 8" Serrated



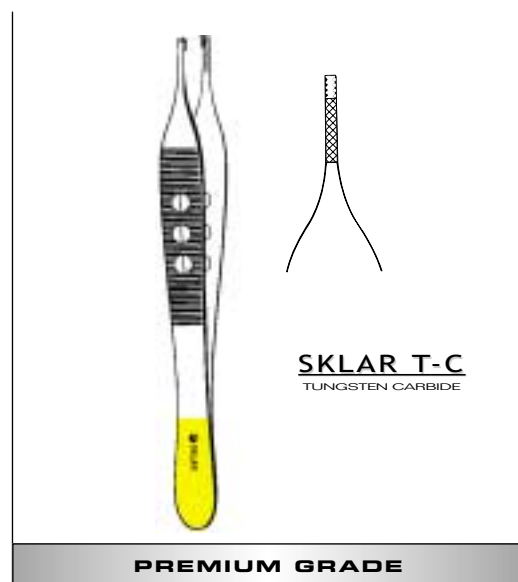
T-C ADSON FORCEPS

51-3447 4 3/4" Serrated
51-3049 4 3/4" 1x2 Teeth With Platform



T-C ADSON-BROWN FORCEPS

51-1447 4 3/4" Side Grasping



LITEGRIP™ T-C ADSON-BROWN TISSUE AND SUTURE FORCEPS

51-1448 4 3/4" Side Grasping With Tungsten Carbide Insert



SURGI-OR

These instruments are forged from surgical grade stainless steel and then hand crafted in Pakistan. Surgi-OR quality instruments offer significant value to the Operating Room as well as other important surgical settings.

• **Cost Effective “Mid-Grade” Instruments**

• **Quality Crafted To OR Standards**

• **Unconditional Lifetime Guarantee**

Surgi-OR Scissors are precision crafted surgical instruments. Manufactured in Pakistan from surgical grade stainless steel, these O.R. quality instruments are very competitively priced to help bring further value to the Operating Room. Each instrument has been forged to exacting tolerances and specifications.

LISTER BANDAGE SCISSORS

95-226	Lister Bandage Scissors	4½"
95-231	Lister Bandage Scissors	5½"
95-241	Lister Bandage Scissors	7¼"



MULTI-CUT UTILITY SHEARS

95-105	Multi-Cut Utility Shears	7½" Serrated
--------	--------------------------	--------------



OPERATING SCISSORS

95-265	Operating Scissors 4½" Straight, Sharp-Blunt
95-272	Operating Scissors 5½" Straight, Sharp-Blunt
95-281	Operating Scissors 6½" Straight, Sharp-Blunt
95-275	Operating Scissors 5½" Straight, Sharp-Sharp
95-284	Operating Scissors 6½" Straight, Sharp-Sharp
95-292	Operating Scissors 5½" Curved, Sharp-Blunt
95-295	Operating Scissors 5½" Curved, Sharp-Sharp
95-299	Operating Scissors 5½" Curved, Blunt-Blunt

TC OPERATING SCISSORS

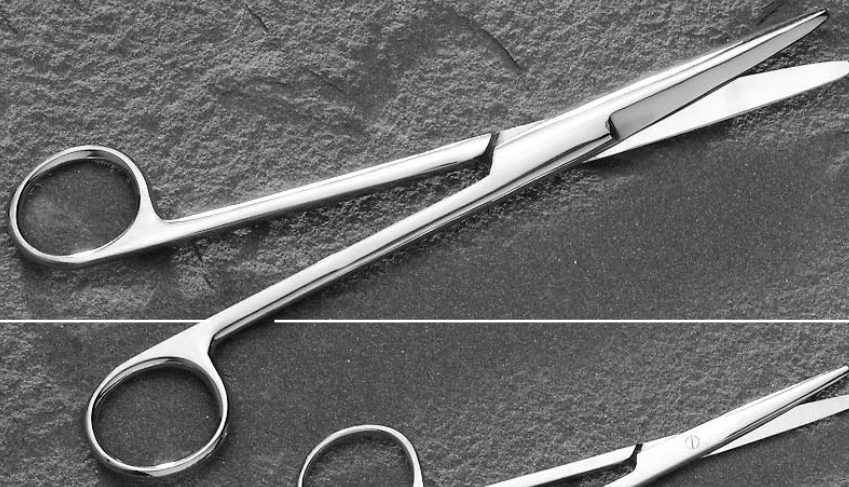
95-110	TC Operating Scissors 5½" Straight, Sharp-Blunt
95-111	TC Operating Scissors 5½" Curved, Sharp-Blunt



TC = Tungsten Carbide

Buy With Confidence...Unconditional Guarantee

General purpose operating scissors are precision sharp for precision cutting. All are available in our most popular sizes. Operating Room finish and balanced for handling comfort, all Surgi-OR instruments are autoclavable.

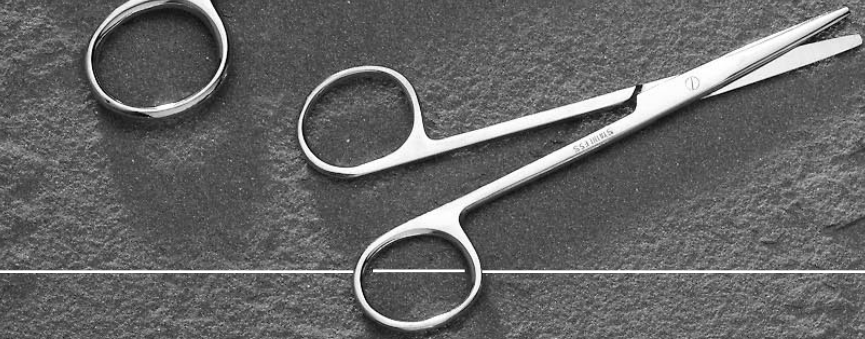


MAYO DISSECTING SCISSORS

95-308	Mayo Dissecting Scissors	5½" Straight
95-321	Mayo Dissecting Scissors	6¾" Straight
95-329	Mayo Dissecting Scissors	6¾" Straight, Serrated
95-330	Mayo Dissecting Scissors	5½" Curved
95-325	Mayo Dissecting Scissors	6¾" Curved
95-332	Mayo Dissecting Scissors	6¾" Curved, Serrated

TC MAYO DISSECTING SCISSORS

95-112	TC Mayo Dissecting Scissors	6¾" Straight
95-113	TC Mayo Dissecting Scissors	6¾" Curved

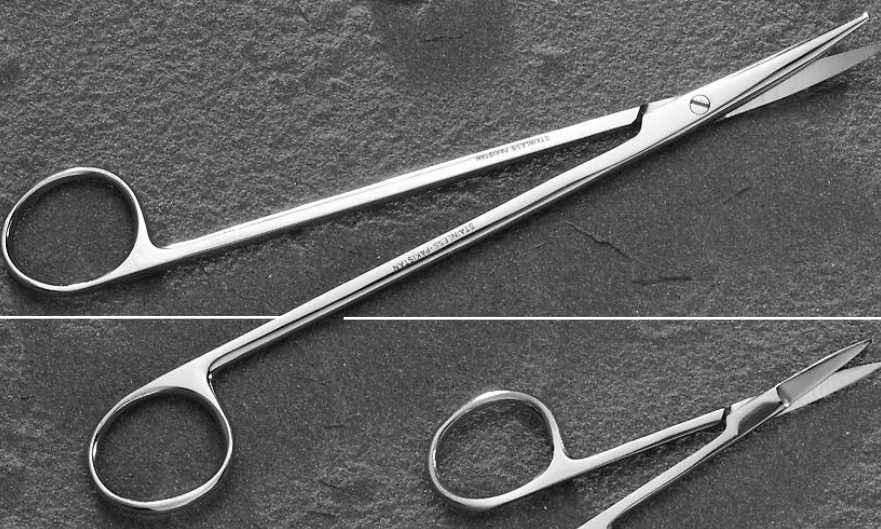


STRABISMUS SCISSORS

95-160	Stevens Dissecting Scissors	4½" Straight-Blunt
95-161	Stevens Dissecting Scissors	4½" Curved-Blunt
95-360	Strabismus Scissors	4½" Straight
95-361	Strabismus Scissors	4½" Curved

TC STRABISMUS SCISSORS

95-126	TC Strabismus Sciss. Str.	4½" Blunt/Blunt
95-127	TC Strabismus Sciss. Cvd.	4½" Blunt/Blunt



METZENBAUM SCISSORS

95-335	Metzenbaum-Lahey Scissors	5½" Straight
95-339	Metzenbaum Scissors	7" Straight
95-336	Metzenbaum-Lahey Scissors	5½" Curved
95-340	Metzenbaum Scissors	7" Curved

TC METZENBAUM SCISSORS

95-114	TC Metzenbaum Scissors	7" Str., Delicate
95-115	TC Metzenbaum Scissors	7" Str., Standard
95-116	TC Metzenbaum Scissors	7" Cvd., Delicate
95-117	TC Metzenbaum Scissors	7" Cvd., Standard
95-118	TC Metzenbaum Diss. Scissors	5¾" Str., Delicate
95-119	TC Metzenbaum Diss. Scissors	5¾" Str., Standard
95-120	TC Metzenbaum Diss. Scissors	5¾" Cvd., Delicate
95-122	TC Metzenbaum Diss. Scissors	5¾" Cvd., Standard

IRIS SCISSORS

95-103	Iris Scissors	3½" Straight
95-104	Iris Scissors	4½" Straight
95-107	Iris Scissors	3½" Curved
95-109	Iris Scissors	4½" Curved

TC IRIS SCISSORS

95-124	TC Iris Scissors, Straight	4½" Sh/Sh
95-125	TC Iris Scissors, Curved	4½" Sh/Sh

TC = Tungsten Carbide

Call Or Fax Your Distributor For Price Quote.

Sklar maintains an on-site repair facility for 24 hour service.

WIRE SCISSORS

95-364	Wire Cutting Scissors	4¾" Angular Serrated
--------	-----------------------	----------------------

TC WIRE SCISSORS

95-128	TC Wire Cutting Scissors	4¾" Angular Serrated
--------	--------------------------	----------------------


SPENCER STITCH SCISSORS

95-346	Spencer Stitch Scissors	3½"
95-352	Spencer Stitch Scissors	4½"


LITTAUER STITCH SCISSORS

95-358	Littauer Stitch Scissors	5½"
--------	--------------------------	-----

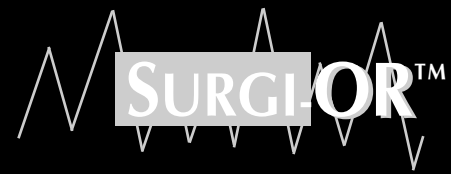

KNOWLES BANDAGE SCISSORS

95-254	Knowles Bandage Scissors	5½"
--------	--------------------------	-----

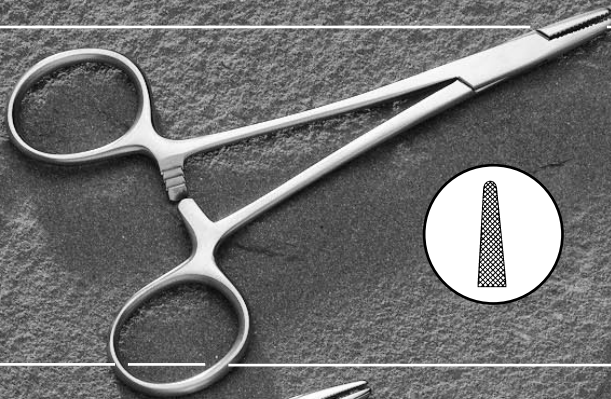


TC = Tungsten Carbide
 Buy With Confidence...Unconditional Guarantee

NEEDLE HOLDERS



Surgical grade stainless steel durability, expertly handcrafted to prevent rotating and slippage of needles.



BAUMGARTNER NEEDLE HOLDER

95-832	Baumgartner Needle Holder	5½"
--------	---------------------------	-----

TC BAUMGARTNER NEEDLE HOLDER

95-135	TC Baumgartner Needle Holder	5½" Serr.
--------	------------------------------	-----------

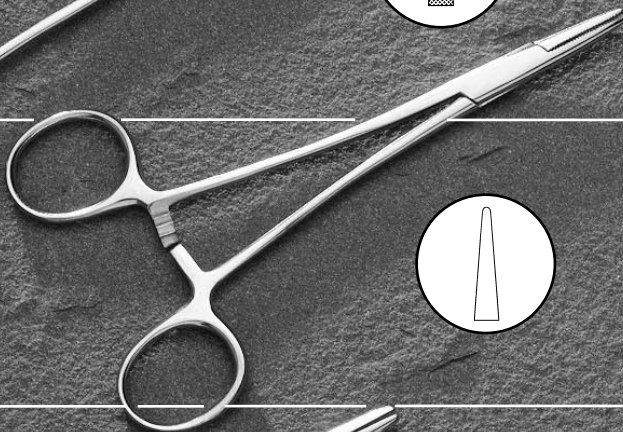


MAYO-HEGAR NEEDLE HOLDER

95-842	Mayo-Hegar Needle Holder	5½"
95-847	Mayo-Hegar Needle Holder	6"
95-853	Mayo-Hegar Needle Holder	7"
95-869	Mayo-Hegar Needle Holder	8"

TC MAYO-HEGAR NEEDLE HOLDER

95-140	TC Mayo-Hegar Needle Holder	5½" Serr.
95-141	TC Mayo-Hegar Needle Holder	6" Serr.
95-142	TC Mayo-Hegar Needle Holder	7" Serr.
95-143	TC Mayo-Hegar Needle Holder	8" Serr.

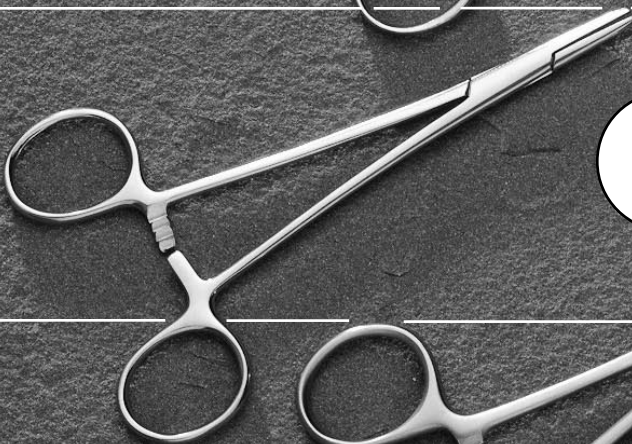


HALSEY NEEDLE HOLDER

95-810	Halsey Needle Holder	5½" Smooth
--------	----------------------	------------

TC HALSEY NEEDLE HOLDER

95-132	TC Halsey Needle Holder	5½" Smooth
95-133	TC Halsey Needle Holder	5½" Serrated

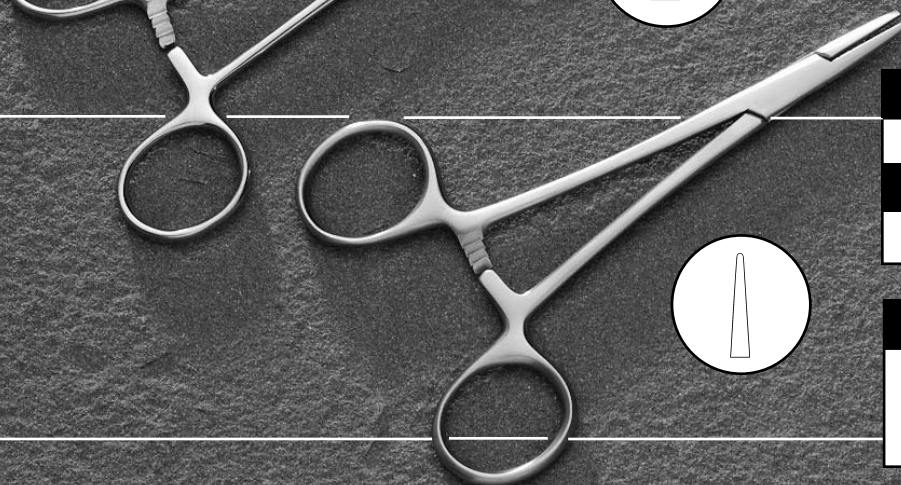


DERF NEEDLE HOLDER

95-826	Dorf Needle Holder	4½"
--------	--------------------	-----

TC DERF NEEDLE HOLDER

95-136	TC Dorf Needle Holder	4½" Serrated
--------	-----------------------	--------------



WEBSTER NEEDLE HOLDER

95-809	Webster Needle Holder	5½" Smooth
--------	-----------------------	------------

TC WEBSTER NEEDLE HOLDER

95-130	TC Webster Needle Holder	5½" Smooth
--------	--------------------------	------------

TC CRILE-WOOD NEEDLE HOLDER*

95-137	TC Crile-Wood Needle Holder	6" Serrated
95-138	TC Crile-Wood Needle Holder	7" Serrated
95-139	TC Crile-Wood Needle Holder	8" Serrated

*Not Pictured

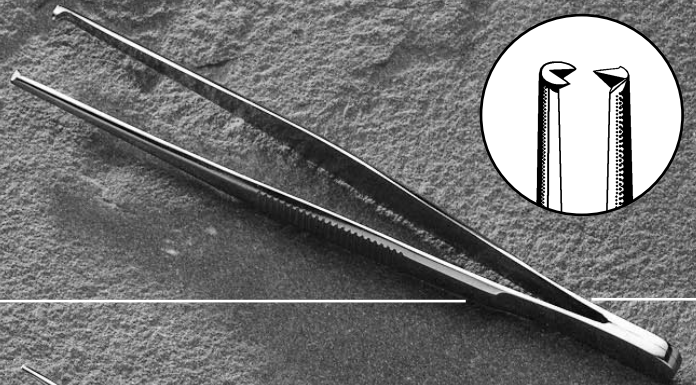
TC = Tungsten Carbide

Call Or Fax Your Distributor For Price Quote.

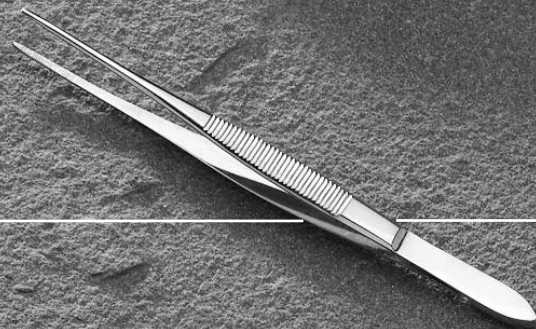
Consistent superior craftsmanship at value prices make Surgi-OR the cost effective choice for quality forceps.

TISSUE FORCEPS

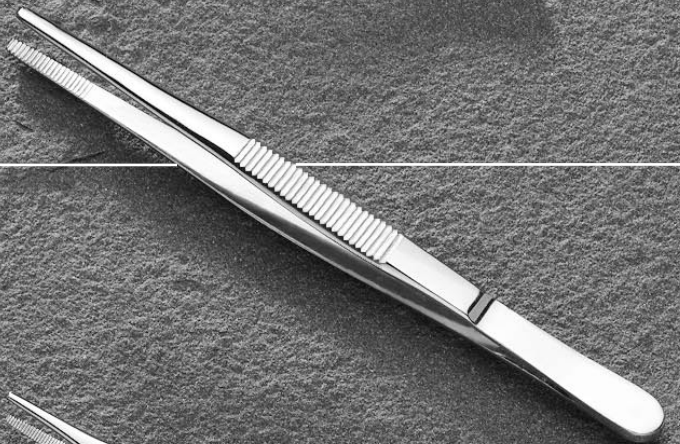
95-753	Tissue Forceps	4½" 1x2 Teeth
95-757	Tissue Forceps	5" 1x2 Teeth
95-762	Tissue Forceps	5½" 1x2 Teeth
95-766	Tissue Forceps	6" 1x2 Teeth


SPLINTER FORCEPS

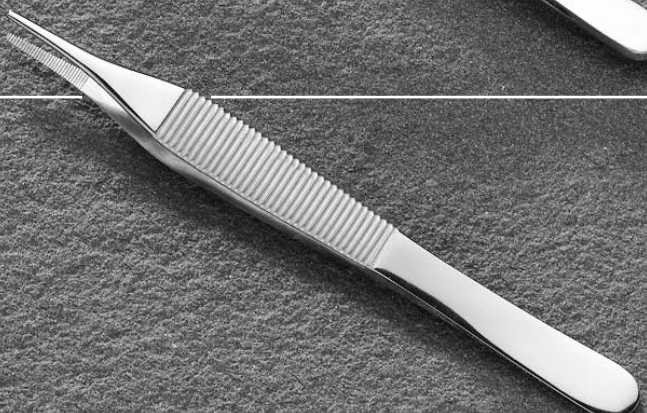
95-777	Plain Splinter Forceps	3½"
95-781	Plain Splinter Forceps	4½"


DRESSING FORCEPS

95-705	Thumb Forceps	4½" Serrated
95-710	Thumb Forceps	5" Serrated
95-727	Thumb Forceps	5½" Serrated
95-731	Thumb Forceps	6" Serrated
95-736	Thumb Forceps	8" Serrated


ADSON FORCEPS

95-771	Adson Dressing Forceps-Standard	4¾" Serrated
95-772	Adson Dressing Forceps-Delicate	4¾" Serrated
95-775	Adson Tissue Forceps-Standard	4¾" 1x2 Teeth
95-776	Adson Tissue Forceps-Delicate	4¾" 1x2 Teeth
95-778	Adson-Brown Tissue Forceps	4¾" Side-Grasping



Surgi-OR's comprehensive selection of patterns to suit your specific needs.



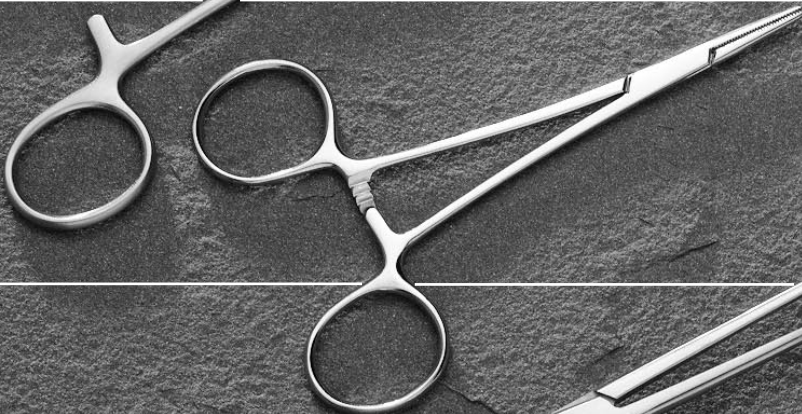
CRILE FORCEPS

95-447	Crile Forceps	5½" Straight
95-458	Crile Forceps	6¼" Straight
95-452	Crile Forceps	5½" Curved
95-463	Crile Forceps	6¼" Curved



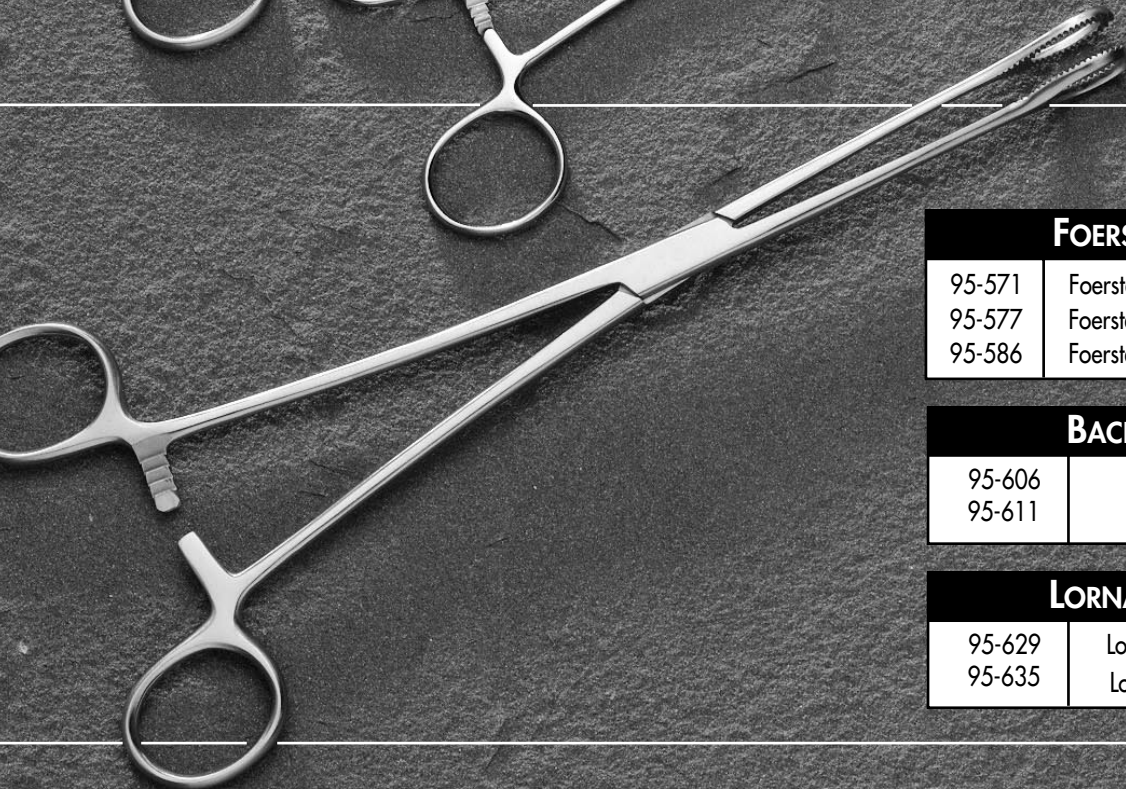
RANKIN-KELLY FORCEPS

95-465	Rankin-Kelly Forceps	6¾" Straight
95-469	Rankin-Kelly Forceps	6¾" Curved



MOSQUITO FORCEPS

95-426	Halsted Mosquito Forceps	5" Straight
95-431	Halsted Mosquito Forceps	5" Curved



FOERSTER SPONGE FORCEPS

95-571	Foerster Sponge Forceps	7" Straight Serrated
95-577	Foerster Sponge Forceps	9½" Straight Serrated
95-586	Foerster Sponge Forceps	9½" Curved Serrated

BACKHAUS TOWEL CLAMP

95-606	Backhaus Towel Clamp	3½"
95-611	Backhaus Towel Clamp	5¼"

LORNA EDNA TOWEL CLAMP

95-629	Lorna Edna Towel Clamp	3½"
95-635	Lorna Edna Towel Clamp	5¼"

Handcrafted in Pakistan by skilled instrument craftsmen from surgical grade stainless steel. Surgi-OR instruments are economy without compromise.

ROCHESTER-PEAN FORCEPS

95-470	Rochester-Pean Forceps	5½"	Straight
95-473	Rochester-Pean Forceps	6¼"	Straight
95-481	Rochester-Pean Forceps	7¼"	Straight
95-471	Rochester-Pean Forceps	5½"	Curved
95-477	Rochester-Pean Forceps	6¼"	Curved
95-485	Rochester-Pean Forceps	7¼"	Curved
95-492	Rochester-Pean Forceps	8"	Straight
95-483	Rochester-Pean Forceps	9"	Straight
95-494	Rochester-Pean Forceps	10¼"	Straight

KELLY FORCEPS

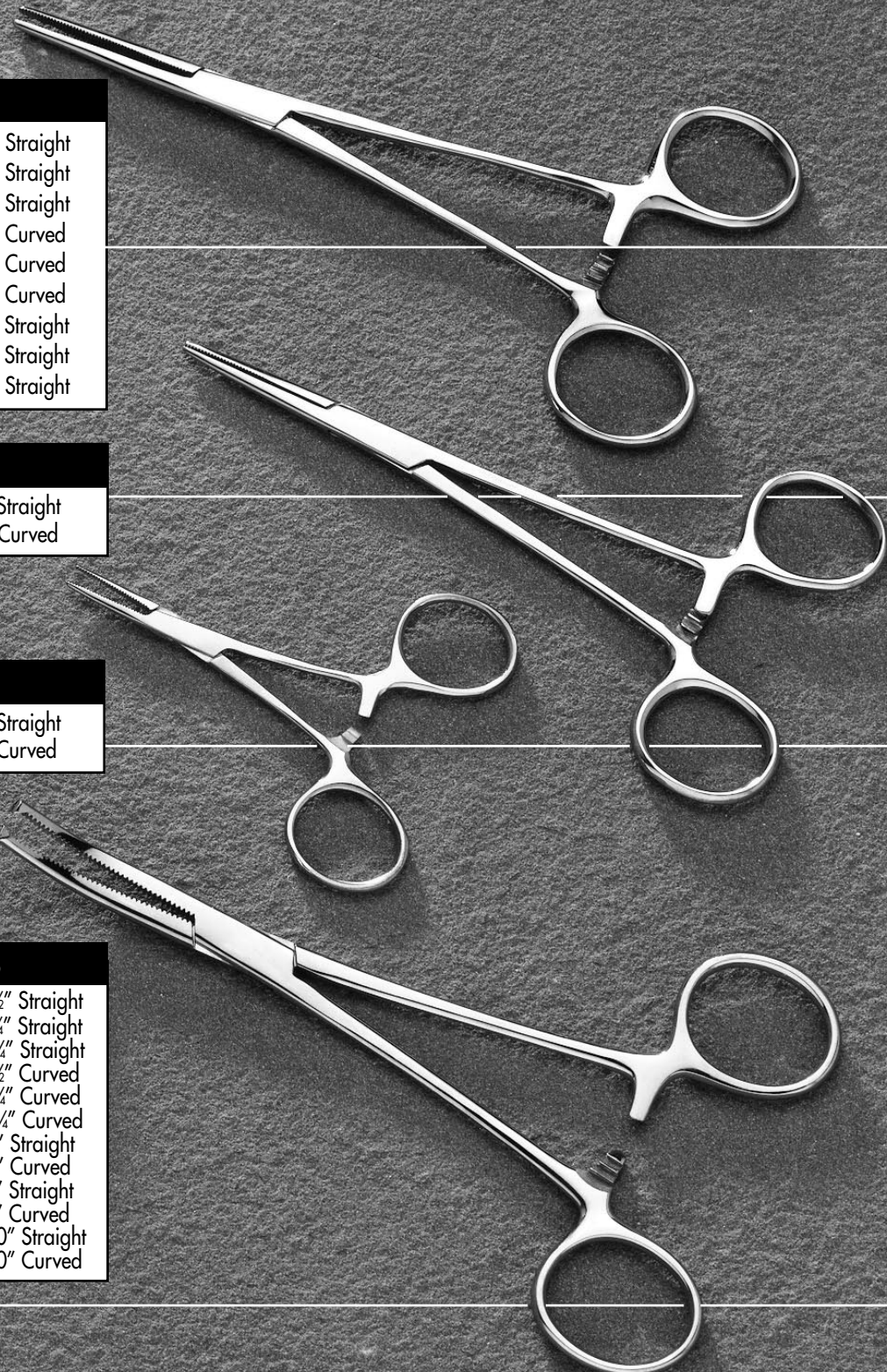
95-436	Kelly Forceps	5½"	Straight
95-442	Kelly Forceps	5½"	Curved

HARTMANN FORCEPS

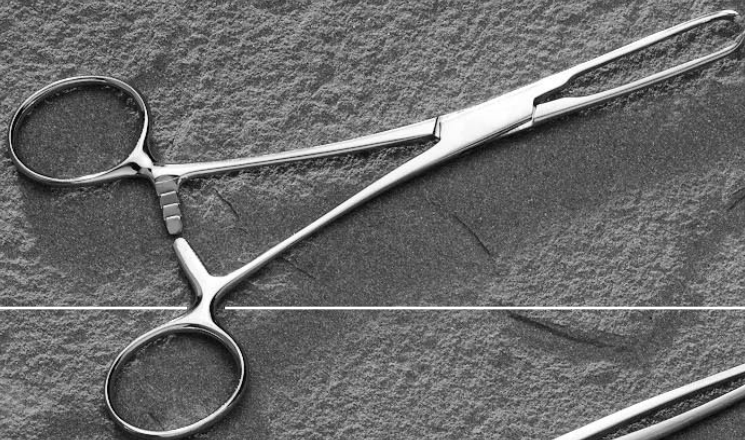
95-409	Hartmann Mosquito Forceps	3½"	Straight
95-421	Hartmann Mosquito Forceps	3½"	Curved

ROCHESTER-OCHSNER FORCEPS

95-500	Rochester-Ochsner (Kocher) Forceps	5½"	Straight
95-504	Rochester-Ochsner Forceps	6¼"	Straight
95-521	Rochester-Ochsner Forceps	7¼"	Straight
95-501	Rochester-Ochsner (Kocher) Forceps	5½"	Curved
95-512	Rochester-Ochsner Forceps	6¼"	Curved
95-525	Rochester-Ochsner Forceps	7¼"	Curved
95-513	Rochester-Ochsner Forceps	8"	Straight
95-514	Rochester-Ochsner Forceps	8"	Curved
95-515	Rochester-Ochsner Forceps	9"	Straight
95-516	Rochester-Ochsner Forceps	9"	Curved
95-517	Rochester-Ochsner Forceps	10"	Straight
95-518	Rochester-Ochsner Forceps	10"	Curved

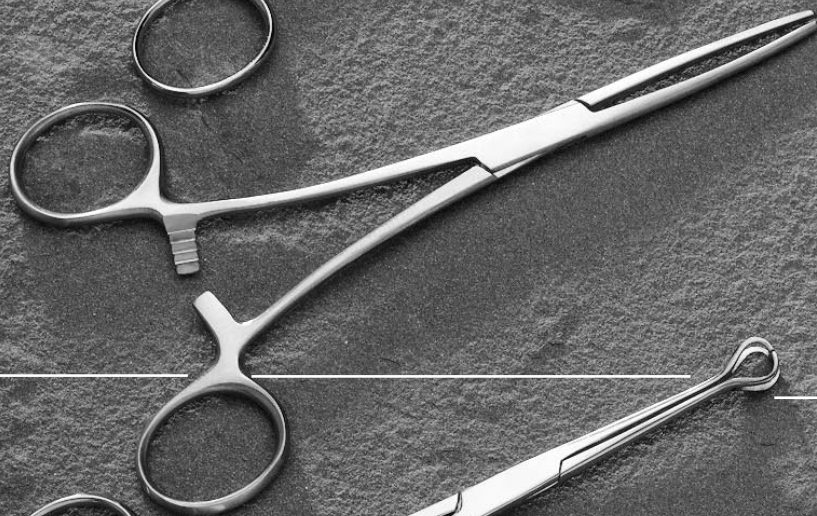


Surgi-OR forceps are built to last, precision engineering and stringent quality control guidelines insure you superior performance. All instruments are inspected using our 29 pt. quality control guidelines.



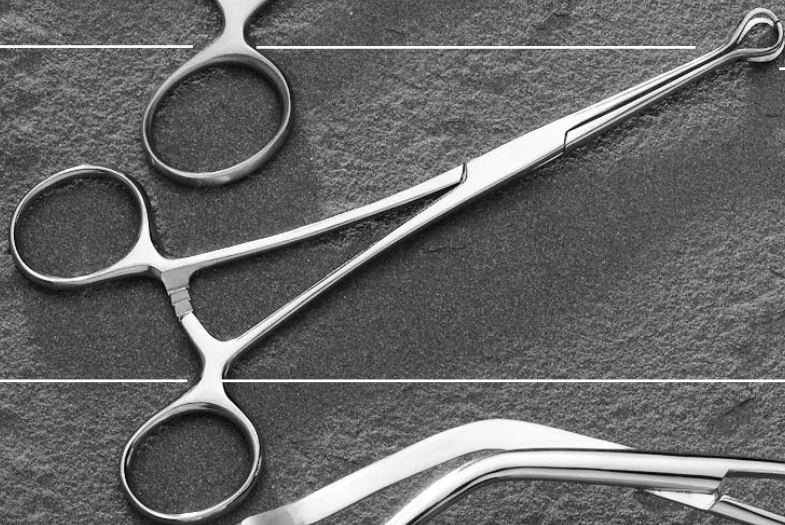
ALLIS TISSUE FORCEPS

95-934	Allis Tissue Forceps	6" 5x6 Teeth
95-938	Allis Tissue Forceps	7½" 5x6 Teeth



PRESBYTERIAN TUBE OCCLUDING CLAMP

95-592	Presbyterian Tube Occluding Clamp	7" Straight Smooth Jaws
--------	-----------------------------------	-------------------------



BABCOCK FORCEPS

95-952	Babcock Forceps	6¼"
--------	-----------------	-----



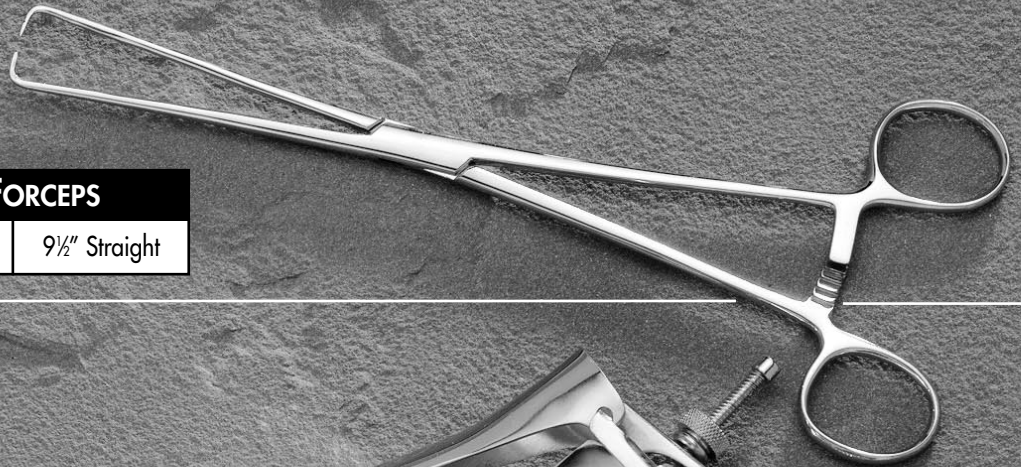
MAGILL CATHETER FORCEPS

95-289	Magill Catheter Forceps	Adult
95-285	Magill Catheter Forceps	Child

The cost effective solution with a wide selection of quality instruments in the most popular patterns.

SCHROEDER TENACULUM FORCEPS

95-386	Schroeder Tenaculum Forceps	9½" Straight
--------	-----------------------------	--------------



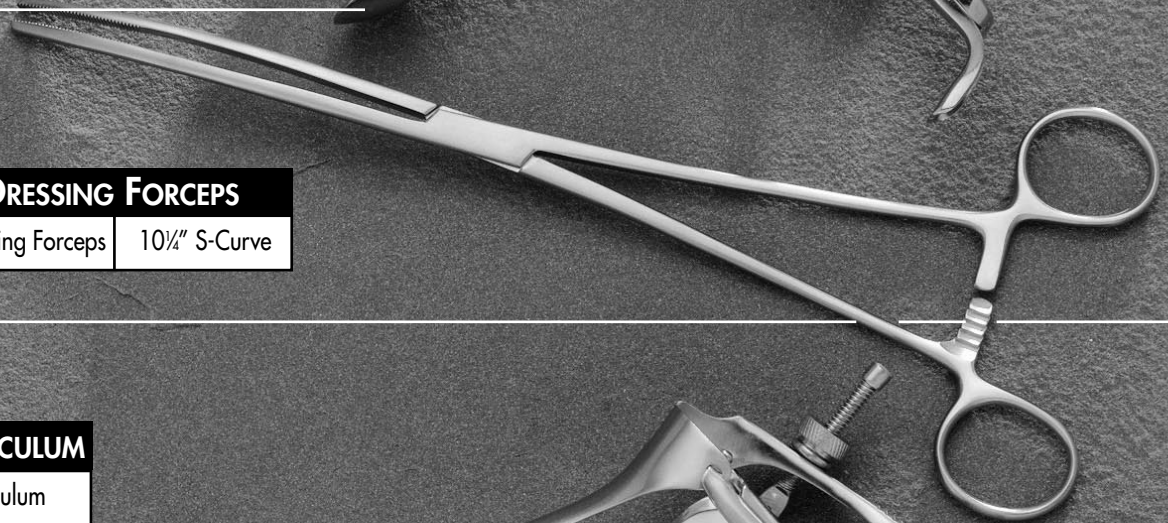
GRAVES VAGINAL SPECULUM

95-304	Graves Vaginal Speculum <i>⅝" x 2¼" Extra Small Blades</i>
95-303	Graves Vaginal Speculum <i>¾" x 3" Small Blades</i>
95-312	Graves Vaginal Speculum <i>1¼" x 4" Medium Blades</i>
95-324	Graves Vaginal Speculum <i>1⅜" x 4½" Large Blades</i>
95-322	Graves Vaginal Speculum <i>1½" x 4¾" Extra Large Blades</i>



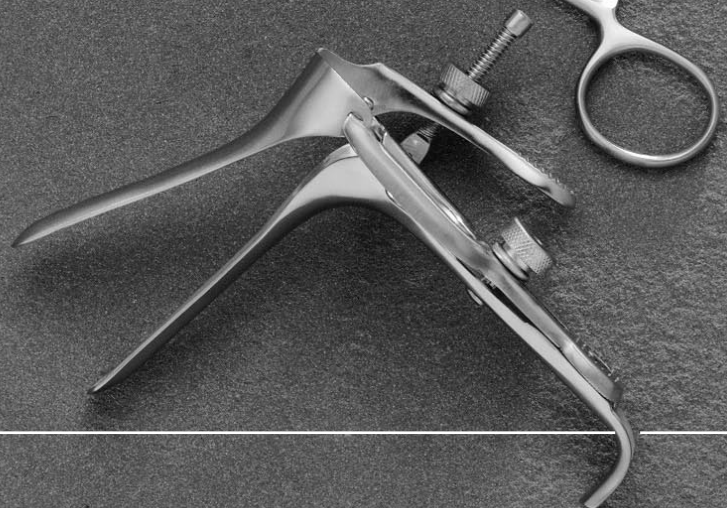
BOZEMAN UTERINE DRESSING FORCEPS

95-374	Bozeman Uterine Dressing Forceps	10¼" S-Curve
--------	----------------------------------	--------------



PEDERSON VAGINAL SPECULUM

95-347	Pederson Vaginal Speculum <i>½" x 3" Small Blades</i>
95-348	Pederson Vaginal Speculum <i>⅞" x 4" Medium Blades</i>
95-362	Pederson Vaginal Speculum <i>1" x 4¾" Large Blades</i>



MERIT™

**A Cost-Effective Line of Quality Instruments
from Pakistan, Designed for Routine Surgical Use.**

• Forged from Surgical Grade Stainless Steel

**• Manufactured in FDA registered facilities
by skilled Instrument Craftsman**

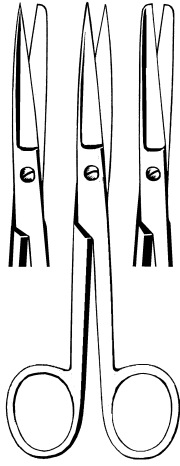
• 10 Year Guarantee

• Complete MERIT Catalog Available

CALL CUSTOMER SERVICE FOR A COMPLETE CATALOG OF MERIT™ INSTRUMENTS

OPERATING SCISSORS

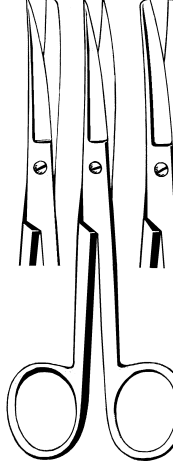
Straight
S/B
97-263 4½"
97-272 5½"
97-281 6½"
S/S
97-266 4½"
97-275 5½"
97-284 6½"
B/B
97-269 4½"
97-278 5½"
97-288 6½"



MERIT™

OPERATING SCISSORS


Curved
S/B
97-292 5½"
S/S
97-295 5½"
B/B
97-299 5½"



MERIT™

METZENBAUM SCISSORS

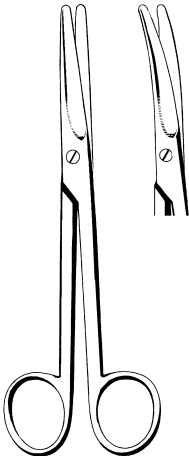
Straight
97-335 5½"
97-339 7"
Curved
97-336 5½"
97-340 7"



MERIT™

MAYO DISSECTING SCISSORS

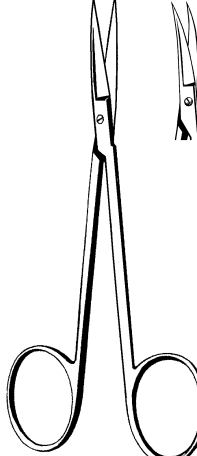
Straight
97-308 5½"
97-321 6½"
Curved
97-312 5½"
97-325 6½"



MERIT™

IRIS SCISSORS

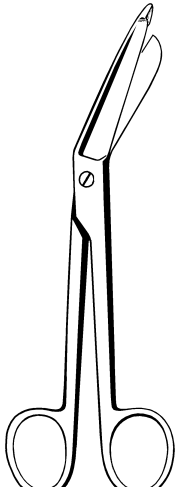
Straight
98-103 3½"
98-104 4½"
Curved
98-107 3½"
98-109 4½"



MERIT™

LISTER BANDAGE SCISSORS

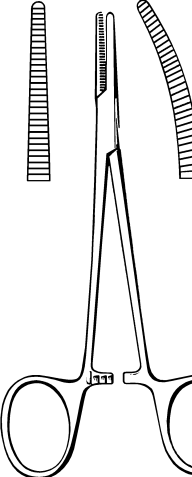
97-222 3½"
97-226 4½"
97-231 5½"
97-237 5½" With Clip
97-241 7¼"



MERIT™

HALSTED MOSQUITO FORCEPS

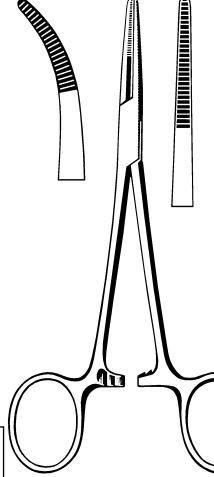
97-426 5" Str.
97-431 5" Cvd.



MERIT™

KELLY FORCEPS

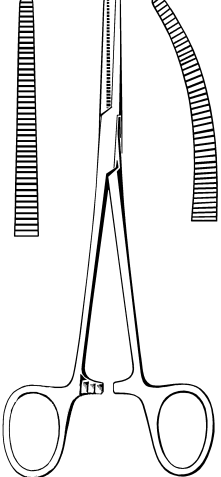
97-436 5½" Str.
97-442 5½" Cvd.



MERIT™

CRILE FORCEPS

Straight
97-447 5½"
97-458 6½"
Curved
97-452 5½"
97-463 6½"



MERIT™

BACKHAUS TOWEL CLAMP

97-606	3½"		
97-611	5½"		
97-623	5½"	Roeder	With Ball Stops

Roeder

FOERSTER SPONGE FORCEPS

97-571	7"	Str.	Serr.
97-577	9½"	Str.	Serr.
97-586	9½"	Cvd.	Serr.

PRESBYTERIAN TUBE OCCL. CLAMP

Straight	Smooth Jaws		
97-592	6½"		

DRESSING/TISSUE FORCEPS

Dressing-Serrated			
97-705	4½"		
97-710	5"		
97-727	5½"		
97-731	6"		
97-736	8"		
97-742	10"		
97-748	12"		
Tissue-1x2, 2x3 Teeth			
97-753	4½"	1x2	
97-757	5"	1x2	
97-762	5½"	1x2	
97-769	5½"	2x3	

ADSON DRESSING/TISSUE FORCEPS

Dressing-Serrated			
97-771	4¾"		
97-772	4¾"	Delicate	
Tissue-1x2			
97-775	4¾"		
97-776	4¾"	Delicate	

ADSON-BROWN TISSUE FORCEPS

97-603	4¾"		
--------	-----	--	--

IRIS DRESSING/TISSUE FORCEPS

Dressing-Serrated			
98-123	4"	Straight	
98-129	4"	Half Curved	
98-135	4"	Full Curved	
Tissue-1x2			
98-142	4"	Straight	
98-146	4"	Half Curved	
98-151	4"	Full Curved	

PLAIN SPLINTER FORCEPS

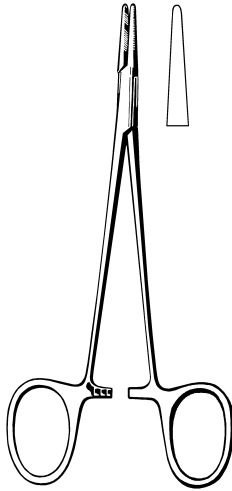
97-777	3½"		
97-781	4½"		

ALLIS TISSUE FORCEPS

97-930	6"	4x5	
97-934	6"	5x6	
97-938	7½"	5x6	

HALSEY NEEDLE HOLDER

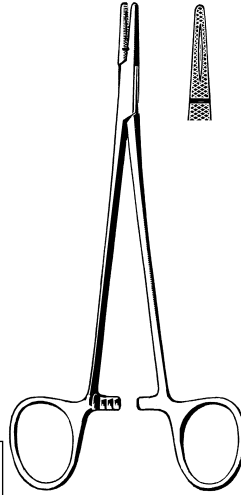
97-810 5"
Smooth



MERIT™

CRILE-WOOD NEEDLE HOLDER

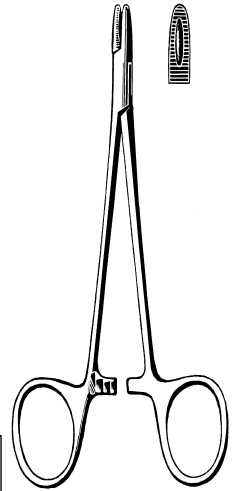
97-838 6"



MERIT™

DERF NEEDLE HOLDER

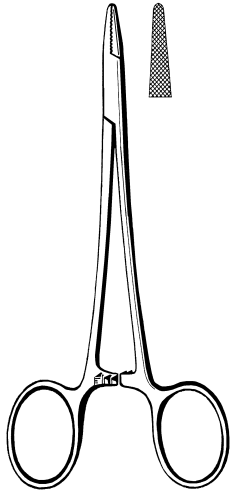
97-826 4 1/2"



MERIT™

BAUMGARTNER NEEDLE HOLDER

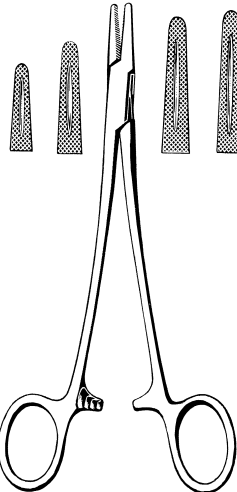
97-832 5 1/2"



MERIT™

MAYO-HEGAR NEEDLE HOLDER

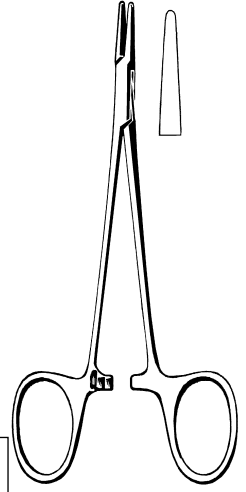
97-842 5 1/4"
97-847 6"
97-853 7"
97-869 8"



MERIT™

WEBSTER NEEDLE HOLDER

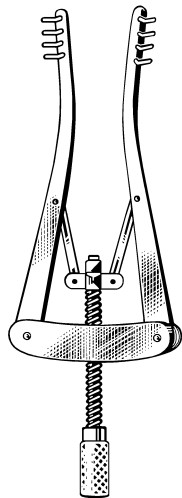
97-809 5"
Smooth



MERIT™

ALM RETRACTOR

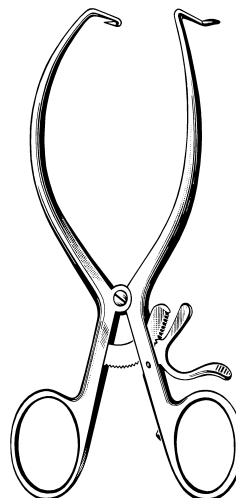
97-384 2 1/4"



MERIT™

GELPI RETRACTOR

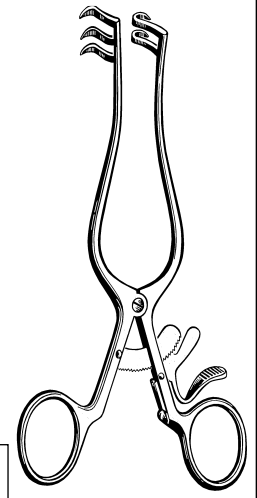
97-388 6 1/4"



MERIT™

WEITLANER RETRACTOR

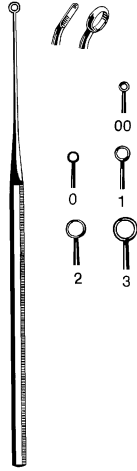
97-370 4" Sharp
2x3 Teeth
97-371 4" Blunt
2x3 Teeth



MERIT™

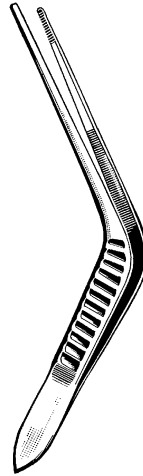
BUCK EAR CURETTE

- Angled Blunt**
 98-162 Sz 00
 98-164 Sz 0
 98-165 Sz 1
 98-166 Sz 2
 98-167 Sz 3
- Straight Blunt**
 98-170 Sz 00
 98-171 Sz 0
 98-172 Sz 1
 98-173 Sz 2
 98-174 Sz 3



WILDE EAR FORCEPS

- 98-180 5" Serrated



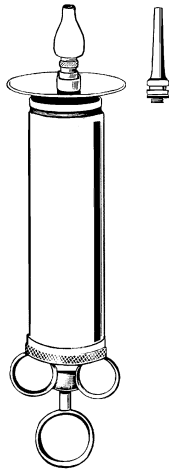
LUCAE EAR FORCEPS

- 98-182 5½" Serrated Bayonet Delicate



METAL EAR SYRINGE

- With Tips and Shield Chrome**
 98-243 2 oz.
 98-247 3 oz.
 98-251 4 oz.



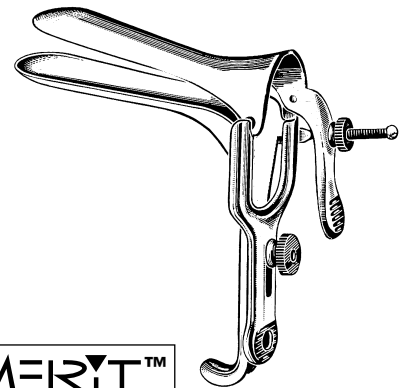
VIENNA NASAL SPECULUM

- 98-258 Adult
 98-267 Child
 98-268 Infant



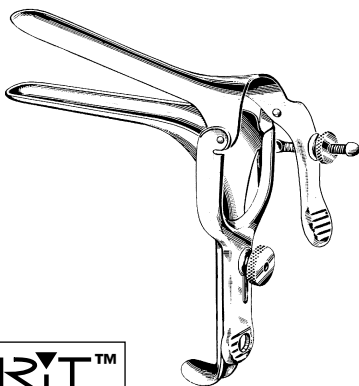
GRAVES SPECULUM

- 98-303 ¾" x 3" Small
 98-312 1¼" x 4" Medium
 98-324 1⅜" x 4½" Large



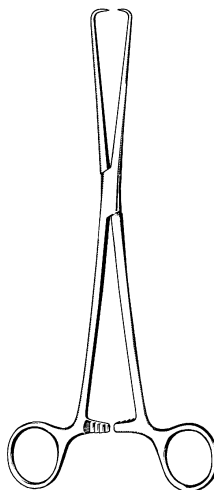
PEDERSON SPECULUM

- 98-336 ½" x 3" Small
 98-348 ⅞" x 4" Medium
 98-362 1" x 4¼" Large



SCHROEDER TENACULUM FORCEPS

- Straight
 98-386 9½"



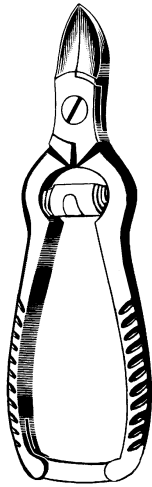
SIMPSON UTERINE SOUND

- 98-382 12½"
 With cm measurements



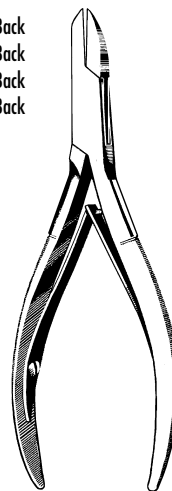
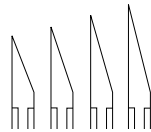
NAIL NIPPER

- 98-485 4½" Concave Jaw
Barrel Spring
- 98-472 5½" Concave Jaw
Barrel Spring



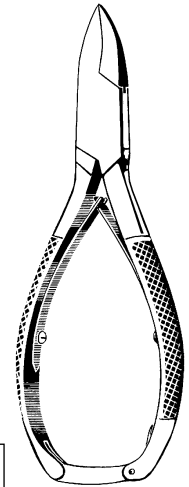
LITTAUER CUTTING FORCEPS

- 98-475 4" Straight Back
- 98-476 4½" Straight Back
- 98-477 5" Straight Back
- 98-478 6" Straight Back



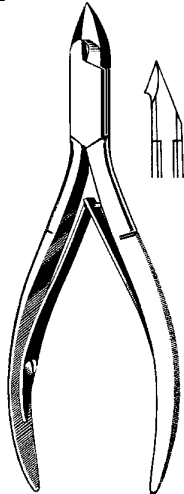
NAIL NIPPER

- 98-483 5½" Curved
W/Lock



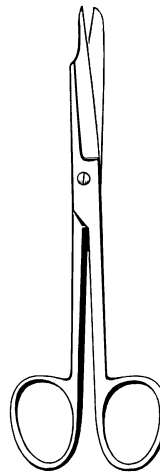
TISSUE NIPPER

- Convex Blade
- 98-489 4½"



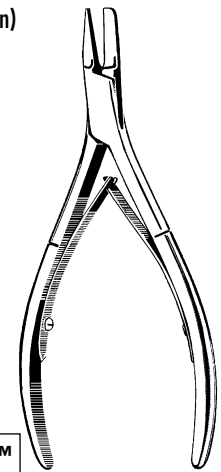
NAIL SPLITTING SCISSORS

- One Pointed Blade
- 98-490 6" Serrated



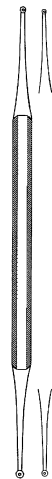
NAIL SPLITTING FORCEPS

- English (Anvil Pattern)
- 98-492 5"



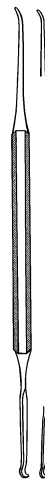
CURETTE EXCAVATOR

- Single Ended with Hole
- 98-503 5" 1.0mm
- Double Ended with Hole
- 98-505 5½" 1.0mm/2.0mm



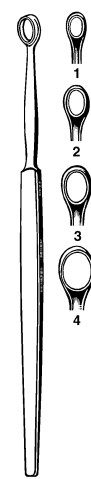
PROBE AND EXCAVATOR

- 98-508 6" Double End



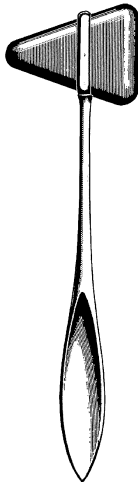
FOX DERMAL CURETTE

- 98-413 #1
- 98-414 #2
- 98-415 #3
- 98-416 #4



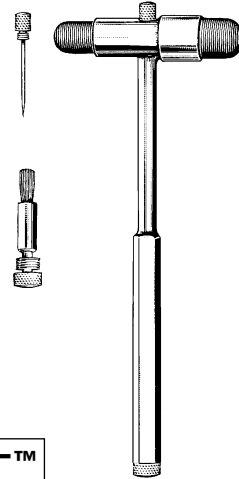
TAYLOR PERCUSSION HAMMER

97-010 Adult



BUCK NEURO HAMMER

97-021
7" Chrome



WARTENBERG PINWHEEL

97-029 Chrome



SCALPEL HANDLE #3

97-033 For Blades
10, 11, 12, 15



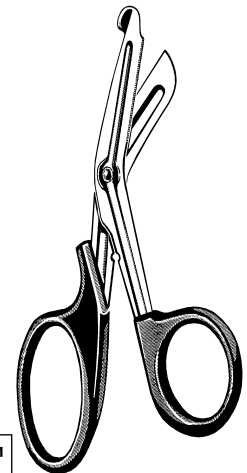
SCALPEL HANDLE #4

97-038 For Blades
20, 21, 22, 23
24, 25



MULTI-CUT UTILITY SCISSORS

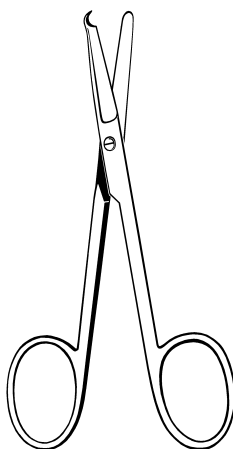
97-105 7 1/2"
Serrated



SPENCER STITCH SCISSORS

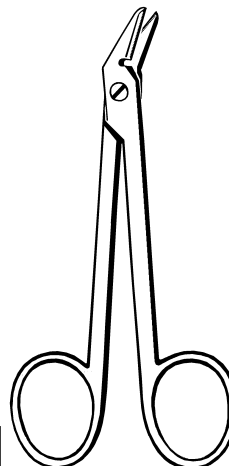
97-346 3 1/2"
97-352 4 3/4"

Littauer Stitch
Scissors
97-358 5 1/2"



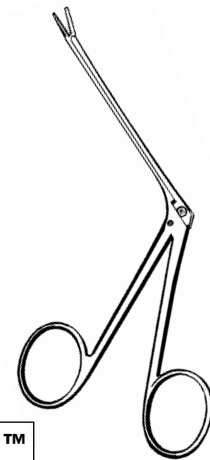
WIRE CUTTING SCISSORS

97-364 4 3/4" Angular
Serrated



HARTMANN ALLIGATOR FORCEPS

Serrated Jaws
98-209 3 1/2"
98-224 5 1/2"
98-232 6 1/2"



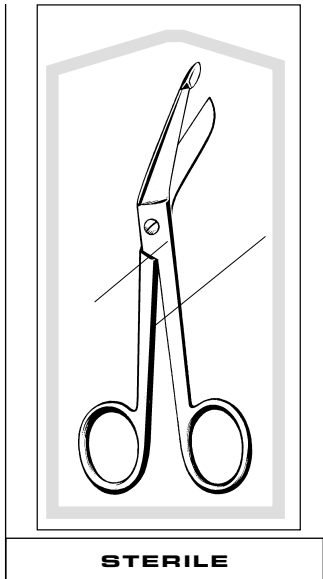
Econo™ Sterile



These instruments provide the value of economical Pakistan instruments as well as the convenience of ready-to-use sterile instruments.

**Box of 25 Box of 50 Box of 100
Sterile Instruments**

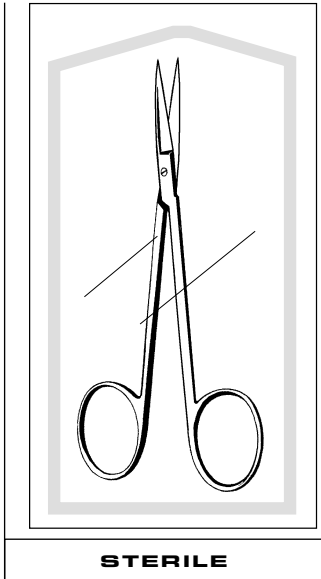
Visit Our Website: www.sklarcorp.com



STERILE

LISTER BANDAGE SCISSORS, STERILE

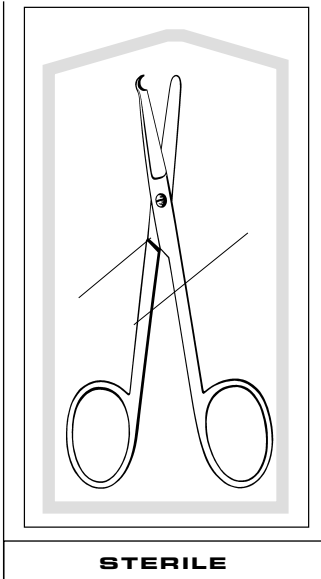
Box/50
96-2502 5½"
Box/25
96-2503 5½"
Box/100
96-2654 5½"



STERILE

IRIS SCISSORS, STERILE

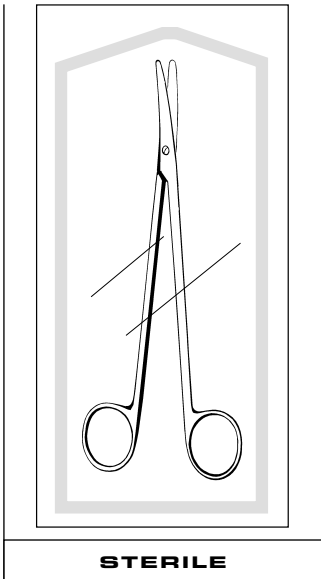
Box/50
96-2504 4½" Str.
96-2506 4½" Cvd.
Box/25
96-2505 4½" Str.
96-2507 4½" Cvd.
Box/100
96-2650 4½" Str.
96-2651 4½" Cvd.



STERILE

LITTAUER STITCH SCISSORS, STERILE

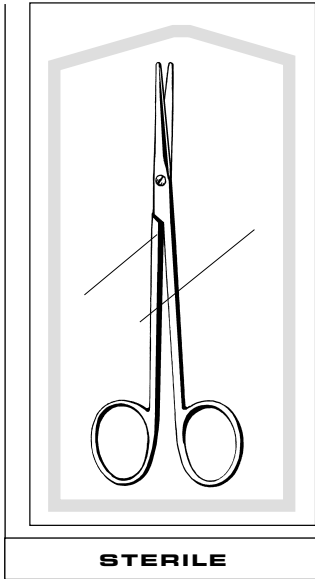
Box/50
96-2510 3½"
96-2512 5½"
Box/25
96-2511 3½"
96-2513 5½"
Box/100
96-2663 3½"
96-2662 5½"



STERILE

METZENBAUM DISSECTING SCISSORS, STERILE

Box/50
96-2680 7" Cvd.
Box/25
96-2682 7" Cvd.

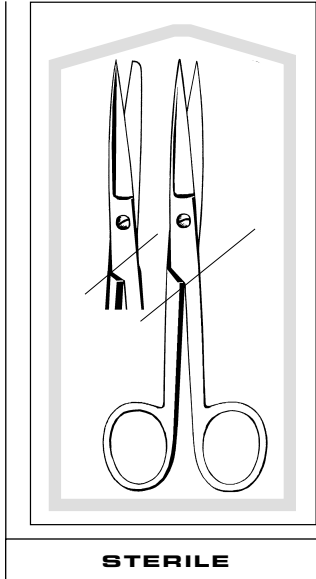


STERILE

METZENBAUM SCISSORS, STERILE

Box/50
96-2516 5 3/4" Str.

Box/25
96-2517 5 3/4" Str.

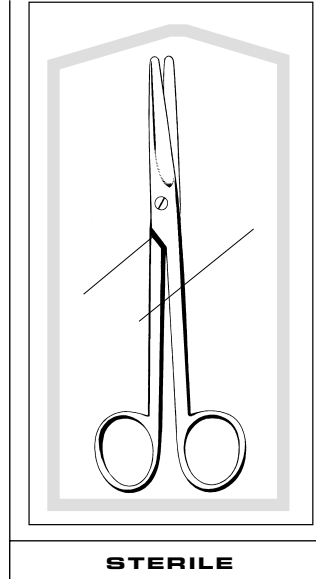


STERILE

OPERATING SCISSORS, STERILE

Box/50
96-2520 5 1/2" Str. S/B
96-2522 5 1/2" Str. S/S

Box/25
96-2521 5 1/2" Str. S/B
96-2523 5 1/2" Str. S/S
Box/100
96-2649 5 1/2" Str. S/B

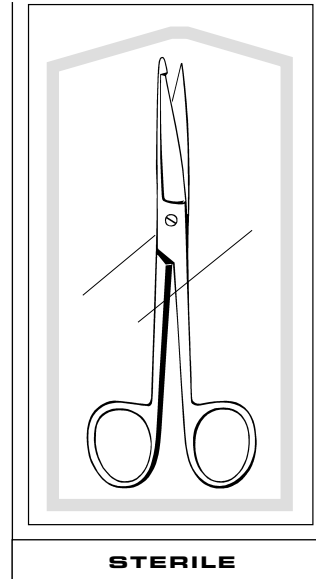


STERILE

MAYO SCISSORS, STERILE

Box/50
96-2530 5 1/2" Str.

Box/25
96-2531 5 1/2" Str.

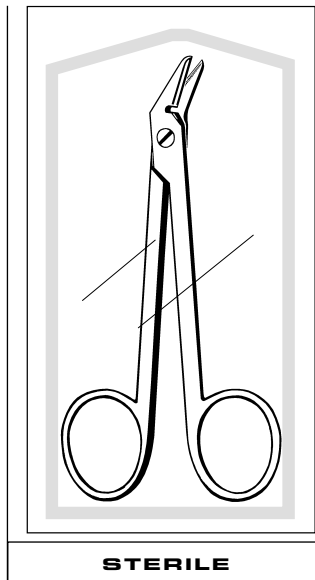


STERILE

KNOWLES BANDAGE SCISSORS, STERILE

Box/50
96-2402 5 1/2"

Box/25
96-2404 5 1/2"

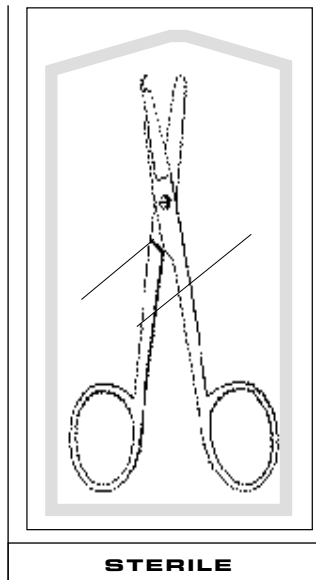


STERILE

WIRE CUTTING SCISSORS, STERILE

Box/50
96-2518 4 3/4"

Box/25
96-2519 4 3/4"

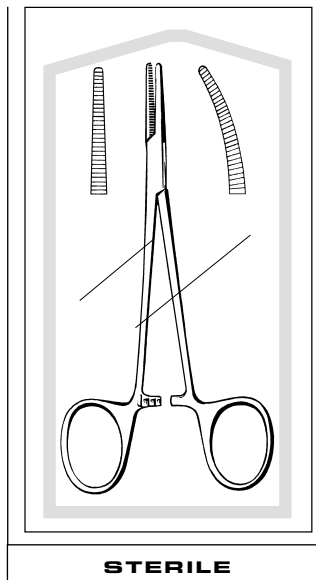


STERILE

SPENCER STITCH SCISSORS, STERILE

Box/50
96-2596 4 1/2"

Box/25
96-2598 4 1/2"



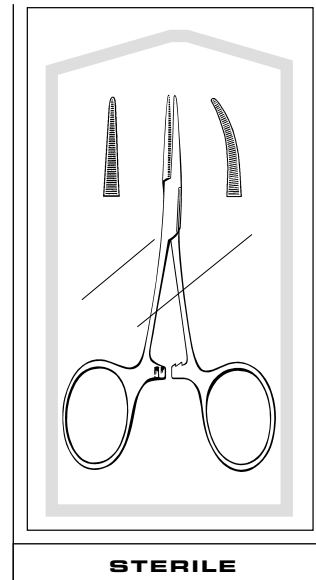
STERILE

HALSTEAD MOSQUITO FORCEPS, STERILE

Box/50
96-2536 5" Str.
96-2538 5" Cvd.

Box/25
96-2537 5" Str.
96-2539 5" Cvd.

Box/100
96-2657 5" Str.
96-2658 5" Cvd.

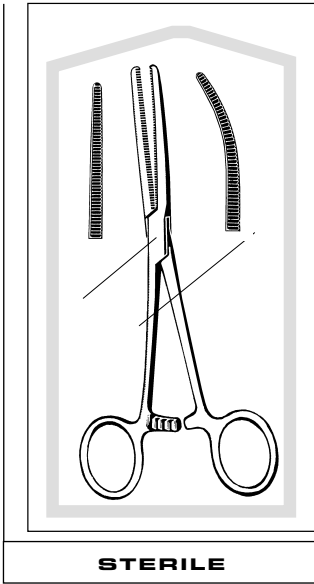


STERILE

HARTMANN MOSQUITO HEMOSTATS, STERILE

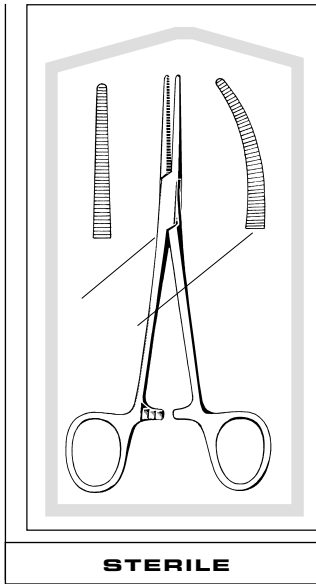
Box/50
96-2554 3 1/2" Str.
96-2555 3 1/2" Cvd.

Box/25
96-2556 3 1/2" Str.
96-2557 3 1/2" Cvd.



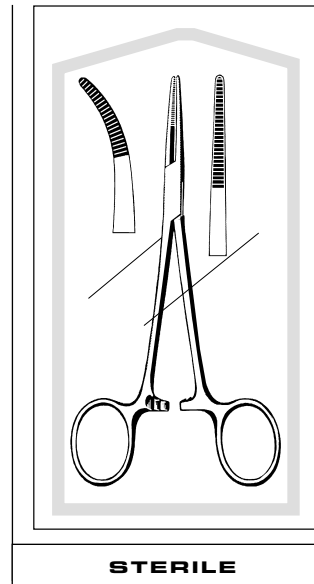
ROCHESTER-PEAN FORCEPS, STERILE

Box/50
 96-2544 6 1/4" Str.
 96-2546 6 1/4" Cvd.
 Box/25
 96-2545 6 1/4" Str.
 96-2547 6 1/4" Cvd.



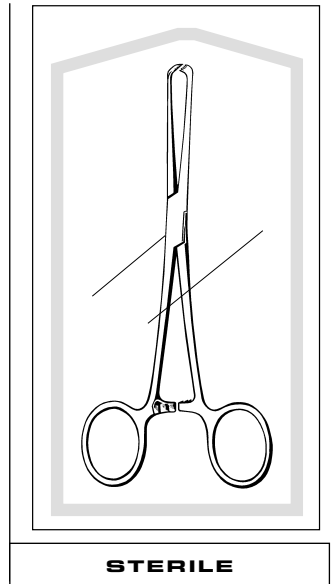
CRILE FORCEPS, STERILE

Box/50
 96-2550 5 1/2" Str.
 96-2552 5 1/2" Cvd.
 Box/25
 96-2551 5 1/2" Str.
 96-2553 5 1/2" Cvd.



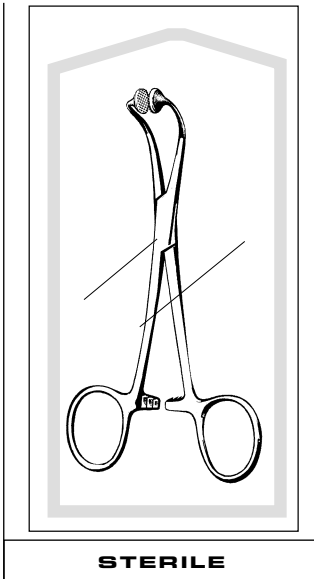
KELLY FORCEPS, STERILE

Box/50
 96-2560 5 1/2" Str.
 96-2562 5 1/2" Cvd.
 Box/25
 96-2561 5 1/2" Str.
 96-2563 5 1/2" Cvd.
 Box/100
 96-2652 5 1/2" Str.
 96-2653 5 1/2" Cvd.



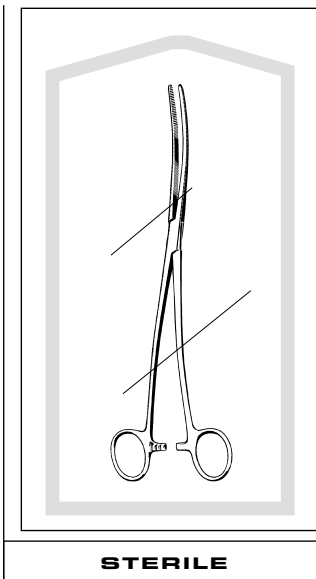
ALLIS TISSUE FORCEPS, STERILE

Box/50
 96-2576 6" Str.
 Box/25
 96-2575 6" Str.



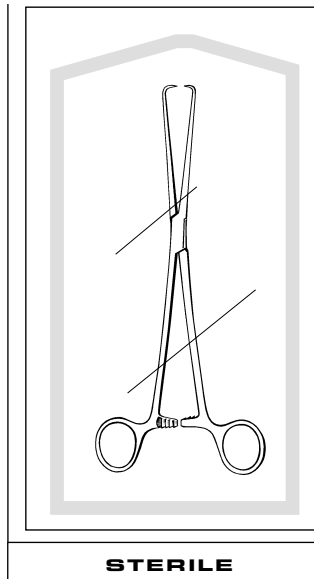
HOFF TOWEL FORCEPS, STERILE

Box/50
 96-2564 5 1/2"
 Box/25
 96-2565 5 1/2"



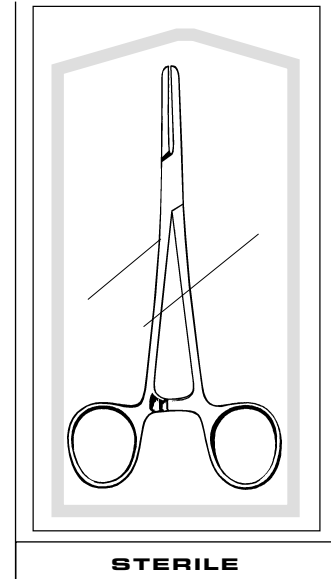
BOZEMAN FORCEPS, STERILE

Box/50
 96-2620 10 1/4" S-Curve
 Box/25
 96-2622 10 1/4" S-Curve



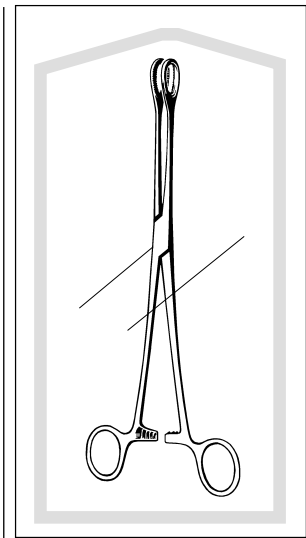
SCHROEDER TENACULUM FORCEPS, STERILE

Box/50
 96-2626 9 1/2"
 Box/25
 96-2624 9 1/2"



TUBE OCCLUDING FORCEPS, STERILE

Box/50
 96-2406 7" Smooth
 Box/25
 96-2408 7" Smooth

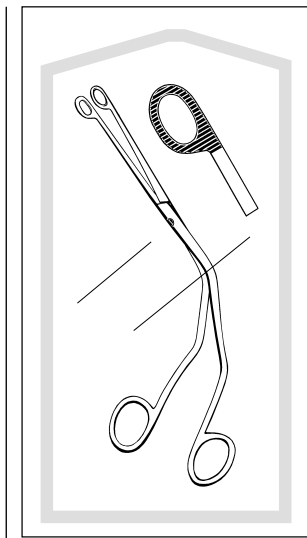


STERILE

**SPONGE FORCEPS,
STERILE**

Box/50
96-2532 9½" Serrated

Box/25
96-2533 9½" Serrated

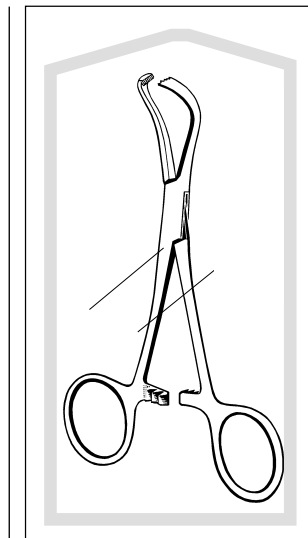


STERILE

**MAGILL CATHETER
FORCEPS, STERILE**

Box/50
96-2684 Adult

Box/25
96-2685 Adult

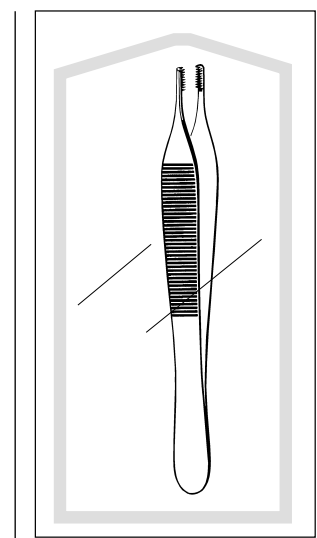


STERILE

**LORNA (EDNA) TOWEL
CLAMP, STERILE**

Box/50
96-2528 3½"

Box/25
96-2529 3½"

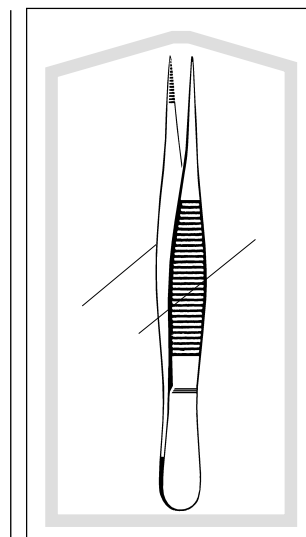


STERILE

**ADSON-BROWN FORCEPS,
STERILE**

Box/50
96-2558 4¼" Side Grasping

Box/25
96-2559 4¼" Side Grasping

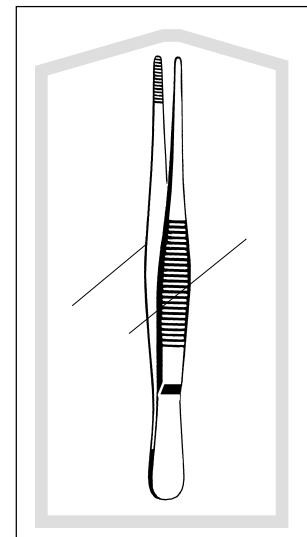


STERILE

**FINE POINT SPLINTER
FORCEPS, STERILE**

Box/50
96-2410 4½"

Box/25
96-2412 4½"



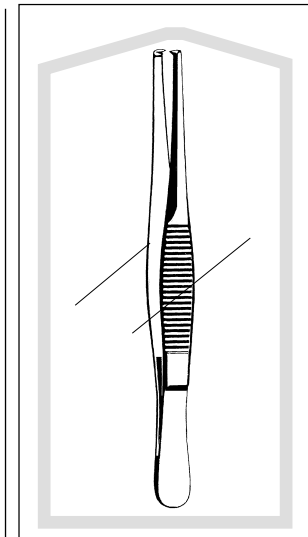
STERILE

**DRESSING FORCEPS,
STERILE**

Box/50
96-2568 5"

Box/25
96-2569 5"

Box/100
96-2660 5"



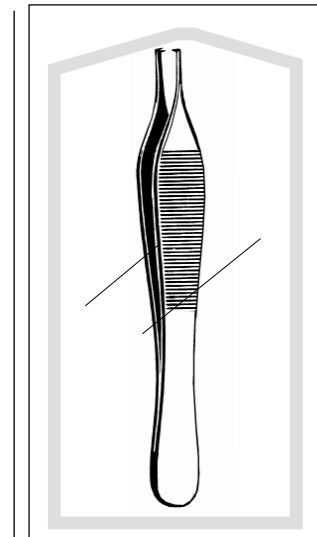
STERILE

TISSUE FORCEPS, STERILE

Box/50
96-2578 5" 1x2

Box/25
96-2579 5" 1x2

Box/100
96-2661 5" 1x2



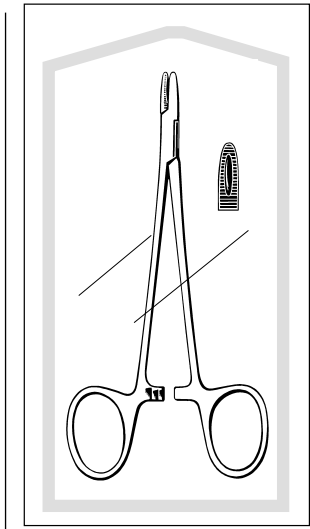
STERILE

ADSON FORCEPS, STERILE

Box/50
96-2570 4¼" Serr.
96-2572 4¼" 1x2

Box/25
96-2571 4¼" Serr.
96-2573 4¼" 1x2

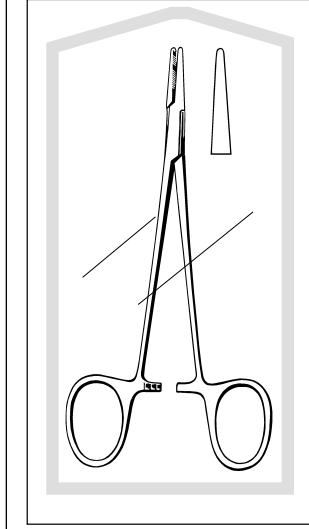
Box/100
96-2655 4¼" Serr.
96-2656 4¼" 1x2



STERILE

DERF NEEDLE HOLDER, STERILE

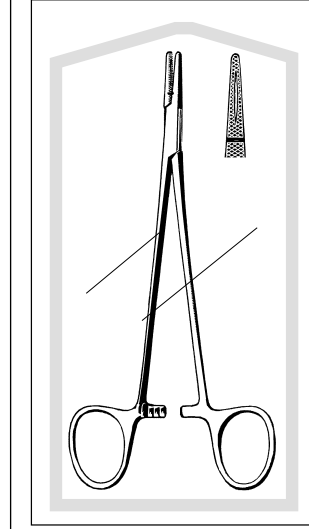
Box/50
96-2582 4 3/4" Serrated
Box/25
96-2583 4 3/4" Serrated



STERILE

HALSEY NEEDLE HOLDER, STERILE

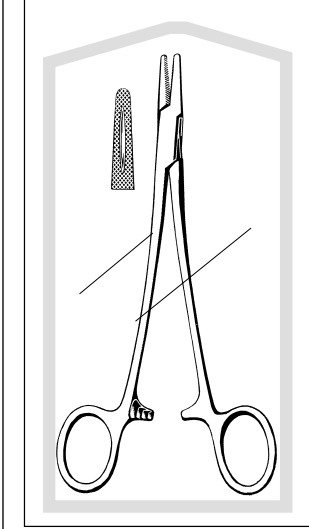
Box/50
96-2584 5 1/4" Smooth
Box/25
96-2585 5 1/4" Smooth



STERILE

CRILE-WOOD NEEDLEHOLDER, STERILE

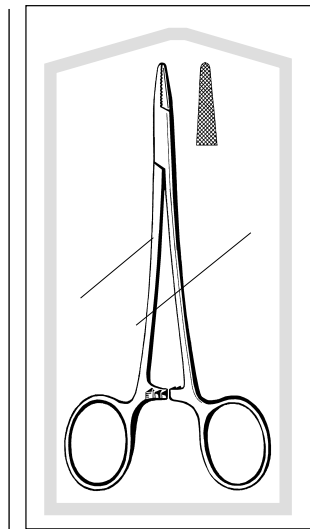
Box/50
96-2590 6"
Box/25
96-2591 6"



STERILE

MAYO-HEGAR NEEDLEHOLDER, STERILE

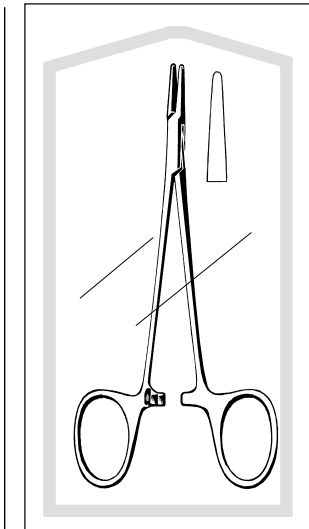
Box/50
96-2594 6"
Box/25
96-2595 6"



STERILE

BAUMGARTNER NEEDLEHOLDER, STERILE

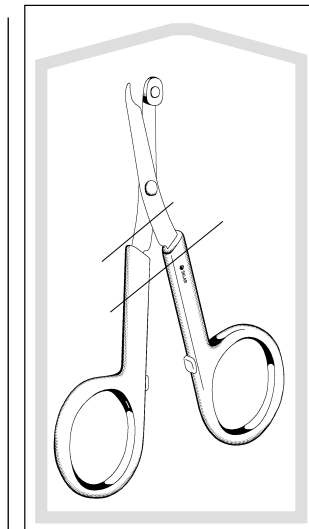
Box/50
96-2580 5 1/2"
Box/25
96-2581 5 1/2"



STERILE

WEBSTER NEEDLEHOLDER, STERILE

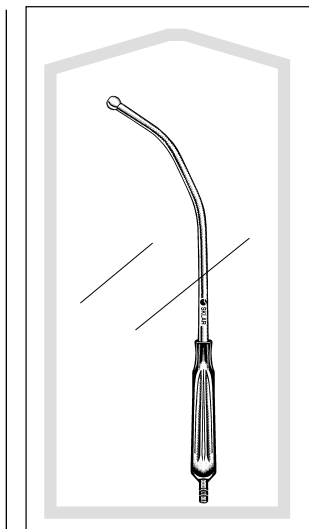
Box/50
96-2586 5 1/4" Smooth
Box/25
96-2587 5 1/4" Smooth
Box/100
96-2659 5 1/4" Smooth



STERILE

SUTURE REMOVAL INSTRUMENT

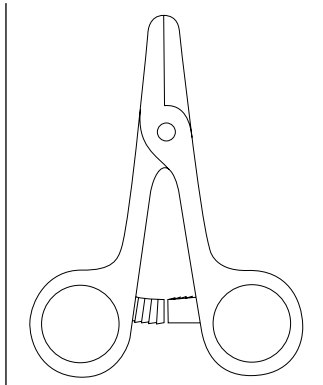
Sterile, Plastic - 70/Box
96-2640



STERILE

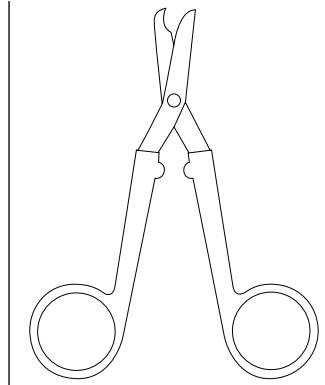
YANKAUER SUCTION TUBE, DISPOSABLE

Box/10 Sterile
96-4174 Vented
96-4175 Non-Vented



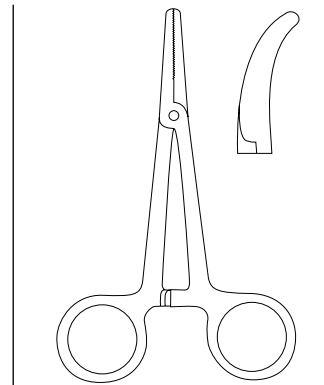
TUBING CLAMP, PLASTIC

Box of 100, Non-Sterile
96-2902 Small



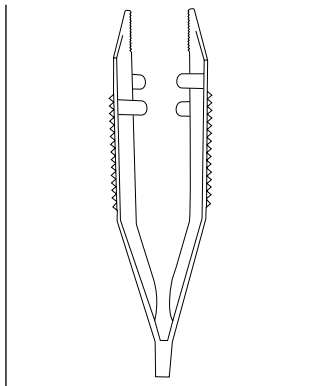
LITTAUER SUTURE SCISSORS, PLASTIC

Box of 100, Non-Sterile
96-2905 4 1/2"



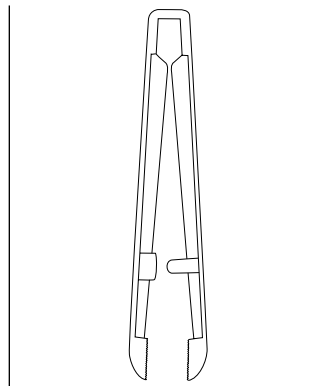
HEMOSTAT, PLASTIC

Box of 100, Non-Sterile
96-2907 5 1/4" Straight
96-2908 5 1/4" Curved



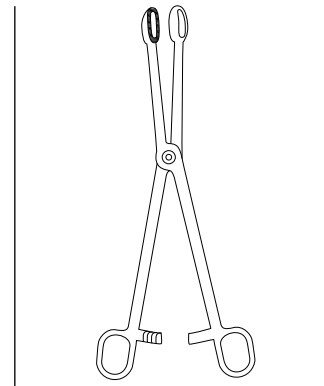
UTILITY FORCEPS, PLASTIC

Box of 100, Non-Sterile
96-2914 4" Narrow Jaw



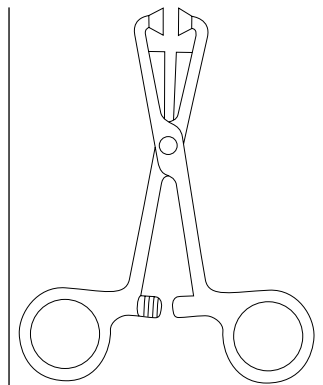
DRESSING FORCEPS, PLASTIC

Box of 100, Non-Sterile
96-2916 5"



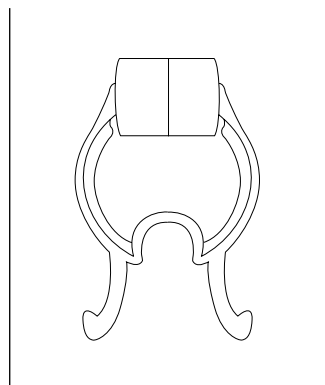
SPONGE FORCEPS, PLASTIC

Box of 100, Non-Sterile
96-2918 9 1/2"



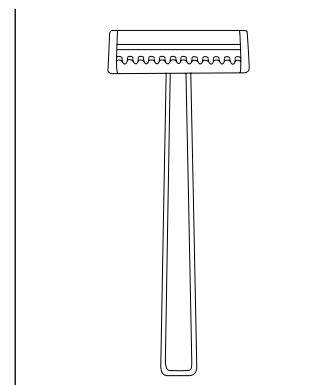
TOWEL CLAMP, PLASTIC

Box of 100, Non-Sterile
96-2930 5" Non-Perforating



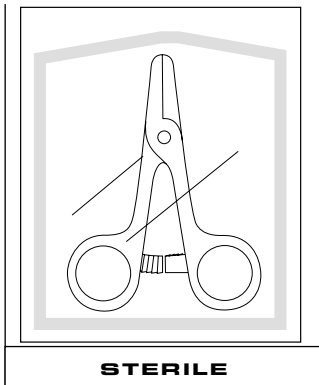
NOSE CLIP, PLASTIC

Box of 100, Non-Sterile
96-2950 Foam



SURGICAL PREP RAZOR, PLASTIC, DOUBLE EDGE

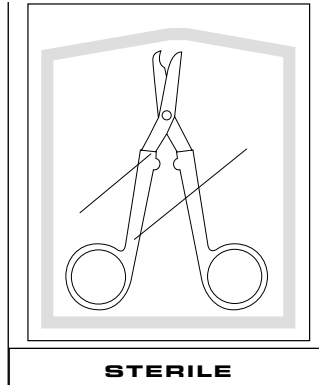
Box of 100, Non-Sterile
96-2955



STERILE

TUBING CLAMP, PLASTIC

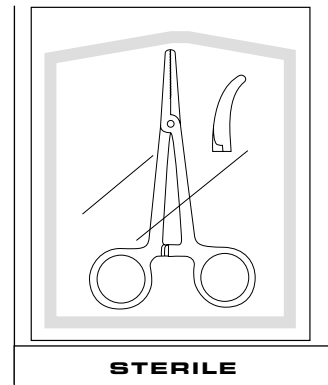
Box of 100, Sterile
96-2903 Small



STERILE

LITTAUER SUTURE SCISSORS, PLASTIC

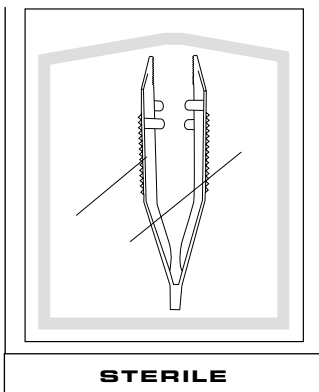
Box of 100, Sterile
96-2906 4 1/2"



STERILE

HEMOSTAT, PLASTIC

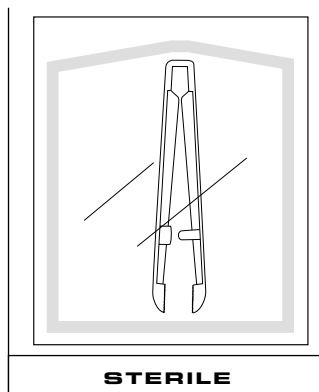
Box of 100, Sterile
96-2909 5 1/4" Straight
96-2910 5 1/4" Curved



STERILE

UTILITY FORCEPS, PLASTIC

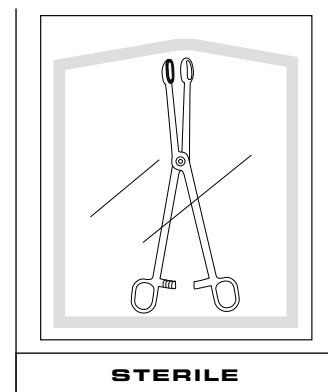
Box of 100, Sterile
96-2915 4" Narrow Jaw



STERILE

DRESSING FORCEPS, PLASTIC

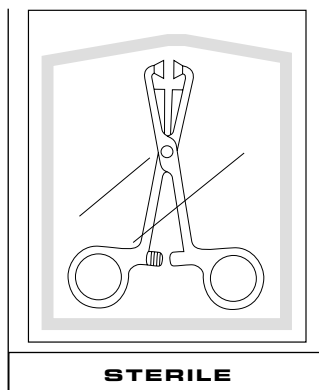
Box of 100, Sterile
96-2917 5"



STERILE

SPONGE FORCEPS, PLASTIC

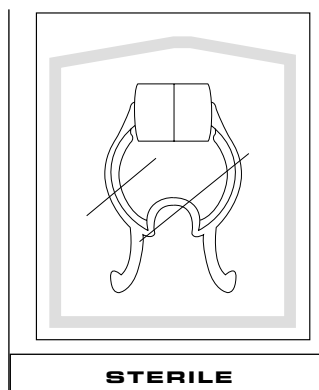
Box of 100, Sterile
96-2919 9 1/2"



STERILE

TOWEL CLAMP, PLASTIC

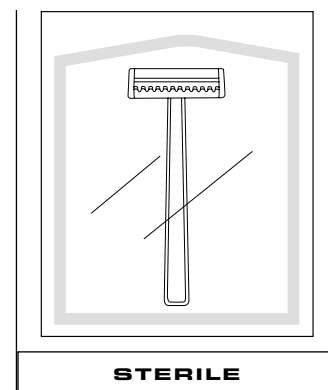
Box of 100, Sterile
96-2931 5" Non-Perforating



STERILE

NOSE CLIP, PLASTIC

Box of 100, Sterile
96-2951 Foam



STERILE

SURGICAL PREP RAZOR, PLASTIC, DOUBLE EDGE

Box of 100, Sterile
96-2956

DISPOSABLE PROCEDURE TRAYS, STERILE



GENERAL PURPOSE TRAY - Cs/25 WITH ECONO FLOOR GRADE INSTRUMENTS

96-1700 Contents:

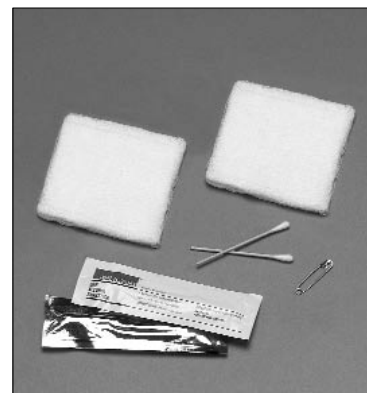
Tray	Tissue Forceps
Kelly Hemostat, Curved	OR Scissors S/B
2 Cotton Tip Applicators, 3"	Safety Pin, #2
2 Sponges, 4 x 4, 12 Ply	CSR Wrap
Iodophor Swabstick, 1's	Alcohol Swabstick, 1's
Sterilization Pouch	



GENERAL PURPOSE TRAY - Cs/25 WITH PLASTIC/WIRE-FORM INSTRUMENTS

96-1701 Contents:

Foam Tray	Plastic Tissue Forcep
Wire Formed Scissors	Plastic Hemostat, Curved
Safety Pin, #2	(2) Cotton Tip Applicators, 3"
PVP Swabstick, Single	(2) Gauze Sponges, 4 x 4, 12 Ply
Alcohol Swabstick, Single	CSR Wrap
Sterilization Pouch	



GENERAL PURPOSE TRAY - Cs/25 WITHOUT INSTRUMENTS

96-1757 Contents:

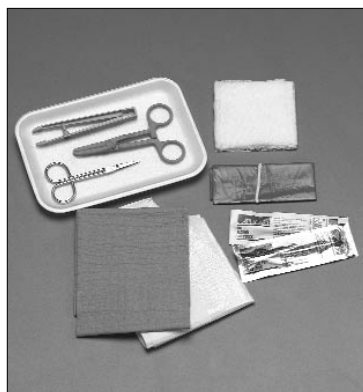
Safety Pin, #2
PVP Swabstick, Single
Alcohol Swabstick, Single
Sterilization Pouch
(2) Cotton Tip Applicators, 3"
(2) Gauze Sponges, 4 x 4 12 Ply
CSR Wrap



WOUND CLOSURE TRAY - Cs/25 WITH ECONO FLOOR GRADE INSTRUMENTS

96-1730 Contents:

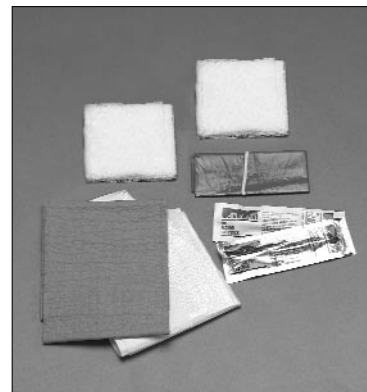
Tray	OR Scissors S/B
(4) Sponges, 4x4, 12 Ply	Kelly Hemostat, Curved
Iodophor Swabstick, 1's	Fenestrated Drape (Paper)
Alcohol Swabstick, 1's	Absorbent Towel
Webster Needle Holder	Refuse Bag w/Tie
Tissue Forcep	CSR Wrap
Sterilizer Pouch	



WOUND CLOSURE TRAY - Cs/25 WITH PLASTIC/WIRE-FORM INSTRUMENTS

96-1731 Contents:

Foam Tray	Plastic Dressing Forceps
Wire Formed Scissors	Plastic Hemostat, Curved
(4) Gauze 4 x 4, 12 Ply	PVP Swabstick, 1's
Alcohol Swabstick, 1's	Fenestrated Drape, Paper
Absorbent Towel	Refuse Bag W/ Tie
CSR Wrap	Sterilization Pouch



WOUND CLOSURE TRAY - Cs/25 WITHOUT INSTRUMENTS

96-1759 Contents:

(4) Gauze 4 x 4, 12 Ply	PVP Swabstick, 1's
Alcohol Swabstick, 1's	Fenestrated Drape, Paper
Absorbent Towel	Refuse Bag W/ Tie
CSR Wrap	Sterilization Pouch



SUTURE REMOVAL TRAY - "A" - C_s/50 WITH ECONO FLOOR GRADE INSTRUMENTS

96-1734 Contents:
 Iris Scissors, Str. Iodophor Prep Pad
 (2) Tip Protector Sterilization Pouch
 Dressing Forceps Alcohol Prep Pad
 Sponge, 4 x 4



SUTURE REMOVAL TRAY - "B" - C_s/50 WITH ECONO FLOOR GRADE INSTRUMENTS

96-1736 Contents:
 Littauer Scissors, Del. Iodophor Prep Pad
 (2) Tip Protector Sterilization Pouch
 Dressing Forceps Alcohol Prep Pad
 Sponge, 4 x 4



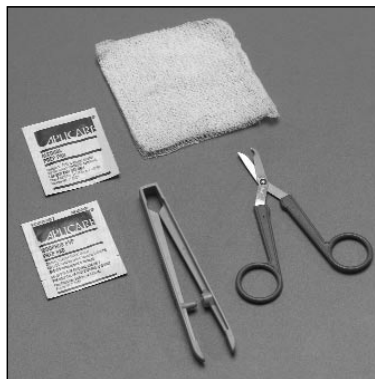
SUTURE REMOVAL TRAY - "C" - C_s/50 WITH ECONO FLOOR GRADE INSTRUMENTS

96-1738 Contents:
 Littauer Scissors Sponge, 4 x 4
 (2) Tip Protector Sterilization Pouch
 Dressing Forceps



SUTURE REMOVAL TRAY - "D" - C_s/50 WITH ECONO FLOOR GRADE INSTRUMENTS

96-1740 Contents:
 Iris Scissors, Str Sponge, 4x4
 (2) Tip Protector Sterilization Pouch
 Dressing Forceps



SUTURE REMOVAL TRAY - "E" - C_s/50 WITH PLASTIC/WIRE-FORM INSTRUMENTS

96-1735 Contents:
 Alcohol Prep Pad Plastic Dressing Forcep
 PVP Prep Pad Gauze, 4 x 4, 12 Ply
 Plastic Littauer Scissors Sterilization Pouch



SUTURE REMOVAL TRAY - "F" - C_s/50 WITH PLASTIC/WIRE-FORM INSTRUMENTS

96-1737 Contents:
 Alcohol Prep Pad Plastic Dressing Forcep
 PVP Prep Pad Gauze, 4 x 4, 12 Ply
 Wire Formed Scissors Sterilization Pouch

DISPOSABLE PROCEDURE TRAYS, STERILE



STAPLE REMOVER TRAY WITH PLASTIC INSTRUMENT - Cs/50

96-1732 Contents:
 Staple Remover
 Sponge, 4 x 4
 Sterilization Pouch



PREMIUM SUTURE REMOVAL TRAY WITH SKLARCLIP - Cs/10

96-1729 Contents:
 Sklar Clip Suture Removal Scissors
 Thumb Forcep
 Tip Protector
 Prep Tray
 (2) Gauze Sponge
 Iodophor Prep Pad
 Alcohol Prep Pad
 CSR Wrap
 Sterilization Pouch



MINOR PREP TRAY - Cs/25

96-1724 Contents:
 16 Oz. Bowl
 CSR Wrap
 PVP Prep Pad
 (4) Gauze, 4 x 4, 12 Ply
 Sterilization Pouch
 Alcohol Prep Pad



SUTURE TRAY TRAY - Cs/10 WITH ECONO FLOOR GRADE INSTRUMENTS

96-1725 Contents:
 Tray, 2 Compartment
 Lidocaine, 1%, 5ml
 Forcep, Adson, 1 x 2, 4 3/4"
 Iris Scissors, ST/SH, 4 1/2"
 Needle, 20 ga. x 1 1/2"
 PVP Prep Packet
 Drape, Blue, 18 x 26, W/Fenes.
 (20) Gauze, 4 x 4, 12 Ply
 Needle Holder, Baumg., 5 1/2"
 Syringe, 5cc L/L
 Needle, 25 ga. x 3/8"
 Drape, Plain, 18 x 26
 CSR Wrap
 Sterilization Pouch



MAJOR LACERATION TRAY - Cs/12 WITH ECONO FLOOR GRADE INSTRUMENTS

- 96-1710 Tray
Halsted Mosquito, Curved
Adson Forcep, Serr.
Adson Forcep, 1 x 2
Webster Needle Holder
Iris Scissors, Str.
Lidocaine, 1%, 5ml
- Needle, 27ga. x 1½"
Needle, 25ga. x ¾"
Needle, 18ga. x 1½"
Needle, 30ga. x ¾"
Control Syringe, 10cc
(10) Sponges, 4 x 4, 12 Ply
(5) Sponges, 2 x 2, 12 Ply
- (2) Medicine Cups
(2) OR Towels (Cloth)
CSR Wrap
Sterilization Pouch
Fenestrated Drape (Cloth)



FACIAL PLASTIC LACERATION TRAY - Cs/10 WITH ECONO FLOOR GRADE INSTRUMENTS

- 96-1707 Tray
Halsted Mosquito, Curved
Adson Forcep, Serr. Del.
Adson Forcep, 1 x 2 Del.
Webster Needle Holder, Del.
(10) Sponges, 4 x 4, 12 Ply
- Needle, 27ga. x 1½"
Needle, 25ga. x ¾"
Needle, 18ga. x 1½"
Needle, 30ga. x ¾"
Control Syringe, 10cc
Iris Scissors, Del.
- (2) Medicine Cups
(5) Sponges, 2 x 2, 12 Ply
Fenestrated Drape (Cloth)
(2) OR Towels (Cloth)
CSR Wrap
Sterilization Pouch



INCISION AND DRAINAGE TRAY - Cs/25 WITH ECONO FLOOR GRADE INSTRUMENTS

- 96-1713 Contents:
- | | |
|---------------------|------------------------------|
| Foam Tray | Iodophor PVP Swabsticks, 3's |
| Scissors, S/B | Alcohol Swabsticks, 3's |
| Dressing Forcep | Fenestrated Drape (Paper) |
| Kelly Hemostat | Poly Back Towel (Drape) |
| Scalpel, #11 | Refuse Bag w/Tie |
| (4) Sponges, 4 x 4 | CSR Wrap |
| Sterilization Pouch | |



INCISION AND DRAINAGE TRAY - Cs/25 WITH PLASTIC/WIRE-FORM INSTRUMENTS

- 96-1753 Contents:
- | | |
|--------------------------|---------------------------|
| Foam Tray | Fenestrated Drape (Paper) |
| Wire Formed Scissors | Towel/Drape, 3 Ply |
| Plastic Dressing Forcep | Refuse Bag w/Tie |
| Plastic Hemostat | CSR Wrap |
| Scalpel, #11 Long | Sterilization Pouch |
| (4) Sponges, 4x4, 12 Ply | PVP Swabsticks, 3's |
| Alcohol Swabsticks, 3's | |



INCISION AND DRAINAGE TRAY - Cs/25 WITHOUT INSTRUMENTS

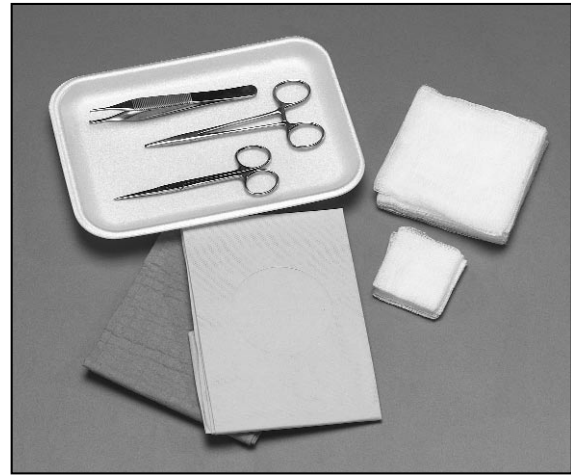
- 96-1755 Contents:
- | | |
|-------------------------|----------------------------|
| Foam Tray | Scalpel, #11 Long |
| Towel/Drape, 3 Ply | Sterilization Pouch |
| Refuse Bag w/Tie | (4) Sponges, 4 x 4, 12 Ply |
| CSR Wrap | PVP Swabsticks, 3's |
| Alcohol Swabsticks, 3's | Fenestrated Drape (Paper) |

DISPOSABLE PROCEDURE TRAYS, STERILE



MINOR LACERATION TRAY "A" - C_s/12 WITH ECONO FLOOR GRADE INSTRUMENTS

- | | | | |
|---------|-----------------------------|----------------------------|-----------------------|
| 96-1715 | Tray | (5) Sponges, 2 x 2, 12 Ply | (2) Medicine Cups |
| | Needle, 25ga. x 3/8 | Webster Needle Holder | CSR Wrap |
| | Needle, 27ga. x 1 1/2 | Iris Scissors, Str | (2) OR Towels (Cloth) |
| | Needle, 18ga. x 1 1/2 | Halsted Mosquito, Curved | Sterilization Pouch |
| | Syringe, 10cc | Adson Forcep, Serrated | |
| | (10) Sponges, 4 x 4, 12 Ply | Fenestrated Drape (Cloth) | |



MINOR LACERATION TRAY "B" - C_s/12 WITH ECONO FLOOR GRADE INSTRUMENTS

- | | | | |
|---------|---------------------------|----------------------------|---------------------|
| 96-1718 | Foam Tray | 5 Ea. Gauze, 4 x 4, 12 Ply | Absorbent Towel |
| | Baumgartner Needle Holder | 2 Ea. Gauze, 2 x 2, 12 Ply | Sterilization Pouch |
| | Scissors, Sharp/Sharp | Fenestrated Drape (Paper) | C.S.R. Wrap |
| | Tissue Forceps | | |



MINOR LACERATION TRAY - C_s/12 WITH PLASTIC/WIRE-FORM INSTRUMENTS

- | | | | |
|---------|-----------------------|--------------------------|---------------------------|
| 96-1716 | Foam Tray | (2) 2oz. Medicine Cups | (10) Gauze, 4 x 4, 12 Ply |
| | Needle, 25ga. x 3/8 | Absorbent Towel, Paper | (5) Gauze, 2 x 2, 12 Ply |
| | Needle, 27ga. x 1 1/2 | Fenestrated Drape, Paper | Sterilization Pouch |
| | Needle, 18ga. x 1 1/2 | Wire Formed Scissors | CSR Wrap |
| | L/L Syringe, 10cc | Plastic Tissue Forcep | Plastic Hemostat, Curved |



MINOR LACERATION TRAY - C_s/12 WITHOUT INSTRUMENTS

- | | | | |
|---------|-----------------------|--------------------------|---------------------------|
| 96-1717 | Foam Tray | (2) 2oz. Medicine Cups | L/L Syringe, 10cc |
| | Needle, 25ga. x 3/8 | Absorbent Towel, Paper | C.S.R. Wrap |
| | Needle, 27ga. x 1 1/2 | Fenestrated Drape, Paper | (10) Gauze, 4 x 4, 12 Ply |
| | Needle, 18ga. x 1 1/2 | Sterilization Pouch | (5) Gauze, 2 x 2, 12 Ply |



DEBRIDEMENT TRAY - Cs/10 WITHOUT INSTRUMENTS

96-1804

Contents:
Latex Gloves, Pair
Bag and Tie
2 oz. Medicine Cup
Tongue Blade
75cc, 0.9%, Sodium Chloride
ABD Pad
1" Transpore Tape
Protective Barrier Film
Tray

Sterilization Pouch
Absorption Dressing
Drape/Towel, 3 Ply
75cc Sterile Water
60cc Syringe
(6) 4 x 4, 12-Ply Gauze Sponge
Cotton Tipped Applicator
Measuring Device
Dressing Change Label
CSR Wrap



DEBRIDEMENT TRAY - Cs/20 WITH ECONO FLOOR GRADE INSTRUMENTS

96-1904

Contents:
Gloves, Pair
Alcohol Prep Pad
PVP Prep Pad
Gauze, 4 x 4, 12 Ply
Iris Scissors
#15 Scalpel
Dressing Forcep
(2) Tip Protectors



MINOR DRESSING TRAY - Cs/25 WITH ECONO FLOOR GRADE INSTRUMENTS

96-1702

Tray	Iodophor PVP Prep Pad
Scissors, S/B	Alcohol Prep Pad
Dressing Forceps	Poly Back Towel (Drape)
Adson Forceps, 1 x 2	Refuse Bag w/Tie
Micropore Tape, 1 x 36	CSR Wrap
Sterilization Pouch	(3) Cotton Filled Sponges, 4 x 4



MINOR DRESSING TRAY - Cs/25 WITH PLASTIC/WIRE-FORM INSTRUMENTS WITH DURAPORE DRESSING™

96-1704

Towel/Drape, 3 Ply	Foam Tray
Wire Formed Scissors	Plastic Dressing Forcep
Plastic Tissue Forcep	Micropore Tape™ 1 x 36
Alcohol Prep Pad	Sterilization Pouch
Refuse Bag w/ Tie	3 Ea. Gauze Sponge, 4 x 4, 12 Ply
PVP Prep Pad	CSR Wrap
Durapore is a trademark of 3M	

DISPOSABLE PROCEDURE TRAYS, STERILE



IV START TRAY - Cs/50

- 96-1705 Contents:
- | | |
|------------------------|--------------------------------|
| Tray | Transparent Tegaderm™ Dressing |
| Dressing Change Label | Alcohol Prep Pad |
| Transpare Tape, 1 x 16 | Tourniquet |
| (2) Sponges | Gloves, Pair |
| PVP Prep Pad | Sterilization Pouch |
- Tegaderm is a trademark of 3M



TEGADERM™ IV START TRAY - Cs/50

- 94-4024 Contents:
- | | |
|-------------------------|-----------------------------|
| Tourniquet | Medical Tape, ½" x 18" Roll |
| Alcohol Prep Pad | Dressing Change Label |
| PVP Prep Pad | Sterilization Pouch |
| (2) Gauze 2 x 2, 12 Ply | Tegaderm™ Dressing |
- Tegaderm is a trademark of 3M



TEGADERM™ DRESSING CHANGE TRAY - Cs/50

- 94-4026
- | | |
|---------------------|-----------------------------|
| Towel/Drape, 3 Ply | (2) Masks W/ Ear Loops |
| Gloves, Pair | Alcohol Swabsticks, 3's |
| PVP Swabsticks, 3's | Benzoin Tincture Applicator |
| Tegaderm™ Dressing | Dressing Change Label |
| Sterilization Pouch | |
- Tegaderm is a trademark of 3M



CENTRAL LINE DRESSING TRAY - Cs/50 WITH DURAPORE™ DRESSING

- 94-4025
- | | |
|----------------------------|-----------------------------|
| Gloves, Pair | (2) Gauze 2 x 2 12 Ply |
| Towel/Drape, 3 Ply | Adhesive Patch |
| (2) Mask W/ Ear Loops | Dressing Change Label |
| Alcohol Swabstick, 3's | Sterilization Pouch |
| PVP Swabstick, 3's | PVP Ointment, 1 Gram |
| (2) IV Split Sponge, 2 x 2 | Benzoin Tincture Applicator |
- Durapore is a trademark of 3M



IV CATHETER DRESSING TRAY - Cs/25

- 96-1708
- | | |
|-------------------------|--------------------------------|
| Tray | Gloves, Pair |
| Dressing Change Label | Mask W/ Ear Loops |
| Transpare Tape 1x18 | C.S.R. Wrap |
| Sponge, 2 x 2, 8 Ply | Sterilization Pouch |
| Non Adhering Pad, 2 x 2 | Iodophor PVP Swabstick, 3's |
| Sponge, 4 x 4, 8 Ply | Acetone Alcohol Swabstick, 3's |
| Iodophor PVP Ointment | Transparent Tegaderm™ Dressing |
- Tegaderm is a trademark of 3M

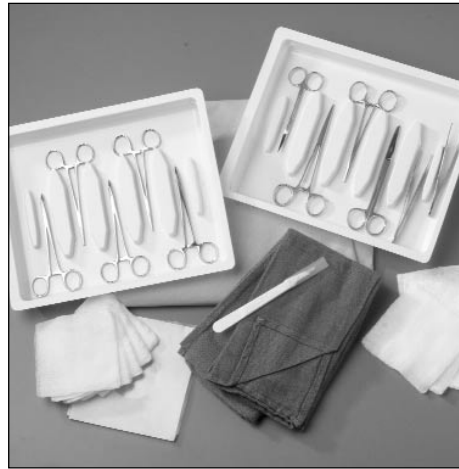


BIOPSY PUNCH TRAY - Cs/25 WITH ECONO FLOOR GRADE INSTRUMENTS

96-1712 - With 4mm Biopsy Punch
96-1714 - With 3mm Biopsy Punch

Contents:

Tray	CSR Wrap
(4) Sponges, 3 x 3, 12 Ply	Needle, 30ga. x 1/2
Iodophor Ointment	Needle, 25ga. x 3/8
Webster Needle Holder	Syringe, 3cc
Iris Scissor, Curved	Alcohol Prep Pad
Tissue Forcep	(2) Band-aids
Fenestrated Drape (Paper)	Gloves, Pair
Sterilization Pouch	



MINOR SURGERY TRAY - Cs/10 WITH ECONO FLOOR GRADE INSTRUMENTS

96-1744 Contents:

Utility Drape, Clear	(2) OR Towels, Linen
Scalpel, #15 Long Handle	(2) Halsted Mosq. Fcps, Str. 5"
(3) Halsted Mosq. Fcps, Cvd. 5"	Kelly Fcps, Str. 5 1/2"
Webster Nd Hld, Sm. 5"	Scissors, Str. SH/BL 5 1/2"
Iris Scissors, Cvd. 4 1/2"	Adson Fcps. 1 x 2, 4 3/4"
(15) Gauze, 4 x 4, 12 Ply	(2) Instrument Trays
CSR Wrap	Sterilization Pouch



EAR TRAY - Cs/10 WITH ECONO FLOOR GRADE INSTRUMENTS

96-1728 Contents:

Bulb Syringe	Ear Forcep
Ear Curette, Ring	Deep Prep Tray
(2) Gauze Sponge	CSR Wrap
Sterilization Pouch	Calgiswab



EPISTAXIS TRAY - Cs/25 WITH ECONO FLOOR GRADE INSTRUMENTS

96-1743 Contents:

Nasal Speculum, Plastic	Standard Nasal Dressing
Bayonet Forcep	Gauze, 4 x 4, 12 Ply
Prep Tray	Sterilization Pouch
CSR Wrap	

DISPOSABLE PROCEDURE TRAYS, STERILE



BASIC BIOPSY TRAY - Cs/10

96-1726 Contents:
 Fenestrated Drape
 Syringe, 3cc L/L NT
 Syringe, 5cc L/L NT
 Needle, 20 ga. x 1 1/2"
 #11 Long Scalpel
 (2) Specimen Tube
 Plastic Ruler, 6"
 (1) Solution Cup
 (4) Gauze, 4 x 4, 12 Ply

(2) Absorbent Towels
 Needle, 25 ga. x 3/8"
 Syringe, 20cc L/L NT
 Needle, 22 ga. x 1 1/2"
 Lidocaine, 1%, 5ml
 Pocket Single, 10cc #12
 (6) Slides, Glass, Frosted
 (2) Angled Sponge Sticks

CSR Wrap
 Sterilization Pouch
 Procedure Tray
 PVP Swabsticks, 3's
 (5) Micron Filter Straw
 Bandaid



DIALYSIS TRAY - Cs/50

94-4038 Contents:
 Gloves, Pair
 Mask W/ Ear Loops
 Towel/Drape, 3 Ply
 PVP Swabsticks, 3's

Alcohol Swabsticks, 3's
 Non Adhering Pad W/ Tape
 (4) Each Tape Strips 1 x 5
 Sterilization Pouch



GENERAL UTILITY TRAY - Cs/10

96-1727 Contents:
 Drape, Fenestrated
 PVP Swabstick, 3's
 Syringe, 10cc, L/L
 Needle, 18 ga. x 1 1/2"
 Needle, 25 ga. x 3/8"
 (2) Specimen Tubes, Clear
 Insert for Xylocaine
 (3) Gauze, 4 x 4, 12 Ply
 CSR Wrap

(2) Absorbent Towels
 Syringe, 5cc, L/L
 Syringe, 20cc, L/L
 Needle, 21 ga. x 1 1/2"
 Mini Scalpel
 Lidocaine, 1%, 5ml
 Bandaid
 Procedure Tray
 Sterilization Pouch



*Sklar Sterile
 "Custom"
 Procedure Trays
 Are Available.
 Call Sklar At
 800-221-2166*



BASIC SKIN PREP TRAY - Cs/20

96-1805 Contents:
 (3) 16 oz. Bowls (12) Gauze, 4 x 4, 12-Ply
 (2) 6" Prep Sticks PVP Scrub, 2 oz.
 PVP Paint, 2 oz. Absorbent Towel
 CSR Wrap Sterilization Pouch



SHAVE PREP TRAY - Cs/10

96-1806 Contents:
 Razor Waterproof Underpad
 Pre-soaped Sponge Pad (2) Cotton Tip Applicators
 (4) Absorbent Towels Prep Tray
 Sterilization Pouch



NAIL TRAY - Cs/12

96-1838 Contents:
 Small Blade #11 Sterilization Pouch
 (3) 4 x 4, 12 Ply Gauze Sponge Tissue Forceps, Plastic
 (2) Alcohol Prep Pads
 Procedure Catch Pad/Absorbent Towel
 Prep Tray CSR Wrap



CYST ASPIRATION TRAY - Cs/25

96-1807 Contents:
 PVP Swabsticks, 3's (5) Gauze, 4 x 4, 12 Ply
 Syringe, 10cc Needle, 21ga x 1 1/2"
 Prep Tray CSR Wrap
 Sterilization Pouch

DISPOSABLE PROCEDURE TRAYS, STERILE



LLETZ ELECTROSURGERY TRAY - Cs/10

- 96-1916** Contents:
- | | |
|---|---------------------------------|
| (1) Ea. 20ml Lidocaine HCl 2% Injection Vial | (6) 8" Cotton Applicator Sticks |
| (1) Ea. 20ml Lidocaine w/Epinephrin HCl 2% Injection Vial | Pantyliner |
| Needle, 30 ga. x 1" | Alcohol Prep Pad |
| Endocervical Needle, 27 ga. x 3 1/2" Reinf. | Absorbent Underpad |
| Lugol's Iodine Contrast Medium | Sterilization Pouch |
| Monsel's Hemostatic Paste | CSR Wrap |



HYSTEROSALPINGOGRAM (BASIC) TRAY - Cs/10

- 96-1721** Contents:
- | | |
|------------------------------------|--------------------------|
| (2) 8" Jumbo Cotton Tip Applicator | Control Syringe |
| Fenestrated Drape | Tray, Mayo Small |
| Gloves, Exam Universal Latex | Uterine Injector, 2.0 |
| Needle, 18 ga. x 1 1/2" | Drape, 40 x 48 |
| PVP, Ointment, 1 gram | (6) Gauze, 4 x 4, 12 Ply |
| Uterine Sound | Lube Jelly Pack |
| Stopcock, 1 Way L/L Male | PVP, Iodine Prep, 1 Oz. |
| Syringe, 10cc L/L | Extension Set |
| Tray, Half Deep | Vaginal Speculum, Med. |
| | CSR Wrap |
| | Sterilization Pouch |



AMNIOCENTESIS TRAY - Cs/10

- 96-1722** Contents:
- | | |
|------------------------------------|---------------------------|
| Fenestrated Drape, 24 x 24 w/Patch | Needle, 22 ga. x 1 1/2" |
| Absorbent Towel | Needle, 22 ga. x 3 1/2" |
| Syringe, 5cc L/L NT | PVP Swabsticks, 3's |
| Syringe, 10cc L/L NT | 6 Inch Ruler |
| Syringe, 20cc L/L NT | Ultrasound Gel Pack |
| Needle, 25 ga. x 3/4" | (8) Gauze, 4 x 4, 12 Ply |
| (3) Specimen Tubes | Bandaid |
| Procedure Tray | CSR Wrap, 24 x 24 |
| Micron Filter Straw | Lidocaine, 1%, 5ml Ampule |
| | Sterilization Pouch |



STANDARD CT BIOPSY TRAY - Cs/10

- 96-1723** Contents:
- | | |
|------------------------|----------------------------|
| Prep Tray | Plastic Needle Stop |
| (2) Xylocaine, 1% 5ml | Needle, 25 ga. x 3/4" |
| 6" Paper Ruler | Needle, 22 ga. x 1 1/2" |
| Bandaid | PVP Swabsticks, 3's |
| Alcohol Prep Pad | Gauze, 4 x 4, 12 Ply |
| Mini Scalpel | (2) Absorbent Towels |
| (4) Syringes, 10cc L/L | Drape, Fenestrated w/Patch |
| | CSR Wrap |



ULTRASOUND TRAY - Cs/10

96-1801 Contents:

Procedure Tray	Solution Cup
Lidocaine, 1% 5ml	Applicator Prep Stick 6"
CSR Wrap	Gauze, 3 x 3, 12 Ply
Needle, 20ga x 1½"	Syringe, 10cc LL
Needle, 25ga x 1½"	Drape, Plain 18 x 26
6" Paper Ruler	Drape, Minor Procedure
Bandaid	
Sterilization Pouch	



SPINAL TRAY - Cs/20

96-1802 Contents:

Tray, 1/2 Shallow	Bandaid
PVP, 1 Gram Ointment	Syringe, 10cc LS
Specimen Tube	Syringe, 3cc LL
Needle, 21ga x 1½"	Needle, 22ga x 3½"
Needle, 25ga x 5/8"	Needle, 18ga x 1½"
Gauze, 4x4, 12 Ply	Alcohol Swabsticks, 3's
PVP Swabsticks, 3's	(2) Fenestrated Drape
CSR Wrap	Sterilization Pouch



CYST/FNA/CORE TRAY - Cs/10

96-1803 Contents:

Duct Drape	Needle, 22ga. x 1½"
PVP Swabsticks, 3's	Latex Ultrasound Probe Cover
5cc L/L Syringe	Alcohol Swabsticks, 3's
Needle, 18ga. x 1½"	10cc LL Syringe
Needle, 25ga. x 5/8"	Needle, 21ga x 1½"
Ampule Holder	1%, 5ml Lidocaine
16 oz. Solution bowl	#11 Scalpel, Long Handle
(6) Gauze Sponges, 4 x 4, 12 Ply	Ziplock Bag
Half Deep Tray	Sterilization Pouch
	CSR Wrap



TRACH CARE TRAY - Cs/20

96-1703 Contents:

3 Trays	Paper/Poly Drape
Twill Tape, ½" x 30"	Gloves
Trach Brush	CSR Wrap
Trach Dressing	Sterilization Pouch
Cotton Tipped Applicator, 6"	(3) Sponges, 4 x 4, 8 Ply
Sponge Forcep, Plastic	

DISPOSABLE PROCEDURE TRAYS, STERILE



ARTHROGRAM TRAY - Cs/10

96-1745

Contents:

Fenestrated Drape w/Tape
Lidocaine, 1%, 5ml
Needle, 18ga x 1 1/2"
20" Extension Set
20cc L/L Syringe
(5) Gauze, 3x3, 12 Ply
Needle, 25ga x 5/8"
10cc L/L Syringe
CSR Wrap

Bandaid
Needle, 20ga x 1 1/2"
Needle, 21ga x 1 1/2"
PVP Swabsticks, 3's
Procedure Tray
3-Way Stopcock, L/L
Absorbent Towel/Drape
Sterilization Pouch

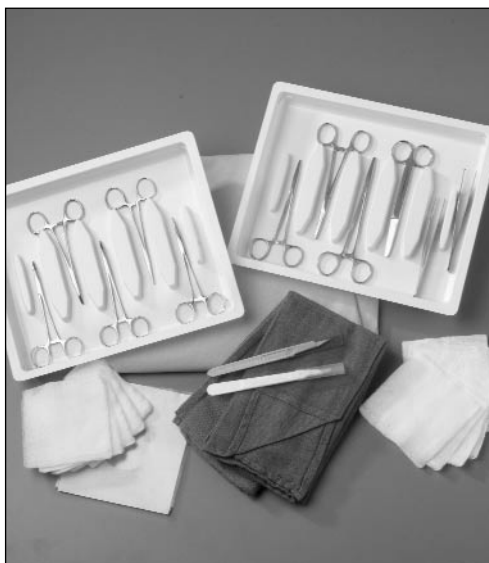


STANDARD CIRCUMCISION TRAY - Cs/20 WITH ECONO FLOOR GRADE INSTRUMENTS

96-1746

Probe w/eye
(2) Halsted Mosq. Str.
Scissors, SH/BL
#10 Scalpel, Long Handle
2 Oz. Med. Cup
(10) Gauze, 3x3, 12 Ply
1 Oz. Prep Iodine Solution
Fenestrated Cloth
Gloves, Pair

Sterilization Pouch
Halsted Mosq. Cvd.
Adson Serrated Forceps
Instrument Tray
#2 Safety Pins
Vaseline Gauze
Cloth Towel, Blue
CSR Wrap



CUT DOWN TRAY - Cs/10 WITH ECONO FLOOR GRADE INSTRUMENTS

96-1747

(2) Instrument Tray
Scissors, Str, SH/BL
Kelly Forceps, Str, 5 1/2"
Thumb Fcps. Serr. 4 3/4"
Instrument Tray
(2) Halsted Mosq. Fcps, Str. 5"
Scalpel, #11 Long
Utility Drape, Clear
Sterilization Pouch

Adson Forcep, 1x2, 4 3/4"
Mayo Hegar Nd Hld. 6"
Webster Nd Hld. Sm. 5"
(2) OR Towels, Linen
Scalpel, #15 Long Handle
(3) Halsted Mosq. Fcps, Cvd. 5"
(15) Gauze, 4 x 4, 12 Ply
CSR Wrap



NERVE BLOCK PAIN TRAY - Cs/10

96-1748

Contents:

Syringe, 3cc
Syringe, 20cc
Needle, 25ga x 1 1/2"
(10) Gauze, 4 x 4, 12 Ply
PVP 1 Oz. Solution
(4) Utility Drapes
Bandaid
Tray

(2) ea. Syringe, 5cc
(2) ea. Needle, 18ga x 1 1/2"
Fenestrated Drape
(3) Prep Sticks 6"
(2) Absorbent Towels
(2) Lidocaine, 1% 5ml Ampule
CSR Wrap, 24 x 24
Sterilization Pouch
NaCl Solution, 0.9%



LEFT HEART CATH TRAY - Cs/5 WITH ECONO FLOOR GRADE INSTRUMENTS

- | | | | |
|---------|---|---|---|
| 94-2027 | Back Table Cover
Blue Linen OR Towels
Absorbent Towel, White
Band Bags, 36 x 30
5cc L/L Syringe
10cc L/L Syringe
22ga x 1" Needle
#11 Long Scalpel | Left Heart Manifold Kit
Dual Window Angio Drape
Set Up Cover, 54 x 70
80 oz. Guidewire Bowl
20cc L/L Syringe W/ Lido Label
18ga x 1-1/2" Needle
25ga x 5/8" Needle
18ga x 2-3/4" Arterial Needle | Ziplock Bag, 10 x 15
4 x 4 12 Ply Gauze Sponge
16 oz. Bowl
PVP Prep Packet W/Sticks
Tray
Halsted Mosq. Frc. Cvd
Sterilization Pouch |
|---------|---|---|---|



ELECTROPHYSIOLOGY TRAY - Cs/5 WITH ECONO FLOOR GRADE INSTRUMENTS

- | | | | |
|---------|--|--|--|
| 94-2031 | Contents:
Back Table Cover
#11 Long Scalpel
21ga x 1-1/2" Needle
25ga x 5/8" Needle
20cc Syringe
4" x 4" 12 Ply Gauze
Halsted Mosq Frc 5" | Guidewire Bowl
Kelly Cvd, 5-1/2"
18ga x 2-3/4" Arterial Needle
10cc Syringe
36" x 30" Bandbag
Linen OR Towel
PVP Paint With Sticks | Rt Window Angio Drape
Absorbent Towels
54" x 70" Set Up Cover
22ga x 1-1/2" Needle
Tray
Sterilization Pouch |
|---------|--|--|--|

COMPLETE HEART SIDEPACK - Cs/12

- | | | | | | |
|---------|-----------|---|------------------------------------|---|--|
| 94-2029 | Contents: | CSR Wrap
Linen Towels
10cc Syringes | Tray
Merit™ Kit
3cc Syringes | 1/2 x 1" Label "AO"
1/2 x 1" Label "PA"
1/2 x 1" Label "RA" | 1/2 x 1" Label "SVC"
1/2 x 1" Label "IVC" |
|---------|-----------|---|------------------------------------|---|--|



PTCA SIDEPACK - Cs/10 WITH ECONO FLOOR GRADE INSTRUMENTS

- | | | | |
|---------|--|---|--|
| 94-2028 | Central Supply Overwraps
4" x 4" Cotton Gauze Sponges
10cc Syringes
5" Cvd Halsted Forceps
2 oz. Medicine Cups
6-1/2" oz. Specimen Cups
Label Stating "Cardene"+ | Blue Line OR Towels
2-0 Suture
20cc Syringe
5-1/2" Str Scissors
Tray
1/2 x 1" Label "Morphine"
1/2 x 1" Label "Adensoine" | 1/2 x 1" Yellow "Nitro" Label
1/2 x 1" Label "Heparin"
1/2 x 1" Label "Cocktail"
1/2 x 1" Label "Aramine"
1/2 x 1" Label "Inderal"
1/2 x 1" Label "Valium"
Sterilization Pouch |
|---------|--|---|--|
- + THIS PRODUCT CONTAINS NATURAL RUBBER LATEX. WHICH MAY CAUSE ALLERGIC REACTIONS.



PACEMAKER TRAY - Cs/5

- | | | | |
|---------|---|---|---|
| 94-2032 | Contents:
Back Table Cover
Linen OR Towel
36" x 30" Bandbag
Scalpel #10
Scalpel #11
Scalpel #15 | 2-Compartment Tray
Gauze, 4" x 4" 12 Ply
54" x 70" Set Up Cover
Rt. Window Angio Drape
10cc Syringe | Needle, 20ga x 1-1/2"
Needle, 21ga x 1-1/2"
Needle, 22ga x 1-1/2"
Needle, 25ga x 5/8"
Sterilization Pouch |
|---------|---|---|---|



COBAN™

COBAN IS A TRADEMARK OF 3M

Sterile Cs/20
 96-1780 4"
 96-1782 6"



ELASTIC BANDAGES

Sterile Cs/20
 96-1784 2"
 96-1786 3"
 96-1788 4"
 96-1790 6"



ESMARK BANDAGES

Latex Sterile Cs/20		Synthetic Sterile Cs/20	
96-1792	3" x 9'	96-1649	3" x 9'
96-1793	3" x 12'	96-1680	3" x 12'
96-1794	4" x 9'	96-1650	4" x 9'
96-1795	4" x 12'	96-1651	4" x 12'
96-1796	6" x 9'	96-1652	6" x 9'
96-1797	6" x 12'	96-1653	6" x 12'



SOF-ROL™

SOF-ROL IS A
 TRADEMARK OF
 JOHNSON & JOHNSON

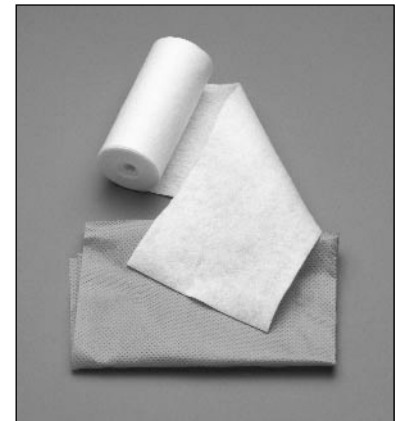
Sterile Cs/20
 96-1799 2"
 96-1811 3"
 96-1812 4"
 96-1813 6"



SPECIALIST™

SPECIALIST IS A
 TRADEMARK OF
 JOHNSON & JOHNSON

Sterile Cs/20
 96-1814 2"
 96-1815 3"
 96-1816 4"
 96-1817 6"



WEBRIL™

WEBRIL IS A
 TRADEMARK OF KENDALL

Sterile Cs/20
 96-1818 2"
 96-1819 3"
 96-1820 4"
 96-1821 6"



SPONGES

Sterile Cs/500

96-1830 2 x 2 / 12 Ply 50 Packs Of 10

96-1834 4 x 4 / 12 Ply 50 Packs Of 10

Sterile Cs/1000

96-1832 2 x 2 / 12 Ply 100 Packs Of 10

96-1836 4 x 4 / 12 Ply 100 Packs Of 10



OR TOWELS

Sterile Cs/100

96-1662 50 Packs Of 2

Sterile Cs/80

96-1621 20 Packs Of 4



EYE DRAPES

Sterile Cs/25

96-1684 Lasik Eye Drape, Oval Fenestration, 48 x 48

96-1697 Eye Drape, Oval Fenestration 48 x 48

96-1685 Large Incise Drape, Square Fenestration, 40 x 48

96-1686 Non Woven Open, Oval Fenestration, 40 x 48

96-1687 Incise Drape, Round Fenestration, 40 x 48

96-1688 Fluid Control Bag

96-1689 Non Woven, Round Fenestration, 40 x 48

96-1690 Embossed Plastic, Oval Fenestration, 40 x 48

96-1691 Non-Woven Incise, 48 x 48-1/2

96-1693 Full Body Incise, 55 x 55

96-1694 Full Body Closed Incise, 65 x 100

96-1695 Full Body Oval Aperture And Pouches, 65 x 100

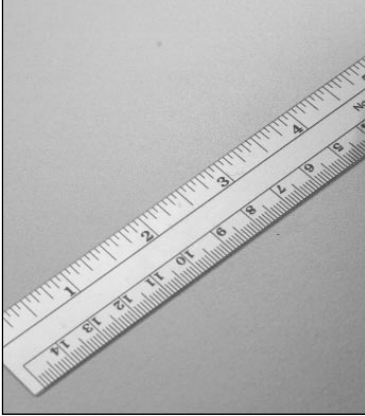
96-1696 3/4 Length Oval Aperture And Pouches, 48 x 100



ABSORBENT TOWELS

Sterile Cs/100

96-1664 25 Packs Of 4



PLASTIC RULERS

Sterile Cs/100
 96-1674 6" Plastic, Package Of 1



UROLOGICAL DRAINAGE BAGS

Cs/10		
96-1654	Sterile	Fits All Standard Liebel™ Tables
96-1655	Non-Sterile	
Cs/20		
96-1656	Sterile	Fits All Standard Siemens™ Tables
96-1657	Non-Sterile	



BAND BAGS

Sterile Cs/25

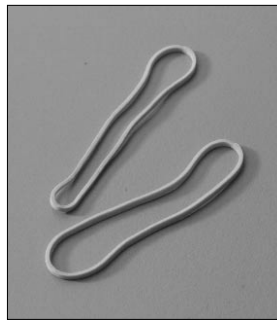
96-1675	30 x 15
96-1676	30 x 36
96-1677	36 x 30
96-1678	50 x 50



SAFETY PINS

Sterile Cs/100

96-1667	#2	50 Packs Of 2
96-1668	#3	50 Packs Of 2



RUBBER BANDS

Sterile Cs/100

96-1671	#16	50 Packs Of 2
96-1672	#31	50 Packs Of 2
96-1673	#32	50 Packs Of 2



COTTON BALLS

Sterile Cs/100

96-1669	Medium	50 Packs Of 2
96-1670	Large	50 Packs Of 2



COTTON TIPPED APPLICATORS

Sterile Cs/500

96-1665	6"	50 Packs Of 10
Sterile Cs/250		
96-1666	3"	25 Packs Of 10



OR BASIN

Sterile Cs/10
96-1679 7 Quart



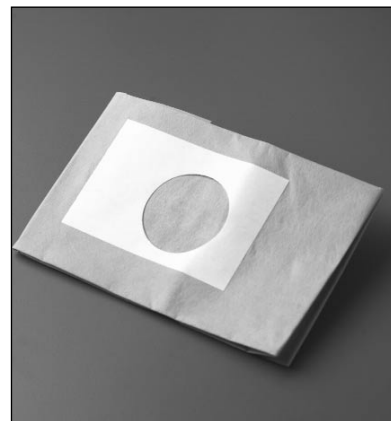
INFILTUBE INSUFFLATION

Sterile Box of 10
31-2450 0.1 Micron Filter



FLUOROSCOPE COVERS

Sterile Cs/25
96-1640 Small
96-1641 Medium
96-1642 Large

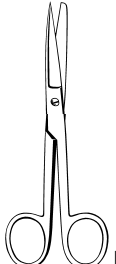
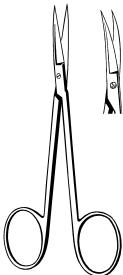
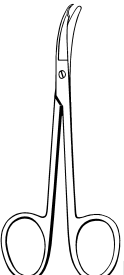

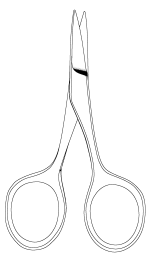


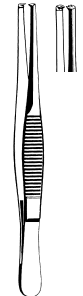
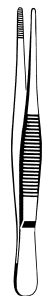


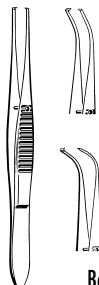
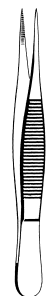
MINOR PROCEDURE FENESTRATED DRAPE

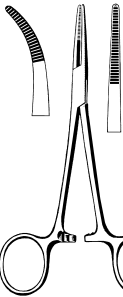
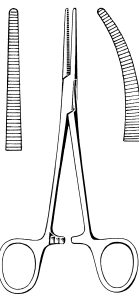
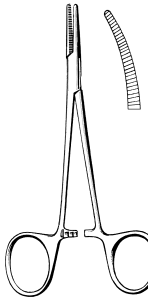
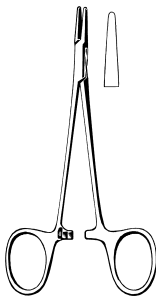
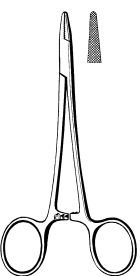
Sterile Cs/25
96-1627 24 x 24

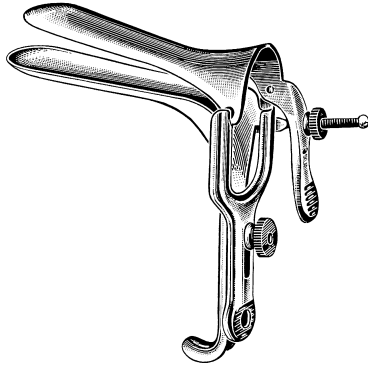
ECONO™ INSTRUMENTS - FLOOR GRADE



ECONO		ECONO		ECONO		ECONO		ECONO	
OPERATING SCISSORS		IRIS SCISSORS		STITCH SCISSORS		LISTER BANDAGE SCISSORS		SMALL UTILITY SCISSORS	
									
Box/12		Box/12		Box/12		Box/12		Box/12	
Straight-S/B 21-263 4½" 21-272 5½" 21-281 6½"		21-102 2½" Straight 21-103 3½" Straight 21-104 4½" Straight 21-107 3½" Curved 21-109 4½" Curved		21-346 3½" 21-352 4½" 21-358 5½"		21-222 3½" 21-226 4½" 21-231 5½" 21-237 5½" W/Clip 21-241 7½"		21-060 2½" Straight	

ECONO		ECONO		ECONO		ECONO		ECONO		ECONO	
THUMB TISSUE FORCEPS		THUMB DRESSING FORCEPS		GRAEFE FIXATION FORCEPS WITH LOCK		ADSON DRESSING/TISSUE FORCEPS		IRIS FORCEPS		REGULAR SPLINTER FORCEPS	
											
Box/12		Box/12		Box/12		Box/12		Box/12		Box/12	
21-753 4½" 1x2 21-757 5" 1x2 21-762 5½" 1x2 21-766 6" 1x2 21-769 5½" 2x3		21-705 4½" 21-710 5" 21-727 5½" 21-731 6" 21-736 8" 21-742 10"		21-788 4½"		21-775 4¼" 1x2 21-776 4¼" 1x2 Del. 21-771 4¼" Serrated 21-772 4¼" Serrated Del.		21-123 4¼" Straight Serrated 21-124 4¼" Straight 1x2 21-129 4¼" Curved ½ Cvd. Serr. 21-135 4¼" Curved Full Cvd. Serr. 21-146 4¼" Curved ½ Cvd. 1x2 21-151 4¼" Curved Full Cvd. 1x2		21-777 3½" 21-781 4½"	

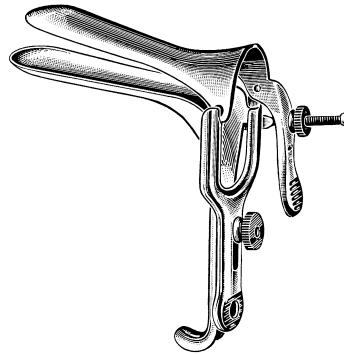
ECONO		ECONO		ECONO		ECONO		ECONO	
KELLY FORCEPS		CRILE FORCEPS		HALSTED MOSQUITO FORCEPS		WEBSTER NEEDLEHOLDER		BAUMGARTNER NEEDLEHOLDER	
									
Box/12		Box/12		Box/12		Box/12		Box/12	
21-436 5½" Straight 21-442 5½" Curved		21-447 5½" Straight 21-452 5½" Curved		21-426 5" Straight 21-431 5" Curved		21-809 5½"		21-832 5½"	



OR GRADE

GRAVES VAGINAL SPECULUM

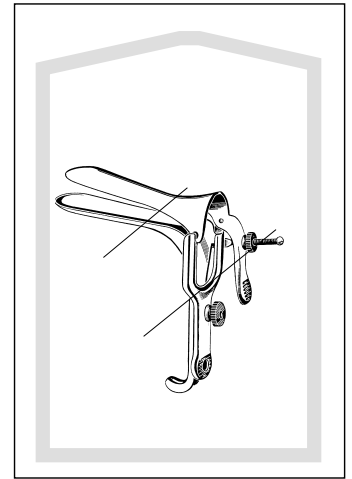
90-3700	3" x 3/4"	Small
90-3701	4" x 1 1/4"	Medium
90-3702	4 1/2" x 1 3/8"	Large
90-3800	2 3/4" x 3/8"	Extra Small
90-3802	4 3/4" x 1 1/2"	Extra Large
90-3803	6" x 1 3/4"	Extra Long



MID-GRADE

GRAVES VAGINAL SPECULUM

95-303	3" x 3/4"	Small
95-312	4" x 1 1/4"	Medium
95-324	4 1/2" x 1 3/8"	Large



FLOOR-GRADE, STERILE

GRAVES VAGINAL SPECULUM, STERILE

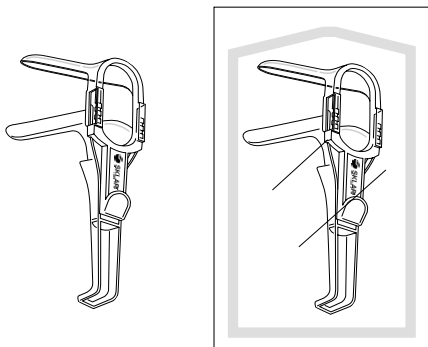
Box/25		
96-2603	3" x 3/4"	Small
96-2605	4" x 1 1/4"	Medium
96-2607	4 1/2" x 1 3/8"	Large

Sklar Lubricating Jelly

96-1610 Case of 4 boxes (Box 150/5 gm Packets)



Sklar-Spec™



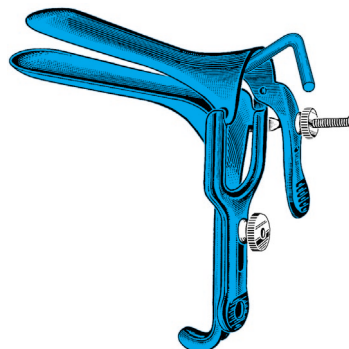
STERILE

PLASTIC VAGINAL SPECULUM, GRAVES STYLE

Disposable (Non-Sterile)		Disposable (Sterile)	
96-0857	Sm Cs/100 10 Pks/10	96-2602	Sm Cs/50
96-0867	Md Cs/100 10 Pks/10	96-2604	Md Cs/50
96-0877	Lg Cs/100 10 Pks/10	96-2606	Lg Cs/50

Sklar Blue™ ELECTROSURGICAL

Autoclavable



SKLAR BLUE™ GRAVES VAGINAL SPECULUM

With permanent smoke evacuation tube

91-5020	3" x 3/4"	Small
91-5022	4" x 1 1/4"	Medium
91-5024	4 1/2" x 1 3/8"	Large
91-5028	4 3/4" x 1 1/2"	Extra Large

Sklar Black™ LASER

Autoclavable



LASER GRAVES VAGINAL SPECULUM

With permanent smoke evacuation tube

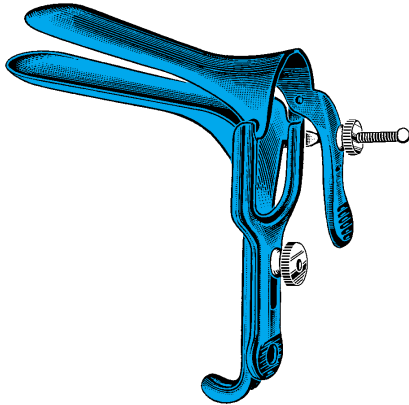
90-9015	3" x 3/4"	Small
90-9016	4" x 1 1/4"	Medium
90-9018	4 1/2" x 1 3/8"	Large
90-9020	4 3/4" x 1 1/2"	Extra Large

GYNECOLOGICAL INSTRUMENTS SPECULUM



Sklar Blue™
ELECTROSURGICAL

Autoclavable



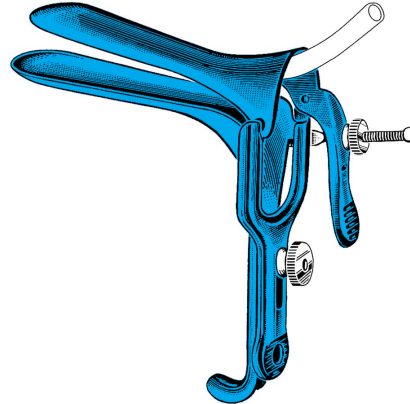
SKLAR BLUE™ GRAVES VAGINAL SPECULUM

Without Tube or Ring

91-5060	3" x 3/4"	Small
91-5062	4" x 1 1/4"	Medium
91-5064	4 1/2" x 1 3/8"	Large
91-5066	2 3/4" x 5/8"	Extra Small
91-5068	4 3/4" x 1 1/2"	Extra Large

Sklar Blue™
ELECTROSURGICAL

Autoclavable



SKLAR BLUE™ GRAVES VAGINAL SPECULUM

With slip rings for disposable smoke evacuation tube

91-5010	3" x 3/4"	Small
91-5012	4" x 1 1/4"	Medium
91-5014	4 1/2" x 1 3/8"	Large
91-5015	2 3/4" x 5/8"	Extra Small
91-5018	4 3/4" x 1 1/2"	Extra Large

Sklar Black™
LASER

Autoclavable



LASER GRAVES VAGINAL SPECULUM

Without Tube or Ring

90-3804	3" x 3/4"	Small
90-3806	4" x 1 1/4"	Medium
90-3808	4 1/2" x 1 3/8"	Large
90-3812	2 3/4" x 5/8"	Extra Small
90-3810	4 3/4" x 1 1/2"	Extra Large

Sklar Black™
LASER

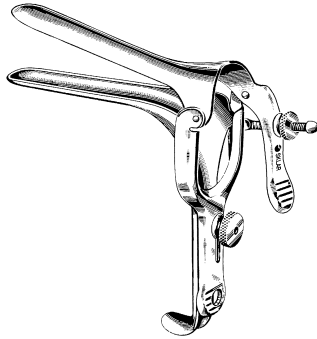
Autoclavable



LASER GRAVES VAGINAL SPECULUM

With slip rings for disposable smoke evacuation tube

90-9000	3" x 3/4"	Small
90-9002	4" x 1 1/4"	Medium
90-9004	4 1/2" x 1 3/8"	Large
90-9005	2 3/4" x 5/8"	Extra Small
90-9006	4 3/4" x 1 1/2"	Extra Large

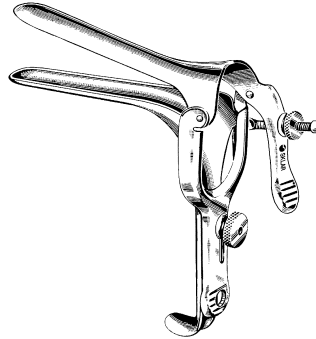


OR GRADE

PEDERSON VAGINAL SPECULUM

Narrow Blades

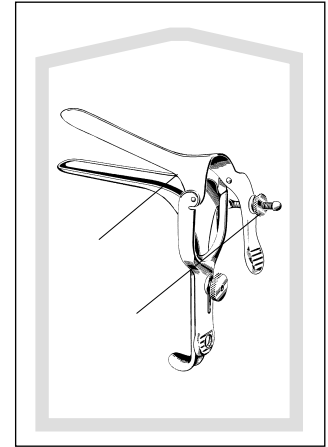
90-3710	3" x 1/2"	Small
90-3713	4" x 3/8"	Medium
90-3711	4 3/4" x 1"	Large
90-3849	2 3/4" x 1/2"	Extra Small
90-3851	4 3/4" x 1 3/8"	Extra Large
90-3712	4" x 3/4"	Slender



MID-GRADE

PEDERSON VAGINAL SPECULUM

95-347	3" x 1/2"	Small
95-348	4" x 3/8"	Medium
95-362	4 3/4" x 1"	Large



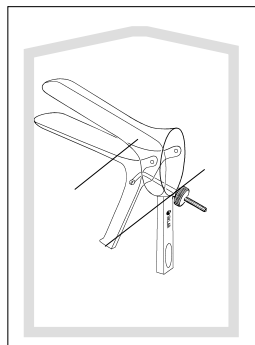
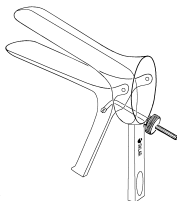
FLOOR-GRADE, STERILE

PEDERSON VAGINAL SPECULUM, STERILE

Box/25		
96-2613	3" x 1/2"	Small
96-2615	4" x 3/8"	Medium
96-2617	4 3/4" x 1"	Large

Sklar Lubricating Jelly

96-1615 Case 48/4 oz. Bottles



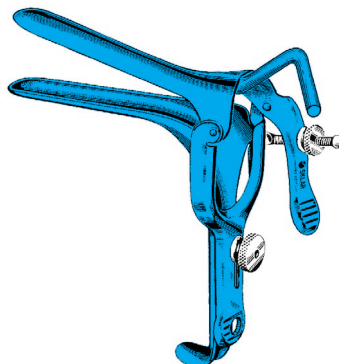
STERILE

PLASTIC VAGINAL SPECULUM, CUSCO STYLE

Disposable (Non-Sterile)		Disposable (Sterile)	
96-0557	Sm Cs/100 10 Pks/10	96-2642	Sm Cs/50
96-0567	Md Cs/100 10 Pks/10	96-2644	Md Cs/50
96-0577	Lg Cs/100 10 Pks/10	96-2648	Lg Cs/50

Sklar Blue™ ELECTROSURGICAL

Autoclavable



SKLAR BLUE™ PEDERSON VAGINAL SPECULUM

With permanent smoke evacuation tube

91-5042	3" x 1/2"	Small
91-5044	4" x 3/8"	Medium
91-5046	4 3/4" x 1"	Large
91-5047	4 3/4" x 1 3/8"	Extra Large
91-5050	4" x 3/4"	Slender

Sklar Black™ LASER

Autoclavable



LASER PEDERSON VAGINAL SPECULUM

With permanent smoke evacuation tube

90-9040	3" x 1/2"	Small
90-9042	4" x 3/8"	Medium
90-9044	4 3/4" x 1"	Large
90-9048	4 3/4" x 1 3/8"	Extra Large
90-9050	4" x 3/4"	Slender

GYNECOLOGICAL INSTRUMENTS SPECULUM



Sklar Blue™
ELECTROSURGICAL

Autoclavable



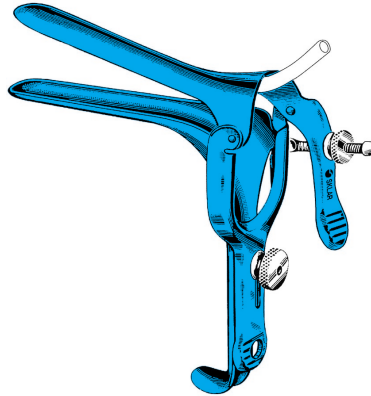
SKLAR BLUE™ PEDERSON VAGINAL SPECULUM

Without Tube or Ring

91-5082	3" x 1/2"	Small
91-5084	4" x 3/8"	Medium
91-5086	4 3/4" x 1"	Large
91-5088	2 3/4" x 1/2"	Extra Small
91-5092	4" x 3/8"	Slender

Sklar Blue™
ELECTROSURGICAL

Autoclavable



SKLAR BLUE™ PEDERSON VAGINAL SPECULUM

With slip rings for disposable smoke evacuation tube

91-5032	3" x 1/2"	Small
91-5034	4" x 3/8"	Medium
91-5036	4 3/4" x 1"	Large
91-5038	2 3/4" x 1/2"	Extra Small
91-5040	4" x 3/8"	Slender

Sklar Black™
LASER

Autoclavable



LASER PEDERSON VAGINAL SPECULUM

Without Tube or Ring

90-3833	3" x 1/2"	Small
90-3839	4" x 3/8"	Medium
90-3835	4 3/4" x 1"	Large
90-3837	4" x 3/8"	Slender
90-3841	2 3/4" x 1/2"	Extra Small

Sklar Black™
LASER

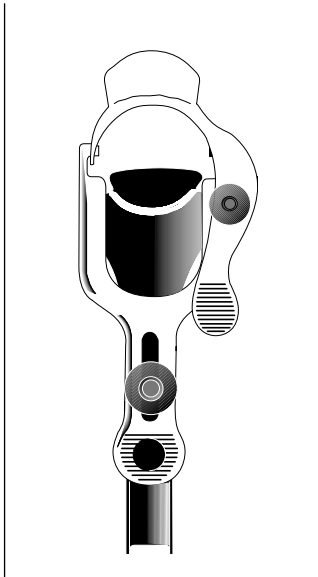
Autoclavable



LASER PEDERSON VAGINAL SPECULUM

With slip rings for disposable smoke evacuation tube

90-9030	3" x 1/2"	Small
90-9032	4" x 3/8"	Medium
90-9034	4 3/4" x 1"	Large
90-9038	4" x 3/8"	Slender
90-9035	2 3/4" x 1/2"	Extra Small



GRAVES VAGINAL SPECULUM WIDE VIEW PATTERN

With large proximal opening for instrumentation

90-3705 4" x 1 1/4" Medium



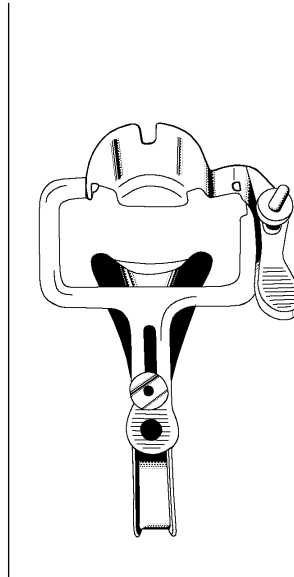
Sklar Blue™
ELECTROSURGICAL

Autoclavable

SKLAR BLUE™ GRAVES VAGINAL SPECULUM WIDE VIEW PATTERN

With large proximal opening for instrumentation

91-5080 4" x 1 1/4" Medium, With loops for holding and directing Smoke Evacuation Tubing



GRAVES OB-VIEW VAGINAL SPECULUM

90-3740 4" x 1 1/4" Medium
90-3741 4 3/4" x 1 1/2" Large



Sklar Blue™
ELECTROSURGICAL

Autoclavable

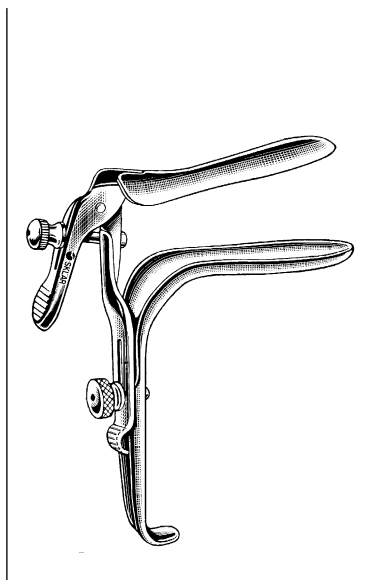
SKLAR BLUE™ GRAVES OB-VIEW VAGINAL SPECULUM

91-3740 4" x 1 1/4" Medium
91-3741 4 3/4" x 1 1/2" Large

Both With Permanent Smoke Evacuation Tubing (not illustrated)

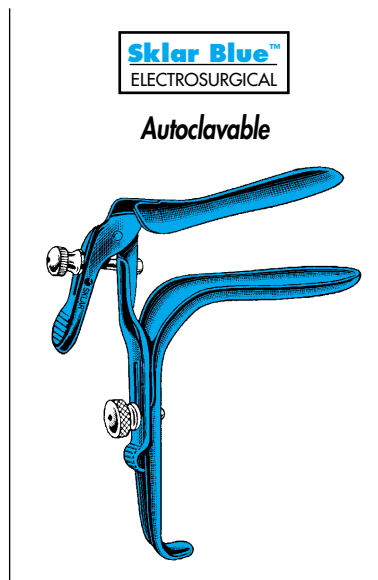
Sklar Lubricating Jelly

96-1610 Case of 4 boxes (Box 150/5 gm Packets)



FREEWAY GRAVES VAGINAL SPECULUM

Open Side 90° Angle
90-3750 4" x 1 1/4"

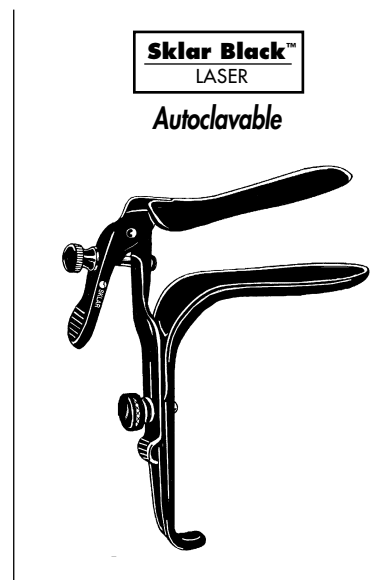


Sklar Blue™
ELECTROSURGICAL

Autoclavable

SKLAR BLUE™ FREEWAY GRAVES VAGINAL SPECULUM

Open Side 90° Angle
91-5160 4" x 1 1/4" with permanent smoke evacuation tube (not illustrated)



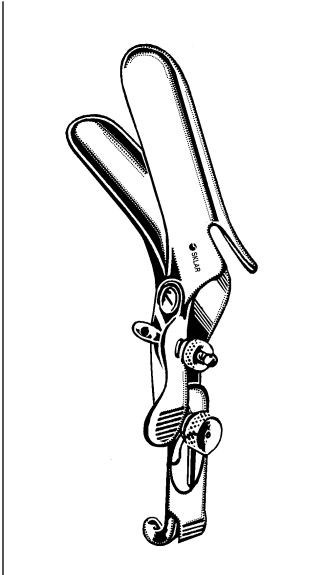
Sklar Black™
LASER

Autoclavable

LASER FREEWAY GRAVES VAGINAL SPECULUM

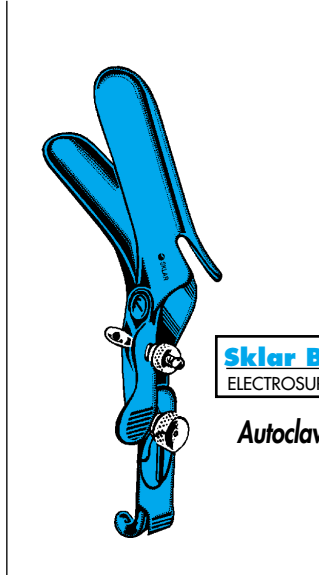
Open Side, 90° Angle
90-3754 4" x 1 1/4" with permanent smoke evacuation tube (not illustrated)
90-3755 4" x 1 1/4" with loop to hold and direct disposable smoke evacuation tubing

GYNECOLOGICAL INSTRUMENTS SPECULUM



FREEWAY GRAVES VAGINAL SPECULUM

Open Side, 45° Angle
90-3752 4" x 1 1/4"

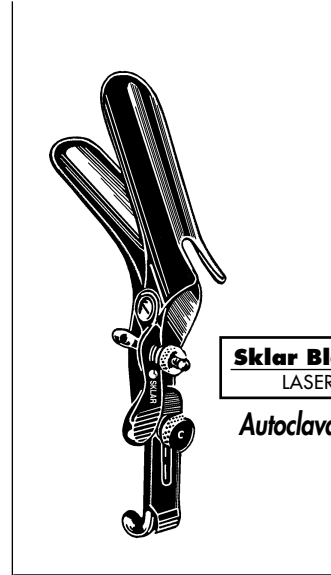


Sklar Blue™
ELECTROSURGICAL

Autoclavable

SKLAR BLUE™ FREEWAY GRAVES VAGINAL SPECULUM

Open Side, 45° Angle
91-5162 4" x 1 1/4" with permanent smoke
evacuation tube (not illustrated)

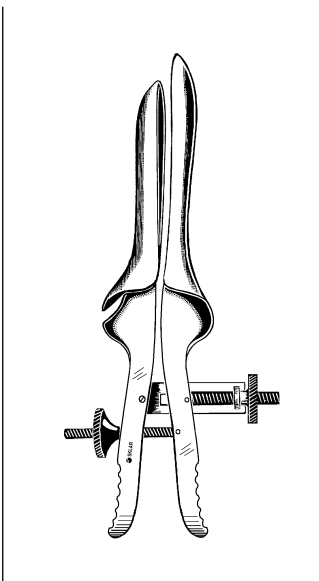


Sklar Black™
LASER

Autoclavable

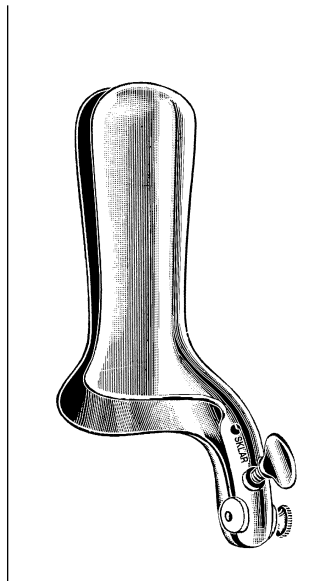
LASER FREEWAY GRAVES VAGINAL SPECULUM

Open Side, 45° Angle
90-3814 4" x 1 1/4" with permanent smoke
evacuation tube (not illustrated)
90-3815 4" x 1 1/4" with loop to hold and direct
disposable smoke evacuation tubing



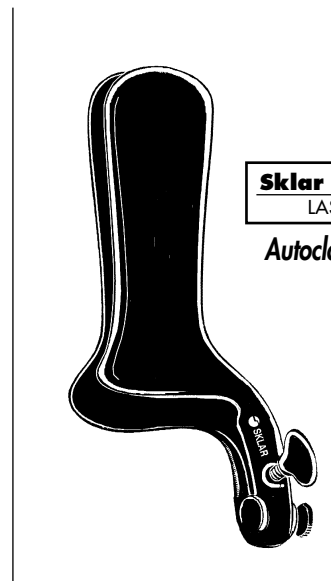
DE VILBISS VAGINAL SPECULUM

(Miller)
90-3865 4 x 1 1/4" Blades Parallel Opening



COLLIN VAGINAL SPECULUM

90-3945 4 1/4" x 1 1/4" Blades



Sklar Black™
LASER

Autoclavable

LASER COLLIN VAGINAL SPECULUM

90-3946 4 1/4" x 1 1/4" Blades



CUSCO VAGINAL SPECULUM

90-3957	3" x 1 1/4"	Small
90-3959	3 1/2" x 1 1/2"	Medium
90-3960	3 3/4" x 1 3/4"	Large

Sklar Blue™
ELECTROSURGICAL

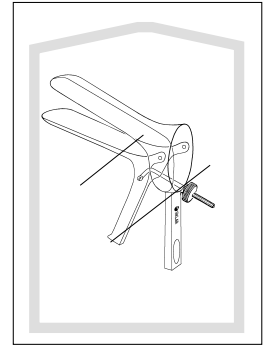
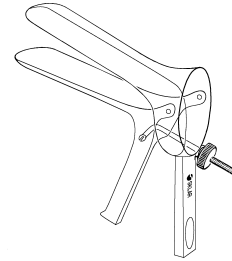
Autoclavable



SKLAR BLUE™ CUSCO VAGINAL SPECULUM

91-5150	3" x 1 1/4"	Small
91-5152	3 1/2" x 1 1/2"	Medium
91-5154	3 3/4" x 1 3/4"	Large

All with permanent smoke evacuation tube



STERILE

PLASTIC VAGINAL SPECULUM, CUSCO STYLE

Disposable (Non-Sterile)

96-0557	Sm	Cs/100	10 Pks /10
96-0567	Md	Cs/100	10 Pks /10
96-0577	Lg	Cs/100	10 Pks /10

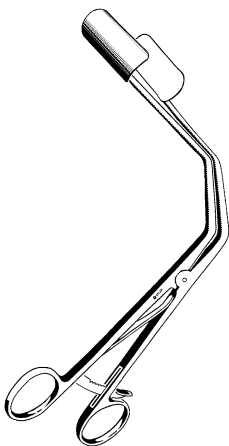
Disposable (Sterile)

96-2642	Sm	Cs/50
96-2644	Md	Cs/50
96-2648	Lg	Cs/50



Sklar Lubricating Jelly

96-1615 Case 48/4 oz. Bottles



LATERAL VAGINAL RETRACTOR

Ratchet Handle

90-3980 Blades Fit inside Vaginal Speculum

Sklar Blue™
ELECTROSURGICAL

Autoclavable



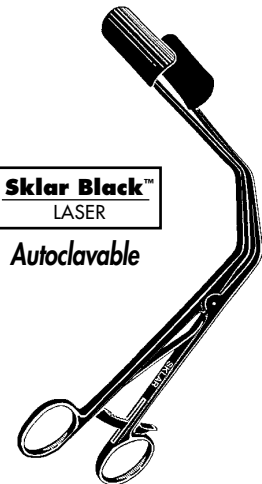
SKLAR BLUE™ LATERAL VAGINAL RETRACTOR

Ratchet Handle

91-5190 Blades Fit inside Vaginal Speculum

Sklar Black™
LASER

Autoclavable

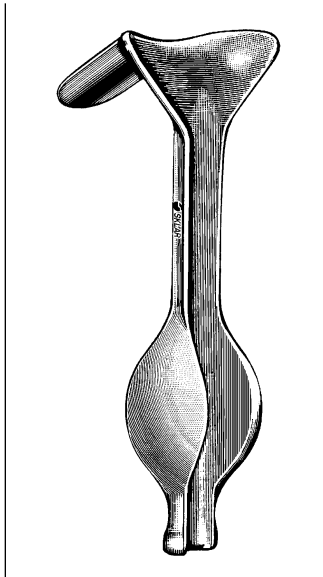


LASER LATERAL VAGINAL RETRACTOR

Ratchet Handle

90-8845 Blades Fit inside Vaginal Speculum

GYNECOLOGICAL INSTRUMENTS SPECULUM



AUVARD WEIGHTED VAGINAL SPECULUM

Blades 2 3/4" x 1 1/2"

- | | | |
|---------|--------|------------|
| 90-3525 | Light | 2 lbs. |
| 90-3526 | Medium | 2 1/2 lbs. |
| 90-3527 | Heavy | 3 lbs. |

Extra Long Blades 4" x 1 3/4"

- | | | |
|---------|--------|------------|
| 90-3530 | Medium | 2 1/2 lbs. |
|---------|--------|------------|



Sklar Blue™
ELECTROSURGICAL

Autoclavable

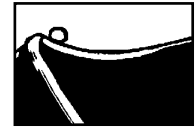
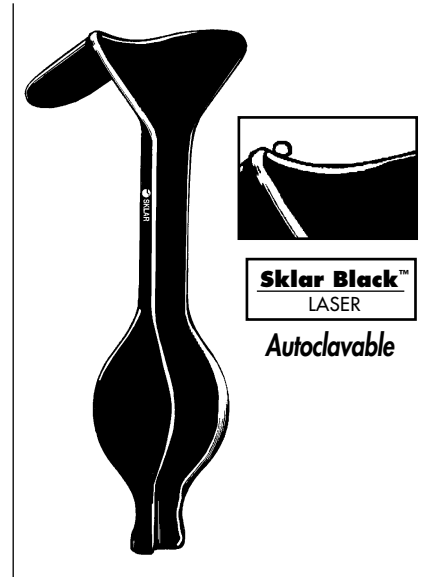
SKLAR BLUE™ AUVARD VAGINAL SPECULUM

Blades 2 3/4" x 1 1/2"

- | | | |
|---------|--------|--|
| 91-5120 | Medium | 2 1/2 lbs. |
| 91-5122 | Medium | 2 1/2 lbs., with loop to hold and direct disposable evacuation tubing. |

Large Blade 4" x 1 3/4"

- | | | |
|---------|--------|--|
| 91-5130 | Medium | 2 1/2 lbs. |
| 91-5132 | Medium | 2 1/2 lbs., with loop to hold and direct disposable evacuation tubing. |



Sklar Black™
LASER

Autoclavable

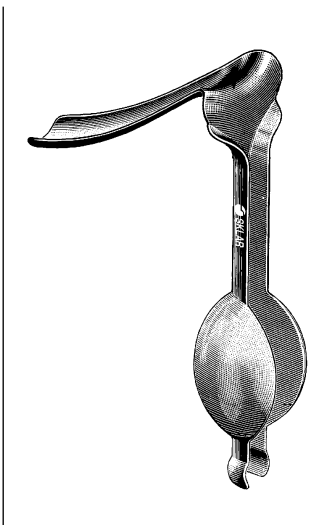
LASER AUVARD VAGINAL SPECULUM

Blades 2 3/4" x 1 1/2"

- | | | |
|---------|--------|--|
| 90-9100 | Medium | 2 1/2 lbs. Without loop |
| 90-9102 | Medium | 2 1/2 lbs., With loop to hold and direct disposable evacuation tubing. |

Large Blade 4" x 1 3/4"

- | | | |
|---------|--------|--|
| 90-9106 | Medium | 2 1/2 lbs. Without loop |
| 90-9108 | Medium | 2 1/2 lbs., With loop to hold and direct disposable evacuation tubing. |



STEINER-AUVARD WEIGHTED VAGINAL SPECULUM

Blades 5 1/2" x 1 1/4"

- | | |
|---------|------------|
| 90-3559 | 2 1/2 lbs. |
|---------|------------|



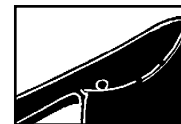
Sklar Blue™
ELECTROSURGICAL

Autoclavable

SKLAR BLUE™ STEINER-AUVARD VAGINAL SPECULUM

Extra long Blade 5 1/2" x 1 1/4"

- | | |
|---------|---|
| 91-5140 | 2 1/2 lbs. |
| 91-5142 | 2 1/2 lbs. With loop to hold and direct disposable evacuation tubing. |



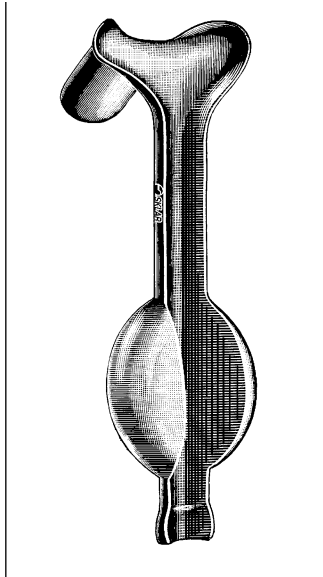
Sklar Black™
LASER

Autoclavable

LASER STEINER-AUVARD VAGINAL SPECULUM

Blades 5 1/2" x 1 1/4"

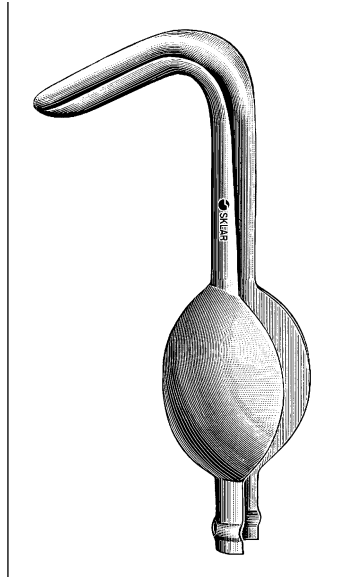
- | | |
|---------|--|
| 90-3560 | 2 1/2 lbs. Without loop |
| 90-3561 | 2 1/2 lbs., With loop to hold and direct disposable evacuation tubing. |



**GARRIGUE WEIGHTED
VAGINAL SPECULUM**

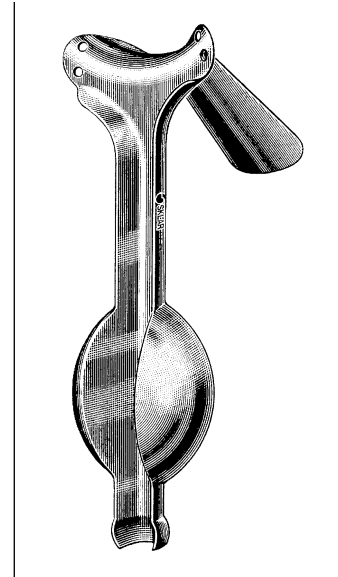
Blades 3" x 1 1/2"

90-3535 Light 2 lbs.
90-3536 Medium 2 1/2 lbs.
90-3537 Heavy 3 lbs.



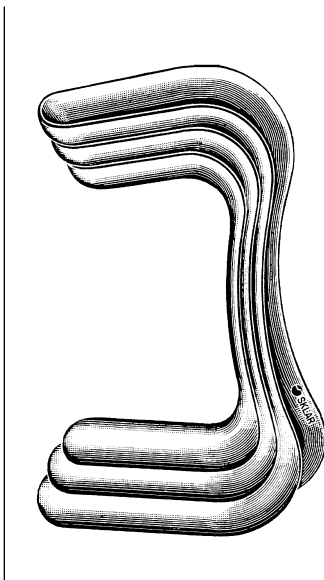
**HENROTIN WEIGHTED
VAGINAL SPECULUM**

90-3555 3 lbs. 3/4" x 1 1/4"
Blade Angled Down



**BERLIND-AUVARD
WEIGHTED VAGINAL
SPECULUM**

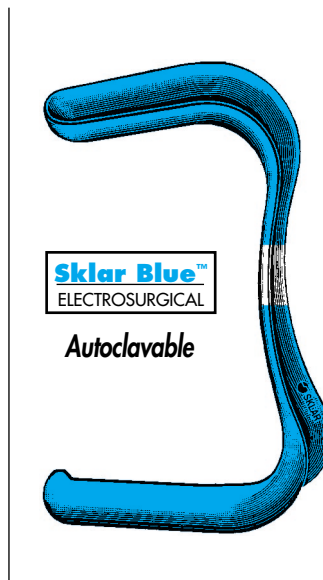
90-3558 2 1/2 lbs. 4/4" x 1 3/8"



**SIMS VAGINAL
RETRACTOR**

Double End

90-3150 3/8" x 2 1/2" and 1" x 3" #1
90-3151 1" x 2 1/2" and 1 1/4" x 3" #2
90-3152 1" x 3" and 1 1/2" x 3 1/4" #3
90-3153 1 1/4" x 3" and 1 1/2" x 3 3/4" #4
90-3154 1 1/4" x 3 3/4" and 1 1/2" x 4" #5



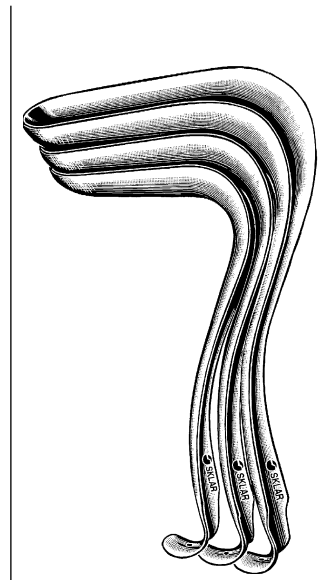
Sklar Blue™
ELECTROSURGICAL

Autoclavable

**SKLAR BLUE™ SIMS
RETRACTOR**

Double End

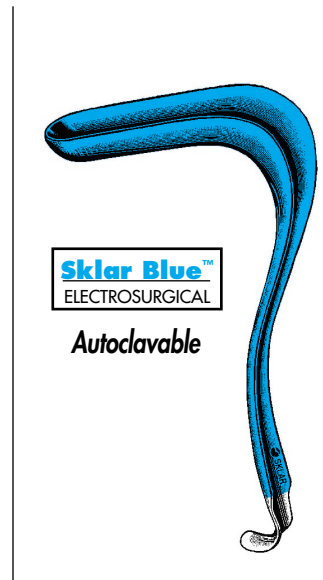
91-5210 Medium
91-5212 Medium, With loop to
hold and direct disposable
smoke evacuation tubing.



**SIMS VAGINAL
RETRACTOR**

Single end

90-3225 2 1/2" x 1" Small
90-3230 3" x 1 1/4" Medium
90-3235 3 1/2" x 1 1/2" Large



Sklar Blue™
ELECTROSURGICAL

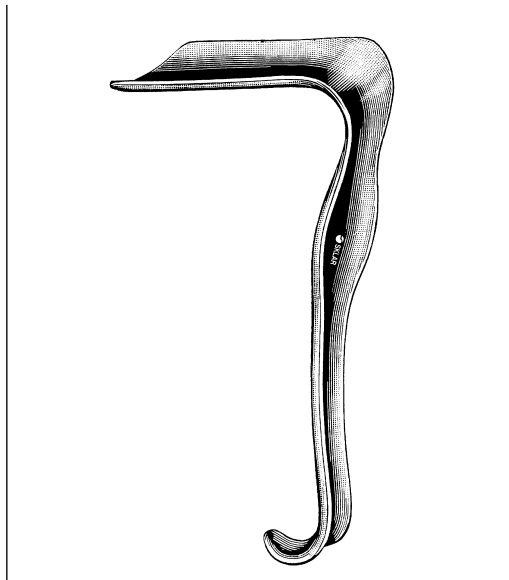
Autoclavable

SKLAR BLUE™ SIMS RETRACTOR

Single End

91-5200 Medium 3" x 1 1/4"
91-5202 Medium, With loop to
hold and direct disposable
smoke evacuation tubing.

GYNECOLOGICAL INSTRUMENTS RETRACTORS



JACKSON VAGINAL RETRACTOR

Single End

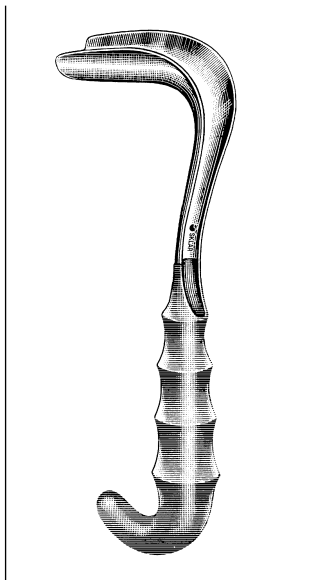
90-3130	3" x 1½"	Small
90-3135	3½" x 1½"	Medium
90-3140	4" x 1½"	Large



LASER JACKSON VAGINAL RETRACTOR

Single End

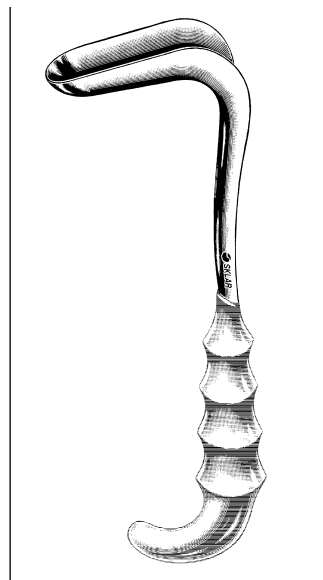
90-9065	3½" x 1½"	Medium with permanent smoke evacuation tube
90-9066	3½" x 1½"	With loop to hold and direct disposable smoke evacuation tubing
90-9067	4" x 1½"	Large with permanent smoke evacuation tube
90-9068	4" x 1½"	With loop to hold and direct disposable smoke evacuation tubing



SIMS-KELLY VAGINAL RETRACTOR

Sklar-Grip Handle

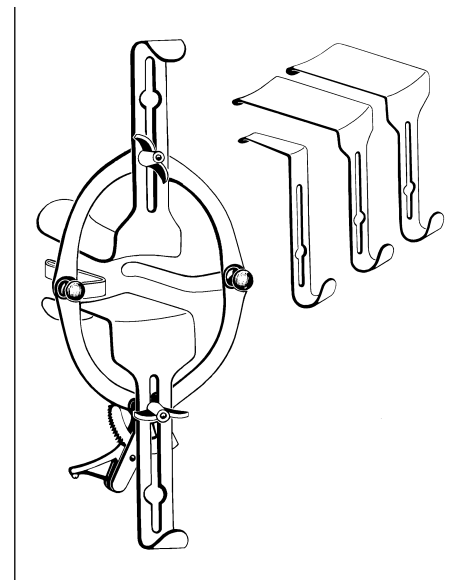
90-3422	2¼" x 1"	Small
90-3427	2½" x 1¼"	Medium
90-3430	3" x 1½"	Large



SIMS VAGINAL RETRACTOR

Sklar-Grip Handle

90-3327	2¼" x 1"	Small
90-3330	3" x 1¼"	Medium
90-3335	3½" x 1½"	Large

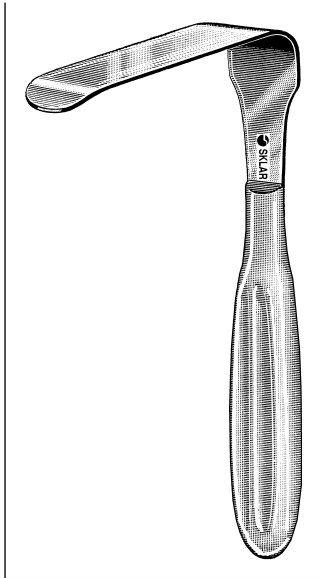


O'SULLIVAN-O'CONNOR VAGINAL RETRACTOR

90-3045

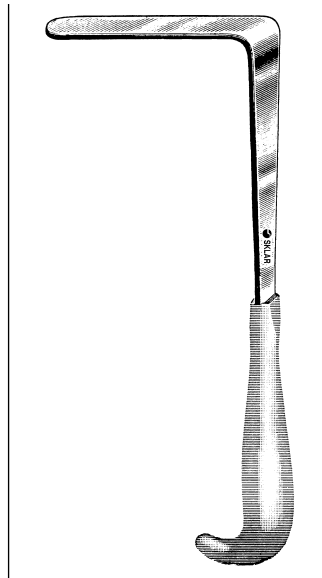
With 3 Interchangeable Blades

1½" x ¾"	Small Blade
3" x 1½"	Medium Blade
3½" x 1¾"	Large Blade



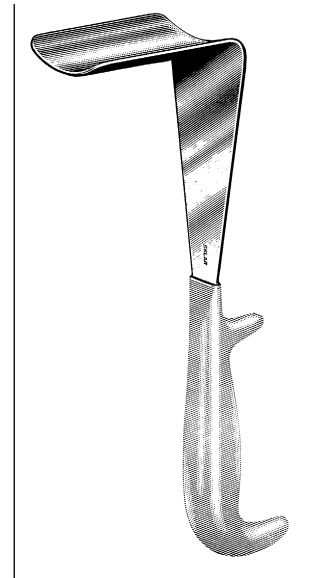
**BRANTLEY-TURNER
VAGINAL RETRACTOR**

90-3470 7" 4" x 1 1/4" Blade



**PRYOR-PEAN VAGINAL
RETRACTOR**

90-3510 10 1/4" 4 1/4" x 1" Blade



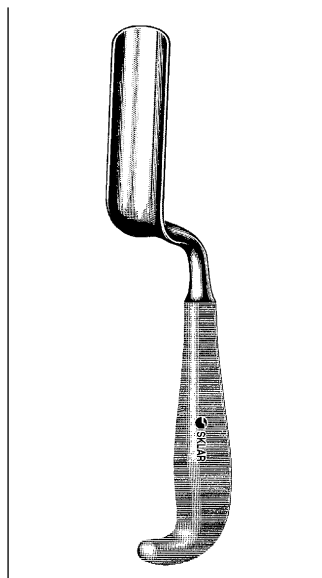
DOYEN RETRACTOR

60-2185	8 1/2"	1 3/4" x 2 1/2"	Small
60-2190	8 1/2"	2 1/8" x 3"	Medium
60-2195	8 1/2"	2 1/4" x 3 1/2"	Large



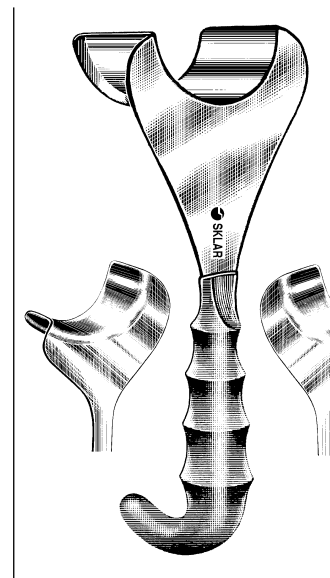
SECOND VAGINAL SPATULA

90-3610 10 1/2" 4 3/4" x 1 1/4"



**TAUBER VAGINAL
SPATULA**

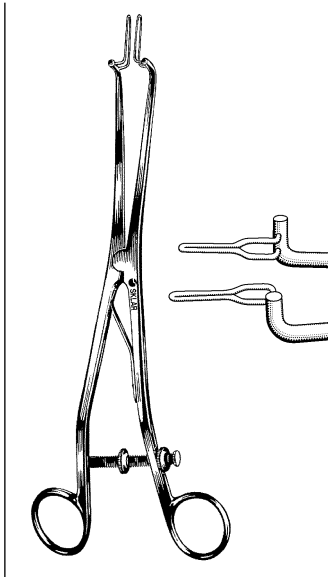
90-3692 9 1/4" 3 1/2" x 1 1/4"



DELEE RETRACTOR

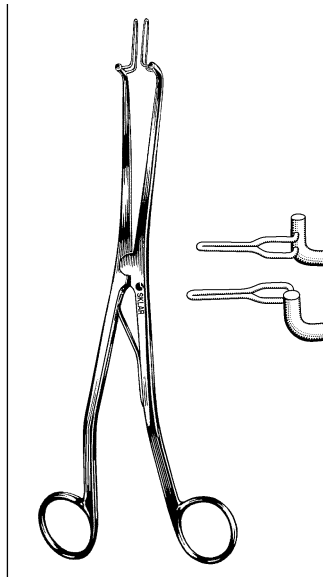
Right	
90-3450	2 3/4" x 2"
Left	
90-3451	2 3/4" x 2"
Universal	
90-3452	2 3/4" x 2"

GYNECOLOGICAL INSTRUMENTS ENDOSPECULUM



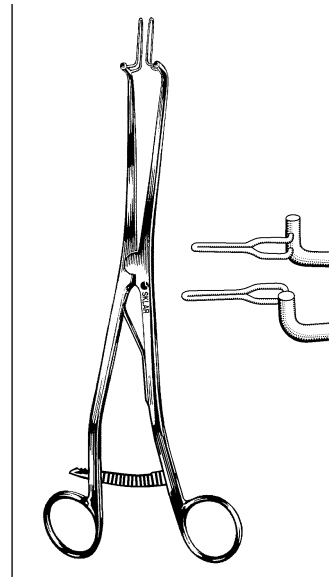
KOGAN ENDOCERVICAL SPECULUM

With Gauge and Screws
90-3990 Narrow Wire Blades



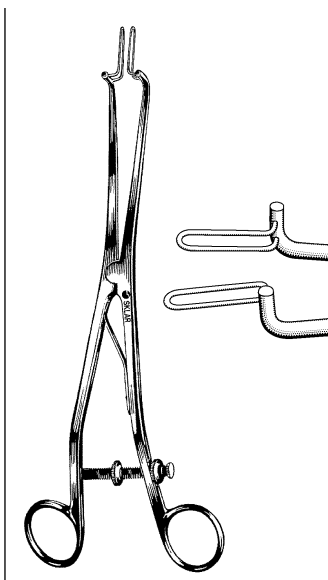
KOGAN ENDOCERVICAL SPECULUM

With Spring Handle
90-3996 Narrow Wire Blades



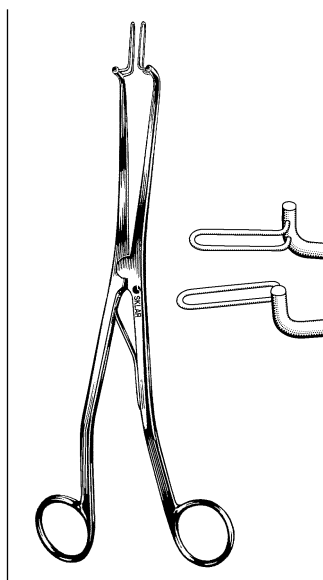
KOGAN ENDOCERVICAL SPECULUM

With Ratchet Handle
90-3997 Narrow Wire Blades



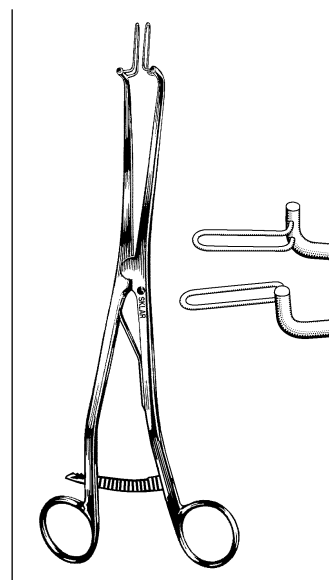
KOGAN ENDOCERVICAL SPECULUM

With Gauge and Screws
90-3995 Wide Wire Blades



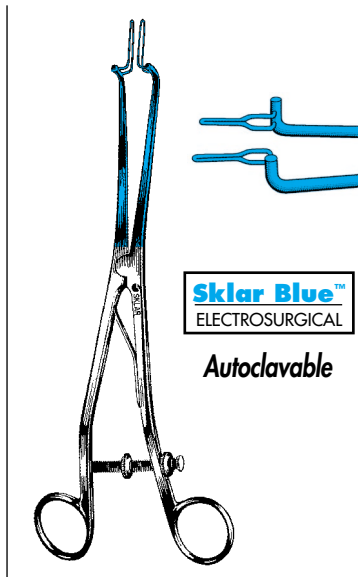
KOGAN ENDOCERVICAL SPECULUM

With Spring Handle
90-3994 Wide Wire Blades



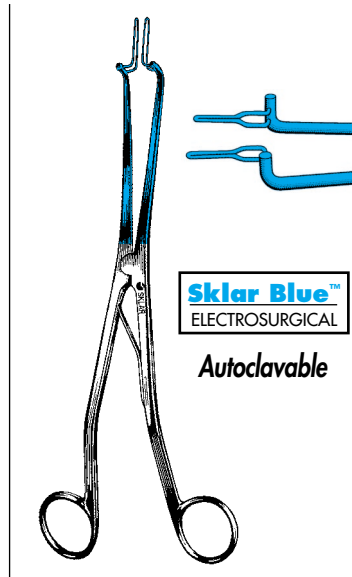
KOGAN ENDOCERVICAL SPECULUM

With Ratchet Handle
90-3998 Wide Wire Blades



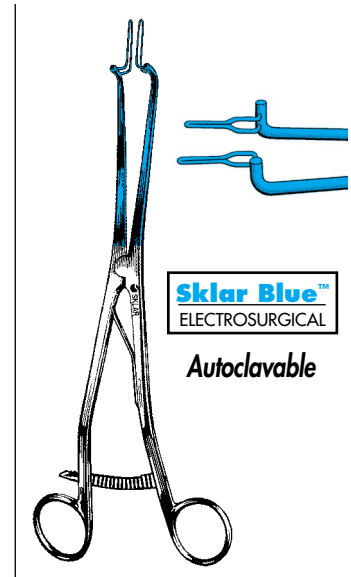
**SKLAR BLUE™ KOGAN
ENDOSPECULUM**

With Gauge and Screws
91-5230 Narrow Wire Blades



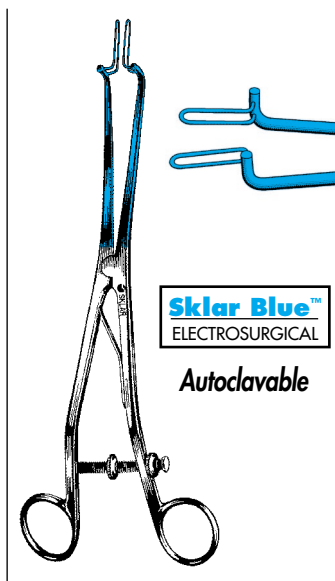
**SKLAR BLUE™ KOGAN
ENDOSPECULUM**

With Spring Handle
91-5228 Narrow Wire Blades



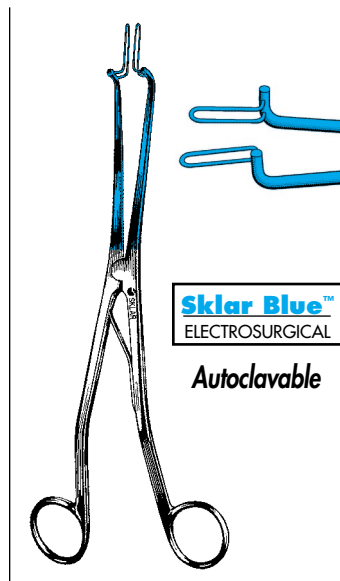
**SKLAR BLUE™ KOGAN
ENDOSPECULUM**

With Ratchet Handle
91-5235 Narrow Wire Blades



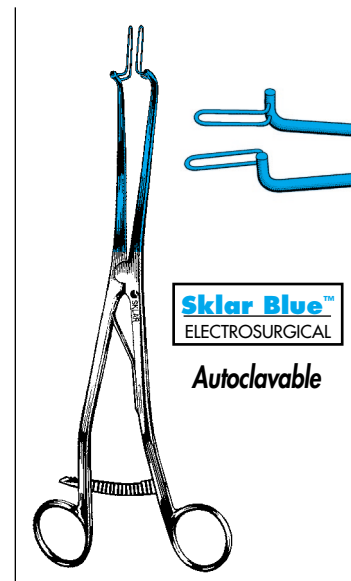
**SKLAR BLUE™ KOGAN
ENDOSPECULUM**

With Gauge and Screws
91-5232 Wide Wire Blades



**SKLAR BLUE™ KOGAN
ENDOSPECULUM**

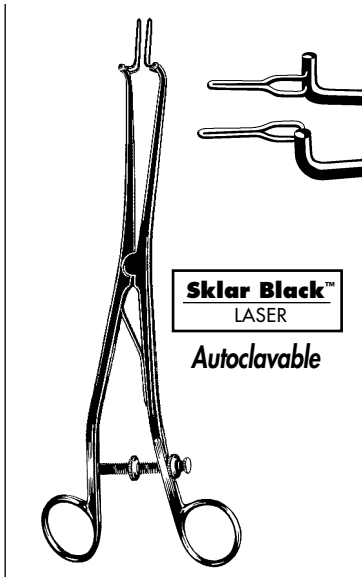
With Spring Handle
91-5226 Wide Wire Blades



**SKLAR BLUE™ KOGAN
ENDOSPECULUM**

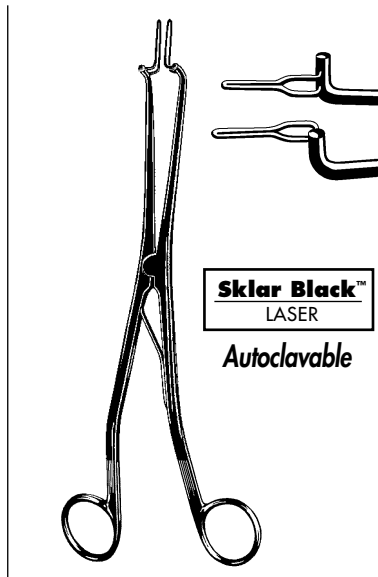
With Ratchet Handle
91-5234 Wide Wire Blades

GYNECOLOGICAL INSTRUMENTS ENDOSPECULUM



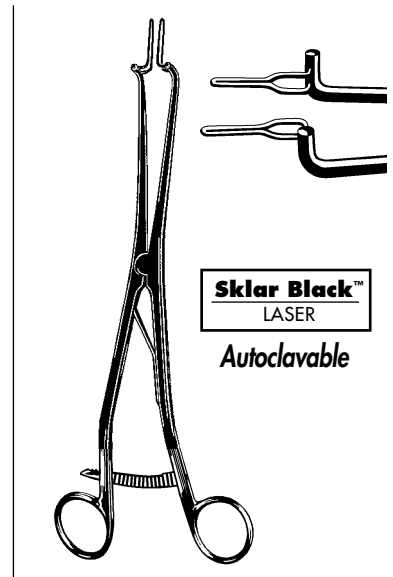
LASER KOGAN ENDOSPECULUM

With Gauge and Screws
90-8855 Narrow Wire Blades



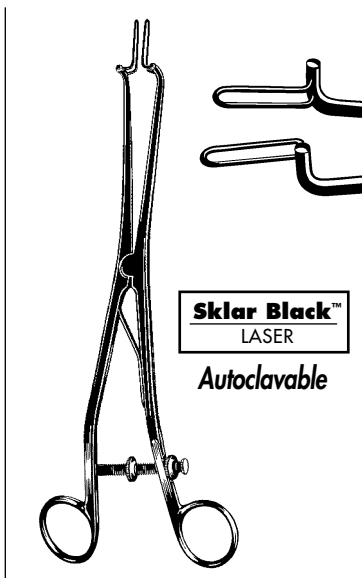
LASER KOGAN ENDOSPECULUM

With Spring Handle
90-8865 Narrow Wire Blades



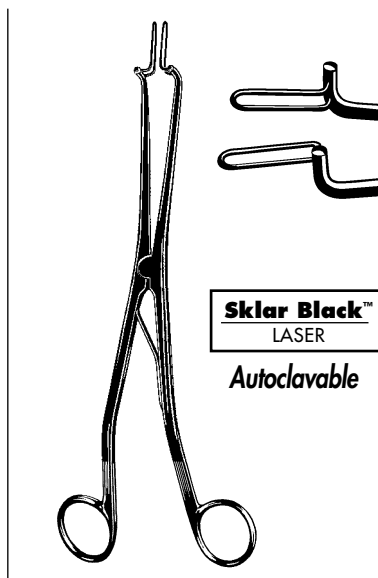
LASER KOGAN ENDOSPECULUM

With Ratchet Handle
90-8862 Narrow Wire Blades



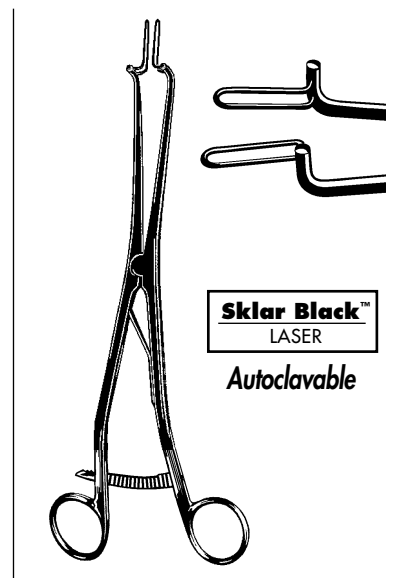
LASER KOGAN ENDOSPECULUM

With Gauge and Screws
90-8858 Wide Wire Blades



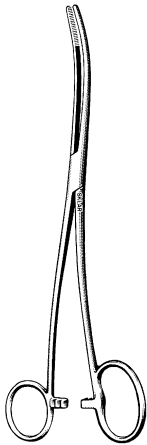
LASER KOGAN ENDOSPECULUM

With Spring Handle
90-8850 Wide Wire Blades



LASER KOGAN ENDOSPECULUM

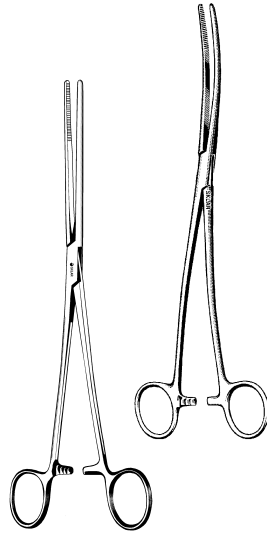
With Ratchet Handle
90-8860 Wide Wire Blades



OR GRADE

BOZEMAN FORCEPS

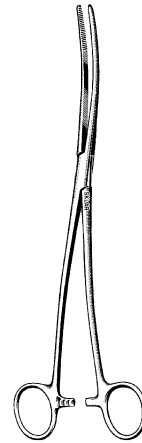
One Large Ring
90-7710 10 1/4" S-Curve



OR GRADE

BOZEMAN FORCEPS

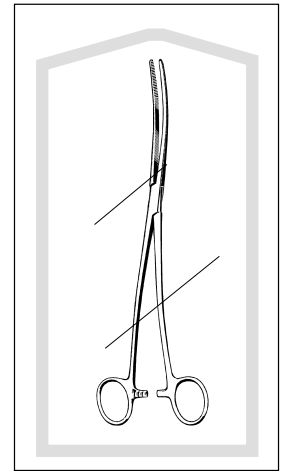
90-7610 10 1/2" Straight
80-1410 10 1/2" S-Curve
80-1419 10 1/2" S-Curve Heavy Pattern



MID-GRADE

BOZEMAN FORCEPS

95-374 10 1/2" S-Curve



FLOOR-GRADE, STERILE

BOZEMAN FORCEPS

Box/50
96-2620 10 1/2" S-Curve
Box/25
96-2622 10 1/2" S-Curve



Sklar Blue™
ELECTROSURGICAL

Autoclavable

SKLAR BLUE™ BOZEMAN FORCEPS

One Large Ring
91-5310 10 1/4" S-Curve



Sklar Blue™
ELECTROSURGICAL

Autoclavable

SKLAR BLUE™ BOZEMAN FORCEPS

91-5307 10 1/2" Straight
91-5308 10 1/2" S-Curve



Sklar Black™
LASER

Autoclavable

LASER BOZEMAN FORCEPS

One Large Ring
90-2342 10 1/4" S-Curve



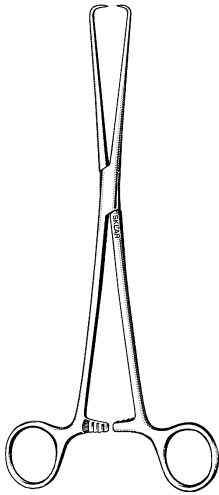
Sklar Black™
LASER

Autoclavable

LASER BOZEMAN FORCEPS

90-2340 10 1/2" S-Curve

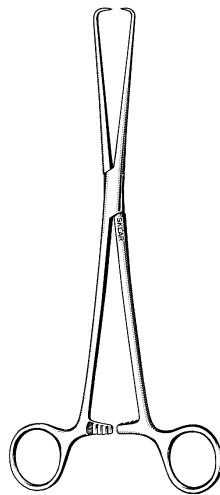
GYNECOLOGICAL INSTRUMENTS TENACULUM



OR GRADE

SCHROEDER TENACULUM FORCEPS

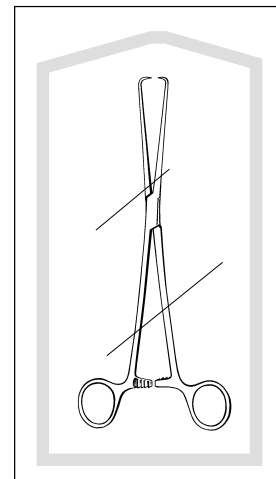
91-1290 9½" (Braun)
91-1298 10¼" (Pozzi)



MID-GRADE

SCHROEDER TENACULUM FORCEPS

95-386 9½"

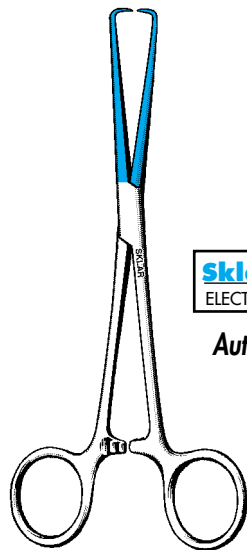


FLOOR-GRADE, STERILE

SCHROEDER TENACULUM FORCEPS

Box/50
96-2626 9½"

Box/25
96-2624 9½"

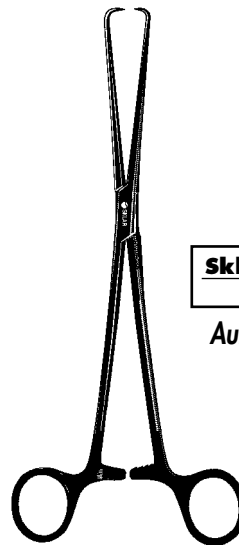


Sklar Blue™
ELECTROSURGICAL

Autoclavable

SKLAR BLUE™ SCHROEDER TENACULUM FORCEPS

91-5450 9½" (Braun)
91-5455 10¼" (Pozzi)

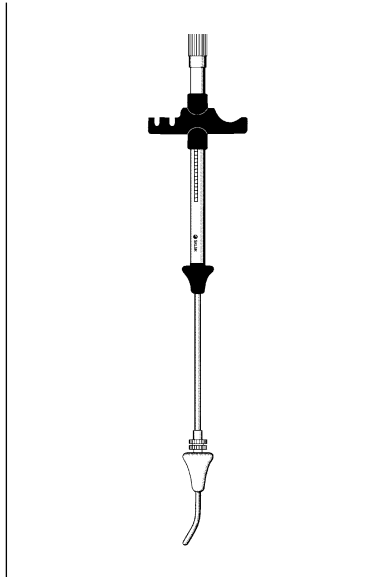


Sklar Black™
LASER

Autoclavable

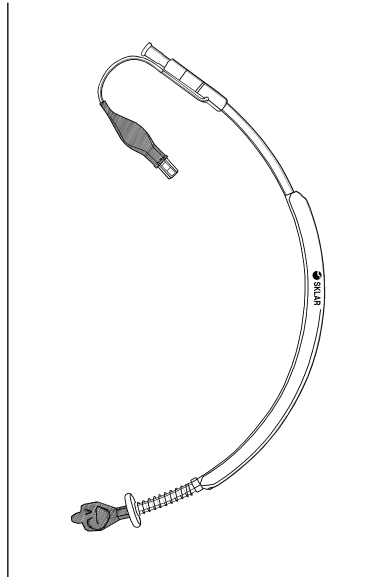
LASER SCHROEDER TENACULUM FORCEPS

90-2325 9½" (Braun)
90-2326 10¼" (Pozzi)



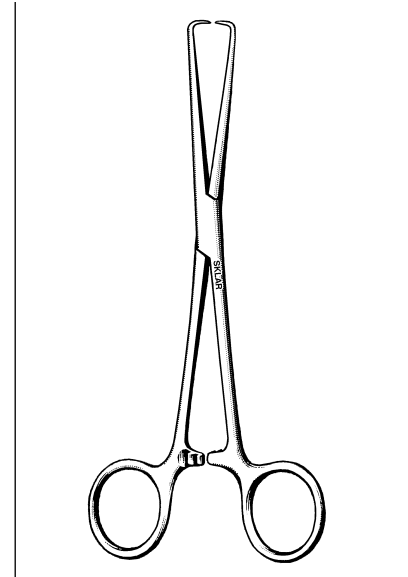
COHEN UTERINE MANIPULATOR

91-1293



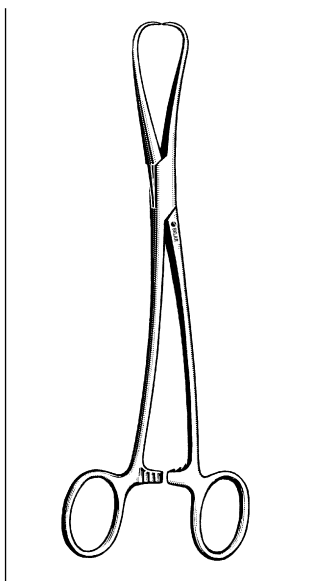
**UTERINE MANIPULATOR/
INJECTOR, DISPOSABLE**

96-4120 Case of 12, Sterile



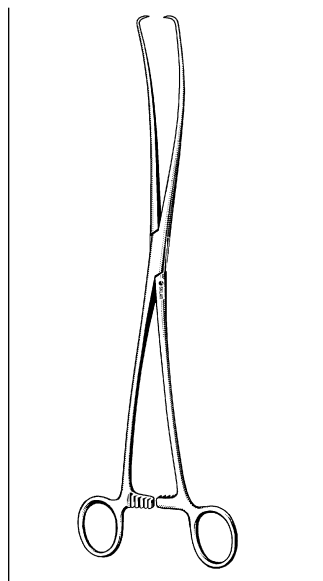
BARRETT TENACULUM FORCEPS

91-1070 7"
18-2257 5 1/4" Delicate



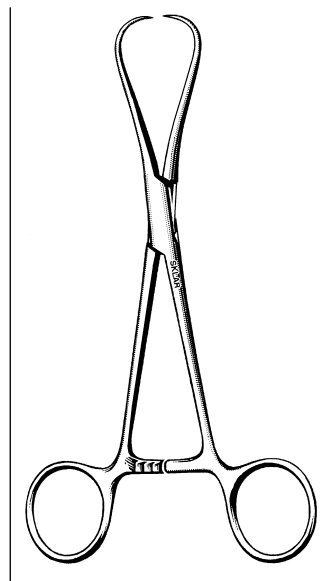
**JARCHO TENACULUM
FORCEPS**

91-1275 7 1/2" Double Curve



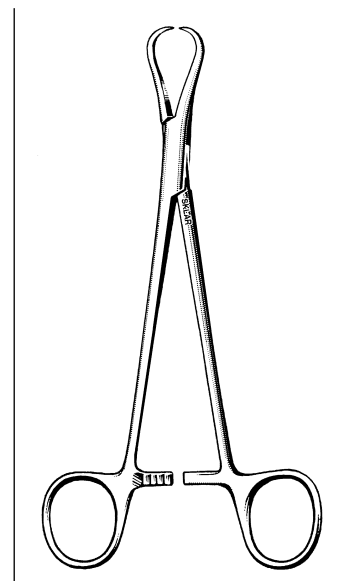
**DUPLAY TENACULUM
FORCEPS**

91-1111 11" S-Curve



**STAUDE TENACULUM
FORCEPS**

91-1455 5 1/2"

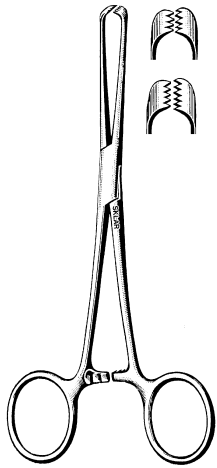


**ADAIR BREAST
TENACULUM FORCEPS**

36-1865 6 1/2"

Staude-Moore
91-1465 6 1/2"

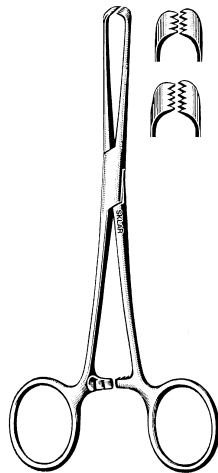
GYNECOLOGICAL INSTRUMENTS ALLIS FORCEPS



OR GRADE

ALLIS TISSUE FORCEPS

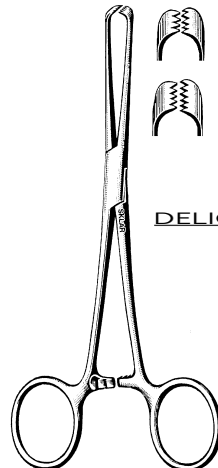
36-2060	6"	3 x 4
36-2160	6"	4 x 5
36-2260	6"	5 x 6
36-2275	7½"	5 x 6
36-2295	9½"	5 x 6



MID-GRADE

ALLIS TISSUE FORCEPS

95-934	6"	5 x 6
95-938	7½"	5 x 6

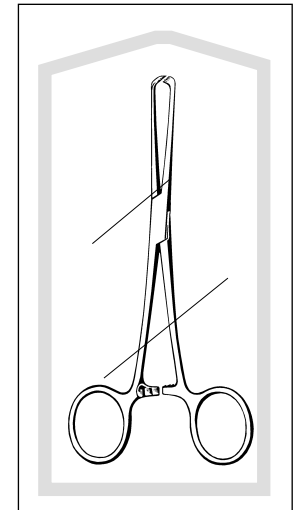


DELICATE

PREMIUM GRADE

ALLIS TISSUE FORCEPS DELICATE

18-2140	4"	4 x 5
18-2155	5"	4 x 5
18-2162	6"	4 x 5
18-2164	6"	5 x 6



FLOOR-GRADE, STERILE

ALLIS TISSUE FORCEPS

Box/50		
96-2576	6"	5 x 6
Box/25		
96-2575	6"	5 x 6

SKLARLITE™
WEIGHT TOUCH

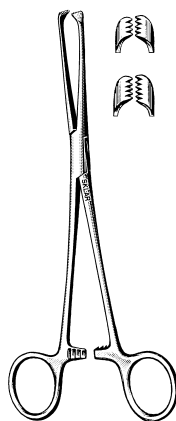


PREMIUM GRADE

SKLARLITE™ ALLIS TISSUE FORCEPS

23-2851	6"	4 x 5
23-2852	6"	5 x 6

SKLARLITE XD™
EXTRA DELICATE



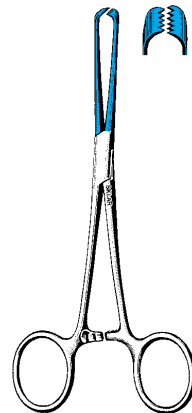
PREMIUM GRADE

SKLARLITE™ EXTRA DELICATE™ ALLIS TISSUE FORCEPS

23-2861	5"	4 x 5
23-2864	6"	4 x 5
23-2865	6"	5 x 6

Sklar Blue™
ELECTROSURGICAL

Autoclavable

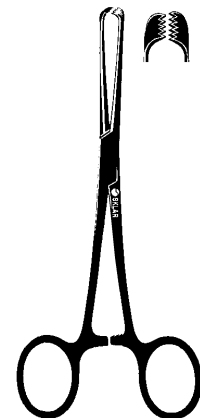


SKLAR BLUE ALLIS TISSUE FORCEPS

91-5278	7½"	5 x 6 Teeth
91-5440	9½"	5 x 6 Teeth

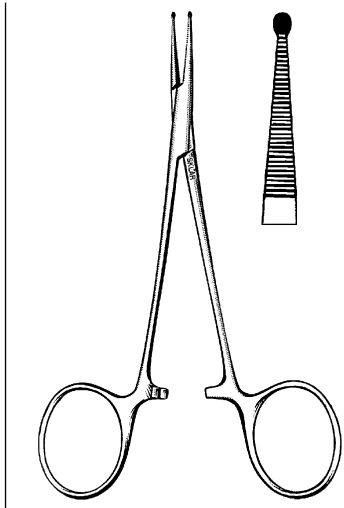
Sklar Black™
LASER

Autoclavable



LASER ALLIS FORCEPS

90-2276	7½"	5 x 6
90-2279	9½"	5 x 6



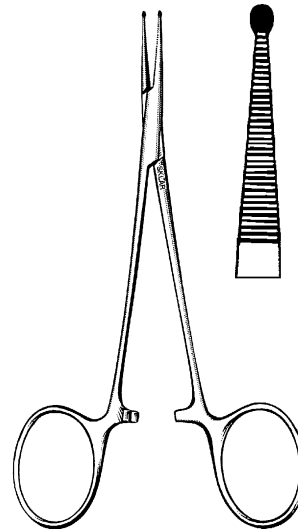
A newly designed and patented hemostatic forcep permits a less traumatic separation of the foreskin from the glans while performing newborn circumcisions. With the unique "bead tip" mosquito forcep it is nearly impossible to inadvertently enter the urethra or cause trauma to the glans. In addition, visualizing the bead through the skin makes it less likely to separate too much foreskin.

Patent # 5931843

MID-GRADE

DUNAWAY CIRCUMCISION FORCEPS

95-456 4" With Bead Tip



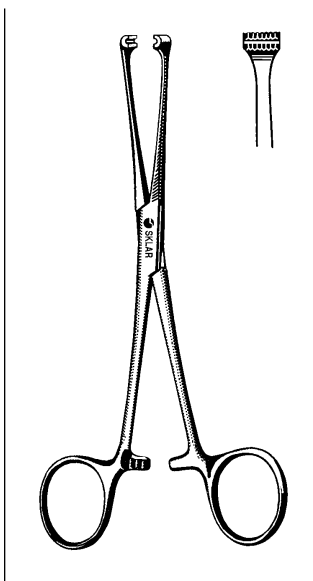
A newly designed and patented hemostatic forcep permits easier dissection of lipomas, cysts and other soft tissue masses. Available are 2.0 mm wide bead tips on six inch curved and six inch straight forceps. The smaller four inch bead tipped mosquito forcep is designed for newborn circumcisions.

Patent # 5931843

MID-GRADE

DUNAWAY DISSECTING FORCEPS

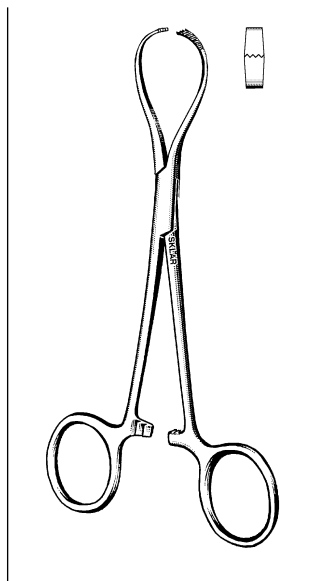
95-466 6" With Bead Tip Straight
95-467 6" With Bead Tip Curved



ALLIS FORCEPS

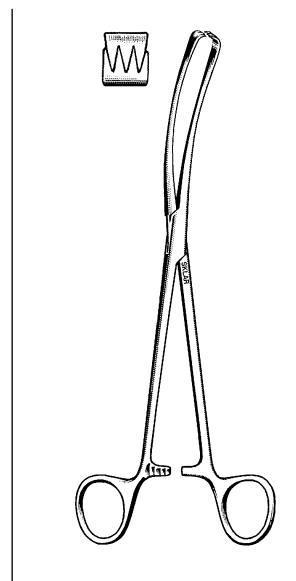
With Atraumatic Jaws

36-2298 6" Straight
36-2280 8" Straight
36-2385 10" Straight



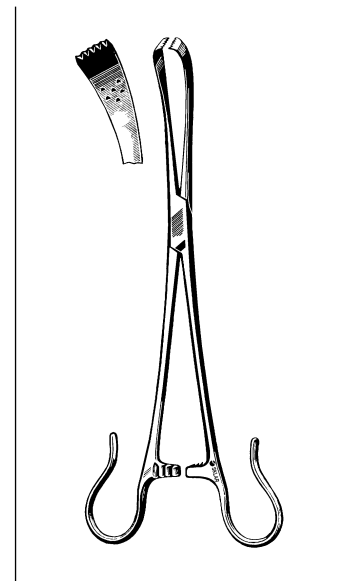
ABRAMSON-ALLIS FORCEPS

Small Jaw
91-1562 5 1/2"



TEALE VULSELLUM FORCEPS

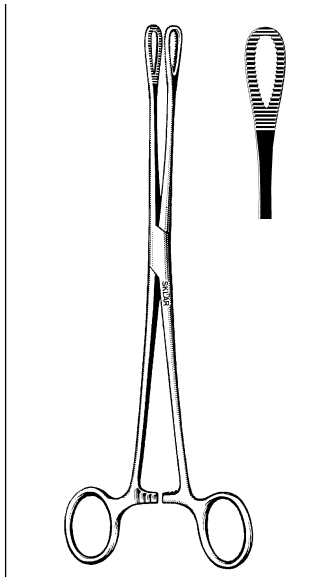
Curved Sideways
91-2695 9" 3 x 4 teeth



CRAIG FORCEPS

74-1280 8" 2 Open Rings

GYNECOLOGICAL INSTRUMENTS UTERINE FORCEPS



**SCHWEIZER
UTERINE FORCEPS**

90-7995 9½" Straight

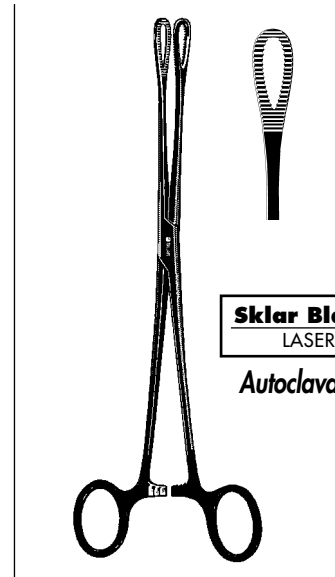


Sklar Blue™
ELECTROSURGICAL

Autoclavable

**SKLAR BLUE™
SCHWEIZER UTERINE FORCEPS**

91-5404 9½" Straight

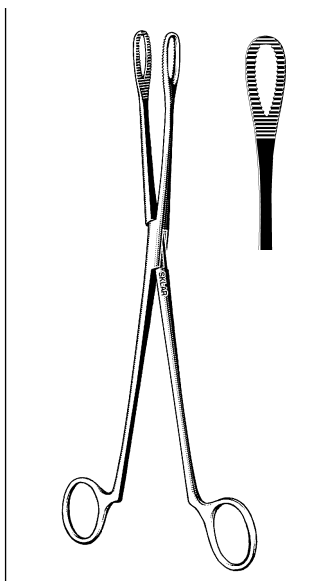


Sklar Black™
LASER

Autoclavable

**LASER
SCHWEIZER UTERINE FORCEPS**

90-2350 9½" Straight



CLEMETSON UTERINE FORCEPS

90-7895 9½" Straight, No Ratchet



Sklar Blue™
ELECTROSURGICAL

Autoclavable

**SKLAR BLUE™
CLEMETSON UTERINE FORCEPS**

91-5400 9½" Straight, No Ratchet

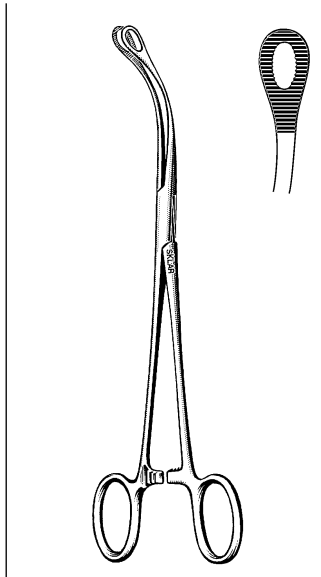


Sklar Black™
LASER

Autoclavable

**LASER
CLEMETSON UTERINE FORCEPS**

90-2348 9½" Straight, No Ratchet



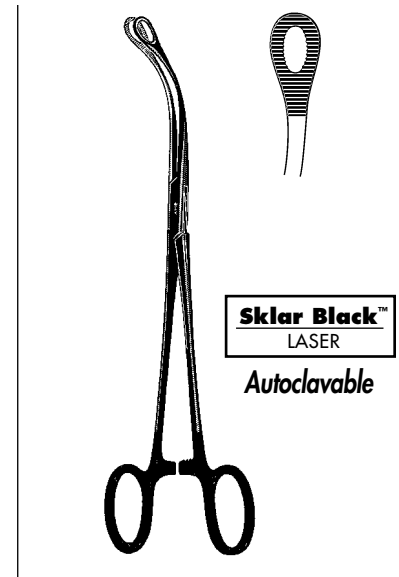
**LAUFE UTERINE
POLYP FORCEPS**

90-7977 7 3/4" Curved



**SKLAR BLUE™ LAUFE
UTERINE POLYP FORCEPS**

91-5408 7 3/4" Curved



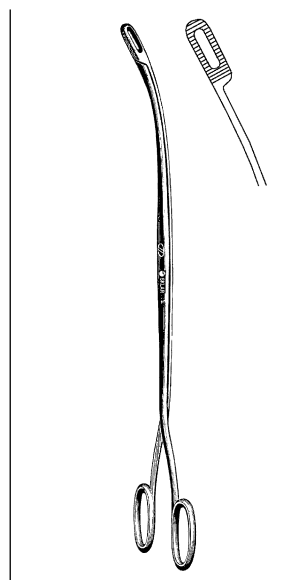
**LASER LAUFE UTERINE
POLYP FORCEPS**

90-2345 7 3/4" Curved



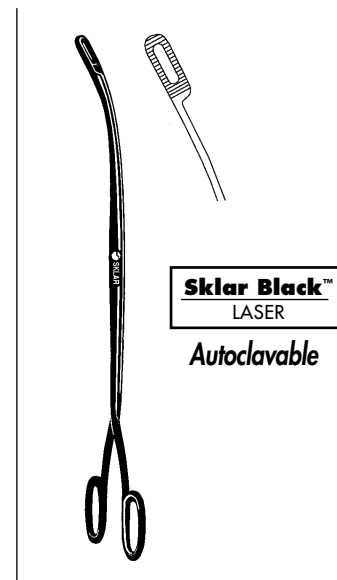
DELEE UTERINE FORCEPS

90-8111 11" Heavy, S-Curve



**CAMPION UTERINE
FORCEPS**

90-7898 9 1/4" Curved



**LASER CAMPION
UTERINE FORCEPS**

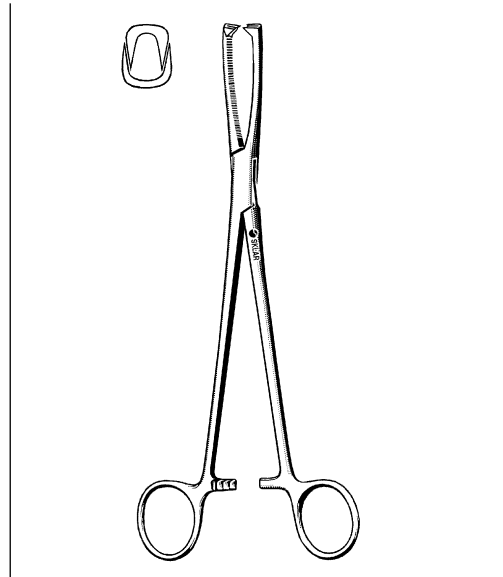
90-2298 9 1/4" Curved

GYNECOLOGICAL INSTRUMENTS VULSELLUM FORCEPS



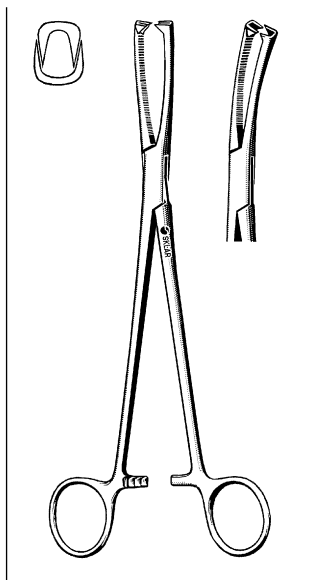
HENROTIN VULSELLUM FORCEPS

91-2585 8½" 2 x 3 teeth



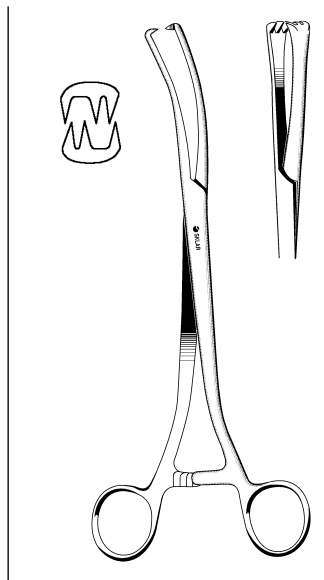
DOYEN VULSELLUM FORCEPS

91-2482 8½"



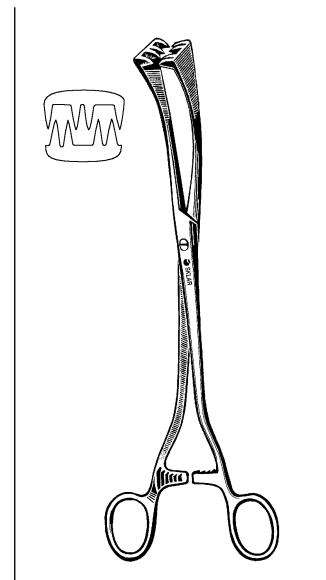
**JACOBS VULSELLUM
FORCEPS**

91-2282 8½" Straight
91-2382 8½" Angular



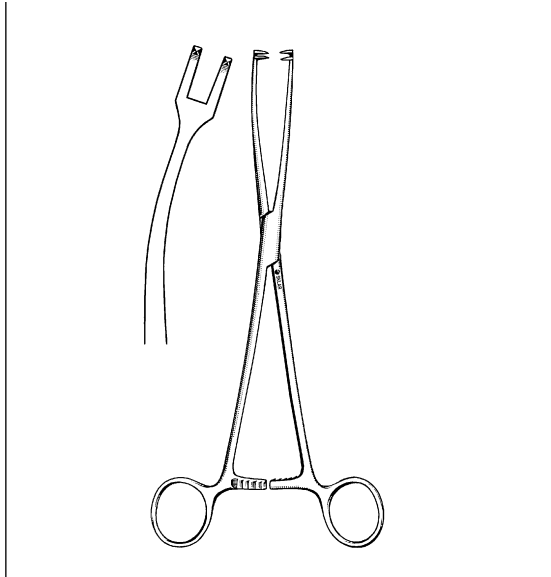
SECOND (COLLIN) FORCEPS

3 x 3 Teeth
91-3095 9½" Straight
91-3195 9½" Curved sideways



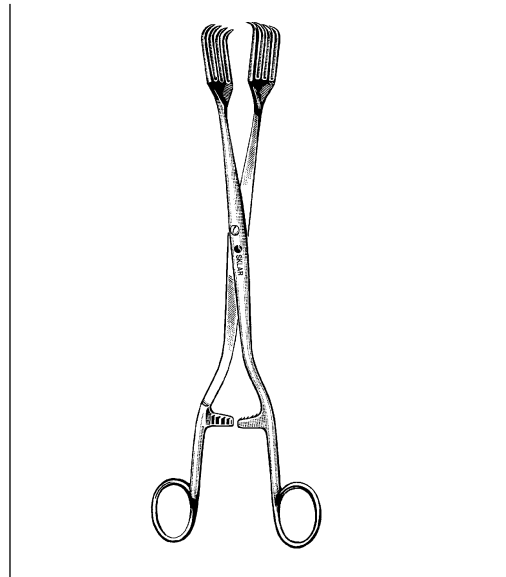
SECOND (COLLIN) FORCEPS

4 x 4 Teeth
91-3795 9½" Curved on flat



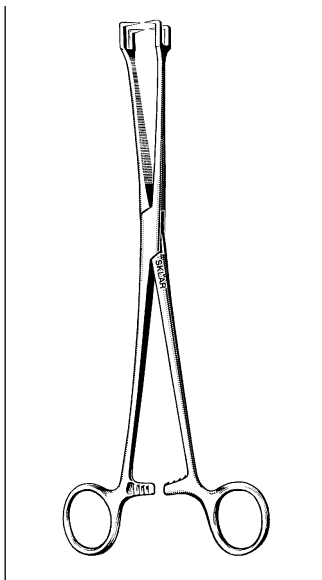
SCHROEDER VULSELLUM FORCEPS

Curved
91-1690 9"



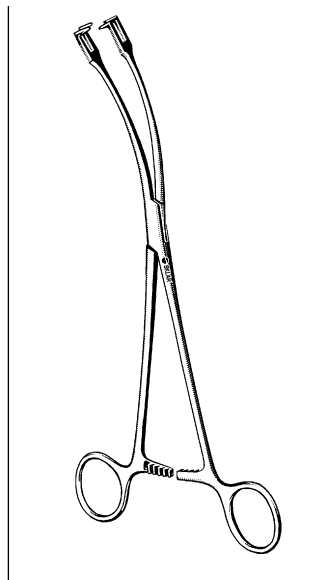
BILLROTH FORCEPS

91-3810 10" 4 x 4 teeth
91-3910 10" 3 x 3 teeth



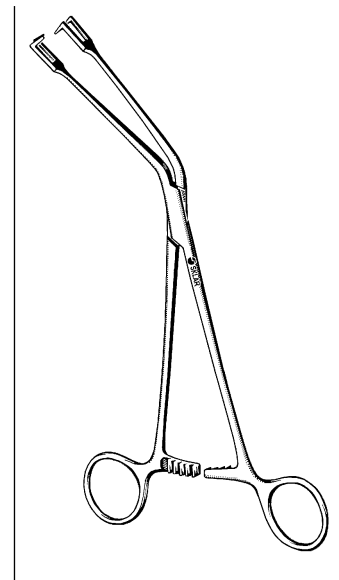
**SCHROEDER VULSELLUM
FORCEPS**

91-1590 9 1/2"



**SCHROEDER VULSELLUM
FORCEPS**

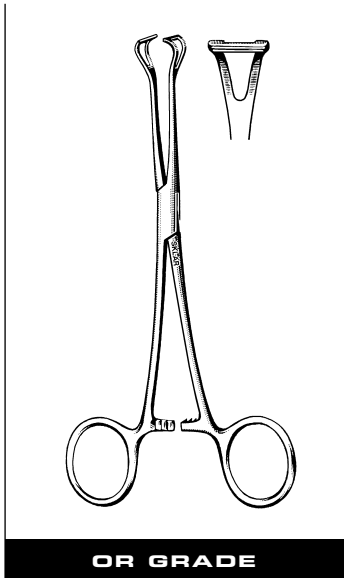
Slight Curve Sideways
91-1890 9 1/2"



**SCHROEDER VULSELLUM
FORCEPS**

Angled Sideways
91-1990 9"

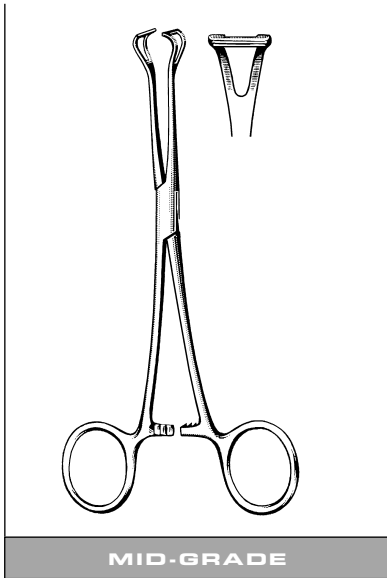
GYNECOLOGICAL INSTRUMENTS BABCOCK FORCEPS



OR GRADE

BABCOCK FORCEPS

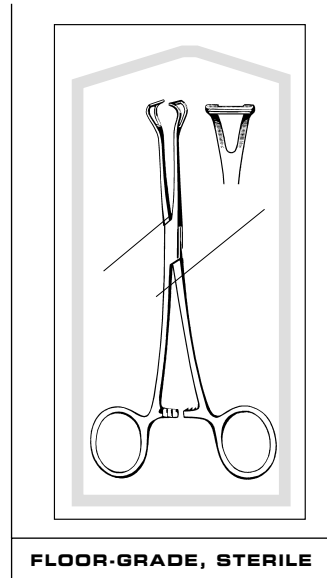
22-6155 5½" Delicate
36-1662 6¼"
36-1677 8"
36-1692 9½"



MID-GRADE

MID-GRADE BABCOCK FORCEPS

95-952 6¼"



FLOOR-GRADE, STERILE

BABCOCK FORCEPS, STERILE

Box/50
96-2705 6¼"
Box/25
96-2706 6¼"

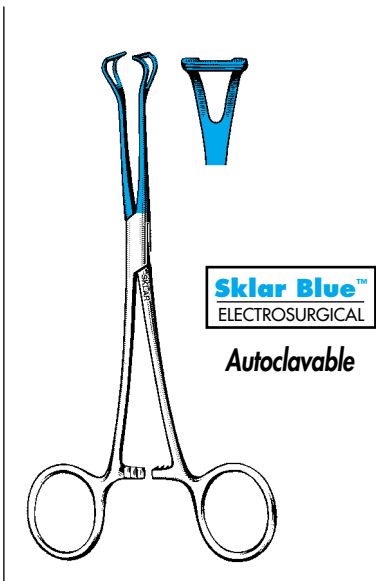


SKLAR T-C
TUNGSTEN CARBIDE

PREMIUM GRADE

T-C BABCOCK FORCEPS

97-1565 6¼"
97-1570 8"

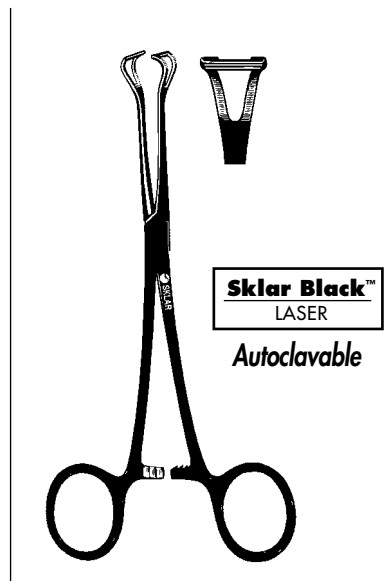


Sklar Blue™
ELECTROSURGICAL

Autoclavable

SKLAR BLUE™ BABCOCK FORCEPS

91-5268 8"
91-5270 9½"

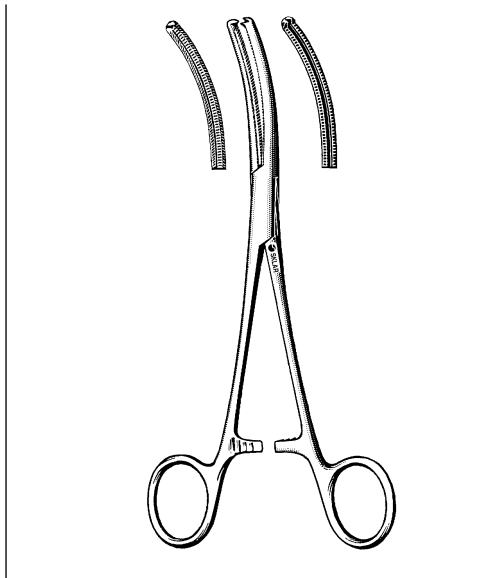


Sklar Black™
LASER

Autoclavable

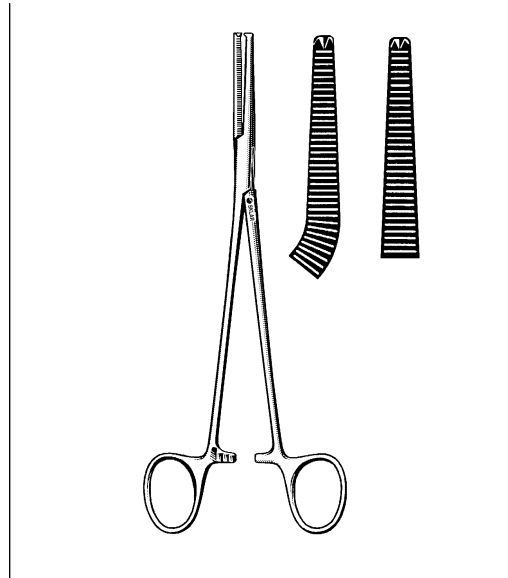
LASER BABCOCK FORCEPS

90-2278 8"
90-2295 9½"



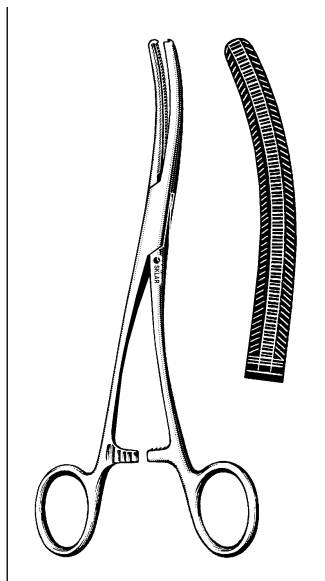
GELPI-LOWRIE FORCEPS

90-1885 8½"



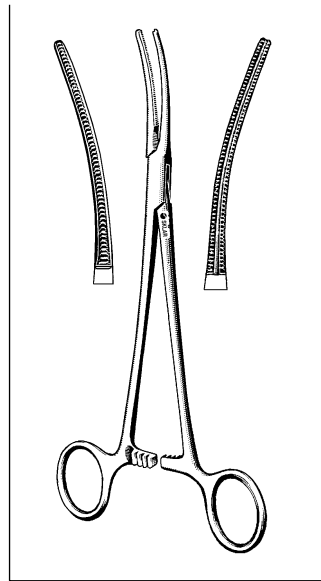
PHANEUF FORCEPS

90-2680 8¼" Angled
90-2682 8¼" Straight



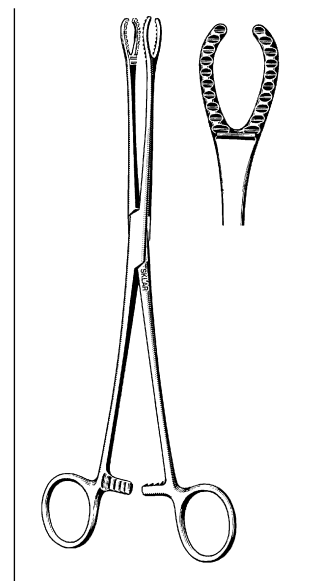
DE ALVAREZ CLAMP

90-2782 8¼" Double Curve



**GUSBERG HYSTERECTOMY
CLAMP**

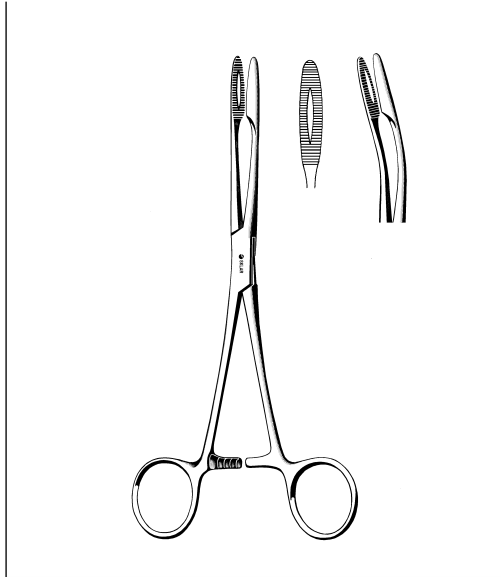
90-2780 8" Curved



**GUTGLASS CERVIX
FORCEPS**

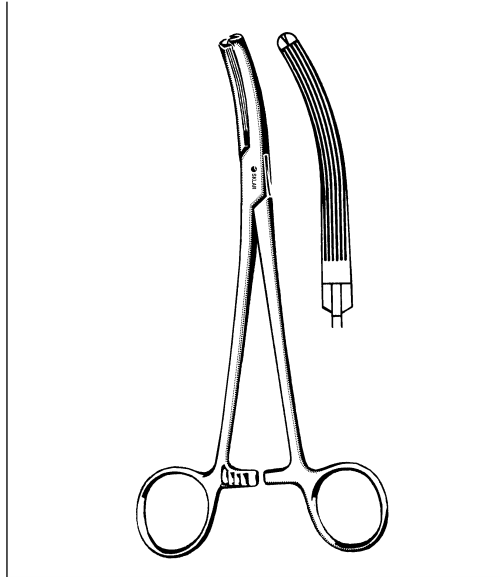
90-8090 9½"

GYNECOLOGICAL INSTRUMENTS FORCEPS



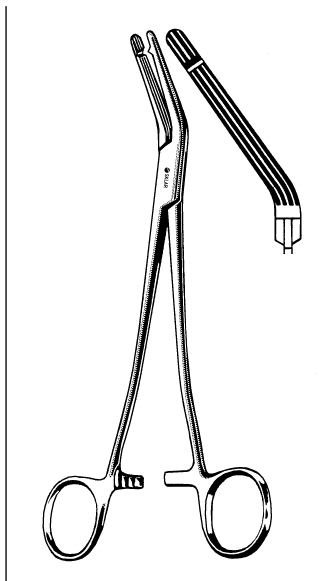
MAIER (GROSS) UTERINE DRESSING FORCEPS

90-8080 8" Straight
90-8082 8" Curved
90-8110 10" Straight
90-8112 10" Curved



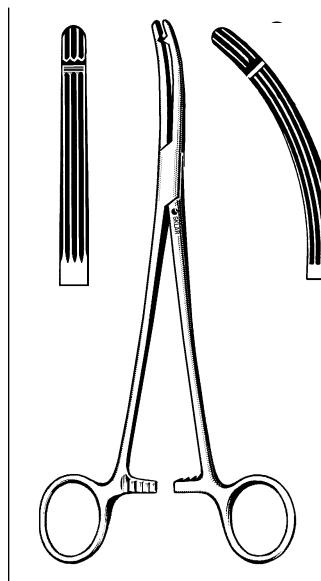
LONG FORCEPS

Longitudinal Serrations
90-2690 7 1/2"



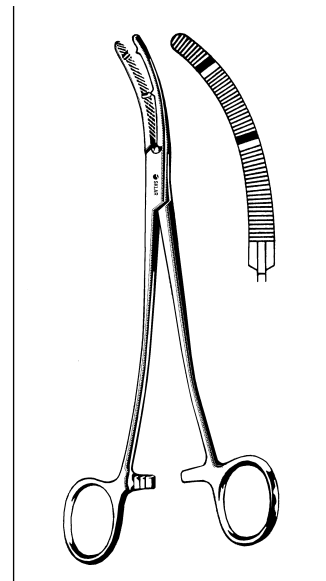
LAWTON FORCEPS

Longitudinal Serrations
90-2180 8 1/2"



HEANEY-BALLENTINE FORCEPS

Longitudinal Serrations
90-2480 8" Straight
90-2580 8" Curved



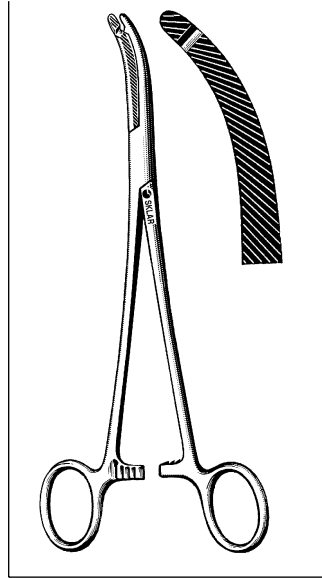
HEANEY-KANTER FORCEPS

90-2379 8"



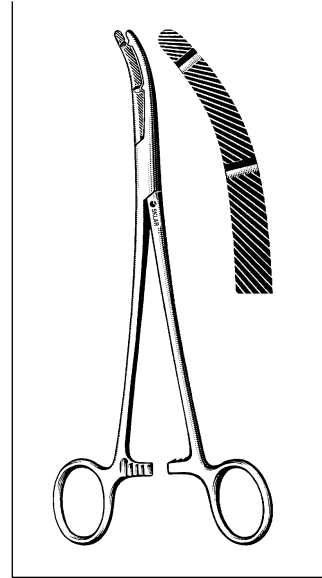
HEANEY FORCEPS

Single tooth
90-1977 7 3/4" Light Model



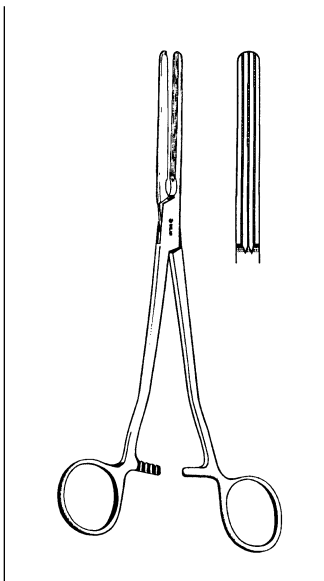
HEANEY FORCEPS

Single tooth
90-2177 8 3/4" Heavy Model



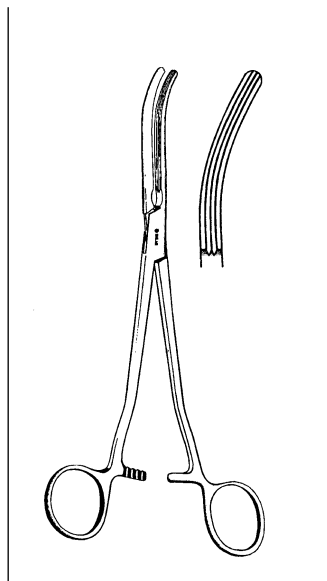
HEANEY FORCEPS

Double Tooth
90-2280 8" Heavy Model
90-2387 8 3/4" Heavy Model



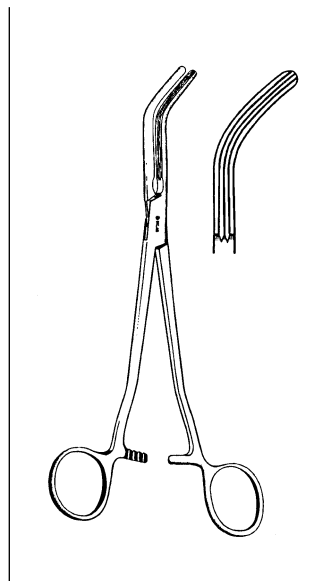
HYSTERECTOMY CLAMP

Longitudinal Serrations
90-2790 9 1/2" Straight



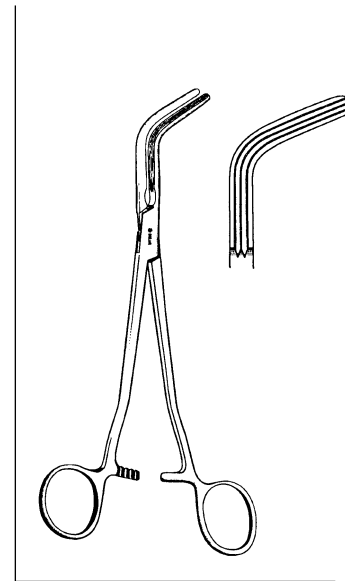
HYSTERECTOMY CLAMP

Longitudinal Serrations
90-2792 9 1/2" Slight Curve



HYSTERECTOMY CLAMP

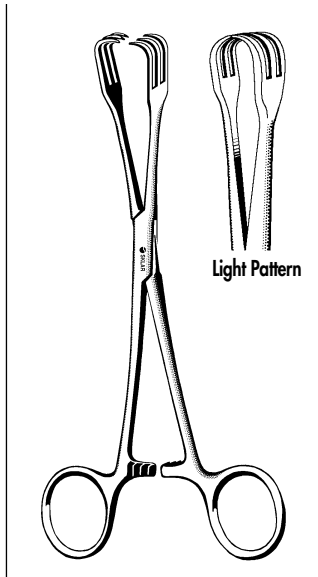
Longitudinal Serrations
90-2793 9 1/2" Full Curve



HYSTERECTOMY CLAMP

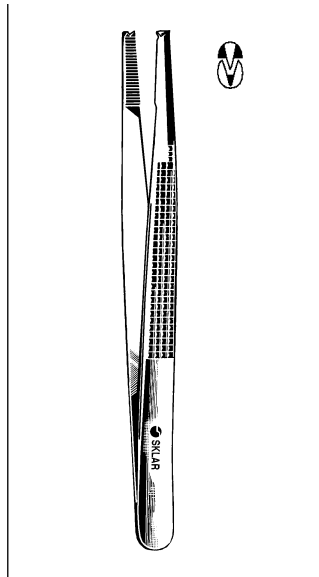
Longitudinal Serrations
90-2794 9 1/2" Angular

GYNECOLOGICAL INSTRUMENTS FORCEPS



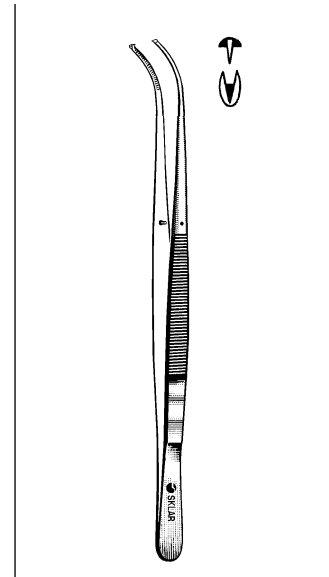
LAHEY TRACTION FORCEPS

17-3562 6 1/4" Light Pattern
91-2080 8" Regular Pattern (MGH)



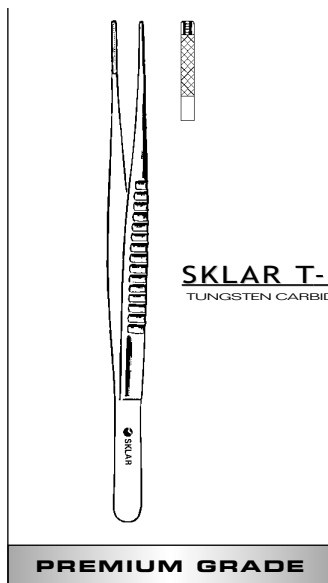
BONNEY TISSUE FORCEPS

1 x 2 Teeth
19-2170 7"



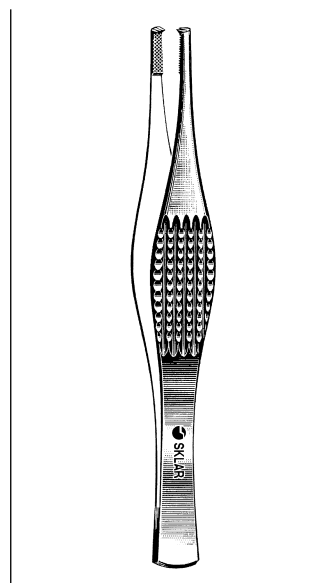
KANTROWITZ TISSUE FORCEPS

52-3597 9 3/4" Curved, 1 x 2



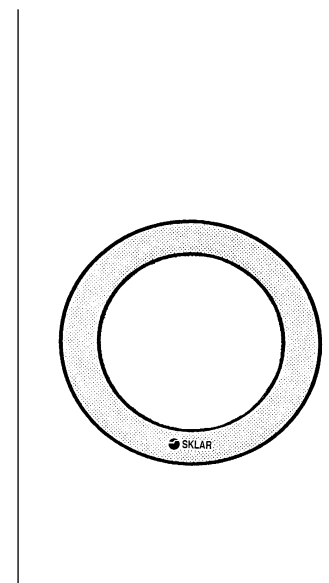
T-C DEBAKEY ATRAUMATIC FORCEPS

97-1530 6" 2.0 mm Tips
97-1531 6" 2.7 mm Tips
97-1540 8" 2.0 mm Tips
97-1541 8" 2.7 mm Tips



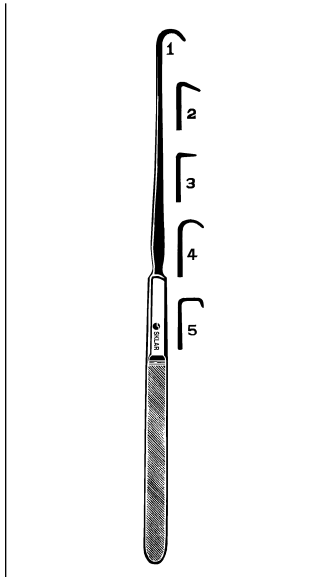
FERRIS-SMITH TISSUE FORCEPS

47-1470 7" 1 x 2 teeth
52-3970 7" 2 x 3 teeth



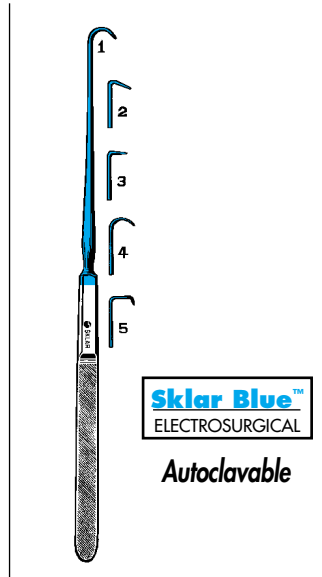
LAPAROTOMY RING

90-8715 1 1/2" ID
90-8717 1 3/4" ID



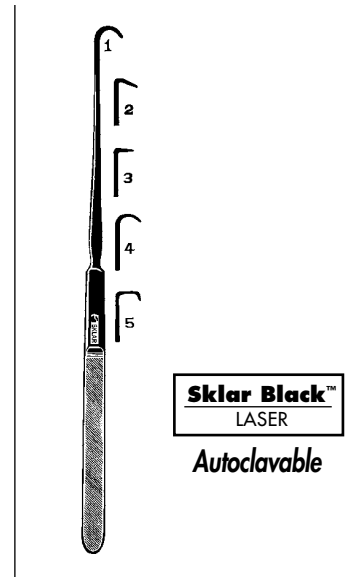
EMMETT HOOK 9"

- 90-8301 Style 1
- 90-8302 Style 2
- 90-8303 Style 3
- 90-8304 Style 4
- 90-8305 Style 5
- 90-8306 Set of 5



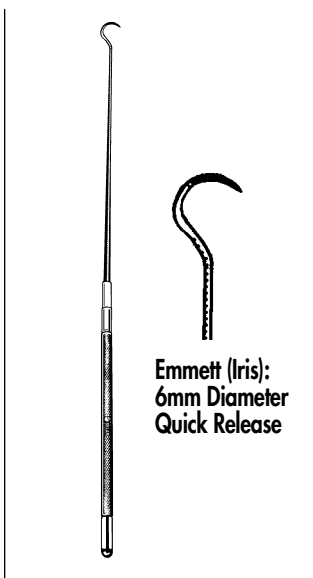
SKLAR BLUE™ EMMETT HOOKS 9"

- 91-5251 Style 1
- 91-5252 Style 2
- 91-5253 Style 3
- 91-5254 Style 4
- 91-5255 Style 5
- 91-5250 Set of 5



LASER EMMETT HOOKS 9"

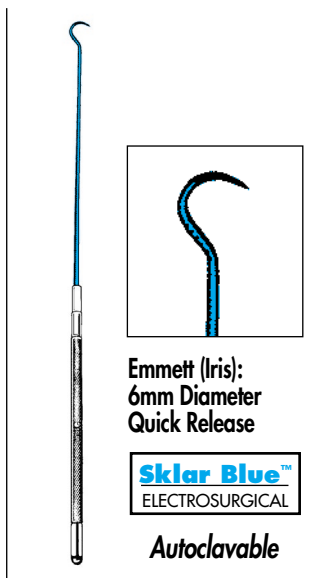
- 90-2171 #1
- 90-2172 #2
- 90-2173 #3
- 90-2174 #4
- 90-2175 #5
- 90-2170 Set of 5



Emmett (Iris):
6mm Diameter
Quick Release

EMMETT HOOK (IRIS)

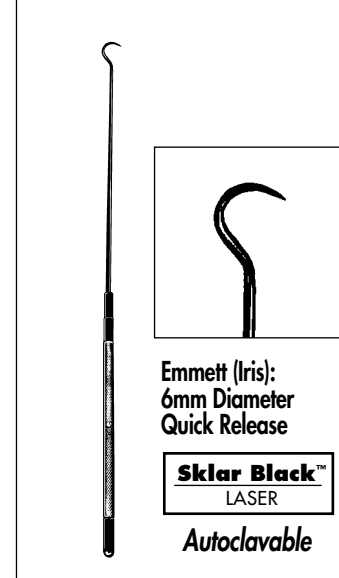
- 6mm
- 90-8333 9" #1
- 90-8342 12" #1
- 90-8332 Quick Release Tissue Hooks
9" Set of 4 (6, 4, 3, 1mm)
- 90-8341 Quick Release Tissue Hooks
12" Set of 4 (6, 4, 3, 1mm)



Emmett (Iris):
6mm Diameter
Quick Release

SKLAR BLUE™ EMMETT HOOK (IRIS)

- 6mm
- 91-5241 9" #1
- 91-5245 12" #1

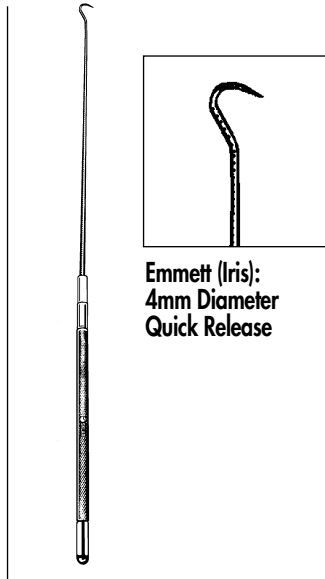


Emmett (Iris):
6mm Diameter
Quick Release

LASER EMMETT HOOK (IRIS)

- 6mm
- 90-2114 9" #1
- 90-2116 12" #1

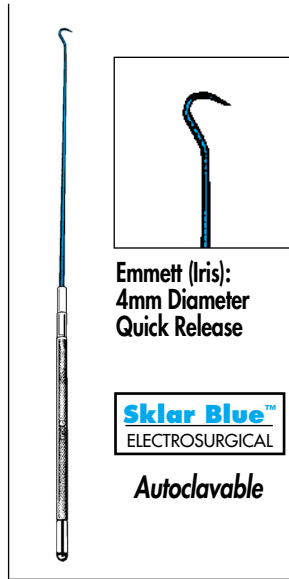
GYNECOLOGICAL INSTRUMENTS HOOKS



Emmett (Iris):
4mm Diameter
Quick Release

EMMETT HOOK (IRIS)

4mm
90-8334 9" #2
90-8344 12" #2



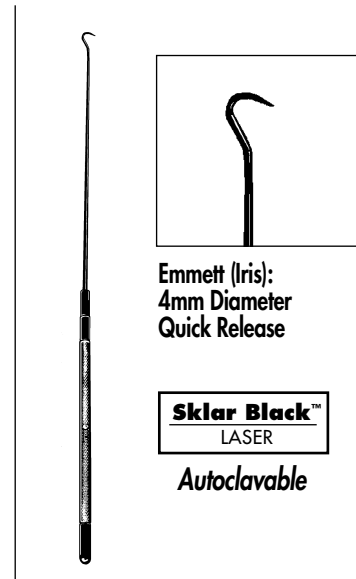
Emmett (Iris):
4mm Diameter
Quick Release

Sklar Blue™
ELECTROSURGICAL

Autoclavable

SKLAR BLUE™ EMMETT HOOK (IRIS)

4mm
91-5242 9" #2
91-5246 12" #2



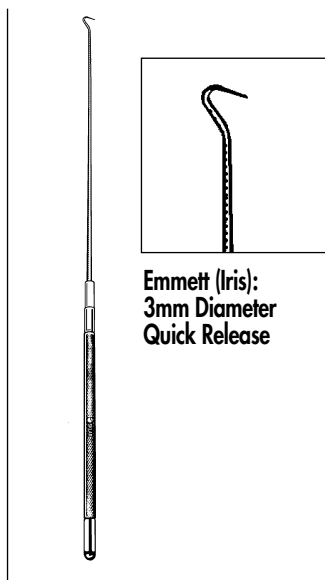
Emmett (Iris):
4mm Diameter
Quick Release

Sklar Black™
LASER

Autoclavable

LASER EMMETT HOOK (IRIS)

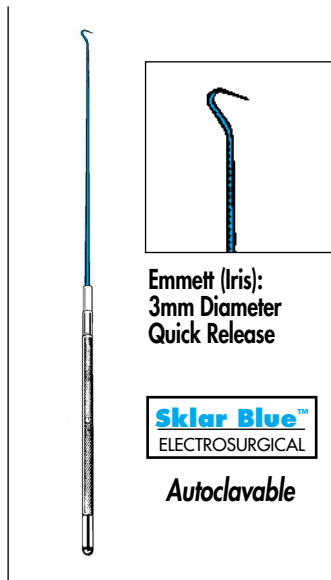
4mm
90-2118 9" #2
90-2120 12" #2



Emmett (Iris):
3mm Diameter
Quick Release

EMMETT HOOK (IRIS)

3mm
90-8335 9" #3
90-8346 12" #3



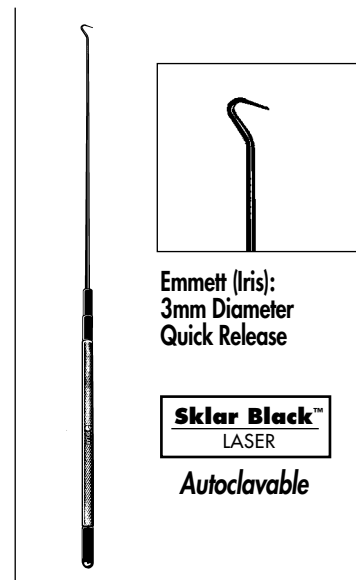
Emmett (Iris):
3mm Diameter
Quick Release

Sklar Blue™
ELECTROSURGICAL

Autoclavable

SKLAR BLUE™ EMMETT HOOK (IRIS)

3mm
91-5243 9" #3
91-5247 12" #3



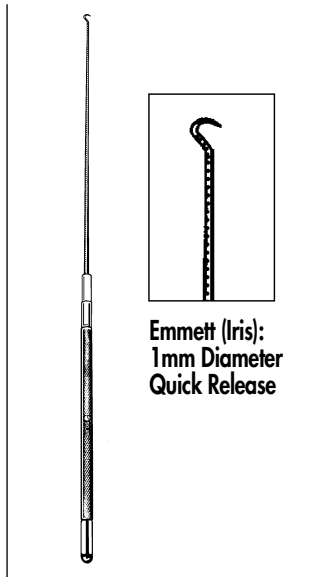
Emmett (Iris):
3mm Diameter
Quick Release

Sklar Black™
LASER

Autoclavable

LASER EMMETT HOOK (IRIS)

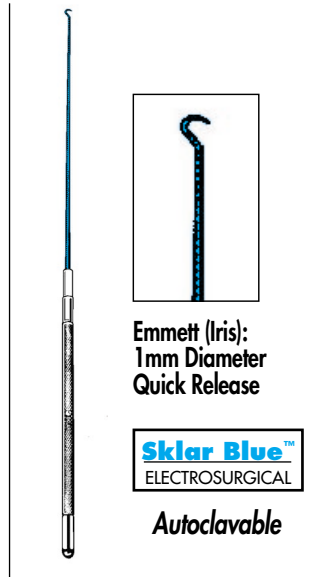
3mm
90-2122 9" #3
90-2124 12" #3



Emmett (Iris):
1mm Diameter
Quick Release

EMMETT HOOK (IRIS)

1mm
90-8336 9" #4
90-8348 12" #4



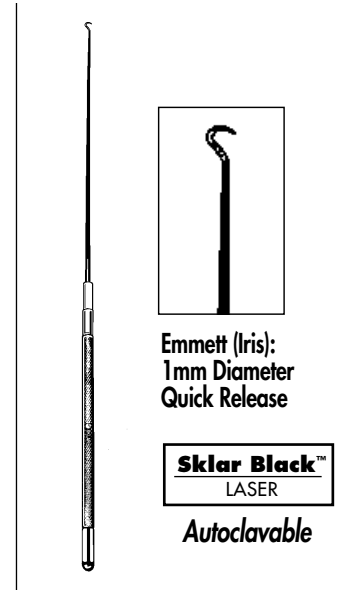
Emmett (Iris):
1mm Diameter
Quick Release

Sklar Blue™
ELECTROSURGICAL

Autoclavable

SKLAR BLUE™ EMMETT HOOK (IRIS)

1mm
91-5244 9" #4
91-5248 12" #4



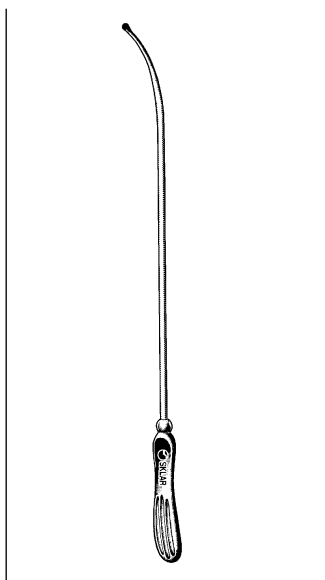
Emmett (Iris):
1mm Diameter
Quick Release

Sklar Black™
LASER

Autoclavable

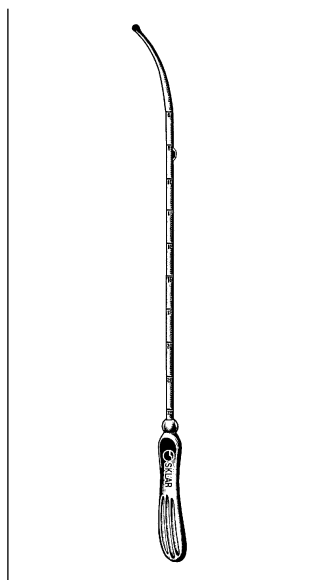
LASER EMMETT HOOK (IRIS)

1mm
90-2126 9" #4
90-2128 12" #4



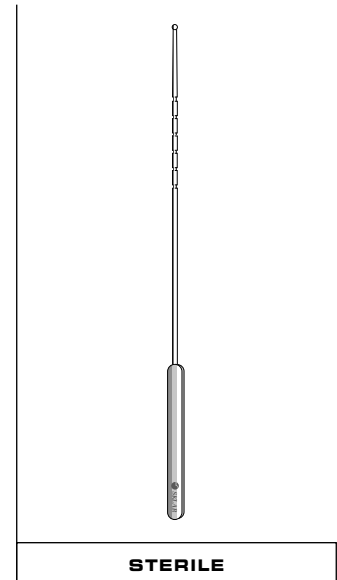
SIMS UTERINE SOUND MALLEABLE

Non-Graduated - Silver Plated
90-5312 12 1/2"
Graduated - Silver Plated
90-5314 12 1/2" Cm Markings



SIMPSON UTERINE SOUND MALLEABLE

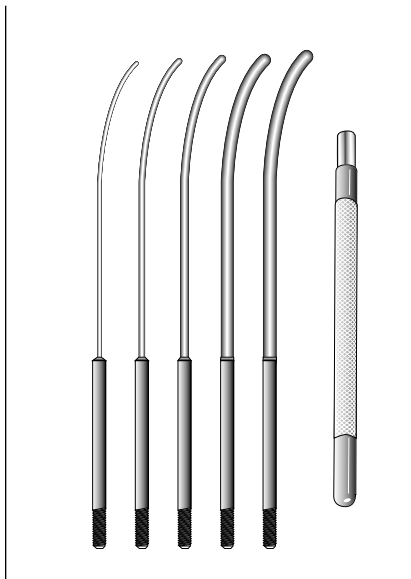
Graduated - Silver Plated
90-5412 12 1/2" Inch Markings
90-5413 12 1/2" Cm Markings



SKLAR INTRA-UTERINE SOUND, DISPOSABLE

Malleable Box/50 Packaged Sterile
96-4170

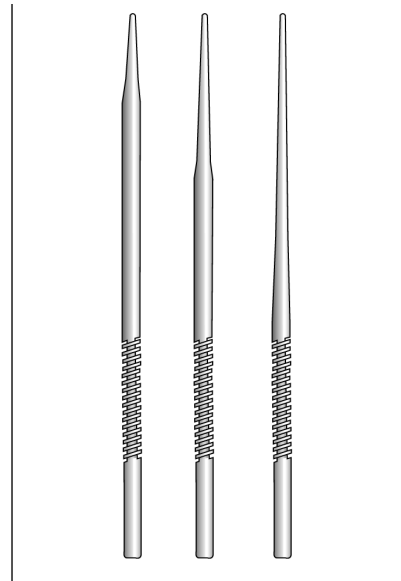
GYNECOLOGICAL INSTRUMENTS DILATORS/PUNCH



SKLAR MINI-DILATOR/ OS FINDER SET

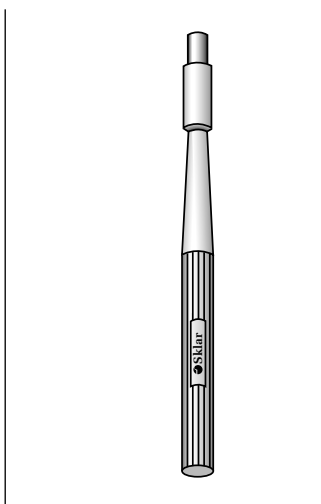
Small Size Dilator Uterine

- 90-6280 From 1mm to 3mm in .5mm increments. All five dilators interchange on a universal handle.
- 90-6281 Handle Only



OS DILATOR SET, TEFLON

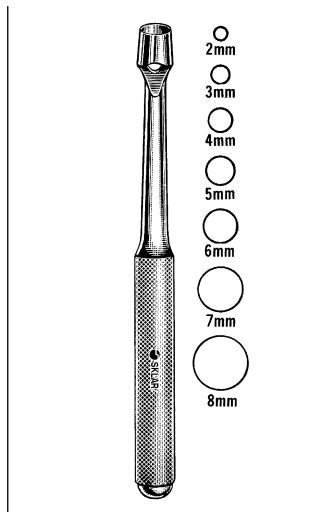
Reusable
96-4150 Set of 3 Dilators



SKLAR TRU-PUNCH DISPOSABLE VULVAR BIOPSY PUNCH

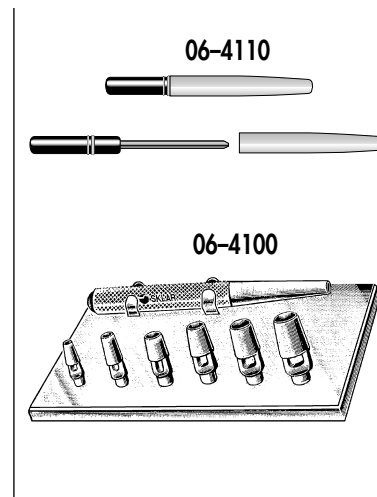
- | | |
|-----------------|-----------------|
| Box/25, Sterile | Box/50, Sterile |
| 96-1140 2mm | 96-1100 2mm |
| 96-1142 3mm | 96-1105 3mm |
| 96-1144 3.5mm | 96-1110 3.5mm |
| 96-1146 4mm | 96-1115 4mm |
| 96-1148 5mm | 96-1120 5mm |
| 96-1150 6mm | 96-1125 6mm |
| 96-1152 8mm | 96-1130 8mm |

Box/25, Sterile
96-1160 Assorted (5 of each-2,3, 3.5, 4, 5)



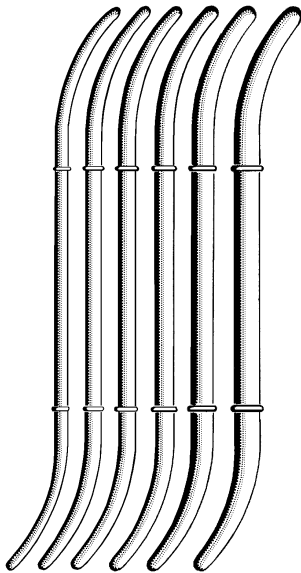
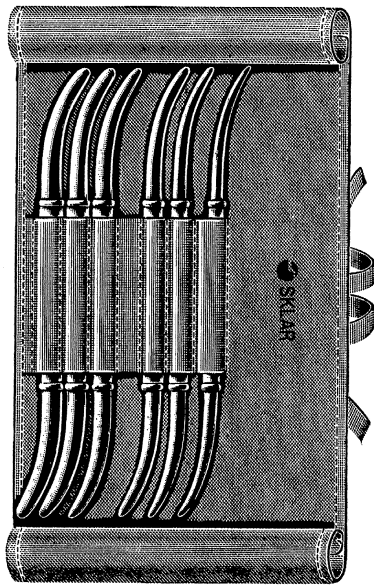
KEYES BIOPSY PUNCH

- | | |
|---------|-----|
| 06-4142 | 2mm |
| 06-4143 | 3mm |
| 06-4144 | 4mm |
| 06-4145 | 5mm |
| 06-4146 | 6mm |
| 06-4147 | 7mm |
| 06-4148 | 8mm |



KEYES VULVAR/DERMAL PUNCH

- 06-4100 6 Punches interchangeable on Universal Handle 2mm thru 7mm with sterilizable base.
- 06-4110 Keyes Punch Sharpener to maintain a keen edge on all Keyes Punches.



HANK UTERINE DILATOR

90-4925 Set of 6 without Khaki Roll

90-4926 Set of 6 with Khaki Roll

American Scale

90-4910 9-10

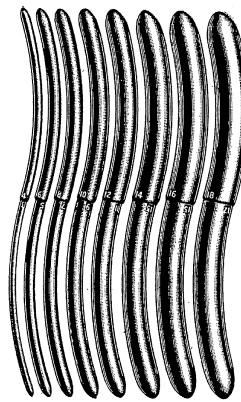
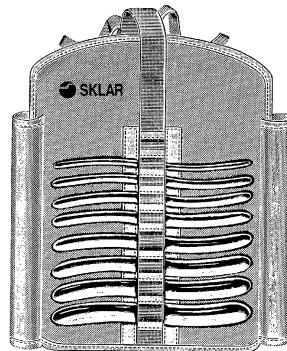
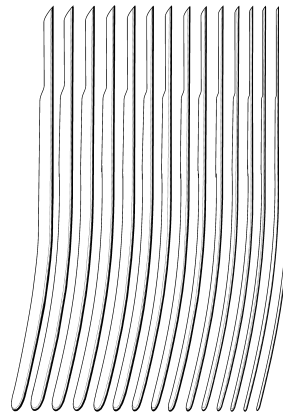
90-4912 11-12

90-4914 13-14

90-4916 15-16

90-4918 17-18

90-4920 19-20



HEGAR UTERINE DILATOR

90-4825 Set of 8 without Khaki Roll, Double End

90-4826 Set of 8 with Khaki Roll, Double End

Double End

90-4802 1-2 mm

90-4804 3-4 mm

90-4806 5-6 mm

90-4808 7-8 mm

90-4810 9-10 mm

90-4812 11-12 mm

90-4814 13-14 mm

90-4816 15-16 mm

90-4818 17-18 mm

Single End

90-4784 1.0 mm

90-4785 1.5 mm

90-4786 2.0 mm

90-4787 2.5 mm

90-4788 3.0 mm

90-4789 3.5 mm

90-4790 4.0 mm

90-4791 4.5 mm

90-4792 5.0 mm

90-4793 5.5 mm

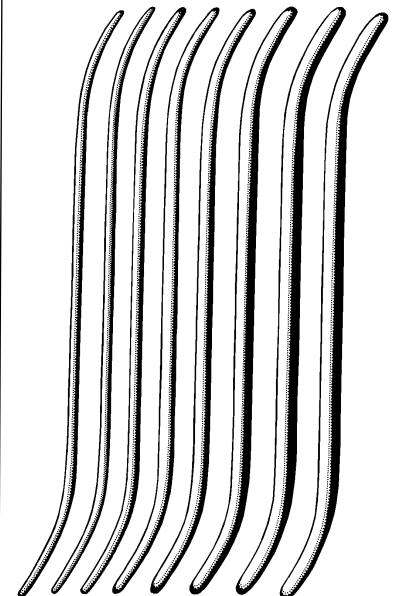
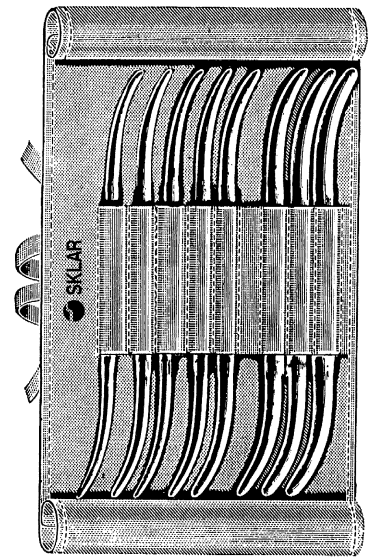
90-4794 6.0 mm

90-4795 6.5 mm

90-4796 7.0 mm

90-4797 7.5 mm

90-4798 8.0 mm



PRATT UTERINE DILATOR

90-5250 Set of 8

90-5215 13-15 French

90-5219 17-19 French

90-5223 21-23 French

90-5227 25-27 French

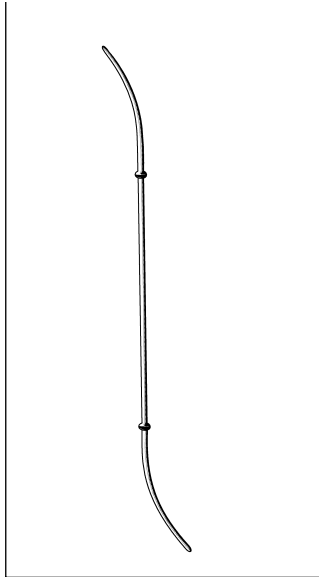
90-5231 29-31 French

90-5235 33-35 French

90-5239 37-39 French

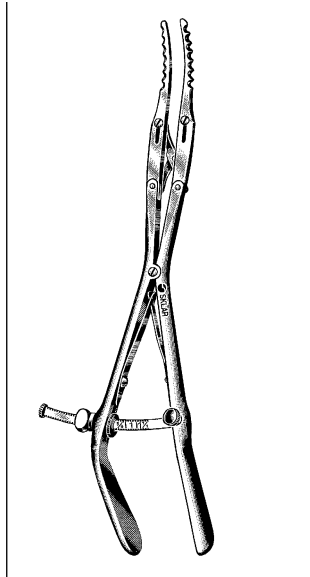
90-5243 41-43 French

GYNECOLOGICAL INSTRUMENTS DILATORS/CURETTES



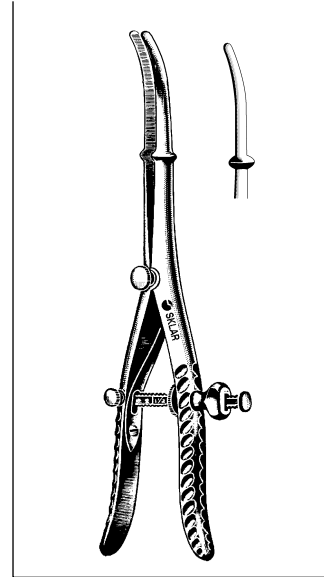
KLEEGMAN DILATOR

90-4902 10½" Narrow



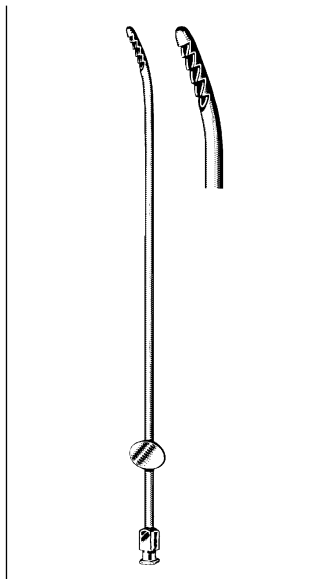
GOODELL UTERINE DILATOR

90-4713 13"



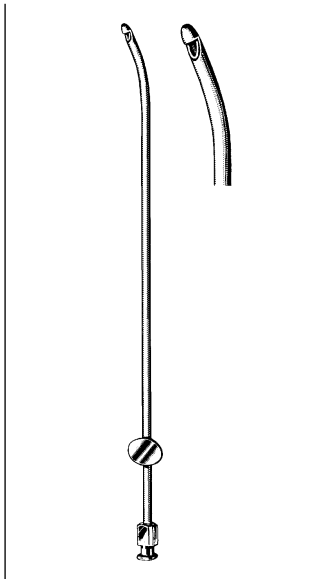
WYLIE UTERINE DILATOR

90-4212 12" Smooth



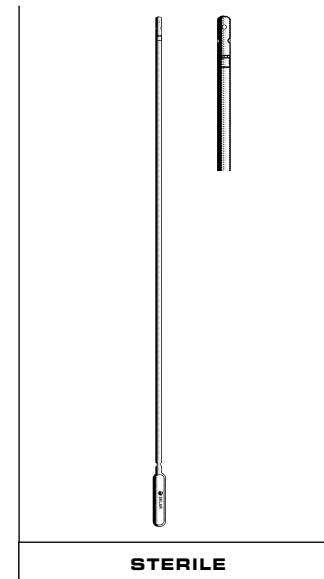
**NOVAK ENDOMETRIAL
CURETTE**

90-6289 9½" 1mm
90-6290 9½" 2mm
90-6291 9½" 3mm
90-6292 9½" 4mm



**RANDALL ENDOMETRIAL
CURETTE**

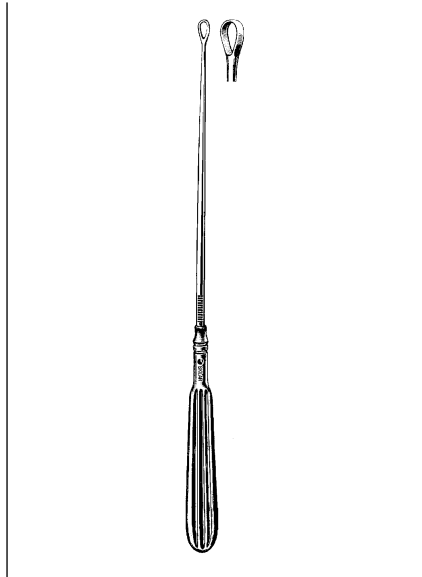
90-6295 9½"



STERILE

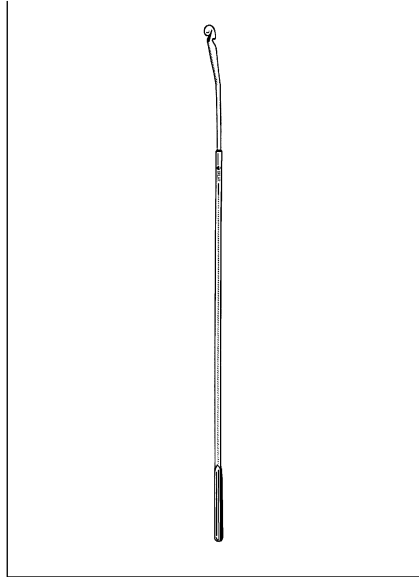
**ENDOMETRIAL BIOPSY
CANNULA PLASTIC**

Sterile Box/25, Disposable
96-4100 For Aspiration Biopsy



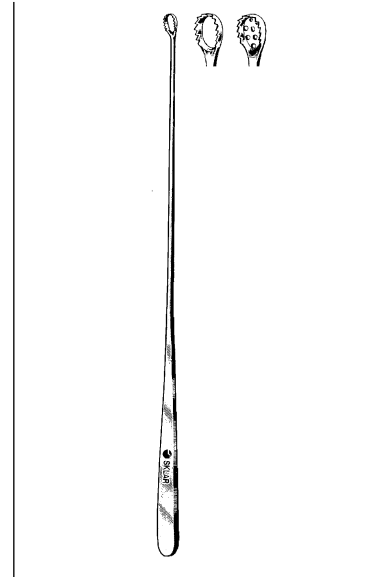
HOLDEN UTERINE CURETTE

Semi-Sharp
90-5710 10 $\frac{3}{4}$ " Extra Small



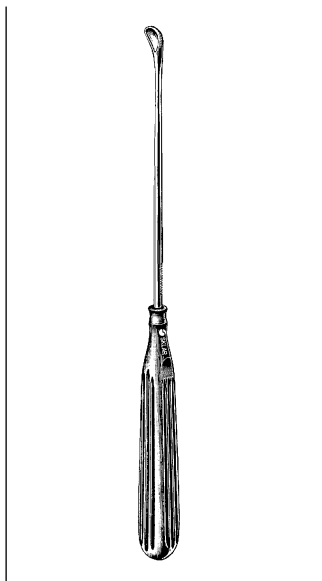
IUD EXTRACTOR

90-8210 10 $\frac{1}{2}$ "



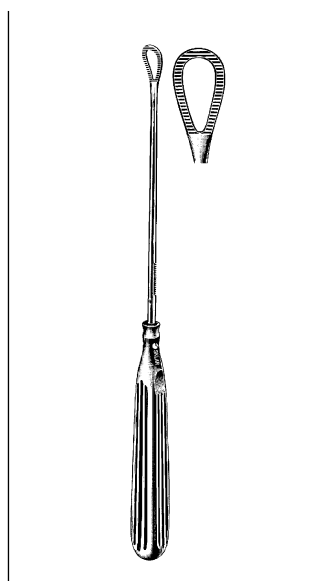
HEANEY UTERINE CURETTE

Serrated
90-6095 9 $\frac{1}{2}$ " Open Curette
90-6195 9 $\frac{1}{2}$ " With Basket



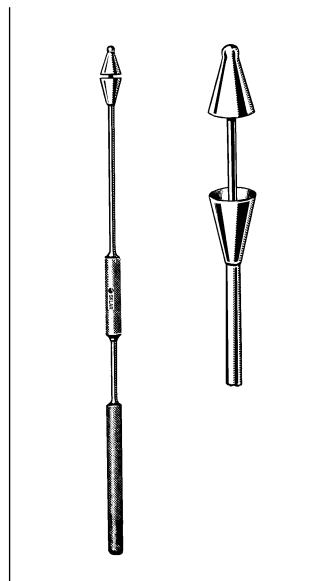
SKENE UTERINE CURETTE

90-5542 10 $\frac{1}{2}$ " Spoon



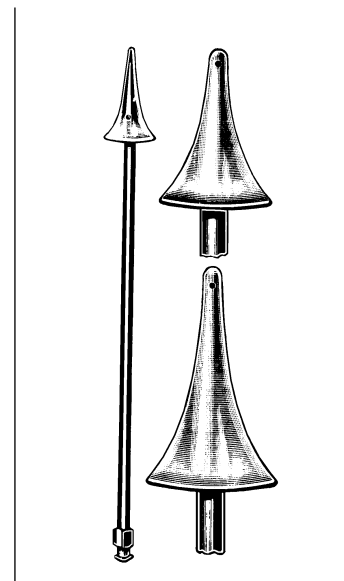
GREENE UTERINE CURETTE

90-5566 11" Serrated



**GUSBERG ENDOCERVICAL
CURETTE**

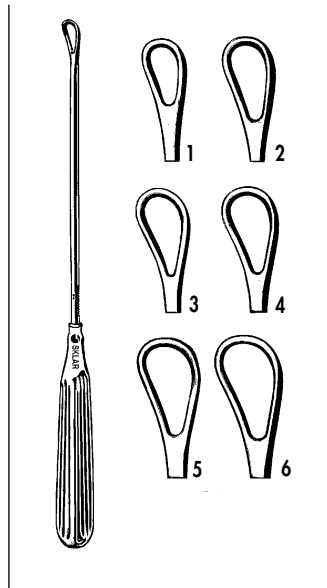
90-7195 Medium 9 $\frac{1}{2}$ "



**HOLMAN-MATHIEU
CANNULA**

For Hysterosalpingography
90-6582 8 $\frac{3}{4}$ " (21cm)
With Luer-Lok Hub
Chrome Plated Small Size
90-6590 9" (22.9cm)
Large Size

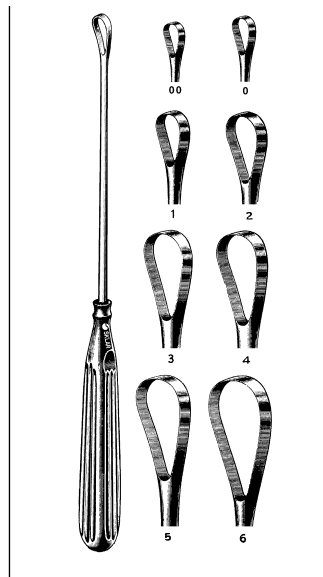
GYNECOLOGICAL INSTRUMENTS CURETTES



THOMAS UTERINE CURETTES

Blunt, 11"

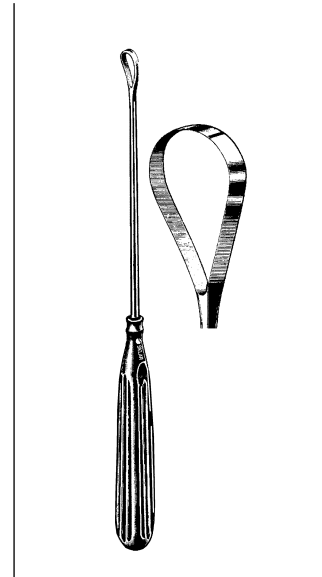
- 90-5431 No. 1
- 90-5432 No. 2
- 90-5433 No. 3
- 90-5434 No. 4
- 90-5435 No. 5
- 90-5436 No. 6
- 90-5438 Set of 6



SIMS UTERINE CURETTES

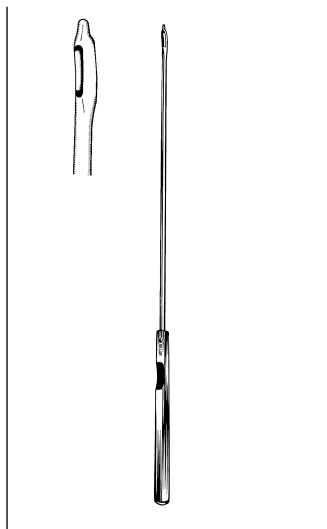
Sharp, 11"

- 90-5499 No. 00
- 90-5500 No. 0
- 90-5421 No. 1
- 90-5422 No. 2
- 90-5423 No. 3
- 90-5424 No. 4
- 90-5425 No. 5
- 90-5426 No. 6
- 90-5428 Set of 6



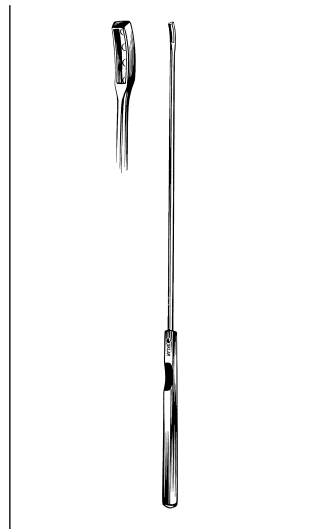
LOUNSBURY PLACENTA CURETTE

90-5713 13" 3/4" Wide



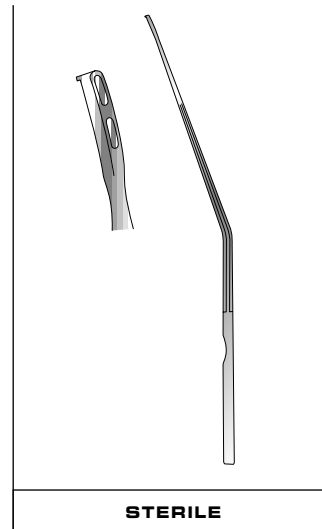
SKLAR MINI ENDOCERVICAL CURETTE

90-6285 Small rounded tip for easier entry into stenosed cervix



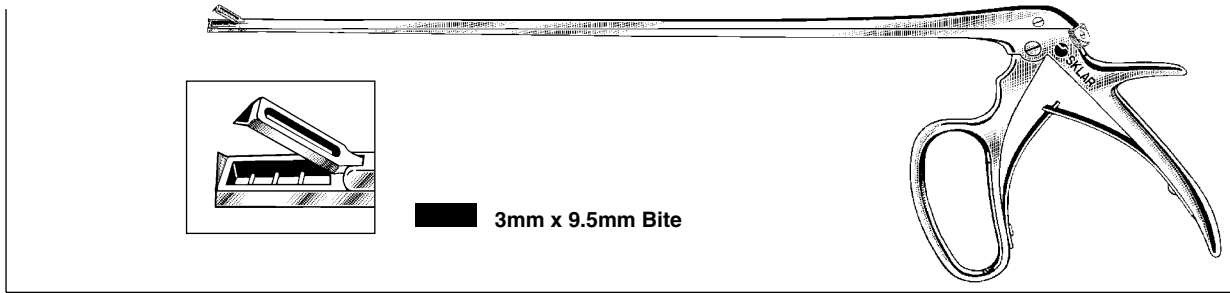
KEVORKIAN-YOUNG ENDOCERVICAL CURETTE

Narrow Tip
90-6611 12" Without Basket
90-6612 12" With Basket



ENDOCERVICAL CURETTE, PLASTIC

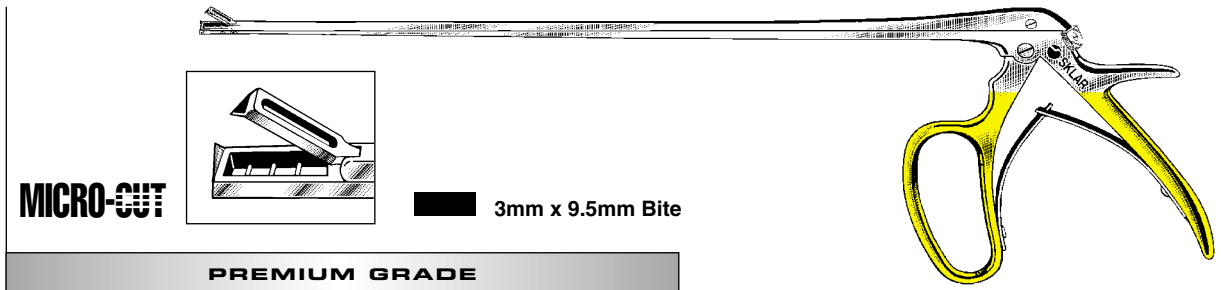
Sterile Box/25, Disposable
96-4143



TISCHLER CERVICAL BIOPSY FORCEP
With Kevorkian Style Bite

90-6887

3mm x 9.5mm Bite

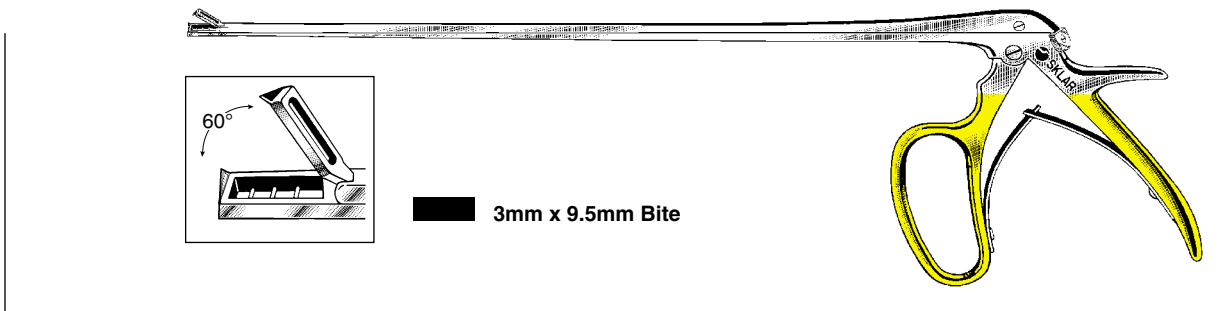


MICRO-CUT

MICRO-CUT TISCHLER CERVICAL BIOPSY FORCEP
Micro-Cut with Kevorkian Style Bite

90-8920

3mm x 9.5mm Bite



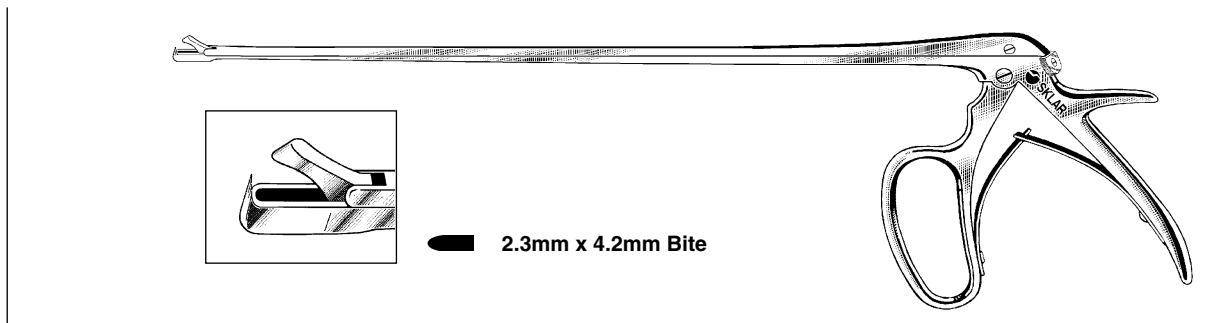
WIDE BITE TISCHLER CERVICAL BIOPSY FORCEP
With Kevorkian Style Bite

90-9570

3mm x 9.5mm Bite

GYNECOLOGICAL INSTRUMENTS

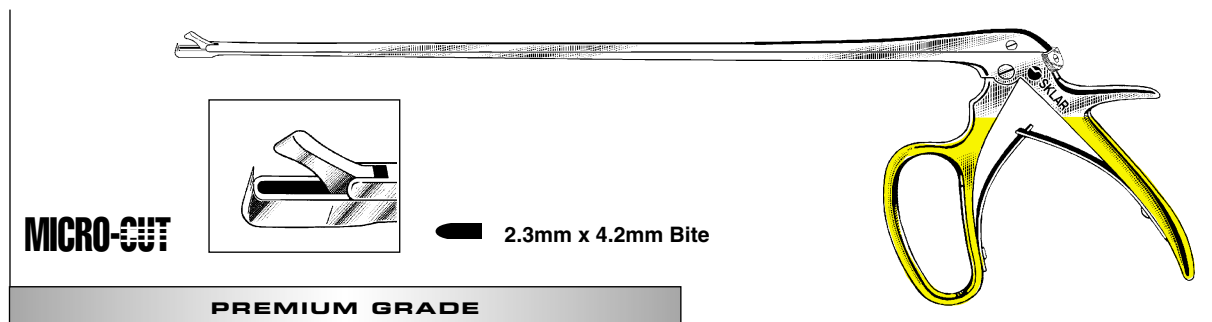
BIOPSY FORCEPS



MINI TISCHLER BIOPSY FORCEP

90-7530

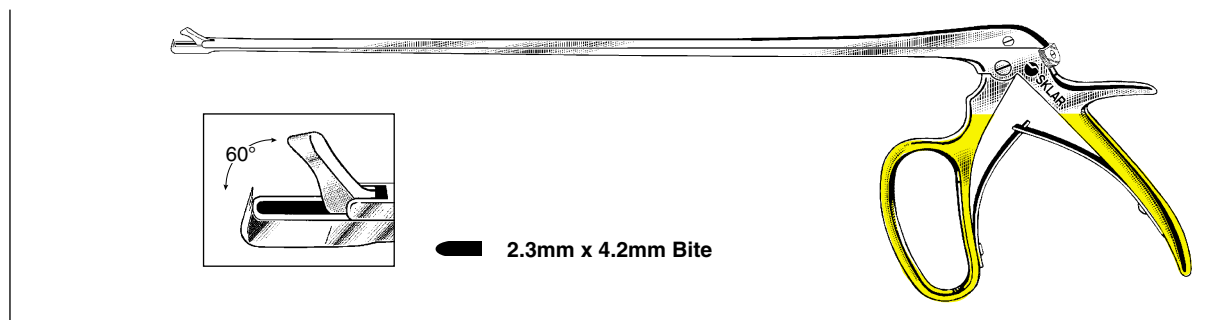
2.3mm x 4.2mm Bite (Baby Tischler)



MICRO-CUT MINI TISCHLER BIOPSY FORCEP

90-8945

2.3mm x 4.2mm Bite (Baby Tischler)

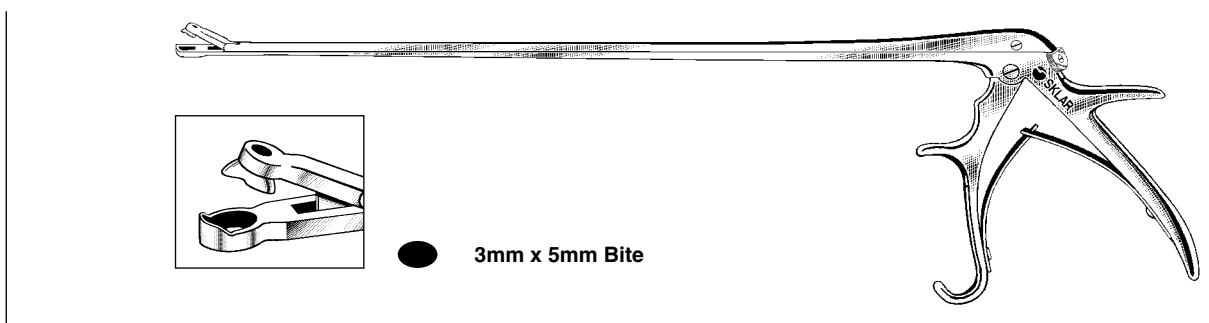


WIDE BITE MINI TISCHLER BIOPSY FORCEP

90-9555

2.3mm x 4.2mm Bite (Baby Tischler)

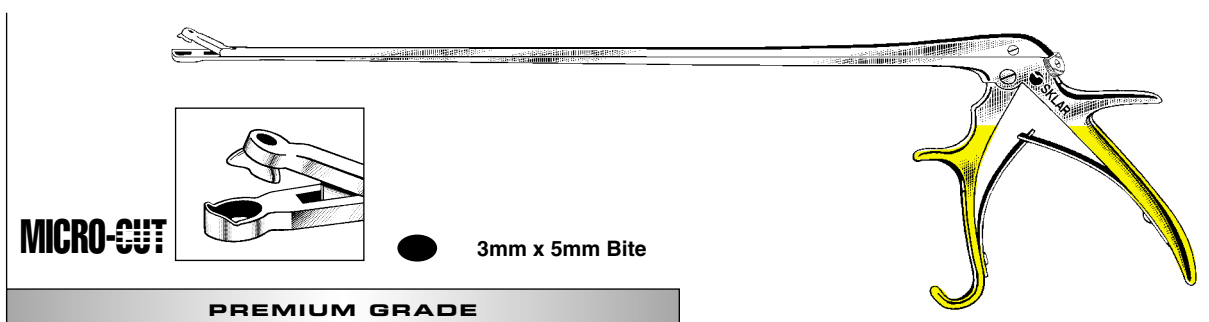
Opens to 60° for easy removal of biopsy and safer cleaning



OVAL BIOPSY FORCEP

90-7525

3mm x 5mm Bite



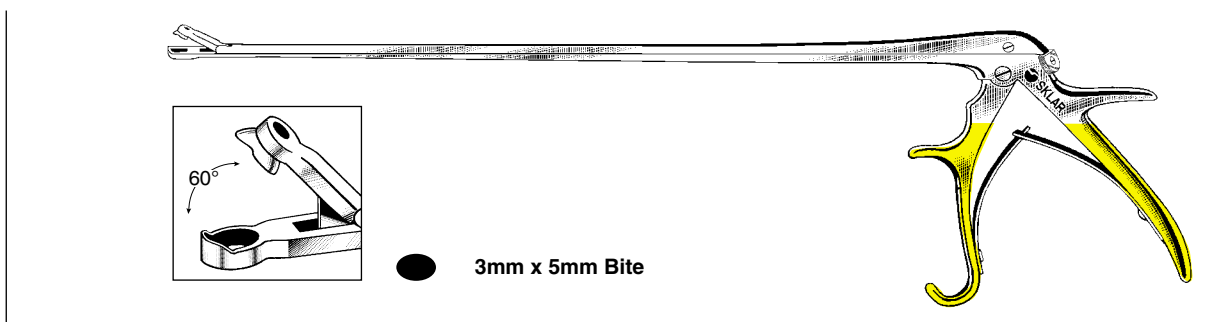
MICRO-CUT

PREMIUM GRADE

MICRO-CUT OVAL BIOPSY FORCEP

90-8948

3mm x 5mm Bite



WIDE BITE OVAL BIOPSY FORCEP

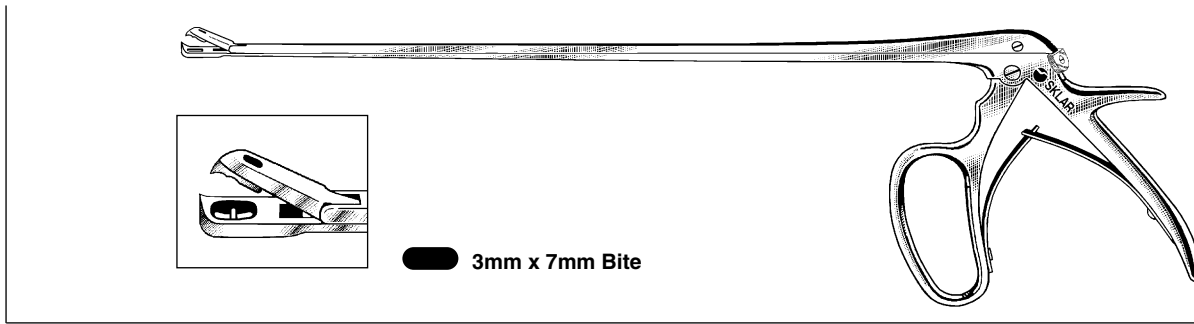
90-9565

3mm x 5mm Bite

Opens to 60° for easy removal of biopsy and safer cleaning

GYNECOLOGICAL INSTRUMENTS

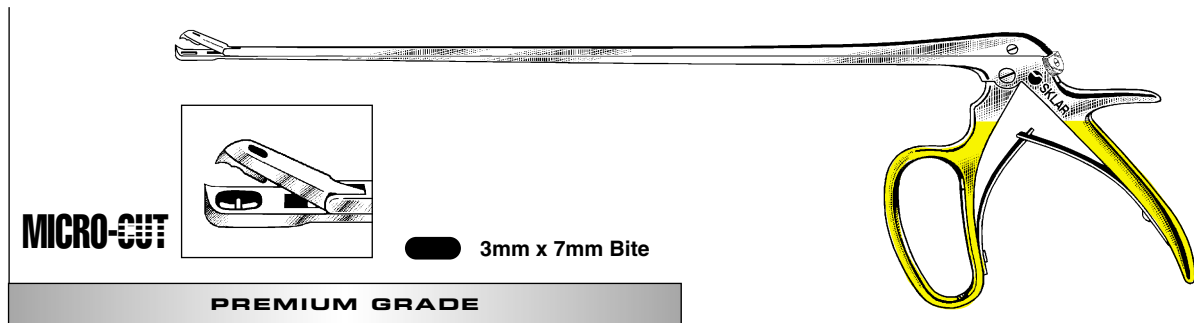
BIOPSY FORCEPS



TISCHLER OVAL BIOPSY FORCEP

90-7520

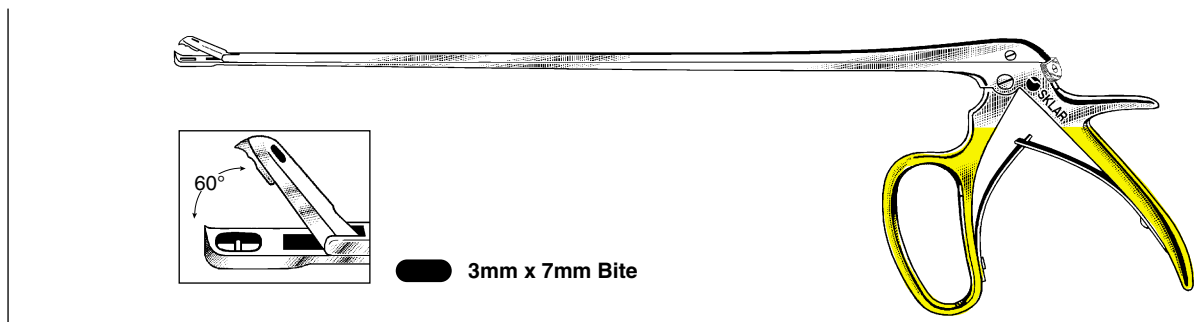
3mm x 7mm Bite



MICRO-CUT TISCHLER OVAL BIOPSY FORCEP

90-8940

3mm x 7mm Bite

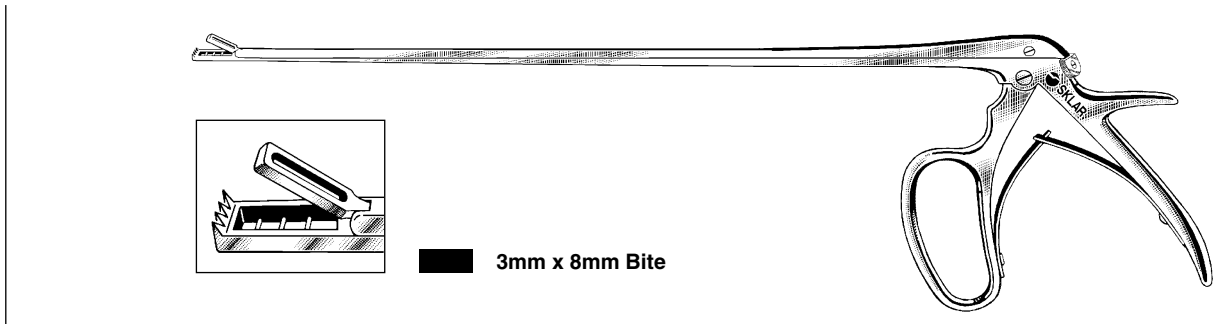


WIDE BITE TISCHLER OVAL BIOPSY FORCEP

90-9560

3mm x 7mm Bite

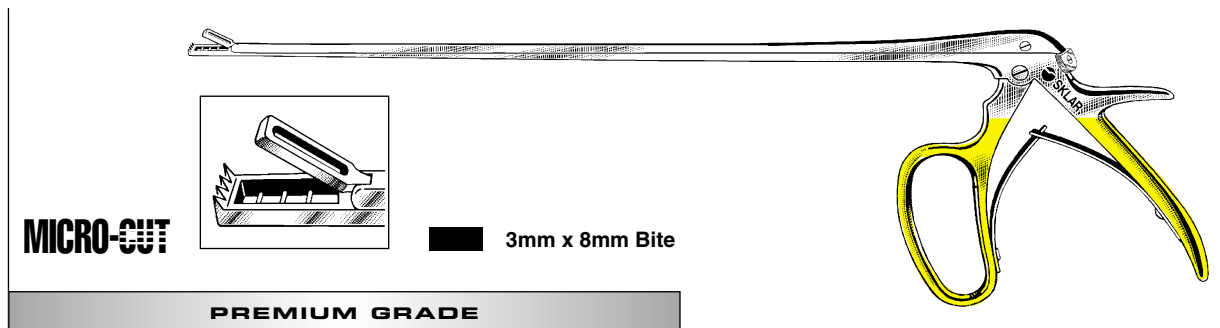
Opens to 60° for easy removal of biopsy and safer cleaning



KEVORKIAN BIOPSY FORCEP

90-7540

3mm x 8mm Bite



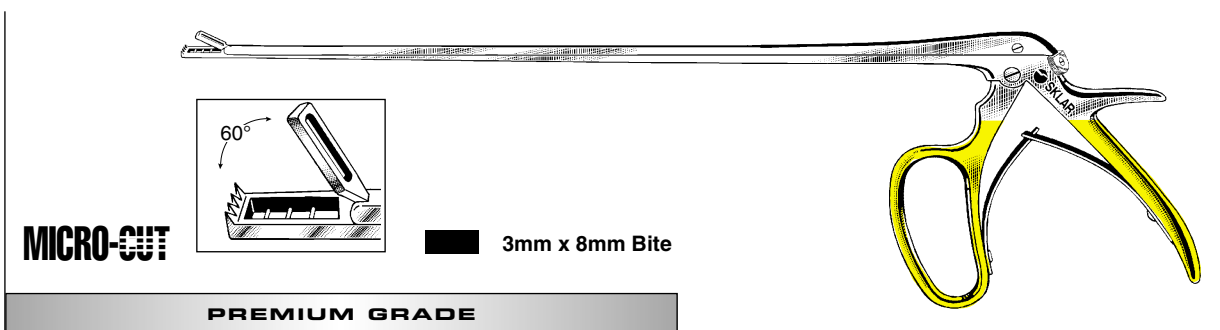
MICRO-CUT

PREMIUM GRADE

MICRO-CUT KEVORKIAN BIOPSY FORCEP

90-8952

3mm x 8mm Bite



MICRO-CUT

PREMIUM GRADE

WIDE BITE KEVORKIAN BIOPSY FORCEP

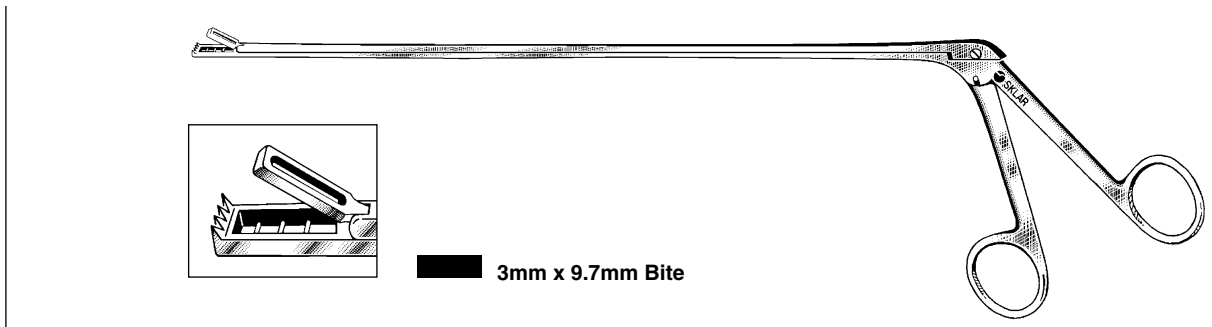
Opens to 60° for easy removal of biopsy and safer cleaning

90-9575

3mm x 8mm Bite

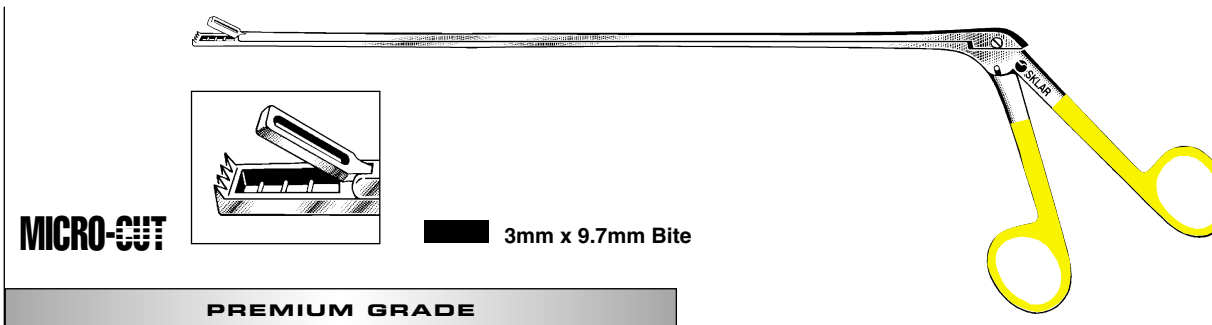
GYNECOLOGICAL INSTRUMENTS

BIOPSY FORCEPS



KEVORKIAN-YOUNGE BIOPSY FORCEP

90-6610 Teeth on lower jaw 3mm x 9.7mm Bite

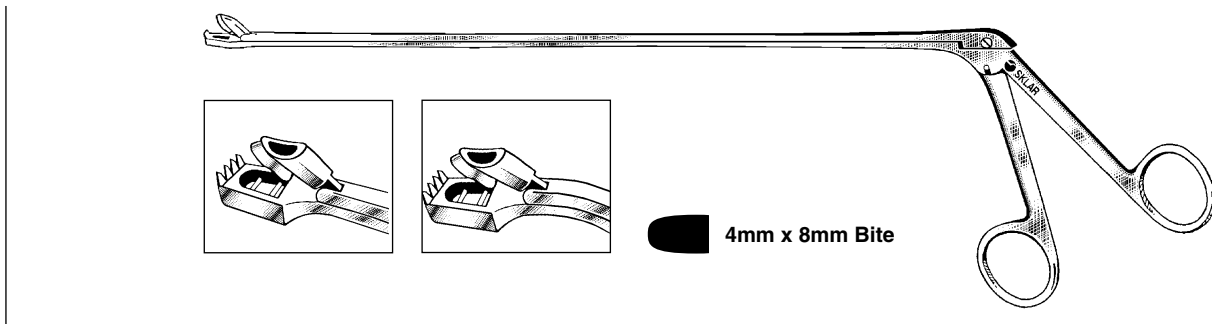


MICRO-CUT

PREMIUM GRADE

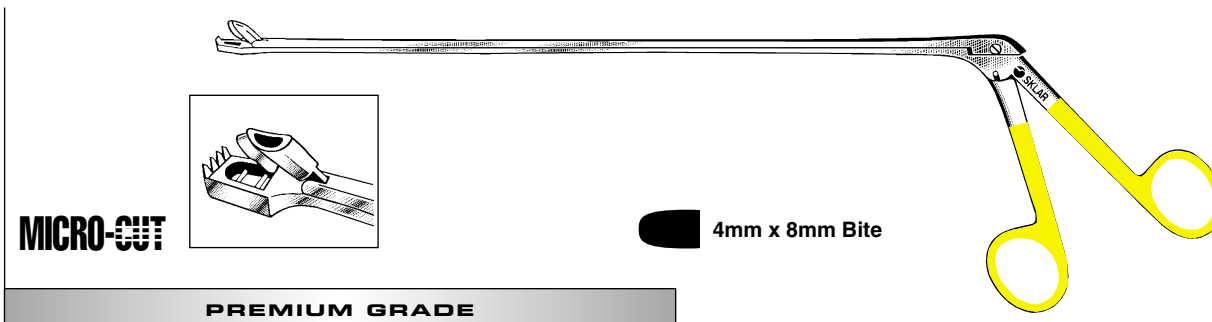
MICRO-CUT KEVORKIAN-YOUNGE BIOPSY FORCEP

90-8905 Teeth on lower jaw 3mm x 9.7mm Bite



WITNER UTERINE BIOPSY FORCEP

90-6600 Straight 4mm x 8mm Bite
90-6602 Angular 4mm x 8mm Bite

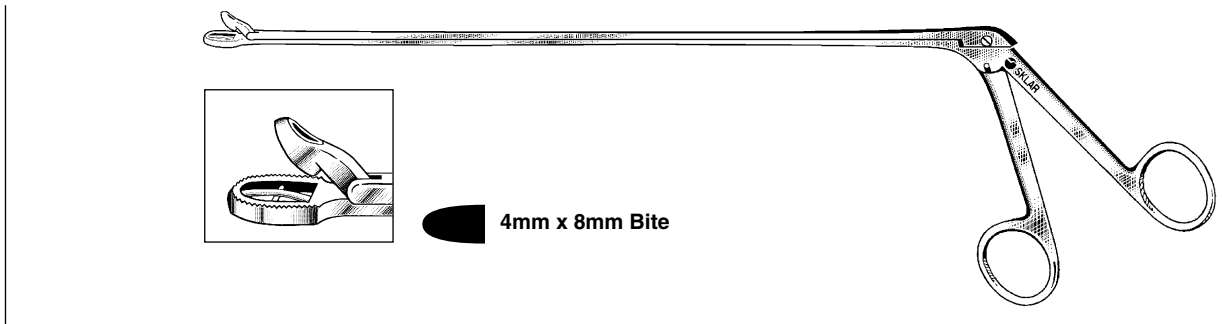


MICRO-CUT

PREMIUM GRADE

MICRO-CUT WITNER UTERINE BIOPSY FORCEP

90-8900 Straight 4mm x 8mm Bite

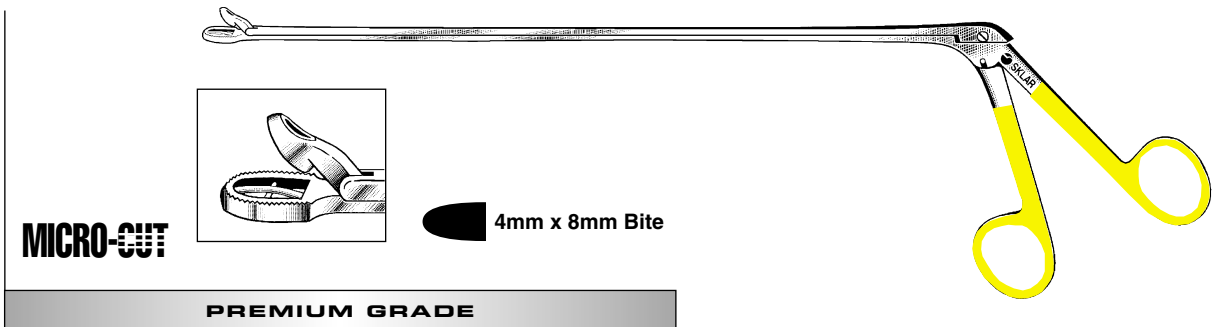


EPPENDORFER BIOPSY FORCEP

90-6820

4mm x 8mm Bite

Improved jaws

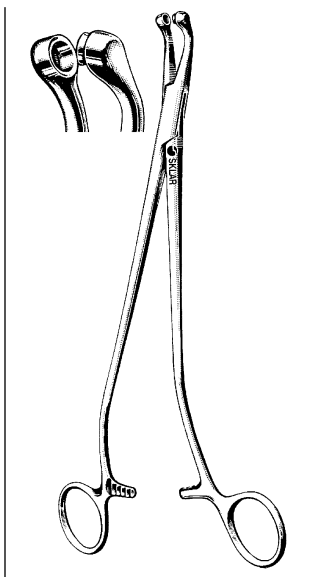


MICRO-CUT EPPENDORFER BIOPSY FORCEP

90-8010

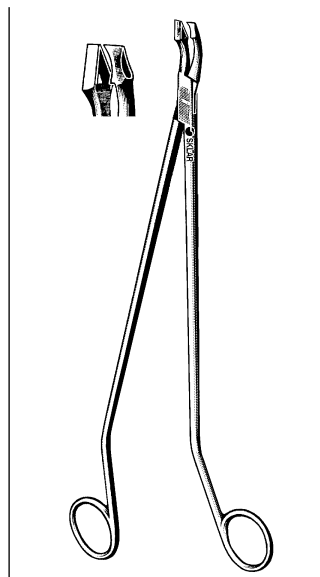
4mm x 8mm Bite

Improved jaws



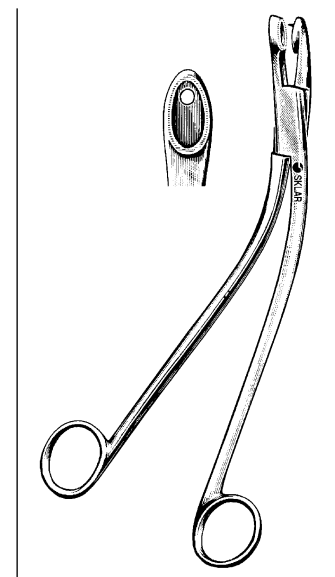
GAYLOR BIOPSY PUNCH

90-7385 8½" Standard
90-8925 8½" Micro-Cut



**SCHUBERT-VAN DOREN
BIOPSY PUNCH**

90-7511 10" Angular Tip and Shanks



GELHORN BIOPSY PUNCH

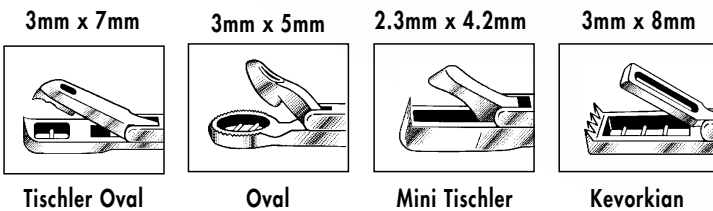
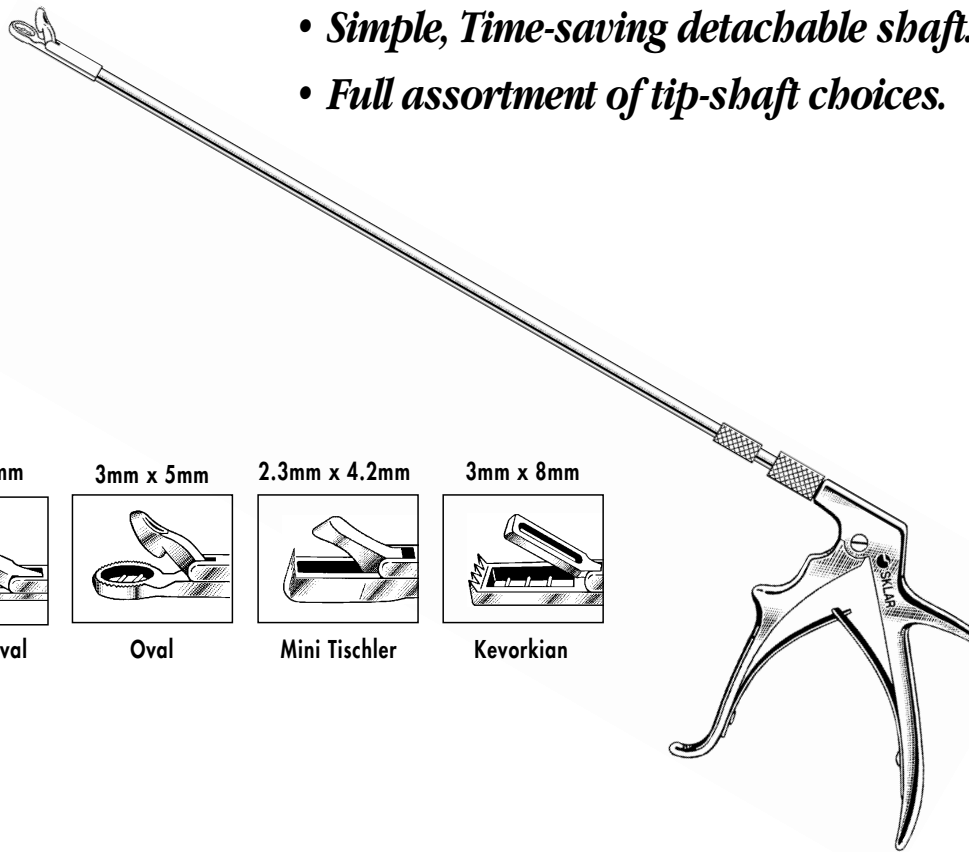
90-7492 9½"
90-8930 9½" Micro-Cut



INTRODUCING SKLAR FULLY ROTATIONAL BIOPSY PUNCH FORCEPS



- *360° Rotating Shaft*
- *Completely unobstructed biopsy site.*
- *Simple, Time-saving detachable shaft.*
- *Full assortment of tip-shaft choices.*

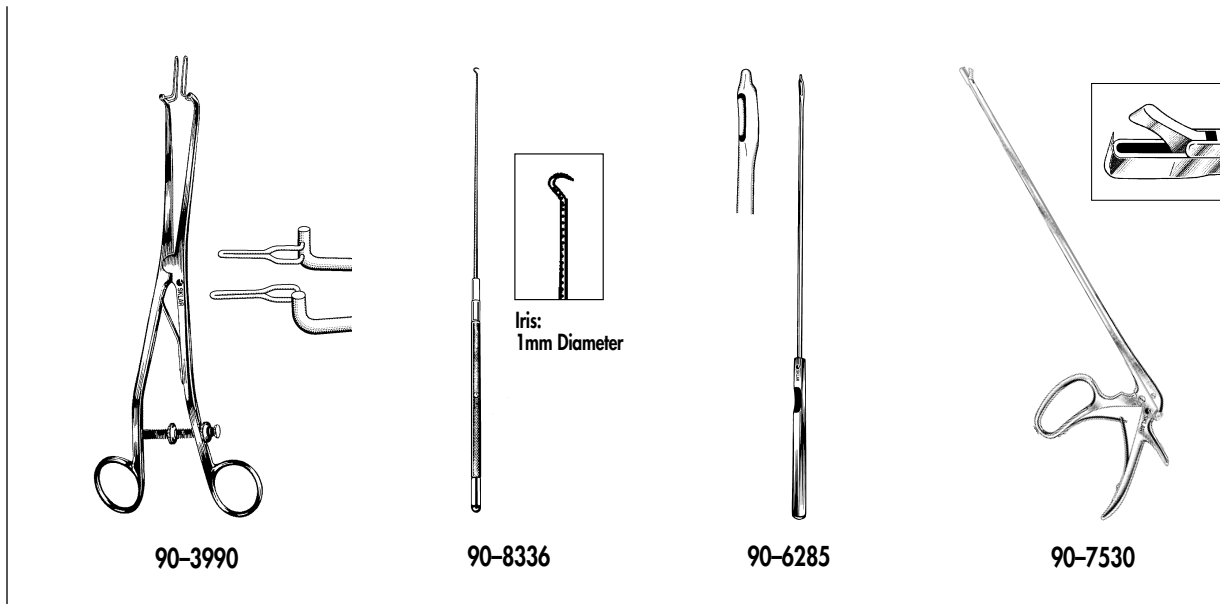


UNIVERSAL STYLE BIOPSY INSTRUMENTS

Complete Instrument		Cannula W/Tip Only	
90-7571	Tischler Oval	90-7576	Tischler Oval
90-7572	Oval	90-7577	Oval
90-7573	Mini Tischler	90-7578	Mini Tischler
90-7574	Kevorkian	90-7579	Kevorkian
90-7575	Universal Handle		

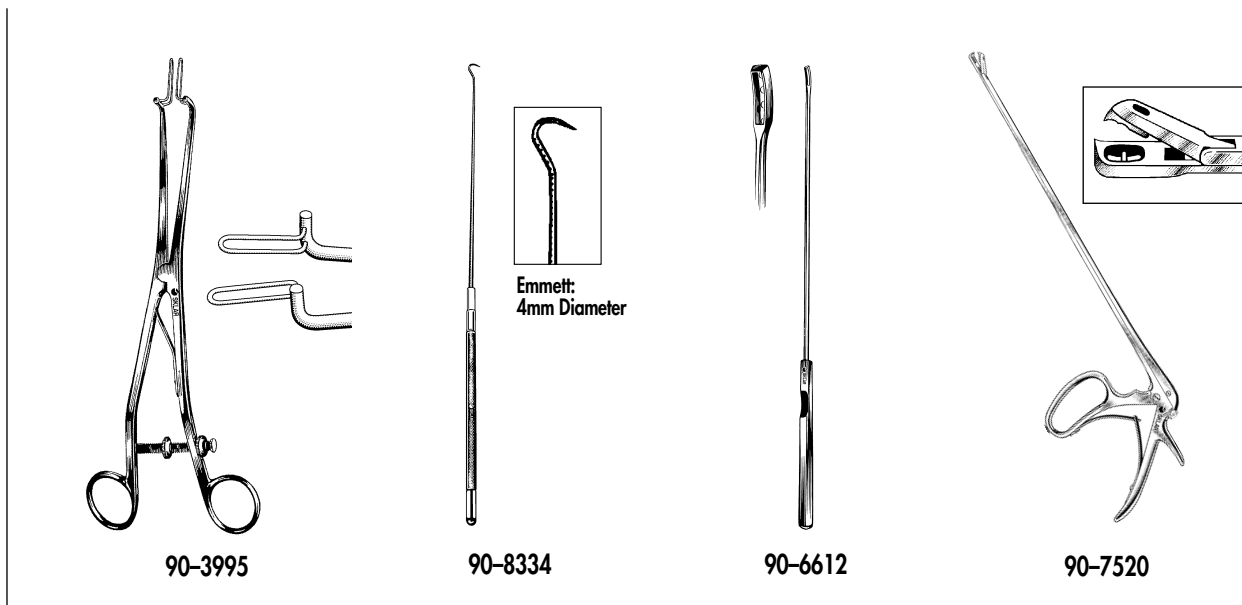
MICRO-CUT UNIVERSAL STYLE BIOPSY INSTRUMENTS

PREMIUM GRADE			
Complete Instrument		Cannula W/Tip Only	
90-8981	Tischler Oval	90-8986	Tischler Oval
90-8982	Oval	90-8987	Oval
90-8983	Mini Tischler	90-8988	Mini Tischler
90-8984	Kevorkian	90-8989	Kevorkian
90-8985	Universal Gold Handle		



90-8555 - MINI COLPOSCOPY SET (INCLUDES THE FOLLOWING)

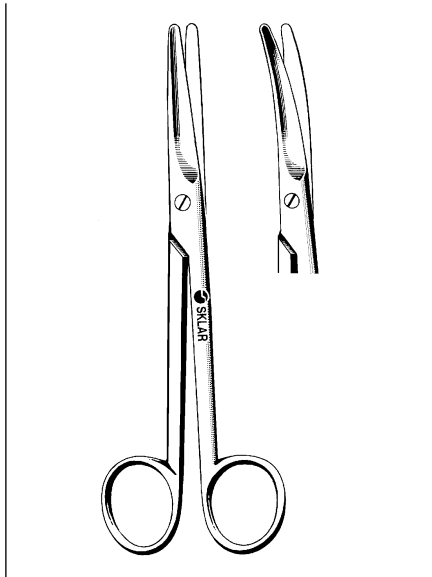
- 90-3990 Kogan Endocervical Speculum - Narrow Wire Blades
- 90-8336 Iris Hook - 1mm Diameter, 9" Long
- 90-6285 Mini Endocervical Curette
- 90-7530 Mini Tischler Delicate Forcep - 2.3mm x 4.2mm Bite



90-8557 - STANDARD COLPOSCOPY SET (INCLUDES THE FOLLOWING)

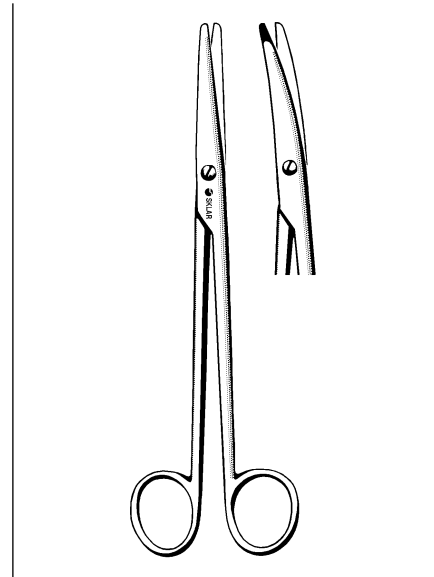
- 90-3995 Kogan Endocervical Speculum - Wide Wire Blades
- 90-8334 Emmett Hook - 4mm Diameter, 9" Long
- 90-6612 Kevorkian-Young Endocervical Curette - 12" With Basket
- 90-7520 Tischler Oval Biopsy Forcep - 3mm x 7mm Bite

GYNECOLOGICAL INSTRUMENTS SCISSORS



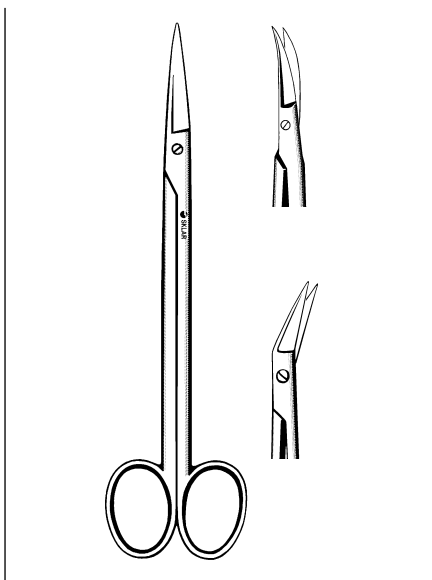
MAYO DISSECTING SCISSORS

Straight		Curved	
15-1555	5½"	15-2555	5½"
15-1567	6¾"	15-2567	6¾"
90-1590	9"	90-1690	9"



MAYO-STILLE DISSECTING SCISSORS ROUNDED BLADES

Straight		Curved	
15-1655	5½"	15-2655	5½"
15-1667	6¾"	15-2667	6¾"



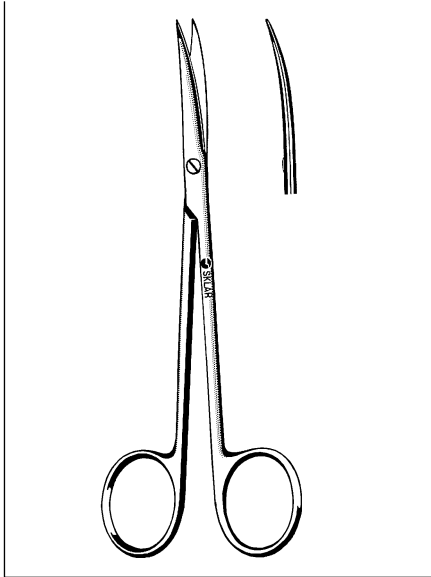
KELLY-ADSON SCISSORS

Straight			Curved		
50-4562	6¼"	Smooth	50-4662	6¼"	Smooth
50-4563	6¼"	Serrated			
Angular					
50-4462	6¼"	Smooth			



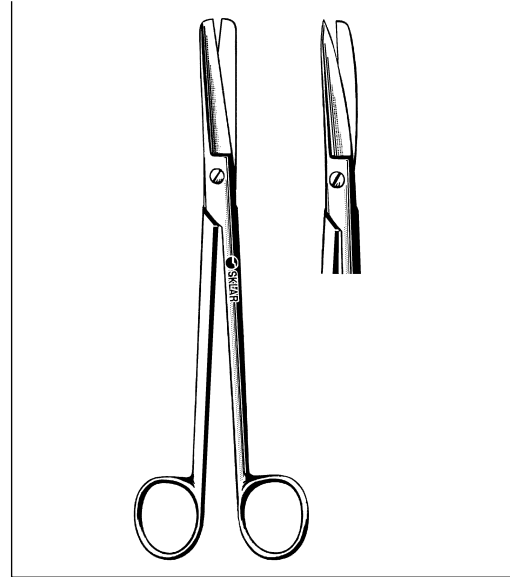
DOYEN SCISSORS

Straight, Blunt			Curved, Blunt		
15-1307	7"	Smooth	15-2307	7"	Smooth
15-1308	7"	Serrated	15-2308	7"	Serrated



BROPHY (SULLIVAN) SCISSORS

Curved Sharp Points
22-2755 5 3/4" Serrated



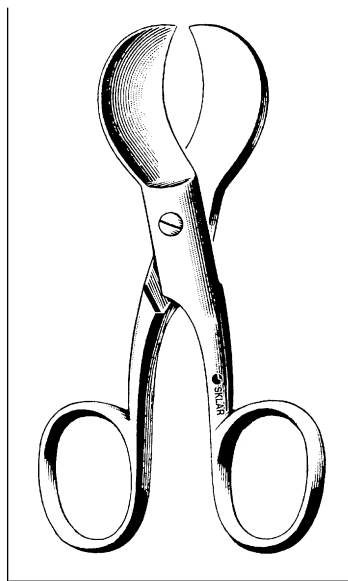
SIMS SCISSORS

Straight		Curved	
90-1280	8" S/S	90-1580	8" S/S
90-1180	8" S/B	90-1480	8" S/B
90-1080	8" B/B	90-1380	8" B/B



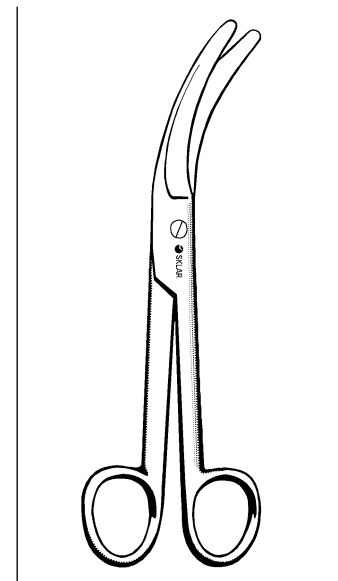
BRAUN EPISIOTOMY SCISSORS

Angular, Guarded Blade
90-1755 5 1/2"
90-1785 8 1/2"



UMBILICAL SCISSORS

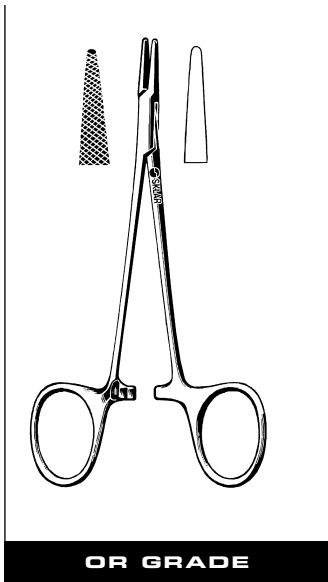
92-5540 4"



BUSCH UMBILICAL SCISSORS

Curved On Side
92-5565 6 1/2"

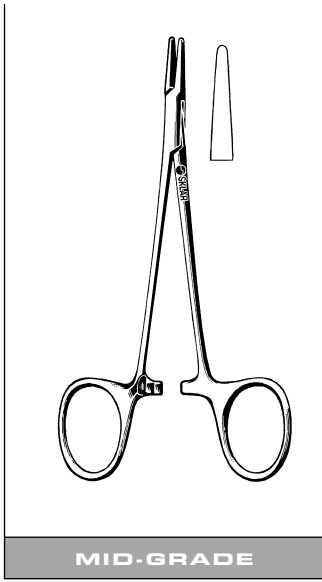
GYNECOLOGICAL INSTRUMENTS NEEDLE HOLDERS



OR GRADE

WEBSTER NEEDLE HOLDER

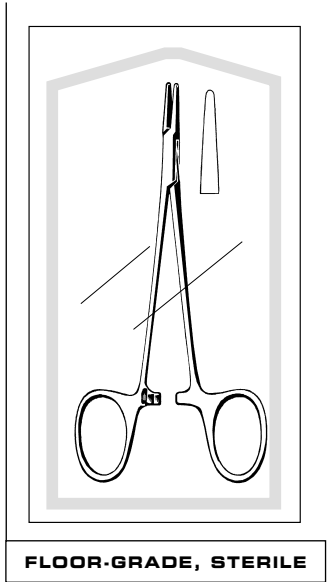
20-1350 5/4" Smooth
20-1352 5/4" Serrated



MID-GRADE

WEBSTER NEEDLE HOLDER

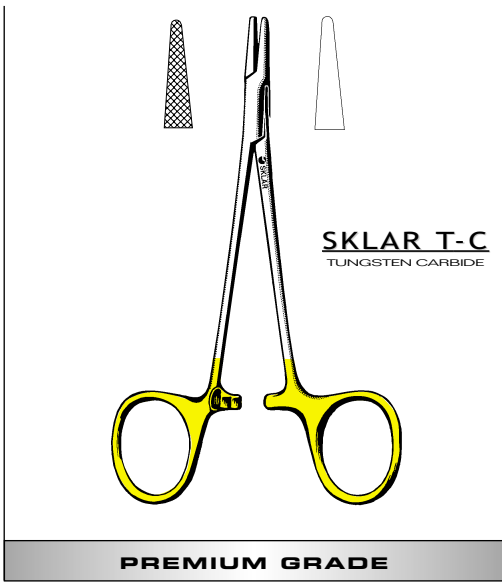
95-809 5/4" Smooth



FLOOR-GRADE, STERILE

WEBSTER NEEDLE HOLDER, STERILE

Box/50
96-2586 5/4" Smooth
Box/25
96-2587 5/4" Smooth



SKLAR T-C
TUNGSTEN CARBIDE

PREMIUM GRADE

T-C WEBSTER NEEDLE HOLDER

21-8002 5/4" Smooth
21-8080 5/4" Serrated

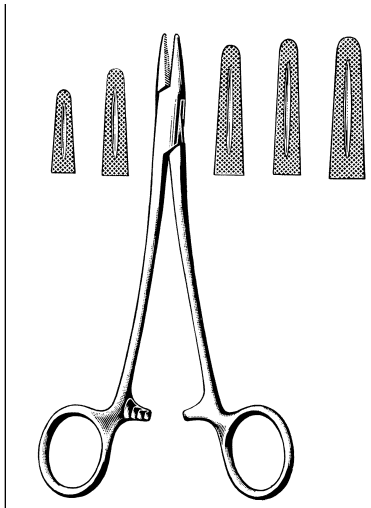


SKLARGRIP
CARBIDE COATING

PREMIUM GRADE

SKLARGRIP™ CARBIDE WEBSTER NEEDLE HOLDER

21-1650 5/4" Smooth
21-1652 5/4" Serrated

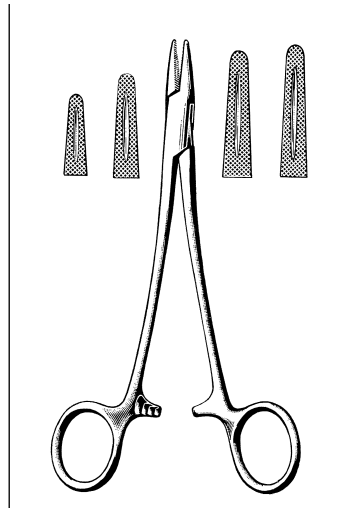


OR GRADE

MAYO-HEGAR NEEDLE HOLDER

Serrated

20-2052	5 1/4"	20-2480	8"
20-2060	6"	20-2910	10 1/2" Masson
20-2070	7"	20-2911	11 1/2" Masson
20-2270	7" Broad Jaw		

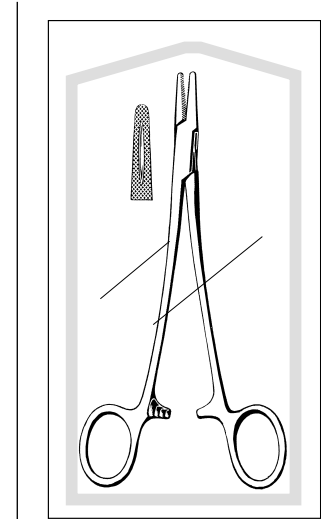


MID-GRADE

MAYO-HEGAR NEEDLE HOLDER

Serrated

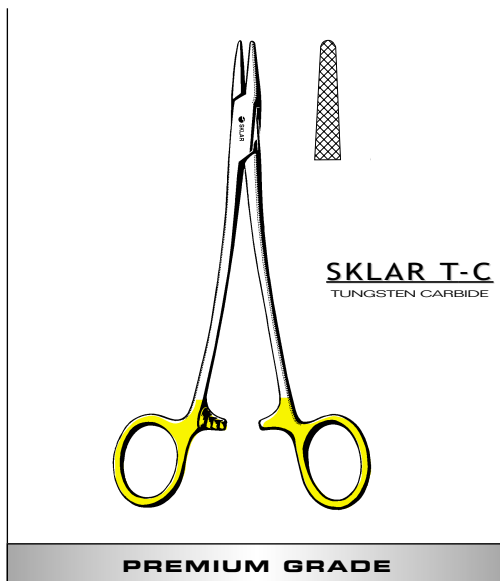
95-842	5 1/4"
95-847	6"
95-853	7"
95-869	8"



FLOOR-GRADE, STERILE

MAYO-HEGAR NEEDLE HOLDER, STERILE

Box/50	
96-2594	6"
Box/25	
96-2595	6"

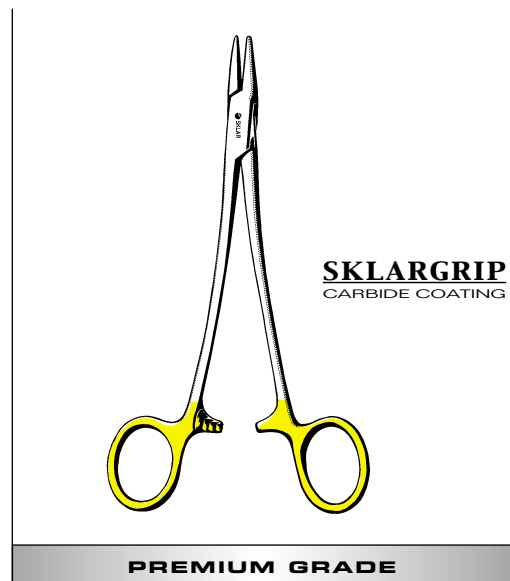


PREMIUM GRADE

T-C MAYO-HEGAR NEEDLE HOLDER

Serrated

21-8031	6"
21-8032	7"
21-8033	8"
21-8034	10 1/2"
21-8035	12"



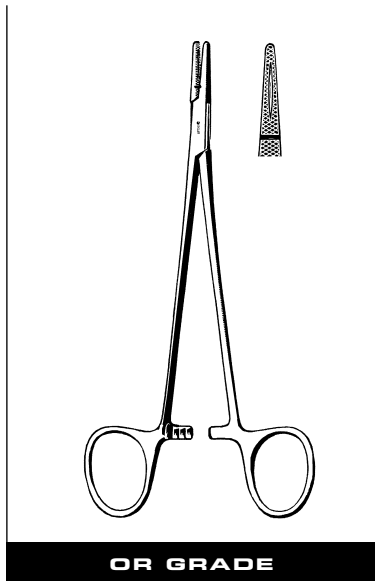
PREMIUM GRADE

SKLARGRIP™ CARBIDE MAYO-HEGAR NEEDLE HOLDER

Serrated

21-2060	6"
21-2070	7"
21-2480	8"
21-2910	10 1/2" Masson

GYNECOLOGICAL INSTRUMENTS NEEDLE HOLDERS

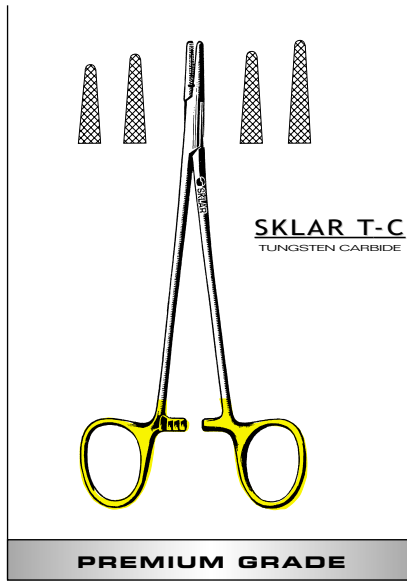


OR GRADE

CRILE-WOOD NEEDLE HOLDER

Serrated

20-1265	6"	Narrow Jaw
20-1270	7"	
20-1280	8"	
20-1290	9"	
20-1295	10½"	

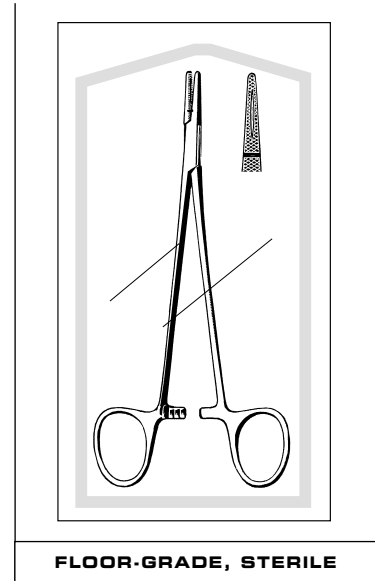


PREMIUM GRADE

T-C CRILE-WOOD NEEDLE HOLDER

Serrated

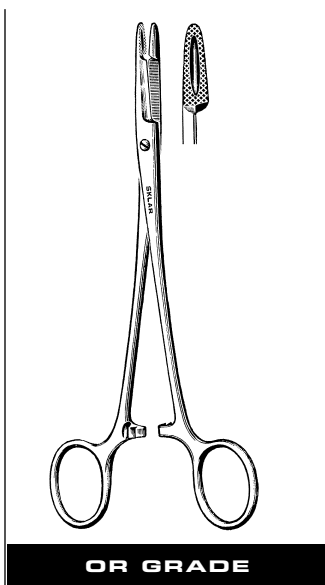
21-8006	6"
21-8007	7"
21-8008	8"
21-8009	9"
21-8010	10½"
21-8011	12"



FLOOR-GRADE, STERILE

CRILE-WOOD NEEDLEHOLDER, STERILE

Box/50	
96-2590	6"
Box/25	
96-2591	6"

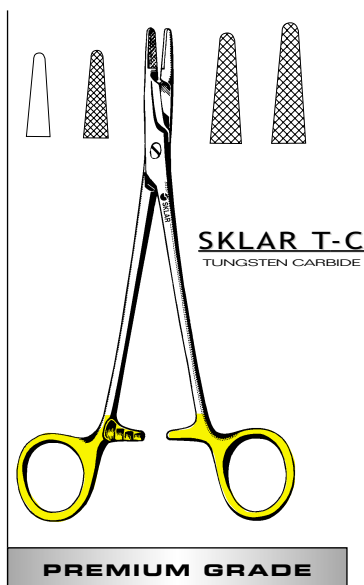


OR GRADE

OLSEN-HEGAR NEEDLE HOLDER

Scissors combination

20-2747	4¾"	Delicate
20-2755	5½"	
20-2765	6½"	
20-2775	7"	

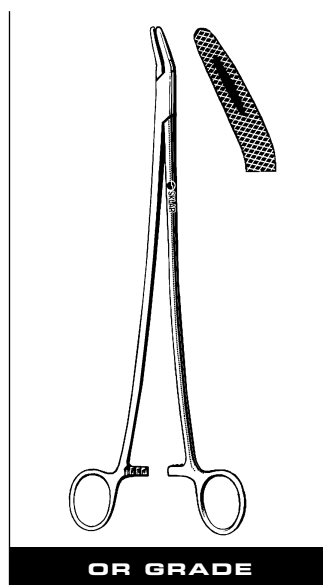


PREMIUM GRADE

T-C OLSEN-HEGAR NEEDLE HOLDERS

Scissors combination

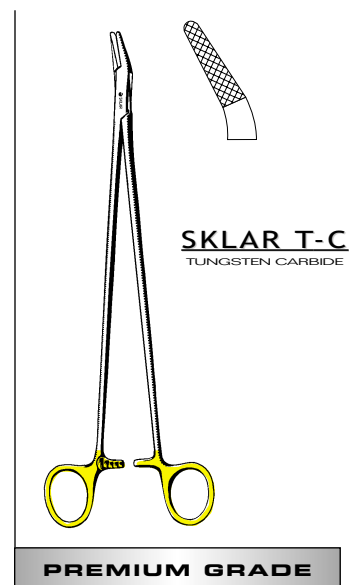
21-8025	4¾"	Serrated	Delicate
21-8027	5½"	Serrated	
21-8028	6½"	Serrated	
21-8029	7½"	Serrated	
21-8026	4¾"	Smooth	



OR GRADE

FINOCHIETTO NEEDLE HOLDER

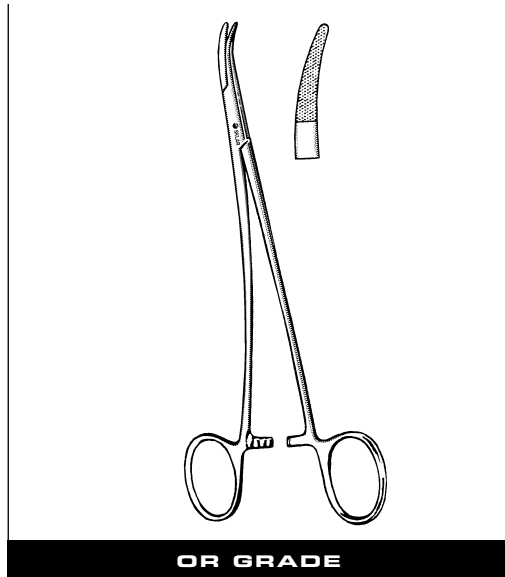
20-4510 10¼"



PREMIUM GRADE

T-C FINOCHIETTO NEEDLE HOLDER

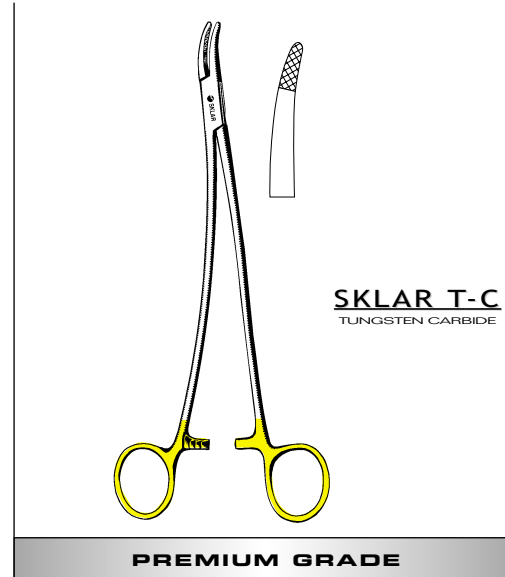
21-8039 10½" Serrated



OR GRADE

STRATTE NEEDLE HOLDER

20-4795 9" Standard

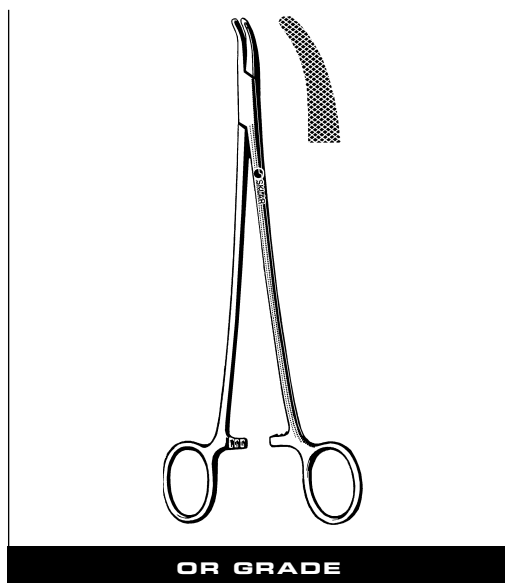


SKLAR T-C
TUNGSTEN CARBIDE

PREMIUM GRADE

T-C STRATTE NEEDLE HOLDER

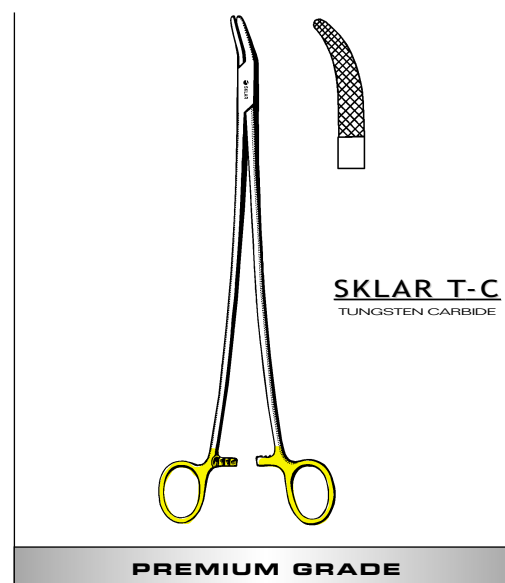
"S" Shaped
21-8065 9" Serrated



OR GRADE

HEANEY NEEDLE HOLDER

20-4682 8 1/2"



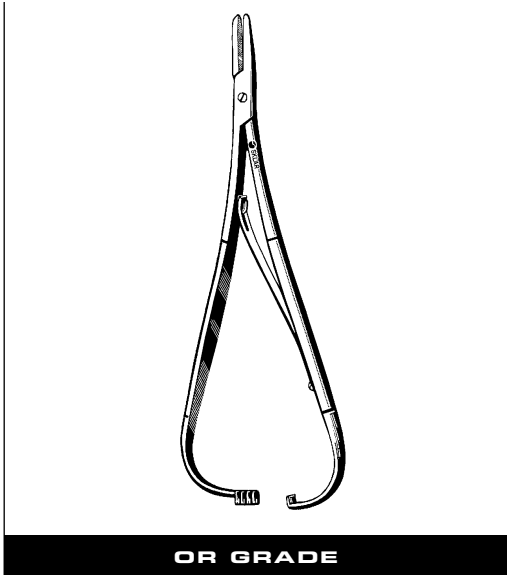
SKLAR T-C
TUNGSTEN CARBIDE

PREMIUM GRADE

T-C HEANEY NEEDLE HOLDER

Curved
21-8060 8 1/2" Serrated
21-8061 10" Serrated

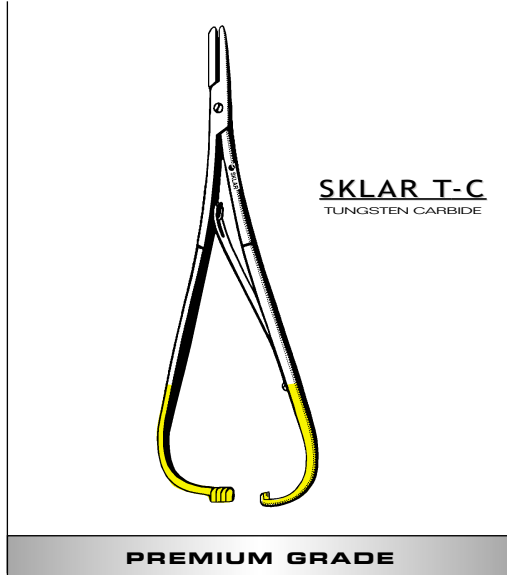
GYNECOLOGICAL INSTRUMENTS NEEDLE HOLDERS



OR GRADE

MATHIEU NEEDLE HOLDER

20-3075 7½" Standard



SKLAR T-C
TUNGSTEN CARBIDE

PREMIUM GRADE

T-C MATHIEU NEEDLE HOLDER

21-8070 5½"
21-8072 7½"

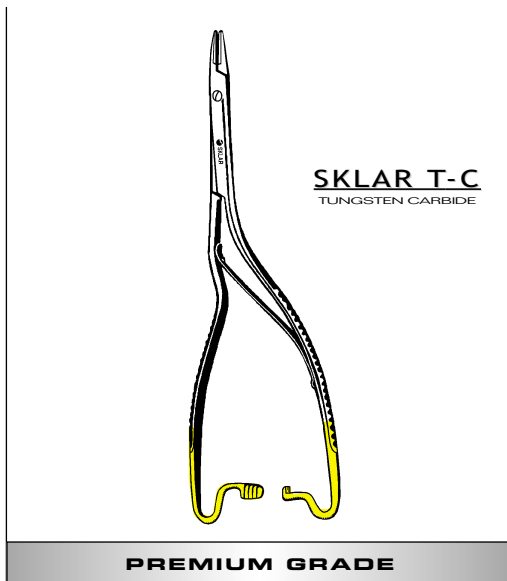


SKLAR T-C
TUNGSTEN CARBIDE

PREMIUM GRADE

T-C BOZEMAN-HEANEY NEEDLE HOLDER

21-2180 8" S-Curve
21-2195 9½" S-Curve
21-8062 10½" S-Curve

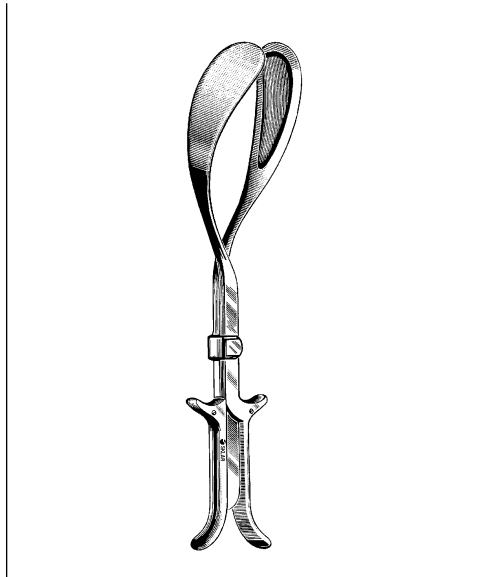


SKLAR T-C
TUNGSTEN CARBIDE

PREMIUM GRADE

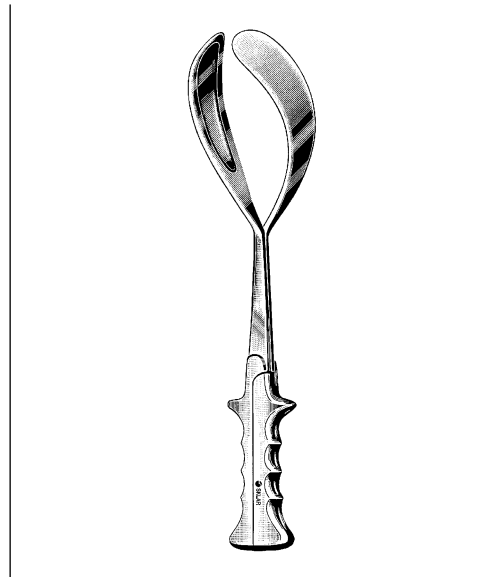
T-C LUETHY-BECK NEEDLE HOLDER

21-8064 8"



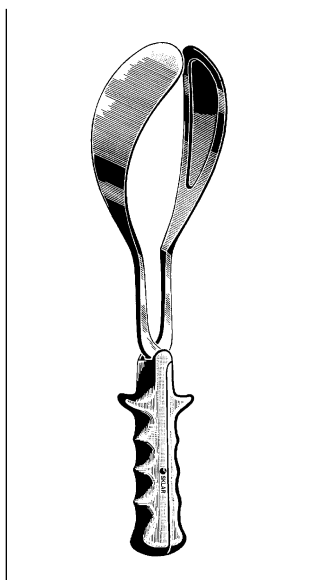
LUIKART OBSTETRICAL FORCEPS

92-2015 15 3/4"



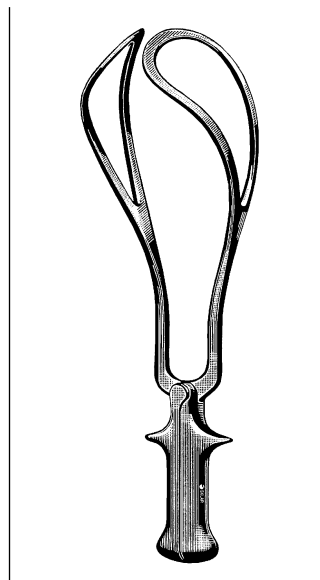
**McLANE-TUCKER-LUIKART OBSTETRICAL
FORCEPS**

92-2215 15 3/4"



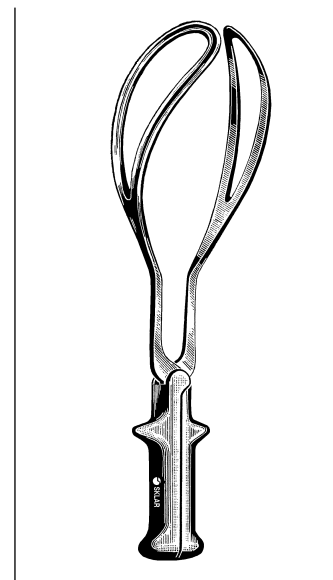
**SIMPSON-LUIKART
OBSTETRICAL FORCEPS**

92-2314 14"



**DE LEE OBSTETRICAL
FORCEPS**

92-1012 12" for cesarean section



**SIMPSON OBSTETRICAL
FORCEPS**

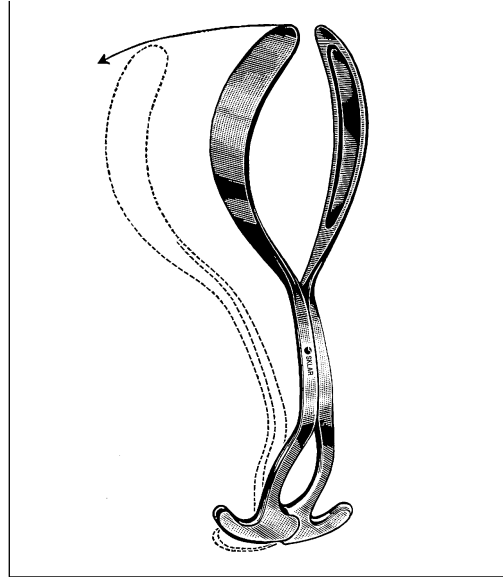
92-1112 12" Short
92-1114 14 1/4" Long

OBSTETRICAL FORCEPS



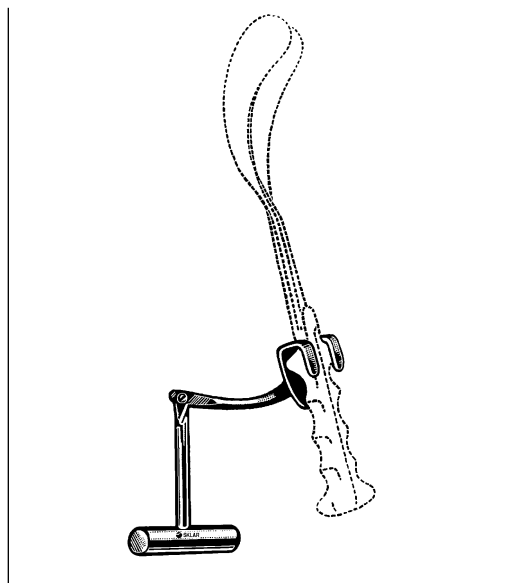
McLANE-TUCKER OBSTETRICAL FORCEPS

92-1415 15 1/4"



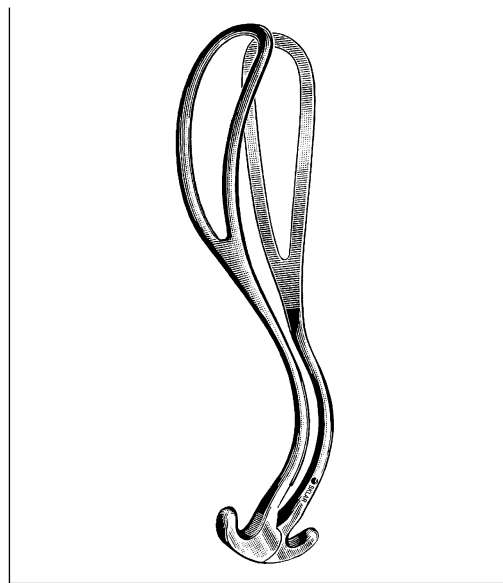
LAUFE DIVERGENT OBSTETRICAL FORCEPS

92-2912 12 1/2"



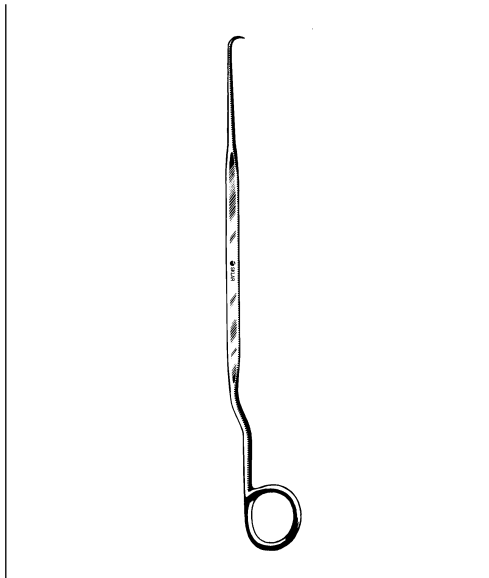
BILL TRACTION HANDLE

For Use on Standard Forceps as Shown
92-3350



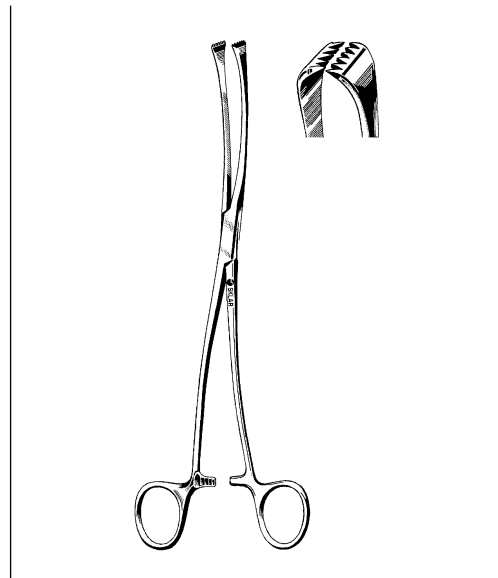
LAUFE-PIPER OBSTETRICAL FORCEPS

For Breech Presentation
92-2812 12"



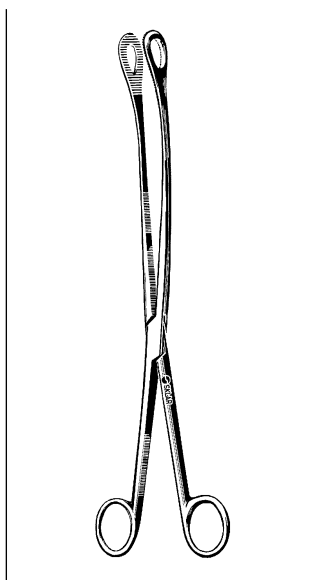
BEACHAM AMNIOTOME

91-4210 10 1/2"



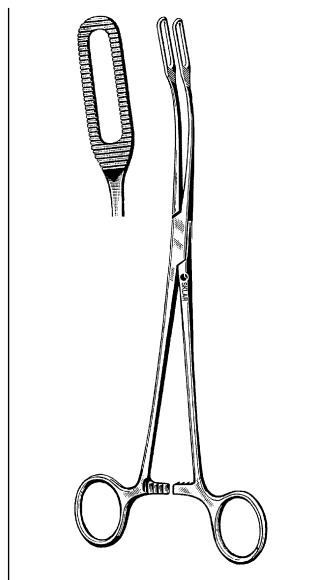
IOWA MEMBRANE FORCEPS

91-4310 10" S-Curve



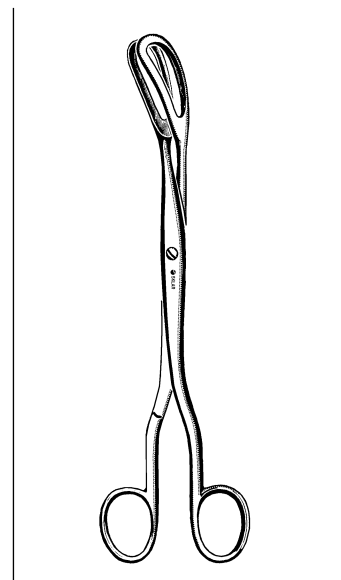
KELLY PLACENTA FORCEPS

Curved
92-5012 12"



JAVERTS PLACENTA FORCEPS

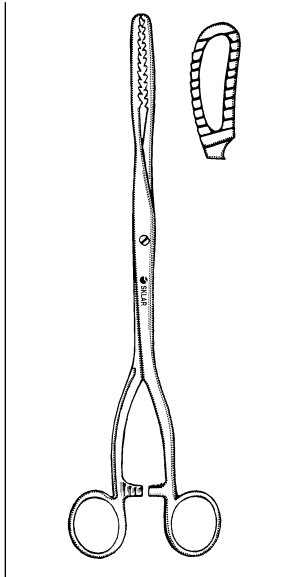
92-5095 9 1/2" Serrated



COREY OVUM FORCEPS

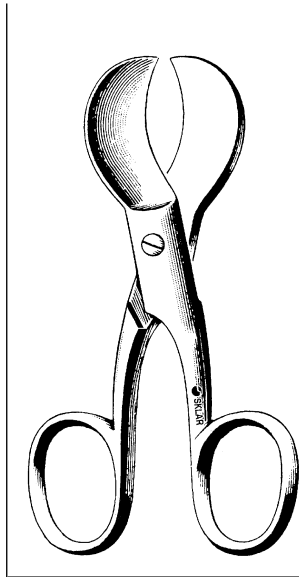
92-5295 9 1/2"

OBSTETRICAL INSTRUMENTS



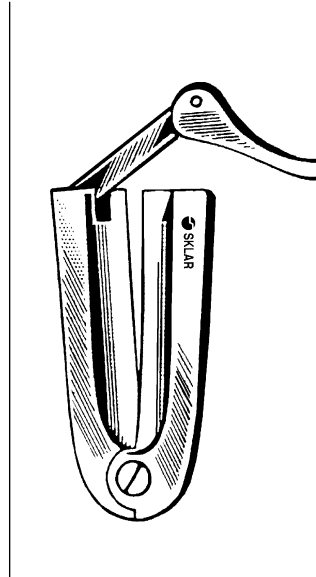
BIERER OVUM FORCEPS

Serrated Jaw
92-5298 11"



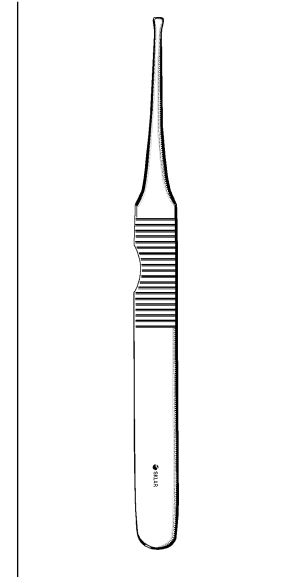
UMBILICAL SCISSORS

92-5540 4"



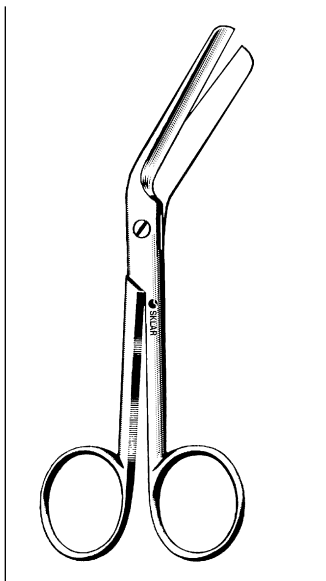
MOGEN CIRCUMCISION CLAMP

85-6550 2.5 mm Aperture



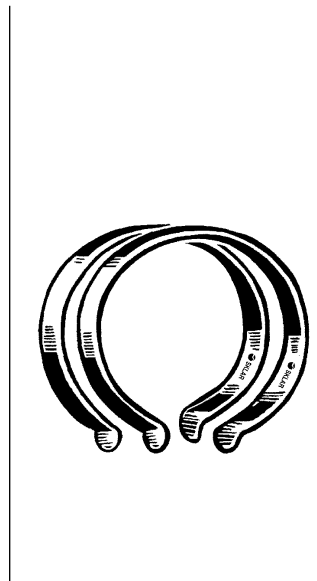
CIRCUMCISION PROBE

85-6551 5"



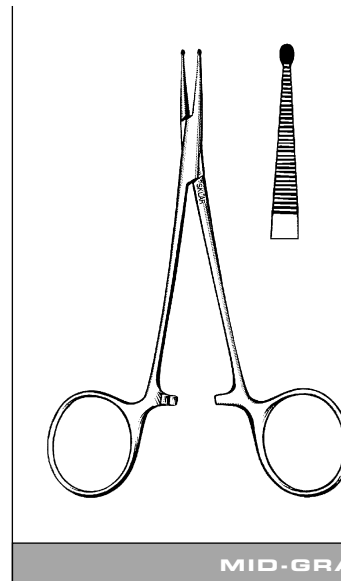
BRAUN EPISIOTOMY SCISSORS

Angular, Guarded Blade
90-1755 5 1/2"
90-1785 8 1/2"



BETHEA SHEET HOLDER

92-6535 Pair



DUNAWAY CIRCUMCISION FORCEPS

95-456 4" With Bead Tip

A newly designed and patented hemostatic forcep permits a less traumatic separation of the foreskin from the glans while performing newborn circumcisions. With the unique "bead tip" mosquito forcep it is nearly impossible to inadvertently enter the urethra or cause trauma to the glans. In addition, visualizing the bead through the skin makes it less likely to separate too much foreskin.

Patent # 5931843

MID-GRADE

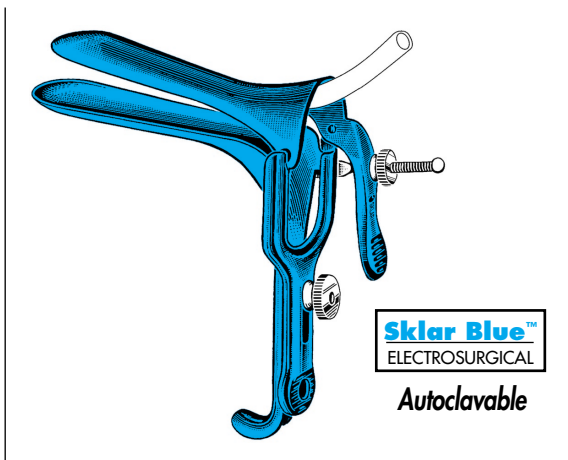
Sklar's new line of electrosurgical instruments features our exclusive Sklar Blue™ coating. Manufactured of the highest quality stainless steel, these instruments are fully autoclavable, and can even be cleaned ultrasonically.

These instruments are designed to provide an effective patient-safe surface that prevents transmission of RF current through the instrument.

All Sklar Blue™ electrosurgery coatings are guaranteed one year against manufacturing defects.

Sklar Blue™
ELECTROSURGICAL

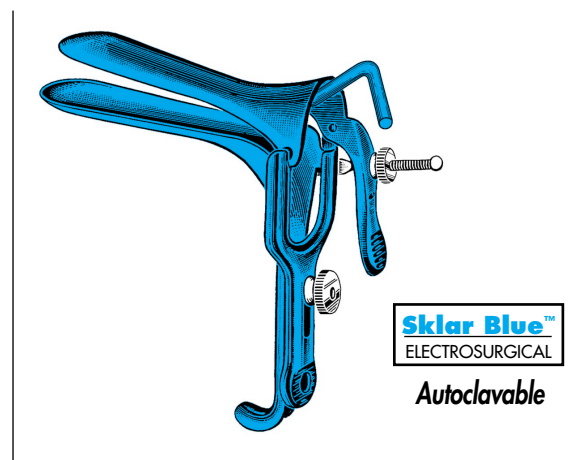
Sklar Blue™ Electrosurgery Instrumentation



SKLAR BLUE™ GRAVES VAGINAL SPECULUM

With slip rings for disposable smoke evacuation tube

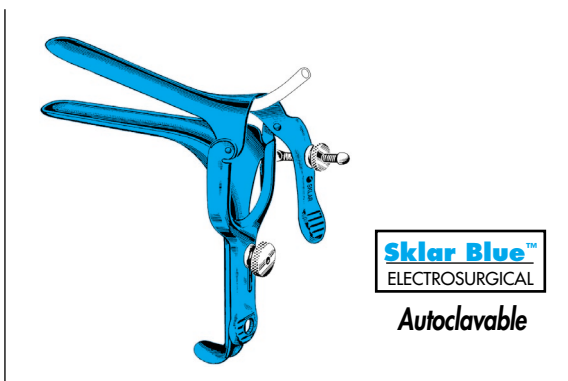
91-5010	3" x 3/4"	Small
91-5012	4" x 1 1/4"	Medium
91-5014	4 1/2" x 1 3/8"	Large
91-5015	2 3/4" x 3/8"	Extra Small
91-5018	4 3/4" x 1 1/2"	Extra Large



SKLAR BLUE™ GRAVES VAGINAL SPECULUM

With permanent smoke evacuation tube

91-5020	3" x 3/4"	Small
91-5022	4" x 1 1/4"	Medium
91-5024	4 1/2" x 1 3/8"	Large
91-5028	4 3/4" x 1 1/2"	Extra Large



SKLAR BLUE™ PEDERSON VAGINAL SPECULUM

With slip rings for disposable smoke evacuation tube

91-5032	3" x 1/2"	Small
91-5034	4" x 3/8"	Medium
91-5036	4 3/4" x 1"	Large
91-5040	4" x 3/8"	Slender
91-5038	2 3/4" x 1/2"	Extra Small



SKLAR BLUE™ PEDERSON VAGINAL SPECULUM

With permanent smoke evacuation tube

91-5042	3" x 1/2"	Small
91-5044	4" x 7/8"	Medium
91-5046	4 3/4" x 1"	Large
91-5047	4 3/4" x 1 3/8"	Extra Large
91-5050	4" x 3/8"	Slender

GYNECOLOGY ELECTROSURGICAL INSTRUMENTS



Sklar Blue™
ELECTROSURGICAL

Autoclavable

SKLAR BLUE™ GRAVES VAGINAL SPECULUM

Without Tube or Ring

91-5060	3" x 3/4"	Small
91-5062	4" x 1 1/4"	Medium
91-5064	4 1/2" x 1 1/2"	Large



Sklar Blue™
ELECTROSURGICAL

Autoclavable

SKLAR BLUE™ GRAVES VAGINAL SPECULUM

Without Tube or Ring

91-5066	2 3/4" x 3/8"	Extra Small
91-5068	4 3/4" x 1 1/2"	Extra Large



Sklar Blue™
ELECTROSURGICAL

Autoclavable

SKLAR BLUE™ PEDERSON VAGINAL SPECULUM

Without Tube or Ring

91-5082	3" x 1/2"	Small
91-5084	4" x 3/8"	Medium
91-5086	4 3/4" x 1"	Large



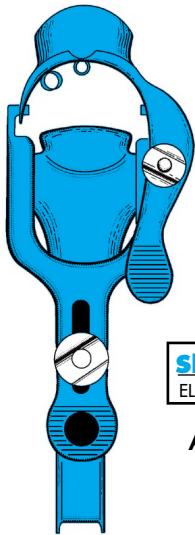
Sklar Blue™
ELECTROSURGICAL

Autoclavable

SKLAR BLUE™ PEDERSON VAGINAL SPECULUM

Without Tube or Ring

91-5088	2 3/4" x 3/8"	Extra Small
91-5092	4" x 3/8"	Slender



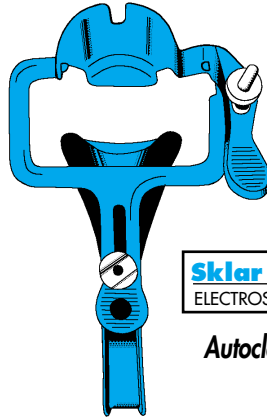
Sklar Blue™
ELECTROSURGICAL

Autoclavable

SKLAR BLUE™ GRAVES VAGINAL SPECULUM WIDE VIEW PATTERN

With large proximal opening for instrumentation

91-5080 4" x 1 1/4" Medium, With loops for holding and directing Smoke Evacuation Tubing



Sklar Blue™
ELECTROSURGICAL

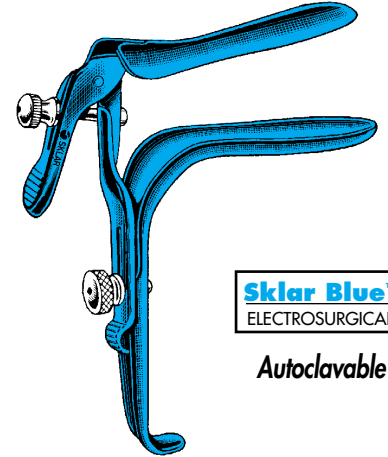
Autoclavable

SKLAR BLUE™ GRAVES OB-VIEW VAGINAL SPECULUM

91-3740 4" x 1 1/4" Medium

91-3741 4 3/4" x 1 1/2" Large

Both With Permanent Smoke Evacuation Tubing (not illustrated)



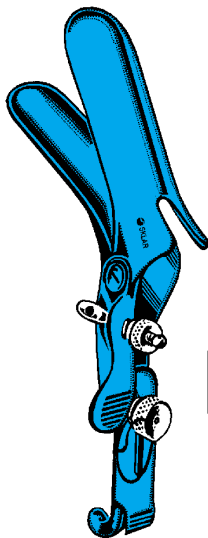
Sklar Blue™
ELECTROSURGICAL

Autoclavable

SKLAR BLUE™ FREEWAY GRAVES VAGINAL SPECULUM

Open Side, 90° Angle

91-5160 4" x 1 1/4" With Permanent Smoke Evacuation Tubing (not illustrated)



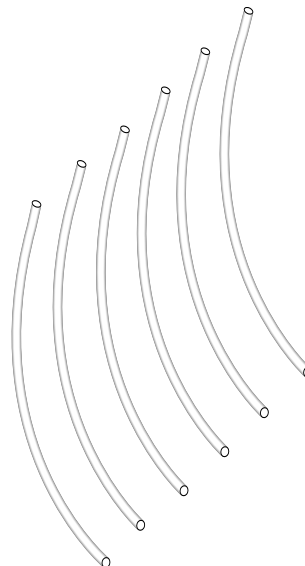
Sklar Blue™
ELECTROSURGICAL

Autoclavable

SKLAR BLUE™ FREEWAY GRAVES VAGINAL SPECULUM

Open Side, 45° Angle

91-5162 4" x 1 1/4" With Permanent Smoke Evacuation Tubing (not illustrated)



DISPOSABLE SMOKE EVACUATION TUBING

93-2160 Case of 50 in 10" precut 3/16" ID 1/4" OD

GYNECOLOGY ELECTROSURGICAL INSTRUMENTS



SKLAR BLUE™ CUSCO VAGINAL SPECULUM

With Permanent Smoke Evacuation Tubing

91-5150	3" x 1¼"	Small
91-5152	3½" x 1½"	Medium
91-5154	3¾" x 1¾"	Large



SKLAR BLUE™ LATERAL VAGINAL RETRACTOR

Ratchet Handle
Blades Fit Inside Vaginal Speculum
91-5190



SKLAR BLUE™ SIMS RETRACTOR

Single End

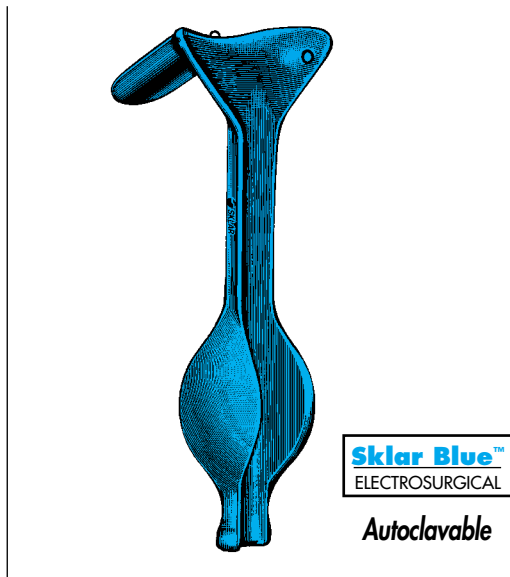
91-5200	Medium
91-5202	Medium, With loop to hold and direct disposable smoke evacuation tubing.



SKLAR BLUE™ SIMS RETRACTOR

Double End

91-5210	Medium
91-5212	Medium, With loop to hold and direct disposable smoke evacuation tubing.



Sklar Blue™
ELECTROSURGICAL

Autoclavable

SKLAR BLUE™ AUWARD VAGINAL SPECULUM

Blades 2¾" x 1½"

91-5120 Medium

2½ lbs.

91-5122 Medium

2½ lbs., with loop to hold and direct disposable evacuation tubing.



Sklar Blue™
ELECTROSURGICAL

Autoclavable

SKLAR BLUE™ AUWARD VAGINAL SPECULUM

Long Blade 4" x 1¾"

91-5130 Medium

2½ lbs.

91-5132 Medium

2½ lbs., with loop to hold and direct disposable evacuation tubing.

Sklar Blue™ Electrosurgery Instruments

- Insulates From Transmission of Electrosurgical Current
- Non-Conductive
- Ultrasonically Cleanable
- Autoclavable
- One Year Guarantee Against Manufacturing Defects



Sklar Blue™
ELECTROSURGICAL

Autoclavable

SKLAR BLUE™ STEINER-AUWARD VAGINAL SPECULUM

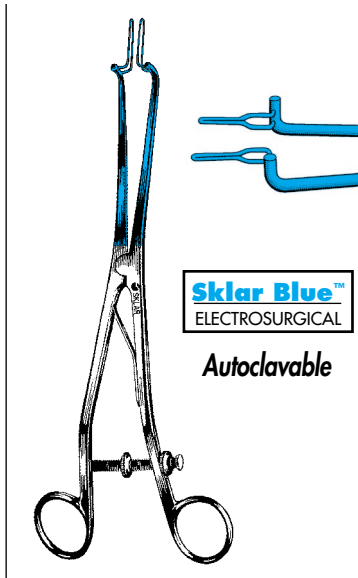
Extra long Blade 5½" x 1¼"

91-5140 2½ lbs.

91-5142 2½ lbs.

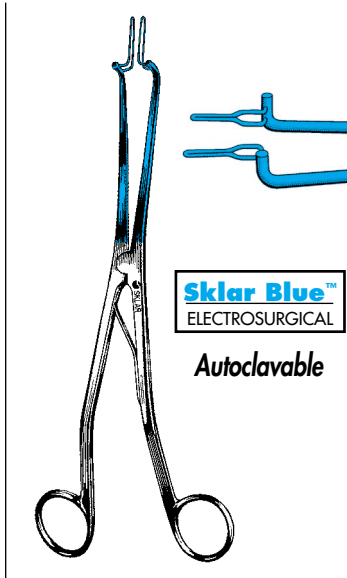
With loop to hold and direct disposable evacuation tubing.

GYNECOLOGY ELECTROSURGICAL INSTRUMENTS



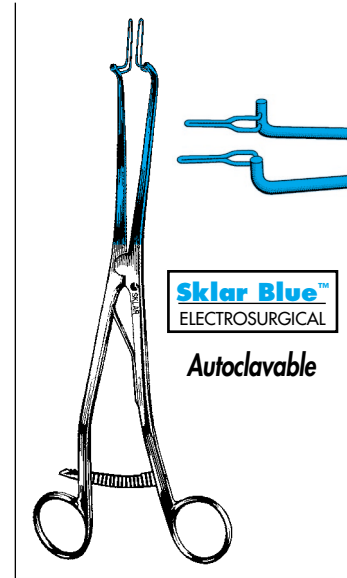
SKLAR BLUE™ KOGAN ENDOSPECULUM

With Gauge and Screws
91-5230 Narrow Wire Blades



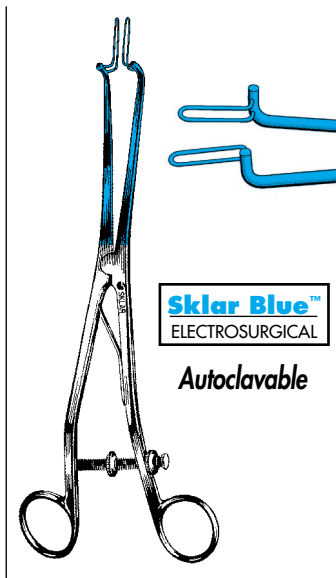
SKLAR BLUE™ KOGAN ENDOSPECULUM

With Spring Handle
91-5228 Narrow Wire Blades



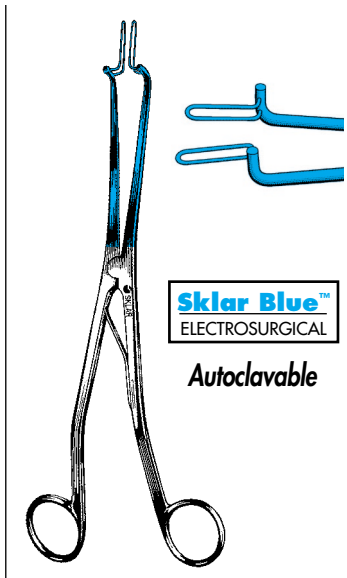
SKLAR BLUE™ KOGAN ENDOSPECULUM

With Ratchet Handle
91-5235 Narrow Wire Blades



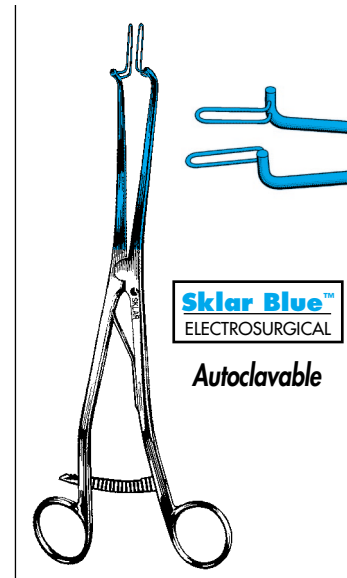
SKLAR BLUE™ KOGAN ENDOSPECULUM

With Gauge and Screws
91-5232 Wide Wire Blades



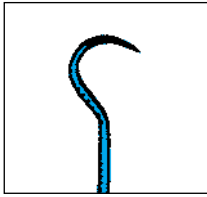
SKLAR BLUE™ KOGAN ENDOSPECULUM

With Spring Handle
91-5226 Wide Wire Blades



SKLAR BLUE™ KOGAN ENDOSPECULUM

With Ratchet Handle
91-5234 Wide Wire Blades



Emmett (Iris):
6mm Diameter
Quick Release

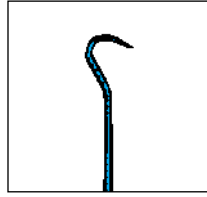


Sklar Blue™
ELECTROSURGICAL

Autoclavable

SKLAR BLUE™ EMMETT HOOK (IRIS)

6 mm
91-5241 9" #1
91-5245 12" #1



Emmett (Iris):
4mm Diameter
Quick Release

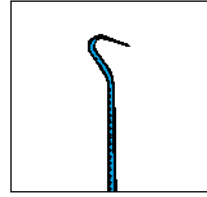


Sklar Blue™
ELECTROSURGICAL

Autoclavable

SKLAR BLUE™ EMMETT HOOK (IRIS)

4mm
91-5242 9" #2
91-5246 12" #2



Emmett (Iris):
3mm Diamete
Quick Release

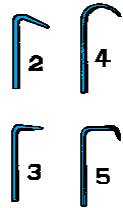


Sklar Blue™
ELECTROSURGICAL

Autoclavable

SKLAR BLUE™ EMMETT HOOK (IRIS)

3mm
91-5243 9" #3
91-5247 12" #3



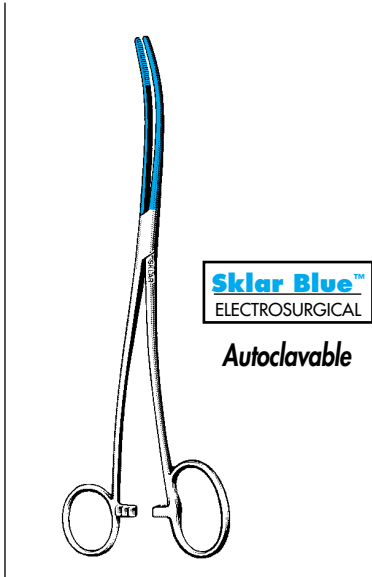
Sklar Blue™
ELECTROSURGICAL

Autoclavable

SKLAR BLUE™ EMMETT HOOKS

91-5251 Style 1
91-5252 Style 2
91-5253 Style 3
91-5254 Style 4
91-5255 Style 5
91-5250 Set of 5

GYNECOLOGY ELECTROSURGICAL INSTRUMENTS



Sklar Blue™
ELECTROSURGICAL

Autoclavable

SKLAR BLUE™ BOZEMAN FORCEPS

One Large Ring
91-5310 10¼" S-Curve

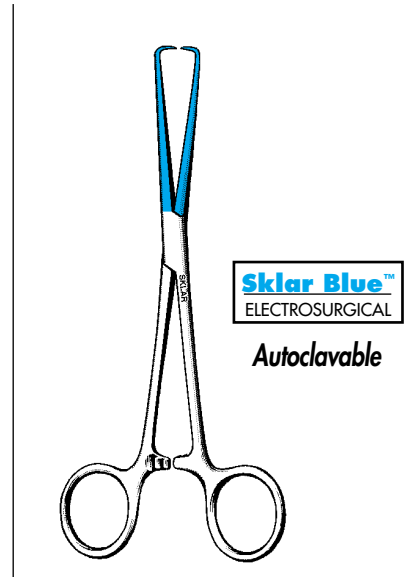


Sklar Blue™
ELECTROSURGICAL

Autoclavable

SKLAR BLUE™ BOZEMAN FORCEPS

91-5307 10½" Straight
91-5308 10¼" S-Curve

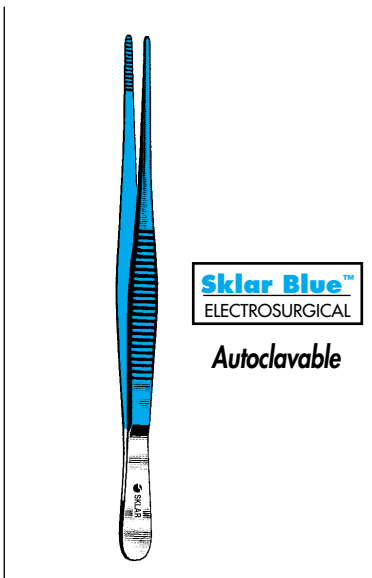


Sklar Blue™
ELECTROSURGICAL

Autoclavable

SKLAR BLUE™ SCHROEDER TENACULUM FORCEPS

91-5450 9½" (Braun)
91-5452 10"
91-5455 10¼"



Sklar Blue™
ELECTROSURGICAL

Autoclavable

SKLAR BLUE™ DRESSING FORCEPS

91-5420 8"
91-5422 10"
91-5424 12"



Sklar Blue™
ELECTROSURGICAL

Autoclavable

SKLAR BLUE™ ADSON FORCEPS

91-5428 4¾" Serrated



Sklar Blue™
ELECTROSURGICAL

Autoclavable

SKLAR BLUE™ POTTS-SMITH FORCEPS

91-5411 7" Serrated
91-5412 10" Serrated
91-5413 8¾" 1 x 2
91-5414 10" 1 x 2

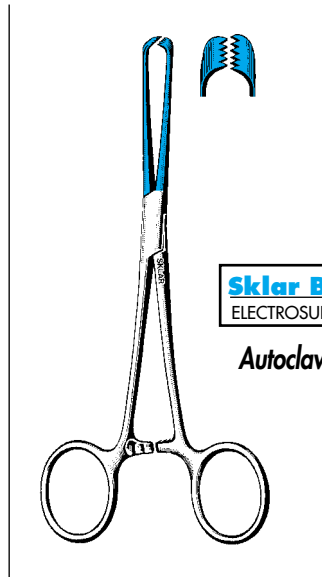


Sklar Blue™
ELECTROSURGICAL

Autoclavable

SKLAR BLUE™ TUTTLE/SINGLEY FORCEPS

91-5300 7" Tuttle
91-5302 9" Singley

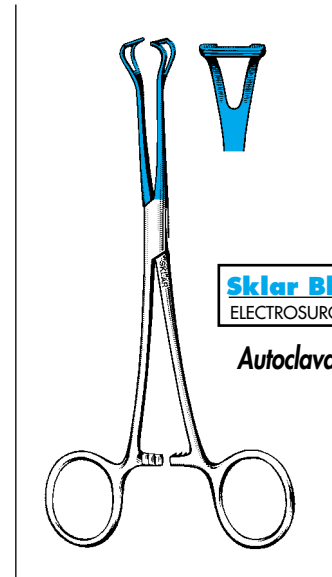


Sklar Blue™
ELECTROSURGICAL

Autoclavable

SKLAR BLUE™ ALLIS TISSUE FORCEPS

91-5278 7½" 5 x 6 Teeth
91-5440 9½" 5 x 6 Teeth

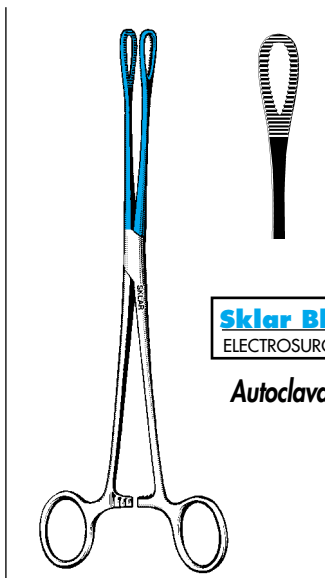


Sklar Blue™
ELECTROSURGICAL

Autoclavable

SKLAR BLUE™ BABCOCK FORCEPS

91-5268 8"
91-5270 9½"



Sklar Blue™
ELECTROSURGICAL

Autoclavable

SKLAR BLUE™ SCHWEIZER FORCEPS

91-5404 9½" Straight



Sklar Blue™
ELECTROSURGICAL

Autoclavable

SKLAR BLUE™ CLEMETSON FORCEPS

91-5400 9½" Straight
No Ratchet



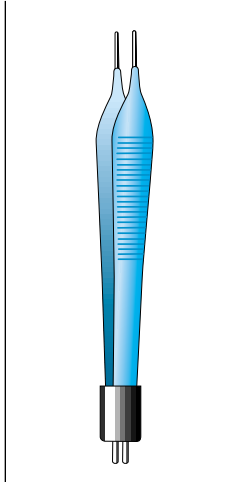
Sklar Blue™
ELECTROSURGICAL

Autoclavable

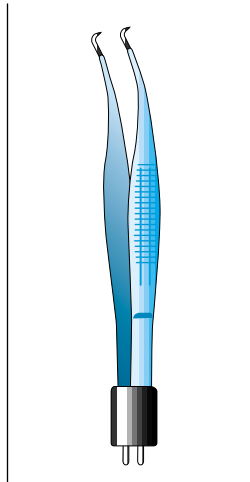
SKLAR BLUE™ LAUFE UTERINE POLYP FORCEPS

91-5408 7¾" Curved

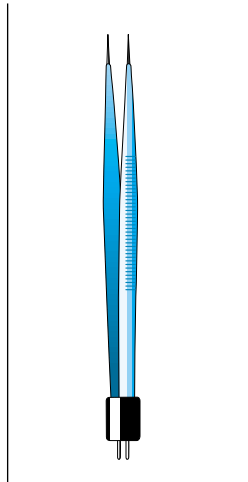
BIPOLAR ELECTROSURGICAL FORCEPS, INSULATED



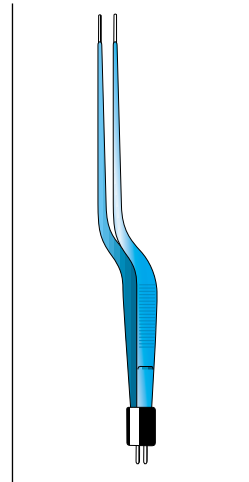
ADSON FORCEP
91-6100 1mm 4 $\frac{1}{4}$ "



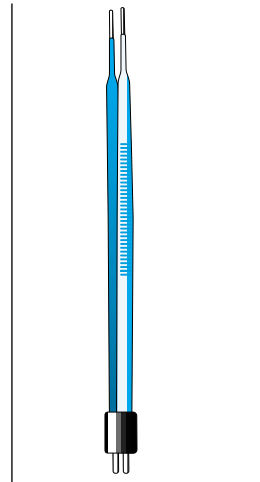
COAPTATION FORCEP
91-6101 .5mm 4"



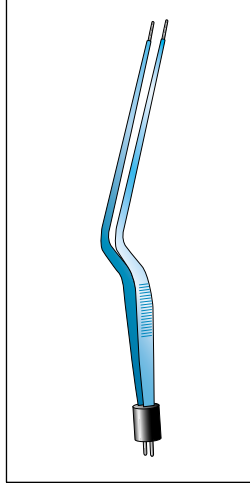
CUSHING FORCEP
91-6102 1mm 6"



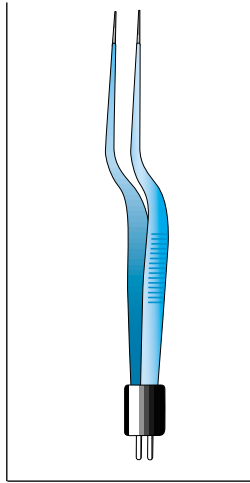
GERALD BAYONET FORCEP
91-6103 1mm 7"



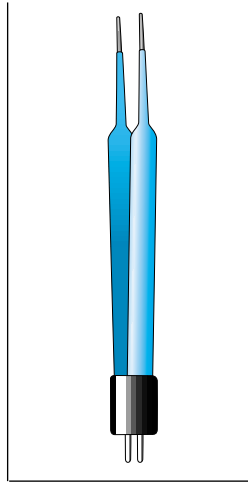
GERALD FORCEP
Straight
91-6104 1mm 7"



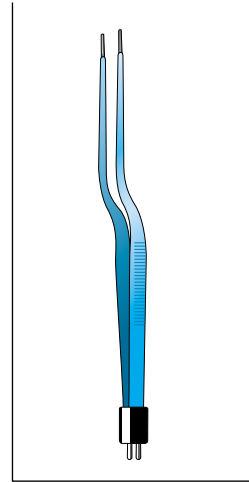
HARDY BAYONET FORCEP
Angled
91-6105 1mm 8 $\frac{1}{2}$ "



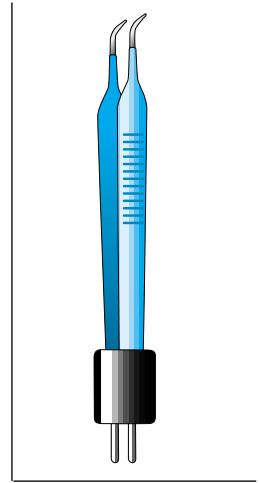
JANSEN BAYONET FORCEP
91-6106 1mm 6"



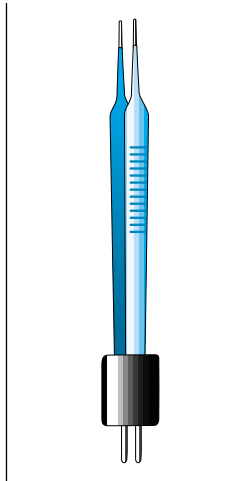
JEWELER #5 FORCEP
91-6107 .5mm 4 $\frac{1}{2}$ "



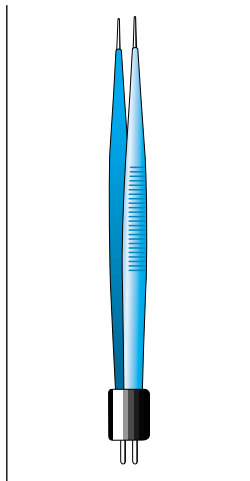
MALIS FORCEP
91-6108 1mm 7"



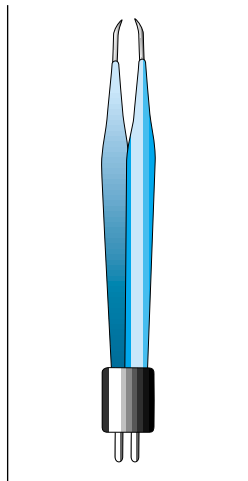
MCPHERSON FORCEP
Curved
91-6109 .5mm 3 $\frac{1}{2}$ "



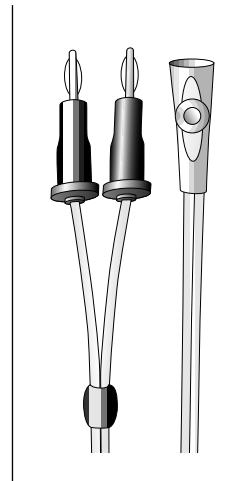
MCPHERSON FORCEP
Straight
91-6110 .5mm 3 $\frac{1}{2}$ "



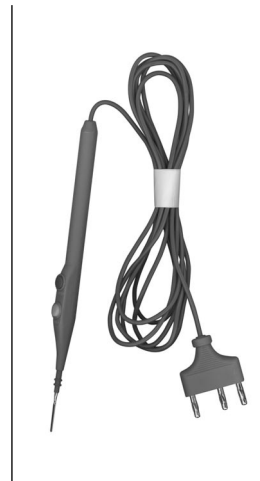
SEMKIN FORCEP
91-6111 .5mm 5 $\frac{1}{2}$ "



TENZEL FORCEP
91-6112 .5mm 4"



SILICONE BIPOLAR CABLE
91-6113 10'



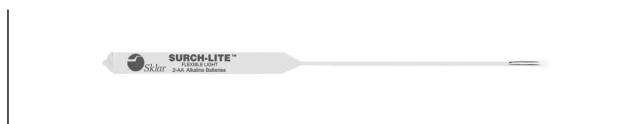
ELECTROSURGICAL PENCIL
w/ cut-coag finger switch
91-6114 box/10
91-6115 case/100



NERVE STIMULATOR/LOCATOR 96-1300 Box/10



COBALT BLUE LIGHT (A) 96-1304 **PEN LIGHT (B)** 96-1305
FOR USE WITH FLOUROSCEN DYE



10" FLEXIBLE SURGICAL LIGHT 96-1308 Box/10



LOW TEMPERATURE CAUTERY 96-1310 Box/10
FOR USE DURING OPHTHALMIC PROCEDURES



VASECTOMY CAUTERY 96-1312 Box/10



HIGH TEMPERATURE CAUTERY 96-1315 Box/10



HIGH TEMPERATURE CAUTERY 96-1318 Box/10
LOOP TIP



HIGH TEMPERATURE CAUTERY 96-1316 Box/10
2" LOOP TIP



EXTENDED NEEDLE ELECTRODE 96-1320 Box/25



EXTENDED MODIFIED NEEDLE 96-1321 Box/25



EXTENDED BLADE ELECTRODE 96-1325 Box/25



EXTENDED MODIFIED BLADE 96-1326 Box/25



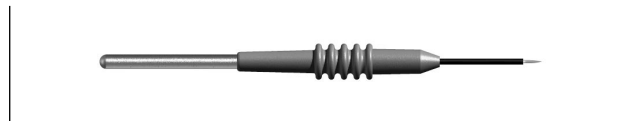
STANDARD NEEDLE ELECTRODE 96-1328 Box/25



STANDARD BLADE ELECTRODE 96-1332 Box/50



MODIFIED BLADE ELECTRODE 96-1334 Box/25



MODIFIED NEEDLE ELECTRODE 96-1336 Box/25



Gynecology Laser Instrumentation

Sandblasted vs Coated Instruments

Testing demonstrated that the Sklar black coating over a roughened surface reduced reflected laser energy to less than one-tenth of one percent!

Sklar uses an improved black polymer coating developed specifically for Laser surgery. The coating is durable and safe, resulting in an instrument you can use with confidence and rely on for years of service.

All Sklar Laser coatings are guaranteed one year against manufacturing defects.

Sklar Black™
LASER

Sklar Exclusive!



LASER GRAVES VAGINAL SPECULUM

With slip rings for smoke evacuation tubing

90-9000	3" x 3/4"	Small
90-9002	4" x 1 1/4"	Medium
90-9004	4 1/2" x 1 3/8"	Large
90-9005	2 3/4" x 3/8"	Extra Small
90-9006	4 3/4" x 1 1/2"	Extra Large



LASER GRAVES VAGINAL SPECULUM

With permanent smoke evacuation tubing

90-9015	3" x 3/4"	Small
90-9016	4" x 1 1/4"	Medium
90-9018	4 1/2" x 1 3/8"	Large
90-9020	4 3/4" x 1 1/2"	Extra Large



LASER PEDERSON VAGINAL SPECULUM

With slip rings for smoke evacuation tubing

90-9030	3" x 1/2"	Small
90-9032	4" x 3/8"	Medium
90-9034	4 3/4" x 1"	Large
90-9038	4" x 3/8"	Slender
90-9035	2 3/4" x 1/2"	Extra Small



LASER PEDERSON VAGINAL SPECULUM

With permanent smoke evacuation tubing

90-9040	3" x 1/2"	Small
90-9042	4" x 7/8"	Medium
90-9044	4 3/4" x 1"	Large
90-9048	4 3/4" x 1 3/8"	Extra Large
90-9050	4" x 3/8"	Slender



Sklar Black™
LASER
Autoclavable

LASER GRAVES VAGINAL SPECULUM

90-3804	3" x 3/4"	Small
90-3806	4" x 1 1/4"	Medium
90-3808	4 1/2" x 1 3/8"	Large
90-3812	2 3/4" x 5/8"	Extra Small
90-3810	4 3/4" x 1 1/2"	Extra Large



Sklar Black™
LASER
Autoclavable

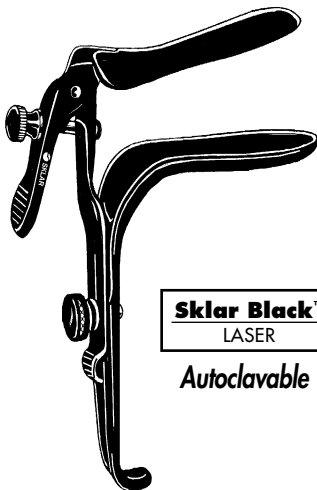
LASER PEDERSON VAGINAL SPECULUM

90-3833	3" x 1/2"	Small
90-3835	4 3/4" x 1"	Large
90-3837	4" x 3/8"	Slender
90-3839	4" x 1/4"	Medium
90-3841	2 3/4" x 1/2"	Extra Small

Sklar Black™
LASER
Autoclavable

LASER GRAVES WIDE VIEW VAGINAL SPECULUM

Wide proximal opening for instrumentation
 90-9054 4" x 1 1/4" with Permanent Tube
 90-9055 4" x 1 1/4" with loop to hold and direct disposable smoke evacuation tubing

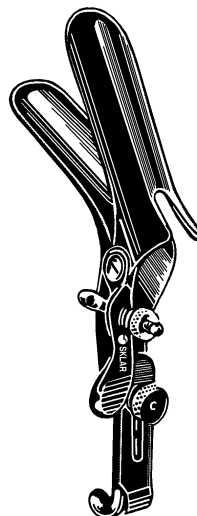


Sklar Black™
LASER
Autoclavable

LASER FREEWAY GRAVES VAGINAL SPECULUM

Open Side, 90° Angle

90-3754	4" x 1 1/4" with permanent smoke evacuation tube
90-3755	4" x 1 1/4" with loop to hold and direct disposable smoke evacuation tubing

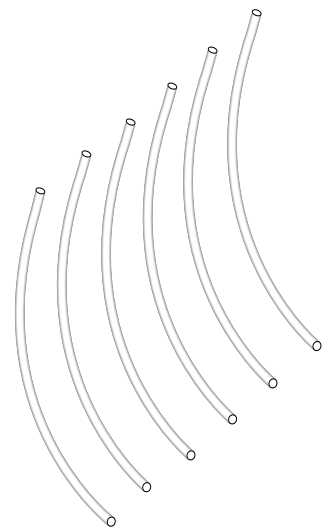


Sklar Black™
LASER
Autoclavable

LASER FREEWAY GRAVES VAGINAL SPECULUM

Open Side, 45° Angle

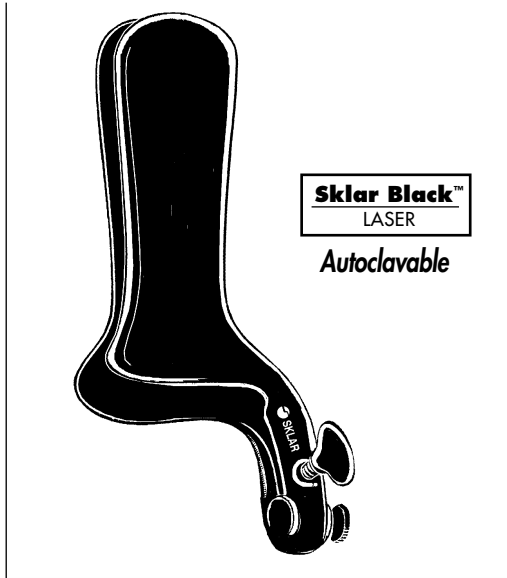
90-3814	4" x 1 1/4" with permanent smoke evacuation tube
90-3815	4" x 1 1/4" with loop to hold and direct disposable smoke evacuation tubing



DISPOSABLE SMOKE EVACUATION TUBING

93-2160 Case of 50 in 10" precut 3/4" ID 1/2" OD

GYNECOLOGY LASER INSTRUMENTS



Sklar Black™
LASER

Autoclavable

LASER COLLIN VAGINAL SPECULUM

90-3946 4 1/4" x 1 1/2" Blades

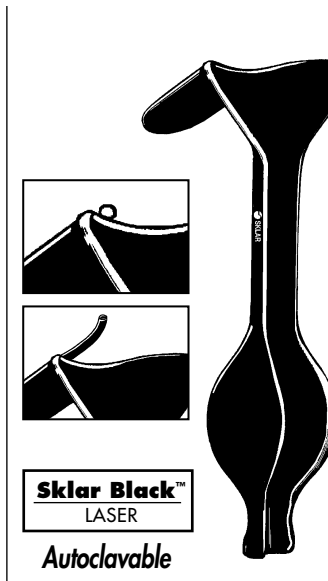


Sklar Black™
LASER

Autoclavable

LASER LATERAL VAGINAL RETRACTOR

90-8845 Ratchet Handle



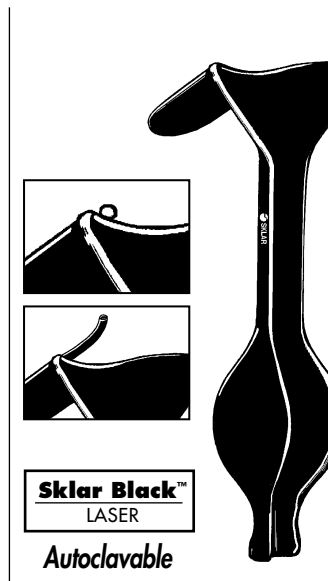
Sklar Black™
LASER

Autoclavable

LASER AUVARD VAGINAL SPECULUM

Blades 2 3/4" x 1 1/2"

- 90-9100 Medium 2 1/2 lbs. Without loop
- 90-9102 Medium 2 1/2 lbs., With loop to hold and direct disposable evacuation tubing.
- 90-9103 With Tube



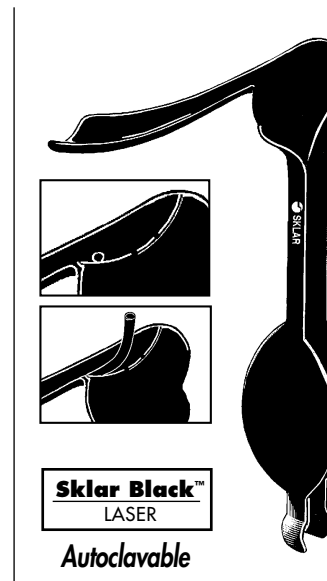
Sklar Black™
LASER

Autoclavable

LASER AUVARD VAGINAL SPECULUM

Large Blade 4" x 1 1/2"

- 90-9106 Medium 2 1/2 lbs. Without loop
- 90-9108 Medium 2 1/2 lbs., With loop to hold and direct disposable evacuation tubing.
- 90-9109 With Tube



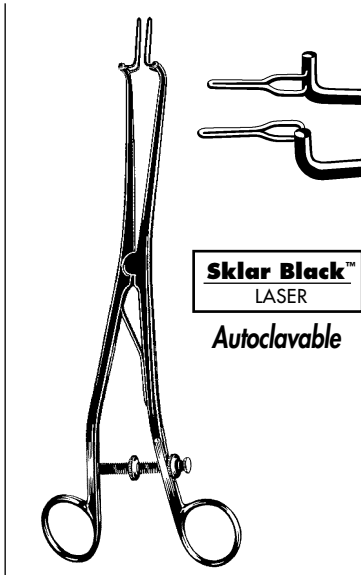
Sklar Black™
LASER

Autoclavable

LASER STEINER-AUVARD VAGINAL SPECULUM

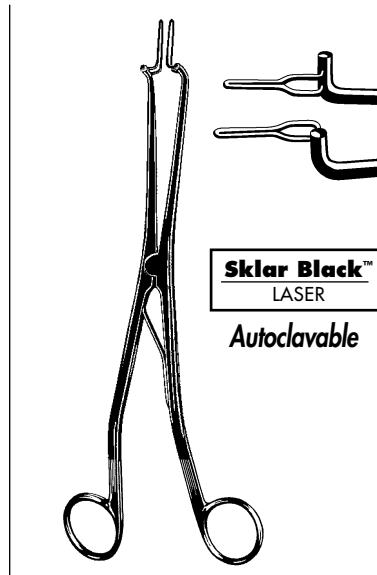
Blades 5 1/2" x 1 1/4"

- 90-3560 2 1/2 lbs. Without loop
- 90-3561 2 1/2 lbs., With loop to hold and direct disposable evacuation tubing.
- 90-3562 With Tube



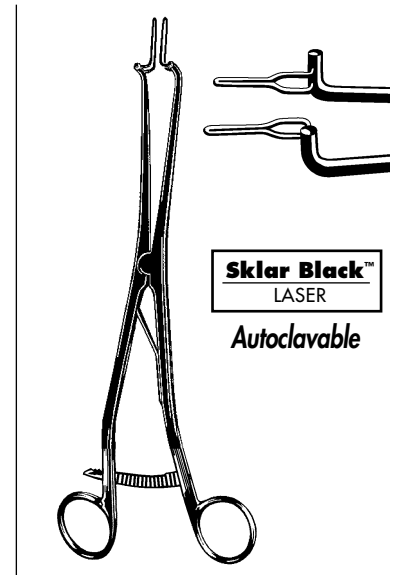
LASER KOGAN ENDOSPECULUM

With Gauge and Screws
90-8855 Narrow Wire Blades



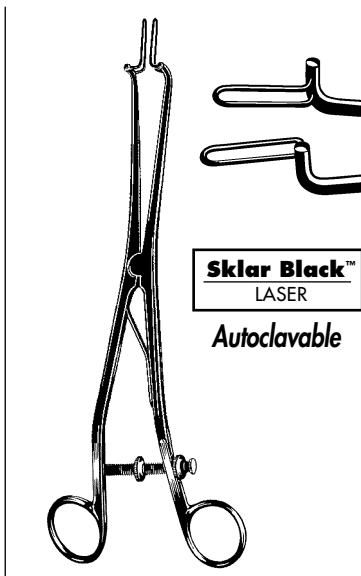
LASER KOGAN ENDOSPECULUM

With Spring
90-8865 Narrow Wire Blades



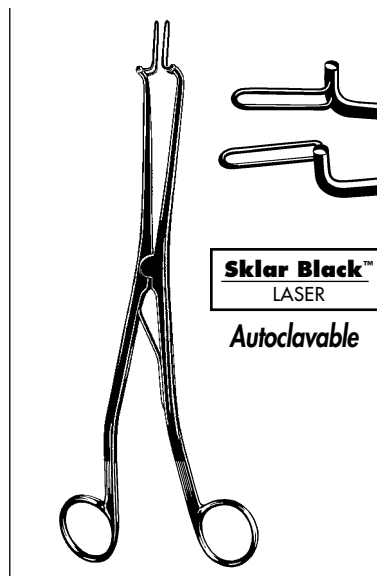
LASER KOGAN ENDOSPECULUM

With Ratchet
90-8862 Narrow Wire Blades



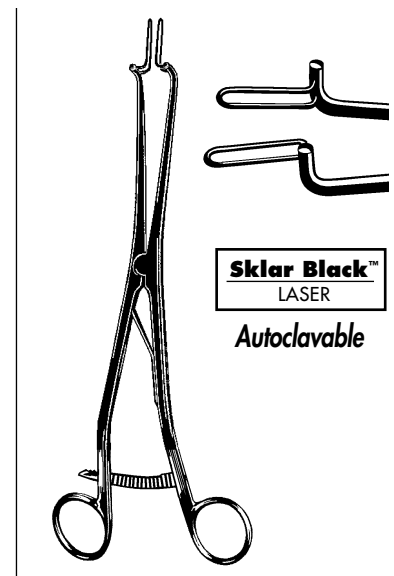
LASER KOGAN ENDOSPECULUM

With Gauge and Screws
90-8858 Wide Wire Blades



LASER KOGAN ENDOSPECULUM

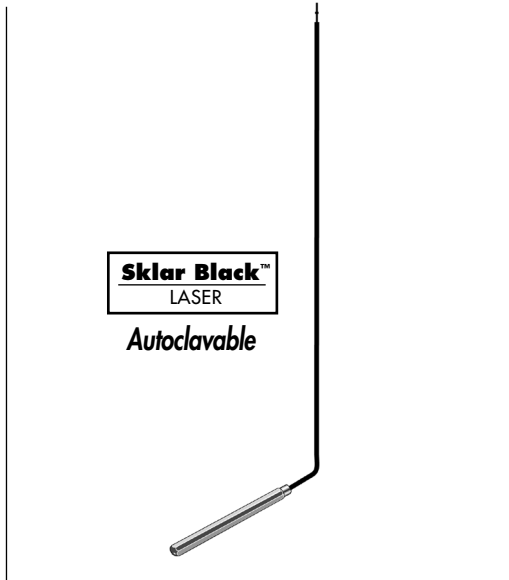
With Spring
90-8850 Wide Wire Blades



LASER KOGAN ENDOSPECULUM

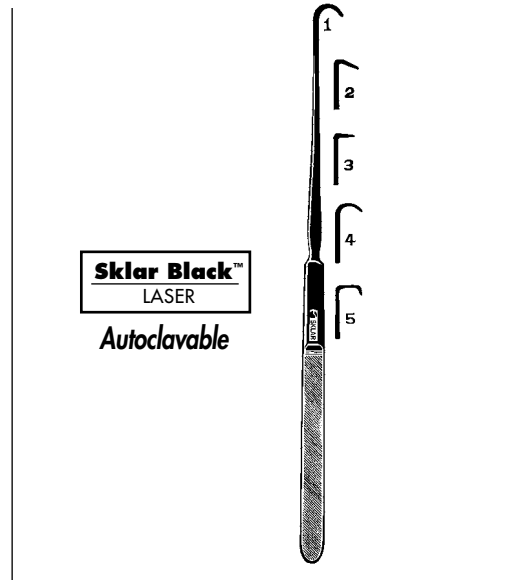
With Ratchet
90-8860 Wide Wire Blades

GYNECOLOGY LASER INSTRUMENTS



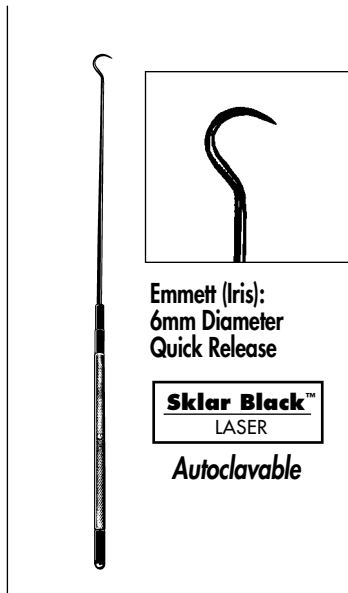
LASER DEPTH RULER IN MM

90-2242



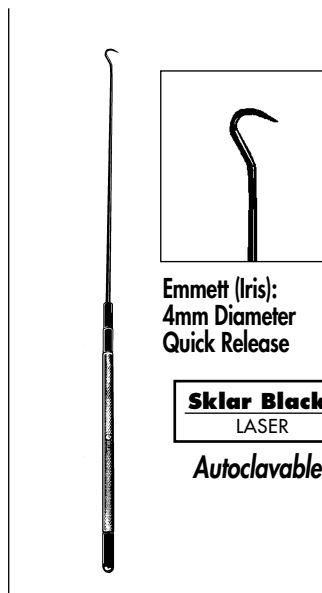
LASER EMMETT TENACULUM HOOKS 9"

- 90-2171 #1
- 90-2172 #2
- 90-2173 #3
- 90-2174 #4
- 90-2175 #5
- 90-2170 Set of 5



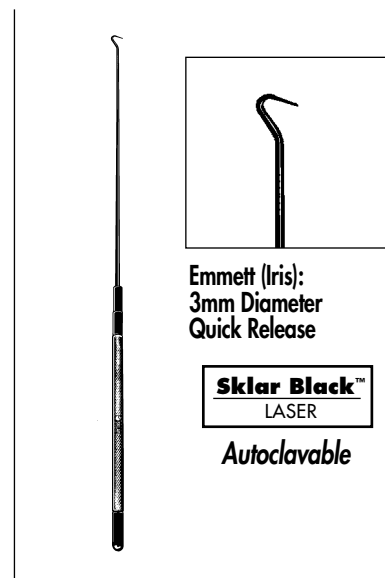
LASER EMMETT HOOK (IRIS)

- 6mm
- 90-2114 9"
- 90-2116 12"



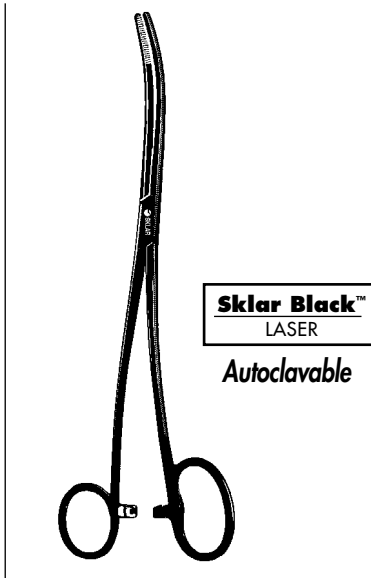
LASER EMMETT HOOK (IRIS)

- 4mm
- 90-2118 9"
- 90-2120 12"



LASER EMMETT HOOK (IRIS)

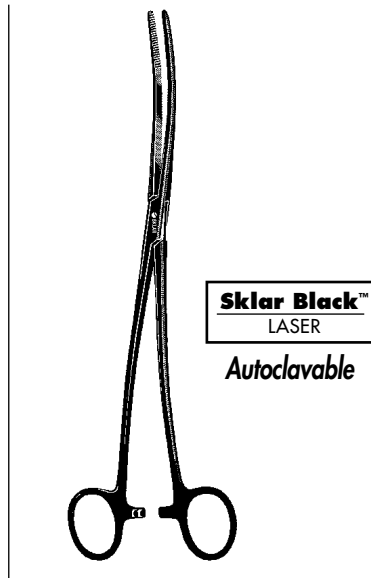
- 3mm
- 90-2122 9"
- 90-2124 12"



Sklar Black™
LASER
Autoclavable

LASER BOZEMAN FORCEPS

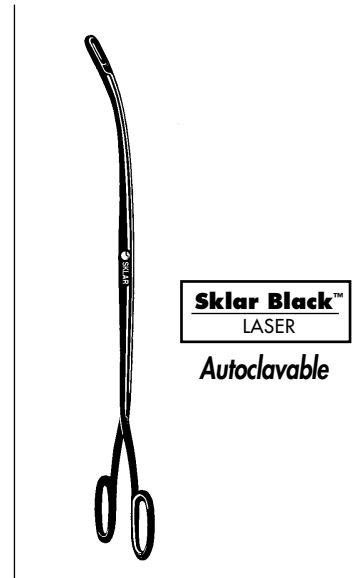
One Large Ring
90-2342 10 1/4" S-Curve



Sklar Black™
LASER
Autoclavable

LASER BOZEMAN FORCEPS

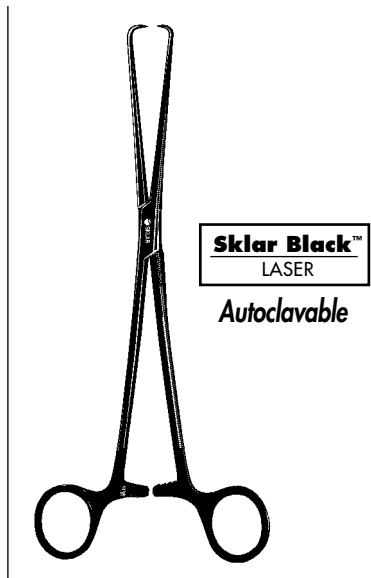
90-2340 10 1/4" S-Curve



Sklar Black™
LASER
Autoclavable

LASER CAMPION GRASPING FORCEPS

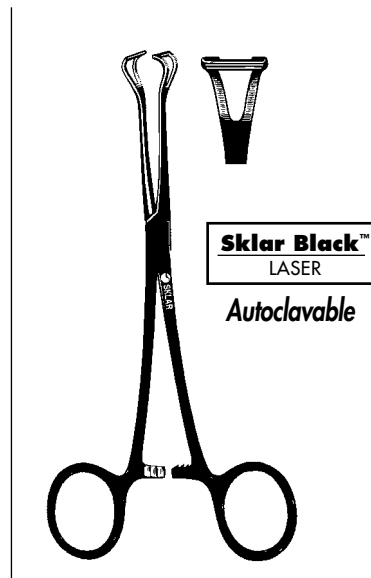
90-2298 9 1/2" Curved



Sklar Black™
LASER
Autoclavable

LASER SCHROEDER TENACULUM FORCEPS

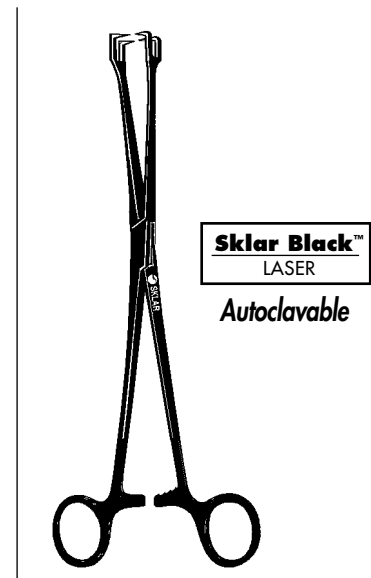
90-2325 9 1/2" (Braun)
90-2326 10 1/4" (Pozzi)



Sklar Black™
LASER
Autoclavable

LASER BABCOCK FORCEPS

90-2278 8"
90-2295 9 1/2"

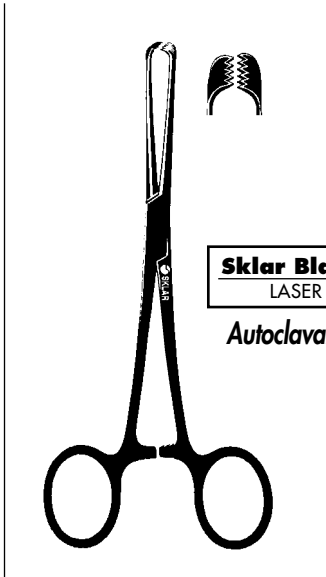


Sklar Black™
LASER
Autoclavable

LASER SCHROEDER VULSELLUM FORCEPS

90-1790 9 1/2" Straight
90-1890 9 1/2" Curved

GYNECOLOGY LASER INSTRUMENTS

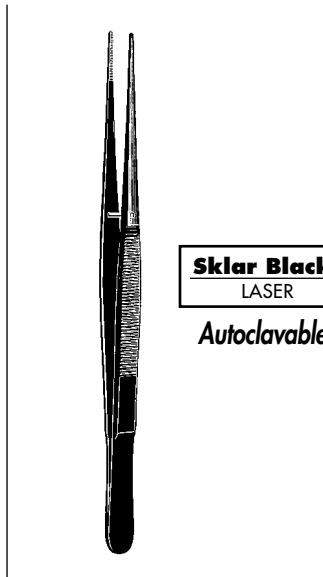


Sklar Black™
LASER

Autoclavable

LASER ALLIS FORCEPS

90-2276 7½" 5 x 6
90-2279 9½" 5 x 6

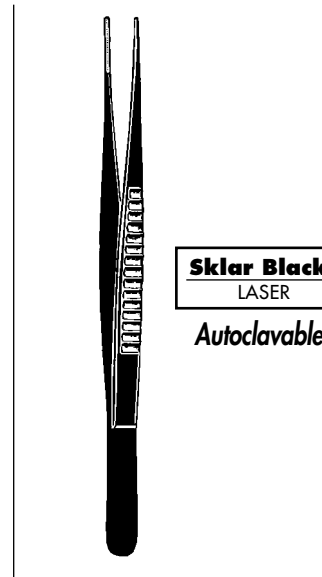


Sklar Black™
LASER

Autoclavable

LASER POTTS-SMITH FORCEPS

90-2304 7" Serrated
90-2306 10" Serrated

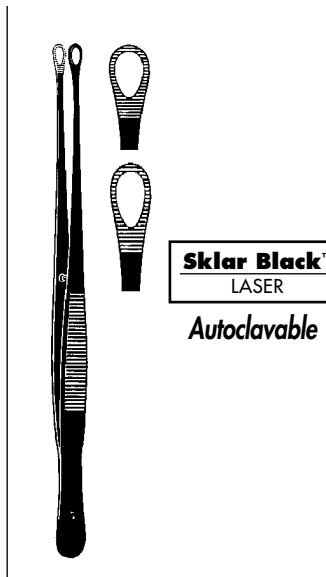


Sklar Black™
LASER

Autoclavable

LASER DEBAKEY ATRAUMATIC TISSUE FORCEPS

2.0 mm jaws
90-2310 7¼"
90-2312 9½"

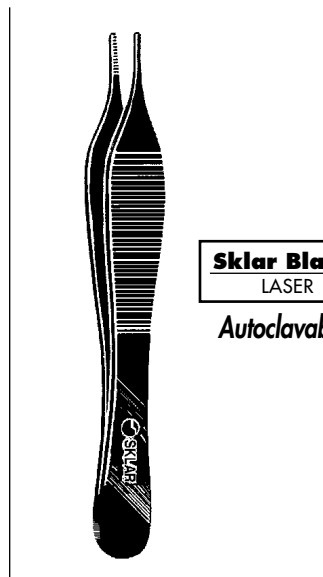


Sklar Black™
LASER

Autoclavable

LASER TUTTLE/SINGLEY FORCEPS

90-2270 7" Tuttle
90-2272 9" Singley

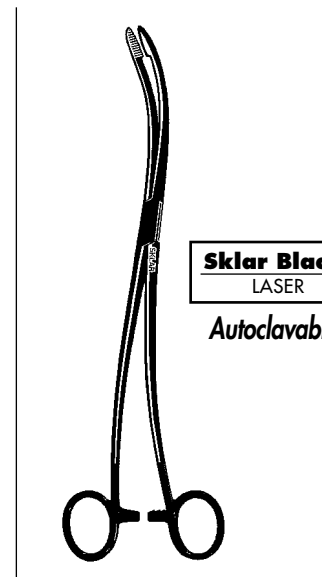


Sklar Black™
LASER

Autoclavable

LASER ADSON DRESSING FORCEPS

90-2261 4¾" Serrated

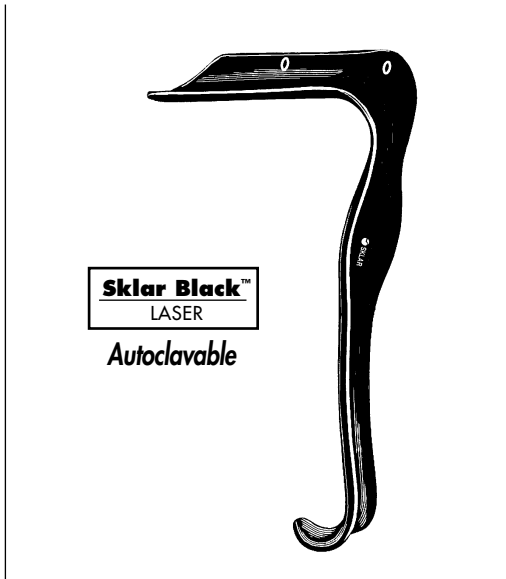


Sklar Black™
LASER

Autoclavable

LASER DELEE UTERINE FORCEPS

90-7111 11" Heavy



LASER JACKSON VAGINAL RETRACTOR

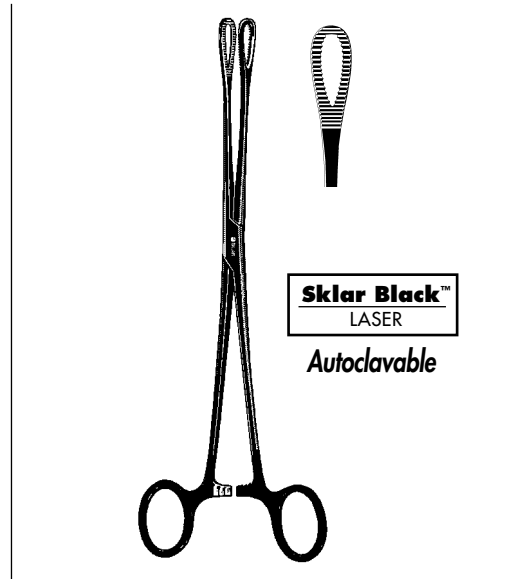
Single End

90-9065 3½" x 1½" Medium with permanent smoke evacuation tube

90-9066 3½" x 1½" With loop to hold and direct disposable smoke evacuation tubing

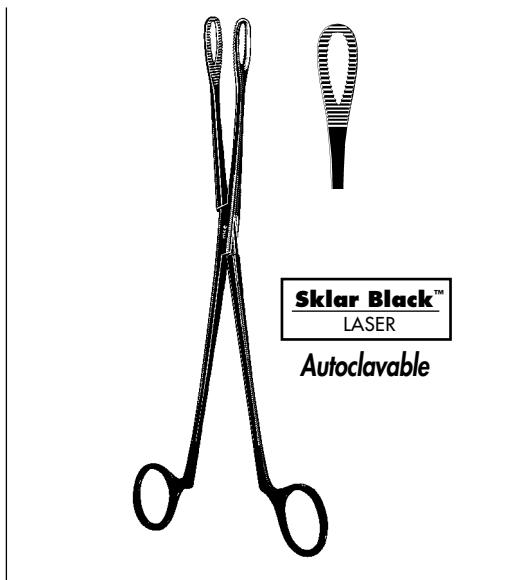
90-9067 4" x 1½" Large with permanent smoke evacuation tube

90-9068 4" x 1½" With loop to hold and direct disposable smoke evacuation tubing



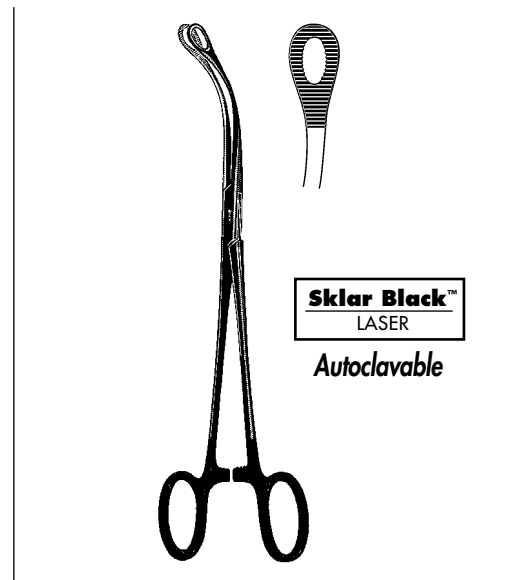
LASER SCHWEIZER FORCEPS

90-2350 9½" Straight



LASER CLEMETSON FORCEPS

90-2348 9½" No-Ratchet



LASER LAUFE UTERINE POLYP FORCEPS

90-2345 7¾" Curved

SKLARTECH
4000

LAPAROSCOPIC SCISSORS

METZENBAUM SCISSORS

STRAIGHT – 32CM 5MM

31-4510X Complete Instrument 31-4510 Replacement Insert

METZENBAUM SCISSORS

CURVED – 32CM 5MM

31-4010X Complete Instrument 31-4010 Replacement Insert

METZENBAUM SCISSORS

CURVED, SERRATED – 32CM 5MM

31-4514X Complete Instrument 31-4514 Replacement Insert

HOOK SCISSORS

32CM 5MM

31-4012X Complete Instrument 31-4012 Replacement Insert

MICROSCISSOR

STRAIGHT – 32CM 5MM

31-2747X Complete Instrument 31-2747 Replacement Insert

MICROSCISSOR

CURVED – 32CM 5MM

31-2749X Complete Instrument 31-2749 Replacement Insert

PERITONEAL SCISSORS

32CM 5MM

31-6184X Complete Instrument 31-6184 Replacement Insert

OPERATING SCISSORS

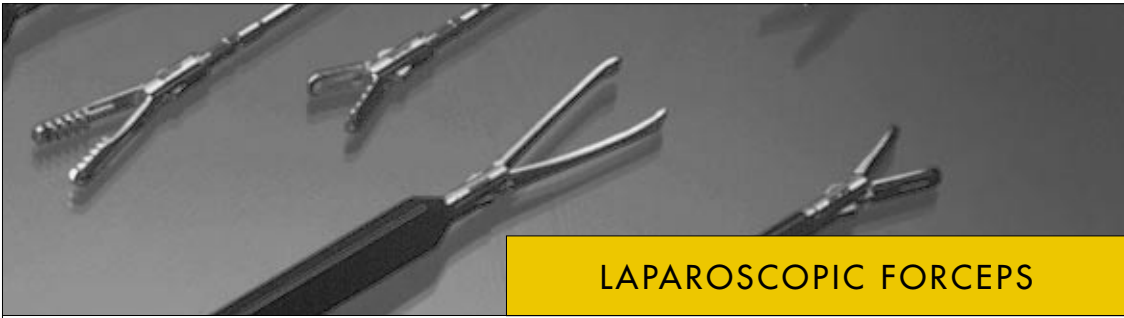
32CM 10MM

31-2632X Complete Instrument 31-2632 Replacement Insert

COMPLETE
INSTRUMENT:
INSERT WITH TIP
INSULATED
CANNULA
HANDLE WITH
COLLAR











“X” Handle

When purchased as a complete instrument, Sklartech Laparoscopic Scissors, Dissectors and Forceps include the insert with tip, insulated cannula and handle with locking collar. The illustrated handle is a non-ratchet pattern which may be fully rotated. Featuring an electrosurgical connector, the “X” handle is fully insulated.



LAPAROSCOPIC FORCEPS

SKLARTECH
4000

<p>MARYLAND DISSECTOR CROSS SERRATIONS - 32CM 5MM</p> <p>31-4088X Complete Instrument 31-4088 Replacement Insert</p>		
<p>MARYLAND DISSECTOR DIAMOND SERRATIONS - 32CM 5MM</p> <p>31-4080X Complete Instrument 31-4080 Replacement Insert</p>		
<p>MIXTER FORCEPS CROSS SERRATIONS - 32CM 5MM</p> <p>31-2572X Complete Instrument 31-2572 Replacement Insert</p>		
<p>MIXTER FORCEPS DIAMOND SERRATIONS - 32CM 5MM</p> <p>31-4086X Complete Instrument 31-4086 Replacement Insert</p>		
<p>CURVED DISSECTING FORCEPS CROSS SERRATIONS, CURVED - 32CM 5MM</p> <p>31-2568X Complete Instrument 31-2568 Replacement Insert</p>		
<p>DOLPHIN FORCEPS WITH SPOON - 32CM 5MM</p> <p>31-4082X Complete Instrument 31-4082 Replacement Insert</p>		
<p>FENESTRATED FORCEPS 32CM 5MM</p> <p>31-4504X Complete Instrument 31-4504 Replacement Insert</p>		
<p>KELLY FORCEPS 32CM 5MM</p> <p>31-4084X Complete Instrument 31-4084 Replacement Insert</p>		
<p>CLAW FORCEPS 32CM 5MM</p> <p>31-4090X Complete Instrument 31-4090 Replacement Insert</p>		
<p>PROBE EXCISION PUNCH 32CM 5MM</p> <p>31-2569X Complete Instrument 31-2569 Replacement Insert</p>		

LAPAROSCOPIC FORCEPS



STANDARD GRASPING FORCEPS

32CM 5MM

31-4508Y Complete Instrument 31-4508 Replacement Insert



TAPERED GRASPING FORCEPS

32CM 5MM

31-4509Y Complete Instrument 31-4509 Replacement Insert



GRASPING FORCEPS

WITH SPOON - 32CM 5MM

31-2756Y Complete Instrument 31-2756 Replacement Insert



POINTED GRASPING FORCEPS

WITH SPOON - 32CM 5MM

31-2560Y Complete Instrument 31-2560 Replacement Insert



BLUNT GRASPING FORCEPS

32CM 5MM

31-2532Y Complete Instrument 31-2532 Replacement Insert



FENESTRATED GRASPING FORCEPS

32CM 5MM

31-4081Y Complete Instrument 31-4081 Replacement Insert



FENESTRATED GRASPING FORCEPS

LONG JAWS - 32CM 5MM

31-2554Y Complete Instrument 31-2554 Replacement Insert



ATRAUMATIC GRASPING FORCEPS

DOUBLE ACTION - 32CM 5MM

31-2566Y Complete Instrument 31-2566 Replacement Insert



ATRAUMATIC GRASPING FORCEPS

SINGLE ACTION - 32CM 5MM

31-2562Y Complete Instrument 31-2562 Replacement Insert



MAXI (FUNDUS) GRASPING FORCEPS









32CM 5MM

31-4089Y Complete Instrument 31-4089 Replacement Insert



LAPAROSCOPIC FORCEPS

SKLARTECH
4000

<p>ENDO CLINCH GRASPING FORCEPS 32CM 5MM</p> <p>31-4087Y Complete Instrument 31-4087 Replacement Insert</p>		
<p>WAVE GRASPING FORCEPS 32CM 5MM</p> <p>31-4085Y Complete Instrument 31-4085 Replacement Insert</p>		
<p>DEBAKEY FORCEPS 40MM JAWS - 32CM 5MM</p> <p>31-2771Y Complete Instrument 31-2771 Replacement Insert</p>		
<p>ALLIS TC FORCEPS TUNGSTEN CARBIDE - 32CM 5MM</p> <p>31-2539Y Complete Instrument 31-2539 Replacement Insert</p>		
<p>ALLIGATOR GRASPING FORCEPS DOUBLE ACTION - 32CM 5MM</p> <p>31-2598Y Complete Instrument 31-2598 Replacement Insert</p>		
<p>ALLIGATOR GRASPING FORCEPS SINGLE ACTION - 32CM 5MM</p> <p>31-2577Y Complete Instrument 31-2577 Replacement Insert</p>		
<p>COBRA GRASPING FORCEPS 32CM 5MM</p> <p>31-4083Y Complete Instrument 31-4083 Replacement Insert</p>		
<p>SHARP TRAUMATIC GRASPING FORCEPS 32CM 5MM</p> <p>31-2564Y Complete Instrument 31-2564 Replacement Insert</p>		

The grasping forceps illustrated above include all of the same important features found on the Sklar Laparoscopic scissors, however, these instruments have a Y handle which has a ratchet and ensures a delicate yet precise grasp of tissue.



COMPLETE INSTRUMENT:
INSERT WITH TIP
INSULATED CANNULA
HANDLE WITH COLLAR

SKLARTECH
4000

LAPAROSCOPIC FORCEPS



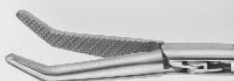
MARYLAND DISSECTOR
DIAMOND SERRATIONS - 32CM 10MM

31-4526X Complete Instrument 31-4526 Replacement Insert



MIXTER FORCEPS
90° ANGLE - 32CM 10MM

31-6176X Complete Instrument 31-6176 Replacement Insert



MIXTER FORCEPS
45° ANGLE - 32CM 10MM

31-2573X Complete Instrument 31-2573 Replacement Insert



KOCHER FORCEPS
60 MM JAWS - 32CM 10MM

31-2578X Complete Instrument 31-2578 Replacement Insert



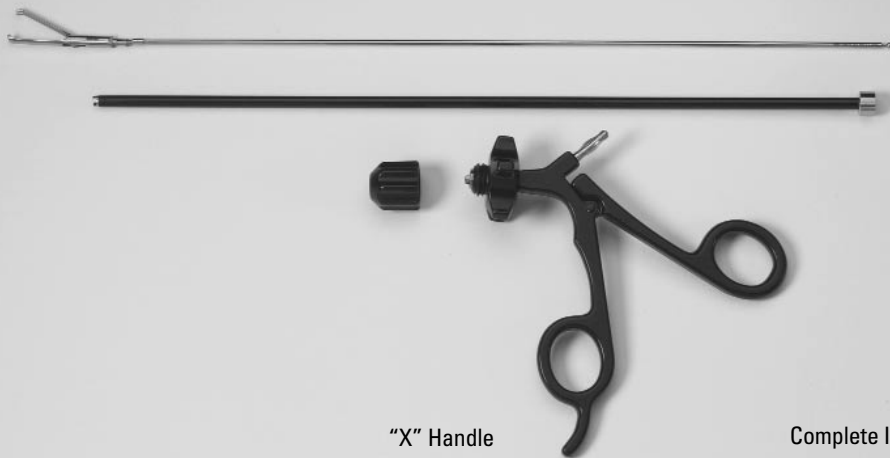
CLAW FORCEPS
32CM 10MM

31-2575X Complete Instrument 31-2575 Replacement Insert



SPOON FORCEPS
32CM 10MM

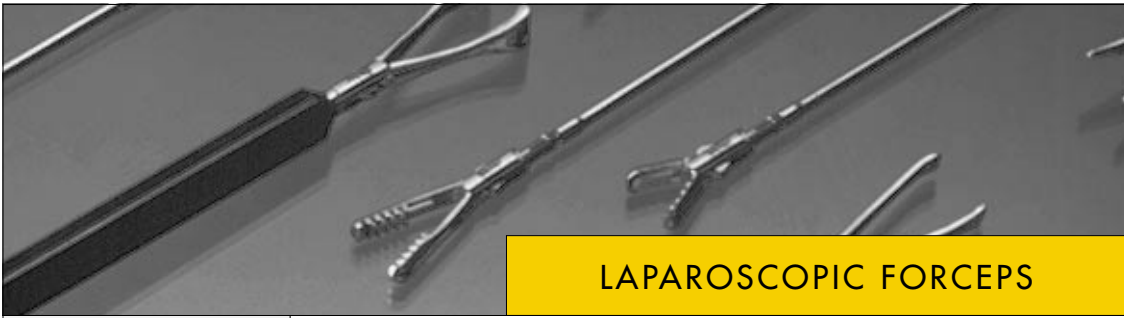
31-2579X Complete Instrument 31-2579 Replacement Insert



"X" Handle

Complete Instrument

As with all Sklar complete laparoscopic instruments, the handles and replacement inserts are easily interchangeable to perform as intended and required by the surgeon. A Sklartech 4000 instrument includes the handle, insert with tip, the insulating cannula and a locking collar which secures the insert/cannula to the handle while allowing full rotation.



LAPAROSCOPIC FORCEPS

SKLARTECH
4000



BABCOCK FORCEPS
32CM 10MM
31-4528Y Complete Instrument 31-4528 Replacement Insert



BABCOCK-DEBAKEY FORCEPS
32CM 10MM
31-4520Y Complete Instrument 31-4520 Replacement Insert

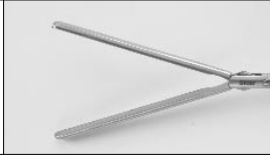


Complete Instruments at right include "Y" Handle

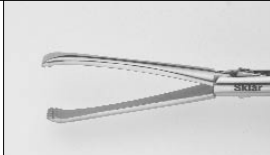
DEBAKEY FORCEPS
40MM JAWS - 32CM 10MM
31-4522Y Complete Instrument 31-4522 Replacement Insert



DEBAKEY FORCEPS
60MM JAWS - 32CM 10MM
31-2576Y Complete Instrument 31-2576 Replacement Insert



DEBAKEY ALLIS FORCEPS
32CM 10MM
31-2574Y Complete Instrument 31-2574 Replacement Insert



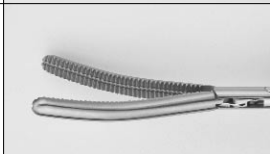
ALLIS TC FORCEPS
TUNGSTEN CARBIDE - 32CM 10MM
31-2540Y Complete Instrument 31-2540 Replacement Insert



STRONG ATRAUMATIC CLAMP
STRAIGHT - 32CM 10MM
31-2571Y Complete Instrument 31-2571 Replacement Insert



STRONG ATRAUMATIC CLAMP
CURVED - 32CM 10MM
31-2570Y Complete Instrument 31-2570 Replacement Insert



COMPLETE INSTRUMENT:
INSERT WITH TIP
INSULATED CANNULA
HANDLE WITH COLLAR

The replacement insert and insulated cannula are easily separated for cleaning and reprocessing by gently pushing the stem upward from the proximal end. To re-attach these parts simply align the tip and cannula at the distal end and snap together.

SKLARTECH
4000

LAPAROSCOPIC HANDLES/CANNULAS



SKLAR "X" HANDLE

31-4001X Non-ratcheted handle which may be fully rotated to precisely position tip. Handle is insulated to accommodate the high-frequency connector. Includes locking collar.



SKLAR "Y" HANDLE

31-4002Y Ratchet handle, also rotating, but permits graduated closure of the tip. Handle is insulated to accommodate the high-frequency connector. Includes locking collar.



SKLAR "XC" CARBON HANDLE

31-4001XC Lightweight, carbon fiber reinforced non-conductive safety handle with locking collar. Non-ratchet design and fully rotating as well as a proximally positioned high-frequency connector. "XC" handle used primarily with miniature instruments.



SKLAR "YC" CARBON HANDLE

31-4002YC Lightweight, carbon reinforced non-conductive safety handle with locking collar. Ratchet design and fully rotating as well as a proximally positioned high-frequency connector. "YC" handle used primarily with miniature instruments.



REPLACEMENT LOCKING COLLAR

31-4322



INSULATED CANNULA 32CM 5MM
31-2790



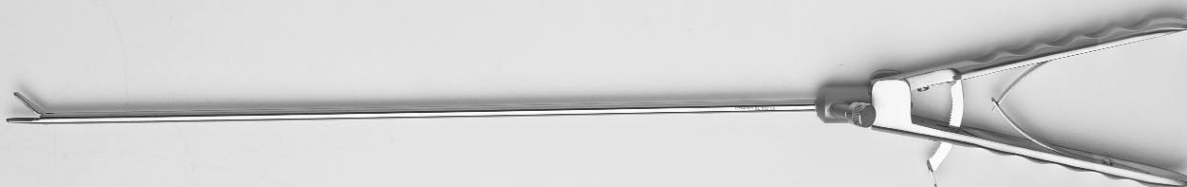
INSULATED CANNULA 32CM 10MM
31-2794 with permanent locking collar attached

LAPAROSCOPIC NEEDLE HOLDERS



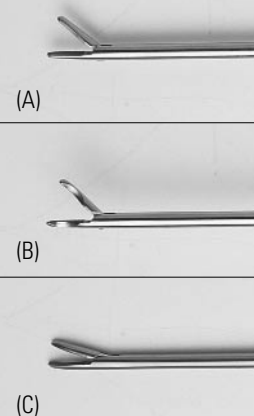
TC NEEDLE HOLDER
TUNGSTEN CARBIDE - 5MM SOLID SHAFT

31-2553 non-insulated, solid shaft with inline handle, tungsten carbide jaw inserts



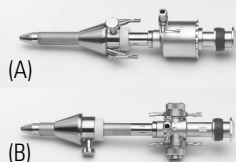
TC NEEDLE HOLDER
TUNGSTEN CARBIDE - 5MM FLUSHABLE SHAFT

non-insulated, flushable shaft with inline handle, tungsten carbide jaw inserts
31-2550 (A) straight
31-2551 (B) curved right
31-2552 (C) curved left



SKLARTECH
4000

LAPAROSCOPIC TROCARS



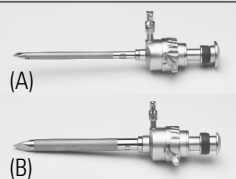
HASSON TROCAR 11MM WITH OBTURATOR

31-1001 (A) Trap Door – complete with 11mm obturator
31-1002 (B) Trumpet Valve – complete with 11mm obturator
31-0004 Replacement Obturator



S-RETRACTOR

60-6130 Set of 2



STANDARD TRAP DOOR CANNULA & TROCAR

31-1003 (A) Trap Door Cannula with 5.5mm trocar
31-1004 (B) Trap Door Cannula with 11mm trocar



STANDARD TRUMPET VALVE CANNULA & TROCAR

31-1007 Trumpet valve cannula with 5.5mm trocar 31-1009 Trumpet valve cannula with 12mm trocar
31-1008 Trumpet valve cannula with 11mm trocar



REPLACEMENT TROCAR FOR STANDARD CANNULAS

31-1010 Pyramidal Trocar 5.5mm 31-1011 Pyramidal Trocar 11mm 31-1012 Pyramidal Trocar 12mm



SAFETY TROCAR

31-1030 Trocar with safety shield and lock 5.5mm 31-1032 Trocar with safety shield and lock 11mm



THREADED CANNULA SLEEVE

INTERCHANGEABLE WITH STANDARD SMOOTH CANNULA

31-1020 (A) 5.5mm
31-1022 (B) 11mm



SNAP ON FLIP REDUCER

31-1042 11mm to 5.5mm

TROCAR CANNULA SEALS

	3 mm	5.5 mm	11 mm	12 mm	Hasson 11 mm
External Seal For Use With Trap Door And Trumpet Valve Cannula	Red 31-4320	Red 31-0003	Blue 31-0001	Green 31-0010	Blue/Gray 31-0001/31-0002
Internal Seal For Use With Trap Door Cannula	Gray 31-4321	Gray 31-4323	Yellow 31-4324		Yellow 31-4324



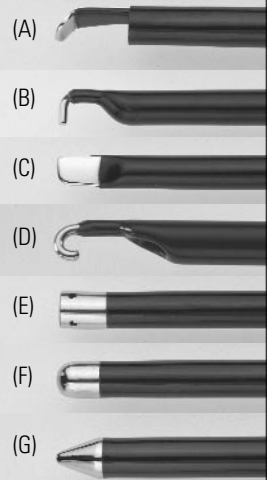
LAPAROSCOPIC ELECTROSURGERY

SKLARTECH
4000

INSULATED ELECTRODES, WITH SUCTION

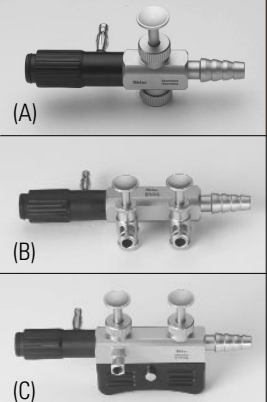
- 31-2235 (A) Spatula Electrode 5mm
- 31-2237 (B) L-Hook Electrode 5mm
- 31-2241 (C) Knife Electrode 5mm
- 31-2243 (D) J-Hook Electrode 5mm
- 31-2244 (E) Blunt Electrode 5mm
- 31-2245 (F) Button Electrode 5mm
- 31-2247 (G) Cone Electrode 5mm

Each coagulating electrode (A through G) is able to connect to the suction control valve of choice listed below, choose from A, B, or C. Insulated electrode and valve ordered separately.



HIGH FREQUENCY SUCTION CONTROL VALVES

- 31-2227 (A) Insulated Suction Control with Single Trumpet Valve
- 31-2233 (B) Insulated Suction Control with Double Trumpet Valve
- 31-2229 (C) Insulated Suction Control with Double Trumpet Valve and Handle



ELECTROSURGICAL CABLE

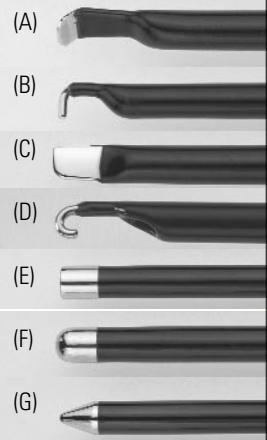
- 31-2242 Monopolar



INSULATED ELECTRODES, WITHOUT SUCTION

- 31-2435 (A) Spatula Electrode 5mm
- 31-2437 (B) L-Hook Electrode 5mm
- 31-2441 (C) Knife Electrode 5mm
- 31-2443 (D) J-Hook Electrode 5mm
- 31-2444 (E) Blunt Electrode 5mm
- 31-2445 (F) Button Electrode 5mm
- 31-2447 (G) Cone Electrode 5mm

Each electrode has a permanently fitted adapter for connecting to the electro-surgical cable. Cable is ordered separately.



SKLARTECH
4000

LAPAROSCOPIC SUCTION/IRRIGATION



SUCTION IRRIGATION SYSTEM NON-INSULATED

- 31-2238 (A) Dual Trumpet Valve – fits 5mm or 10mm Sheath (includes 5mm Sheath)
- 31-2258 (B) Single Trumpet Valve – fits 5mm or 10mm Sheath (includes 5mm Sheath)
- 31-4003 (C) 5mm Sheath only
- 31-4004 10mm Sheath only (not shown)



HIGH VOLUME SUCTION IRRIGATION SYSTEM NON-INSULATED

- 31-2239 (A) Dual Trumpet Valve – includes 5mm and 10mm Sheath (shown with 10mm Sheath)
- 31-2347 (B) 5mm Replacement Sheath
- 31-2349 (C) 10mm Replacement Sheath



LAPAROSCOPIC ACCESSORIES

SKLARTECH
4000



VERRES NEEDLE WITH STOPCOCK

- 31-2327 100mm
- 31-2350 120mm
- 31-2352 150mm



NEEDLE FOR INJECTION & IRRIGATION

- 31-2355 Luer Lock – 32cm 5mm



GRADUATED PROBE

- 31-2365 32cm 5mm

SKLARTECH
4000
 MINIATURE

MINIATURE LAPAROSCOPIC SCISSORS



MINIATURE METZENBAUM SCISSORS
 STRAIGHT – 32CM 3MM

31-4306XC Complete Instrument 31-4306 Replacement Cannula/Insert (one piece)



MINIATURE METZENBAUM SCISSORS
 CURVED – 32CM 3MM

31-4303XC Complete Instrument 31-4303 Replacement Cannula/Insert (one piece)



MINIATURE METZENBAUM SCISSORS
 CURVED, SERRATED – 32CM 3MM

31-4307XC Complete Instrument 31-4307 Replacement Cannula/Insert (one piece)



MINIATURE HOOK SCISSORS
 32CM 3MM

31-4304XC Complete Instrument 31-4304 Replacement Cannula/Insert (one piece)



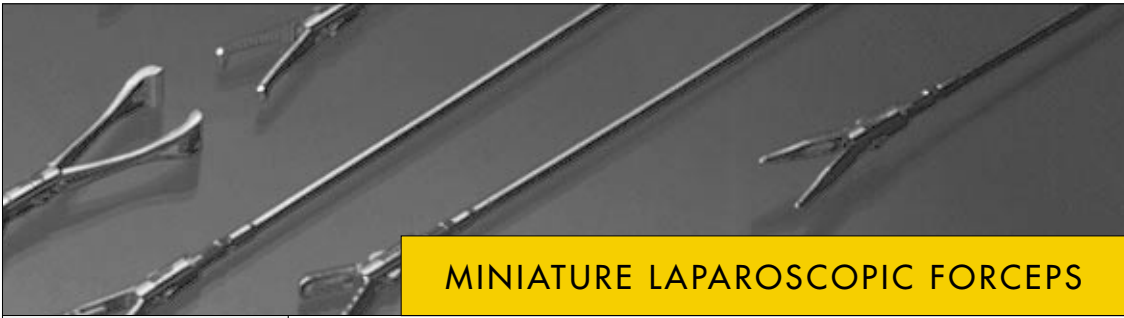
MINIATURE PUNCH
 32CM 3MM

31-4305XC Complete Instrument 31-4305 Replacement Cannula/Insert (one piece)



Complete Instrument:
 Handle with collar and
 cannula/insert

The complete Miniature Laparoscopic instrument is provided with the much lighter carbon handle in either ratchet (YC) or non-ratchet (XC) pattern. However, unlike the standard laparoscopic instrument, the insert/cannula, either as part of a complete instrument or as a replacement, is a permanent one-piece construction.



MINIATURE LAPAROSCOPIC FORCEPS

SKLARTECH
4000
 MINIATURE



MINIATURE MARYLAND DISSECTOR
 CROSS SERRATIONS – 32CM 3MM
 31-4310XC Complete Instrument 31-4310 Replacement Cannula/Insert (one piece)



MINIATURE ATRAUMATIC DISSECTOR
 32CM 3MM
 31-4311XC Complete Instrument 31-4311 Replacement Cannula/Insert (one piece)

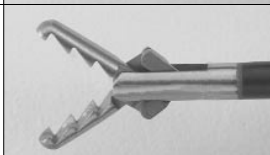


Complete Instruments at right include "XC" Handle

MINIATURE SPOON FORCEPS
 32CM 3MM
 31-4315XC Complete Instrument 31-4315 Replacement Cannula/Insert (one piece)



MINIATURE SPOON FORCEPS
 SERRATED – 32CM 3MM
 31-4316XC Complete Instrument 31-4316 Replacement Cannula/Insert (one piece)



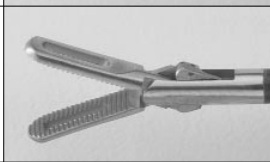
MINIATURE KELLY FORCEPS
 32CM 3MM
 31-4309XC Complete Instrument 31-4309 Replacement Cannula/Insert (one piece)



MINIATURE DUCK NOSE FORCEPS
 32CM 3MM
 31-4314YC Complete Instrument 31-4314 Replacement Cannula/Insert (one piece)



MINIATURE FENESTRATED GRASPING FORCEPS
 32CM 3MM
 31-4317YC Complete Instrument 31-4317 Replacement Cannula/Insert (one piece)



Complete Instruments at right include "YC" Handle

MINIATURE GRASPING FORCEPS
 32CM 3MM
 31-4308YC Complete Instrument 31-4308 Replacement Cannula/Insert (one piece)



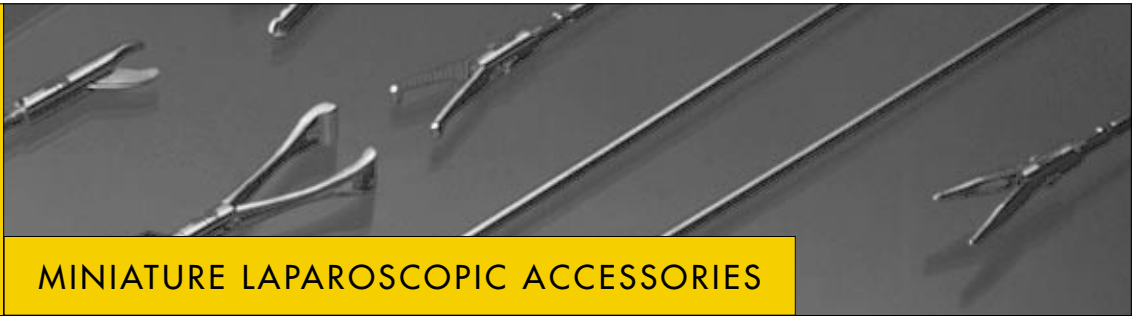
MINIATURE GRASPING FORCEPS
 HEAVY SERRATIONS – 32CM 3MM
 31-4312YC Complete Instrument 31-4312 Replacement Cannula/Insert (one piece)



MINIATURE COBRA GRASPING FORCEPS
 32CM 3MM
 31-4313YC Complete Instrument 31-4313 Replacement Cannula/Insert (one piece)



SKLARTECH
4000
 MINIATURE



MINIATURE LAPAROSCOPIC ACCESSORIES



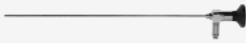
SKLAR "XC" CARBON HANDLE

31-4001XC Lightweight, carbon fiber reinforced non-conductive safety handle with locking collar. Non-ratchet design and fully rotating as well as a proximally positioned high-frequency connector.



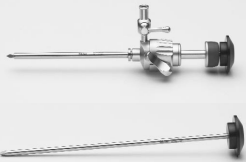
SKLAR "YC" HANDLE

31-4002YC Lightweight, carbon fiber reinforced non-conductive safety handle with locking collar. Ratchet design and fully rotating as well as a proximally positioned high-frequency connector.



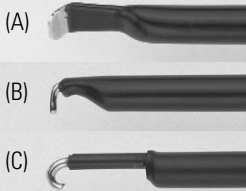
MINIATURE ENDOSCOPE
 AUTOCLAVABLE – 3MM

31-4301



MINIATURE TROCAR SET
 REUSABLE – 3MM

31-4302 Trocar Set
 31-4318 Replacement Obturator 3mm



MINIATURE ELECTRODES, WITHOUT SUCTION
 HIGH FREQUENCY, INSULATED - 3MM

31-4325 (A) Spatula Electrode
 31-4326 (B) L-Hook Electrode
 31-4327 (C) J-Hook Electrode

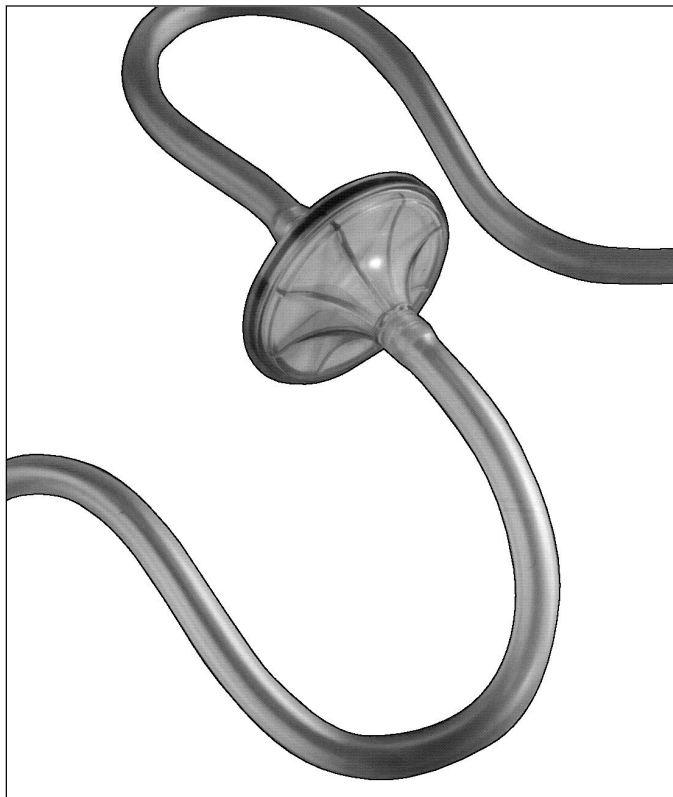
Each electrode has a permanently fitted adapter for connecting to the electrosurgical cable (ordered separately).



ELECTROSURGICAL CABLE

31-2242 Monopolar

- Double-Funnel Configuration For Turbulence Reduction And Uniform Pressure Distribution.
- Hydrophobic Medium Removes 99.99% Of All Particles 0.1 Micron Or Larger.
- Compatible To Insufflators With Flow Capacities Of 24 Liters/Min.



**NORTHGATE
ADAPTER**

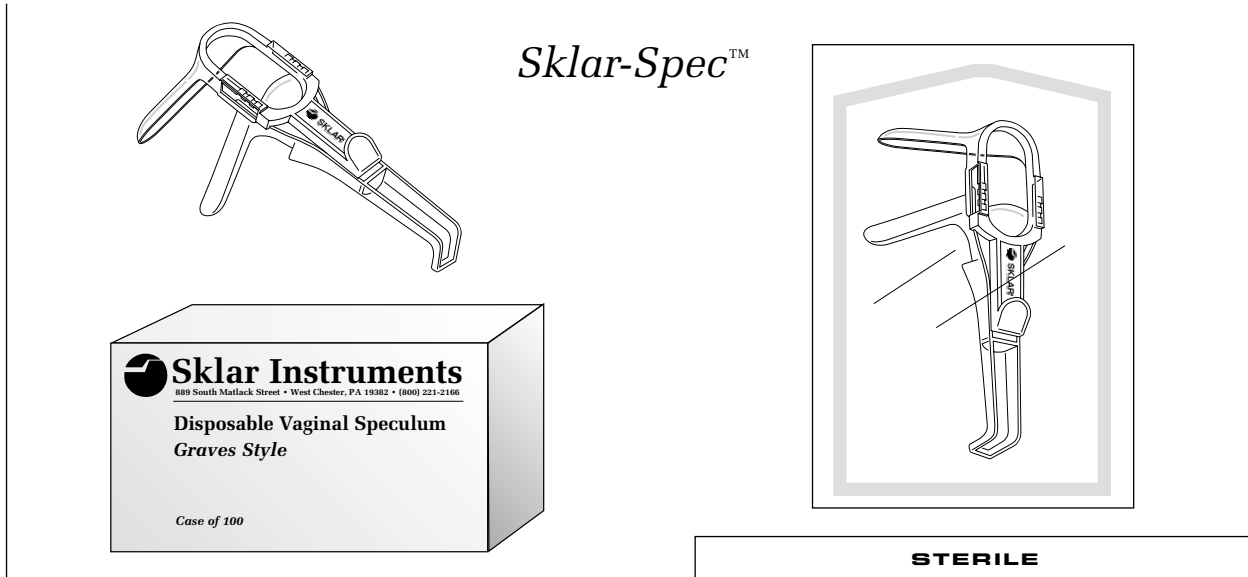
In-Line Filter For Particulates And Bacteria In CO₂ Gas Used For Laparoscopic Insufflation And To Protect From Fluid Backflow.

INSUFFLATION TUBING WITH FILTER

31-2450 Tubing With Filter, Sterile Box of 10

31-2451 Adapter, Sterile Box of 10

GYNECOLOGY INSTRUMENTS, DISPOSABLE



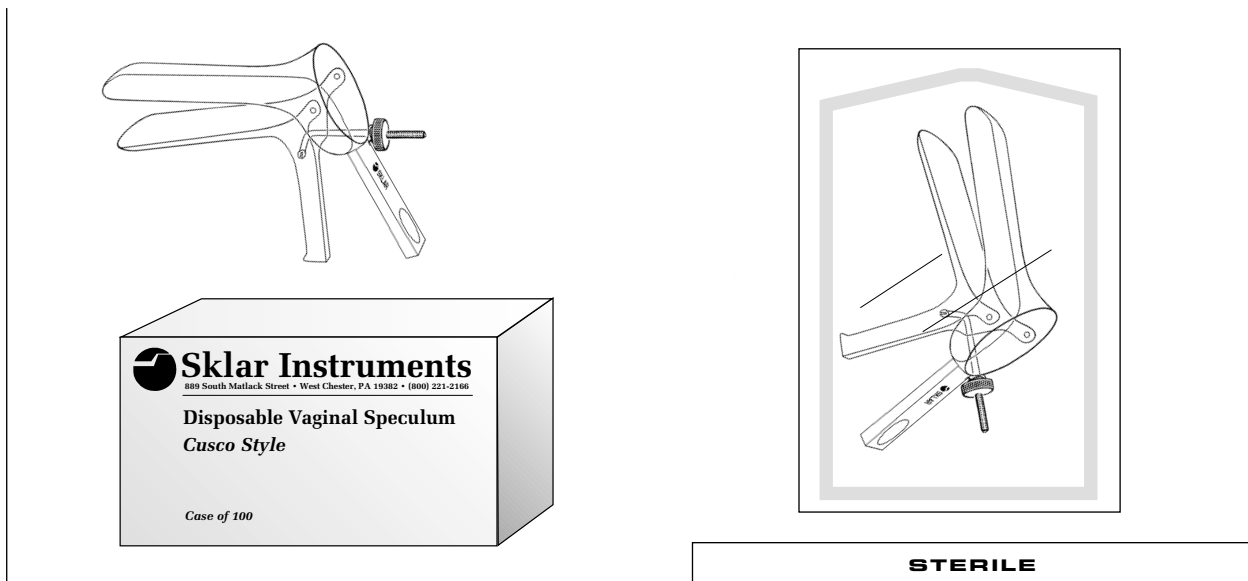
PLASTIC VAGINAL SPECULUM, GRAVES STYLE

Disposable (Non Sterile)

96-0857	Small	Cs/100	10 Packs of 10
96-0867	Medium	Cs/100	10 Packs of 10
96-0877	Large	Cs/100	10 Packs of 10

Disposable (Sterile)

96-2602	Small	Cs/50
96-2604	Medium	Cs/50
96-2606	Large	Cs/50



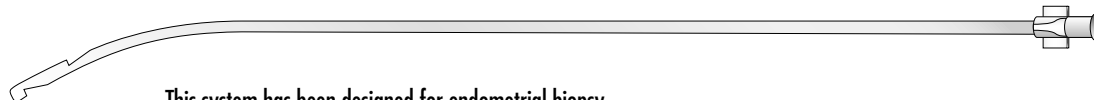
PLASTIC VAGINAL SPECULUM, CUSCO STYLE

Disposable (Non Sterile)

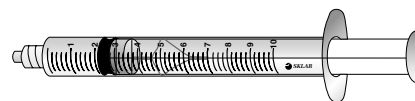
96-0557	Small	Cs/100	10 Packs of 10
96-0567	Medium	Cs/100	10 Packs of 10
96-0577	Large	Cs/100	10 Packs of 10

Disposable (Sterile)

96-2642	Small	Cs/50
96-2644	Medium	Cs/50
96-2648	Large	Cs/50



This system has been designed for endometrial biopsy without the need for anesthesia. It consists of a 3mm catheter attached to a standard syringe. It enables the gynecologist to perform a biopsy and collect specimens which may be examined histologically or cytologically.

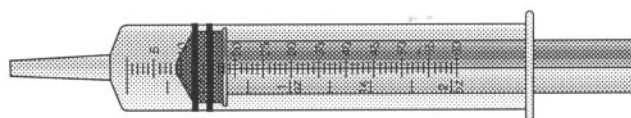


ENDOMETRIAL SAMPLING SET

Sterile Box/10
96-4160 3mm



The aspiration system employs a 60cc syringe attached to a slightly flexible cannula for simple yet effective uterine aspiration.



ENDOMETRIAL SAMPLING SET WITH 60 CC SYRINGE

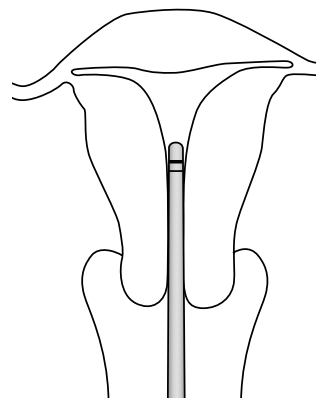
Sterile Box/10
96-4162 4mm
96-4164 5mm
96-4166 6mm



The comfortably thin endometrial cannula is designed with the correct flexibility to ensure ease-of-introduction. It also allows for accommodation to normal uterine curvature as well as achieving contact with the uterine wall.

This disposable instrument permits rapid tissue collection with little or no subsequent bleeding or patient discomfort.

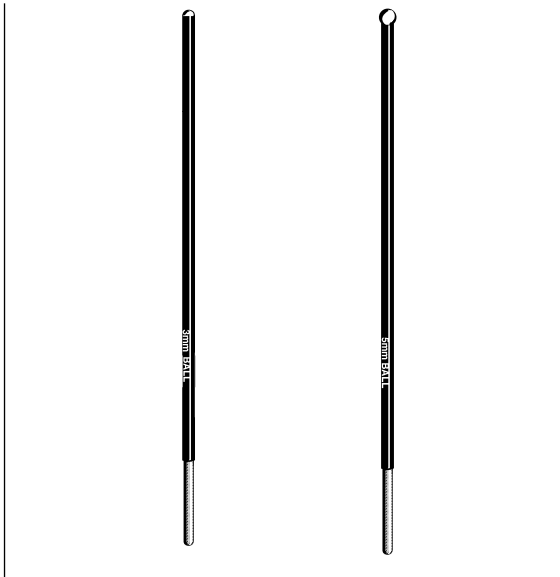
The Endometrial Sampling Device of clinical choice provides simple, economical screening of endometrium. It quickly and comfortably extracts histological sample for a variety of evaluations: monitor hormonal therapy, fertility problems, uterine pathogens including endometrial carcinoma.



ENDOMETRIAL BIOPSY CANNULA

Sterile Box/25
96-4100 For Aspiration Biopsy

GYNECOLOGICAL ELECTROSURGERY INSTRUMENTS, DISPOSABLE



LLETZ BALL ELECTRODES

Sterile Box/5

96-1040 3mm/0.3cm

96-1045 5mm/0.5cm



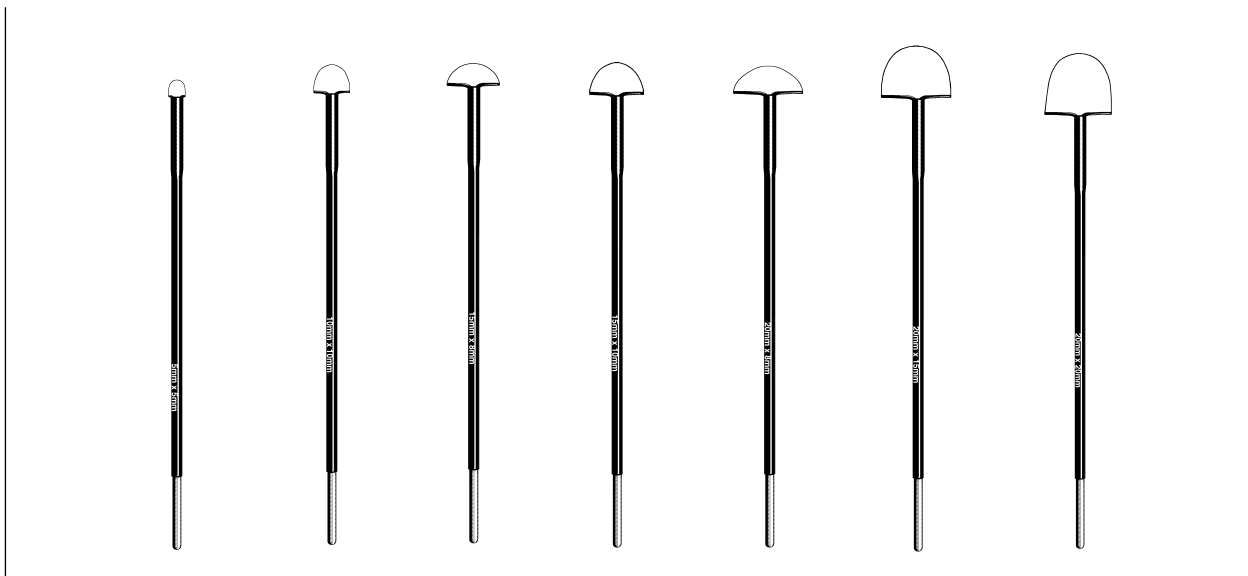
LLETZ SQUARE ELECTRODES

Sterile Box/5

96-1090 5 x 5mm/0.5 x 0.5cm

96-1095 10 x 4mm/1.0 x 0.4cm

96-1099 10 x 8mm/1.0 x 0.8cm



LLETZ LOOP ELECTRODES

Sterile Box/5

96-1050 5 x 5mm/0.5 x 0.5cm

96-1060 15 x 8mm/1.5 x 0.8cm

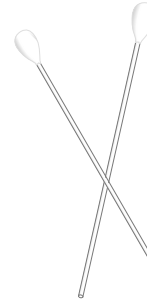
96-1075 20 x 8mm/2.0 x 0.8cm

96-1085 20 x 20mm/2.0 x 2.0cm

96-1055 10 x 10mm/1.0 x 1.0cm

96-1065 15 x 10mm/1.5 x 1.0cm

96-1080 20 x 15mm/2.0 x 1.5cm



A ready-to-use, thickened hemostatic agent which should be applied to the surgical site following excision of diseased tissue or subsequent to a biopsy.

MONSEL'S PASTE

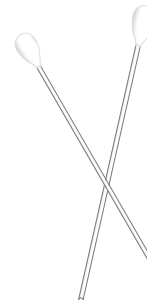
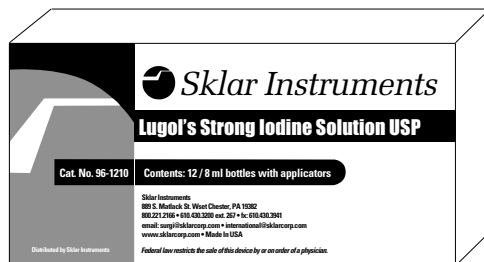
Box/12
96-1200 8ml bottles with applicators



Contents:
2 Lidocaine HCl 2% (5ml Vial)
2 Lidocaine w/Epinephrin HCl 2% (5ml Vial)
Needle, 30 ga. x 1
Endocervical Needle, 27 ga. x 3-1/4" Reinf.
Lugol's (Iodine Contrast Medium)
Monse's Hemostatic Paste
6 8" Cotton Applicator Sticks
Pantyliner
Alcohol Prep Pad
Absorbent Underpad

LLETZ ELECTROSURGERY TRAY

96-1916 Box of 10



A strong iodine contrast medium used for identification of diseased tissue.

LUGOL'S SOLUTION

Box/12
96-1210 8ml bottles with applicators

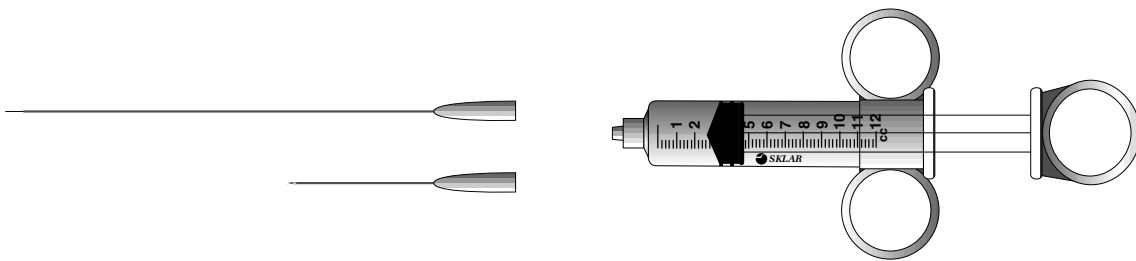
GYNECOLOGICAL INSTRUMENTS, DISPOSABLE



The Cervical Needle allows injection to the cervix, overcoming both distance and tissue obstacles. The reinforced and lengthened needle shaft, when fitted to a standard syringe, makes cervical application a simplified procedure.

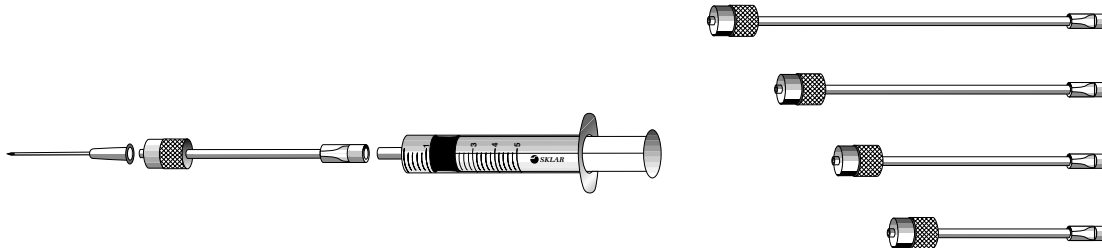
CERVICAL BLOCK NEEDLES

Box of 10
96-4184 27 gauge (tip)
21 gauge (shaft)



CERVICAL BLOCK NEEDLE KIT

Case of 10
96-4180 Includes:
Cervical Needle
Short Needle - 18 Gauge
Finger Grip Syringe



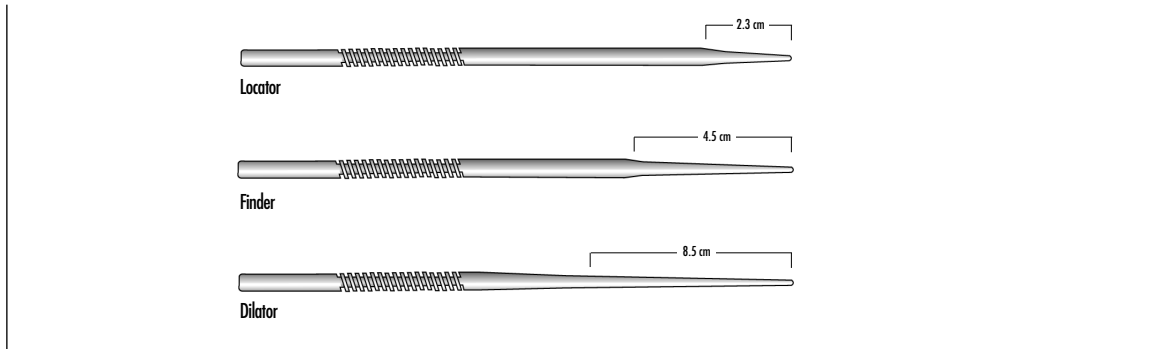
When adapted to a standard hypodermic syringe the "extended needle" offers greater control over difficult cervical injections.

NEEDLE EXTENDERS, REUSABLE

Each
96-4190 3" 96-4194 5"
96-4192 4" 96-4196 6"

NEEDLE EXTENDERS, DISPOSABLE PLASTIC LUER LOCK ADAPTER

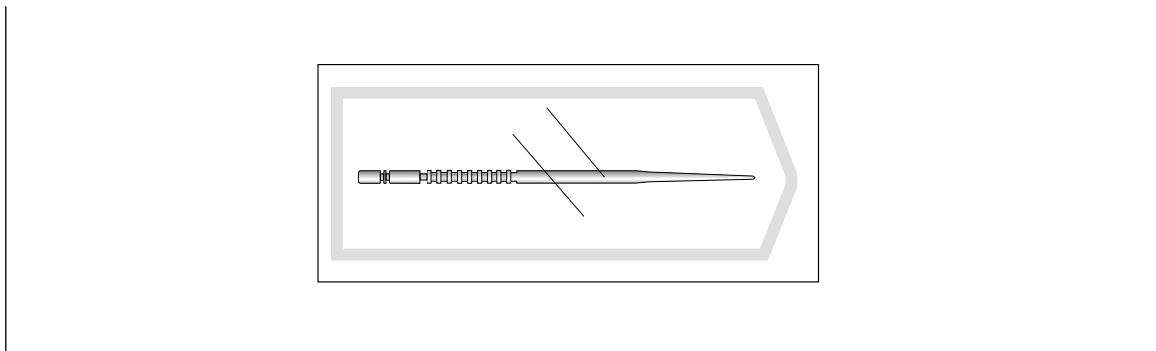
Each
96-5190 3" Box/10, Sterile 96-5194 5" Box/10, Sterile
96-5192 4" Box/10, Sterile 96-5196 6" Box/10, Sterile



OS DILATOR SET, REUSABLES

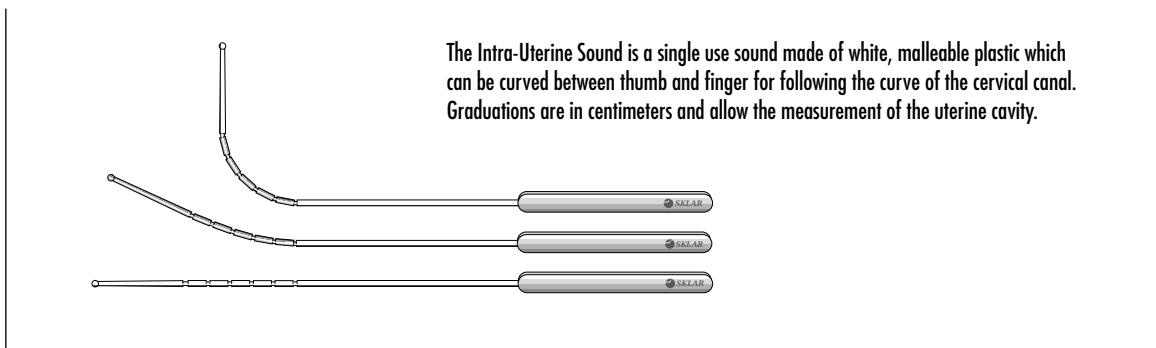
Teflon

96-4150 Set of 3 Dilators - Os Locator, Canal Finder, Fundus Dilator



OS DILATOR, DISPOSABLE

96-4155 Box of 50, Sterile

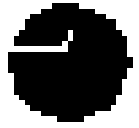


The Intra-Uterine Sound is a single use sound made of white, malleable plastic which can be curved between thumb and finger for following the curve of the cervical canal. Graduations are in centimeters and allow the measurement of the uterine cavity.

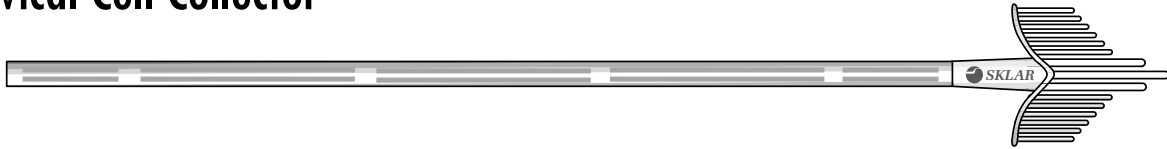
SKLAR INTRA-UTERINE SOUND

Malleable Box/50 Packaged Sterile
96-4170

GYNECOLOGICAL INSTRUMENTS, DISPOSABLE



Cervical Cell Collector



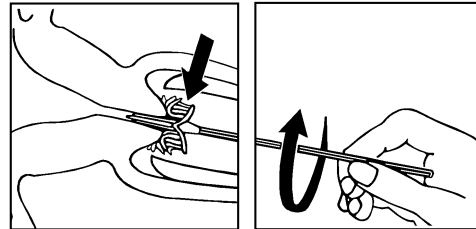
The Sklar Cervex Brush provides the most comprehensive and efficient means of cervical sampling to insure highly accurate Pap test readings. In one step, the Cervex Brush collects the broad spectrum of clinical cells, including the transformation zone, thereby eliminating the more complex brush and spatula approach.

Instructions For Use:

Depending on methodology, record patient information on the patient record card and the appropriate accessory, e.g., microscope slide or transport tube. Do not use lubricant in the vagina prior to cervical sampling with the Sklar Cervex-Brush. Perform vaginal sampling before doing manual examination.

Insert the longest, central bristles of the brush into the endocervical canal. Apply gentle pressure until the shorter, side bristles bend from contact with the ecto-cervix. While maintaining gentle pressure sufficient to keep the side bristles bent, hold the stem between thumb and forefinger and rotate the brush five times in a clockwise direction.

Caution: NEVER REUSE THE SKLAR CERVEX-BRUSH.



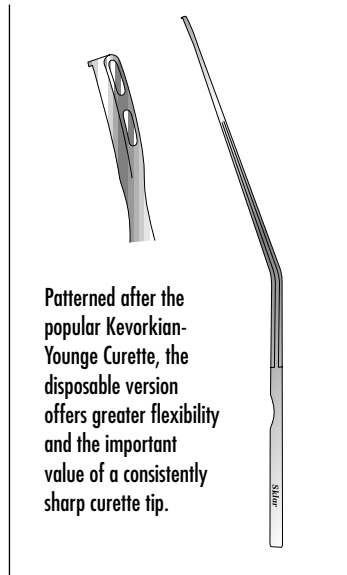
SKLAR CERVEX-BRUSH

96-4140 Box of 100 – Individually Packaged in Sterile Pouches



PAP BRUSH, STANDARD

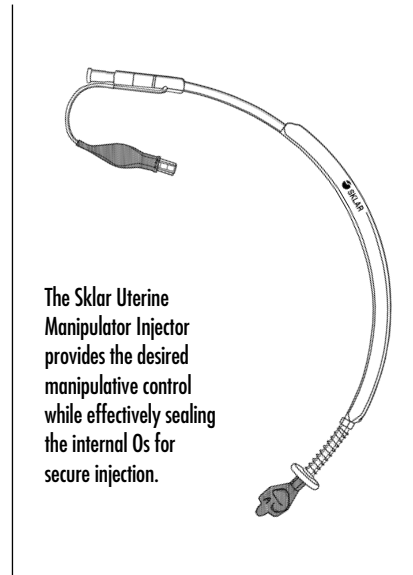
96-4141 Package of 100 Non Sterile



Patterned after the popular Kevorkian-Younger Curette, the disposable version offers greater flexibility and the important value of a consistently sharp curette tip.

ENDOCERVICAL CURETTE

Sterile Box/25
96-4143

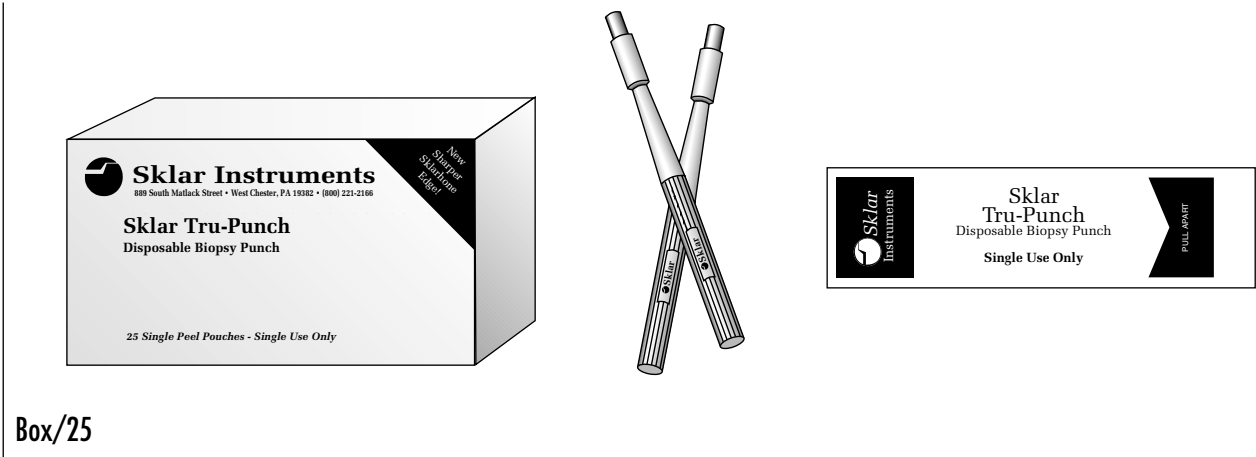


The Sklar Uterine Manipulator Injector provides the desired manipulative control while effectively sealing the internal Os for secure injection.

UTERINE MANIPULATOR/INJECTOR, DISPOSABLE

96-4120 Case of 12, Sterile
4.5mm O.D. - 33cm Length

The Sklar Tru-Punch™ has a “seamless” steel tip carefully honed for a razor sharp incision and perfect sample. The ribbed and hollow handle permits tissue to be easily dislodged.

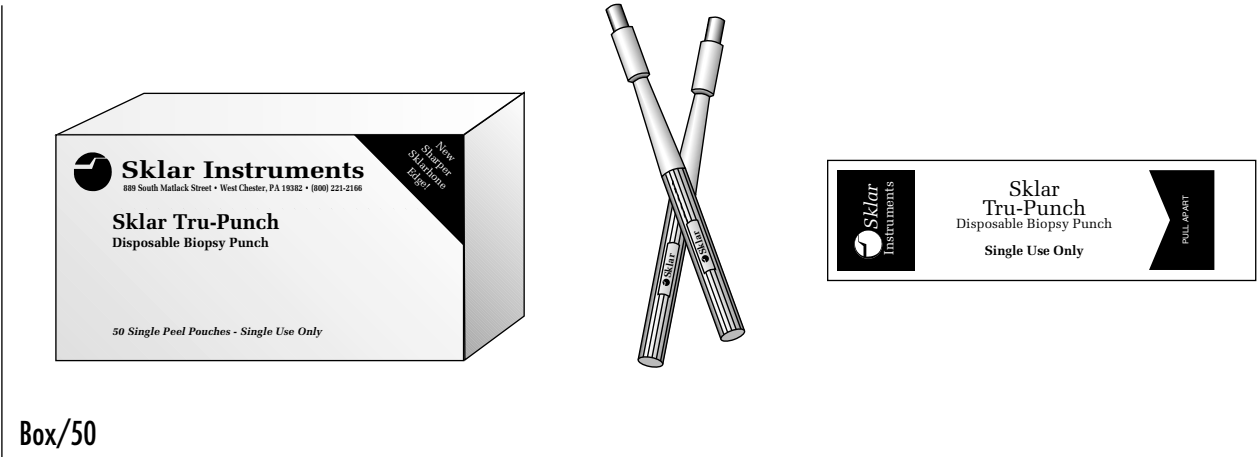


Box/25

SKLAR TRU-PUNCH™ – DISPOSABLE VULVAR BIOPSY PUNCH

Box/25, Sterile

96-1140	2mm	96-1148	5mm
96-1142	3mm	96-1150	6mm
96-1144	3.5mm	96-1152	8mm
96-1146	4mm		



Box/50

SKLAR TRU-PUNCH™ – DISPOSABLE VULVAR BIOPSY PUNCH

Box/50, Sterile

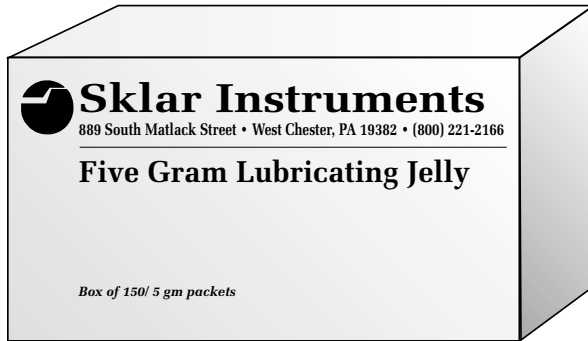
96-1100	2mm	96-1120	5mm
96-1105	3mm	96-1125	6mm
96-1110	3.5mm	96-1130	8mm
96-1115	4mm		

SKLAR TRU-PUNCH™ – DISPOSABLE VULVAR BIOPSY PUNCH

Box/25, Sterile

96-1160	Assorted (5 of each - 2, 3, 3.5, 4, 5)
---------	---

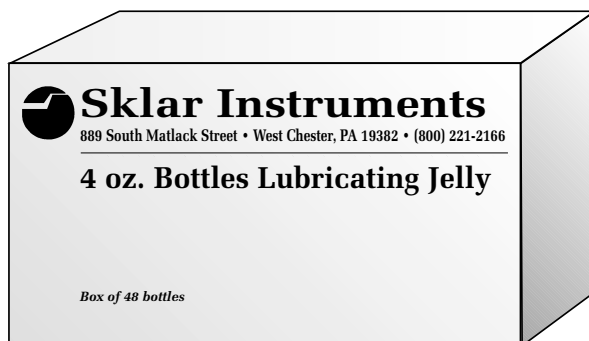
GYNECOLOGICAL INSTRUMENTS, DISPOSABLE



Sklar lubrication jelly is ideal for use with surgical instruments. It is water soluble and very useful as a general purpose lubricating jelly in the hospital and all professional settings. Non-irritating formula.

LUBRICATION JELLY

96-1610 Box 150/5gm packets Case/4
96-1612 Box 150/5gm packets 1 Box Only



LUBRICATION JELLY

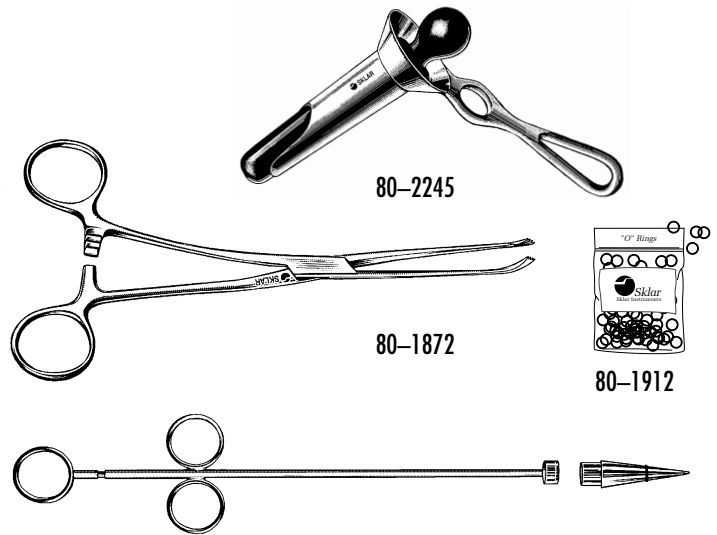
96-1615 4 oz. bottles Case/48
96-1616 4 oz. bottles Box/4

RUDD CLINIC LIGATOR SET

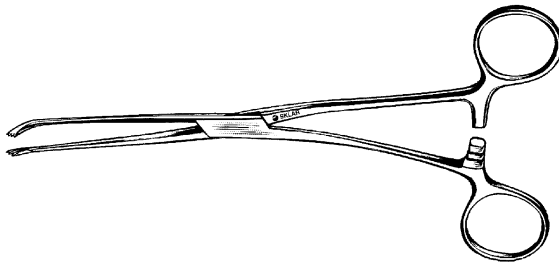
The Rudd Clinic Hemorrhoidal Ligator is an improved instrument for elastic band ("O" Ring) ligation of hemorrhoids. It is simply designed with only one moving part for greater dependability and trouble-free performance. Separate loading cone facilitates loading "O" ring bands on cylinder.

Instead of suddenly releasing the band around entire hemorrhoid, the Rudd Ligator releases the band from one side of applicator for a more gradual encirclement of the hemorrhoid.

This instrument also features a shorter and wider cylinder to allow for use on larger hemorrhoids and mucosal prolapse. It provides better visibility ... before, during and after ligation to assure proper placement of bands.

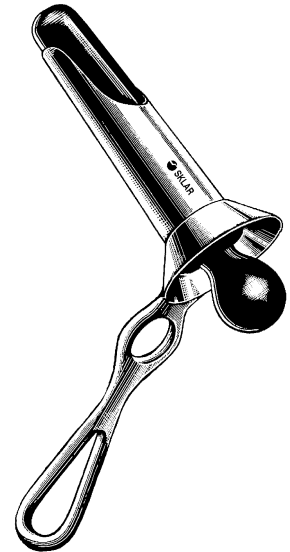


80-1914 Set Includes: Ligator, Forceps, 100 "O" Rings and Speculum



HEMORRHOIDAL FORCEPS

80-1872 7 1/4"



IVES RECTAL SPECULUM (FANSLER)

80-2245 3 1/4" Long
80-2244 Obturator only (Autoclavable)



RUDD CLINIC HEMORRHOIDAL LIGATOR

With Loading Cone and 100 "O" Rings

- 80-1910 Complete
- 80-1911 Loading Cone Only
- 80-1912 Ligating "O" Rings
Package of 100

RECTAL INSTRUMENTS

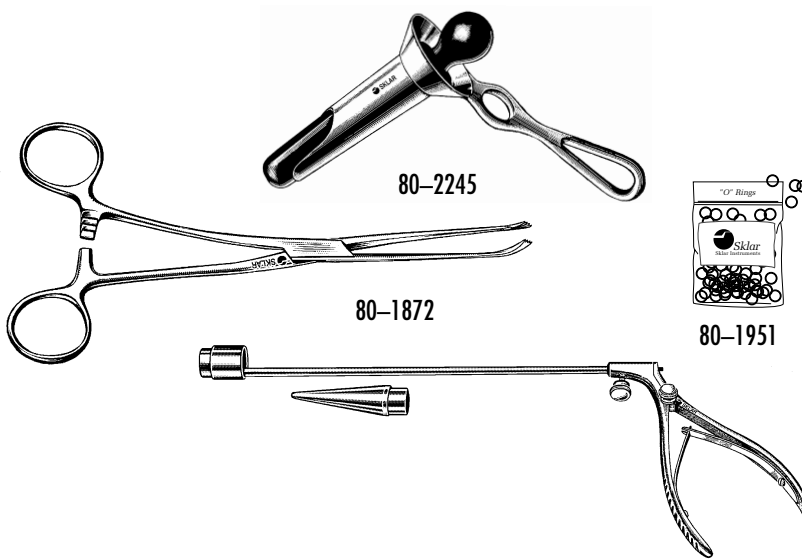


McGIVNEY HEMORRHOIDAL LIGATOR SET

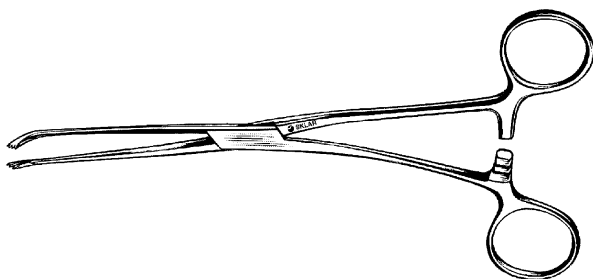
The McGivney Hemorrhoidal Ligator Set provides the convenience of a plier handle elastic band applicator.

- It is supplied with a separate loading cone.
- A specially designed double bend forceps that provides better visualization.
- The Ives (Fansler) Rectal Speculum is the instrument of choice for Ligation procedures.

Also included are 100 elastic "O" Rings that can be reordered as 80-1951.

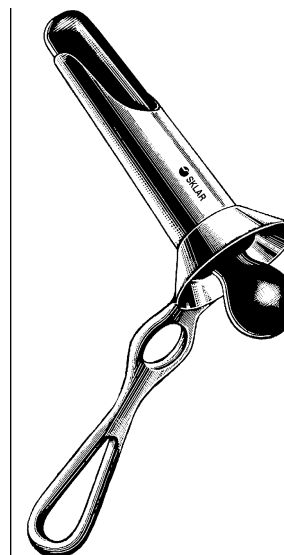
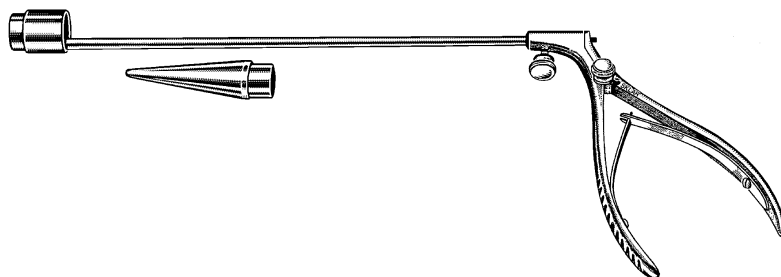


80-1945 Set Includes: Ligator, Forceps, 100 "O" Rings and Speculum



HEMORRHOIDAL FORCEPS

80-1872 7 1/4"

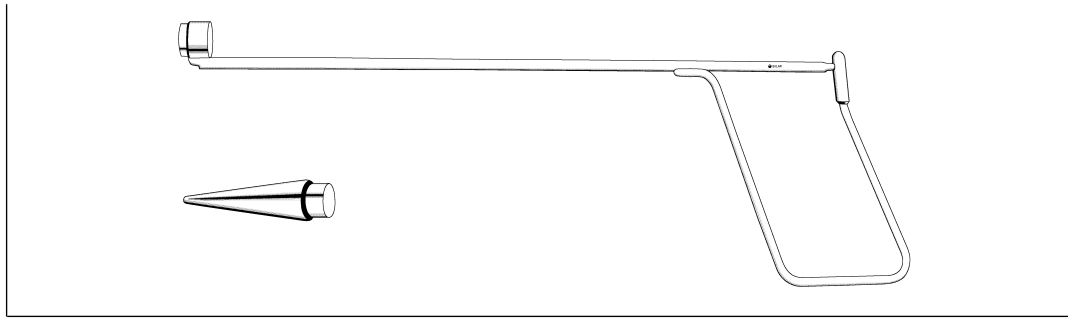


IVES RECTAL SPECULUM (FANSLER)

80-2245 3 1/4" Long
80-2244 Obturator only (Autoclavable)

McGIVNEY HEMORRHOIDAL LIGATOR

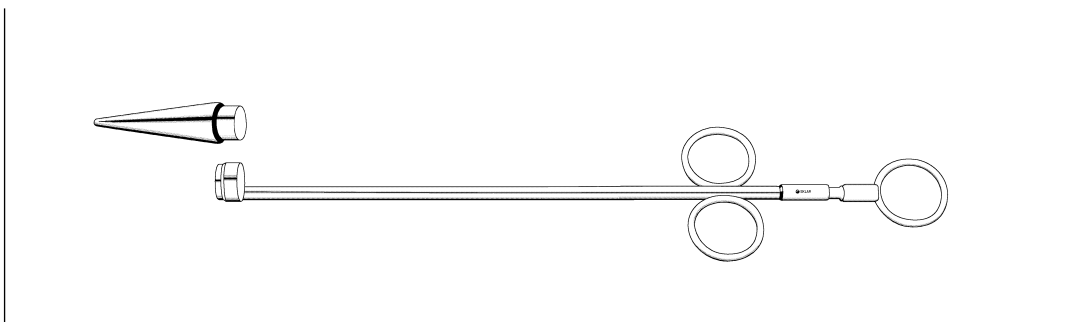
- 80-1950 7" Complete With Loading Cone and 100 "O" Rings
- 80-1952 Loading Cone Only for McGivney
- 80-1951 Elastic "O" Rings Package of 100



SKLAR IMPROVED HEMORRHOID LIGATOR

Pistol-Grip for Better Placement Control and Detachable for Easy Cleaning

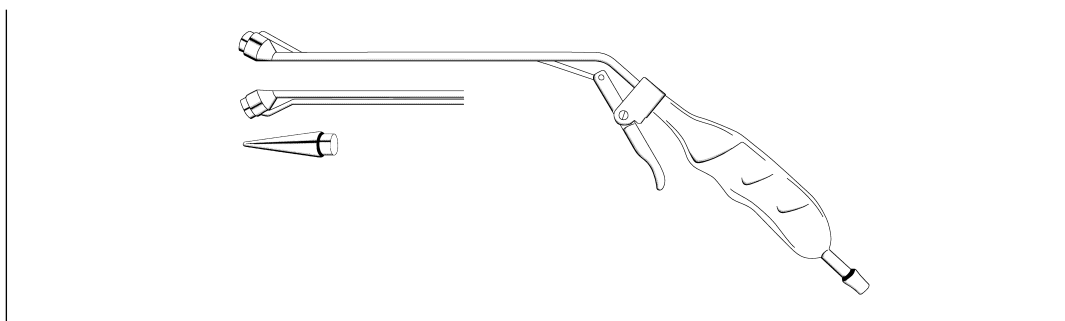
- 80-1930 Ligator and Loading Cone
- 80-1931 Loading Cone Only
- 80-1951 Elastic "O" Rings Package of 100



IMPROVED RUDD LIGATOR

Integrated Resetting Spring and Detachable for Easy Cleaning

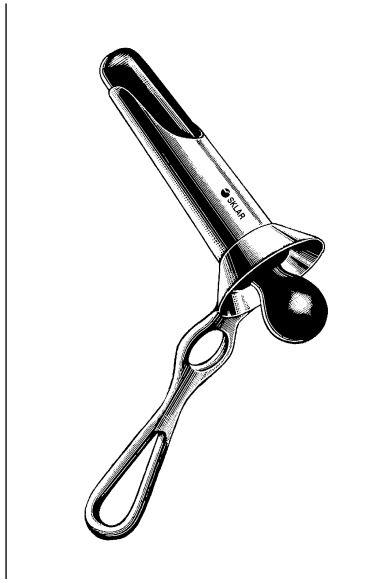
- 80-1918 Ligator and Loading Cone
- 80-1951 Elastic "O" Rings Package of 100



HEMORRHOID SUCTION LIGATOR

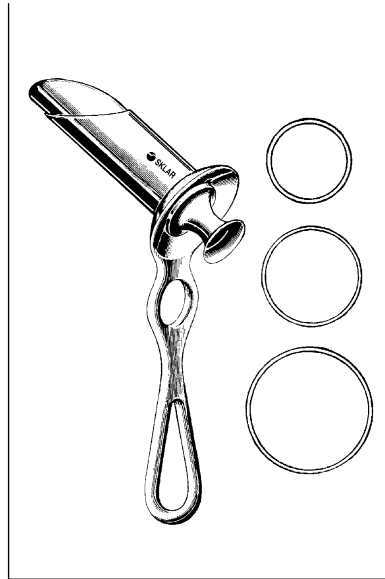
- 80-1970 Angled Up, 30°
- 80-1972 Angled Down, 30°
- 80-1974 Loading Cone for 80-1970 and 80-1972
- 80-1951 Elastic "O" Rings Package of 100

RECTAL INSTRUMENTS



IVES RECTAL SPECULUM (FANSLER)

80-2245 3 1/4" Long
80-2244 Obturator only (Autoclavable)

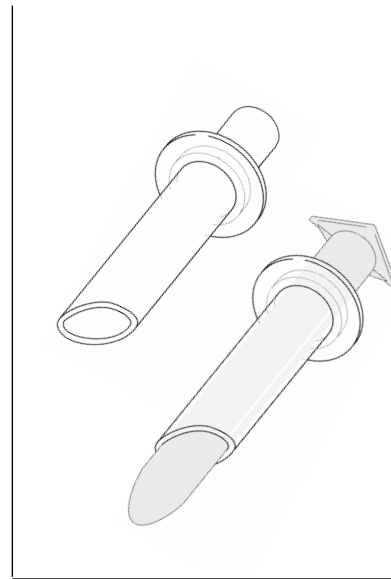


HIRSCHMAN ANOSCOPE

80-2688 2 3/4" Long Small
80-2689 2 3/4" Long Med
80-2690 2 7/8" Long Large

Proctoscope

80-2595 5" Long x 7/8"



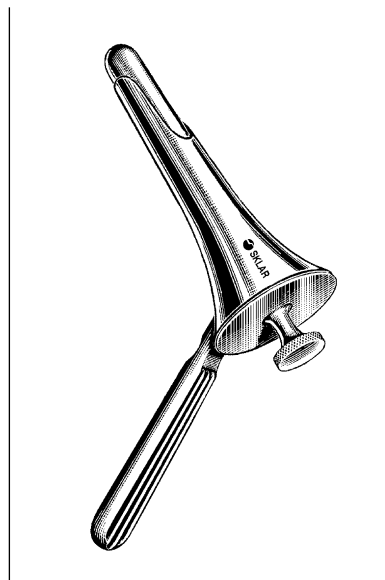
HIRSCHMAN TYPE ANOSCOPE, DISPOSABLE

96-0910 Medium; Pack of 25
96-0911 Medium; Case of 100



BRINCKERHOFF SPECULUM

80-2142 Small
80-2143 Medium
80-2144 Large



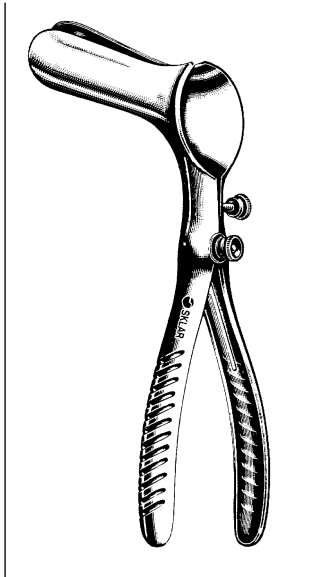
HINKLE-JAMES SPECULUM

80-2272 4 3/4" Long
Tapered from 3/8" to 2"



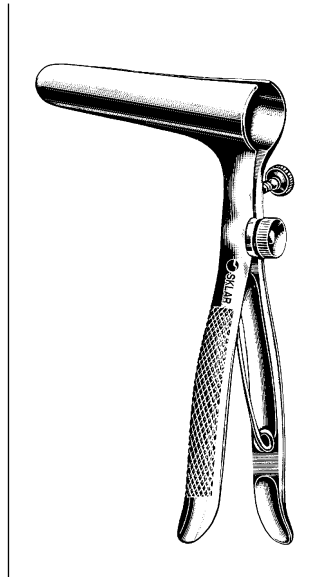
CHELSEA EATON ANAL SPECULUM

80-2260 Small
80-2261 Large



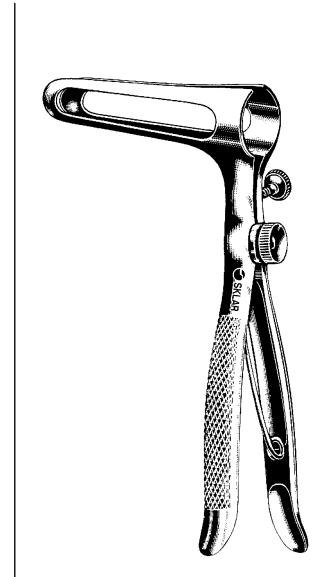
**PRATT
RECTAL SPECULUM**

With Set Screw
80-2132



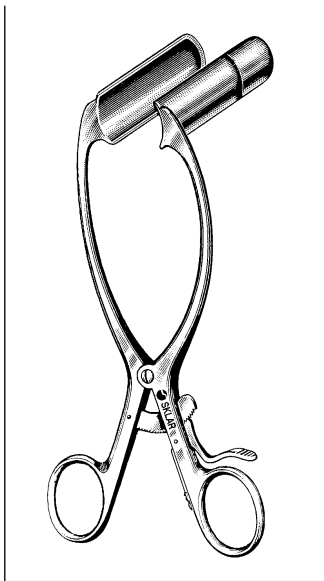
**BODENHAMMER (SIMS)
RECTAL SPECULUM**

With Set Screw
80-2120 3/4" Solid Blades



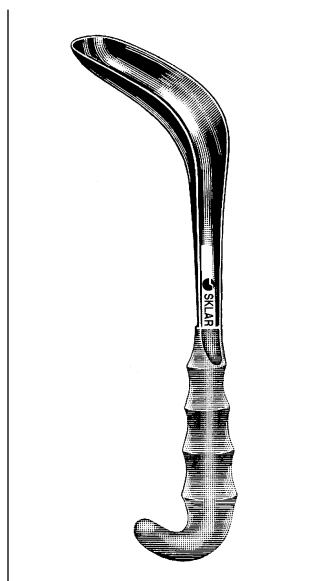
SIMS RECTAL SPECULUM

With Set Screw
80-2125 Fenestrated Blades



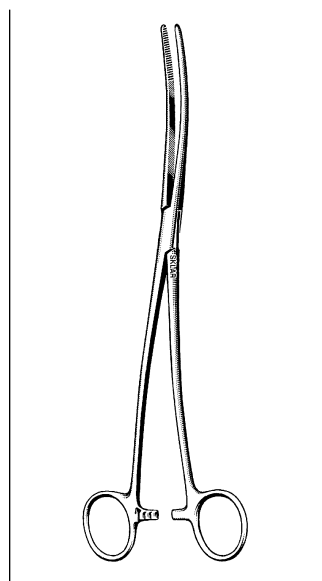
BARR RECTAL RETRACTOR

Tru-Grip Ratchet
80-2100 2 1/2" Blades



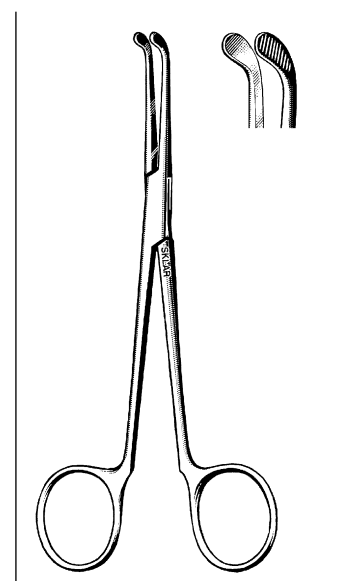
**SAWYER RECTAL
RETRACTOR**

With Sklar Grip Handle
80-3922 2 1/4" x 3/8" Small
80-3927 2 3/4" x 1" Medium
80-3935 3 1/2" x 1 1/4" Large



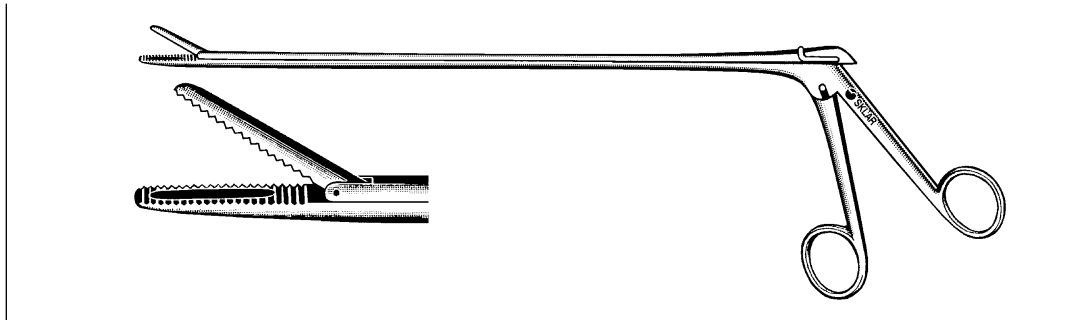
**BOZEMAN DRESSING
FORCEPS**

80-1410 10 1/4" S-Curve
90-7610 10 1/2" Straight
One large ring
90-7710 10 1/4" S-Curve



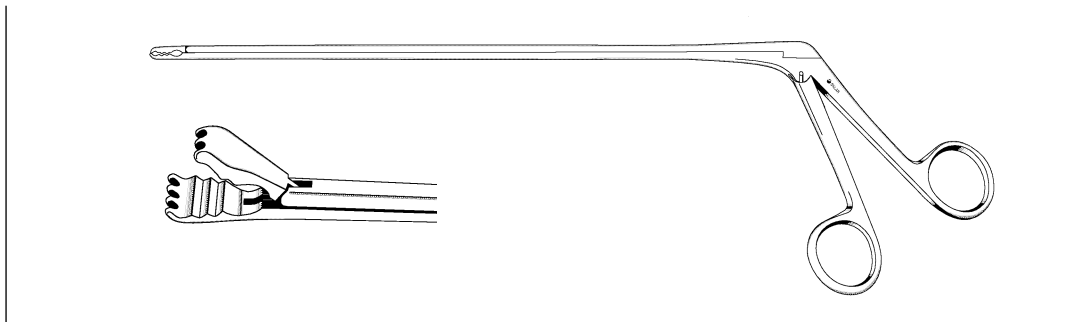
**BENSON PYLORUS
SEPARATOR**

22-6557 5 3/4"



JACKSON ALLIGATOR GRASPING FORCEPS

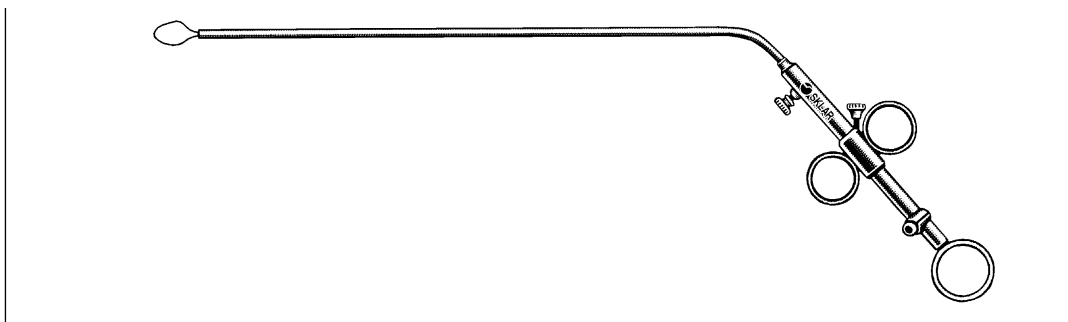
79-3230 12" Serrated



BARON ALLIGATOR HEMORRHOIDAL FORCEPS

Improved Grip with Atraumatic Jaws for Less Tissue Damage

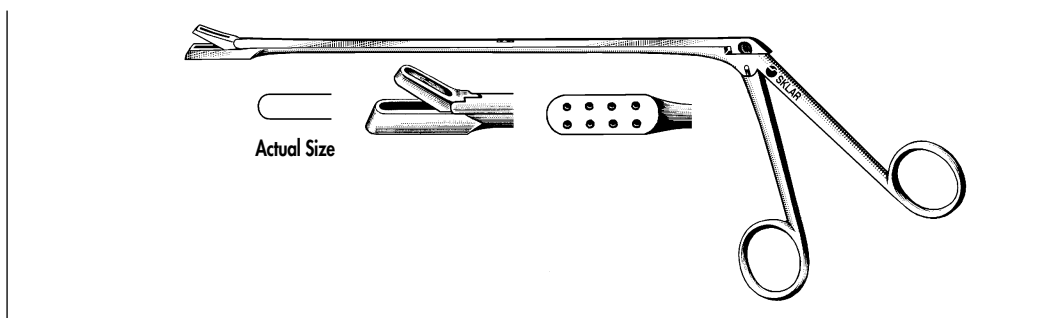
80-1940 10"



WESTON RECTAL SNARE

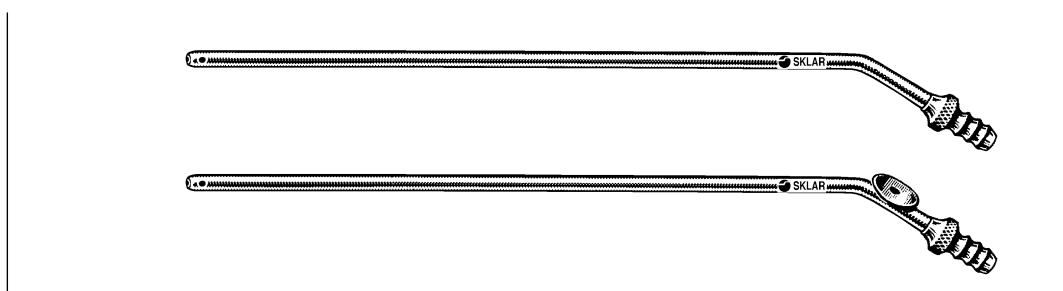
80-3812 12" Instrument With Wire

80-3814 Cut Snare Wires #5 (Package of 12)



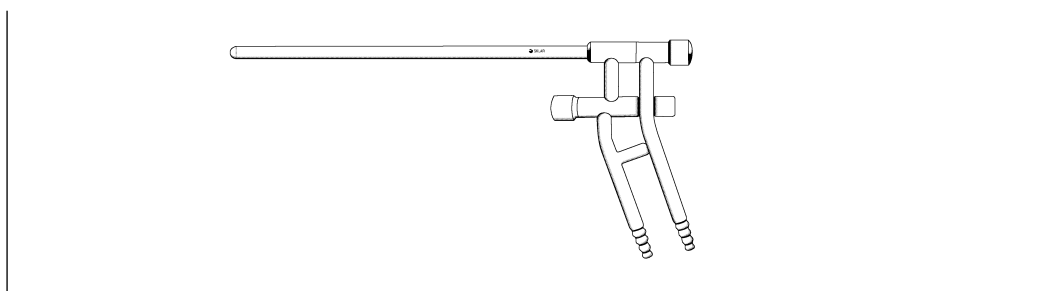
YEOMAN RECTAL BIOPSY PUNCH

With Basket	Without Basket
80-1735 13 $\frac{3}{4}$ "	80-1742 16 $\frac{1}{2}$ "



BUIE SUCTION TUBE 15FR

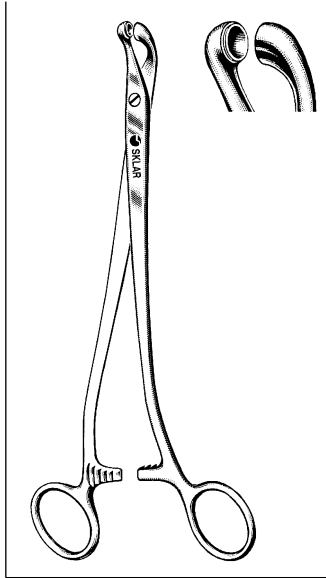
80-2815 without Valve	80-2715 with Valve
-----------------------	--------------------



TRUMPET VALVE SUCTION-IRRIGATION TUBE

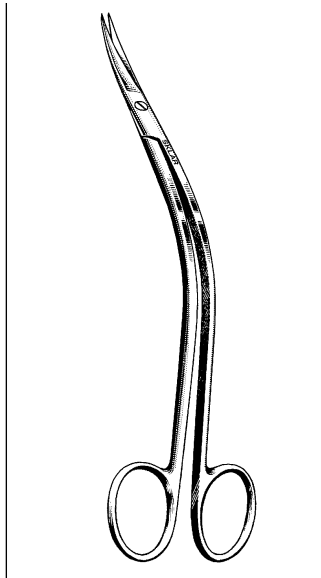
80-2700 10"

RECTAL INSTRUMENTS



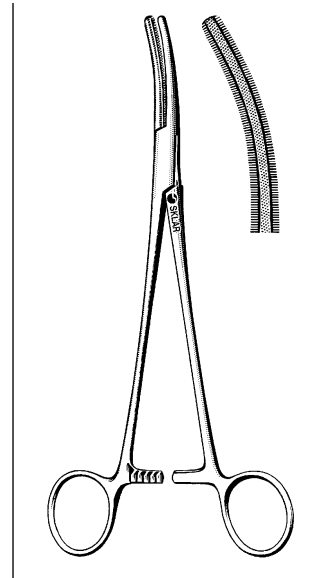
THOMS-GAYLOR BIOPSY FORCEPS

Improved
80-1695 9½"



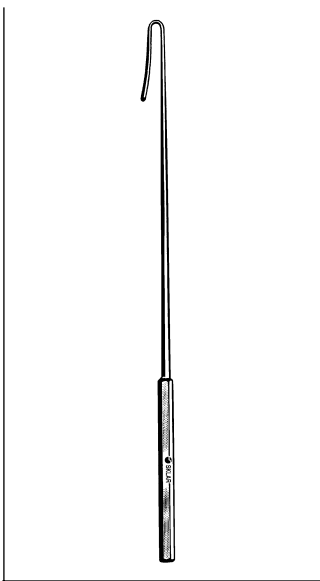
MILLER RECTAL SCISSORS

Double Curve
80-1565 6½" Serrated



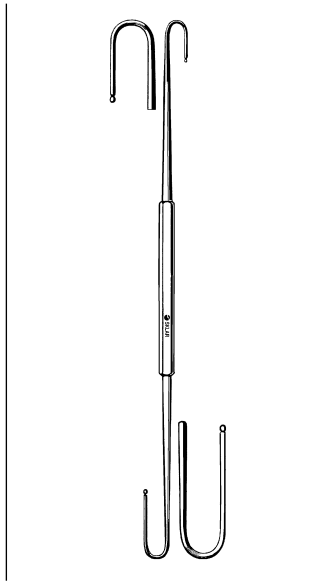
BUIE PILE CLAMP

80-1082 8½"



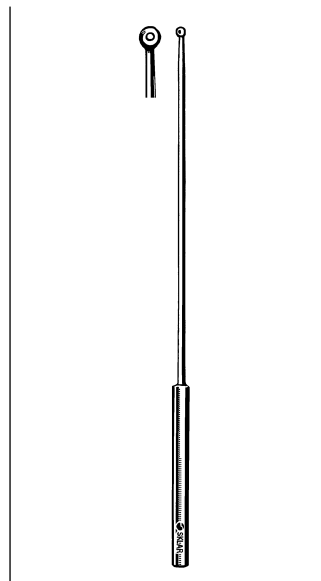
PRATT CRYPT HOOK

80-3185 8½"



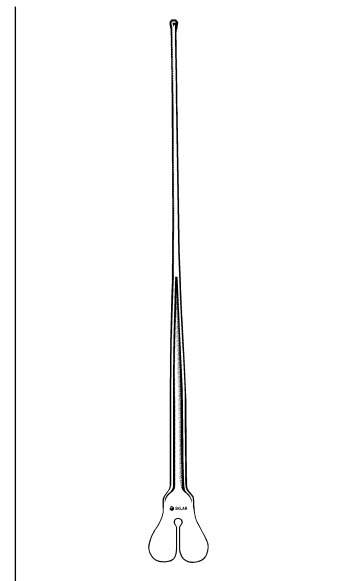
BARR CRYPT HOOK

Double End
80-3510 10½"



BARR FISTULA PROBE

With Eye
80-2910 10¾" Malleable



LARRY RECTAL PROBE

80-2870 7¼"



Sklar Black™
LASER

Autoclavable

LASER TUTTLE FORCEPS

90-2270 7" Tuttle



Sklar Black™
LASER

Autoclavable

LASER POTTS-SMITH FORCEPS

90-2306 10" Dressing
90-2304 7" Dressing

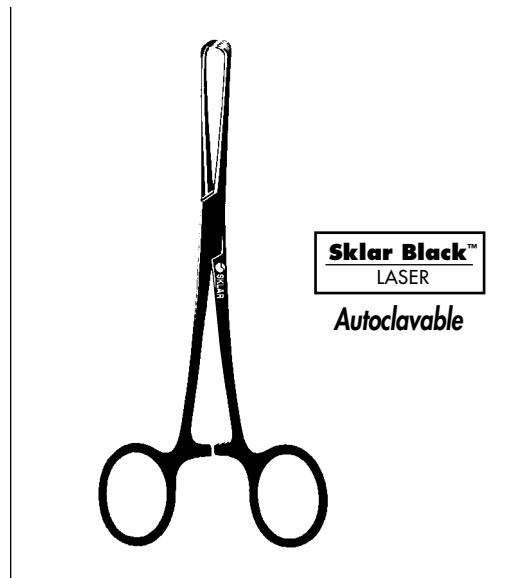


Sklar Black™
LASER

Autoclavable

LASER BABCOCK FORCEPS

90-2278 8"

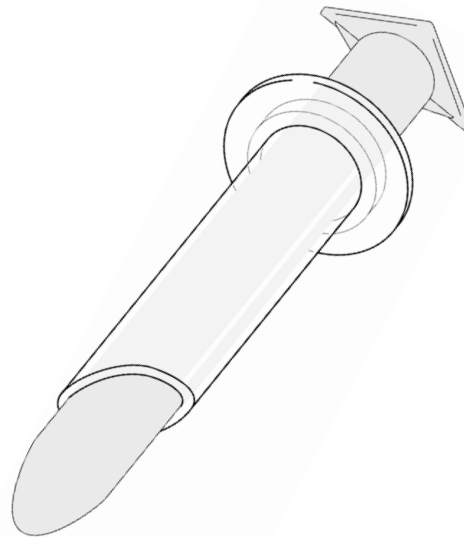
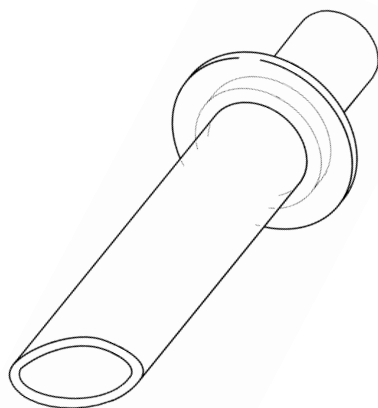
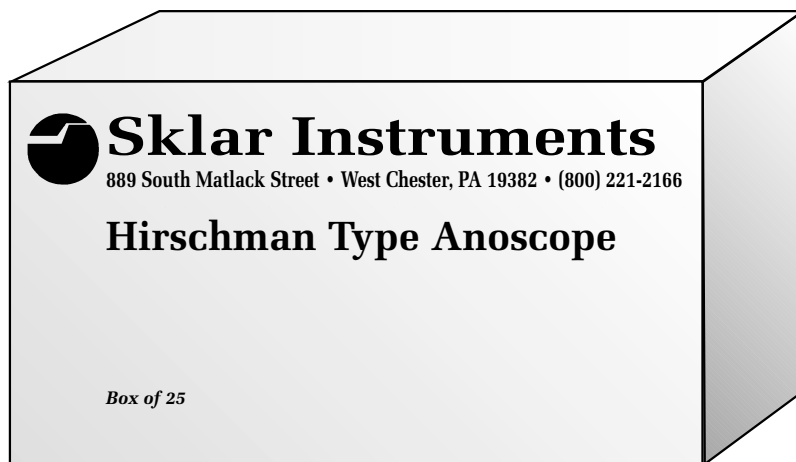


Sklar Black™
LASER

Autoclavable

LASER ALLIS FORCEPS

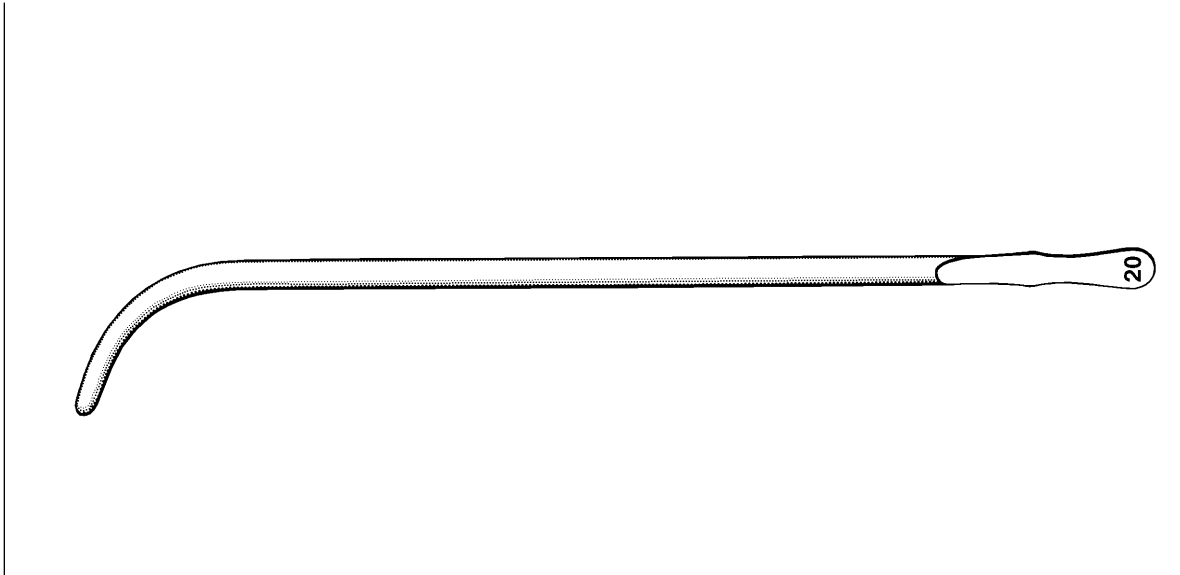
90-2276 7½"



HIRSCHMAN TYPE ANOSCOPE

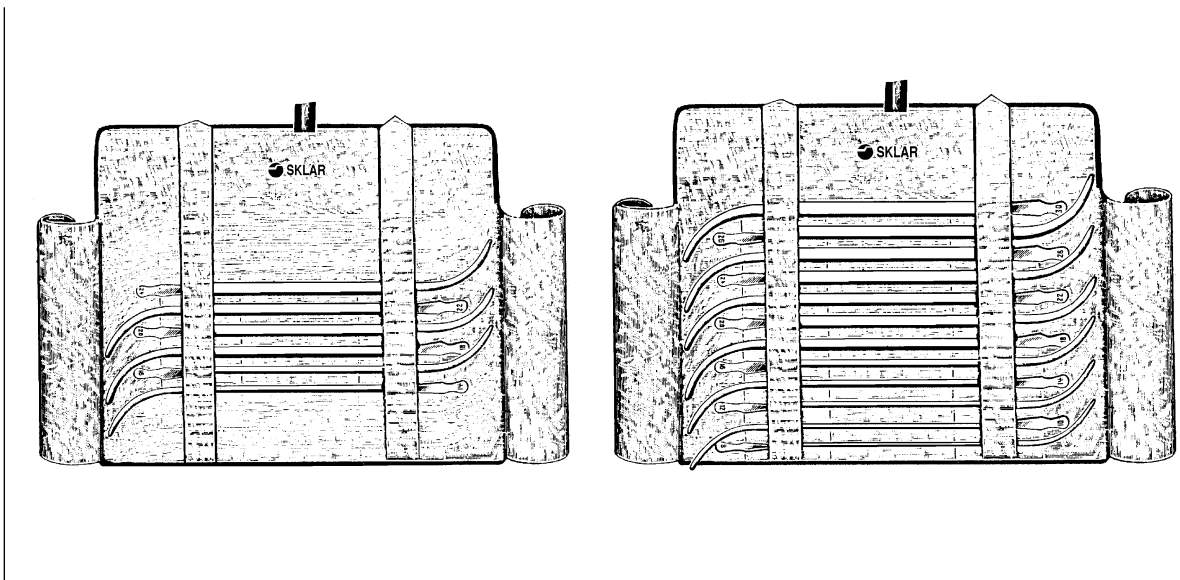
96-0910 Medium; Pack of 25
96-0911 Medium; Case of 100

The Sklar disposable proctoscope is convenient and easy to use. The transparent material offers a wider field of view during surgery or examination while eliminating the risk of cross infection.



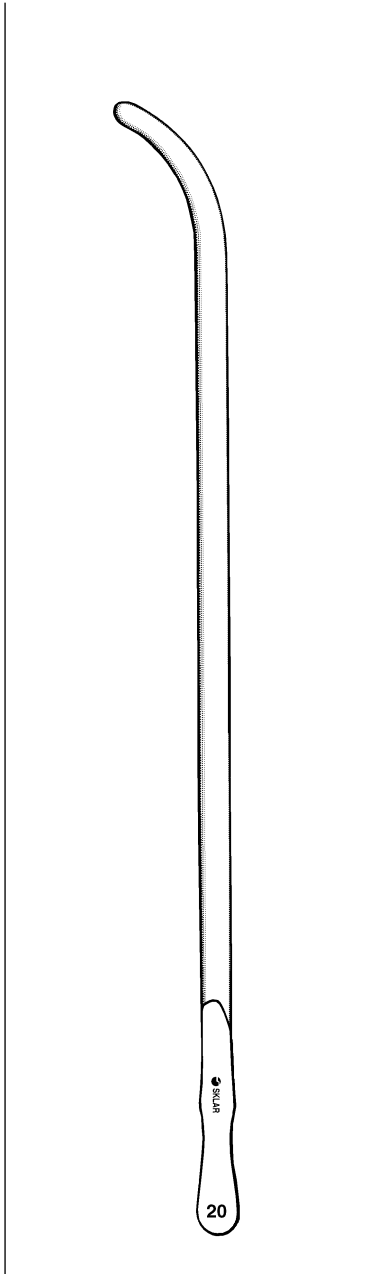
VAN BUREN URETHRAL SOUND

85-1008	8 Fr.	85-1018	18 Fr.	85-1028	28 Fr.	85-1038	38 Fr.
85-1010	10 Fr.	85-1020	20 Fr.	85-1030	30 Fr.	85-1040	40 Fr.
85-1012	12 Fr.	85-1022	22 Fr.	85-1032	32 Fr.		
85-1014	14 Fr.	85-1024	24 Fr.	85-1034	34 Fr.		
85-1016	16 Fr.	85-1026	26 Fr.	85-1036	36 Fr.		



VAN BUREN URETHRAL SOUND SETS

85-1065	Van Buren Sounds, Complete Set of 17
85-1070	Set of 6, Sizes 14-16-18-20-22-24 French Diameter
85-1075	Set of 12, Sizes 8-10-12-14-16-18-20-22-24-26-28-30 French Diameter

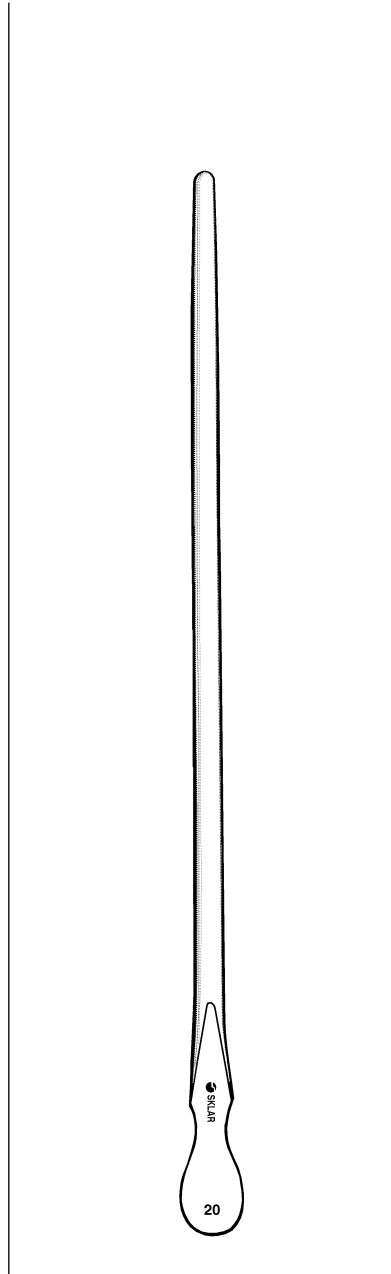


OTIS/DITTEL URETHRAL SOUND

Short Curve

85-1408	8 Fr.	85-1426	26 Fr.
85-1410	10 Fr.	85-1428	28 Fr.
85-1412	12 Fr.	85-1430	30 Fr.
85-1414	14 Fr.	85-1432	32 Fr.
85-1416	16 Fr.	85-1434	34 Fr.
85-1418	18 Fr.	85-1436	36 Fr.
85-1420	20 Fr.	85-1438	38 Fr.
85-1422	22 Fr.	85-1440	40 Fr.
85-1424	24 Fr.		

85-1442	Set of 8 16-30 French
85-1446	Set of all 17 sizes

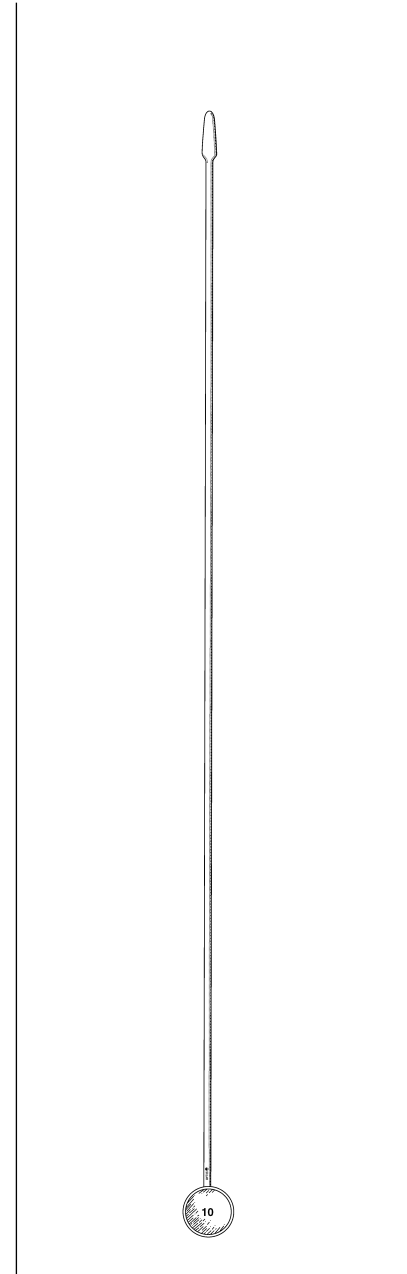


DITTEL URETHRAL SOUND

Straight—French Diameter

85-1308	8 Fr.	85-1326	26 Fr.
85-1310	10 Fr.	85-1328	28 Fr.
85-1312	12 Fr.	85-1330	30 Fr.
85-1314	14 Fr.	85-1332	32 Fr.
85-1316	16 Fr.	85-1334	34 Fr.
85-1318	18 Fr.	85-1336	36 Fr.
85-1320	20 Fr.	85-1338	38 Fr.
85-1322	22 Fr.	85-1340	40 Fr.
85-1324	24 Fr.		

85-1342	Set of 6 Sizes 8, 12, 16, 20, 24, 30
85-1345	Set of all 17 sizes

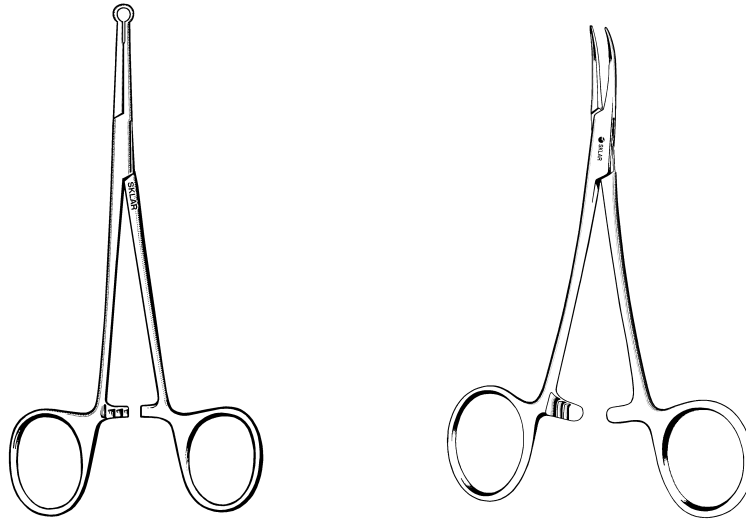


OTIS BOUGIE A BOULE

85-1608	8 Fr.	85-1622	22 Fr.
85-1610	10 Fr.	85-1624	24 Fr.
85-1612	12 Fr.	85-1626	26 Fr.
85-1614	14 Fr.	85-1628	28 Fr.
85-1616	16 Fr.	85-1630	30 Fr.
85-1618	18 Fr.	85-1632	32 Fr.
85-1620	20 Fr.		

85-1635	Set of 8 Sizes 16, 18, 20, 22, 24, 26, 28, 30
85-1636	Set of all 13 sizes

NEW!

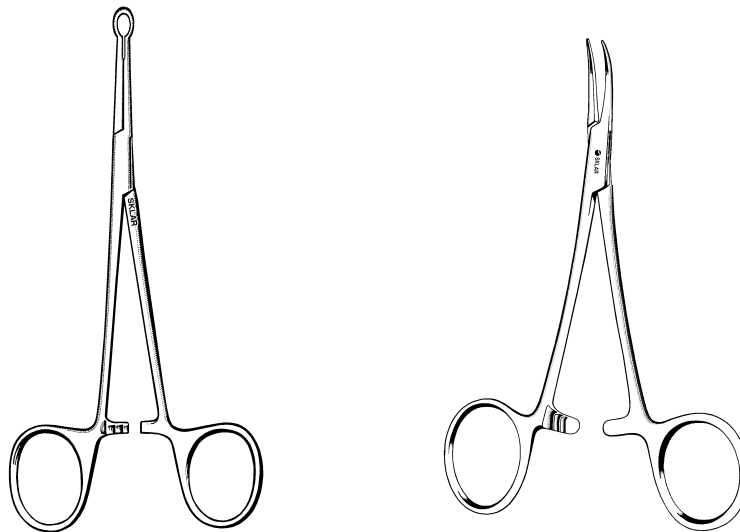


STANDARD SUTURELESS VASECTOMY SET, RING TIP

85-6220 Both Forceps 4 1/2"

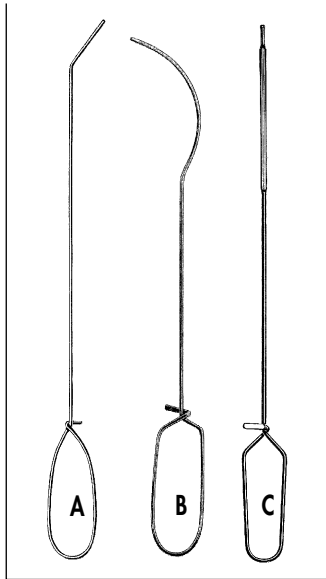
Each set consists of a sharply pointed forcep to puncture the scrotal skin and an elevation clamp to encircle and elevate the vas.

NEW!



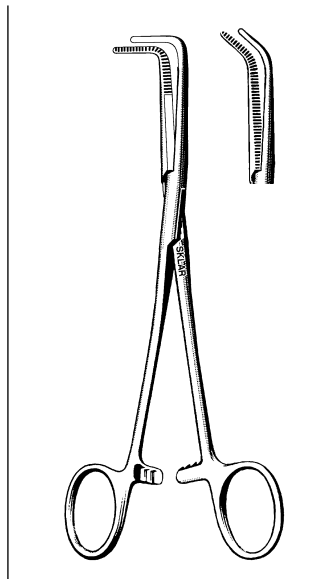
WILSON SUTURELESS VASECTOMY SET, OVAL TIP

85-6222 Both Forceps 4 1/2"



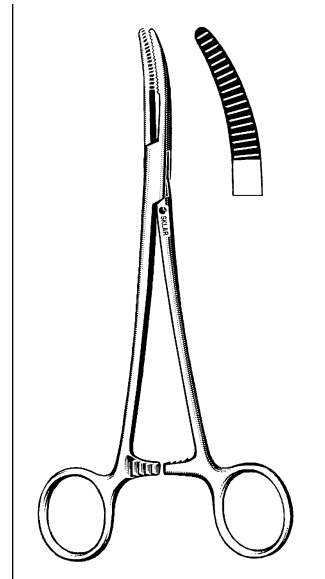
CATHETER GUIDES

- 85-2355 BENIQUE Catheter Guide
Flexible 8 Fr. 'A'
- 85-2360 GUYON Catheter Guide
Flexible 8 Fr. 'B'
- 85-2365 Catheter Guide, Straight
Flexible 8 Fr. 'C'



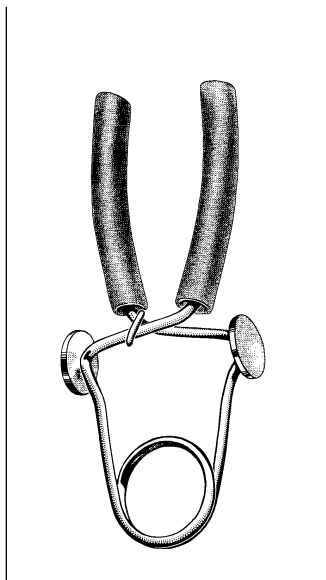
MIXER FORCEPS

- Right Angle
- 18-1250 5½"
- 17-1762 6¼"
- 17-1772 7½"
- 55-2892 9¼" Slightly Curved
- 55-2894 10¼" Longitudinal Serrations
- 55-3012 12" Longitudinal Serrations



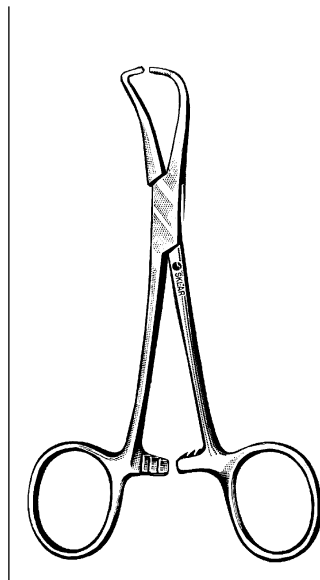
KELLY EXTRA HEAVY FORCEPS

- 74-3260 7" Straight
- 74-3270 7" Curved



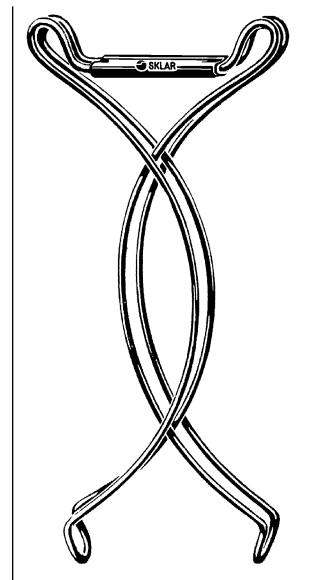
STRAUSS PENIS CLAMP

85-6460



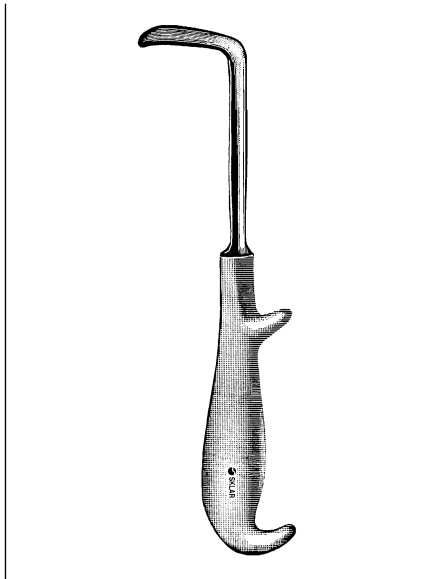
TEXTOR VASECTOMY CLAMP

85-6555 5½"



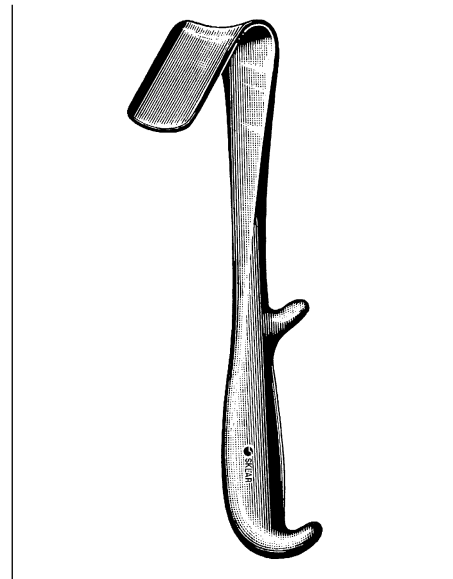
STOCKMAN (ZIPSER) PENIS CLAMP

85-6450



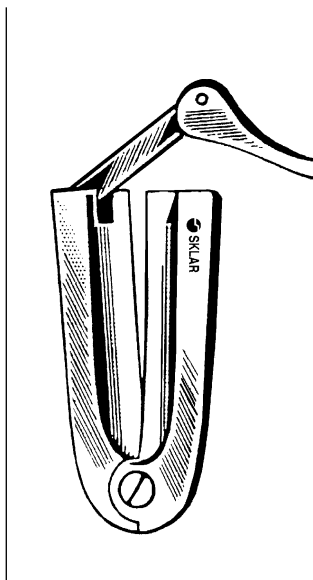
YOUNG PROSTATIC RETRACTOR

85-4697 8½" Lateral



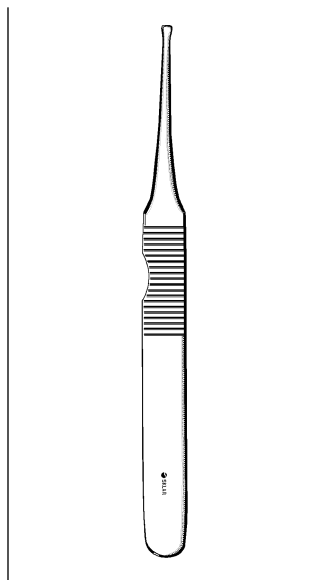
YOUNG PROSTATIC RETRACTOR

85-4780 8" Anterior



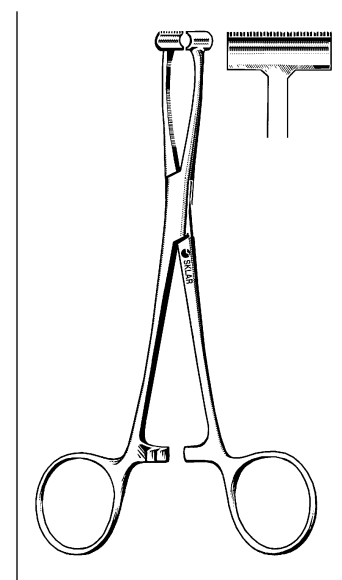
**MOGEN CIRCUMCISION
CLAMP**

85-6550 2.5 mm Aperture



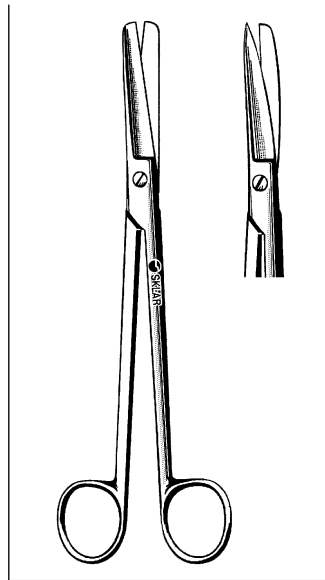
CIRCUMCISION PROBE

85-6551 5"



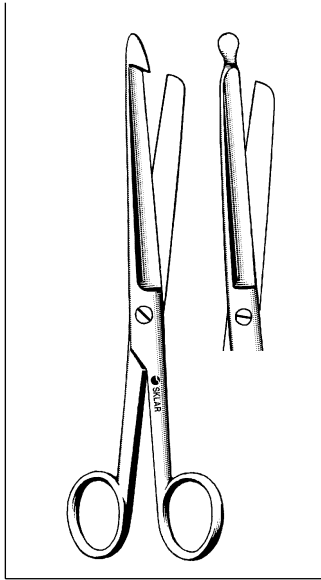
PRATT T-SHAPED FORCEPS

17-1055 6"



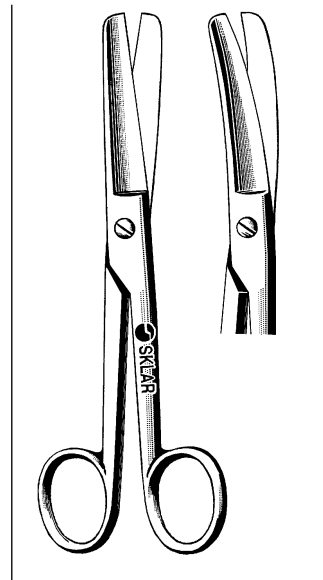
SIMS SCISSORS

Straight		Curved	
90-1280	8" S/S	90-1580	8" S/S
90-1180	8" S/B	90-1480	8" S/B
90-1080	8" B/B	90-1380	8" B/B



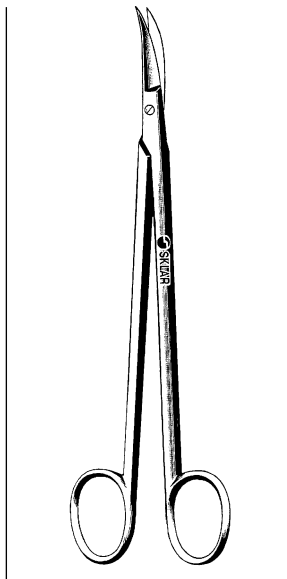
ENTEROTOME SCISSORS

15-1282	8 1/4"	Hook Point
15-1285	8 1/4"	Probe Point



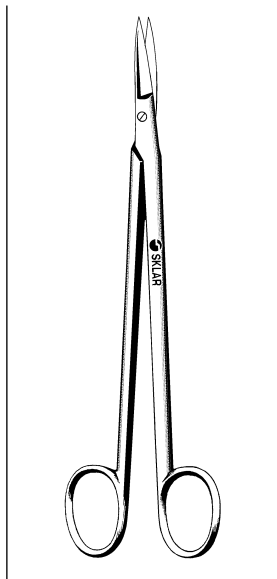
DOYEN SCISSORS

Straight	
15-1307	7"
15-1308	7" Serrated
Curved	
15-2307	7"
15-2308	7" Serrated



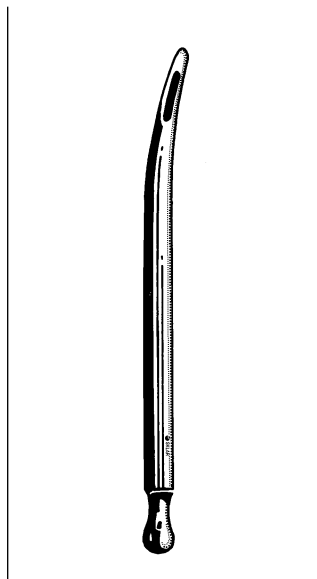
KELLY-ADSON SCISSORS

Curved	
50-4662	6 1/4" Smooth



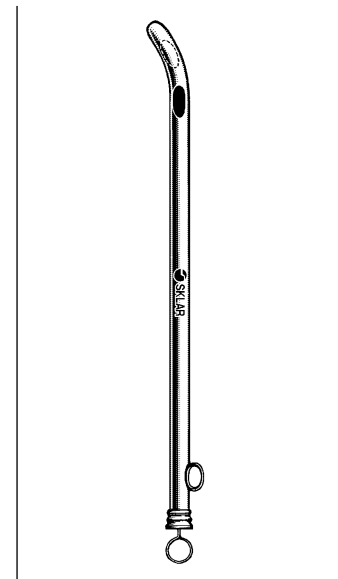
KELLY-ADSON SCISSORS

Straight	
50-4562	6 1/4" Smooth
50-4563	6 1/4" Serrated



WALTHER DILATOR-CATHETERS 5 1/4"

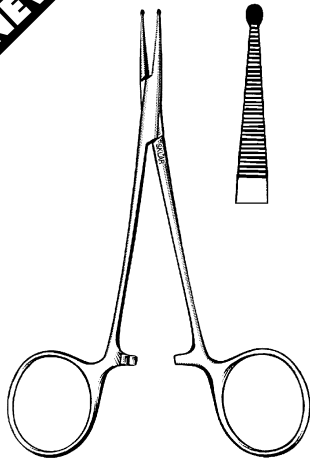
85-2010	Set of 14		
85-2012	12 Fr.	85-2026	26 Fr.
85-2014	14 Fr.	85-2028	28 Fr.
85-2016	16 Fr.	85-2030	30 Fr.
85-2018	18 Fr.	85-2032	32 Fr.
85-2020	20 Fr.	85-2034	34 Fr.
85-2022	22 Fr.	85-2036	36 Fr.
85-2024	24 Fr.	85-2038	38 Fr.



FEMALE CATHETERS

85-2210	10 Fr.
85-2212	12 Fr.
85-2214	14 Fr.
85-2216	16 Fr.
85-2218	18 Fr.
85-2220	20 Fr.

NEW!



A newly designed and patented hemostatic forcep permits a less traumatic separation of the foreskin from the glans while performing newborn circumcisions. With the unique "bead tip" mosquito forcep it is nearly impossible to inadvertently enter the urethra or cause trauma to the glans. In addition, visualizing the bead through the skin makes it less likely to separate too much foreskin.

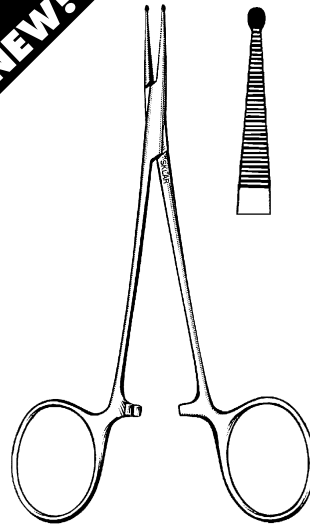
Patent # 5931843

MID-GRADE

DUNAWAY CIRCUMCISION FORCEPS

95-456 4" With Bead Tip

NEW!



A newly designed and patented hemostatic forcep permits easier dissection of lipomas, cysts and other soft tissue masses. Available are 2.0 mm wide bead tips on six inch curved and six inch straight forceps.

Patent # 5931843

MID-GRADE

DUNAWAY DISSECTING FORCEPS

95-466 6" With Bead Tip Straight
95-467 6" With Bead Tip Curved



UROLOGICAL DRAINAGE BAGS

Cs/10
96-1654 Sterile
96-1655 Non-Sterile



UROLOGICAL DRAINAGE BAGS

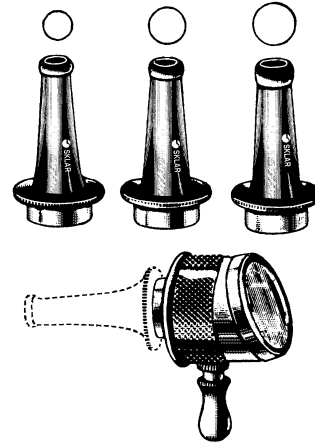
Cs/20
96-1656 Sterile
96-1657 Non-Sterile

ENT/PLASTIC SURGERY EAR SPECULUM



OTOSCOPE WITH THREE SPECULA

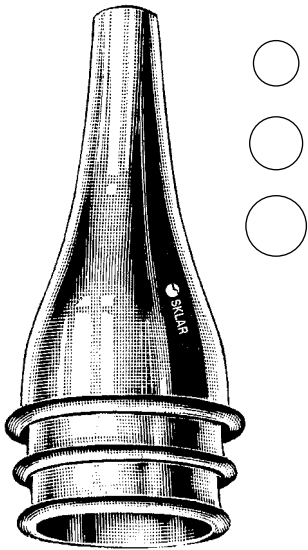
67-6250 The Sklar Otoscope employs a rheostat so that light intensity may be varied. Use alkaline battery size C.



BRUENING MAGNIFIER OTOSCOPE

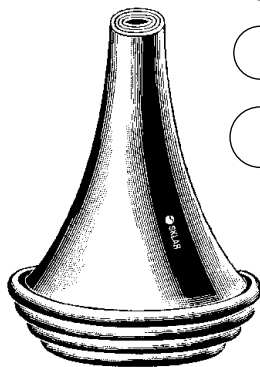
67-6200 Chrome with 3 specula
Small, Medium and Large
Complete with inflation bulb and tubing.

67-6202 Single speculum, small
67-6204 Single speculum, medium
67-6206 Single speculum, large



GRUBER EAR SPECULUM, INFANT & CHILD SIZES

67-6020 Chrome Set of 3
67-6025 Small
67-6026 Medium
67-6027 Large



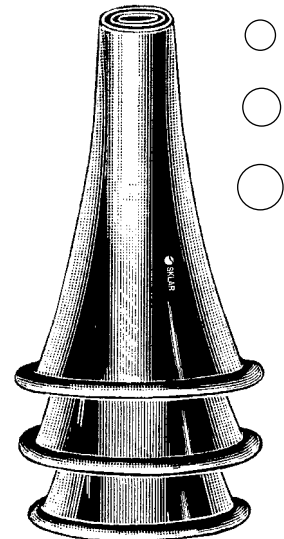
BOUCHERON EAR SPECULUM

Set of 4
67-6010 Chrome
67-6011 5mm
67-6012 6mm
67-6013 7mm
67-6014 8mm



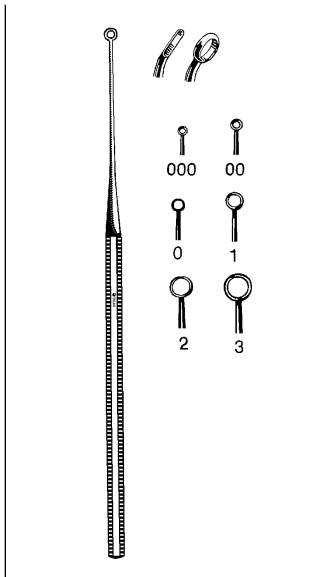
SHEA SPECULUM HOLDER

67-6050 30cm - Overall Length



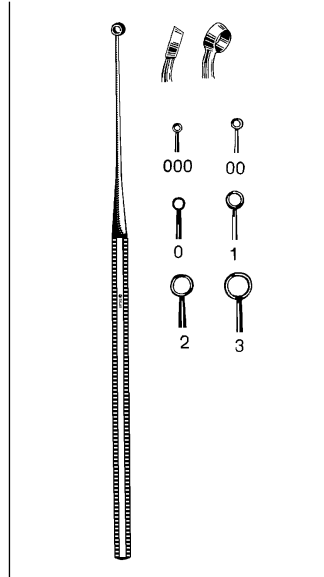
TOYNBEE EAR SPECULUM

67-6030 Set of 3 Chrome
67-6031 Small Chrome
67-6032 Medium Chrome
67-6033 Large Chrome



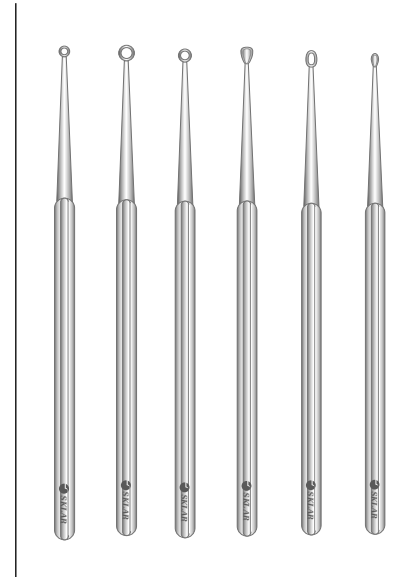
BUCK EAR CURETTE

Blunt		Angled	
Straight			
67-2488	#000	67-2508	#000
67-2489	#00	67-2509	#00
67-2490	#0	67-2510	#0
67-2491	#1	67-2511	#1
67-2492	#2	67-2512	#2
67-2493	#3	67-2513	#3



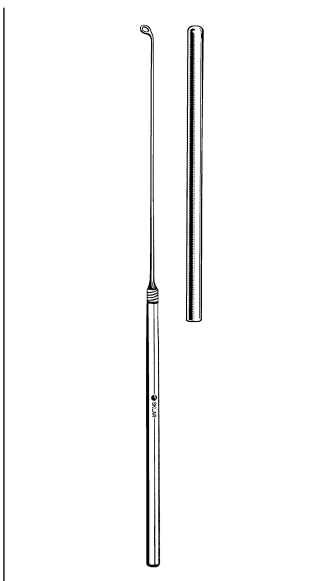
BUCK EAR CURETTE

Sharp		Angled	
Straight			
67-2519	#000	67-2498	#000
67-2514	#00	67-2499	#00
67-2515	#0	67-2500	#0
67-2516	#1	67-2501	#1
67-2517	#2	67-2502	#2
67-2518	#3	67-2503	#3



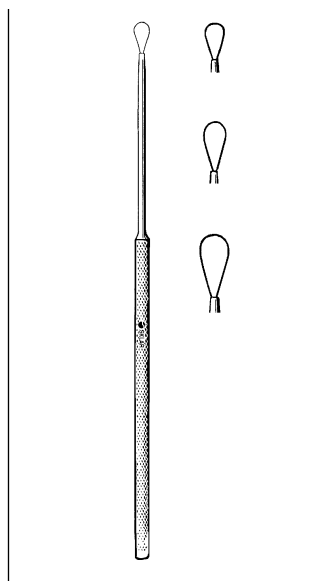
EAR CURETTES, DISPOSABLE

96-1001	Cup	Box/50
96-1006	Loop	Box/50
96-1031	Spoon	Box/50
96-1011	Child Ring - Medium	Box/50
96-1016	Adult Ring - Large	Box/50
96-1021	Pedi-Ring - Small	Box/50
Assorted		
96-1035	10 Each of 96-1001, 96-1006, 96-1011, 96-1016, 96-1021 Box/50	



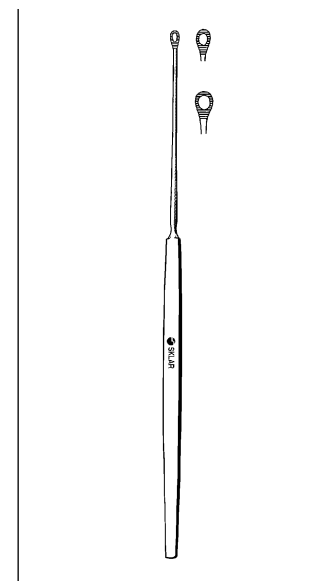
WEISMAN INFANT EAR CURETTE

67-2480	Blunt	Size 0	2 mm
67-2481	Blunt	Size 1	3 mm



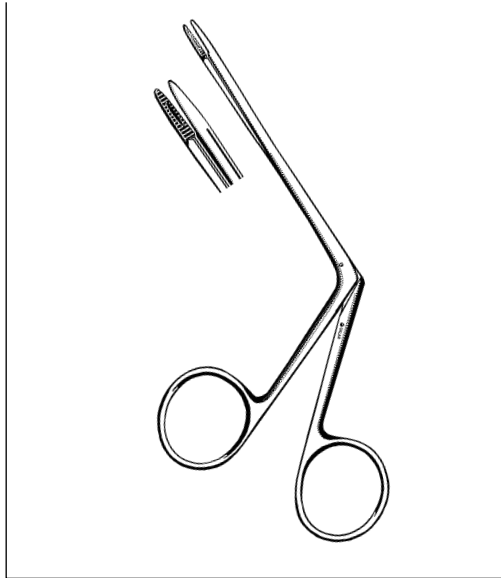
BILLEAU EAR LOOP

67-2521	Small
67-2522	Medium
67-2523	Large



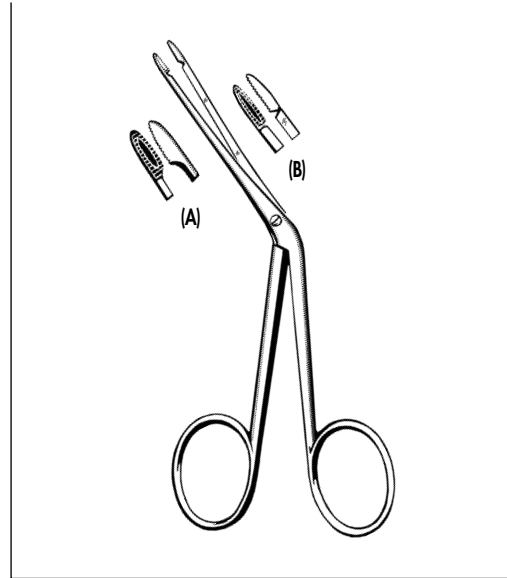
SHAPLEIGH EAR CURETTES

6 1/4" Serrated Loop	
67-2525	Small Size 1
67-2526	Large Size 2



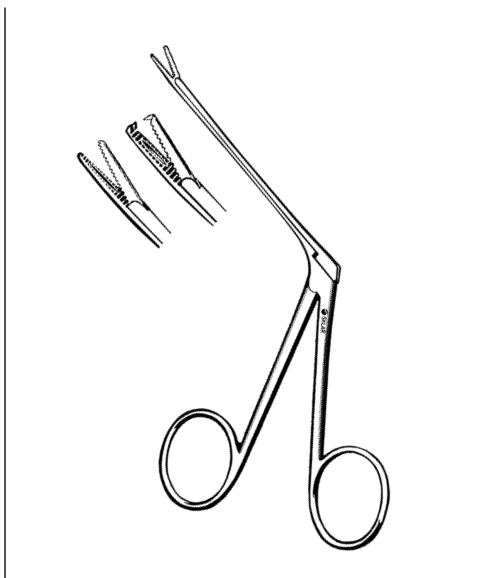
LITTAUER FORCEPS

67-1052 Serrated 3"



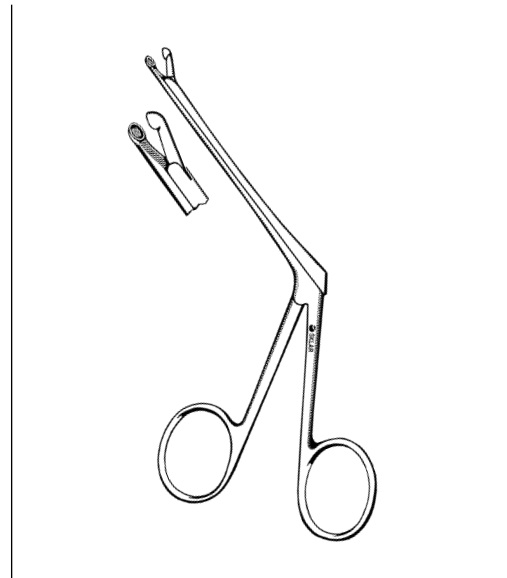
HARTMANN GRASPING FORCEPS

67-1045 Standard-Serrated (A)
67-1050 Fine-Serrated (B)



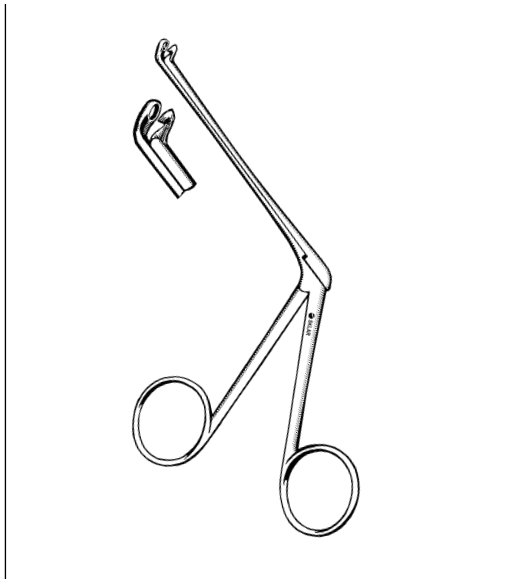
HARTMANN ALLIGATOR GRASPING FORCEPS

67-1035 3 1/2" Serrated
67-1036 3 1/2" Serrated Extra Delicate
67-1038 5 1/2" Serrated
67-1039 6 1/2" Serrated
67-1040 3 1/2" 1 x 2 Teeth



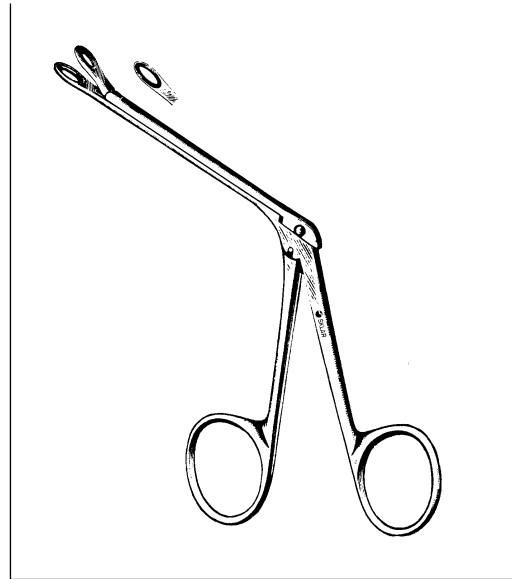
HARTMANN PUNCH FORCEPS

Spoon Shaped Jaws
67-1020 Standard
67-1021 (Wullstein) Delicate



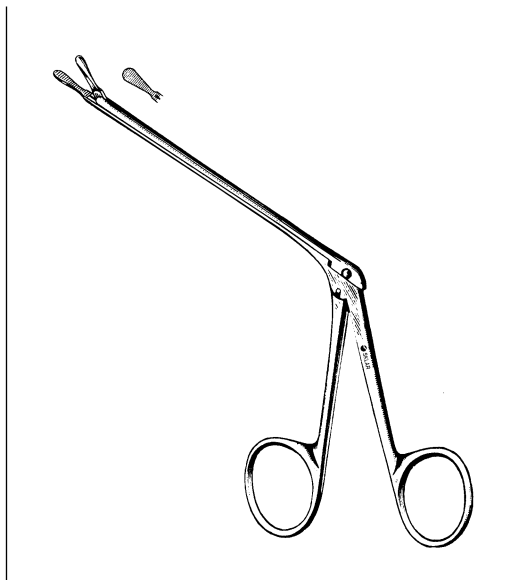
HARTMANN PUNCH FORCEPS

67-1030 Jaws curved up



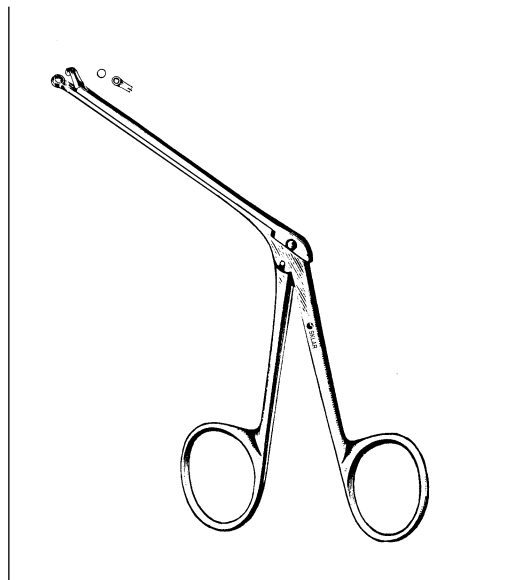
STRUEMPEL EAR FORCEPS

67-1032 Oval Spoon Jaws



DUCKBILL EAR FORCEPS

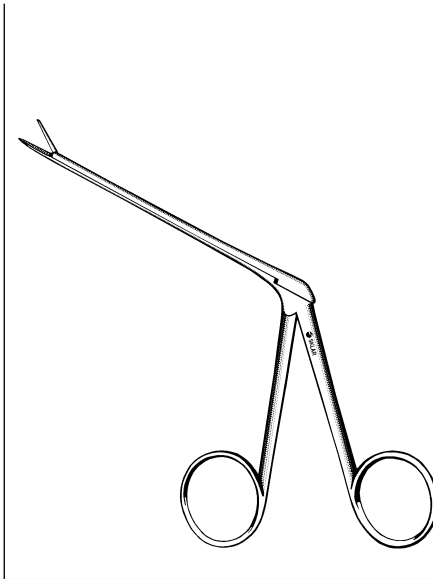
67-1033 Flat Serrated Jaws



HOFFMAN EAR FORCEPS

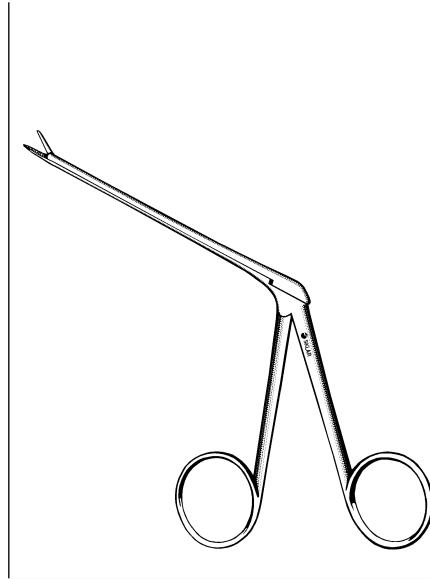
67-1034 Round Jaws

ENT/PLASTIC SURGERY EAR FORCEPS



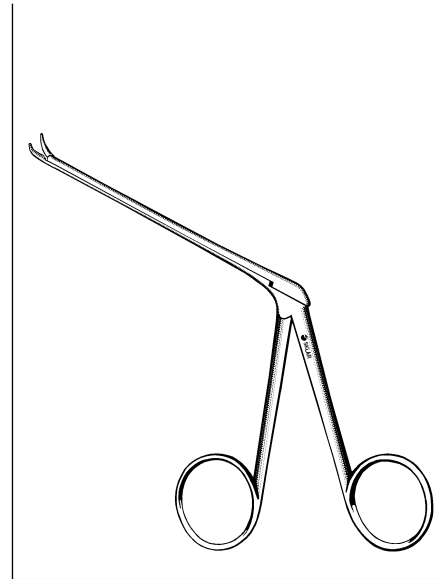
DELICATE ALLIGATOR EAR FORCEPS

67-8000 3/4" Straight jaw, 7mm
Serrated



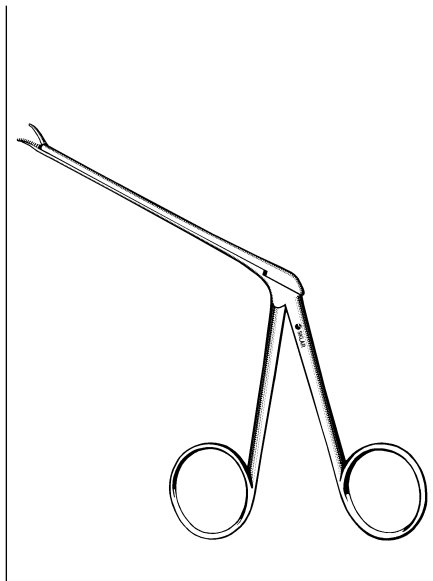
DELICATE ALLIGATOR EAR FORCEPS

67-8006 3/4" Straight jaw, 4mm
Serrated



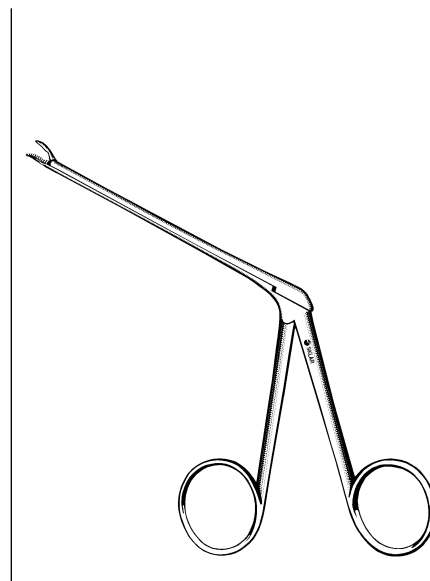
DELICATE ALLIGATOR EAR FORCEPS

67-8008 3/4" Jaw Curved Right
Serrated



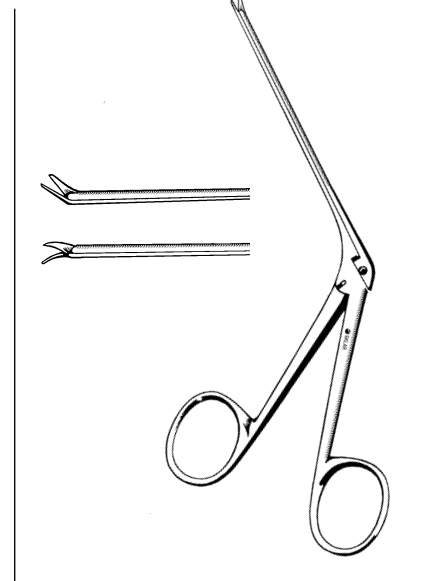
DELICATE ALLIGATOR EAR FORCEPS

67-8010 3/4" Jaw Curved Left
Serrated



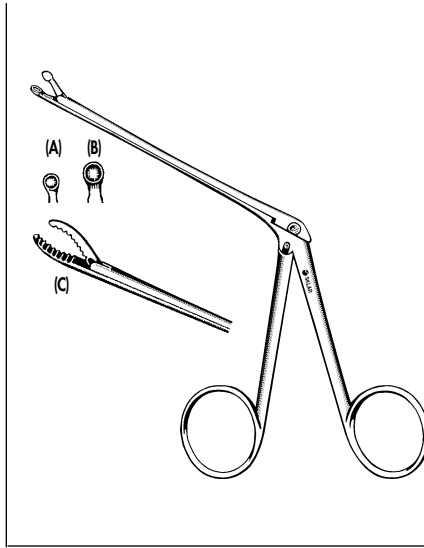
DELICATE ALLIGATOR EAR FORCEPS

67-8024 3/4" Top jaw curved down
Serrated



DELICATE ALLIGATOR EAR SCISSORS

67-8014 3/4" Straight
67-8016 3/4" Angled Up
67-8018 3/4" Left Curved



HARTMANN-HERZFELD FORCEPS

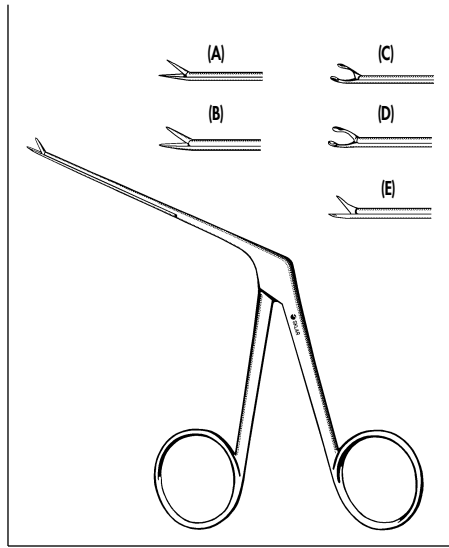
Alligator Type Cup-shape

- 67-8150 3" shaft 2 mm cup (A)
- 67-8152 3" shaft 3 mm cup (B)

WEINGARTNER EAR FORCEPS

Alligator Type Concave Serrated Jaws

- 67-8155 3" shaft (C)



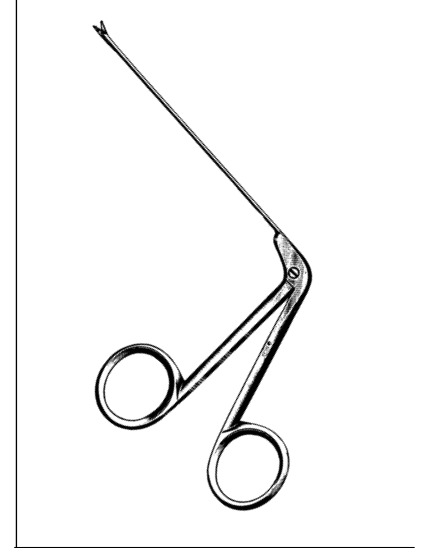
MICRO ALLIGATOR EAR FORCEPS

- 67-8170 3/4" Shaft Serrated 0.6 mm tip (A)
- 67-8172 3/4" Shaft Serrated 0.6 mm tip Ebony finish (A)
- 67-8174 3/4" Shaft Serrated 0.8 mm tip (B)
- 67-8176 3/4" Shaft Serrated 0.8 mm tip Ebony finish (B)
- 67-8177 3/4" Shaft Oval cup 0.5 mm tip Ebony finish (C)
- 67-8178 3/4" Shaft Oval cup 0.8 mm tip (D)
- 67-8180 3/4" Shaft Oval cup 0.8 mm tip Ebony finish (D)

BELLUCCI MICRO EAR SCISSORS

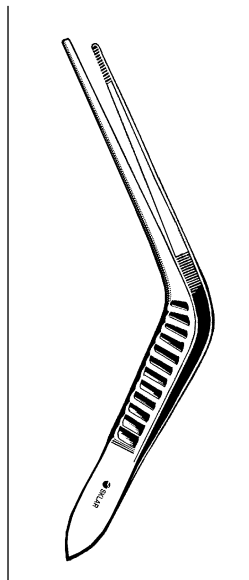
4 mm Blades, Ebony Finish

- 67-8188 2 3/4" Shaft (E)



WULLSTEIN EAR SCISSORS

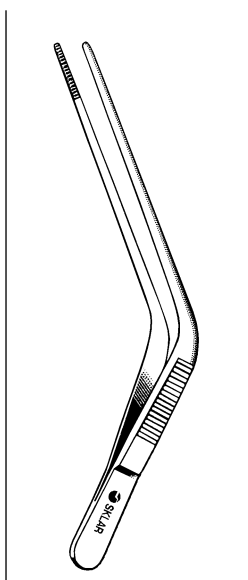
- 67-8140 3" Shaft Extra Delicate



WILDE EAR FORCEPS

Angled

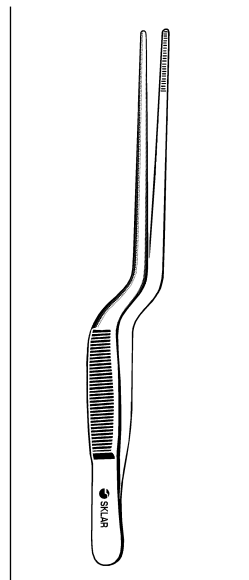
- 67-1150 5" Serrated
- 70-4470 7" Serrated



BLAKE EAR FORCEPS

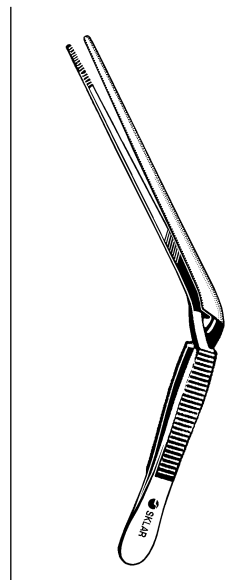
Delicate

- 67-1058 4 1/2" Angular Serrated



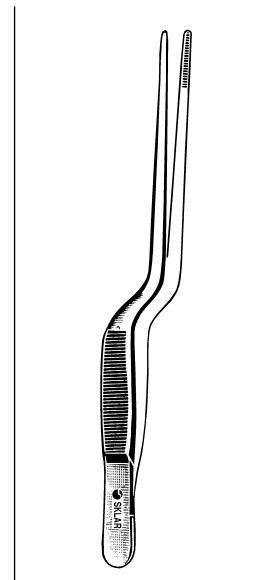
LUCAE BAYONET FORCEPS

- 67-1455 5 1/2"



WILDE EAR FORCEPS

- 67-1350 5" Cross action, serrated jaws

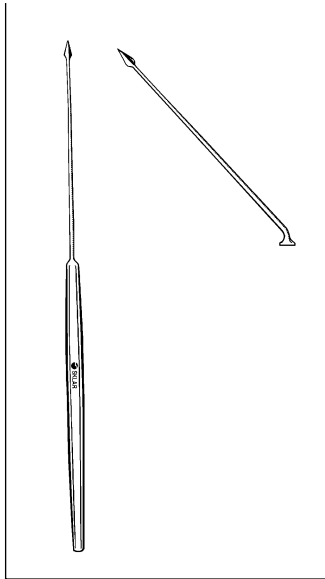


ADSON BAYONET FORCEPS

- 50-3371 7 1/2" Delicate

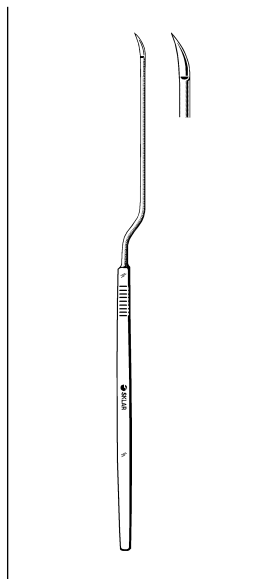
ENT/PLASTIC SURGERY

EAR KNIVES



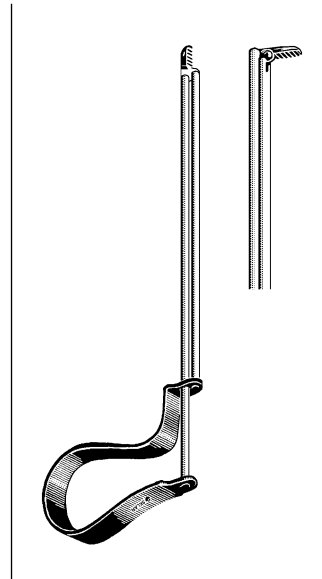
POLITZER TYMPANUM PERFORATOR

67-2005 Straight
67-2007 Angular



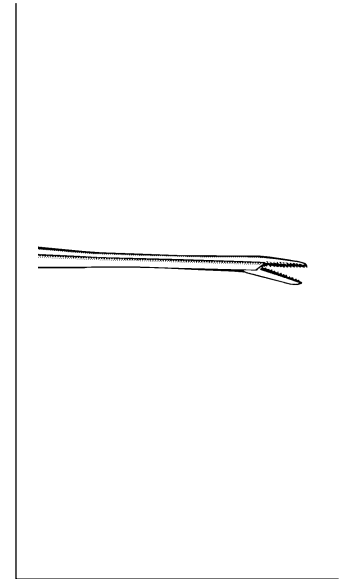
ROYCE TYMPANUM PERFORATOR

67-2145



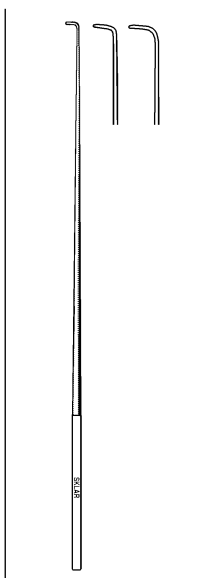
QUIRE FOREIGN BODY INSTRUMENT

Spring Handle
67-1732 4"



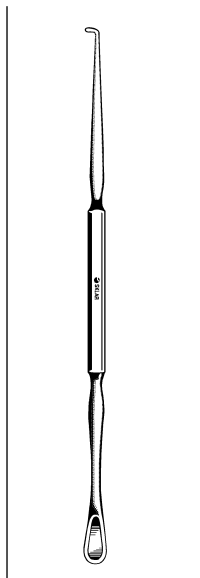
NOYES ALLIGATOR FORCEPS

67-1734 Spring Handle



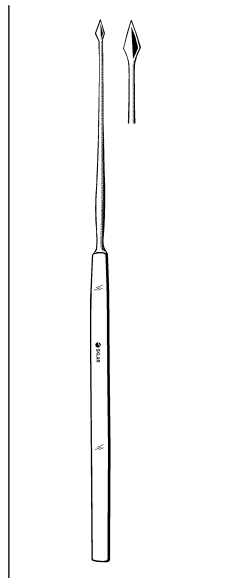
DAY EAR HOOK

67-2550 6 1/2" Small
67-2552 6 1/2" Large



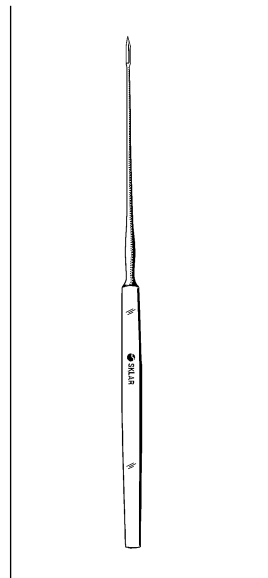
GROSS HOOK AND SPOON

Double Ended
67-2540



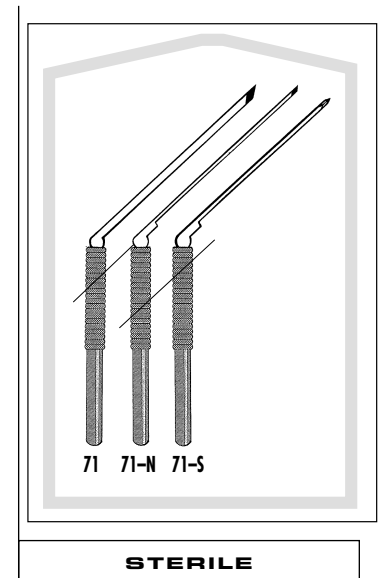
BUCK MYRINGOTOME

67-2115



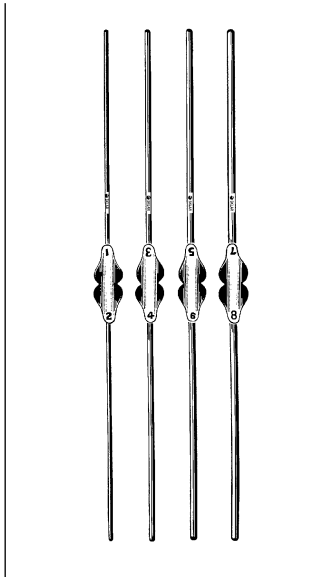
GERZOG (SEXTON) EAR KNIFE

67-2015 Straight



DISPOSABLE MINIATURE EAR KNIVES

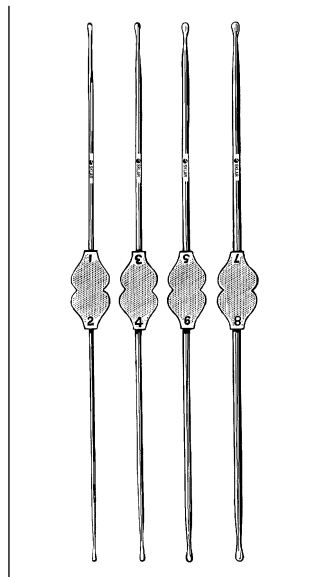
Sterile 12 Per Pack
67-2020 Ear Knife Angled Broad Tip 71
67-2022 Ear Knife Angled Narrow Tip 71-N
67-2024 Ear Knife Angled Spear Tip 71-S



BOWMAN LACHRYMAL DILATORS/PROBES

Double Ended

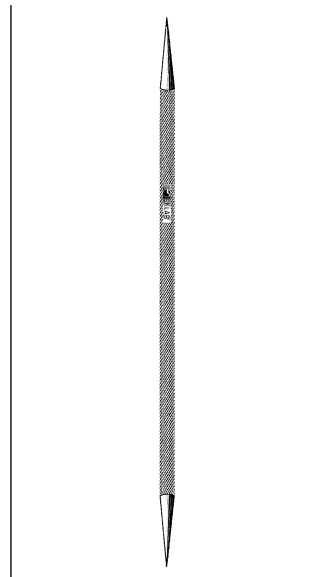
65-4100	Set of 4	#1 thru #8
65-4098	#0000/000	
65-4099	#00/0	
65-4101	#1-2	
65-4103	#3-4	
65-4105	#5-6	
65-4107	#7-8	



WILLIAMS LACHRYMAL DILATORS/PROBES

Double Ended Sterling Silver

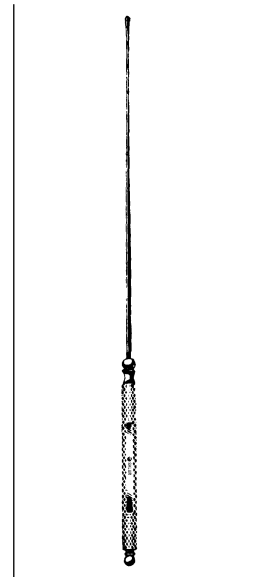
65-4120	Set of 4	#1 thru #8
65-4121	#1-2	
65-4123	#3-4	
65-4125	#5-6	
65-4127	#7-8	



CASTROVIEJO LACHRYMAL DILATOR

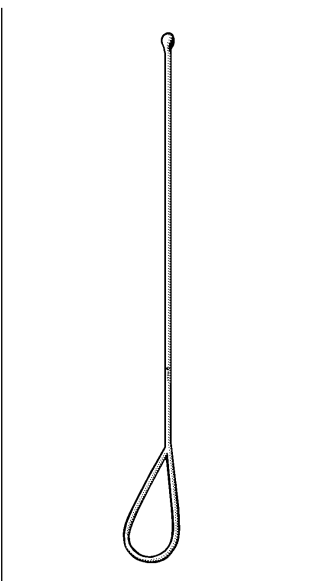
Double Ended Tapers
22 mm x 18 mm 5/8"

65-6960



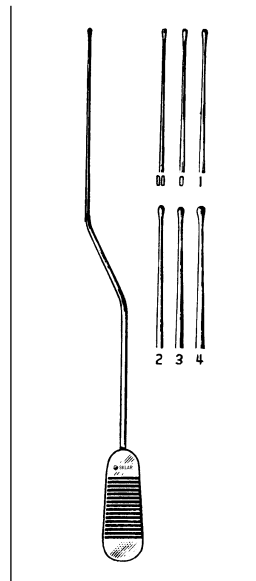
BUCK (SPENCER) EAR PROBE

30-1030 5/8"



STACKE EAR PROBE

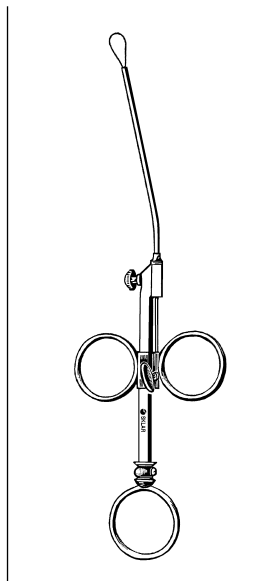
30-1040 4"



FRENCH PATTERN LACRIMAL PROBES

5" Bayonet Shape

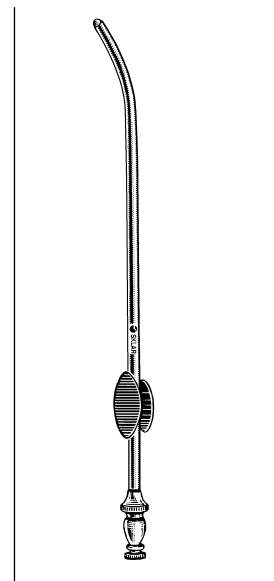
65-4130	Size 00
65-4131	Size 0
65-4132	Size 1
65-4133	Size 2
65-4134	Size 3
65-4135	Size 4



KRAUSE EAR SNARE

With 1 Dozen Snare Wires

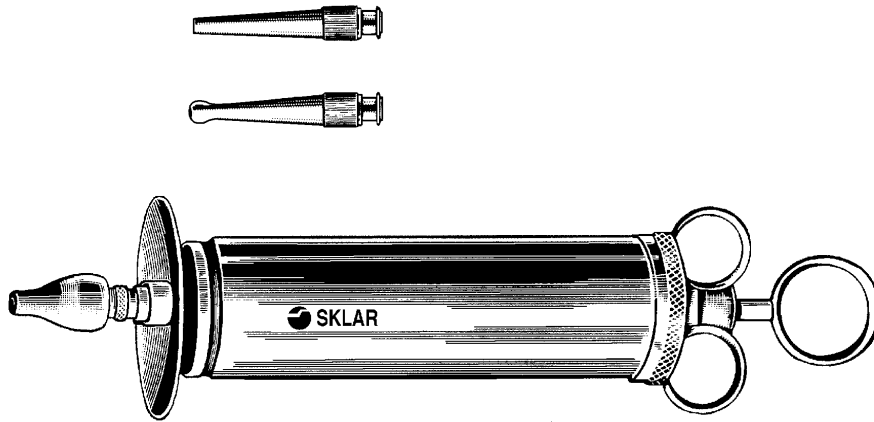
67-1750	Complete
67-1753	Cut and Bent Snare Wires #4 for 67-1750 1 Dozen
67-1752	Cut and Bent Snare Wires #4 for 67-1750 1 Gross



ADSON SUCTION TUBE

50-1982 6" 12 French

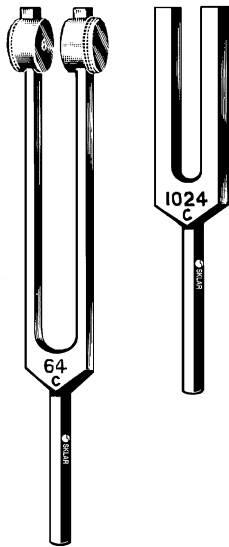
ENT/PLASTIC SURGERY EAR SYRINGE/TUNING FORKS



POMEROY EAR SYRINGE

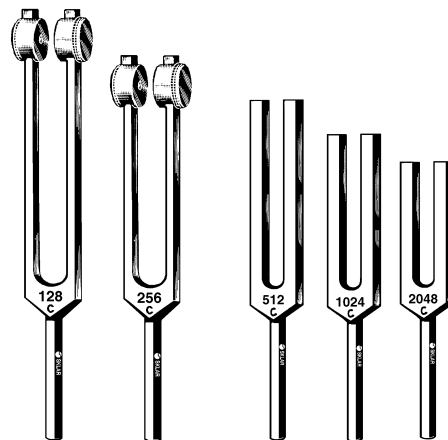
Chrome Plated

- 67-3402 Complete 2 oz. with Luer Lock
- 67-3404 Complete 4 oz. with Luer Lock
- 67-3424 Shield only for Ear Syringe
- 67-3411 Conical tip only for Ear Syringe
- 67-3412 Bulbous tip only for Ear Syringe



ALUMINUM ALLOY TUNING FORK

- 67-7064 C-64
- 67-7128 C-128
- 67-7256 C-256
- 67-7512 C-512
- 67-7524 C-1024
- 67-7548 C-2048

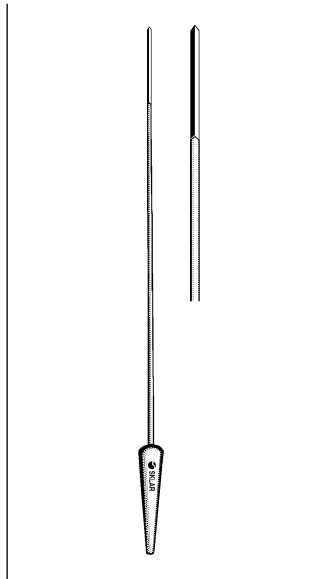


TUNING FORK SET

Aluminum Alloy

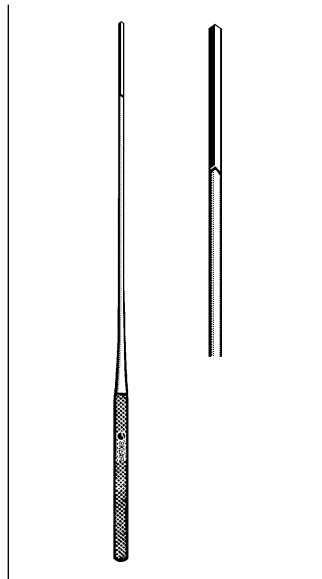
Set of 5

- 67-7605 Including C-128 C-1024
- C-256 C-2048
- C-512



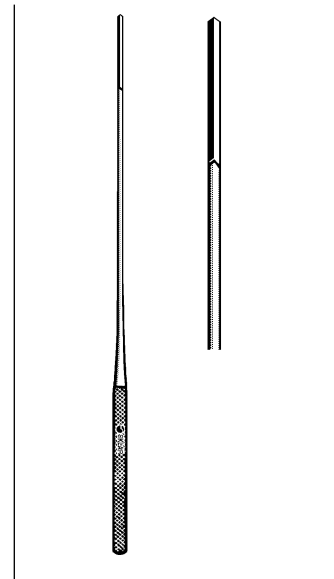
BROWN APPLICATOR

68-1257 5 3/4" Triangle
68-1357 5 3/4" Triangle Copper



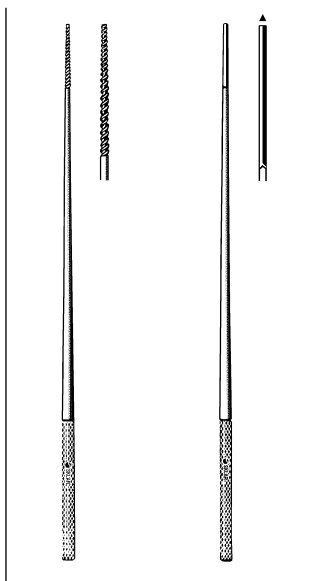
KYLE APPLICATOR

68-1557 5 1/2" Triangle



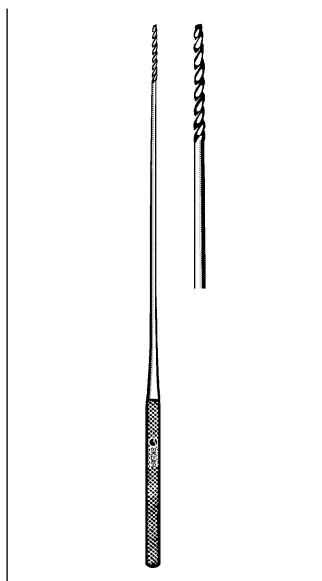
SAWTELL APPLICATOR

68-1665 6 1/2" Triangle



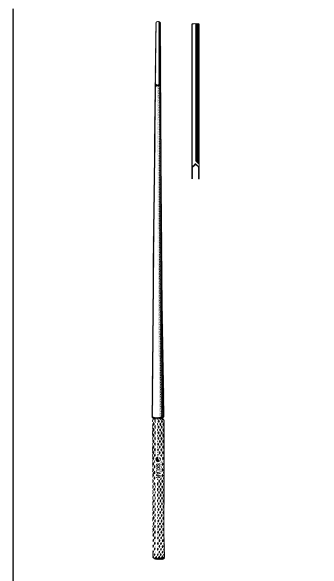
FARRELL APPLICATOR

68-1765 6 1/2" Twist End
68-1865 6 1/2" Triangle End
68-1890 9" Triangle End



BUCK APPLICATOR

68-2175 7 1/2" Twisted



BUCK APPLICATOR

68-1050 5" Triangle

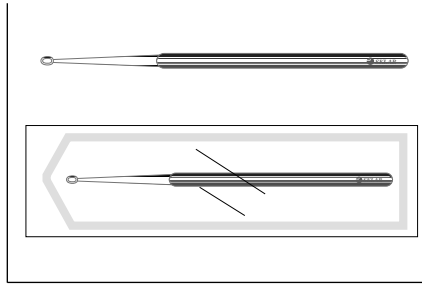
ENT/PLASTIC SURGERY EAR CURETTES, DISPOSABLE



SKLAR EAR CURETTE

Cup, Disposable (Non-Sterile)
96-1001 Box/50

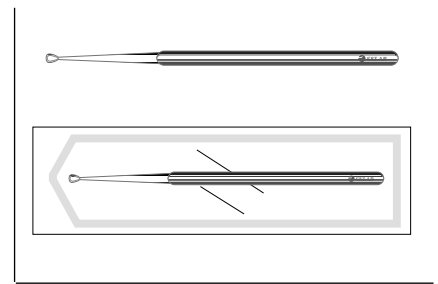
Cup, Disposable (Sterile)
96-1002 Box/50



SKLAR EAR CURETTE

Loop, Disposable (Non-Sterile)
96-1006 Box/50

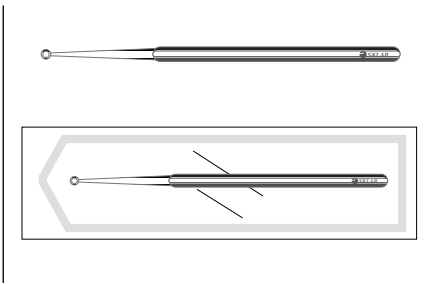
Loop, Disposable (Sterile)
96-1007 Box/50



SKLAR EAR CURETTE

Spoon, Disposable (Non-Sterile)
96-1031 Box/50

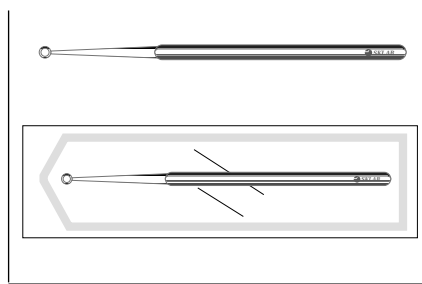
Spoon, Disposable (Sterile)
96-1032 Box/50



SKLAR EAR CURETTE

Child Ring - Medium, Disposable (Non-Sterile)
96-1011 Box/50

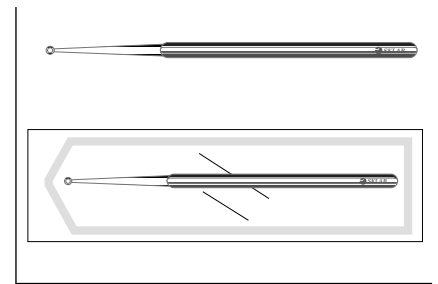
Child Ring - Medium, Disposable (Sterile)
96-1012 Box/50



SKLAR EAR CURETTE

Adult Ring - Large, Disposable (Non-Sterile)
96-1016 Box/50

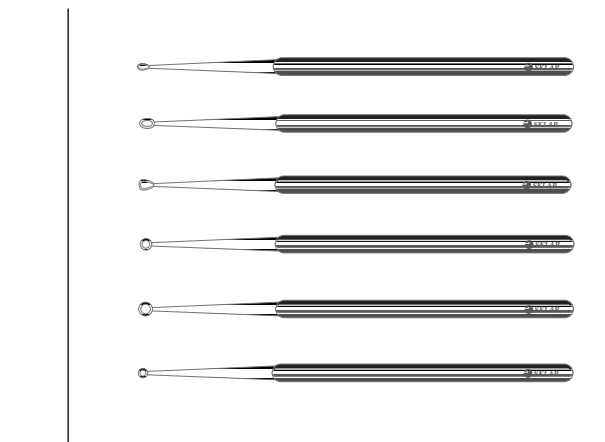
Adult Ring - Large, Disposable (Sterile)
96-1017 Box/50



SKLAR EAR CURETTE

Pedi-Ring - Small, Disposable (Non-Sterile)
96-1021 Box/50

Pedi-Ring - Small, Disposable (Sterile)
96-1022 Box/50



ASSORTED EAR CURETTES

Disposable (Non-Sterile)
96-1035 Box/50, 10 Each of 96-1001, 96-1006, 96-1011, 96-1016, 96-1021

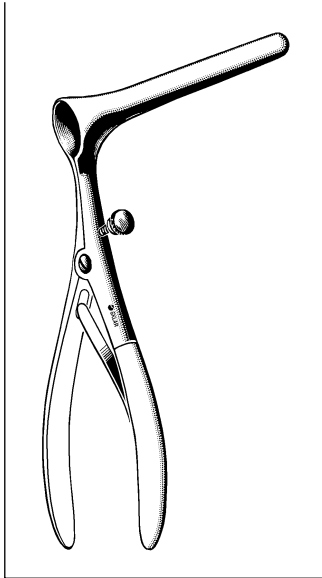
Disposable (Sterile)
96-1036 Box/50, 10 Each of 96-1002, 96-1007, 96-1012, 96-1017, 96-1022



EAR TRAY 96-1728 Case of 10

Contents:
Bulb Syringe
Ear Curette, Ring
2 Gauze Sponges
Sterilization Pouch

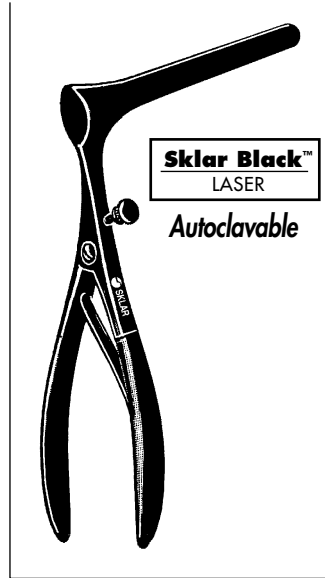
Calgiswab
Ear Forcep
Deep Prep Tray
CSR Wrap



COTTLE NASAL SPECULUM

With Set Screw

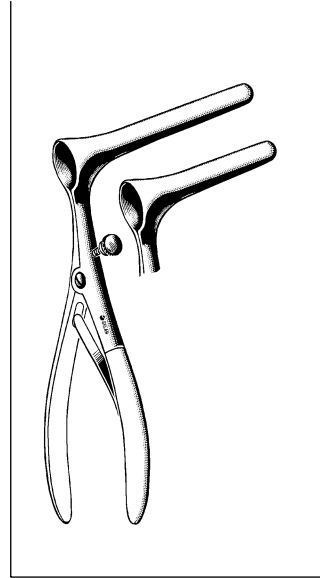
41-1190	6" Long	1½" Blade
41-1192	6" Long	2" Blade
41-1194	6" Long	3" Blade
41-1196	6" Long	3½" Blade



LASER COTTLE SPECULUM

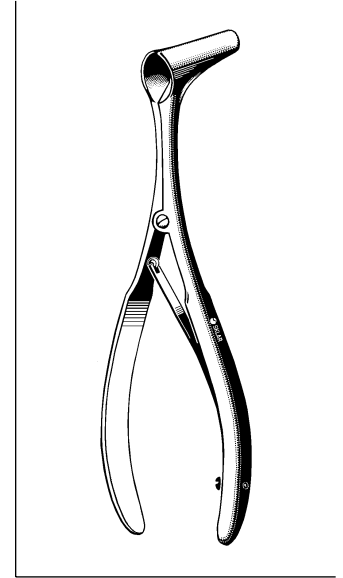
With Set Screw

41-1198	6" x 2"
41-1200	6" x 3"



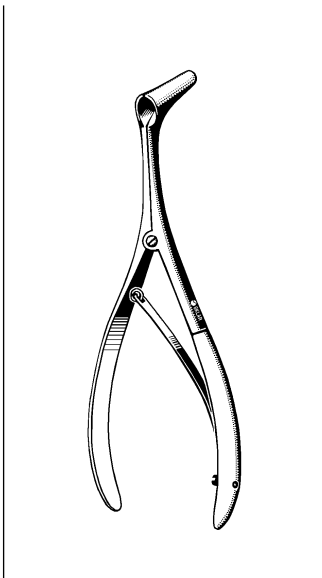
KILLIAN NASAL SPECULUM

70-1020	Small	2"
70-1030	Medium	3"
70-1035	Large	3½"
70-1038	Extra Large	4"



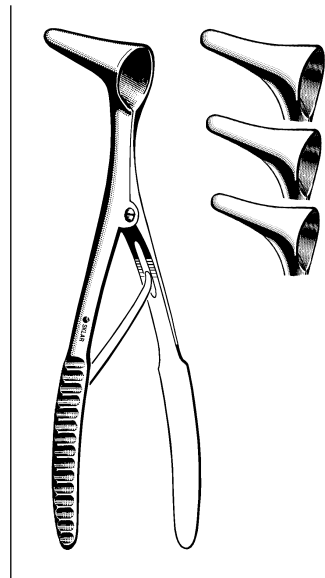
HALLE NASAL SPECULUM

70-1041 Adult



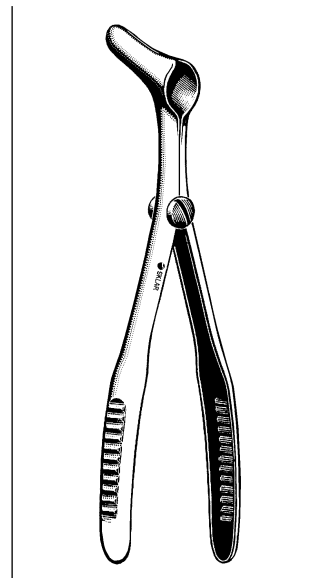
TIECK-HALLE NASAL SPECULUM

70-1040 Infant



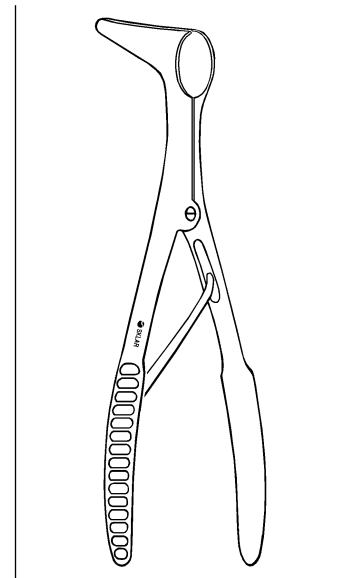
VIENNA NASAL SPECULUM

70-1070	Infant
70-1071	Child
70-1072	Adult



VIENNA NASAL SPECULUM

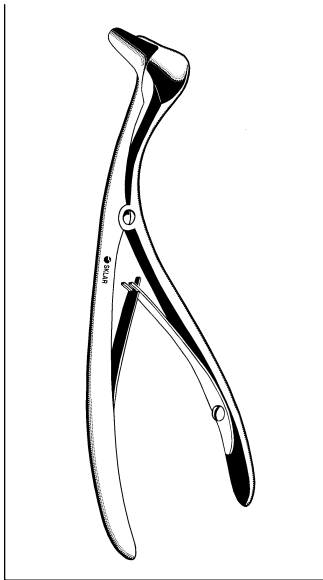
Wrought Metal—Lightweight
70-1075 Adult



NASAL SPECULUM, DISPOSABLE

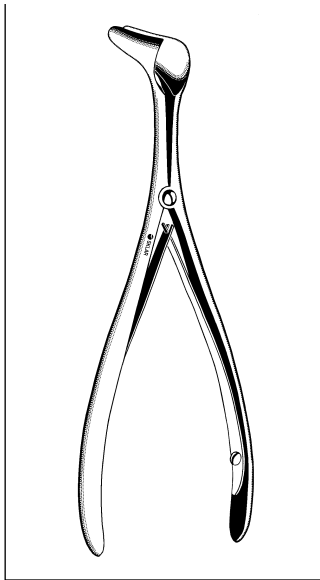
Pack/48, Plastic
96-0670 6¼"

ENT/PLASTIC SURGERY NASAL SPECULUM/FORCEPS



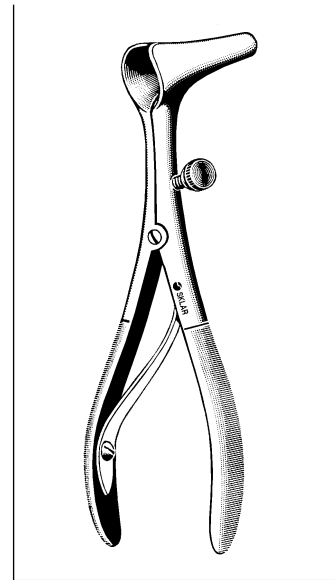
BECKMAN NASAL SPECULUM

70-1092 5 1/2"



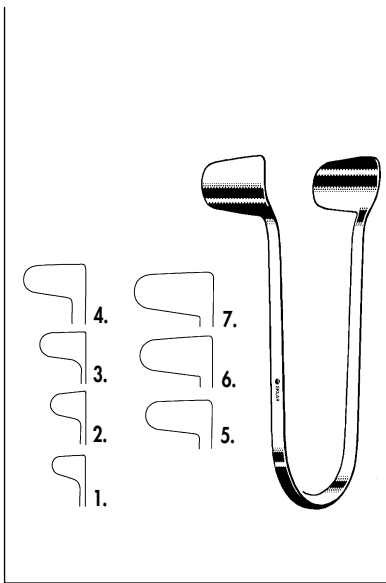
SONNENSCHN NASAL SPECULUM

70-1096 6"



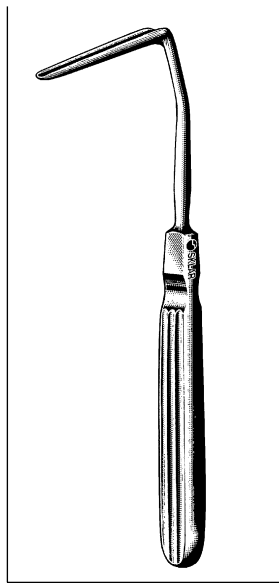
GERZOG NASAL SPECULUM

With Set Screw
70-1060 Adult



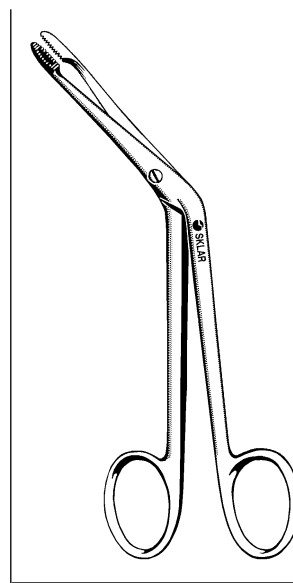
THUDICHUM NASAL SPECULUM

70-1081 Fig. 1 70-1085 Fig. 5
70-1082 Fig. 2 70-1086 Fig. 6
70-1083 Fig. 3 70-1087 Fig. 7
70-1084 Fig. 4



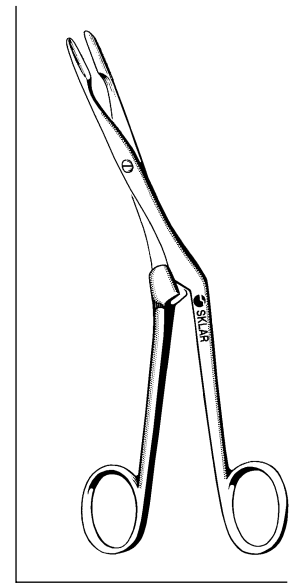
AUFRICT RETRACTOR

Solid Blade
41-1410 7" x 1 1/4"



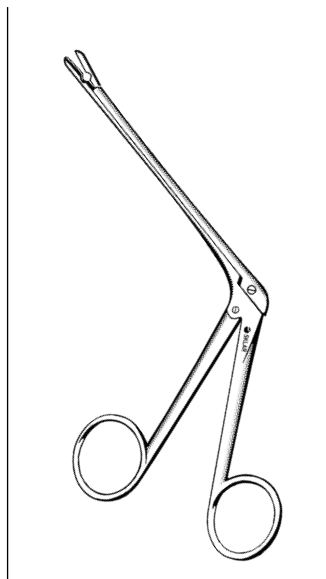
HARTMANN NASAL FORCEPS

70-4160 6" Serrated Jaw



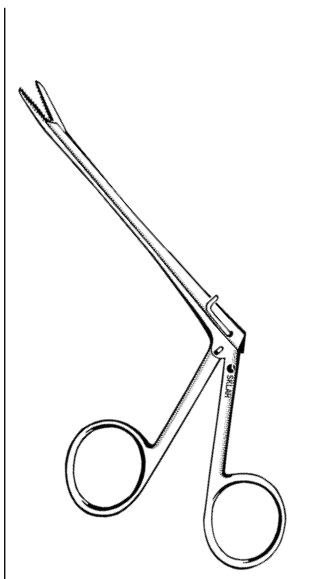
KNIGHT SEPTUM FORCEPS

Cupped Jaws, Cutting
70-5170 7"



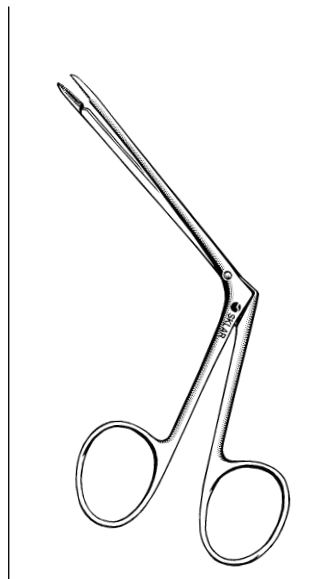
TAKAHASHI FORCEPS

70-5090 Slender Cup Jaws



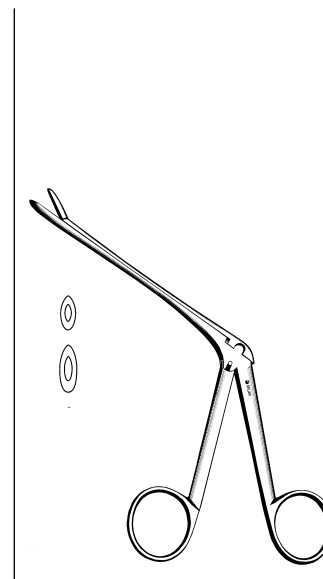
NOYES ALLIGATOR FORCEPS

70-5332 3 1/2" Serrated
70-5335 5 1/2" Serrated
70-5336 6 1/2" Serrated
70-5232 3 1/4" 1 x 2 Teeth
70-5235 5 1/2" 1 x 2 Teeth



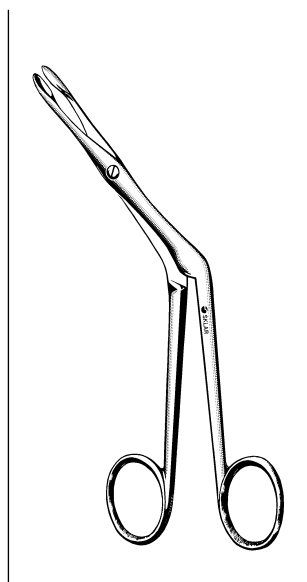
LITTAUER NASAL FORCEPS

70-4170 5" Shaft
67-1052 3" Shaft (Light Pattern)



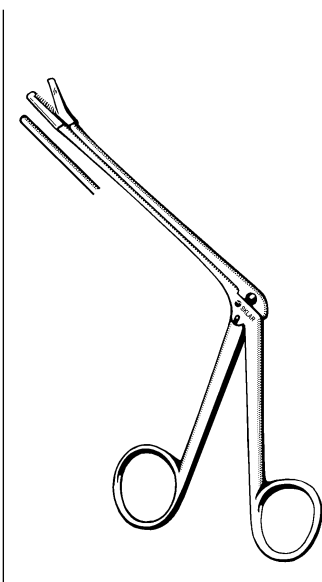
BLAKESLEY NASAL FORCEPS (WILDE)

70-5410 7 1/2" Small
70-5411 7 1/2" Standard



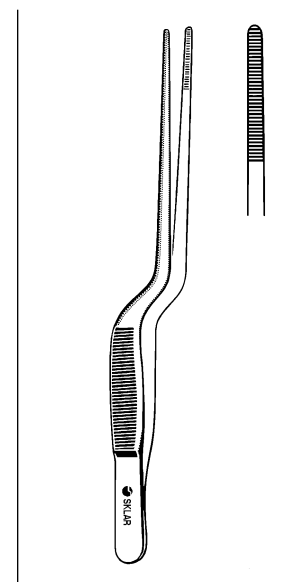
HEYMANN SEPTUM FORCEPS

70-4270 7"



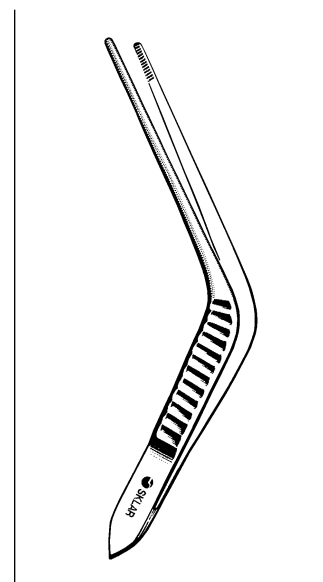
STRUYCKEN CUTTING FORCEPS

70-5176 5" shaft



JANSEN BAYONET NASAL FORCEPS

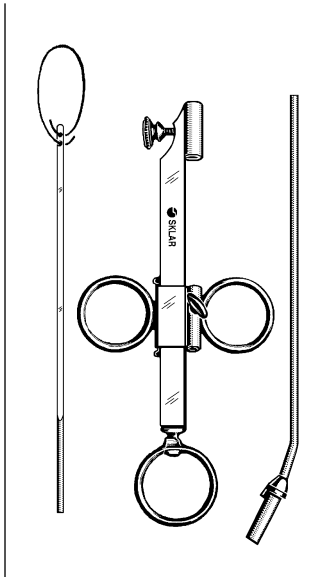
67-1465 6 1/2"
70-4375 7 1/2"
70-4385 8 1/2"



WILDE DRESSING FORCEPS

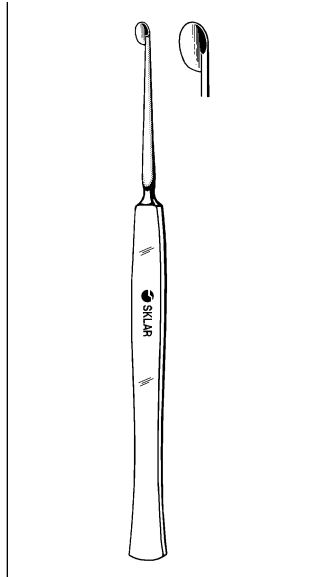
70-4470 7" Serrated
70-4472 7" 1 x 2 Teeth
67-1150 5" Serrated

ENT/PLASTIC SURGERY ELEVATORS/SNARE



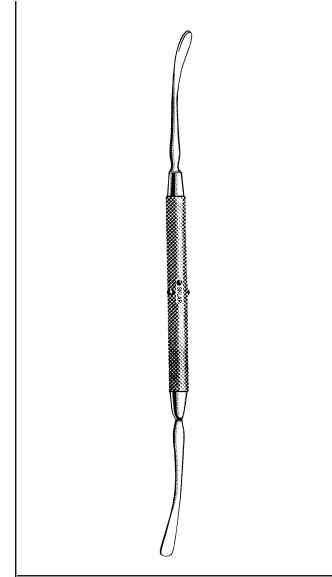
KRAUSE NASAL SNARE

70-6165 Complete with one dozen snare wires
 70-6166 Stylet only for 70-6165
 70-6168 Cut and Bent Snare Wires only #6 for 70-6165, One Gross



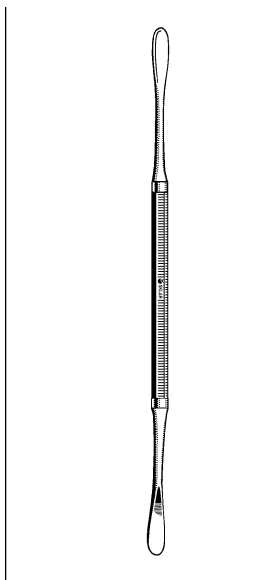
FREER SEPTUM KNIFE

Half Round Blade
 70-7062 6 1/4"



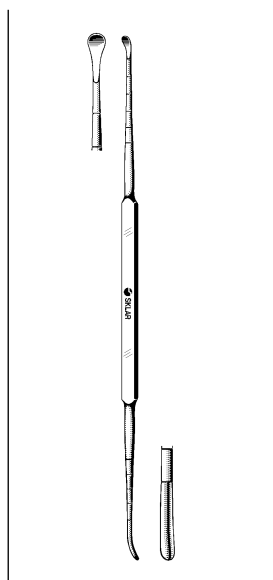
FREER SEPTUM ELEVATOR

47-2380 7 1/4" Double End S/B



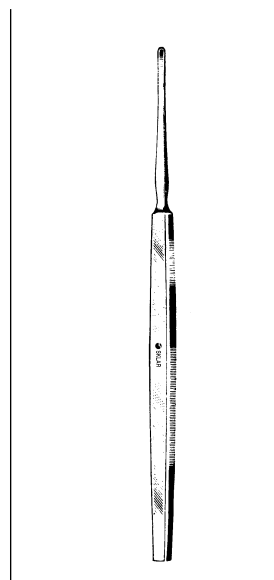
HAJEK-BALLENGER SEPTUM ELEVATOR

Double Ended
 70-7185 8 1/2" S/B



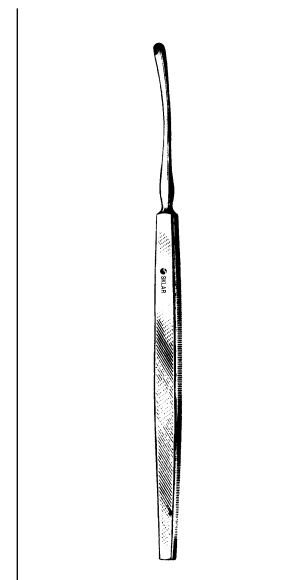
COTTLE ELEVATOR

Shaft Graduated in cm
 41-1235 9" Double End



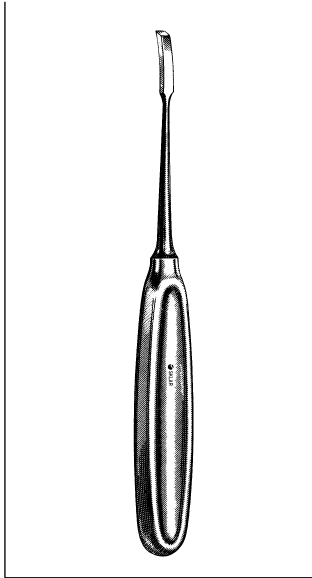
LEMPERT ELEVATOR

Straight
 40-7470 7 1/4" 2mm Blade



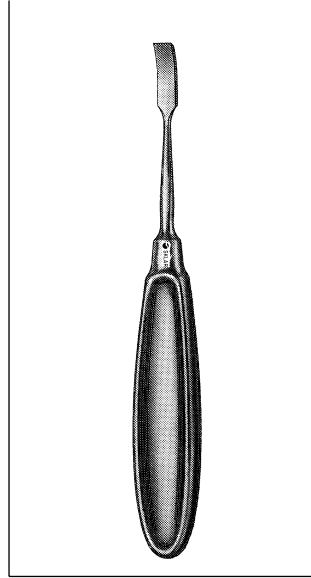
LEMPERT ELEVATOR

Curved
 40-7472 7 1/4" 3mm Blade



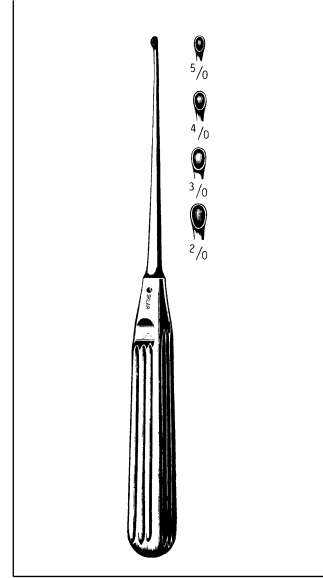
LEMPERT ELEVATOR

Curved
40-7474 7 1/4" 4 mm Blade



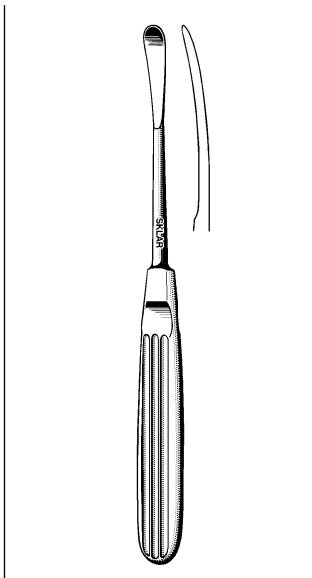
LEMPERT ELEVATOR

Curved
40-7476 7 1/4" 7 mm Blade



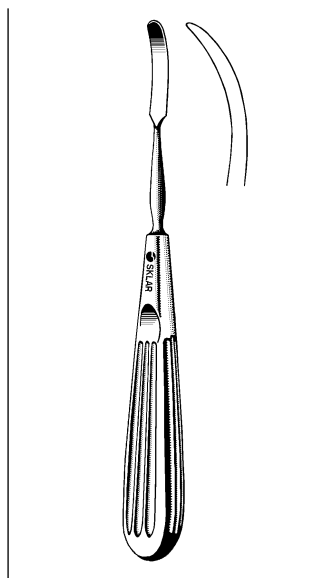
LEMPERT ENDAURAL CURETTE

Oval Cup
40-7380 8 1/4" Size 5/0
40-7381 8 1/4" Size 4/0
40-7382 8 1/4" Size 3/0
40-7383 8 1/4" Size 2/0



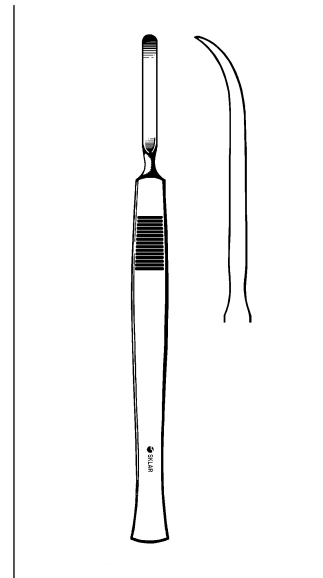
COTTLE PERIOSTEAL ELEVATOR

Slight Curve
41-1250 7 1/2" 9 mm



JOSEPH PERIOSTEAL ELEVATOR

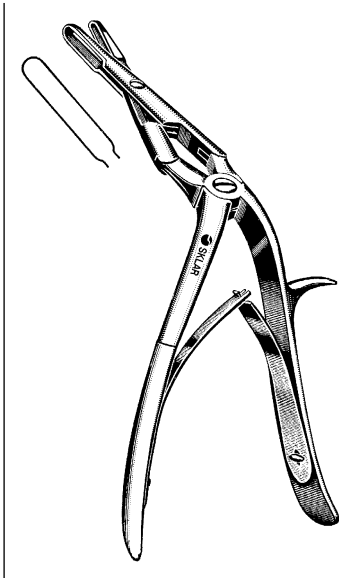
41-1240 7" 6.5 mm



McKENY SEPTUM ELEVATOR

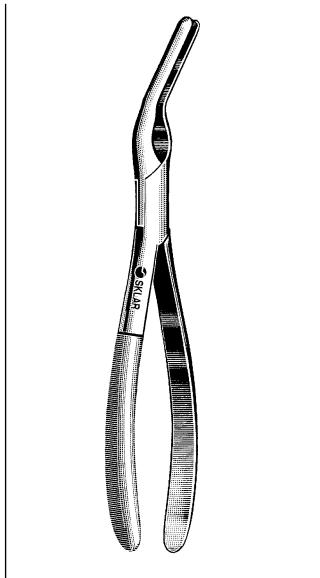
47-2385 6" 4 mm Curved
47-2388 6" 5 mm Curved

ENT/PLASTIC SURGERY FORCEPS/SAWS



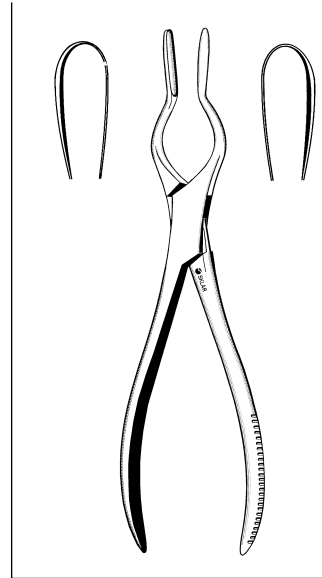
JANSEN-MIDDLETON SEPTUM FORCEPS

Double Action
70-5673 7½" Cutting



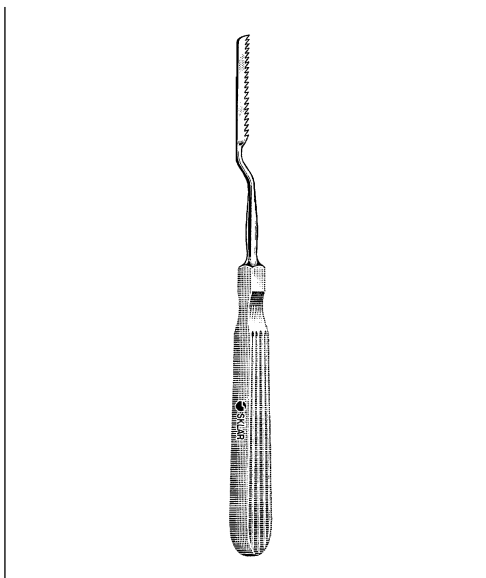
ASCH SEPTUM STRAIGHTENING FORCEPS

70-5190 9"



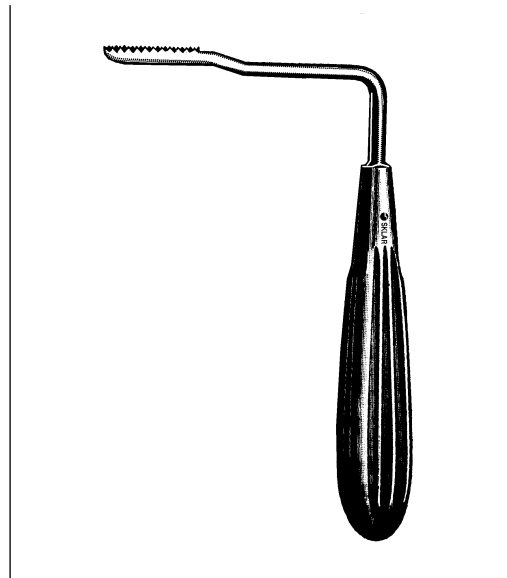
WALSHAM SEPTUM STRAIGHTENING FORCEPS

70-5290 9" Straight
70-5292 9" Left
70-5294 9" Right



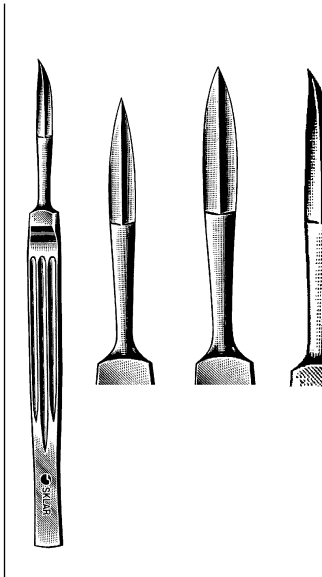
JOSEPH BONE SAW

Bayonet
70-7801 7½" Right
70-7802 7½" Left



JOSEPH NASAL BONE SAW

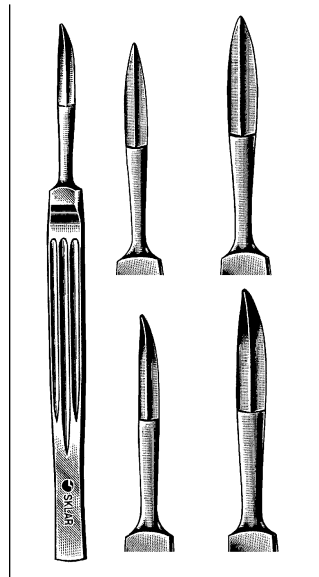
Left Angle
70-7822



JOSEPH KNIFE

Sharp Point

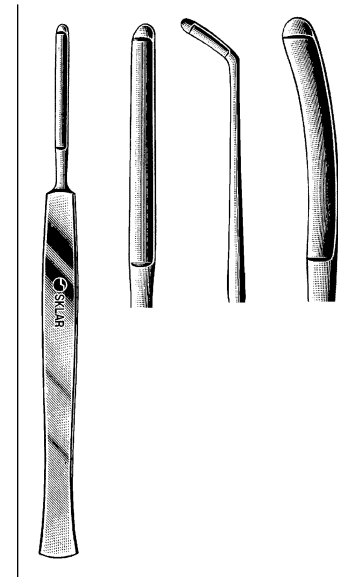
41-1260	6"	Small, Straight
41-1262	6"	Large, Straight
41-1264	6"	Small, Curved
41-1266	6"	Large, Curved



JOSEPH KNIFE

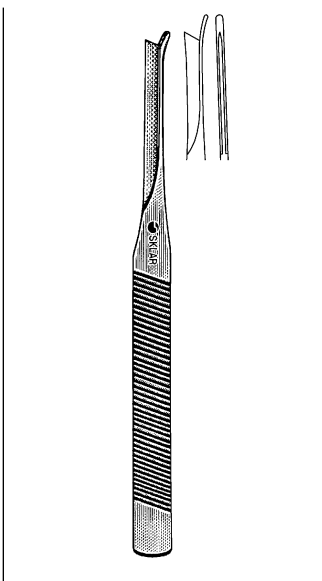
Blunt Point

41-1270	6"	Small, Straight
41-1272	6"	Large, Straight
41-1274	6"	Small, Curved
41-1276	6"	Large, Curved



JOSEPH BUTTON END KNIFE

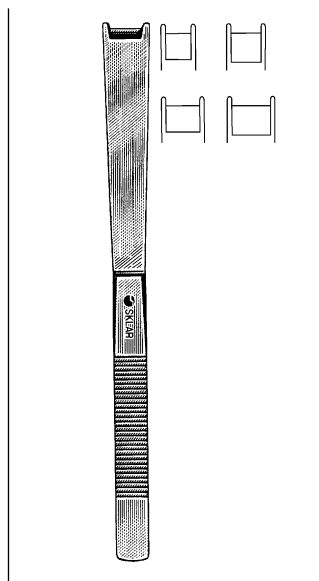
41-1300	6"	Straight
41-1305	6"	Angular
41-1310	6"	Curved



SILVER OSTEOTOME

Guarded One Side

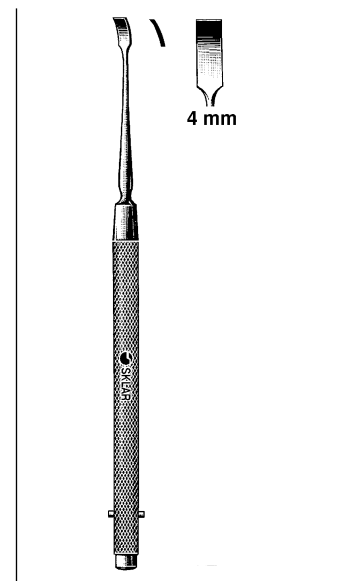
41-1350	7"	Straight
41-1355	7"	Guarded Right
41-1360	7"	Guarded Left



CINELLI OSTEOTOME

Guarded Both Sides

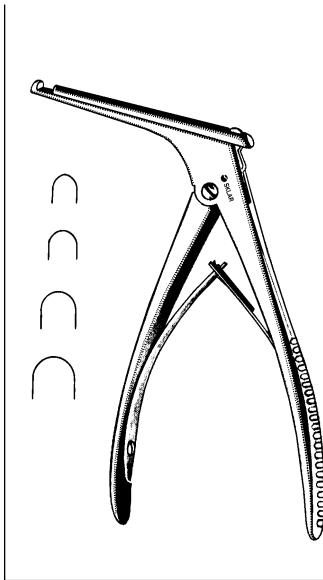
41-1370	6½" x 10 mm	Straight
41-1372	6½" x 12 mm	Straight
41-1374	6½" x 14 mm	Straight
41-1376	6½" x 16 mm	Straight



FREER CHISEL

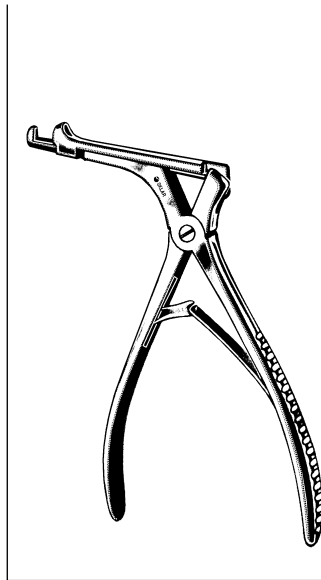
41-1330	6½"	Straight	4 mm
41-1332	6½"	Curved	4 mm

ENT/PLASTIC SURGERY RONGEURS/CHISELS



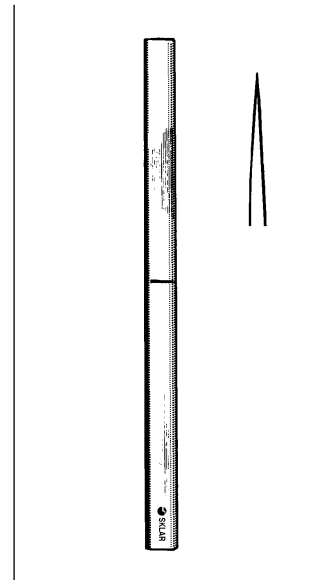
KERRISON RONGEURS

3" Shaft
 65-7400 Size 0 3.5 mm
 65-7401 Size 1 4.5 mm
 65-7402 Size 2 5.5 mm
 65-7403 Size 3 6.5 mm



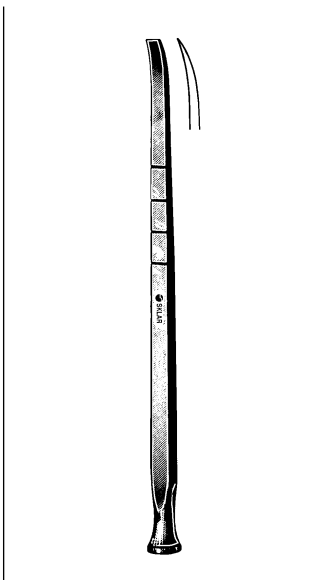
CITELLI RONGEURS

2½" Shaft
 65-7410 Size 1 2 mm
 65-7411 Size 2 3 mm



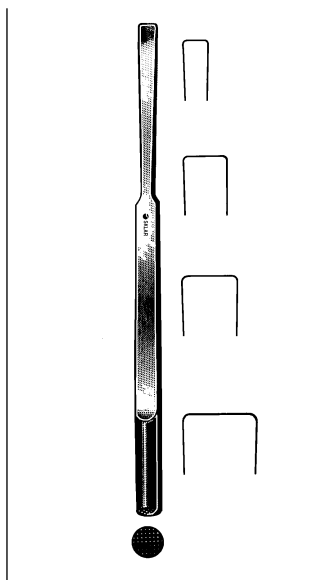
LAMBOTTE OSTEOTOMES

5½"
 40-6535 5 mm
 40-6537 7 mm



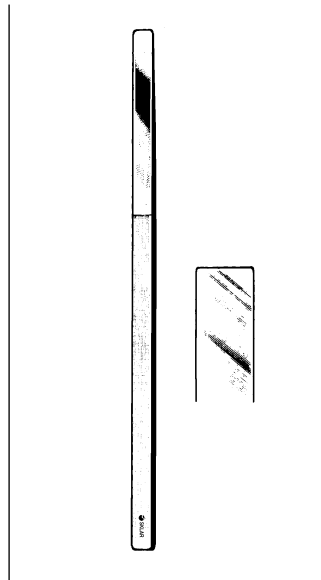
COTTLE NASAL OSTEOTOME

41-1340 6½" Curved



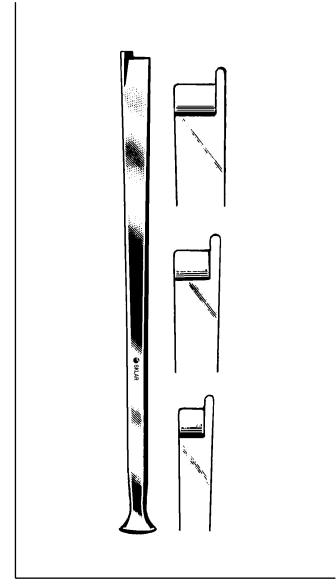
COTTLE NASAL CHISEL

7" With Rounded Corners
 41-1342 4 mm
 41-1344 7 mm
 41-1346 9 mm
 41-1348 12 mm



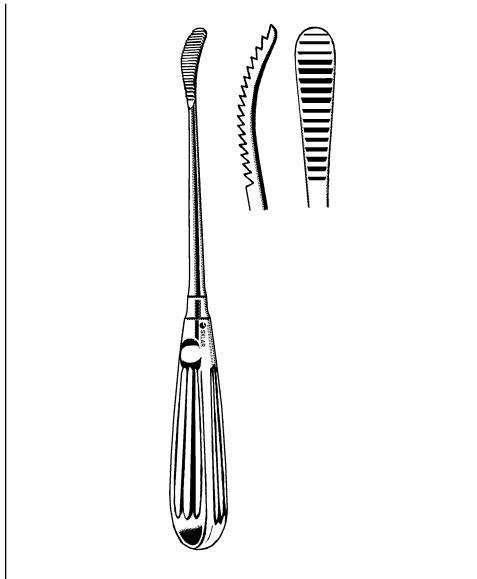
COTTLE BONE LEVER

41-1365 8"



FOMON NASAL CHISELS

5¾" With Guarded Tip
 41-1366 5 mm
 41-1367 7 mm
 41-1368 8 mm



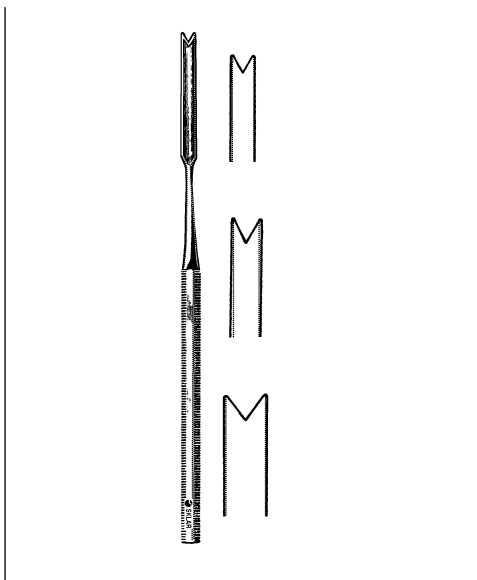
AUFRICHT GLABELLAR RASPS

40-9840 8" Forward cutting
40-9841 8" Backward cutting



LEWIS NASAL RASP

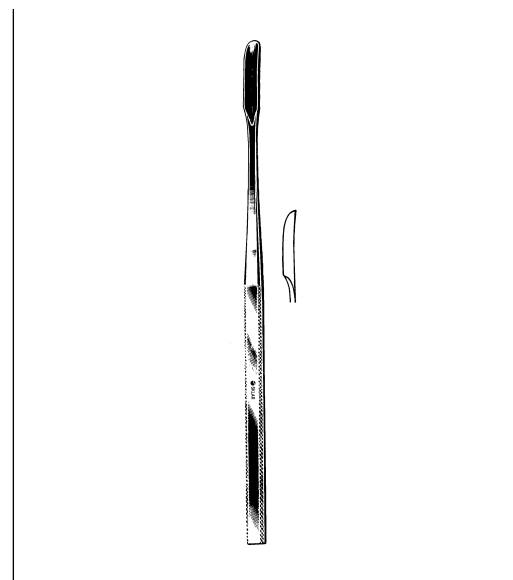
70-2292 7" Fine
70-2293 7" Coarse



HAJEK SEPTUM CHISELS

6" V-Shaped cutting edge enhanced forward cutting effect

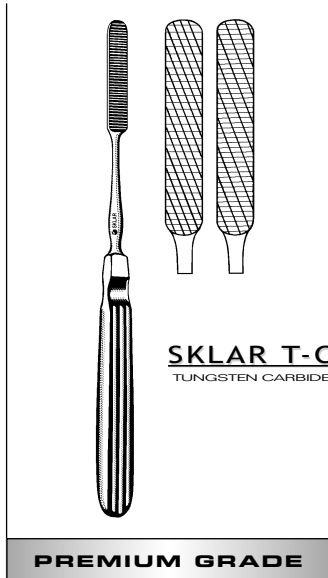
41-1361 4 mm Small
41-1362 6 mm Medium
41-1363 8 mm Large



WEST BONE GOUGE

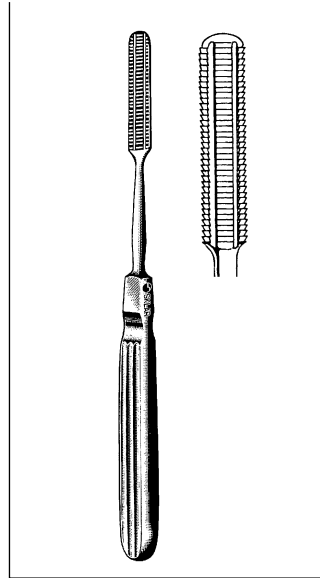
41-1338 7 1/2"

ENT/PLASTIC SURGERY RASPS



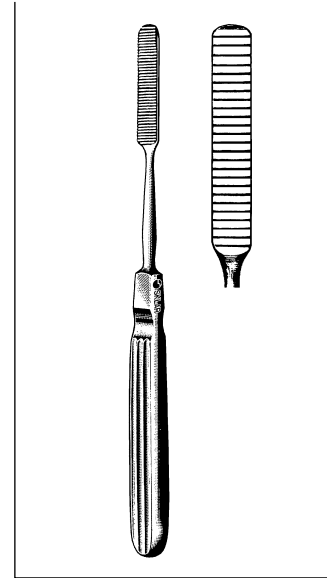
T-C MALTZ RASP

Single End
97-1505 Fine
97-1506 Medium



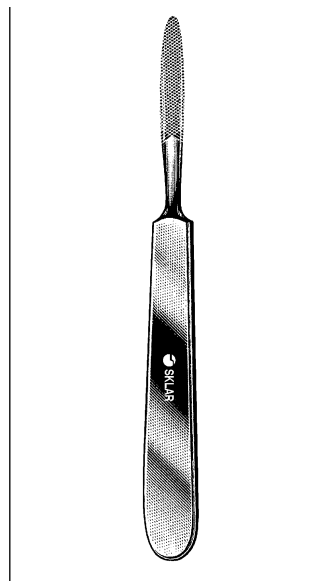
MALTZ RASP

40-9815 7" Backward Cutting



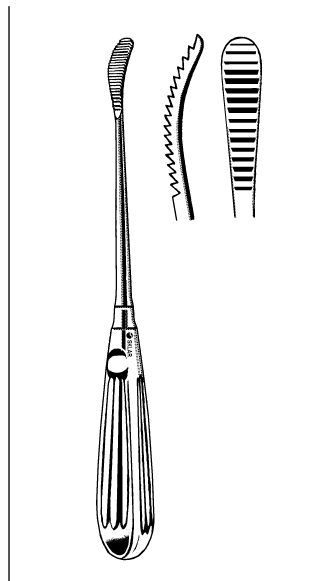
COTTLE RASP

40-9820 8" Backward Cutting



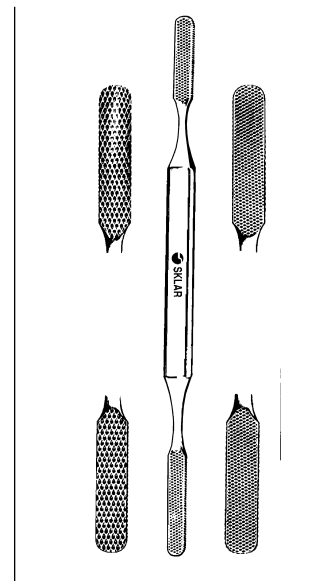
JOSEPH RASP

Straight Handle
40-9825 6 1/4" Fine Cross Serrations



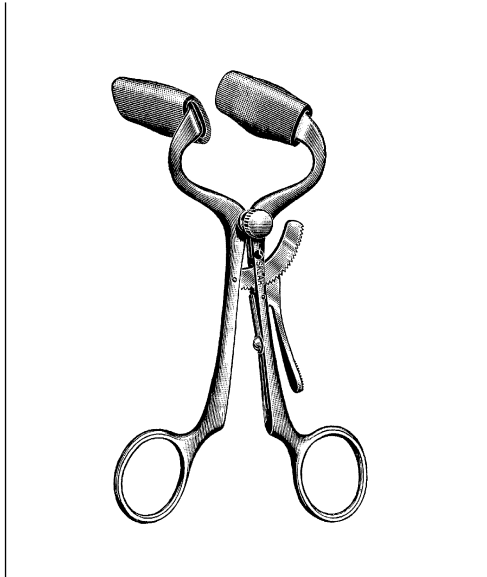
AUFRICHT GLABELLAR RASPS

40-9840 8" Forward cutting
40-9841 8" Backward cutting



FOMON RASP AND FILE

Double End-4 Sided
40-9688 8 1/2"

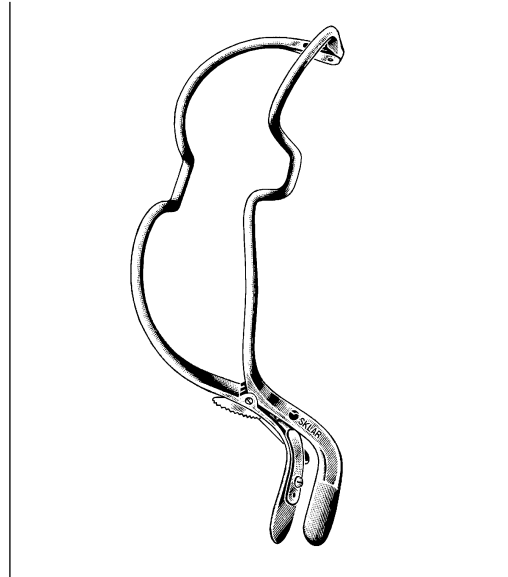


DOYEN-JANSEN MOUTH GAG

Tru-Grip Ratchet

75-1025 Adult, With Cushions

22-8945 Child, With Cushions



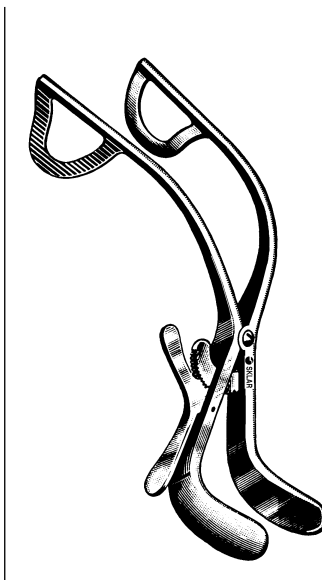
JENNINGS MOUTH GAG

Tru-Grip Ratchet

75-1015 Small

75-1016 Medium

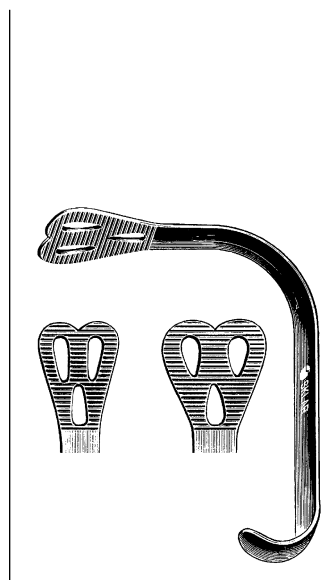
75-1017 Large



WESSON MOUTH GAG

Tru-Grip Ratchet

75-1010 With Finger Guard

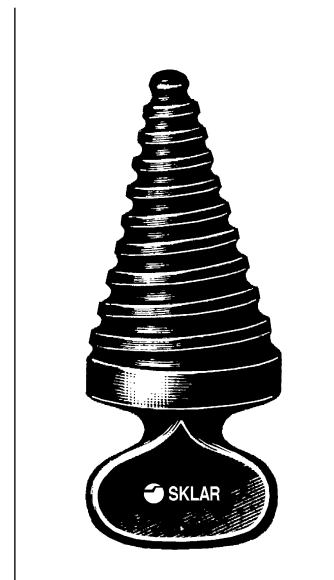


WIEDER TONGUE DEPRESSOR

Fenestrated and Serrated Blade

75-2160 Small

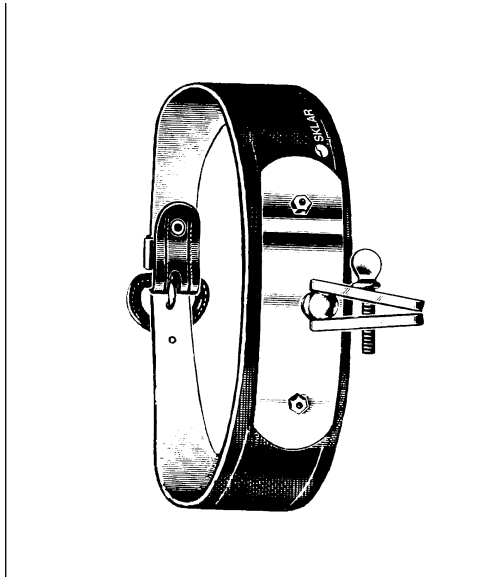
75-2161 Large



ORAL SCREW, PLASTIC

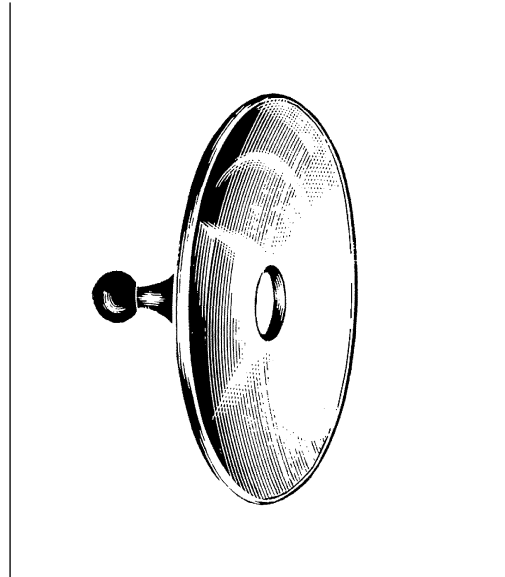
Mouth Opener

75-1400



JEFFERSON LEATHER HEADBAND

73-1015 1½" With Pad



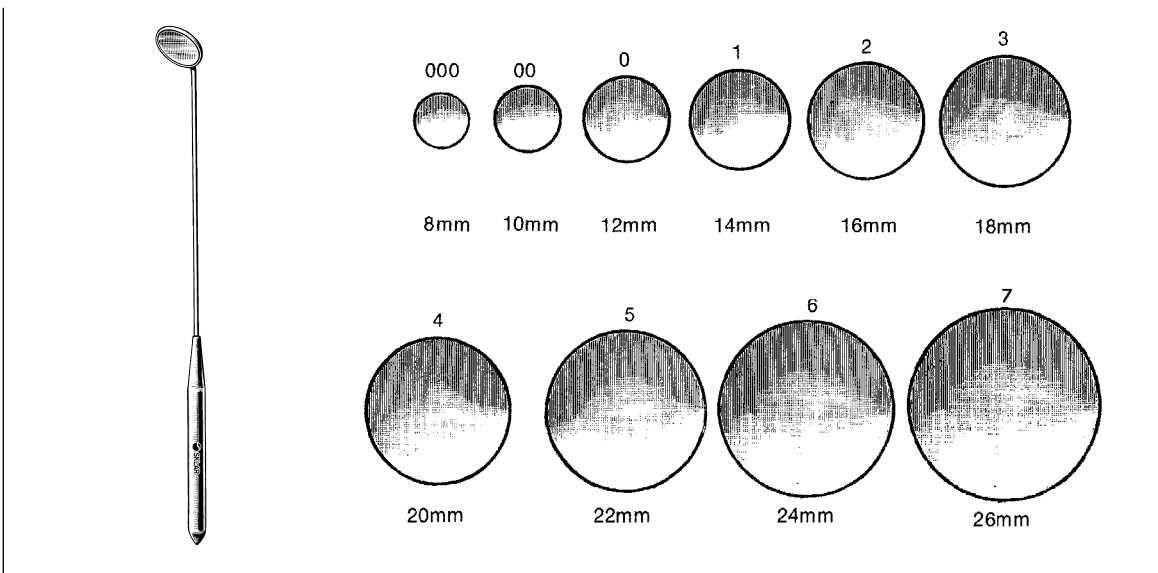
HEAD MIRROR

Boilable

73-1082 Headband (Plastic)

73-1085 3½" Diameter ½" Hole

73-1086 3" With Stainless Steel Back



LARYNGEAL MIRROR REGULAR

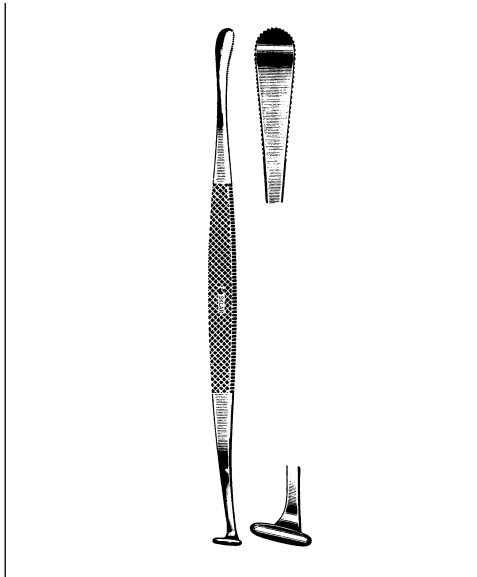
Chromeback Mirror With Stainless Steel Handle

- 73-1188 #000
- 73-1189 #00
- 73-1190 #0
- 73-1191 #1
- 73-1192 #2
- 73-1193 #3
- 73-1194 #4
- 73-1195 #5
- 73-1196 #6
- 73-1197 #7

LARYNGEAL MIRROR EVERCLEAR

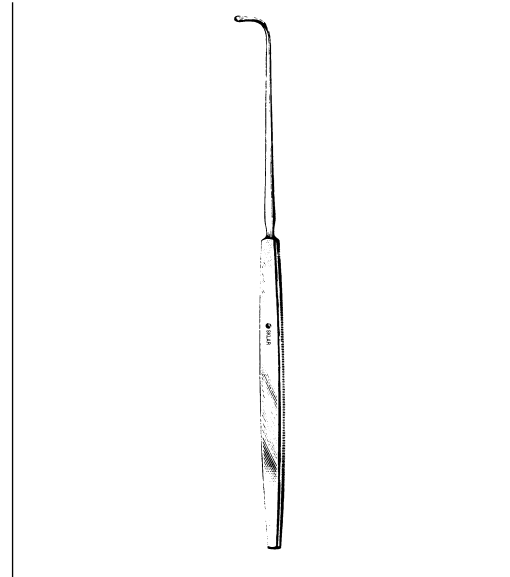
Chromeback Mirror With Stainless Steel Handle

- 73-1351 #1
- 73-1352 #2
- 73-1353 #3
- 73-1354 #4
- 73-1355 #5
- 73-1356 #6



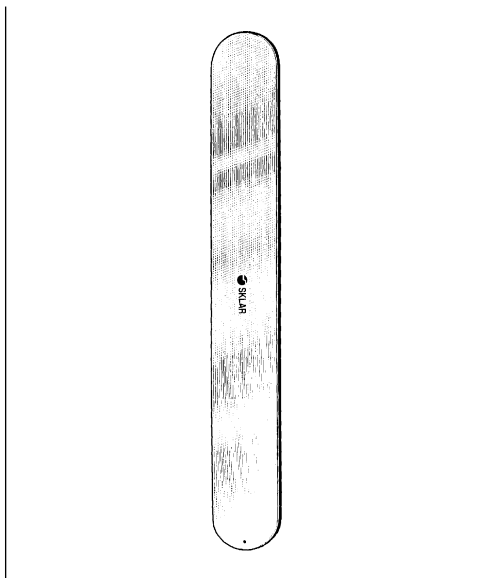
**MORRISON-HURD TONSIL DISSECTOR
AND PILLAR RETRACTOR**

74-1200 9" Serrated Blade



**COLVER TONSIL EXAMINING
RETRACTOR**

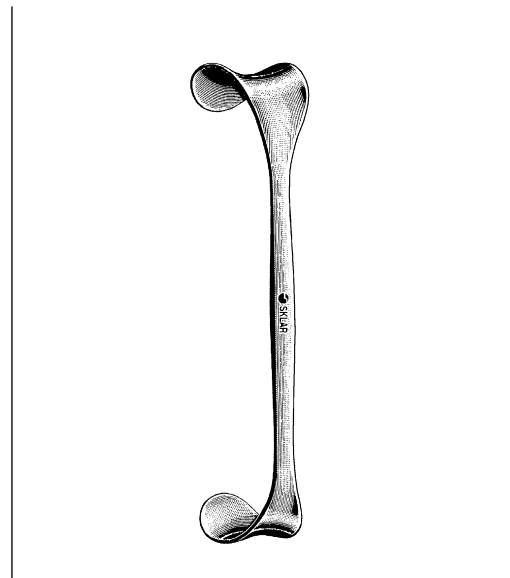
74-1202 8" Blunt Tip



ZALKIND (RIBBON) RETRACTOR

Malleable

60-3594	¼" x 7¾"	60-3607	¾" x 13"
60-3596	½" x 7¾"	60-3610	1" x 13"
22-8067	⅝" x 7¾"	60-3612	1¼" x 13"
60-3598	¾" x 7¾"	60-3615	1½" x 13"
22-8075	1" x 7¾"	60-3617	1¾" x 13"
		60-3620	2" x 13"
		60-3625	2½" x 13"

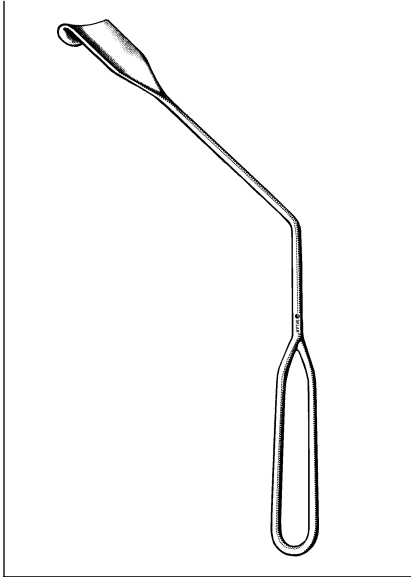


GOELET RETRACTOR

Double End

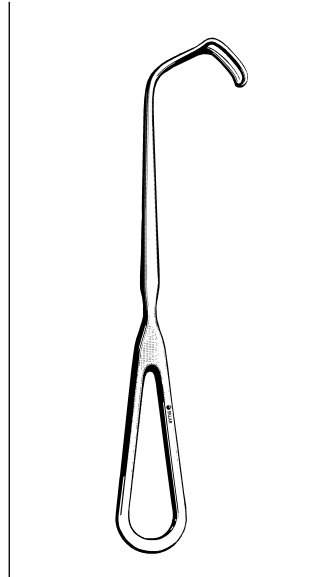
60-1075 7½" Long 1¼" x 1½"

ENT/PLASTIC SURGERY RETRACTORS



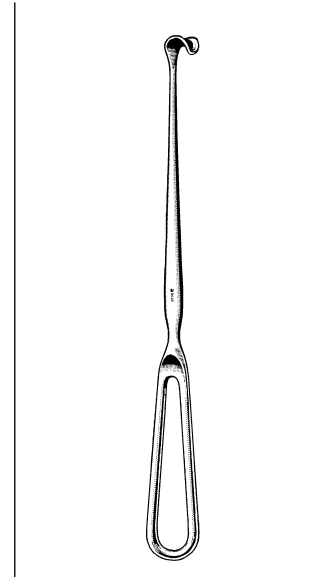
LOTHROP UVULA RETRACTOR

75-2315 20 mm wide



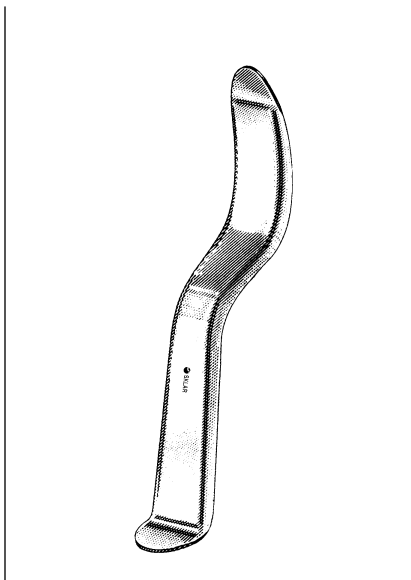
**CUSHING DECOMPRESSION
RETRACTOR**

50-1280 8"



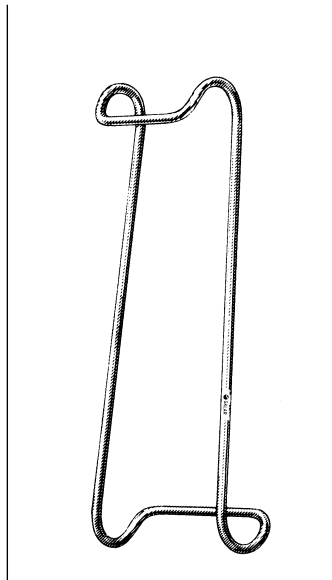
**CUSHING NERVE/VEIN
RETRACTOR**

50-1290 9"



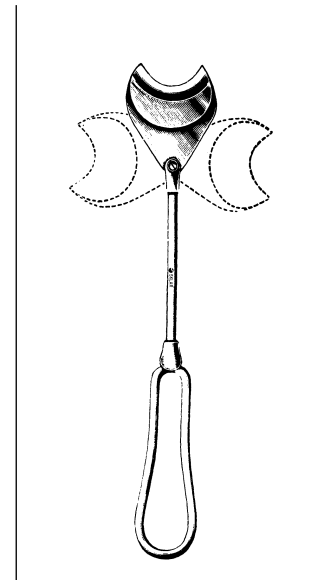
**UNIVERSITY OF MINNESOTA
CHEEK RETRACTOR**

Double End
75-1120 5 1/2"



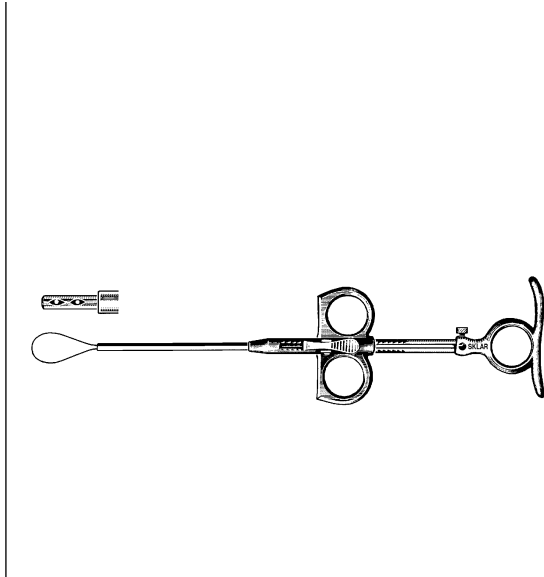
COLUMBIA LIP RETRACTOR

Double End
75-1122 5 1/2"



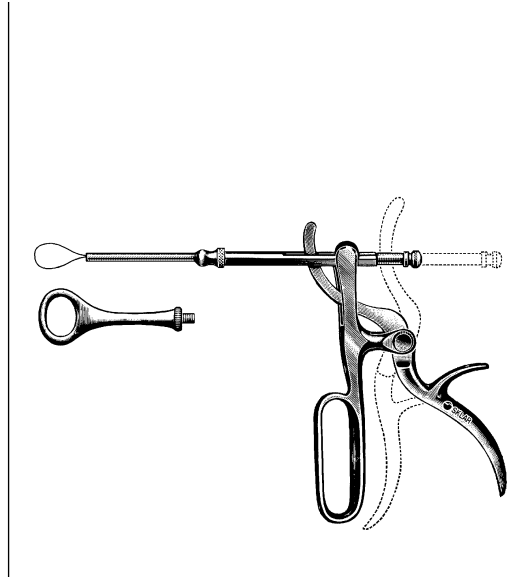
CHEEK RETRACTOR

With Swivel Blade
75-1124 7 1/4"



EVES TONSIL SNARE

75-9070 Plain
75-9075 With Ratchet



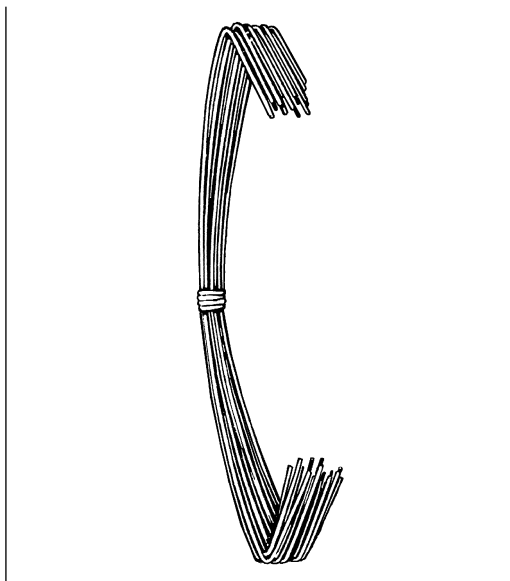
TYDING TONSIL SNARE

Complete

75-9245 Includes One Straight Tip,
One V-edder Tip,
One Dozen Cut Snare Wires

75-9250 Includes One Straight Tip Only,
One Dozen Cut Snare Wires

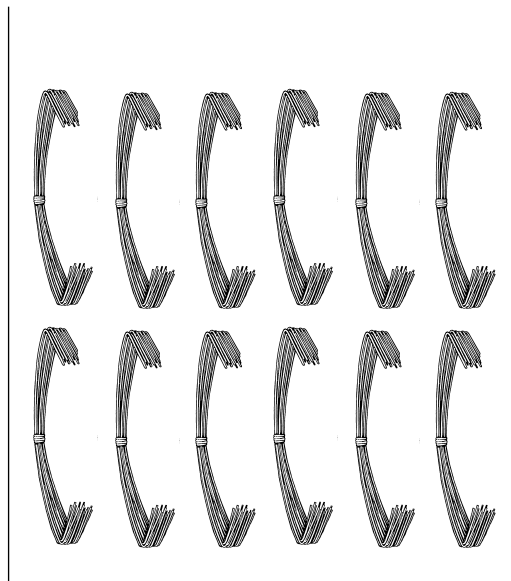
75-9155 One Dozen Twisted Wire Loops #8



SNARE WIRES CUT & BENT

1 Package of 12 (12 Wires)

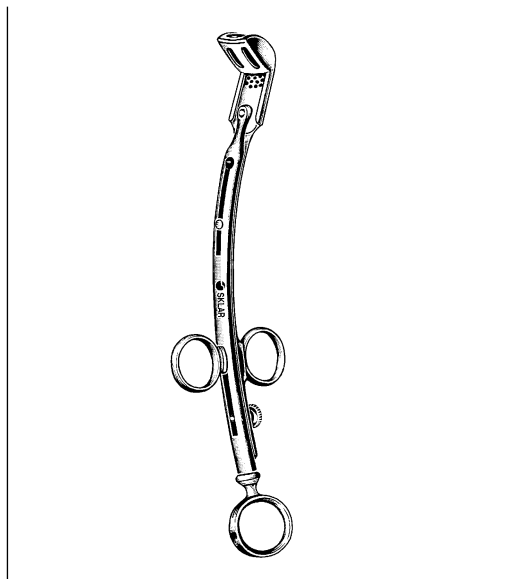
75-9505 #5 4" Long
75-9506 #6 4" Long
75-9507 #7 4" Long
75-9508 #8 4" Long
75-9509 #9 4" Long



SNARE WIRES CUT & BENT

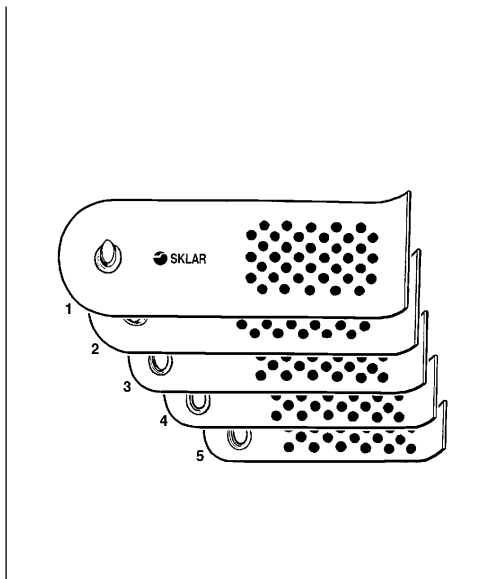
12 Package of 12 (144 Wires)

75-9405 #5 4" Long
75-9406 #6 4" Long
75-9407 #7 4" Long
75-9408 #8 4" Long
75-9409 #9 4" Long



LA FORCE ADENOTOME

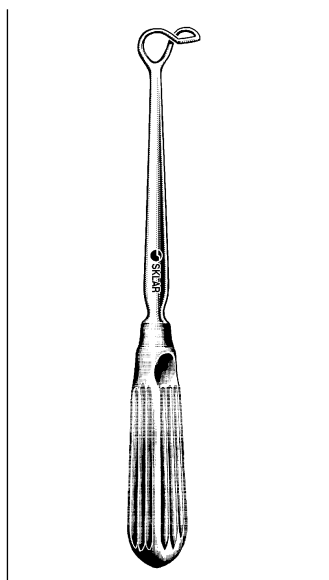
- 70-9001 No. 1 Large Size
- 70-9002 No. 2 Medium
- 70-9003 No. 3 Small
- 70-9004 No. 4 Extra Small
- 70-9005 No. 5 Infant



LA FORCE ADENOTOME

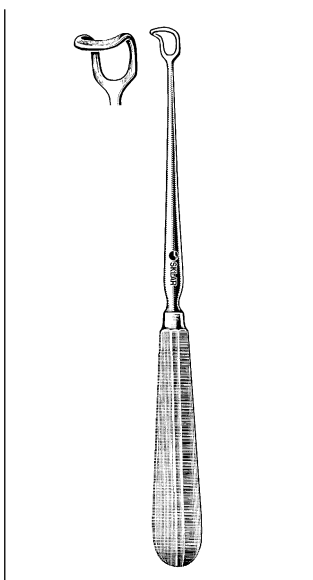
Blades Only

- 70-9101 No. 1 Large Size
- 70-9102 No. 2 Medium
- 70-9103 No. 3 Small
- 70-9104 No. 4 Extra Small
- 70-9105 No. 5 Infant



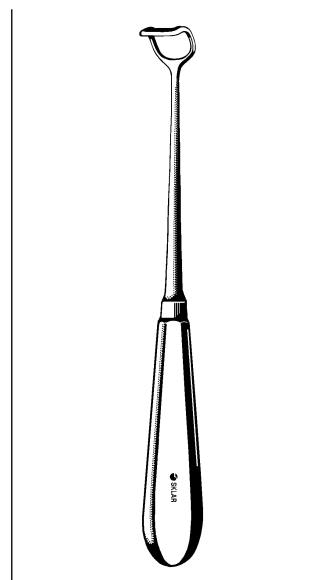
BARNHILL ADENOID CURETTE

- 70-9200 No. 0 8/4"
- 70-9201 No. 1 8/4"
- 70-9202 No. 2 8/4"
- 70-9203 No. 3 8/4"
- 70-9204 No. 4 8/4"



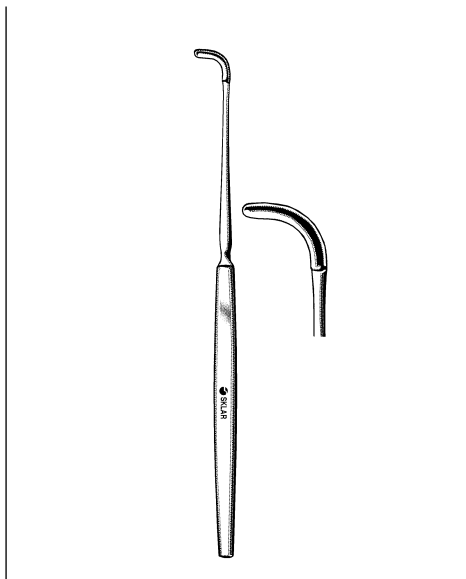
VOGEL ADENOID CURETTE

- 70-9210 Infant



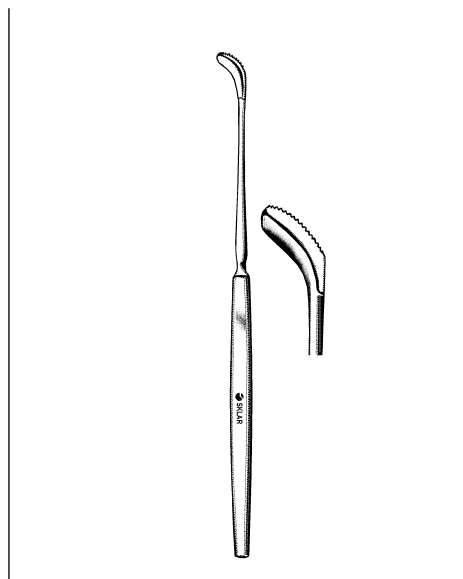
BECKMANN ADENOID CURETTE

- 70-9220 #1 8/2"
- 70-9221 #2 8/2"
- 70-9222 #3 8/2"
- 70-9223 #4 8/2"
- 70-9224 #5 8/2"



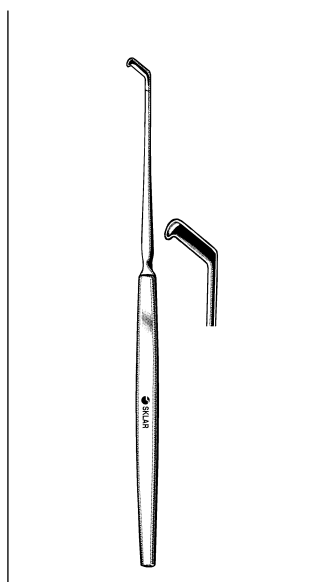
TYDING TONSIL KNIFE

75-7482 8½"



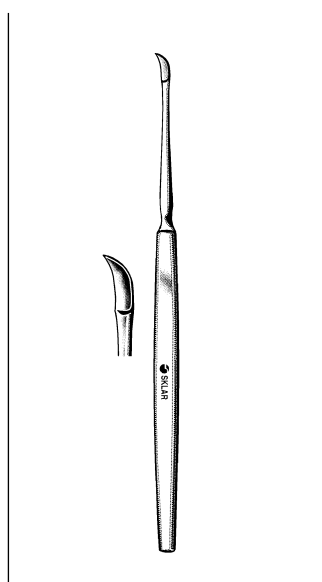
FISHER TONSIL KNIFE

75-7590 8½"



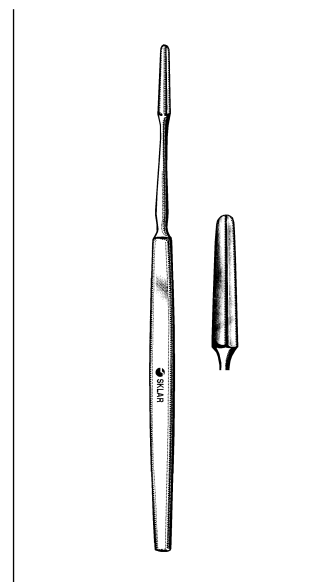
DOUGLAS TONSIL KNIFE

75-7282 8¼" Angled



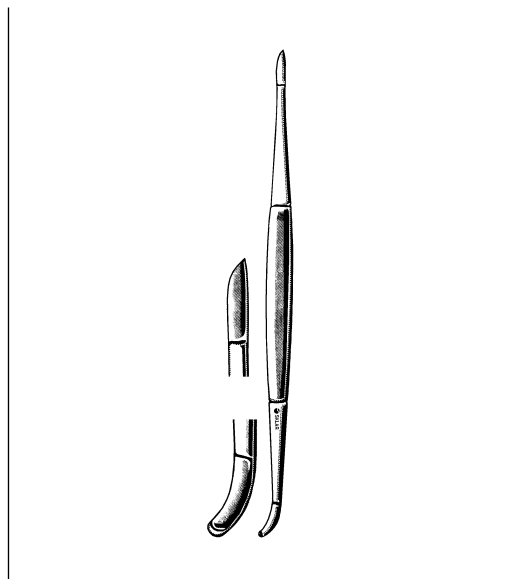
ATKINS TONSIL KNIFE

75-7077 7¼"



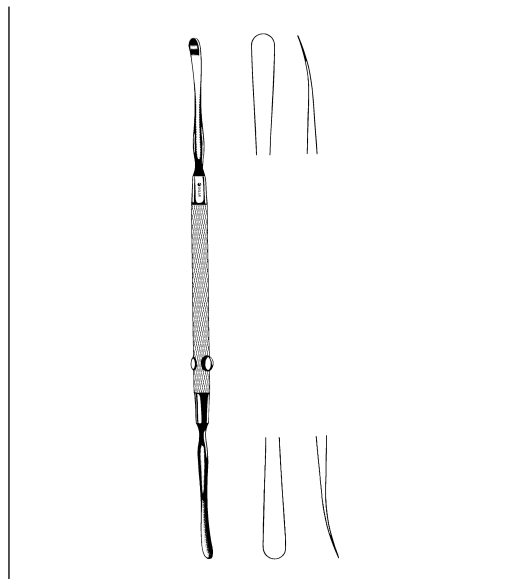
DEAN TONSIL KNIFE

Double Edge
75-7492 7¼" Straight



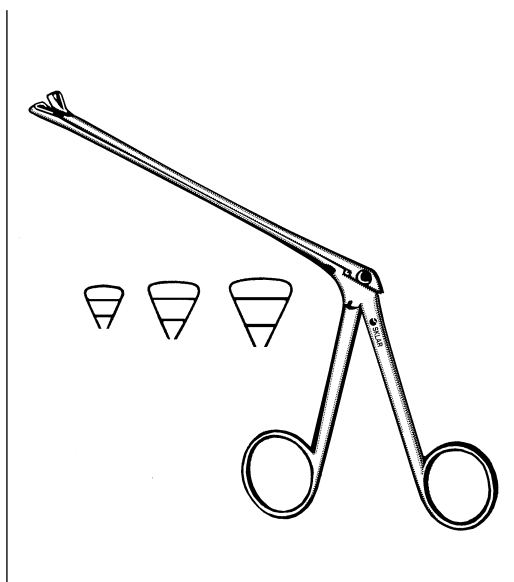
LOTHROP TONSIL KNIFE

Double End
75-7575 8"



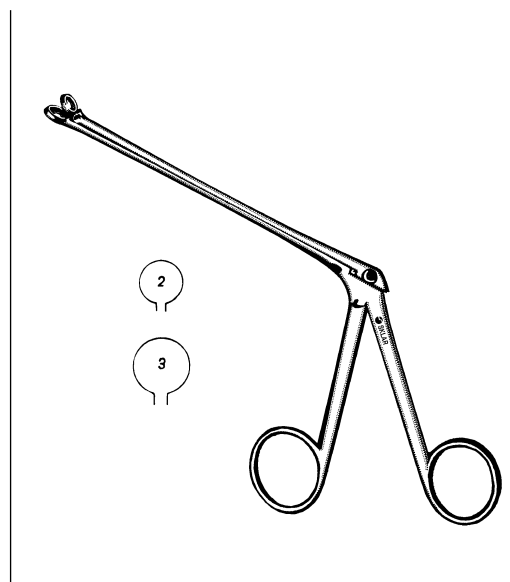
FREER ELEVATOR

Double End
47-2380 7 1/4" S/B
47-2382 7 3/4" S/B



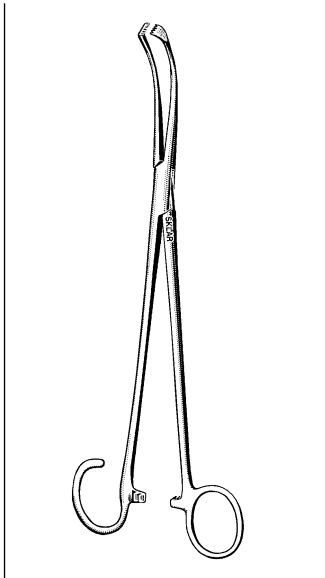
SCHMEDEN TONSIL PUNCHES

5 1/2" shank with triangular basket tip
75-9601 Size 1
75-9602 Size 2
75-9603 Size 3



HARTMANN (MOSHER) TONSIL PUNCHES

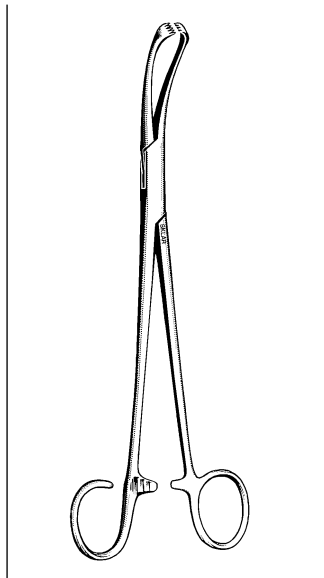
5 1/2" shank with round basket tip
75-9612 Size 2
75-9613 Size 3



WHITE TONSIL FORCEPS

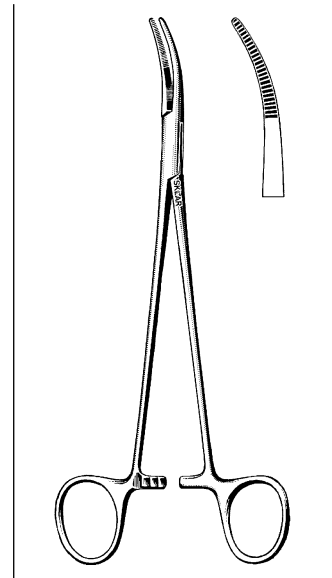
One Open Ring

74-2575 7" Curved
74-2590 9" Curved



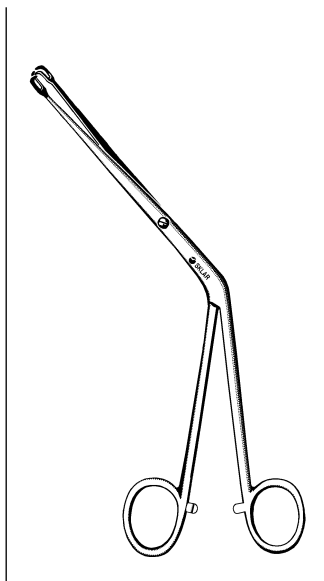
**COLVER-COAKLEY TONSIL
FORCEPS**

74-2475 7½" Curved



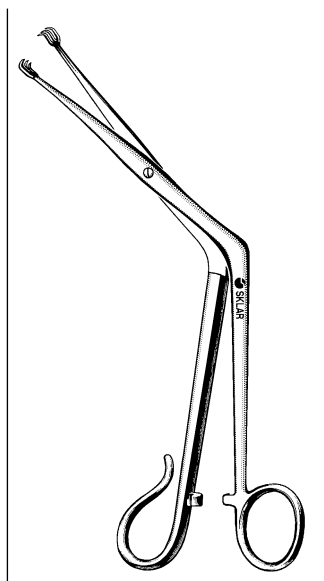
SCHNIDT TONSIL FORCEPS

74-3075 7½" Half Curved Jaw



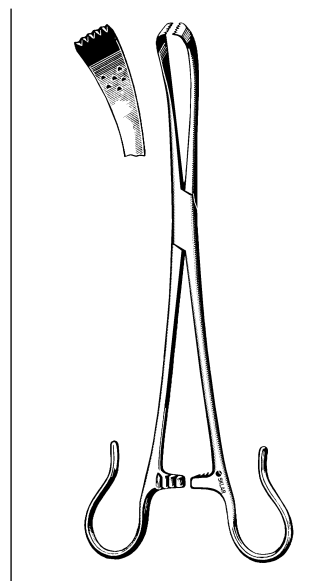
**TYDING TONSIL SEIZING
FORCEPS**

74-1975 7½" 2 x 2 Angular With Catch



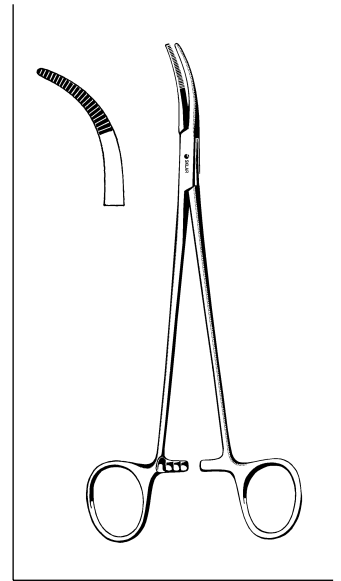
**TIVNEN TONSIL SEIZING
FORCEPS**

74-2175 7½" 3 x 3 Angular With Catch



**CRAIG TONSIL SEIZING
FORCEPS**

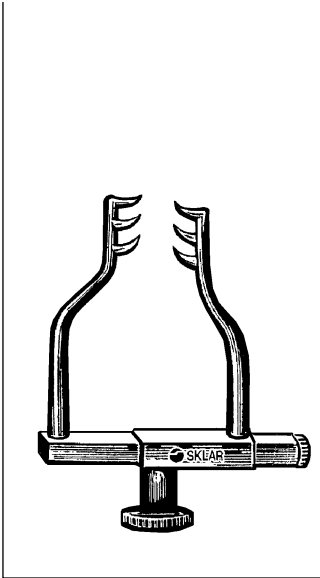
74-1280 8"



SAWTELL TONSIL FORCEPS

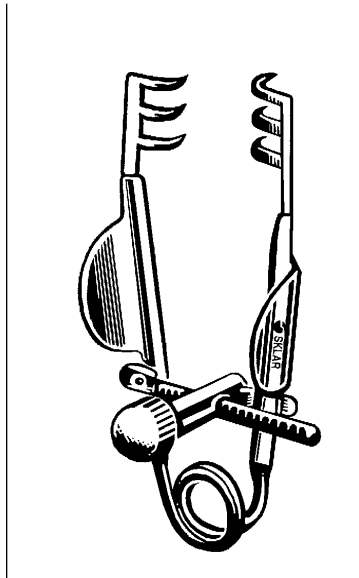
74-3175 7½" Full Curved

ENT/PLASTIC SURGERY RETRACTORS



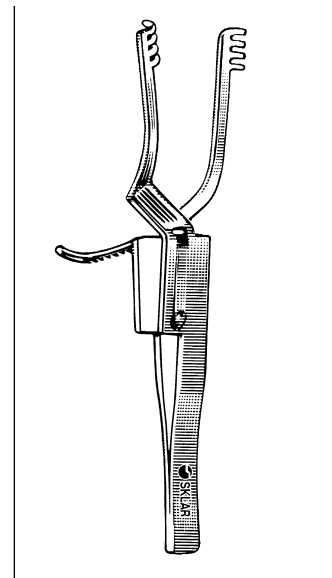
GOLDSTEIN RETRACTOR

47-2913 1½" 3 x 3 Sharp Prongs



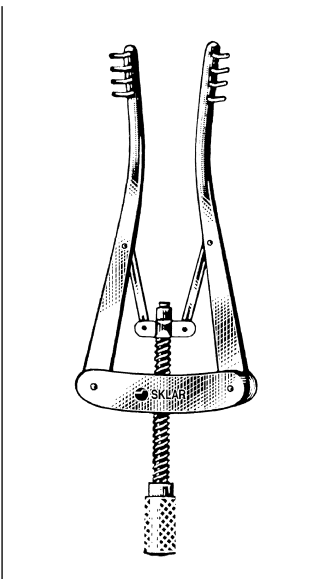
MELLER RETRACTOR

Delicate
65-1815 3 x 3 Sharp Prongs 1½"



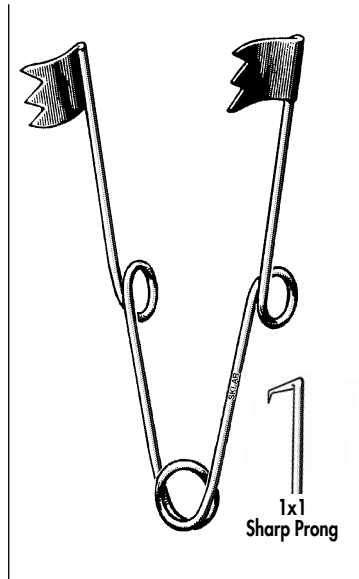
HOLZHEIMER SELF-RETAINING RETRACTOR

Sharp
22-8920 4" 4 x 4 Teeth
Blunt
22-8940 4" 4 x 4 Teeth



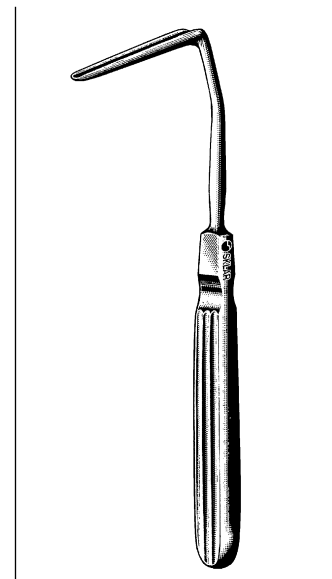
ALM RETRACTOR

22-9027 2¾" 4 x 4 Teeth Blunt
60-6340 4" 4 x 4 Teeth Blunt
22-9029 2¾" 4 x 4 Teeth Sharp
60-6342 4" 4 x 4 Teeth Sharp



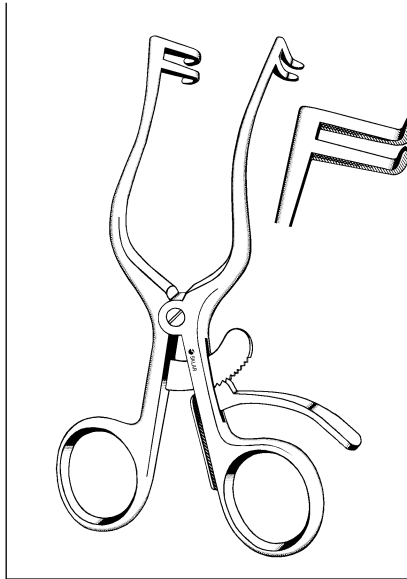
WIRE RETAINING RETRACTOR

22-8832 ¾" 3x3 Blade
22-8834 ¾" 1x1 Sharp Prong



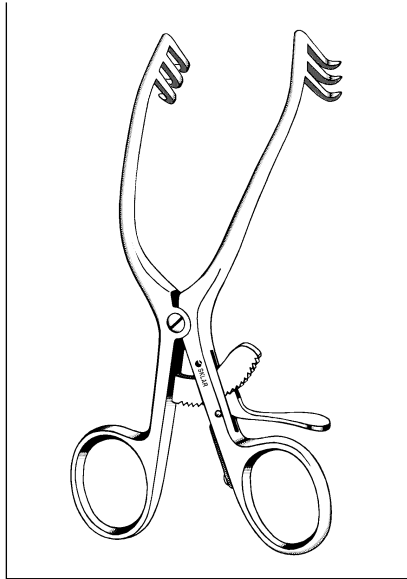
AUFRICHT RETRACTOR

Solid blade
41-1410 7" x 1½"



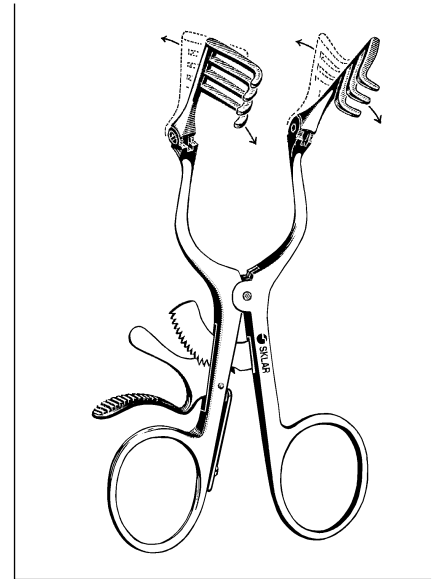
**PAPARELLA WEITLANER
RETRACTOR**

42-1820 5" 2 x 2 Semi Sharp Teeth



**SCHUKNECHT POSTAURICULAR
RETRACTOR**

42-1822 5" 3 x 3 Teeth

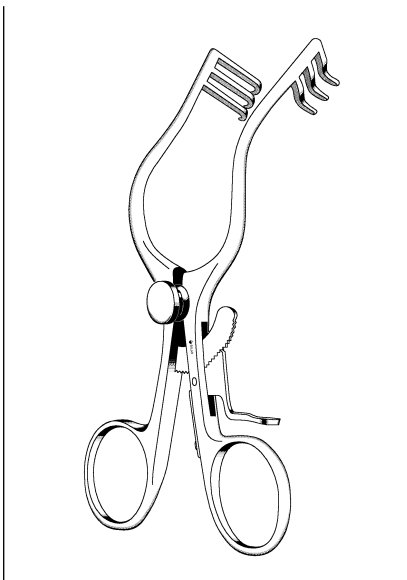


WEITLANER-BECKMAN RETRACTOR

Tru-Grip Ratchet

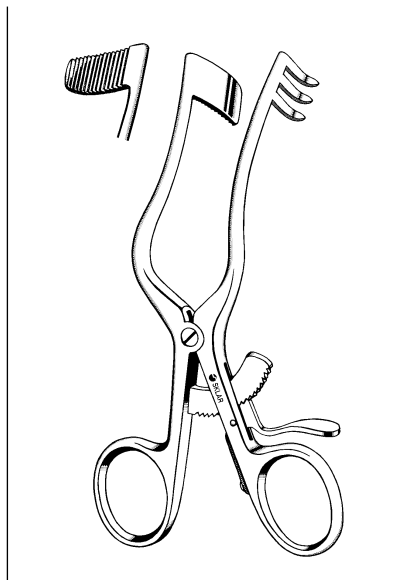
42-1655 6" with hinged blades, 3 x 4 Blunt

42-1765 6" with hinged blades, 3 x 4 Sharp



**WULLSTEIN ENDAURAL
RETRACTOR**

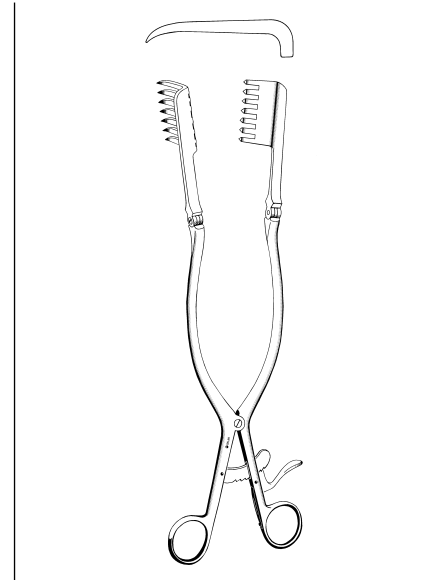
42-1824 5" 3 x 3 Sharp Teeth



**PERKINS ENDAURAL
RETRACTOR**

42-1826 5 1/4" Left Serrated Solid Blade

42-1828 5 1/4" Right Serrated Solid Blade



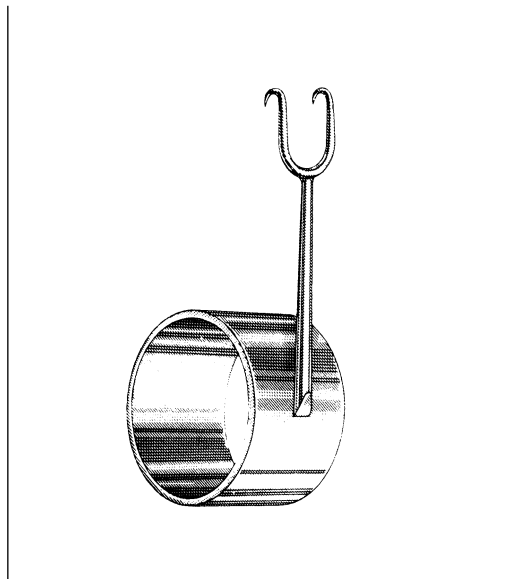
BECKMAN-EATON RETRACTOR

Tru-Grip Ratchet

57-1325 13" 7 x 7 Sharp Prongs

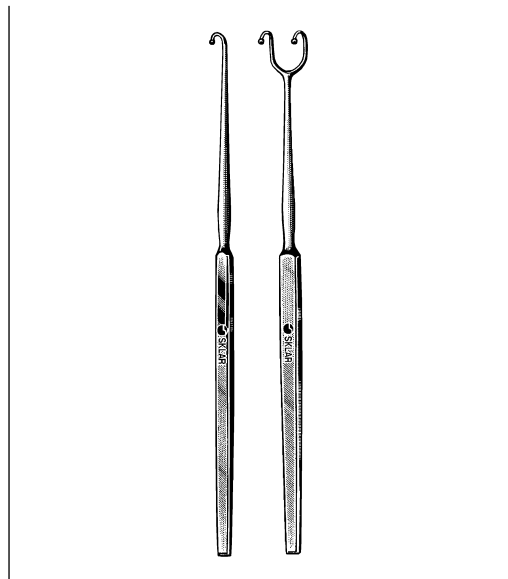
With Hinged Blades

ENT/PLASTIC SURGERY HOOKS/RETRACTORS



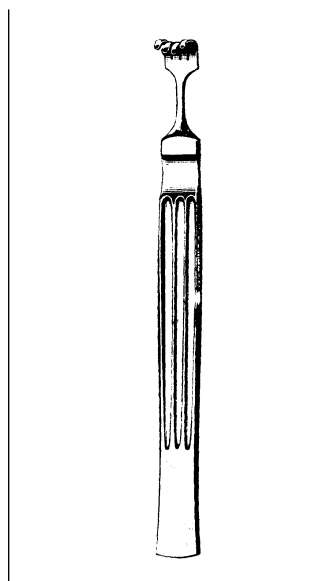
COTTLE THUMB RETRACTOR

41-1380 1½" Sharp Double Hook



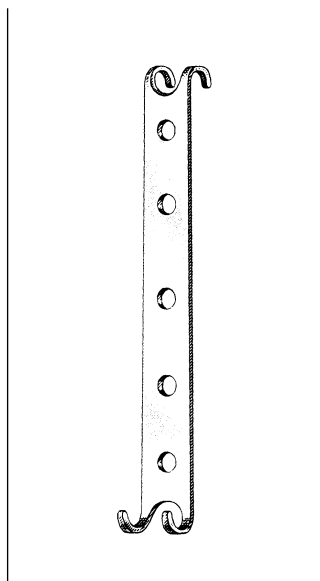
FOMON RETRACTOR

Ball End
41-1395 6¼" Single
41-1396 6¼" Double



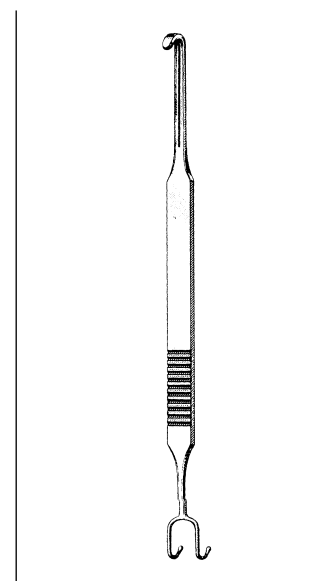
COTTLE RETRACTOR

41-1385 5½" Two Center Prongs Recessed



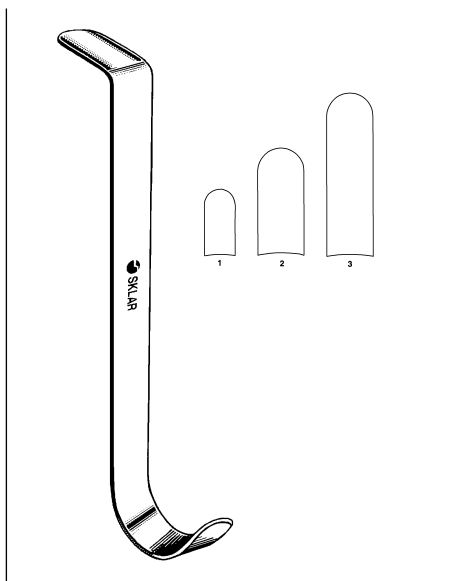
**CONVERSE ALAR
RETRACTOR**

41-1398 4" Double End Blunt



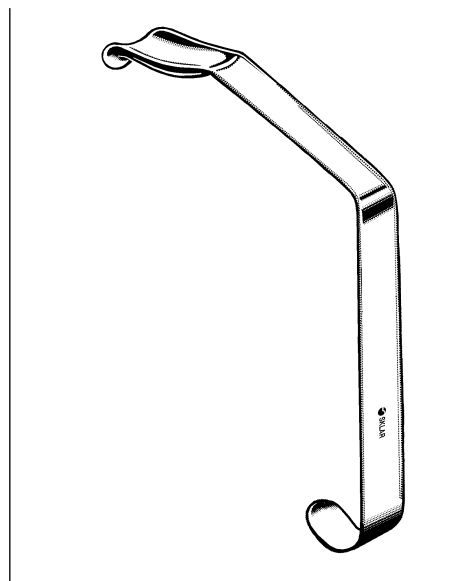
**COTTLE KNIFE GUARD AND
RETRACTOR**

5mm Wide Slotted Hook
41-1382 8"



CONVERSE BLADE RETRACTOR

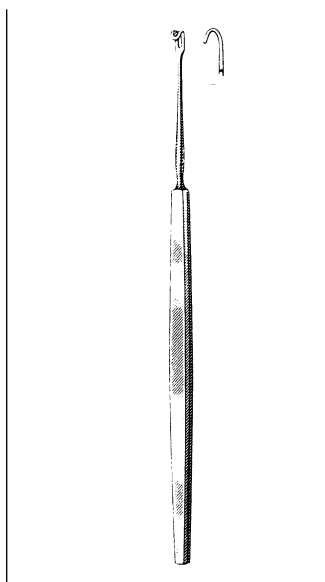
41-1401 3 3/4" Size 1
 41-1402 3 3/4" Size 2
 41-1403 3 3/4" Size 3



LOVE UVULA RETRACTORS

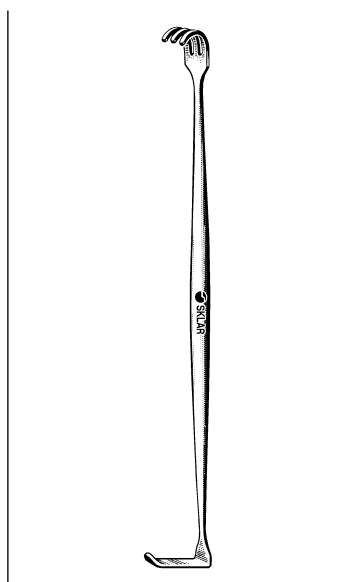
Lifts soft palate and allows for easy removal of adenoid tissue

75-2318 18 mm wide
 75-2320 20 mm wide
 75-2322 22 mm wide



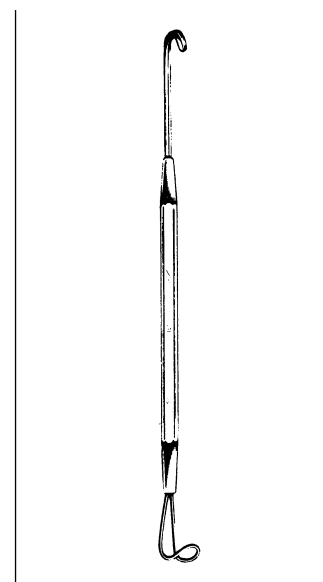
MCGANNON IRIS RETRACTOR

65-3258 5 1/4"



MATHIEU RETRACTOR

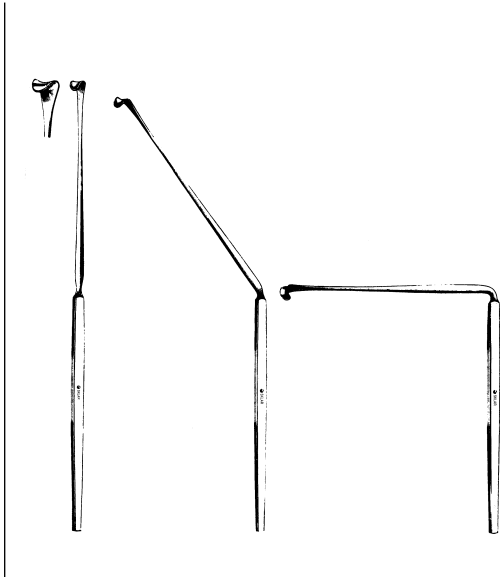
Double Ended
 60-6062 6 1/4" Blunt



NEIVERT KNIFE GUIDE AND RETRACTOR

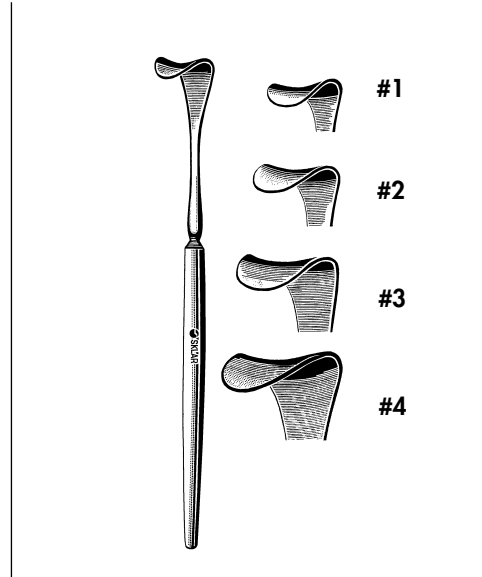
41-1383 6 1/2" Double End

ENT/PLASTIC SURGERY RETRACTORS/HOOKS



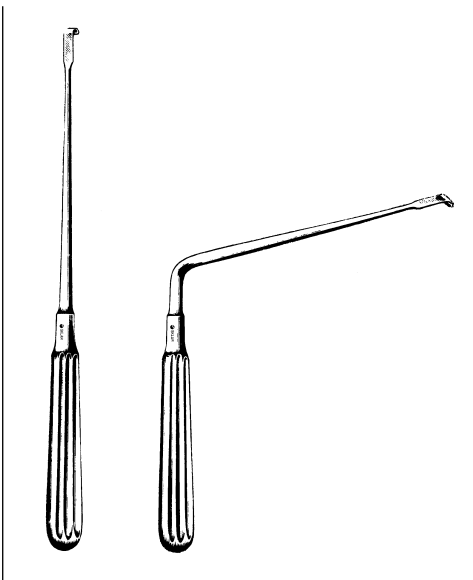
LOVE RETRACTOR

- 50-1301 7½" Nerve Retractor Straight 7mm Blade
- 50-1302 7½" Nerve Root Retractor Angled 45° 7mm Blade
- 50-1303 7½" Nerve Root Retractor Angled 90° 7mm Blade



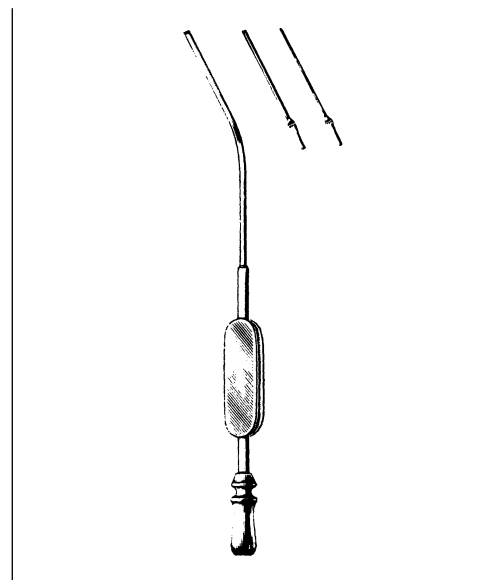
DESMARRES LID RETRACTOR

- 65-1841 #1 5½" with 12mm Blade
- 65-1842 #2 5½" with 14mm Blade
- 65-1843 #3 5½" with 16mm Blade
- 65-1844 #4 5½" with 18mm Blade



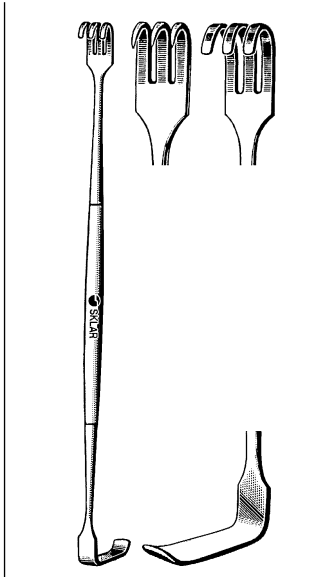
SCOVILLE RETRACTOR

- 50-1304 9" Nerve Retractor Straight 8mm Blade
- 50-1305 9" Nerve Retractor Angular 8mm Blade



EAR SUCTION TUBE

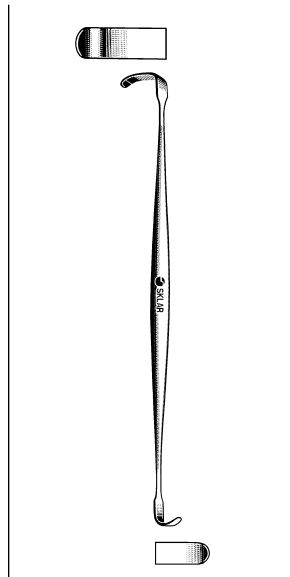
- With Two Interchangeable Tips - 20ga, 22ga
- 50-1950



SENN RETRACTOR

Double Ended

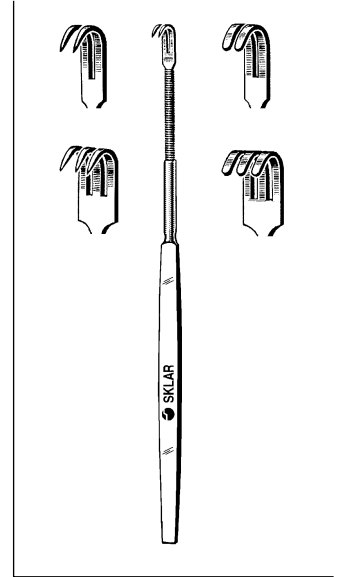
60-6162 6" Sharp
60-6164 6" Blunt



RAGNELL RETRACTOR

Double End

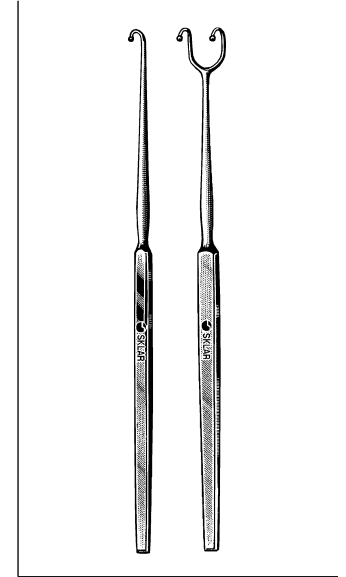
22-8560 6"



PLASTIC SURGERY RETRACTOR

6" - Flexible Shank

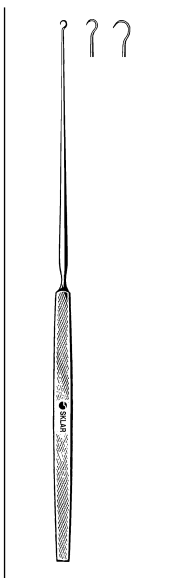
22-9132 Sharp 2 Prong
22-9133 Sharp 3 Prong
22-9142 Blunt 2 Prong
22-9143 Blunt 3 Prong



FOMON RETRACTOR

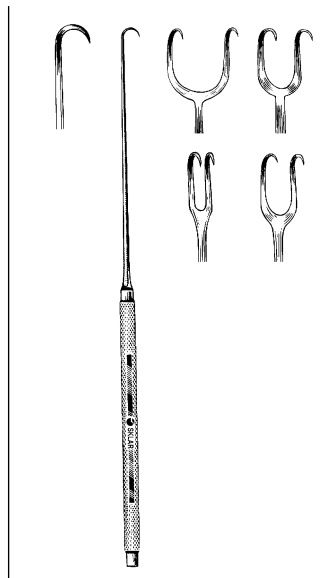
Ball End

41-1395 6 1/4" Single
41-1396 6 1/4" Double



GILLIES SKIN HOOK

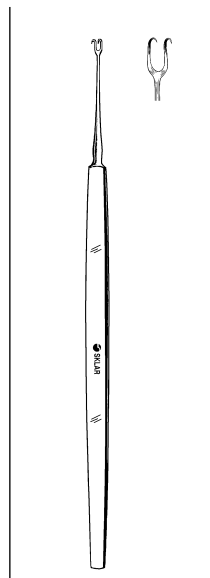
47-2570 7" 3 mm
47-2572 7" 4 mm



JOSEPH SKIN HOOK

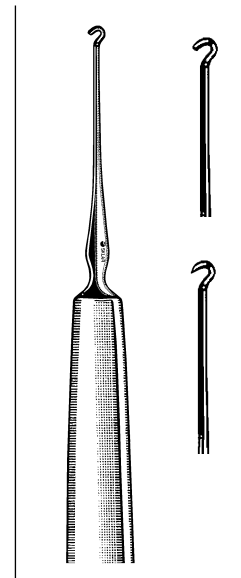
Single End

47-2500 6 1/4" 1 Sharp Prong
47-2502 6 1/4" 2 Sharp Prongs 2 mm
47-2505 6 1/4" 2 Sharp Prongs 5 mm
47-2507 6 1/4" 2 Sharp Prongs 7 mm
47-2510 6 1/4" 2 Sharp Prongs 10 mm



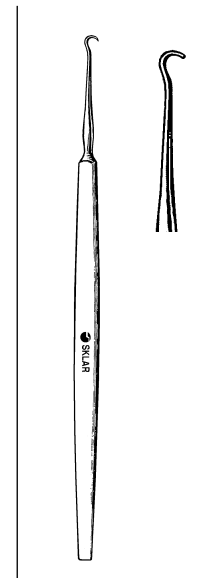
GUTHRIE DOUBLE HOOK

47-2650 5" Two Large
Sharp Prongs



TYRELL IRIS HOOK

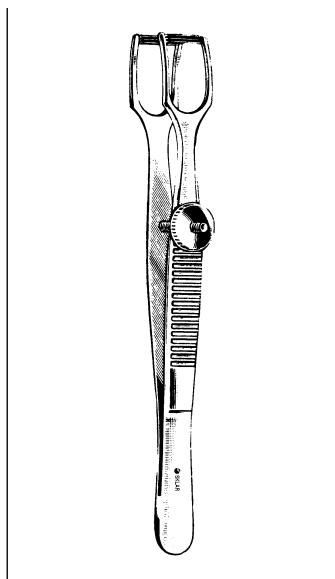
65-3205 5" Blunt
65-3206 5" Sharp



FRAZIER MICRO HOOK

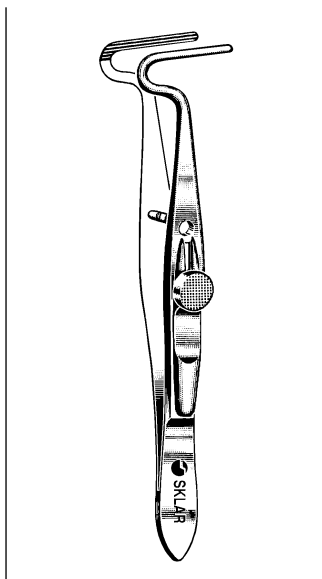
Extra Delicate
47-2555 5" Sharp
47-2556 5" Blunt

ENT/PLASTIC SURGERY FORCEPS/RULERS



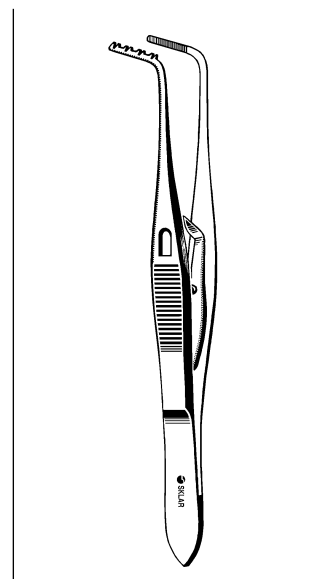
**COTTLE COLUMELLA
FORCEPS**

66-1040 4½"



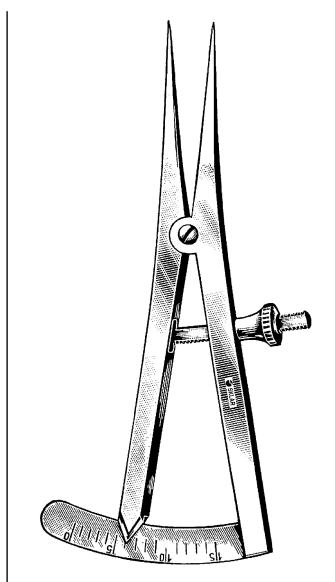
BERKE PTOSIS FORCEPS

66-6342 4¼"



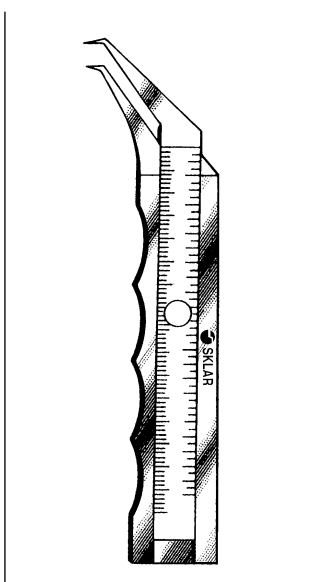
**PRINCE MUSCLE
FORCEPS**

66-5942 4¼"



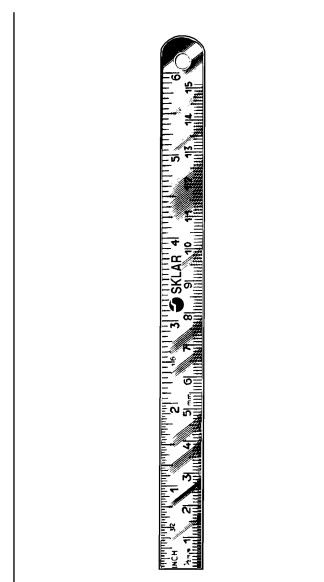
CASTROVIEJO CALIPER

65-6732 3¼"



THORPE CALIPER

Graduated in inches and mm
65-6735 4½"

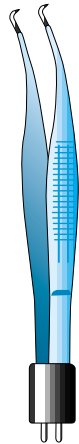


STEEL RULER

Graduated in inches and mm
06-2860 6"
06-2861 12"



ADSON FORCEP
91-6100 1mm 4¾"



COAPTATION FORCEP
91-6101 .5mm 4"



CUSHING FORCEP
91-6102 1mm 6"



GERALD BAYONET FORCEP
91-6103 1mm 7"



GERALD FORCEP
Straight
91-6104 1mm 7"



HARDY BAYONET FORCEP
Angled
91-6105 1mm 8½"



JANSEN BAYONET FORCEP
91-6106 1mm 6"



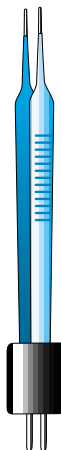
JEWELER #5 FORCEP
91-6107 .5mm 4½"



MALIS FORCEP
91-6108 1mm 7"



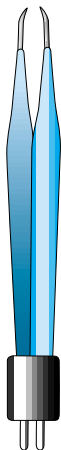
MCPHERSON FORCEP
Curved
91-6109 .5mm 3½"



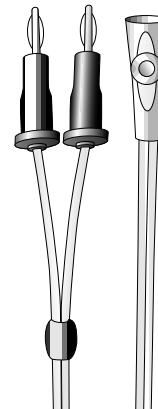
MCPHERSON FORCEP
Straight
91-6110 .5mm 3½"



SEMKIN FORCEP
91-6111 .5mm 5½"



TENZEL FORCEP
91-6112 .5mm 4"



SILICONE BIPOLAR CABLE
91-6113 10'



ELECTROSURGICAL PENCIL
w/ cut-coag finger switch
91-6114 box/10
91-6115 case/100

CAUTERIES/SURGICAL ELECTRODES



NERVE STIMULATOR/LOCATOR 96-1300 Box/10



COBALT BLUE LIGHT (A) 96-1304 **PEN LIGHT (B)** 96-1305
FOR USE WITH FLOUROSCIEIN DYE



10" FLEXIBLE SURGICAL LIGHT 96-1308 Box/10



LOW TEMPERATURE CAUTION 96-1310 Box/10
FOR USE DURING OPHTHALMIC PROCEDURES



VASECTOMY CAUTION 96-1312 Box/10



HIGH TEMPERATURE CAUTION 96-1315 Box/10



HIGH TEMPERATURE CAUTION 96-1318 Box/10
LOOP TIP



HIGH TEMPERATURE CAUTION 96-1316 Box/10
2" LOOP TIP



EXTENDED NEEDLE ELECTRODE 96-1320 Box/25



EXTENDED MODIFIED NEEDLE 96-1321 Box/25



EXTENDED BLADE ELECTRODE 96-1325 Box/25



EXTENDED MODIFIED BLADE 96-1326 Box/25



STANDARD NEEDLE ELECTRODE 96-1328 Box/25



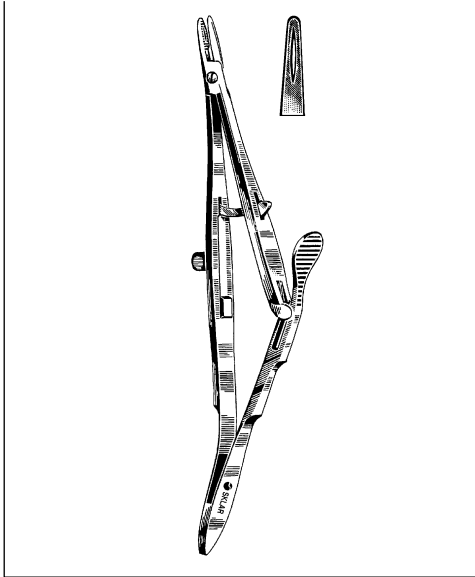
STANDARD BLADE ELECTRODE 96-1332 Box/50



MODIFIED BLADE ELECTRODE 96-1334 Box/25

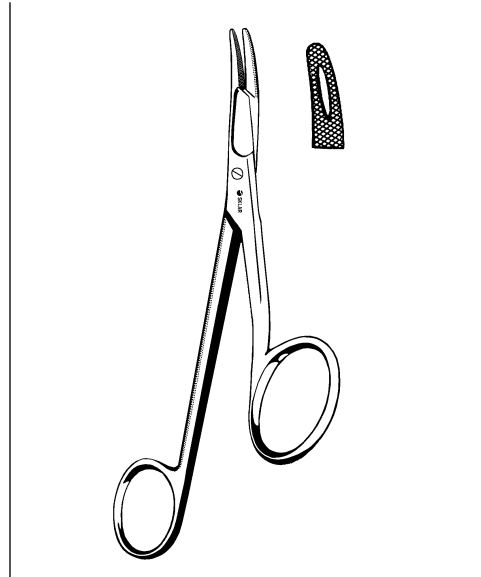


MODIFIED NEEDLE ELECTRODE 96-1336 Box/25



CASTROVIEJO-KALT NEEDLE HOLDER

65-6055 5 1/2"



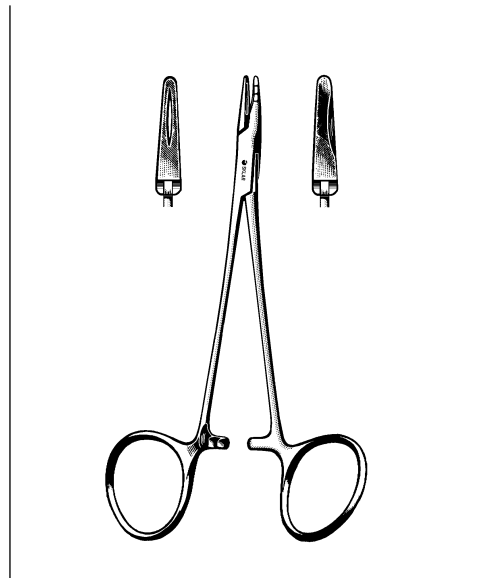
GILLIES NEEDLE HOLDER

20-2662 6" Serrated



CONVERSE NEEDLE HOLDER

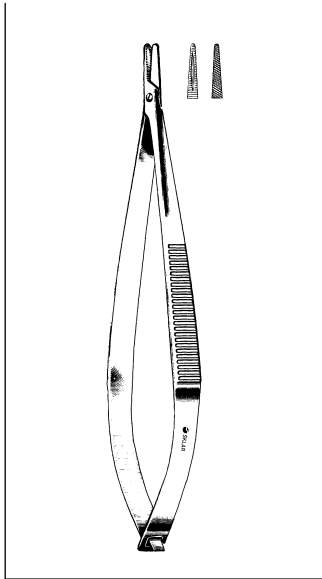
20-3350 4 1/4"



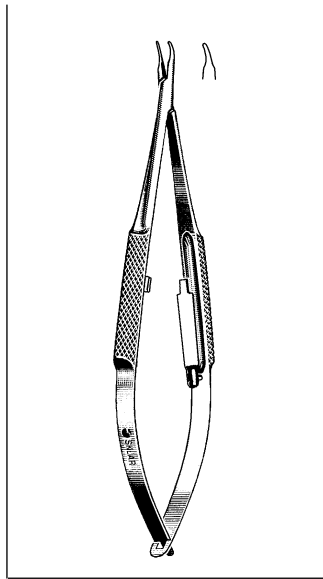
NEIVERT NEEDLE HOLDER

20-1760 5" One Offset Ring

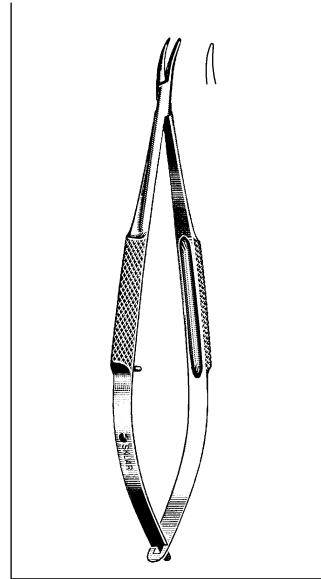
ENT/PLASTIC SURGERY SCISSORS/NEEDLE HOLDERS



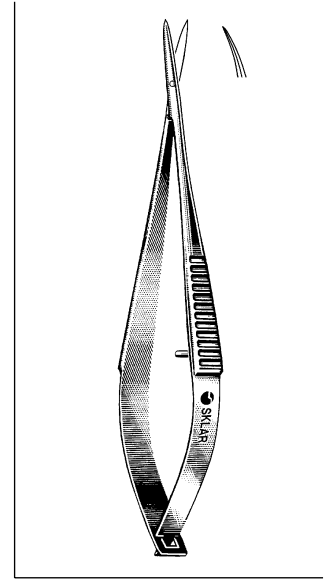
PATON NEEDLE HOLDER
65-6442 4 1/2" Straight Without Lock



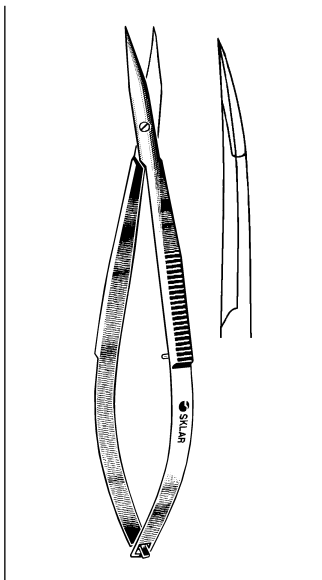
BARRAQUER NEEDLE HOLDERS
Round grip spring handle, with inside catch
65-6446 5 1/4" Delicate Curved Jaw
65-6448 5 1/4" Smooth Curved Jaw



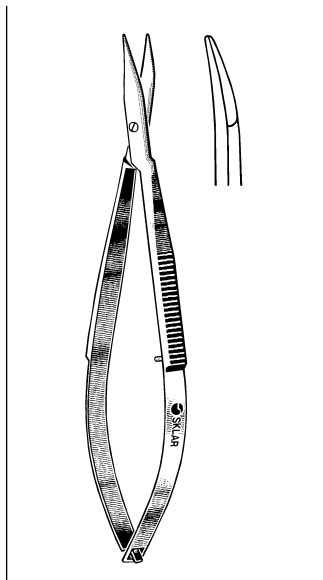
BARRAQUER NEEDLE HOLDER
Delicate curved jaw, round grip spring handle, without catch
65-6452 5 1/4"



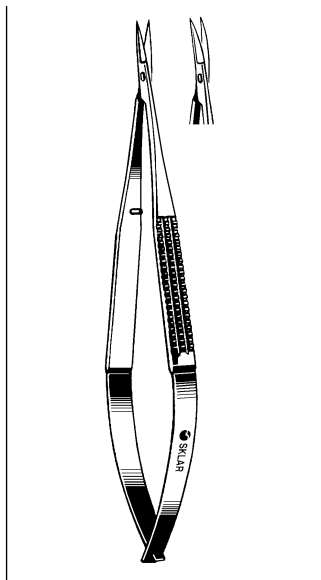
MCPHERSON-VANNAS SCISSORS
Very Delicate, Without Catch
64-1960 3" Straight
64-1961 3" Curved



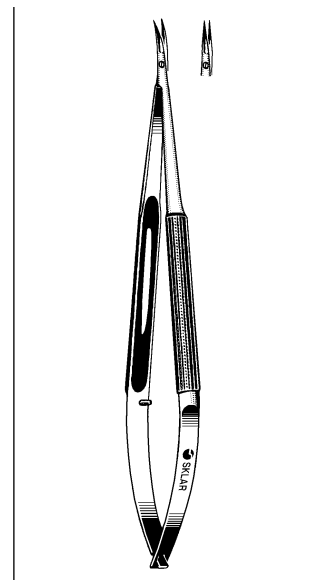
WESTCOTT TENOTOMY SCISSORS
64-3145 4 1/2" Sharp tips with spring handle



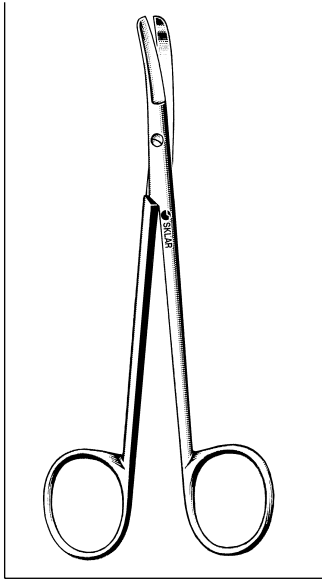
WESTCOTT TENOTOMY SCISSORS
64-3146 4 1/2" Blunt tips with spring handle



MICRO SURGERY SCISSORS
6" Sharp Points Flat Handle
98-7810 Straight
98-7812 Curved

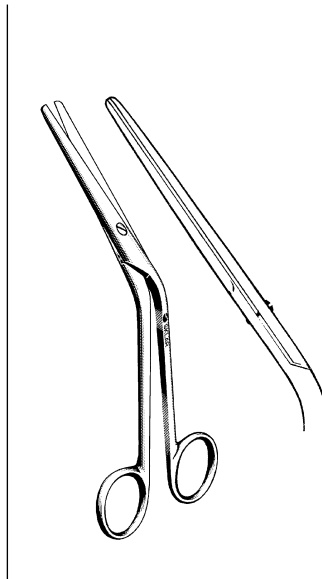


MICRO SURGERY SCISSORS
7 1/2" Round Handle
98-7816 Straight
98-7817 Curved



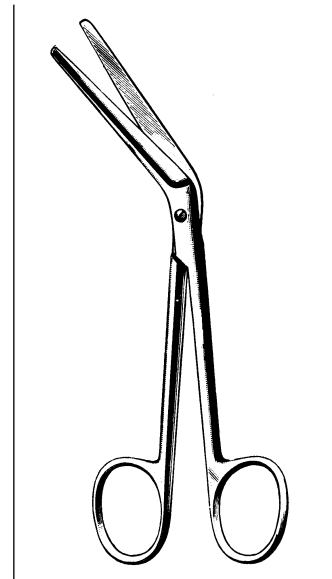
**COTTLE NASAL
SCISSORS**

Strong Short Blades
41-1168 6½" Curved



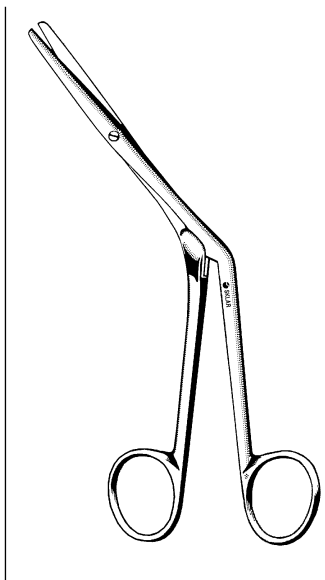
**COTTLE DORSAL
SCISSORS**

Heavy Rounded Blades
41-1169 6½" Angular



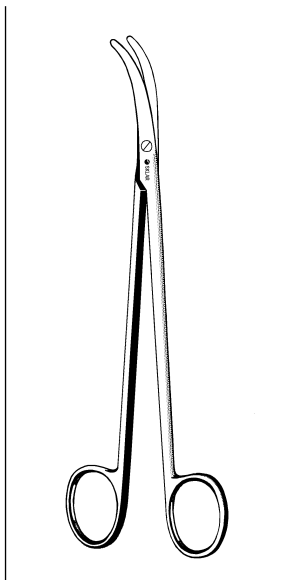
**SEILER TURBINATE
SCISSORS**

41-1165 6½" Angled On Side



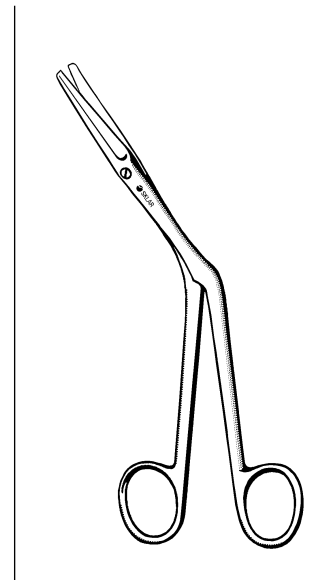
**KNIGHT NASAL
SCISSORS**

70-4262 6½"



**HALLE NASAL
SCISSORS**

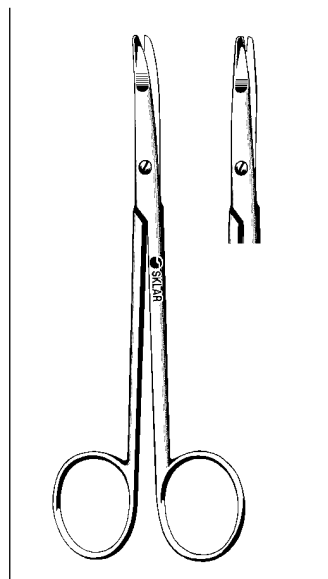
70-4265 7½" Curved



**HEYMAN NASAL
SCISSORS**

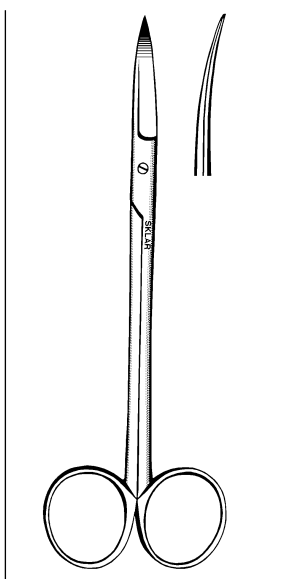
Angled on Side
70-4270 7"

ENT/PLASTIC SURGERY SCISSORS



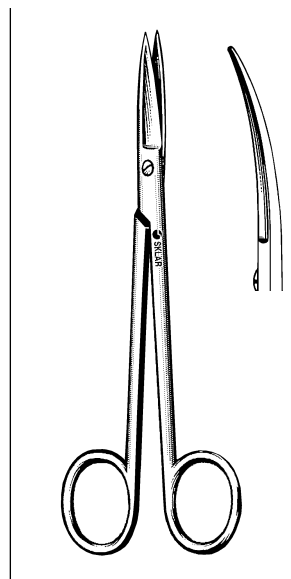
**RAGNELL DISSECTING
SCISSORS (FLAT TIPS)**

22-2652 5" Half Curved
22-2653 5" Straight



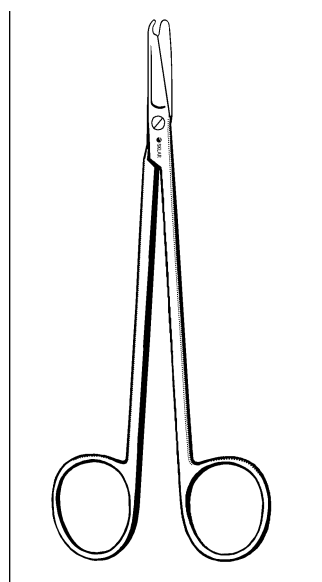
**RHYTIDECTOMY
SCISSORS**

Double Edged Blade
41-1105 6½" Curved



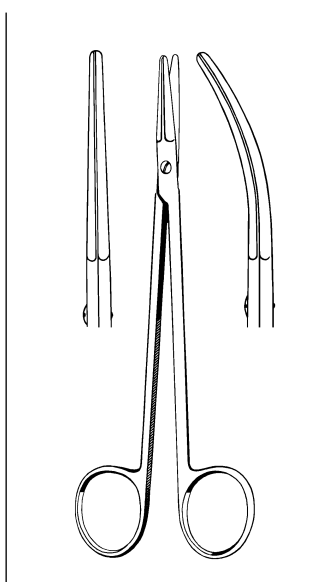
JOSEPH SCISSORS

41-1050 5¼" Straight
41-1054 5¼" Curved



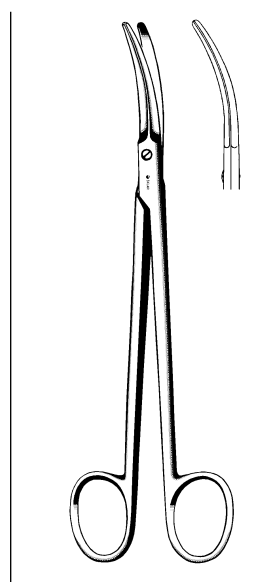
LONG STITCH SCISSORS

15-1358 6½"



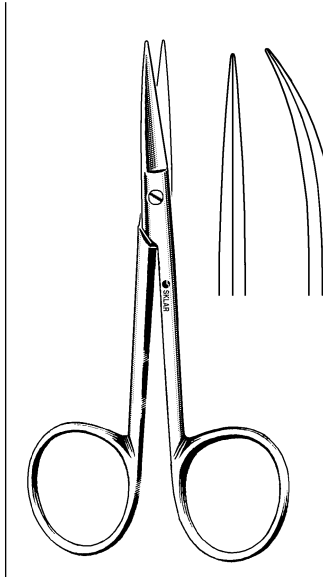
**KAHN DISSECTING
SCISSORS**

41-1132 5½" Straight
41-1134 5½" Curved
41-1136 7" Straight
41-1138 7" Curved



**LILLY DISSECTING
SCISSORS**

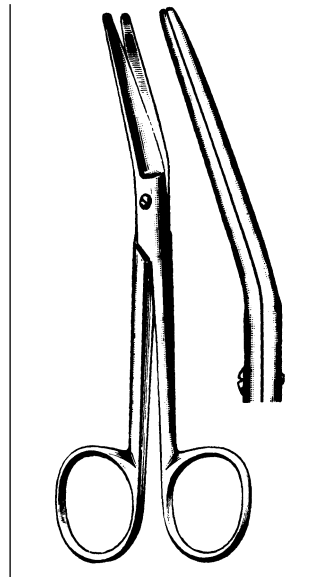
41-1147 7½" Strong Curve



SEALY DISSECTING SCISSORS

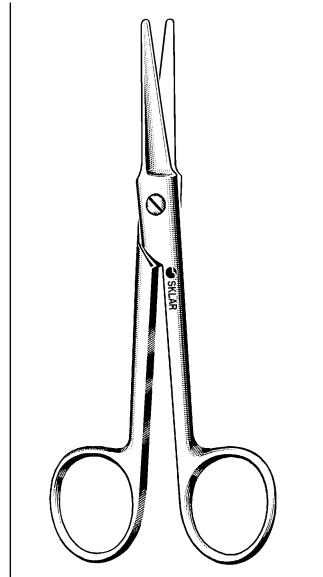
Two Blunt Tips, Medium Weight
Delicate Blades

64-3285 4 1/4" Straight
64-3288 4 1/4" Curved



NEW'S SUTURE SCISSORS

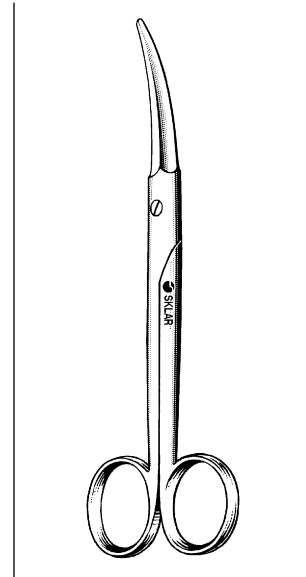
41-1163 5 1/2" Angled On Flat



BROWN DISSECTING SCISSORS

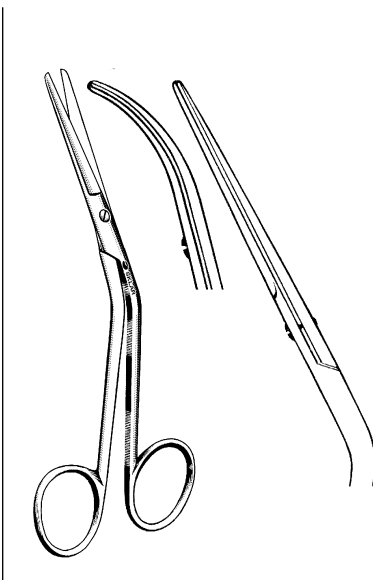
Heavy Pattern

41-1078 5 1/2" Straight
41-1079 5 1/2" Curved



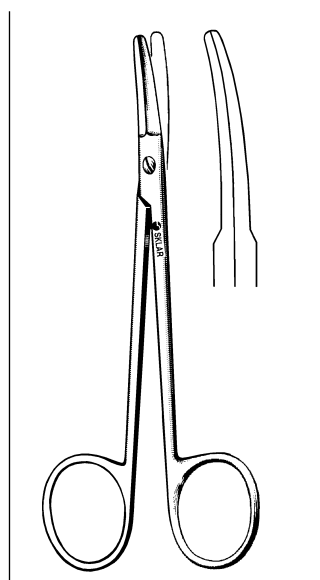
AUFRICHT FACE LIFT SCISSORS

Curved Triangular Blades
41-1167 5 1/2"



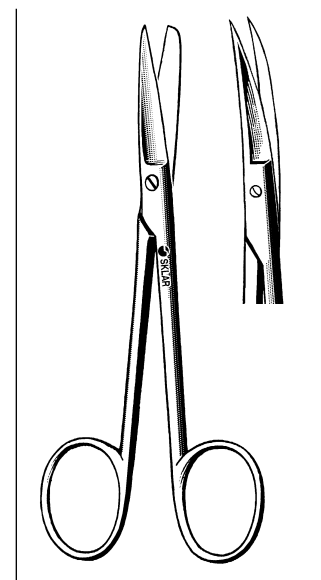
FOMON NASAL SCISSORS

70-4352 5 1/2" Lower Lateral-Curved
70-4350 5 1/2" Dorsal-Angular



FOMON SABER BACK SCISSORS

Semi Sharp Back Edges
41-1076 5 1/2" Curved

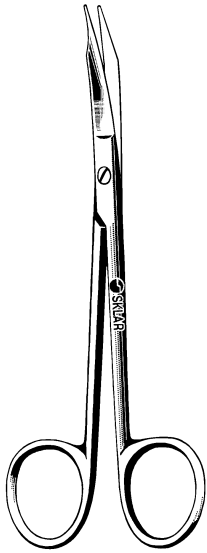


WAGNER SCISSORS

Straight, Smooth
47-1047 S/S 4 1/2"
47-1048 S/B 4 1/2"

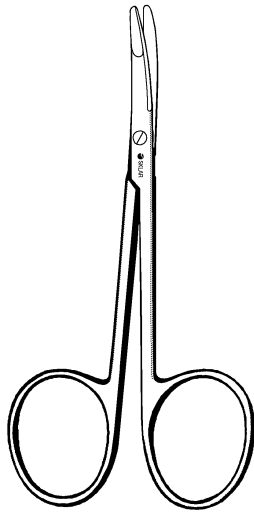
Curved, Smooth
47-1058 S/S 4 1/2"
47-1068 S/B 4 1/2"

ENT/PLASTIC SURGERY SCISSORS



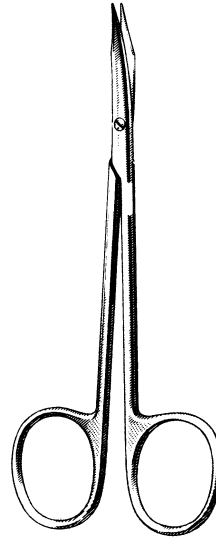
GOLDMAN-FOX SCISSORS

Curved
22-2520 5" Serrated



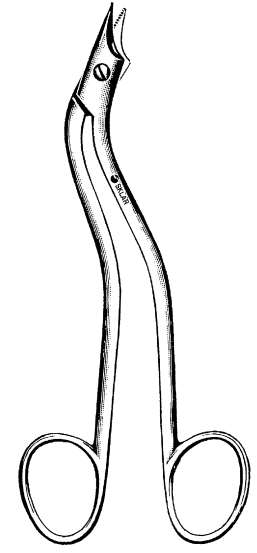
BLEPHAROPLASTY SCISSORS

Curved Flat Tips
47-1147 4 3/4" Serrated



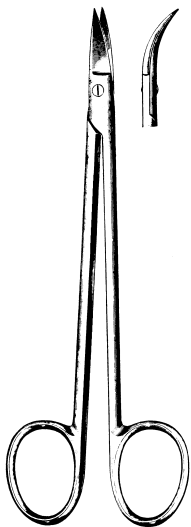
KLEINERT-KUTZ TENOTOMY SCISSORS

64-1250 5" Curved



HEATH SCISSORS

24-1962 6 1/4" Serrated



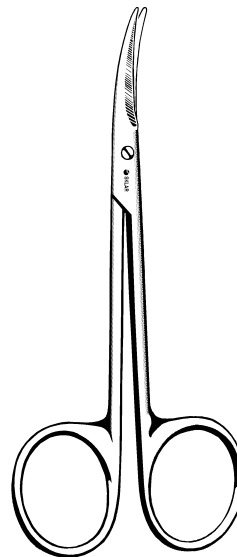
QUIMBY GUM SCISSORS

22-2750 5" Straight
22-2751 5" Curved



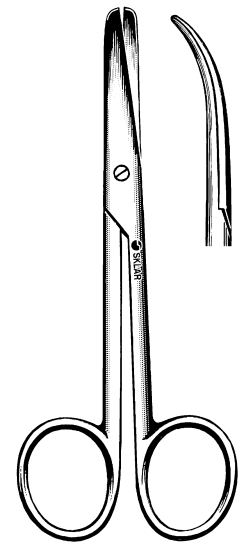
PLASTIC SURGERY SCISSORS

Curved
47-1345 4 1/2" S/S



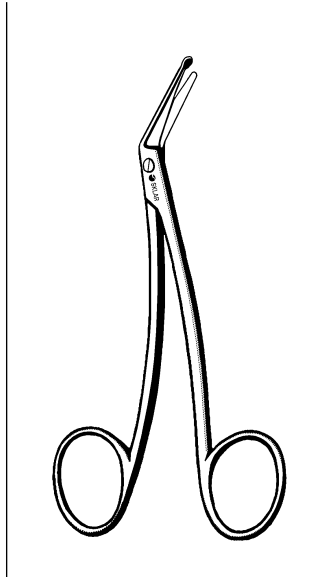
DURA SCISSORS SEMI-SHARP

Curved
22-2742 4 1/4"



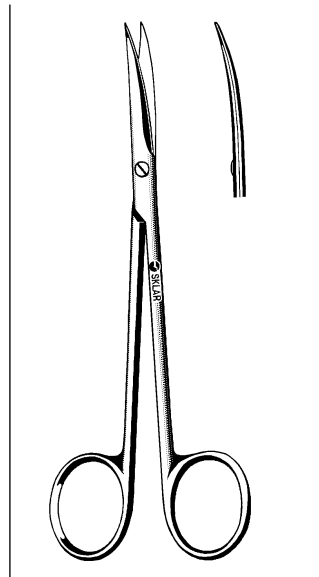
ENUCLEATION SCISSORS

64-1150 5" Curved



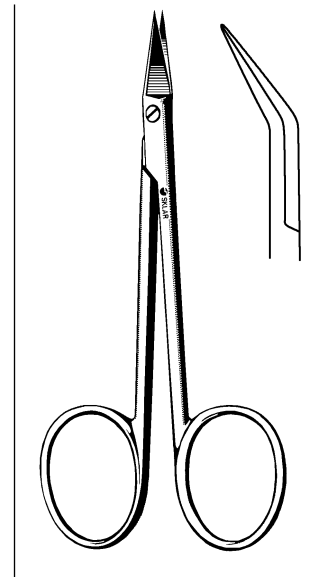
TAYLOR DURAL SCISSORS

50-4655 5½" With Probe Tip



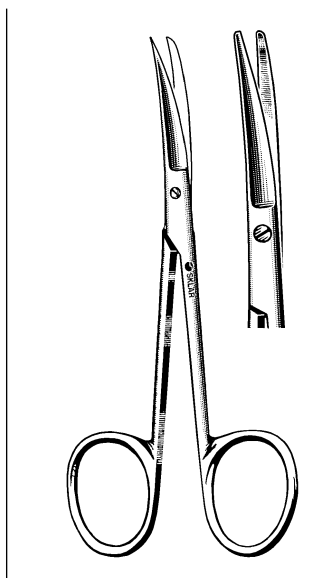
**BROPHY (SULLIVAN)
SCISSORS**

Curved Sharp Points
22-2755 5½" Serrated



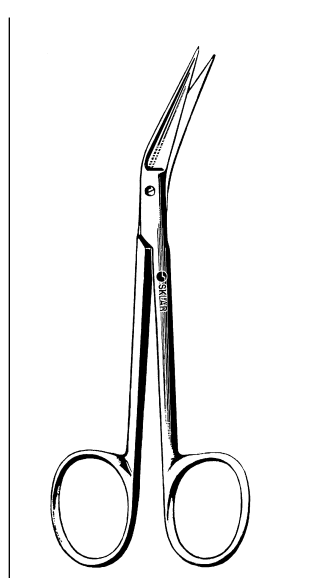
WILMER SCISSORS

Angled on Flat
64-1735 4"



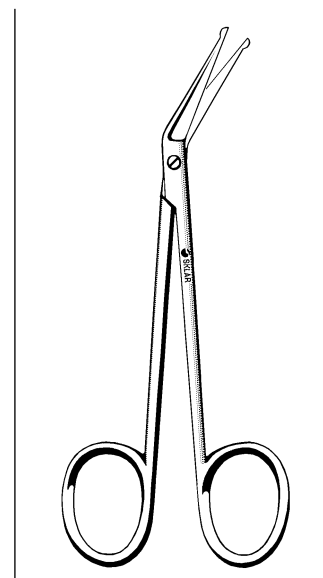
KNAPP IRIS SCISSORS

Curved
64-3230 4" Sharp/Blunt
64-3235 4" Blunt/Blunt



ANGULAR SCISSORS

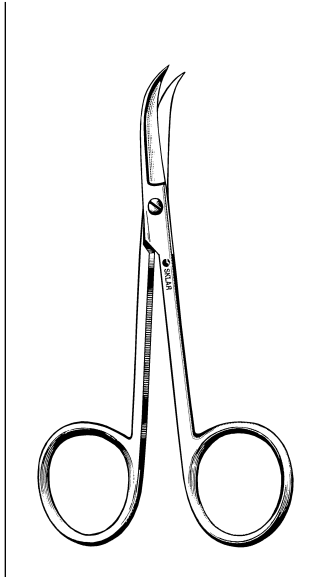
47-1080 S/S 4¾" Smooth
47-1081 S/S 4¾" Serrated



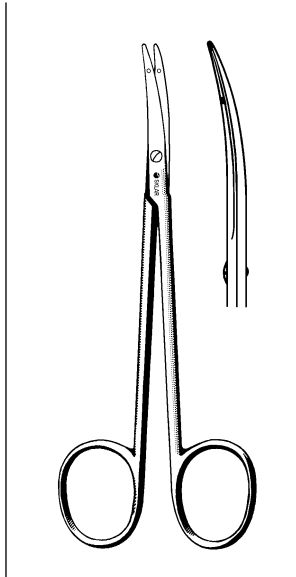
**ANGULAR IRIS SCISSORS
PROBE POINT**

64-2042 4½"

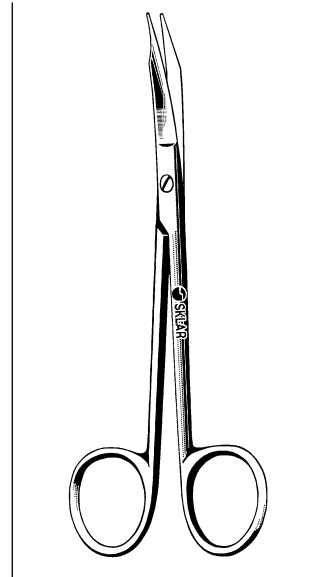
ENT/PLASTIC SURGERY SCISSORS



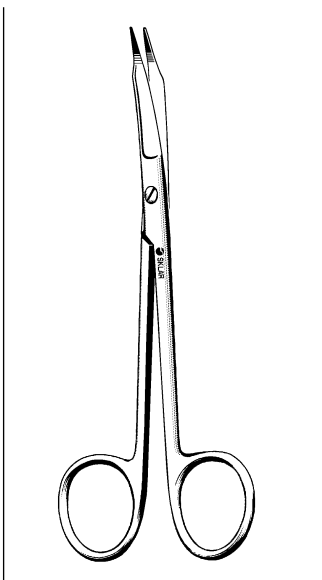
HILL SCISSORS
Sharp Points Curved Sideways
22-2955 4 3/4"



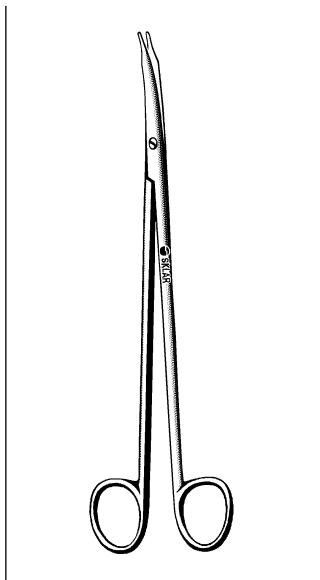
**LITTLER SUTURE
CARRYING SCISSORS**
Curved
22-2645 4 1/2"



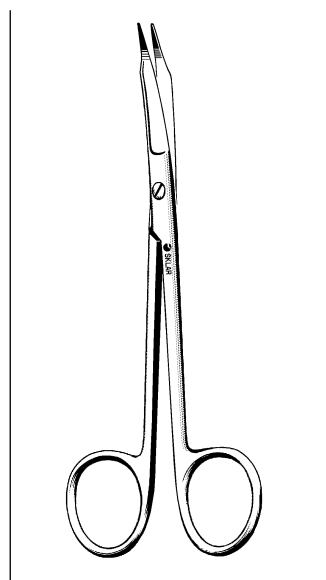
**GOLDMAN-FOX
SCISSORS**
Curved
22-2520 5" Serrated



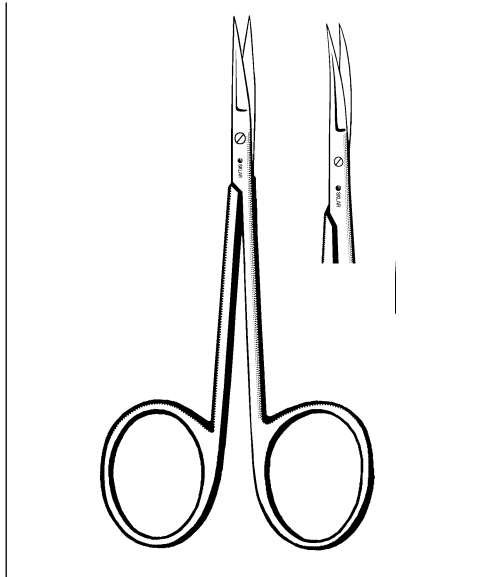
**MILLER DISSECTING
SCISSORS**
Back Edges Semi-Sharp
41-1125 5" Serrated



REYNOLDS SCISSORS
Narrow Tip, Curved
22-2760 6"
22-2762 6" Serrated

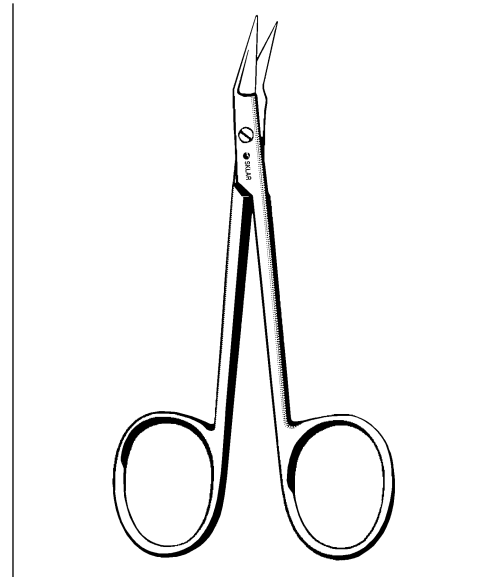


MARTIN SCISSORS
41-1120 8" Heavy Serrated, Curved



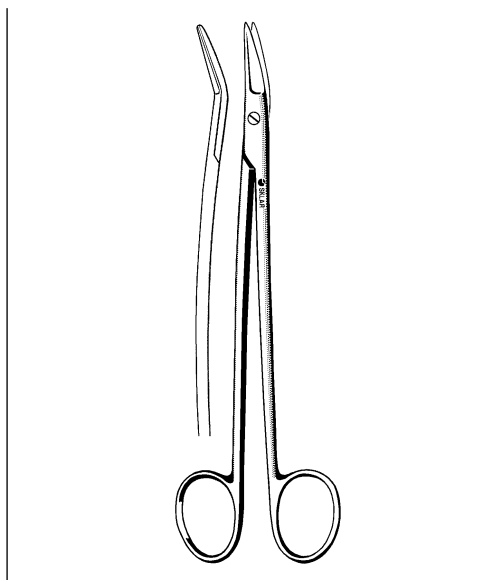
BONN MINIATURE IRIS SCISSORS

64-2035 3/2" Straight
64-2036 3/2" Curved



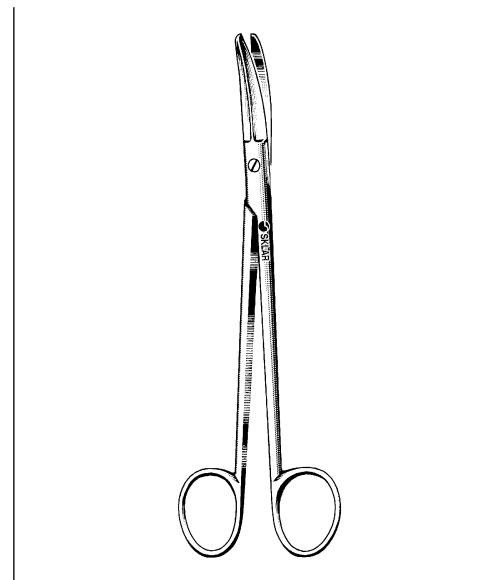
O'BRIEN STITCH SCISSORS

Angled Blade
22-2837 3/4" Straight Tips



DEAN TONSIL SCISSORS

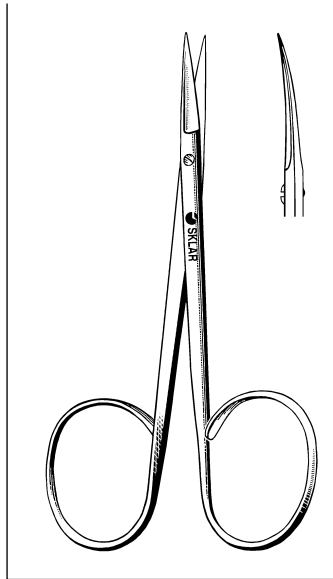
Angular Blade
75-5267 6 3/4" Serrated



BOETTCHER TONSIL SCISSORS

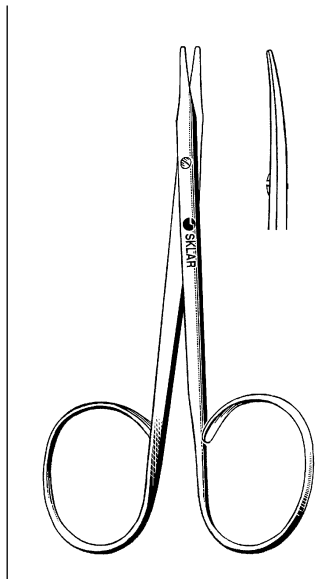
75-5070 7" Curved

ENT/PLASTIC SURGERY SCISSORS



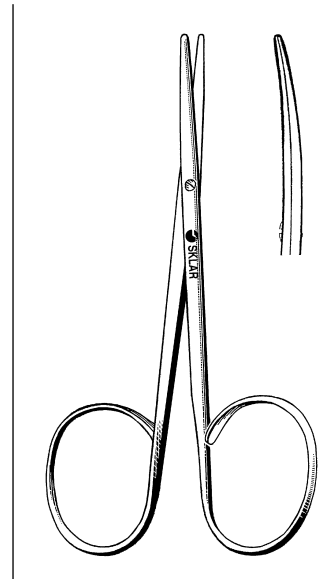
RIBBON IRIS SCISSORS

Straight 47-1250 4"
Curved 47-1255 4"



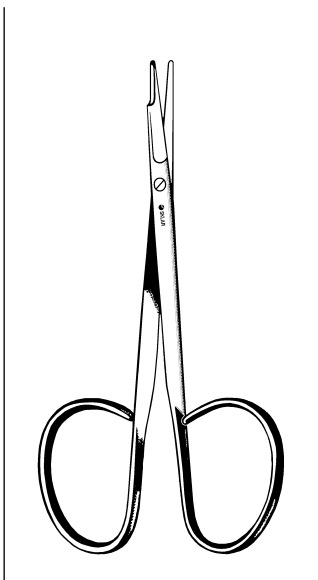
RIBBON STEVENS TENOTOMY SCISSORS

Straight 64-1241 4"
Curved 64-1341 4"



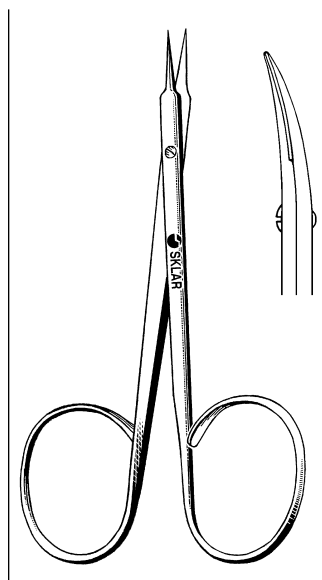
RIBBON STRABISMUS SCISSORS

Straight 64-1240 4"
Curved 64-1340 4"



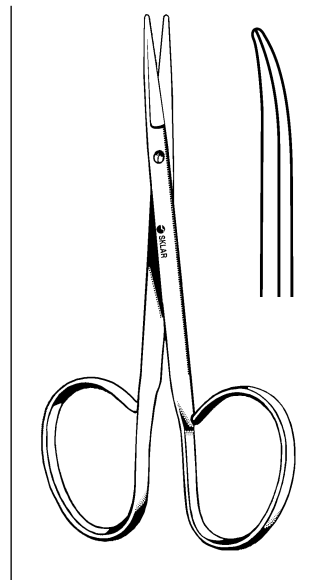
KAYE UNDERMINING RIBBON SCISSORS

47-1084 4 1/2" Straight



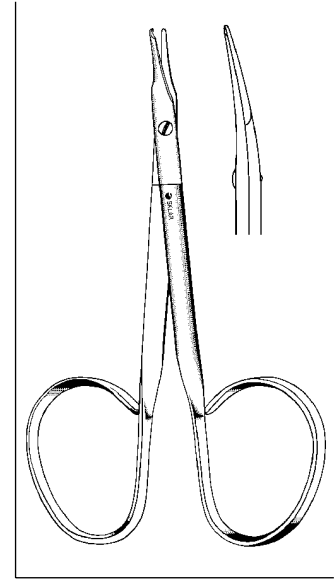
RIBBON STITCH SCISSORS

64-1345 4" Straight
64-1445 4" Curved



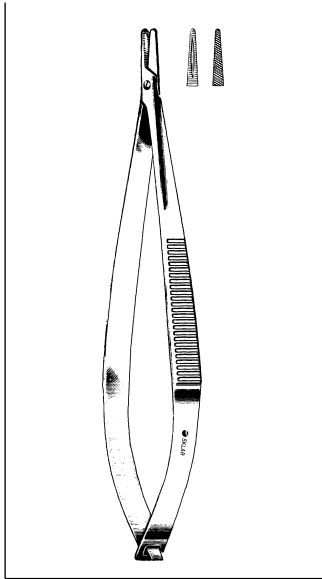
RIBBON UTILITY SCISSORS

15mm Blunt Tips
47-1146 4" Straight
47-1247 4" Curved

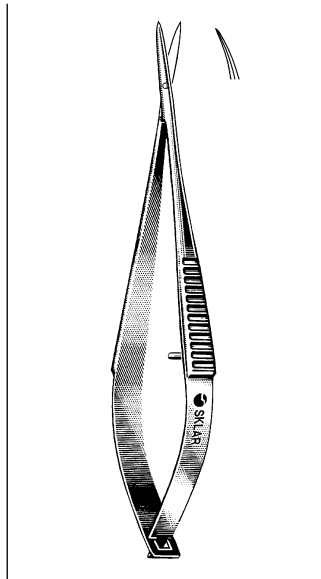


REEH STITCH SCISSORS

Sharp Tips
64-1348 3 3/4" Small Hook At
End Of One Blade



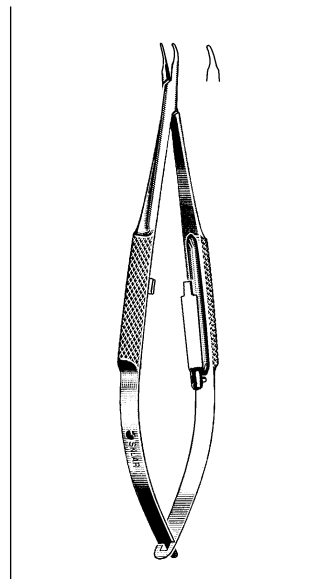
PATON NEEDLE HOLDER
65-6442 4½" Straight Without Lock



**McPHERSON-VANNAS
SCISSORS**

Very Delicate

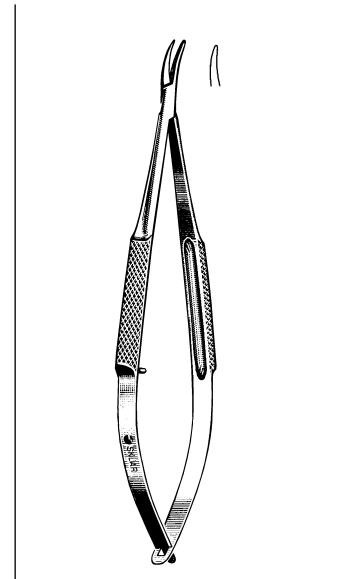
64-1960 3" Straight
64-1961 3" Curved



**BARRAQUER NEEDLE
HOLDERS**

Round grip spring handle, with inside
catch

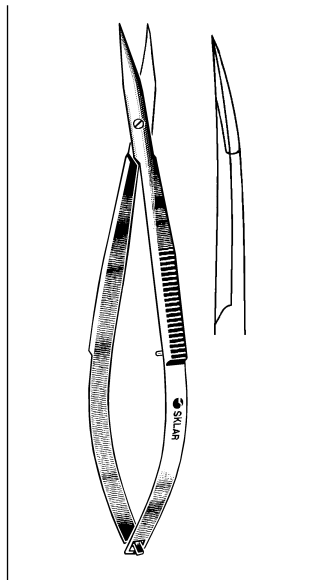
65-6446 5¼" Delicate Curved Jaw
65-6448 5¼" Smooth Curved Jaw



**BARRAQUER NEEDLE
HOLDER**

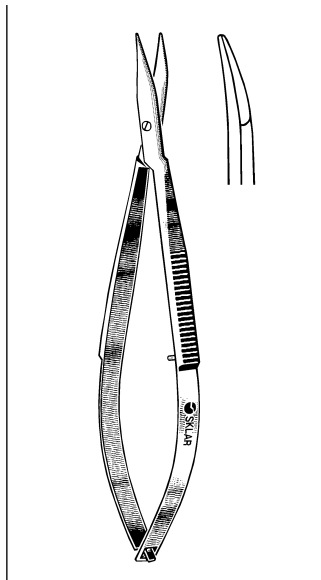
Delicate curved jaw, round grip spring
handle, without catch

65-6452 5¼"



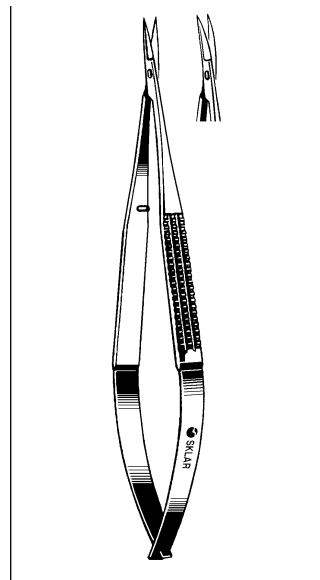
**WESTCOTT TENOTOMY
SCISSORS**

64-3145 4¼" Sharp tips with
spring handle



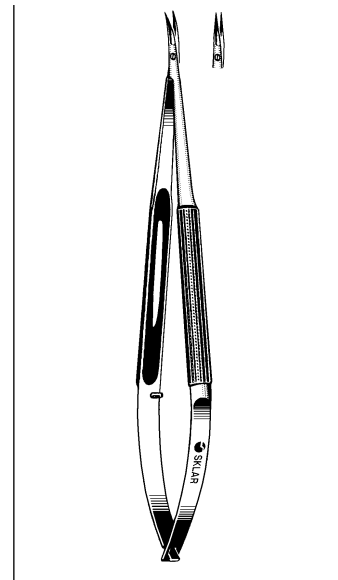
**WESTCOTT TENOTOMY
SCISSORS**

64-3146 4¼" Blunt tips with
spring handle



**MICRO SURGERY
SCISSORS**

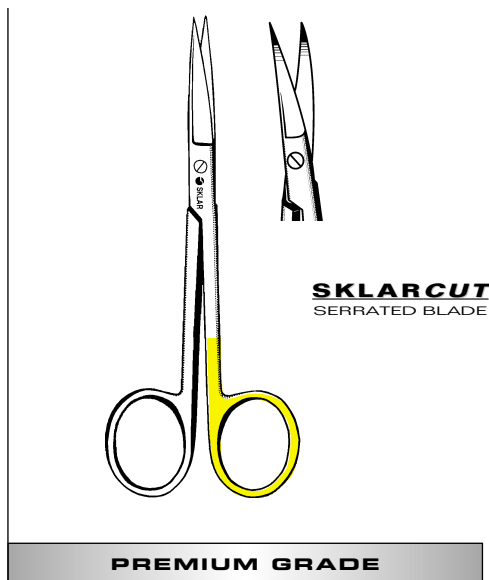
6" Sharp Points Flat Handle
98-7810 Straight
98-7812 Curved



**MICRO SURGERY
SCISSORS**

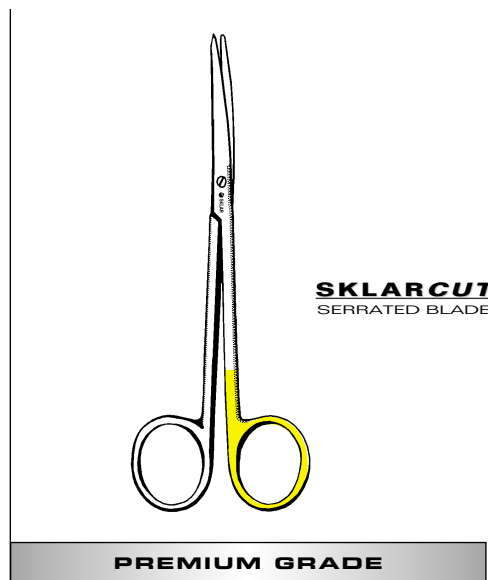
7½" Round Handle
98-7816 Straight
98-7817 Curved

ENT/PLASTIC SURGERY SKLARCUT SCISSORS



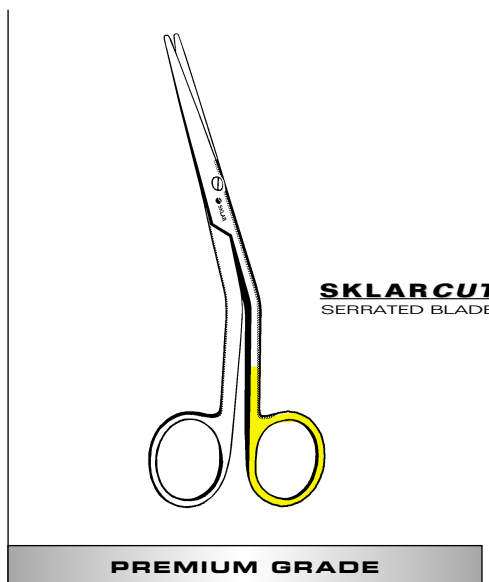
SKLARCUT™ PLASTIC SURGERY SCISSORS

15-3520 4 1/2" Straight
15-3525 4 1/2" Curved



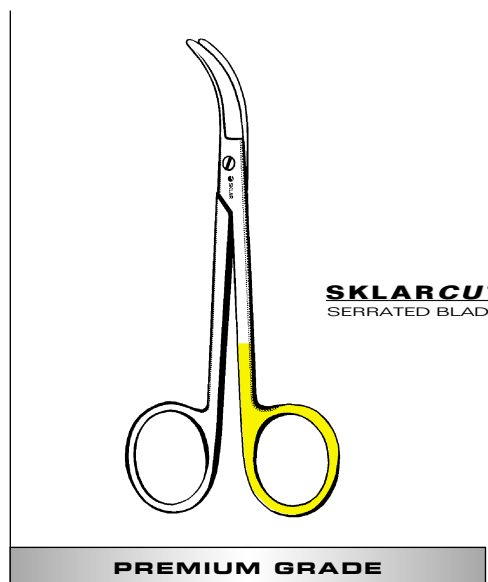
SKLARCUT™ PLASTIC SURGERY SCISSORS

15-3530 4 1/2" Straight
15-3535 4 1/2" Curved



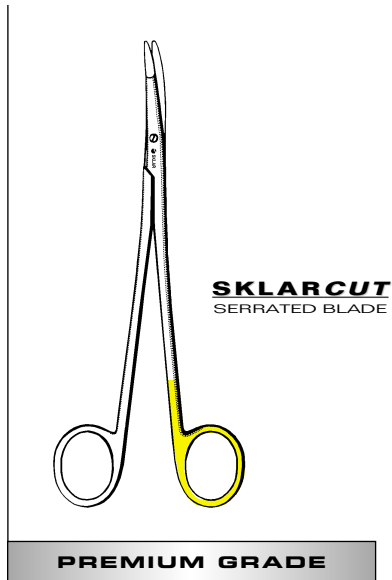
SKLARCUT™ COTTLE DORSAL SCISSORS

Angled on Flat
15-3547 6 1/2"



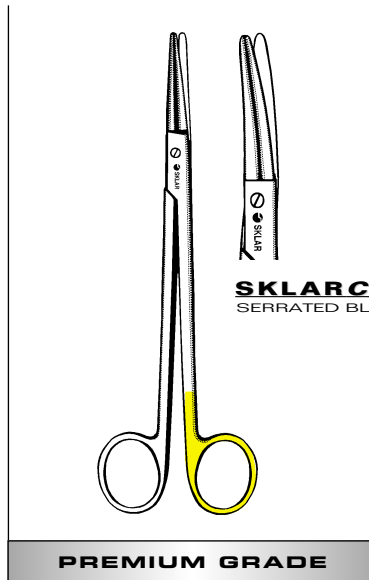
SKLARCUT™ FOMON LATERAL SCISSORS

Full Curved
15-3548 5"



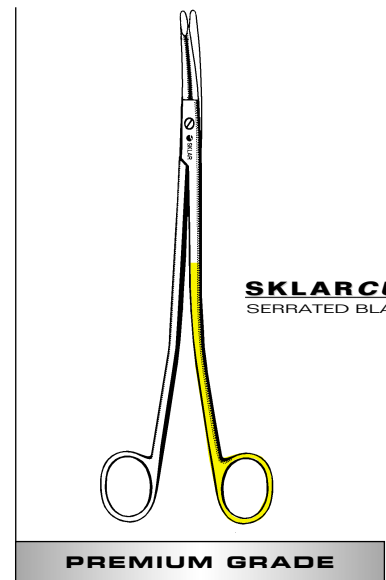
SKLARCUT™ RHYTIDECTOMY SCISSORS

Curved with flat tips, Delicate
15-3576 6½" Curved



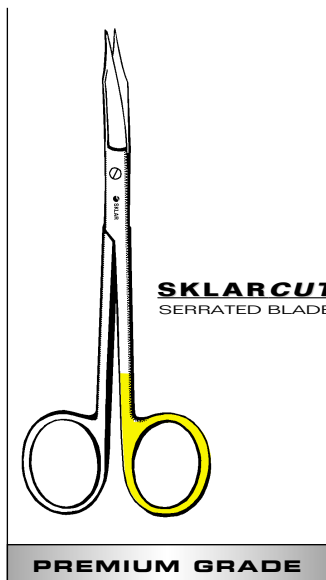
SKLARCUT™ GORNEY PLASTIC SURGERY SCISSORS

Bevelled blades have semi-sharp outer edges
15-3577 7¼" Straight
15-3578 7¼" Curved



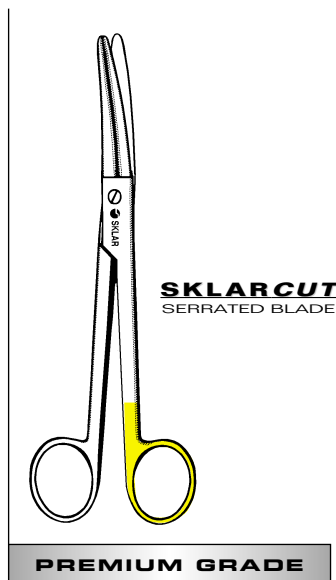
SKLARCUT™ KELLY PLASTIC SURGERY SCISSORS, DELICATE

Semi-sharp outer edges with flat, tapered tips
15-3572 9" Curved



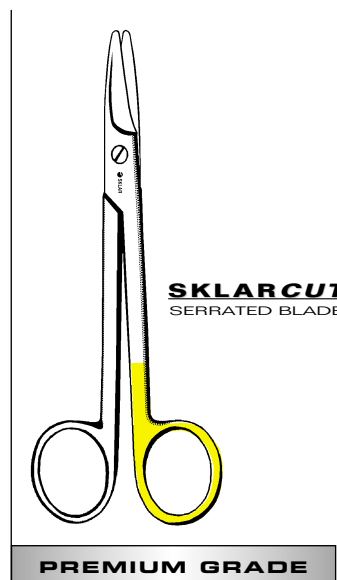
SKLARCUT™ GOLDMAN-FOX SCISSORS

15-3536 5"



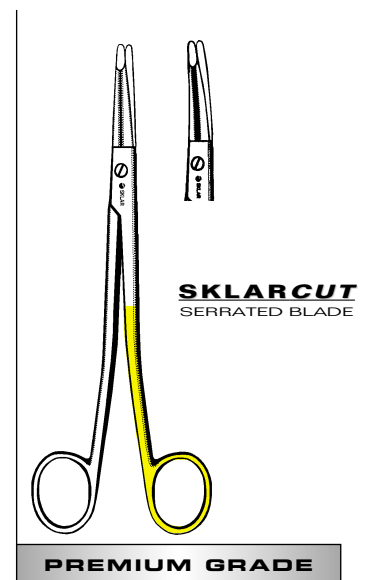
SKLARCUT™ KAYE FACE LIFT SCISSORS

Curved
15-3579 6"
15-3580 7½"



SKLARCUT™ CASTANARES FACE LIFT SCISSORS

Straight
15-3549 6¼"



SKLARCUT™ GORNEY FACE LIFT SCISSORS

Semi-sharp outer edges with flat, tapered tips
15-3583 7½" Straight
15-3584 7½" Curved

PLASTIC SURGERY LIPO-SUCTION CANNULA



LIPO-SUCTION CANNULA

One Central Hole

Fork Shape, Rounded Tips, Dissector Between Tips

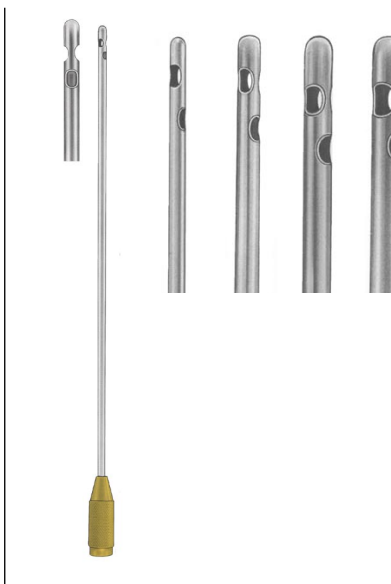
47-5010	2mm - 2"	47-5014	3mm - 11 $\frac{3}{4}$ "
47-5011	2mm - 6"	47-5015	4mm - 2"
47-5012	3mm - 2"	47-5016	4mm - 10"
47-5019	3mm - 6"	47-5017	4mm - 11 $\frac{3}{4}$ "
47-5013	3mm - 10"	47-5018	5mm - 11 $\frac{3}{4}$ "



LIPO-SUCTION CANNULA

One High Central Hole, Two Lateral Holes

47-5020	3mm - 8"
47-5021	3mm - 11 $\frac{3}{4}$ "
47-5022	4mm - 11 $\frac{3}{4}$ "
47-5023	5mm - 11 $\frac{3}{4}$ "
47-5024	6mm - 11 $\frac{3}{4}$ "



LIPO-SUCTION CANNULA

Two Lateral Holes, One Lower Central Hole

47-5030	3mm - 8"	47-5033	5mm - 11 $\frac{3}{4}$ "
47-5031	3mm - 11 $\frac{3}{4}$ "	47-5034	6mm - 11 $\frac{3}{4}$ "
47-5032	4mm - 11 $\frac{3}{4}$ "		



LIPO-SUCTION CANNULA

One Oval Central Hole, Two Lateral Holes

47-5035	4mm - 11 $\frac{3}{4}$ "
47-5036	5mm - 11 $\frac{3}{4}$ "



LIPO-SUCTION CANNULA

Three Holes, Diagonal

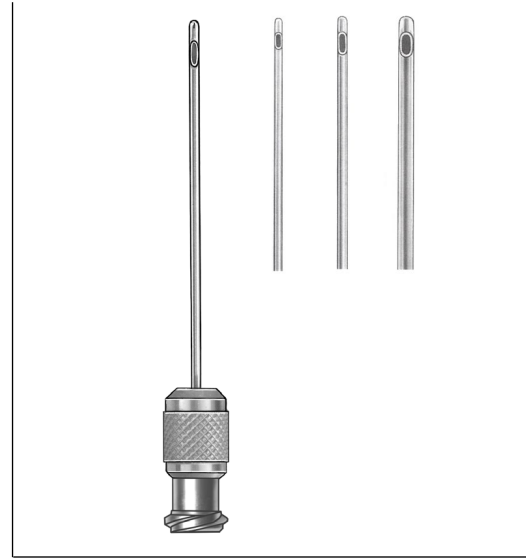
47-5040	3mm - 8"	47-5043	4mm - 15 $\frac{3}{4}$ "
47-5041	3mm - 11 $\frac{3}{4}$ "	47-5044	5mm - 11 $\frac{3}{4}$ "
47-5042	4mm - 11 $\frac{3}{4}$ "	47-5045	6mm - 11 $\frac{3}{4}$ "



LIPO-SUCTION CANNULA

One Lateral Hole

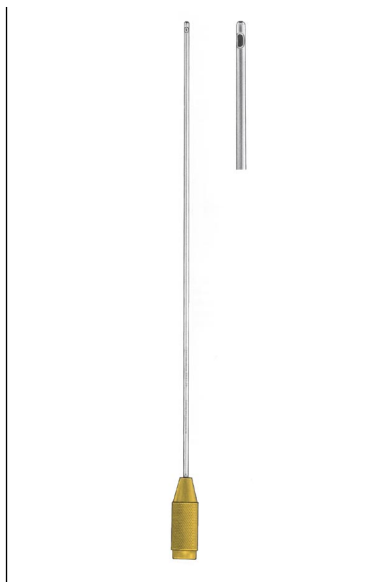
47-5046	1.5mm - 2"	47-5049	1.5mm - 6"
47-5047	2mm - 2"	47-5050	2mm - 6"
47-5048	3mm - 2"	47-5051	3mm - 6"



LIPO-SUCTION CANNULA

One Lateral Hole/With Luer-Lock Connector
For Fine Proportioning in Facial Sections

47-5060	1.5 mm - 2"	47-5163	1.5 mm - 6"
47-5061	2 mm - 2"	47-5164	2 mm - 6"
47-5162	3 mm - 2"	47-5165	3 mm - 6"



LIPO-SUCTION CANNULA

Tip With Hole, One Lateral Hole

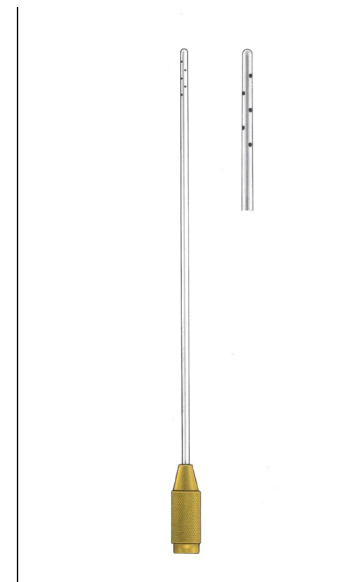
47-5058	3mm - 8"
47-5059	3mm - 11 1/4"



LIPO-SUCTION CANNULA

Open End

47-5055	6mm - 11 1/4"
47-5056	6mm - 13 3/4"



LIPO-SUCTION CANNULA

For Infiltration

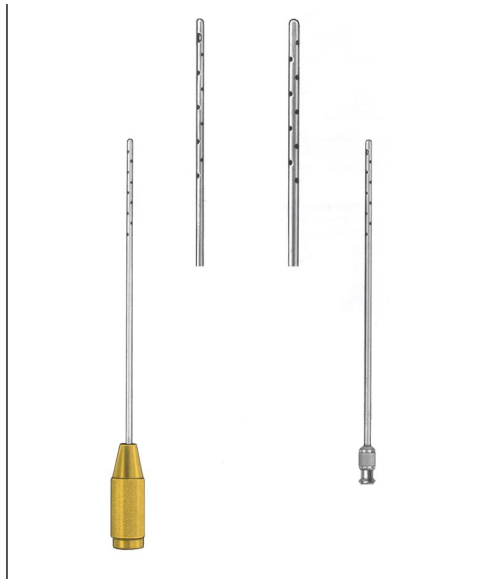
47-5057	3mm - 10"
---------	-----------

Cannula with Luer-Lock connector is for vacuum syringes with corresponding connection. Cannula with Handle Connector is for pumps with handle shown on page 315 or with disposable syringes.

PLASTIC SURGERY

LIPO-SUCTION CANNULA

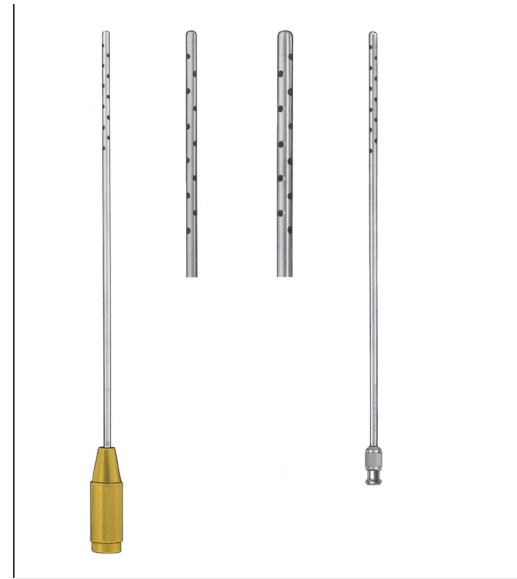
Tumescent Local Anesthesia Technique



LIPO-SUCTION CANNULA

Eighteen Hole

- 47-5062 2mm - 6" - Handle Connector
- 47-5063 3mm - 6" - Handle Connector
- 47-5064 2mm - 6" - Luer-Lock Connector
- 47-5065 3mm - 6" - Luer-Lock Connector



LIPO-SUCTION CANNULA

Twenty-Two Hole

- 47-5066 3mm - 8" - Handle Connector
- 47-5067 4mm - 8" - Handle Connector
- 47-5068 3mm - 8" - Luer-Lock Connector
- 47-5069 4mm - 8" - Luer-Lock Connector



LIPO-SUCTION CANNULA

Twenty-Two Hole, Angled

- 47-5070 3mm - 8" - Handle Connector
- 47-5072 3mm - 8" - Luer-Lock Connector



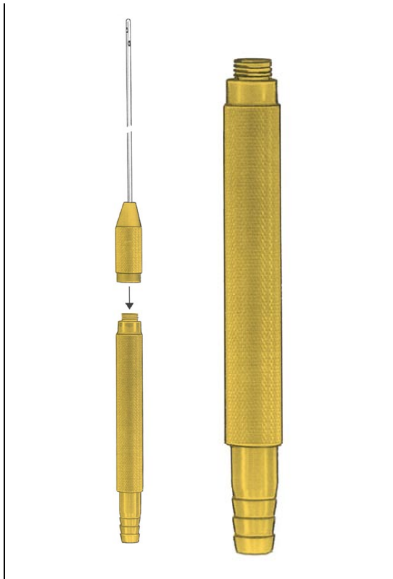
LIPO-SUCTION CANNULA

Thirty Hole

- 47-5074 3mm - 11 $\frac{3}{4}$ " - Handle Connector
- 47-5075 4mm - 11 $\frac{3}{4}$ " - Handle Connector
- 47-5076 3mm - 11 $\frac{3}{4}$ " - Luer-Lock Connector
- 47-5077 4mm - 11 $\frac{3}{4}$ " - Luer-Lock Connector

Cannula with Luer-Lock connector is for vacuum syringes with corresponding connection. Cannula with Handle Connector is for pumps with handle shown on page 315 or with disposable syringes.

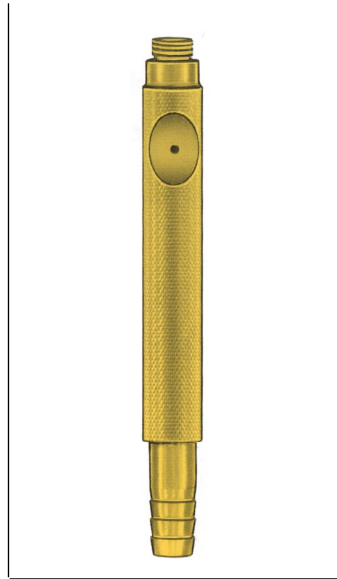
PLASTIC SURGERY LIPO-SUCTION HANDLES AND ACCESSORIES



LIPO-SUCTION HANDLE

With Connection Thread For Cannulas
And a 13mm Hose Connection For Operation
With a Suction Pump

47-5080

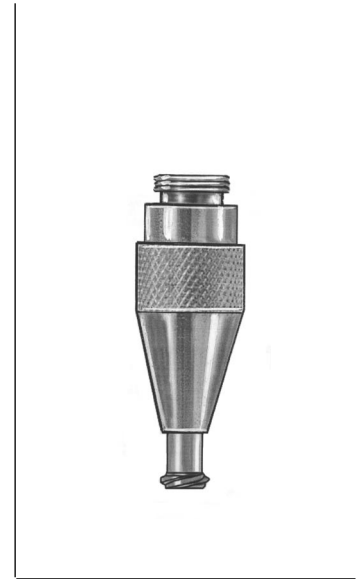


SUCTION HANDLE

With Connection Thread For Cannulas
And a 13mm Hose Connection For Operation
With a Suction Pump

Hole For Interruption Of Suction
Especially Developed For Tumescence Technique

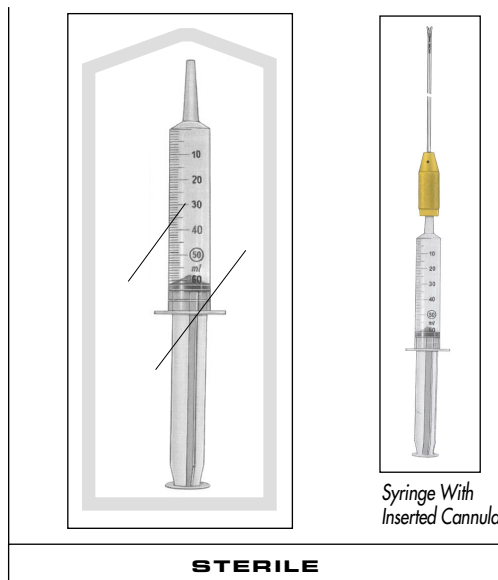
47-5082



LUER-LOCK ADAPTER

For Use On Cannulas With Handle
Connector Or Luer-Lock Syringes

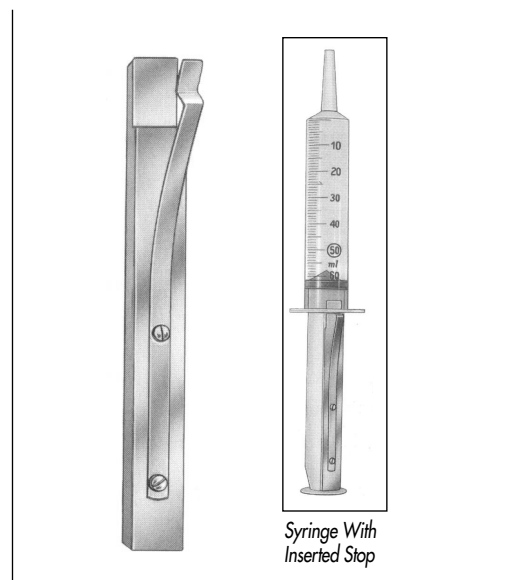
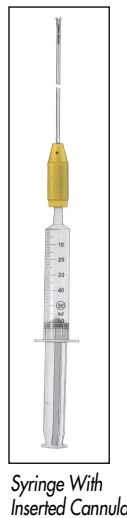
47-5090



PLASTIC SYRINGE, DISPOSABLE

50/60 ml

47-5084 Package Of 60

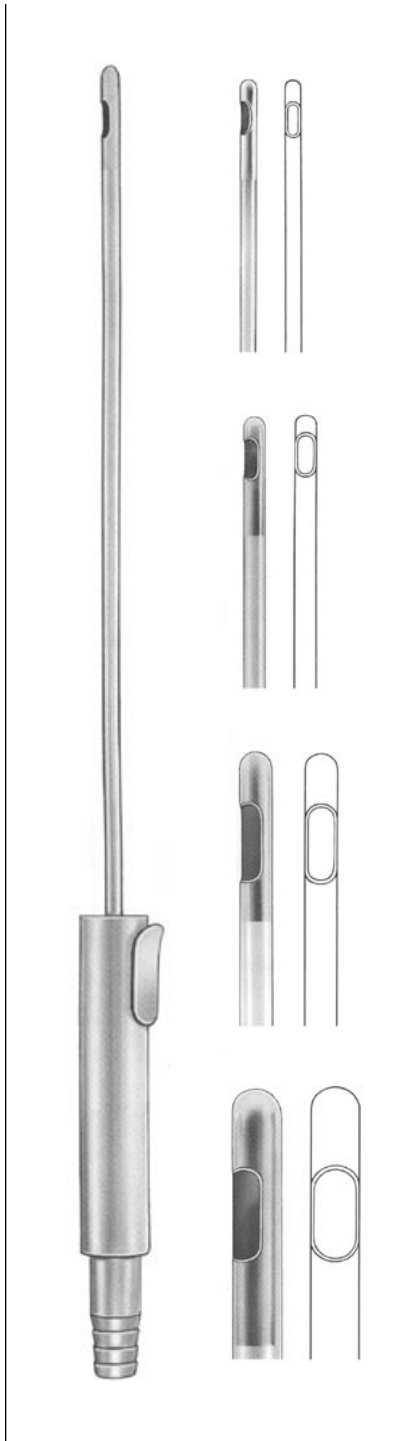


ALUMINUM STOP

Maintains Vacuum In The Syringe

47-5085

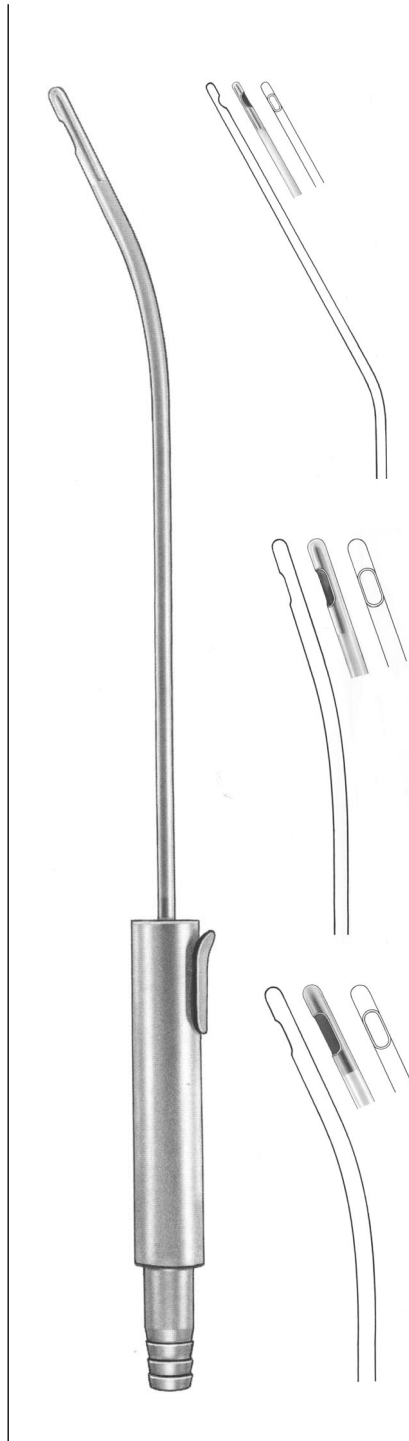
PLASTIC SURGERY LIPO-SUCTION CANNULA



LIPO-SUCTION CANNULA

One Central Hole

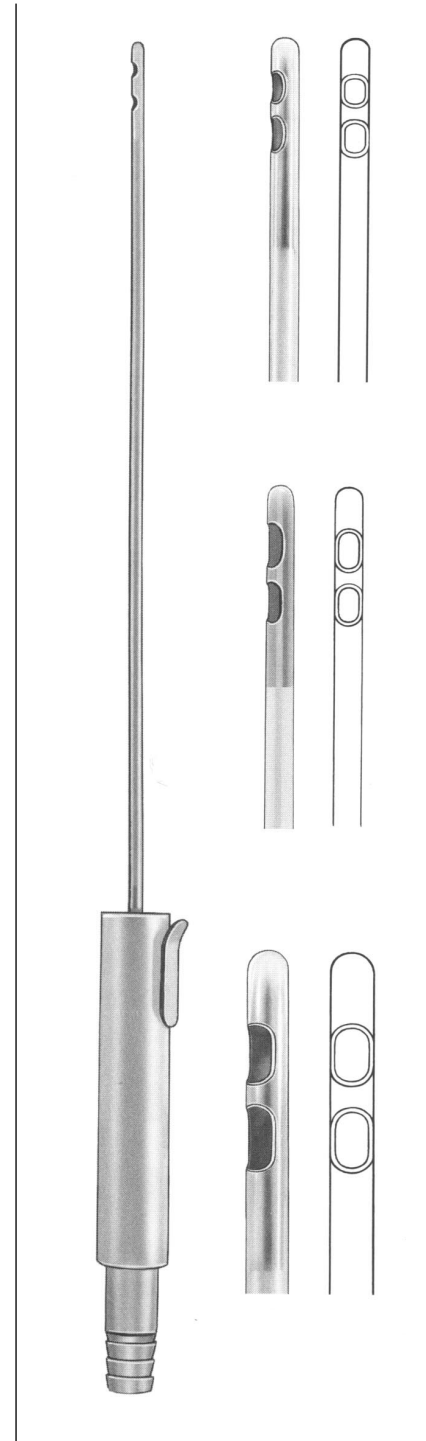
47-5100	3mm - 6"
47-5101	4mm - 10"
47-5102	6mm - 6"
47-5103	6mm - 10"
47-5104	9mm - 11¾"



LIPO-SUCTION CANNULA

One Central Hole, Angled

47-5106	3mm - 6"
47-5107	6mm - 6"
47-5108	6mm - 10"

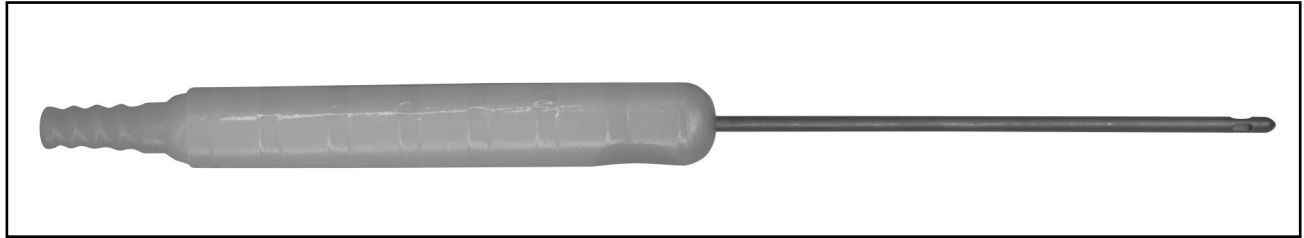


LIPO-SUCTION CANNULA

Two Central Holes

47-5110	4mm - 6"
47-5112	4mm - 10"
47-5114	6mm - 11¾"

One Piece Cannula With Thumbplate And Hose Connection



**SURGICAL GRADE STAINLESS STEEL CANNULA/TIP
WITH EASY-GRIP PLASTIC HANDLE**



TIP #1 Sterile, Box/10 Three (3) eyelets near the bullet shape tip. Each are equally spaced and equidistant from the tip.



TIP #2 Sterile, Box/10 Also Three (3) eyelets but positioned in a triangular pattern near the tip.

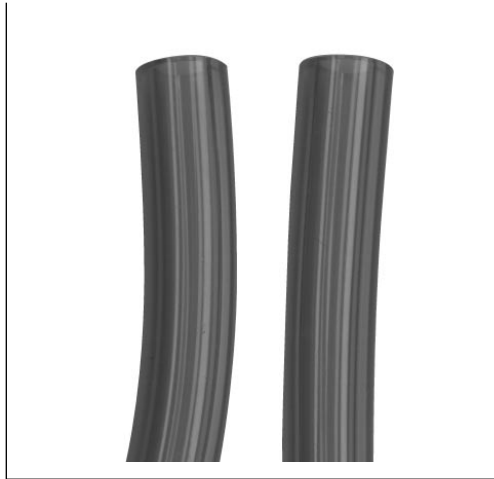


TIP #3 Sterile, Box/10 This cannula tip resembles a spatula and has a single eyelet.

DISPOSABLE

CANNULA DIMENSIONS	TIP #1	TIP #2	TIP #3
3 mm x 15 cm	96-2040	96-2050	96-2060
3 mm x 26 cm	96-2041	96-2051	
4 mm x 15 cm	96-2042	96-2052	96-2062
4 mm x 26 cm	96-2043	96-2053	
4 mm x 32 cm	96-2044	96-2054	
5 mm x 26 cm	96-2045	96-2055	
5 mm x 32 cm	96-2046	96-2056	
6 mm x 26 cm	96-2047	96-2057	
6 mm x 32 cm	96-2048	96-2058	
6 mm x 15 cm			96-2069

PLASTIC SURGERY LIPO-SUCTION, DISPOSABLE



LIPOSUCTION TUBING, DISPOSABLE

Sterile, Box/10

96-2020 Thick Wall Design To Accommodate Full Suctioning,
Each Tube Is 8'



INFILTRATION TUBING, DISPOSABLE

Sterile, Box/10

A Luer-Lock Fitting Permits Connection To Adapter
Handle Or Directly To Infiltration Tips

96-2022 Single Spike.

96-2024 Y-Type Design (Not pictured).



PERISTALTIC PUMP INFILTRATION TUBING DISPOSABLE

Sterile, Box/10

This Large Bore Tubing, With A Working Length Of 10', Will Deliver Large
Fluid Volume And Will Fit Most Commercial Peristaltic Pumps.

96-2026 Luer-Lock Fitting And Bag Spikes With Tubing Clamps.



INFILTRATION SYRINGE, DISPOSABLE

Sterile, Box/10

96-2028 Multiple Injection System For Infiltration Delivers Up To
10 cc At A Time.

SURGICAL PANTIES, DISPOSABLE

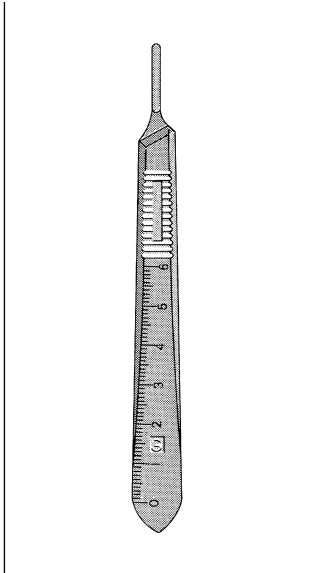
Single Pkg., Box/20

Fabricated Of A Modest And Comfortable Material For Examinations, Photography Or Surgery.

96-2030 Small

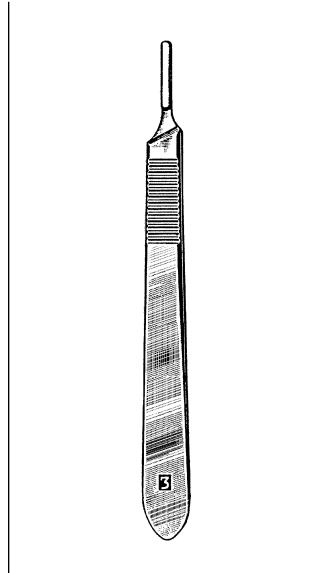
96-2032 Medium

96-2034 Large



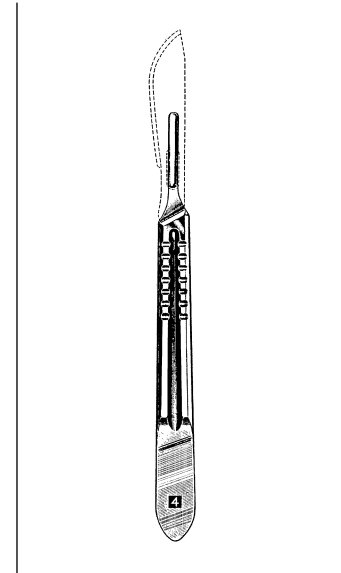
SCALPEL HANDLE

06-2910 Scalpel Handle #3
w/metric scale



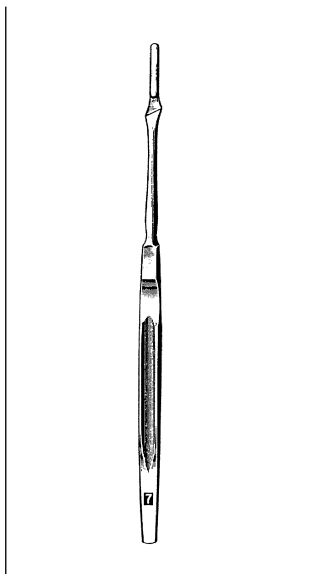
SCALPEL HANDLE

06-2903 Scalpel Handle #3
fits Blade #10, 11, 12, 15



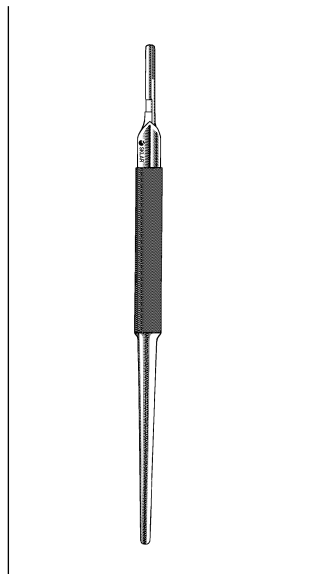
SCALPEL HANDLE

06-2904 Scalpel Handle #4
fits Blade #20, 21, 22, 23



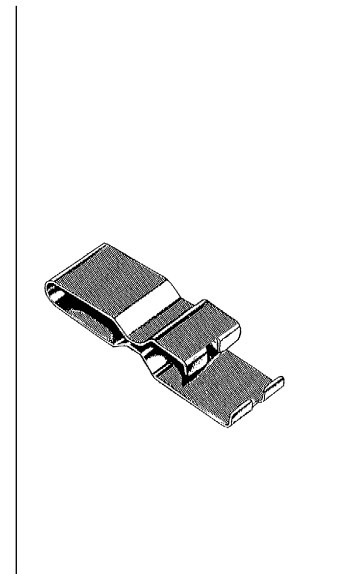
SCALPEL HANDLE

06-2907 Scalpel Handle #7
fits Blade #10, 11, 12, 15



SCALPEL HANDLE

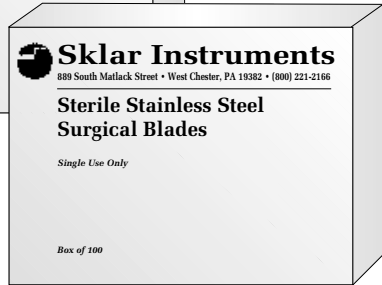
06-2908 Round Handle
Straight



BLADE REMOVER

06-3090

DISPOSABLE BLADES



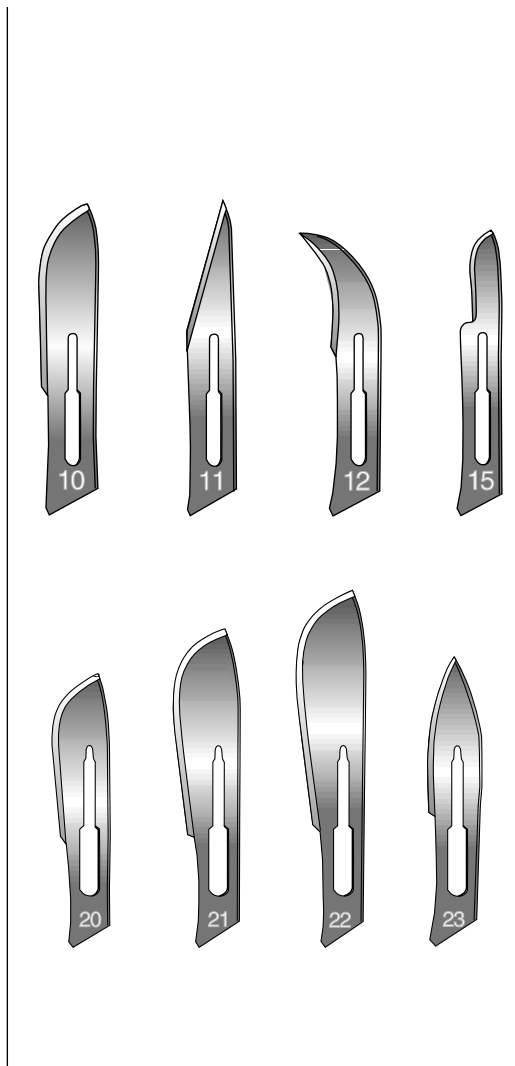
DISPOSABLE CARBON STEEL SURGICAL BLADES - Sterile, Box of 100

06-3010 #10	06-3020 #20	Securely and safely packaged in heavy foil and packed in a dispenser box of 100 blades.
06-3011 #11	06-3021 #21	
06-3012 #12	06-3022 #22	
06-3015 #15	06-3023 #23	



DISPOSABLE STAINLESS STEEL SURGICAL BLADES - Sterile, Box of 100

06-3100 #10	06-3104 #20
06-3101 #11	06-3105 #21
06-3102 #12	06-3106 #22
06-3103 #15	06-3107 #23



ADDITIONAL SURGICAL CONTROL WITH RIGID-CUT BLADES, STAINLESS STEEL

Sterile, Box of 50

06-3070 #10	06-3076 #20
06-3071 #11	06-3077 #21
06-3072 #12	06-3078 #22
06-3075 #15	06-3079 #23

- A reinforced dorsal edge reduces flexing and blade distortion.

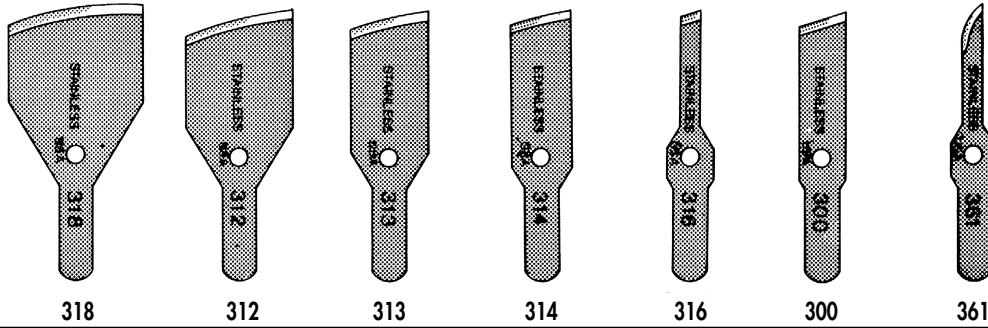


DISPOSABLE SCALPEL - Sterile, Pack of 10

06-3110	#10	06-3112	#12	06-3120	#20	06-3122	#22
06-3111	#11	06-3115	#15	06-3121	#21	06-3123	#23

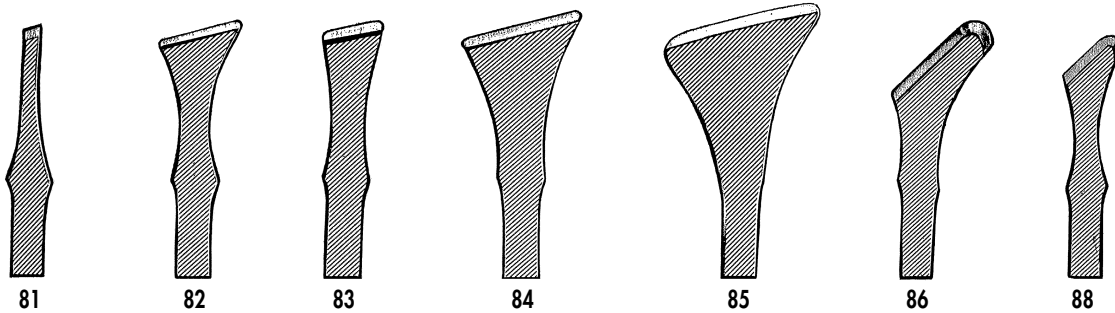
CLICK HERE TO SEE THIS WEEK'S SPECIALS - www.sklarcorp.com

BLADES/HANDLES



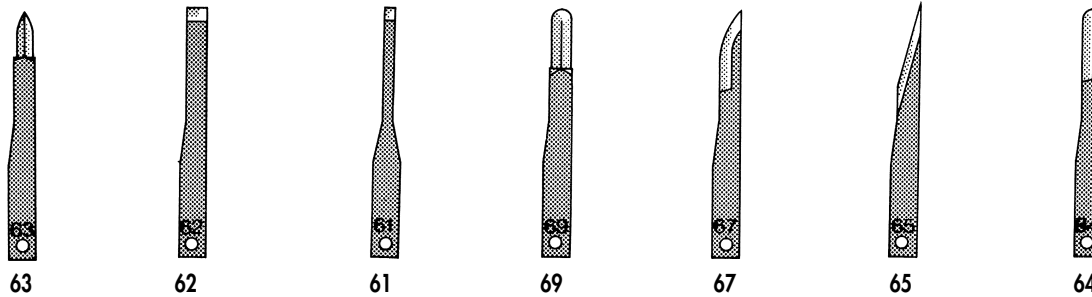
SPECIALTY BLADES- Non-Sterile, Box of 12

- | | | | | | |
|---------|-------------|-------|---------|---------------|------|
| 97-1400 | Curved Edge | # 318 | 97-1420 | Straight Edge | #316 |
| 97-1405 | Curved Edge | #312 | 97-1425 | Straight Edge | #300 |
| 97-1410 | Curved Edge | #313 | 97-1430 | Knife Edge | #361 |
| 97-1415 | Curved Edge | #314 | | | |
- (Box of 5) #314 Only



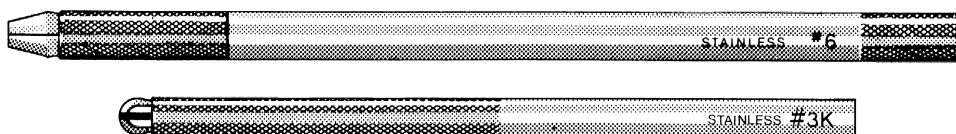
SPECIALTY BLADES – Non-Sterile, Box of 5 *Note: 96-1700 only - Box/12

- | | | | | | | | | |
|----------|---------------|-----|---------|---------------|-----|---------|-------------|-----|
| 97-1700* | Straight Edge | #81 | 97-1703 | Straight Edge | #84 | 97-1705 | Angled Edge | #86 |
| 97-1701 | Straight Edge | #82 | 97-1704 | Straight Edge | #85 | 97-1706 | Angled Edge | #88 |
| 97-1702 | Straight Edge | #83 | | | | | | |



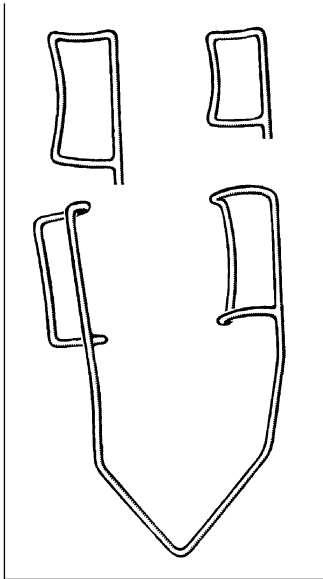
MINIATURE EDGE BLADES- Sterile, Box of 12

- | | | | | | | | | |
|---------|----------------------|-----|---------|----------------------|-----|---------|----------------------|-----|
| 97-1720 | Miniature Edge Blade | #63 | 97-1723 | Miniature Edge Blade | #69 | 97-1725 | Miniature Edge Blade | #65 |
| 97-1721 | Miniature Edge Blade | #62 | 97-1724 | Miniature Edge Blade | #67 | 97-1726 | Miniature Edge Blade | #64 |
| 97-1722 | Miniature Edge Blade | #61 | | | | | | |



HANDLE FOR SPECIALTY BLADES Packed Individually Stainless Steel

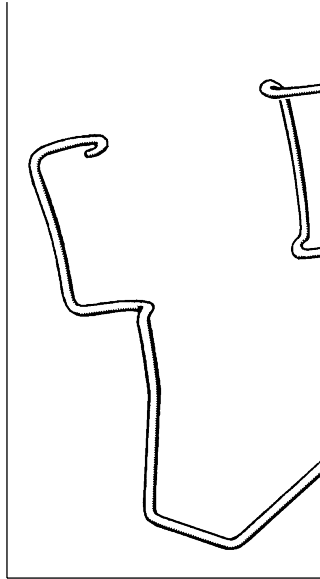
- 97-1445 #6 Handle, Self Locking For Podiatry Blades
 97-1450 #3K Handle For Miniature Edge Blades



BARRAQUER WIRE SPECULUM

1½" long

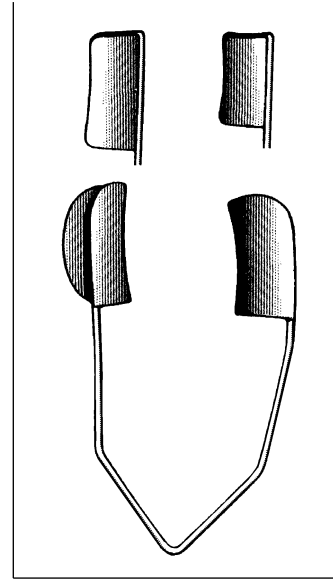
- 65-1740 10 mm loop, child
- 65-1742 15 mm loop, adult
- 65-1744 15 mm loop, adult, heavy wire
- 65-1746 8 mm loop, infant



KRATZ-BARRAQUER WIRE EYE SPECULUM

Blade width 14 mm

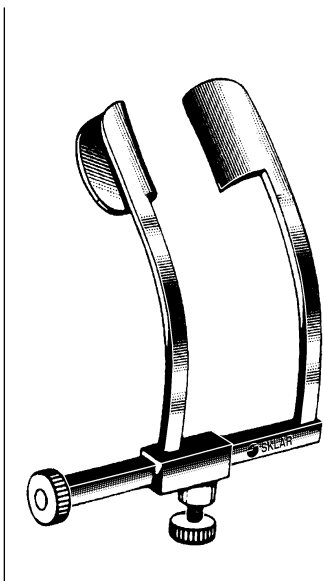
- 65-1750 18 mm blade spread adult
- 65-1752 15 mm blade spread child
- 65-1754 12 mm blade spread infant



BARRAQUER BLADE SPECULUM

1½" long

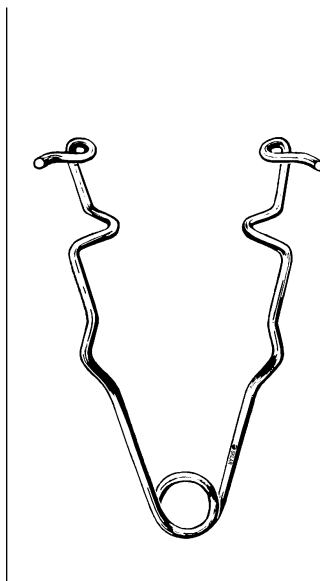
- 65-1756 10 mm solid blade child
- 65-1758 15 mm solid blade adult



COOK EYE SPECULUM

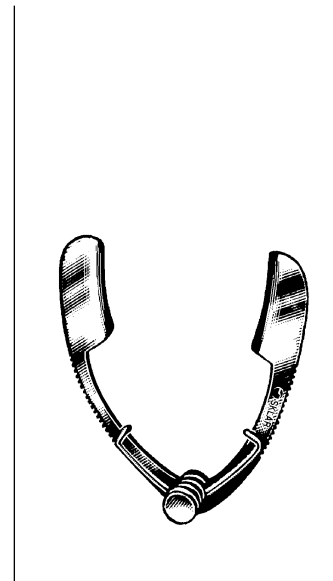
2" Long

- 65-1765 9 x 3 mm solid blade spread 25 mm



PLAIN WIRE SPECULUM

65-1127 2¼" Adult



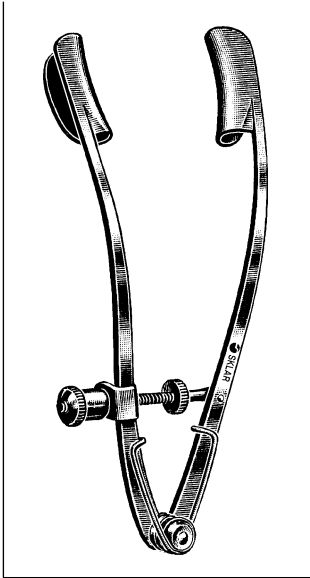
SAUER EYE SPECULUM

Infant

- 65-1012 1¼" 10 mm

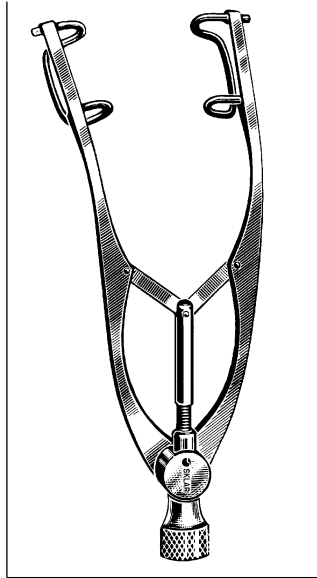
EYE INSTRUMENTS

SPECULA/RETRACTORS



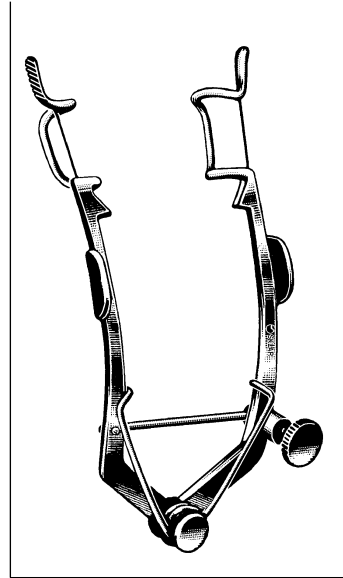
LANCASTER EYE SPECULUM

65-1532 3/4"



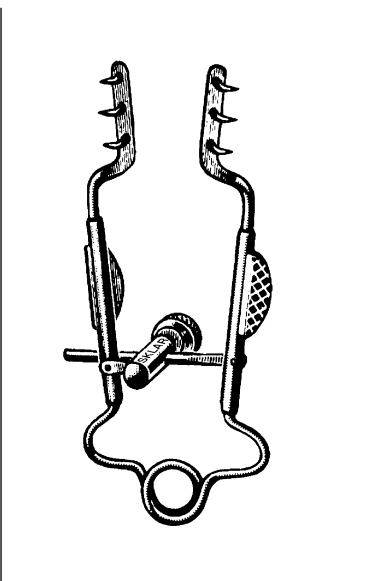
CASTROVIEJO SPECULUM

65-1535 3/4"



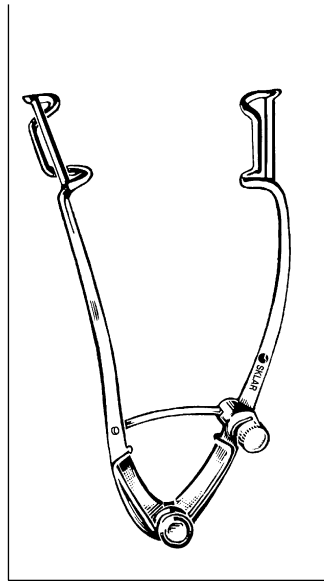
WEEKS EYE SPECULUM

65-1730 3" long 15 x 5 mm loop



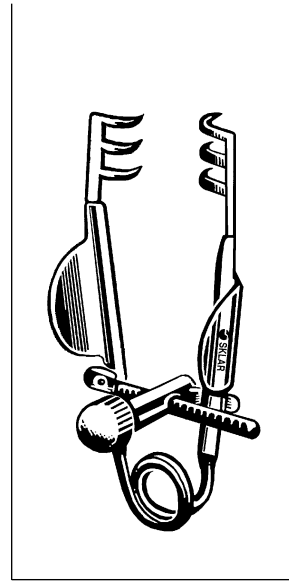
MELLER LACHRYMAL SAC RETRACTOR

65-1830 3"



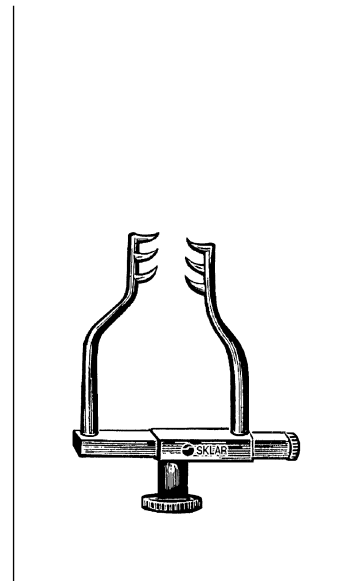
WILLIAMS SPECULUM

65-1227 2 3/4" Child
65-1332 3 1/4" Adult



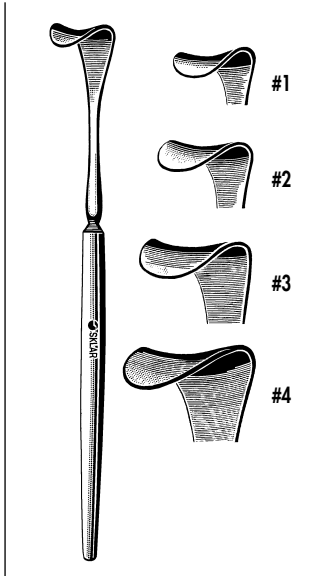
MELLER RETRACTOR DELICATE

65-1815 3 x 3 Sharp



GOLDSTEIN RETRACTOR

47-2913 1 1/2" 3 x 3 Sharp

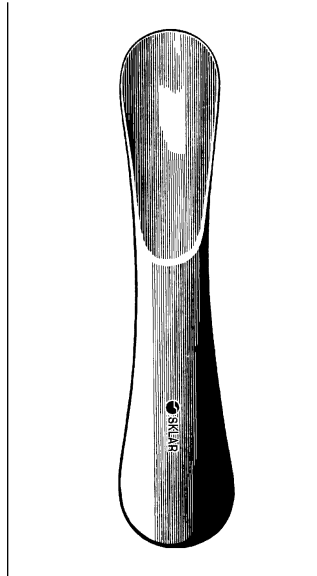


DESMARRES LID RETRACTOR

- 65-1841 #1 12 mm 5/8"
- 65-1842 #2 14 mm 5/8"
- 65-1843 #3 16 mm 5/8"
- 65-1844 #4 18 mm 5/8"

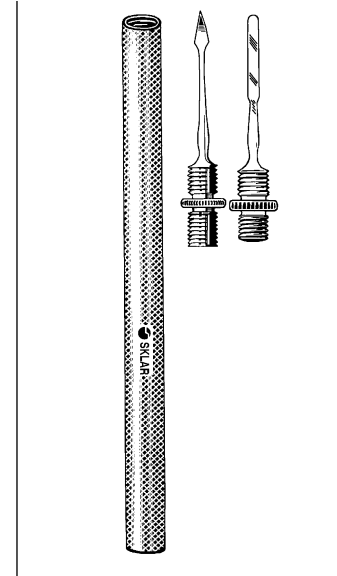
LASER DESMARRES LID RETRACTOR

- 90-1038 Small #2 5/8"
- 90-1036 Med. #3 5/8"
- 90-1035 Large #4 5/8"



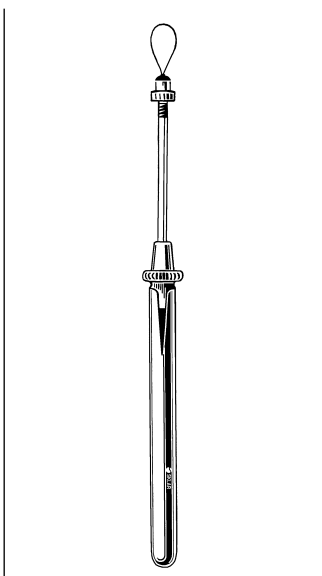
JAEGER LID RETRACTOR

- Non-Conductive
- 65-1835 3/8" Plastic



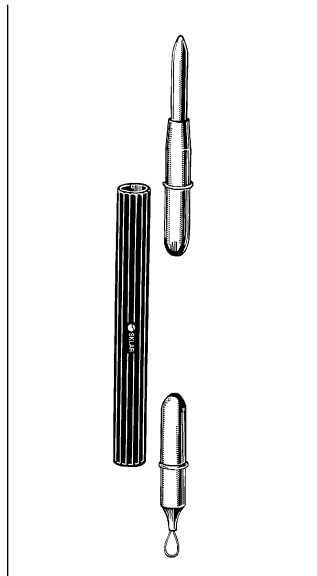
DIX NEEDLE AND SPUD

- Reversible Handle
- 65-4030 Complete Chrome
- 65-4025 Needle Only
- 65-4026 Spud Only
- 65-4031 Single End Handle Only Chrome
- 65-4032 Double End Handle Only Chrome



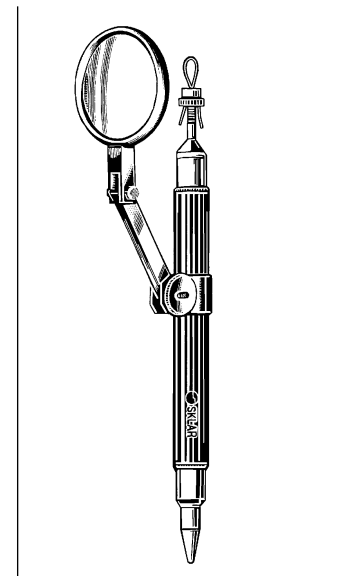
BAILEY FOREIGN BODY REMOVER

- Reversible Handle
- 65-4080 Chrome



JUNIOR MAGNETIC PROBE & FOREIGN BODY LOOP

- Reversible Handle, Non-Autoclavable
- 65-7422

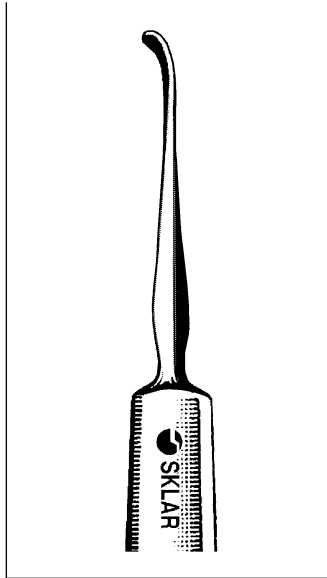


EYE MAGNETIC PROBE & FOREIGN BODY LOOP

- Reversible Handle
- 65-7425 With Magnifier
- Non-Autoclavable

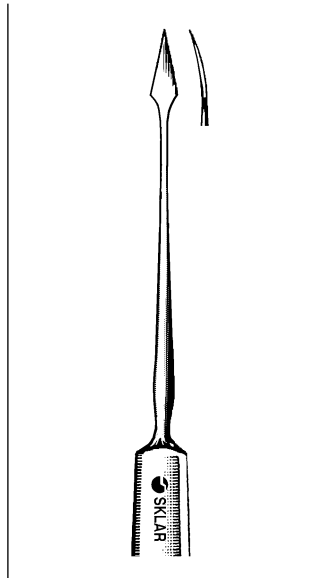
EYE INSTRUMENTS

FOREIGN BODY SPUDS



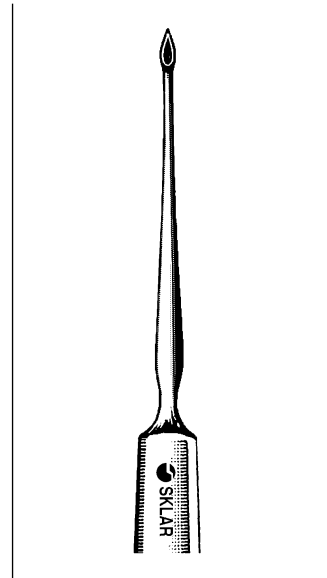
ELLIS FOREIGN BODY SPUD

Curved
65-7265 4 1/2" 1.2 mm Blade



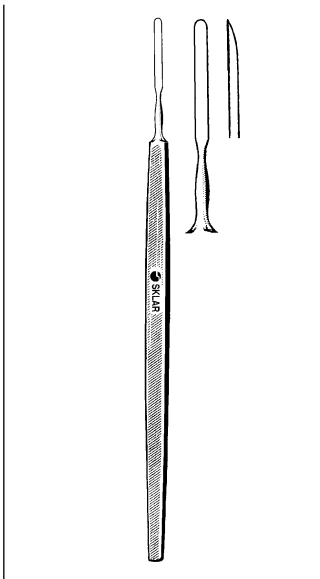
FOREIGN BODY NEEDLES

65-7270 Straight
65-7272 Curved



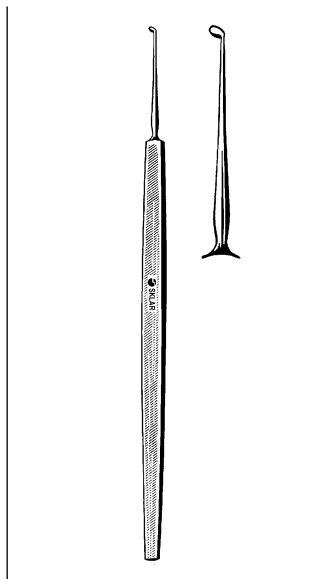
ALVIS FOREIGN BODY SPUD

With Fine Point
65-7275 4 3/4" 1 mm x 3 mm
Oval curette



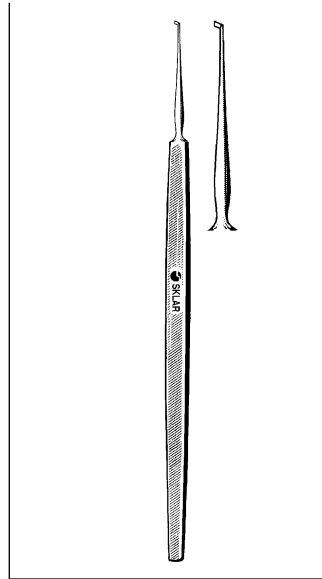
DIX FOREIGN BODY SPUD

65-7254 Blade beveled at tip



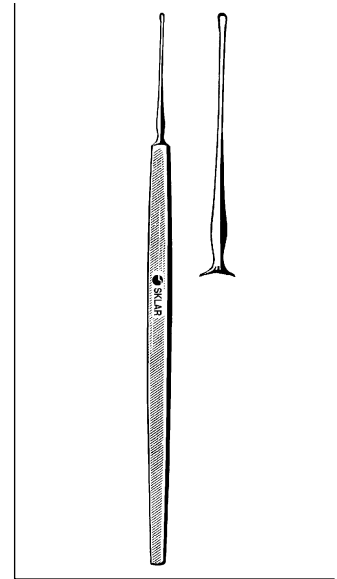
LAFORCE FOREIGN BODY SPUD

65-7255



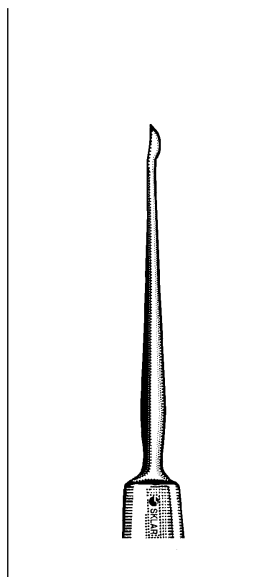
FRANCIS FOREIGN BODY SPUD

65-7257 Flag-shaped blade



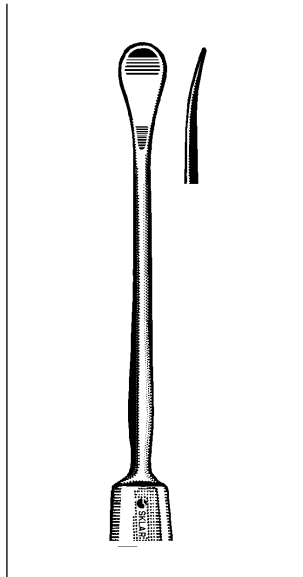
DAVIS FOREIGN BODY SPUD

65-7260 Chisel shape



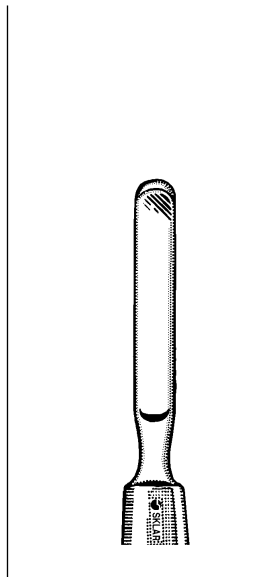
BARKAN GONIOTOMY KNIFE

65-3022 4 1/2"



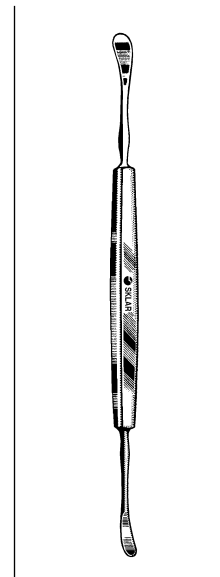
GILL CORNEAL KNIFE

65-3025 4 3/4" Blade is slightly curved



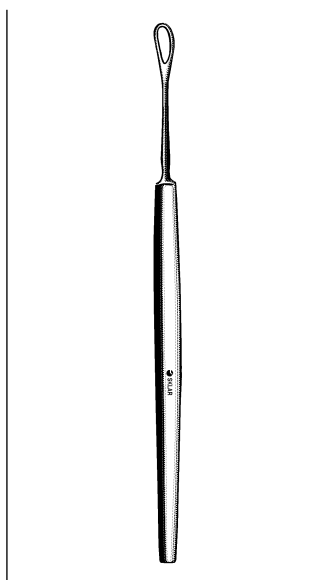
TOOKE CORNEAL KNIFE

65-3028 4 1/2"



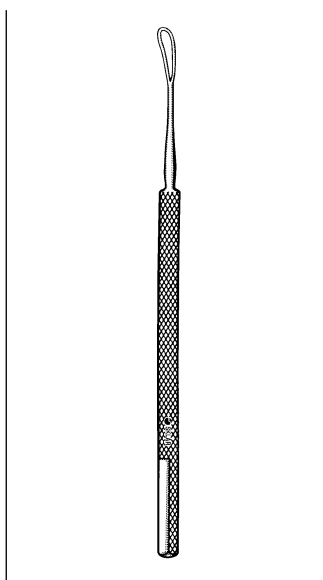
GREEN SPATULA

Slightly Curved
65-4074 6"



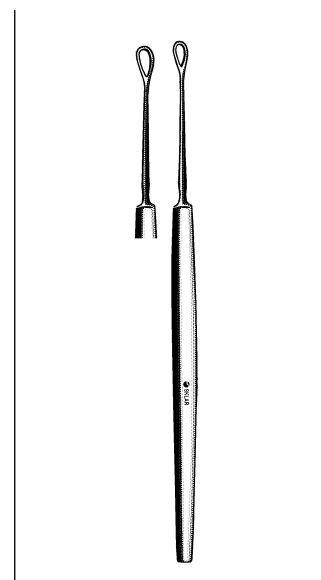
NEW ORLEANS LENS LOOP

65-8185 5 mm loop



WILDER LENS LOOP

65-8215 Serrated

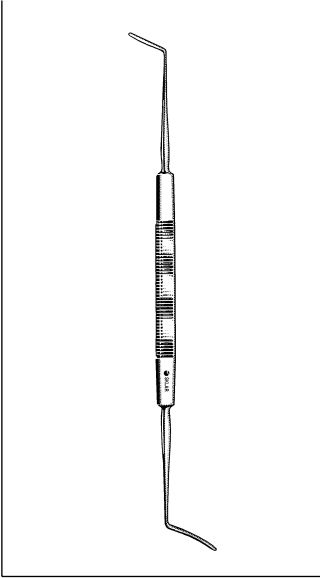


LEWIS LENS LOOP

65-8206 Smooth

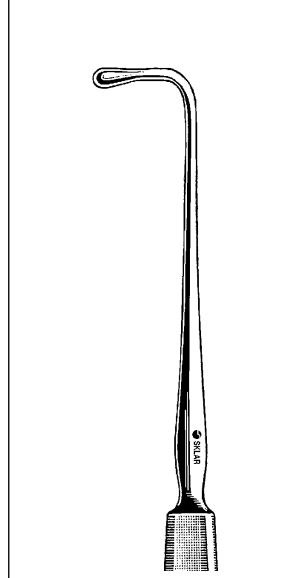
EYE INSTRUMENTS

SPATULAS/HOOKS



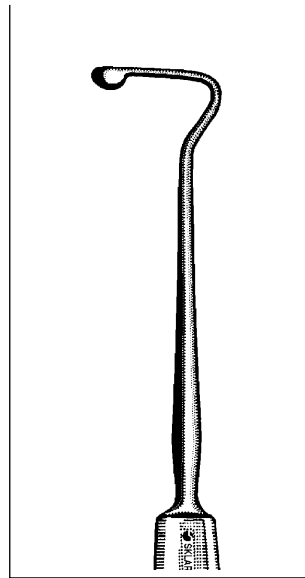
CASTROVIEJO CYCLODIALYSIS SPATULAS

10 and 15 mm Blade Lengths
 65-4062 0.5 mm wide
 65-4064 .75 mm wide
 65-4066 1 mm wide (Single End)



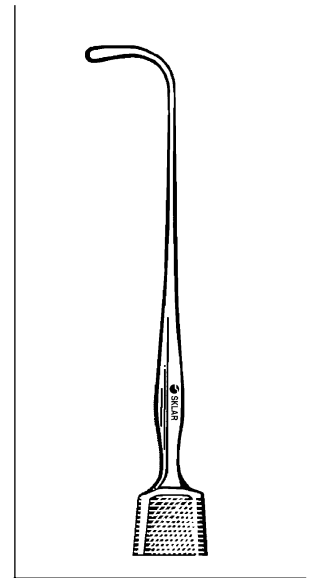
GRAEFE STRABISMUS HOOK

65-3215 Small
 65-3216 Medium
 65-3217 Large



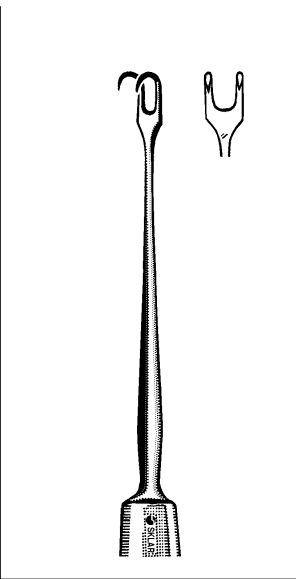
JAMISON STRABISMUS HOOK

65-3195 5"
 w/10 mm hook



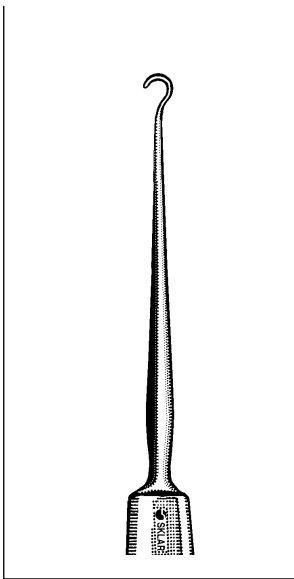
STEVENS TENOTOMY HOOK

65-3191



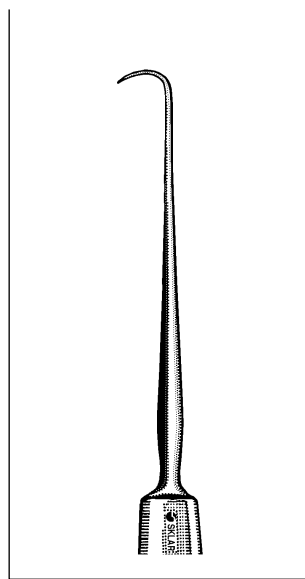
GUTHRIE FIXATION HOOK

47-2650 5" Two Large Sharp Prongs
 47-2651 5" Two Small Sharp Prongs



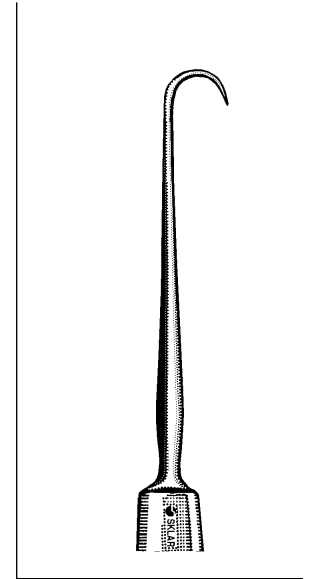
TYRELL IRIS HOOK

65-3205 5" Blunt
 65-3206 5" Sharp



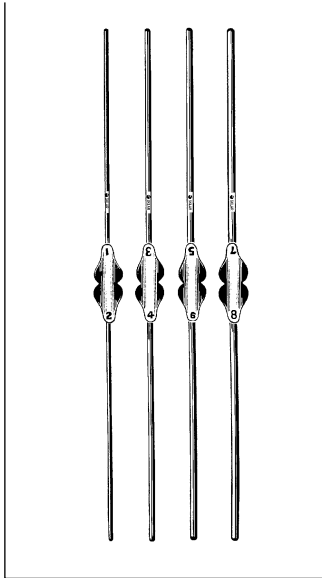
WIENER SCLERAL HOOK

65-3250 5" Sharp



O'CONNOR HOOK

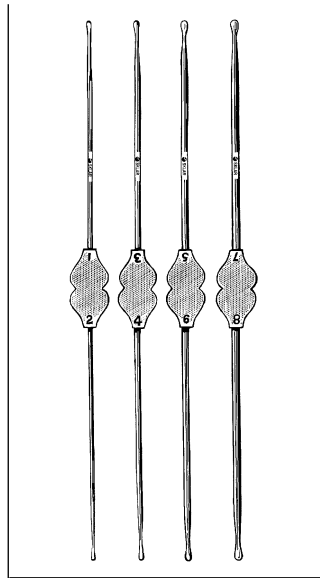
65-3265 5" Sharp



BOWMAN LACHRYMAL DILATOR/PROBE

Double Ended

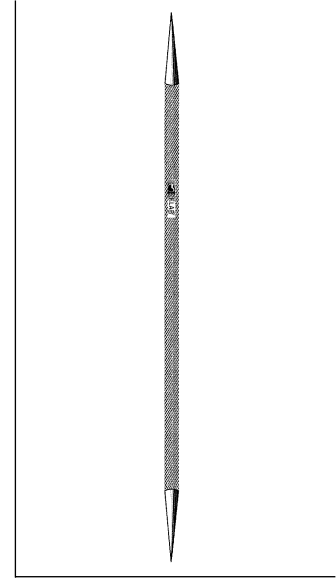
65-4100 Set of 4 #1 thru #8
 65-4098 #0000/000
 65-4099 #00/0
 65-4101 #1-2
 65-4103 #3-4
 65-4105 #5-6
 65-4107 #7-8



WILLIAMS LACHRYMAL DILATOR/PROBE

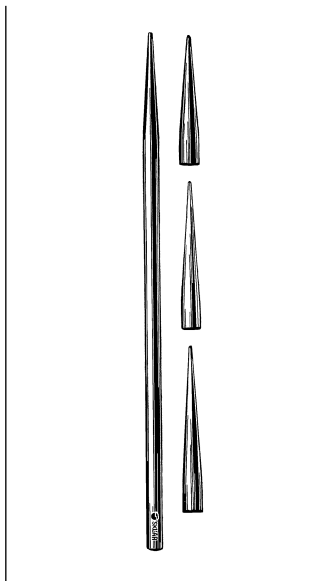
Double Ended Sterling Silver

65-4120 Set of 4 #1 thru #8
 65-4121 #1-2
 65-4123 #3-4
 65-4125 #5-6
 65-4127 #7-8



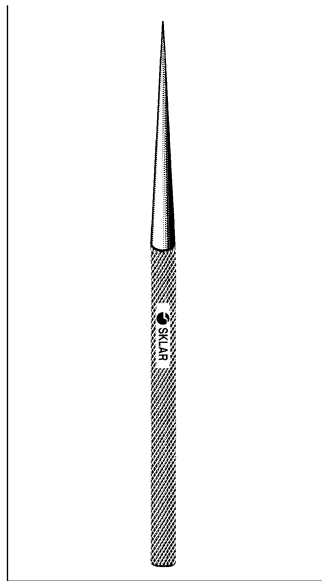
CASTROVIEJO LACHRYMAL DILATOR

Double Ended, Tapers
 22 mm x 18 mm 5/2"
 65-6960



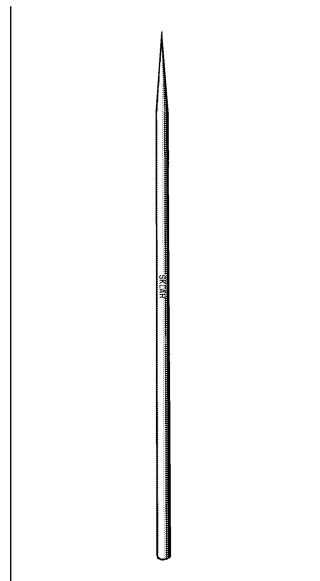
WILDER LACHRYMAL DILATOR

65-7001 Short Taper
 65-7002 Medium Taper
 65-7003 Long Taper



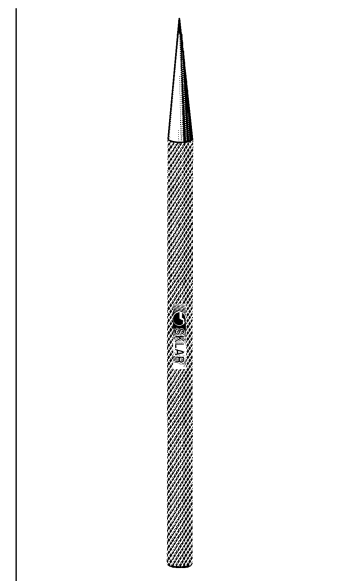
INFANT LACHRYMAL DILATOR

Extra Delicate 2 3/4"
 65-7000 0.5 mm at tip



RUEDEMANN LACHRYMAL DILATOR

2 3/4"
 65-6950 Short delicate needle tip

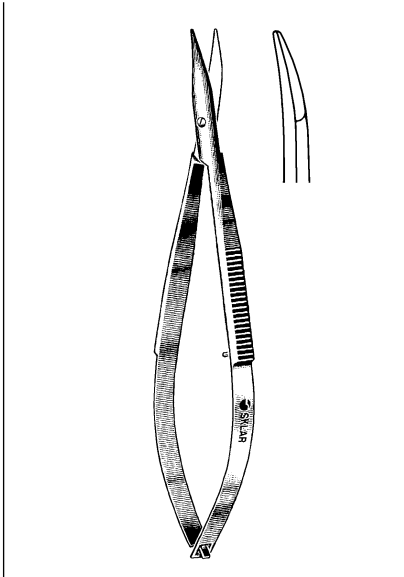


MULDOON LACHRYMAL DILATOR

With Straight Distal End to Guide
 Dilator 4"
 65-6952

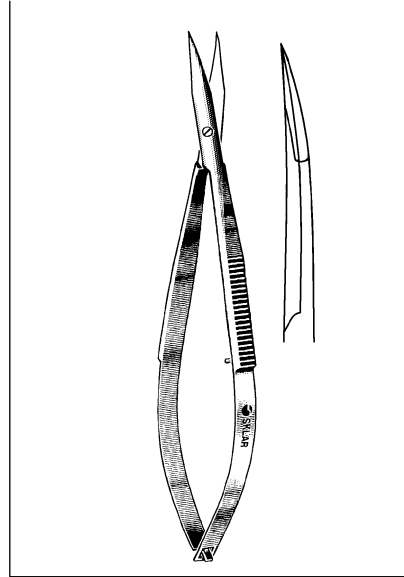
EYE INSTRUMENTS

SCISSORS



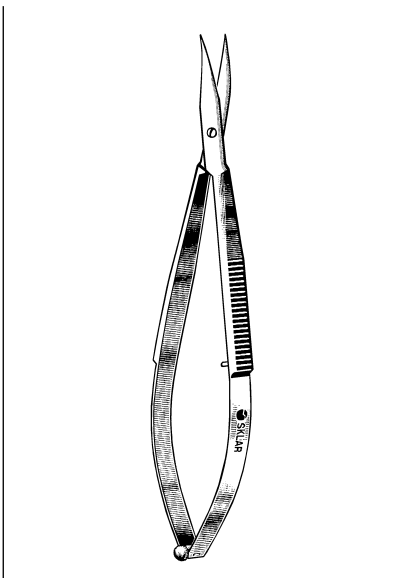
WESTCOTT TENOTOMY SCISSORS

64-3146 4 1/2" Blunt Tips With Spring Handle



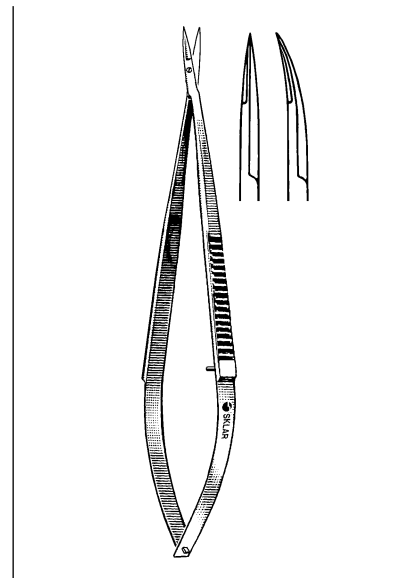
WESTCOTT TENOTOMY SCISSORS

64-3145 4 1/2" Sharp Tips With Spring Handle



WESTCOTT TENOTOMY SCISSORS

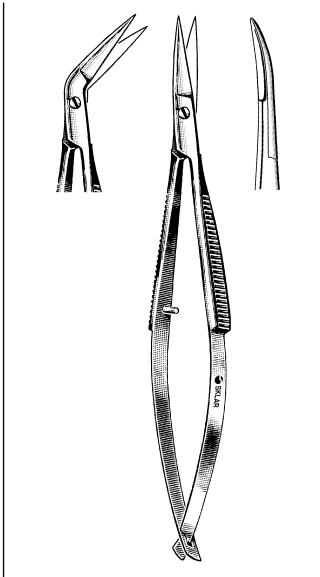
64-3142 5" Right
64-3144 5" Left



IRIS MICRO-MINIATURE SCISSORS

Extra delicate, sharp points

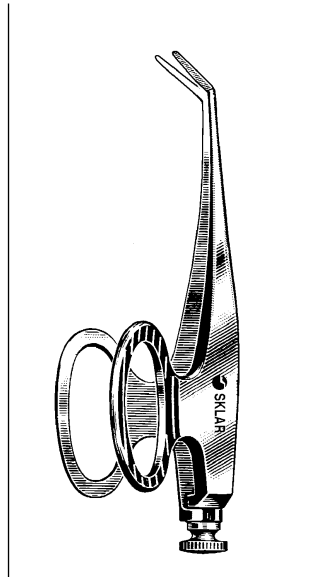
64-3050 4" Straight
64-3052 4" Curved



McCLURE IRIS SCISSORS

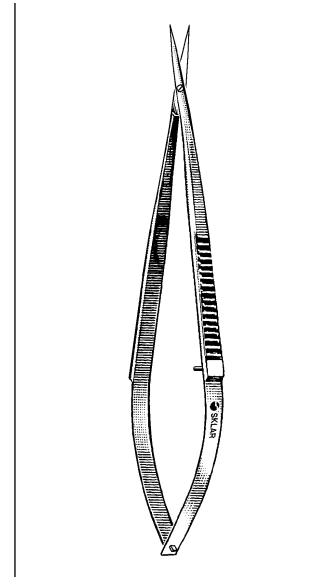
Spring Handle

- 64-1742 4 1/4" Angled To Side
- 64-1842 4 1/4" Straight
- 64-1942 4 1/4" Curved



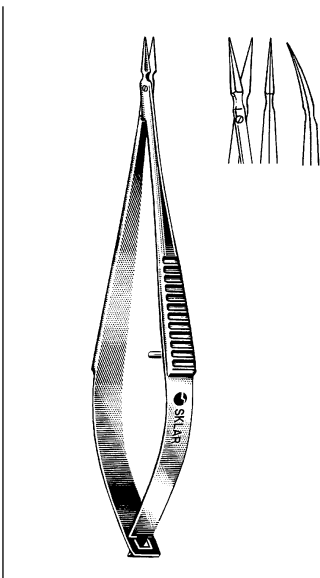
BARRAQUER-DEWECKER IRIS SCISSORS

- 64-3225 2 1/4" Delicate blades



FINE STITCH SCISSORS

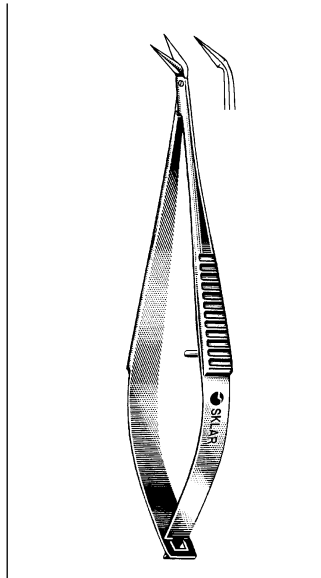
- 64-3260 4 1/4" Delicate
Sharp blades



VANNAS SCISSORS

Delicate Blades With Spring Handle

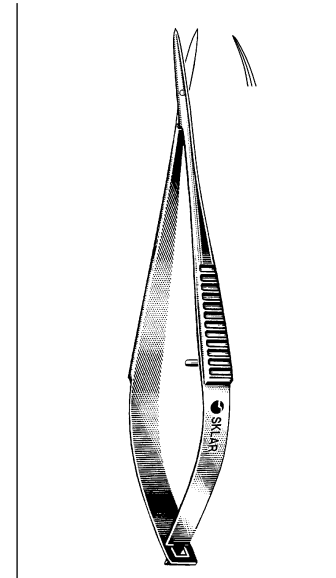
- 64-1950 3" Straight
- 64-1951 3" Curved



VANNAS SCISSORS

Extremely Delicate Blades With
Spring Handle

- 64-1955 3" Angled on flat
- 64-1958 3" Angled to side



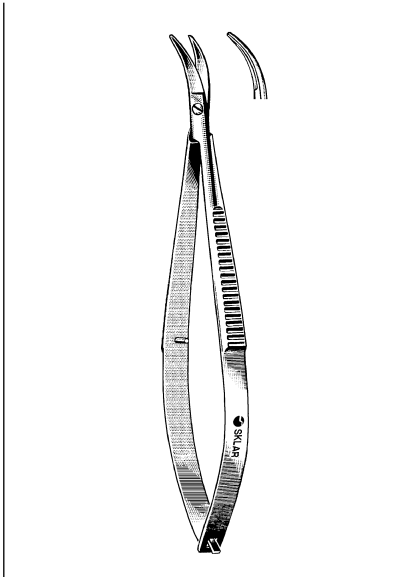
McPHERSON-VANNAS SCISSORS

Very Delicate Blades With Spring Handle

- 64-1960 3" Straight
- 64-1961 3" Curved

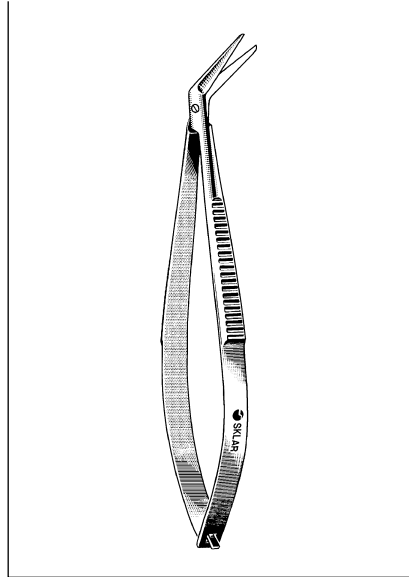
EYE INSTRUMENTS

SCISSORS



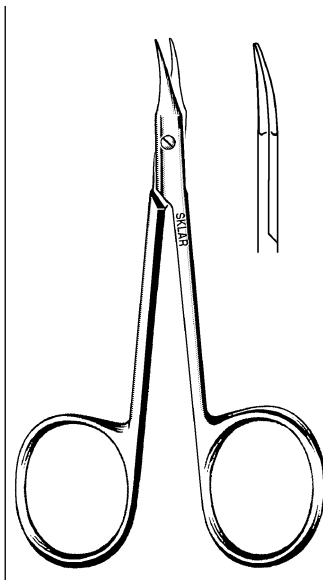
CASTROVIEJO CORNEAL SCISSORS

64-2442 4" Curved blunt blades
Spring Handles



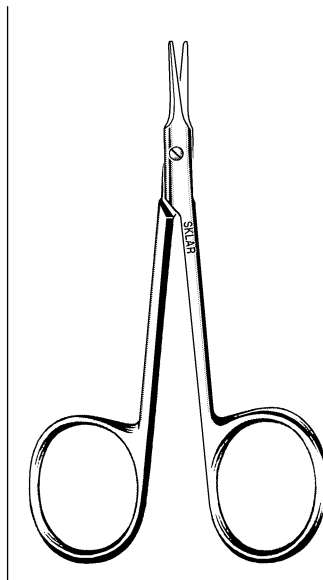
CASTROVIEJO CORNEAL SCISSORS

64-2535 4" 13 mm blunt angled blades



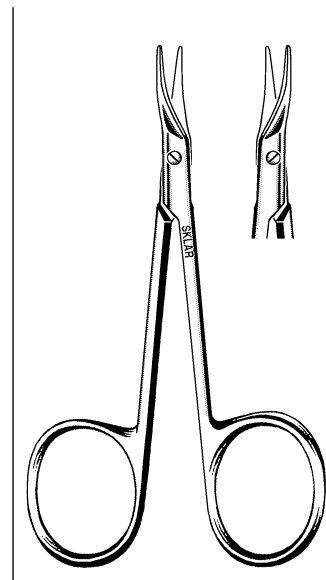
GRADLE SCISSORS

Slightly curved, Sharp
64-3280 3/4"



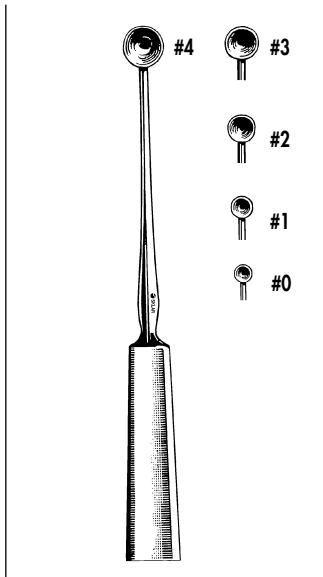
AEBLI CORNEAL SCISSORS

64-3270 4" Straight



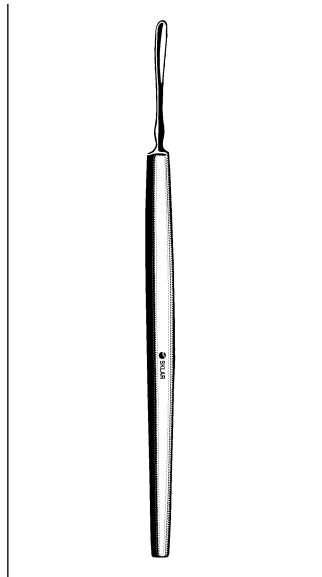
MCGUIRE CORNEAL SCISSORS

64-3297 4/4" 16 mm delicate sharp
blades. Curved right.
64-3298 4/4" 16 mm delicate sharp
blades. Curved left.



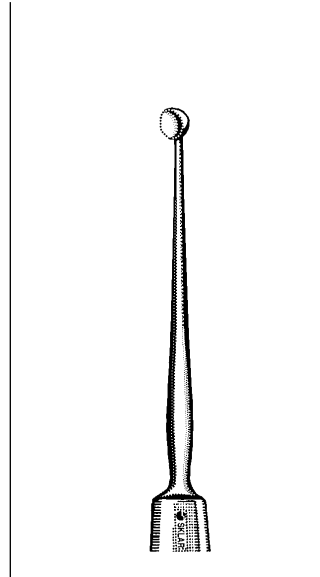
**MEYHOEFER CHALAZION
CURETTE**

65-3170	#0	1.5 mm
65-3171	#1	1.7 mm
65-3172	#2	2.2 mm
65-3173	#3	2.5 mm
65-3174	#4	3.0 mm



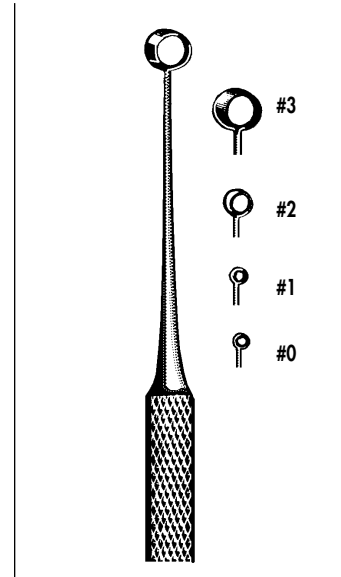
**DAVIEL CHALAZION
CURETTE**

65-3140	3 mm spoon
---------	------------



**SKEELE CHALAZION
CURETTE**

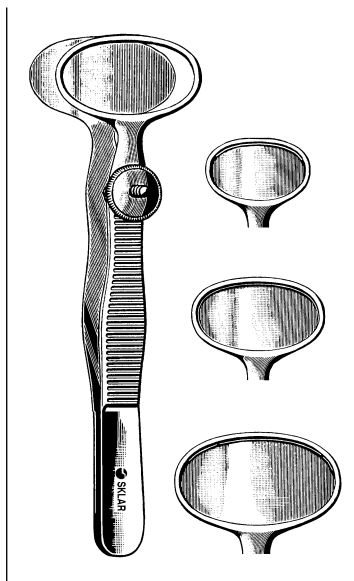
65-3162	Serrated, 2 mm
---------	----------------



HEATH CHALAZION CURETTE

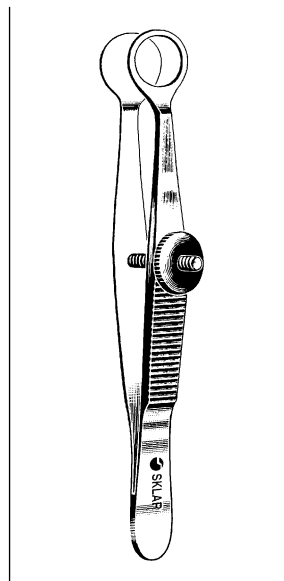
One Sharp Edge and One Dull Edge

65-3180	#0	½ mm
65-3181	#1	1 mm
65-3182	#2	2 mm
65-3183	#3	3 mm



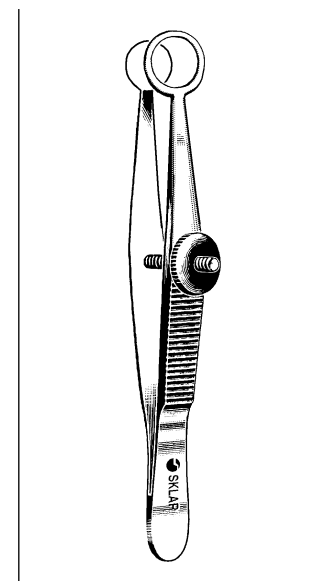
DESMARRES CHALAZION FORCEPS

66-1038	3/4"	Small
66-1036	3/4"	Medium
66-1035	3/4"	Large



**LAMBERT CHALAZION
FORCEPS**

	Fenestrated	Smooth jaws
66-1235	3/2"	8.0 mm
66-1236	3/2"	11.0 mm

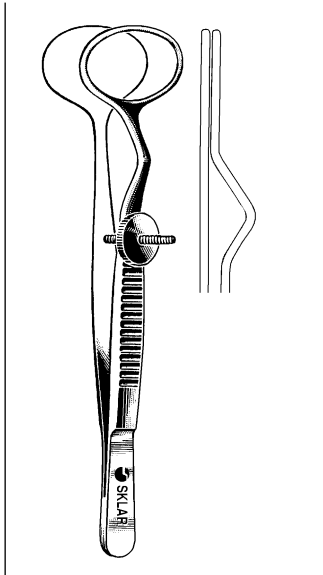


**AYERS CHALAZION
FORCEPS**

66-1435	3/2"	9 mm inside diameter
---------	------	----------------------

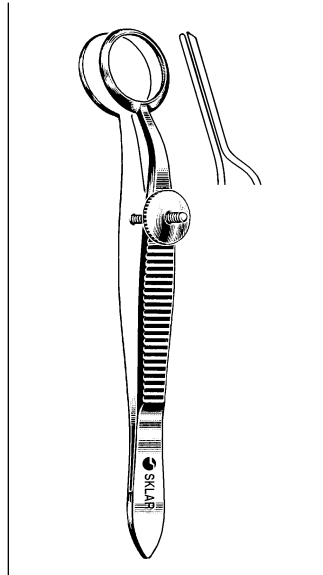
EYE INSTRUMENTS

FORCEPS



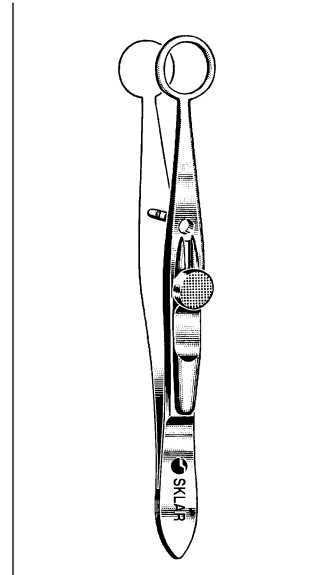
FRANCIS CHALAZION FORCEPS

3 3/4" Long
66-1255 12 mm x 14 mm
upper plate



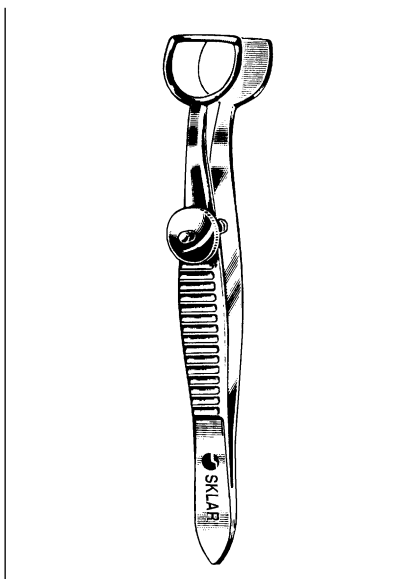
HEATH CHALAZION FORCEPS

Lower shaft curved
Upper shaft offset to prevent
crushing of lid
66-1037 11 mm diameter 3 1/2"
66-1137 16 mm diameter 3 1/2"



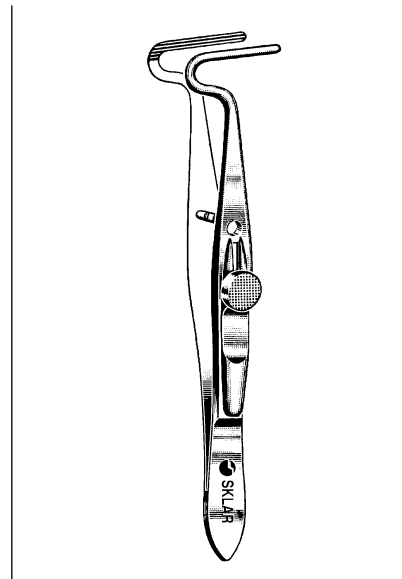
SPENCER CHALAZION FORCEPS

With lock Fenestrated Smooth jaws
66-1240 4" 9.5 mm Jaw



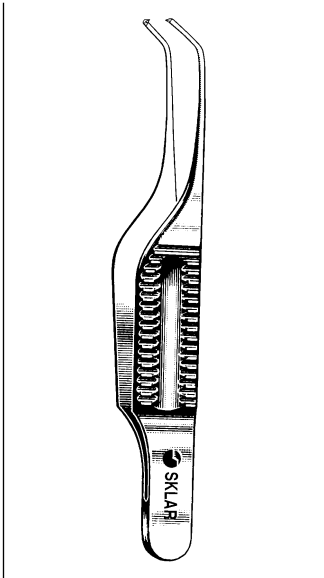
WEIS CHALAZION FORCEPS

Serrated and Fenestrated
66-1265 4" 9 mm x 12 mm jaw



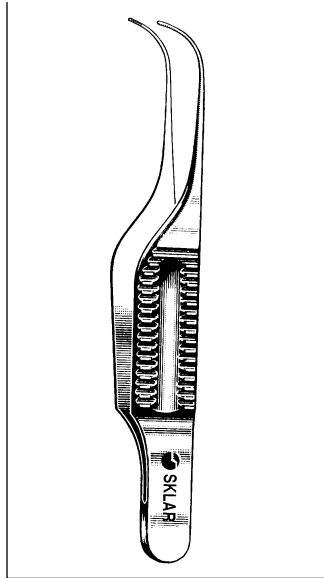
BERKE PTOSIS FORCEPS

66-6342 4 1/4"



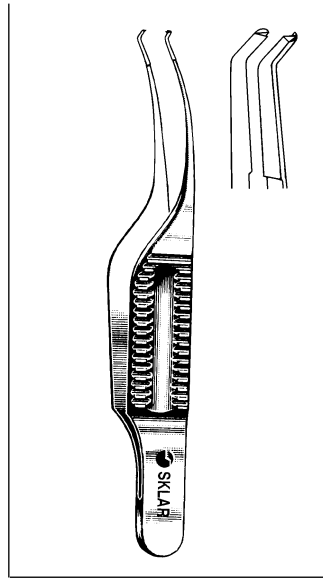
GILL IRIS FORCEPS

66-7130 1 x 2 Curved,
length 3"



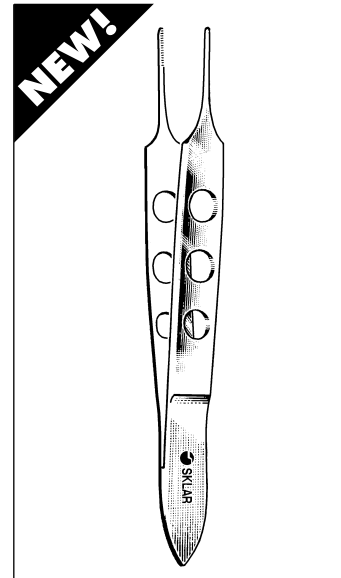
GILL (CHANDLER) IRIS FORCEPS

66-7244 3" Fine cross serrated tips
0.6 mm wide, Curved



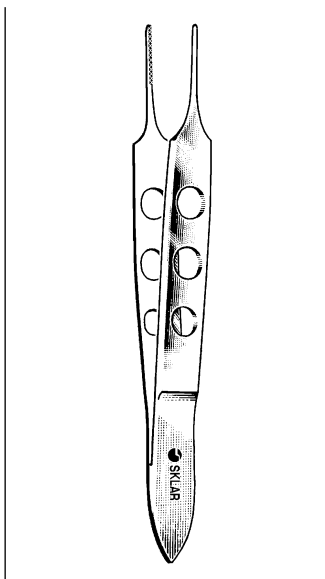
TROUTMAN-BARRAQUER CORNEAL UTILITY FORCEPS

Colibri Type
66-7250 1 x 2 0.5 mm teeth, set at 45°
with tying platform.



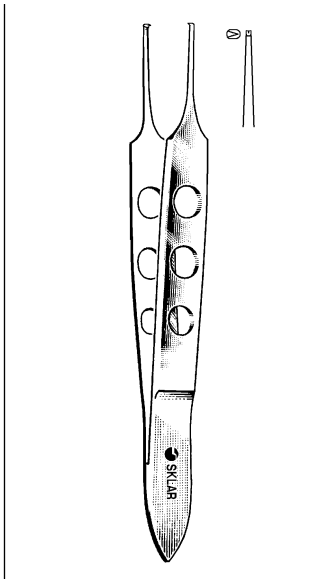
SKLAR LITEGRIP™ BISHOP-HARMON FORCEPS

66-4034 3/2" Serrated
66-4134 3/2" 1 x 2 Teeth



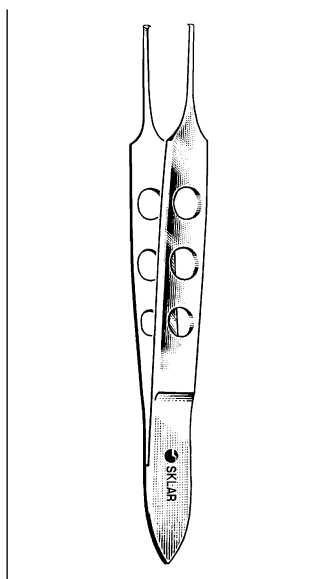
BISHOP-HARMON EYE DRESSING FORCEPS

Serrated, straight tips
66-4032 3/2"



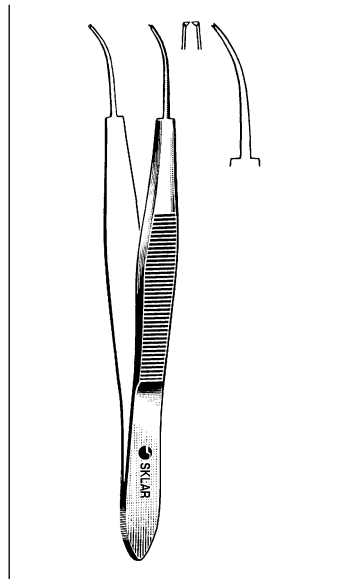
BISHOP-HARMON EYE TISSUE FORCEPS

3/2" Straight, 1 x 2 Teeth
66-4132 Standard pattern
66-4133 Extra delicate for
microsurgery



BISHOP-HARMON FORCEPS (IOWA)

1 x 2 straight teeth, Micro tip
66-4232 3/2"

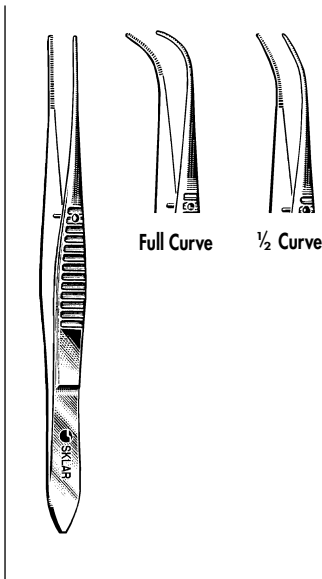


STEVENS IRIS FORCEPS

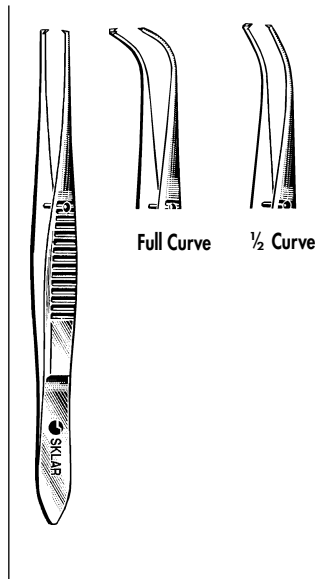
4/4"
66-4950 Straight without catch 1 x 2
66-4951 Curved without catch 1 x 2

EYE INSTRUMENTS

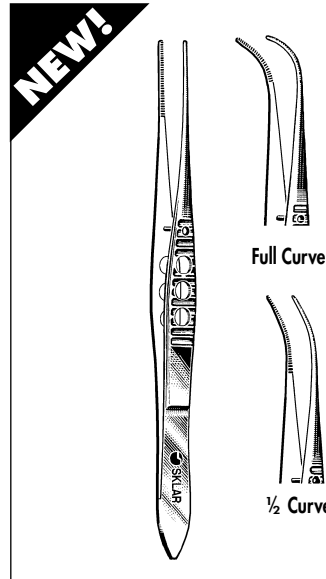
FORCEPS



Full Curve 1/2 Curve

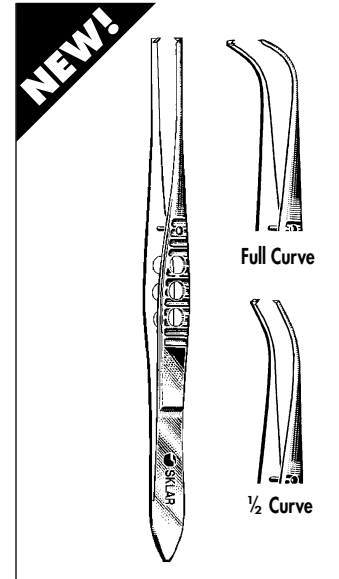


Full Curve 1/2 Curve



Full Curve

1/2 Curve



Full Curve

1/2 Curve

EYE DRESSING FORCEPS

- Serrated
 66-2740 4" Straight
 66-2940 4" Half Curve
 66-3140 4" Full Curve
 Non-Magnetic
 66-2840 4" Straight

EYE TISSUE FORCEPS

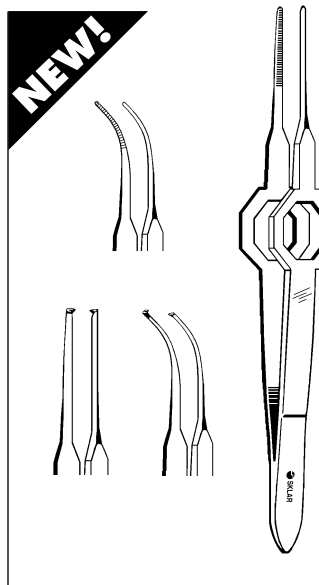
- 1 x 2 Teeth
 66-3340 4" Straight
 66-3540 4" Half Curve
 66-3740 4" Full Curve
 Non-Magnetic
 66-3240 4" Straight

SKLAR LITEGRIP™ EYE DRESSING FORCEPS

- Serrated
 66-2742 4" Straight
 66-2942 4" 1/2 Curved
 66-3142 4" Full Curve

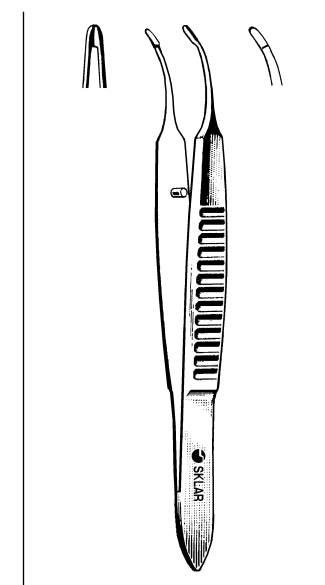
SKLAR LITEGRIP™ EYE TISSUE FORCEPS

- 1 x 2 Teeth
 66-3342 4" Straight
 66-3542 4" 1/2 Curved
 66-3742 4" Full Curve



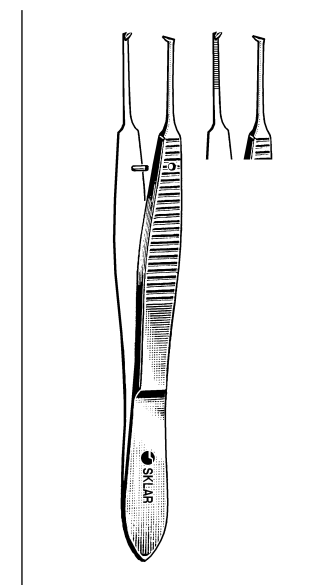
FOERSTER FORCEPS

- 66-6036 3/4" Straight
 66-6037 3/4" Curved
 66-6038 3/4" Straight w/ 1x2 Teeth
 66-6039 3/4" Curved w/ 1x2 Teeth



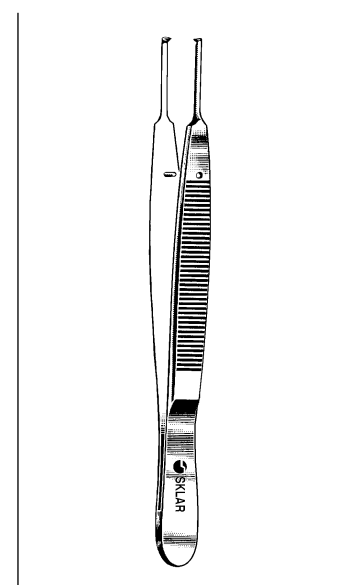
CHANDLER IRIS FORCEPS

- 66-3927 2 3/4" Curved with Platform Tips



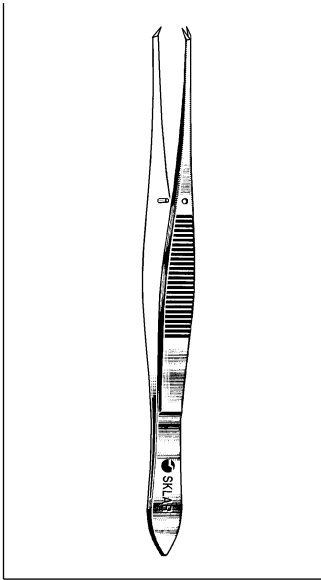
GRAEFE FORCEPS

- 66-4525 2 3/4" Straight 1 x 2 teeth
 66-4625 2 3/4" Curved 1 x 2 teeth
 66-4526 2 3/4" Straight Serrated
 66-4626 2 3/4" Curved Serrated



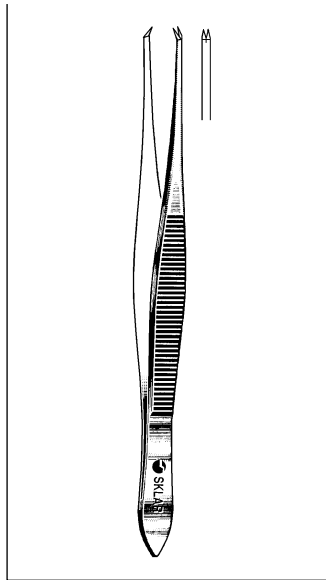
LESTER CONJUNCTIVAL FORCEPS

- 66-4235 3 1/2" 1 x 2 teeth, non-magnetic



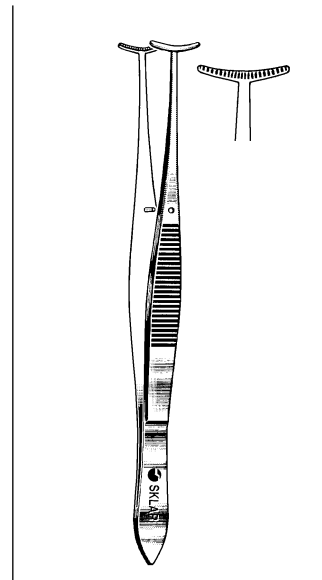
**O'BRIEN-ELSCHNIG
FORCEPS**

66-2540 4"



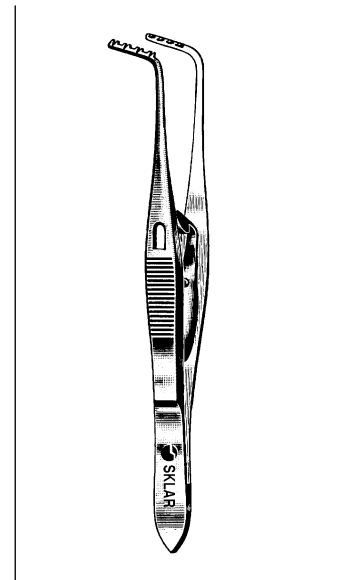
**ELSCHNIG FIXATION
FORCEPS**

4 1/4" Angled Upwards
66-2350 Strong 1 x 2 teeth,
0.9 mm wide



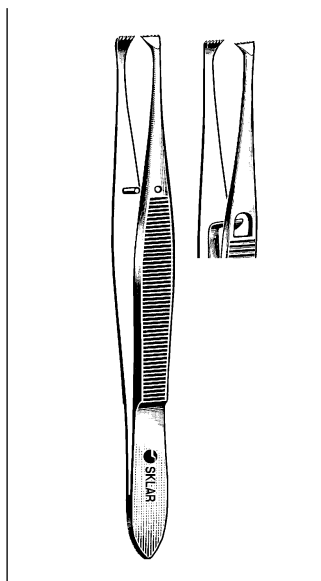
**GREEN FIXATION
FORCEPS**

4"
66-2005 5 mm jaws
66-2009 9 mm jaws
66-2012 12.5 mm jaws



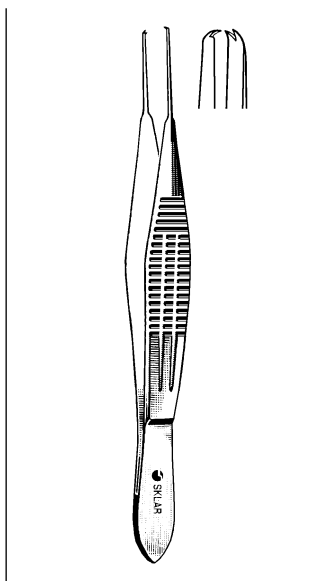
PRINCE MUSCLE FORCEPS

66-5942 4 1/4"



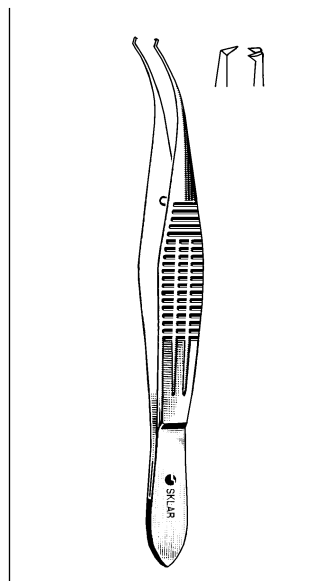
**GRAEFE FIXATION
FORCEPS**

66-1940 4 1/4" Without Lock
66-2140 4 1/4" With Lock
66-2040 4 1/4" Without Lock
Non-Magnetic



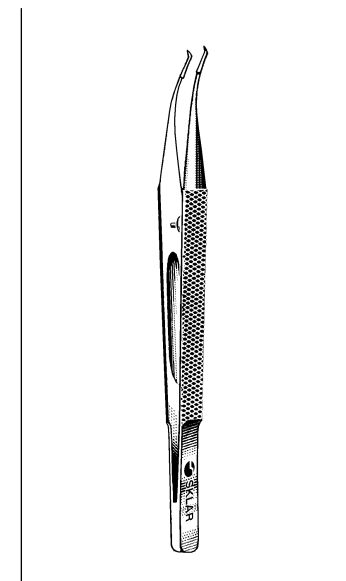
**CASTROVIEJO FIXATION
FORCEPS**

4"
66-2640 1 x 2 0.3 mm teeth
without tying platform
66-2635 1 x 2 0.5 mm teeth
without tying platform



**CASTROVIEJO COLIBRI
FORCEPS**

Wide Handle 4.25" Extra Delicate
66-3450 1 x 2 0.12 mm teeth

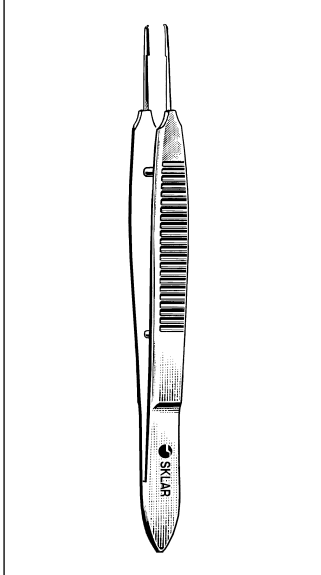


**GIRARD CORNEAL UTILITY
FORCEPS**

4.0" with tying platform, smooth tip,
0.5 mm wide
66-6120

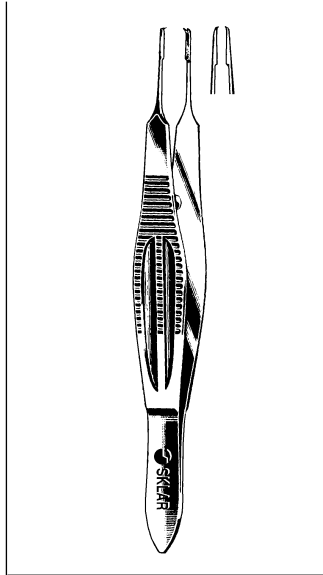
EYE INSTRUMENTS

FORCEPS



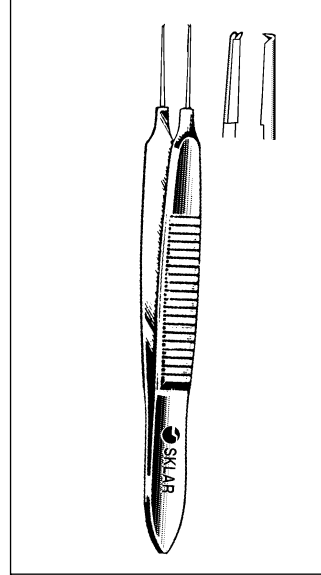
CASTROVIEJO FORCEPS

66-6105 4" .5 mm teeth
66-6109 4" .9 mm teeth



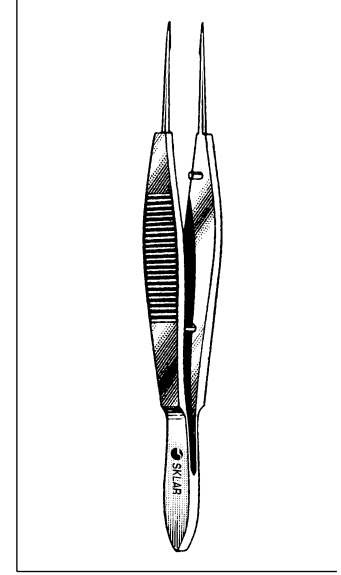
CASTROVIEJO SUTURE FORCEPS

4 1/4" 1 x 2 Platform behind teeth limits depth of penetration Wide handle
66-6115 0.5 mm delicate teeth
66-6118 1.5 mm delicate teeth



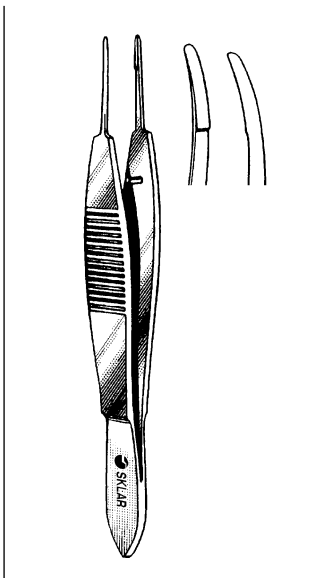
BONN MICRO SUTURING FORCEPS

66-6125 2 3/4" 1 x 2 teeth
0.12 mm with tying platform
66-6126 3 3/4" 1 x 2 teeth
0.12 mm with tying platform



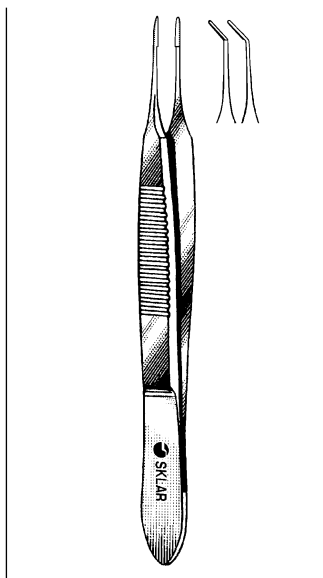
BONN TYING FORCEPS

With tying platform 0.3 mm tip width
66-6160 Straight 4"



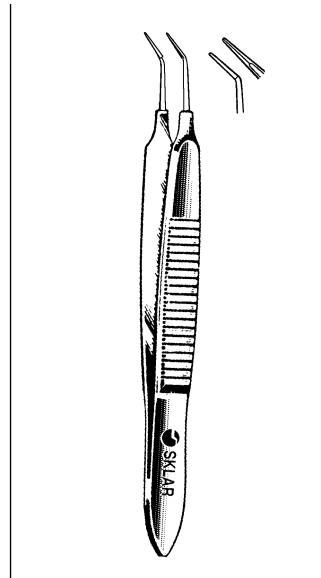
HARMS TYING FORCEPS WITH TYING PLATFORM

0.5 mm tip width
66-6140 4" Straight
66-6142 4" Curved



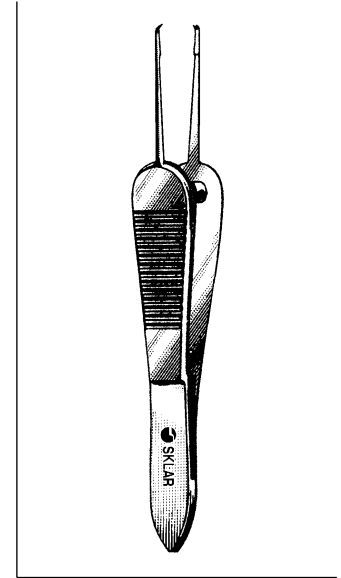
McPHERSON TYING FORCEPS WITH TYING PLATFORM

0.3 mm tip width
66-6150 4" Straight
66-6152 4" Angled



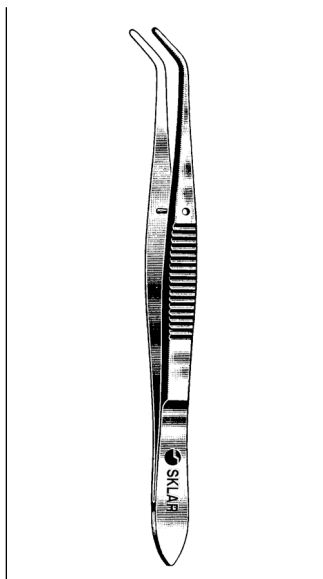
McPHERSON MICRO IRIS SUTURING FORCEPS

Smooth platform 0.3 x 5 mm
66-6164 3 1/2" Straight
66-6166 3 1/2" Curved



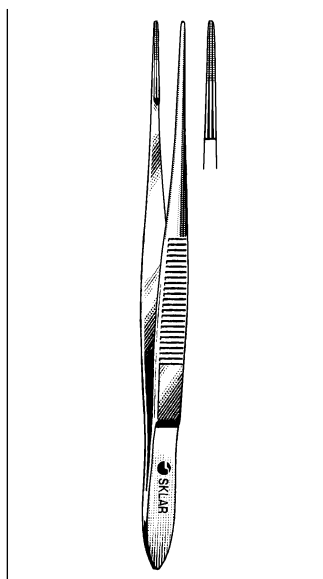
MANHATTAN EYE & EAR SUTURING FORCEPS

3 1/2" with smooth platform
1 x 2 curved teeth overlapping each other 0.7 mm wide
66-6168



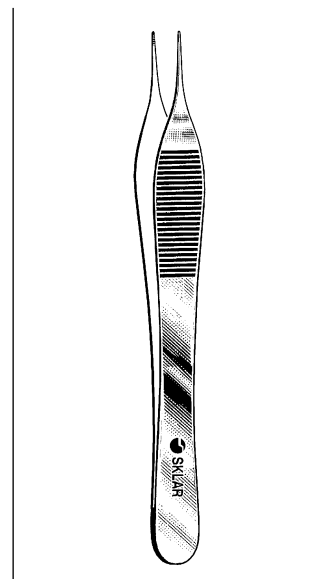
NUGENT UTILITY FORCEPS

66-6240 4 1/4" Angular smooth tips
66-6242 4 1/4" Angular serrated tips



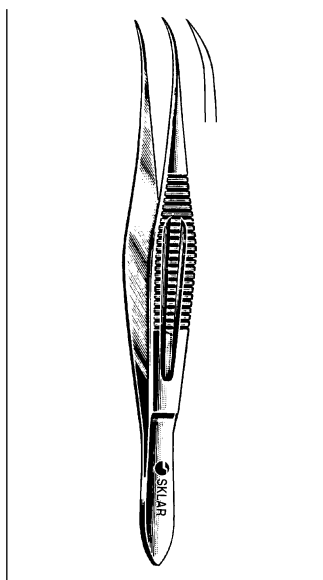
BONACCOLTO UTILITY FORCEPS

Cross serrated at tips for better pick up
Delicate pattern
66-6340 4" 1.2 mm jaws
66-6338 4" 1.7 mm jaws



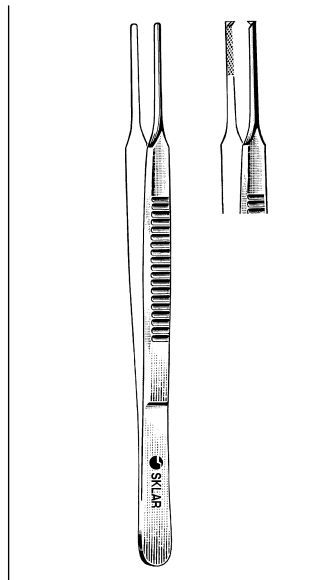
THORPE CORNEOSCLERAL FORCEPS

66-7347 4 3/4"



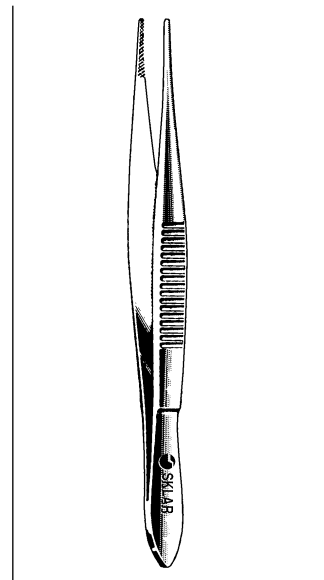
MANHATTAN EYE AND EAR SUTURE FORCEPS

66-6250 4 1/4" with fine tips



McCULLOUGH UTILITY FORCEPS

66-6110 4" Serrated
66-6112 4" Smooth
66-6114 4" 1 x 2 teeth with serrations

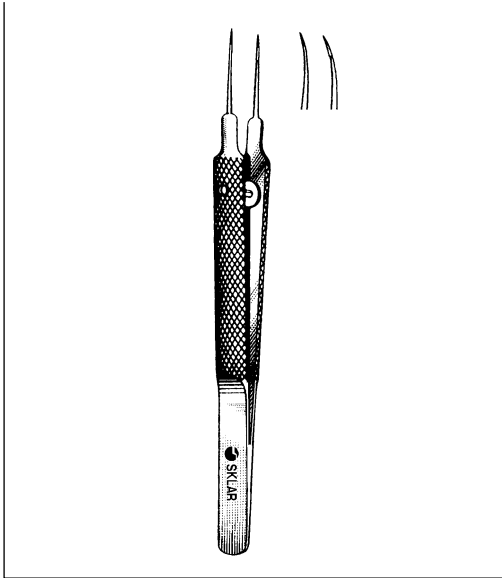


WILLS HOSPITAL UTILITY FORCEPS

66-6268 4" cross serrations on tips

EYE INSTRUMENTS

FORCEPS



TENNANT TYING FORCEPS

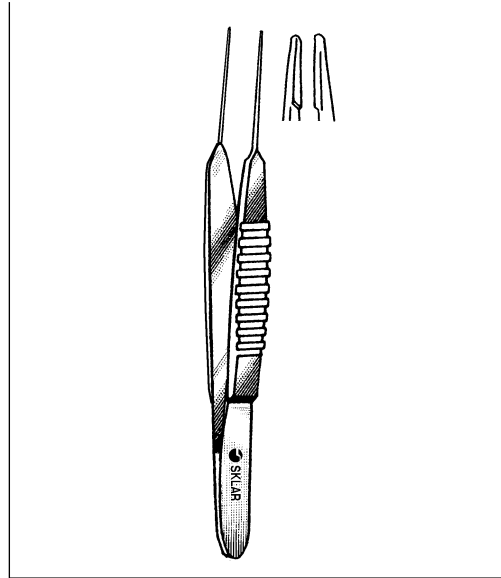
Round Handle

Extra delicate with tying platform

6 mm x 0.3 mm tip width

66-6194 Straight 4"

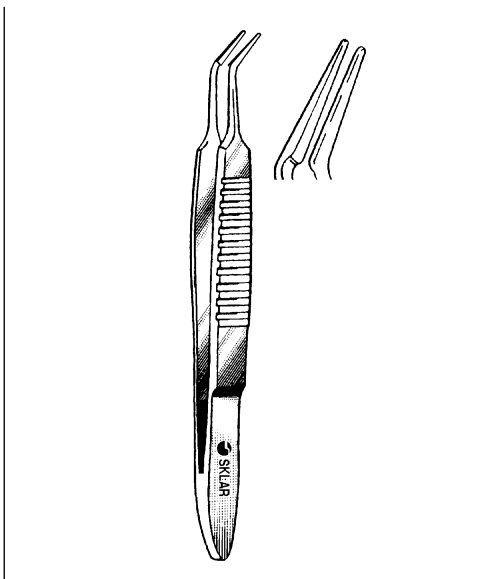
66-6196 Curved 4"



KELMAN-McPHERSON TYING FORCEPS

Straight 3 1/4"

66-6175 Smooth

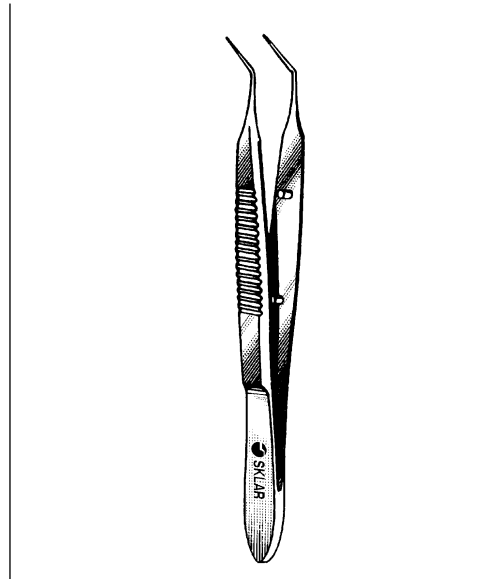


BECHERT-McPHERSON TYING FORCEPS

10 mm tying platform

3 1/8"

66-6178 Smooth jaws, angled

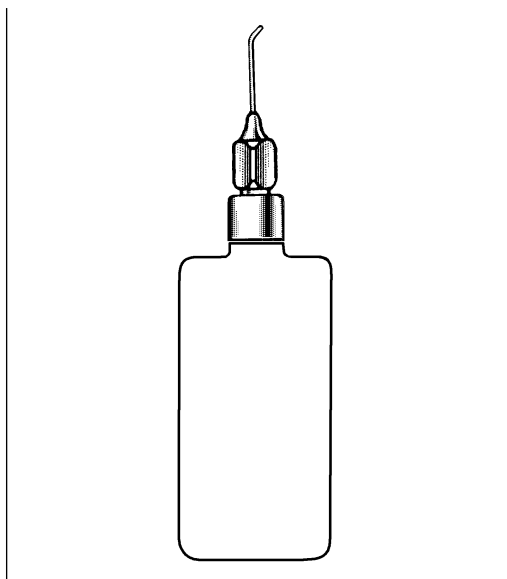


KELMAN-McPHERSON TYING FORCEPS

With tying platform 7.5 mm long

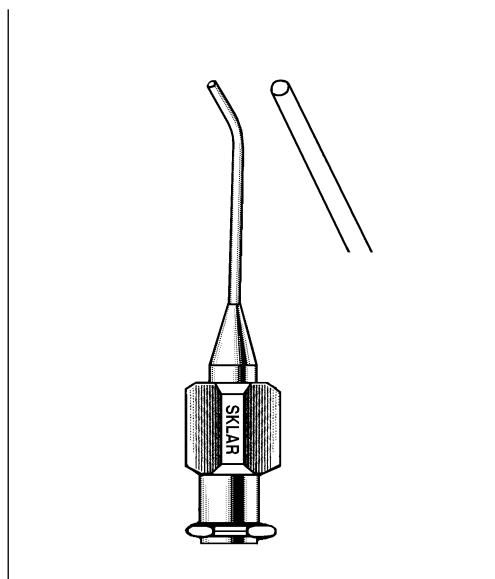
0.3 mm tip width Angled 3 1/8"

66-6180



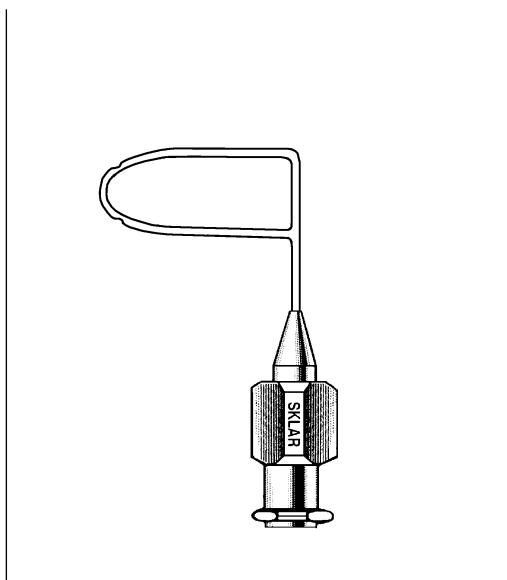
BISHOP-HARMON ANTERIOR CHAMBER CANNULA

- 66-6810 Flattened 19 Gauge Angled 7 mm tip
complete with bulb and adapter
- 66-6811 Bishop-Harmon cannula only
- 66-6812 Adaptor for irrigator
- 66-6813 Silicone bulb only



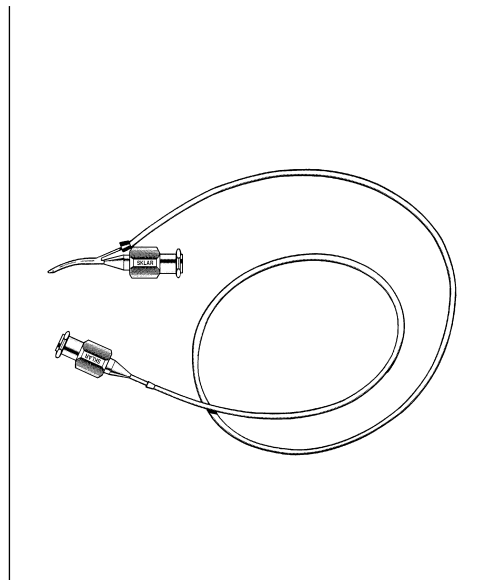
AIR INJECTION CANNULA

- 66-6900 27 Gauge
- 66-6902 30 Gauge



SIMCOE NUCLEUS DELIVERY CANNULA

- Thin Wall
- 66-6925 25 Gauge Two parts Loop
13 mm long 4 mm Wide
Serrations on lens loop, right

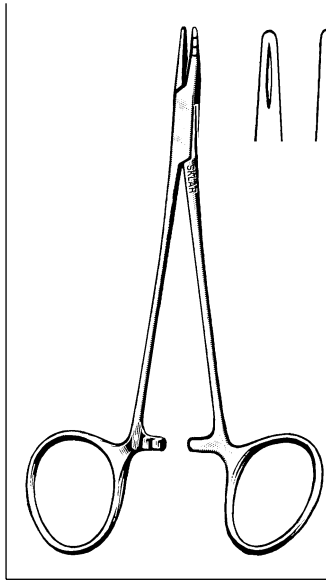


SIMCOE IRRIGATING/ASPIRATING CANNULA

- Reverse 15 mm long
- 66-6930 23 Gauge T.W. x 23 gauge T.W. aspirating port facing into
curve, aspiration on needle hub, irrigation in tubing hub

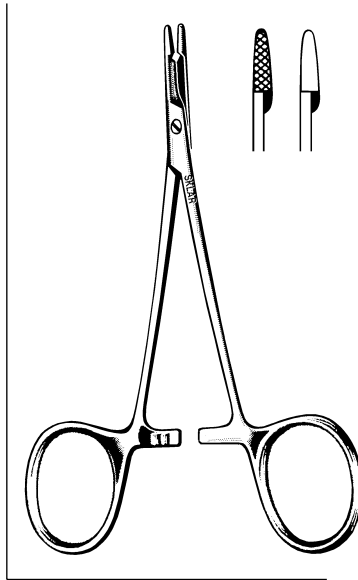
EYE INSTRUMENTS

NEEDLE HOLDERS



NEIVERT NEEDLE HOLDER

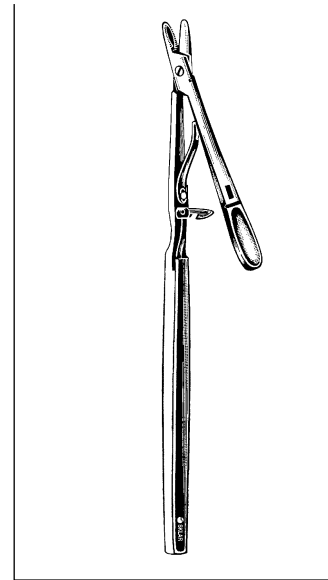
20-1760 5" One offset ring



OLSEN-HEGAR COMBINED NEEDLE HOLDERS AND SCISSORS

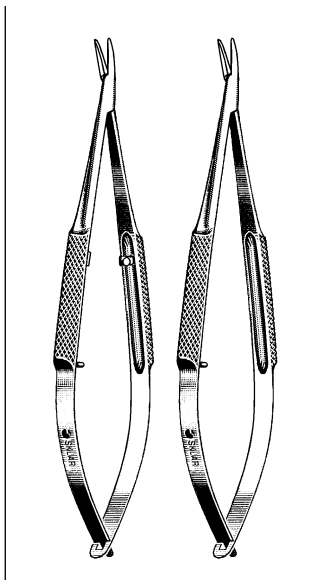
Delicate

20-2747 4 3/4" Serrated jaws
20-2748 4 3/4" Smooth jaws



STEVENS NEEDLE HOLDER

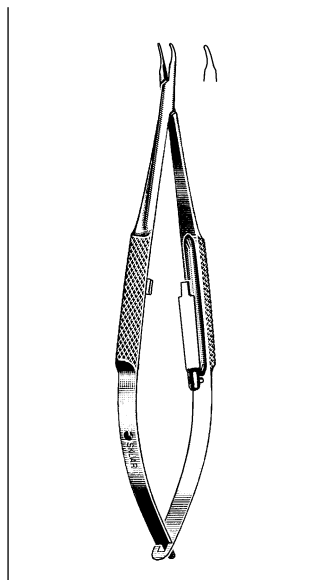
65-6265 6 1/2"



COHAN NEEDLE HOLDER

Mini-micro 7 mm jaws

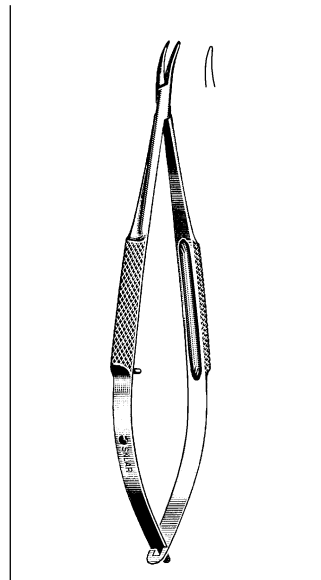
65-6470 4" Curved without lock
65-6475 4" Curved with lock



BARRAQUER NEEDLE HOLDER

Round grip spring handle, with inside catch

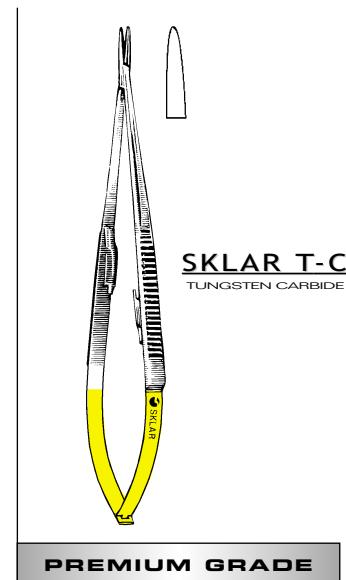
65-6446 5 1/4" Delicate Curved Jaw
65-6448 5 1/4" Smooth Curved Jaw



BARRAQUER NEEDLE HOLDER

Delicate curved jaw, round grip spring handle, without catch

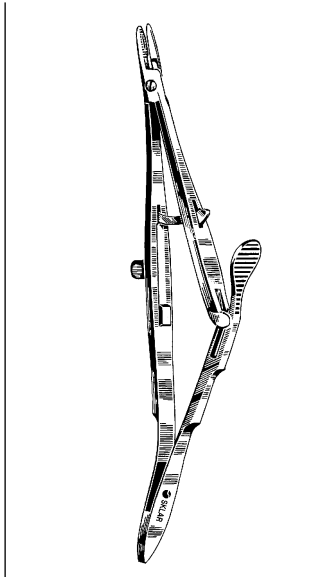
65-6452 5 1/4"



T-C JACOBSON NEEDLE HOLDER

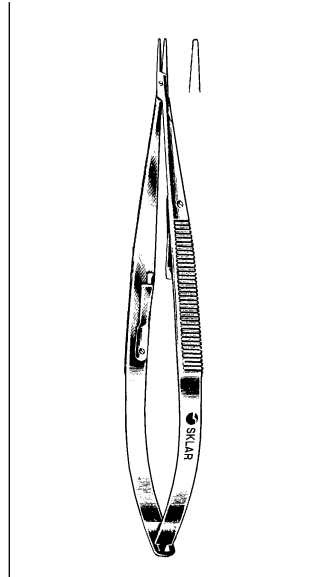
Straight-Delicate

21-8055 8 1/4" Smooth, With Lock
21-8058 8 1/4" Smooth, Without Lock



CASTROVIEJO-KALT NEEDLE HOLDER

65-6055 5½"

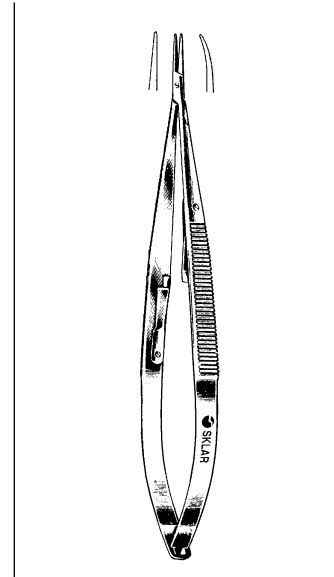


CASTROVIEJO NEEDLE HOLDER

With Catch

65-6357 5½" Straight, Smooth

65-6358 5½" Curved, Smooth



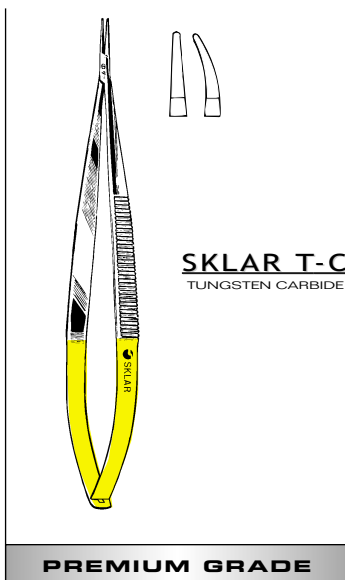
CASTROVIEJO NEEDLE HOLDERS

Standard handle, Extra Delicate, Smooth Jaws to hold 7-0 Sutures (especially milled handle to improve traction)

65-6350 5½" Straight jaw without catch

65-6352 5½" Straight jaw with catch

65-6354 5½" Curved jaw with catch

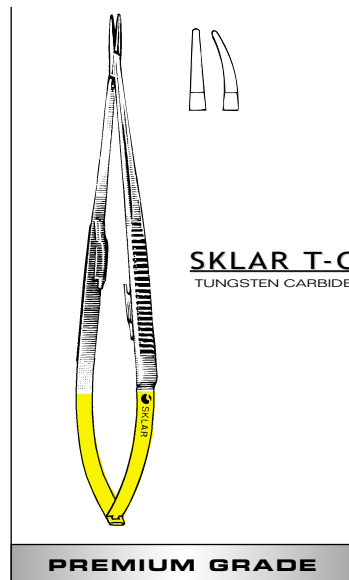


T-C CASTROVIEJO NEEDLE HOLDER

Extra Delicate - Without Lock

21-8044 5½" Straight, Smooth

21-8045 5½" Curved, Smooth

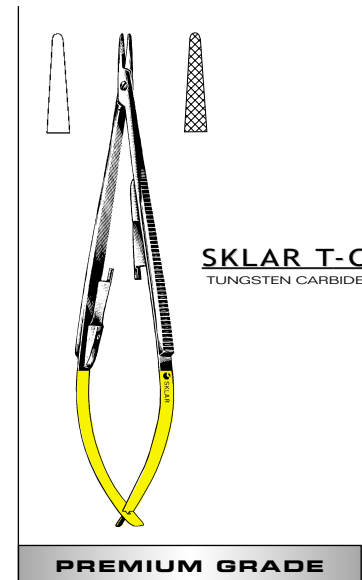


T-C CASTROVIEJO NEEDLE HOLDER

Extra Delicate - With Lock

21-8042 5½" Straight, Smooth

21-8043 5½" Curved, Smooth



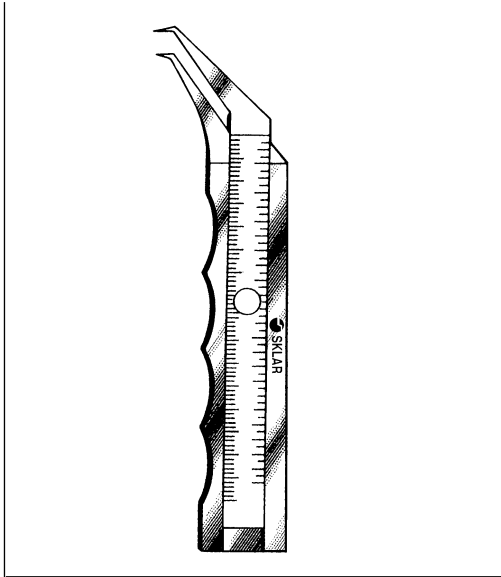
T-C CASTROVIEJO NEEDLE HOLDER

Straight - With Lock

21-8040 5½" Smooth

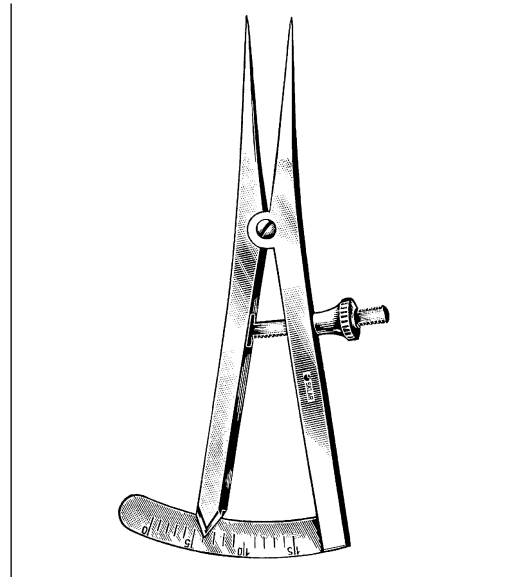
21-8046 5½" Serrated

EYE INSTRUMENTS ACCESSORIES



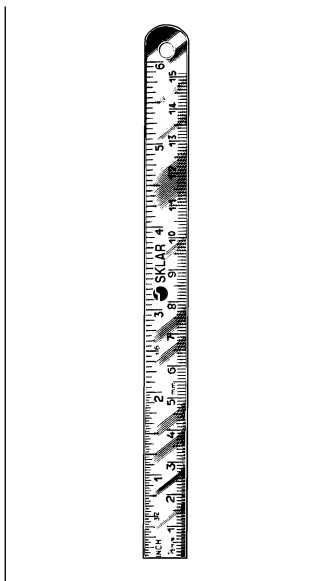
THORPE CALIPER

Graduated in inches and mm
65-6735 4½"



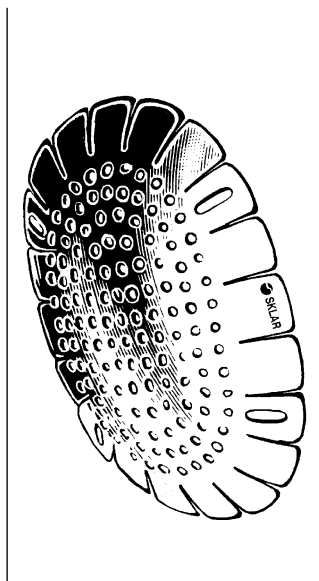
CASTROVIEJO CALIPER

65-6732 3½"



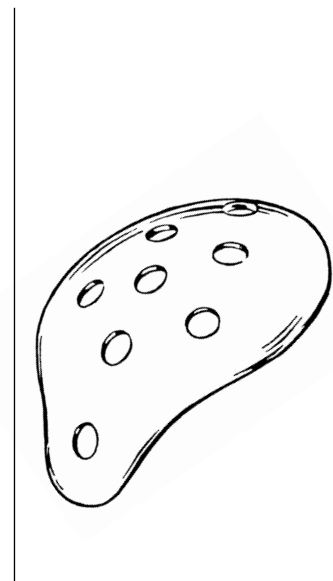
STEEL RULER

Graduated in inches and mm
06-2860 6"



FOX ALUMINUM EYE SHIELD

65-7634 Package of 12
65-7635 Package of 1



DISPOSABLE EYE SHIELDS

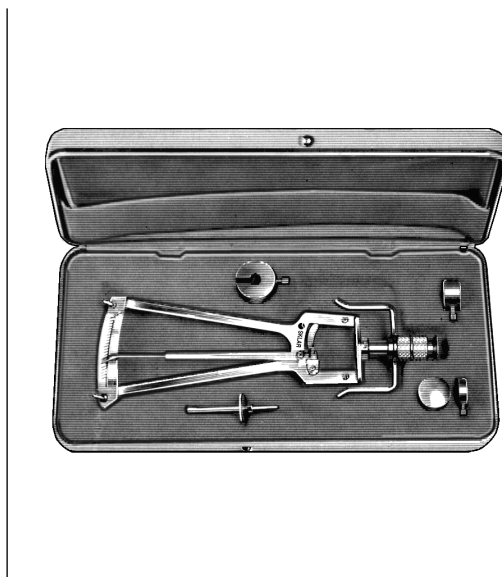
96-1070 Each
96-1071 Dozen
Lighter in weight, Sklar disposable eye shields offer an alternative to metal shields. Made of high impact plastic. Not Autoclavable.



SCHIOTZ TONOMETER

Sklar Original
65-7523

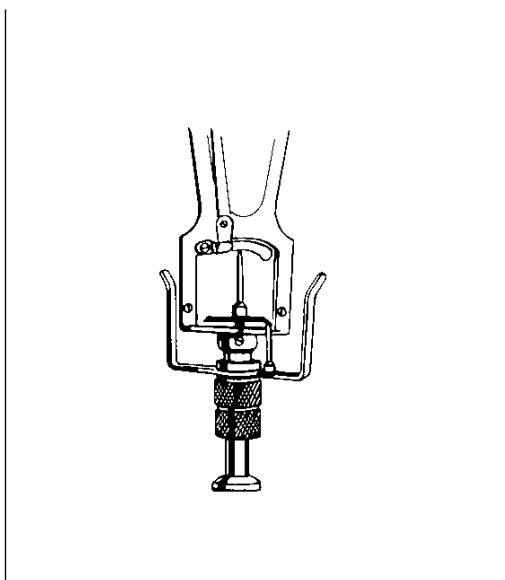
- Screw-on 5.5 gr. weight
- 2 Additional weights 7.5, 10 gr.
- Test Block • Fitted Tonometer Case • Certified



SCHIOTZ TONOMETER

Sklar Exclusive Improved Model
65-7525

- Inclined scale for accurate reading
- 3 Additional weights 7.5, 10 gr, 15 gr.
- Test Block • Fitted Tonometer • Certified

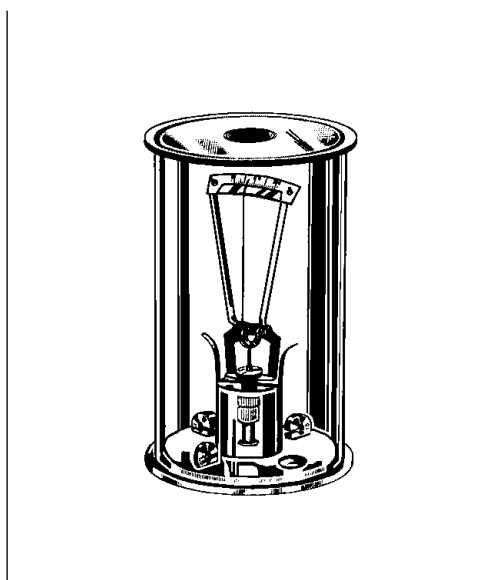


SCHIOTZ TONOMETER

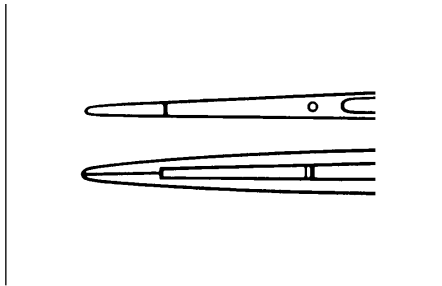
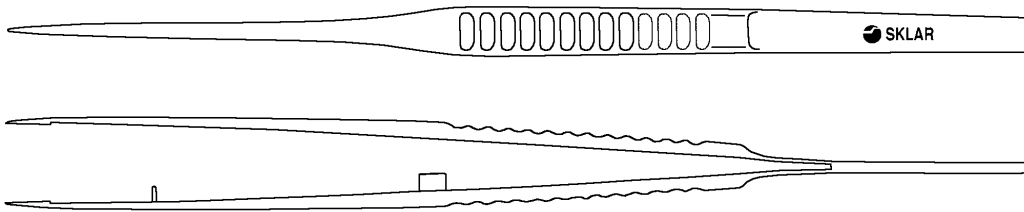
Allen Modification

65-7526 Same as 65-7525 with Allen Modification
65-7531 Same as 65-7523 with Allen Modification

- Improved Tonometer with Allen modification that retracts the plunger presenting the smooth footplate to the cornea.



65-7528 Sklar's Tonometer Sterilizing Stand With Cover



MICRO FORCEPS

Straight Flat Handle

Straight Blunt Tip

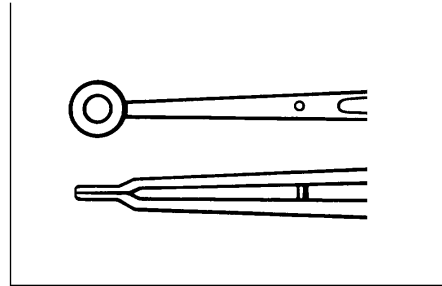
98-7700 6 1/4" Long

98-7702 8" Long

Straight Pointed Tip

98-7706 6 1/4" Long

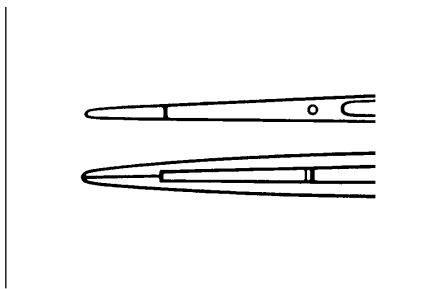
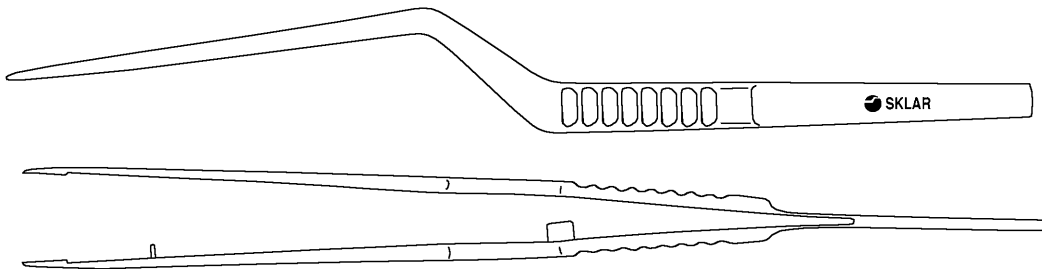
98-7708 8" Long



TUMOR GRASPING FORCEPS

Straight Flat Tip

98-7718 8" Long



MICRO FORCEPS

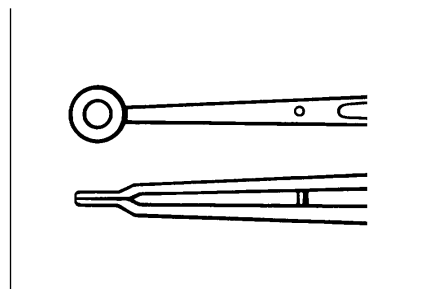
Bayonet Flat Handle

Straight Blunt Tip

98-7740 6 1/4" Long

98-7742 8" Long

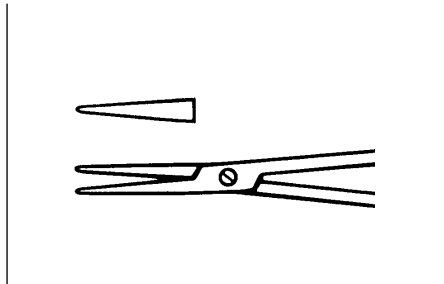
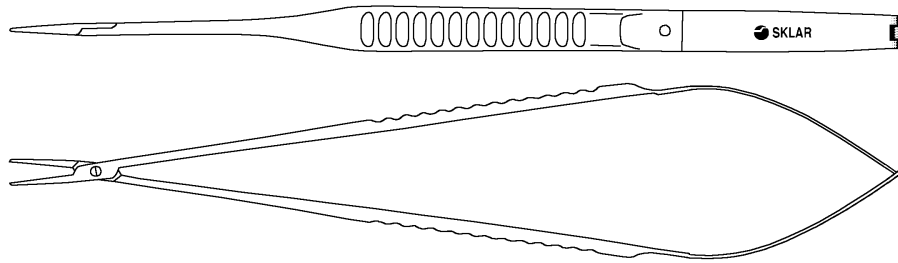
98-7744 9 1/2" Long



TUMOR GRASPING FORCEPS

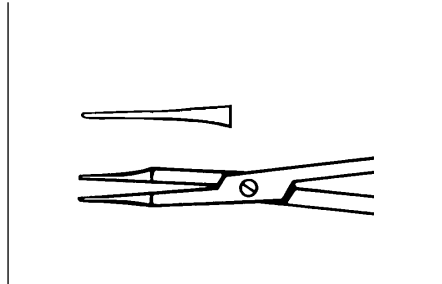
Bayonet Flat Handle

98-7758 8" Long



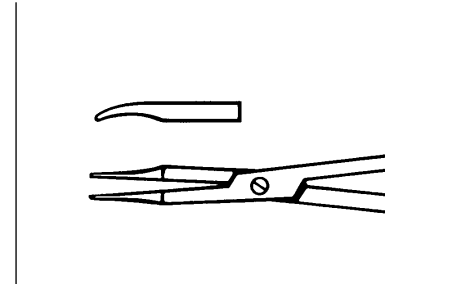
NEEDLE HOLDER

Straight Flat Handle
 Straight Tip, without Lock
 98-7780 6 1/4" Long
 98-7782 8" Long



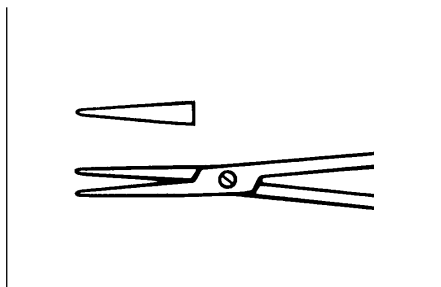
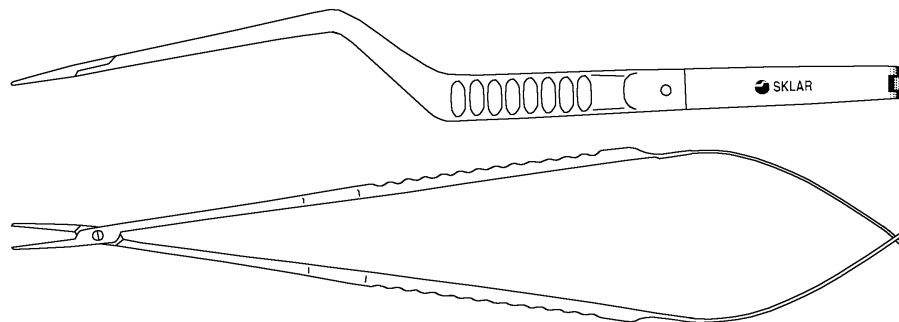
MICRO NEEDLE HOLDER

Straight Flat Handle
 Straight Tip, without Lock
 98-7786 6 1/4" Long
 98-7788 8" Long



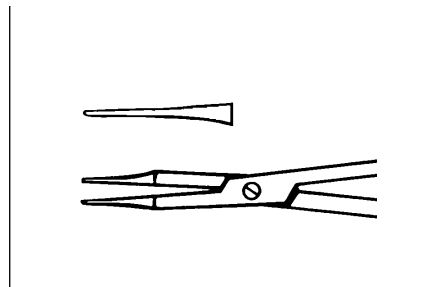
MICRO NEEDLE HOLDER

Slightly Curved Tip, without Lock
 98-7792 6 1/4" Long
 98-7794 8" Long



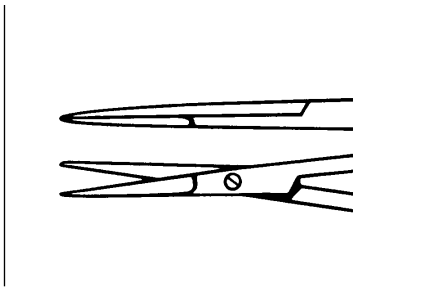
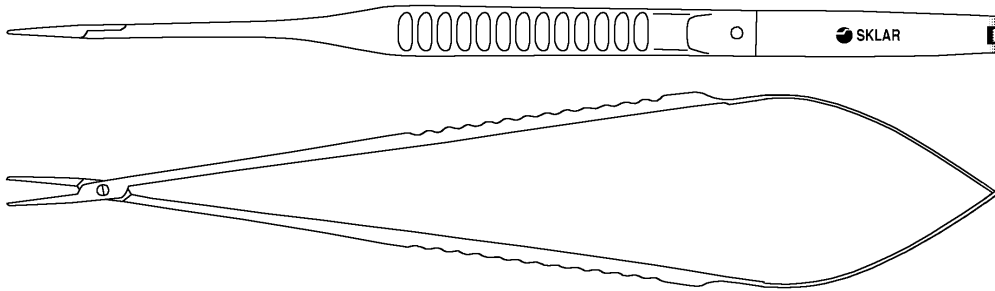
NEEDLE HOLDER

Bayonet Flat Handle (without Lock)
 Straight Tip
 98-7820 6 1/4" Long
 98-7822 8" Long



MICRO NEEDLE HOLDER

Bayonet Flat Handle (without Lock)
 Straight Tip
 98-7832 6 1/4" Long
 98-7834 8" Long



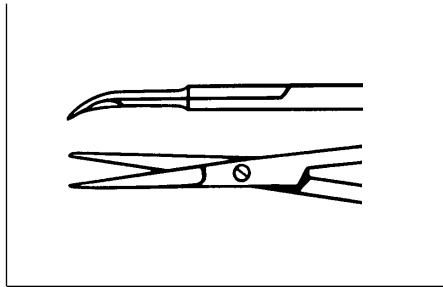
MICRO SCISSORS

Straight Flat Handle

Straight Tip

98-7860 6 1/4" Long

98-7862 8" Long



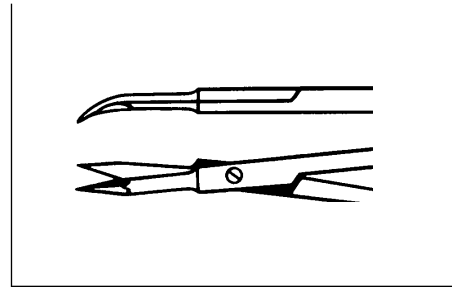
MICRO SCISSORS

Straight Flat Handle

Curved Tip

98-7866 6 1/4" Long

98-7868 8" Long



MICRO SCISSORS

Straight Flat Handle

Curved Tip Vannas Blades

98-7872 6 1/4" Long

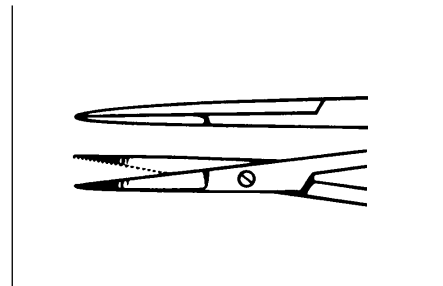
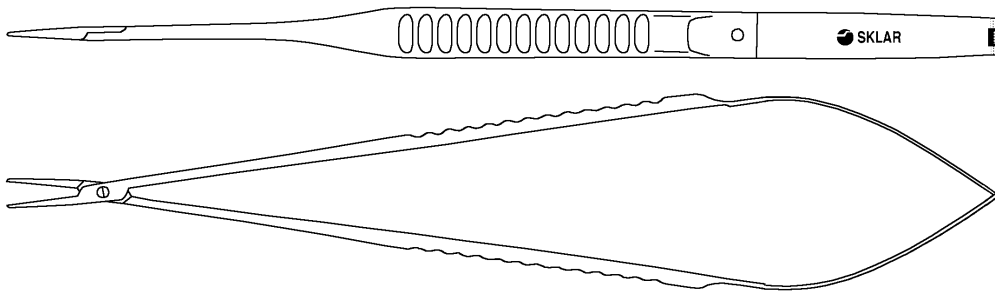
98-7874 8" Long

Straight Flat Handle

Straight Tip Vannas Blades

98-7277 6 1/4" Long

98-7278 8" Long



MICRO SCISSORS

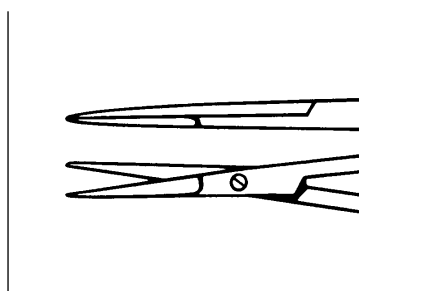
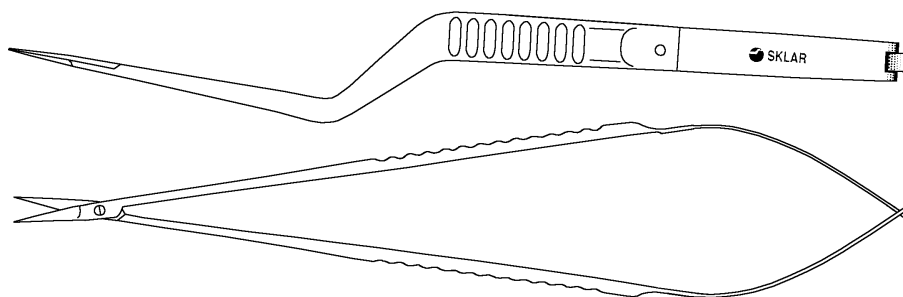
Straight Flat Handle

Straight Tip Toothed Blades

98-7890 6 1/4" Long

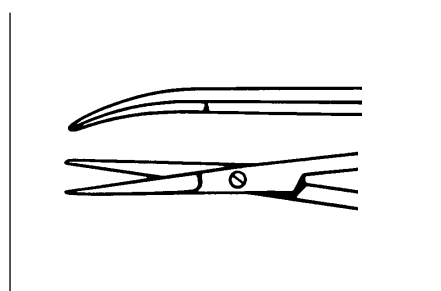
98-7892 8" Long

98-7894 9 1/2" Long



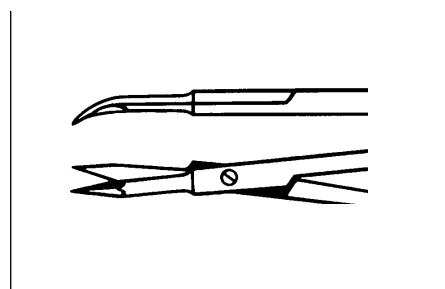
MICRO SCISSORS

Bayonet Flat Handle
 Straight Tip
 98-7922 8" Long
 98-7924 9 1/2" Long



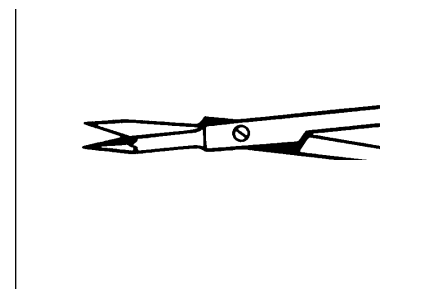
MICRO SCISSORS

Bayonet Flat Handle
 Curved Tip
 98-7928 8" Long
 98-7930 9 1/2" Long



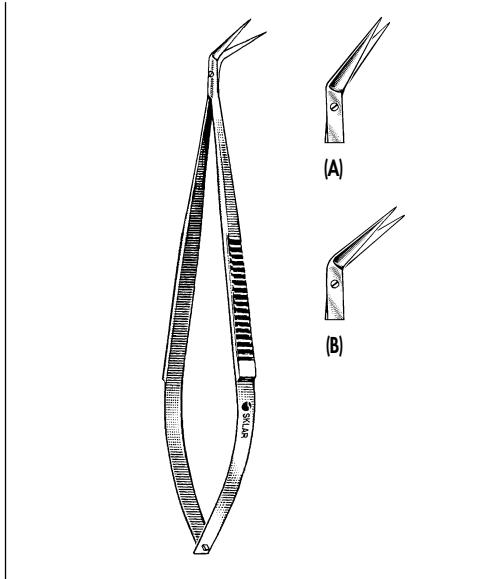
MICRO SCISSORS

Bayonet Flat Handle
 Curved Tip Vannas Blades
 98-7950 6 1/4" Long
 98-7952 8" Long
 98-7954 9 1/2" Long



MICRO SCISSORS

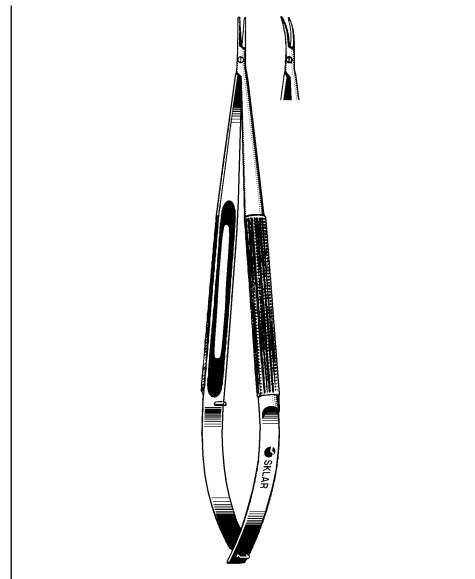
Bayonet Flat Handle
 Straight Tip Vannas Blades
 98-7934 8" Long
 98-7936 9 1/2" Long



POTTS-SMITH VASCULAR SCISSORS

With Spring Handle

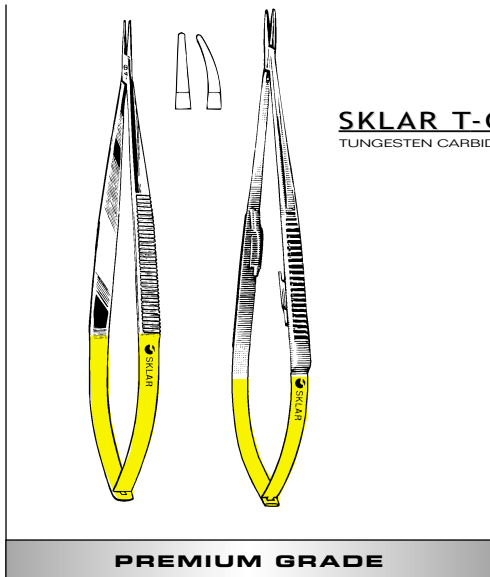
- 98-1075 7" 25° Angle (A)
- 98-1076 7" 45° Angle (B)



MICRO SURGERY NEEDLE HOLDERS

7 1/8" With Round Handle

- 98-3186 Straight Jaws 0.6 mm tips
- 98-3188 Curved Jaws 0.6 mm tips



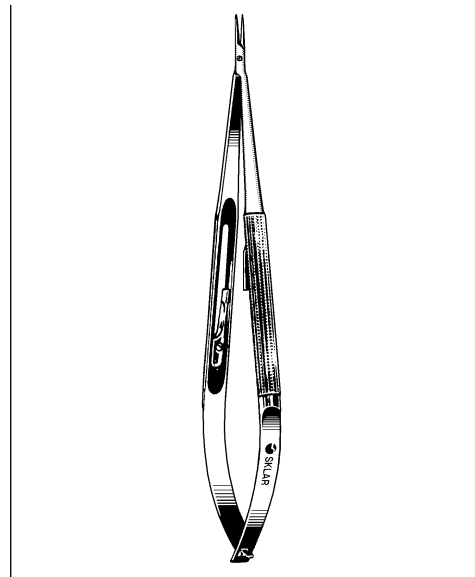
T-C CASTROVIEJO NEEDLE HOLDER

Extra Delicate—Without Lock

- 21-8044 5 1/2" Straight, Smooth
- 21-8045 5 1/2" Curved, Smooth

Extra Delicate—With Lock

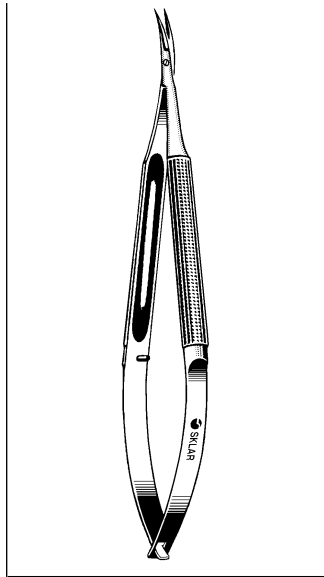
- 21-8042 5 1/2" Straight, Smooth
- 21-8043 5 1/2" Curved, Smooth



MICRO SURGERY NEEDLE HOLDERS

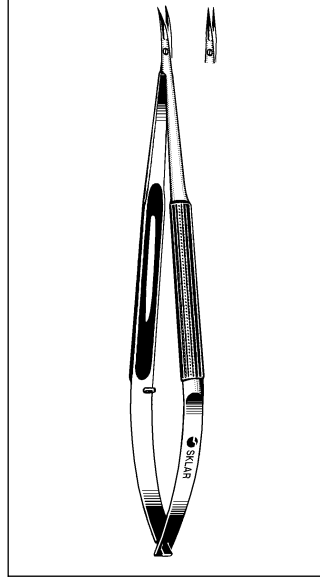
7 1/8" With Round Handle

- 98-3190 Straight Jaws with Lock
0.6 mm tips
- 98-3192 Curved Jaws with Lock
0.6 mm tips



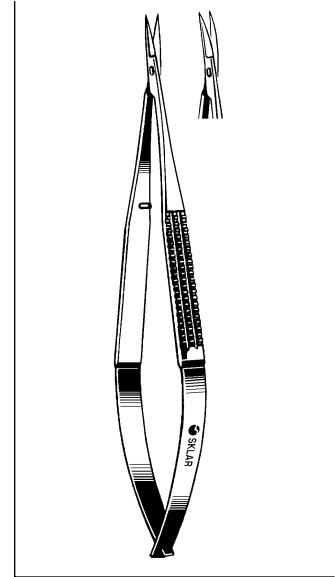
MICRO SURGERY SCISSORS

7" Sharp Points Round Handle
98-7815 Curved



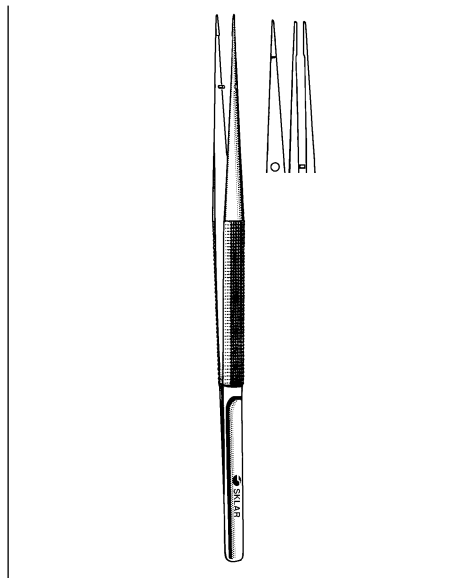
MICRO SURGERY SCISSORS

7 1/2" Round Handle
98-7816 Straight
98-7817 Curved



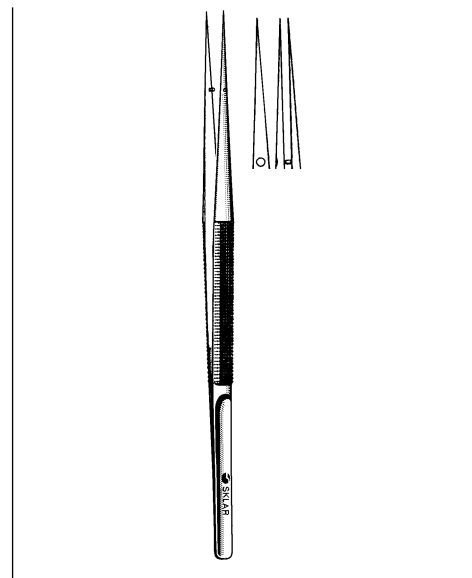
MICRO SURGERY SCISSORS

6" Sharp Points Flat Handle
98-7810 Straight
98-7812 Curved



RHOTON MICRO SUTURE FORCEPS

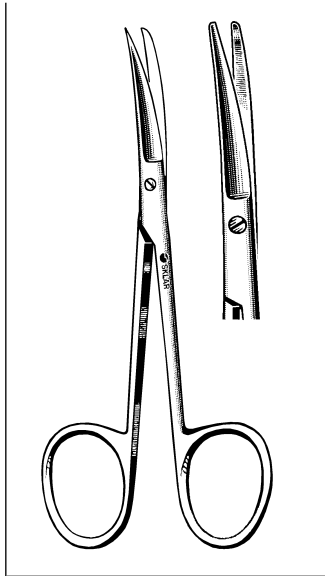
7" 0.7 mm Tying Platform
98-3055 Straight



RHOTON MICRO FORCEPS

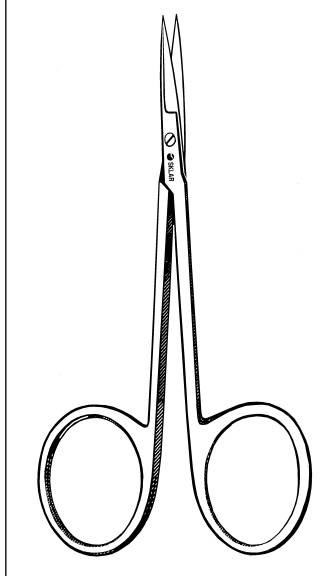
98-3056 7" Straight

DERMAL - SCISSORS



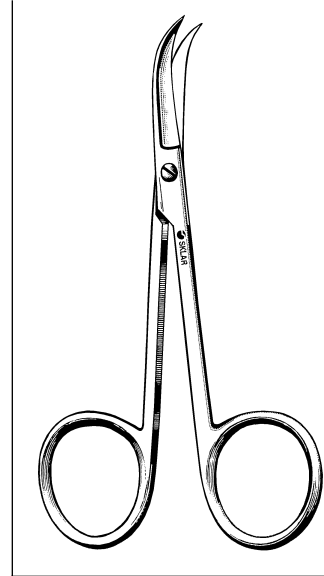
KNAPP IRIS SCISSORS

Curved
 64-3230 4" Sharp/Blunt
 64-3235 4" Blunt/Blunt



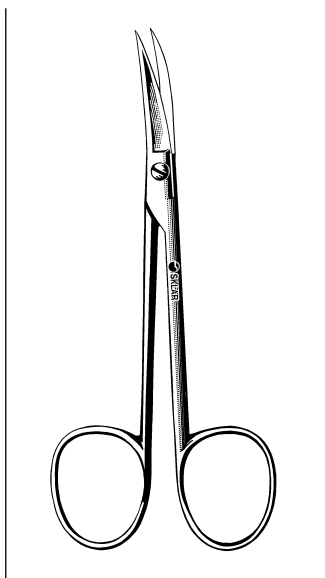
BONN SCISSORS

Delicate
 64-2035 S/S Straight 3½"
 64-2036 S/S Curved 3½"



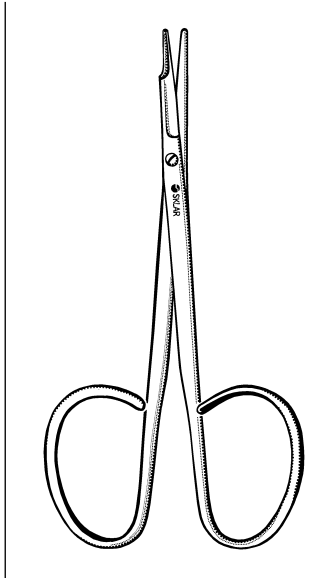
HILL SCISSORS

Sharp Points Curved Sideways
 22-2955 4½"



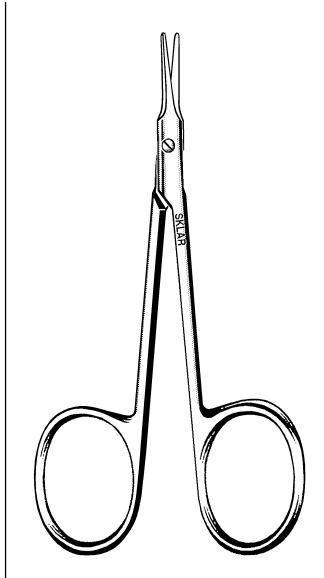
PLASTIC SURGERY SCISSORS

Curved
 47-1345 4½" S/S



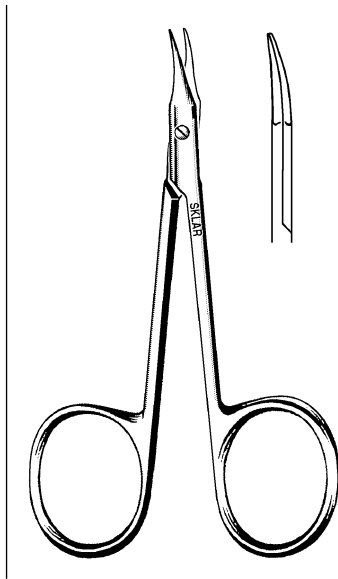
KAYE RIBBON UNDERMINING SCISSORS

47-1084 4½" Straight



FINE TIP (AEBLI) TISSUE SCISSORS

64-3270 4" Straight

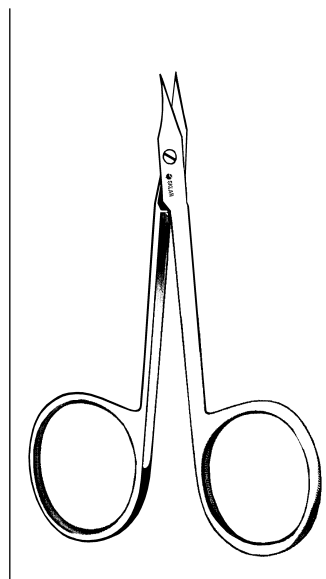


GRADLE SCISSORS

Slightly Curved, Sharp

64-3280 3 1/2"

64-3284 4"



GIBBS-GRADLE SCISSORS

Slightly Curved Blades

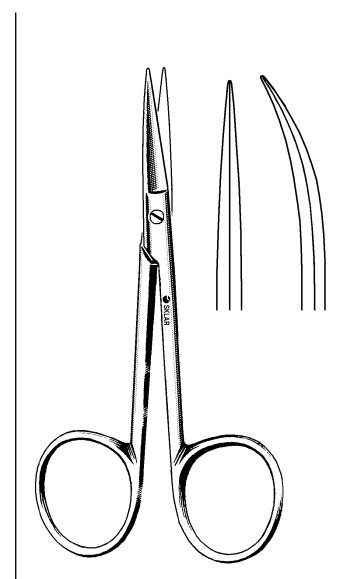
64-3282 3 1/2"



GOLDMAN-FOX SCISSORS

Curved

22-2520 5" Serrated



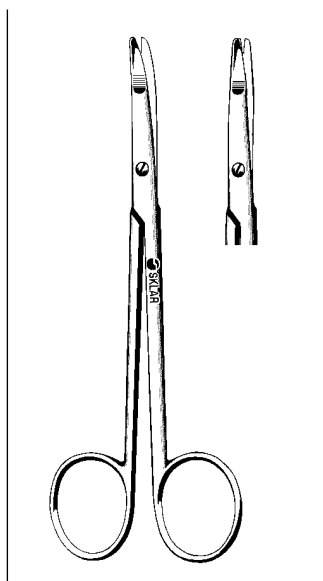
SEALY DISSECTING SCISSORS

Two Blunt Tips, Medium weight

Delicate blades

64-3285 4 1/4" Straight

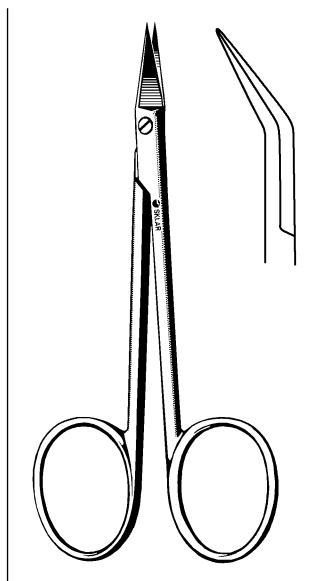
64-3288 4 1/4" Curved



RAGNELL DISSECTING SCISSORS (FLAT TIPS)

22-2652 5" Half Curved

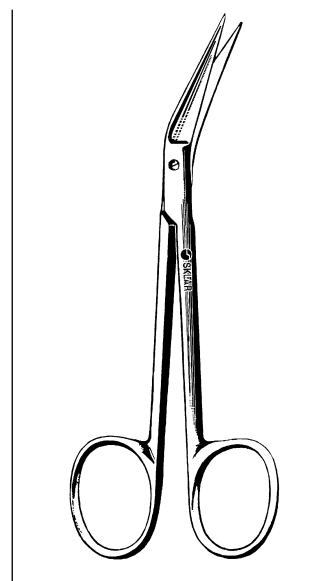
22-2653 5" Straight



WILMER SCISSORS

Angled On Flat

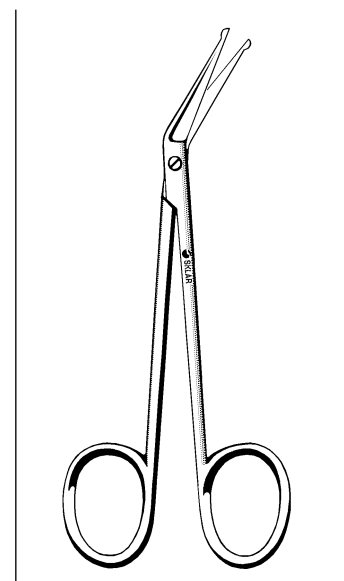
64-1735 4"



ANGULAR SCISSORS

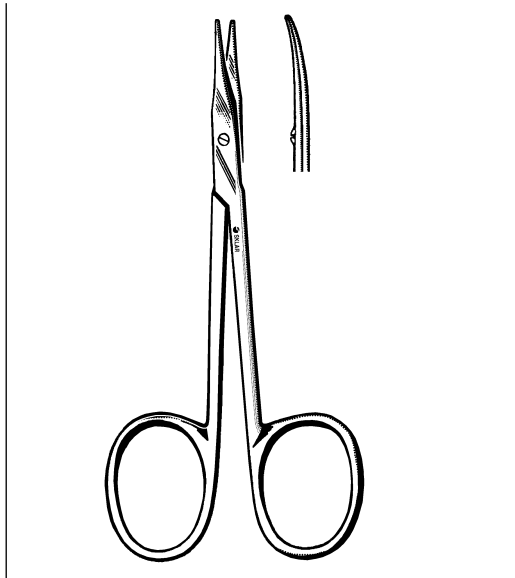
47-1080 4 1/4" Smooth

47-1081 4 1/4" Serrated



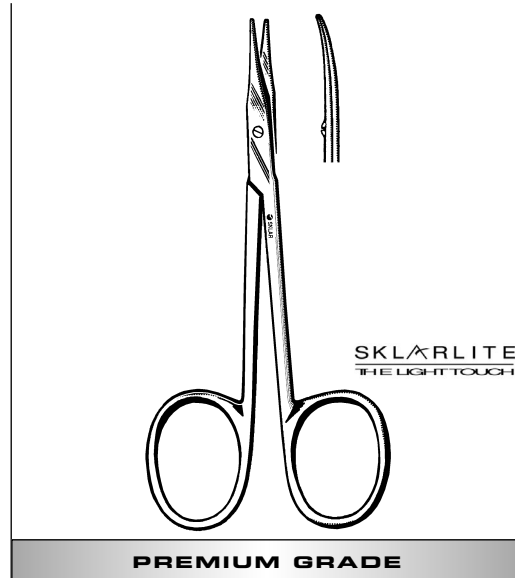
ANGULAR IRIS SCISSORS PROBE POINT

64-2042 4 1/4"



STEVENS TENOTOMY SCISSORS

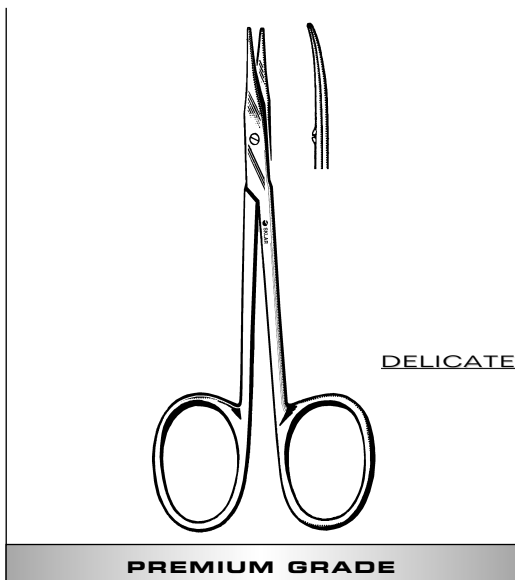
Straight	Curved
64-1242 4½" B/B	64-1342 4½" B/B



PREMIUM GRADE

SKLARLITE™ STEVENS TENOTOMY SCISSORS

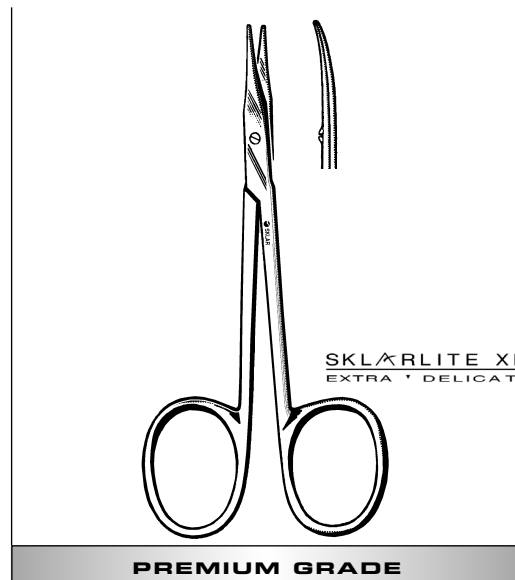
Straight	Curved
23-1156 4½" B/B	23-1157 4½" B/B



PREMIUM GRADE

STEVENS TENOTOMY SCISSORS DELICATE

Straight	Curved
22-1242 4½" B/B	22-1342 4½" B/B
22-1240 4½" S/S	22-1241 4½" S/S



PREMIUM GRADE

SKLARLITE™ EXTRA DELICATE STEVENS TENOTOMY SCISSORS

Straight	Curved
23-1160 4½" B/B	23-1161 4½" B/B



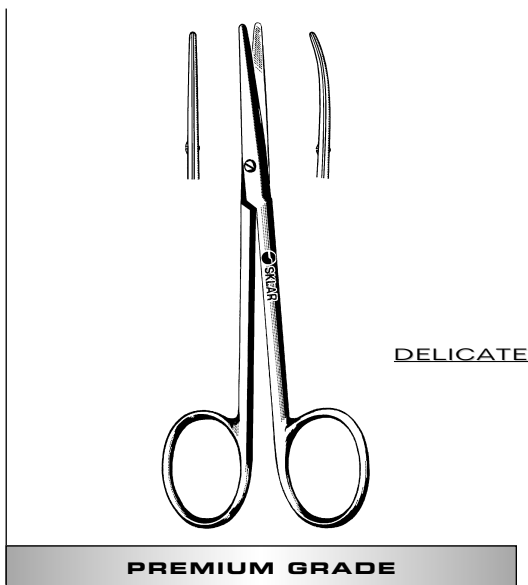
STRABISMUS SCISSORS

Straight	Curved
64-1442 4 1/2"	64-1542 4 1/2"



SKLARLITE™ STRABISMUS SCISSORS

Straight	Curved
23-1158 4 1/2"	23-1159 4 1/2"



STRABISMUS SCISSORS DELICATE

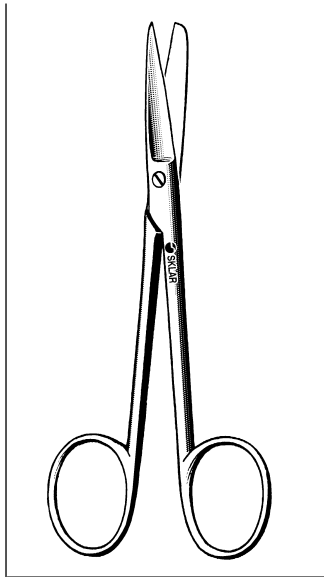
Straight	Curved
22-1442 4 1/2"	22-1542 4 1/2"



SKLARLITE™ EXTRA DELICATE STRABISMUS SCISSORS

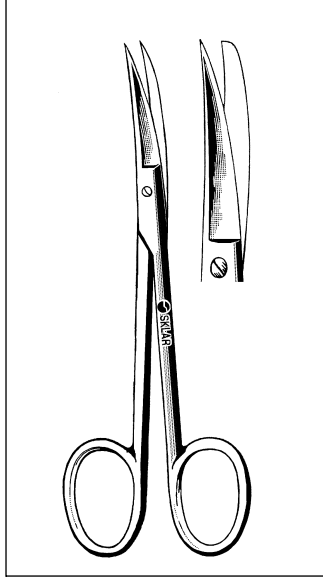
Straight	Curved
23-1162 4 1/2"	23-1163 4 1/2"

DERMAL - SCISSORS



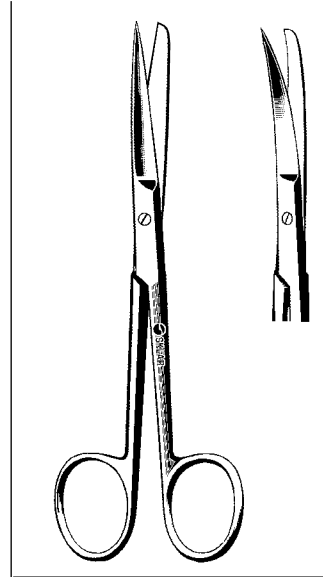
WAGNER SCISSORS STRAIGHT

Smooth
47-1047 S/S 4½"
47-1048 S/B 4½"
Serrated
47-1049 S/S 4½"



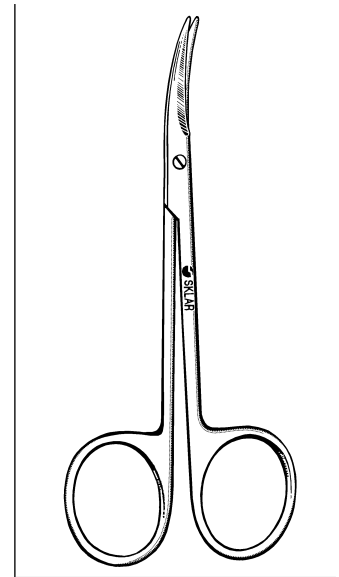
WAGNER SCISSORS CURVED

Smooth
47-1058 S/S 4½"
47-1068 S/B 4½"
Serrated
47-1059 S/S 4½"
47-1069 S/B 4½"



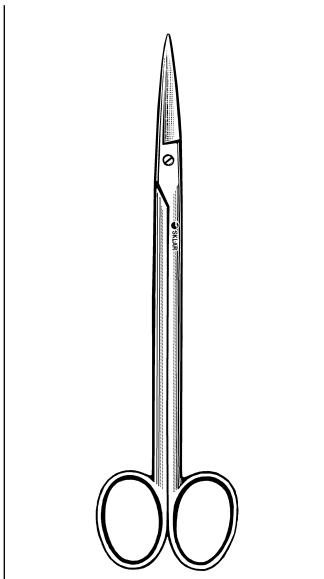
DEAVER SCISSORS DELICATE

Straight
13-1155 S/S 5½"
14-1155 S/B 5½"
15-1155 B/B 5½"
Curved
13-2155 S/S 5½"
14-2155 S/B 5½"



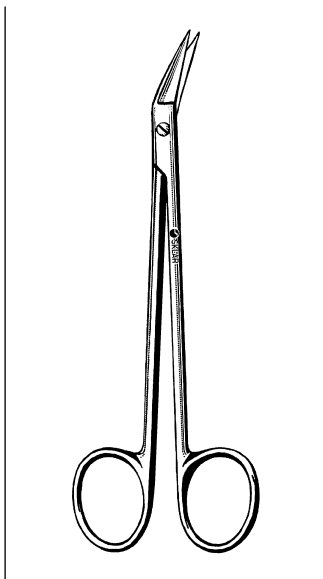
DURA SCISSORS SEMI-SHARP

Curved
22-2742 4¼"



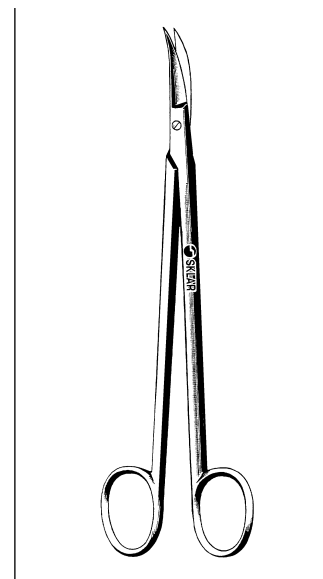
KELLY-ADSON SCISSORS

50-4562 6¼" Smooth
50-4563 6¼" Serrated



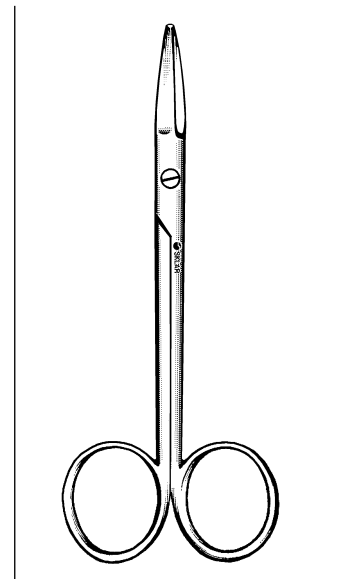
KELLY-ADSON SCISSORS

Angular
50-4462 6¼" Smooth



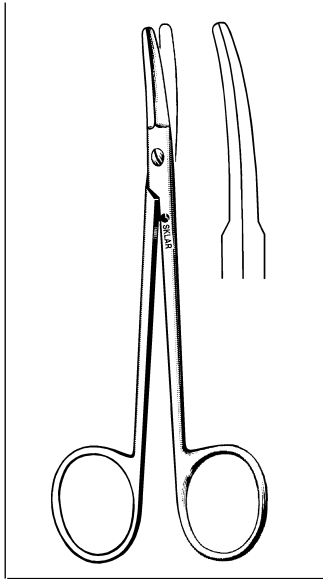
KELLY-ADSON SCISSORS

Curved
50-4662 6¼" Smooth



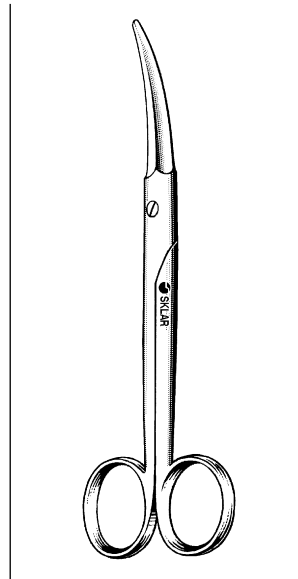
JOSEPH SCISSORS

Double Edge
41-1058 5¾" Straight



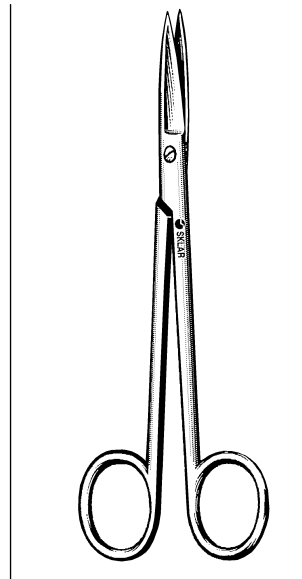
FOMON SABER BACK SCISSORS

Semi Sharp Back Edges
41-1076 5 1/2" Curved



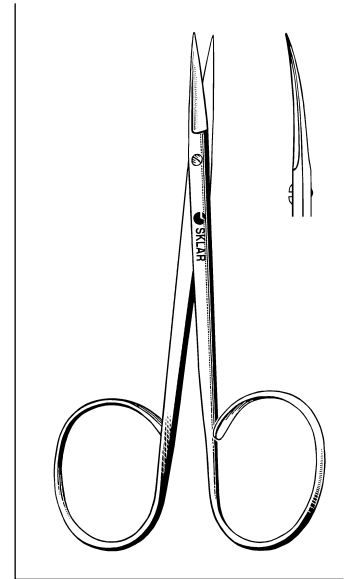
AUFRICHT FACE LIFT SCISSORS

Curved Triangular Blades
41-1167 5 3/4"



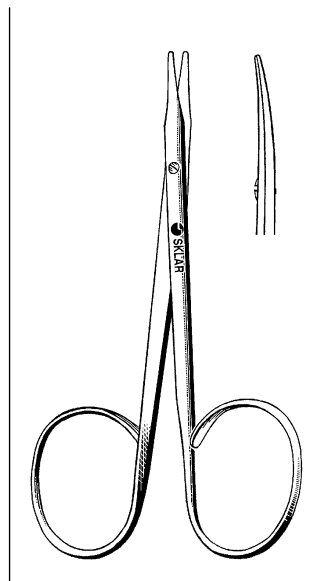
JOSEPH SCISSORS

41-1050 5 3/4" Straight
41-1054 5 3/4" Curved



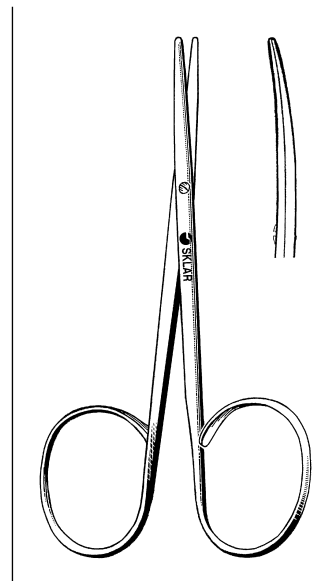
RIBBON IRIS SCISSORS

Straight 47-1250 4"
Curved 47-1255 4"



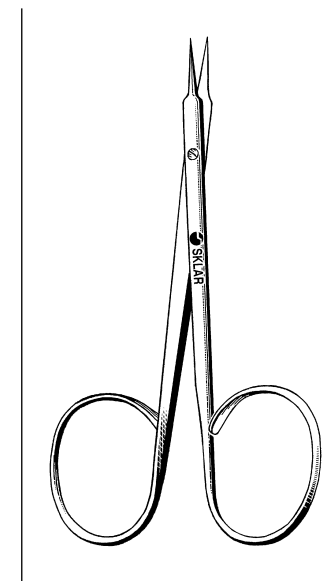
RIBBON STEVENS TENOTOMY SCISSORS

Straight 64-1241 4"
Curved 64-1341 4"



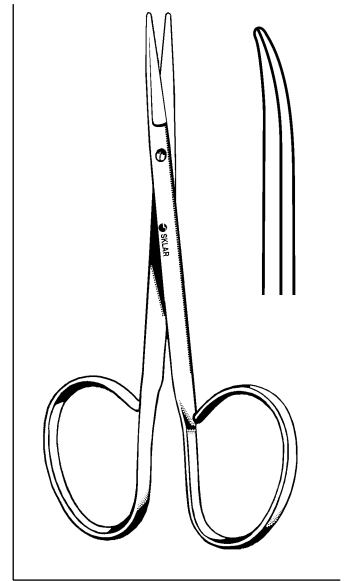
RIBBON STRABISMUS SCISSORS

Straight 64-1240 4"
Curved 64-1340 4"



RIBBON STITCH SCISSORS

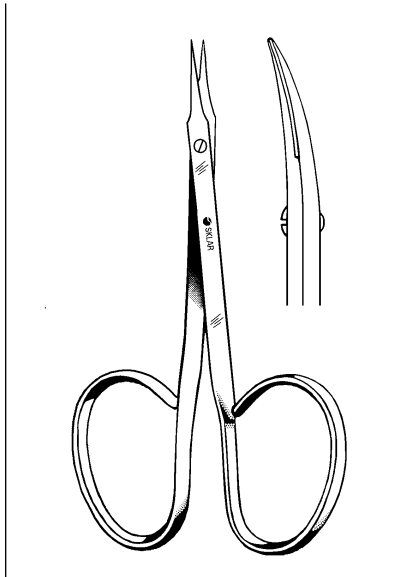
64-1345 4" Straight
64-1445 4" Curved



RIBBON UTILITY SCISSORS

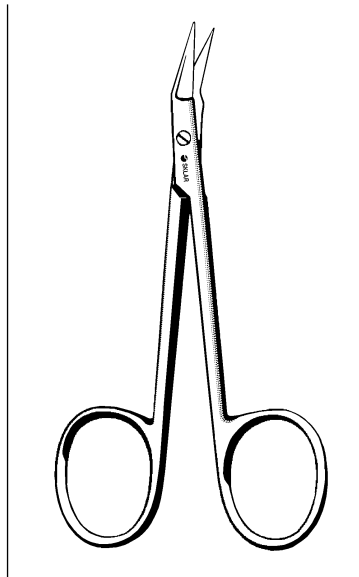
47-1146 4" Straight
47-1247 4" Curved

DERMAL - SCISSORS



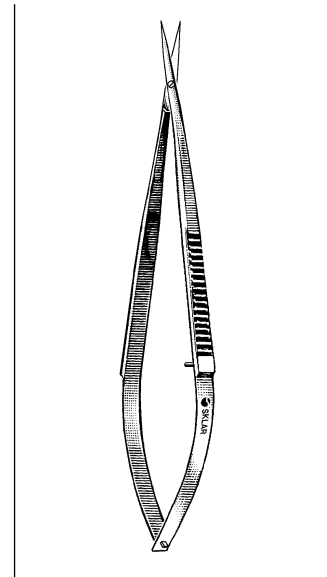
RIBBON STITCH SCISSORS

Straight 64-1345 4"
 Curved 64-1445 4"



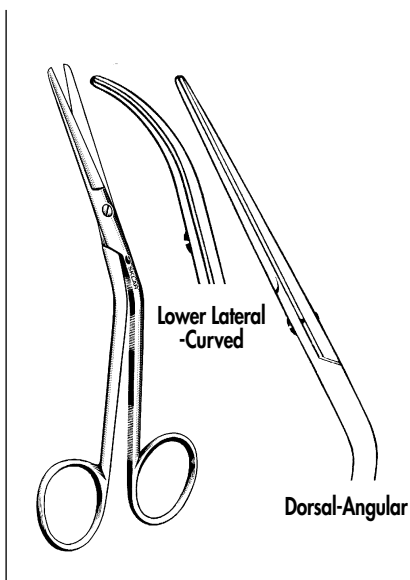
O'BRIEN STITCH SCISSORS

Angled Blade 22-2837 3 3/4"



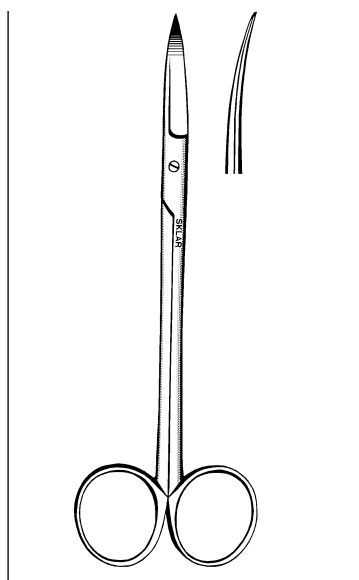
FINE STITCH SCISSORS

64-3260 4" Delicate Sharp Blades



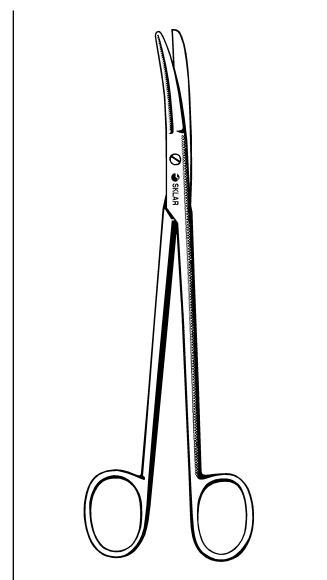
FOMON SCISSORS

70-4352 5 1/2" Lower Lateral-Curved
 70-4350 5 1/2" Dorsal-Angular



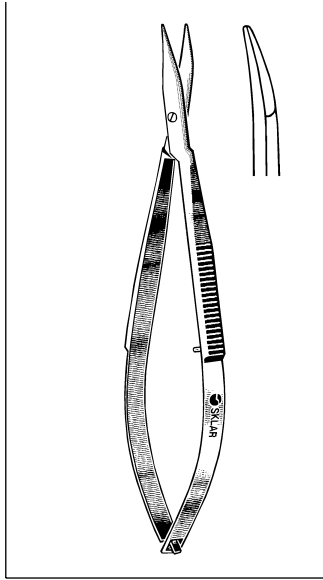
RHYTIDECTOMY SCISSORS

41-1100 6 1/2" Straight
 41-1105 6 1/2" Curved



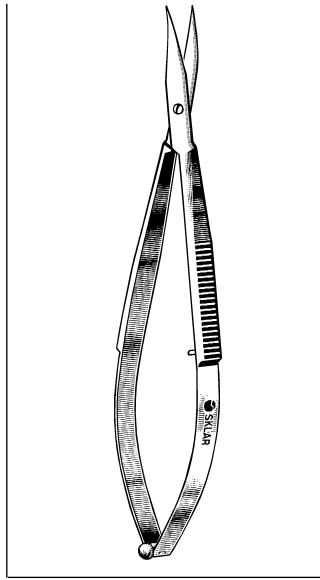
BOETTCHER SCISSORS

75-5070 7" Scalp Reduction, Curved



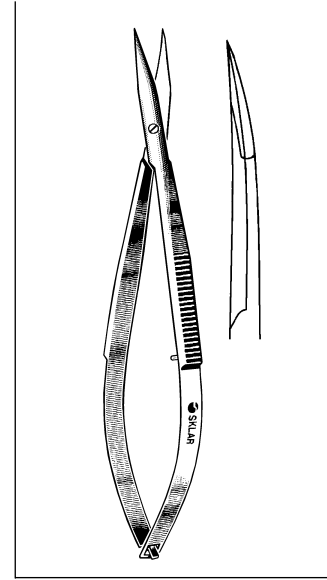
**WESTCOTT TENOTOMY
SCISSORS**

64-3146 4 1/4" Blunt tips with spring
handle



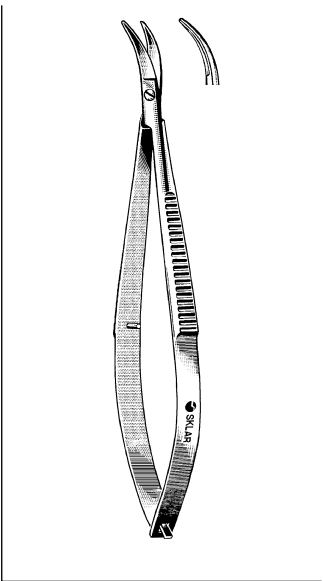
**WESTCOTT TENOTOMY
SCISSORS**

64-3142 5" 13 cm Right
64-3144 5" 13 cm Left



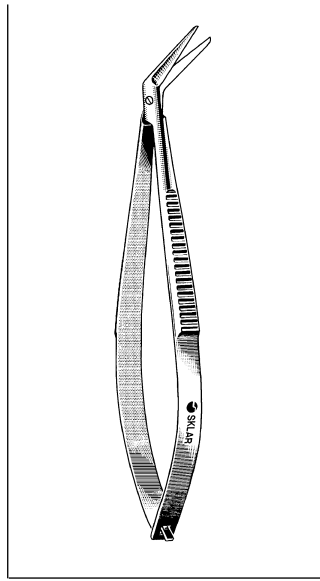
WESTCOTT SCISSORS

64-3145 4 1/4" Sharp tips with
spring handle



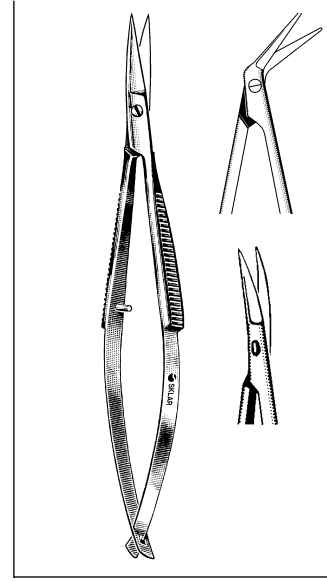
CASTROVIEJO SCISSORS

64-2442 4" Curved blunt blades



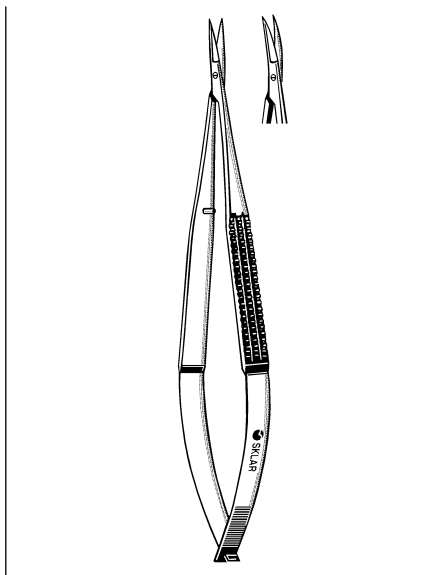
CASTROVIEJO SCISSORS

64-2535 4" 13 mm blunt
angled blades



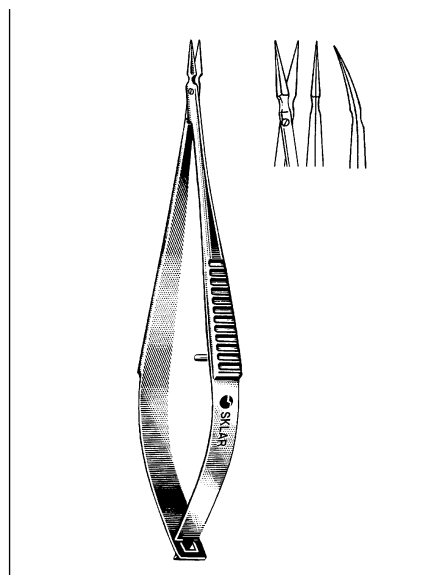
**McCLURE SPRING HANDLE
SCISSORS**

64-1742 4 1/4" Angled
64-1842 4 1/4" Straight
64-1942 4 1/4" Curved



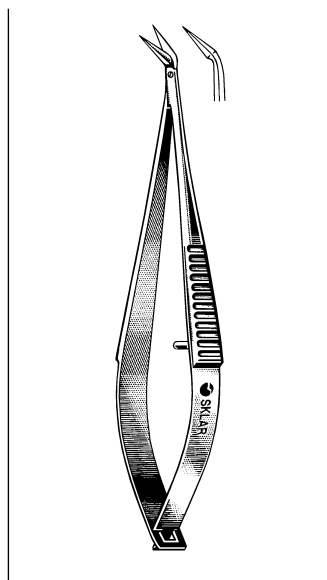
MICRO SURGERY SCISSORS

6" Sharp Points Flat Handle
 98-7810 Straight
 98-7812 Curved



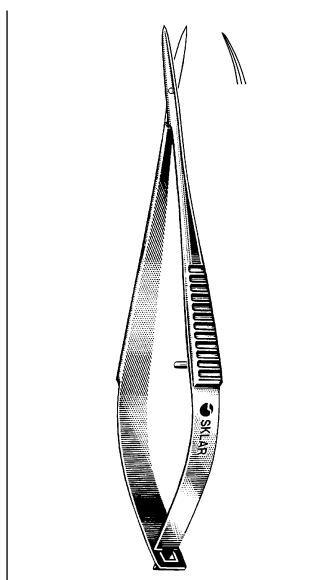
VANNAS SCISSORS

Delicate Blades With Spring Handle
 64-1950 3" Straight
 64-1951 3" Curved



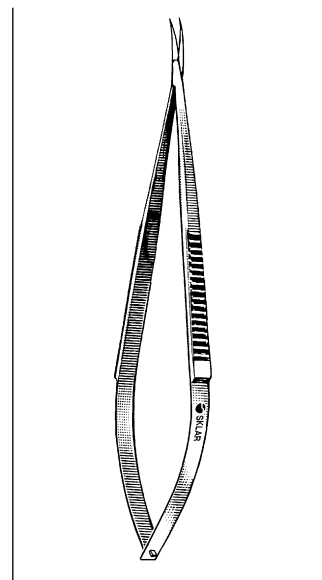
VANNAS SCISSORS

Extremely delicate blades with
 spring handle
 64-1955 Angled on flat
 64-1958 Angled to side



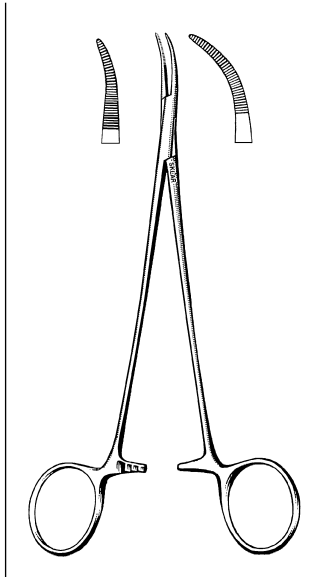
McPHERSON-VANNAS SCISSORS

Very Delicate
 64-1960 3" Straight
 64-1961 3" Curved



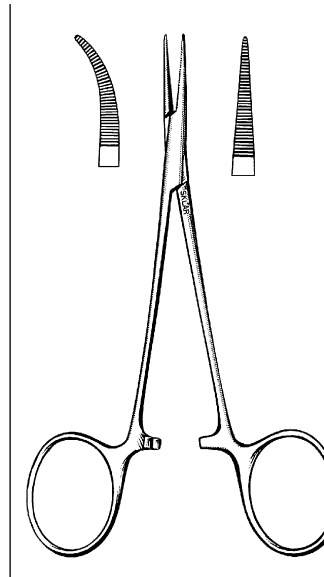
JACOBSON SPRING HANDLE SCISSORS

Standard
 98-1055 6 1/4" Straight
 98-1052 5 1/4" Curved
 98-1067 6 1/4" Curved



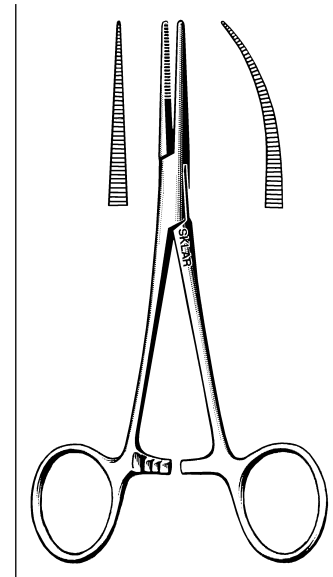
JACOBSON MOSQUITO FORCEPS EXTRA DELICATE

98-2070 7" Slight Curve
98-2071 7" Full Curve



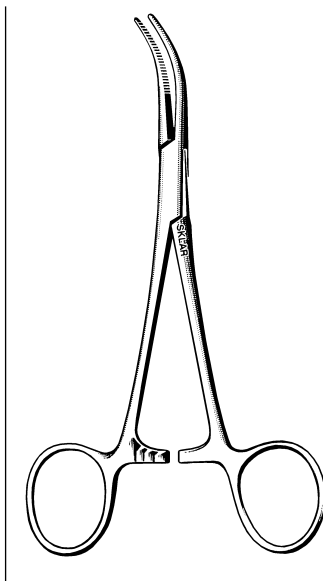
JACOBSON MOSQUITO FORCEPS DELICATE

98-2050 5" Straight
98-2051 5" Curved



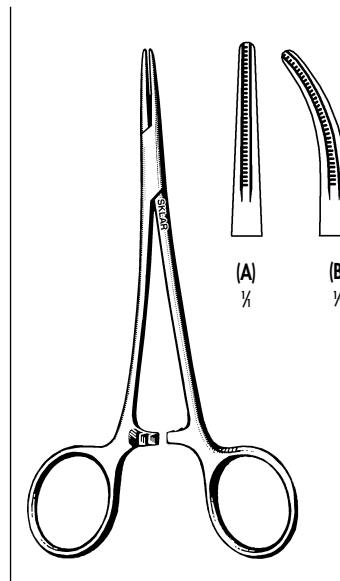
MICRO MOSQUITO FORCEPS

17-1220 5" Straight
17-1225 5" Curved



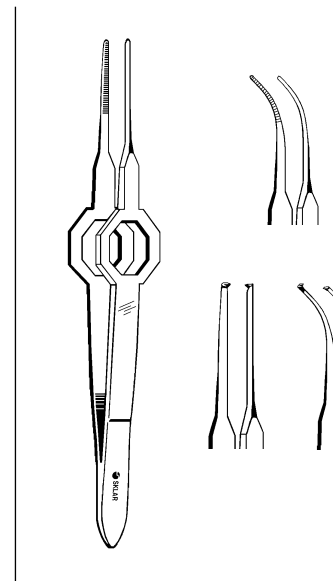
DANDY SCALP HEMOSTAT

Curved to Side
50-1355 5 1/2" Serrated
50-1357 5 1/2" Serrated 1 x 2 Teeth



DEBAKEY HALSTED MOSQUITO FORCEPS

52-6830 5" Straight (A)
52-6832 5" Curved (B)



FOERSTER FORCEPS

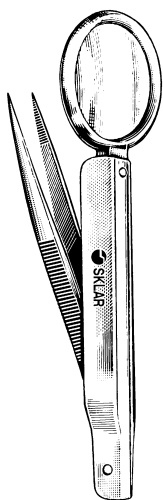
66-6036 3/4" Straight
66-6037 3/4" Curved
66-6038 3/4" Straight w/ 1x2 Teeth
66-6039 3/4" Curved w/ 1x2 Teeth

DERMAL - FORCEPS



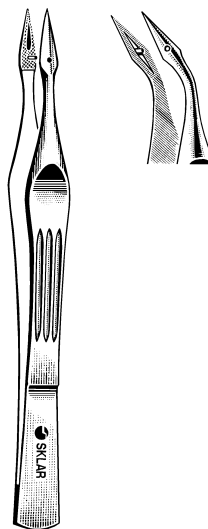
FINE POINT SPLINTER FORCEPS

19-3035 3½"
19-3040 4"
19-3045 4½"



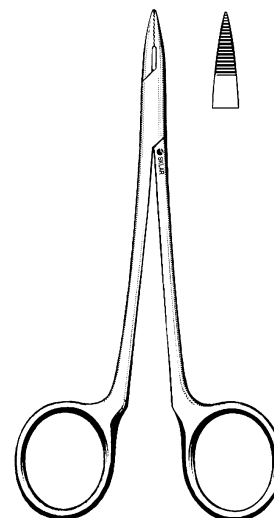
PLAIN SPLINTER FORCEPS WITH MAGNIFIER

19-3030 3" Chrome
Non-Autoclavable



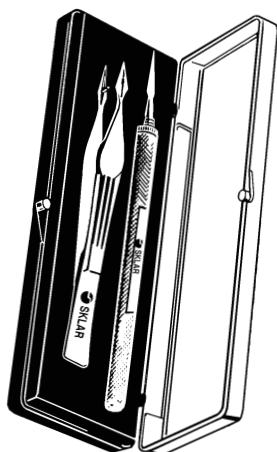
CARMALT SPLINTER FORCEPS

19-3240 4¼" Straight
19-3340 4¼" Curved



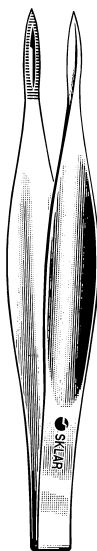
PHYSICIANS SPLINTER FORCEPS

19-3050 5"



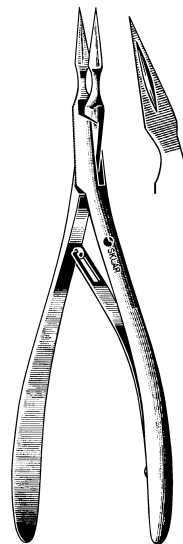
SKLAR SPLINTER REMOVAL KIT

19-3360 containing one 19-3240 and one 19-3350 in a convenient storage case.



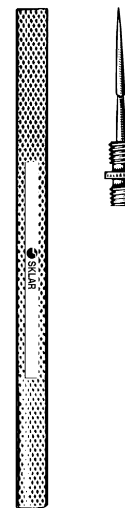
FEILCHENFELD SPLINTER FORCEPS

19-2930 3"
19-2945 4½"



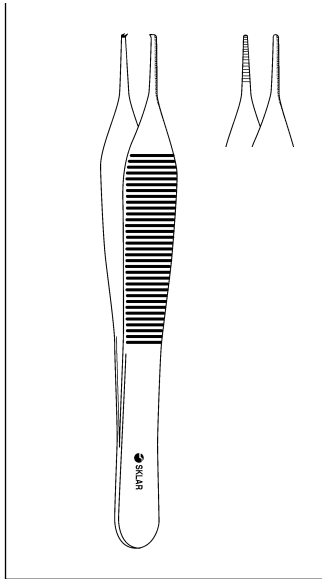
VIRTUS SPLINTER FORCEPS

19-3160 6" Straight
19-3162 6" Angled



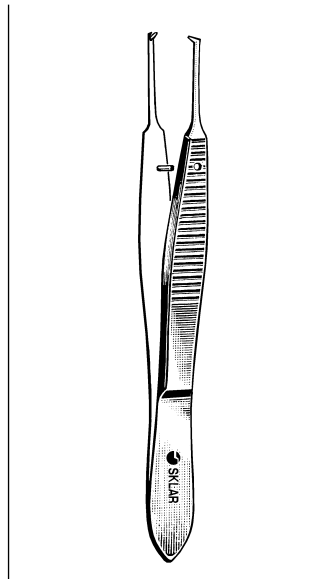
VANGUARD SPLINTER PICK

19-3350 3" Chrome
Non-Autoclavable



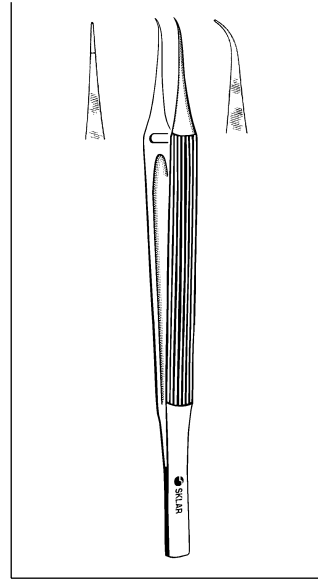
MICRO ADSON FORCEPS

98-2047 4 3/4" 1 x 2 Teeth
98-2048 4 3/4" Serrated



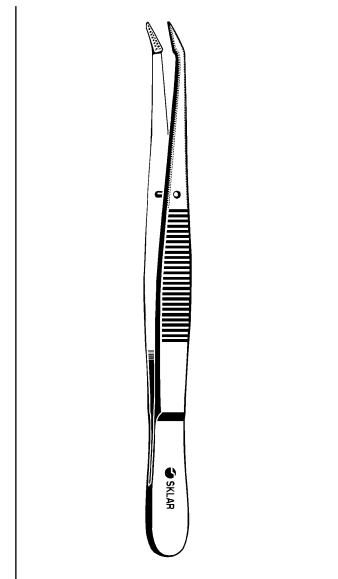
GRAEFE IRIS FORCEPS

66-4525 2 3/4" Straight 1 x 2
66-4625 2 3/4" Full Curved 1 x 2



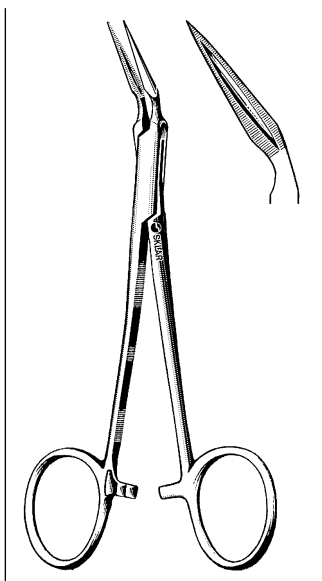
MICRO SUTURE TYING FORCEPS

98-2080 6" Straight
98-2081 6" Curved



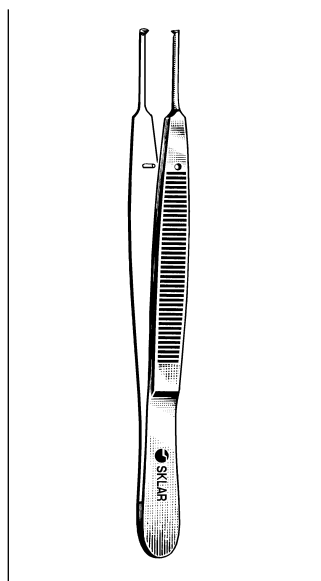
HEALY SUTURE FORCEPS

24-2155 5 1/2"



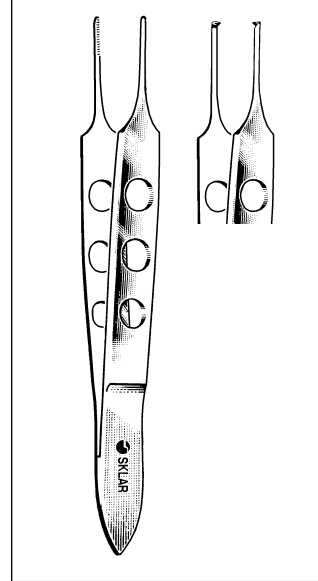
WILLIAMS (STIEGLITZ) SPLINTER FORCEPS

19-3055 5 1/2" Angular



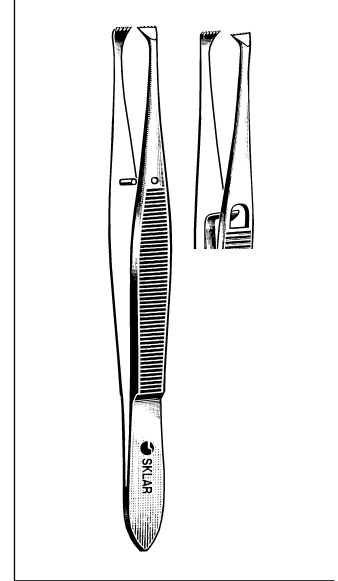
LESTER CONJUNCTIVAL FORCEPS

66-4235 3 1/2" 1 x 2
Non-Magnetic



BISHOP-HARMON FORCEPS

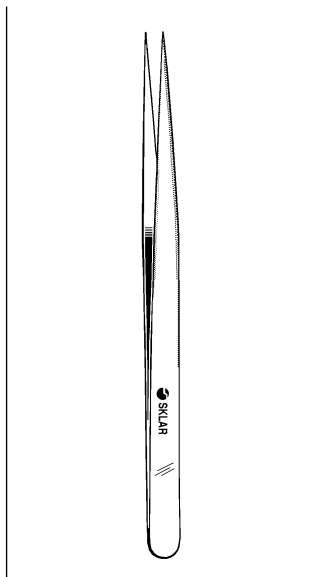
66-4032 3 1/2" Serrated
66-4132 3 1/2" 1 x 2
66-4232 3 1/2" 1 x 2 Micro (Iowa)
66-4234 3 1/2" 1 x 2 Delicate
66-4230 3 1/2" 1 x 2 Micro



GRAEFE FIXATION FORCEPS

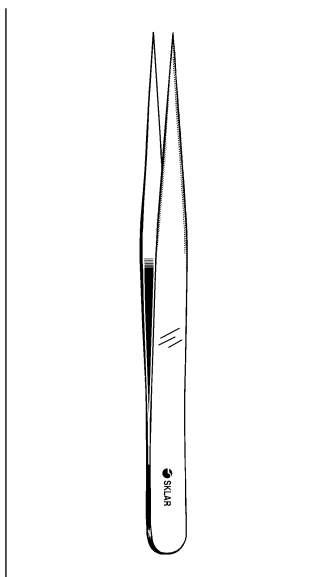
66-1940 4 1/2" Without Lock
66-2140 4 1/2" With Lock

DERMAL - FORCEPS



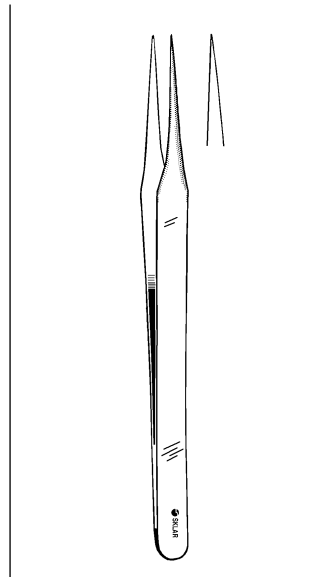
JEWELERS STYLE FORCEPS

66-7436 4 3/4" With extra fine tips, Style P



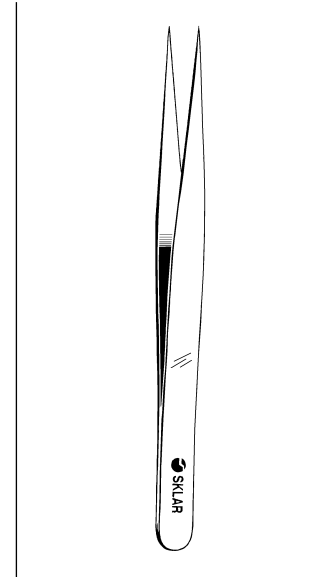
JEWELERS STYLE FORCEPS

66-7438 4 3/4" With fine tips, Style 1



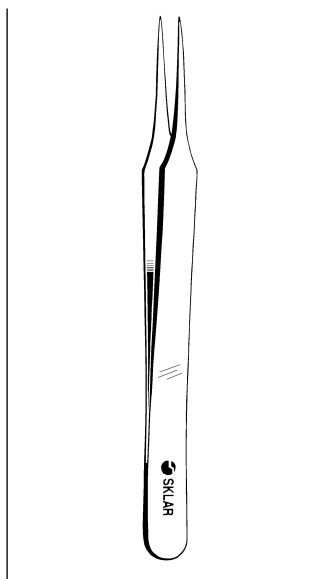
JEWELERS STYLE FORCEPS

66-7440 4 3/4" With fine tips, Style 2



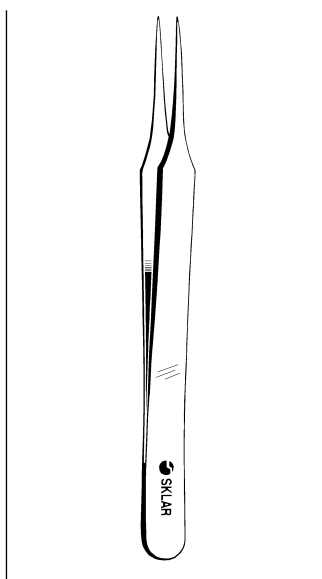
JEWELERS STYLE FORCEPS

66-7447 4 3/4" #3 Straight
66-7442 4 3/4" #3C Straight Delicate



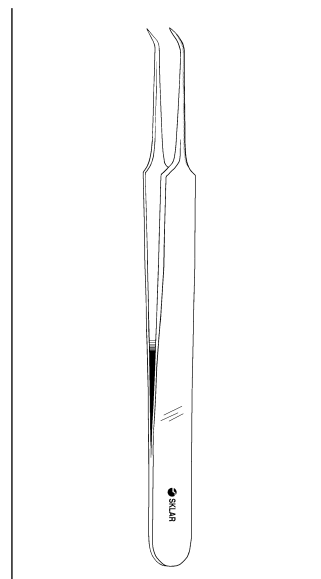
JEWELERS STYLE FORCEPS

66-7542 4 3/4" #4 Straight Delicate



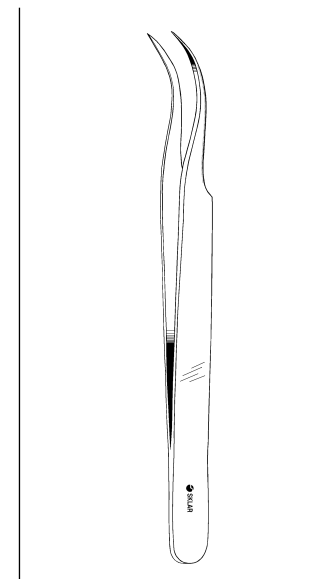
JEWELERS STYLE FORCEPS

66-7642 4 3/4" #5 Straight



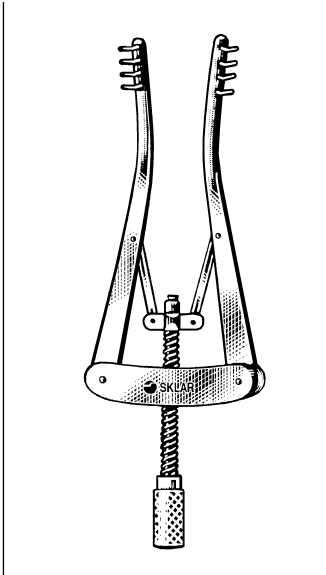
JEWELERS STYLE FORCEPS

66-7645 4 3/4" #5 Angled



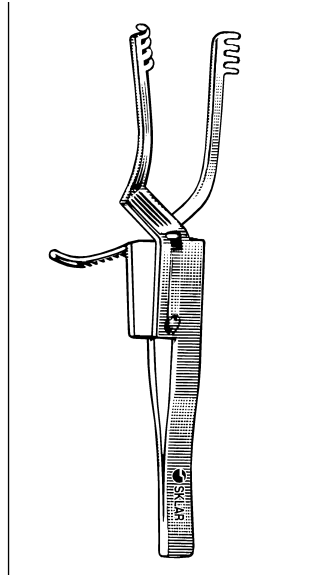
JEWELERS STYLE FORCEPS

66-7644 4 3/4" #7 Curved



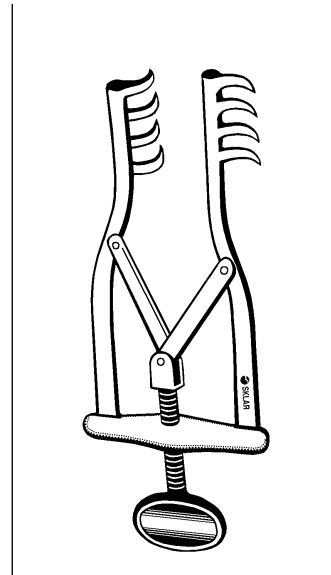
ALM RETRACTOR

22-9027 2 3/4" 4 x 4 Teeth Blunt
 60-6340 4" 4 x 4 Teeth Blunt
 22-9029 2 3/4" 4 x 4 Teeth Sharp
 60-6342 4" 4 x 4 Teeth Sharp



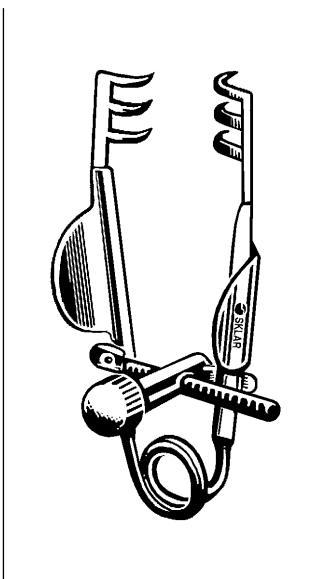
HOLZHEIMER RETRACTOR

Sharp
 22-8920 4" 4 x 4 Teeth
 Blunt
 22-8940 4" 4 x 4 Teeth



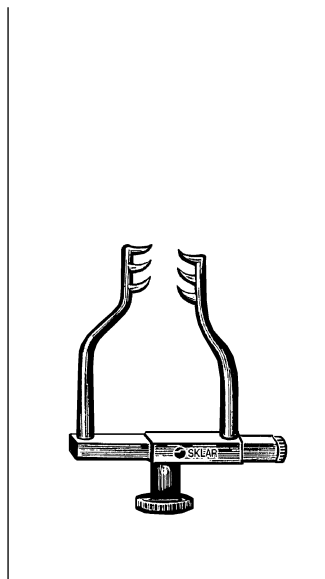
ALLPORT RETRACTOR

60-6320 4" Sharp
 60-6322 4" Blunt



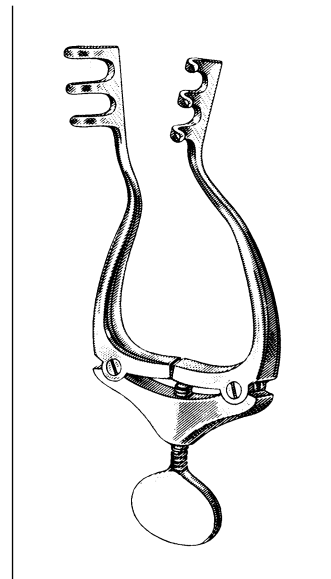
MELLER RETRACTOR

Delicate
 65-1815 3 x 3 Sharp Prongs 1 1/2"



GOLDSTEIN RETRACTOR

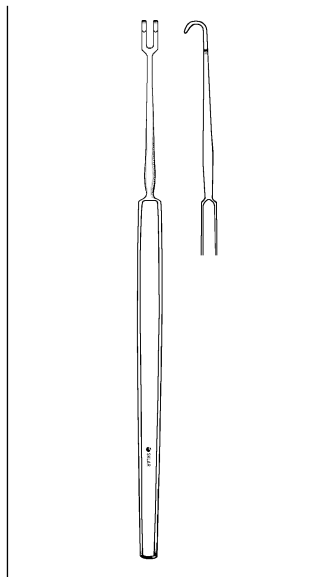
47-2913 3 x 3 Sharp Prongs 1 1/2"



DAVIS RETRACTOR

47-3833 3 x 3 Blunt Prongs 4 1/2"

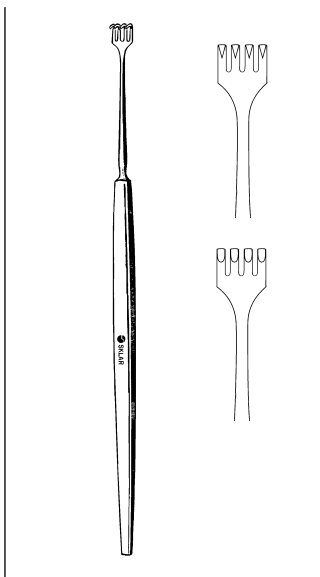
DERMAL - RETRACTORS



DERMAL RETRACTOR

Two Prong

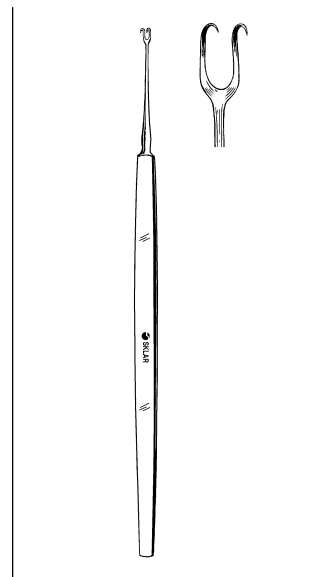
47-2514 5/8" Sharp
47-2516 5/8" Blunt



BLAIR (ROLLET) RETRACTOR

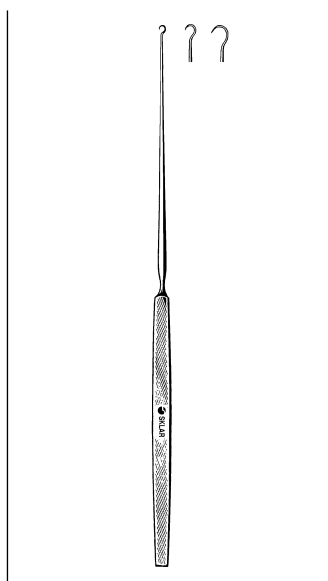
4 Prong-Delicate

47-2655 5/8" Sharp
47-2752 5/8" Blunt



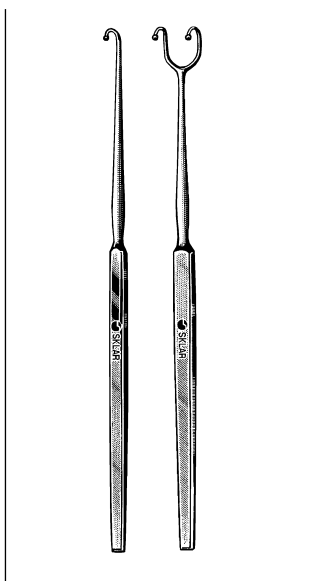
GUTHRIE DOUBLE HOOK

47-2650 5" 2 Large Prongs
47-2651 5" 2 Small Prongs



GILLIES SKIN HOOK

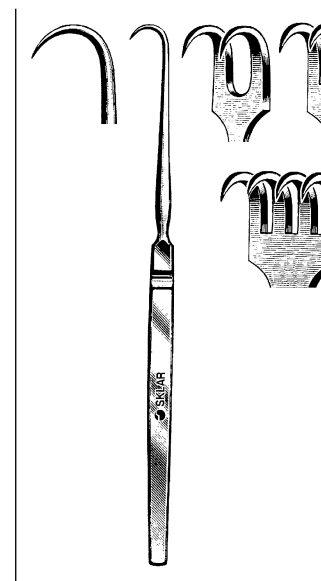
47-2570 7" 3 mm
47-2572 7" 4 mm



FOMON RETRACTOR

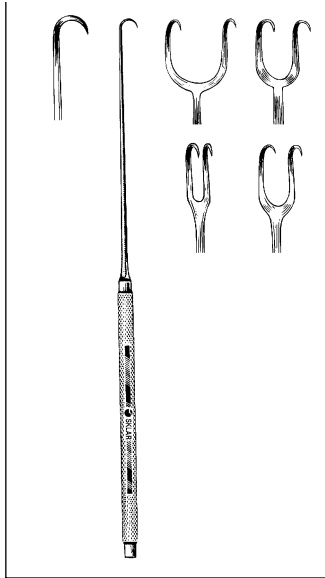
Ball End

41-1395 6 1/4" Single
41-1396 6 1/4" Double



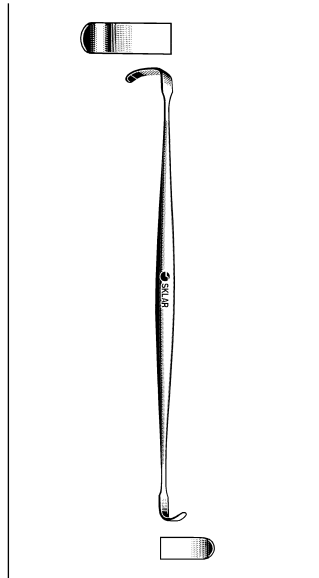
RIGID DERMAL RETRACTOR

6"- Sharp	6"- Blunt
22-9122 1 Prong	22-9123 1 Prong
22-9124 2 Prong	22-9125 2 Prong
22-9126 3 Prong	22-9127 3 Prong
22-9128 4 Prong	22-9129 4 Prong



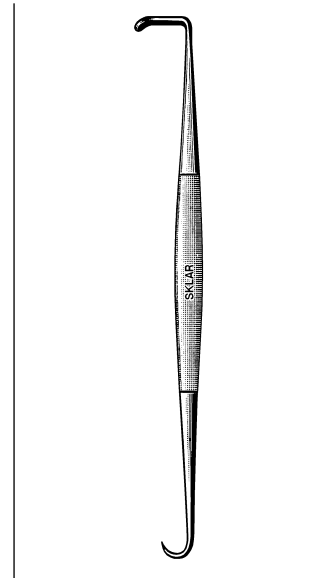
JOSEPH SKIN HOOK

47-2500	6 1/4"	1 Sharp Prong
47-2502	6 1/4"	2 Prong 2 mm
47-2505	6 1/4"	2 Prong 5 mm
47-2507	6 1/4"	2 Prong 7 mm
47-2510	6 1/4"	2 Prong 10 mm
47-2512	6 1/4"	2 Prong 12 mm



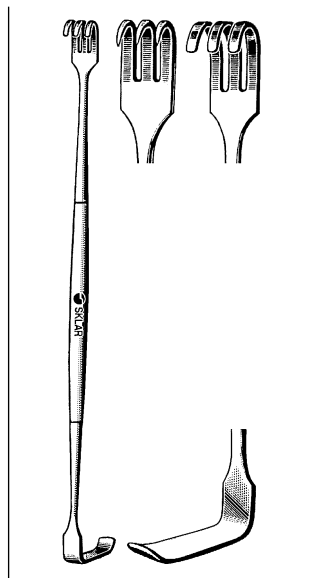
RAGNELL RETRACTOR

Double End	
22-8560	6"



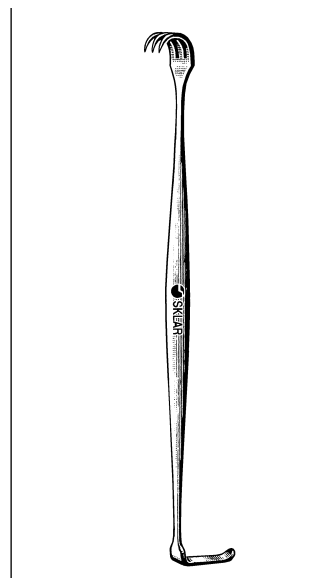
MEYERDING SKIN HOOK AND RETRACTOR

Double End	
47-2462	6 1/4"



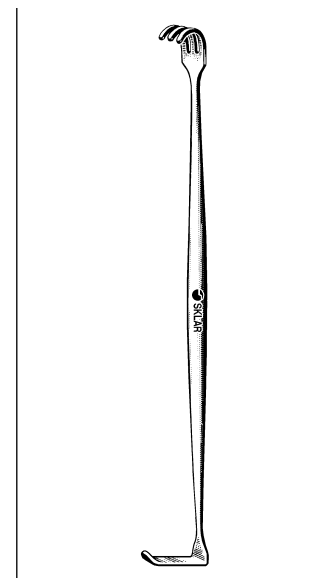
SENN RETRACTOR

Double Ended	
60-6162	6" Sharp
60-6164	6" Blunt



MILLER-SENN RETRACTOR

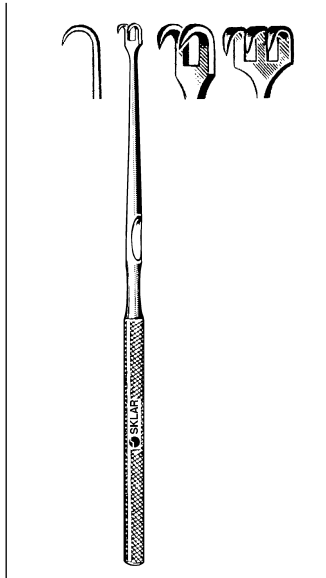
Double Ended	
22-8360	6" Sharp
	Solid End 5 mm x 18 mm
22-8460	6" Blunt
	Solid End 5 mm x 18 mm



MATHIEU RETRACTOR

Double Ended	
60-6062	6 1/4" Blunt

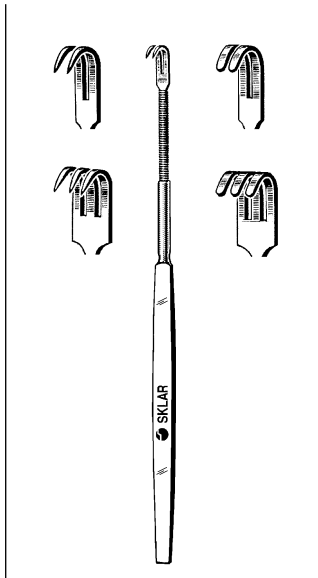
DERMAL - RETRACTORS



LAHEY RETRACTOR

4 3/4" Sharp

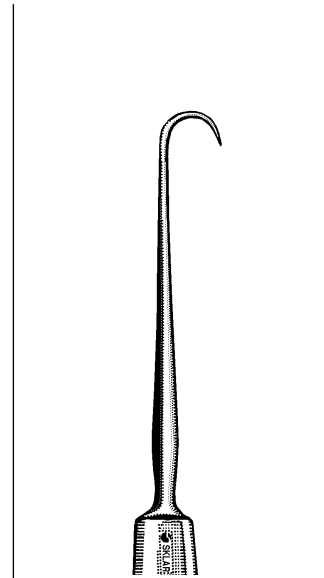
78-1201 1 prong
78-1202 2 prong
78-1203 3 prong



PLASTIC SURGERY RETRACTOR

6" - Flexible Shank

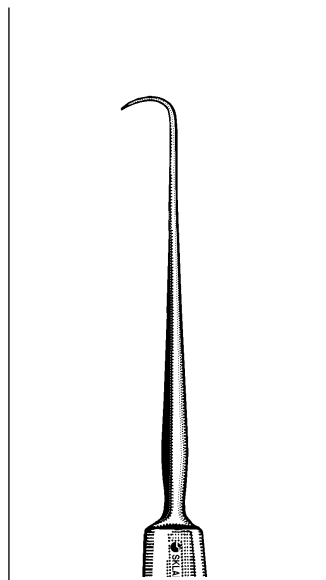
22-9132 Sharp 2 Prong
22-9133 Sharp 3 Prong
22-9142 Blunt 2 Prong
22-9143 Blunt 3 Prong
22-9144 Sharp 1 Prong



O'CONNOR SKIN HOOK

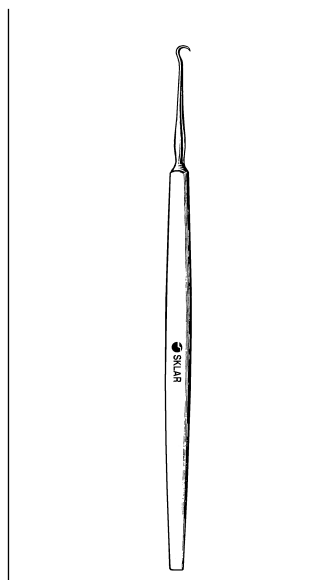
Sharp

65-3265 5"



WIENER SCLERAL HOOK

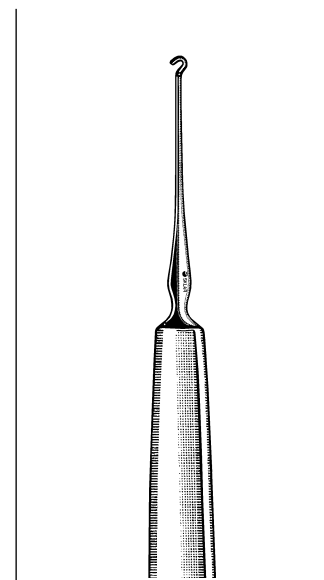
65-3250 5" Sharp



FRAZIER TISSUE HOOK

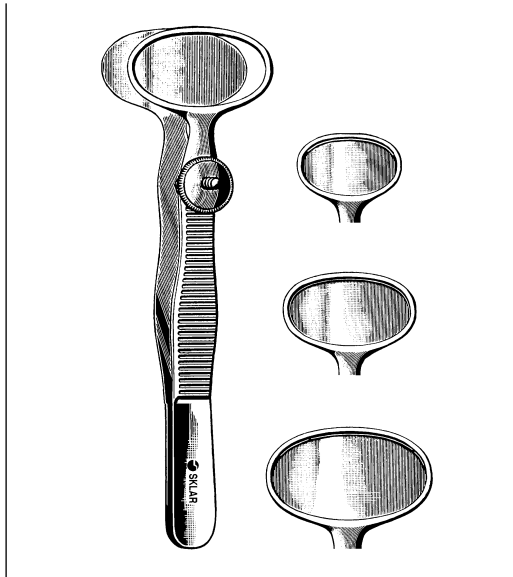
Extra Delicate

47-2555 5" Sharp
47-2556 5" Blunt



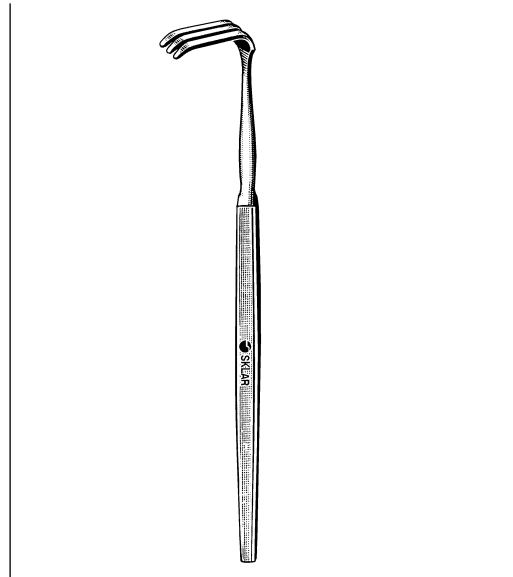
TYRELL IRIS HOOK

65-3205 5" Blunt
65-3206 5" Sharp



DESMARRES CHALAZION FORCEPS

- 66-1038 3/2" Small
- 66-1036 3/2" Medium
- 66-1035 3/2" Large
- 90-1038 3/2" Small - Laser Coated
- 90-1036 3/2" Medium - Laser Coated
- 90-1035 3/2" Large - Laser Coated



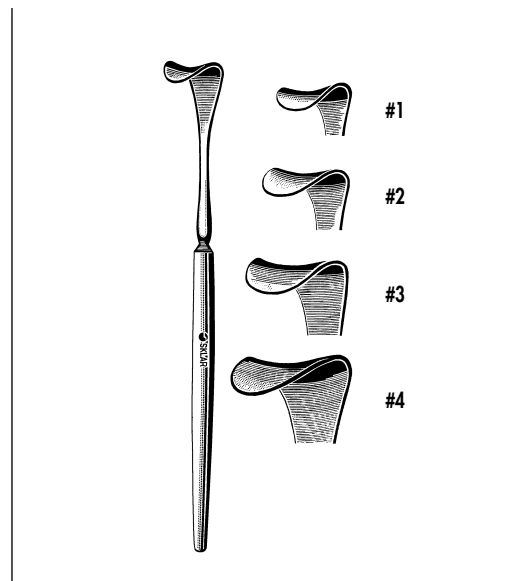
PAUL RETRACTOR

- 47-2647 4 3/4" 3 Prong Blunt



JAEGER LID RETRACTOR

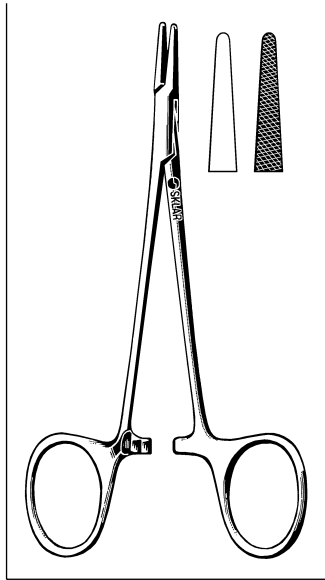
- Non-Conductive
- 65-1835 3 1/2" Plastic



DESMARRES LID RETRACTOR

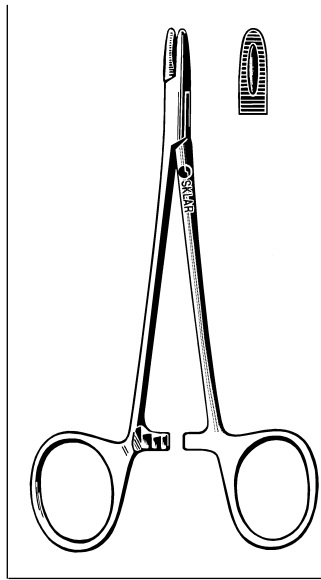
- 65-1841 #1 5 1/2" 12 mm
- 65-1842 #2 5 1/2" 14 mm
- 65-1843 #3 5 1/2" 16 mm
- 65-1844 #4 5 1/2" 18 mm

DERMAL - NEEDLE HOLDERS



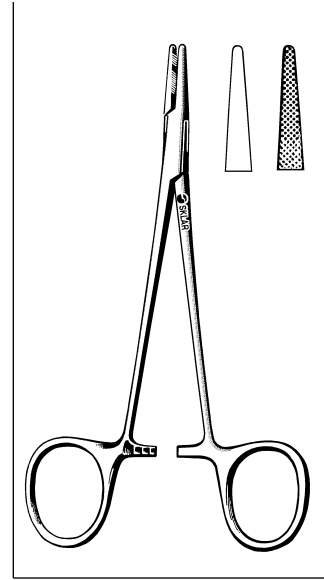
WEBSTER NEEDLE HOLDER

20-1350 5¼" Smooth
20-1352 5¼" Serrated



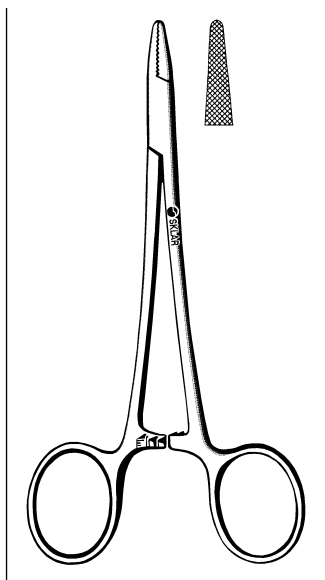
DERF NEEDLE HOLDER

20-1547 4¾" Serrated



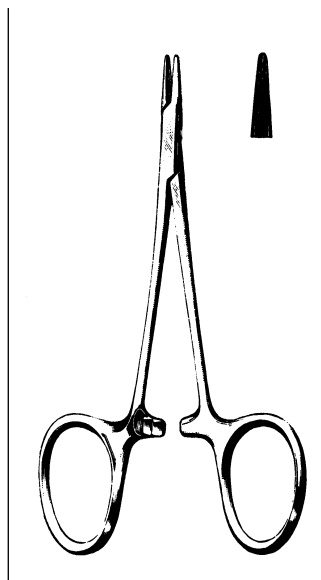
HALSEY NEEDLE HOLDER

20-1750 5¼" Smooth
20-1751 5¼" Serrated



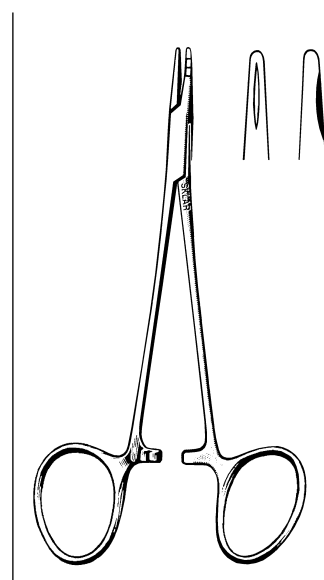
**BAUMGARTNER
NEEDLE HOLDER**

20-1450 5½" Serrated



**CONVERSE
NEEDLE HOLDER**

20-3350 4¾"



NEIVERT NEEDLE HOLDER

20-1760 5" One Offset Ring

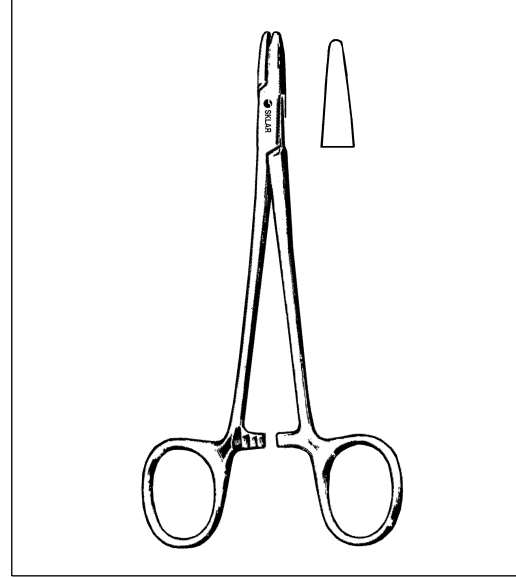


OLSEN-HEGAR COMBINED NEEDLE HOLDERS AND SCISSORS

Delicate

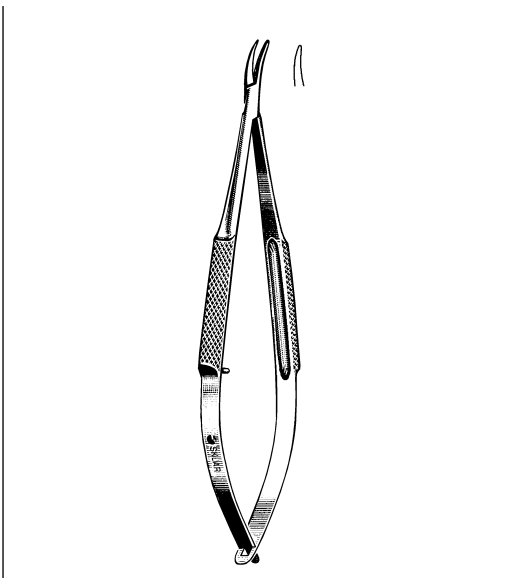
20-2747 4 3/4" Serrated Jaws

20-2748 4 3/4" Smooth Jaws



CARROLL NEEDLE HOLDER

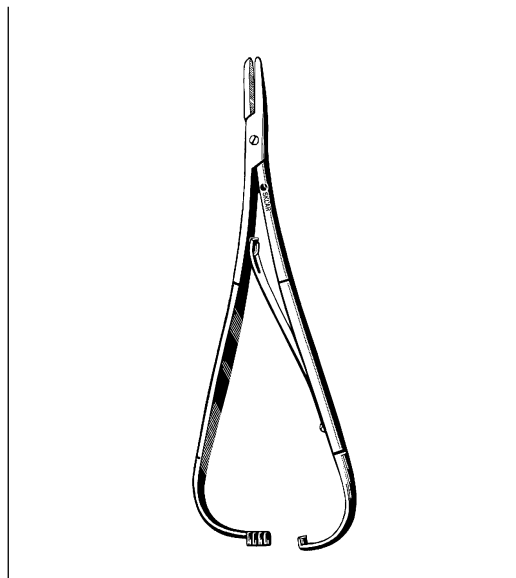
20-3090 6" Heavy Smooth Jaws



BARRAQUER NEEDLE HOLDER

Curved Without Catch

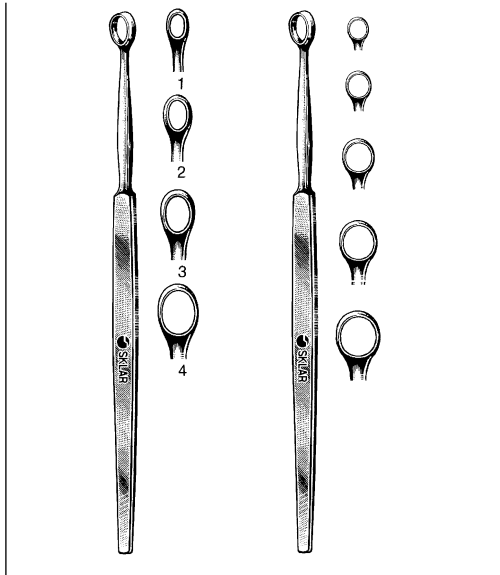
65-6452 5 1/2"



MATHIEU NEEDLE HOLDER

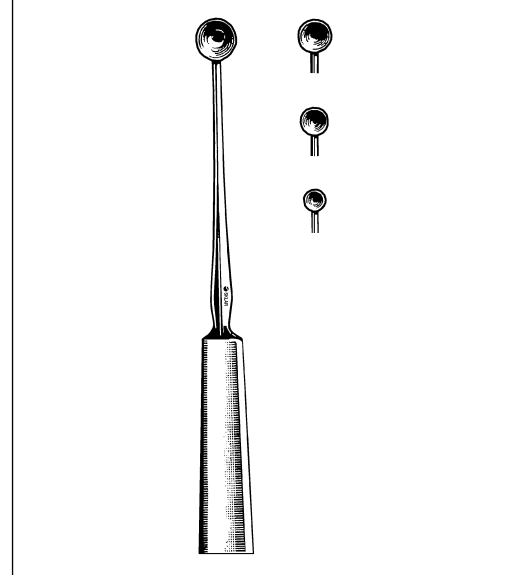
20-3055 5 1/2"

20-3075 7 1/2"



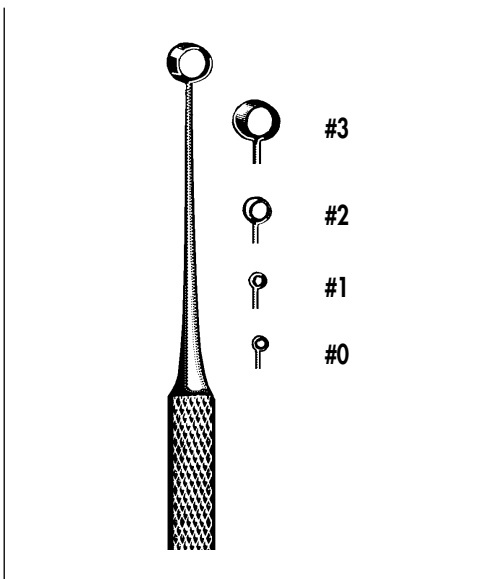
FOX DERMAL CURETTE

Oval 5 1/2"		Round 5 1/2"	
06-4133	3 mm	06-4137	2 mm
06-4134	4 mm	06-4138	3 mm
06-4135	5 mm	06-4139	4 mm
06-4136	6 mm	06-4140	5 mm
		06-4141	6 mm



MEYHOEFER CHALAZION CURETTE

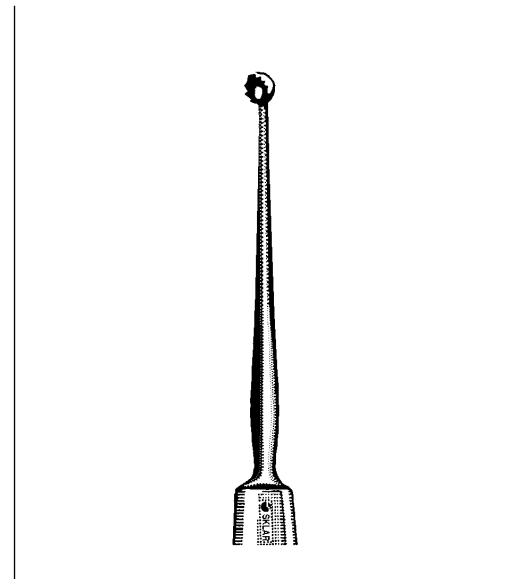
65-3170	#0	1.5mm
65-3171	#1	1.7mm
65-3172	#2	2.2mm
65-3173	#3	2.5mm
65-3174	#4	3.0mm



HEATH CURETTE

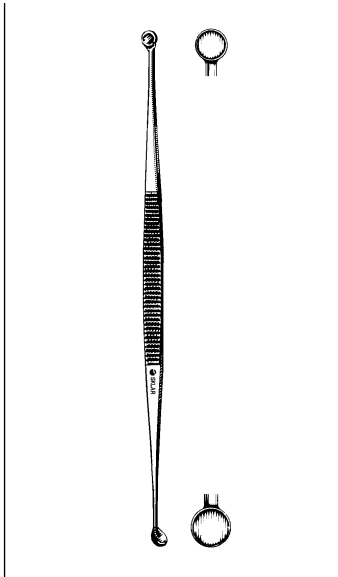
One Sharp Edge and One Dull Edge

65-3180	#0	1/2mm
65-3181	#1	1mm
65-3182	#2	2mm
65-3183	#3	3mm



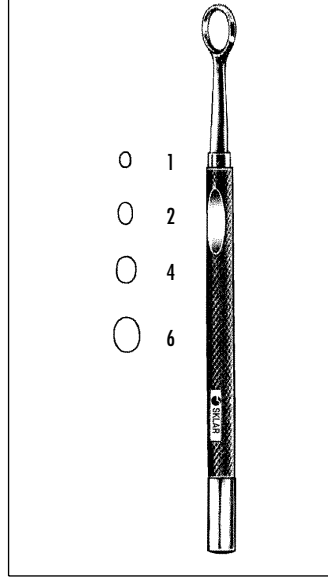
SKEELE CURETTE

65-3162	Serrated, 2mm
	Blade only, Stainless Steel



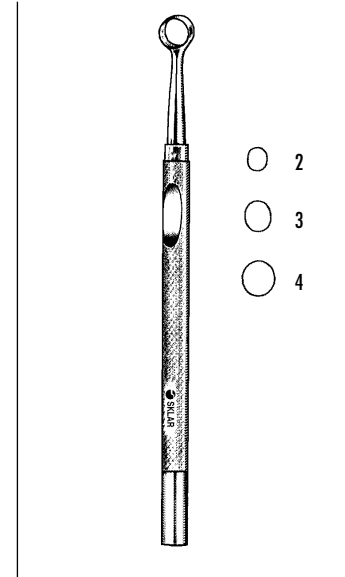
MARTINI CURETTE

Double End,
4mm and 5mm round cups
40-7284 5 1/2"



REIN OVAL CURETTE

06-4053 Size 1
06-4054 Size 2
06-4056 Size 4
06-4058 Size 6



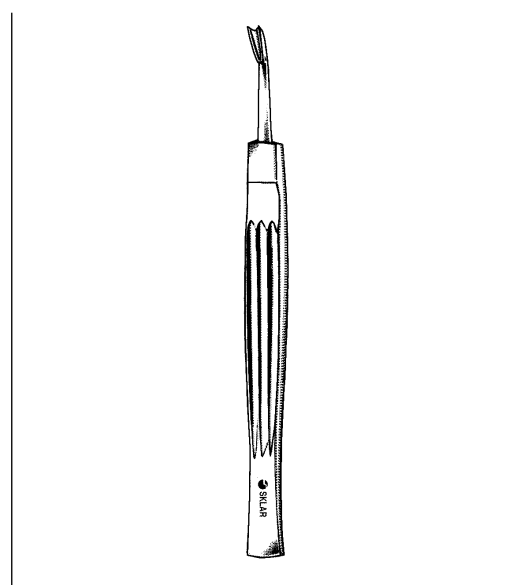
REIN ROUND CURETTE

06-4059 Size 2
06-4060 Size 3
06-4061 Size 4



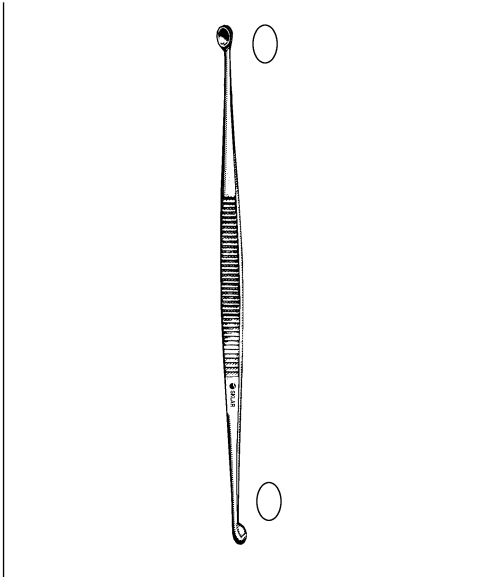
PIFFARD CURETTE

06-4130 #1
06-4131 #2
06-4132 #3



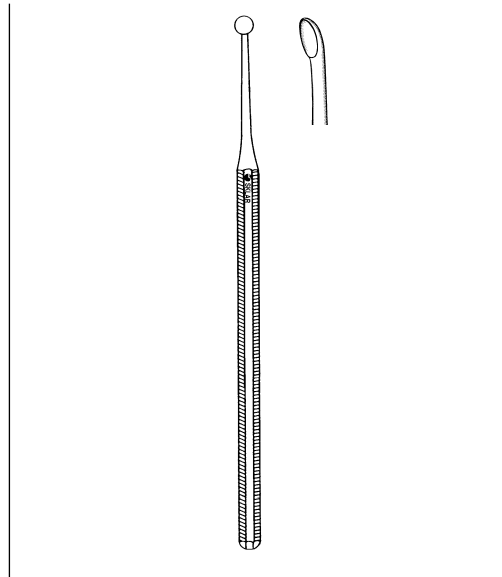
MOLLUSCUM CURETTE

06-4039



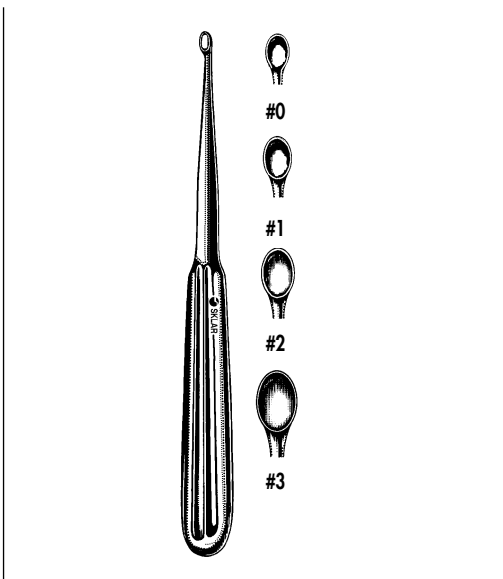
WILLIGER CURETTE

Double End, 3mm and 4mm
round cups
40-7286 5½"



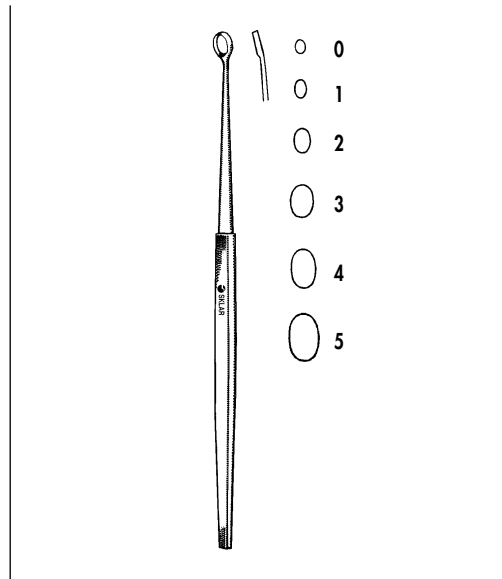
VERUCCA CURETTE

97-0564 4 mm, Without Hole



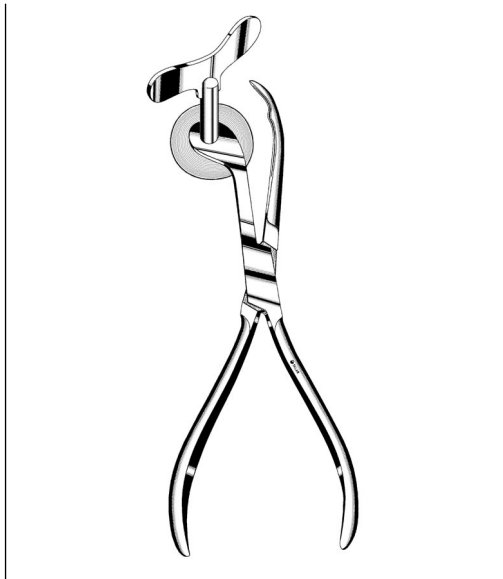
SKLAR DERMAL CURETTE

6¼" Oval
06-4112 #0
06-4113 #1
06-4114 #2
06-4115 #3



CANNON CURETTE

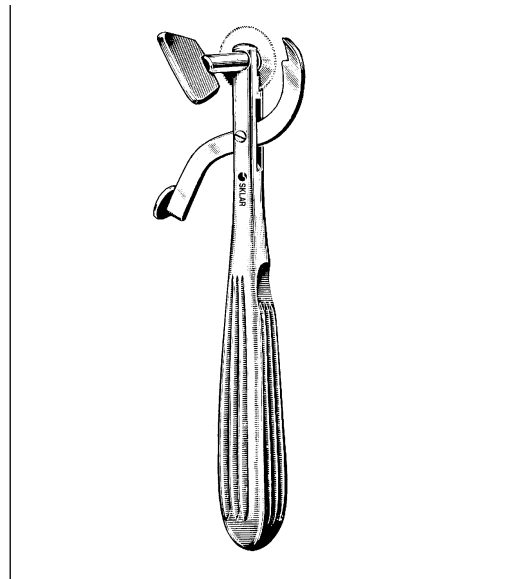
06-4002 Size 0
06-4003 Size 1
06-4004 Size 2
06-4005 Size 3
06-4006 Size 4
06-4007 Size 5



KEYES FINGER RING CUTTER

Stainless Steel

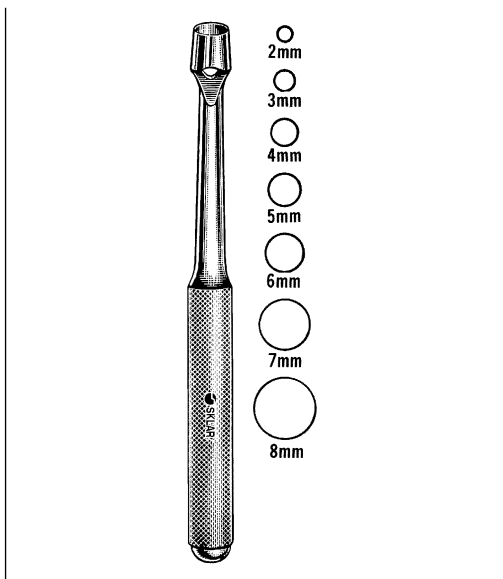
- 06-4150 Ring Cutter Complete
- 06-4151 Blades w/Brass Bushings
Attached for above ring cutter



SKLAR FINGER RING CUTTER

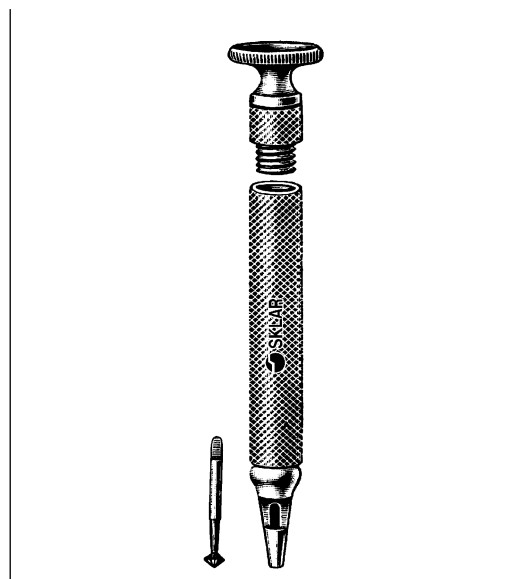
Chrome

- 06-4152 6"
- 06-4153 Blade for Sklar Finger Ring Cutter



KEYES CUTANEOUS PUNCH

- | | | | |
|---------|-----|---------|-----|
| 06-4142 | 2mm | 06-4146 | 6mm |
| 06-4143 | 3mm | 06-4147 | 7mm |
| 06-4144 | 4mm | 06-4148 | 8mm |
| 06-4145 | 5mm | | |

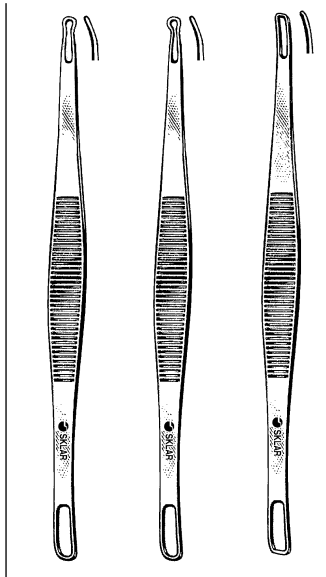


SKLAR NAIL DRILL

Three Drills in Handle

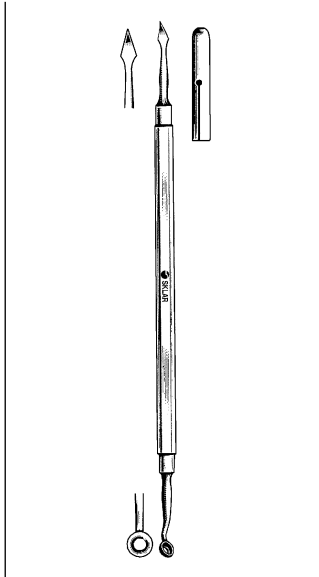
- 06-4160 Complete
- 06-4161 Set of Drill Points Only

DERMAL - EXTRACTORS



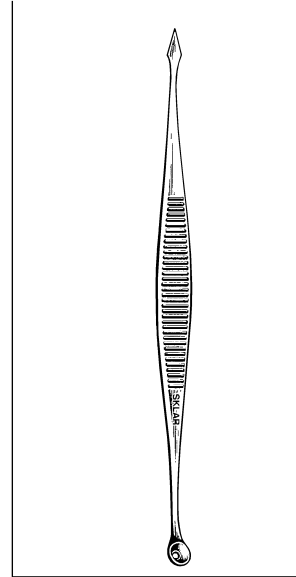
SCHAMBERG COMEDONE EXTRACTOR

- 06-4120 Regular Size
- 06-4121 One End Extra Fine
- 06-4122 Square Ends



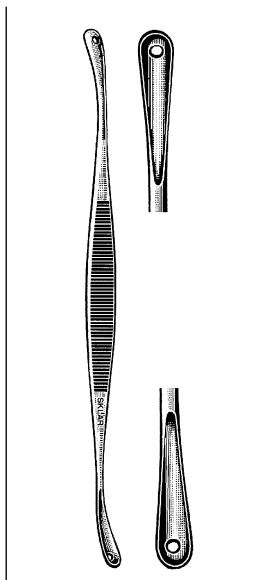
SKLAR COMEDONE EXTRACTOR

- Spear Point with Cover
- 06-4128 Double End



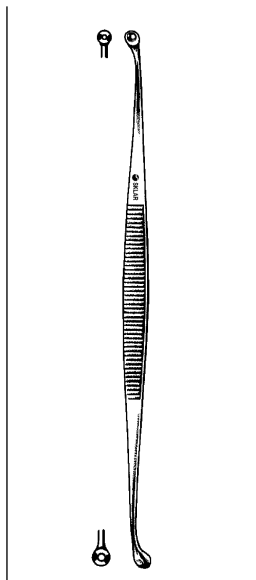
COMEDONE EXTRACTOR

- Spear Point
- 06-4126



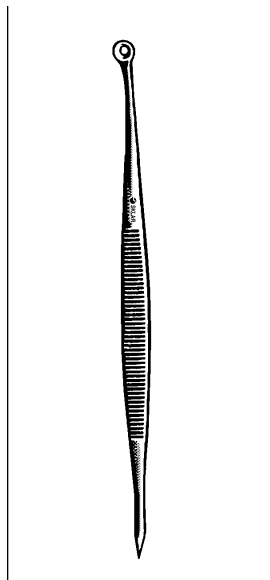
UNNA COMEDONE EXTRACTOR

- 5 3/4" Double End, Oval
- 06-4125



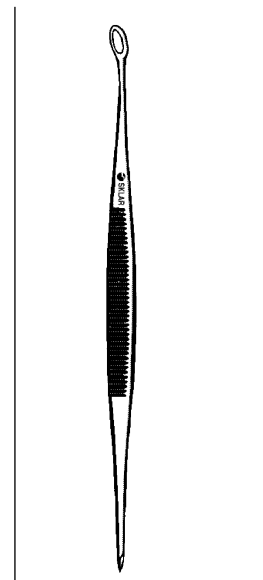
UNNA COMEDONE EXTRACTOR

- 5 3/4" Double End, Round
- 06-4191



HEINLEIN EXPRESSOR

- 06-4186



FONDE HARMAR EXPRESSOR

- 06-4178

The Sklar Tru-Punch™ has a “seamless” steel tip carefully honed for a razor sharp incision and perfect sample. The ribbed and hollow handle permits tissue to be easily dislodged.



SKLAR TRU-PUNCH™ – DISPOSABLE DERMAL BIOPSY PUNCH

Box/25, Sterile

96-1140	2mm
96-1142	3mm
96-1144	3.5mm
96-1146	4mm
96-1148	5mm
96-1150	6mm
96-1152	8mm

Box/25



SKLAR TRU-PUNCH™ – DISPOSABLE DERMAL BIOPSY PUNCH

Box/50, Sterile

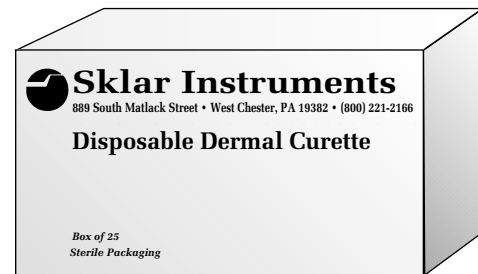
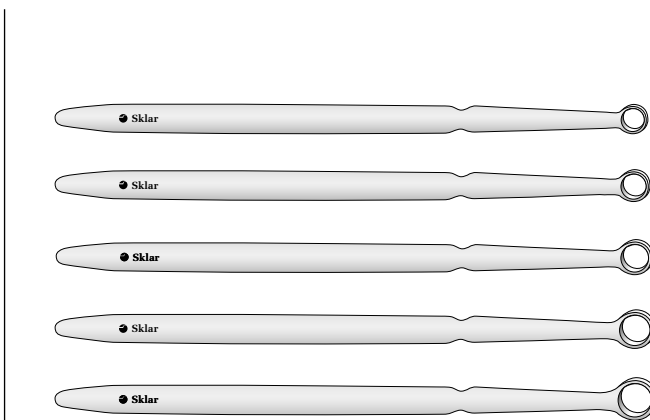
96-1100	2mm
96-1105	3mm
96-1110	3.5mm
96-1115	4mm
96-1120	5mm
96-1125	6mm
96-1130	8mm

Box/50

SKLAR TRU-PUNCH™ – DISPOSABLE DERMAL BIOPSY PUNCH

Box/25, Sterile

96-1160	Assorted (5 of each - 2, 3, 3.5, 4, 5)
---------	---



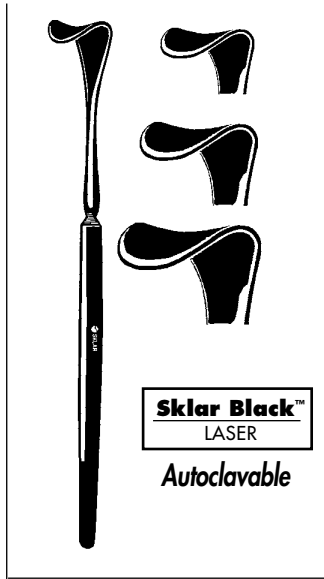
SKLAR DISPOSABLE DERMAL CURETTES

Surgical Steel Tip with Plastic Handle, Box of 25
Individually Packaged in Sterile Pouches

96-1190	2mm	96-1194	4mm	96-1198	7mm
96-1192	3mm	96-1196	5mm	96-1199	Assorted 5 of Each

The surgical grade steel tip is mounted on a sturdy plastic handle and correctly positioned to efficiently affect curettage.

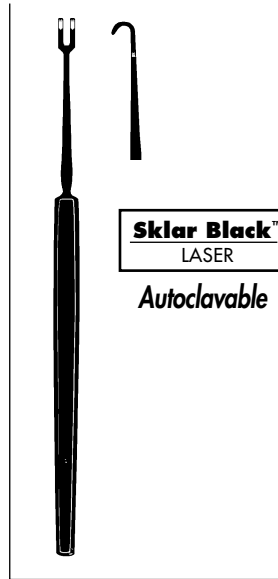
DERMATOLOGY LASER INSTRUMENTS



Sklar Black™
LASER
Autoclavable

LASER DESMARRS LID RETRACTOR

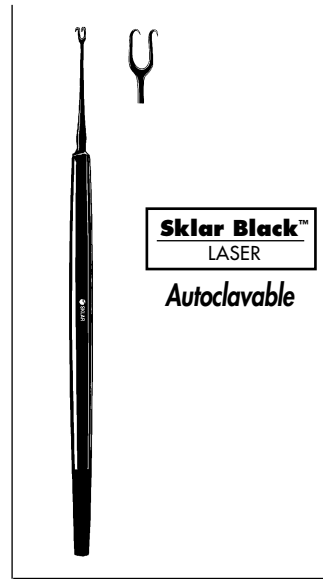
- 90-1038 Small
- 90-1036 Medium
- 90-1035 Large



Sklar Black™
LASER
Autoclavable

LASER DERMAL RETRACTOR

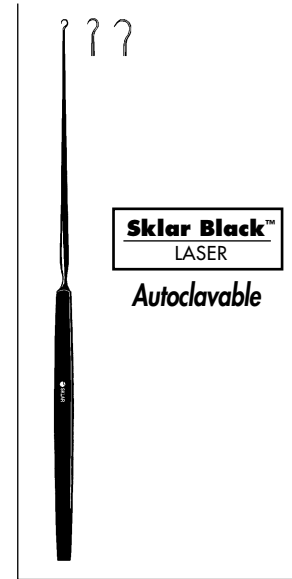
- Two Prong
- 90-1040 5/8" Sharp
- 90-1042 5/4" Blunt



Sklar Black™
LASER
Autoclavable

LASER GUTHRIE DOUBLE HOOK

- 90-1044 5" 5mm Sharp With 2 Lrg Prongs
- 90-1046 5" 3mm Sharp With 2 Sm Prongs



Sklar Black™
LASER
Autoclavable

LASER GILLIES SKIN HOOK

- 90-1045 7" 3mm
- 90-1047 7" 4mm

Sandblasted vs Coated Instruments

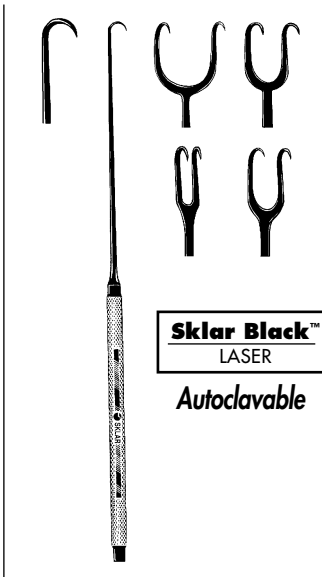
Testing demonstrated that the Sklar black coating over a roughened surface reduced reflected laser energy to less than one-tenth of one percent! Sklar uses an improved black polymer coating developed specifically for Laser surgery. The coating is durable and safe, resulting in an instrument you can use with confidence and rely on for years of service. All Sklar Laser coatings are guaranteed one year against manufacturing defects.



Sklar Black™
LASER
Autoclavable

LASER FRAZIER TISSUE HOOK

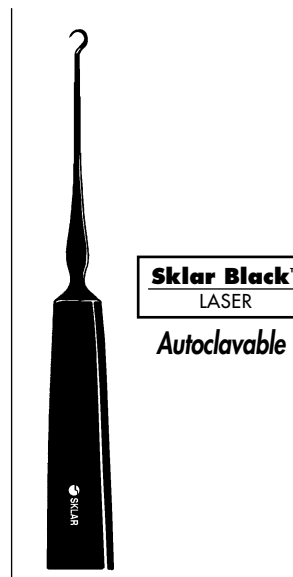
- Extra Delicate
- 90-1048 5" Sharp
- 90-1049 5" Blunt



Sklar Black™
LASER
Autoclavable

LASER JOSEPH SKIN HOOK

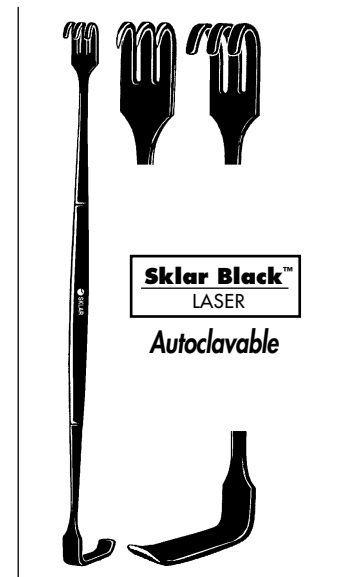
- 90-1050 6 1/4" 1 Sharp Prong
- 90-1051 6 1/4" 2 Prong 2 mm
- 90-1052 6 1/4" 2 Prong 5 mm
- 90-1053 6 1/4" 2 Prong 7 mm
- 90-1054 6 1/4" 2 Prong 10 mm
- 90-1055 6 1/4" 2 Prong 12 mm



Sklar Black™
LASER
Autoclavable

LASER TYRELL IRIS HOOK

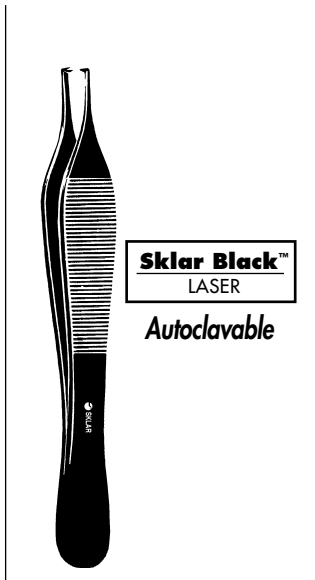
- 90-1056 5" 3mm Blunt
- 90-1058 5" 3mm Sharp



Sklar Black™
LASER
Autoclavable

LASER SENN RETRACTOR

- Double Ended
- 90-1057 6" Sharp
- 90-1059 6" Blunt



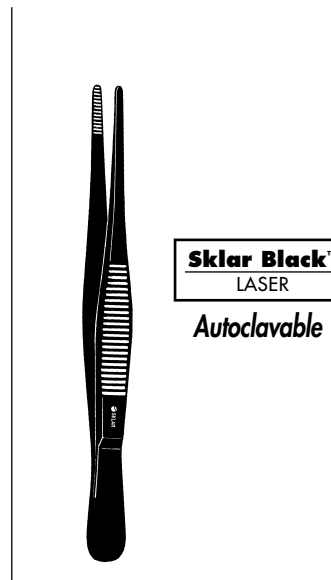
LASER ADSON TISSUE FORCEPS

90-1060 4 3/4" 1X2
90-1061 4 3/4" 2X3



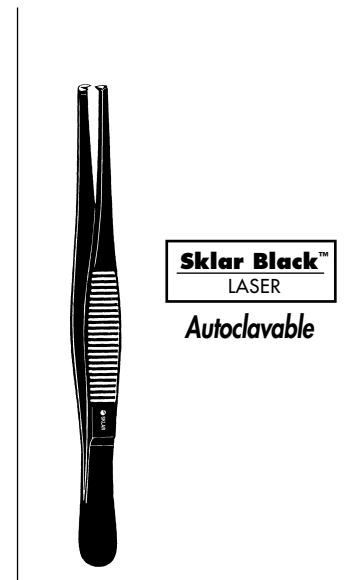
LASER ADSON-BROWN FORCEPS

90-1062 4 3/4"



LASER DRESSING FORCEPS

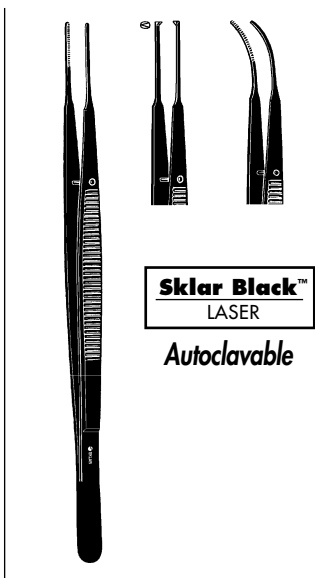
Serrated
90-1063 4 1/2"
90-1064 5"
90-1065 5 1/2"
90-1066 6"



LASER TISSUE FORCEPS

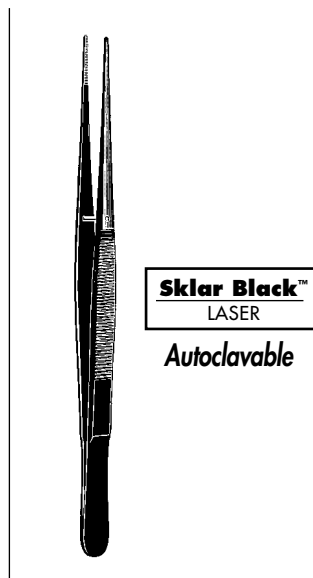
1 x 2 teeth
90-1020 4 1/2"
90-1021 5"
90-1022 5 1/2"
90-1023 6"

Most of our Dermal Instruments can be laser coated for a minimal charge. Please call our customer service department at 800-221-2166 for details.



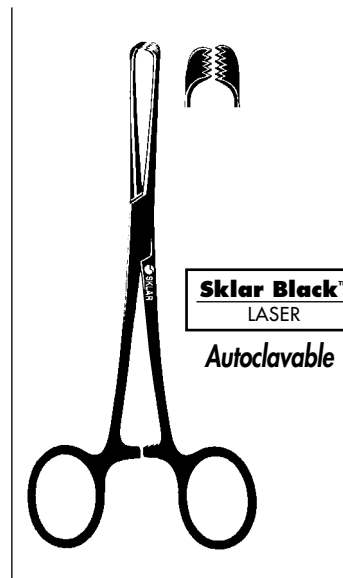
LASER GERALD FORCEPS

Serrated
90-1025 7" Straight
90-1026 7" Curved
1 x 2 Teeth
90-1027 7" Straight



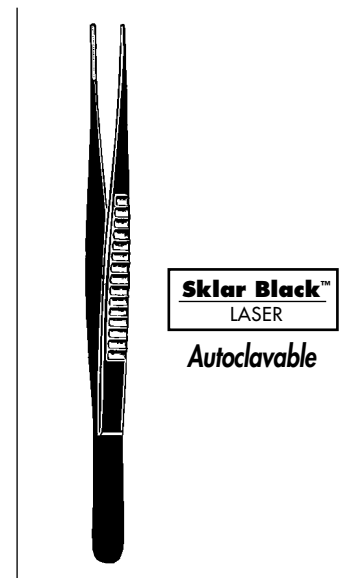
LASER POTTS-SMITH FORCEPS

90-2304 7" Serrated
90-2306 10" Serrated



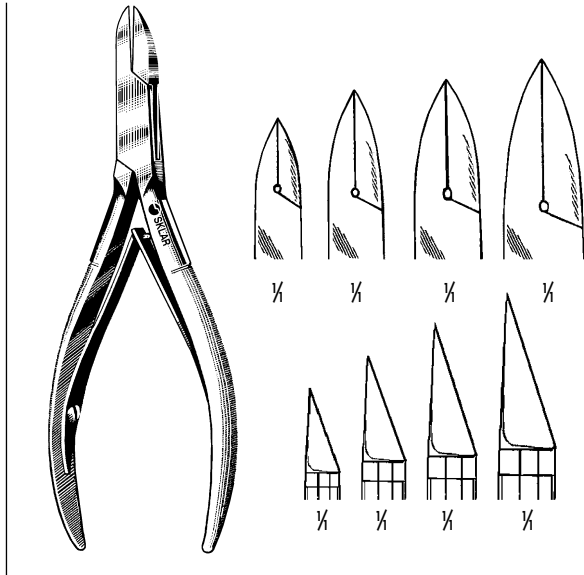
LASER ALLIS FORCEPS

90-2276 7 1/2" 5 x 6
90-2279 9 1/2" 5 x 6



LASER DEBAKEY ATRAUMATIC TISSUE FORCEPS

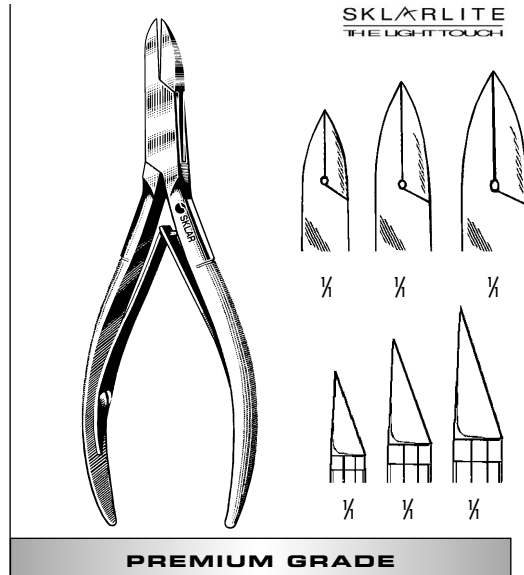
2.0 mm jaws
90-2310 7 3/4"
90-2312 9 1/2"



LITTAUER CUTTING FORCEPS

Straight Back—Stainless

- 97-1251 4"
- 97-1255 4½"
- 97-1259 5"
- 97-1262 6"

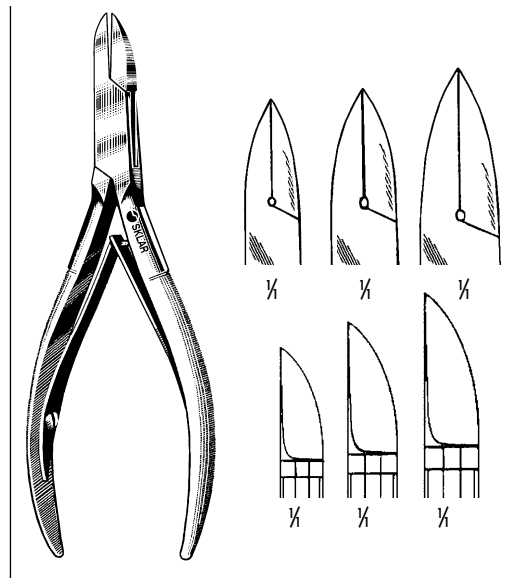


PREMIUM GRADE

SKLARLITE™ LITTAUER CUTTING FORCEPS

Straight Back—Stainless

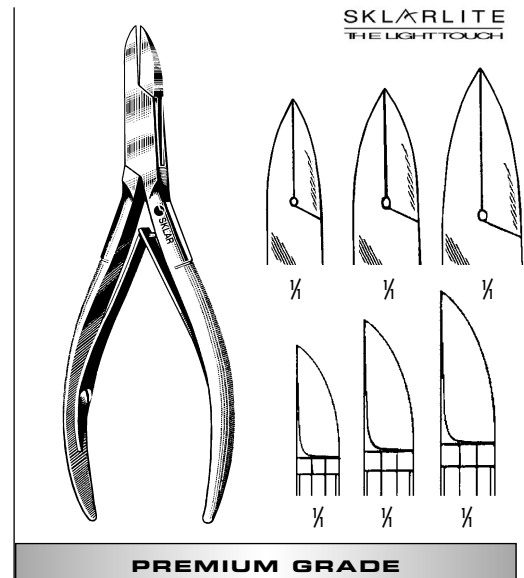
- 23-9251 4"
- 23-9255 4½"
- 23-9259 5"



LITTAUER CUTTING FORCEPS

Curved Back—Stainless

- 97-1280 4½"
- 97-1285 5"
- 97-1286 6"

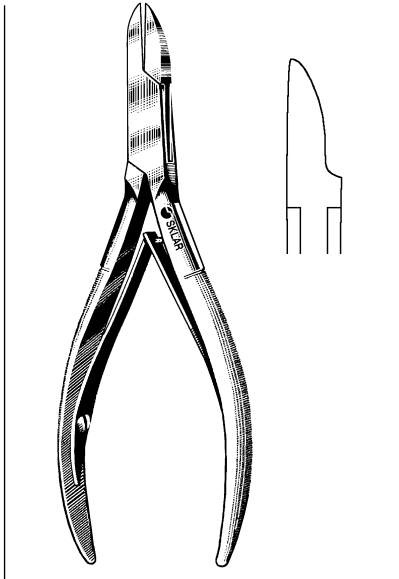


PREMIUM GRADE

SKLARLITE™ LITTAUER CUTTING FORCEPS

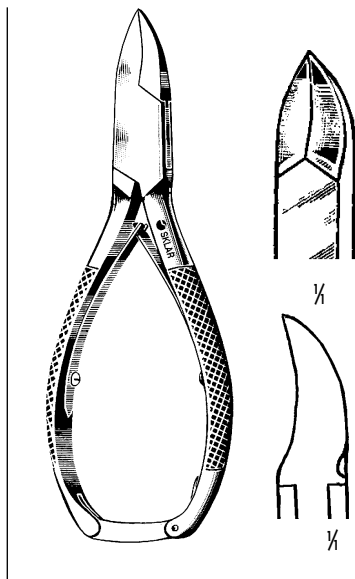
Curved Back—Stainless

- 23-9273 4½"
- 23-9275 5"
- 23-9276 6"



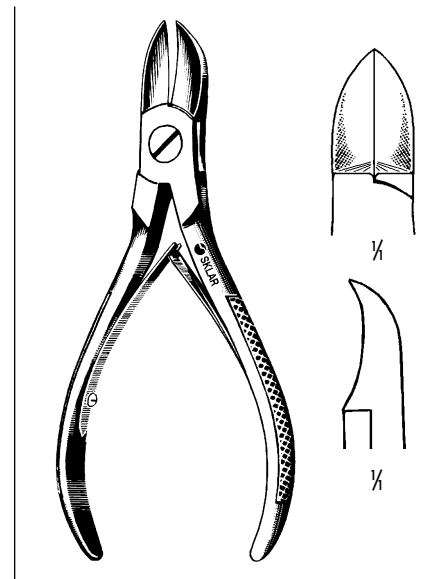
SKLAR-TAPER™ LITTAUER CUTTING FORCEPS

Stainless
97-1174 5"



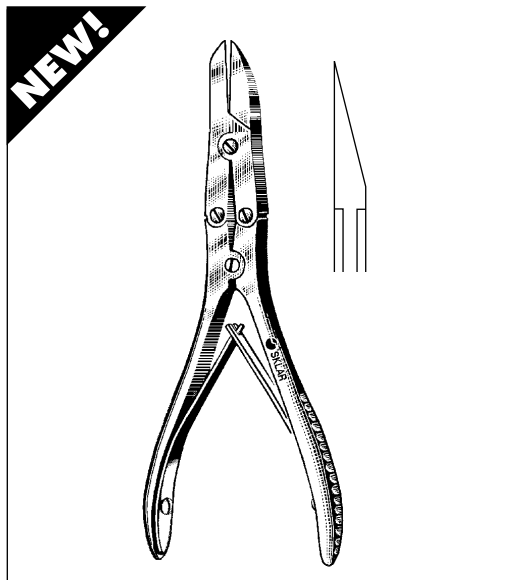
NAIL NIPPER

Concave Blades, Double Spring with Lock
97-1055 5½" Stainless



NAIL NIPPER

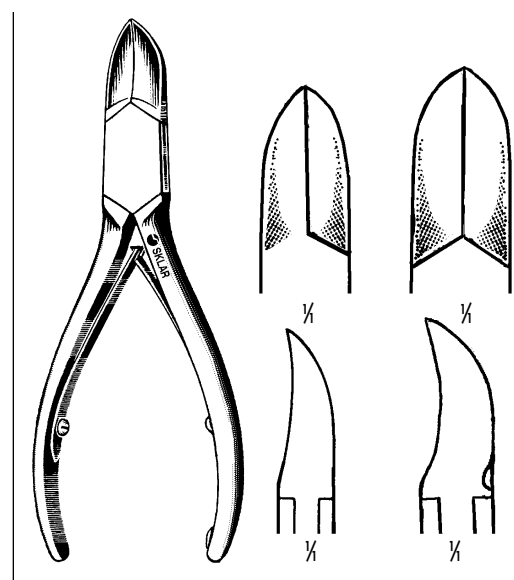
Concave Blades—Double Spring
97-1148 4½" Stainless



SKLAR DOUBLE-ACTION LITTAUER CUTTING FORCEPS

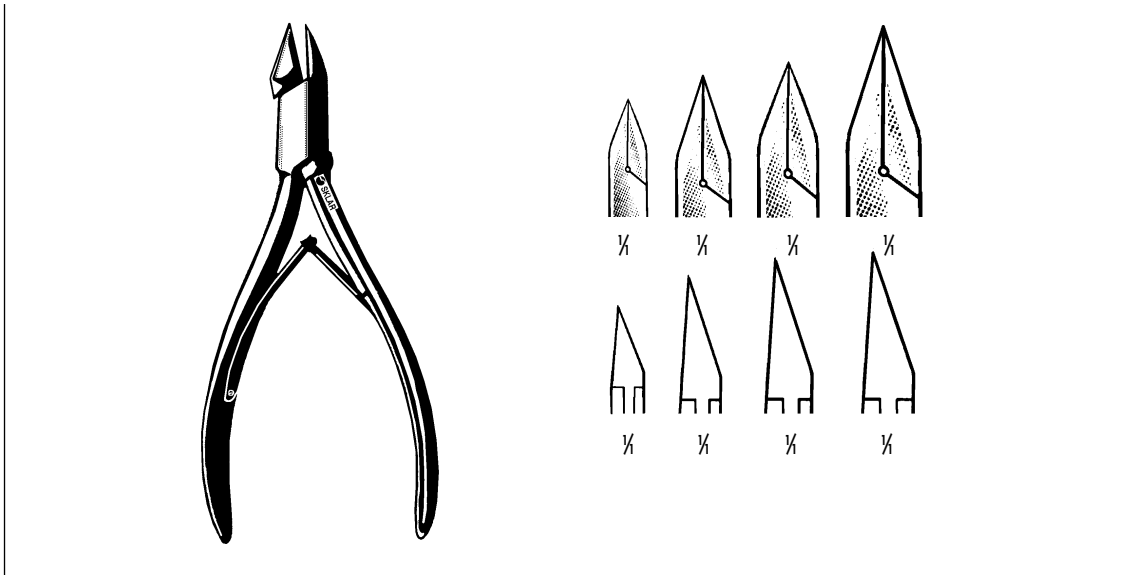
97-1185 6" Straight

Exclusive Sklar design, offers increased mechanical advantage with the most popular Littauer cutting jaw.



NAIL NIPPER

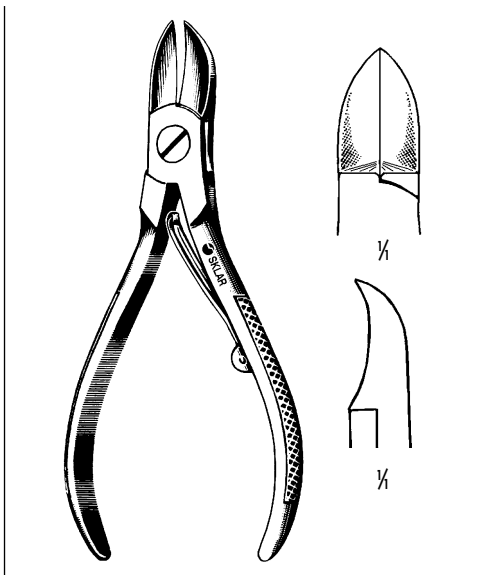
Concave Blades, Double Spring
97-1308 6" Stainless Narrow
97-1309 5½" Stainless Heavy



NAIL SPLITTER

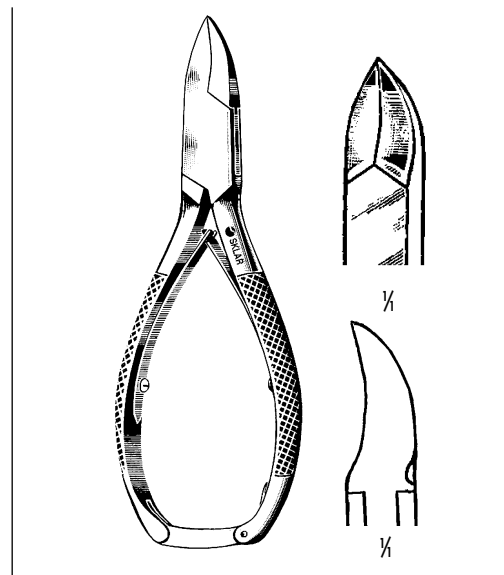
Tapered Jaw
Straight Back—Stainless

- 97-1660 4"
- 97-1661 4½"
- 97-1662 5"
- 97-1663 6"



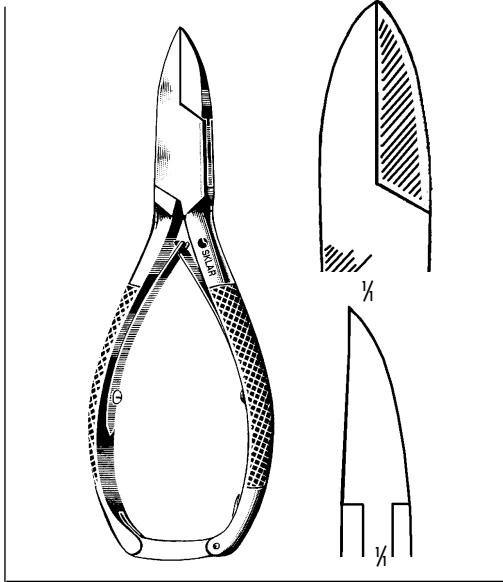
NAIL NIPPER

Concave Blades—Folding Spring
97-1146 4½" Stainless



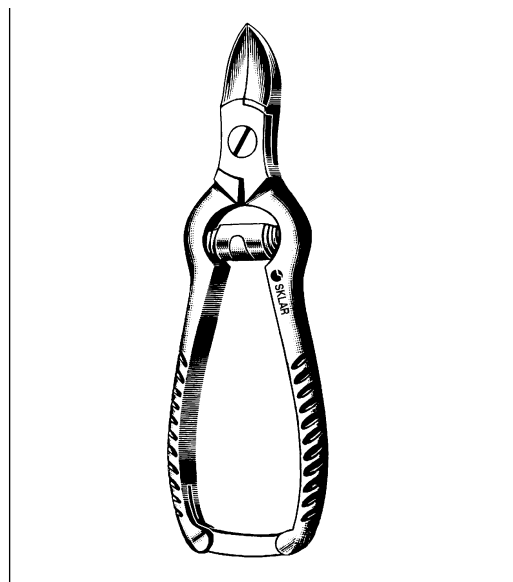
NAIL NIPPER

Concave Blades, Double Spring with Lock
97-0474 5½" Stainless



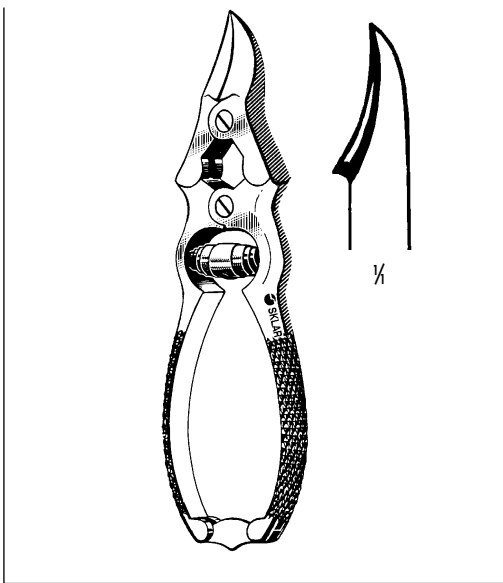
**NAIL NIPPER,
DOUBLE SPRING WITH LOCK**

97-1056 5½" Straight Back, Stainless Steel



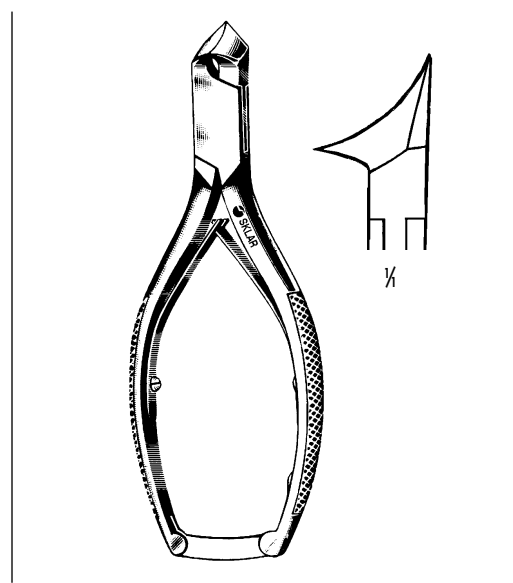
NAIL NIPPER

Concave Blades—Barrel Spring
97-1045 4½"
97-1046 5½"



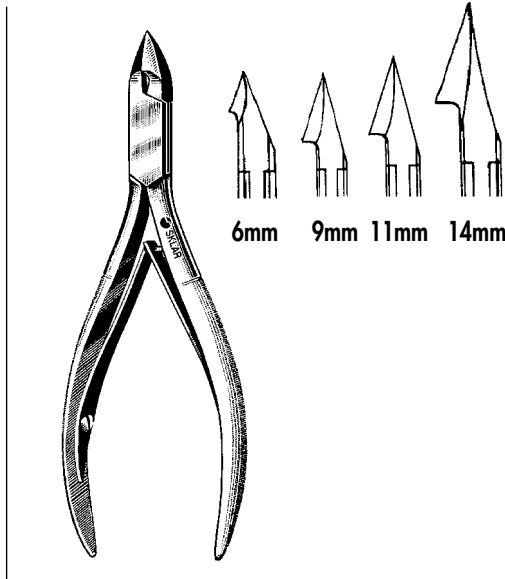
MYCOTIC NAIL NIPPER

Double Action—Barrel Spring
97-1057 5¾" Stainless



NAIL NIPPER

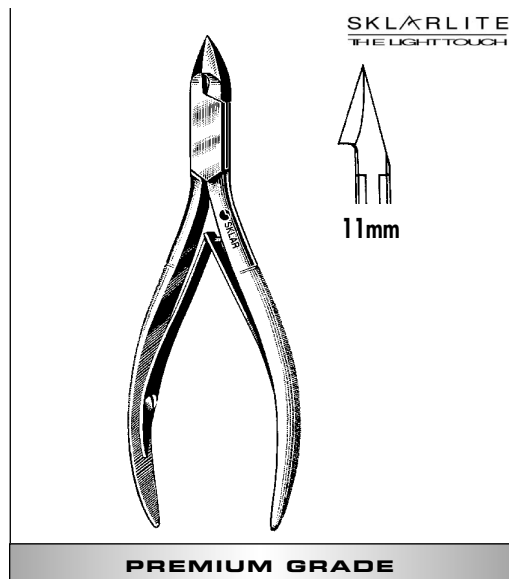
Angled Concave Blades
97-1156 5½" Stainless



TISSUE NIPPER

Convex Blades

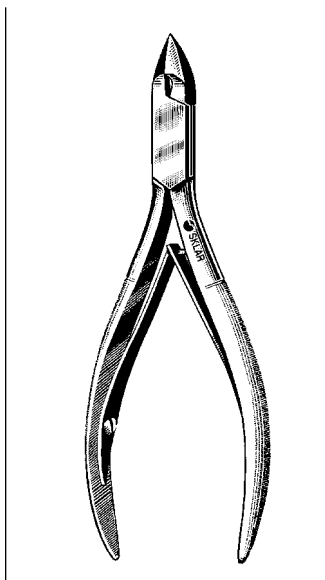
97-1241	4"	Stainless	6mm
97-0335	4"	Stainless	9mm
97-1242	4½"	Stainless	11mm
97-1243	5"	Stainless	14mm



SKLARLITE TISSUE NIPPER

Convex Blades—Stainless

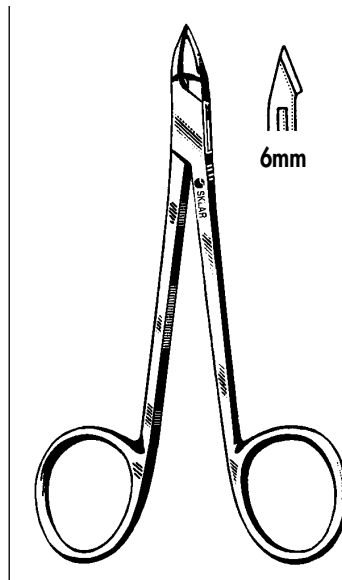
23-9292	4½"	Double Spring	11mm
---------	-----	---------------	------



CUTICLE NIPPER

Convex Blades

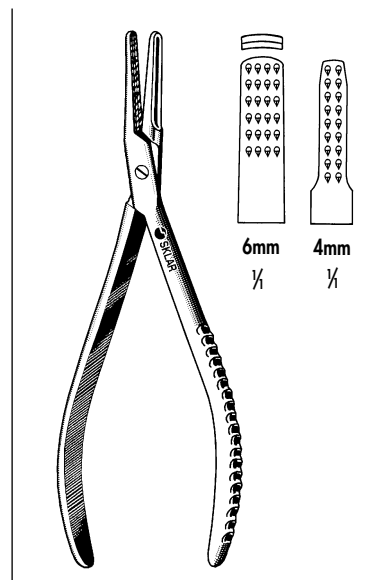
97-1240	4"	Stainless	6mm
---------	----	-----------	-----



TISSUE NIPPERS

Ring Handle—Straight Jaws

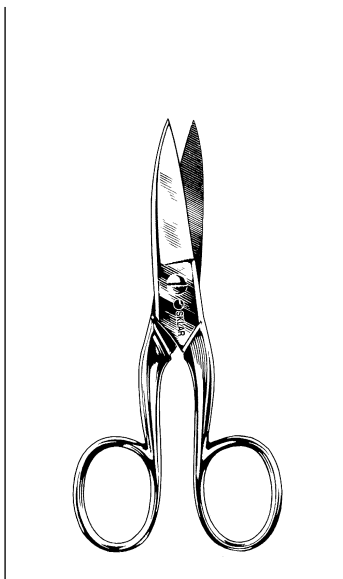
97-1238	Stainless	4"
---------	-----------	----



PLATYPUS NAIL PULLING FORCEPS

Plier Handle

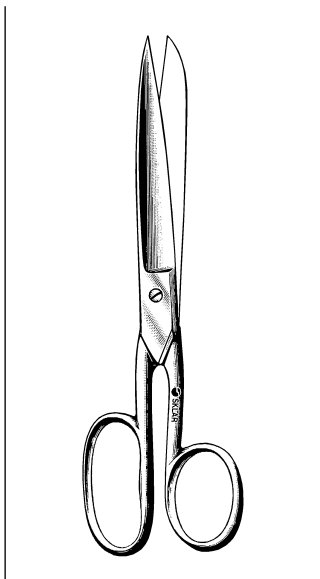
97-1318	5½"	6mm wide
97-1315	5½"	4mm wide



CUTICLE AND NAIL SCISSORS

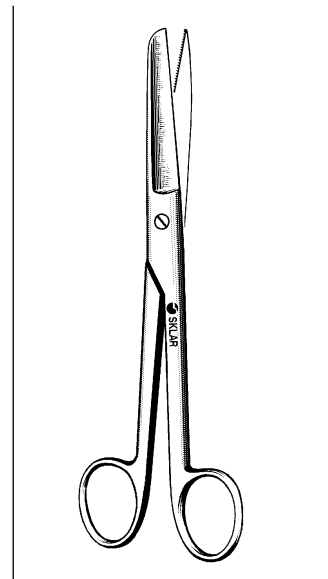
Ring Handle

97-1235 3½" Finger Nail, Straight
97-1245 4½" Toe Nail, Curved



**U.S. ARMY PATTERN
GAUZE SCISSORS**

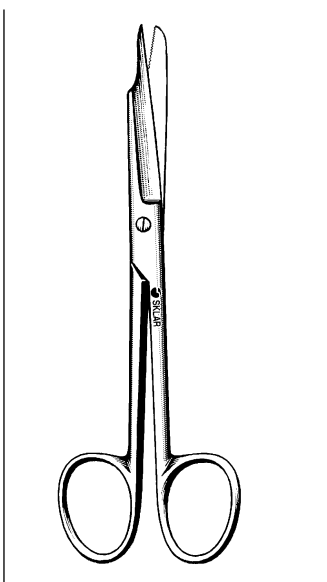
11-1180 8" Stainless



MOLESKIN SCISSORS

One Blade Serrated

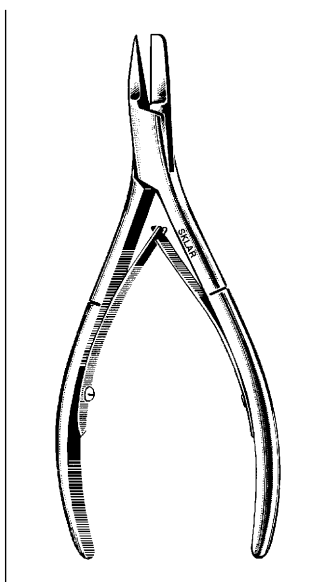
97-1350 7½" Straight
97-1351 7½" Curved



NAIL SPLITTING SCISSORS

One Pointed Blade

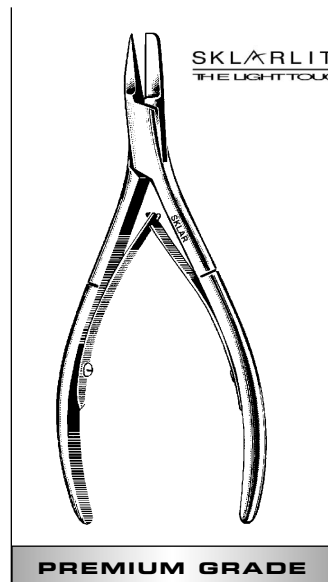
97-0555 6" One Blade Serrated



NAIL SPLITTING FORCEPS

English (Anvil) Pattern

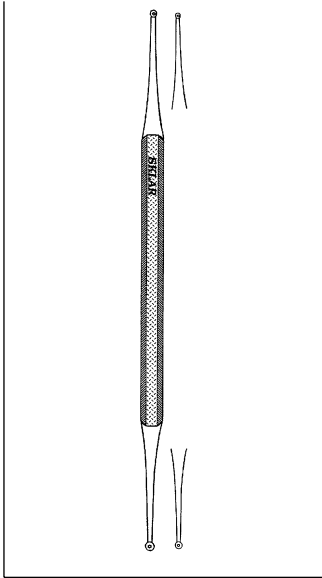
97-1150 5" Stainless



**SKLARLITE NAIL SPLITTING
FORCEPS**

English (Anvil) Pattern

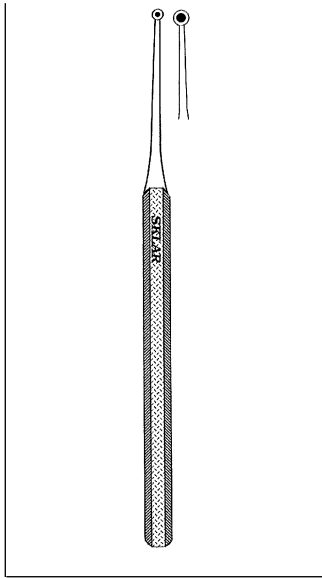
23-9250 5" Stainless



CURETTE-EXCAVATOR

Double End with Hole 5 1/2"

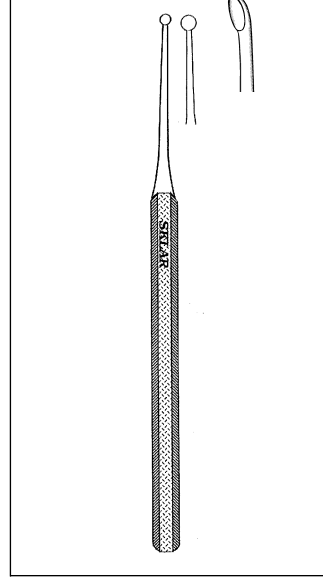
97-0532 1.5-2.0 mm
97-0536 1.5-2.5 mm



CURETTE-EXCAVATOR

Single End with Hole 5"

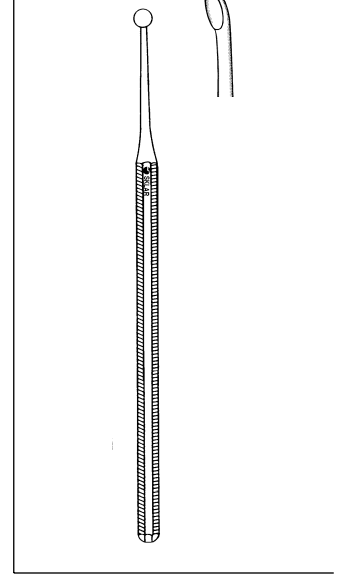
97-0512 1.0 mm
97-0522 1.5 mm
97-0524 2.0 mm
97-0528 2.5 mm



CURETTE-EXCAVATOR

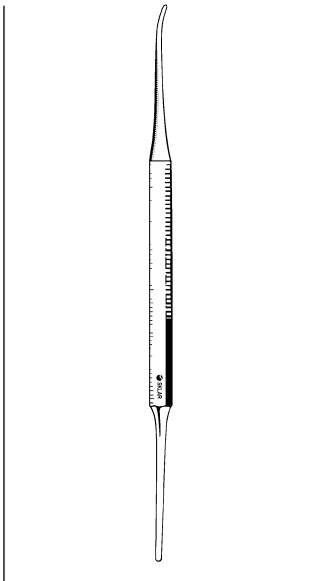
Single End without Hole 5"

97-0503 1.0 mm
97-0505 1.5 mm
97-0507 2.0 mm
97-0509 2.5 mm



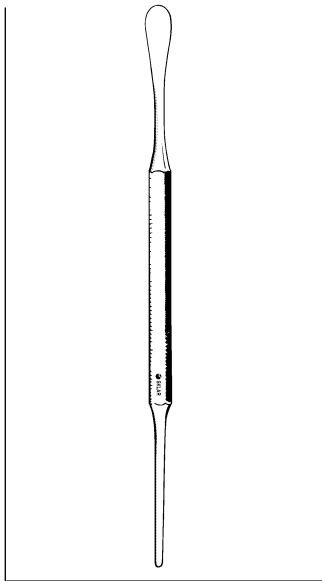
VERUCA CURETTE

97-0564 4 mm Cup 5"



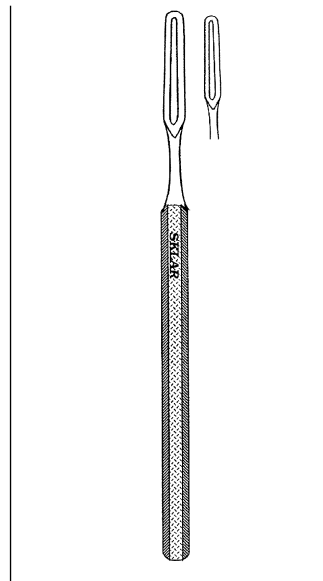
PROBE AND PACKER

Double End 6"
97-0539 Blunt



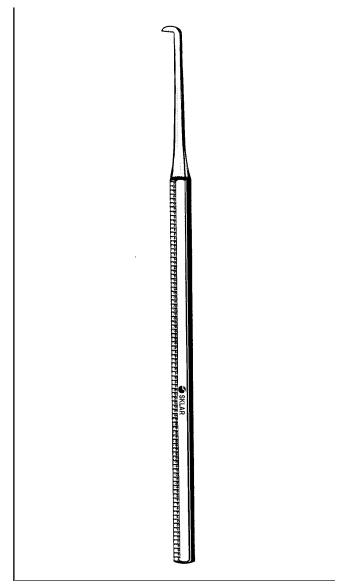
SPATULA AND PACKER

Double End 5 3/4"
97-0542



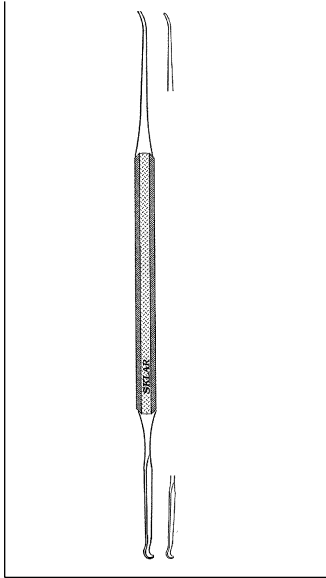
INGROWN NAIL SHAVER

Fenestrated
97-0554



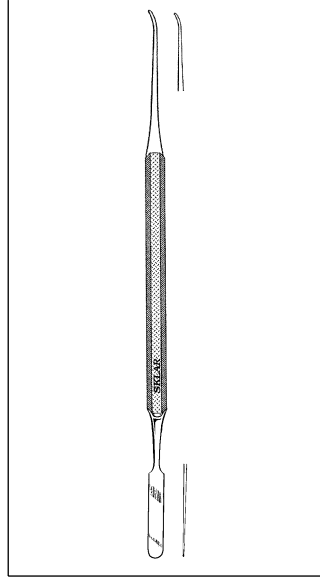
BAKER INGROWN NAIL CUTTER

97-0552 5"



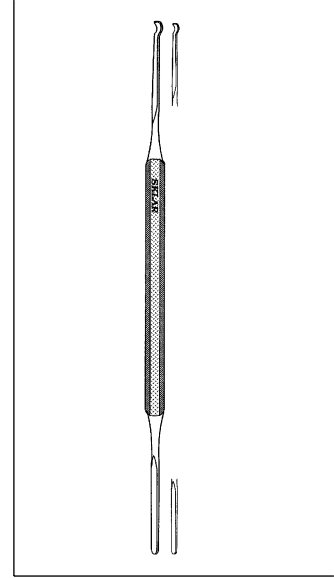
EXCAVATOR & PROBE

Double End
97-0562 6"



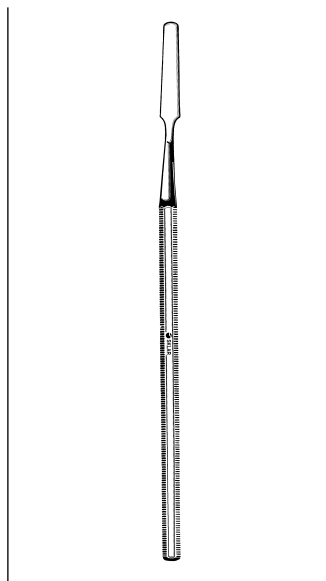
PROBE & SPATULA

Double End
97-0548 6"



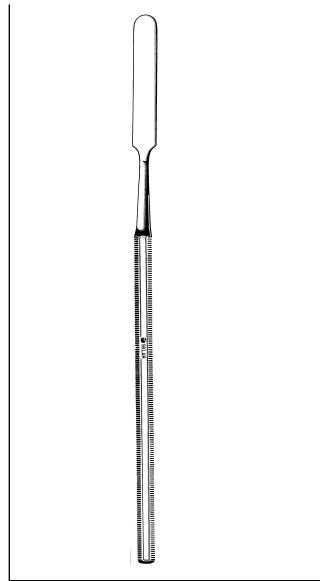
EXCAVATOR & PACKER

Double End 5 3/4"
97-0546



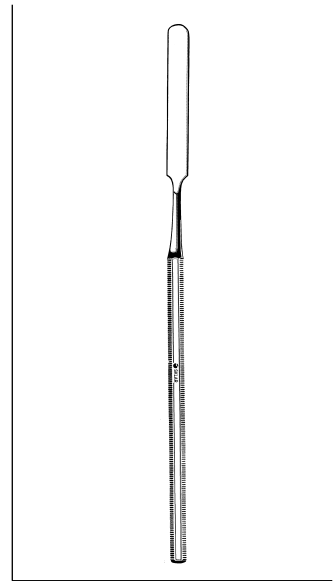
SPATULA

Rounded End
97-0581 4 mm



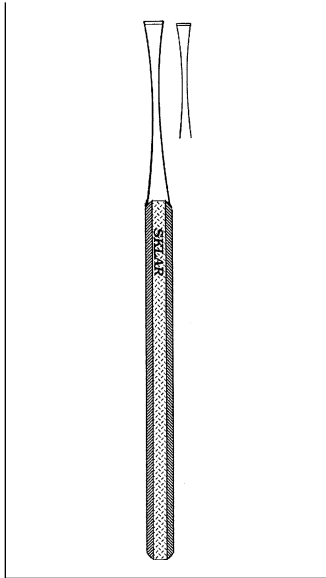
SPATULA

Rounded End
97-0582 6 mm



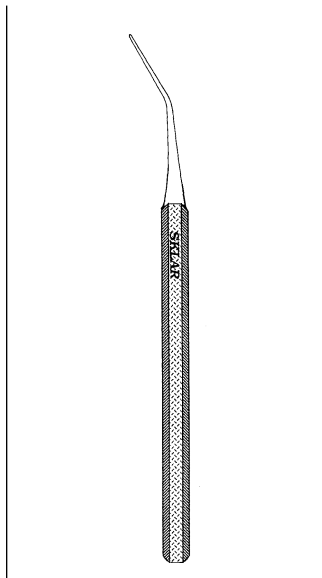
SPATULA

Rounded End
97-0583 7 mm



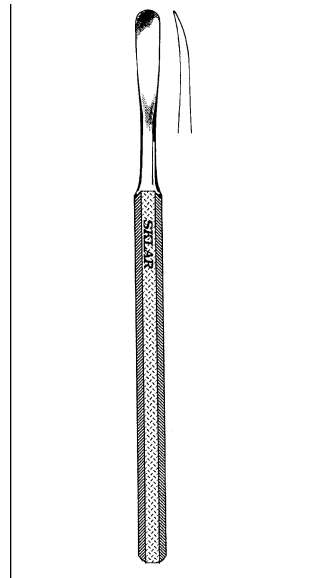
NAIL SPLITTER

97-0601 Straight-Narrow 2mm
97-0604 Straight-Wide 3.5mm



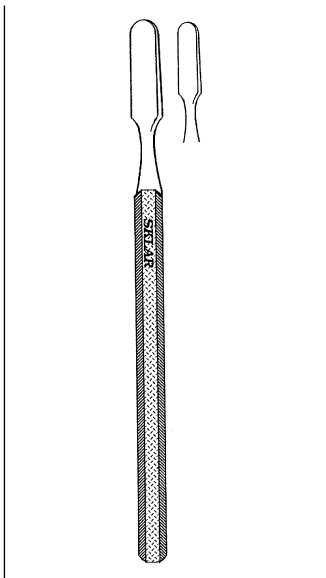
NAIL SPLITTER

97-0606 Angular-Narrow 2mm



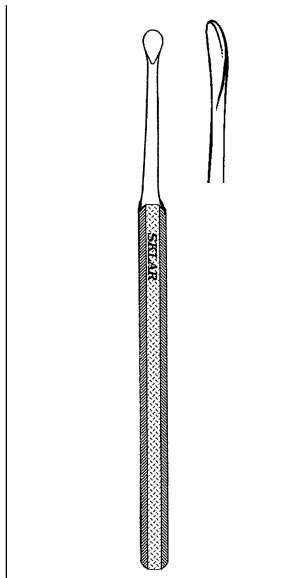
ELEVATOR

Semi-Sharp, Curved Edge
97-0048 5/8"



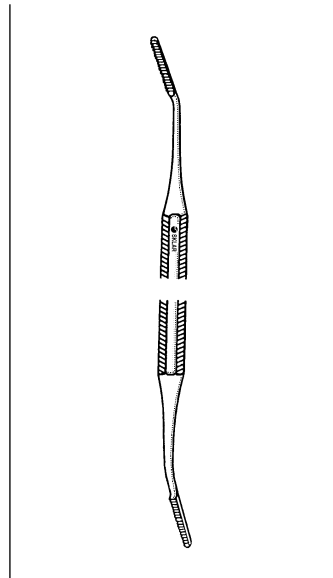
LOCKE ELEVATOR

97-0623 Narrow 3 x 15mm
97-0634 Wide 5 x 20mm



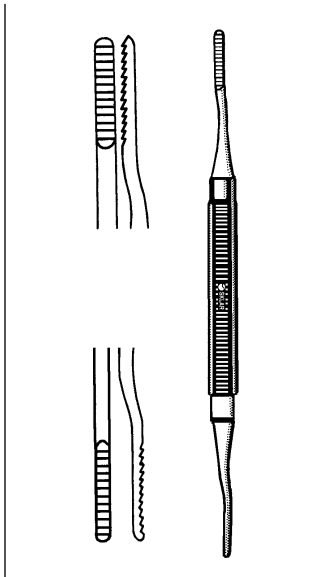
SOFT CORN KNIFE

97-0035 Straight Blade
97-0036 Curved Blade



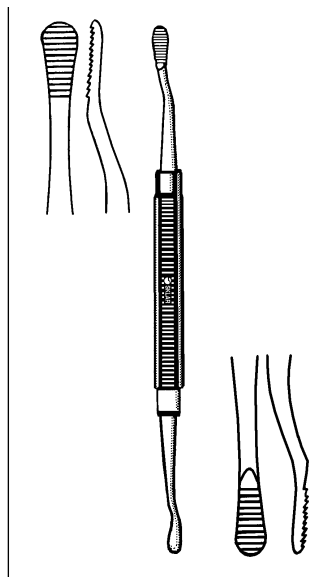
NAIL AND BONE FILE

97-1610 Double End Inside/Outside Cut
97-1600 Single End/Inside Cut
97-1605 Single End/Outside Cut



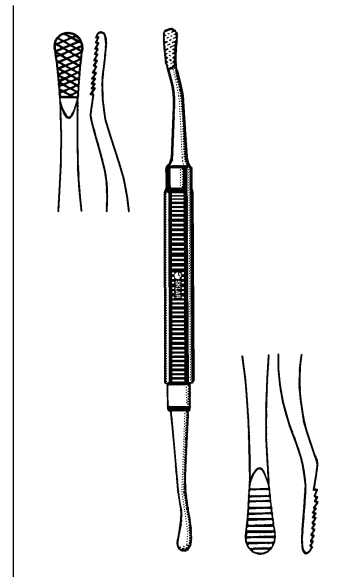
NAIL AND BONE RASP

97-1640 7" Plain Serrations
Double End, 3mm & 4mm



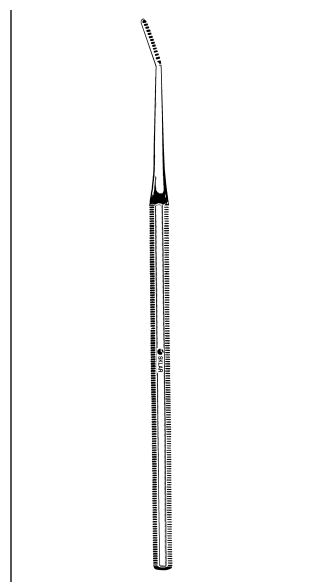
BONE FILE #12

Double End
97-1620 7" Plain Serrations
Both Ends



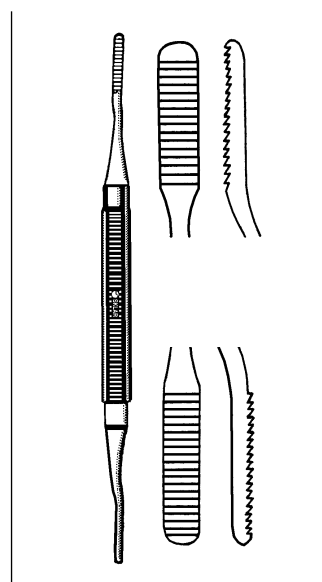
BONE FILE #12A

Double End
97-1625 7" Plain Serrations
& Cross Serrations



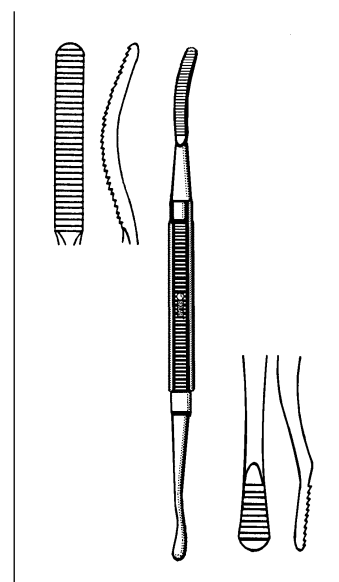
POLOKOFF RASP

97-1642 6 1/2" Medium Serrations
Single End



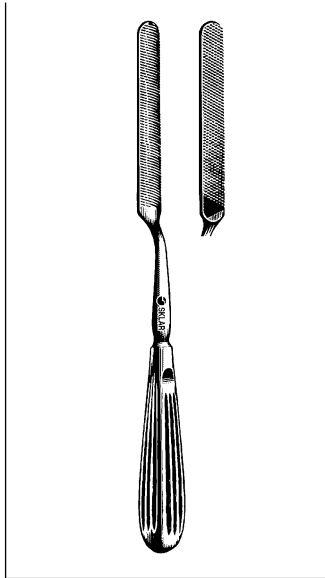
NAIL AND BONE RASP

Double End
97-1645 8 1/2" Plain Serrations



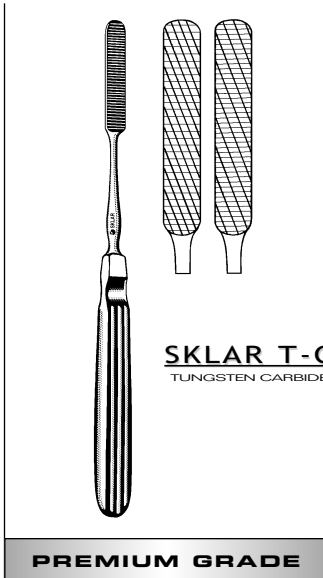
BONE RASP #10

Double End—Curved & Flat Ends
97-1615 7"



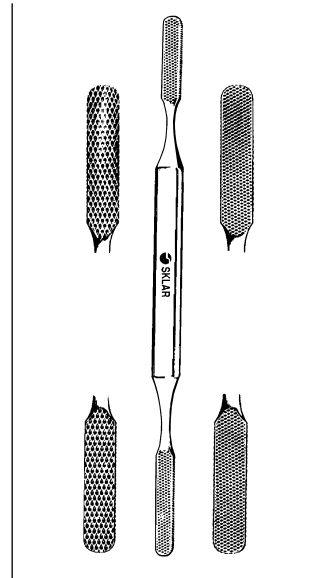
BONE FILE

Bayonet Handle
40-9685 9"



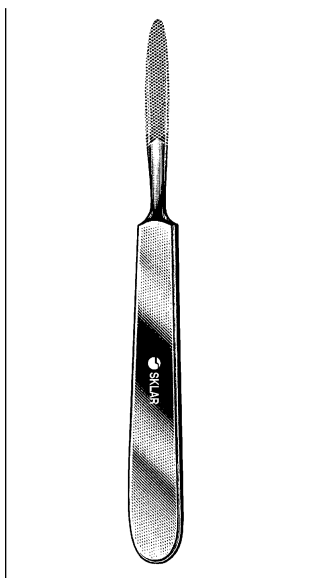
T-C MALTZ RASP

Single End
97-1505 Fine
97-1506 Medium



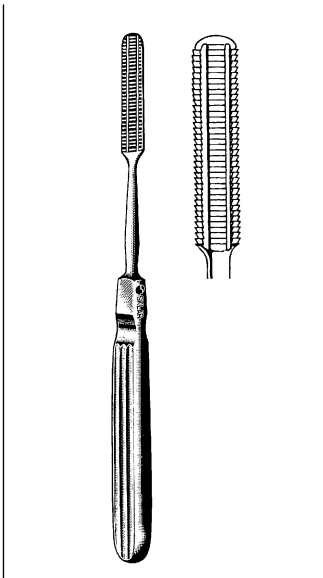
FOMON RASP AND FILE

Double End-4 Sided
40-9688 8 1/2"



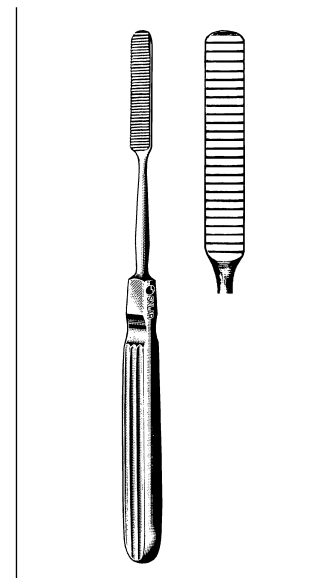
JOSEPH RASP

Straight Handle
40-9825 6 1/2"



MALTZ RASP

Backward Cutting
40-9815 7"



COTTLE RASP

Backward Cutting
40-9820 8"

Contents:
Sterilization Pouch
Small Blade #11
Tissue Forceps, Plastic
(3) 4 x 4, 12 Ply Gauze Sponge
(2) Alcohol Prep Pads
Procedure Catch Pad/Absorbent Towel
Prep Tray
CSR Wrap



NAIL TRAY - Cs/12

96-1838

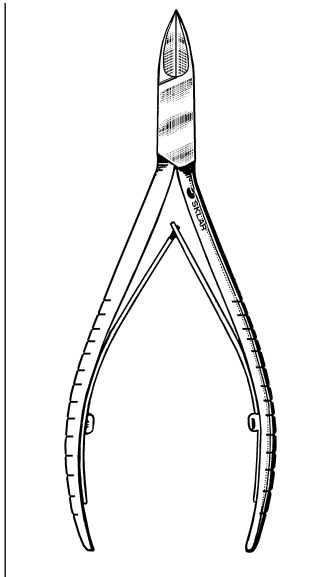
Create a comfortable yet durable digital appliance in less than 3 minutes!
SklarMold is tissue compatible and washes easily with gentle soap and water. Both base and catalyst are easy to use compounds, odorless and patient friendly. Sufficient material for 10 appliances or more.



SKLARMOLD

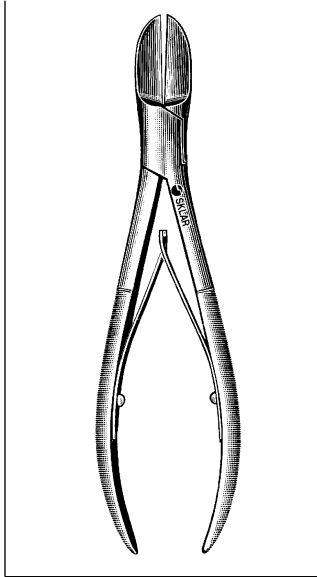
Moldable Silicone Compound For Digital Appliances
96-2012 1 of Each Compound, Base and Catalyst

ORTHOPEDIC/BONE FORCEPS



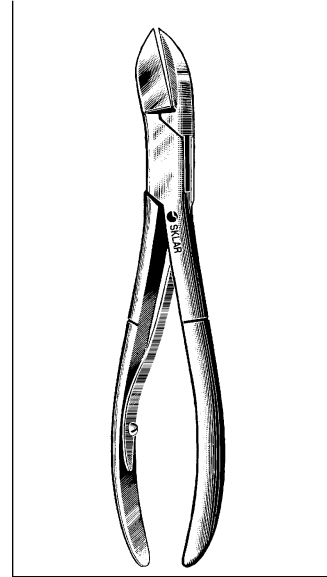
P AND A FORCEPS

97-1340 4½"



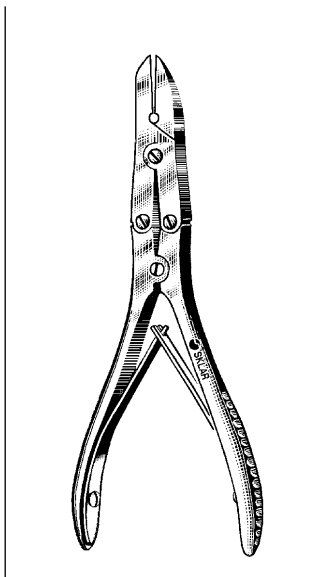
LISTON BONE FORCEPS

40-3055 5½" Straight
40-3077 7¾" Straight
40-3087 8¾" Straight



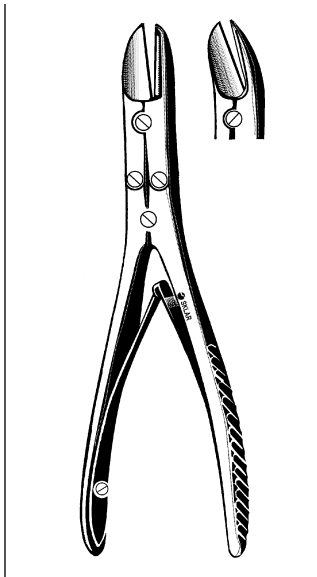
LISTON BONE FORCEPS

40-3155 5½" Angular
40-3177 7¾" Angular
40-3187 8¾" Angular



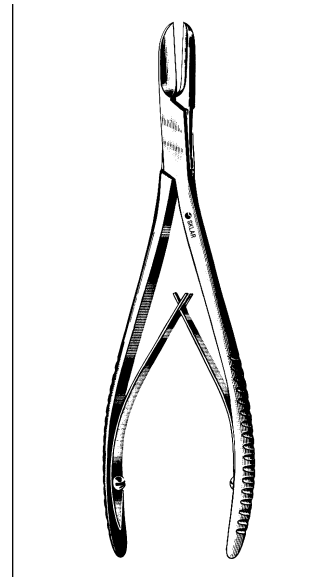
KLEINERT-KUTZ BONE CUTTING FORCEPS

Double Action
40-4560 6" Straight



RUSKIN-LISTON BONE CUTTING FORCEPS

Double Action
40-4572 7¾" Straight
40-4575 7¾" Angular



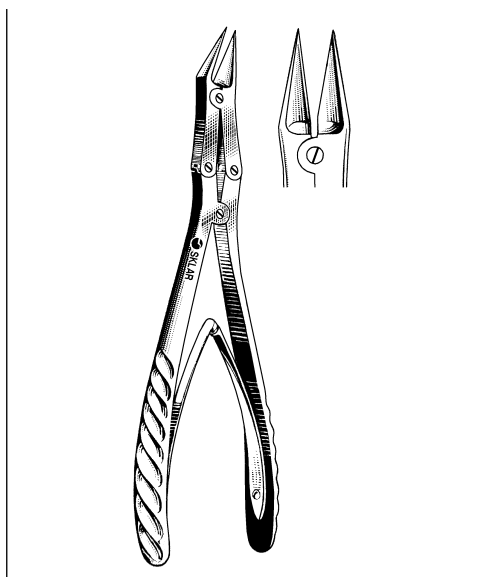
COTTLE-KAZANJAN BONE CUTTING FORCEPS

41-1180 8" Slender Jaws



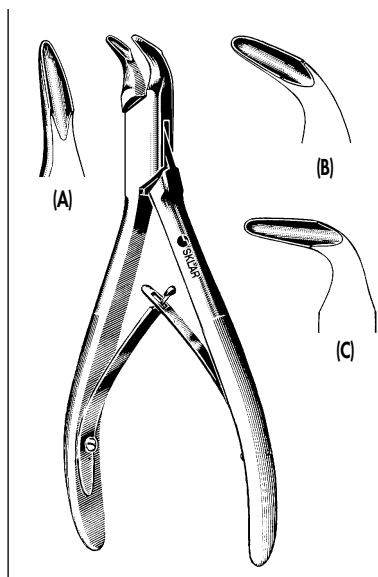
ROWLAND BONE FORCEPS

Double Action
41-1175 7" Narrow Jaws



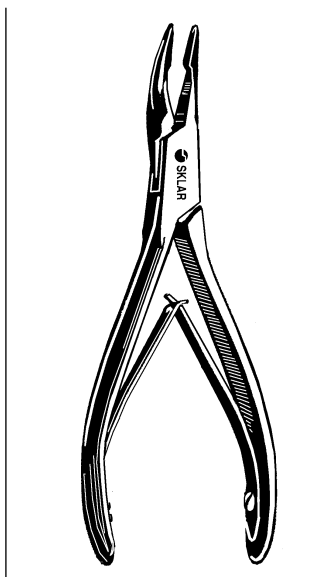
McINDOE BONE CUTTING FORCEPS

Double Action
41-1170 7½" Slight Angle



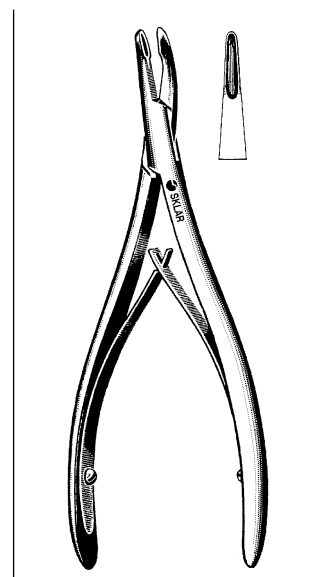
BLUMENTHAL RONGEUR

67-5990 6" 30° Angle (A)
67-5992 6" 45° Angle (B)
67-5994 6" 90° Angle (C)



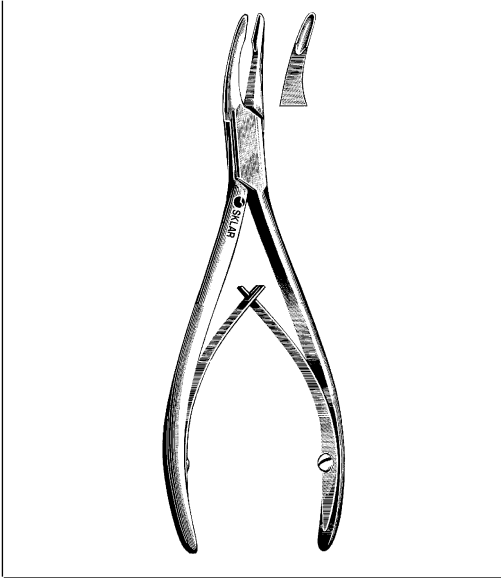
MINI BLUMENTHAL RONGEUR

Delicate
67-5987 4¾" 30° Angle



LEMPERT RONGEUR

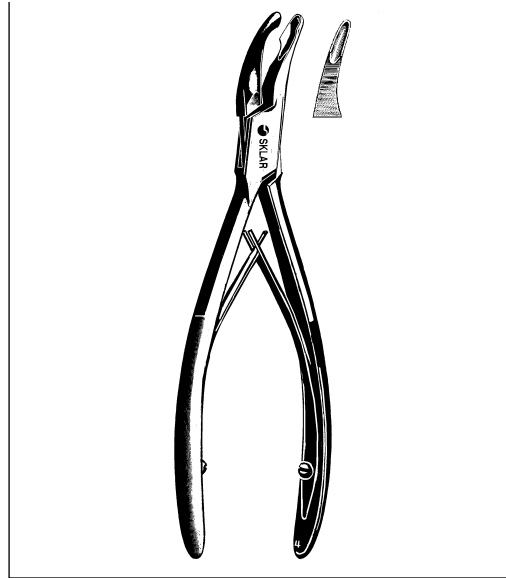
6¾" Delicate
47-2467 2.5mm Straight
47-2468 2.5mm Curved



FRIEDMAN BONE RONGEUR

Delicate

40-3190 5½" Curved
40-3192 6½" Curved



CLEVELAND RONGEUR

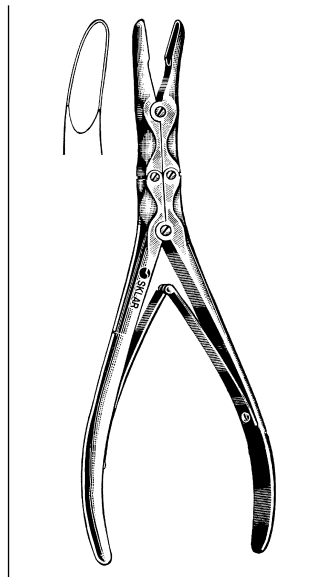
Curved

40-3200 5½"
40-3202 6½"



MEAD RONGEUR

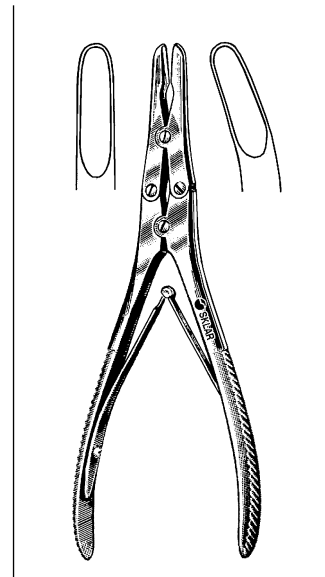
40-3206 6½" Slightly Curved Jaws



ZAUFEL-JANSEN RONGEUR

Double Action

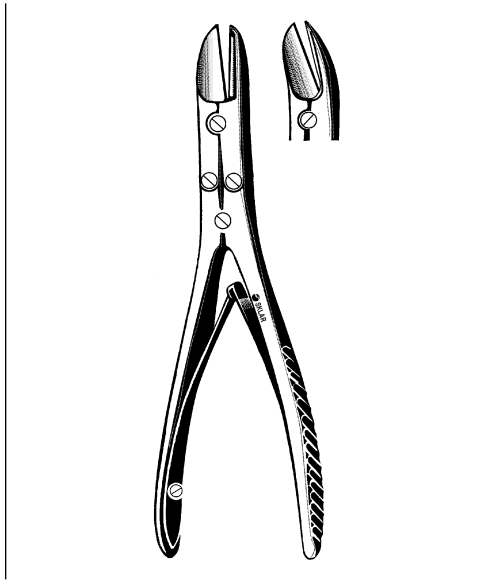
40-4265 7" 5 x 15 mm Curved



RUSKIN RONGEUR

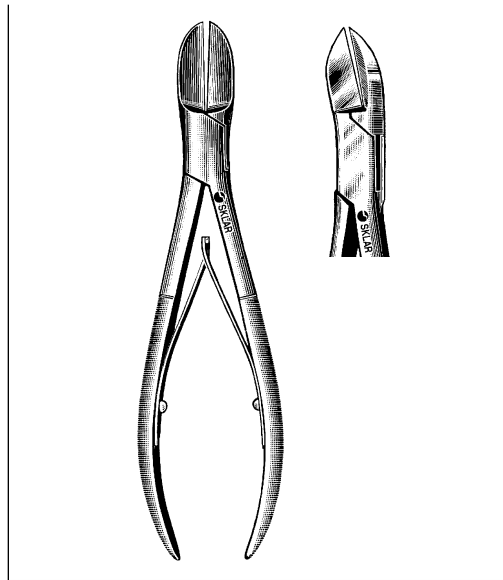
Double Action

40-4360	6"	Straight	2mm Bite
40-4365	6"	Curved	2mm Bite
40-4272	7¼"	Straight	5mm Bite
40-4372	7¼"	Curved	5mm Bite



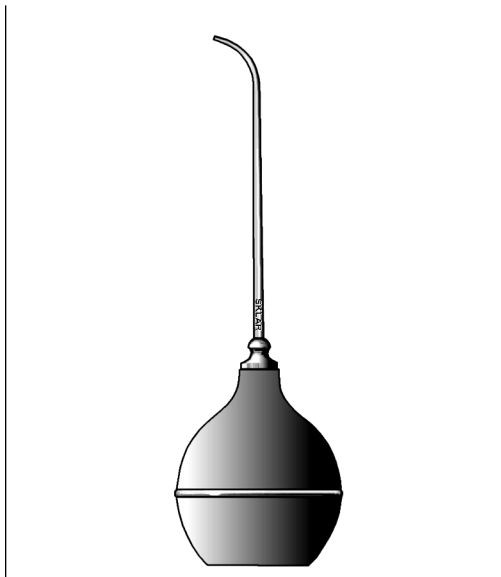
RUSKIN-LISTON BONE CUTTING FORCEPS

Double Action
 40-4572 7 1/4" Straight
 40-4575 7 1/4" Angular



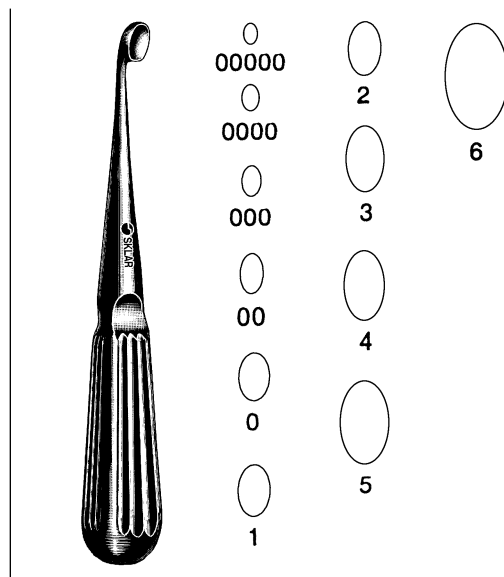
LISTON BONE FORCEPS

40-3055	5 1/2"	Straight	40-3155	5 1/2"	Angular
40-3077	7 3/4"	Straight	40-3177	7 3/4"	Angular
40-3087	8 3/4"	Straight			



CHIP BLOWER

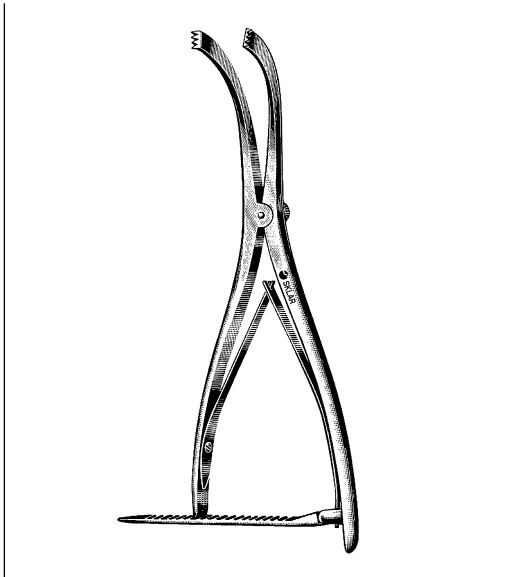
97-1650 Chip Blower Complete
 97-1652 Tip Only
 97-1654 Bulb Only



BRUNS CURETTE

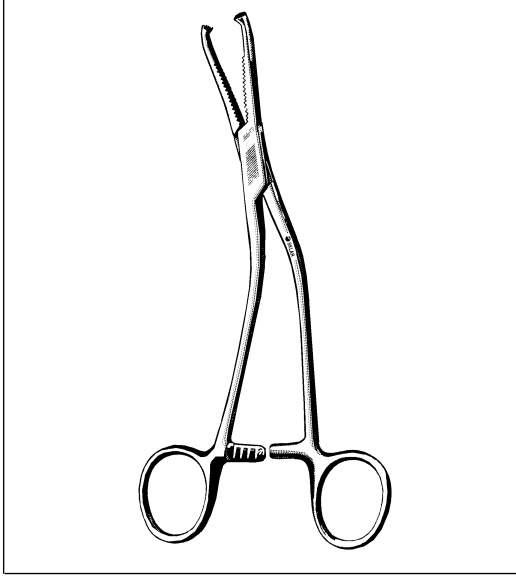
Single End-Oval Straight 6 1/2"

40-7118	#00000	40-7113	#3
40-7120	#0000	40-7114	#4
40-7000	#000	40-7115	#5
40-7100	#00	40-7116	#6
40-7110	#0		
40-7111	#1		
40-7112	#2		



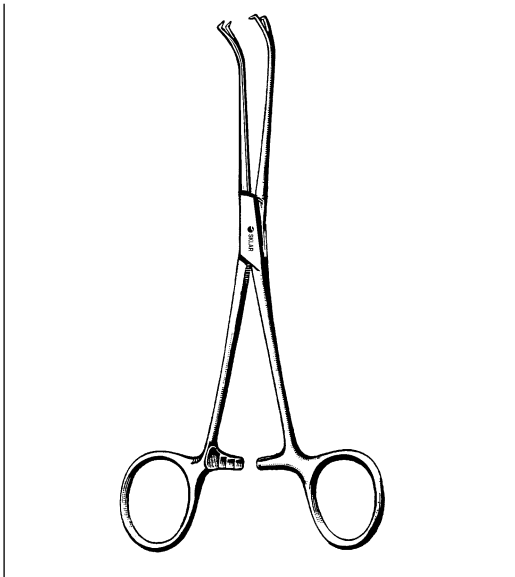
INGE LAMINA RETRACTOR

42-1420 6½" with Teeth
42-1425 10½" with Teeth
42-1422 10½" without Teeth



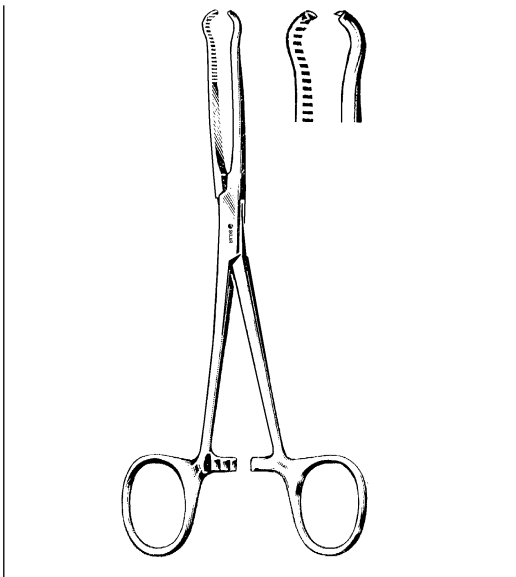
DINGMAN SMALL BONE AND CARTILAGE CLAMP

40-2660 7½" Serrated jaws, 4 mm
2 x 2 teeth



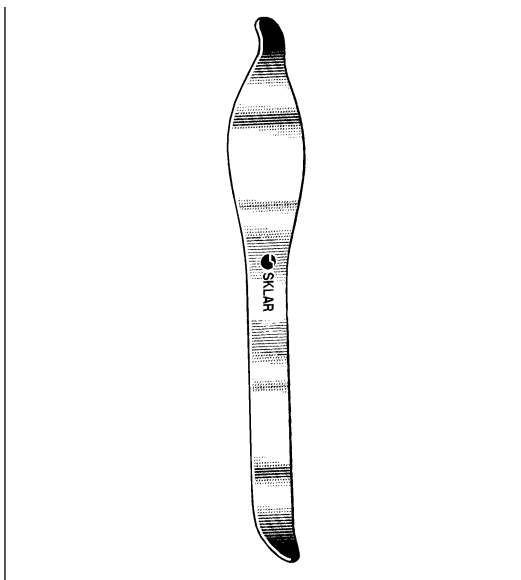
SESAMOID CLAMP

40-2655 6½"



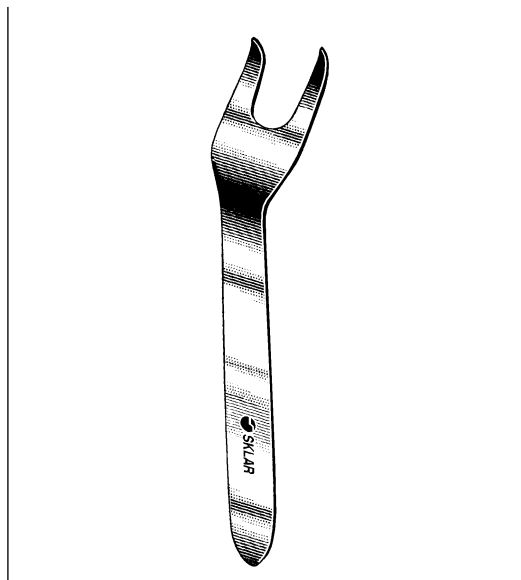
LOCKE PHALANGEAL FORCEPS

40-2650 6"



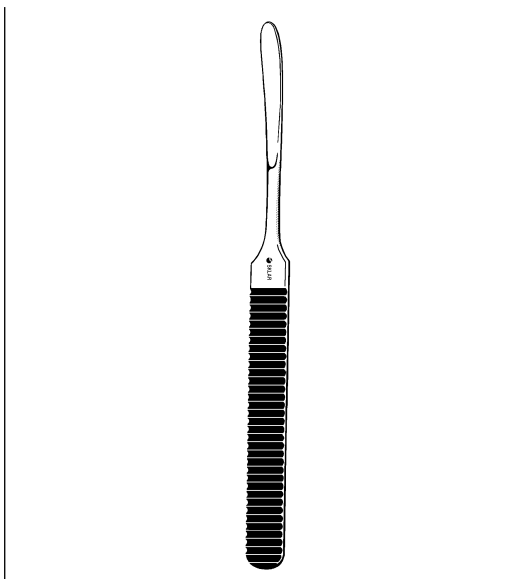
BLOUNT SINGLE PRONG RETRACTOR

40-8252 10 1/2" 37mm blade width



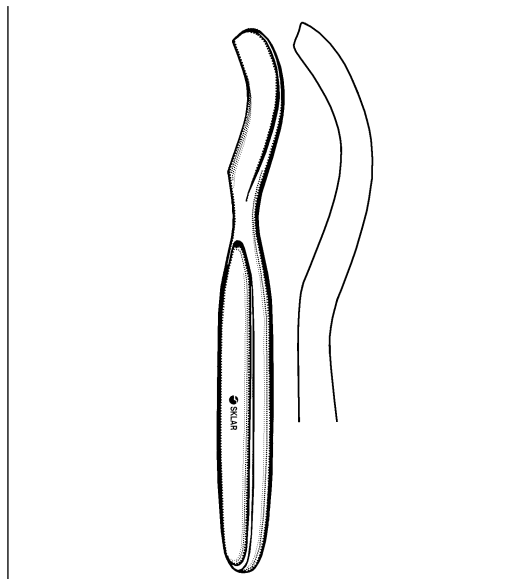
BLOUNT DOUBLE PRONG RETRACTOR

40-8255 10 1/2" 44 mm blade width



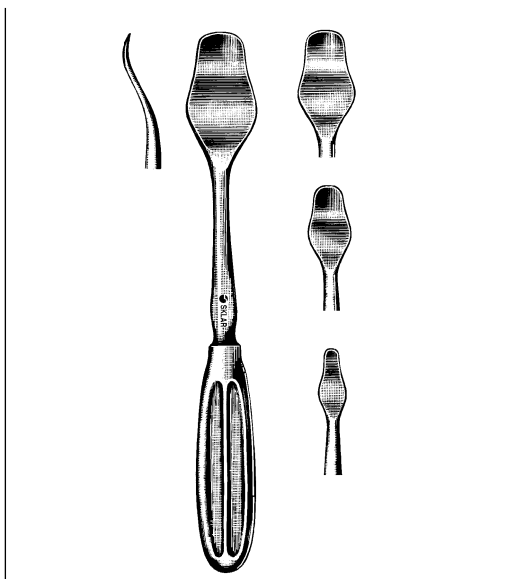
WILLIGER ELEVATOR

40-7155 6 1/2"



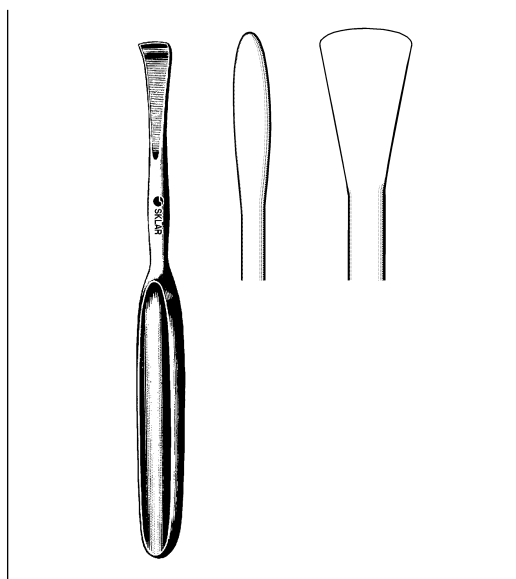
MCGLAMRY ELEVATOR

40-7480 6 1/2" 11mm
40-7482 6 1/2" 13mm
40-7484 6 1/2" 15mm
40-7486 6 1/2" 17mm



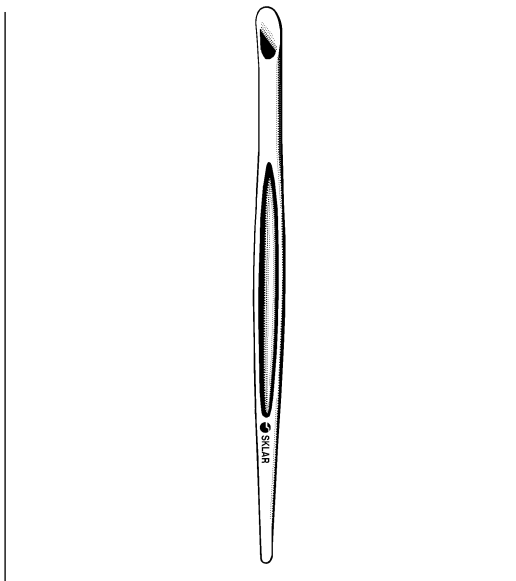
CHANDLER ELEVATOR

40-7430	7"	1/2"	Width
40-7435	8"	3/4"	Width
40-7440	9"	1"	Width
40-7445	10"	1 1/4"	Width



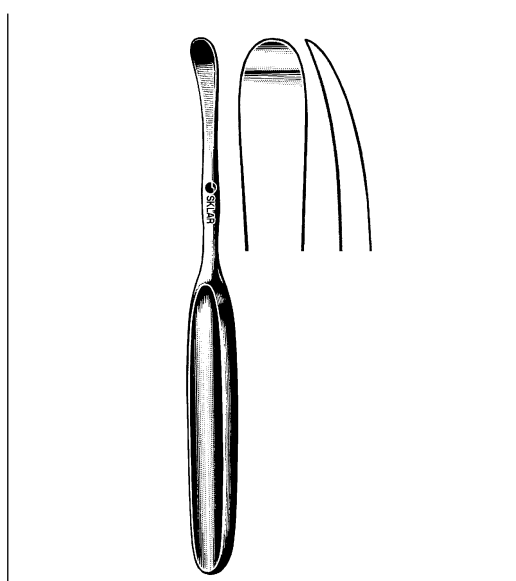
LANGENBECK ELEVATOR

Single End			
40-8675	7 1/2"	Narrow	
40-8775	7 1/2"	Broad	



SAYRE ELEVATOR

Double End			
40-9265	6 1/2"	Sharp	
40-9365	6 1/2"	Blunt	



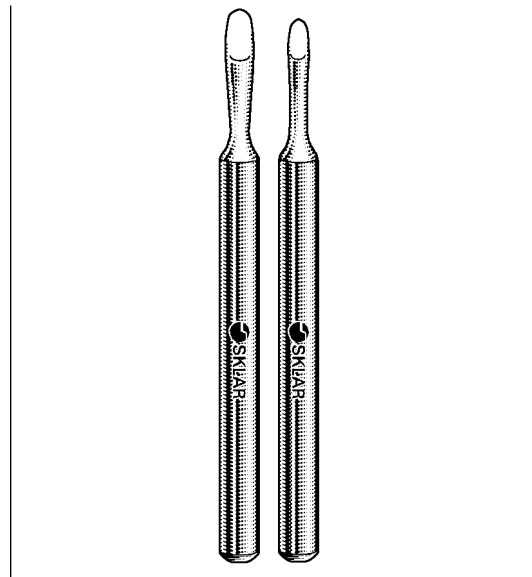
LANE ELEVATOR

Single End			
40-8375	7 1/2"	Narrow	
40-8275	7 1/2"	Wide	



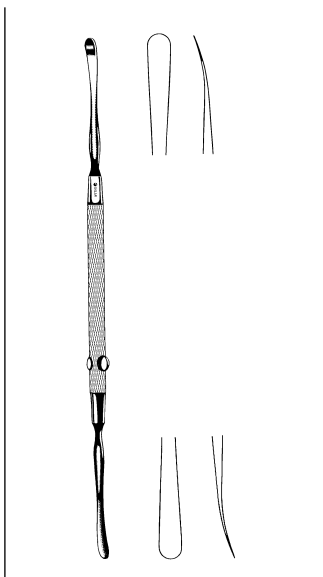
SELDIN ELEVATOR

97-0527 8" Double End



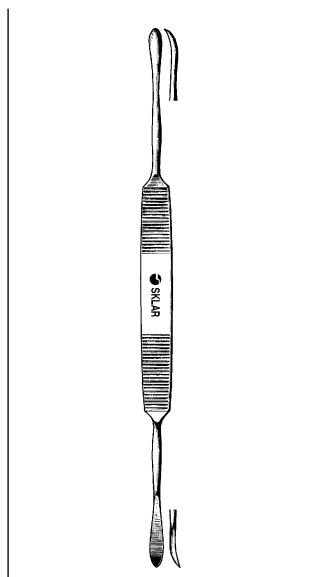
FROST ELEVATOR

97-0640 Narrow
97-0641 Wide



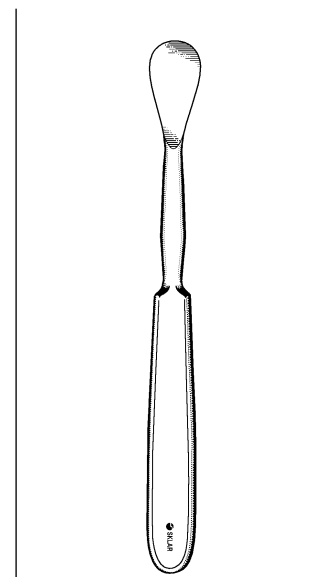
FREER ELEVATOR

Double End
47-2380 7 1/4" S/B
47-2382 7 3/4" S/B



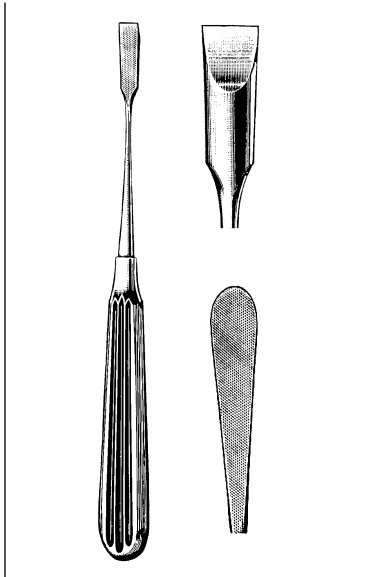
OHL ELEVATOR

Double End
97-0050 7"



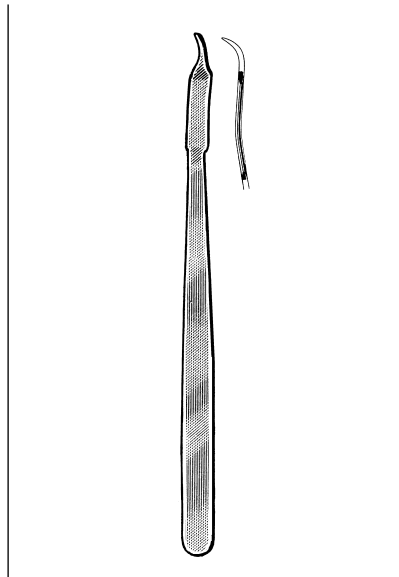
**SEDILOT PERIOSTEAL
ELEVATOR**

40-9370 7" 16 mm sharp blade



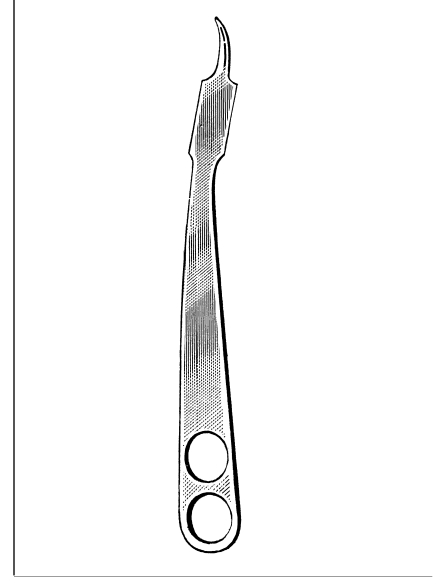
ADSON ELEVATOR

40-8270 6³/₄" Square End
40-8272 6³/₄" Round End



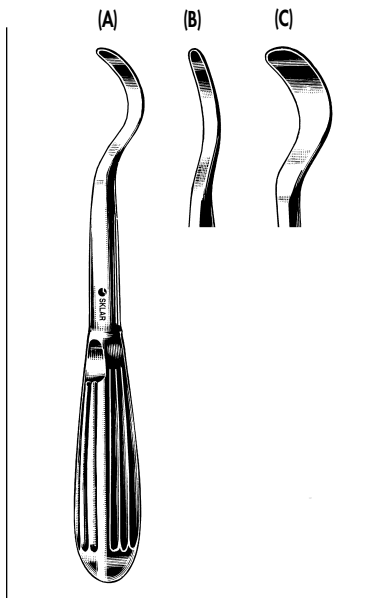
MINI HOHMANN BONE ELEVATOR

40-7450 6¹/₂" 6 mm
40-7451 6¹/₂" 8 mm



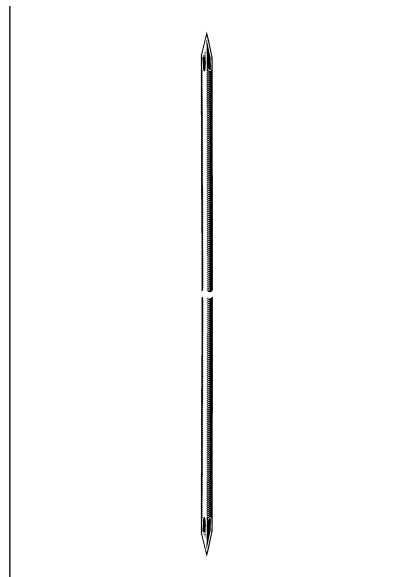
HOHMANN BONE ELEVATOR

40-7452 9¹/₂" 18 mm
40-7453 9¹/₂" 43 mm
40-7454 10" 24 mm
40-7455 10" 20 mm



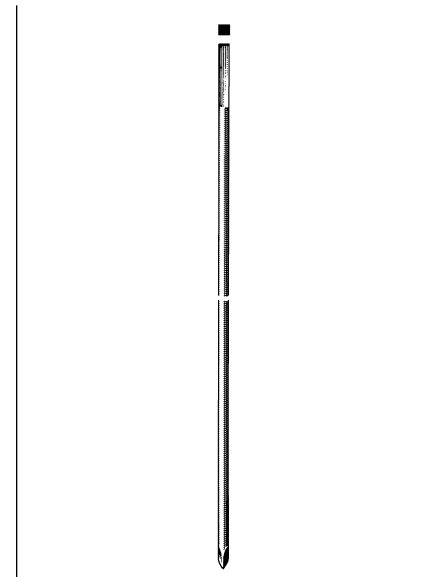
CREGO ELEVATOR

40-7415 8" Full Curve 6 mm (A)
40-7420 8" Slight Curve 6 mm (B)
40-7410 7³/₄" Full Curve 10 mm (C)



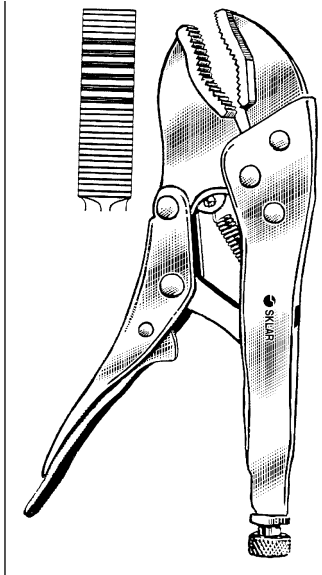
KIRSCHNER WIRES

Two Trocar Ends
40-1535 12" x .035
40-1545 12" x .045
40-1562 12" x .062
40-1565 4" x .028
40-1566 4" x .035
40-1567 4" x .045
40-1568 4" x .054
40-1569 4" x .062
40-1580 9" x .035
40-1582 9" x .045
40-1584 9" x .062



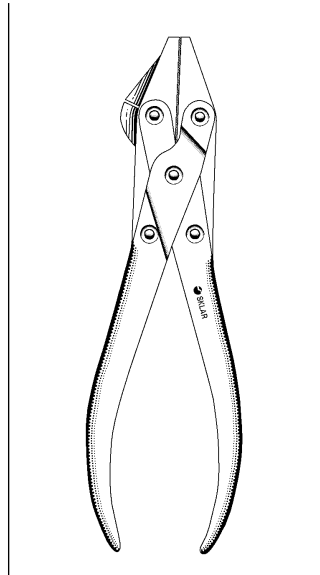
STEINMANN PINS

Trocar Point
40-1590 9" x 2 mm
40-1591 9" x 2.4 mm
40-1592 9" x 2.8 mm
40-1593 9" x 3.2 mm
40-1594 9" x 3.5 mm
40-1595 9" x 4.0 mm
40-1596 9" x 4.5 mm



SNAP LOCK PIN/WIRE EXTRACTOR

40-1725



DOUBLE ACTION PARALLEL PLIERS

With Side Wire Cutter

40-1727 7 1/2"

Cuts Up To: 1.6 mm Hard Wire
2.0 mm Soft Wire

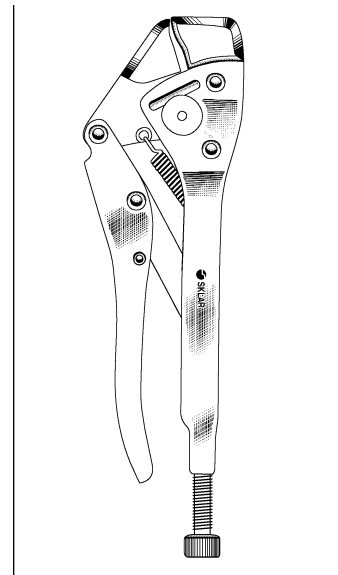
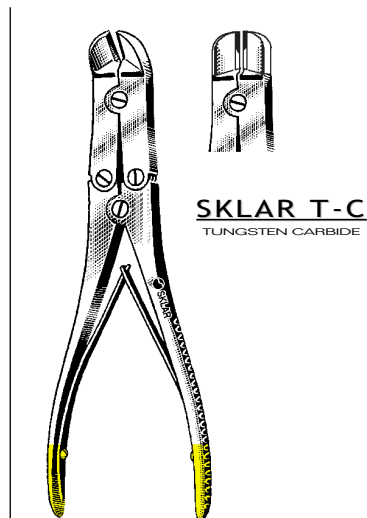


PLATE BENDING FORCEPS

40-1729 7"

Cuts Bone Plates Up To 1mm in Width



SKLAR T-C
TUNGSTEN CARBIDE

PREMIUM GRADE

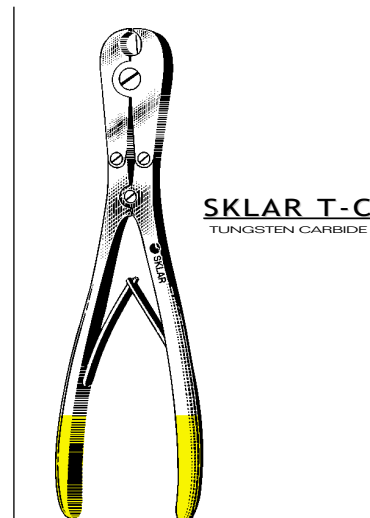
T-C PIN CUTTER

Double Action

40-1023 7" Straight

40-1024 8 1/2" Angular

Cuts Up To: 1.5 mm Hard Wire
2.0 mm Soft Wire



SKLAR T-C
TUNGSTEN CARBIDE

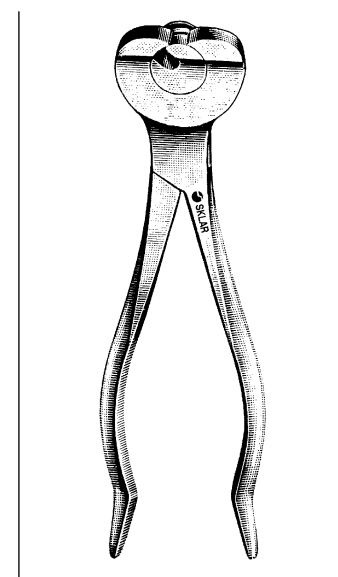
PREMIUM GRADE

T-C PIN CUTTER

Double Action

40-1045 7" End Cut-Side Cut
Tungsten Carbide

Cuts Up To: 1.5 mm Hard Wire
2.0 mm Soft Wire

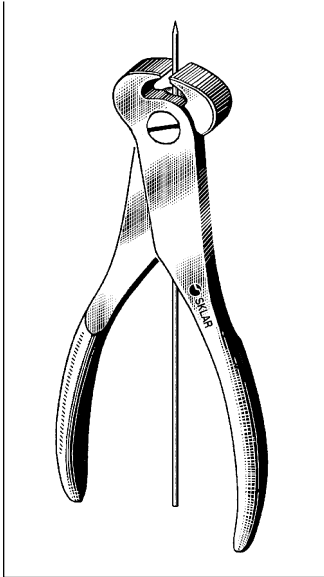


DIAMOND PIN CUTTER

40-1762 6 1/4"

Cuts Up To: 2.0 mm Hard Wire

ORTHOPEDIC/BONE PIN INSTRUMENTS



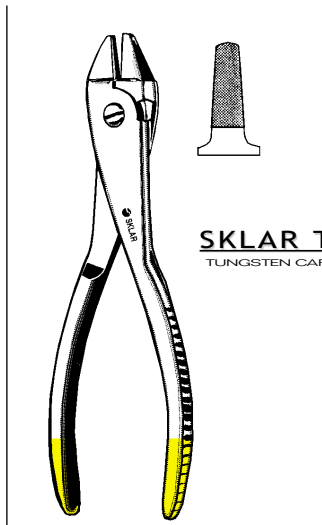
SKLAR PIN CUTTER

End Cutting

40-1048 7"

Cannulated

Cuts up to: 1.5mm, Hardwire
3.2mm, Softwire

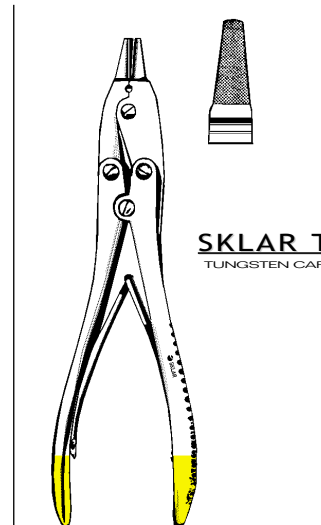


SKLAR T-C
TUNGSTEN CARBIDE

PREMIUM GRADE

T-C WIRE PULLER

40-1730 8" Flat Jaws



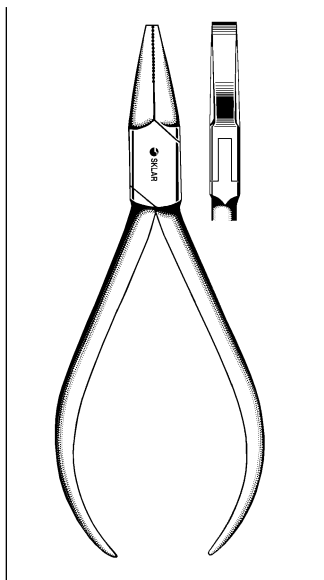
SKLAR T-C
TUNGSTEN CARBIDE

PREMIUM GRADE

T-C WIRE PULLER

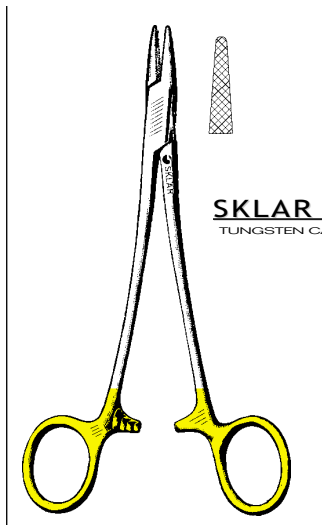
Double Action

40-1735 7" 4 mm



FLAT NOSE PLIERS

40-1778 5 1/2" Square End

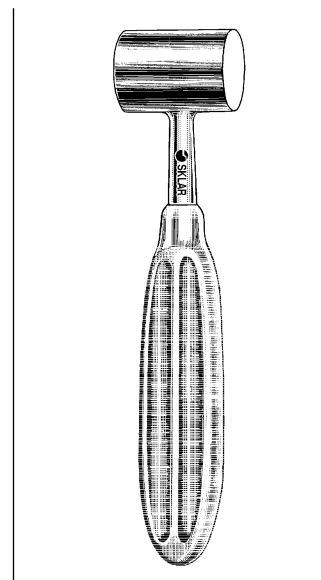


SKLAR T-C
TUNGSTEN CARBIDE

PREMIUM GRADE

T-C RING HANDLE WIRE EXTRACTOR

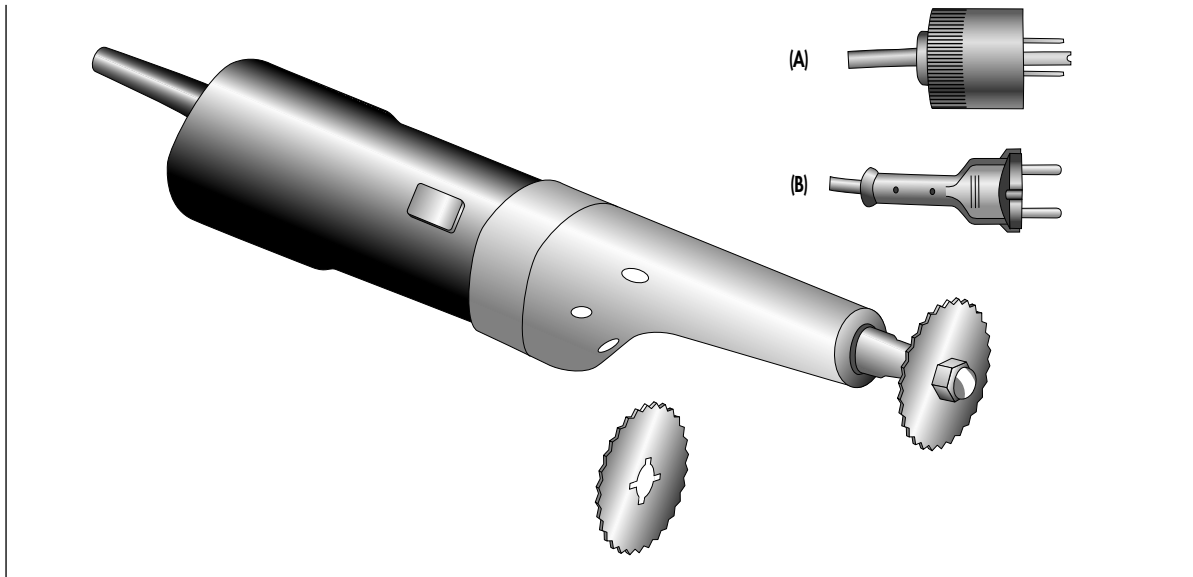
40-1720 7" Tungsten Carbide



GERZOG BONE Mallet

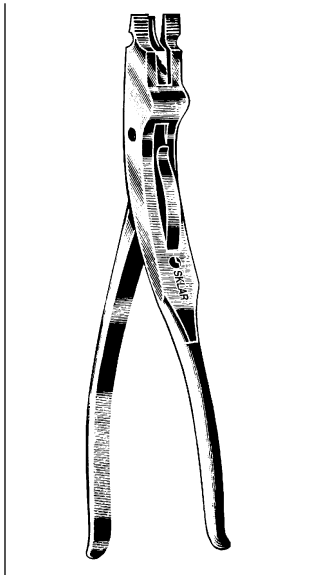
Lead Filled-14 oz.

40-5765 7 1/2" 1" Diameter



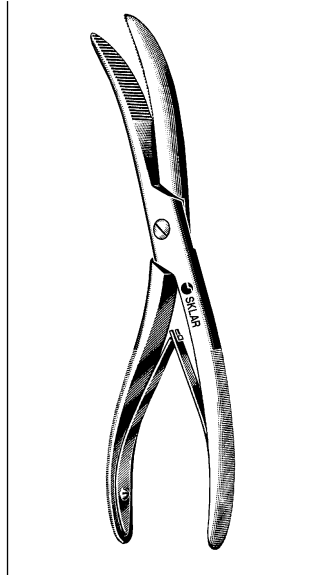
OSCILLATING PLASTER SAW

- 11-2100 110V Complete (USA Only) - (A)
- 11-2101 220V Complete (International Only) - (B)
- 11-2105 Blade Only 50 mm
- 11-2110 Blade Only 65 mm



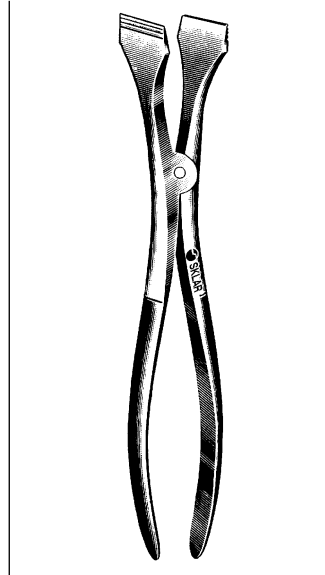
WALTON PLASTER SPREADER

3 Blade
11-1990 9"



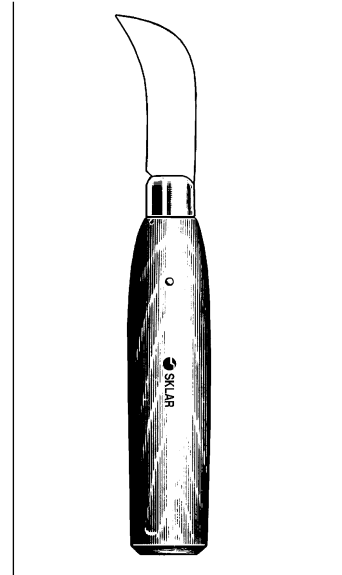
WOLFE-BOEHLER CAST BREAKER

11-2095 10"



HENNIG PLASTER SPREADER

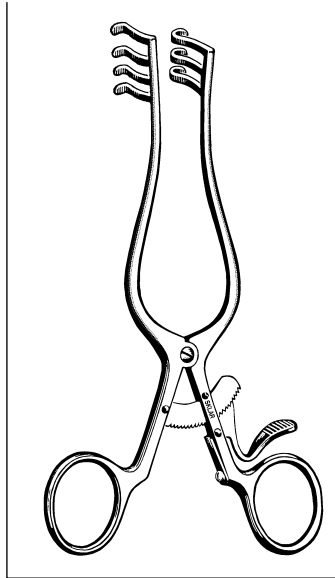
2 Blade
11-1910 11"



MURPHY PLASTER KNIFE

Wood Handle
11-1540

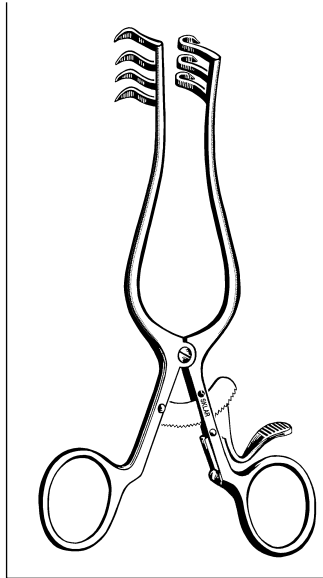
ORTHOPEDIC SELF-RETAINING RETRACTORS



WEITLANER RETRACTOR

Tru-Grip Ratchet
Blunt

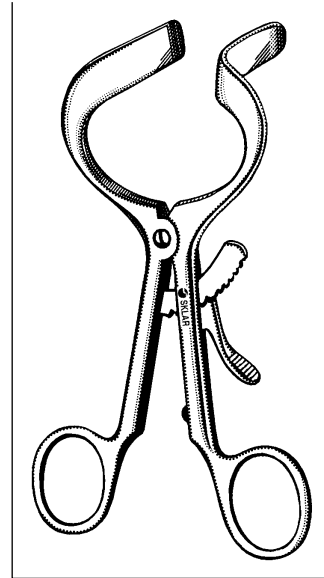
22-8345	4 1/2"	2 x 3 Teeth
22-8355	5 1/2"	3 x 4 Teeth
42-1865	6 1/2"	3 x 4 Teeth
42-1875	8"	3 x 4 Teeth
42-1895	9 1/2"	3 x 4 Teeth



WEITLANER RETRACTOR

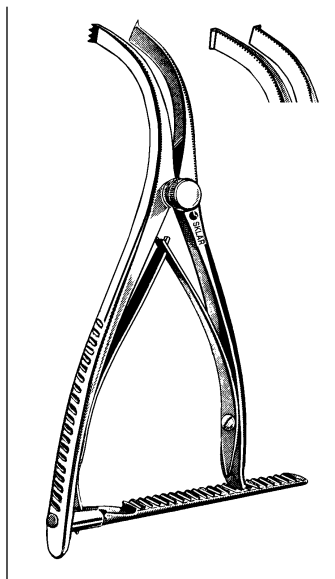
Tru-Grip Ratchet
Sharp

22-8245	4 1/2"	2 x 3 Teeth
22-8255	5 1/2"	3 x 4 Teeth
42-1965	6 1/2"	3 x 4 Teeth
42-1975	8"	3 x 4 Teeth
42-1995	9 1/2"	3 x 4 Teeth



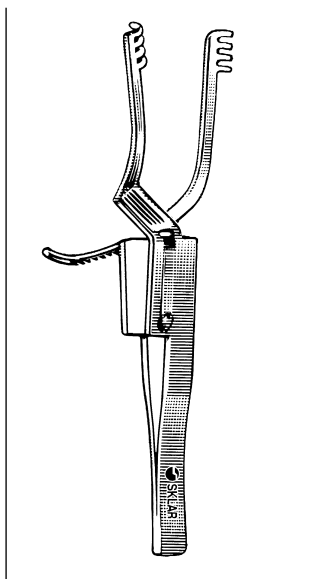
SCHINK METATARSAL SPREADER

97-5045 4 1/2"



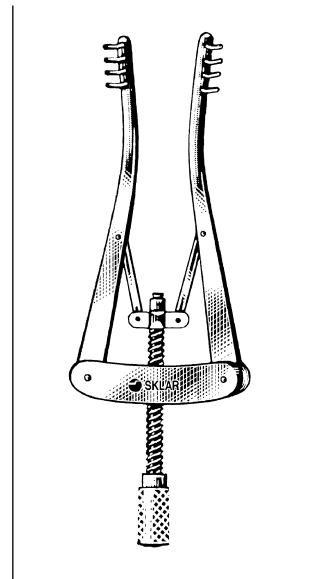
INGE LAMINA RETRACTOR

42-1420	6 1/2"	with Teeth
42-1425	10 1/2"	with Teeth
42-1422	10 1/2"	without Teeth



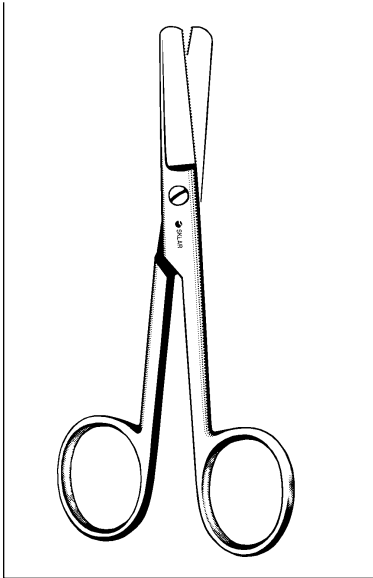
HOLZHEIMER SELF-RETAINING RETRACTOR

Sharp		
22-8920	4"	4 x 4 Teeth
Blunt		
22-8940	4"	4 x 4 Teeth



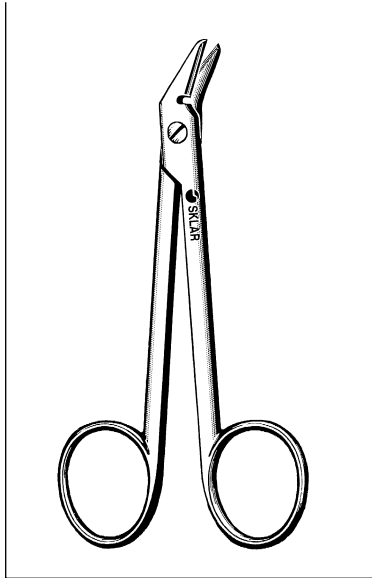
ALM SELF-RETAINING RETRACTOR

22-9027	2 3/4"	4 x 4 Teeth Blunt
60-6340	4"	4 x 4 Teeth Blunt
22-9029	2 3/4"	4 x 4 Teeth Sharp
60-6342	4"	4 x 4 Teeth Sharp



SUTURE WIRE CUTTING SCISSORS

24-2347 4 3/4" Straight, Heavy Serrated Edges



SUTURE WIRE CUTTING SCISSORS

Angular Serrated
24-2342 4 3/4"

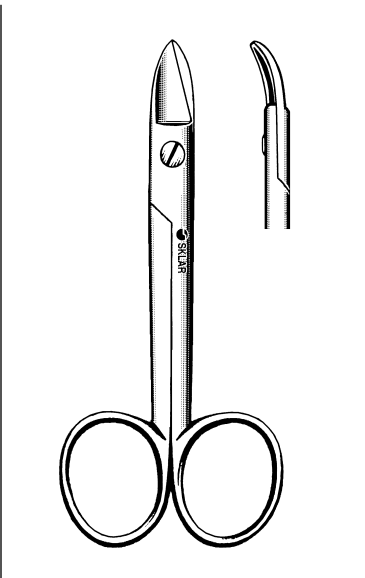


SKLAR EDGE
TUNGSTEN CARBIDE

PREMIUM GRADE

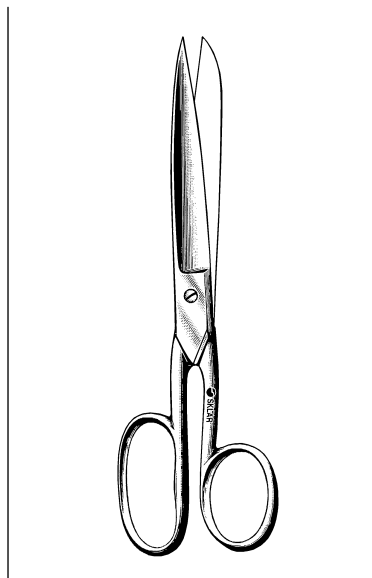
SKLAR EDGE™ T-C WIRE CUTTING SCISSORS

16-2800 4 3/4" Tungsten Carbide Angular Serrated



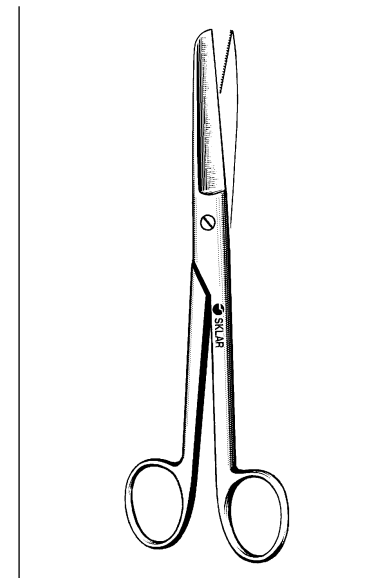
CROWN & COLLAR CUTTING SCISSORS

Straight	Curved
24-2345 4" Smooth	24-2346 4" Smooth
24-2340 4" Serrated	24-2341 4" Serrated



U.S. ARMY PATTERN GAUZE SCISSORS

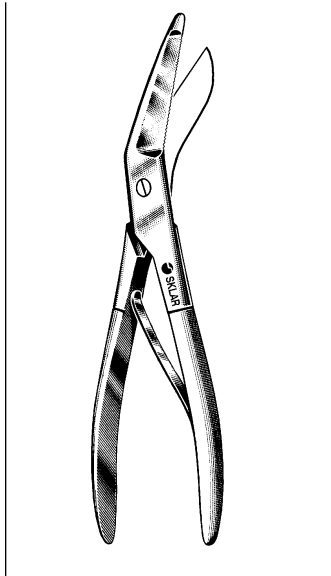
11-1180 8" Stainless



MOLESKIN SCISSORS

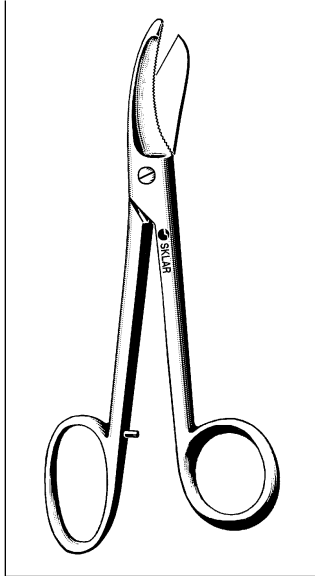
One Blade Serrated
97-1350 7 1/2" Straight
97-1351 7 1/2" Curved

ORTHOPEDIC SHEARS



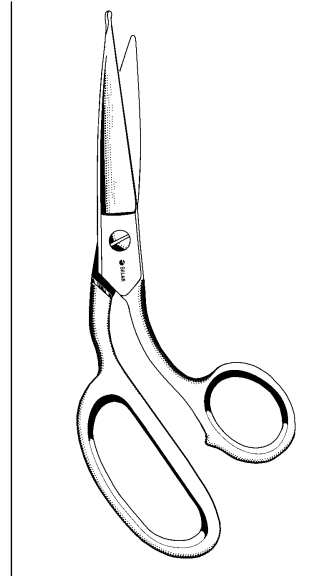
SEUTIN PLASTER SHEARS

Heavy Plier Handle
11-1490 9" Serrated



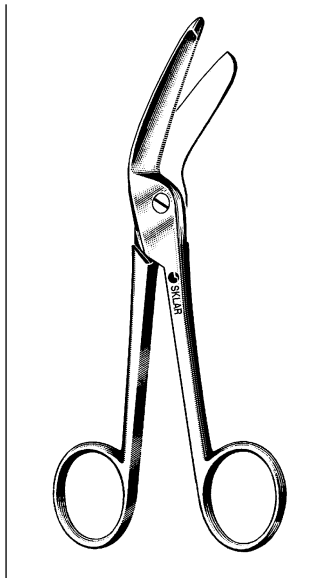
BRUNS PLASTER SHEARS

Serrated
11-1295 9 1/4"



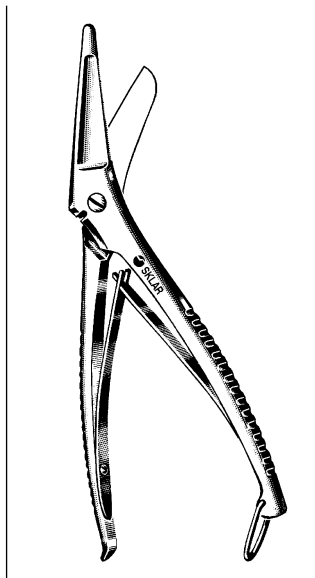
HEAVY DUTY EMERGENCY SHEARS

11-1300 9"



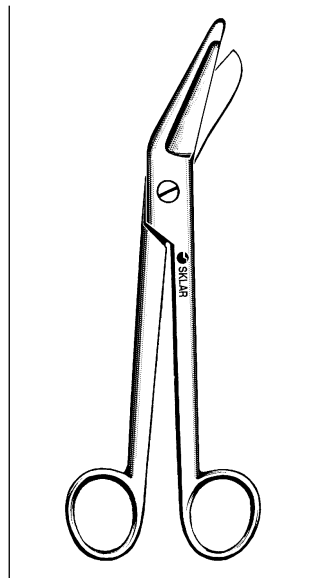
HERCULES UTILITY SCISSORS

11-1297 7 1/2" Serrated



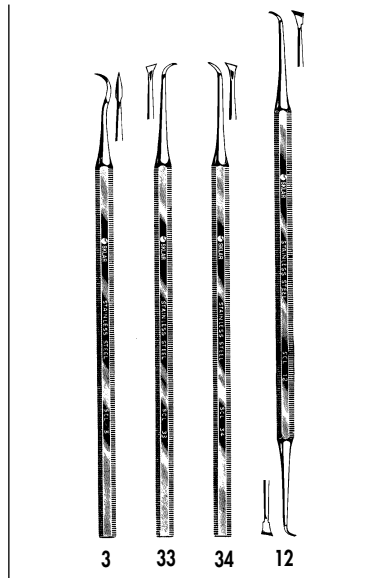
COMMANDER UTILITY SHEARS

Heavy Duty with Wire Cutting Notch
11-1298 8 1/2" Serrated



ESMARCH PLASTER SHEARS

Heavy Pattern
11-1380 8"
11-1390 9"



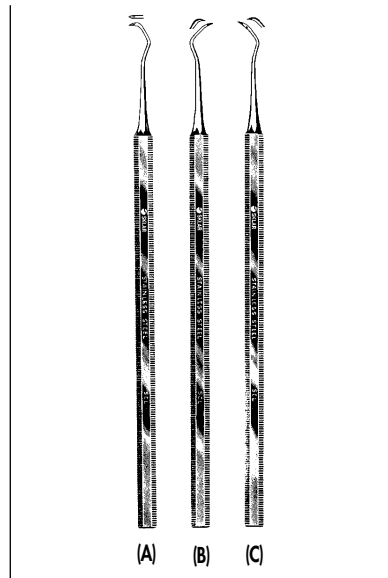
UNIVERSAL SCALER

Single End

41-604 No. 3
41-612 No. 33
41-626 No. 34

Double End

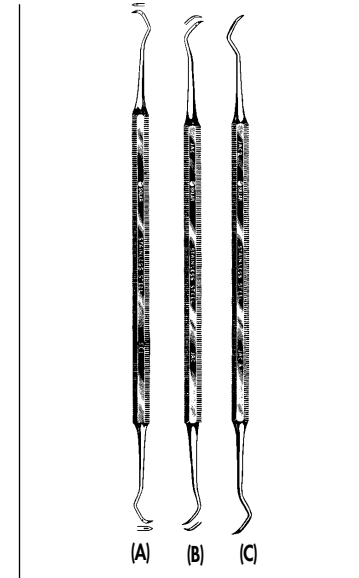
41-638 No. 12



JAQUETTE SCALER

Single End

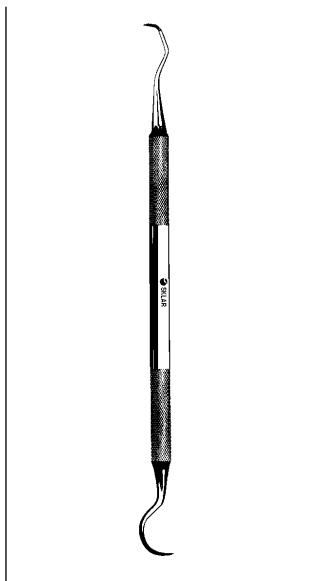
41-652 No. 1S (A)
41-654 No. 2S (B)
41-658 No. 3S (C)



JAQUETTE SCALER

Double End

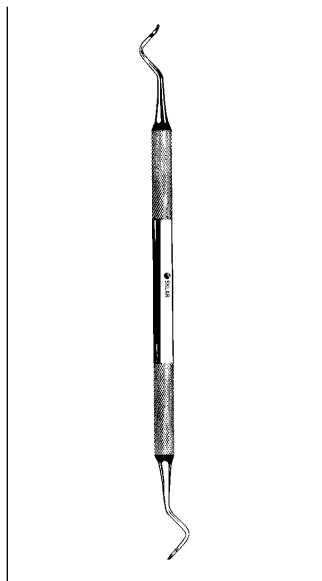
41-662 No. 1S & 1S Delicate (A)
41-666 No. 2S & 3S Delicate (B)
41-674 No. 2 & 3 Regular (C)



TOWNER SCALER

Double End

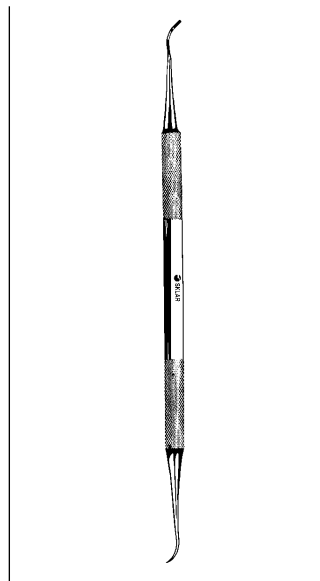
41-709 Nos. U15 & 30



TAYLOR SCALER

Double End

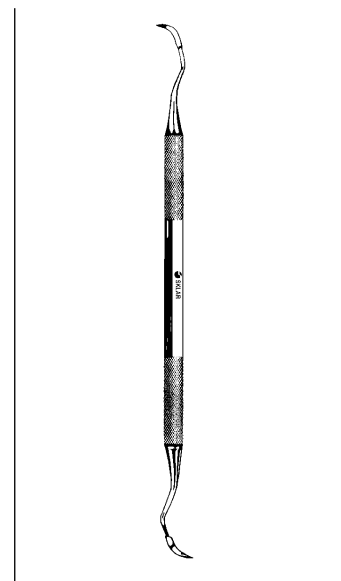
41-721 Nos. 2 & 3



YOUNGER-GOOD SCALER

Double End

41-733 Nos. 7 & 8

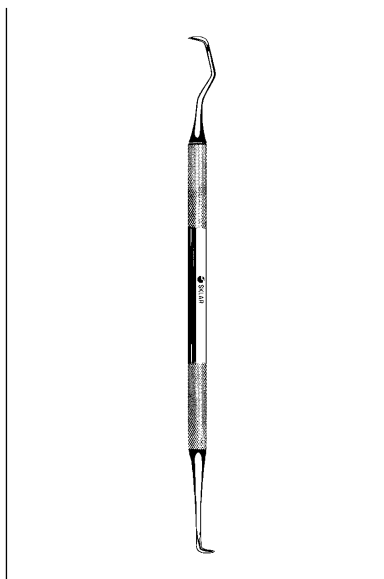


CRANE-KAPLAN SCALER

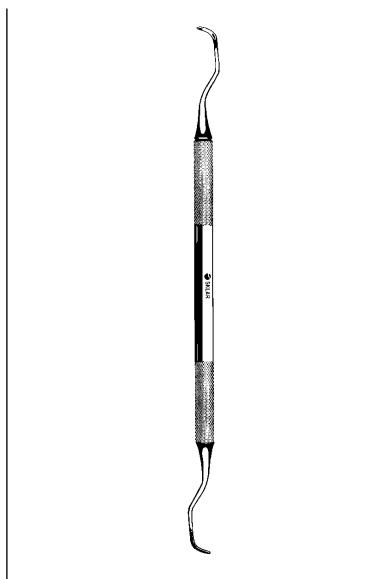
Double End

41-792 No. 6

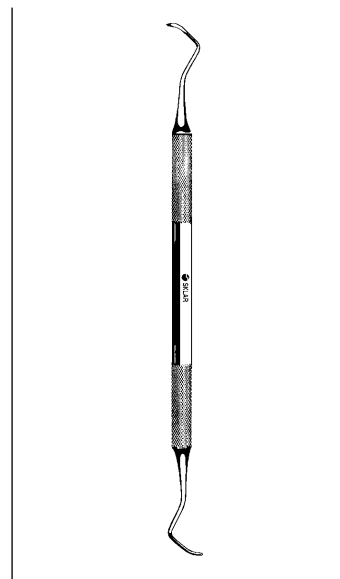
OR GRADE DENTAL INSTRUMENTS SCALERS/CURETTES



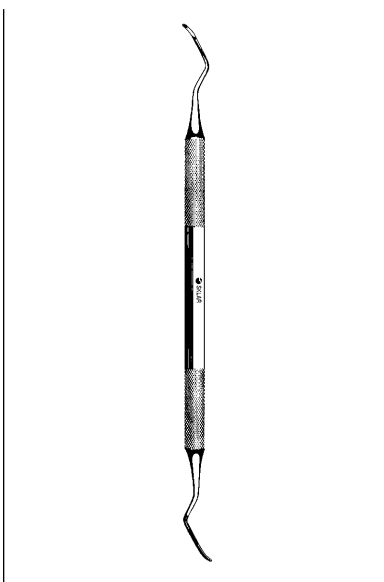
GOLDMAN-FOX
Double End
41-757 No. 1 Scaler



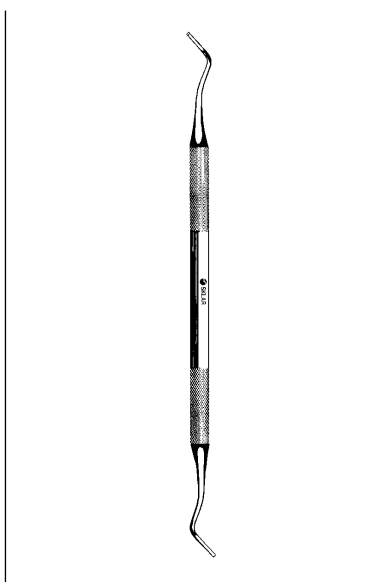
GOLDMAN-FOX
Double End
41-761 No. 2 Scaler



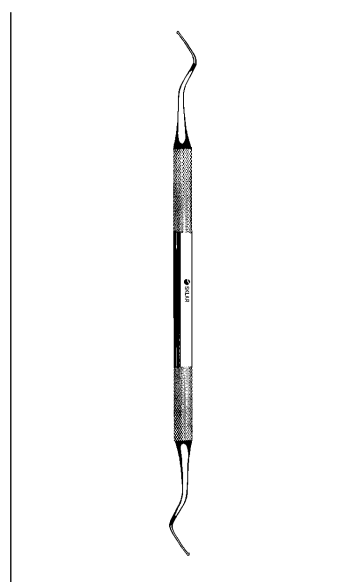
GOLDMAN-FOX
Double End
41-765 No. 3 Scaler



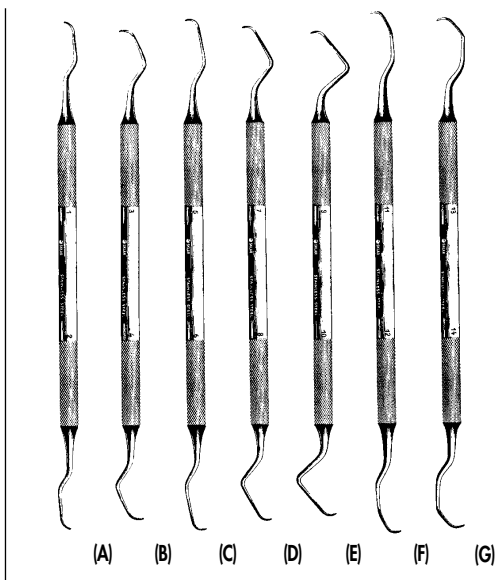
GOLDMAN-FOX
Double End
41-769 No. 4 Scaler



GOLDMAN-FOX
Double End
41-773 No. 5 Scaler



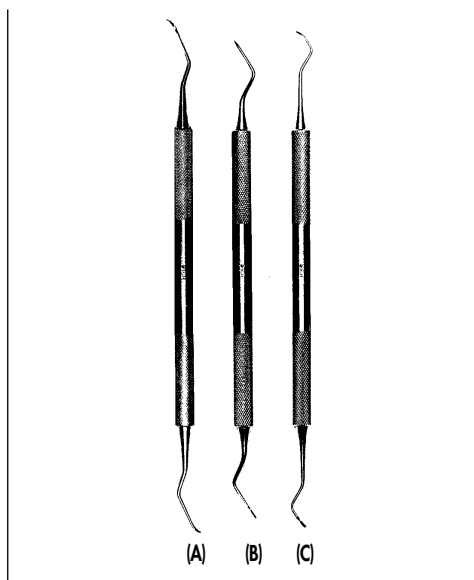
GOLDMAN-FOX
Double End
41-777 No. 6 Scaler



GRACEY FINISHING CURETTES

Double End

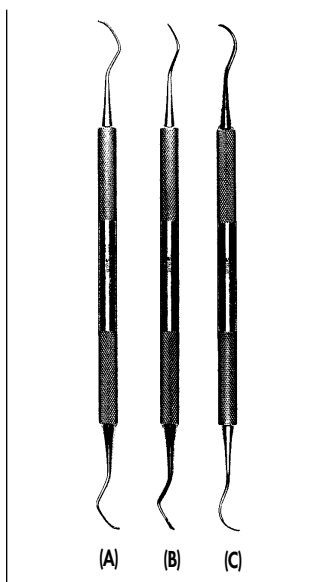
41-800	Nos. 1 & 2 (A)	41-824	Nos. 9 & 10 (E)
41-808	Nos. 3 & 4 (B)	41-828	Nos. 11 & 12 (F)
41-812	Nos. 5 & 6 (C)	41-832	Nos. 13 & 14 (G)
41-820	Nos. 7 & 8 (D)		



COLUMBIA FINISHING CURETTES

Double End

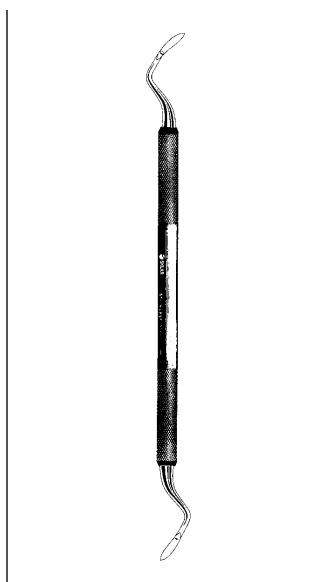
41-848	Nos. 2L & 2R (A)
41-852	Nos. 4L & 4R (B)
41-856	Nos. 13 & 14 (C)



MCCALLS FINISHING CURETTES

Double End

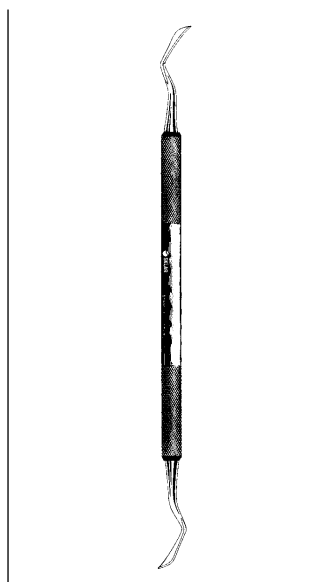
41-864	Nos. 13 & 14 (A)
41-870	Nos. 13S & 14S (B)
41-878	Nos. 17S & 18S (C)



ORBAN GINGIVECTOMY KNIFE

Double End

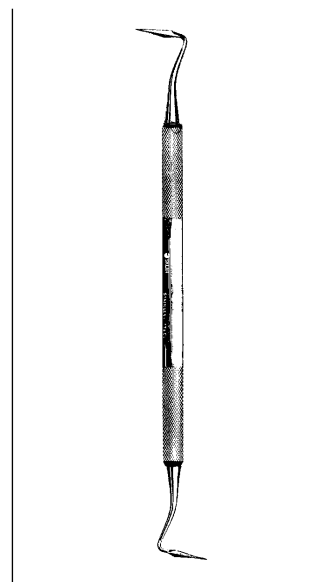
41-932	Nos. 1 & 2
--------	------------



KIRKLAND GINGIVECTOMY KNIFE

Double End

41-938	Nos. 15 & 16
--------	--------------

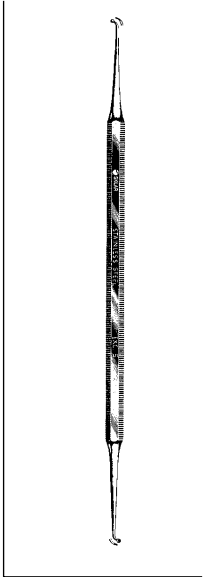


BUCK GINGIVECTOMY KNIFE

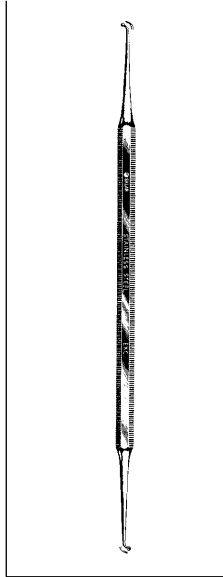
Double End

41-944	Nos. 5 & 6
--------	------------

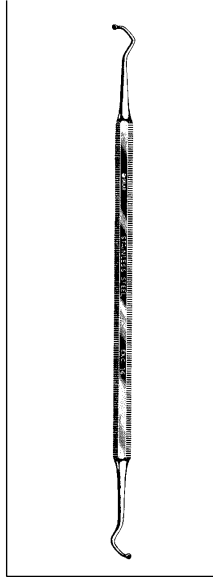
**OR GRADE
DENTAL INSTRUMENTS
EXCAVATORS/PROBES**



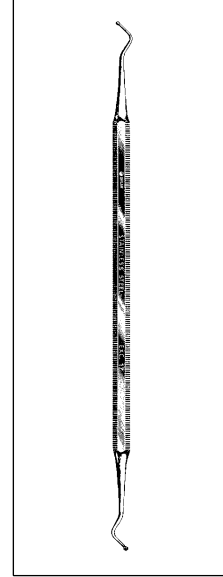
EXCAVATOR
Double End
42-103 No. 5



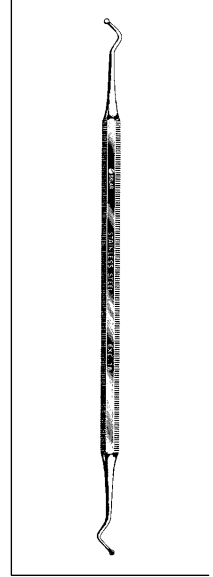
EXCAVATOR
Double End
42-105 No. 6



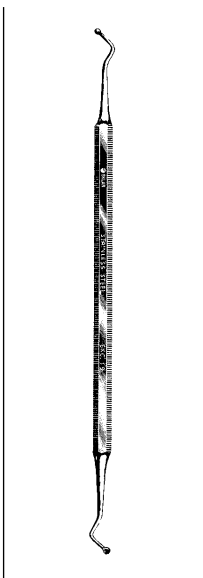
EXCAVATOR
Double End
42-121 No. 14



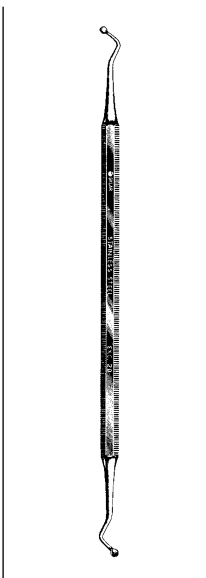
EXCAVATOR
Double End
42-127 No. 17



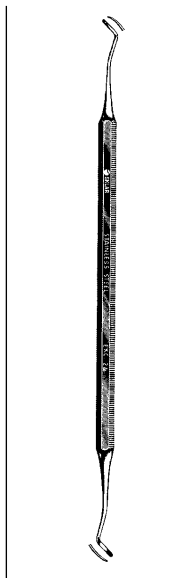
EXCAVATOR
Double End
42-133 No. 18



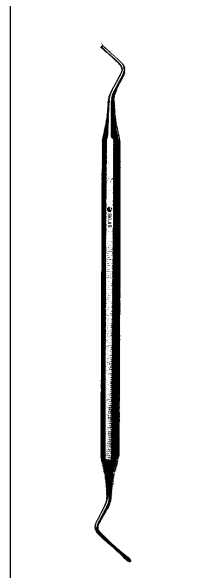
EXCAVATOR
Double End
42-135 No. 19



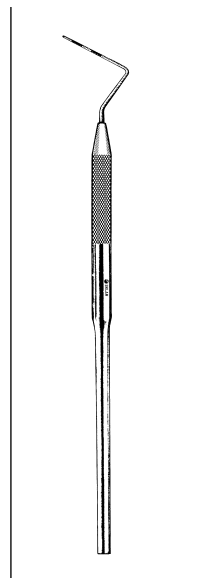
EXCAVATOR
Double End
42-139 No. 20



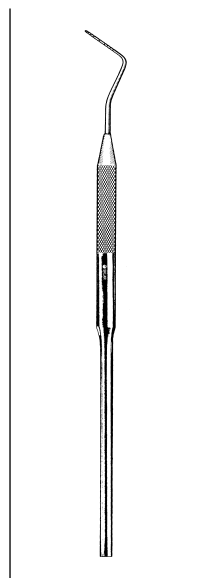
EXCAVATOR
Double End
42-145 No. 24



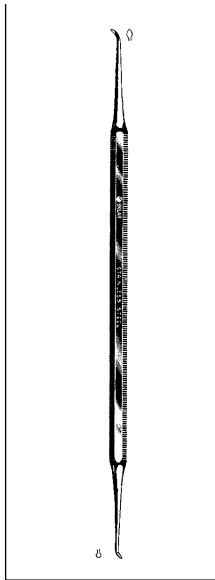
EXCAVATOR
Double End
42-149 No. 31L



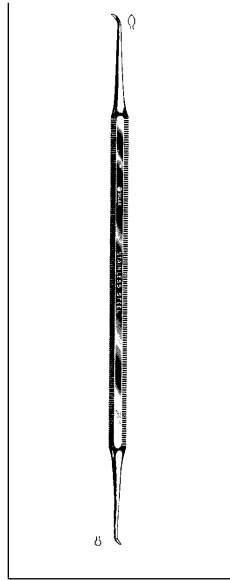
CODED PROBE
Single End
41-994 No. 12



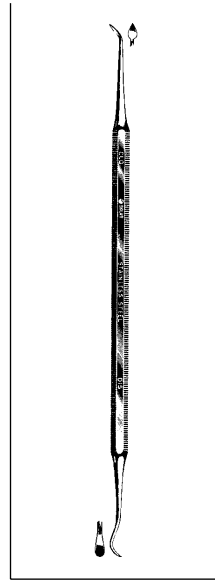
WILLIAMS PROBE
Single End
41-972



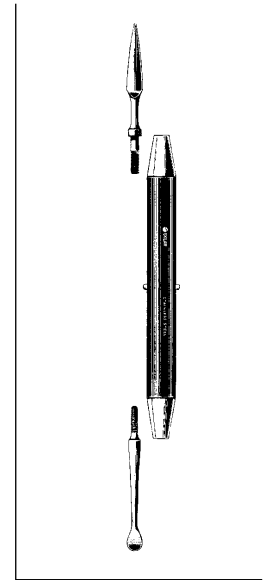
CLEOID DISCOID
Double End
42-154 Nos. 90 & 93



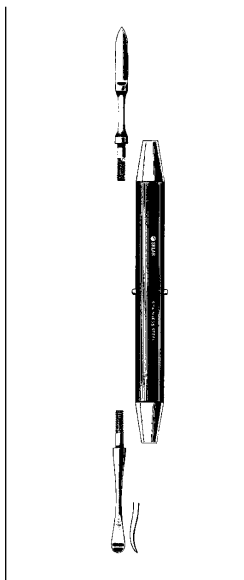
CLEOID DISCOID
Double End
42-157 Nos. 89 & 92



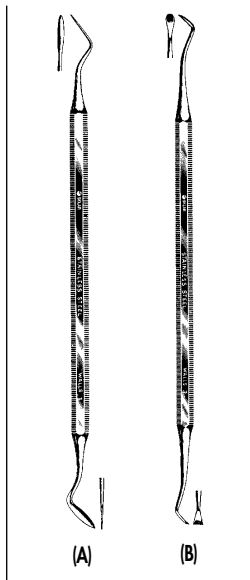
CLEOID DISCOID
Double End
42-163 Large



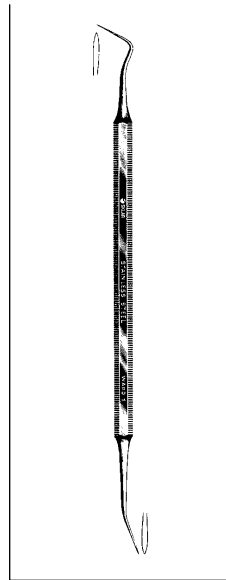
**AKERS WAX KNIFE
AND SPOON**
Double End
42-171 Complete
42-183 Knife Only
42-187 Spoon Only
42-197 Handle Only



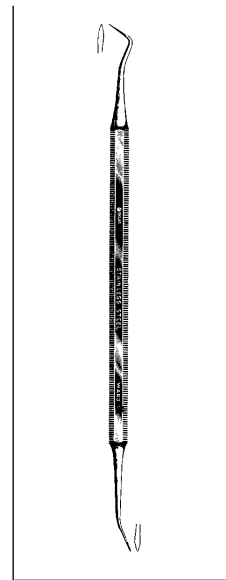
**EVANS WAX KNIFE
AND SPOON**
Double End
42-177 Complete
42-191 Knife Only
42-193 Spoon Only
42-197 Handle Only



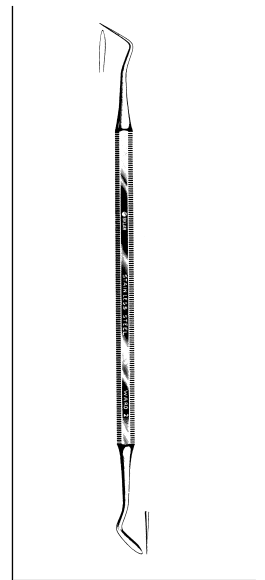
WALLS CARVERS
Double End
42-256 No. 1 (A)
42-266 No. 3 (B)



WARD CARVER
Double End
42-246 No. 1



WARD CARVER
Double End
42-248 No. 15



WARD CARVER
Double End
42-252 No. 2

**OR GRADE
DENTAL INSTRUMENTS
AMALGAM PLUGGERS**



BLACK PLUGGER

Single End
42-301 No. 1



BLACK PLUGGER

Single End
42-307 No. 2



BLACK PLUGGER

Double End, Serrated
42-321 Nos. 0 & 1 (Marquette)



BLACK PLUGGER

Double End, Serrated
42-325 Nos. 1 & 2



BLACK PLUGGER

Double End, Smooth
42-327 Nos. 0 & 1



BLACK PLUGGER

Double End, Smooth
42-328 Nos. 1 & 2



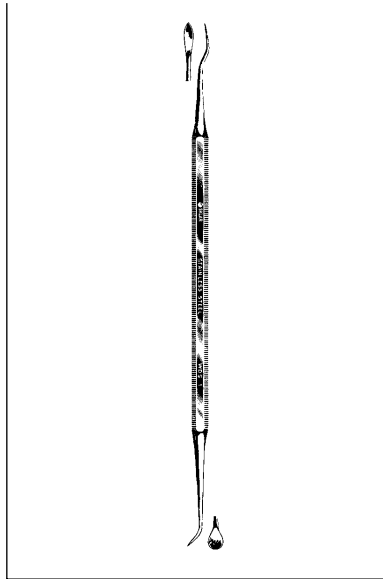
HOLLENBACK CONDENSER

Double End, Smooth
42-329 No. 1

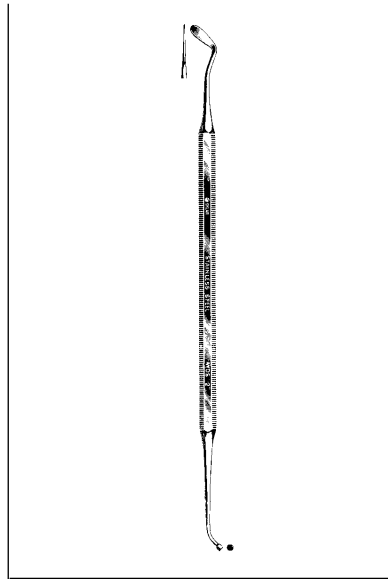


HOLLENBACK CONDENSER

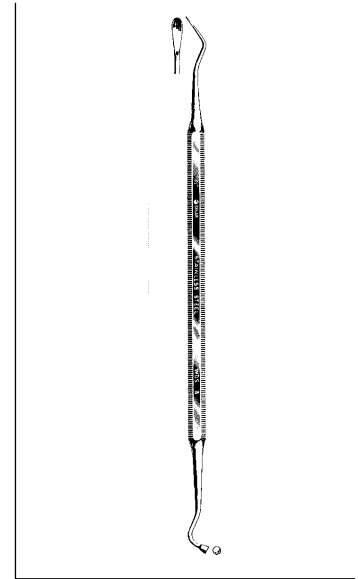
Double End, Smooth
42-330 No. 2



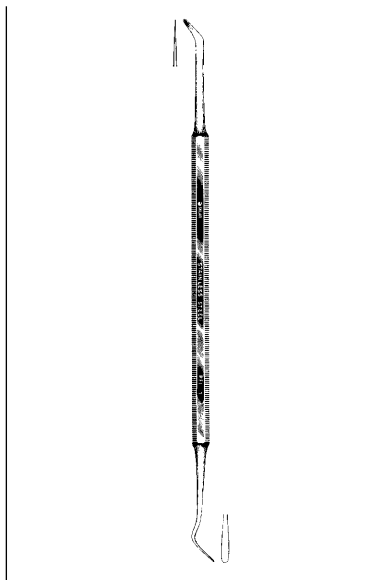
WOODSON
Double End
42-339 No. 1



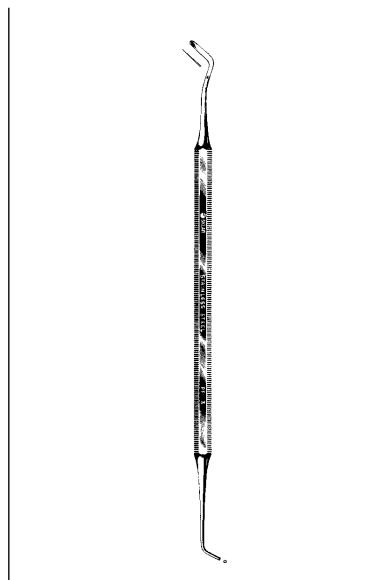
WOODSON
Double End
42-443 No. 2



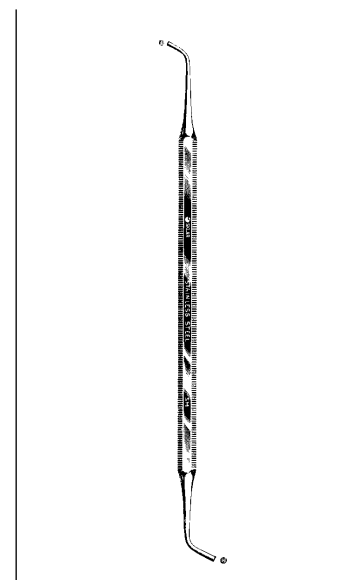
WOODSON
Double End
42-447 No. 3



PLASTIC FILLING INSTRUMENT
Double End
42-455 No. 1

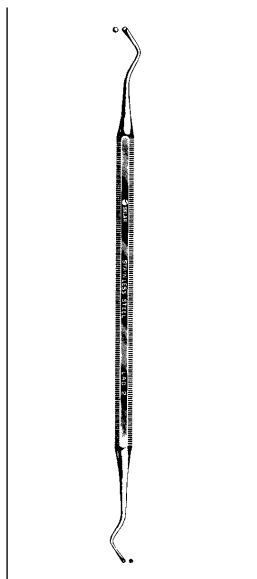


PLASTIC FILLING INSTRUMENT
Double End
42-461 No. 3

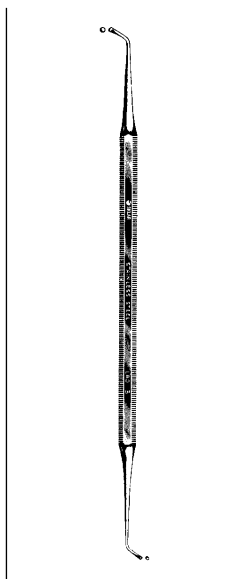


SMITH SPECIAL
Double End
42-465

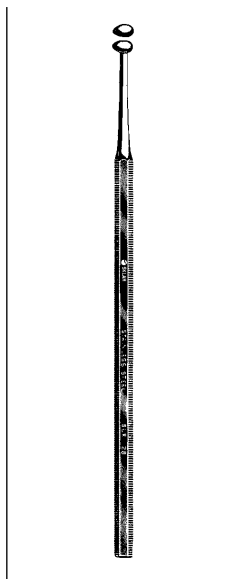
OR GRADE DENTAL INSTRUMENTS BURNISHERS



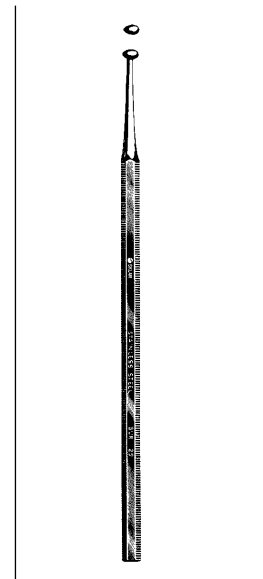
LADMORE
Double End
42-331 No. 2



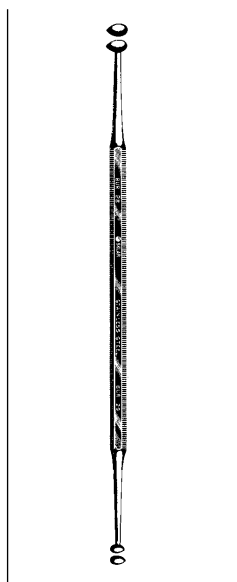
LADMORE
Double End
42-335 No. 3



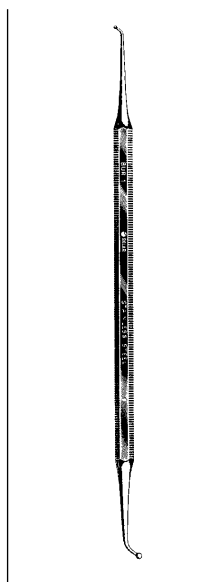
BURNISHER
Single End
42-473 No. 28



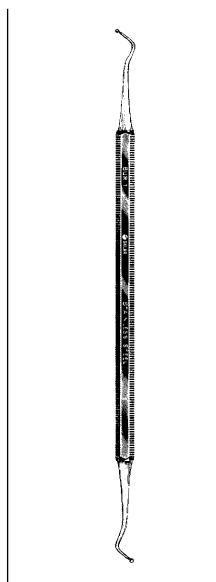
BURNISHER
Single End
42-475 No. 29



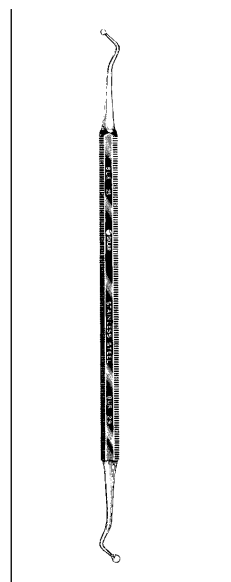
BURNISHER
Double End
42-479 No. 28 & 29



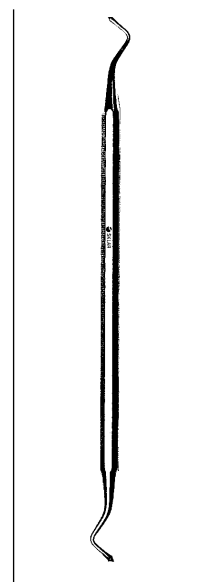
BALL
Double End
42-483 No. 1



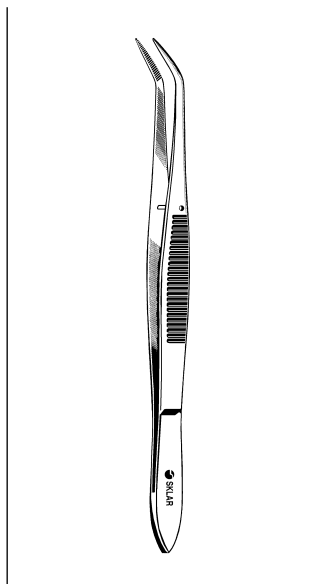
**UNIVERSITY OF
MICHIGAN**
Double End
42-489 No. 1



**UNIVERSITY OF
MICHIGAN**
Double End
42-493 No. 2

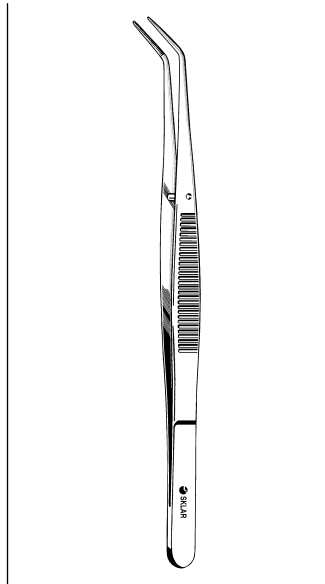


ACORN
Double End
42-497



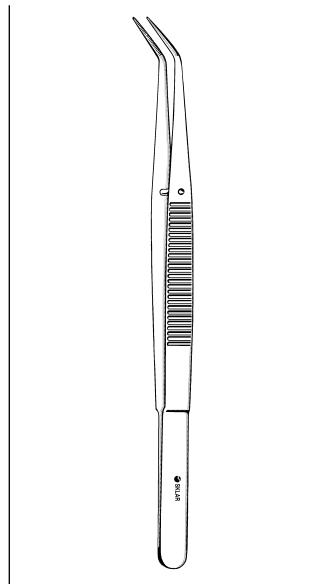
PERRY PLIERS

No. 312
Serrated Tips
41-315 Sklar
48-315 Mid-Grade



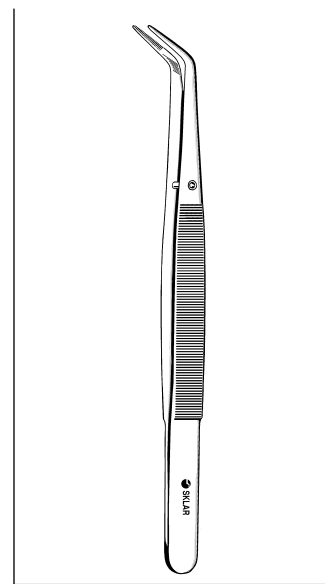
COLLEGE PLIERS

No. 317A
Extra Fine Serrated Tips
41-318 Sklar
48-318 Mid-Grade



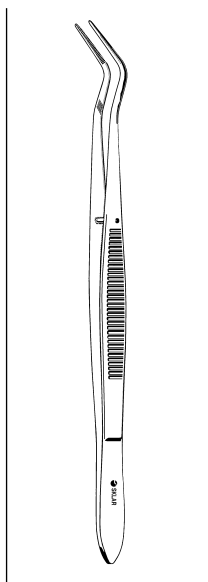
NON-PINCH COLLEGE PLIERS

Serrated Tips
41-330 Sklar
48-330 Mid-Grade



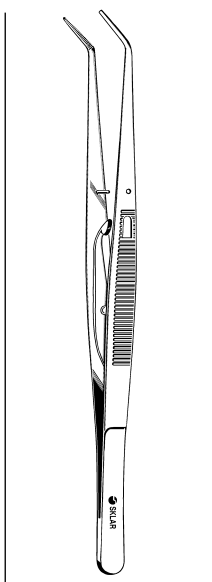
NON-PINCH COLLEGE PLIERS

No. 49, Serrated Tips
41-350 Sklar
48-350 Mid-Grade



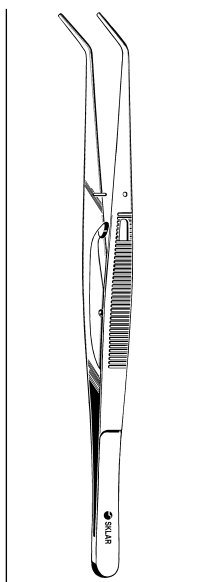
MERIAM PLIERS

No. 318
Serrated Tips
41-368 Sklar
48-368 Mid-Grade



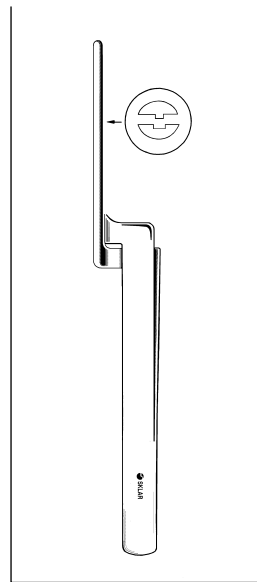
SELF-LOCKING COLLEGE PLIERS

Serrated Tips
41-372 Sklar
48-128 Mid-Grade



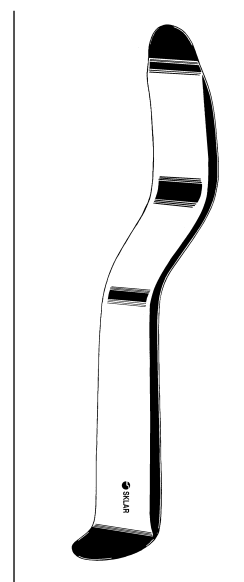
SELF-LOCKING COLLEGE PLIERS

Grooved Tips
41-378 Sklar
48-378 Mid-Grade



MILLER GROOVELOK

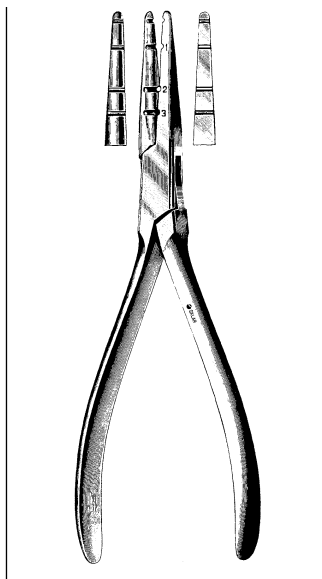
Grooved Tips For
Silver Point Holding
41-388 Sklar
48-388 Mid-Grade



CHEEK RETRACTOR

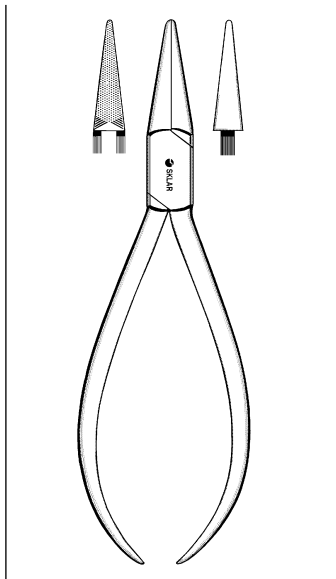
University of Minnesota
44-489 Sklar
48-489 Mid-Grade

OR GRADE & MID-GRADE DENTAL INSTRUMENTS/PLIERS



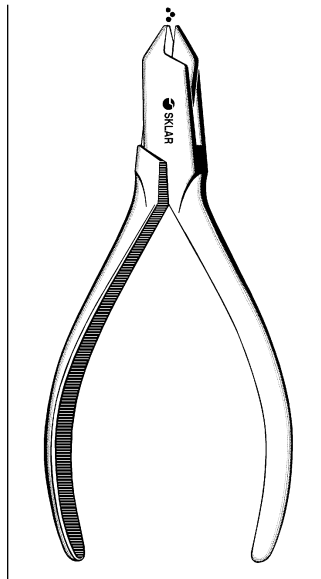
WIRE BENDING PLIER

No. 101
45-796



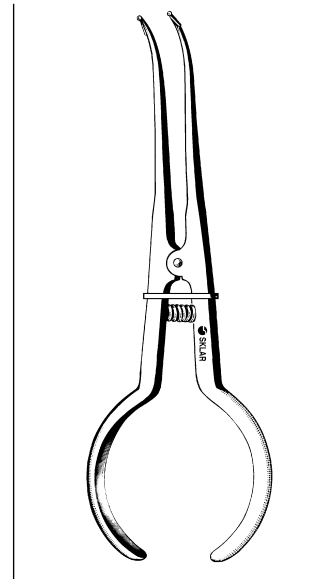
GOSLEE CONTOURING PLIER

No. 136
One Beak Smooth, One Beak Serrated
45-507 Sklar
48-507 Mid-Grade



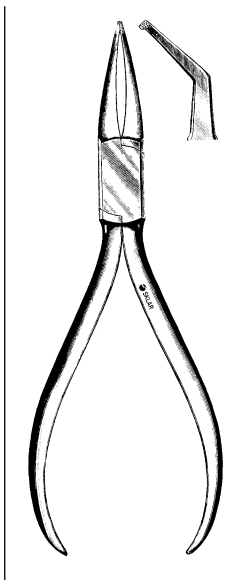
CLASP ADJUSTING PLIER

No. 200
45-738 Sklar
48-738 Mid-Grade



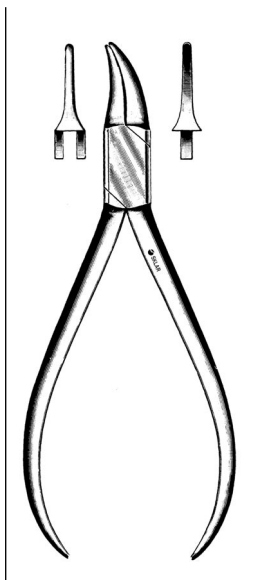
RUBBER DAM FORCEPS

University of Washington
45-236 Sklar
48-236 Mid-Grade



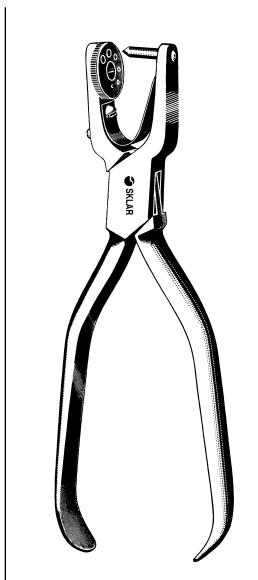
HOW PLIER

No. 111
Curved, Serrated Tips
46-356



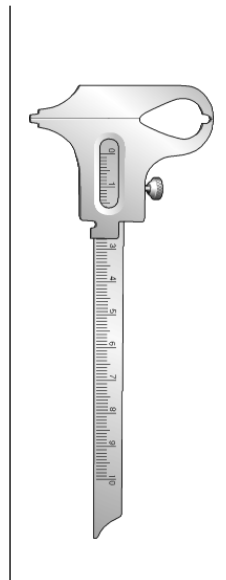
GORDON PLIER

No. 137C
Chrome Plated
45-545



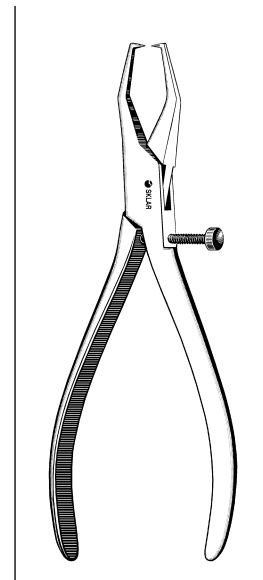
RUBBER DAM PUNCH

W-Type
45-266 Sklar
48-266 Mid-Grade



BOLEY GAUGE

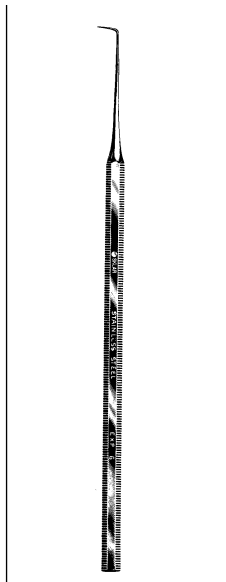
45-202 Sklar
48-202 Mid-Grade



BAADE CROWN PLIER

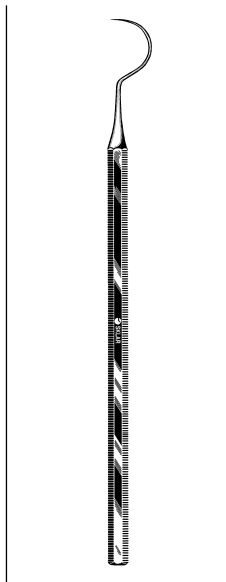
No. 255
45-835 Sklar
48-835 Mid-Grade

OR GRADE & MID-GRADE DENTAL INSTRUMENTS EXPLORERS/PLUGGERS/CARVERS



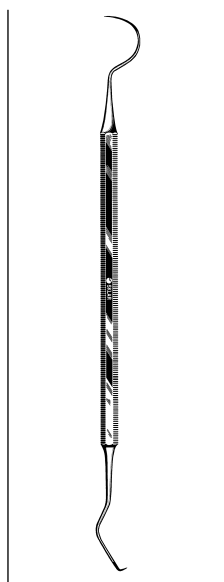
EXPLORER

Single End, No. 6
Solid Octagonal Handle
Serrated Grip
41-410 Sklar



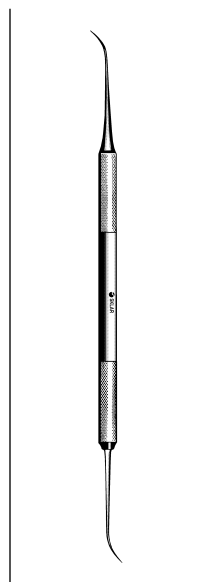
EXPLORER

Single End, No. 23
Solid Octagonal Handle
Serrated Grip
41-434 Sklar
48-434 Mid-Grade



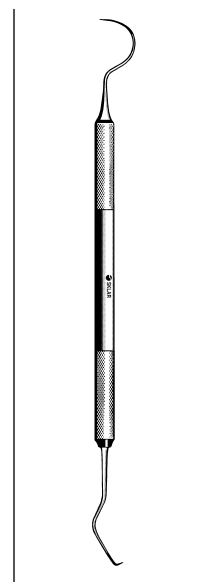
EXPLORER

Double End, No. 5
Solid Octagonal Handle
Serrated Grip
41-472 Sklar
48-472 Mid-Grade



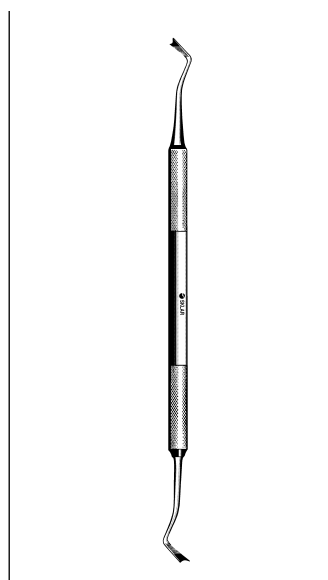
NEVER BREAK EXPLORER

Double End, No. 3
Solid Round Handle
Knurled Grip
41-561 Sklar
48-561 Mid-Grade



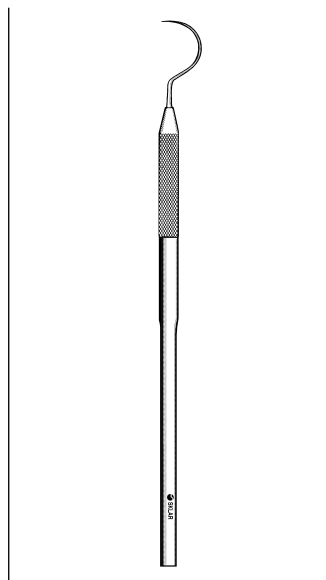
NEVER BREAK EXPLORER

Double End, No. 5
Solid Round Handle
Knurled Grip
41-573 Sklar
48-130 Mid-Grade



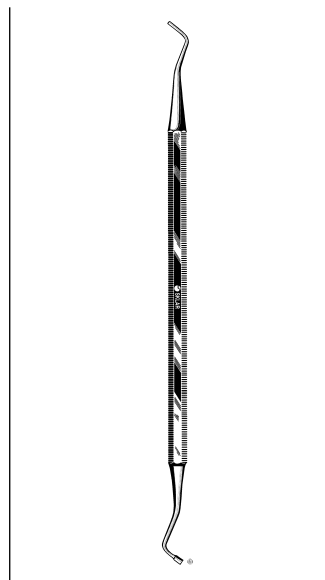
GOLDMAN-FOX KNIFE

Gingivectomy, No. 10
41-922 Sklar
48-922 Mid-Grade



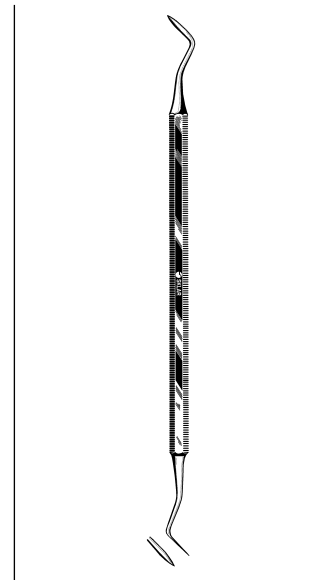
NEVER BREAK EXPLORER

Single End, No. 23
Solid Round Handle
Knurled Grip
41-535 Sklar
48-535 Mid-Grade



MARQUETTE BLACK PLUGGER

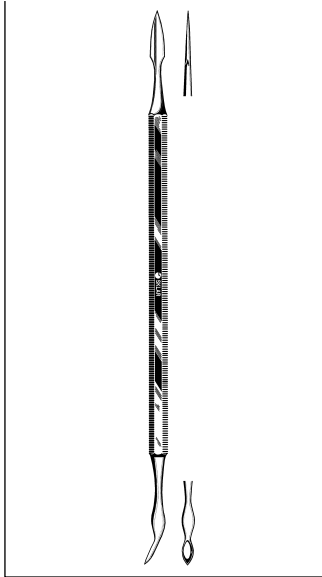
Double End, No. 0 & 1
42-321 Sklar
42-325 Sklar No. 1 & 2
48-321 Mid-Grade



HOLLENBACK CARVER

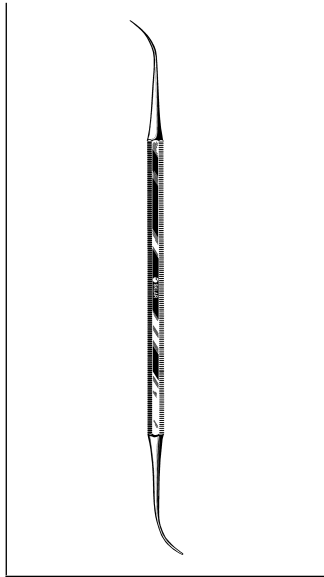
Double End, Wax - No. 3
42-228 Sklar
48-228 Mid-Grade

OR GRADE & MID-GRADE DENTAL INSTRUMENTS/CARVERS



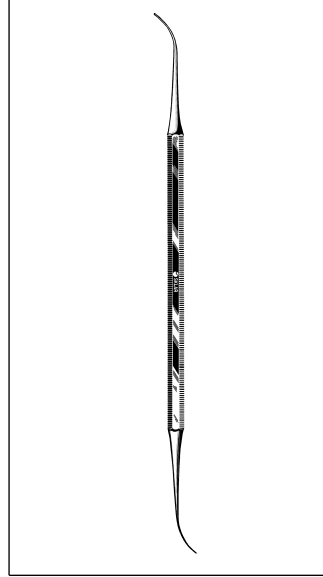
ROACH CARVER

Double End, Porcelain & Wax
42-273 Sklar
48-428 Mid-Grade



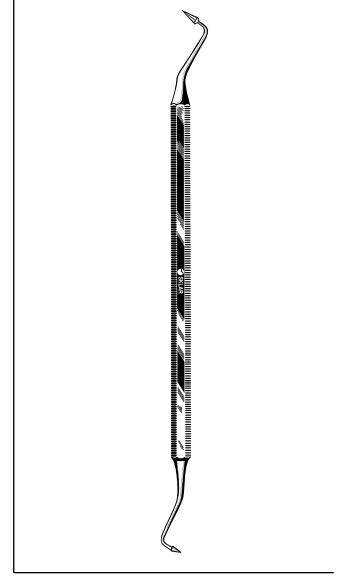
PK THOMAS WAX PLACER

Double End, No. 1
42-274 Sklar
48-274 Mid-Grade



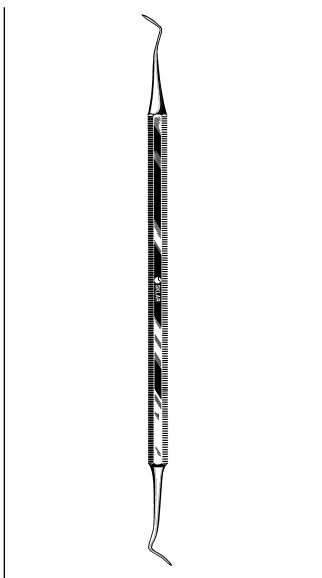
PK THOMAS WAX PLACER

Double End, No. 2
42-278 Sklar
48-278 Mid-Grade



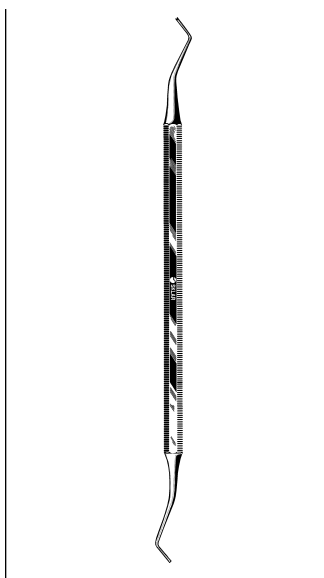
PK THOMAS WAX PLACER

Double End, No. 3
42-282 Sklar
48-282 Mid-Grade



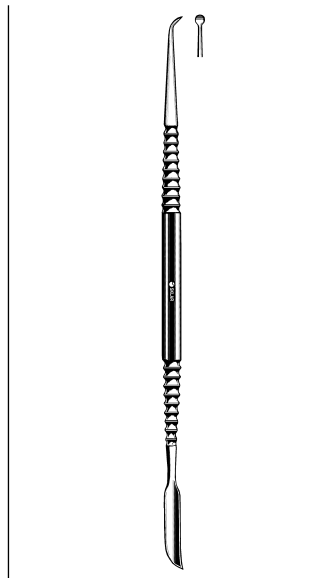
PK THOMAS WAX PLACER

Double End, No. 4
42-288 Sklar
48-288 Mid-Grade



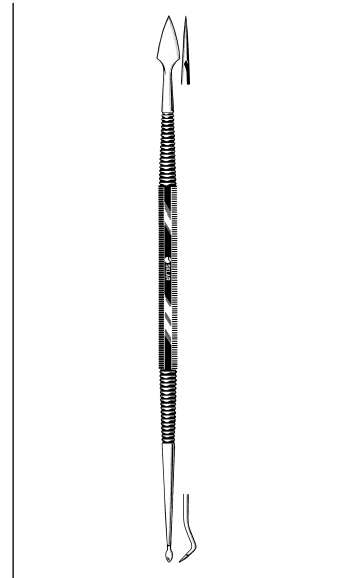
PK THOMAS WAX PLACER

Double End, No. 5
42-296 Sklar
48-296 Mid-Grade



LE CRON CARVER

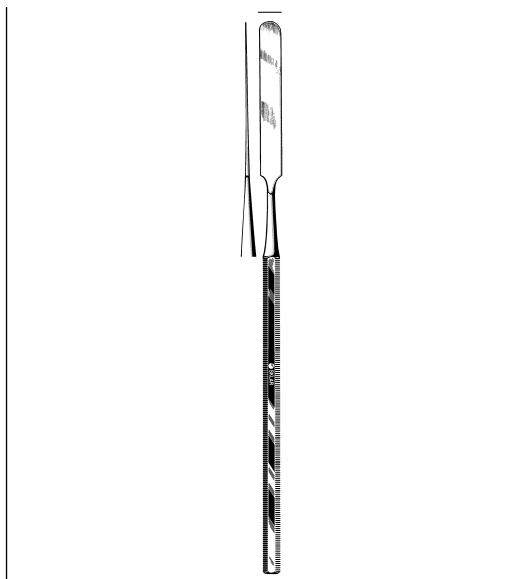
Double End, Porcelain & Wax
42-270 Sklar
48-422 Mid-Grade



VEHE CARVER

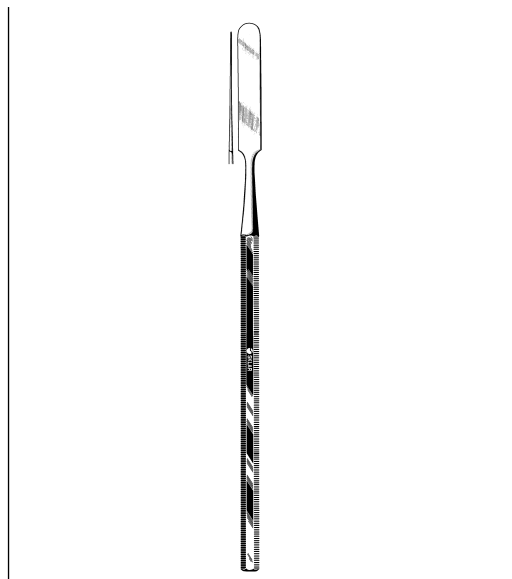
Double End, Porcelain & Wax
42-271 Sklar
48-424 Mid-Grade

OR GRADE & MID-GRADE DENTAL INSTRUMENTS CEMENT/WAX SPATULAS



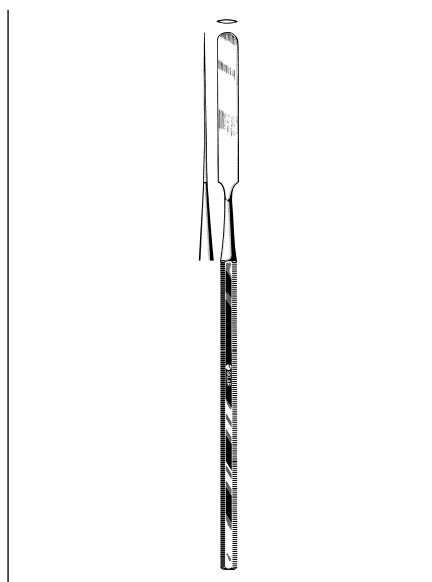
CEMENT SPATULA

No. 24
42-532 Sklar
48-526 Mid-Grade



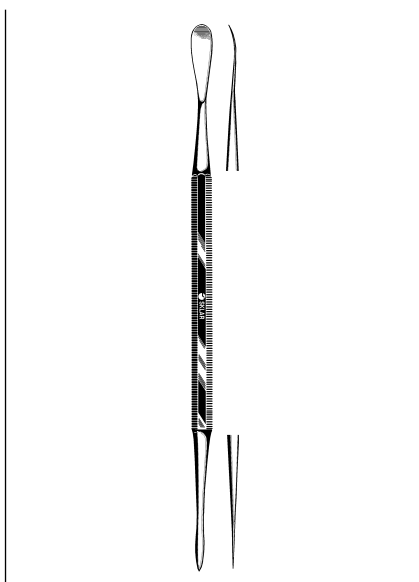
CEMENT SPATULA

No. 24A
42-524 Sklar
48-524 Mid-Grade



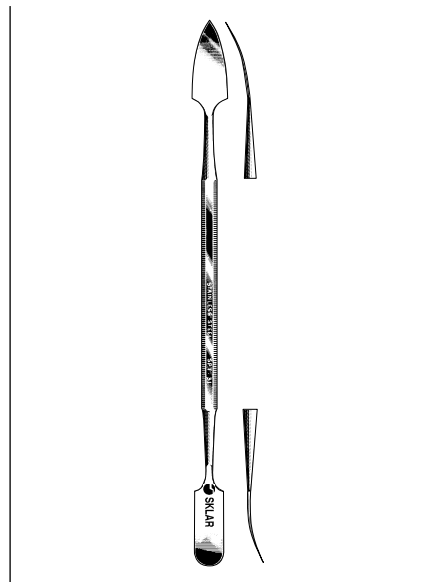
CEMENT SPATULA

No. 324
42-538 Sklar
48-538 Mid-Grade



WAX SPATULA

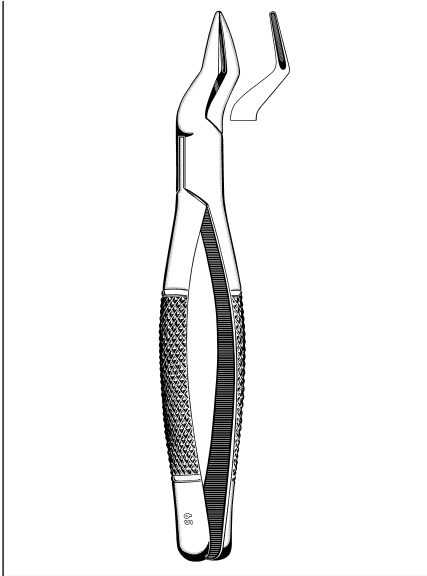
Double End, No. 7
42-552 Sklar
48-542 Mid-Grade



GRITMAN WAX SPATULA

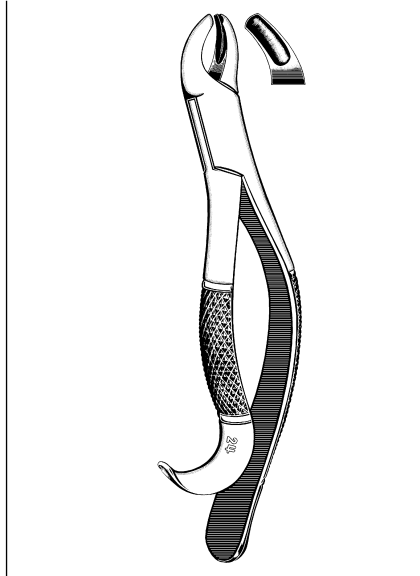
No. 31
42-572 Sklar
48-572 Mid-Grade

MID-GRADE DENTAL INSTRUMENTS EXTRACTING FORCEPS



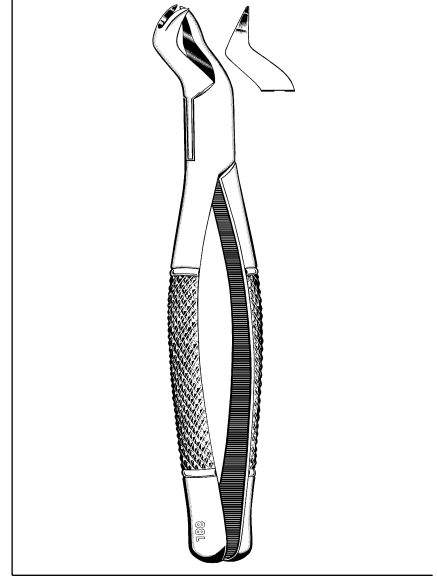
EXTRACTING FORCEPS

No. 65 - Bayonet
Upper Bicuspid, Incisor Root
48-204 Mid-Grade



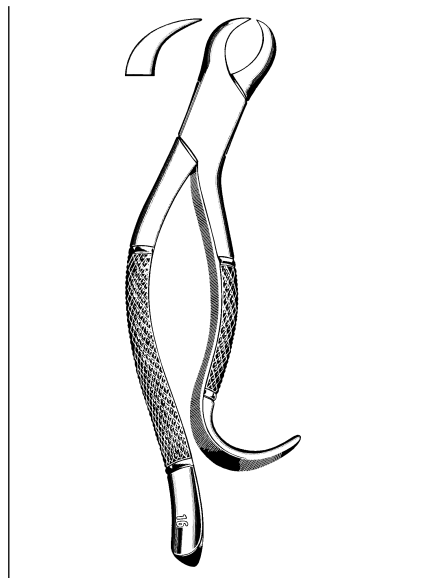
EXTRACTING FORCEPS

No. 24
Upper Molar, Universal
48-226 Mid-Grade



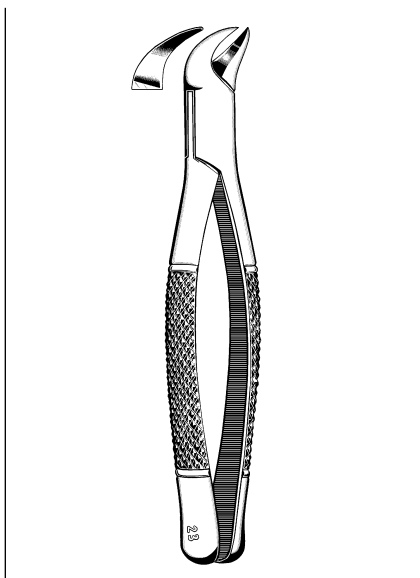
EXTRACTING FORCEPS

No. 88L - Left
Upper First and Second Molar
48-252 Mid-Grade



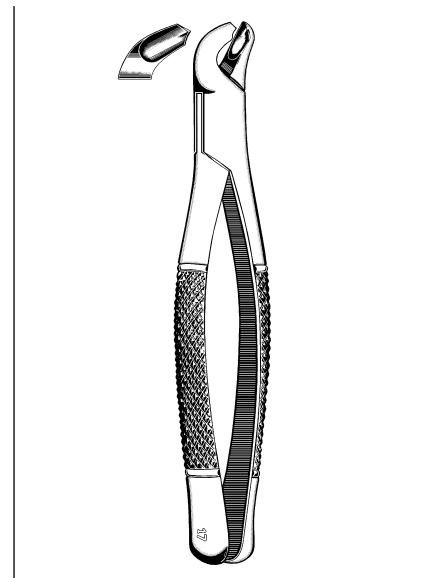
EXTRACTING FORCEPS

No. 16
Lower First and Second Molar
Universal - Cow Horn Beak, Hook Handle
48-264 Mid-Grade



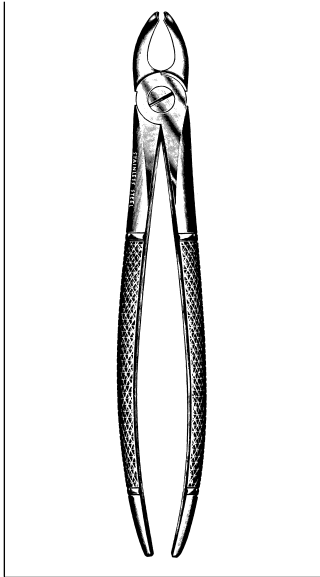
EXTRACTING FORCEPS

No. 23
Lower First and Second Molar
Universal - Cow Horn Beak, Str. Handle
48-276 Mid-Grade



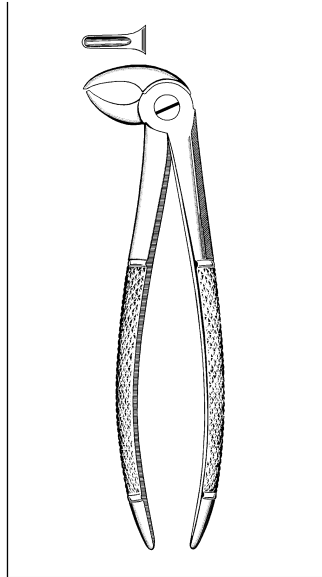
EXTRACTING FORCEPS

No. 17
Lower First and Second Molar Universal
48-289 Mid-Grade



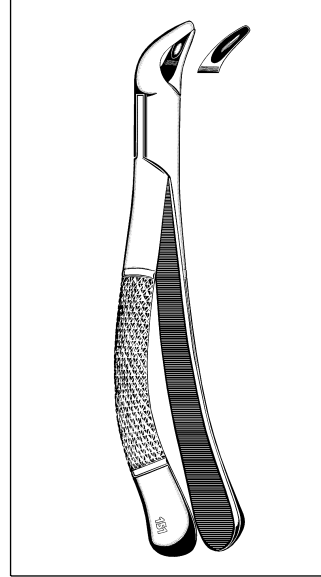
EXTRACTING FORCEPS

No. MD2 - Universal Upper
First, Second, Third Molar
48-105 Mid-Grade



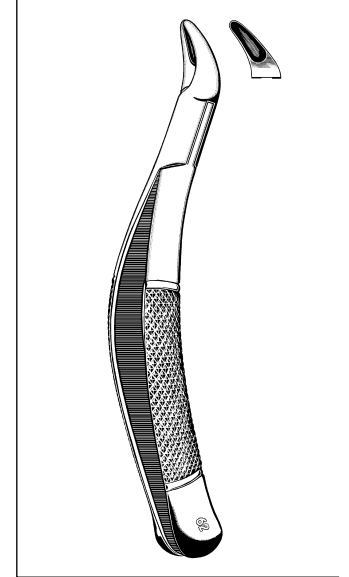
EXTRACTING FORCEPS

Mead - No. MD 3
Lower Universal
Incisor Cuspid, Bicuspid Root
48-109 Mid-Grade



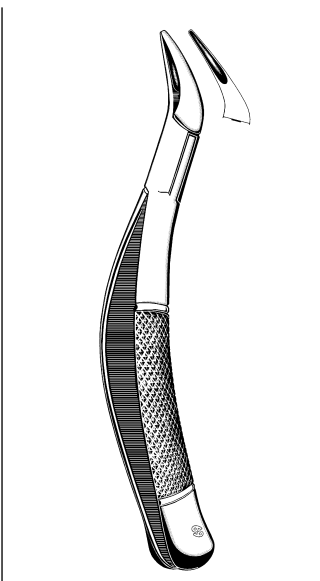
EXTRACTING FORCEPS

No. 151
Lower Universal
Incisor Bicuspid Root
48-327 Mid-Grade



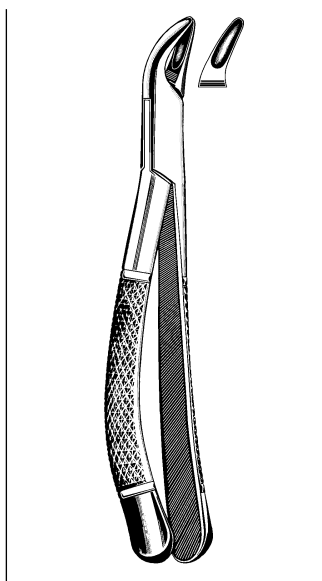
EXTRACTING FORCEPS

No. 62
Upper or Lower Universal
Incisor Bicuspid, Deciduous Cuspids
48-339 Mid-Grade



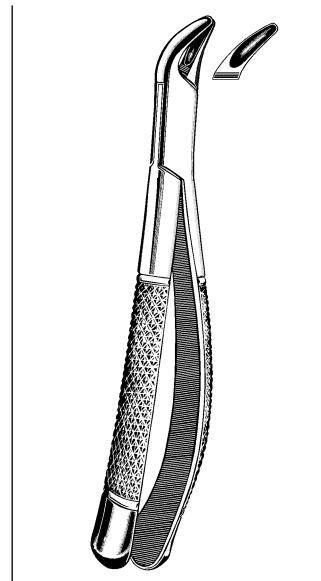
EXTRACTING FORCEPS

No. 69
Upper or Lower Fragment
Small Root
48-351 Mid-Grade



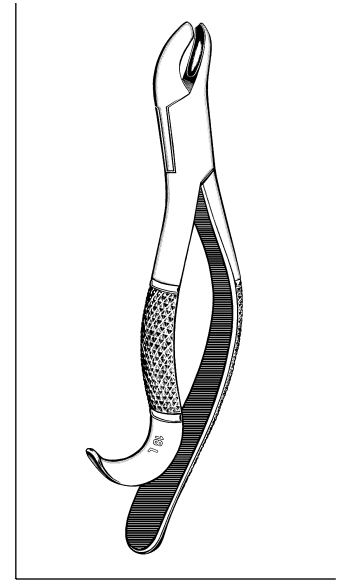
PEDO EXTRACTING FORCEPS

Children's - No. 150 S
Upper Universal
48-363 Mid-Grade



PEDO EXTRACTING FORCEPS

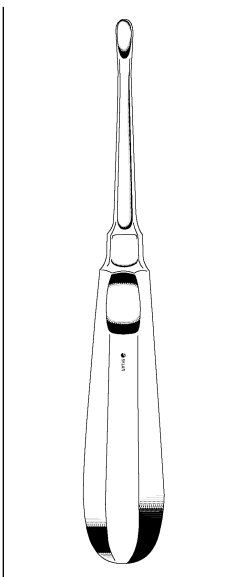
Children's - No. 151 S
Lower Universal
48-375 Mid-Grade



EXTRACTING FORCEPS

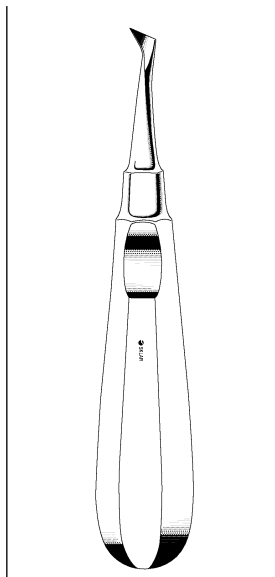
No. 18L - Left
Upper First
Second Molar
48-752 Mid-Grade

OR GRADE & MID-GRADE DENTAL INSTRUMENTS MISCELLANEOUS



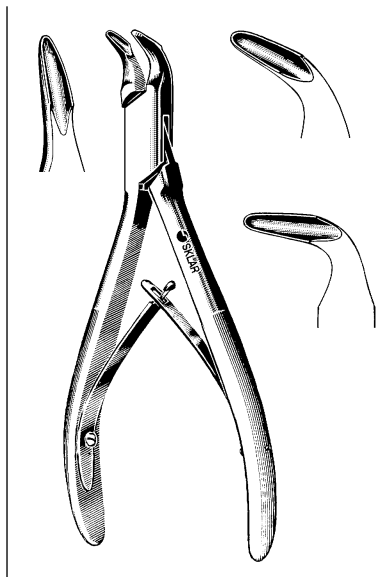
SELDIN ELEVATOR

43-385 Sklar #4R



COGSWELL ELEVATOR

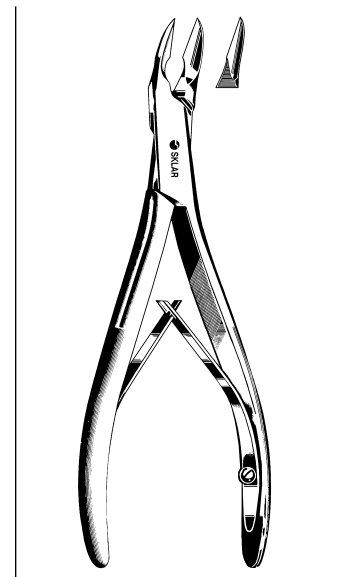
43-412 Sklar #D



BLUMENTHAL RONGEUR

Angular, 6"

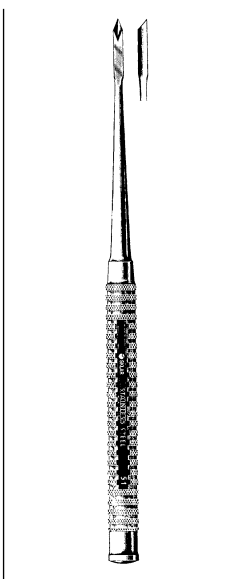
42-621	Sklar	30°
42-625	Sklar	45°
42-629	Sklar	90°



RONGEUR

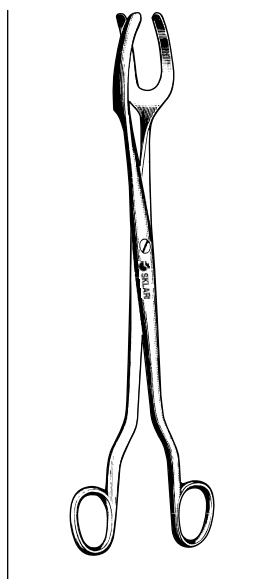
Side Cutting

42-653 #5 S Sklar 5 1/2"



GARDNER CHISEL

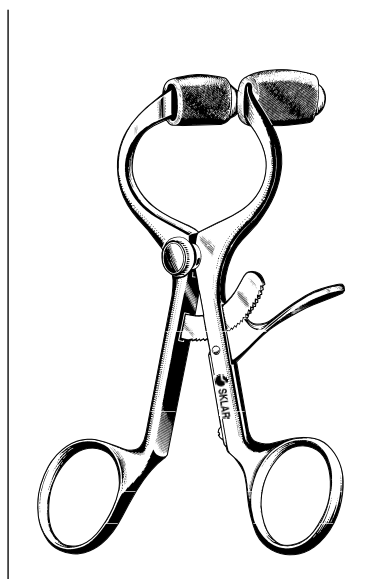
43-622 Sklar #51



STERILIZER FORCEPS

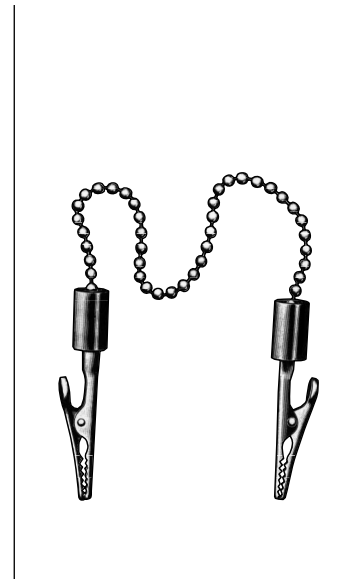
Three Prong, Straight

10-1280	Sklar	8"
48-761	Mid-Grade	8"



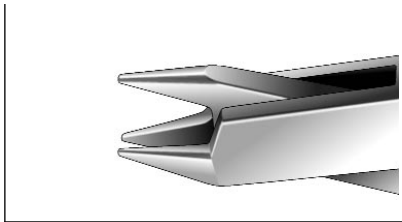
MOLT MOUTH GAG

44-475	Sklar
48-785	Mid-Grade



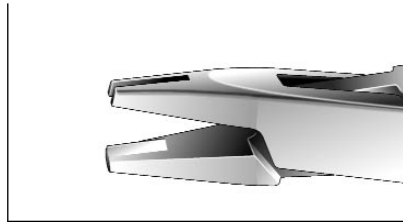
ALLIGATOR CLIPS

44-427	Sklar	Without Sleeve
44-441	Sklar	With Sleeve



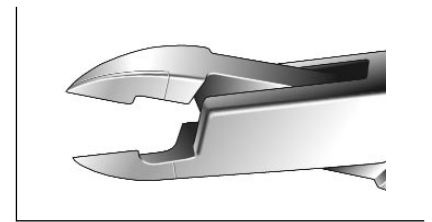
ADJUSTING PLIER

3 Prong With Small Tip
49-8181



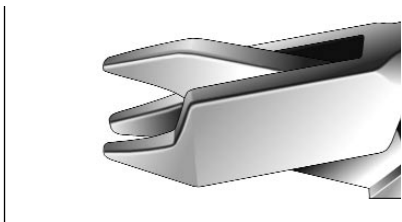
STOP PLIER

3 Prong
49-8180



PIN & LIGATURE CUTTER

Standard, Straight
49-8039



ADJUSTING PLIER

3 Prong
49-8182



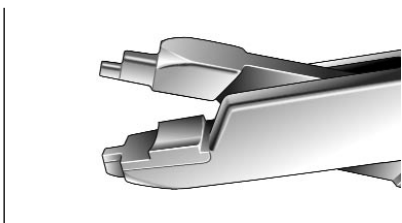
LIGATURE FORMING PLIER

49-8157



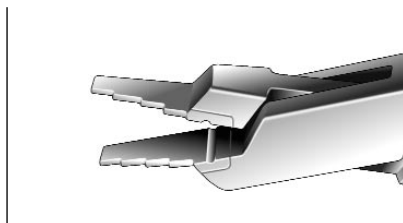
DISTAL END CUTTER

Cut & Hold
49-8026



RETAINER FORMING PLIER

Hawley
49-8150 Small



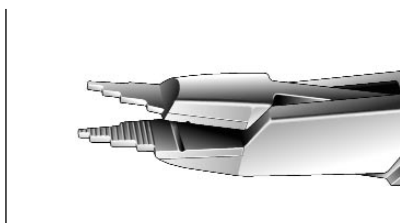
FORMING & CLOSING PLIER

Loop
49-8166



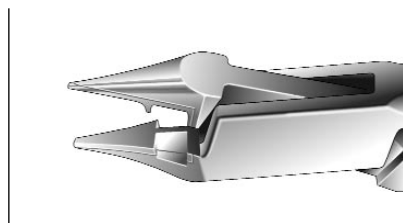
DISTAL END CUTTER

Cut & Hold
49-8027 Flush Cut, Small



LOOP FORMING PLIER

4 Step Jaw
49-8148



WIRE FORMING PLIER

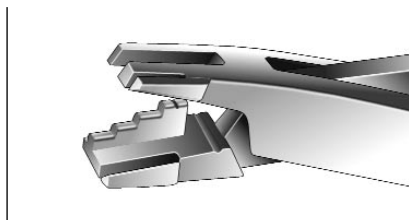
Light Wire with Cutter
49-8163



DISTAL END CUTTER

Non-Holding
49-8032

MID-GRADE DENTAL INSTRUMENTS ORTHODONTIC PLIERS



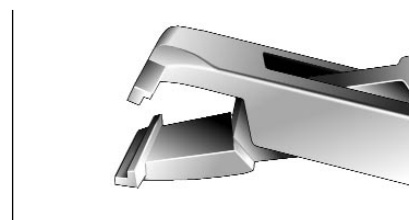
LOOP TIE BACK PLIER

49-8170



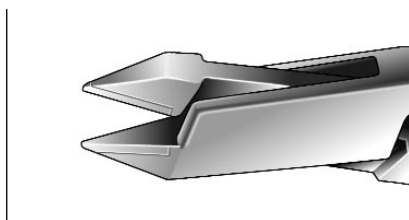
BAYONET BENDING PLIER

49-8138 .5mm
49-8139 .75mm
49-8140 1mm



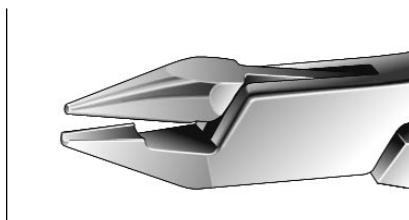
DISTAL END CUTTER

Shear with Safety Hold
49-8033



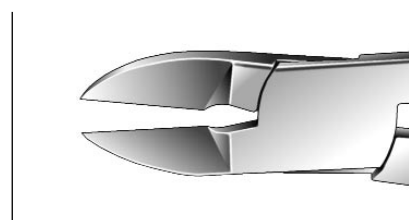
ADAMS PLIER

49-8131



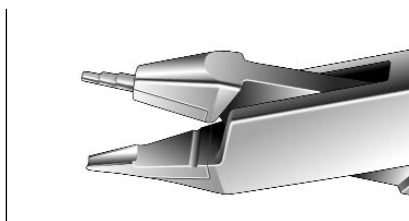
OPTICAL PLIER

49-8174



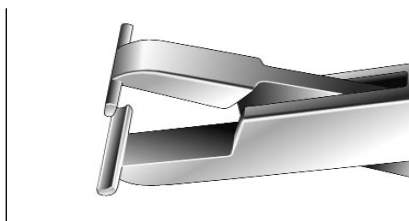
HARD WIRE CUTTER

Straight
49-8034



LOOP FORMING PLIER

Tweed & Helix
49-8183



STEP BENDING PLIER

Intra Oral
49-8179



PIN & FINE WIRE CUTTER

For Ligature Wire Only
49-8045 15°



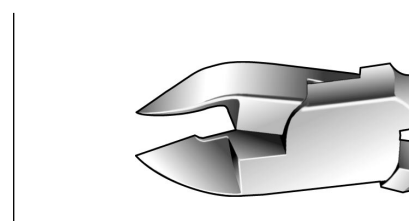
LOOP FORMING PLIER

4 Step Automatic
49-8147



ARCH FORMING PLIER

Large No Grooves
49-8134



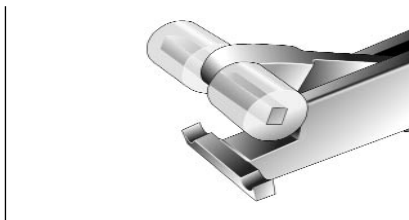
PIN & LIGATURE CUTTER

Small Tip Regular
49-8047



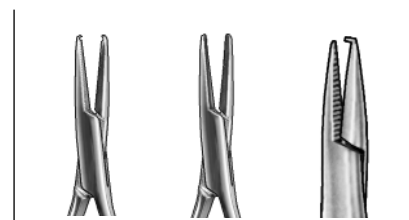
DISTAL END CUTTER

Cut & Hold
49-8028



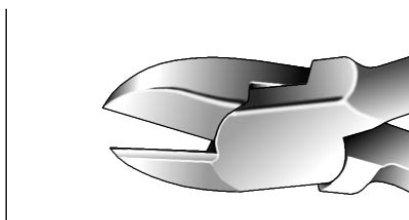
REMOVING PLIER

Bracket & Adhesive
49-8251



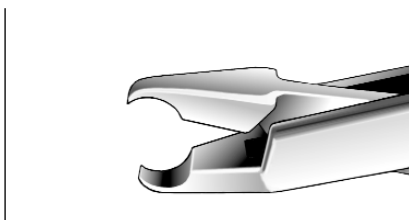
MATHIEU PLIERS

49-8081 Elastics Inserting Plier With Groove Tips
49-8087 Ligating
49-8080 Elastics Inserting Plier With Hook



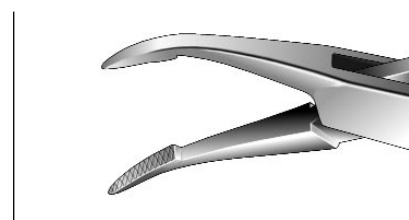
HARD WIRE CUTTER

49-8031



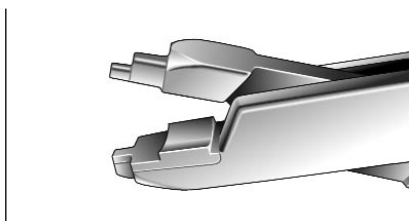
REMOVING PLIER

49-8067



WEINGART UTILITY PLIER

Narrow
49-8438



RETAINER FORMING PLIER

Hawley
49-8150



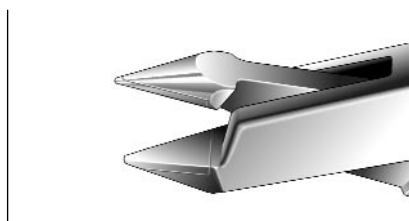
REMOVING PLIER

Bracket & Adhesive
49-8065



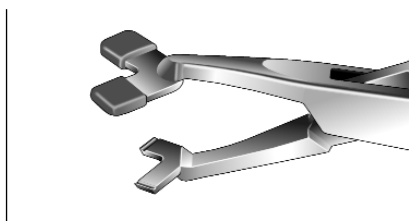
HOW-STYLE 110 PLIER

49-8359 Angled
49-8358 Straight, Carbide Insert



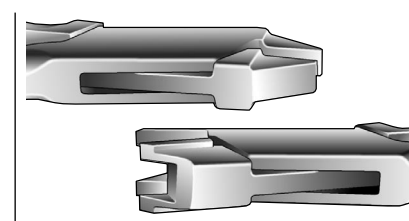
BENDING PLIER

Bird Beak
49-8141



REMOVING PLIER

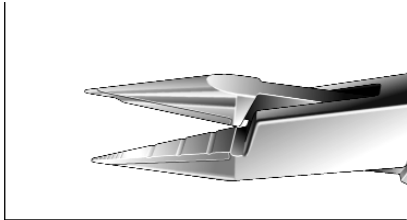
Bracket & Band
49-8063



TORQUING PLIER

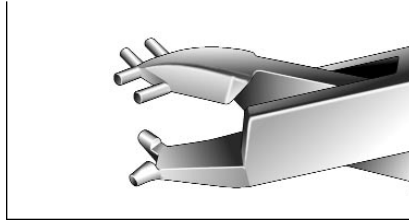
Set-Keyless
49-8325

MID-GRADE DENTAL INSTRUMENTS ORTHODONTIC PLIERS



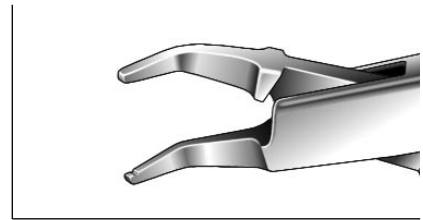
JARABAK PLIER

49-8153



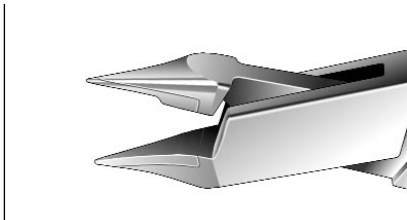
THREE JAW OFFSET PLIER

49-8245



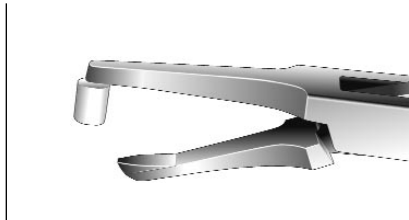
REMOVING PLIER

Lingual Arch
49-8249



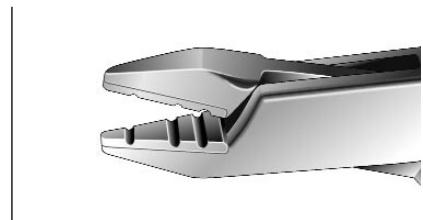
FORMING PLIER

Light Wire
49-8159



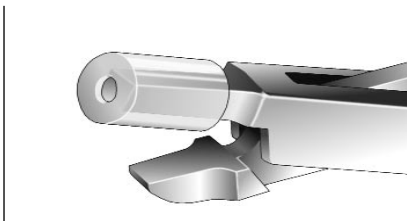
BAND REMOVING PLIER

#347, Posterior Band
49-8059



ADJUSTING PLIER

Facebow
49-8125



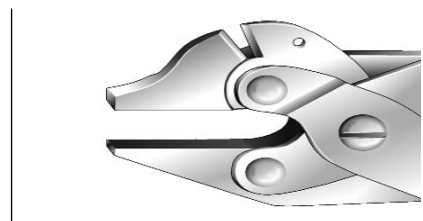
BAND REMOVING PLIER

Anterior
49-8054 Small



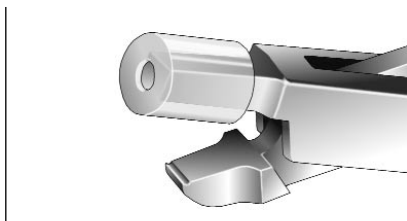
BAND REMOVING PLIER

Posterior
49-8060



BERNARD FACEBOW PLIER

With Cutter
49-8124



REMOVING PLIER

Bracket & Adhesive
49-8064



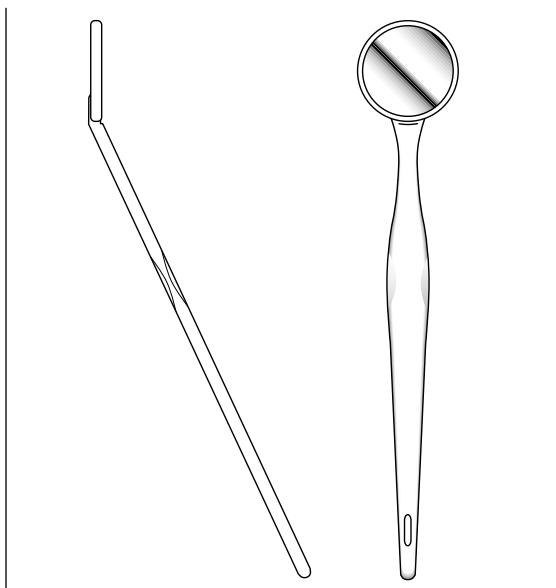
REMOVING PLIER

Bracket
49-8069



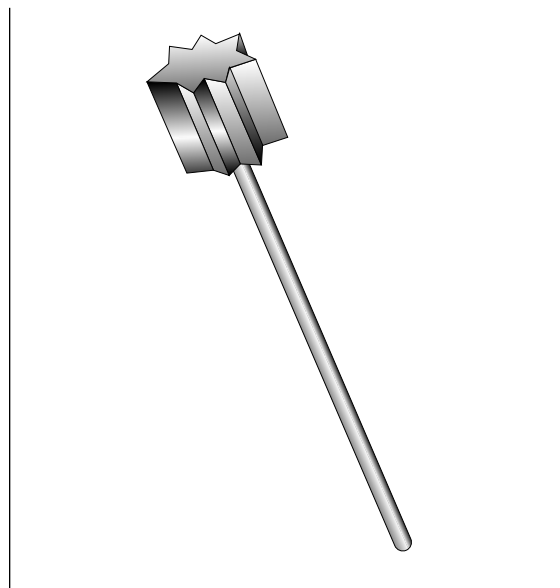
BAND CRIMPING PLIER

49-8010



DISPOSABLE MIRROR

Non-Sterile, Box of 144
96-2452



SKLARDENT™ DISPOSABLE ORAL SWAB

Individually Wrapped, Mint Flavored

- Soft foam swab is gentle on sensitive oral tissue.
- No water or rinsing required.
- Effectively removes food particles and freshens breath.

96-5601	1,000	4 Boxes/250
96-5602	500	2 Boxes/250



DISPOSABLE TOOTHBRUSH

Individually Packaged, Toothbrush and Toothpaste in one
96-2445 Box/200

DISPOSABLE LARYNGOSCOPE BLADES AND HANDLES



07-1374 Set Of Disposable Blades With Handle (Medium)

Blades - Miller
3, 2, 1, 0

Blades - MacIntosh
4, 3, 2



Do Not Autoclave – Disinfect Handle With Sklar Soak 10-1603, Case of 4-1 Gallon Bottles

MACINTOSH DISPOSABLE BLADES

Box of 50		Box of 10	
07-1359	Size 2	07-1363	Size 2
07-1360	Size 3	07-1364	Size 3
07-1362	Size 4	07-1365	Size 4

MILLER DISPOSABLE BLADES

Box of 50		Box of 10	
07-1366	Size 0	07-1370	Size 0
07-1367	Size 1	07-1371	Size 1
07-1368	Size 2	07-1372	Size 2
07-1369	Size 3	07-1373	Size 3



FIBEROPTIC HANDLES

Washable

07-1400	Medium	07-1402	Stubby
07-1401	Pediatric	07-1403	Infant



FIBEROPTIC AND STANDARD COMBO-HEAD HANDLES

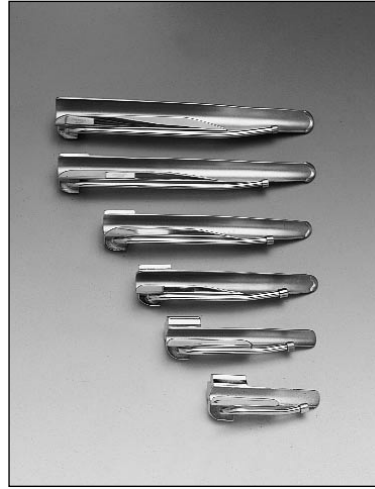
07-1408	Medium Fiberoptic and Standard Handle
07-1409	Pediatric Fiberoptic and Standard Handle
3 Volt Lithium Battery	
07-1410	2 each used in Combo Handles (Not Pictured)



FIBEROPTIC MACINTOSH BLADES-AMERICAN STYLE

Washable - Stainless Steel Polished

07-1240	Size 0	07-1243	Size 3
07-1241	Size 1	07-1244	Size 4
07-1242	Size 2		



FIBEROPTIC MILLER BLADES-AMERICAN STYLE

Washable - Stainless Steel Polished

07-1246	Size 0	07-1249	Size 3
07-1247	Size 1	07-1250	Size 4
07-1248	Size 2		



FIBEROPTIC WISCONSIN BLADES-AMERICAN STYLE

Washable - Stainless Steel Polished

07-1251	Size 0	07-1254	Size 3
07-1252	Size 1	07-1255	Size 4
07-1253	Size 2	07-1256	Size 1½ Wis-Hipple



FIBEROPTIC MACINTOSH BLADES-ENGLISH STYLE

Washable - Stainless Steel Satin

07-1268	Size 1	07-1270	Size 3
07-1269	Size 2	07-1271	Size 4



FIBEROPTIC MILLER BLADES-ENGLISH STYLE

Washable - Stainless Steel Satin

07-1263	Size 0	07-1266	Size 3
07-1264	Size 1	07-1267	Size 4
07-1265	Size 2		



FIBEROPTIC WISCONSIN BLADES-ENGLISH STYLE

Washable - Stainless Steel Satin

07-1257	Size 0	07-1260	Size 3
07-1258	Size 1	07-1261	Size 4
07-1259	Size 2	07-1262	Size 1½ Wis-Hipple

STANDARD LARYNGOSCOPE BLADES



MACINTOSH ENGLISH STYLE, STANDARD

Stainless Steel

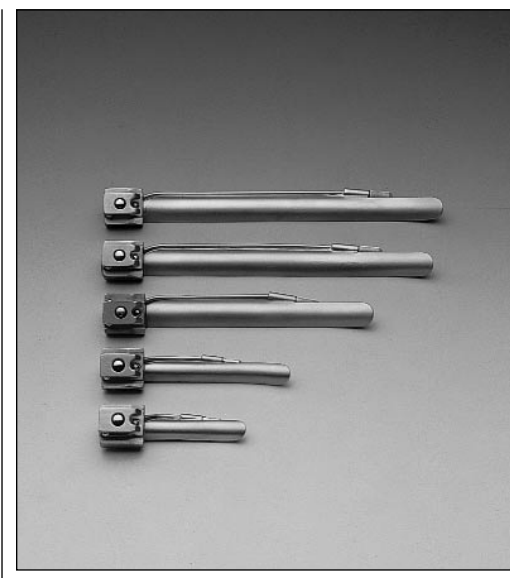
07-1200	Infant	Size 1	92mm
07-1201	Child	Size 2	100mm
07-1202	Adult	Size 3	130mm
07-1203	Lg. Adult	Size 4	155mm
07-1204	Left Handed	Size 3	130mm



MACINTOSH AMERICAN STYLE, STANDARD

Stainless Steel

07-1206	Infant	Size 1	87mm
07-1207	Child	Size 2	108mm
07-1208	Med. Adult	Size 3	124mm
07-1209	Adult	Size 3½	144mm
07-1210	Lg. Adult	Size 4	158mm



MILLER ENGLISH STYLE, STANDARD

Stainless Steel

07-1212	Premature	Size 0	75mm
07-1213	Infant	Size 1	102mm
07-1214	Child	Size 2	153mm
07-1215	Adult	Size 3	195mm
07-1216	Lg. Adult	Size 4	205mm
07-1217	Sm. Child	Size 1½	125mm



MILLER AMERICAN STYLE, STANDARD

Stainless Steel

07-1220	Neo-Natal	Size 00	58mm
07-1221	Premature	Size 0	75mm
07-1222	Infant	Size 1	102mm
07-1223	Child	Size 2	152mm
07-1224	Med. Adult	Size 3	190mm
07-1225	Lg. Adult	Size 4	198mm
07-1226	Sm. Child	Size 1½	125mm



STANDARD HOOK-ON HANDLES

Washable, Stainless Steel

- 07-1420 Medium Handle
- 07-1421 Lightweight Handle
- 07-1422 Pediatric Handle
- 07-1423 Infant Handle
- 07-1424 Stubby Handle
- 07-1425 "D" Handle



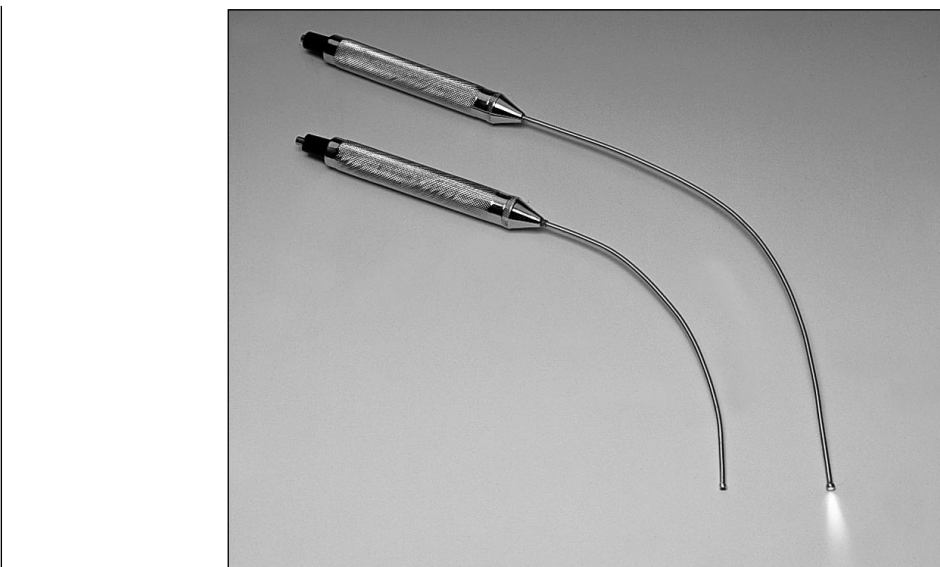
STANDARD LARYNGOSCOPE BLADES PHILLIPS STYLE

Stainless Steel

- | | | | |
|---------|-----------|--------|-------|
| 07-1230 | Pediatric | Size 1 | 113mm |
| 07-1231 | Adult | Size 2 | 166mm |

Chrome Plated Brass

- | | | | |
|---------|-----------|--------|-------|
| 07-1232 | Pediatric | Size 1 | 113mm |
| 07-1233 | Adult | Size 2 | 166mm |



SKLARVIEW LIGHTED STILETTE FOR TRACHEAL EXAMINATION

Stainless Steel Construction Can Be Sterilized Adjustable Stop To Regulate Length of Stilette in E.T. Tube

- | | | | |
|---------|-----------|-------------|-------------------------|
| 07-1480 | Adult | 33cm Length | 4.5mm E.T. Tube Minimum |
| 07-1482 | Pediatric | 21cm Length | 3.5mm E.T. Tube Minimum |



CONVENTIONAL LARYNGOSCOPE LAMPS

For Children Size Blades - Pkg/3

- 07-1100 Frosted lamp with nickel knurled base.
Generic version of a Welch Allyn lamp #04700.
- 07-1101 Clear and pre-focused lamp with nickel knurled base.

For Adult Size Blades - Pkg/3

- 07-1102 Clear and pre-focused lamp with nickel knurled base.
- 07-1126 Frosted lamp with nickel knurled base.
Generic version of a Welch Allyn lamp #04800.
- 07-1104 Clear and pre-focused lamp with nickel knurled base.
Medium Diameter lamp used on Penlon Conventional Laryngoscope Blades & other European Blades.

XENON FIBER OPTIC LARYNGOSCOPE LAMPS

Gold Plated Base - Pkg/3

- 07-1108 Use in a Fiber Optic Laryngoscope with standard threads.
- 07-1128 This lamp is 3.5 Volt, used with standard threads.

Nickel Plated Base - Pkg/3

- 07-1110 Use in a Fiber Optic Laryngoscope with standard threads.

XENON FIBER OPTIC LARYNGOSCOPE LAMPS

Nickel Plated Base - Pkg/3

- 07-1130 Use in a Fiber Optic Laryngoscope with metric threads.

Gold Plated Base - Pkg/3

- 07-1112 Use in a Fiber Optic Laryngoscope with metric threads.

HALOGEN FIBER OPTIC LAMPS

Nickel Plated Base - Pkg/3

- 07-1132 With standard threads

MEDIFLECTOR® - Pkg/3

- 07-1114 Presently used in Fiber Optic Laryngoscopes made by Amtec, AMS, RSP and Vital Signs. This is the largest size Mediflector® Brand medical lamp available.

Nickel Plated Base - Pkg/3

- 07-1116 For Adult Conventional Laryngoscope Blades.
Nickel knurled base, with a lamp & reflector combination.
Provides 50% more focused light.
- 07-1138 For Adult Fiber Optic Laryngoscope Handles.
Smooth Nickel base with a lamp reflector combination.
Fiber Optic - Is a higher performing lamp and provides 40-50% more light into a fiber optic bundle.

REPLACEMENT LAMPS (GENERIC)

Child Size - Pkg/3

- 07-1164 Generic version of a Welch Allyn lamp #WA 04700.
Conventional Laryngoscope Lamp for Child Size Blade.

Adult Size - Pkg/3

- 07-1166 Generic version of a Welch Allyn lamp #WA 04800.
Conventional Vacuum Laryngoscope Lamp for Adult Size Blade.

Nickel Plated Base - Pkg/3

- 07-1118 Generic version of a Welch Allyn lamp #WA 03000.
Used in a Welch Allyn Ophthalmoscope.
- 07-1160 Generic version of a Welch Allyn lamp #WA 06000.
Used in a Welch Allyn Fiber Optic Laryngoscope.
- 07-1120 Generic version of a Welch Allyn lamp #WA 03100.
Used in a Welch Allyn Fiber Optic Otolaryngoscope.
- 07-1162 Generic version of a Welch Allyn lamp #WA 04900.
Used in a Welch Allyn Coaxial Ophthalmoscope.
- 07-1122 Generic version of a Welch Allyn lamp #WA 00200.
Used in a Welch Allyn Vacuum Otolaryngoscope.



STETHOSCOPES

With 2 extra ear pieces and
1 extra diaphragm

06-1600	Cardiology	Gray	Stainless Steel
06-1601	Adult	Gray	Stainless Steel
06-1602	Pediatric	Gray	Stainless Steel
06-1603	Infant	Gray	Stainless Steel



DELUXE SPRAGUE RAPPAPORT STETHOSCOPE

With heavy tubing

06-1625	Gray
---------	------



DUAL HEAD STETHOSCOPE

Overall length 30"

06-1630	Black
06-1632	Gray



NURSE STETHOSCOPE

Overall length 30"

06-1635	Black
06-1638	Gray

STETHOSCOPES



PEDIATRIC STETHOSCOPE

Overall length 30"

06-1640 Gray



NEWBORN STETHOSCOPE

Overall length 30"

06-1642 Gray



BOWLES STETHOSCOPE

Chrome-plated binaural, chrome-plated, raised metal stem chestpiece, and 22" black Y-tubing

06-1648 Black



NURSE STETHOSCOPE

With Timepiece

06-1652 Blue

06-1654 Black



FETAL STETHOSCOPE

Chrome-plated inner spring binaural and vinyl coated headrest

06-1660 Black 8" Y-tubing

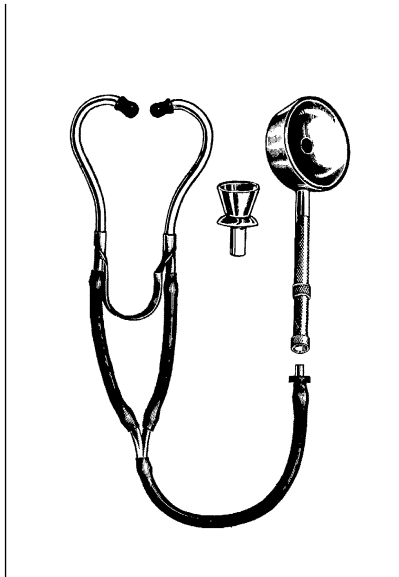
06-1662 Black 22" Y-tubing



TEACHING/TRAINING STETHOSCOPE

Is designed for multi-function teaching applications. With complete two binaurals, two pieces of Y-tubing, and an extension tube.

06-1668 Black



LEFF STETHOSCOPE FOR FETAL HEART

With Weighted Bell and Small Bell

- 06-1201 Chrome Plated
- 06-1202 With Weighted Bell Only
- 06-1210 Double/Teaching Stethoscope



DELEE-HILLIS OBSTETRICAL STETHOSCOPE

Metal Headband and Rigid Shank

- 06-1301 Chrome Plated



PERELL FETOSCOPE

06-1701 With Slip on Tubing Adaptor



DISPOSABLE STETHOSCOPE

- 96-1201 Blue
- 96-1202 Yellow



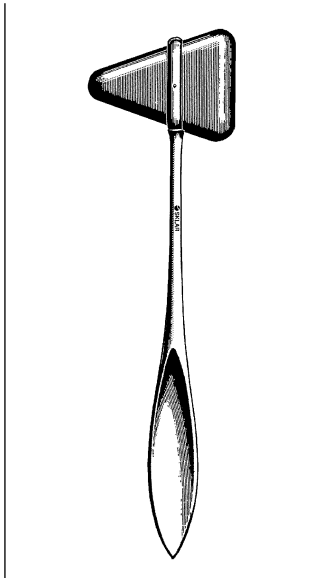
OTOSCOPE WITH THREE SPECULA

67-6250 The Sklar Otoscope employs a rheostat so that light intensity may be varied. Use alkaline battery size C.



SKLAR DERMATOSCOPE

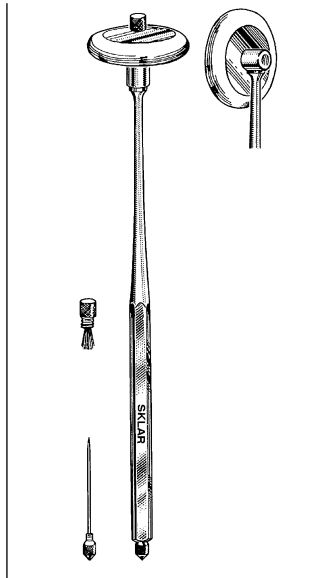
06-6250



TAYLOR PERCUSSION HAMMER

Solid Handle

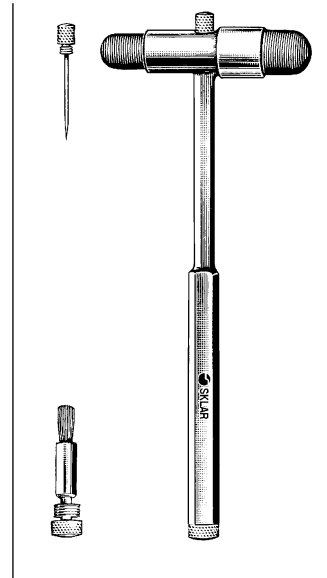
06-3170 Small 7"
06-3175 Large 7½"



RABINER NEUROLOGICAL HAMMER

With Pin and Brush

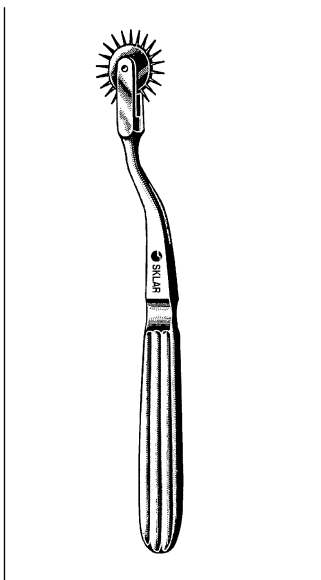
06-3290



BUCK NEUROLOGICAL HAMMER

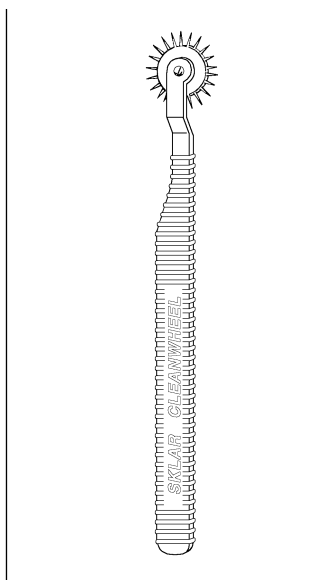
With Pin and Brush

06-3370



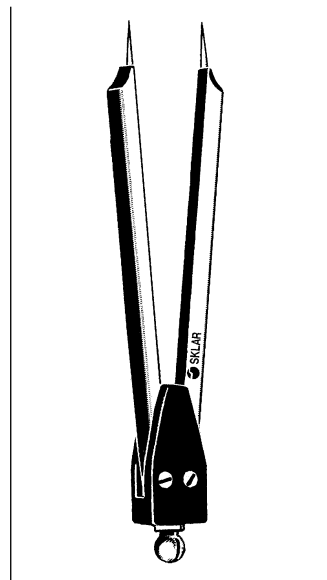
WARTENBERG NEUROLOGICAL PINWHEEL

06-3375



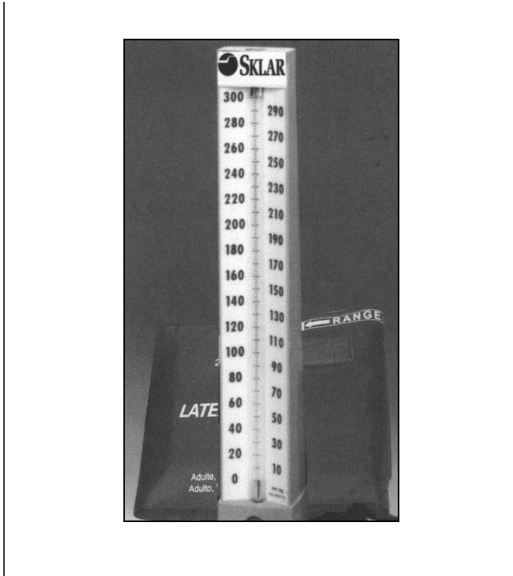
SKLAR DISPOSABLE CLEANWHEEL

96-7906 Pack/12
96-7907 Pack/144



EKG CALIPER

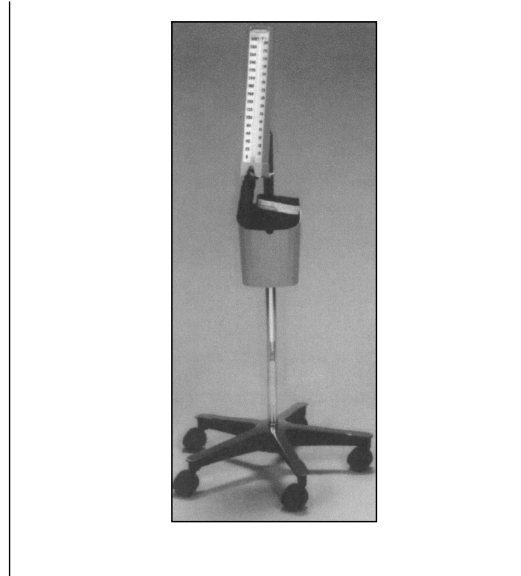
06-2808 7"



MERCURIAL SPHYGMOMANOMETER

06-2650 Wall Model

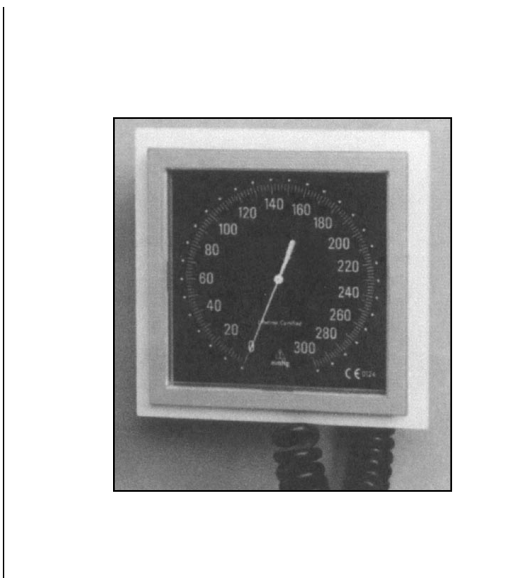
- Unit Features Latex-Free Cuff (Adult), Basket And Tubing (8').



MERCURIAL SPHYGMOMANOMETER

06-2651 Tilt Face Stand Model

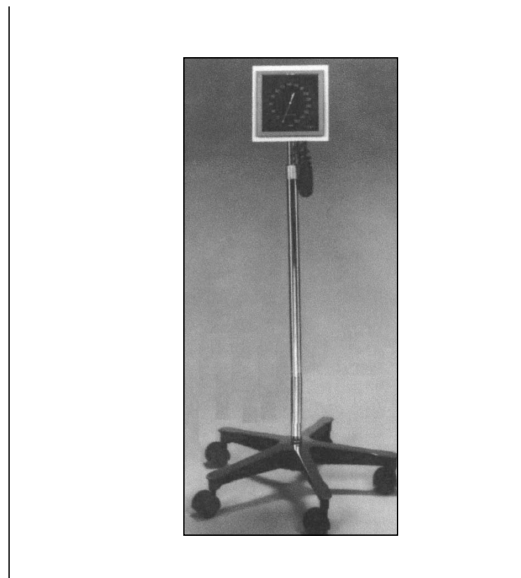
- Same Unit But Mounted On A 45° Stand With Full Rotation - Tubing Extends 5'.



ANEROID SPHYGMOMANOMETER

06-2652 Wall Model

- Unit Features Latex-Free Cuff (Adult), Basket And Tubing.
- Full Range Of 0-300 mm Hg With No Pin Stop And Precise Air Flow.

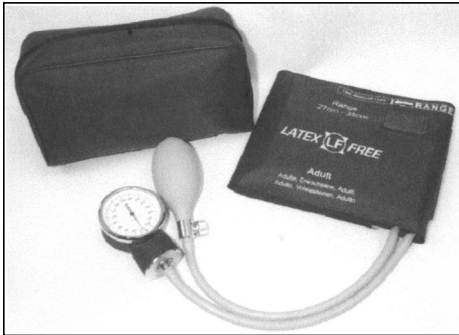


ANEROID SPHYGMOMANOMETER

06-2653 Hi-Lo Stand

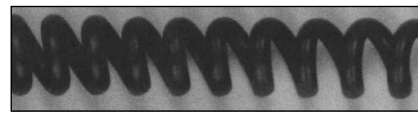
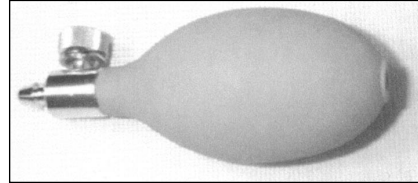
- Same Unit But Mounted On An Adjustable (44"-60") Stand.

BLOOD PRESSURE PRODUCTS



HAND-HELD POCKET GAUGE

- | | | |
|---------|-------------|---|
| 06-2654 | Adult | • Each Product Includes Latex-Free Inflation System, Aneroid Gauge And Carrying Case. |
| 06-2655 | Large Adult | |
| 06-2656 | Child | • Calibrated From 20-300 mm Hg With No Pin Stop |
| 06-2657 | Gauge Only | |



BLOOD PRESSURE ACCESSORIES

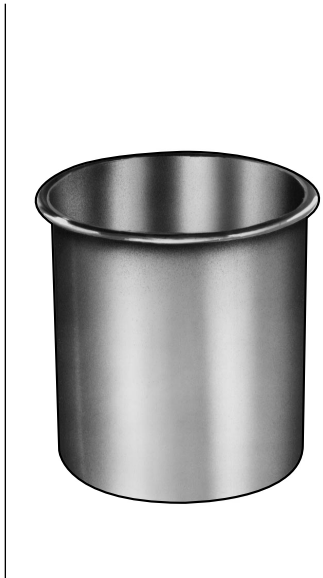
- | | | |
|---------|-------------------|--------------------------------------|
| 06-2658 | Bulb And Valve | • Anodized Valve And Non-Latex Bulb. |
| 06-2659 | Extendable Tubing | • 8' Tubing For Wall Or Stand Models |



COMPLETE CUFFING SYSTEM

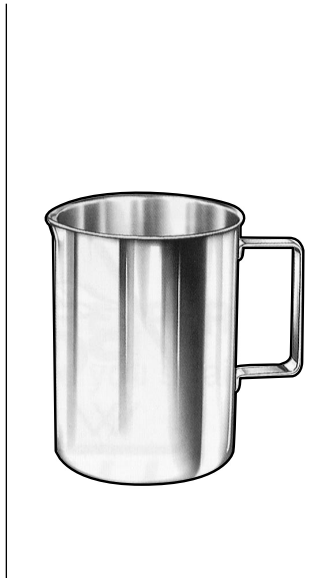
- | | |
|-----------------------------------|---------------------------|
| Cuff, Bladder, Bulb, Valve | Cuff, Bladder Only |
| 06-2660 Adult | 06-2665 Adult |
| 06-2661 Thigh | 06-2666 Thigh |
| 06-2662 Large Adult | 06-2667 Large Adult |
| 06-2663 Small Adult | 06-2668 Small Adult |
| 06-2664 Child | 06-2669 Child |

- Inflation System Includes Cuff, Bladder, Anodized Valve And Inflation Bulb.
- Design Promotes Accurate Measurement On Right/Left Arms.
- Exterior Range Finder Assists Determining Correct Cuff Size.



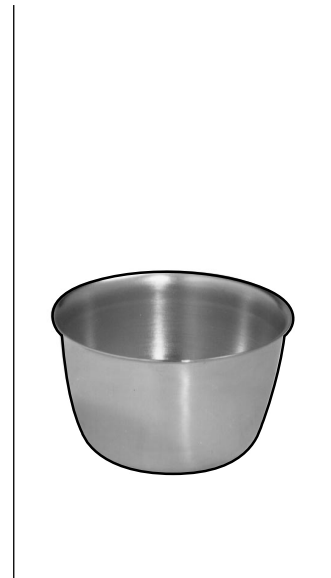
STORAGE CONTAINER

10-1540 2 Qt. 5¹/₁₆" x 6⁵/₁₆"



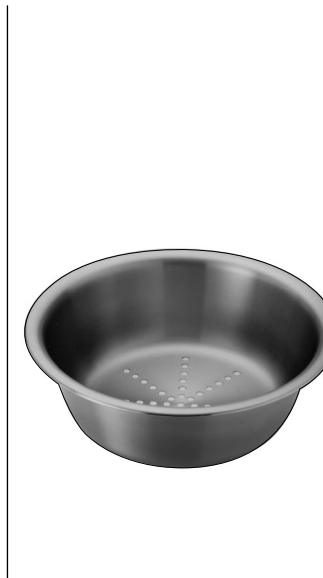
PITCHER/BEAKER

With Handle
10-1539 2000ml 5¹/₁₆" x 6⁵/₁₆"



IODINE CUP

10-1670 6 Oz. 3³/₁₆" x 2"
10-1671 14 Oz. 4³/₁₆" x 2⁵/₁₆"



PERFORATED SOAKING/ STERILIZATION BASIN

10-1506 7 Qt. 13³/₁₆" x 4³/₁₆"
Fits in 10-1505 Solution Basin



SOLUTION BASIN

10-1489 4¹/₂ Qt. 12" x 4¹/₂"
10-1505 7 Qt. 13³/₁₆" x 4³/₁₆"
10-1507 9¹/₂ Qt. 14¹/₂" x 5"



MIXING/SOLUTION BOWL

10-1488 ⁷/₈ Qt. 6³/₁₆" x 2¹/₂"
10-1491 1¹/₂ Qt. 8¹/₁₆" x 3"
10-1492 3 Qt. 9³/₁₆" x 4"
10-1493 5 Qt. 11¹/₈" x 4¹/₂"
10-1494 6³/₄ Qt. 12³/₄" x 5¹/₄"
10-1495 8 Qt. 13³/₁₆" x 5¹/₁₆"

SURGICAL PRODUCTS STAINLESS STEELWARE



SPONGE BOWL

10-1496	12 Oz.	4 $\frac{1}{4}$ " x 2"
10-1498	22 Oz.	5" x 2 $\frac{3}{8}$ "
10-1484	29 Oz.	5 $\frac{3}{16}$ " x 2 $\frac{3}{16}$ "
10-1485	36 Oz.	6 $\frac{1}{4}$ " x 2 $\frac{3}{4}$ "
10-1483	48 Oz.	7 $\frac{1}{8}$ " x 2 $\frac{3}{4}$ "
10-1486	64 Oz.	7 $\frac{1}{16}$ " x 3"



DRESSING JAR, WITH COVER

10-1523	½ Qt.	4 $\frac{1}{8}$ " x 2 $\frac{1}{4}$ "
10-1533	1¼ Qt.	4 $\frac{1}{8}$ " x 5 $\frac{1}{2}$ "
10-1538	1¼ Qt.	4 $\frac{1}{8}$ " x 6 $\frac{1}{4}$ "
10-1527	3 Qt.	5 $\frac{1}{8}$ " x 6 $\frac{3}{4}$ "
10-1543	4¼ Qt.	6 $\frac{3}{8}$ " x 7 $\frac{1}{4}$ "
10-1544	6 Qt.	7 $\frac{1}{2}$ " x 8 $\frac{3}{8}$ "
10-1547	8 Qt.	8" x 9 $\frac{1}{8}$ "



OINTMENT JAR, WITH COVER

10-1525	9 Oz.	3 $\frac{3}{8}$ " x 2 $\frac{3}{4}$ "
---------	-------	---------------------------------------



MEDICINE CUP

10-1675	2 Oz.	2 $\frac{1}{8}$ " x 2"
---------	-------	------------------------



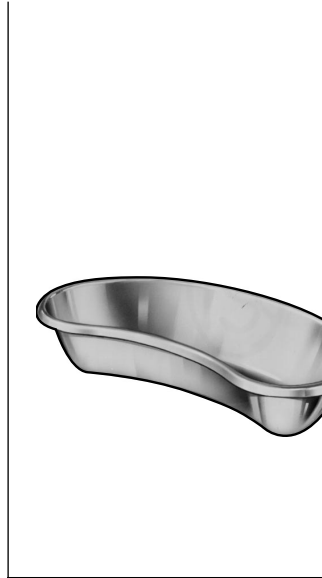
FORCEPS JAR

10-1550	Base 2 $\frac{1}{16}$ "	1" x 4"
10-1541	Base 3 $\frac{3}{16}$ "	2 $\frac{1}{4}$ " x 4 $\frac{1}{2}$ "
10-1545	Base 3 $\frac{1}{16}$ "	2 $\frac{1}{4}$ " x 7"



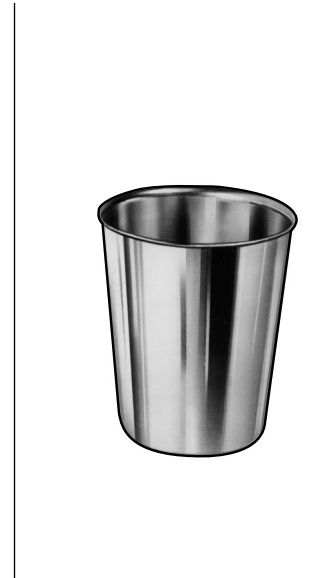
GRADUATED MEASURES

10-1552	16 Oz.	3 $\frac{3}{4}$ " x 4 $\frac{1}{8}$ "
10-1510	32 Oz.	4 $\frac{3}{4}$ " x 5 $\frac{1}{4}$ "
10-1674	64 Oz.	5 $\frac{1}{2}$ " x 6 $\frac{1}{2}$ "



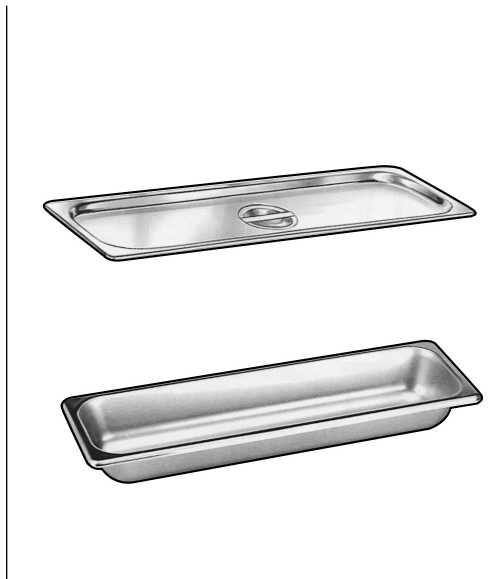
EMESIS BASIN

10-1497	10 Oz.	6 $\frac{5}{8}$ " x 3 $\frac{1}{2}$ " x 1 $\frac{1}{2}$ "
10-1698	12 Oz.	8 $\frac{1}{8}$ " x 3 $\frac{5}{8}$ " x 1 $\frac{1}{8}$ "
10-1699	26 Oz.	9 $\frac{1}{8}$ " x 4 $\frac{1}{2}$ " x 2 $\frac{1}{8}$ "



TUMBLERS

10-1536	7 Oz.	2 $\frac{1}{8}$ " x 3 $\frac{1}{8}$ "
10-1554	12 Oz.	3 $\frac{3}{16}$ " x 4"



STERILIZATION TRAY

10-1750	6 Qt.	20 $\frac{3}{4}$ " x 6 $\frac{3}{8}$ " x 4"
10-1752	9 Qt.	20 $\frac{3}{4}$ " x 6 $\frac{3}{8}$ " x 6"
10-1854	Cover Fits Above 2 Trays	



INSTRUMENT TRAY

With Very Slight Flange		
10-1889	10 $\frac{3}{16}$ "	x 5 $\frac{1}{2}$ " x 4"

INSTRUMENT TRAYS STAINLESS STEELWARE



INSTRUMENT TRAY

Heavy Duty, Recessed Strap Handle Cover

10-1738	8 ⁷ / ₈ " x 5" x 2"	10-1755	6 ⁷ / ₈ " x 4 ¹ / ₄ " x 2"
10-1760	8 ⁷ / ₈ " x 5" x 3"	10-1737	Cover Fits Above Tray
10-1722	Cover Fits Above 2 Trays	10-1753	13 ³ / ₈ " x 12 ⁵ / ₈ " x 2 ¹ / ₂ "
10-1877	12 ¹ / ₄ " x 7 ³ / ₄ " x 2 ¹ / ₄ "	10-1754	Cover Fits Above Tray
10-1878	Cover Fits Above Tray	10-1741	6 ⁷ / ₈ " x 6 ³ / ₈ " x 4"
10-1748	16 ¹ / ₂ " x 10" x 2 ¹ / ₂ "	10-1835	Cover Fits Above Tray
10-1756	Cover Fits Above Tray	10-1742	10 ³ / ₈ " x 6 ³ / ₈ " x 2 ¹ / ₂ "
		10-1542	Cover Fits Above Tray



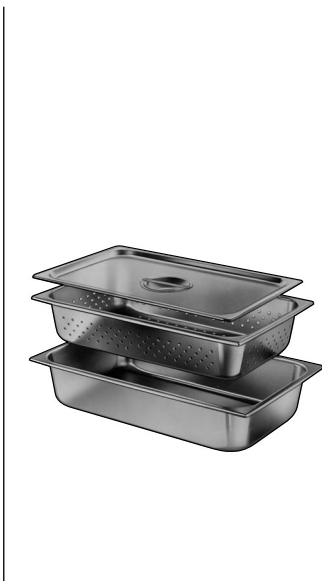
INSTRUMENT TRAY

Standard Weight, 22 Ga.

10-1744	12 ³ / ₄ " x 6 ⁷ / ₈ " x 2 ¹ / ₂ "
10-1724	Cover Fits Above Tray
10-1746	12 ³ / ₄ " x 10 ³ / ₈ " x 2 ¹ / ₂ "
10-1747	12 ³ / ₄ " x 10 ³ / ₈ " x 4"
10-1882	Cover Fits Above 2 Trays

Heavy Weight, 20 Ga.

10-1950	12 ³ / ₄ " x 10 ³ / ₈ " x 2 ¹ / ₂ "
10-1952	12 ³ / ₄ " x 10 ³ / ₈ " x 4"
10-1882	Cover Fits Above 2 Trays
10-1953	20 ¹ / ₄ " x 12 ⁵ / ₈ " x 2 ¹ / ₂ "
10-1954	20 ¹ / ₄ " x 12 ⁵ / ₈ " x 4"
10-1535	Cover Fits Above 2 Trays



STERILIZATION TRAYS/ BATH SETS

Hot/Cold

10-1948	Solid Tray	20 ¹ / ₂ " x 12 ⁵ / ₈ " x 6"
10-1949	Perforated Tray	20 ¹ / ₂ " x 12 ⁵ / ₈ " x 4"
10-1535	Flat, Solid Cover	Fits Above 2 Trays



CATHETER TRAY

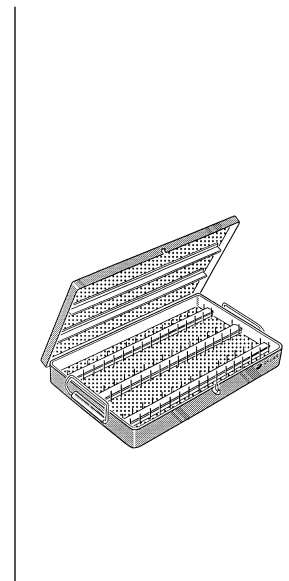
10-1738	8 ⁷ / ₈ " x 5" x 2"
10-1760	8 ⁷ / ₈ " x 5" x 3"
10-1761	Cover Fits Above 2 Trays
10-1955	8 ⁷ / ₈ " x 3 ¹ / ₂ " x 1 ¹ / ₂ "
10-1956	Cover Fits Above Tray
10-1886	17 ¹ / ₄ " x 4 ¹ / ₂ " x 2"
10-1887	Cover Fits Above Tray



OBLONG INSTRUMENT/ DRYING TRAY

With Rolled Bead Edge

10-1876	10" x 6 ¹ / ₂ " x 3 ¹ / ₄ "
10-1883	13 ¹ / ₁₆ " x 9 ³ / ₁₆ " x 3 ¹ / ₄ "
10-1884	15 ¹ / ₈ " x 10 ⁵ / ₈ " x 3 ¹ / ₄ "
10-1683	17" x 11 ¹ / ₈ " x 3 ¹ / ₄ "
10-1888	19 ¹ / ₈ " x 12 ⁵ / ₈ " x 3 ¹ / ₄ "
10-1680	21 ¹ / ₄ " x 16 ¹ / ₄ " x 1 ¹ / ₈ "



SMALL INSTRUMENT STERILIZATION/ STORAGE TRAY

10-1700	8 ¹ / ₂ " x 8" x 1 ¹ / ₄ "
10-1707	8 ¹ / ₂ " x 12" x 1 ¹ / ₄ "
10-1708	8" x 14" x 1 ¹ / ₄ "
10-1702	10 ¹ / ₂ " x 10" x 1 ¹ / ₂ "
10-1703	15" x 10 ¹ / ₂ " x 1 ¹ / ₄ "



MAYO TRAY

Perforated

10-1684	10" x 6½" x ¾"
10-1685	13¾" x 9¾" x ¾"
10-1686	15½" x 10¾" x ¾"
10-1687	17" x 11¾" x ¾"
10-1688	19½" x 12¾" x ¾"
10-1689	21¼" x 16¼" x ¾"

MAYO TRAY

Non-Perforated

10-1690	10" x 6½" x ¾"
10-1691	13¾" x 9¾" x ¾"
10-1692	15½" x 10¾" x ¾"
10-1693	17" x 10¾" x ¾"
10-1694	19" x 12¾" x ¾"
10-1695	21¼" x 16¼" x ¾"



PLASTIC PROCEDURE TRAYS

Reusable and Autoclavable

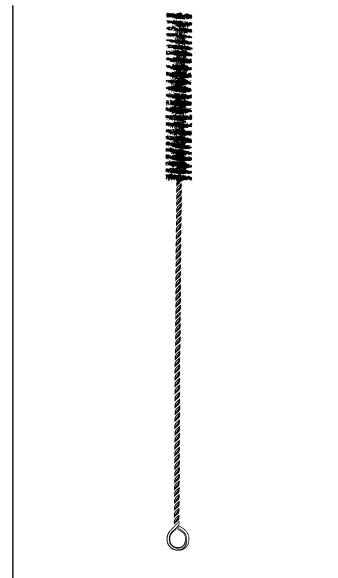
Can be used as Mayo Tray, Floor Tray, Custom Tray and Procedure Tray. Reusable. Textured surface will not rust.

Perforated

10-1965	Mini	10¼" x 6½"	Blue
10-1966	Small	10¼" x 13¾"	Blue
10-1967	Medium	11¾" x 16"	Blue

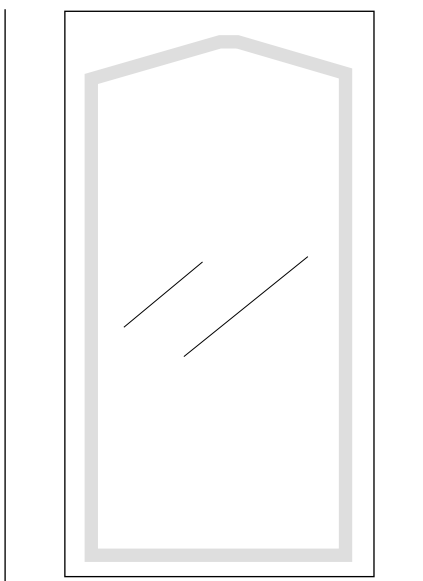
Non-Perforated

10-1960	Mini
10-1961	Small



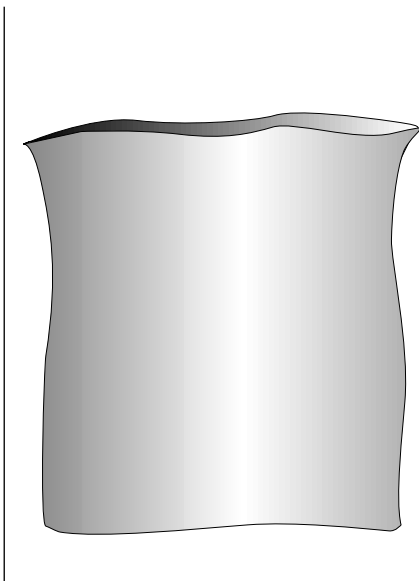
INSTRUMENT CLEANING BRUSH - BRISTLE END

10-1660	2¼" x ¼" x 12" Long	Pack. of 3
10-1664	2½" x ¾" x 15" Long	Pack. of 3
10-1668	3½" x 1" x 15" Long	Pack. of 3



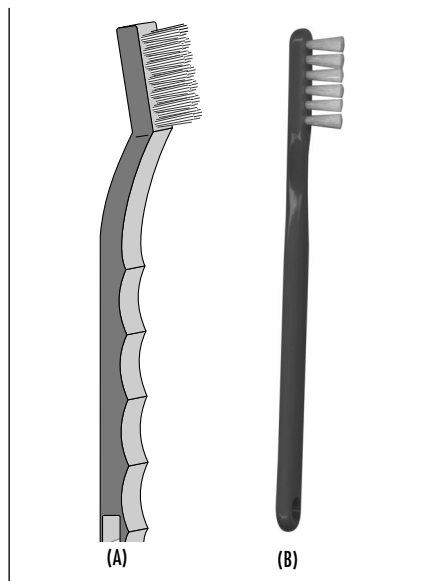
SKLAR STERILE POUCHES

Heat Sealed 200/Box		Self Sealed 200/Box	
10-1928	3½" x 8½"	10-1933	3½" x 8"
10-1930	6" x 10"	10-1934	5½" x 10"
10-1931	7½" x 13"	10-1935	7½" x 13"
10-1932	10" x 15"	10-1937	12" x 15"



SKLAR DUST COVERS

Heat Sealed 250/Box	
10-1915	8" x 12"
10-1916	10" x 15"
10-1917	16" x 22"
10-1918	24" x 30"



INSTRUMENT CLEANING BRUSH

10-1650	Stainless Steel Bristles (A)	Pack. of 3
10-1651	Nylon Bristles (A)	Pack. of 3
10-1652	Stainless Steel Bristles (A)	Pack. of 12
10-1657	Nylon Bristles (A)	Pack. of 12

Disposable

10-1465	Nylon Bristles (B)	Pack. of 12
10-1468	Nylon Bristles (B)	Pack. of 24



INSULIN SYRINGES

Permanent Needle Cs/500 5 boxes/100

62-1328 29 ga. x 1/2 Needle 1cc U100

62-1117 29 ga. x 1/2 Needle 1/2cc U100

Luer-Slip Cs/1,000 10 boxes/100

62-1648 27 ga. x 1/2 Needle 1cc U100
Needle-Dual Scale

Permanent Needle Box of 100

62-1328m 29 ga. x 1/2 Needle 1cc U100

62-1117m 29 ga. x 1/2 Needle 1/2cc U100

Luer-Slip Box of 100

62-1648m 27 ga. x 1/2 Needle 1cc U100
Needle-Dual Scale



TUBERCULIN SYRINGES

Luer-Slip 1cc Cs/1,000 10 boxes/100

62-1645 27 ga. x 1/2 Needle

62-1646 25 ga. x 1/2 Needle

62-1659 w/o Needle

Luer-Slip Box of 100

62-1645m 27 ga. x 1/2 Needle

62-1646m 25 ga. x 1/2 Needle

62-1659m w/o Needle



ALCOHOL PREP PAD

96-1681 Bx/200

96-1682 Cs/1000, 5 Bxs/200



3CC SYRINGES

Luer-Lock 3cc Cs/1000 10 boxes/100

- 62-3702 25 ga. x 3/8 Needle
- 62-3703 25 ga. x 1 Needle
- 62-3704 25 ga. x 1 1/2 Needle
- 62-3706 23 ga. x 1 Needle
- 62-3707 22 ga. x 3/8 Needle
- 62-3708 22 ga. x 1 Needle
- 62-3710 22 ga. x 1 1/2 Needle

- 62-3711 21 ga. x 1 Needle
- 62-3713 21 ga. x 1 1/2 Needle
- 62-3715 20 ga. x 1 Needle
- 62-3716 20 ga. x 1 1/2 Needle
- 62-3717 18 ga. x 1 1/2 Needle
- 62-3718 w/o Needle

Luer-Lock 3cc Box of 100

- 62-3702m 25 ga. x 3/8 Needle
- 62-3703m 25 ga. x 1 Needle
- 62-3704m 25 ga. x 1 1/2 Needle
- 62-3706m 23 ga. x 1 Needle
- 62-3707m 22 ga. x 3/8 Needle
- 62-3708m 22 ga. x 1 Needle
- 62-3710m 22 ga. x 1 1/2 Needle

Luer-Slip 3cc Cs/1000 10 boxes/100

- 62-3602 w/o Needle
- Luer-Slip 3cc Box of 100
- 62-3602m w/o Needle



5CC SYRINGES

Luer-Lock 5cc Cs/1000 10 boxes/100

- 62-4701 22 ga. x 1 Needle
- 62-4702 22 ga. x 1 1/2 Needle
- 62-4703 21 ga. x 1 Needle
- 62-4704 21 ga. x 1 1/2 Needle
- 62-4705 20 ga. x 1 Needle
- 62-4706 20 ga. x 1 1/2 Needle
- 62-4707 w/o Needle

Luer-Lock 5cc Box of 100

- 62-4701m 22 ga. x 1 Needle
- 62-4702m 22 ga. x 1 1/2 Needle
- 62-4703m 21 ga. x 1 Needle
- 62-4704m 21 ga. x 1 1/2 Needle
- 62-4705m 20 ga. x 1 Needle
- 62-4706m 20 ga. x 1 1/2 Needle
- 62-4707m w/o Needle

Luer-Slip 5cc Cs/1000 10 boxes/100

- 62-4628 w/o Needle
- Box of 100
- 62-4628m w/o Needle

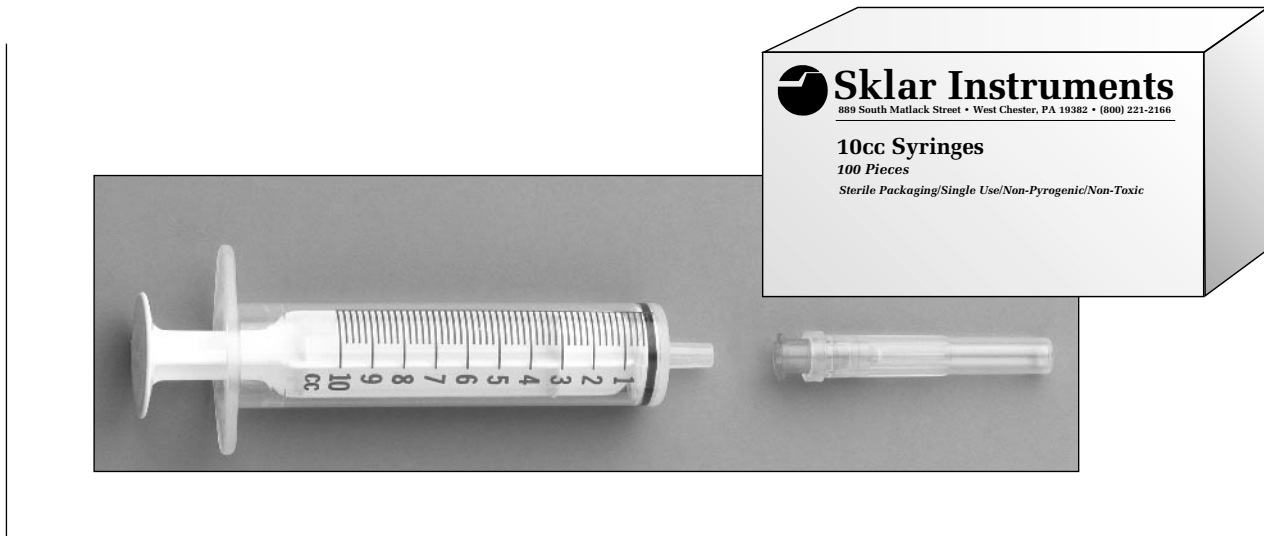
Bulk Syringes

- 62-4714 Luer-Lock 5cc Cs/3000



ALCOHOL PREP PAD

- 96-1681 Bx/200
- 96-1682 Cs/1000, 5 Bxs/200



10CC SYRINGES

Luer-Lock 10cc Cs/1000 10 boxes/100

- 62-6701 22 ga. x 1 Needle
- 62-6702 22 ga. x 1½ Needle
- 62-6703 21 ga. x 1 Needle
- 62-6704 21 ga. x 1½ Needle
- 62-6705 20 ga. x 1 Needle
- 62-6706 20 ga. x 1½ Needle
- 62-6707 w/o Needle

Luer-Lock 10cc Box of 100

- 62-6701m 22 ga. x 1 Needle
- 62-6702m 22 ga. x 1½ Needle
- 62-6703m 21 ga. x 1 Needle
- 62-6704m 21 ga. x 1½ Needle
- 62-6705m 20 ga. x 1 Needle
- 62-6706m 20 ga. x 1½ Needle
- 62-6707m w/o Needle

Bulk Syringes

62-6634 Luer-Slip 10cc Cs/1800
Eccentric Tip

Luer-Slip 10cc
Cs/1000 10 boxes/100

62-6633 w/o Needle

Luer-Slip 10cc
Box of 100

62-6633m w/o Needle



20CC SYRINGES

Luer-Lock 20cc Cs/500 10 boxes/50

62-7701 w/o Needle

Luer-Slip 20cc Cs/500 10 boxes/50

62-7625 w/o Needle
Eccentric Tip

Luer-Lock 20cc Box of 50

62-7701m w/o Needle

Luer-Slip 20cc Box of 50

62-7625m w/o Needle
Eccentric Tip

Bulk Syringes

62-7627 Luer-Slip 20cc Cs/900
Eccentric Tip

62-7706 Luer-Lock 20cc Cs/900



ALCOHOL PREP PAD

96-1681 Bx/200

96-1682 Cs/1000, 5 Bxs/200



35CC SYRINGES

Luer-Lock 35cc Cs/200 10 boxes/20
62-9553 w/o Needle

Luer-Slip 35cc Cs/200 10 boxes/20
62-9503 w/o Needle

Luer-Lock 35cc Box of 20
62-9553m w/o Needle

Luer-Slip 35cc Box of 20
62-9503m w/o Needle



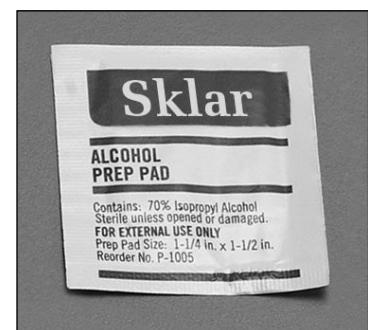
60CC SYRINGES

Luer-Lock 50/60cc Cs/100 4 boxes/25
62-8453 w/o Needle

Bulk Syringes
62-8464 Catheter Tip 60cc Cs/400
62-8465 Luer-Lock 60cc Cs/400
62-8485 w/o Needle Eccentric Tip Cs/400

Catheter Tip 50/60cc Cs/100 4 boxes/25
62-8454 w/o Needle

Box/25
62-8474 w/o Needle
62-8494 w/o Needle Eccentric Tip



ALCOHOL PREP PAD

96-1681 Bx/200
96-1682 Cs/1000, 5 Bxs/200



100CC SYRINGES

Catheter Tip 100cc Cs/150 10 boxes/15
62-8714 w/o Needle

Box/15
62-8714m w/o Needle



ALCOHOL PREP PAD

96-1681 Bx/200
96-1682 Cs/1000, 5 Bxs/200



SUPERSOFT™ HYPODERMIC NEEDLES

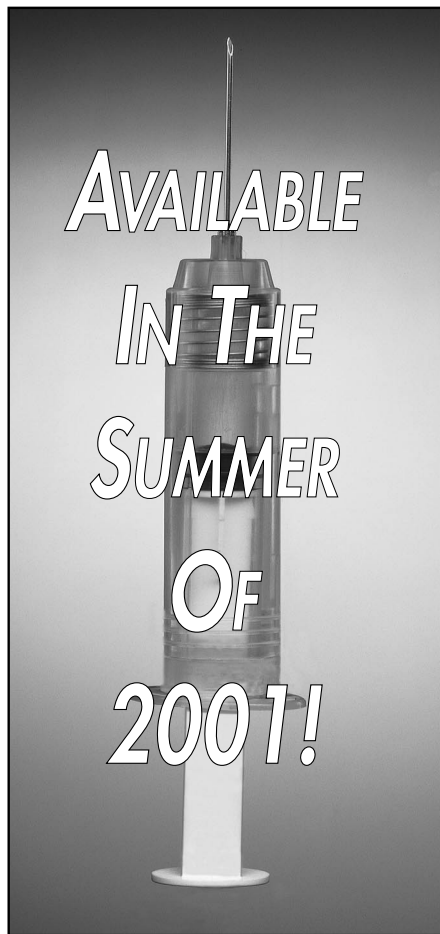
Single Use Cs/1000 10 boxes/100

62-181000	18 ga. x 1 Needle	Pink	62-201500	20 ga. x 1½ Needle	Yellow	62-221000	22 ga. x 1 Needle	Black	62-251000	25 ga. x 1 Needle	Orange
62-181500	18 ga. x 1½ Needle	Pink	62-211000	21 ga. x 1 Needle	Green	62-221500	22 ga. x 1½ Needle	Black	62-251500	25 ga. x 1½ Needle	Orange
62-200700	20 ga. x ¾ Needle	Yellow	62-211500	21 ga. x 1½ Needle	Green	62-231000	23 ga. x 1 Needle	Blue	62-261200	26 ga. x ½ Needle	Tan
62-201000	20 ga. x 1 Needle	Yellow	62-220700	22 ga. x ¾ Needle	Black	62-250600	25 ga. x ¾ Needle	Orange	62-270500	27 ga. x ½ Needle	Grey

Single Use Boxes/100

62-181000m	18 ga. x 1 Needle	Pink	62-201500m	20 ga. x 1½ Needle	Yellow	62-221000m	22 ga. x 1 Needle	Black	62-251000m	25 ga. x 1 Needle	Orange
62-181500m	18 ga. x 1½ Needle	Pink	62-211000m	21 ga. x 1 Needle	Green	62-221500m	22 ga. x 1½ Needle	Black	62-251500m	25 ga. x 1½ Needle	Orange
62-200700m	20 ga. x ¾ Needle	Yellow	62-211500m	21 ga. x 1½ Needle	Green	62-231000m	23 ga. x 1 Needle	Blue	62-261200m	26 ga. x ½ Needle	Tan
62-201000m	20 ga. x 1 Needle	Yellow	62-220700m	22 ga. x ¾ Needle	Black	62-250600m	25 ga. x ¾ Needle	Orange	62-270500m	27 ga. x ½ Needle	Grey

NEEDLESTICK PROTECTION!



The SklarSafe™ Protective Syringe utilizes two separate features which guard against accidental needlesticks.

- *After injection, the needle is easily retracted into the syringe barrel.*
- *Exposing a used needle is impossible once retracted since the plunger becomes unusable.*

SKLARSAFE™ PROTECTIVE SYRINGE, DISPOSABLE

3cc Syringe L/L Needle, Box/100

- 62-3740 25g x 5/8 Needle
- 62-3742 25g x 1 Needle
- 62-3744 23g x 1 Needle
- 62-3746 22g x 1 Needle
- 62-3748 22g x 1-1/2 Needle
- 62-3750 21g x 1 Needle
- 62-3752 21g x 1-1/2 Needle
- 62-3754 20g x 1 Needle
- 62-3756 20g x 1-1/2 Needle

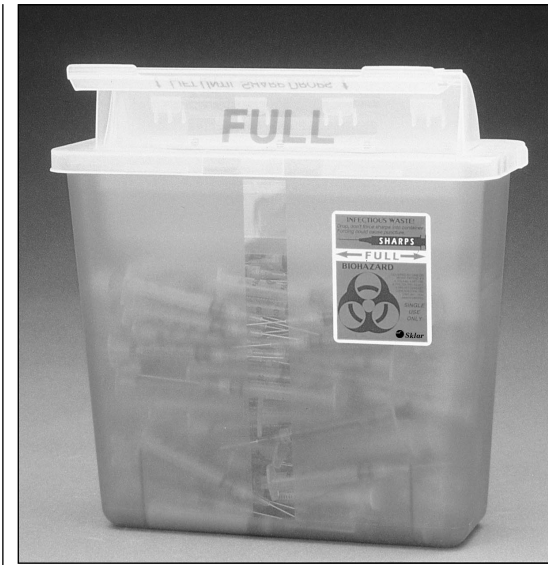
5cc Syringe L/L Needle, Box/100

- 62-4720 21g x 1-1/2 Needle

10cc Syringe L/L Needle, Box/100

- 62-6720 21g x 1-1/2 Needle

SHARPS CONTAINERS/ BIOHAZARD BAGS



SKLAR SHARPS CONTAINERS

- Clearly indicates when container is full.
 - Stops in "FULL" position when it reaches normal capacity.
 - The "Always Open" lid ready for quick disposal.
 - Easily accommodates 60cc syringes.
 - 5 qt. container available in transparent red.
- | | | | |
|---------|-------|-----------------|---------|
| 10-1265 | 5 qt. | Transparent Red | 20/case |
| 10-1264 | 5 qt. | Transparent Red | Each |



SHARPS CONTAINERS

- | | | | | | |
|--|--------|----------|---------|--------|---------|
| Tray Size | | | | | |
| 10-1268 | 20 oz. | Case/100 | 10-1269 | 20 oz. | Pack/10 |
| High Volume Size, Red, With Locking Rotor (Not Pictured) | | | | | |
| 10-1270 | 2 gal. | Case/20 | 10-1271 | 2 gal. | Each |
| High Volume Size, Red, With Living Hinge (Not Pictured) | | | | | |
| 10-1272 | 8 gal. | Case/10 | 10-1273 | 8 gal. | Each |



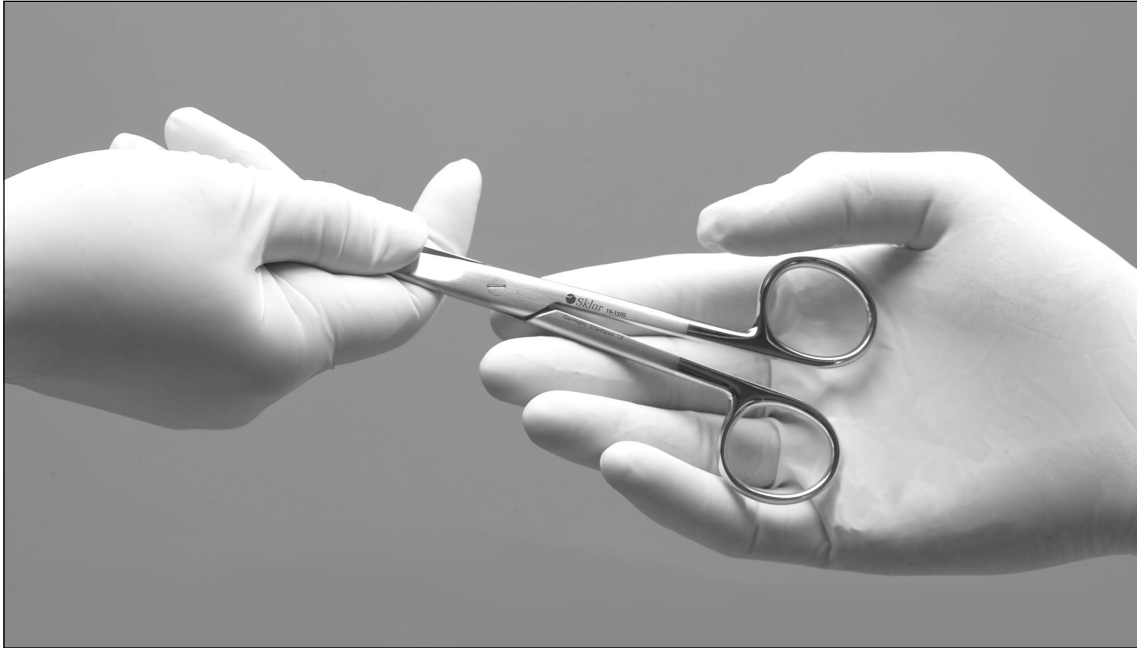
SKLAR PHLEBOTOMY CONTAINER

- | | | |
|---------|-------|-----------------|
| 10-1201 | 1 qt. | Transparent Red |
|---------|-------|-----------------|



BIOHAZARD BAGS

- | | | |
|--|--------------------------------------|-------------|
| X-Large Biohazard Bag with Extra Heavy Duty Security | | |
| 10-1410 | Seals attached 20" W x 39" L x 13" D | Pack of 5 |
| X-Large Biohazard Bag Only | | |
| 10-1412 | 4 ml thick | Pack of 25 |
| Extra Heavy Duty Security | | |
| 10-2126 | Seals with prongs, numbered | Pack of 100 |



Introducing the glove that goes beyond the ordinary and gives you protection and comfort you never thought possible. These new gloves will give you all you have been looking for in a Latex or Nitrile Glove.

SKLARTOUCH™ NITRILE EXAMINATION GLOVES

Box Of 100, Disposable, Non-Sterile, Dispensing Box
Pre-Powdered, Ambidextrous, 10" Length

96-2170	Small	96-2176	X-Large
96-2172	Medium	96-2178	XX-Large
96-2174	Large		

Case Of 1000, (10 Boxes Of 100), Disposable, Non-Sterile,
Pre-Powdered, Ambidextrous, 10" Length

96-3170	Small	96-3176	X-Large
96-3172	Medium	96-3178	XX-Large
96-3174	Large		

“Caution: Powder should be removed from gloves after donning by wiping gloves thoroughly with a sterile wet sponge, sterile wet towel or other effective method.”

SKLARTOUCH™ NITRILE EXAMINATION GLOVES

Box Of 100, Disposable, Non-Sterile, Dispensing Box
Powder-Free, Ambidextrous, 10" Length

96-2190	Small	96-2196	X-Large
96-2192	Medium	96-2198	XX-Large
96-2194	Large		

Case Of 1000, (10 Boxes Of 100), Disposable, Non-Sterile,
Powder-Free, Ambidextrous, 10" Length

96-3190	Small	96-3196	X-Large
96-3192	Medium	96-3198	XX-Large
96-3194	Large		

SKLARTOUCH™ LATEX EXAMINATION GLOVES

Box Of 100, Disposable, Non-Sterile, Dispensing Box
Pre-Powdered, Ambidextrous, 10" Length

96-2180	Small	96-2184	Large
96-2182	Medium	96-2186	X-Large

Case Of 1000, (10 Boxes Of 100), Disposable, Non-Sterile,
Pre-Powdered, Ambidextrous, 10" Length

96-3180	Small	96-3184	Large
96-3182	Medium	96-3186	X-Large

“Caution: This product contains natural rubber latex, which may cause allergic reaction in some individuals.”

SKLARTOUCH™ LATEX EXAMINATION GLOVES

Box Of 100, Disposable, Non-Sterile, Dispensing Box
Powder-Free, Ambidextrous, 10" Length

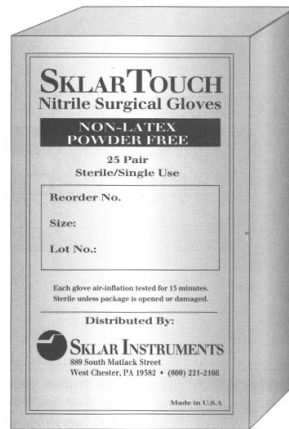
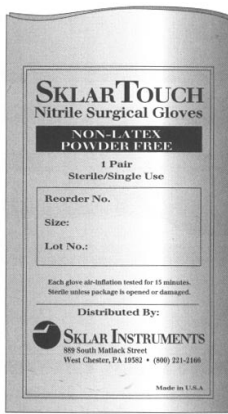
96-2160	Small	96-2164	Large
96-2162	Medium	96-2166	X-Large

Case Of 1000, (10 Boxes Of 100), Disposable, Non-Sterile,
Powder-Free, Ambidextrous, 10" Length

96-3160	Small	96-3164	Large
96-3162	Medium	96-3166	X-Large

“Caution: This product contains natural rubber latex, which may cause allergic reaction in some individuals.”

NITRILE SURGICAL/LATEX SURGICAL GLOVES & GLOVE LINERS



- Patented “thermal” responsive formula made from 100% nitrile.
- Ideal for individuals allergic to latex.
- Delivers excellent barrier protection against bloodborne pathogens.
- “Thermal responsive” nitrile compound quickly and comfortably conforms to the contour of the hand, yielding unparalleled tactile perception.
- Features strong puncture resistance without compromising enhanced tactile perception and dexterity.
- Powder free, latex-free and fragrance free.

SKLARTOUCH™ NITRILE SURGICAL GLOVES

Case/100 (25 Pair Per Box), Nitrile Surgical Gloves, Powder Free

96-2100	6	96-2106	7.5
96-2102	6.5	96-2108	8
96-2104	7	96-2110	8.5

Sterile, Hypoallergenic Non-Latex Gloves For Unparalleled Protection, Comfort and Performance

SKLARTOUCH™ LATEX SURGICAL GLOVES

Case/100 (25 Pair Per Box), Powder Free

96-2140	6	96-2146	7.5
96-2142	6.5	96-2148	8
96-2144	7	96-2150	8.5

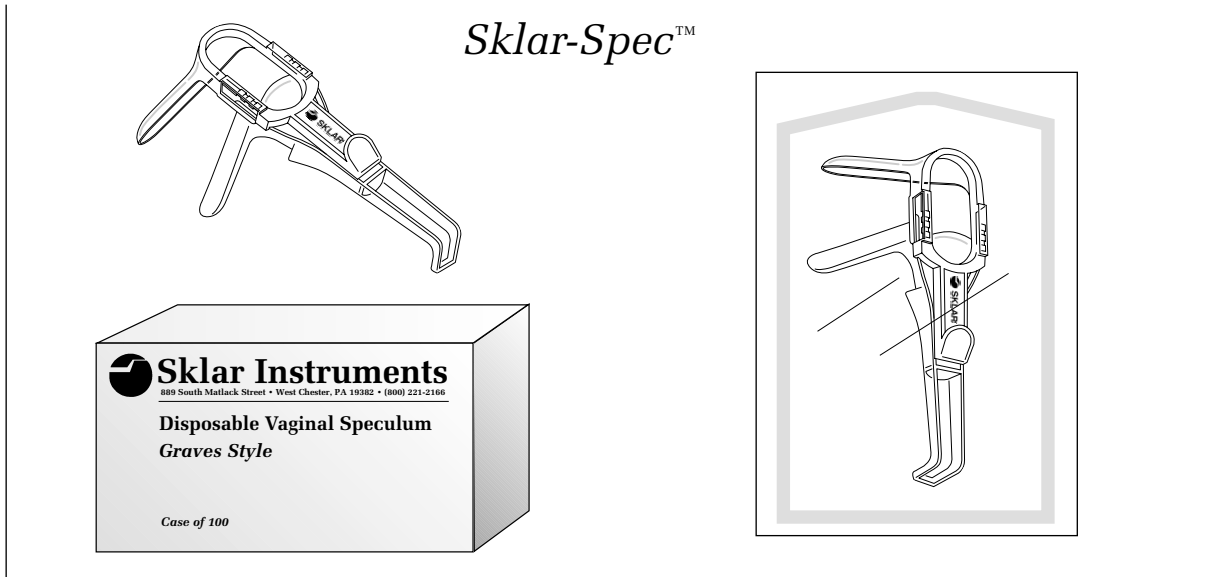
“Caution: This product contains natural rubber latex, which may cause allergic reaction in some individuals.”



SKLAR GLOVE LINERS CUT RESISTANT, STERILE

96-2136 (S)	Box of 10
96-2137 (M)	Box of 10
96-2138 (L)	Box of 10

Sklar Glove Liners are manufactured of high performance fiber to ensure cut resistant hand protection. (Disposable)



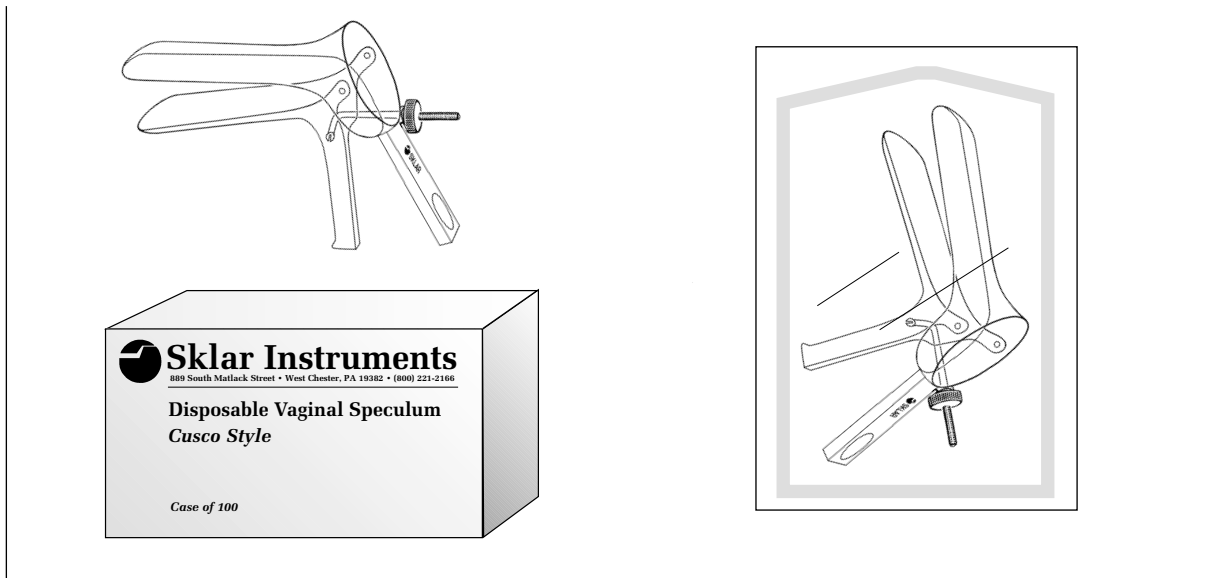
PLASTIC VAGINAL SPECULUM, GRAVES STYLE

Disposable (Non Sterile)

96-0857	Small	Cs/100	10 Packs of 10
96-0867	Medium	Cs/100	10 Packs of 10
96-0877	Large	Cs/100	10 Packs of 10

Disposable (Sterile)

96-2602	Small	Cs/50
96-2604	Medium	Cs/50
96-2606	Large	Cs/50



PLASTIC VAGINAL SPECULUM, CUSCO STYLE

Disposable (Non Sterile)

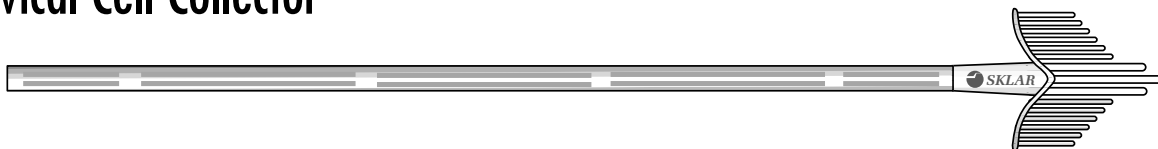
96-0557	Small	Cs/100	10 Packs of 10
96-0567	Medium	Cs/100	10 Packs of 10
96-0577	Large	Cs/100	10 Packs of 10

Disposable (Sterile)

96-2642	Small	Cs/50
96-2644	Medium	Cs/50
96-2648	Large	Cs/50



Cervical Cell Collector



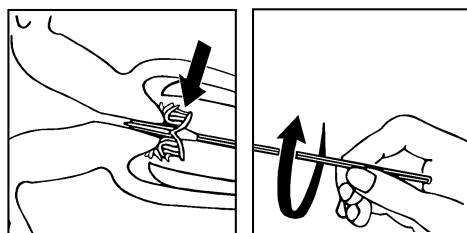
The Sklar Cervex Brush provides the most comprehensive and efficient means of cervical sampling to insure highly accurate Pap test readings. In one step, the Cervex Brush collects the broad spectrum of clinical cells, including the transformation zone, thereby eliminating the more complex brush and spatula approach.

Instructions For Use:

Depending on methodology, record patient information on the patient record card and the appropriate accessory, e.g., microscope slide or transport tube. Do not use lubricant in the vagina prior to cervical sampling with the Sklar Cervex-Brush. Perform vaginal sampling before doing manual examination.

Insert the longest, central bristles of the brush into the endocervical canal. Apply gentle pressure until the shorter, side bristles bend from contact with the ecto-cervix. While maintaining gentle pressure sufficient to keep the side bristles bent, hold the stem between thumb and forefinger and rotate the brush five times in a clockwise direction.

Caution: NEVER REUSE THE SKLAR CERVEX-BRUSH.



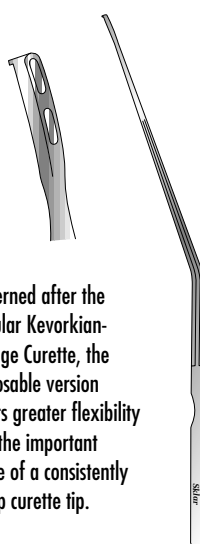
SKLAR CERVEX-BRUSH

96-4140 Box of 100 – Individually Packaged in Sterile Pouches



PAP BRUSH, STANDARD

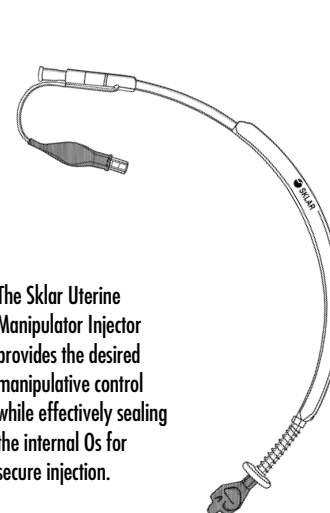
96-4141 Package of 100 Non Sterile



Patterned after the popular Kevorkian-Younger Curette, the disposable version offers greater flexibility and the important value of a consistently sharp curette tip.

ENDOCERVICAL CURETTE

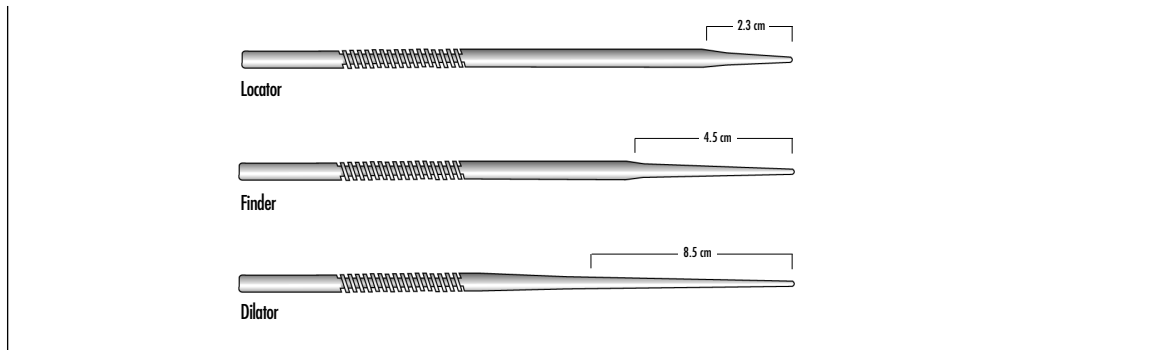
Sterile Box/25
96-4143



The Sklar Uterine Manipulator Injector provides the desired manipulative control while effectively sealing the internal Os for secure injection.

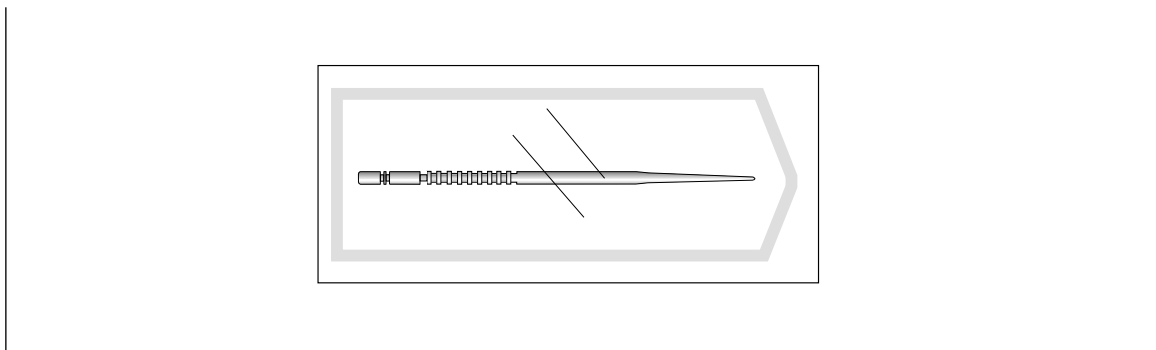
UTERINE MANIPULATOR/INJECTOR, DISPOSABLE

96-4120 Case of 12, Sterile
4.5mm O.D. - 33cm Length



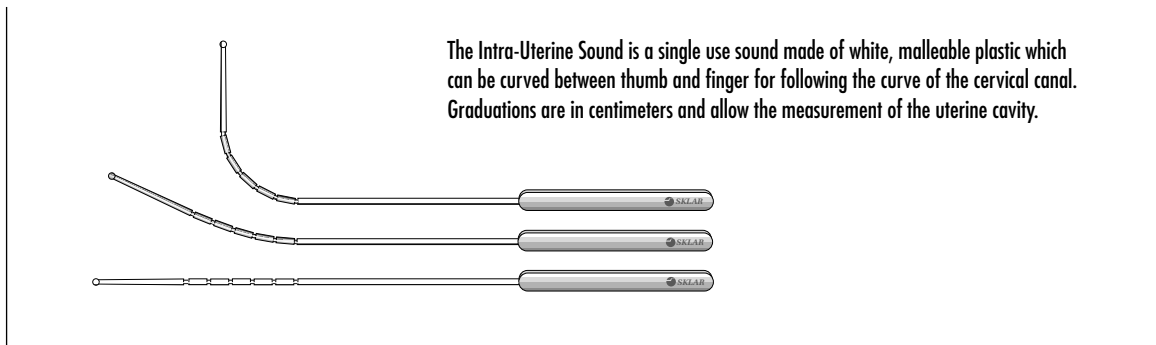
OS DILATOR SET, REUSABLES

Teflon
96-4150 Set of 3 Dilators - Os Locator, Canal Finder, Fundus Dilator



OS DILATOR, DISPOSABLE

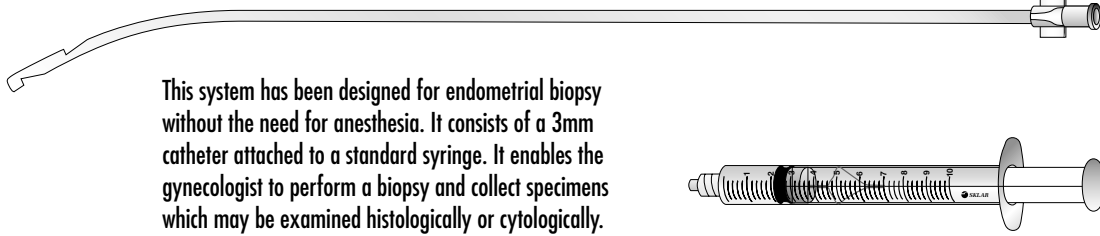
96-4155 Box of 50, Sterile



The Intra-Uterine Sound is a single use sound made of white, malleable plastic which can be curved between thumb and finger for following the curve of the cervical canal. Graduations are in centimeters and allow the measurement of the uterine cavity.

SKLAR INTRA-UTERINE SOUND

Malleable Box/50 Packaged Sterile
96-4170



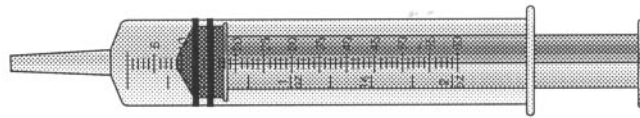
This system has been designed for endometrial biopsy without the need for anesthesia. It consists of a 3mm catheter attached to a standard syringe. It enables the gynecologist to perform a biopsy and collect specimens which may be examined histologically or cytologically.

ENDOMETRIAL SAMPLING SET

Sterile Box/10
96-4160 3mm



The aspiration system employs a 60cc syringe attached to a slightly flexible cannula for simple yet effective uterine aspiration.



ENDOMETRIAL SAMPLING SET WITH 60 CC SYRINGE

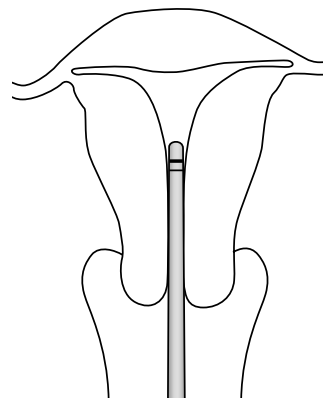
Sterile Box/10
96-4162 4mm
96-4164 5mm
96-4166 6mm



The comfortably thin Sklar endometrial cannula is designed with the correct flexibility to ensure ease-of-introduction. It also allows for accommodation to normal uterine curvature as well as achieving contact with the uterine wall.

This Sklar disposable instrument permits rapid tissue collection with little or no subsequent bleeding or patient discomfort.

The Endometrial Sampling Device of clinical choice provides simple, economical screening of endometrium. It quickly and comfortably extracts histological sample for a variety of evaluations: monitor hormonal therapy, fertility problems, uterine pathogens including endometrial carcinoma.



ENDOMETRIAL CANNULA

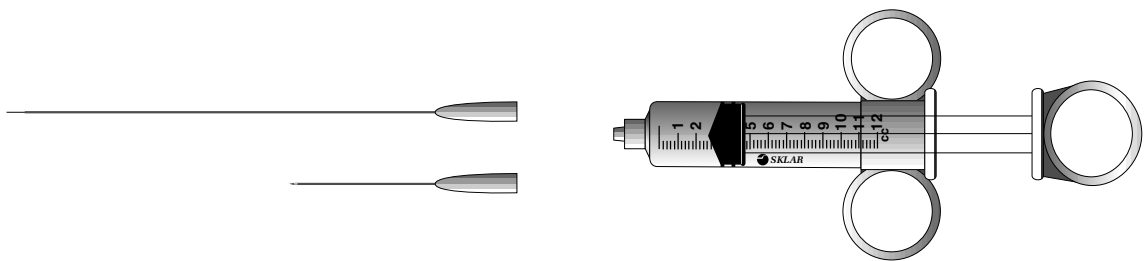
Sterile Box/25
96-4100 For Aspiration Biopsy



The Cervical Needle allows injection to the cervix, overcoming both distance and tissue obstacles. The reinforced and lengthened needle shaft, when fitted to a standard syringe, makes cervical application a simplified procedure.

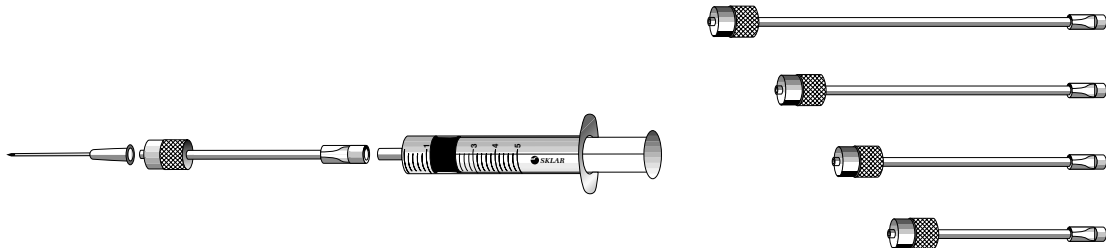
CERVICAL BLOCK NEEDLES

Box of 10, Sterile
 96-4184 27 gauge (tip)
 21 gauge (shaft)



CERVICAL BLOCK NEEDLE KIT

Case of 10, Sterile
 96-4180 Includes:
 Cervical Needle
 Short Needle - 18 Gauge
 Finger Grip Syringe



When adapted to a standard hypodermic syringe the "extended needle" offers greater control over difficult cervical injections.

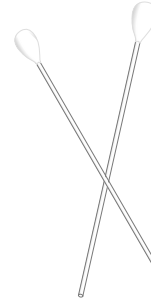
NEEDLE EXTENDERS, REUSABLE

Each
 96-4190 3" 96-4194 5"
 96-4192 4" 96-4196 6"

NEEDLE EXTENDERS, DISPOSABLE PLASTIC LUER LOCK ADAPTER

Each
 96-5190 3" Box/10, Sterile 96-5194 5" Box/10, Sterile
 96-5192 4" Box/10, Sterile 96-5196 6" Box/10, Sterile

GYNECOLOGICAL PRODUCTS, ELECTROSURGERY



A ready-to-use, thickened hemostatic agent which should be applied to the surgical site following excision of diseased tissue or subsequent to a biopsy.

MONSEL'S PASTE

Box/12
96-1200 8ml bottles with applicators



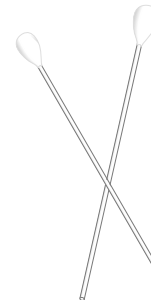
Contents:

2 Lidocaine HCl 2% (5ml Vial)
2 Lidocaine w/Epinephrin HCl 2% (5ml Vial)
Needle, 30 ga. x 1"
Endocervical Needle, 27 ga. x 3/4" Reinf.
Lugol's Iodine Contrast Medium
Monse's Hemostatic Paste

6 8" Cotton Applicator Sticks
Pantyliner
Alcohol Prep Pad
Absorbent Underpad

LLETZ ELECTROSURGERY TRAY - Cs/10

96-1916



A strong iodine contrast medium used for identification of diseased tissue.

LUGOL'S SOLUTION

Box/12
96-1210 8ml bottles with applicators



LLETZ BALL ELECTRODES

Sterile Box/5

96-1040 3mm/0.3cm

96-1045 5mm /0.5cm



LLETZ SQUARE ELECTRODES

Sterile Box/5

96-1090 5 x 5mm/0.5 x 0.5cm

96-1099 10 x 8mm/1.0 x 0.8cm

96-1095 10 x 4mm/1.0 x 0.4cm



LLETZ LOOP ELECTRODES

Sterile Box/5

96-1050 5 x 5mm/0.5 x 0.5cm

96-1060 15 x 8mm/1.5 x 0.8cm

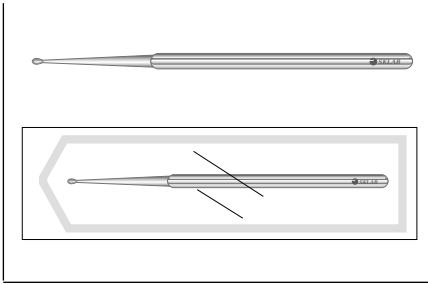
96-1075 20 x 8mm/2.0 x 0.8cm

96-1085 20 x 20mm/2.0 x 2.0cm

96-1055 10 x 10mm/1.0 x 1.0cm

96-1065 15 x 10mm/1.5 x 1.0cm

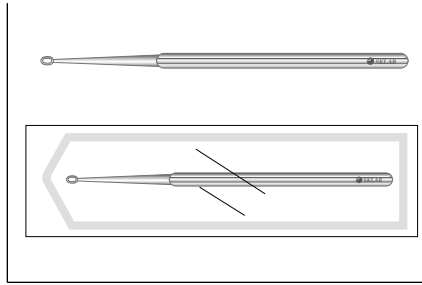
96-1080 20 x 15mm/2.0 x 1.5cm



SKLAR EAR CURETTE

Cup, Disposable (Non-Sterile)
96-1001 Box/50

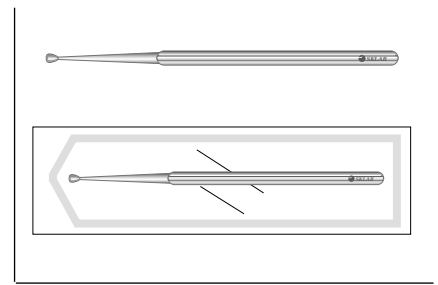
Cup, Disposable (Sterile)
96-1002 Box/50



SKLAR EAR CURETTE

Loop, Disposable (Non-Sterile)
96-1006 Box/50

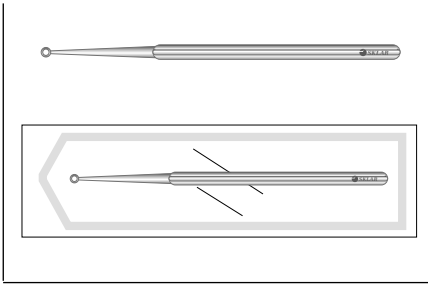
Loop, Disposable (Sterile)
96-1007 Box/50



SKLAR EAR CURETTE

Spoon, Disposable (Non-Sterile)
96-1031 Box/50

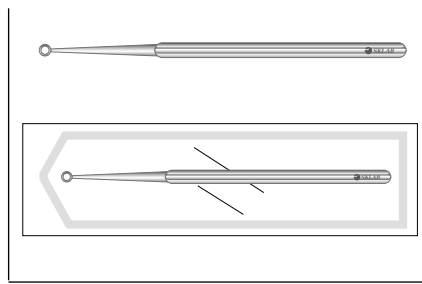
Spoon, Disposable (Sterile)
96-1032 Box/50



SKLAR EAR CURETTE

Child Ring - Medium, Disposable (Non-Sterile)
96-1011 Box/50

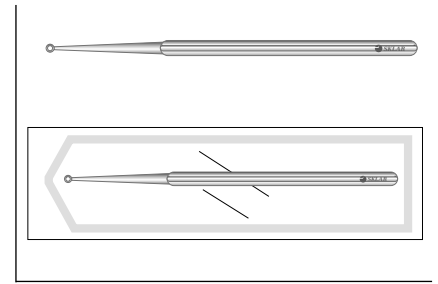
Child Ring - Medium, Disposable (Sterile)
96-1012 Box/50



SKLAR EAR CURETTE

Adult Ring - Large, Disposable (Non-Sterile)
96-1016 Box/50

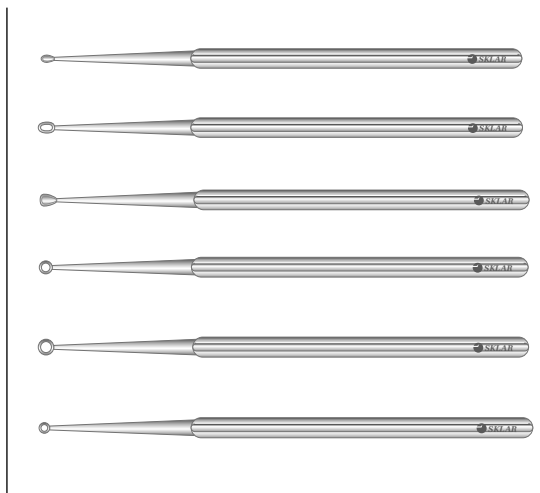
Adult Ring - Large, Disposable (Sterile)
96-1017 Box/50



SKLAR EAR CURETTE

Pedi-Ring - Small, Disposable (Non-Sterile)
96-1021 Box/50

Pedi-Ring - Small, Disposable (Sterile)
96-1022 Box/50



ASSORTED EAR CURETTES

Disposable (Non-Sterile)

96-1035 Box/50, 10 Each of 96-1001, 96-1006, 96-1011, 96-1016, 96-1021

Disposable (Sterile)

96-1036 Box/50, 10 Each of 96-1002, 96-1007, 96-1012, 96-1017, 96-1022



EAR TRAY - Cs/10

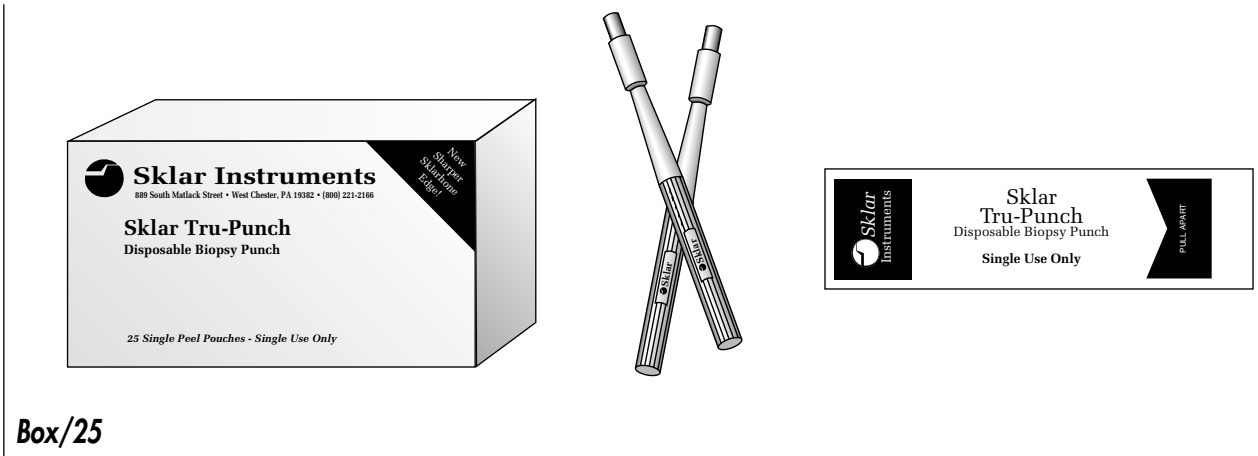
96-1728

Contents:

Bulb Syringe
Calgiswab
Ear Curette, Ring
2 Gauze Sponges
Sterilization Pouch

Ear Forcep
Deep Prep Tray
CSR Wrap

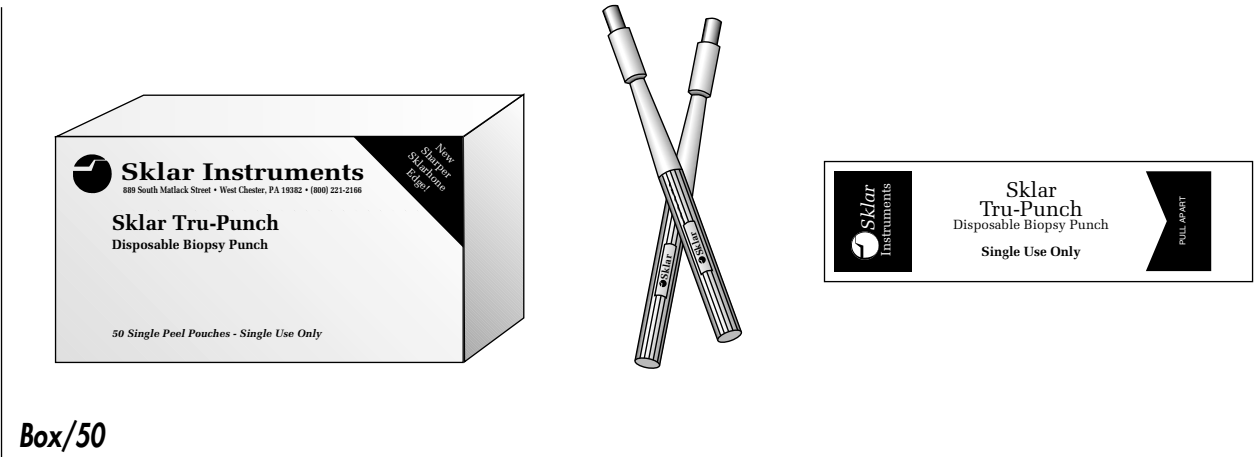
The Sklar Tru-Punch™ has a “seamless” steel tip carefully honed for a razor sharp incision and perfect sample. The ribbed and hollow handle permits tissue to be easily dislodged.



SKLAR TRU-PUNCH™ – DISPOSABLE BIOPSY PUNCH

Box/25, Sterile

96-1140	2mm	96-1148	5mm
96-1142	3mm	96-1150	6mm
96-1144	3.5mm	96-1152	8mm
96-1146	4mm		



SKLAR TRU-PUNCH™ – DISPOSABLE BIOPSY PUNCH

Box/50, Sterile

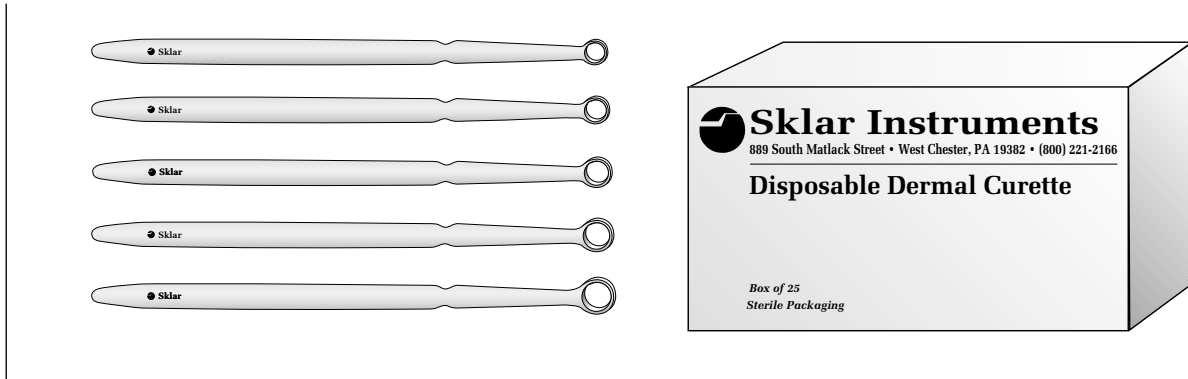
96-1100	2mm	96-1120	5mm
96-1105	3mm	96-1125	6mm
96-1110	3.5mm	96-1130	8mm
96-1115	4mm		

SKLAR TRU-PUNCH™ – DISPOSABLE BIOPSY PUNCH

Box/25, Sterile

96-1160	Assorted (5 of each - 2, 3, 3.5, 4, 5)
---------	---

DISPOSABLES MISCELLANEOUS PRODUCTS



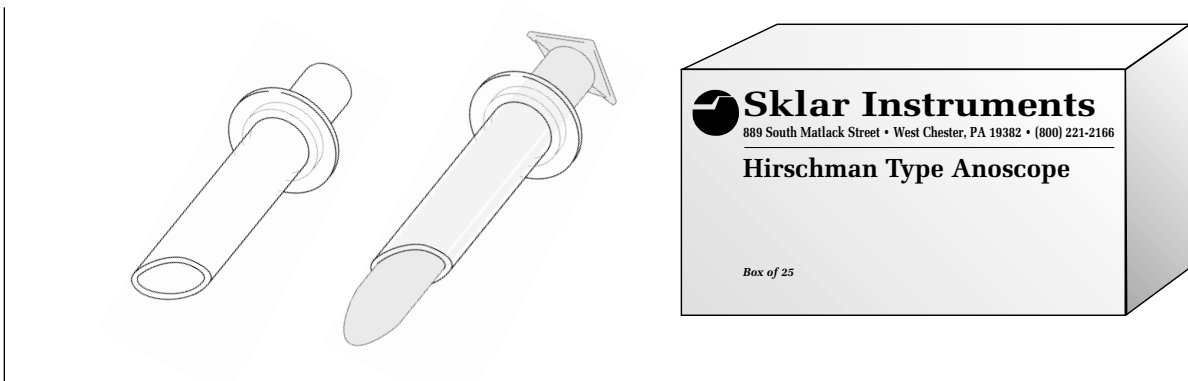
DERMAL CURETTES, DISPOSABLE

Surgical Steel Tip, Box of 25

Individually Packaged in Sterile Pouches

96-1190	2mm	96-1196	5mm
96-1192	3mm	96-1198	7mm
96-1194	4mm	96-1199	Assorted 5 Of Each

The surgical grade steel tip is mounted on a sturdy plastic handle and correctly positioned to efficiently affect curettage.



HIRSCHMAN TYPE ANOSCOPE

96-0910	Medium; Pack of 25
96-0911	Medium; Case of 100

The Sklar disposable anoscope is convenient and easy to use. The transparent material offers a wider field of view during surgery or examination while eliminating the risk of cross infection.

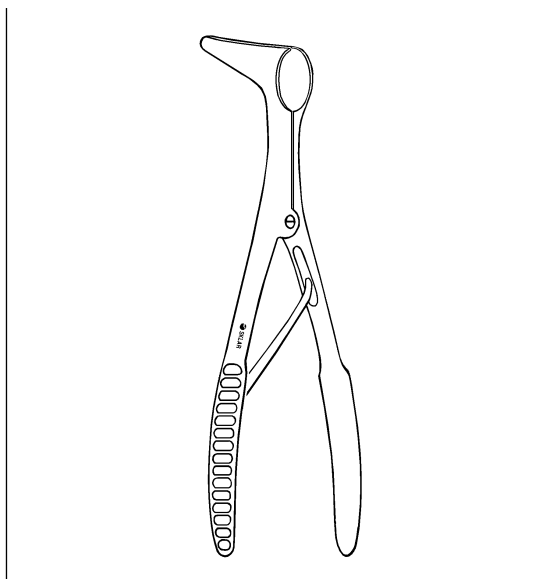


SILICONE LOOPS

2 Loops Per Sterile Pack, 10 Packs Per Box

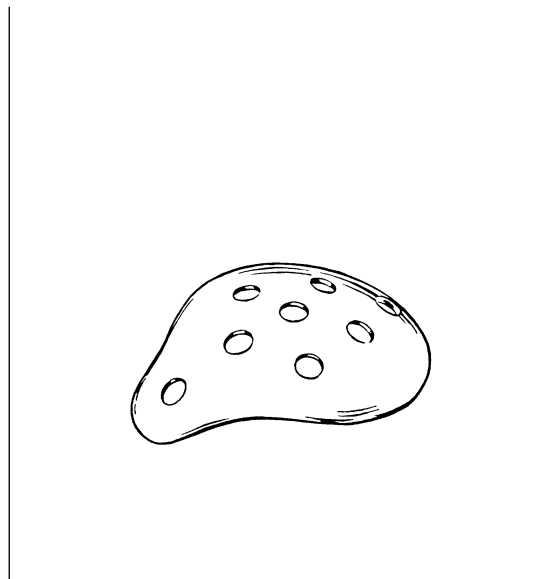
96-1880	Maxi Loops	Red	96-1890	Mini Loops	Red
96-1882	Maxi Loops	Blue	96-1892	Mini Loops	Blue
96-1884	Maxi Loops	Yellow	96-1894	Mini Loops	Yellow
96-1886	Maxi Loops	White	96-1896	Mini Loops	White

Permit a safe and smooth retraction, occlusion or identification of vessels during surgery. As a vascular tie allows for a gentle handling of arteries, veins, nerves, tendons, cords, ureters, or other delicate structures. Sklar loops are made of medical grade silicone and are radiopaque. These 16" loops are non-latex.



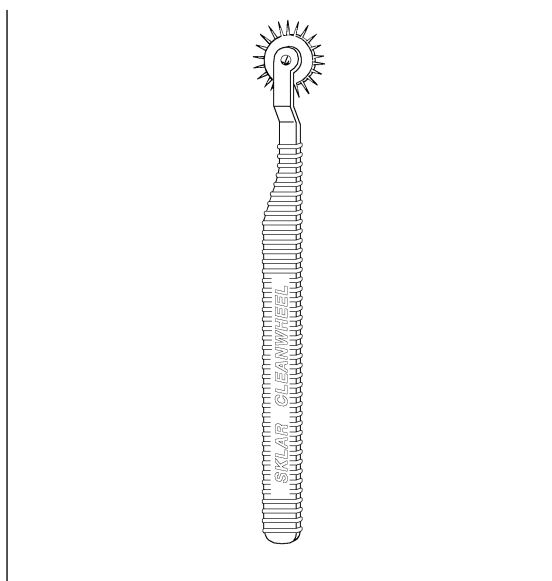
**NASAL SPECULUM,
DISPOSABLE**

Pack/48, Plastic
96-0670 6¼"



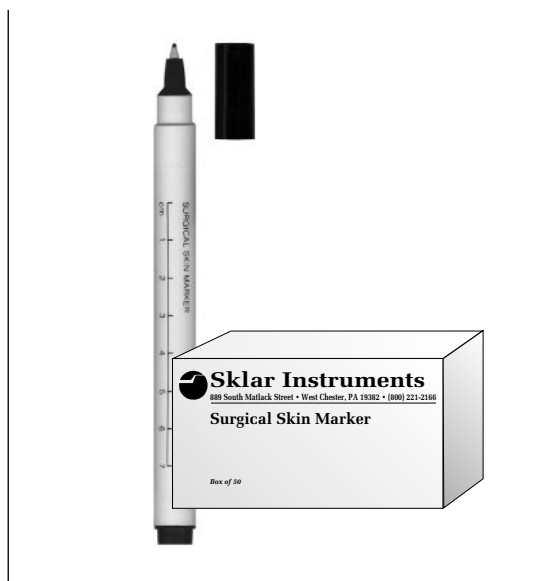
DISPOSABLE EYE SHIELD

Plastic
96-1070 Each
96-1071 Dozen



**DISPOSABLE CLEANWHEEL
(PINWHEEL)**

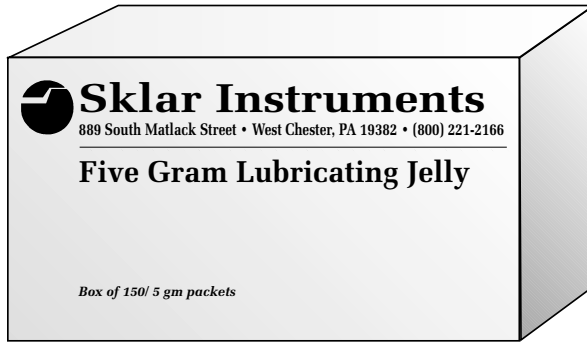
96-7906 Pack/12
96-7907 Pack/144



SKIN MARKER

Standard Tip, Sterile
10-1440 Box/50

DISPOSABLES LUBRICATION JELLY



Sklar lubrication jelly is ideal for use with surgical instruments. It is water soluble and very useful as a general purpose lubricating jelly in the hospital and all professional settings. Non-irritating formula.

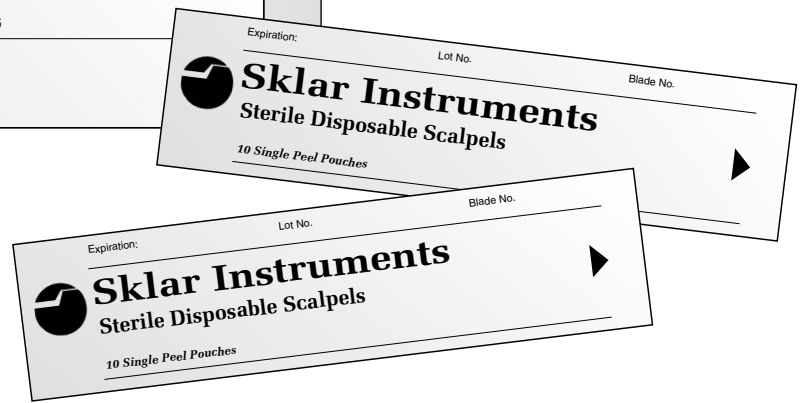
LUBRICATION JELLY

96-1610 Box 150/5gm packets Case/4
96-1612 Box 150/5gm packets



LUBRICATION JELLY

96-1615 4 oz. bottles Case/48
96-1616 4 oz. bottles Box/4

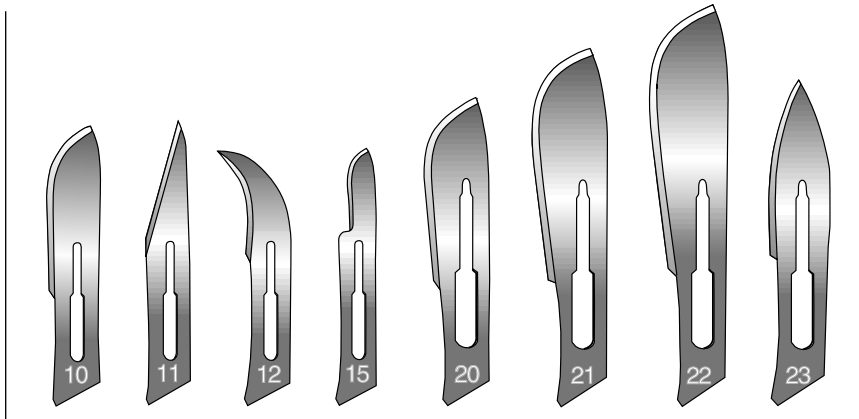


DISPOSABLE SCALPEL - Sterile, Pack of 10

06-3110 #10	06-3112 #12	06-3120 #20	06-3122 #22
06-3111 #11	06-3115 #15	06-3121 #21	06-3123 #23

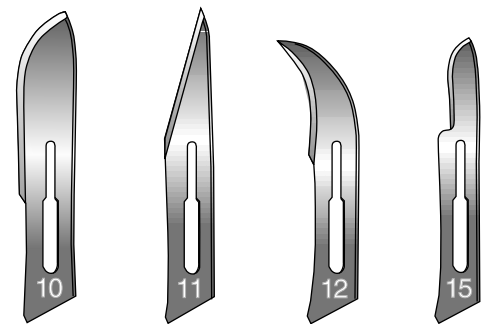
Sklar single-use scalpels feature surgical grade stainless steel blades mounted on a contoured plastic handle. Each English steel blade is packaged in a clear plastic peel pouch and available 10 in a box.

BLADES, DISPOSABLE



DISPOSABLE CARBON STEEL SURGICAL BLADES - Sterile, Box of 100

06-3010	#10	06-3020	#20	Securely and safely packaged in heavy foil and packed in a dispenser box of 100 blades.
06-3011	#11	06-3021	#21	
06-3012	#12	06-3022	#22	
06-3015	#15	06-3023	#23	



DISPOSABLE STAINLESS STEEL SURGICAL BLADES - Sterile, Box of 100

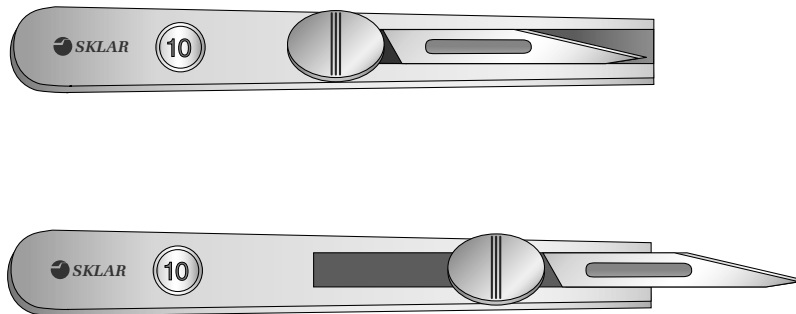
06-3100	#10	06-3104	#20
06-3101	#11	06-3105	#21
06-3102	#12	06-3106	#22
06-3103	#15	06-3107	#23

ADDITIONAL SURGICAL CONTROL WITH RIGID-CUT BLADES, STAINLESS STEEL

Sterile, Box of 50

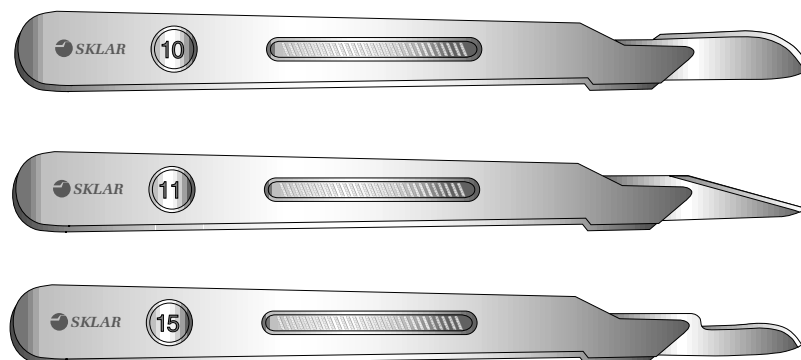
06-3070	#10	06-3076	#20
06-3071	#11	06-3077	#21
06-3072	#12	06-3078	#22
06-3075	#15	06-3079	#23

• A reinforced dorsal edge reduces flexing and blade distortion.



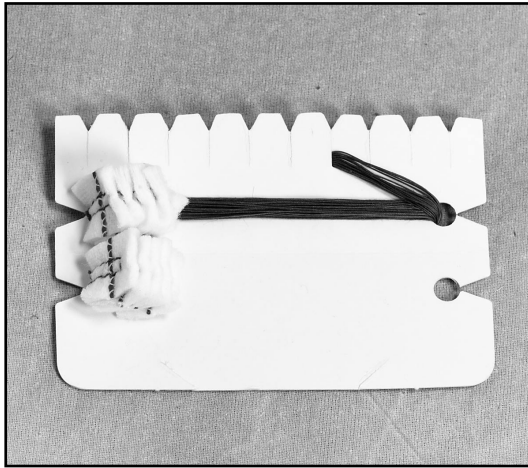
SKLARSAFE™ PROTECTIVE SCALPELS - Sterile, Box of 10

06-3094 #10
06-3095 #11
06-3096 #15



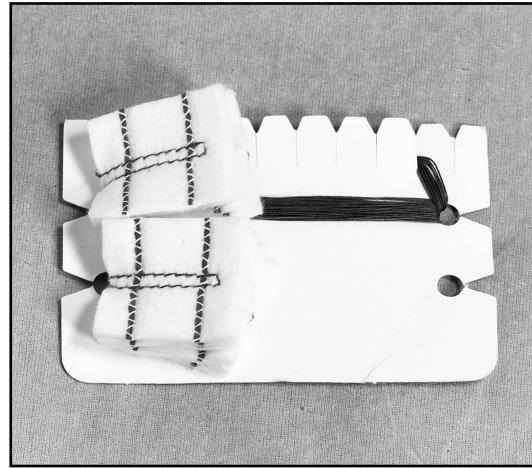
ECONOMY STAINLESS STEEL SURGICAL SCALPELS, DISPOSABLE - Sterile, Box of 10

21-810 #10
21-811 #11
21-815 #15



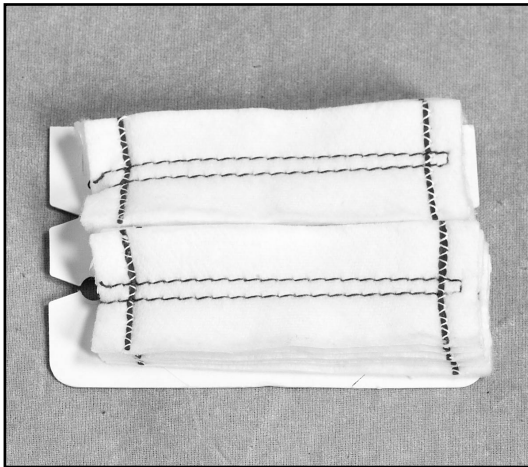
NEURO SPONGES

Sterile Box/200 - 10/Accountability Card
96-1750 1/2" x 1/2" (12.7 mm x 12.7 mm)



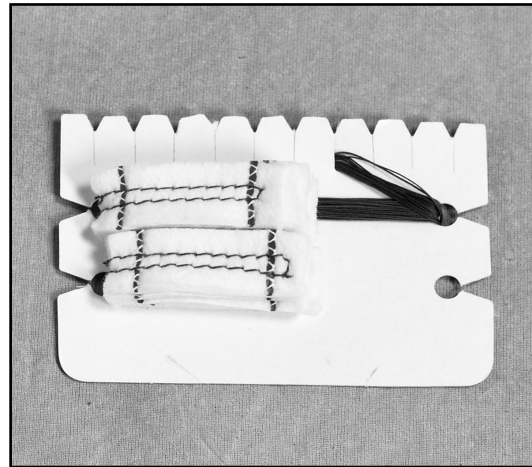
NEURO SPONGES

Sterile Box/200 - 10/Accountability Card
96-1752 1" x 1" (25.4 mm x 25.4 mm)



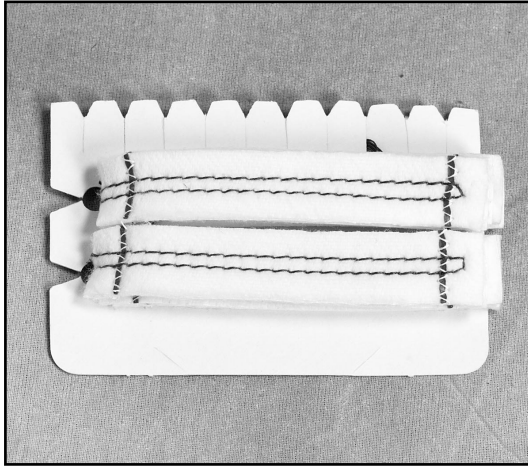
NEURO SPONGES

Sterile Box/200 - 10/Accountability Card
96-1754 1" x 3" (25.4 mm x 76.2 mm)



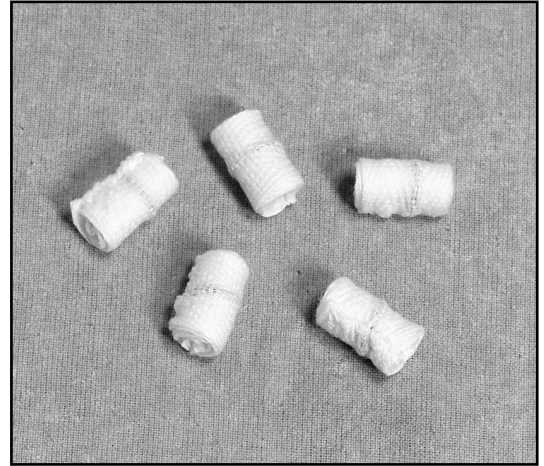
NEURO SPONGES

Sterile Box/200 - 10/Accountability Card
96-1756 1/2" x 1 1/2" (12.7 mm x 38.1 mm)



NEURO SPONGES

Sterile Box/200 - 10/Accountability Card
96-1758 $\frac{1}{2}$ " x 3" (12.7 mm x 76.2 mm)



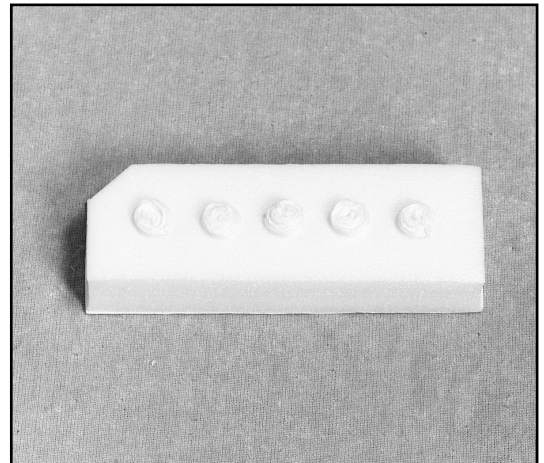
"K" DISSECTOR SPONGES

Sterile Box/200 - 5/Tray
96-1760 $\frac{1}{4}$ " x $\frac{3}{16}$ " (6.35 mm x 14.29 mm)



"K" DISSECTOR SPONGES

Sterile Box/200 - 5/Plastic Holder
96-1762 $\frac{1}{4}$ " x $\frac{3}{16}$ " (6.35 mm x 14.29 mm)



"K" DISSECTOR SPONGES

Sterile Box/200 - 5/Foam Holder
96-1764 $\frac{1}{4}$ " x $\frac{3}{16}$ " (6.35 mm x 14.29 mm)



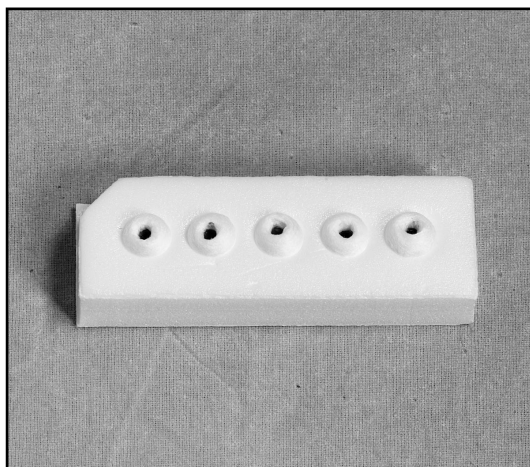
PEANUT SPONGES

Sterile Box/200 - 5/Plastic Holder
96-1766 $\frac{3}{8}$ " (9.53 mm)



PEANUT SPONGES

Sterile Box/200 - 5/Foam Holder
96-1768 $\frac{3}{8}$ " (9.53 mm)



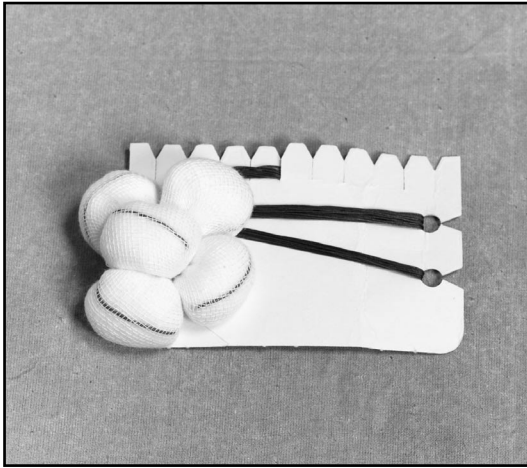
CHERRY SPONGES

Sterile Box/200 - 5/Foam Holder
96-1770 $\frac{3}{8}$ " (9.53 mm)



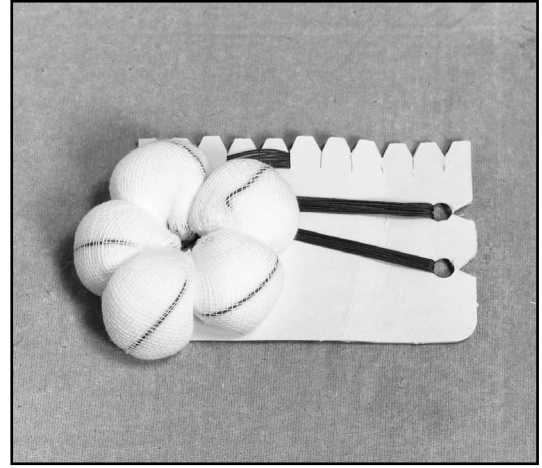
ROSEBUD SPONGES

Sterile Box/200 - 10/Accountability Card
96-1772 $\frac{1}{4}$ " (6.35 mm)



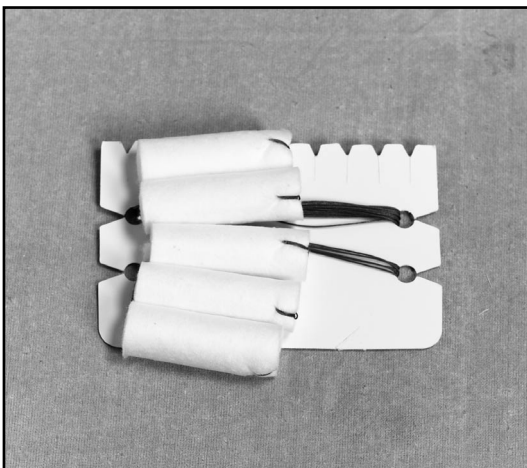
TONSIL SPONGES

Sterile Box/100 - 5/Accountability Card
96-1774 Medium



TONSIL SPONGES

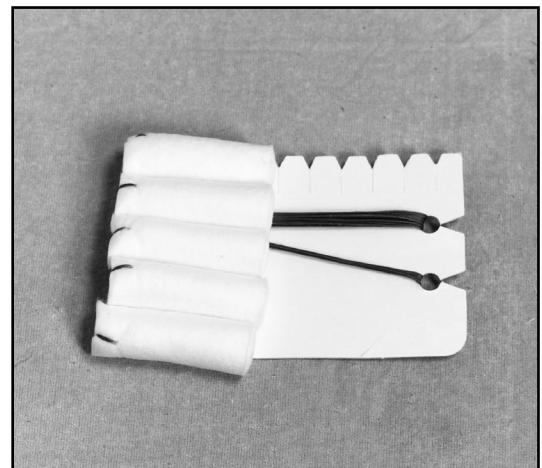
Sterile Box/500 - 5/Accountability Card
96-1775 Large



CYLINDRICAL SPONGES

END STRUNG

Sterile Box/100 - 5/Accountability Card
96-1776 $\frac{1}{2}$ " x $1\frac{1}{2}$ " (12.7 mm x 38.1 mm)



CYLINDRICAL SPONGES

CENTER STRUNG

Sterile Box/100 - 5/Accountability Card
96-1777 $\frac{1}{2}$ " x $1\frac{1}{2}$ " (12.7 mm x 38.1 mm)

INSTRUMENT IDENTIFICATION & NON-LATEX PROTECTORS



Box of 100 96-1400 Maroon
11.0 mm
 $\frac{1}{32}$ " x $\frac{3}{4}$ "

Box of 100 96-1402 Yellow
6.0 mm
 $\frac{3}{16}$ " x 1"

Box of 100 96-1410 White
1.5 mm
 $\frac{1}{16}$ " x $\frac{3}{4}$ "

Box of 100 96-1404 Red
4.0 mm
 $\frac{1}{8}$ " x 1"

Box of 100 96-1412 Black
25 X 3.0 mm
 $\frac{1}{8}$ " x 1" x 1"

Box of 100 96-1406 Green
3.0 mm
 $\frac{7}{64}$ " x $\frac{3}{4}$ "

Box of 100 96-1414 Brown
18 X 3.0 mm
 $\frac{5}{64}$ " x $\frac{5}{8}$ " x 1"

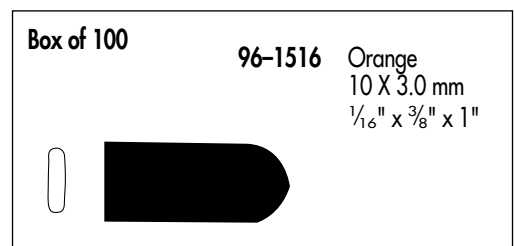
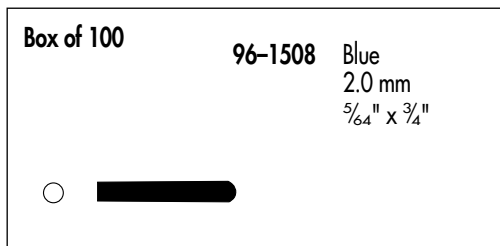
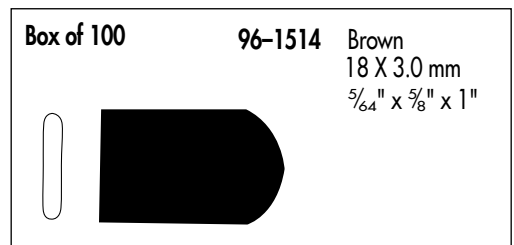
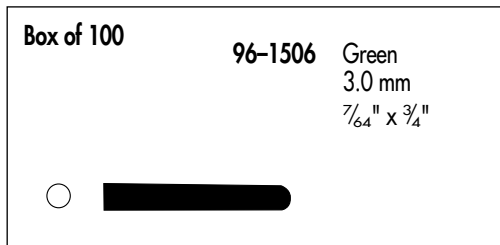
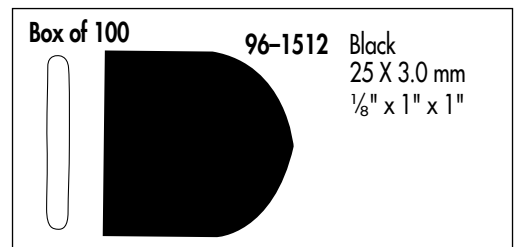
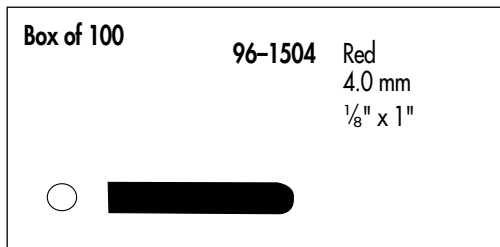
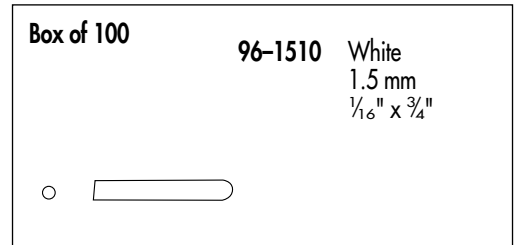
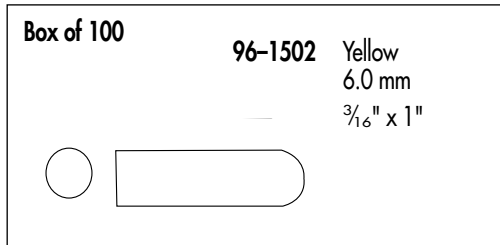
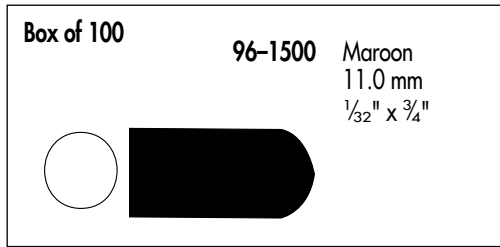
Box of 100 96-1408 Blue
2.0 mm
 $\frac{5}{64}$ " x $\frac{3}{4}$ "

Box of 100 96-1416 Orange
10 X 3.0 mm
 $\frac{1}{16}$ " x $\frac{3}{8}$ " x 1"

SKLARTIP™ INSTRUMENT PROTECTORS - VENTED

Box of 100 Color Coded Sizes

SklarTip™ Instrument Protectors are a convenient, color-coded way to protect surgical instrument tips and edges. SklarTip™ Instrument Protectors provide exceptional protection, as they are steam permeable, autoclavable, and stretch to fit a wide variety of instrument shapes and sizes.

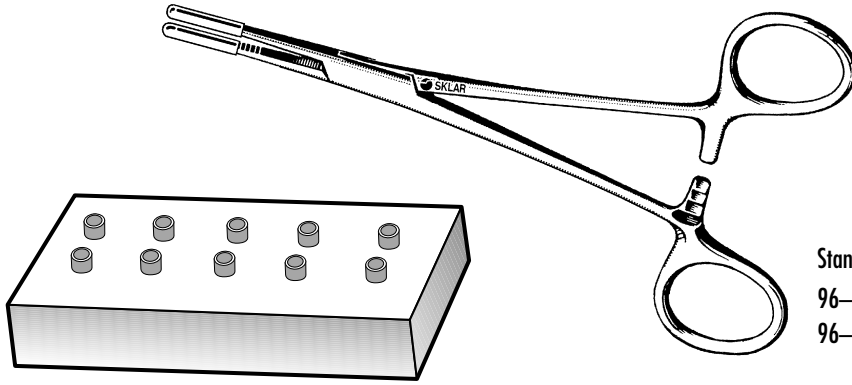


SKLARTIP™ INSTRUMENT PROTECTORS - NON-VENTED

Box of 100 Color Coded Sizes

SklarTip™ Instrument Protectors are a convenient, color-coded way to protect surgical instrument tips and edges. SklarTip™ Instrument Protectors provide exceptional protection, as they are steam permeable, autoclavable, and stretch to fit a wide variety of instrument shapes and sizes.

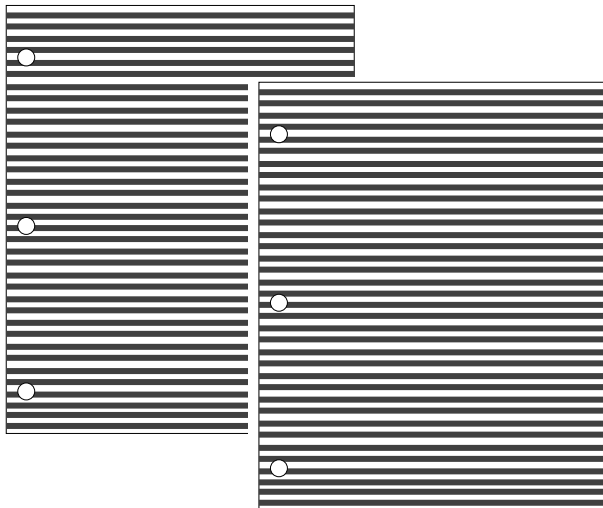
INSTRUMENT IDENTIFICATION



Standard Yellow
96-1550 Mini Package (3 pair)
96-1552 Standard Package (5 pair)

BOOTS

Color-coded Sklar Boots eliminate the use of cut tubing and catheters, while providing a firmer grip for tagging sutures. Conveniently sterile-packed, radiopaque and non-toxic, Sklar Boots will not damage even the most delicate suture materials.



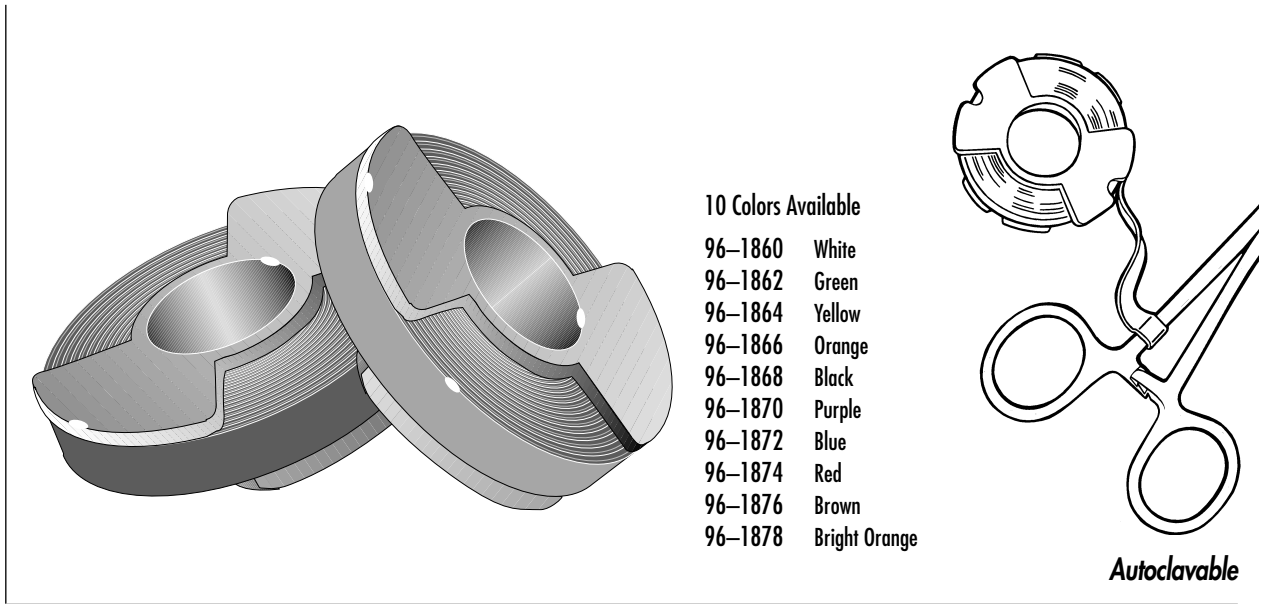
9 Colors with White Strips

96-1845 Dark Blue w/White Stripes
96-1846 Dark Green w/White Stripes
96-1847 Red w/White Stripes
96-1848 Yellow w/White Stripes
96-1849 Orange w/White Stripes
96-1850 Brown w/White Stripes
96-1851 Lavender w/White Stripes
96-1852 Light Blue w/White Stripes
96-1853 Pink w/White Stripes

Autoclavable

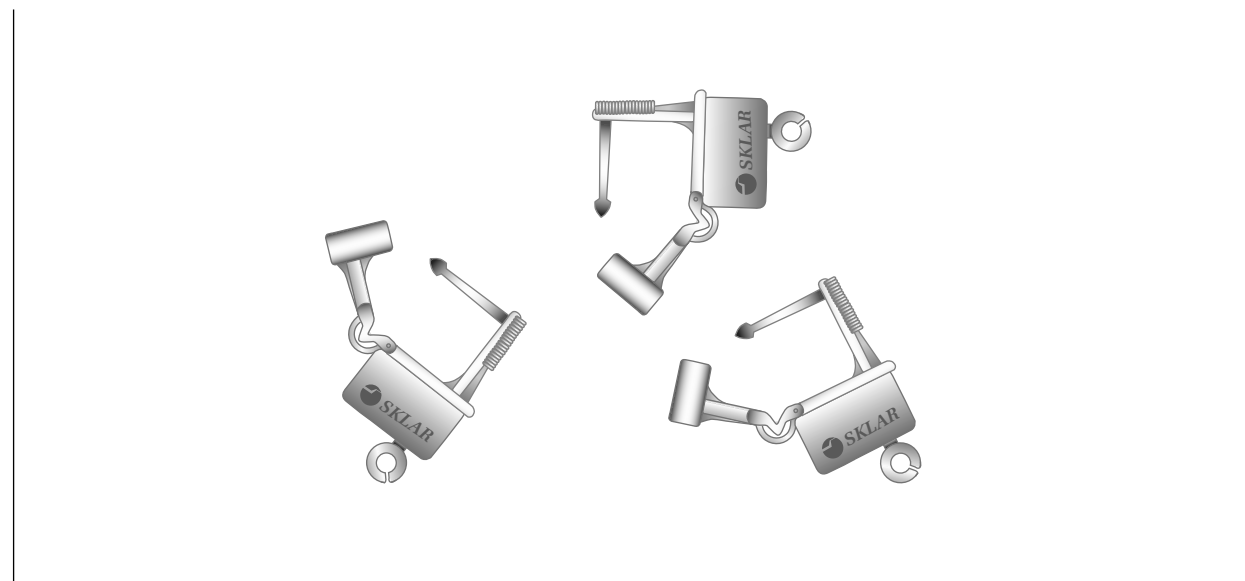
ID SHEET TAPE

Color coding is convenient with Sklar ID Sheet Tape. There are many combinations of tapes fixed to an easily removed backing. Each 8½" x 11" Sheet contains 374" of tape. Lasts through many autoclaving and gas sterilizing procedures.



ID ROLL TAPE

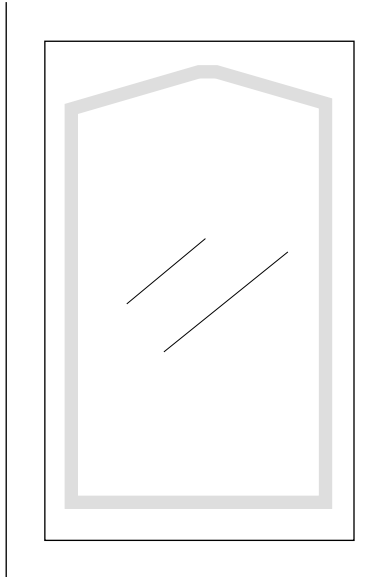
Sklar ID Roll Tape is a convenient color coding tape to make instruments easily recognized. It's autoclavable, available in 10 colors. Each roll contains 300" and is 1/4" wide. Lasts through many autoclaving and gas sterilizing procedures.



INSTRUMENT ID TAGS

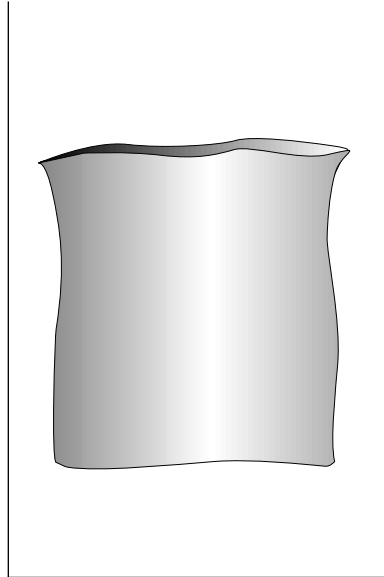
Plastic Identification Tags for Serviced Instruments and Equipment

96-1900	Repair Tag	Red	Pack of 100
96-1901	Repair Tag	Red	Case of 1,000
96-1905	Sharpen Tag	Blue	Pack of 100
96-1906	Sharpen Tag	Blue	Case of 1,000



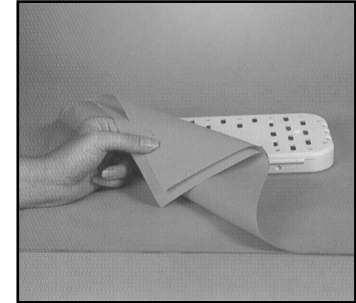
STERILE POUCHES

Heat Sealed 200/Box		Self Sealed 200/Box	
10-1928	3½" x 8½"	10-1933	3½" x 8"
10-1930	6" x 10"	10-1934	5¼" x 10"
10-1931	7½" x 13"	10-1935	7½" x 13"
10-1932	10" x 15"	10-1937	12" x 15"



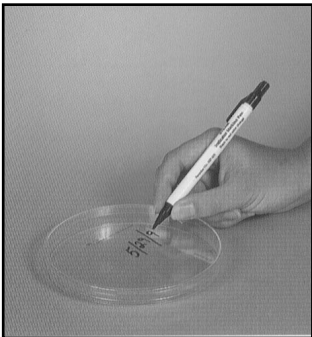
DUST COVERS

Heat Sealed 250/Box	
10-1915	8" x 12"
10-1916	10" x 15"
10-1917	16" x 22"
10-1918	24" x 30"



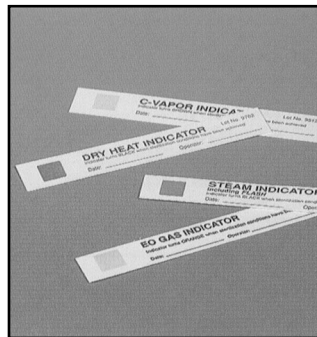
DISPOSABLE CSR WRAP

Cs/100		Cs/250	
10-1101	45" x 45"	10-1104	12" x 12"
10-1102	54" x 54"	10-1105	15" x 15"
Cs/150	36" x 36"	10-1106	18" x 18"
		10-1107	20" x 20"
		10-1108	24" x 24"
10-1109	30" x 30"		



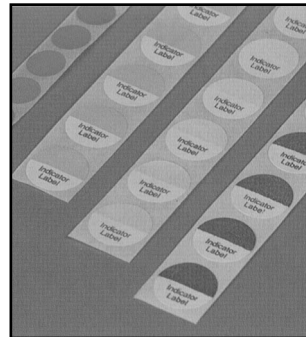
STEAM INDICATOR PEN

10-1114 1 Each



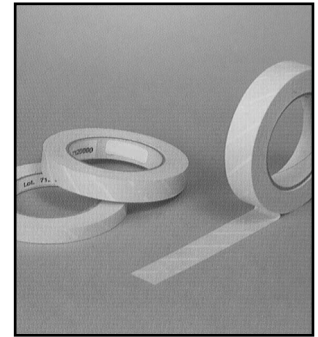
INDICATOR STRIPS 4"

Box/100	
10-1115	EO Gas
10-1117	Dry Heat
10-1119	C-Vapor
Box/250	
10-1113	Steam



INDICATOR LABELS

Roll/1000	
10-1120	EO Gas
10-1122	Dry Heat
10-1124	C-Vapor
10-1126	Steam



INDICATOR TAPES

10-1130	Steam	1/2" x 60 yds.
10-1131	Steam	3/4" x 60 yds.
10-1132	Steam	1" x 60 yds.
10-1133	EO Gas	3/4" x 60 yds.
10-1134	Dry Heat	3/4" x 60 yds.
10-1135	C-Vapor	3/4" x 60 yds.

Surgical Instrument Decontamination and Cleaning ***AS EASY AS ABC!***

A. *Decontaminating—* **SKLAR SOAK™**

The use of SKLAR SOAK™ for 10 minutes substantially reduces the risk of exposure to many infectious organisms including TB, and viruses including HIV-1 (Aids Virus), bacteria and fungi. Pre-cleaning and disinfecting soiled instruments in one step prior to handling is safer and more efficient. The formula includes a proprietary series of surfactants, solvents and sequestering agents that combine synergistically to quickly break down protein and penetrate the target organisms. Environmentally friendly, SKLAR SOAK™ meets all OSHA standards for blood borne pathogen destruction and is an EPA registered disinfectant. SKLAR SOAK™ contains no dangerous phenols that require skin, eye or respiratory protection and is approved for stainless steel instruments, plastic, chrome, rubber, and glass. The unique combination of ingredients speeds the cleaning process.



B. *Cleaning—* **SKLAR KLEEN™**

SKLAR KLEEN™ is specially formulated for both manual and ultrasonic cleaners; and is safe for metals, plastic, glassware and rubber. Available as a liquid and in powdered form, the superior wetting power of SKLAR KLEEN™ penetrates crevices to lift away organic debris.

SKLAR KLEEN LF™ (Low Foam) is designed for use in mechanical washers, disperses quickly, and is well suited for automatic injection systems. SKLAR KLEEN LF™ is available in liquid form and is an especially effective and economical liquid cleaner for surgical instruments and laboratory glassware.



C. *Lubrication—* **SKLAR LUBE™** *with Rust Inhibitor!*

(Not recommended with dry heat)

Regular use of SKLAR LUBE™ in your cleaning regimen will help extend the life of surgical instruments. It's concentrated! One gallon makes 7 gallons of lubricant. Simply immerse entire instrument in SKLAR LUBE™, no need to concentrate only on moving parts. SKLAR LUBE™ is a water soluble, non-oil based and non-silicone solution. Its effective formula keeps instruments looking and operating like new. Instruments go directly from SKLAR LUBE™ to the autoclave without rinsing or wiping.



D. **STERILIZE** SKLAR recommends autoclaving.



Step A. **Sklar Soak™** *Disinfectant/Decontaminant*

The use of SKLAR SOAK™ for 10 minutes substantially reduces the risk of exposure to many infectious organisms including TB, and viruses such as HIV-1 (Aids Virus), bacteria and fungi.

- **Non-caustic formula.**
- **Effective against HIV-1 (Aids Virus), TB, bacteria and fungi.**
- **EPA registered.**
- **Meets all OSHA standards on blood borne pathogen destruction.**

NON-GLUTARALDEHYDE!

Sklar Soak™

Liquid

10-1603

Case of 4 Gallons

	<i>Effective</i>	<i>Non-Caustic</i>	<i>No Special Handling or Disposal</i>	<i>Non-Irritating</i>
Sklar Soak™	Yes	Yes	Yes	Yes
<i>Glutaraldehydes</i>	<i>Yes</i>	<i>No</i>	<i>No</i>	<i>No</i>
<i>Phenols</i>	<i>Sometimes</i>	<i>No</i>	<i>No</i>	<i>No</i>
<i>Chlorine</i>	<i>Sometimes</i>	<i>No</i>	<i>No</i>	<i>No</i>

Step B. Cleaning

Sklar Recognizes That User Requirements Vary, Therefore, Sklar Offers Four Custom Detergent Formulations.

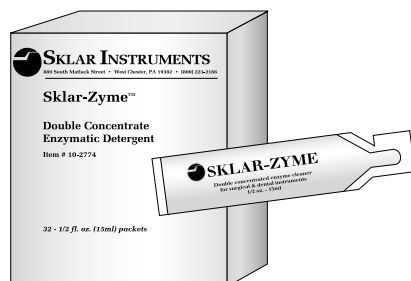
- Sklar Enzymatic™
- Sklar Kleen Powder™
- Sklar Kleen Liquid™
- Sklar Kleen LF (Low Foam)™

Sklar Enzymatic™ ***Multi-Enzyme Detergent Concentrate***

Rapidly dissolves organic debris on instruments and clothes.

SKLAR ENZYMATIC™ DETERGENT is a low-foaming, quick cleaning detergent specifically designed for use in areas where instruments and/or cloth materials may become soiled with organic debris. SKLAR ENZYMATIC™ DETERGENT may be used as a manual instrument cleaner; as a pre-soak for blood-contaminated linens, clothing and instruments; in ultrasonic units; and in washer/sterilizer/decontaminators. It contains no animal enzymes and maintains a pleasant odor. It contains four enzymes and three enhancers that make it exceptionally effective in breaking down protein, blood and fat from lumens, box locks and channels. When used as directed, the enzymatic's pH neutral formula is safe for use on rubber, plastic, stainless steel instruments, surgical equipment as well as linens, etc. It is 100% biodegradable, is not a carcinogen, and may be used in temperatures up to 180°F.

Sklar Enzymatic™ - 10-2777 Case of 4 Gallons



Sklar-Zyme Enzymatic Detergent

10-2774

Box of 32 1/2 oz. Pouches

- Double Concentrate Enzymatic Detergent
- Each Packet Produces One Gallon Enzymatic



Sklar Kleen™

For Hand and Ultrasonic Cleaning

Specially formulated for both hand and ultrasonic cleaning, SKLAR KLEEN™ provides superior wetting power to penetrate locks, serrations and crevices of surgical instruments, glassware, plastics and rubber.

Sklar Kleen Powder™

The pH balanced formula of SKLAR KLEEN™ is an excellent way to reduce or eliminate the effects of corrosive minerals that are inherent in virtually all communities' water supplies. One 3¼ pound container makes in excess of 150 gallons of cleaning solution.

Sklar Kleen Liquid™

SKLAR KLEEN LIQUID™ is non-corrosive, non-aggressive, phosphate free and biodegradable. We have specifically developed SKLAR KLEEN LIQUID™ for manual and ultrasonic cleaning.

It is moderately alkaline, affording optimum cleaning without etching glassware or attacking instrument metal. Concentrated.

SKLAR KLEEN LIQUID CONCENTRATE

10-1612 Case of 6 8 oz.
10-1613 Case of 4 Gallons

SKLAR KLEEN

Powder

10-1607 5 Lb. Pail
10-1608 Case of 4 - 5 Lb. Pails

SKLAR KLEEN

Powder

10-1630 Case of 6 - 3¼ Lb. Pitchers

Sklar Kleen LF™

Low Foam-For Washers

SKLAR KLEEN LF™ (Low Foam) is an especially effective and economical liquid cleaner for surgical instruments and laboratory glassware. SKLAR KLEEN LF™ maintains a low foam level to assure efficient and trouble-free action in instrument washer/sterilizers and tunnel washers. The low, non-aggressive pH (7.5 ± 0.5) is non-corroding to surgical instrumentation and will not etch glassware. SKLAR KLEEN LF™ concentration and viscosity are maintained to disburse quickly and are well suited for automatic injection systems. SKLAR KLEEN LF™ is highly concentrated, 1/6 oz. (5 ml.) per gallon of water, and provides a very cost-effective solution.

SKLAR KLEEN LF

Liquid Concentrate

10-2701 Case of 4 Gallons





Step C.

Sklar Instru-Guard Lube™ *Extends Instrument Life And Performance*



SKLAR LUBE™ is an easy-to-use, water soluble, non-silicone lubricant and rust inhibitor. When used daily as a second rinse after every cleaning, it keeps box locks operating smoothly, is effective even after autoclaving, and leaves no oily residue.

Regular lubrication is essential no matter which cleaning method is employed (including ultrasonic). SKLAR LUBE™ is ideal for maintaining instrument quality and performance.

SKLAR LUBE™

- 10-1636 Case of 12-8 Oz. Ready To Use Spray Bottles
- 10-1635 Case of 4 Gallons-Concentrated

No Steel is Truly "Stainless"

It's a fact that so-called stainless steel is subject to both water-spotting and staining. However what many people identify as a "rust" problem usually turns out to be something else.

Most often the problem is actually a stain caused by a surface deposit. These deposits appear in a variety of colors depending upon the type of deposit involved. Once the cause is found and eliminated, most of the time the problem quickly diminishes or disappears completely.

As you probably know, stainless steel is ideally suited for the surgical suite because it is rust resistant, it can be honed to an extremely sharp edge or fine point, and it can be hardened to maintain the delicate, yet precise, requirements of the surgeon. But it is this hardenable quality – the amount of carbon used during the manufacturing process – coupled with harsh chemicals and improper care that renders stainless steel susceptible to corrosion.

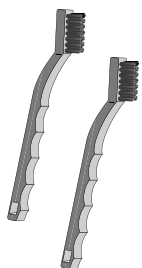
Sklar products are specially formulated to provide cost effective instrument care.

Step D. Sklar Recommends Autoclaving

Sklar Cleaning Accessories

Instrument Cleaning Brush

- | | | |
|------------------------|--------------------|--|
| Stainless Steel | Nylon | |
| 10-1650 Pack of 3 | 10-1651 Pack of 3 | |
| 10-1652 Pack of 12 | 10-1657 Pack of 12 | |
| Disposable | | |
| 10-1465 Pack of 12 | | |
| 10-1468 Pack of 24 | | |



Sklar Polish™

Is The Answer To Tough Stains And Tarnish

Sklar Polish™ is safe for all your stainless steel, chrome, nickel, brass, instrument trays, basins and racks. It also works well on all porcelain and tile surfaces.

The true value in regular Sklar Polish™ use is that it removes minerals from your instruments and other metal surfaces without changing the surface qualities of the items.

- 10-1626 Case of 12-8 Oz. Jars
- 10-1629 Case of 6-8 Oz. Jars



SKLAR INSTRU-GUARD™

ONE-STEP INSTRUMENT CLEANER & LUBRICANT



This multi-purpose cleaner is chemically engineered for use as a presoak, for manual cleaning and in washer/sterilizers, washer/decontaminators, manual systems, ultrasonic cleaners, and cart washers.



Eliminates Milking—

A special penetrating lubricant is blended into the formula, protecting the instruments and extending their life.

Cleaner & Brighter Instruments, Fast—

The detergents and emulsifiers quickly break up and remove organic soils from box locks and other hard-to-reach places, virtually restoring the feel of a new instrument.

Removes Stains, Blood, Rust and Mineral Deposits—

Sklar Instru-Guard™ One-Step Instrument Cleaner & Lubricant contains four rust inhibitors to control corrosion and eliminate scaling and spotting.

Biodegradable—

Does not contain phosphates.

Lower Cost Per Use—

Sklar Instru-Guard™ One-Step Instrument Cleaner & Lubricant can reduce the time and cost involved in processing your instruments by cleaning and lubricating in one easy step.

Sklar Instru-Guard™
One-Step Instrument
Cleaner and Lubricant

Ordering Information:

10-2800 Case of 4 Gallons
10-2801 1 Gallon



The Tradition Continues



*Sklar Disinfectant*TM

- Is specially formulated for the control of cross contamination.
- Effective against TB, Hydrophilic and Lipophilic viruses including HIV-1 (Aids Virus), bacteria and fungi on inanimate objects.
- Non-irritating formula.
- EPA registered.

	<i>Effective</i>	<i>Non-Caustic</i>	<i>No Special Handling or Disposal</i>	<i>Non-Irritating</i>
<i>Sklar Disinfectant</i> TM	<i>Yes</i>	<i>Yes</i>	<i>Yes</i>	<i>Yes</i>
<i>Glutaraldehydes</i>	<i>Maybe</i>	<i>No</i>	<i>No</i>	<i>No</i>
<i>Phenols</i>	<i>No</i>	<i>No</i>	<i>No</i>	<i>No</i>
<i>Chlorine</i>	<i>Yes</i>	<i>No</i>	<i>No</i>	<i>No</i>

Glutaraldehyde-Free!



*Sklar Disinfectant*TM

10-2762
Case of 12-24 Oz. Spray Bottles

10-1643
Case of 6-24 Oz. Spray Bottles



*Sklar Disinfectant*TM

Liquid

10-1653
Case of 4 Gallons



SKLAR SOAK™

Liquid

10-1603 Case of 4 Gallons

Glutaraldehyde Free!



SKLAR DISINFECTANT™

Liquid

10-1643 Case of 6-24 Oz. Spray Bottles

10-2762 Case of 12-24 Oz. Spray Bottles

10-1653 Case of 4 Gallons

SAFETY

No need to handle infectious instruments before sterilization. Pre-cleans and disinfects soiled instruments in one efficient step.

NO SPECIAL HANDLING

Contains no dangerous phenols that require skin, eye or respiratory protection. No disposal restrictions, no toxic fumes or emissions. Non-Glutaraldehyde. Non toxic formula.

ALL PURPOSE DISINFECTANT

Approved for use on surgical instruments, plastics, stainless steel, chrome, glass, plexiglass, nurseries, OR lights, respiratory therapy equipment and painted surfaces.

ECONOMICAL

Clean and disinfect using the same product. No need to purchase and store other products.

CONVENIENT

No mixing, no measuring, just use as supplied. No rinsing required. Formulated to help avoid cross contamination on inanimate objects and medical surfaces.

NO SPECIAL HANDLING

Contains no dangerous phenols that require skin, eye or respiratory protection. No disposal restrictions, no toxic fumes or emissions. Non toxic formula.



SKLAR KLEEN LF™

Low Foam (Liquid) Concentrate
10-2701 Case of 4 Gallons

For use in washer/sterilizers and mechanical washers.
Safe for all metals, glassware, plastics, and rubber.

Non-corroding to surgical instrument alloys;
non-etching to glassware.

Only 1/6 oz. liquid per gallon of water.



SKLAR ENZYMATIC™

Detergent Concentrate
10-2777 Case of 4 Gallons

For use on rubber, plastic, cloth, as well as instruments.

Usable in washer/sterilizer and mechanical washers
and decontaminators.

Non-caustic, non-flammable, 100% biodegradable,
Concentrated.



SKLAR KLEEN™

Powder
10-1630 Case of 6-3/4 Lb. Pitcher

Powder
10-1607 5 Lb. Pail

Only 1 to 2 tablespoons of concentrated powder per gallon of
water. Available in a variety of sizes.

Superior wetting power of Sklar Kleen™ penetrates crevices to
lift away organic debris.

pH balanced, for use in manual or ultrasonic cleaning.
Appropriate for all metals, glassware, plastics, and rubber.

SKLAR-ZYME ENZYMATIC DETERGENT

10-2774 Box of 32 1/2 oz. Pouches

- Double Concentrate Enzymatic Detergent
- Each Pouch Produces One Gallon Enzymatic Detergent





SKLAR KLEEN™

Liquid Concentrate
 10-1612 Case of 6-8 Oz. liquid
 10-1613 Case of 4 Gallons

For manual and ultrasonic cleaning.

Non-corrosive, non-aggressive, phosphate free and biodegradable.

Concentrated—1 gallon makes 750 gallons of cleaning solution.



SKLAR INSTRU-GUARD LUBE™

Liquid Concentrate
 10-1636 Case of 12, Ready to use spray
 8 Oz. Bottles
 10-1635 Case of 4 Gallons

Effective, non-toxic formula keeps instruments looking and operating like new.

It's concentrated! One gallon makes 7 gallons of lubricant.

Contains anti-corrosives and rust inhibitors that help prevent staining.



SKLAR POLISH™

10-1626 Case/12-8 Oz. Jars
 10-1629 Case/6-8 Oz. Jars

Extends the life of surgical instruments by removing corrosive stains.

Non-toxic powder does not pose the health hazards of some liquid stain removers.

For use on surgical instruments, stainless sinks and countertops, as well as porcelain and tile.



SKLAR FRESH™

Liquid
 10-2842 Case of 12-22 Oz. Spray Bottles

Not an enzyme or chemical mask. Environmentally friendly.

Non-allergic - a blend of plant extracts that neutralize odor. Spray directly in the air or on the source.

Neutralize odors at their sources including: bathrooms, refuse, soiled items from vomitus, incontinence odors, etc.



SKLAR HYPOALLERGENIC SOAP

10-1616

Case of 12 - 8 Oz. Pumps

- With Aloe Vera.
- All natural.
- Hypoallergenic

SKLAR HAND SANITIZER

10-2850

Case of 12 - 8 Oz. Pumps

- With moisturizers.
- Kills germs without water.



SKLAR PRODUCT SAMPLES

10-2655 Sklar Zyme Sample - 1 Pouch

10-2630 Sklar Lube Sample - 4 Oz.

10-2610 Sklar Kleen Powder Sample - 4 Oz.

10-2612 Sklar Kleen Liquid Sample - 8 Oz.

10-2616 Hypoallergenic Soap Sample - 8 Oz.

10-2629 Sklar Polish Sample - 8 Oz.

10-2636 Sklar Lube Sample - 8 Oz.

10-2654 Sklar Hand Sanitizing Gel Sample - 2 Oz.

Corrosion

Problem: Debris and residue in box locks, serrations and ratchets.

Solution: Serrations, box locks and ratchets should be carefully cleaned and rinsed. A soft bristle brush is effective in these difficult areas.

Problem: Moisture remaining on the instruments within the sterile wrapped packs; excessive moisture in autoclave during sterilization and termination of cycle.

Solution: Preheat autoclave – drying time cannot be accelerated – open autoclave door slightly. Routinely inspect valves. Malfunctioning valves can precipitate corrosion.

Problem: Some local water supplies contain excessive quantities of alkali. This can manifest itself by depositing corrosive matter on the instruments.

Solution: It is generally accepted that cold distilled or demineralized water be used during sterilization. An alternative is to use the local water supply, while instituting a program of preventative maintenance. Carefully clean surfaces with SKLAR KLEEN™, using SKLAR POLISH™ to remove difficult stains and SKLAR LUBE™ for proper lubrication.

Pitting

Problem: Instruments are inevitably exposed to chemical compounds that initiate pitting. The most common are saline solutions and blood.

Solution: It is essential that instruments be rinsed with distilled or demineralized water and then cleaned routinely.

Problem: Some Non-Sklar detergents contain a chloride or have an acid base. If rinsing is not thorough, the residual detergent can precipitate pitting. Hydrochloric acid can be formed by the combination of chloride in the cleaner and steam, causing the instrument to pit.

Solution: Evaluate detergents without a chloride base. SKLAR KLEEN™ is recommended.

Problem: Instruments may be pitted when the detergent used has an excessively high PH. If instruments are not rinsed thoroughly, and then autoclaved, the heat increases the effect of the solution on the instruments.

Solution: Use only detergents specifically developed for instrument cleaning. Sklar Kleen™ products are pH balanced.

Brownish Stain

Problem: This stain is more obvious on dull finish

instruments. Most likely, it is a deposit of chromium oxide. The thin hard layer protects stainless steel from corrosion precipitated by the atmosphere. The brownish film (sometimes dull blue) occurs naturally when stainless is heated. Occasionally this stain can be traced to the sterilizer. Improper cleaning compounds could contain polyphosphates that cause the copper components in the sterilizer to be deposited by electrolytic action on the stainless steel instruments.

Solution: Water supply to autoclave should be cold and demineralized. Use the correct amount of SKLAR KLEEN™ as recommended by the manufacturer.

Bluish Gray Stains

Problem: Cold sterilizing solutions.

Solution: In the preparation of the solution make certain the manufacturer's directions are followed accurately. To minimize discoloration use distilled water and add a rust inhibitor. Using the solution beyond recommended time limitations will cause the solution to become corrosive.

Rust Deposit

Problem: Sterilizing instruments of different metals in the same cycle will cause rusting. An electrolytic action carries the carbon particles from the exposed metal and deposits them on the stainless steel instruments. The rapid oxidation of molecules results in a surface film of rust.

Solution: The ideal technique would be to sterilize the two types of instruments separately. It is recommended that chrome plated instruments that indicate signs of peeling or flaking be replaced with stainless steel instruments.

Problem: The rust film on the surface of stainless steel instruments can be caused by chemicals in the detergent. Excess amounts of iron or other minerals from the local water supply may cause the rust deposits.

Solution: It is recommended that instruments be rinsed with distilled or demineralized water. Surface rust can be removed by light buffing or an application of SKLAR POLISH™.

Light and Dark Colored Spots

Problem: Spotting caused by slow evaporation of water drops identified with the mineral content of the water.

Solution: Eliminate water droplets by adhering to autoclave manufacturer's operating instructions. Autoclave door should not be opened until steam has been completely vented.

*Who knows more about the cost-effective care, cleaning and disinfecting of surgical instruments?
Sklar Technical Hotline: (800) 221-2166*

CONVERSION CHART

Ten millimeters = one centimeter.

To convert inches to centimeters, multiply inches in decimals by 2.54.

To convert centimeters to inches, multiply centimeters by .3937.

To convert millimeters to inches, multiply millimeters by .03937.

The standard French, or Charriere, Scale (abbreviated Fr.) is generally used in the size calibration of catheters and other tubular instruments. It is based on the metric system, with each unit being approximately 0.33 mm in diameter between consecutive sizes.

CM	INCHES	CM	INCHES	OZ.	GRAMS	OZ.	GRAMS
1	= .39	8	= 3.15	1	= 28.4	6	= 170.1
2	= .79	9	= 3.54	2	= 56.7	7	= 198.5
3	= 1.18	10	= 3.93	3	= 85.5	8	= 226.8
4	= 1.58	20	= 7.87	4	= 113.4	9	= 255.2
5	= 1.97	30	= 11.81	5	= 141.8	10	= 283.5
6	= 2.36	40	= 15.75				
7	= 2.76						

INCHES MM

$\frac{1}{16}$	= 1.588
$\frac{1}{8}$	= 3.175
$\frac{3}{16}$	= 4.763
$\frac{1}{4}$	= 6.35
$\frac{5}{16}$	= 7.938
$\frac{3}{8}$	= 9.525
$\frac{7}{16}$	= 11.113
$\frac{1}{2}$	= 12.7
$\frac{9}{16}$	= 14.288
$\frac{5}{8}$	= 15.875
$\frac{11}{16}$	= 17.463
$\frac{3}{4}$	= 19.05
$\frac{13}{16}$	= 20.638
$\frac{7}{8}$	= 22.225
$\frac{15}{16}$	= 23.813
1	= 25.4

INCHES CM

1	= 2.5
$1\frac{1}{4}$	= 3.2
$1\frac{1}{2}$	= 3.8
$1\frac{3}{4}$	= 4.4
2	= 5
$2\frac{1}{4}$	= 5.7
$2\frac{1}{2}$	= 6.4
$2\frac{3}{4}$	= 7
3	= 7.6
$3\frac{1}{4}$	= 8.3
$3\frac{1}{2}$	= 8.9
$3\frac{3}{4}$	= 9.5
4	= 10.2
$4\frac{1}{4}$	= 10.8
$4\frac{1}{2}$	= 11.4
$4\frac{3}{4}$	= 12
5	= 12.7
$5\frac{1}{4}$	= 13.3
$5\frac{1}{2}$	= 14
$5\frac{3}{4}$	= 14.6
6	= 15.2
$6\frac{1}{4}$	= 15.9
$6\frac{1}{2}$	= 16.5
$6\frac{3}{4}$	= 17.1
7	= 17.8
$7\frac{1}{4}$	= 18.4
$7\frac{1}{2}$	= 19.1
$7\frac{3}{4}$	= 19.7
8	= 20.3
$8\frac{1}{4}$	= 21
$8\frac{1}{2}$	= 21.6
$8\frac{3}{4}$	= 22.2
9	= 22.9
$9\frac{1}{4}$	= 23.5
$9\frac{1}{2}$	= 24.1
$9\frac{3}{4}$	= 24.8
10	= 25.4
$10\frac{1}{4}$	= 26
$10\frac{1}{2}$	= 26.7
$10\frac{3}{4}$	= 27.3
11	= 27.9
$11\frac{1}{4}$	= 28.6
$11\frac{1}{2}$	= 29.2
$11\frac{3}{4}$	= 29.8
12	= 30.5

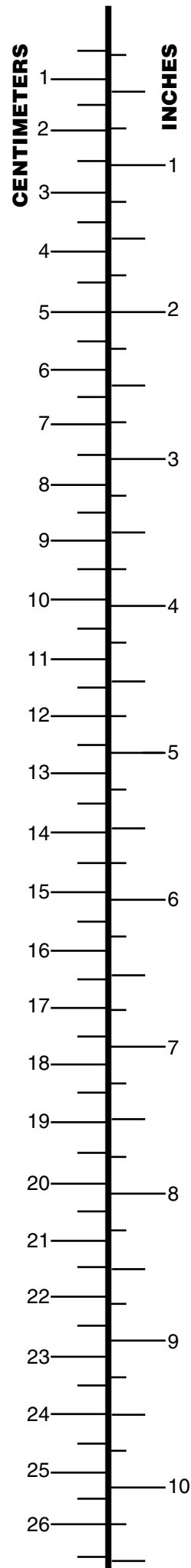
LIQUID CONVERSIONS

When you know	fluid oz.	quarts	gallons	ml	liters
Multiply by	29.57	0.95	3.79	0.03	1.06
To find	ml	liters	liters	fl. oz	quarts gallons

COMPARATIVE SCALES OR GAUGES

Used in Measuring the Diameters of Catheters, Sounds and Bougies

Diameters in Millimeters	American	French	English	Diameters in Millimeters	American	French	English
1-3	-	1	-	7	14	21	-
1-2	1	-	-	7 1-3	-	22	12
2-3	-	2	-	7 1-2	15	-	-
1	2	3	-	7 2-3	-	23	13
1 1-3	-	4	-	8	16	24	-
1 1-2	3	-	-	8 1-3	-	25	14
1 2-3	-	5	-	8 1-2	17	-	-
2	4	6	-	8 2-3	-	26	15
2 1-3	-	7	1	9	18	27	16
2 1-2	5	-	-	9 1-3	-	28	17
2 2-3	-	8	2	9 1-2	19	-	-
3	6	9	3	9 2-3	-	29	-
3 1-3	-	10	-	10	20	30	18
3 1-2	7	-	-	10 1-3	-	31	19
3 2-3	-	11	4	10 1-2	21	-	-
4	8	12	5	10 2-3	-	32	20
4 1-3	-	13	-	11	22	33	21
4 1-2	9	-	-	11 1-3	-	34	22
4 2-3	-	14	-	11 1-2	23	-	-
5	10	15	6	11 2-3	-	35	23
5 1-3	-	16	7	12	24	36	24
5 1-2	11	-	-	12 1-3	-	37	25
5 2-3	-	17	8	12 1-2	25	-	-
6	12	18	9	12 2-3	-	38	26
6 1-3	-	19	10	13	26	39	27
6 1-2	13	-	-	13 1-3	-	40	28
6 2-3	-	20	11				





06-1201	435	06-3079	320,466	06-4143	174,375	07-1241	429
06-1202	435	06-3090	319	06-4144	174,375	07-1242	429
06-1210	435	06-3094	467	06-4145	174,375	07-1243	429
06-1301	435	06-3095	467	06-4146	174,375	07-1244	429
06-1600	433	06-3096	467	06-4147	174,375	07-1246	429
06-1601	433	06-3100	320,466	06-4148	174,375	07-1247	429
06-1602	433	06-3101	320,466	06-4150	375	07-1248	429
06-1603	433	06-3102	320,466	06-4151	375	07-1249	429
06-1625	433	06-3103	320,466	06-4152	375	07-1250	429
06-1630	433	06-3104	320,466	06-4153	375	07-1251	429
06-1632	433	06-3105	320,466	06-4160	375	07-1252	429
06-1635	433	06-3106	320,466	06-4161	375	07-1253	429
06-1638	433	06-3107	320,466	06-4178	376	07-1254	429
06-1640	434	06-3110	321,465	06-4186	376	07-1255	429
06-1642	434	06-3111	321,465	06-4191	376	07-1256	429
06-1648	434	06-3112	321,465	06-6250	435	07-1257	429
06-1652	434	06-3115	321,465	07-1100	432	07-1258	429
06-1654	434	06-3120	321,465	07-1101	432	07-1259	429
06-1660	434	06-3121	321,465	07-1102	432	07-1260	429
06-1662	434	06-3122	321,465	07-1104	432	07-1261	429
06-1668	434	06-3123	321,465	07-1108	432	07-1262	429
06-1701	435	06-3170	436	07-1110	432	07-1263	429
06-2650	437	06-3175	436	07-1112	432	07-1264	429
06-2651	437	06-3290	436	07-1114	432	07-1265	429
06-2652	437	06-3370	436	07-1116	432	07-1266	429
06-2653	437	06-3375	436	07-1118	432	07-1267	429
06-2654	438	06-4002	374	07-1120	432	07-1268	429
06-2655	438	06-4003	374	07-1122	432	07-1269	429
06-2656	438	06-4004	374	07-1126	432	07-1270	429
06-2657	438	06-4005	374	07-1128	432	07-1271	429
06-2658	438	06-4006	374	07-1130	432	07-1359	428
06-2659	438	06-4007	374	07-1132	432	07-1360	428
06-2660	438	06-4039	373	07-1138	432	07-1362	428
06-2661	438	06-4053	373	07-1160	432	07-1363	428
06-2662	438	06-4054	373	07-1162	432	07-1364	428
06-2663	438	06-4056	373	07-1164	432	07-1365	428
06-2664	438	06-4058	373	07-1166	432	07-1366	428
06-2665	438	06-4059	373	07-1200	430	07-1367	428
06-2666	438	06-4060	373	07-1201	430	07-1368	428
06-2667	438	06-4061	373	07-1202	430	07-1369	428
06-2668	438	06-4100	174	07-1203	430	07-1370	428
06-2669	438	06-4110	174	07-1204	430	07-1371	428
06-2808	436	06-4112	374	07-1206	430	07-1372	428
06-2860	296,344	06-4113	374	07-1207	430	07-1373	428
06-2861	296	06-4114	374	07-1208	430	07-1374	428
06-2903	319	06-4115	374	07-1209	430	07-1400	428
06-2904	319	06-4120	376	07-1210	430	07-1401	428
06-2907	319	06-4121	376	07-1212	430	07-1402	428
06-2908	319	06-4122	376	07-1213	430	07-1403	428
06-2910	319	06-4125	376	07-1214	430	07-1408	428
06-3010	320,466	06-4126	376	07-1215	430	07-1409	428
06-3011	320,466	06-4128	376	07-1216	430	07-1410	428
06-3012	320,466	06-4130	373	07-1217	430	07-1420	431
06-3015	320,466	06-4131	373	07-1220	430	07-1421	431
06-3020	320,466	06-4132	373	07-1221	430	07-1422	431
06-3021	320,466	06-4133	372	07-1222	430	07-1423	431
06-3022	320,466	06-4134	372	07-1223	430	07-1424	431
06-3023	320,466	06-4135	372	07-1224	430	07-1425	431
06-3070	320,466	06-4136	372	07-1225	430	07-1480	431
06-3071	320,466	06-4137	372	07-1226	430	07-1482	431
06-3072	320,466	06-4138	372	07-1230	431	07-1777	46
06-3075	320,466	06-4139	372	07-1231	431	07-1780	46
06-3076	320,466	06-4140	372	07-1232	431	07-1797	46
06-3077	320,466	06-4141	372	07-1233	431	07-1801	75
06-3078	320,466	06-4142	174,375	07-1240	429	07-1802	75

Sklar

07-1805.....	75	10-1538.....	440	10-1748.....	442	11-1055.....	30
07-1806.....	75	10-1539.....	439	10-1750.....	441	11-1060.....	30,31
10-1101.....	476	10-1540.....	439	10-1752.....	441	11-1072.....	30
10-1102.....	476	10-1541.....	440	10-1753.....	442	11-1078.....	30
10-1103.....	476	10-1542.....	442	10-1754.....	442	11-1080.....	30
10-1104.....	476	10-1543.....	440	10-1755.....	442	11-1180.....	32,385,405
10-1105.....	476	10-1544.....	440	10-1756.....	442	11-1252.....	31
10-1106.....	476	10-1545.....	440	10-1760.....	442	11-1255.....	31
10-1107.....	476	10-1547.....	440	10-1761.....	442	11-1257.....	31
10-1108.....	476	10-1550.....	440	10-1835.....	442	11-1278.....	33
10-1109.....	476	10-1552.....	441	10-1854.....	441	11-1280.....	33
10-1113.....	476	10-1554.....	441	10-1876.....	442	11-1281.....	33
10-1114.....	476	10-1603.....	2,478,484	10-1877.....	442	11-1282.....	33
10-1115.....	476	10-1607.....	2,480,485	10-1878.....	442	11-1283.....	33
10-1117.....	476	10-1612.....	2,480,486	10-1882.....	442	11-1284.....	33
10-1119.....	476	10-1613.....	2,480,486	10-1883.....	442	11-1295.....	406
10-1120.....	476	10-1616.....	487	10-1884.....	442	11-1297.....	32,406
10-1122.....	476	10-1626.....	481,486	10-1886.....	442	11-1298.....	32,406
10-1124.....	476	10-1629.....	481,486	10-1887.....	442	11-1300.....	33,406
10-1126.....	476	10-1630.....	2,480,485	10-1888.....	442	11-1303.....	33
10-1130.....	476	10-1635.....	2,481,486	10-1889.....	441	11-1380.....	32,406
10-1131.....	476	10-1636.....	2,481,486	10-1915.....	443,476	11-1390.....	32,406
10-1132.....	476	10-1643.....	3,483,484	10-1916.....	443,476	11-1490.....	406
10-1133.....	476	10-1650.....	443,481	10-1917.....	443,476	11-1495.....	32
10-1134.....	476	10-1651.....	443,481	10-1918.....	443,476	11-1496.....	32
10-1135.....	476	10-1652.....	443,481	10-1928.....	443,476	11-1540.....	403
10-1201.....	450	10-1653.....	3,483,484	10-1930.....	443,476	11-1910.....	403
10-1264.....	450	10-1657.....	443,481	10-1931.....	443,476	11-1990.....	403
10-1265.....	450	10-1660.....	443	10-1932.....	443,476	11-2095.....	403
10-1268.....	450	10-1664.....	443	10-1933.....	443,476	11-2100.....	403
10-1269.....	450	10-1668.....	443	10-1934.....	443,476	11-2101.....	403
10-1270.....	450	10-1670.....	439	10-1935.....	443,476	11-2105.....	403
10-1271.....	450	10-1671.....	439	10-1937.....	443,476	11-2110.....	403
10-1272.....	450	10-1674.....	441	10-1948.....	442	13-1045.....	10
10-1273.....	450	10-1675.....	440	10-1949.....	442	13-1050.....	10
10-1280.....	422	10-1680.....	442	10-1950.....	442	13-1055.....	10
10-1410.....	450	10-1683.....	442	10-1952.....	442	13-1060.....	10
10-1412.....	450	10-1684.....	443	10-1953.....	442	13-1065.....	10
10-1440.....	463	10-1685.....	443	10-1954.....	442	13-1155.....	356
10-1465.....	443,481	10-1686.....	443	10-1955.....	442	13-2045.....	12
10-1468.....	443,481	10-1687.....	443	10-1956.....	442	13-2050.....	12
10-1483.....	440	10-1688.....	443	10-1960.....	443	13-2055.....	12
10-1484.....	440	10-1689.....	443	10-1961.....	443	13-2060.....	12
10-1485.....	440	10-1690.....	443	10-1965.....	443	13-2065.....	12
10-1486.....	440	10-1691.....	443	10-1966.....	443	13-2155.....	356
10-1488.....	439	10-1692.....	443	10-1967.....	443	14-1045.....	10
10-1489.....	439	10-1693.....	443	10-2126.....	450	14-1050.....	10
10-1491.....	439	10-1694.....	443	10-2610.....	487	14-1055.....	10
10-1492.....	439	10-1695.....	443	10-2612.....	487	14-1058.....	10
10-1493.....	439	10-1698.....	441	10-2616.....	487	14-1060.....	10
10-1494.....	439	10-1699.....	441	10-2629.....	487	14-1065.....	10
10-1495.....	439	10-1700.....	442	10-2630.....	487	14-1155.....	356
10-1496.....	440	10-1702.....	442	10-2636.....	487	14-2045.....	12
10-1497.....	441	10-1703.....	442	10-2654.....	487	14-2050.....	12
10-1498.....	440	10-1707.....	442	10-2655.....	487	14-2055.....	12
10-1505.....	439	10-1708.....	442	10-2701.....	480,485	14-2060.....	12
10-1506.....	439	10-1722.....	442	10-2762.....	3,483,484	14-2065.....	12
10-1507.....	439	10-1724.....	442	10-2774.....	3,479,485	14-2155.....	356
10-1510.....	441	10-1737.....	442	10-2777.....	3,479,485	15-1045.....	10
10-1523.....	440	10-1738.....	442	10-2800.....	3,482	15-1050.....	10
10-1525.....	440	10-1741.....	442	10-2801.....	3,482	15-1055.....	10
10-1527.....	440	10-1742.....	442	10-2842.....	486	15-1060.....	10
10-1533.....	440	10-1744.....	442	10-2850.....	487	15-1065.....	10
10-1535.....	442	10-1746.....	442	11-1035.....	30	15-1155.....	356
10-1536.....	441	10-1747.....	442	11-1045.....	30	15-1282.....	258



15-1285.....	258	15-3575.....	19,89	17-1855.....	46	19-1060.....	50
15-1307.....	188,258	15-3576.....	311	17-1955.....	46	19-1070.....	50
15-1308.....	188,258	15-3577.....	311	17-2055.....	38	19-1080.....	50
15-1355.....	25	15-3578.....	311	17-2155.....	38	19-1110.....	50
15-1358.....	302	15-3579.....	311	17-2255.....	41	19-1112.....	50
15-1555.....	14,188	15-3580.....	311	17-2262.....	41	19-1245.....	51
15-1567.....	14,188	15-3583.....	311	17-2267.....	41	19-1250.....	51
15-1655.....	188	15-3584.....	311	17-2272.....	41	19-1255.....	51
15-1667.....	188	15-3585.....	21,89	17-2280.....	41	19-1258.....	51
15-2045.....	12	15-3590.....	21,89	17-2362.....	41	19-1260.....	51
15-2050.....	12	15-7032.....	93	17-2455.....	41	19-1270.....	51
15-2055.....	12	16-1055.....	11,91	17-2462.....	41	19-1280.....	51
15-2060.....	12	16-1056.....	11,91	17-2467.....	41	19-1310.....	51
15-2065.....	12	16-1057.....	11,91	17-2472.....	41	19-1312.....	51
15-2307.....	188,258	16-1155.....	13	17-2480.....	41	19-2170.....	56,170
15-2308.....	188,258	16-1156.....	13,91	17-2655.....	40	19-2172.....	56
15-2555.....	14,188	16-1505.....	15,91	17-2662.....	40	19-2260.....	56
15-2567.....	14,188	16-1510.....	15,91	17-2672.....	40	19-2280.....	56
15-2569.....	14	16-1515.....	15,91	17-2680.....	40	19-2310.....	56
15-2655.....	188	16-1605.....	15,91	17-2690.....	40	19-2930.....	59,362
15-2667.....	188	16-1610.....	15,91	17-2762.....	40	19-2945.....	59,362
15-3150.....	26	16-1615.....	15,91	17-2855.....	40	19-3030.....	59,362
15-3306.....	17,93	16-1805.....	17,91	17-2862.....	40	19-3035.....	59,362
15-3310.....	19,93	16-1810.....	17,91	17-2872.....	40	19-3040.....	59,362
15-3311.....	19,93	16-1905.....	17,91	17-2878.....	40	19-3045.....	59,362
15-3315.....	19,93	16-1910.....	17,91	17-2880.....	40	19-3050.....	362
15-3320.....	90	16-2005.....	19,91	17-2890.....	40	19-3055.....	363
15-3325.....	15,93	16-2010.....	19,91	17-2958.....	49	19-3160.....	362
15-3326.....	15,93	16-2105.....	19,91	17-2962.....	40	19-3162.....	362
15-3330.....	15,93	16-2110.....	19,91	17-3055.....	37	19-3240.....	59,362
15-3331.....	15,93	16-2210.....	19,91	17-3062.....	37	19-3340.....	59,362
15-3342.....	11,93	16-2310.....	19,91	17-3068.....	37	19-3350.....	362
15-3343.....	11,93	16-2311.....	19,91	17-3075.....	37	19-3360.....	59,362
15-3348.....	13	16-2405.....	21,91	17-3155.....	37	20-1260.....	67,87
15-3349.....	13,93	16-2505.....	21,91	17-3162.....	37	20-1265.....	67,192
15-3352.....	21,93	16-2605.....	22,92	17-3168.....	37	20-1270.....	67,192
15-3357.....	21,93	16-2610.....	92	17-3175.....	37	20-1280.....	67,192
15-3410.....	19,93	16-2705.....	22,92	17-3265.....	44	20-1290.....	67,192
15-3442.....	11,93	16-2800.....	29,92,405	17-3275.....	44	20-1295.....	67,192
15-3443.....	11,93	16-3552.....	92	17-3365.....	44	20-1350.....	62,190,370
15-3448.....	13,93	16-3557.....	92	17-3375.....	44	20-1352.....	62,190,370
15-3449.....	13,93	16-3562.....	92	17-3455.....	44	20-1450.....	66,370
15-3452.....	21,93	16-3567.....	92	17-3555.....	44	20-1547.....	63,370
15-3457.....	21,93	17-1055.....	46,257	17-3562.....	170	20-1750.....	65,370
15-3460.....	93	17-1062.....	45	17-3995.....	49	20-1751.....	65,370
15-3461.....	93	17-1080.....	45	17-3996.....	49	20-1760.....	299,342,370
15-3500.....	11,88	17-1155.....	45	17-3997.....	49	20-1870.....	69
15-3505.....	11,88	17-1162.....	45	18-1050.....	36	20-2052.....	64,191
15-3510.....	13,88	17-1180.....	45	18-1150.....	36	20-2060.....	191,64
15-3515.....	13,88	17-1220.....	46,361	18-1250.....	45,256	20-2070.....	64,191
15-3520.....	310	17-1225.....	46,361	18-1352.....	46	20-2270.....	64,191
15-3525.....	310	17-1230.....	39	18-1452.....	46	20-2480.....	64,191
15-3530.....	310	17-1232.....	39	18-1552.....	38	20-2490.....	64
15-3535.....	310	17-1235.....	39	18-1652.....	38	20-2662.....	299
15-3536.....	311	17-1262.....	45	18-1952.....	37	20-2747.....	68,192,342,371
15-3542.....	90	17-1335.....	39	18-2052.....	37	20-2748.....	342,371
15-3547.....	310	17-1362.....	45	18-2140.....	42,160	20-2755.....	68,192
15-3548.....	310	17-1450.....	36	18-2155.....	42,160	20-2765.....	68,192
15-3549.....	311	17-1459.....	36	18-2162.....	42,160	20-2775.....	68,192
15-3550.....	15,88	17-1550.....	36	18-2164.....	42,160	20-2910.....	64,191
15-3555.....	15,88	17-1559.....	36	18-2257.....	159	20-2911.....	64,191
15-3560.....	15,88	17-1650.....	36	19-1045.....	50	20-3055.....	371
15-3565.....	15,88	17-1750.....	36	19-1050.....	50	20-3075.....	194,371
15-3570.....	17,89	17-1762.....	45,256	19-1055.....	50	20-3090.....	371,62
15-3572.....	311	17-1772.....	45,256	19-1058.....	50	20-3350.....	299,370

Sklar

20-3910.....	69	21-781.....	142	22-1063.....	51	22-2935.....	26
20-4170.....	69	21-788.....	142	22-1070.....	18	22-2947.....	26
20-4510.....	192	21-8000.....	65,94	22-1071.....	18	22-2950.....	26
20-4682.....	193	21-8001.....	65,94	22-1072.....	30	22-2955.....	306,352
20-4795.....	193	21-8002.....	62,94,190	22-1135.....	20	22-3047.....	45
20-4852.....	69	21-8004.....	63,94	22-1145.....	10	22-3147.....	45
20-4867.....	69	21-8005.....	66,94	22-1150.....	10	22-3255.....	45
21-060.....	142	21-8006.....	67,94,192	22-1155.....	10	22-3270.....	45
21-102.....	142	21-8007.....	67,94,192	22-1161.....	50	22-3555.....	41
21-103.....	142	21-8008.....	67,94,192	22-1162.....	50	22-3655.....	41
21-104.....	142	21-8009.....	67,94,192	22-1163.....	50	22-3755.....	40
21-107.....	142	21-8010.....	67,94,192	22-1164.....	50	22-3855.....	40
21-109.....	142	21-8011.....	67,94,192	22-1235.....	20	22-4150.....	56
21-123.....	142	21-8012.....	95	22-1240.....	23,354	22-4250.....	56
21-124.....	142	21-8013.....	95	22-1241.....	23,354	22-4350.....	56
21-1260.....	67	21-8014.....	95	22-1242.....	23,354	22-4450.....	56
21-129.....	142	21-8016.....	95	22-1245.....	10	22-5050.....	69
21-135.....	142	21-8020.....	95	22-1250.....	10	22-6155.....	43,166
21-1450.....	66	21-8022.....	95	22-1255.....	10	22-6157.....	42
21-146.....	142	21-8023.....	95	22-1342.....	23,354	22-6557.....	247
21-151.....	142	21-8025.....	68,95,192	22-1345.....	10	22-6585.....	75
21-1547.....	63	21-8026.....	68,95,192	22-1350.....	10	22-7470.....	57
21-1650.....	62,190	21-8027.....	68,95,192	22-1354.....	25	22-8067.....	283
21-1652.....	62,190	21-8028.....	68,95,192	22-1355.....	10	22-8075.....	283
21-1750.....	65	21-8029.....	68,95,192	22-1442.....	22,355	22-8210.....	74
21-1850.....	65	21-8030.....	95	22-1445.....	12	22-8211.....	74
21-2060.....	64,191	21-8031.....	64,95,191	22-1450.....	12	22-8212.....	74
21-2070.....	64,191	21-8032.....	64,95,191	22-1455.....	12	22-8213.....	74
21-2180.....	194	21-8033.....	64,95,191	22-1542.....	22,355	22-8214.....	74
21-2195.....	194	21-8034.....	64,95,191	22-1545.....	12	22-8215.....	74
21-222.....	142	21-8035.....	64,95,191	22-1550.....	12	22-8245.....	70,404
21-226.....	142	21-8036.....	96	22-1555.....	12	22-8255.....	70,404
21-231.....	142	21-8037.....	96	22-1556.....	14	22-8345.....	70,404
21-237.....	142	21-8039.....	96,192	22-1567.....	14	22-8355.....	70,404
21-241.....	142	21-8040.....	68,343	22-1645.....	12	22-8360.....	72,367
21-2480.....	64,191	21-8042.....	343,350	22-1650.....	12	22-8460.....	72,367
21-263.....	142	21-8043.....	343,350	22-1655.....	12	22-8560.....	73,295,367
21-272.....	142	21-8044.....	68,343,350	22-2280.....	41	22-8832.....	70,290
21-281.....	142	21-8045.....	68,343,350	22-2450.....	16	22-8834.....	70,290
21-2910.....	64,191	21-8046.....	68,343	22-2460.....	16	22-8850.....	71
21-346.....	142	21-8055.....	342	22-2520.....	304,306,353	22-8853.....	71
21-352.....	142	21-8058.....	342	22-2545.....	16	22-8855.....	71
21-358.....	142	21-8060.....	96,193	22-2550.....	16	22-8920.....	70,290,365,404
21-426.....	142	21-8061.....	96,193	22-2555.....	14	22-8940.....	70,290,365,404
21-431.....	142	21-8062.....	97,194	22-2567.....	14	22-8945.....	281
21-436.....	142	21-8064.....	97,194	22-2645.....	306	22-9027.....	70,290,365,404
21-442.....	142	21-8065.....	96,193	22-2650.....	16	22-9029.....	70,290,365,404
21-447.....	142	21-8070.....	97,194	22-2652.....	302,353	22-9122.....	366
21-452.....	142	21-8071.....	97	22-2653.....	302,353	22-9123.....	366
21-705.....	142	21-8072.....	194	22-2742.....	304,356	22-9124.....	366
21-710.....	142	21-8075.....	67,94	22-2750.....	304	22-9125.....	366
21-727.....	142	21-8080.....	62,94,190	22-2751.....	304	22-9126.....	366
21-731.....	142	21-8082.....	95	22-2755.....	189,305	22-9127.....	366
21-736.....	142	21-8086.....	97	22-2760.....	306	22-9128.....	366
21-742.....	142	21-809.....	142	22-2762.....	306	22-9129.....	366
21-753.....	142	21-810.....	467	22-2820.....	27	22-9132.....	73,295,368
21-757.....	142	21-811.....	467	22-2822.....	27	22-9133.....	73,295,368
21-762.....	142	21-815.....	467	22-2824.....	27	22-9142.....	73,295,368
21-766.....	142	21-832.....	142	22-2825.....	27	22-9143.....	73,295,368
21-769.....	142	21-9016.....	69	22-2834.....	24	22-9144.....	368
21-771.....	142	21-9018.....	69	22-2835.....	24	22-9380.....	49
21-772.....	142	21-9030.....	69	22-2837.....	307,358	22-9480.....	49
21-775.....	142	21-9035.....	69	22-2844.....	24	23-1100.....	10,76
21-776.....	142	22-1054.....	30	22-2845.....	24	23-1101.....	10,76
21-777.....	142	22-1057.....	16	22-2934.....	26	23-1102.....	10,76



23-1104.....	10,76	23-1250.....	80,90	23-2561.....	41,82	31-1020.....	226
23-1105.....	10,76	23-1254.....	80,90	23-2563.....	41,82	31-1022.....	226
23-1106.....	10,76	23-1260.....	11,76,88	23-2568.....	40,82	31-1030.....	226
23-1112.....	10,76	23-1262.....	11,76	23-2577.....	40,82	31-1032.....	226
23-1113.....	10,76	23-1264.....	13,76	23-2585.....	40,82	31-1042.....	226
23-1114.....	10,76	23-1266.....	13,76	23-2600.....	52,84	31-2227.....	227
23-1116.....	10,76	23-1267.....	19,78,89	23-2602.....	53,85	31-2229.....	227
23-1117.....	10,76	23-1268.....	21,78,89	23-2603.....	54,85	31-2233.....	227
23-1118.....	10,76	23-1270.....	21,78,89	23-2604.....	52,84	31-2235.....	227
23-1124.....	12,76	23-1274.....	15,77,88	23-2606.....	53,85	31-2237.....	227
23-1126.....	12,76	23-1278.....	15,77,88	23-2608.....	54,85	31-2238.....	228
23-1128.....	12,76	23-1280.....	17,77	23-2809.....	84	31-2239.....	228
23-1130.....	12,76	23-1290.....	27,80	23-2811.....	51,84	31-2241.....	227
23-1136.....	12,76	23-1292.....	27,80	23-2819.....	51,84	31-2242.....	227,232
23-1138.....	12,76	23-1294.....	27,80	23-2824.....	50,84	31-2243.....	227
23-1140.....	12,76	23-1296.....	27,80	23-2826.....	50,84	31-2244.....	227
23-1142.....	12,76	23-1300.....	27,80	23-2828.....	84,50	31-2245.....	227
23-1148.....	20,78	23-1302.....	27,80	23-2830.....	84,50	31-2247.....	227
23-1149.....	20,78	23-1304.....	80,27	23-2834.....	50,84	31-2258.....	228
23-1150.....	20,78	23-1306.....	27,80	23-2836.....	50,84	31-2327.....	229
23-1151.....	20,78	23-2100.....	39,82	23-2838.....	50,84	31-2347.....	228
23-1152.....	20,78	23-2101.....	39,82	23-2840.....	84	31-2349.....	228
23-1153.....	20,78	23-2105.....	36,81	23-2851.....	42,83	31-2350.....	229
23-1154.....	20,78	23-2106.....	36,81	23-2852.....	42,83,160	31-2352.....	229
23-1155.....	20,78	23-2107.....	38,81	23-2861.....	42,83,160	31-2355.....	229
23-1156.....	23,79,354	23-2108.....	38,81	23-2862.....	42,83	31-2365.....	229
23-1157.....	23,79,354	23-2110.....	37,81	23-2864.....	42,83,160	31-2435.....	227
23-1158.....	22,79,355	23-2113.....	37,81	23-2865.....	42,83,160	31-2437.....	227
23-1159.....	22,79,355	23-2120.....	62,86	23-9250.....	385	31-2441.....	227
23-1160.....	23,79,354	23-2124.....	63,86	23-9251.....	380	31-2443.....	227
23-1161.....	23,79,354	23-2125.....	62,86	23-9255.....	380	31-2444.....	227
23-1162.....	22,79,355	23-2128.....	64,86	23-9259.....	380	31-2445.....	227
23-1163.....	22,79,355	23-2130.....	65,86	23-9273.....	380	31-2447.....	227
23-1164.....	14,77	23-2132.....	66,87	23-9275.....	380	31-2450.....	141,233
23-1165.....	14,77	23-2134.....	67,87	23-9276.....	380	31-2451.....	233
23-1166.....	14,77	23-2135.....	65,86	23-9292.....	384	31-2532.....	220
23-1167.....	14,77	23-2136.....	68,87	24-1962.....	304	31-2532Y.....	220
23-1168.....	14,77	23-2220.....	62,86	24-2155.....	363	31-2539.....	221
23-1169.....	14,77	23-2224.....	63,86	24-2253.....	27	31-2539Y.....	221
23-1170.....	14,77	23-2225.....	62,86	24-2254.....	27	31-2540.....	223
23-1171.....	14,77	23-2228.....	64,86	24-2255.....	27	31-2540Y.....	223
23-1172.....	16,77	23-2230.....	65,86	24-2340.....	29,405	31-2550.....	225
23-1173.....	16,77	23-2232.....	66,87	24-2341.....	29,405	31-2551.....	225
23-1174.....	16,77	23-2234.....	67,87	24-2342.....	29,405	31-2552.....	225
23-1175.....	16,77	23-2235.....	65,86	24-2345.....	29,405	31-2553.....	225
23-1176.....	16,77	23-2236.....	68,87	24-2346.....	29,405	31-2554.....	220
23-1177.....	16,77	23-2500.....	39,82	24-2347.....	29,405	31-2554Y.....	220
23-1178.....	16,77	23-2501.....	39,82	24-2349.....	29	31-2560.....	220
23-1179.....	16,77	23-2505.....	36,81	30-1030.....	267	31-2560Y.....	220
23-1180.....	18,78	23-2506.....	36,81	30-1040.....	267	31-2562.....	220
23-1182.....	18,78	23-2507.....	38,81	31-0001.....	226	31-2562Y.....	220
23-1184.....	18,78	23-2508.....	38,81	31-0002.....	226	31-2564.....	221
23-1186.....	18,78	23-2510.....	37,81	31-0003.....	226	31-2564Y.....	221
23-1188.....	24,80	23-2513.....	37,81	31-0004.....	226	31-2566.....	220
23-1189.....	24,80	23-2516.....	83	31-0010.....	226	31-2566Y.....	220
23-1190.....	25,80	23-2520.....	83	31-1001.....	226	31-2568.....	219
23-1191.....	26,80	23-2521.....	83	31-1002.....	226	31-2568X.....	219
23-1193.....	24,80	23-2525.....	83	31-1003.....	226	31-2569.....	219
23-1194.....	24,80	23-2532.....	41,82	31-1004.....	226	31-2569X.....	219
23-1195.....	25,80	23-2534.....	82	31-1007.....	226	31-2570.....	223
23-1196.....	26,80	23-2538.....	41,82	31-1008.....	226	31-2570Y.....	223
23-1199.....	30,79	23-2542.....	41,82	31-1009.....	226	31-2571.....	223
23-1200.....	30,79	23-2552.....	41,82	31-1010.....	226	31-2571Y.....	223
23-1202.....	30,79	23-2554.....	82	31-1011.....	226	31-2572.....	219
23-1203.....	30,79	23-2560.....	40,82	31-1012.....	226	31-2572X.....	219

Sklar

31-2573.....	222	31-4304XC.....	230	36-2160.....	42,160	40-4572.....	392,395
31-2573X.....	222	31-4305.....	230	36-2260.....	42,160	40-4575.....	392,395
31-2574.....	223	31-4305XC.....	230	36-2275.....	42,160	40-5765.....	402
31-2574Y.....	223	31-4306.....	230	36-2278.....	42	40-6535.....	278
31-2575.....	222	31-4306XC.....	230	36-2280.....	42,161	40-6537.....	278
31-2575X.....	222	31-4307.....	230	36-2295.....	42,160	40-7000.....	395
31-2576.....	223	31-4307XC.....	230	36-2298.....	42,161	40-7100.....	395
31-2576Y.....	223	31-4308.....	231	36-2380.....	44	40-7110.....	395
31-2577.....	221	31-4308YC.....	231	36-2385.....	42,161	40-7111.....	395
31-2577Y.....	221	31-4309.....	231	36-2577.....	49	40-7112.....	395
31-2578.....	222	31-4309XC.....	231	36-2595.....	49	40-7113.....	395
31-2578X.....	222	31-4310.....	231	36-2690.....	41	40-7114.....	395
31-2579.....	222	31-4310XC.....	231	36-2710.....	41	40-7115.....	395
31-2579X.....	222	31-4311.....	231	36-2790.....	41	40-7116.....	395
31-2598.....	221	31-4311XC.....	231	36-2810.....	41	40-7118.....	395
31-2598Y.....	221	31-4312.....	231	40-1023.....	401	40-7120.....	395
31-2632.....	218	31-4312YC.....	231	40-1024.....	401	40-7155.....	397
31-2632X.....	218	31-4313.....	231	40-1045.....	401	40-7284.....	373
31-2747.....	218	31-4313YC.....	231	40-1048.....	402	40-7286.....	374
31-2747X.....	218	31-4314.....	231	40-1535.....	400	40-7380.....	275
31-2749.....	218	31-4314YC.....	231	40-1545.....	400	40-7381.....	275
31-2749X.....	218	31-4315.....	231	40-1562.....	400	40-7382.....	275
31-2756.....	220	31-4315XC.....	231	40-1565.....	400	40-7383.....	275
31-2756Y.....	220	31-4316.....	231	40-1566.....	400	40-7410.....	400
31-2771.....	221	31-4316XC.....	231	40-1567.....	400	40-7415.....	400
31-2771Y.....	221	31-4317.....	231	40-1568.....	400	40-7420.....	400
31-2790.....	224	31-4317YC.....	231	40-1569.....	400	40-7430.....	398
31-2794.....	224	31-4318.....	232	40-1580.....	400	40-7435.....	398
31-4001X.....	224	31-4320.....	226	40-1582.....	400	40-7440.....	398
31-4001XC.....	224,232	31-4321.....	226	40-1584.....	400	40-7445.....	398
31-4002Y.....	224	31-4322.....	224	40-1590.....	400	40-7450.....	400
31-4002YC.....	224,232	31-4323.....	226	40-1591.....	400	40-7451.....	400
31-4003.....	228	31-4324.....	226	40-1592.....	400	40-7452.....	400
31-4004.....	228	31-4325.....	232	40-1593.....	400	40-7453.....	400
31-4010.....	218	31-4326.....	232	40-1594.....	400	40-7454.....	400
31-4010X.....	218	31-4327.....	232	40-1595.....	400	40-7455.....	400
31-4012.....	218	31-4504.....	219	40-1596.....	400	40-7470.....	274
31-4012X.....	218	31-4504X.....	219	40-1720.....	402	40-7472.....	274
31-4080.....	219	31-4508.....	220	40-1725.....	401	40-7474.....	275
31-4080X.....	219	31-4508Y.....	220	40-1727.....	401	40-7476.....	275
31-4081.....	220	31-4509.....	220	40-1729.....	401	40-7480.....	397
31-4081Y.....	220	31-4509Y.....	220	40-1730.....	402	40-7482.....	397
31-4082.....	219	31-4510.....	218	40-1735.....	402	40-7484.....	397
31-4082X.....	219	31-4510X.....	218	40-1762.....	401	40-7486.....	397
31-4083.....	221	31-4514.....	218	40-1778.....	402	40-8252.....	397
31-4083Y.....	221	31-4514X.....	218	40-2650.....	396	40-8255.....	397
31-4084.....	219	31-4520.....	223	40-2655.....	396	40-8270.....	400
31-4084X.....	219	31-4520Y.....	223	40-2660.....	396	40-8272.....	400
31-4085.....	221	31-4522.....	223	40-3055.....	392,395	40-8275.....	398
31-4085Y.....	221	31-4522Y.....	223	40-3077.....	392,395	40-8375.....	398
31-4086.....	219	31-4526.....	222	40-3087.....	392,395	40-8675.....	398
31-4086X.....	219	31-4526X.....	222	40-3155.....	392,395	40-8775.....	398
31-4087.....	221	31-4528.....	223	40-3177.....	392,395	40-9265.....	398
31-4087Y.....	221	31-4528Y.....	223	40-3187.....	392	40-9365.....	398
31-4088.....	219	31-6176.....	222	40-3190.....	394	40-9370.....	399
31-4088X.....	219	31-6176X.....	222	40-3192.....	394	40-9685.....	390
31-4089.....	220	31-6184.....	218	40-3200.....	394	40-9688.....	280,390
31-4089Y.....	220	31-6184X.....	218	40-3202.....	394	40-9815.....	280,390
31-4090.....	219	36-1290.....	57	40-3206.....	394	40-9820.....	280,390
31-4090X.....	219	36-1662.....	43,166	40-4265.....	394	40-9825.....	280,390
31-4301.....	232	36-1677.....	43,166	40-4272.....	394	40-9840.....	279,280
31-4302.....	232	36-1692.....	43,166	40-4360.....	394	40-9841.....	279,280
31-4303.....	230	36-1765.....	44	40-4365.....	394	41-1050.....	302,357
31-4303XC.....	230	36-1865.....	159	40-4372.....	394	41-1054.....	302,357
31-4304.....	230	36-2060.....	42,160	40-4560.....	392	41-1058.....	356



41-1076.....	303,357	41-1385.....	292	42-133.....	410	42-479.....	414
41-1078.....	303	41-1395.....	292,295,366	42-135.....	410	42-483.....	414
41-1079.....	303	41-1396.....	292,295,366	42-139.....	410	42-489.....	414
41-1100.....	358	41-1398.....	292	42-1420.....	396,404	42-493.....	414
41-1105.....	302,358	41-1401.....	293	42-1422.....	396,404	42-497.....	414
41-1120.....	306	41-1402.....	293	42-1425.....	396,404	42-524.....	419
41-1125.....	306	41-1403.....	293	42-145.....	410	42-532.....	419
41-1132.....	302	41-1410.....	272,290	42-149.....	410	42-538.....	419
41-1134.....	302	41-315.....	415	42-1511.....	71	42-552.....	419
41-1136.....	302	41-318.....	415	42-154.....	411	42-572.....	419
41-1138.....	302	41-330.....	415	42-157.....	411	42-621.....	422
41-1147.....	302	41-350.....	415	42-1611.....	71	42-625.....	422
41-1163.....	303	41-368.....	415	42-163.....	411	42-629.....	422
41-1165.....	301	41-372.....	415	42-1655.....	71,291	42-653.....	422
41-1167.....	303,357	41-378.....	415	42-171.....	411	43-105.....	421
41-1168.....	301	41-388.....	415	42-1765.....	71,291	43-385.....	422
41-1169.....	301	41-410.....	417	42-177.....	411	43-412.....	422
41-1170.....	393	41-434.....	417	42-1820.....	291	43-622.....	422
41-1175.....	393	41-472.....	417	42-1822.....	291	44-427.....	422
41-1180.....	392	41-535.....	417	42-1824.....	291	44-441.....	422
41-1190.....	271	41-561.....	417	42-1826.....	291	44-475.....	422
41-1192.....	271	41-573.....	417	42-1828.....	291	44-489.....	415
41-1194.....	271	41-604.....	407	42-183.....	411	45-202.....	416
41-1196.....	271	41-612.....	407	42-1865.....	70,404	45-236.....	416
41-1198.....	271	41-626.....	407	42-187.....	411	45-266.....	416
41-1200.....	271	41-638.....	407	42-1875.....	70,404	45-507.....	416
41-1235.....	274	41-652.....	407	42-1895.....	70,404	45-545.....	416
41-1240.....	275	41-654.....	407	42-191.....	411	45-738.....	416
41-1250.....	275	41-658.....	407	42-193.....	411	45-796.....	416
41-1260.....	277	41-662.....	407	42-1965.....	70,404	45-835.....	416
41-1262.....	277	41-666.....	407	42-197.....	411	46-356.....	416
41-1264.....	277	41-674.....	407	42-1975.....	70,404	47-1047.....	303,356
41-1266.....	277	41-709.....	407	42-1995.....	70,404	47-1048.....	303,356
41-1270.....	277	41-721.....	407	42-228.....	417	47-1049.....	356
41-1272.....	277	41-733.....	407	42-246.....	411	47-1058.....	303,356
41-1274.....	277	41-757.....	408	42-248.....	411	47-1059.....	356
41-1276.....	277	41-761.....	408	42-252.....	411	47-1068.....	303,356
41-1300.....	277	41-765.....	408	42-256.....	411	47-1069.....	356
41-1305.....	277	41-769.....	408	42-266.....	411	47-1080.....	305,353
41-1310.....	277	41-773.....	408	42-270.....	418	47-1081.....	305,353
41-1330.....	277	41-777.....	408	42-271.....	418	47-1084.....	308,352
41-1332.....	277	41-792.....	407	42-273.....	418	47-1135.....	20
41-1338.....	279	41-800.....	409	42-274.....	418	47-1145.....	20
41-1340.....	278	41-808.....	409	42-278.....	418	47-1146.....	28,308,357
41-1342.....	278	41-812.....	409	42-282.....	418	47-1147.....	304
41-1344.....	278	41-820.....	409	42-288.....	418	47-1173.....	58
41-1346.....	278	41-824.....	409	42-296.....	418	47-1175.....	58
41-1348.....	278	41-828.....	409	42-301.....	412	47-1180.....	58
41-1350.....	277	41-832.....	409	42-307.....	412	47-1186.....	58
41-1355.....	277	41-848.....	409	42-321.....	412,417	47-1235.....	20
41-1360.....	277	41-852.....	409	42-325.....	412,417	47-1245.....	20
41-1361.....	279	41-856.....	409	42-327.....	412	47-1246.....	20
41-1362.....	279	41-864.....	409	42-328.....	412	47-1247.....	28,308,357
41-1363.....	279	41-870.....	409	42-329.....	412	47-1248.....	20
41-1365.....	278	41-878.....	409	42-330.....	412	47-1250.....	308,357
41-1366.....	278	41-922.....	417	42-331.....	414	47-1255.....	308,357
41-1367.....	278	41-932.....	409	42-335.....	414	47-1345.....	304,352
41-1368.....	278	41-938.....	409	42-339.....	413	47-1360.....	16
41-1370.....	277	41-944.....	409	42-443.....	413	47-1447.....	54
41-1372.....	277	41-972.....	410	42-447.....	413	47-1448.....	55
41-1374.....	277	41-994.....	410	42-455.....	413	47-1450.....	54
41-1376.....	277	42-103.....	410	42-461.....	413	47-1470.....	56,170
41-1380.....	292	42-105.....	410	42-465.....	413	47-2047.....	53
41-1382.....	292	42-121.....	410	42-473.....	414	47-2049.....	53
41-1383.....	293	42-127.....	410	42-475.....	414	47-2147.....	52

Sklar

47-2380	274,288,399	47-5043	312	48-289	420	49-8147	424
47-2382	288,399	47-5044	312	48-296	418	49-8148	423
47-2385	275	47-5045	312	48-315	415	49-8150	423,425
47-2388	275	47-5046	313	48-318	415	49-8153	426
47-2447	54	47-5047	313	48-321	417	49-8157	423
47-2462	74,367	47-5048	313	48-327	421	49-8159	426
47-2467	393	47-5049	313	48-330	415	49-8163	423
47-2468	393	47-5050	313	48-339	421	49-8166	423
47-2500	74,295,367	47-5051	313	48-350	415	49-8170	424
47-2502	74,295,367	47-5055	313	48-351	421	49-8174	424
47-2505	74,295,367	47-5056	313	48-363	421	49-8179	424
47-2507	74,295,367	47-5057	313	48-368	415	49-8180	423
47-2510	74,295	47-5058	313	48-375	421	49-8181	423
47-2512	367	47-5059	313	48-378	415	49-8182	423
47-2514	366	47-5060	313	48-388	415	49-8183	424
47-2516	366	47-5061	313	48-422	418	49-8245	426
47-2555	74,295,368	47-5062	314	48-424	418	49-8249	426
47-2556	74,295,368	47-5063	314	48-428	418	49-8251	425
47-2570	295,366	47-5064	314	48-434	417	49-8325	425
47-2572	295,366	47-5065	314	48-472	417	49-8358	425
47-2647	369	47-5066	314	48-489	415	49-8359	425
47-2650	74,295,328,366	47-5067	314	48-507	416	49-8438	425
47-2651	74,328,366	47-5068	314	48-524	419	50-1280	284
47-2655	366	47-5069	314	48-526	419	50-1290	284
47-2752	366	47-5070	314	48-535	417	50-1301	294
47-2832	71	47-5072	314	48-538	419	50-1302	294
47-2834	71	47-5074	314	48-542	419	50-1303	294
47-2837	47	47-5075	314	48-561	417	50-1304	294
47-2852	47	47-5076	314	48-572	419	50-1305	294
47-2913	70,290,324,365	47-5077	314	48-738	416	50-1355	361
47-2925	47	47-5080	315	48-752	421	50-1357	361
47-2930	47	47-5082	315	48-761	422	50-1372	45
47-2935	48	47-5084	315	48-785	422	50-1472	45
47-2945	48	47-5085	315	48-835	416	50-1950	294
47-2955	48	47-5090	315	48-922	417	50-1953	75
47-2959	48	47-5100	316	49-8010	426	50-1955	75
47-2960	48	47-5101	316	49-8026	423	50-1957	75
47-3040	47	47-5102	316	49-8027	423	50-1982	267
47-3057	47	47-5104	316	49-8028	425	50-2006	75
47-3833	365	47-5106	316	49-8031	425	50-2007	75
47-5010	312	47-5107	316	49-8032	423	50-2008	75
47-5011	312	47-5108	316	49-8033	424	50-2010	75
47-5012	312	47-5110	316	49-8034	424	50-2012	75
47-5013	312	47-5112	316	49-8039	423	50-2670	57
47-5014	312	47-5114	316	49-8045	424	50-2770	57
47-5015	312	47-5162	313	49-8047	424	50-2870	57
47-5016	312	47-5163	313	49-8054	426	50-2970	57
47-5017	312	47-5164	313	49-8059	426	50-3045	53
47-5018	312	47-5165	313	49-8060	426	50-3047	53
47-5019	312	48-109	421	49-8063	425	50-3048	55
47-5020	312	48-128	415	49-8064	426	50-3049	55
47-5021	312	48-130	417	49-8065	425	50-3050	55
47-5022	312	48-202	416	49-8067	425	50-3145	52
47-5023	312	48-204	420	49-8069	426	50-3147	52
47-5024	312	48-226	420	49-8080	425	50-3148	55
47-5030	312	48-228	417	49-8081	425	50-3371	56,265
47-5031	312	48-236	416	49-8087	425	50-4462	188,356
47-5032	312	48-252	420	49-8124	426	50-4562	188,258,356
47-5033	312	48-264	420	49-8125	426	50-4563	188,258,356
47-5034	312	48-266	416	49-8131	424	50-4655	305
47-5035	312	48-274	418	49-8134	424	50-4662	188,258,356
47-5036	312	48-276	420	49-8138	424	51-1447	55,99
47-5040	312	48-278	418	49-8139	424	51-1448	55,99
47-5041	312	48-282	418	49-8140	424	51-3049	55,99
47-5042	312	48-288	418	49-8141	425	51-3447	55,99



51-3460.....	50,99	60-5604.....	72	62-261200.....	448	62-6701M.....	446
51-3480.....	50,99	60-5606.....	72	62-261200M.....	448	62-6702.....	446
51-4360.....	98	60-5812.....	72	62-270500.....	448	62-6702M.....	446
51-4370.....	98	60-5813.....	72	62-270500M.....	448	62-6703.....	446
51-4382.....	98	60-5814.....	72	62-3602.....	445	62-6703M.....	446
52-3270.....	56	60-5816.....	72	62-3602M.....	445	62-6704.....	446
52-3282.....	56	60-5822.....	72	62-3702.....	445	62-6704M.....	446
52-3310.....	56	60-5823.....	72	62-3702M.....	445	62-6705.....	446
52-3370.....	56	60-5824.....	72	62-3703.....	445	62-6705M.....	446
52-3382.....	56	60-5826.....	72	62-3703M.....	445	62-6706.....	446
52-3410.....	56	60-6062.....	72,293,367	62-3704.....	445	62-6706M.....	446
52-3597.....	170	60-6130.....	226	62-3704M.....	445	62-6707.....	446
52-3970.....	56,170	60-6162.....	72,295,367	62-3706.....	445	62-6707M.....	446
52-5062.....	58	60-6164.....	72,295,367	62-3706M.....	445	62-6720.....	449
52-5077.....	58	60-6320.....	365	62-3707.....	445	62-6722.....	449
52-5095.....	58	60-6322.....	365	62-3707M.....	445	62-7625.....	446
52-5162.....	58	60-6340.....	70,290,365,404	62-3708.....	445	62-7625M.....	446
52-5177.....	58	60-6342.....	70,290,365,404	62-3708M.....	445	62-7627.....	446
52-5195.....	58	60-6467.....	71	62-3710.....	445	62-7701.....	446
52-5262.....	58	60-6570.....	71	62-3710M.....	445	62-7701M.....	446
52-5277.....	58	62-1117.....	444	62-3711.....	445	62-7706.....	446
52-5295.....	58	62-1117M.....	444	62-3711M.....	445	62-8453.....	447
52-6830.....	361	62-1200.....	449	62-3713.....	445	62-8454.....	447
52-6832.....	361	62-1328.....	444	62-3713M.....	445	62-8464.....	447
55-2892.....	45,256	62-1328M.....	444	62-3715.....	445	62-8465.....	447
55-2894.....	256	62-1612.....	449	62-3715M.....	445	62-8474.....	447
55-3012.....	256	62-1614.....	449	62-3716.....	445	62-8485.....	447
55-7340.....	71	62-1616.....	449	62-3716M.....	445	62-8494.....	447
55-7341.....	71	62-1618.....	449	62-3717.....	445	62-8714.....	448
55-9080.....	18	62-1645.....	444	62-3717M.....	445	62-8714M.....	448
55-9084.....	18	62-1645M.....	444	62-3718.....	445	62-9503.....	447
55-9090.....	18	62-1646.....	444	62-3718M.....	445	62-9503M.....	447
55-9180.....	18	62-1646M.....	444	62-3740.....	449	62-9553.....	447
55-9184.....	18	62-1648.....	444	62-3742.....	449	62-9553M.....	447
55-9190.....	18	62-1648M.....	444	62-3744.....	449	64-1150.....	304
55-9210.....	18	62-1659.....	444	62-3746.....	449	64-1240.....	28,308,357
55-9310.....	18	62-1659M.....	444	62-3748.....	449	64-1241.....	28,308,357
55-9311.....	18	62-181000.....	448	62-3750.....	449	64-1242.....	23,354
55-9411.....	18	62-181000M.....	448	62-3752.....	449	64-1250.....	304
55-9612.....	18	62-181500.....	448	62-3754.....	449	64-1340.....	28,308,357
55-9614.....	18	62-181500M.....	448	62-3756.....	449	64-1341.....	28,308,357
57-1325.....	291	62-200700.....	448	62-3758.....	449	64-1342.....	23,354
57-1445.....	73	62-200700M.....	448	62-4628.....	445	64-1345.....	26,28,308,357,358
60-1075.....	283	62-201000.....	448	62-4628M.....	445	64-1348.....	308
60-1085.....	73	62-201000M.....	448	62-4701.....	445	64-1442.....	22,355
60-1460.....	73	62-201500.....	448	62-4701M.....	445	64-1445.....	26,28,308,357,358
60-2185.....	153	62-201500M.....	448	62-4702.....	445	64-1542.....	22,355
60-2190.....	153	62-211000.....	448	62-4702M.....	445	64-1735.....	305,353
60-2195.....	153	62-211000M.....	448	62-4703.....	445	64-1742.....	331,359
60-3594.....	283	62-211500.....	448	62-4703M.....	445	64-1842.....	331,359
60-3596.....	283	62-211500M.....	448	62-4704.....	445	64-1942.....	331,359
60-3598.....	283	62-220700.....	448	62-4704M.....	445	64-1950.....	331,360
60-3607.....	283	62-220700M.....	448	62-4705.....	445	64-1951.....	331,360
60-3610.....	283	62-221000.....	448	62-4705M.....	445	64-1955.....	331,360
60-3612.....	283	62-221000M.....	448	62-4706.....	445	64-1958.....	331,360
60-3615.....	283	62-221500.....	448	62-4706M.....	445	64-1960.....	300,309,331,360
60-3617.....	283	62-221500M.....	448	62-4707.....	445	64-1961.....	300,309,331,360
60-3620.....	283	62-231000.....	448	62-4707M.....	445	64-2035.....	307,352
60-3625.....	283	62-231000M.....	448	62-4714.....	445	64-2036.....	307,352
60-5502.....	72	62-250600.....	448	62-4720.....	449	64-2042.....	305,353
60-5503.....	72	62-250600M.....	448	62-4722.....	449	64-2142.....	20
60-5504.....	72	62-251000.....	448	62-6633.....	446	64-2442.....	332,359
60-5506.....	72	62-251000M.....	448	62-6633M.....	446	64-2535.....	332,359
60-5602.....	72	62-251500.....	448	62-6634.....	446	64-3050.....	330
60-5603.....	72	62-251500M.....	448	62-6701.....	446	64-3052.....	330

64-3142.....	330,359	65-4026.....	325	65-7425.....	325	66-4951.....	335
64-3144.....	330,359	65-4030.....	325	65-7523.....	345	66-5942.....	296,337
64-3145.....	300,309,330,359	65-4031.....	325	65-7525.....	345	66-6036.....	336,361
64-3146.....	300,309,330,359	65-4032.....	325	65-7526.....	345	66-6037.....	336,361
64-3225.....	331	65-4062.....	328	65-7528.....	345	66-6038.....	336,361
64-3230.....	305,352	65-4064.....	328	65-7531.....	345	66-6039.....	336,361
64-3235.....	305,352	65-4066.....	328	65-7634.....	344	66-6105.....	338
64-3260.....	331,358	65-4074.....	327	65-7635.....	344	66-6109.....	338
64-3270.....	332,352	65-4080.....	325	65-8185.....	327	66-6110.....	57,339
64-3280.....	332,353	65-4098.....	267,329	65-8206.....	327	66-6112.....	57,339
64-3282.....	353	65-4099.....	329,267	65-8215.....	327	66-6114.....	57,339
64-3284.....	353	65-4100.....	267,329	66-1035.....	333,369	66-6115.....	338
64-3285.....	303,353	65-4101.....	329,267	66-1036.....	333,369	66-6118.....	338
64-3288.....	303,353	65-4103.....	267,329	66-1037.....	334	66-6120.....	337
64-3297.....	332	65-4105.....	267,329	66-1038.....	333,369	66-6125.....	338
64-3298.....	332	65-4107.....	267,329	66-1040.....	296	66-6126.....	338
65-1012.....	323	65-4120.....	267,329	66-1137.....	334	66-6140.....	338
65-1127.....	323	65-4121.....	267,329	66-1235.....	333	66-6142.....	338
65-1227.....	324	65-4123.....	267,329	66-1236.....	333	66-6150.....	338
65-1332.....	324	65-4125.....	267,329	66-1240.....	334	66-6152.....	338
65-1532.....	324	65-4127.....	267,329	66-1255.....	334	66-6160.....	338
65-1535.....	324	65-4130.....	267	66-1265.....	334	66-6164.....	338
65-1730.....	324	65-4131.....	267	66-1435.....	333	66-6166.....	338
65-1740.....	323	65-4132.....	267	66-1535.....	57	66-6168.....	338
65-1742.....	323	65-4133.....	267	66-1635.....	57	66-6175.....	340
65-1744.....	323	65-4134.....	267	66-1940.....	337,363	66-6178.....	340
65-1746.....	323	65-4135.....	267	66-2005.....	337	66-6180.....	340
65-1750.....	323	65-6055.....	299,343	66-2009.....	337	66-6194.....	340
65-1752.....	323	65-6265.....	342	66-2012.....	337	66-6196.....	340
65-1754.....	323	65-6350.....	343	66-2040.....	337	66-6240.....	339
65-1756.....	323	65-6352.....	343	66-2140.....	337,363	66-6242.....	339
65-1758.....	323	65-6354.....	343	66-2350.....	337	66-6250.....	339
65-1765.....	323	65-6357.....	68,343	66-2540.....	337	66-6268.....	339
65-1815.....	70,290,324,365	65-6358.....	68,343	66-2635.....	337	66-6338.....	339
65-1830.....	324	65-6442.....	300,309	66-2640.....	337	66-6340.....	339
65-1835.....	325,369	65-6446.....	300,309,342	66-2740.....	57,336	66-6342.....	296,334
65-1841.....	73,294,325,369	65-6448.....	300,309,342	66-2742.....	336	66-6810.....	341
65-1842.....	73,294,325,369	65-6452.....	300,309,342,371	66-2840.....	57,336	66-6811.....	341
65-1843.....	73,294,325,369	65-6470.....	342	66-2940.....	57,336	66-6812.....	341
65-1844.....	73,294,325,369	65-6475.....	342	66-2942.....	336	66-6813.....	341
65-3022.....	327	65-6550.....	69	66-3140.....	57,336	66-6900.....	341
65-3025.....	327	65-6732.....	296,344	66-3142.....	336	66-6902.....	341
65-3028.....	327	65-6735.....	296,344	66-3240.....	57,336	66-6925.....	341
65-3140.....	333	65-6950.....	329	66-3340.....	57,336	66-6930.....	341
65-3162.....	333,372	65-6952.....	329	66-3342.....	336	66-7130.....	335
65-3170.....	333,372	65-6960.....	267,329	66-3450.....	337	66-7244.....	335
65-3171.....	333,372	65-7000.....	329	66-3540.....	57,336	66-7250.....	335
65-3172.....	333,372	65-7001.....	329	66-3542.....	336	66-7347.....	339
65-3173.....	333,372	65-7002.....	329	66-3740.....	57,336	66-7436.....	364
65-3174.....	333,372	65-7003.....	329	66-3742.....	336	66-7438.....	364
65-3180.....	333,372	65-7254.....	326	66-3927.....	336	66-7440.....	364
65-3181.....	333,372	65-7255.....	326	66-4032.....	58,335,363	66-7442.....	58,364
65-3182.....	333,372	65-7257.....	326	66-4034.....	335	66-7447.....	58,364
65-3183.....	333,372	65-7260.....	326	66-4132.....	58,335,363	66-7542.....	58,364
65-3191.....	328	65-7265.....	326	66-4133.....	335	66-7642.....	58,364
65-3195.....	328	65-7270.....	326	66-4134.....	335	66-7644.....	364
65-3205.....	295,328,368	65-7272.....	326	66-4230.....	363	66-7645.....	364
65-3206.....	295,328,368	65-7275.....	326	66-4232.....	58,335,363	67-1020.....	262
65-3215.....	328	65-7400.....	278	66-4234.....	363	67-1021.....	262
65-3216.....	328	65-7401.....	278	66-4235.....	336,363	67-1030.....	263
65-3217.....	328	65-7402.....	278	66-4525.....	336,363	67-1032.....	263
65-3250.....	328,368	65-7403.....	278	66-4526.....	336	67-1033.....	263
65-3258.....	293	65-7410.....	278	66-4625.....	336,363	67-1034.....	263
65-3265.....	328,368	65-7411.....	278	66-4626.....	336	67-1035.....	262
65-4025.....	325	65-7422.....	325	66-4950.....	335	67-1036.....	262



67-1038.....	262	67-5987.....	393	70-1060.....	272	70-9210.....	286
67-1039.....	262	67-5990.....	393	70-1070.....	271	70-9220.....	286
67-1040.....	262	67-5992.....	393	70-1071.....	271	70-9221.....	286
67-1045.....	262	67-5994.....	393	70-1072.....	271	70-9222.....	286
67-1050.....	262	67-6010.....	260	70-1075.....	271	70-9223.....	286
67-1052.....	262,273	67-6011.....	260	70-1081.....	272	70-9224.....	286
67-1058.....	265	67-6012.....	260	70-1082.....	272	73-1015.....	282
67-1150.....	265,273	67-6013.....	260	70-1083.....	272	73-1082.....	282
67-1350.....	265	67-6014.....	260	70-1084.....	272	73-1085.....	282
67-1455.....	56,265	67-6020.....	260	70-1085.....	272	73-1086.....	282
67-1465.....	56,273	67-6025.....	260	70-1086.....	272	73-1188.....	282
67-1555.....	56	67-6026.....	260	70-1087.....	272	73-1189.....	282
67-1732.....	266	67-6027.....	260	70-1092.....	272	73-1190.....	282
67-1734.....	266	67-6030.....	260	70-1096.....	272	73-1191.....	282
67-1750.....	267	67-6031.....	260	70-2292.....	279	73-1192.....	282
67-1752.....	267	67-6032.....	260	70-2293.....	279	73-1193.....	282
67-1753.....	267	67-6033.....	260	70-4160.....	272	73-1194.....	282
67-2005.....	266	67-6050.....	260	70-4170.....	273	73-1195.....	282
67-2007.....	266	67-6200.....	260	70-4262.....	301	73-1196.....	282
67-2015.....	266	67-6202.....	260	70-4265.....	301	73-1197.....	282
67-2020.....	266	67-6204.....	260	70-4270.....	273,301	73-1351.....	282
67-2022.....	266	67-6206.....	260	70-4350.....	303,358	73-1352.....	282
67-2024.....	266	67-6250.....	260,435	70-4352.....	358,303	73-1353.....	282
67-2115.....	266	67-7064.....	268	70-4375.....	56,273	73-1354.....	282
67-2145.....	266	67-7128.....	268	70-4385.....	56,273	73-1355.....	282
67-2480.....	261	67-7256.....	268	70-4470.....	265,273	73-1356.....	282
67-2481.....	261	67-7512.....	268	70-4472.....	273	74-1200.....	283
67-2488.....	261	67-7524.....	268	70-5090.....	273	74-1202.....	283
67-2489.....	261	67-7548.....	268	70-5170.....	272	74-1280.....	161,289
67-2490.....	261	67-7605.....	268	70-5176.....	273	74-1370.....	49
67-2491.....	261	67-8000.....	264	70-5190.....	276	74-1470.....	49
67-2492.....	261	67-8006.....	264	70-5232.....	273	74-1570.....	49
67-2493.....	261	67-8008.....	264	70-5235.....	273	74-1670.....	49
67-2498.....	261	67-8010.....	264	70-5290.....	276	74-1975.....	289
67-2499.....	261	67-8014.....	264	70-5292.....	276	74-2175.....	289
67-2500.....	261	67-8016.....	264	70-5294.....	276	74-2475.....	289
67-2501.....	261	67-8018.....	264	70-5332.....	273	74-2575.....	289
67-2502.....	261	67-8024.....	264	70-5335.....	273	74-2590.....	289
67-2503.....	261	67-8140.....	265	70-5336.....	273	74-3075.....	45,289
67-2508.....	261	67-8150.....	265	70-5410.....	273	74-3175.....	289
67-2509.....	261	67-8152.....	265	70-5411.....	273	74-3260.....	38,256
67-2510.....	261	67-8155.....	265	70-5673.....	276	74-3270.....	38,256
67-2511.....	261	67-8170.....	265	70-6165.....	274	75-1010.....	281
67-2512.....	261	67-8172.....	265	70-6166.....	274	75-1015.....	281
67-2513.....	261	67-8174.....	265	70-6168.....	274	75-1016.....	281
67-2514.....	261	67-8176.....	265	70-7062.....	274	75-1017.....	281
67-2515.....	261	67-8177.....	265	70-7185.....	274	75-1025.....	281
67-2516.....	261	67-8178.....	265	70-7801.....	276	75-1120.....	284
67-2517.....	261	67-8180.....	265	70-7802.....	276	75-1122.....	284
67-2518.....	261	67-8188.....	265	70-7822.....	276	75-1124.....	284
67-2519.....	261	68-1050.....	269	70-9001.....	286	75-1400.....	281
67-2521.....	261	68-1257.....	269	70-9002.....	286	75-2160.....	281
67-2522.....	261	68-1357.....	269	70-9003.....	286	75-2161.....	281
67-2523.....	261	68-1557.....	269	70-9004.....	286	75-2315.....	284
67-2525.....	261	68-1665.....	269	70-9005.....	286	75-2318.....	293
67-2526.....	261	68-1765.....	269	70-9101.....	286	75-2320.....	293
67-2540.....	266	68-1865.....	269	70-9102.....	286	75-2322.....	293
67-2550.....	266	68-1890.....	269	70-9103.....	286	75-5070.....	307,358
67-2552.....	266	68-2175.....	269	70-9104.....	286	75-5267.....	307
67-3402.....	268	70-1020.....	271	70-9105.....	286	75-5460.....	16
67-3404.....	268	70-1030.....	271	70-9200.....	286	75-5570.....	18
67-3410.....	268	70-1035.....	271	70-9201.....	286	75-5670.....	18
67-3411.....	268	70-1038.....	271	70-9202.....	286	75-7077.....	287
67-3412.....	268	70-1040.....	271	70-9203.....	286	75-7282.....	287
67-3424.....	268	70-1041.....	271	70-9204.....	286	75-7482.....	287

Sklar

75-7492.....	287	80-2260.....	246	85-1422.....	254	87-2395.....	48
75-7575.....	288	80-2261.....	246	85-1424.....	254	90-1020.....	379
75-7590.....	287	80-2272.....	246	85-1426.....	254	90-1021.....	379
75-9070.....	285	80-2595.....	246	85-1428.....	254	90-1022.....	379
75-9075.....	285	80-2688.....	246	85-1430.....	254	90-1023.....	379
75-9155.....	285	80-2689.....	246	85-1432.....	254	90-1025.....	379
75-9245.....	285	80-2690.....	246	85-1434.....	254	90-1026.....	379
75-9250.....	285	80-2700.....	249	85-1436.....	254	90-1027.....	379
75-9405.....	285	80-2715.....	249	85-1438.....	254	90-1035.....	325,369,378
75-9406.....	285	80-2815.....	249	85-1440.....	254	90-1036.....	325,369,378
75-9407.....	285	80-2870.....	250	85-1442.....	254	90-1038.....	325,369,378
75-9408.....	285	80-2910.....	250	85-1446.....	254	90-1040.....	378
75-9409.....	285	80-3185.....	250	85-1608.....	254	90-1042.....	378
75-9505.....	285	80-3510.....	250	85-1610.....	254	90-1044.....	378
75-9506.....	285	80-3812.....	248	85-1612.....	254	90-1045.....	378
75-9507.....	285	80-3814.....	248	85-1614.....	254	90-1046.....	378
75-9508.....	285	80-3922.....	247	85-1616.....	254	90-1047.....	378
75-9509.....	285	80-3927.....	247	85-1618.....	254	90-1048.....	378
75-9601.....	288	80-3935.....	247	85-1620.....	254	90-1049.....	378
75-9602.....	288	85-1008.....	253	85-1622.....	254	90-1050.....	378
75-9603.....	288	85-1010.....	253	85-1624.....	254	90-1051.....	378
75-9612.....	288	85-1012.....	253	85-1626.....	254	90-1052.....	378
75-9613.....	288	85-1014.....	253	85-1628.....	254	90-1053.....	378
78-1001.....	73	85-1016.....	253	85-1630.....	254	90-1054.....	378
78-1002.....	73	85-1018.....	253	85-1632.....	254	90-1055.....	378
78-1003.....	73	85-1020.....	253	85-1635.....	254	90-1056.....	378
78-1101.....	73	85-1022.....	253	85-1636.....	254	90-1057.....	378
78-1102.....	73	85-1024.....	253	85-2010.....	258	90-1058.....	378
78-1103.....	73	85-1026.....	253	85-2012.....	258	90-1059.....	378
78-1201.....	368	85-1028.....	253	85-2014.....	258	90-1060.....	379
78-1202.....	368	85-1030.....	253	85-2016.....	258	90-1061.....	379
78-1203.....	368	85-1032.....	253	85-2018.....	258	90-1062.....	379
79-3230.....	248	85-1034.....	253	85-2020.....	258	90-1063.....	379
80-1082.....	250	85-1036.....	253	85-2022.....	258	90-1064.....	379
80-1410.....	157,247	85-1038.....	253	85-2024.....	258	90-1065.....	379
80-1419.....	157	85-1040.....	253	85-2026.....	258	90-1066.....	379
80-1565.....	250	85-1065.....	253	85-2028.....	258	90-1080.....	189,258
80-1695.....	250	85-1070.....	253	85-2030.....	258	90-1180.....	189,258
80-1735.....	249	85-1075.....	253	85-2032.....	258	90-1280.....	189,258
80-1742.....	249	85-1308.....	254	85-2034.....	258	90-1380.....	189,258
80-1872.....	243,244	85-1310.....	254	85-2036.....	258	90-1480.....	189,258
80-1910.....	243	85-1312.....	254	85-2038.....	258	90-1580.....	189,258
80-1911.....	243	85-1314.....	254	85-2210.....	258	90-1590.....	14,188
80-1912.....	243	85-1316.....	254	85-2212.....	258	90-1690.....	14,188
80-1914.....	243	85-1318.....	254	85-2214.....	258	90-1755.....	189,198
80-1918.....	245	85-1320.....	254	85-2216.....	258	90-1785.....	189,198
80-1930.....	245	85-1322.....	254	85-2218.....	258	90-1790.....	215
80-1931.....	245	85-1324.....	254	85-2220.....	258	90-1885.....	167
80-1940.....	248	85-1326.....	254	85-2355.....	256	90-1890.....	215
80-1945.....	244	85-1328.....	254	85-2360.....	256	90-1977.....	169
80-1950.....	244	85-1330.....	254	85-2365.....	256	90-2114.....	171,214
80-1951.....	244,245	85-1332.....	254	85-4697.....	257	90-2116.....	171,214
80-1952.....	244	85-1334.....	254	85-4780.....	257	90-2118.....	172,214
80-1970.....	245	85-1336.....	254	85-6220.....	255	90-2120.....	172,214
80-1972.....	245	85-1338.....	254	85-6222.....	255	90-2122.....	172,214
80-1974.....	245	85-1340.....	254	85-6450.....	256	90-2124.....	172,214
80-2100.....	247	85-1342.....	254	85-6460.....	256	90-2126.....	173
80-2120.....	247	85-1345.....	254	85-6550.....	198,257	90-2128.....	173
80-2125.....	247	85-1408.....	254	85-6551.....	198,257	90-2170.....	171,214
80-2132.....	247	85-1410.....	254	85-6555.....	256	90-2171.....	171,214
80-2142.....	246	85-1412.....	254	87-1052.....	47	90-2172.....	171,214
80-2143.....	246	85-1414.....	254	87-2095.....	48	90-2173.....	171,214
80-2144.....	246	85-1416.....	254	87-2195.....	48	90-2174.....	171,214
80-2244.....	243,244,246	85-1418.....	254	87-2199.....	48	90-2175.....	171,214
80-2245.....	243,244,246	85-1420.....	254	87-2295.....	48	90-2177.....	169



90-2180.....	168	90-3555.....	151	90-4795.....	175	90-6295.....	176
90-2242.....	214	90-3558.....	151	90-4796.....	175	90-6582.....	177
90-2261.....	216	90-3559.....	150	90-4797.....	175	90-6590.....	177
90-2270.....	216,251	90-3560.....	150,212	90-4798.....	175	90-6600.....	184
90-2272.....	216	90-3561.....	150,212	90-4802.....	175	90-6602.....	184
90-2276.....	160,216,251,379	90-3562.....	212	90-4804.....	175	90-6610.....	184
90-2278.....	43,166,215,251	90-3610.....	153	90-4806.....	175	90-6611.....	178
90-2279.....	160,216,379	90-3692.....	153	90-4808.....	175	90-6612.....	178,187
90-2280.....	169	90-3700.....	143	90-4810.....	175	90-6820.....	185
90-2295.....	43,166,215	90-3701.....	143	90-4812.....	175	90-6887.....	179
90-2298.....	163,215	90-3702.....	143	90-4814.....	175	90-7111.....	216
90-2304.....	216,251,379	90-3705.....	147	90-4816.....	175	90-7195.....	177
90-2306.....	216,251,379	90-3710.....	145	90-4818.....	175	90-7385.....	185
90-2310.....	216,379	90-3711.....	145	90-4825.....	175	90-7492.....	185
90-2312.....	216,379	90-3712.....	145	90-4826.....	175	90-7511.....	185
90-2325.....	158,215	90-3713.....	145	90-4902.....	176	90-7520.....	182,187
90-2326.....	158,215	90-3740.....	147	90-4910.....	175	90-7525.....	181
90-2340.....	157,215	90-3741.....	147	90-4912.....	175	90-7530.....	180,187
90-2342.....	157,215	90-3750.....	147	90-4916.....	175	90-7540.....	183
90-2345.....	163,217	90-3752.....	148	90-4918.....	175	90-7571.....	186
90-2348.....	162,217	90-3754.....	147,211	90-4920.....	175	90-7572.....	186
90-2350.....	162,217	90-3755.....	147,211	90-4925.....	175	90-7573.....	186
90-2379.....	168	90-3800.....	143	90-4926.....	175	90-7574.....	186
90-2387.....	169	90-3802.....	143	90-5215.....	175	90-7575.....	186
90-2480.....	168	90-3803.....	143	90-5219.....	175	90-7576.....	186
90-2580.....	168	90-3804.....	144,211	90-5223.....	175	90-7577.....	186
90-2680.....	167	90-3806.....	144,211	90-5227.....	175	90-7578.....	186
90-2682.....	167	90-3808.....	144,211	90-5231.....	175	90-7579.....	186
90-2690.....	168	90-3810.....	144,211	90-5235.....	175	90-7610.....	157,247
90-2780.....	167	90-3812.....	144,211	90-5239.....	175	90-7710.....	157,247
90-2782.....	167	90-3814.....	148,211	90-5243.....	175	90-7895.....	162
90-2790.....	169	90-3815.....	148,211	90-5250.....	175	90-7898.....	163
90-2792.....	169	90-3833.....	146,211	90-5312.....	173	90-7977.....	163
90-2793.....	169	90-3835.....	146,211	90-5314.....	173	90-7995.....	49,162
90-2794.....	169	90-3837.....	146,211	90-5412.....	173	90-8010.....	185
90-3045.....	152	90-3839.....	146,211	90-5413.....	173	90-8080.....	168
90-3130.....	152	90-3841.....	146,211	90-5421.....	178	90-8082.....	168
90-3135.....	152	90-3849.....	145	90-5422.....	178	90-8090.....	167
90-3140.....	152	90-3851.....	145	90-5423.....	178	90-8110.....	168
90-3150.....	151	90-3865.....	148	90-5424.....	178	90-8111.....	163
90-3151.....	151	90-3945.....	148	90-5425.....	178	90-8112.....	168
90-3152.....	151	90-3946.....	148,212	90-5426.....	178	90-8210.....	177
90-3153.....	151	90-3957.....	149	90-5428.....	178	90-8301.....	74,171
90-3154.....	151	90-3959.....	149	90-5431.....	178	90-8302.....	74,171
90-3225.....	151	90-3960.....	149	90-5432.....	178	90-8303.....	74,171
90-3230.....	151	90-3980.....	149	90-5433.....	178	90-8304.....	74,171
90-3235.....	151	90-3990.....	154,187	90-5434.....	178	90-8305.....	74,171
90-3327.....	152	90-3994.....	154	90-5435.....	178	90-8306.....	171
90-3330.....	152	90-3995.....	154,187	90-5436.....	178	90-8332.....	171
90-3335.....	152	90-3996.....	154	90-5438.....	178	90-8333.....	171
90-3422.....	152	90-3997.....	154	90-5499.....	178	90-8334.....	172,187
90-3427.....	152	90-3998.....	154	90-5500.....	178	90-8335.....	172
90-3430.....	152	90-4212.....	176	90-5542.....	177	90-8336.....	173,187
90-3450.....	153	90-4713.....	176	90-5566.....	177	90-8341.....	171
90-3451.....	153	90-4784.....	175	90-5710.....	177	90-8342.....	171
90-3452.....	153	90-4785.....	175	90-5713.....	178	90-8344.....	172
90-3470.....	153	90-4786.....	175	90-6095.....	177	90-8346.....	172
90-3510.....	153	90-4787.....	175	90-6195.....	177	90-8348.....	173
90-3525.....	150	90-4788.....	175	90-6280.....	174	90-8555.....	187
90-3526.....	150	90-4789.....	175	90-6281.....	174	90-8557.....	187
90-3527.....	150	90-4790.....	175	90-6285.....	178,187	90-8715.....	170
90-3530.....	150	90-4791.....	175	90-6289.....	176	90-8717.....	170
90-3535.....	151	90-4792.....	175	90-6290.....	176	90-8845.....	149,212
90-3536.....	151	90-4793.....	175	90-6291.....	176	90-8850.....	156,213
90-3537.....	151	90-4794.....	175	90-6292.....	176	90-8855.....	156,213

Sklar

90-8858	156,213	91-1465	159	91-5210	151,202	92-2015	195
90-8860	156,213	91-1562	161	91-5212	151,202	92-2215	195
90-8862	156,213	91-1590	165	91-5226	155,204	92-2314	195
90-8865	156,213	91-1690	165	91-5228	155,204	92-2812	196
90-8900	184	91-1890	165	91-5230	155,204	92-2912	196
90-8905	184	91-1990	165	91-5232	155,204	92-3350	196
90-8920	179	91-2080	170	91-5234	155,204	92-5012	197
90-8925	185	91-2282	164	91-5235	155,204	92-5095	197
90-8930	185	91-2382	164	91-5241	171,205	92-5295	197
90-8940	182	91-2482	164	91-5242	172,205	92-5298	198
90-8945	180	91-2585	164	91-5243	172,205	92-5540	189,198
90-8948	181	91-2695	161	91-5244	173	92-5565	189
90-8952	183	91-3095	164	91-5245	171,205	92-6535	198
90-8981	186	91-3195	164	91-5246	172,205	93-2160	201,211
90-8982	186	91-3740	147,201	91-5247	172,205	94-2027	137
90-8983	186	91-3741	147,201	91-5248	173	94-2028	137
90-8984	186	91-3795	164	91-5250	171,205	94-2029	137
90-8985	186	91-3810	165	91-5251	171,205	94-2031	137
90-8986	186	91-3910	165	91-5252	171,205	94-2032	137
90-8987	186	91-4210	197	91-5253	171,205	94-4024	130
90-8988	186	91-4310	197	91-5254	171,205	94-4025	130
90-8989	186	91-5010	144,199	91-5255	171,205	94-4026	130
90-9000	144,210	91-5012	144,199	91-5268	43,166,207	94-4038	132
90-9002	144,210	91-5014	144,199	91-5270	43,166,207	95-103	20,102
90-9004	144,210	91-5015	144,199	91-5278	160,207	95-104	20,102
90-9005	144,210	91-5018	144,199	91-5300	207	95-105	33,101
90-9006	144,210	91-5020	143,199	91-5302	207	95-107	20,102
90-9015	143,210	91-5022	143,199	91-5307	157,206	95-109	20,102
90-9016	143,210	91-5024	143,199	91-5308	157,206	95-110	101
90-9018	143,210	91-5028	143,199	91-5310	157,206	95-111	101
90-9020	143,210	91-5032	146,199	91-5400	162,207	95-112	102
90-9030	146,210	91-5034	146,199	91-5404	162,207	95-113	102
90-9032	146,210	91-5036	146,199	91-5408	163,207	95-114	102
90-9034	146,210	91-5038	146	91-5411	206	95-115	102
90-9035	146,210	91-5040	146,199	91-5412	206	95-116	102
90-9038	146,210	91-5042	145,199	91-5413	206	95-117	102
90-9040	145,210	91-5044	145,199	91-5414	206	95-118	102
90-9042	145,210	91-5046	145,199	91-5420	206	95-119	102
90-9044	145,210	91-5047	145,199	91-5422	206	95-120	102
90-9048	145,210	91-5050	145,199	91-5424	206	95-122	102
90-9050	145,210	91-5060	144,200	91-5428	206	95-124	102
90-9054	211	91-5062	144,200	91-5440	160,207	95-125	102
90-9055	211	91-5064	144,200	91-5450	158,206	95-126	102
90-9065	152,217	91-5066	144,200	91-5452	206	95-127	102
90-9066	152,217	91-5068	144,200	91-5455	158,206	95-128	103
90-9067	152,217	91-5080	147,201	91-6100	208,297	95-130	104
90-9068	152,217	91-5082	146,200	91-6101	208,297	95-132	104
90-9100	150,212	91-5084	146,200	91-6102	208,297	95-133	104
90-9102	150,212	91-5086	146,200	91-6103	208,297	95-135	104
90-9103	212	91-5088	146,199,200	91-6104	208,297	95-136	104
90-9106	150,212	91-5092	146,200	91-6105	208,297	95-137	104
90-9108	150,212	91-5120	150,203	91-6106	208,297	95-138	104
90-9109	212	91-5122	150,203	91-6107	208,297	95-139	104
90-9555	180	91-5130	150,203	91-6108	208,297	95-140	104
90-9560	182	91-5132	150,203	91-6109	208,297	95-141	104
90-9565	181	91-5140	150,203	91-6110	208,297	95-142	104
90-9570	179	91-5142	150,203	91-6111	208,297	95-143	104
90-9575	183	91-5150	149,202	91-6112	208,297	95-160	102
91-1070	159	91-5152	149,202	91-6113	208,297	95-161	102
91-1111	159	91-5154	149,202	91-6114	208,297	95-222	30
91-1275	159	91-5160	147,201	91-6115	208,297	95-226	30,101
91-1290	158	91-5162	148,201	92-1012	195	95-231	30,101
91-1293	159	91-5190	149,202	92-1112	195	95-241	30,101
91-1298	158	91-5200	151,202	92-1114	195	95-254	31,103
91-1455	159	91-5202	151,202	92-1415	196	95-265	10,101



95-272	10,101	95-516	40,107	96-1050	236,459	96-1504	473
95-275	10,101	95-517	40,107	96-1055	236,459	96-1506	473
95-281	10,101	95-518	40,107	96-1060	236,459	96-1508	473
95-284	10,101	95-521	40,107	96-1065	236,459	96-1510	473
95-285	46,108	95-525	40,107	96-1070	344,463	96-1512	473
95-289	46,108	95-571	48,106	96-1071	344,463	96-1514	473
95-292	12,101	95-577	48,106	96-1075	236,459	96-1516	473
95-295	12,101	95-586	48,106	96-1080	236,459	96-1550	474
95-299	12,101	95-592	49	96-1085	236,459	96-1552	474
95-303	109,143	95-606	48,106	96-1090	236,459	96-1610	143,464,147,242
95-304	109	95-611	48,106	96-1095	236,459	96-1612	242,464
95-308	14,102	95-629	47,106	96-1099	236,459	96-1615	242,464,145,149
95-312	109,143	95-635	47,106	96-1100	174,241,377,461	96-1616	242,464
95-321	14,102	95-705	50,105	96-1105	174,241,377,461	96-1621	139
95-322	109	95-710	50,105	96-1110	174,241,377,461	96-1627	141
95-324	109,143	95-727	50,105	96-1115	174,241,377,461	96-1640	141
95-325	14,102	95-731	105,50	96-1120	174,241,377,461	96-1641	141
95-329	102	95-736	105,50	96-1125	174,241,377,461	96-1642	141
95-330	14,102	95-753	51,105	96-1130	174,241,377,461	96-1649	138
95-332	102	95-757	51,105	96-1140	174,241,377,461	96-1650	138
95-335	16,102	95-762	51,105	96-1142	174,241,377,461	96-1651	138
95-336	16,102	95-766	51,105	96-1144	174,241,377,461	96-1652	138
95-339	18,102	95-771	52,105	96-1146	174,241,377,461	96-1653	138
95-340	18,102	95-772	52,105	96-1148	174,241,377,461	96-1654	140,259
95-346	24,103	95-775	53,105	96-1150	174,241,377,461	96-1655	140,259
95-347	109,145	95-776	53,105	96-1152	174,241,377,461	96-1656	140,259
95-348	109,145	95-777	59,105	96-1160	174,241,377,461	96-1657	140,259
95-352	24,103	95-778	54,105	96-1190	377,462	96-1662	139
95-358	25,103	95-781	59,105	96-1192	377,462	96-1664	139
95-360	22,102	95-809	62,104,190	96-1194	377,462	96-1665	140
95-361	22,102	95-810	65,104	96-1196	377,462	96-1666	140
95-362	109,145	95-826	63,104	96-1198	377,462	96-1667	140
95-364	29,103	95-832	66,104	96-1199	377,462	96-1668	140
95-374	109,157	95-842	64,104,191	96-1200	237,458	96-1669	140
95-386	109,158	95-847	64,104,191	96-1201	435	96-1670	140
95-409	39,107	95-853	64,104,191	96-1202	435	96-1671	140
95-421	39,107	95-869	64,104,191	96-1210	237,458	96-1672	140
95-426	36,106	95-934	42,108,160	96-1300	209,298	96-1673	140
95-431	36,106	95-938	42,108,160	96-1304	209,298	96-1674	140
95-436	38,107	95-952	43,108,166,	96-1305	209,298	96-1675	140
95-442	38,107	96-0557	145,149,234,453	96-1308	209,298	96-1676	140
95-447	37,106	96-0567	145,149,234,453	96-1310	209,298	96-1677	140
95-452	37,106	96-0577	145,149,234,453	96-1312	209,298	96-1678	140
95-456	44,161,198,259	96-0670	271,463	96-1315	209,298	96-1679	141
95-458	37,106	96-0857	143,234,453	96-1316	209,298	96-1680	138
95-463	37,106	96-0867	143,234,453	96-1318	209,298	96-1681	444,445,446,447,448
95-466	44,161,259	96-0877	143,234,453	96-1320	209,298	96-1682	444,445,446,447,448
95-467	44,161,259	96-0910	246,252,462	96-1321	209,298	96-1684	139
95-469	106	96-0911	246,252,462	96-1325	209,298	96-1685	139
95-470	41,107	96-1001	261,270,460	96-1326	209,298	96-1686	139
95-471	41,107	96-1002	270,460	96-1328	209,298	96-1687	139
95-473	41,107	96-1006	261,270,460	96-1332	209,298	96-1688	139
95-477	41,107	96-1007	270,460	96-1334	209,298	96-1689	139
95-481	41,107	96-1011	261,270,460	96-1336	209,298	96-1690	139
95-483	41,107	96-1012	270,460	96-1400	472	96-1691	139
95-485	41,107	96-1016	261,270,460	96-1402	472	96-1693	139
95-492	41,107	96-1017	270,460	96-1404	472	96-1694	139
95-494	41,107	96-1021	261,270,460	96-1406	472	96-1695	139
95-500	40,107	96-1022	270,460	96-1408	472	96-1696	139
95-501	40,107	96-1031	261,270,460	96-1410	472	96-1697	139
95-504	40,107	96-1032	270,460	96-1412	472	96-1700	124
95-512	40,107	96-1035	261	96-1414	472	96-1701	124
95-513	40,107	96-1036	270,460	96-1416	472	96-1702	129
95-514	40,107	96-1040	236,459	96-1500	473	96-1703	135
95-515	40,107	96-1045	236,459	96-1502	473	96-1704	129

Sklar

96-1705.....	130	96-1796.....	138	96-2030.....	318	96-2502.....	30,117
96-1707.....	127	96-1797.....	138	96-2032.....	318	96-2503.....	30,117
96-1708.....	130	96-1799.....	138	96-2034.....	318	96-2504.....	20,117
96-1710.....	127	96-1801.....	135	96-2040.....	317	96-2505.....	20,117
96-1712.....	131	96-1802.....	135	96-2041.....	317	96-2506.....	20,117
96-1713.....	127	96-1803.....	135	96-2042.....	317	96-2507.....	20,117
96-1714.....	131	96-1804.....	129	96-2043.....	317	96-2508.....	24
96-1715.....	128	96-1805.....	133	96-2044.....	317	96-2509.....	24
96-1716.....	128	96-1806.....	133	96-2045.....	317	96-2510.....	117
96-1717.....	128	96-1807.....	133	96-2046.....	317	96-2511.....	117
96-1718.....	128	96-1811.....	138	96-2047.....	317	96-2512.....	25,117
96-1721.....	134	96-1812.....	138	96-2048.....	317	96-2513.....	25,117
96-1722.....	134	96-1813.....	138	96-2050.....	317	96-2516.....	16,118
96-1723.....	134	96-1814.....	138	96-2051.....	317	96-2517.....	16,118
96-1724.....	126	96-1815.....	138	96-2052.....	317	96-2518.....	29,118
96-1725.....	126	96-1816.....	138	96-2053.....	317	96-2519.....	29,118
96-1726.....	132	96-1817.....	138	96-2054.....	317	96-2520.....	10,118
96-1727.....	132	96-1818.....	138	96-2055.....	317	96-2521.....	10,118
96-1728.....	131,460,270	96-1819.....	138	96-2056.....	317	96-2522.....	10,118
96-1729.....	126	96-1820.....	138	96-2057.....	317	96-2523.....	10,118
96-1730.....	124	96-1821.....	138	96-2058.....	317	96-2524.....	12
96-1731.....	124	96-1830.....	139	96-2060.....	317	96-2525.....	12
96-1732.....	126	96-1832.....	139	96-2062.....	317	96-2526.....	12
96-1734.....	125	96-1834.....	139	96-2069.....	317	96-2527.....	12
96-1735.....	125	96-1836.....	139	96-2100.....	452	96-2528.....	47,120
96-1736.....	125	96-1838.....	133,391	96-2102.....	452	96-2529.....	47,120
96-1737.....	125	96-1845.....	474	96-2104.....	452	96-2530.....	14,118
96-1738.....	125	96-1846.....	474	96-2106.....	452	96-2531.....	14,118
96-1740.....	125	96-1847.....	474	96-2108.....	452	96-2532.....	48,120
96-1743.....	131	96-1848.....	474	96-2110.....	452	96-2533.....	48,120
96-1744.....	131	96-1849.....	474	96-2136.....	452	96-2534.....	48
96-1745.....	136	96-1850.....	474	96-2137.....	452	96-2535.....	48
96-1746.....	136	96-1851.....	474	96-2138.....	452	96-2536.....	36,118
96-1747.....	136	96-1852.....	474	96-2140.....	452	96-2537.....	36,118
96-1748.....	136	96-1853.....	474	96-2142.....	452	96-2538.....	36,118
96-1750.....	468	96-1860.....	475	96-2144.....	452	96-2539.....	36,118
96-1752.....	468	96-1862.....	475	96-2146.....	452	96-2540.....	22
96-1753.....	127	96-1864.....	475	96-2148.....	452	96-2541.....	22
96-1754.....	468	96-1866.....	475	96-2150.....	452	96-2542.....	22
96-1755.....	127	96-1868.....	475	96-2160.....	451	96-2543.....	22
96-1756.....	468	96-1870.....	475	96-2162.....	451	96-2544.....	41,119
96-1757.....	124	96-1872.....	475	96-2164.....	451	96-2545.....	41,119
96-1758.....	469	96-1874.....	475	96-2166.....	451	96-2546.....	41,119
96-1759.....	124	96-1876.....	475	96-2170.....	451	96-2547.....	41,119
96-1760.....	469	96-1878.....	475	96-2172.....	451	96-2550.....	37,119
96-1762.....	469	96-1880.....	462	96-2174.....	451	96-2551.....	37,119
96-1764.....	469	96-1882.....	462	96-2176.....	451	96-2552.....	37,119
96-1766.....	470	96-1884.....	462	96-2178.....	451	96-2553.....	37,119
96-1768.....	470	96-1886.....	462	96-2180.....	451	96-2554.....	39,118
96-1770.....	470	96-1890.....	462	96-2182.....	451	96-2555.....	39,118
96-1772.....	470	96-1892.....	462	96-2184.....	451	96-2556.....	39,118
96-1774.....	471	96-1894.....	462	96-2186.....	451	96-2557.....	39,118
96-1775.....	471	96-1896.....	462	96-2190.....	451	96-2558.....	54,120
96-1776.....	471	96-1900.....	475	96-2192.....	451	96-2559.....	54,120
96-1777.....	471	96-1901.....	475	96-2194.....	451	96-2560.....	38,119
96-1780.....	138	96-1904.....	129	96-2196.....	451	96-2561.....	38,119
96-1782.....	138	96-1905.....	475	96-2198.....	451	96-2562.....	38,119
96-1784.....	138	96-1906.....	475	96-2402.....	31,118	96-2563.....	38,119
96-1786.....	138	96-1916.....	134,237,458	96-2404.....	31,118	96-2564.....	119
96-1788.....	138	96-2012.....	391	96-2406.....	49,119	96-2565.....	119
96-1790.....	138	96-2020.....	318	96-2408.....	49,119	96-2566.....	40
96-1792.....	138	96-2022.....	318	96-2410.....	59,120	96-2567.....	40
96-1793.....	138	96-2024.....	318	96-2412.....	59,120	96-2568.....	50,120
96-1794.....	138	96-2026.....	318	96-2445.....	427	96-2569.....	50,120
96-1795.....	138	96-2028.....	318	96-2452.....	427	96-2570.....	52,120



96-2571.....	52,120	96-2902.....	122	96-5602.....	427	97-1259.....	380
96-2572.....	53,120	96-2903.....	123	96-7906.....	436,463	97-1262.....	380
96-2573.....	53,120	96-2905.....	122	96-7907.....	436,463	97-1280.....	380
96-2575.....	42,119,160	96-2906.....	123	97-0035.....	388	97-1285.....	380
96-2576.....	42,119	96-2907.....	122	97-0036.....	388	97-1286.....	380
96-2578.....	51,120	96-2908.....	122	97-0048.....	388	97-1308.....	381
96-2579.....	51,120	96-2909.....	123	97-0050.....	399	97-1309.....	381
96-2580.....	66,121	96-2910.....	123	97-010.....	116	97-1315.....	384
96-2581.....	66,121	96-2914.....	122	97-021.....	116	97-1318.....	384
96-2582.....	63,121	96-2915.....	123	97-029.....	116	97-1340.....	392
96-2583.....	63,121	96-2916.....	122	97-033.....	116	97-1350.....	32,385,405
96-2584.....	65,121	96-2917.....	123	97-0335.....	384	97-1351.....	32,385,405
96-2585.....	65,121	96-2918.....	122	97-038.....	116	97-1400.....	322
96-2586.....	62,121,190	96-2919.....	123	97-0474.....	382	97-1405.....	322
96-2587.....	62,121,190	96-2930.....	122	97-0503.....	386	97-1410.....	322
96-2590.....	121,192	96-2931.....	123	97-0505.....	386	97-1415.....	322
96-2591.....	121,192	96-2950.....	122	97-0507.....	386	97-1420.....	322
96-2594.....	64,121,191	96-2951.....	123	97-0509.....	386	97-1425.....	322
96-2595.....	64,121,191	96-2955.....	122	97-0512.....	386	97-1430.....	322
96-2596.....	118	96-2956.....	123	97-0522.....	386	97-1445.....	322
96-2598.....	118	96-3160.....	451	97-0524.....	386	97-1450.....	322
96-2602.....	143,234,453	96-3162.....	451	97-0527.....	399	97-1505.....	280,390
96-2603.....	143	96-3164.....	451	97-0528.....	386	97-1506.....	280,390
96-2604.....	143,234,453	96-3166.....	451	97-0532.....	386	97-1530.....	98,170
96-2605.....	143	96-3170.....	451	97-0536.....	386	97-1531.....	98,170
96-2606.....	143,234,453	96-3172.....	451	97-0539.....	386	97-1540.....	98,170
96-2607.....	143	96-3174.....	451	97-0542.....	386	97-1541.....	98,170
96-2613.....	145	96-3176.....	451	97-0546.....	387	97-1555.....	42,98
96-2615.....	145	96-3178.....	451	97-0548.....	387	97-1560.....	42,98
96-2617.....	145	96-3180.....	451	97-0552.....	386	97-1565.....	43,98,166
96-2620.....	119,157	96-3182.....	451	97-0554.....	386	97-1570.....	43,98,166
96-2622.....	119,157	96-3184.....	451	97-0555.....	385	97-1600.....	388
96-2624.....	119,158	96-3186.....	451	97-0562.....	387	97-1605.....	388
96-2626.....	119,158	96-3190.....	451	97-0564.....	374,386	97-1610.....	388
96-2640.....	27,121	96-3192.....	451	97-0581.....	387	97-1615.....	389
96-2642.....	145,149,234,453	96-3194.....	451	97-0582.....	387	97-1620.....	389
96-2644.....	145,149,234,453	96-3196.....	451	97-0583.....	387	97-1625.....	389
96-2648.....	145,149,234,453	96-3198.....	451	97-0601.....	388	97-1640.....	389
96-2649.....	118	96-4100.....	176,235,456	97-0604.....	388	97-1642.....	389
96-2650.....	117	96-4120.....	159,240,454	97-0606.....	388	97-1645.....	389
96-2651.....	117	96-4140.....	240,454	97-0623.....	388	97-1650.....	395
96-2652.....	119	96-4141.....	240,454	97-0634.....	388	97-1652.....	395
96-2653.....	119	96-4143.....	178,240,454	97-0640.....	399	97-1654.....	395
96-2654.....	117	96-4150.....	174,239,455	97-0641.....	399	97-1660.....	382
96-2655.....	120	96-4155.....	239,455	97-1045.....	383	97-1661.....	382
96-2656.....	120	96-4160.....	235,456	97-1046.....	383	97-1662.....	382
96-2657.....	118	96-4162.....	235,456	97-105.....	116	97-1663.....	382
96-2658.....	118	96-4164.....	235,456	97-1055.....	381	97-1700.....	322
96-2659.....	121	96-4166.....	235,456	97-1056.....	383	97-1701.....	322
96-2660.....	120	96-4170.....	173,239,455	97-1057.....	383	97-1702.....	322
96-2661.....	120	96-4171.....	75	97-1146.....	382	97-1703.....	322
96-2662.....	117	96-4172.....	75	97-1148.....	381	97-1704.....	322
96-2663.....	117	96-4174.....	75,121	97-1150.....	385	97-1705.....	322
96-2680.....	18,117	96-4175.....	75,121	97-1156.....	383	97-1706.....	322
96-2682.....	18,117	96-4180.....	238,457	97-1174.....	381	97-1720.....	322
96-2684.....	46,120	96-4184.....	238,457	97-1185.....	381	97-1721.....	322
96-2685.....	46,120	96-4190.....	238,457	97-1235.....	385	97-1722.....	322
96-2701.....	33	96-4192.....	238,457	97-1238.....	384	97-1723.....	322
96-2702.....	33	96-4194.....	238,457	97-1240.....	384	97-1724.....	322
96-2703.....	33	96-4196.....	238,457	97-1241.....	384	97-1725.....	322
96-2704.....	33	96-5190.....	238,457	97-1242.....	384	97-1726.....	322
96-2705.....	43,166	96-5192.....	238,457	97-1243.....	384	97-222.....	111
96-2706.....	43,166	96-5194.....	238,457	97-1245.....	385	97-226.....	111
96-2707.....	40	96-5196.....	238,457	97-1251.....	380	97-231.....	111
96-2708.....	40	96-5601.....	427	97-1255.....	380	97-237.....	111

Sklar

97-241	111	97-826	113	98-362	114
97-263	111	97-832	113	98-382	114
97-266	111	97-838	113	98-386	114
97-269	111	97-842	113	98-413	115
97-272	111	97-847	113	98-414	115
97-275	111	97-853	113	98-415	115
97-278	111	97-869	113	98-416	115
97-281	111	97-930	112	98-472	115
97-284	111	97-934	112	98-475	115
97-288	111	97-938	112	98-476	115
97-292	111	98-103	111	98-477	115
97-295	111	98-104	111	98-478	115
97-299	111	98-1052	360	98-483	115
97-308	111	98-1055	360	98-485	115
97-312	111	98-1067	360	98-489	115
97-321	111	98-107	111	98-490	115
97-325	111	98-1075	350	98-492	115
97-335	111	98-1076	350	98-503	115
97-336	111	98-109	111	98-505	115
97-339	111	98-123	112	98-508	115
97-340	111	98-129	112	98-7277	348
97-346	116	98-135	112	98-7278	348
97-352	116	98-142	112	98-7700	346
97-358	116	98-146	112	98-7702	346
97-364	116	98-151	112	98-7706	346
97-370	113	98-162	114	98-7708	346
97-371	113	98-164	114	98-7718	346
97-384	113	98-165	114	98-7740	346
97-388	113	98-166	114	98-7742	346
97-426	111	98-167	114	98-7744	346
97-431	111	98-170	114	98-7758	346
97-436	111	98-171	114	98-7780	347
97-442	111	98-172	114	98-7782	347
97-447	111	98-173	114	98-7786	347
97-452	111	98-174	114	98-7788	347
97-458	111	98-180	114	98-7792	347
97-463	111	98-182	114	98-7794	347
97-5045	404	98-2047	55,363	98-7810	300,309,351,360
97-571	112	98-2048	55,363	98-7812	300,309,351,360
97-577	112	98-2050	44,361	98-7815	351
97-586	112	98-2051	44,361	98-7816	300,309,351
97-592	112	98-2070	361	98-7817	300,309,351
97-603	112	98-2071	361	98-7820	347
97-606	112	98-2080	363	98-7822	347
97-611	112	98-2081	363	98-7832	347
97-623	112	98-209	116	98-7834	347
97-705	112	98-224	116	98-7860	348
97-710	112	98-232	116	98-7862	348
97-727	112	98-243	114	98-7866	348
97-731	112	98-247	114	98-7868	348
97-736	112	98-251	114	98-7872	348
97-742	112	98-258	114	98-7874	348
97-748	112	98-267	114	98-7890	348
97-753	112	98-268	114	98-7892	348
97-757	112	98-303	114	98-7894	348
97-762	112	98-3055	351	98-7922	349
97-769	112	98-3056	351	98-7924	349
97-771	112	98-312	114	98-7928	349
97-772	112	98-3186	350	98-7930	349
97-775	112	98-3188	350	98-7934	349
97-776	112	98-3190	350	98-7936	349
97-777	112	98-3192	350	98-7950	349
97-781	112	98-324	114	98-7952	349
97-809	113	98-336	114	98-7954	349
97-810	113	98-348	114		



OR Quality Instruments



OR Premium™ Instruments



Mid-Grade Instruments

A

Abramson-Allis Forceps..... 161
 Absorbent Towels, Sterile..... 139
 Adair Breast Tenaculum..... 159
 Adair-Allis Forceps..... 44
 Adams Plier..... 424
 Adenoid Curette, Barnhill..... 286
 Adenoid Curette, Beckman..... 286
 Adenoid Curette, Vogel..... 286
 Adenotome, La Force..... 286
 Adjusting Plier..... 423,426
 Adson Bayonet Forceps..... 56,256
 Adson Beckman Retractor..... 71
 Adson Bipolar Forceps..... 208,297

Adson Forceps

Adson Dressing/Tissue Forceps, Econo Floor-Grade.. 142
 Adson Dressing/Tissue Forceps, Merit..... 112
 Adson Dressing Forceps, Laser..... 216
 Adson Elevator..... 400
 Adson Ewald Forceps, OR Grade..... 52
 Adson Forceps..... 45
 Adson Forceps, Delicate, Premium..... 52,53
 Adson Forceps, Heavy Pattern..... 52
 Adson Forceps, Micro, OR Grade..... 53,55,363
 Adson Forceps, Mid-Grade..... 52,53
 Adson Forceps, Sklar Blue..... 206
 Adson Forceps, Sklar Litegrip, Premium..... 55
 Adson Forceps, Sklarlite, Premium..... 52,53,84,85
 Adson Forceps, Sterile, Floor-Grade..... 52,53
 Adson Forceps, T-C, Premium..... 55,99
 Adson Forceps, Laser..... 379
 Adson-Brown Forceps, Delicate, Premium..... 54
 Adson-Brown Forceps, Laser..... 379
 Adson-Brown Forceps, Merit..... 112
 Adson-Brown Forceps, Mid-Grade..... 54
 Adson-Brown Forceps, OR Grade..... 54
 Adson-Brown Forceps, Sklarlite, Premium..... 54,85
 Adson-Brown Forceps, Sterile, Floor-Grade..... 54
 Adson-Brown Forceps, T-C, Premium..... 55,99
 Adson-Brown Tissue/Suture Forceps, Litegrip T-C..... 99
 Adson-Kelly Scissors..... 188,258,356
 Adson Suction Tube..... 267
 Aebli Corneal Scissors..... 332
 Akers Wax Knife and Spoon..... 411
 Alar Retractor, Converse..... 292
 Alcohol Prep Pad..... 444,445,446,447,448
 Alligator Clips..... 422
 Alligator Ear Forceps, Delicate..... 264,265
 Alligator Forceps, Hartmann, Merit..... 116
 Alligator Forceps, Noyes..... 266,273
 Alligator Grasping Forceps, Hartmann..... 262

Alligator Grasping Forceps, Jackson..... 248
 Alligator Grasping Forceps, Laparoscopic..... 221
 Alligator Hemorrhoidal Forceps, Baron..... 248

Allis Tissue Forceps

Allis Tissue Forceps..... 42,161
 Allis Tissue Forceps, Laser..... 160,216,251,379
 Allis Tissue Forceps, T-C, Premium..... 42
 Allis T-C Forceps, Laparoscopic..... 221,223
 Allis Tissue Forceps, Delicate, Premium..... 42,160
 Allis Tissue Forceps, Heavy Pattern..... 42
 Allis Tissue Forceps, Merit..... 112
 Allis Tissue Forceps, Mid-Grade..... 42,160
 Allis Tissue Forceps, OR Grade..... 42,160
 Allis Tissue Forceps, Sklar Blue..... 160,207
 Allis Tissue Forceps, Sklarlite, Premium..... 42,83,160
 Allis Tissue Forceps, Sterile, Floor-Grade..... 42,160

Allis-Abramson Forceps..... 161
 Allis-Adair Forceps..... 44
 Allis-Thoms Forceps..... 44
 Alm Retractor..... 70,290,365,404
 Alm Retractor, Merit..... 113
 Aluminum Alloy Tuning Fork, Sklar..... 268
 Aluminum Eye Shield, Fox..... 344
 Alvis Foreign Body Spud..... 326
 Amniocentesis Tray..... 134
 Amniotome, Beacham..... 197
 Anal Speculum, Chelsea Eaton..... 246
 Aneroid Sphygmomanometer..... 437
 Anoscope, Hirschman..... 246,252,462
 Applicator, Brown..... 269
 Applicator, Buck..... 269
 Applicator, Farrell..... 269
 Applicator, Kyle..... 269
 Applicator, Sawtell..... 269
 Applicator, Cotton Tipped..... 140
 Arch Forming Plier..... 424
 Arthrogram Tray..... 136
 Asch Septum Straightening Forceps..... 276
 Aspirating/Irrigating Cannula, Simcoe..... 341
 Atkins Tonsil Knife..... 287
 Aufrecht Face Lift Scissors..... 303,357
 Aufrecht Glabellar Rasps..... 279,280
 Aufrecht Retractor..... 272,290
 Auvard Vaginal Speculum, Laser..... 150,212
 Auvard Vaginal Speculum, Sklar Blue..... 150,203
 Auvard-Berlind Weighted Vaginal Speculum..... 151
 Auvard-Steiner Vaginal Speculum, Laser..... 150,212
 Auvard-Steiner Weighted Vaginal Speculum..... 150
 Ayers Chalazion Forceps..... 33

B

Babcock Forceps, Laparoscopic..... 223

Babcock Forceps, Laser..... 43,166,215,251
 Babcock Forceps, Mid-Grade..... 43,166
 Babcock Forceps, OR Grade..... 43,166
 Babcock Forceps, Sklar Blue..... 43,166,207
 Babcock Forceps, Sterile, Floor-Grade..... 43,166
 Babcock Forceps, T-C, Premium..... 43,98,166
 Backhaus Towel Clamp, Heavy Pattern..... 48
 Backhaus Towel Clamp, Merit..... 112
 Backhaus Towel Clamp, Mid-Grade..... 48
 Backhaus Towel Clamp, OR Grade..... 48
 Backhaus Towel Clamp, Sterile, Floor-Grade..... 48
 Bags, Band, Sterile..... 140
 Bags, Urological Drain..... 140,259
 Bags, Biohazard..... 450
 Bailey Foreign Body Remover..... 325
 Baker Ingrown Nail Cutter..... 386
 Ball Electrodes, Lietz..... 236,459
 Ballenger Sponge Forceps..... 49
 Ballenger-Hajek Septum Elevator..... 274
 Ballentine-Heaney Forceps..... 168
 Band Bags, Sterile..... 140
 Band Crimping Plier..... 426
 Band Removing Plier..... 426

Bandage Scissors

Bandage Scissors, Bantam..... 31
 Bandage Scissors, Knowles, Sterile Floor-Grade..... 31
 Bandage Scissors, Knowles, Mid-Grade..... 31
 Bandage Scissors, Knowles, OR Grade..... 31
 Bandage Scissors, Lister, Delicate, Premium..... 30
 Bandage Scissors, Lister, Heavy Pattern..... 30
 Bandage Scissors, Lister, Large Ring..... 31
 Bandage Scissors, Lister, Merit..... 111
 Bandage Scissors, Lister, Mid-Grade..... 30
 Bandage Scissors, Lister, OR Grade..... 30
 Bandage Scissors, Lister, Sklarlite, Premium..... 30,79
 Bandage Scissors, Lister, Sterile Floor-Grade..... 30
 Bandage Scissors, Nurses'..... 32
 Bandage Scissors, Sklar Hi Level..... 31

Bandage/Material, Moleskin, Scissors..... 32
 Bandages, Elastic..... 138
 Bandages, Esmark..... 138
Bandages, Sterile..... 138
 Bantam Bandage Scissors..... 31
 Barkan Goniotomy Knife..... 327
 Barnhill Adenoid Curette..... 286
 Baron Alligator Hemorrhoidal Forceps..... 248
 Baron Suction Tube..... 75
 Barr Crypt Hook..... 250
 Barr Fistula Probe..... 250
 Barr Rectal Speculum..... 247
 Barraquer Needle Holder..... 300,309,342,371
 Barraquer Blade Speculum..... 323

Barraquer Wire Speculum.....	323
Barraquer-Dewecker Iris Scissors.....	331
Barraquer-Kratz Wire Eye Speculum.....	323
Barraquer-Troutman Corneal Utility Forceps.....	335
Barrett Tenaculum.....	159
Basin, Emesis.....	441
Basin, OR.....	141
Basin, Perforated Soaking/Sterilization.....	439
Bath Sets/Sterilization Trays.....	442

Baumgartner Needle Holder

Baumgartner Needle Holder, Sterile Floor-Grade.....	66
Baumgartner Needle Holder, Econo, Floor-Grade.....	142
Baumgartner Needle Holder, Merit.....	113
Baumgartner Needle Holder, Mid-Grade.....	66
Baumgartner Needle Holder, OR Grade.....	66,370
Baumgartner Needle Holder, Sklargrip, Premium.....	66
Baumgartner Needle Holder, T-C, Premium.....	66,94
Baumgartner Needle Holder, T-C, Surgi OR.....	104

Bayonet Bending Plier.....	424
Bayonet Bipolar Forceps, Gerald.....	208,297
Bayonet Bipolar Forceps, Hardy.....	208,297
Bayonet Bipolar Forceps, Jansen.....	208,297
Bayonet Forceps, Adson.....	56,265
Bayonet Forceps, Lucae.....	56,265
Bayonet Nasal Forceps, Jansen.....	56,273
Beacham Amniotome.....	197
Beaker/Pitcher.....	439
Bechert-McPherson Tying Forceps.....	340
Beck Luethy Needle Holder, T-C Premium.....	97,194
Beckman Adenoid Curette.....	286
Beckman Nasal Speculum.....	272
Beckman-Eaton Retractor.....	291
Beckman-Weitlaner Retractor.....	291
Bellucci Micro Ear Scissors.....	265
Bending Forceps, Plate.....	401
Bending Plier, Bayonet.....	424,425
Benson Pylorus Separator.....	247
Bergh Cilia Forceps.....	57
Berlind-Auvarad Weighted Vaginal Speculum.....	151
Bernard Facebow Plier.....	426
Bethea Sheet Holder.....	198
Bierer Ovum Forceps.....	198
Bill Traction Handle.....	196
Billeau Ear Loop.....	261
Billroth Forceps.....	165
Biohazard Bags.....	450

Biopsy Cannula, Endometrial, Sterile, Plastic.... 176,235

Biopsy Forcep, Eppendorfer.....	185
Biopsy Forcep, Kevorkian-Young.....	184
Biopsy Forcep, Sklar Kevorkian.....	183
Biopsy Forcep, Sklar Mini Tischler.....	180
Biopsy Forcep, Sklar Oval.....	181

Biopsy Forcep, Sklar Tischler Oval.....	182
Biopsy Forcep, Tischler Cervical.....	179
Biopsy Forcep, Wittner Uterine.....	184
Biopsy Forcep, Thoms-Gaylor.....	250
Biopsy Forcep, Universal Style.....	186
Biopsy Punch, Disposable.....	461,377
Biopsy Punch, Gaylor.....	185
Biopsy Punch, Gelhorn.....	185
Biopsy Punch, Keyes.....	174
Biopsy Punch, Schubert-Van Doren.....	185
Biopsy Punch, Vulvar, Disposable.....	241
Biopsy Punch, Yeoman Rectal.....	249
Biopsy Punch Tray W/ Econo Instruments.....	131
Bipolar Cable.....	208,297

Bipolar Forceps

Bipolar Forceps, Adson.....	208,297
Bipolar Forceps, Coaptation.....	208,297
Bipolar Forceps, Cushing.....	208,297
Bipolar Forceps, Gerald Bayonet.....	208,297
Bipolar Forceps, Hardy Bayonet.....	208,297
Bipolar Forceps, Jansen Bayonet.....	208,297
Bipolar Forceps, Jeweler #5.....	208,297
Bipolar Forceps, Malis.....	208,297
Bipolar Forceps, McPherson.....	208,297
Bipolar Forceps, Semkin.....	208,297
Bipolar Forceps, Tenzel.....	208,297

Bishop-Harmon Anterior Chamber Cannula.....	341
Bishop-Harmon Forceps.....	58,335,363
Black Plugger.....	412
Black Plugger, Marquette.....	417
Blade Remover.....	319
Blade Retractor, Converse.....	293
Blades, Fiber Optic Laryngoscope, Macintosh.....	429
Blades, Standard Laryngoscope, Macintosh.....	430,431
Blades, Disposable Laryngoscope, Macintosh.....	428
Blades, Rigid Cut Surgical.....	320,466
Blades, Specialty.....	322
Blades, Surgical Disposable.....	320
Blair Rollet Retractor.....	366
Blake Ear Forceps.....	265
Blakesley Nasal Forceps, Wilde.....	273
Blepharoplasty Scissors.....	304
Blood Pressure Accessories.....	438
Blood Pressure Equipment.....	437
Blount Double Prong Retractor.....	397
Blount Single Prong Retractor.....	397
Blumenthal Rongeur.....	393,422
Bodenhammer Sims Rectal Speculum.....	247
Boehler-Wolfe Cast Breaker.....	403
Boettcher Tonsil Scissors.....	307,358
Boley Gauge.....	416
Bonaccolto Utility Forceps.....	339

Bone and Nail File.....	388,389
Bone Cutting Forceps, Kleinert-Kutz.....	392
Bone Cutting Forceps, Liston.....	392,395
Bone Cutting Forceps, McIndoe.....	393
Bone Cutting Forceps, Rowland.....	393
Bone Cutting Forceps, Ruskin-Liston.....	392,395
Bone Elevator, Hohmann.....	400
Bone File.....	390
Bone File #12.....	389
Bone Gouge, West.....	279
Bone Lever, Cottle.....	278
Bone Mallet, Gerzog.....	402
Bone Rasp #10.....	389
Bone Rongeur, Friedman.....	394
Bone Saw, Joseph Nasal.....	276
Bonn Micro Suturing Forceps.....	338
Bonn Miniature Iris Scissors.....	307
Bonn Scissors.....	352
Bonn Tying Forceps.....	338
Bonney Tissue Forceps.....	56,170
Boots, Suture.....	474
Boucheron Ear Speculum.....	260
Bougie A Boule, Otis.....	254
Bowl, Mixing/Solution.....	439
Bowl, Sponge.....	440
Bowles Stethoscope.....	434
Bowman Lachrymal Dilator/Probe.....	329,267
Bozeman Forceps, Heavy Pattern.....	157
Bozeman Forceps, Laser.....	157,215
Bozeman Forceps, Mid-Grade.....	157
Bozeman Forceps, OR Grade.....	157,247
Bozeman Forceps, Sklar Blue.....	157,206
Bozeman Forceps, Sterile, Floor-Grade.....	157
Bozeman-Heaney Needle Holder, T-C Premium.....	97,194
Brain Forceps, Cushing Delicate, Premium.....	57
Brantley-Turner Vaginal Retractor.....	153
Braun Episiotomy Scissors.....	189,198
Breast Tenaculum, Adair.....	159
Brinckerhoff Speculum.....	246
Brophy Sullivan Scissors.....	189,305
Brown Applicator.....	269
Brown Dissecting Scissors.....	303
Brown Needle Holder.....	69
Bruening Magnifier, Otoscope.....	260
Bruns Curette.....	395
Bruns Plaster Shears.....	406
Brush, Instrument Cleaning.....	443,481

Brush, Sklar Cervex.....240,454

Brush, Sklar Pap, Standard.....	240,454
Buck Applicator.....	269
Buck Ear Curette.....	261
Buck Ear Curette, Merit.....	114
Buck Gingivectomy Knife.....	409
Buck Myringotome.....	266

Buck Neurological Hammer, Merit.....	116
Buck Neurological Hammer, Sklar.....	436
Buck Spencer Ear Probe.....	267
Buie Pile Clamp.....	250
Buie Suction Tube.....	249
Burnisher.....	414
Busch Umbilical Scissors.....	189
Button End Knife, Joseph.....	277

C

Cable, Bipolar.....	208,297
Cable, Electrosurgical.....	227,232
Caliper, Castroviejo.....	296,344
Caliper, EKG.....	436
Caliper, Thorpe.....	296,344
Campion Uterine Forceps, Laser.....	163,215
Cannon Curette.....	374
Carmalt Splinter Forceps.....	59,362
Carroll Needle Holder.....	371
Cartilage Clamp and Small Bone, Dingman.....	396
Carver, Hollenback.....	417
Carver, Le Cron.....	418
Carver, PK Thomas Wax Placer.....	418
Carver, Roach.....	418
Carver, Vehe.....	418
Carver, Ward.....	411
Carver, Walls.....	411
Cast Breaker, Wolfe-Boehler.....	403
Castanares Face Lift Scissor Sklarcut Premium.....	311

Castroviejo

Castroviejo Caliper.....	296,344
Castroviejo Colibri Forceps.....	337
Castroviejo Corneal Scissors.....	332
Castroviejo Cyclodialysis Spatula.....	328
Castroviejo Forceps.....	337,338
Castroviejo Lachrymal Dilator.....	267,329
Castroviejo Needle Holder, T-C, Premium.....	68,343,350
Castroviejo Scissors.....	359
Castroviejo Speculum.....	324
Castroviejo Suture Forceps.....	338
Castroviejo-Kalt Needle Holder.....	299,343
Catheter Forceps, Magill, Mid-Grade.....	46
Catheter Forceps, Magill, OR Grade.....	46
Catheter Guides.....	256
Catheter Tray.....	442
Catheters, Female.....	258
Catheters, Walther Dilator.....	258
Cautery, High Temperature.....	209,298
Cautery, Low Temperature.....	209,298
Cautery, Vasectomy.....	209,298

Cement Spatula.....	419
Central Line Tray W/ Durapore™ Dressing.....	130
Cervex Brush, Sklar.....	240,454

Cervical Biopsy Forceps

Cervical Biopsy Forceps, Eppendorfer.....	185
Cervical Biopsy Forceps, Eppendorfer Micro-Cut.....	185
Cervical Biopsy Forceps, Kevorkian.....	183
Cervical Biopsy Forceps, Kevorkian-Youngue.....	184
Cervical Biopsy Forceps, Kevorkian-Youngue Micro-Cut.....	184
Cervical Biopsy Forceps, Mini Tischler Wide Bite.....	180
Cervical Biopsy Forceps, Mini Tischler.....	180
Cervical Biopsy Forceps, Oval.....	181
Cervical Biopsy Forceps, Oval Micro-Cut.....	181
Cervical Biopsy Forceps, Oval Wide Bite.....	181
Cervical Biopsy Forceps, Rotating.....	186
Cervical Biopsy Forceps, Tischler.....	179
Cervical Biopsy Forceps, Tischler Oval.....	182
Cervical Biopsy Forceps, Tischler Oval Wide Bite.....	182
Cervical Biopsy Forceps, Tischler Wide Bite.....	179
Cervical Biopsy Forceps, Wittner.....	184
Cervical Biopsy Forceps, Wittner Micro-Cut.....	184

Cervical Block Needle Kit.....	238,457
Cervical Block Needles.....	238,457
Cervix Forceps, Gutglass.....	167
Chalazion Curette, Daviel.....	333
Chalazion Curette, Heath.....	333
Chalazion Curette, Meyhoefer.....	333,372
Chalazion Curette, Skeeel.....	333
Chalazion Forceps, Ayers.....	333
Chalazion Forceps, Desmarres.....	333,369
Chalazion Forceps, Francis.....	334
Chalazion Forceps, Heath.....	334
Chalazion Forceps, Lambert.....	333
Chalazion Forceps, Spencer.....	334
Chalazion Forceps, Weis.....	334
Chandler Elevator.....	398
Chandler Iris Forceps.....	335,336
Cheek Retractor.....	284,415
Chelsea Eaton Anal Speculum.....	246
Cherry Sponges.....	470
Chip Blower.....	395
Chisel, Freer.....	277
Chisel, Gardner.....	422
Chisel, Fomon Nasal.....	278
Chisel, Hajek Septum.....	279
Cilia Forceps, Bergh.....	57
Cilia Forceps, Ziegler.....	57
Cinelli Osteotome.....	277
Circumcision Clamp, Mogen.....	198,257
Circumcision Forceps, Dunaway, Mid-Grade.....	44,161,198,259
Circumcision Probe.....	198,257
Citelli Rongeurs.....	278

Clamps

Clamp, Backhaus Towel, Merit.....	112
Clamp, Backhaus Towel, Mid-Grade.....	48
Clamp, Backhaus Towel, OR Grade.....	48
Clamp, Buie Pile.....	250
Clamp, Cartilage and Small Bone, Dingman.....	396
Clamp, De Alvarez.....	167
Clamp, Gusberg Hysterectomy.....	167
Clamp, Hoff Towel.....	47
Clamp, Hysterectomy.....	169
Clamp, Jones Cross Action, Towel.....	47
Clamp, Lorna Edna Towel, Mid-Grade.....	47
Clamp, Lorna Edna Towel, OR Grade.....	47
Clamp, Pratt T-shaped.....	257
Clamp, Presbyterian Tube Occluding, Merit.....	112
Clamp, Roeder Towel.....	47
Clamp, Sesamoid.....	396
Clamp, Stockman Zipser Penis.....	256
Clamp, Strauss Penis.....	256
Clamp, Textor Vasectomy.....	256
Clamp, Towel, Plastic.....	122
Clamp, Towel, Plastic, Sterile.....	123
Clamp, Tubing, Plastic.....	122
Clamp, Tubing, Plastic, Sterile.....	123

Clasp Adjusting Plier.....	416
Cleaner, Liquid.....	2,480,487
Cleaner, Powder.....	2,480,486
Cleaner/Lube, Sklar Instru-Guard 1 Step.....	482
Cleaning Brush, Instrument.....	443,481
Cleanwheel, Sklar Disposable.....	436,463
Clemetson Uterine Forceps, Laser.....	162,217
Clemetson Uterine Forceps, Sklar Blue.....	162,207
Cleoid Discoid.....	411
Cleveland Rongeur.....	394
Clips, Alligator.....	422
Closing & Forming Plier.....	423
Coakley-Colver Tonsil Forceps.....	289
Cobalt Blue Light.....	209,298
Coban™, Sterile.....	138
Cogswell Elevator.....	422
Cohan Needle Holder.....	342
Cohen Uterine Manipulator.....	159
Colibri Forceps, Castroviejo.....	337
Collar & Crown Cutting Scissors.....	29,405
College Pliers.....	415
Coller Hemostatic Forceps.....	44
Collier Needle Holder.....	69
Collin Duval Lung Forceps.....	49
Collin Segond Forceps.....	164
Collin Vaginal Speculum, Laser.....	148,212
Colposcopy Set, Mini.....	187
Colposcopy Set, Standard.....	187

Columbia Finishing Curettes	409
Columbia Lip Retractor	284
Columella Forceps, Cottle	296
Colver Tonsil Examining Retractor	283
Colver-Coakley Tonsil Forceps	289
Comedone Extractor	376
Commander Utility Shears	32,406
Condenser, Hollenback	412
Conjunctival Forceps, Lester	336,363
Container, Storage	439
Containers, Sklar Sharps	450
Converse Alar Retractor	292
Converse Blade Retractor	293
Converse Needle Holder	299,370
Cook Eye Speculum	323
Corey Ovum Forceps	197
Corn Knife, Soft	388
Corneal Knife, Gill	327
Corneal Knife, Tooke	327
Corneal Scissors, Aebli	332
Corneal Scissors, Castroviejo	332
Corneal Scissors, McGuire	332
Corneal Utility Forceps, Girard	337
Corneal Utility Forceps, Troutman-Barraquer	335
Comeoscleral Forceps, Thorpe	339
Cottle Bone Lever	278
Cottle Columella Forceps	296
Cottle Dorsal Scissors	301,310
Cottle Elevator	274,275
Cottle Knife Guard and Retractor	292
Cottle Nasal Osteotome	278
Cottle Nasal Scissors	301
Cottle Nasal Speculum	271
Cottle Rasp	280,390
Cottle Retractor	292
Cottle Speculum, Laser	271
Cotton Balls, Sterile	140
Cotton Tipped Applicators, Sterile	140
Covers, Fluoroscope	141
Covers, Sklar Dust	443,476
Craig Forceps	161,289
Crego Elevator	400

Crile Hemostats

Crile Hemostats, Econo, Floor-Grade	142
Crile Hemostats, Merit	111
Crile Hemostats, Delicate, Premium	37
Crile Hemostats, Heavy Pattern	37
Crile Hemostats, Mid-Grade	37
Crile Hemostats, OR Grade	37
Crile Hemostats, Sklarlite, Premium	37
Crile Hemostats, Sterile Floor-Grade	37
Crile Retractor	73

Crile-Murray Needle Holder, OR Grade	67,87
Crile-Murray Needle Holder, Sklargrip Premium	67
Crile-Murray Needle Holder, T-C, Premium	67,94
Crile-Wood Needle Holder, Merit	113
Crile-Wood Needle Holder, OR Grade	67,192
Crile-Wood Needle Holder, Sklarlite, Premium	67,87
Crile-Wood Needle Holder, Sterile Floor-Grade	192
Crile-Wood Needle Holder, T-C, Premium	67,94,192
Crile-Wood Needle Holder, T-C, Surgi OR	104
Cross Action, Jones Towel Clamp	47
Crown & Collar Cutting Scissors	29,405
Crown Plier, Baade	416
Crypt Hook, Barr	250
Crypt Hook, Pratt	250
CSR Wrap, Disposable	476
Cup, Iodine	439
Cup, Medicine	440

Curettes

Curette, Barnhill Adenoid	286
Curette, Beckman Adenoid	286
Curette, Bruns	395
Curette, Buck Ear	261
Curette, Buck Ear, Merit	114
Curette, Cannon	374
Curette, Daviel Chalazion	333
Curette, Dermal	374
Curette, Ear	270,460
Curette, Endocervical	178,240,454
Curette, Endocervical, Sterile, Plastic	178
Curette-Excavator, Merit	115
Curette-Excavator, Sklar	386
Curette, Fox Dermal	372
Curette, Fox Dermal, Merit	115
Curette, Greene Uterine	177
Curette, Gusberg Endocervical	177
Curette, Heaney Uterine	177
Curette, Heath	372
Curette, Heath Chalazion	333
Curette, Holden Uterine	177
Curette, Kevorkian-Young Endocervical	178
Curette, Lempert Endaural	275
Curette, Lounsbury Placenta	178
Curette, Martini	373
Curette, Meyhoefer Chalazion	333,372
Curette, Molluscum	373
Curette, Novak Endometrial	176
Curette, Piffard	373
Curette, Randall Endometrial	176
Curette, Rein Oval	373
Curette, Rein Round	373
Curette, Skeele Chalazion	333,372
Curette, Skene Uterine	177
Curette, Verucca	374,386

Curette, Vogel Adenoid	286
Curette, Weisman Infant Ear	261
Curette, Williger	374
Curettes, Assorted Ear	270,460
Curettes, Columbia Finishing	409
Curettes, Disposable Dermal	377,462
Curettes, Disposable Ear	261
Curettes, Gracey Finishing	409
Curettes, McCalls Finishing	409
Curettes, Shapleigh Ear	261
Curettes, Sims Uterine	178
Curettes, Thomas Uterine	178

Cusco Speculum	149
Cusco Speculum, Non-sterile, Plastic	145
Cusco Speculum, Sterile, Plastic	145,149,234
Cusco Speculum, Sklar Blue	149,202
Cushing Brain Forceps, Delicate, Premium	57
Cushing Decompression Retractor	284
Cushing Nerve/Vein Retractor	284
Cut Down Tray W/ Econo Instruments	136
Cutaneous Punch, Keyes	375
Cuticle and Nail Scissors	385
Cuticle Nipper	384
Cutting Forceps, Double Action Littauer	381
Cutting Forceps, Kleinert-Kutz Bone	392
Cutting Forceps, Liston Bone	392
Cutting Forceps, Littauer	380
Cutting Forceps, Littauer, Merit	115
Cutting Forceps, Littauer, Sklar-Taper	381
Cutting Forceps, McIndoe Bone	393
Cutting Forceps, Ruskin-Liston Bone	392
Cutting Forceps, Sklarlite Littauer, Premium	380
Cutting Forceps, Struycken	273
Cyclodialysis Spatula, Castroviejo	328
Cyst Aspiration Tray	133
Cyst/FNA/Core Tray	135

D

Dandy Scalp Hemostat	361
Daviel Chalazion Curette	333
Davis Foreign Body Spud	326
Day Ear Hook	266
De Alvarez Clamp	167
De Lee Obstetrical Forceps	195
De Lee Uterine Forceps, Laser	216
De Vilbiss Vaginal Speculum	148
Dean Tonsil Knife	287
Dean Tonsil Scissors	307
Deaver Scissors, Delicate	356
Debakey Atraumatic Forceps	58
Debakey Atraumatic Forceps, Laser	216,379
Debakey Atraumatic Forceps, T-C Premium	98,170



**OR Quality
Instruments**



**OR Premium™
Instruments**



Mid-Grade Instruments

Debakey Halsted Mosquito Forceps.....	361
Debridement Tray W/ Econo Instruments.....	129
Debridement Tray W/O Instruments.....	129
Decompression Retractor, Cushing.....	284
Decontaminant/Disinfectant.....	478,484
Delee Retractor.....	153
Delee Uterine Forceps.....	163
Delee-Hillis Obstetrical Stethoscope.....	435
Dental/Orthodontia.....	407-427
Deodorizer, Sklar Fresh.....	487

Derf Needle Holder

Derf Needle Holder, Merit.....	113
Derf Needle Holder, Mid-Grade.....	63
Derf Needle Holder, OR Grade.....	63,370
Derf Needle Holder, Sklargrip, Premium.....	63
Derf Needle Holder, Sklarlite, Premium.....	63,86
Derf Needle Holder, Sterile, Floor-Grade.....	63
Derf Needle Holder, T-C, Premium.....	63,94
Derf Needle Holder, T-C, Surgi OR.....	104

Dermal Biopsy Punch, Disposable.....	377
Dermal Curette, Disposable.....	462
Dermal Curette, Fox.....	372
Dermal Curette, Fox, Merit.....	115
Dermal Curette, Sklar.....	374
Dermal Retractor.....	366
Dermal Retractor, Laser.....	378
Dermal/Vulvar Punch, Keyes.....	174
Dermatoscope, Sklar.....	435

Dermatology.....352-379

Desmarres Lid Retractor.....	73,294,325,369
Detergent, Enzymatic.....	479,485
Detergent, Instrument.....	480,486
Detergent, Instrument, Low Foam.....	480
Dewecker-Barraquer Iris Scissors.....	331

Diagnostic Products.....433-438

Stethoscopes

Otoscope

Dermatoscope

Blood Pressure Equipment

Percussion Hammers

Neurological Pinwheels

EKG Caliper

Dialysis Tray.....	132
Dilator Set, Os, Reusable.....	239,455
Dilator, Os, Disposable.....	239,455
Dilator, Castroviejo Lachrymal.....	267,329
Dilator, Goodell Uterine.....	176
Dilator, Hank Uterine.....	175
Dilator, Hegar Uterine.....	175
Dilator, Infant Lachrymal.....	329
Dilator, Kleegman.....	176
Dilator, Muldoon Lachrymal.....	329

Dilator, Pratt Uterine.....	175
Dilator, Ruedemann Lachrymal.....	329
Dilator, Wilder Lachrymal.....	329
Dilator, Wylie Uterine.....	176
Dilator-Catheters, Walther.....	258
Dilator/Probe, Bowman Lachrymal.....	329
Dilator/Probe, Williams Lachrymal.....	329
Dingman Small Bone and Cartilage Clamp.....	396
Discoid, Cleoid.....	411
Disinfectant/Decontaminant.....	478,484

Disposables

Disposable Anoscope.....	246,462
Disposable Biopsy Punch.....	461
Disposable Cleanwheel.....	463
Disposable CSR Wrap.....	476
Disposable Dermal Curettes.....	377,462
Disposable Ear Curettes.....	261
Disposable Electrodes.....	459
Disposable Endocervical Curette.....	454
Disposable Endometrial Biopsy.....	235,456
Disposable Eye Shields.....	344,463
Disposable Intra-Uterine Sound.....	173,449
Disposable Lipo-Suction Cannula.....	317
Disposable Miniature Ear Knives.....	266
Disposable Mirror.....	427
Disposable Nasal Speculum.....	271,463
Disposable Needle Extenders.....	238,457
Disposable Oral Swab, Sklardent.....	427
Disposable Procedure Trays.....	125-137
Disposable Rigid Cut Surgical Blades.....	320,466
Disposable Smoke Evacuation Tubing.....	201,211
Disposable Speculum.....	453
Disposable Sounds.....	455
Disposable Stethoscope.....	435
Disposable Surgical Blades.....	320,466
Disposable Surgical Panties.....	318
Disposable Surgical Scalpels.....	321,465,467
Disposable Toothbrush.....	427
Disposable Uterine Manipulator/Injector.....	159,40,454
Disposable Vulvar Biopsy Punch.....	241
Disposable Yankauer Tube.....	121

Dissecting Scissors

Dissecting Scissors, Brown.....	303
Dissecting Scissors, Kahn.....	302
Dissecting Scissors, Lilly.....	302
Dissecting Scissors, Mayo SklarEdge T-C Prem.....	91
Dissecting Scissors, Mayo Sklarlite Sklarcut.....	77,88
Dissecting Scissors, Mayo Sterile Floor-Grade.....	14
Dissecting Scissors, Mayo, Delicate, Premium.....	14
Dissecting Scissors, Mayo, Merit.....	111
Dissecting Scissors, Mayo, Mid-Grade.....	14

Dissecting Scissors, Mayo, OR Grade.....	14,188
Dissecting Scissors, Mayo, Sklarcut, Premium.....	15,88
Dissecting Scissors, Mayo, Sklarhone, Premium.....	15,93
Dissecting Scissors, Mayo, Sklarlite, Premium.....	14,77
Dissecting Scissors, Mayo-Stille.....	188
Dissecting Scissors, Metzenbaum Sklarcut.....	89
Dissecting Scissors, Metzenbaum Sklarhone.....	93
Dissecting Scissors, Metzenbaum Sklarlite.....	78
Dissecting Scissors, Metzenbaum SklarEdge T-C.....	91
Dissecting Scissors, Metzenbaum, Mid-Grade.....	18
Dissecting Scissors, Metzenbaum, OR Grade.....	18
Dissecting Scissors, Miller.....	306
Dissecting Scissors, Ragnell.....	302,353
Dissecting Scissors, Ragnell Sklarcut Premium.....	90
Dissecting Scissors, Ragnell Sklarlite Sklarcut.....	80,90
Dissecting Scissors, Sealy.....	303,353
Dissecting Scissors, SklarEdge T-C, Premium.....	92

Dittel Urethral Sound.....	254
Dittel/Otis Urethral Sound.....	254
Dix Needle and Spud.....	325,326
Dorsal Scissors, Cottle.....	301
Dorsal Scissors, Sklarcut Cottle, Premium.....	310
Douglas Tonsil Knife.....	287
Doyen Retractor.....	153
Doyen Scissors.....	188,258
Doyen Vulsellum Forceps.....	164
Doyen-Jansen Mouth Gag.....	281
Drape, Fenestrated, Minor Procedure, Sterile.....	141
Drapes, Eye, Sterile.....	139
Drapes, Sterile.....	139

Dressing Forceps

Dressing Forceps, Delicate, Premium.....	50
Dressing Forceps, Heavy Pattern.....	50
Dressing Forceps, Laser.....	379
Dressing Forceps, Mid-Grade.....	50
Dressing Forceps, OR Grade.....	50
Dressing Forceps, Plastic.....	122
Dressing Forceps, Plastic, Sterile.....	123
Dressing Forceps, Sklar Blue.....	206
Dressing Forceps, Sklarlite, Premium.....	50,84
Dressing Forceps, Sterile, Floor-Grade.....	50
Dressing Forceps, T-C, Premium.....	50,99
Dressing Forceps, Thumb, Econo Floor-Grade.....	142
Dressing/Tissue Forceps, Merit.....	112

Drill, Sklar Nail.....	375
Duplay Tenaculum.....	159
Dura Scissors, Semi-Sharp.....	304,356
Dural Scissors, Taylor.....	305
Dust Covers.....	443,476
Duval Collin Lung Forceps.....	49

E

Ear Curette	460
Ear Curette, Buck	261
Ear Curette, Buck, Merit	114
Ear Curette, Sklar	270
Ear Curette, Weisman Infant	261
Ear Currettes, Assorted	270,460
Ear Currettes, Disposable	261
Ear Currettes, Shapleigh	261
Ear Forceps, Alligator, Delicate	264
Ear Forceps, Blake	265
Ear Forceps, Duckbill	263
Ear Forceps, Hoffman	263
Ear Forceps, Littauer	262
Ear Forceps, Lucae, Merit	114
Ear Forceps, Micro Alligator	265
Ear Forceps, Struempel	263
Ear Forceps, Weingartner	265
Ear Forceps, Wilde	265
Ear Forceps, Wilde, Merit	114
Ear Hook, Day	266
Ear Knife, Gerzog Sexton	266
Ear Loop, Billeau	261
Ear Probe, Buck Spencer	267
Ear Probe, Stacke	267
Ear Scissors, Micro, Bellucci	265
Ear Scissors, Wullstein	265
Ear Snare, Krause	267
Ear Speculum, Boucheron	260
Ear Speculum, Gruber	260
Ear Speculum, Toynebee	260
Ear Suction Tube	294
Ear Syringe, Metal, Merit	114
Ear Syringe, Pomeroy	268
Ear Tray	270,460
Ear Tray W/ Econo Instruments	131
Eaton-Beckman Retractor	291

Econo™ Floor Grade Instruments

Econo Floor-Grade Adson Dressing/Tissue Forceps	142
Econo Floor-Grade Baumgartner Needle Holder	142
Econo Floor-Grade Crile Hemostats	142
Econo Floor-Grade Graefe Fixation Forceps	142
Econo Floor-Grade Halsted Mosquito Forceps	142
Econo Floor-Grade Iris Forceps	142
Econo Floor-Grade Iris Scissors	142
Econo Floor-Grade Kelly Hemostats	142
Econo Floor-Grade Lister Bandage Scissors	142
Econo Floor-Grade Operating Scissors	142
Econo Floor-Grade Regular Splinter Forceps	142
Econo Floor-Grade Small Utility Scissors	142
Econo Floor-Grade Stitch Scissors	142

Econo Floor-Grade Thumb Dressing Forceps	142
Econo Floor-Grade Thumb Tissue Forceps	142
Econo Floor-Grade Webster Needle Holder	142

Econo Sterile™ Instruments

Econo Sterile Adson Forceps	120
Econo Sterile Adson-Brown Forceps	120
Econo Sterile Allis Tissue Forceps	119
Econo Sterile Baumgartner Needle Holder	121
Econo Sterile Bozeman Forceps	119
Econo Sterile Crile Hemostats	119
Econo Sterile Crile-Wood Needle Holder	121
Econo Sterile Derf Needle Holder	121
Econo Sterile Dressing Forceps	120
Econo Sterile Fine Point Splinter Forceps	120
Econo Sterile Halsey Needle Holder	121
Econo Sterile Halsted Mosquito Hemostats	118
Econo Sterile Hartmann Mosquito Hemostats	118
Econo Sterile Hoff Towel Forceps	119
Econo Sterile Iris Scissors	117
Econo Sterile Kelly Hemostats	119
Econo Sterile Knowles Bandage Scissors	118
Econo Sterile Lister Bandage Scissors	117
Econo Sterile Littauer Suture Scissors	117
Econo Sterile Lorna Edna Towel Clamp	120
Econo Sterile Magill Catheter Forceps	120
Econo Sterile Mayo Scissors	118
Econo Sterile Mayo-Hegar Needle Holder	121
Econo Sterile Metzenbaum Dissecting Scissors	117,118
Econo Sterile Operating Scissors	118
Econo Sterile Rochester-Pean Forceps	119
Econo Sterile Schroeder Tenaculum Forceps	119
Econo Sterile Spencer Stitch Scissors	118
Econo Sterile Sponge Forceps	120
Econo Sterile Suture Removal Instrument	121
Econo Sterile Tissue Forceps	120
Econo Sterile Tube Occluding Forceps	119
Econo Sterile Webster Needle Holder	121
Econo Sterile Wire Cutting Scissors	118
Econo Sterile Yankauer Suction Tube	121

EKG Caliper	436
Elastic Bandages, Sterile	138
Electrode, Extended Blade	209,298
Electrode, Extended Needle	209,298
Electrode, Modified Blade	209,298
Electrode, Modified Needle	209,298
Electrode, Standard Blade	209,298
Electrode, Standard Needle	209,298
Electrodes, Lietz Ball	236,459
Electrodes, Lietz Loop	236,459
Electrodes, Lietz Square	236,459
Electrophysiology Tray W/ Econo Instruments	137

Electrosurgical Forceps/Cauteries208-209

Electrosurgical Pencil	208,297
Elevator, Adson	400
Elevator, Chandler	398
Elevator, Cogswell	422
Elevator, Cottle	274
Elevator, Crego	400
Elevator, Freer	288,399
Elevator, Freer Septum	274
Elevator, Hajek-Ballenger Septum	274
Elevator, Hohmann Bone	400
Elevator, Joseph Periosteal	275
Elevator, Lane	398
Elevator, Langenbeck	398
Elevator, Lempert	275
Elevator, Locke	388
Elevator, McGlamry	397
Elevator, McKenty Septum	275
Elevator, Ohl	399
Elevator, Sayre	398
Elevator, Sedillot Periosteal	399
Elevator, Seldin	399,422
Elevator, Williger	397
Ellen's Utility Scissors	33
Ellis Foreign Body Spud	326
Elschnig Fixation Forceps	337
Elschnig-O'Brien Forceps	337
Emergency Scissors, Heavy Duty	33,406
Emesis Basin	441
Emmett Hook	74
Emmett Hook, Iris	171,172,173
Emmett Hook, Iris, Laser	171,172,214
Emmett Hook, Iris, Sklar Blue	171,172,173,205
ENT/Plastic Surgery.....260-311	
Endaural Curette, Lempert	275
Endaural Retractor, Perkins	291
Endaural Retractor, Wullstein	291
Endocervical Curette	240,454
Endocervical Curette, Gusberg	177
Endocervical Curette, Kevorkian-Young	178
Endocervical Curette, Sklar Mini	178
Endocervical Curette, Sterile, Plastic	178
Endocervical Speculum, Kogan	154
Endometrial Biopsy Cannula, Sterile, Plastic	176,235,456
Endometrial Curette, Novak	176
Endometrial Curette, Randall	176
Endometrial Sampling Set, Sklar	235,456
Endospeculum, Kogan, Laser	156,213
Endospeculum, Kogan, Sklar Blue	155,204
Enterotome Scissors	258
Enucleation Scissors	304
Enzymatic Detergent	479,485
Episiotomy Scissors, Braun	189,198



OR Quality Instruments



OR Premium™ Instruments



Mid-Grade Instruments

Epistaxis Tray W/ Econo Instruments.....131
 Eppendorfer Biopsy Forcep.....185
 Esmarch Plaster Shears.....32,406
 Esmark Bandages, Sterile.....138
 Evacuation Tubing, Smoke, Disposable.....201,211
 Evans Wax Knife and Spoon.....411
 Everclear Laryngeal Mirror.....282
 Eves Tonsil Snare.....285
 Ewald Adson Forceps, OR Grade.....52
 Excavator.....410
 Excavator and Packer.....387
 Excavator and Probe.....387
 Excavator and Probe, Merit.....115
 Excavator and Curette, Merit.....115
 Excavator and Curette.....386
 Explorer.....417
 Expressor, Fonde Harmar.....376
 Expressor, Heinlein.....376
 Extenders, Needle, Disposable.....238,457
 Extenders, Needle, Reusable.....238,457
 Extracting Forceps.....420,421
 Extractor, Comedone.....376
 Extractor, IUD.....177
 Extractor, Snap Lock Pin/Wire.....401
 Extractor, T-C Ring Handle Wire, Premium.....402
 Eye Drapes, Sterile.....139
 Eye Dressing Forceps, Bishop-Harmon.....335
 Eye Dressing Forceps, Litegrip.....336
 Eye Forceps.....57
 Eye Magnetic Probe & Foreign Body Loop.....325
 Eye Shield, Disposable.....463,
 Eye Shield, Fox, Aluminum.....344
 Eye Speculum, Cook.....323
 Eye Speculum, Kratz-Barraquer Blade.....323
 Eye Speculum, Lancaster.....324
 Eye Speculum, Mellinger.....323
 Eye Speculum, Sauer.....323
 Eye Speculum, Weeks.....324
 Eye Tissue Forceps, Bishop-Harmon.....335
 Eye Tissue Forceps, Litegrip.....336

Fetoscope, Perell.....435
 Fiberoptic Handles, Laryngoscopes.....428
 Fiberoptic Lamps, Halogen.....432
 Fiberoptic Lamps, Xenon.....432
 Fiberoptic Macintosh Blades - American Style.....429
 Fiberoptic Macintosh Blades - English Style.....429
 Fiberoptic Miller Blades - American Style.....429
 Fiberoptic Miller Blades - English Style.....429
 Fiberoptic Wisconsin Blades - American Style.....429
 Fiberoptic Wisconsin Blades - English Style.....429
 File #12, Bone.....389
 File and Rasp, Fomon.....280,390
 File, Bone.....390
 Filling Instrument, Plastic.....413
 Fine Point Splinter Forceps.....362
 Fine Point Splinter Forceps, Mid-Grade.....59
 Fine Point Splinter Forceps, OR Grade.....59
 Fine Splinter Forceps, Sterile, Floor-Grade.....59
 Fine Stitch Scissors.....331,358
 Finger Ring Cutter, Keyes.....375
 Finger Ring Cutter, Sklar.....375
 Finishing Curettes, Columbia.....409
 Finishing Curettes, Gracey.....409
 Finishing Curettes, McCalls.....409
 Finocchio Needle Holder, OR Grade.....192
 Finocchio Needle Holder, T-C Premium.....96,192
 Fisher Tonsil Knife.....287
 Fistula Probe, Barr.....250
 Fixation Forceps, Castroviejo.....337
 Fixation Forceps, Elschnig.....337
 Fixation Forceps, Graefe.....337,363
 Fixation Forceps, Graefe, Econo Floor-Grade.....142
 Fixation Forceps, Green.....337
 Fixation Forceps, Iowa State.....335
 Fixation Hook, Guthrie.....328
 Flat Nose Pliers.....402

Floor-Grade Thumb Dressing Forceps, Econo.....142
 Floor-Grade Thumb Tissue Forceps, Econo.....142
 Floor-Grade Webster Needle Holder, Econo.....142

Floor Grade Instruments

ECONO STERILE

Floor-Grade Sterile Adson Forceps.....52,53
 Floor-Grade Sterile Adson-Brown Forceps.....54
 Floor-Grade Sterile Allis Tissue Forceps.....42,160
 Floor-Grade Sterile Babcock Forceps.....43,166
 Floor-Grade Sterile Backhaus Towel Clamp.....48
 Floor-Grade Sterile Baumgartner Needle Holder.....66
 Floor-Grade Sterile Bozeman Forceps.....157
 Floor-Grade Sterile Crile Hemostats.....37
 Floor-Grade Sterile Crile-Wood Needle Holder.....192
 Floor-Grade Sterile Derf Needle Holder.....63
 Floor-Grade Sterile Dressing Forceps.....50
 Floor-Grade Sterile Fine Splinter Forceps.....59
 Floor-Grade Sterile Foerster Sponge Forceps.....48
 Floor-Grade Sterile Graves Speculum.....143
 Floor-Grade Sterile Halsey Needle Holder.....65
 Floor-Grade Sterile Halsted Mosquito Hemostats.....36
 Floor-Grade Sterile Hartmann Hemostats.....39
 Floor-Grade Sterile Iris Scissors.....20
 Floor-Grade Sterile Kelly Hemostats.....38
 Floor-Grade Sterile Knowles Bandage Scissors.....31
 Floor-Grade Sterile Lister Bandage Scissors.....30
 Floor-Grade Sterile Littauer Stitch Scissors.....25
 Floor-Grade Sterile Lorna Edna Towel Clamp.....47
 Floor-Grade Sterile Magill Catheter Forceps.....46
 Floor-Grade Sterile Mayo Dissecting Scissors.....14
 Floor-Grade Sterile Mayo-Hegar Needle Holder.....64,191
 Floor-Grade Sterile Metzenbaum Lahey Scissors.....16
 Floor-Grade Sterile Metzenbaum Scissors.....18
 Floor-Grade Sterile Multi-Cut Utility Scissor.....33
 Floor-Grade Sterile Operating Scissors.....10,12
 Floor-Grade Sterile Pederson Speculum.....145
 Floor-Grade Sterile Rochester-Ochsner Forceps.....40
 Floor-Grade Sterile Rochester-Pean Forceps.....41
 Floor-Grade Sterile Schroeder Tenaculum.....158
 Floor-Grade Sterile Spencer Stitch Scissors.....24
 Floor-Grade Sterile Strabismus Scissors.....22
 Floor-Grade Sterile Suture Removal Instrument.....27
 Floor-Grade Sterile Tissue Forceps.....51
 Floor-Grade Sterile Tube Occluding Forceps.....49
 Floor-Grade Sterile Webster Needle Holder.....62,190
 Floor-Grade Sterile Wire Cutting Scissors.....29
 Floor-Grade Sterile Yankauer Suction Tube.....75
 Fluoroscope Covers, Sterile.....141
 Foerster Sponge Forceps, Heavy Pattern.....48
 Foerster Sponge Forceps, Merit.....112

Floor Grade Instruments

ECONO

Floor-Grade Adson Dressing/Tissue Forceps, Econo.....142
 Floor-Grade Baumgartner Needle Holder, Econo.....142
 Floor-Grade Crile Hemostats, Econo.....142
 Floor-Grade Graefe Fixation Forceps, Econo.....142
 Floor-Grade Halsted Mosquito Forceps, Econo.....142
 Floor-Grade Iris Forceps, Econo.....142
 Floor-Grade Iris Scissors, Econo.....142
 Floor-Grade Kelly Hemostats, Econo.....142
 Floor-Grade Lister Bandage Scissors, Econo.....142
 Floor-Grade Operating Scissors, Econo.....142
 Floor-Grade Regular Splinter Forceps, Econo.....142
 Floor-Grade Small Utility Scissors, Econo.....142
 Floor-Grade Stitch Scissors, Econo.....142

F

Face Lift Scissors, Sklarcut Castanares Premium.....311
 Face Lift Scissors, Aufricht.....303,357
 Face Lift Scissors, Sklarcut Gorney, Premium.....311
 Face Lift Scissors, Sklarcut Kaye, Premium.....311
 Facial Plastic Tray W/ Econo Instruments.....127
 Farabeuf Retractor.....73
 Farrell Applicator.....269
 Feilchenfeld Splinter Forceps.....59,362
 Female Catheters.....258
 Ferris-Smith Forceps.....56,170
 Fetal Stethoscope.....434

Foerster Sponge Forceps, Mid-Grade	48
Foerster Sponge Forceps, OR Grade	48,336,361
Foerster Sponge Forceps, Sterile, Floor-Grade	48
Fomon Lateral Scissors, Sklarcut, Premium	310
Fomon Nasal Chisels	278
Fomon Nasal Scissors.....	303
Fomon Rasp and File	280,390
Fomon Retractor.....	292,295,366
Fomon Saber Back Scissors	303,357,358
Fonde Harmar Expressor	376
Forcep, Cervical Biopsy, Eppendorfer.....	185
Forcep, Cervical Biopsy, Eppendorfer Micro-Cut	185
Forcep, Cervical Biopsy, Kevorkian.....	183
Forcep, Cervical Biopsy, Kevorkian-Younger.....	184
Forcep, Cervical Biopsy, Kevorkian-Younger Micro-Cut.....	184
Forcep, Cervical Biopsy, Mini Tischler Wide Bite	180
Forcep, Cervical Biopsy, Mini Tischler	180
Forcep, Cervical Biopsy, Oval	181
Forcep, Cervical Biopsy, Oval Micro-Cut.....	181
Forcep, Cervical Biopsy, Oval Wide Bite.....	181
Forcep, Cervical Biopsy, Tischler.....	179
Forcep, Cervical Biopsy, Tischler Oval.....	182
Forcep, Cervical Biopsy, Tischler Oval Wide Bite	182
Forcep, Cervical Biopsy, Tischler Wide Bite.....	179
Forcep, Cervical Biopsy, Wittner	184
Forcep, Cervical Biopsy, Wittner Micro-Cut.....	184

Forceps

Forceps, Abramson-Allis	161
Forceps, Adair Breast Tenaculum	159
Forceps, Adson	45
Forceps, Adson Bayonet	56,265
Forceps, Adson Bipolar	208,297
Forceps, Adson Dressing/Tissue Econo Floor-Grade	142
Forceps, Adson Dressing, Laser	216
Forceps, Adson Dressing/Tissue, Merit.....	112
Forceps, Adson Ewald, OR Grade	52
Forceps, Adson, Mid-Grade	52,53
Forceps, Adson, OR Grade	53,55
Forceps, Adson, Sklar Blue	206
Forceps, Adson, Sklarlite, Premium	84,85
Forceps, Adson-Brown Tissue, Merit	112
Forceps, Adson-Brown, Mid-Grade	54
Forceps, Adson-Brown, OR Grade.....	54
Forceps, Alligator Ear, Delicate	264
Forceps, Allis Tissue, T-C, Premium	42
Forceps, Allis Tissue, Merit	112
Forceps, Allis Tissue, Mid-Grade	42,160
Forceps, Allis Tissue, OR Grade	42,160,161
Forceps, Allis Tissue, Sklar Blue	160,207
Forceps, Allis Tissue, Laser	160,216,251
Forceps, Allis-Adair	44
Forceps, Allis-Thoms.....	44
Forceps, Asch Septum Straightening.....	276

Forceps, Ayers Chalazion	333
Forceps, Babcock T-C, Premium	43
Forceps, Babcock, Laser.....	166,215,251
Forceps, Babcock, Mid-Grade.....	43,166
Forceps, Babcock, OR Grade	43,166
Forceps, Babcock, Sklar Blue	166,207
Forceps, Ballenger Sponge.....	49
Forceps, Baron Alligator Hemorrhoidal	248
Forceps, Barrett Tenaculum.....	159
Forceps, Bechert-McPherson Tying.....	340
Forceps, Bergh Cilia	57
Forceps, Berke Ptosis	296,334
Forceps, Bierer Ovum	198
Forceps, Billroth.....	165
Forceps, Bishop-Harmon.....	58,363
Forceps, Bishop-Harmon Eye Dressing.....	335
Forceps, Bishop-Harmon Eye Tissue.....	335
Forceps, Blake Ear	265
Forceps, Blakesley Nasal, Wilde.....	273
Forceps, Bonn Micro Suturing.....	338
Forceps, Bonn Tyding	338
Forceps, Bonney Tissue.....	56,170
Forceps, Bozeman, Laser	157,215
Forceps, Bozeman, Mid-Grade	157
Forceps, Bozeman, OR Grade.....	157,247
Forceps, Bozeman, Sklar Blue.....	157,206
Forceps, Champion Uterine, Laser.....	163,215
Forceps, Carmalt Splinter.....	59,362
Forceps, Castroviejo.....	338
Forceps, Castroviejo Colibri	337
Forceps, Castroviejo Fixation	337
Forceps, Castroviejo Suture.....	338
Forceps, Chandler Iris	336
Forceps, Clemetson Uterine, Laser.....	162,217
Forceps, Clemetson Uterine, Sklar Blue	162,207
Forceps, Coller Hemostat.....	44
Forceps, Collin Duval Lung	49
Forceps, Colver-Coakley Tonsil	289
Forceps, Corey Ovum	197
Forceps, Cottle Columella	296
Forceps, Craig.....	161
Forceps, Craig Tonsil Seizing.....	289
Forceps, Crile Hemostat, Mid-Grade.....	37
Forceps, Crile Hemostat, OR Grade	37
Forceps, Crile, Econo, Floor-Grade.....	142
Forceps, Crile, Merit	111
Forceps, Cushing Brain, Delicate, Premium.....	57
Forceps, De Lee Obstetrical.....	195
Forceps, De Lee Uterine, Laser	216
Forceps, Debakey Atraumatic Tissue.....	58,379
Forceps, Debakey Atraumatic Tissue, Laser.....	216
Forceps, Debakey Halsted Mosquito.....	361
Forceps, Delee Uterine.....	163
Forceps, Desmarres Chalazion.....	333,369
Forceps, Double-Action Littauer Cutting.....	381
Forceps, Doyen Vulsellum.....	164

Dressing Forceps

Forceps, Dressing, Mid-Grade	50
Forceps, Dressing, OR Grade	50
Forceps, Dressing, Plastic.....	122
Forceps, Dressing, Plastic, Sterile.....	123
Forceps, Dressing, Sklar Blue	206
Forceps, Dressing, Sklarlite, Premium	84
Forceps, Dressing, Sterile, Floor-Grade.....	50
Forceps, Dressing, T-C, Premium	50
Forceps, Dressing/Tissue, Merit.....	112
Forceps, Duckbill Ear	263
Forceps, Duplay Tenaculum.....	159
Forceps, Elschmig Fixation	337
Forceps, Extracting.....	420,421
Forceps, Eye	57,336
Forceps, Feilchenfeld Splinter	59,362
Forceps, Ferris-Smith	56,170
Forceps, Fine Point Splinter	362
Forceps, Fine Point Splinter, Mid-Grade	59
Forceps, Fine Point Splinter, OR Grade.....	59
Forceps, Foerster	336,361
Forceps, Foerster Sponge, Merit.....	112
Forceps, Foerster Sponge, Mid-Grade.....	48
Forceps, Foerster Sponge, OR Grade	48
Forceps, Francis Chalazion.....	334
Forceps, Gelpi-Lowrie	167
Forceps, Gerald.....	58
Forceps, Gill Iris.....	335
Forceps, Girard Corneal Utility	337
Forceps, Graefe.....	336,337,363
Forceps, Graefe Fixation, Econo, Floor-Grade	142
Forceps, Green Fixation.....	337
Forceps, Gutglass Cervix	167
Forceps, Halsted Mosquito, Econo, Floor-Grade	142
Forceps, Halsted Mosquito, Merit.....	111
Forceps, Halsted Mosquito, Mid-Grade.....	36
Forceps, Halsted Mosquito, OR Grade	36
Forceps, Harms Tying	338
Forceps, Hartmann Alligator Grasping	262
Forceps, Hartmann Alligator, Merit.....	116
Forceps, Hartmann Punch.....	262,272
Forceps, Hartmann-Herzfeld	265
Forceps, Healy Suture.....	363
Forceps, Heaney	169
Forceps, Heaney-Ballentine	168
Forceps, Heaney-Kanter	168
Forceps, Heath Chalazion.....	334
Forceps, Hemorrhoidal.....	243
Forceps, Henrotin Vulsellum	164
Forceps, Heymann Septum.....	273
Forceps, Hoffman Ear	263
Forceps, Iowa Membrane.....	197



**OR Quality
Instruments**



**OR Premium™
Instruments**



Mid-Grade Instruments

Forceps, Iowa State Fixation.....	335	Forceps, Littauer Cutting, Merit.....	115	Forceps, Russian Tissue.....	56
Forceps, Iris Dressing/Tissue, Merit.....	112	Forceps, Littauer Cutting, Sklar-Taper.....	381	Forceps, Sawtell Tonsil.....	289
Forceps, Iris, Econo, Floor-Grade.....	142	Forceps, Littauer Ear.....	262	Forceps, Schmidt.....	45
Forceps, Jackson Alligator Grasping.....	248	Forceps, Littauer Nasal.....	273	Forceps, Schmidt Tonsil.....	289
Forceps, Jacobs Vulsellum.....	164	Forceps, Locke Phalangeal.....	396	Forceps, Schroeder Tenaculum, Sterile Floor-Grade.....	158
Forceps, Jacobson Mosquito.....	44	Forceps, Long.....	168	Forceps, Schroeder Tenaculum, Laser.....	158,215
Forceps, Jacobson Mosquito, Delicate.....	361	Forceps, Lucae Bayonet.....	56,265	Forceps, Schroeder Tenaculum, Merit.....	114
Forceps, Jansen Bayonet Nasal.....	56,273	Forceps, Lucae Ear, Merit.....	114	Forceps, Schroeder Tenaculum, Mid-Grade.....	158
Forceps, Jansen-Middleton Septum.....	276	Forceps, Luikart Obstetrical.....	195	Forceps, Schroeder Tenaculum, OR Grade.....	158
Forceps, Jarcho Tenaculum.....	159	Forceps, Magill Catheter, Mid-Grade.....	46	Forceps, Schroeder Tenaculum, Sklar Blue.....	158,206
Forceps, Javerts Placenta.....	197	Forceps, Magill Catheter, OR Grade.....	46	Forceps, Schroeder Vulsellum.....	165
Forceps, Jewelers Style.....	58,364	Forceps, Maier Gross Uterine Dressing.....	168	Forceps, Schroeder Vulsellum, Laser.....	215
Forceps, Johns Hopkins Mosquito.....	45	Forceps, Manhattan Eye and Ear Suture.....	339	Forceps, Schweizer.....	49
Forceps, Kantrowitz Tissue.....	170	Forceps, McCullough Utility.....	57,339	Forceps, Schweizer Uterine, Laser.....	162,217
Forceps, Kelly Extra Heavy.....	256	Forceps, McIndoe Bone Cutting.....	393	Forceps, Schweizer Uterine, Sklar Blue.....	162,207
Forceps, Kelly Hemostat, Mid-Grade.....	38	Forceps, McLane-Tucker Obstetrical.....	196	Forceps, Segond Collin.....	164
Forceps, Kelly Hemostat, OR Grade.....	38	Forceps, McPherson Tying.....	338	Forceps, Semkin Dressing/Tissue.....	56
Forceps, Kelly Hemostat, Econo, Floor-Grade.....	142	Forceps, Micro Adson.....	363	Forceps, Simpson Obstetrical.....	195
Forceps, Kelly Hemostat, Merit.....	111	Forceps, Micro Adson, OR Grade.....	55	Forceps, Simpson-Luikart Obstetrical.....	195
Forceps, Kelman-McPherson Tying.....	340	Forceps, Micro Alligator Ear.....	265	Forceps, Singley/Tuttle.....	57
Forceps, Knight Septum.....	272	Forceps, Micro Mosquito.....	46,361		
Forceps, Lahey Traction.....	170	Forceps, Micro Suture Tying.....	363		
Forceps, Lambert Chalazion.....	333	Forceps, Microsurgery.....	346		

Laparoscopic Forceps

Forceps, Laparoscopic Alligator Grasping.....	221
Forceps, Laparoscopic Allis T-C.....	221,223
Forceps, Laparoscopic Babcock.....	223
Forceps, Laparoscopic Blunt Grasping.....	220
Forceps, Laparoscopic Claw.....	219,222
Forceps, Laparoscopic Debakey.....	221,223
Forceps, Laparoscopic Dissecting.....	219
Forceps, Laparoscopic Fenestrated.....	219
Forceps, Laparoscopic Grasping.....	220
Forceps, Laparoscopic Kelly.....	219
Forceps, Laparoscopic Kocher.....	222
Forceps, Laparoscopic Mixer.....	219,222
Forceps, Laparoscopic Pointed Grasping.....	220
Forceps, Laparoscopic Spoon.....	222
Forceps, Laparoscopic Tapered Grasping.....	220
Forceps, Mini Laparoscopic Cobra Grasping.....	231
Forceps, Mini Laparoscopic Duck Nose.....	231
Forceps, Mini Laparoscopic Grasping.....	231
Forceps, Mini Laparoscopic Kelly.....	230
Forceps, Mini Laparoscopic Spoon.....	230
Forceps, Laufe Divergent Obstetrical.....	196
Forceps, Laufe Uterine Polyp, Laser.....	163,217
Forceps, Laufe Uterine Polyp, Sklar Blue.....	163,207
Forceps, Laufe-Piper Obstetrical.....	196
Forceps, Lawton.....	168
Forceps, Lester Conjunctival.....	336,363
Forceps, Liston Bone.....	392,395
Forceps, Littauer Cutting.....	380

Forceps, Littauer Cutting, Merit.....	115
Forceps, Littauer Cutting, Sklar-Taper.....	381
Forceps, Littauer Ear.....	262
Forceps, Littauer Nasal.....	273
Forceps, Locke Phalangeal.....	396
Forceps, Long.....	168
Forceps, Lucae Bayonet.....	56,265
Forceps, Lucae Ear, Merit.....	114
Forceps, Luikart Obstetrical.....	195
Forceps, Magill Catheter, Mid-Grade.....	46
Forceps, Magill Catheter, OR Grade.....	46
Forceps, Maier Gross Uterine Dressing.....	168
Forceps, Manhattan Eye and Ear Suture.....	339
Forceps, McCullough Utility.....	57,339
Forceps, McIndoe Bone Cutting.....	393
Forceps, McLane-Tucker Obstetrical.....	196
Forceps, McPherson Tying.....	338
Forceps, Micro Adson.....	363
Forceps, Micro Adson, OR Grade.....	55
Forceps, Micro Alligator Ear.....	265
Forceps, Micro Mosquito.....	46,361
Forceps, Micro Suture Tying.....	363
Forceps, Microsurgery.....	346
Forceps, Mixer.....	45,256
Forceps, Mixer, Sklarlite, Premium.....	83
Forceps, Nail Splitting.....	385
Forceps, Nail Splitting, Merit.....	115
Forceps, Noyes Alligator.....	266,273
Forceps, Nugent Utility.....	339
Forceps, P and A.....	392
Forceps, Peanut Sponge.....	49
Forceps, Pedo Extracting.....	421
Forceps, Phaneuf.....	167
Forceps, Physicians Splinter.....	362
Forceps, Plain Splinter With Magnifier.....	59,362
Forceps, Plain Splinter, Merit.....	112
Forceps, Plate Bending.....	401
Forceps, Platypus Nail Pulling.....	384
Forceps, Potts-Smith.....	56
Forceps, Potts-Smith, Laser.....	216,251
Forceps, Potts-Smith, Sklar Blue.....	206
Forceps, Pratt.....	46
Forceps, Prince Muscle.....	296,337
Forceps, Providence Hospital.....	46
Forceps, Rankin Hemostatic.....	45
Forceps, Regular Splinter, Econo Floor-Grade.....	142
Forceps, Rochester-Carmalt.....	45
Forceps, Rochester-Ochsner, Mid-Grade.....	40
Forceps, Rochester-Ochsner, OR Grade.....	40
Forceps, Rochester-Ochsner, Mid-Grade.....	41
Forceps, Rochester-Pean, Mid-Grade.....	41
Forceps, Rochester-Pean, OR Grade.....	41
Forceps, Rowland Bone.....	393
Forceps, Rubber Dam.....	416
Forceps, Ruskin-Liston Bone Cutting.....	392,395

**SKLARLITE
THE LIGHT TOUCH**

Forceps, Sklarlite Adson, Premium.....	52,53
Forceps, Sklarlite Adson-Brown, Premium.....	54
Forceps, Sklarlite Allis Tissue, Premium.....	42,83,160
Forceps, Sklarlite Crile Hemostatic, Premium.....	37,81
Forceps, Sklarlite Dressing, Premium.....	50
Forceps, Sklarlite Halsted Mosquito, Premium.....	36,81
Forceps, Sklarlite Hartmann Mosquito, Premium.....	82
Forceps, Sklarlite Kelly Hemostatic, Premium.....	38,81
Forceps, Sklarlite Littauer Cutting, Premium.....	380
Forceps, Sklarlite Nail Splitting, Premium.....	385
Forceps, Sklarlite Rochester-Ochsner, Premium.....	40,82
Forceps, Sklarlite Rochester-Pean, Premium.....	41,82
Forceps, Sklarlite Tissue, Premium.....	51
Forceps, Spencer Chalazion.....	334
Forceps, Sponge, Plastic.....	122
Forceps, Sponge, Plastic, Sterile.....	123
Forceps, Staude Tenaculum.....	159

Econo Sterile™ Forceps

Forceps, Sterile, Adson, Floor-Grade.....	52,53
Forceps, Sterile, Babcock, Floor-Grade.....	43,166
Forceps, Sterile, Crile, Floor-Grade.....	37
Forceps, Sterile, Dressing, Floor-Grade.....	50
Forceps, Sterile, Halsted Mosquito, Floor-Grade.....	36
Forceps, Sterile, Kelly, Floor-Grade.....	38
Forceps, Sterile, Tissue, Floor-Grade.....	51
Forceps, Sterile, Adson-Brown, Floor-Grade.....	54
Forceps, Sterile, Allis Tissue, Floor-Grade.....	42,160
Forceps, Sterile, Bozeman, Floor-Grade.....	157

MERIT
Instruments

ECONO
Floor Grade
Instruments

ECONO
STERILE
Floor Grade
Instruments

Forceps, Sterile, Fine Splinter, Floor-Grade.....59
 Forceps, Sterile, Foerster Sponge Floor-Grade48
 Forceps, Sterile, Magill Catheter Floor-Grade.....46
 Forceps, Sterile, Rochester-Pean, Floor-Grade.....41
 Forceps, Sterile, Tube Occluding, Floor-Grade.....49

 Forceps, Sterilizer.....422
 Forceps, Struempel Ear.....263
 Forceps, Struycken Cutting273

SKLAR T-C
TUNGSTEN CARBIDE

Forceps, T-C Adson, Premium.....55,99
 Forceps, T-C Adson-Brown, Premium.....55,99
 Forceps, T-C Allis, Premium.....98
 Forceps, T-C Babcock, Premium.....98,166
 Forceps, T-C Debakey Atraumatic, Premium.....98,170
 Forceps, T-C Dressing, Premium.....50,99
 Forceps, T-C Potts-Smith Dressing, Premium.....98

Forceps, Takahashi.....273
 Forceps, Teale Vulsellum.....161
 Forceps, Tennant Tying.....340
 Forceps, Thoms-Gaylor Biopsy.....250
 Forceps, Thomson Mosquito.....45
 Forceps, Thorpe Corneoscleral.....339
 Forceps, Thumb Dressing, Econo, Floor-Grade.....142

Tissue Forceps

Forceps, Thumb Tissue, Econo, Floor-Grade.....142
 Forceps, Tissue, Mid-Grade.....51
 Forceps, Tissue, OR Grade.....51
 Forceps, Tissue, Sklarlite, Premium.....84
 Forceps, Tissue, Sterile, Floor-Grade.....51

Forceps, Tivnen Tonsil Seizing.....289
 Forceps, Troutman-Barraquer Corneal Utility.....335
 Forceps, Tube Occluding, Mid-Grade.....49
 Forceps, Tube Occluding, OR Grade.....49
 Forceps, Tuttle/Singley, Laser.....216
 Forceps, Tuttle/Singley, Sklar Blue.....207
 Forceps, Tyding Tonsil Seizing.....289
 Forceps, Utility, Plastic.....122
 Forceps, Utility, Plastic, Sterile.....123
 Forceps, Virtus Splinter.....362
 Forceps, Walsham Septum Straightening.....276
 Forceps, Weingartner Ear.....265
 Forceps, Weis Chalazion.....334
 Forceps, White Tonsil.....289
 Forceps, Wilde Ear.....265
 Forceps, Wilde Ear, Merit.....114
 Forceps, Wilde Nasal.....273
 Forceps, Williams Stieglitz Splinter.....363
 Forceps, Wills Hospital Utility.....339

Forceps, Ziegler Cilia.....57
 Foreign Body Instrument, Quire.....266
 Foreign Body Loop & Eye Magnetic Probe.....325
 Foreign Body Needles.....326
 Foreign Body Remover, Bailey.....325
 Foreign Body Spud, Alvis.....326
 Foreign Body Spud, Davis.....326
 Foreign Body Spud, Dix.....326
 Foreign Body Spud, Ellis.....326
 Foreign Body Spud, Francis.....326
 Foreign Body Spud, Laforce.....326
 Forming & Closing Plier.....423
 Forming Plier.....426
 Forming Plier, Ligature.....423
 Forming Plier, Loop.....423
 Forming Plier, Retainer.....423
 Forming Plier, Wire.....423
 Fox Aluminum Eye Shield.....344
 Fox Dermal Curette.....372
 Fox Dermal Curette, Merit.....115
 Francis Chalazion Forceps.....334
 Frazier Micro Hook.....295
 Frazier Suction Tube.....75
 Frazier Tissue Hook.....74,368
 Frazier Tissue Hook, Laser.....378
 Freer Chisel.....277
 Freer Elevator.....288,399
 Freer Septum Elevator.....274
 Freer Septum Knife.....274
 Freeway Graves Speculum, Laser.....147,148,211
 Freeway Graves Speculum, Sklar Blue.....147,148
 Friedman Bone Rongeur.....394

G

Gardner Chisel.....422
 Garrigue Weighted Vaginal Speculum.....151
 Gauge, Boley.....416
 Gauge, Hand-held Pocket.....438
 Gauze Scissors, U.S. Army Pattern.....385,405
 Gaylor Biopsy Punch.....185
 Gaylor-Thoms Biopsy Forceps.....250
 Gelhorn Biopsy Punch.....185
 Gelpi Retractor.....71
 Gelpi Retractor, Merit.....113
 Gelpi-Lowrie Forceps.....167

General Instruments

Scissors.....10-33
Forceps.....36-59
Needle Holders.....62-69
Retractors.....70-75
 General Purpose Tray W/ Econo Instruments.....124
 General Purpose Tray W/ Plastic Instruments.....124
 General Purpose Tray W/O Instruments.....124

General Utility Tray.....132
 Gerald Forceps.....58
 Gerald Forceps, Laser.....379
 Gerzog Bone Mallet.....402
 Gerzog Nasal Speculum.....272
 Gerzog Sexton Ear Knife.....266
 Gibbs-Gradle Scissors.....353
 Gill Corneal Knife.....327
 Gill Iris Forceps.....335
 Gillies Needle Holder.....299
 Gillies Skin Hook.....295,366
 Gillies Skin Hook, Laser.....378
 Gingivectomy Knife, Buck.....409
 Gingivectomy Knife, Kirkland.....409
 Gingivectomy Knife, Orban.....409
 Girard Corneal Utility Forceps.....337
 Glove Liners, Sterile.....452

Gloves.....451-452

Gloves, Latex Exam.....451
 Gloves, Latex Surgical, Sklartouch.....452
 Gloves, Nitrile Exam.....451
 Gloves, Nitrile Surgical, Sklartouch.....452
 Goelet Retractor.....283
 Goldman-Fox Knife.....417
 Goldman-Fox Scaler.....408
 Goldman-Fox Scissors.....304,306,353
 Goldman-Fox Scissors, Sklarcut, Premium.....311
 Goldstein Retractor.....70,290,324,365
 Goniotomy Knife, Barkan.....327
 Goodell Uterine Dilator.....176
 Gordon Plier.....416
 Gorney Face Lift Scissors, Sklarcut, Premium.....311
 Goslee Contouring Plier.....416
 Gouge, West Bone.....279
 Gracey Finishing Curettes.....409
 Gradle Scissors.....332,353
 Graefe Fixation Forceps.....337,363
 Graefe Fixation Forceps, Econo, Floor-Grade.....142
 Graefe Iris Forceps.....363
 Graefe Strabismus Hook.....328
 Graves Ob-View Speculum.....147
 Graves Ob-View Speculum, Sklar Blue.....201

Graves Speculum

Graves Speculum, Laser.....143,144,210
 Graves Speculum, Merit.....114
 Graves Speculum, Mid-Grade.....143
 Graves Speculum, Non-sterile, Plastic.....143
 Graves Speculum, OR Grade.....143
 Graves Speculum, Sklar Blue.....143,144,199,201
 Graves Speculum, Sterile, Floor-Grade.....143
 Graves Speculum, Sterile, Plastic.....143,234,453
 Graves Wide View Speculum.....147
 Graves Wide View Speculum, Sklar Blue.....147



OR Quality Instruments



OR Premium™ Instruments



Mid-Grade Instruments

Green Fixation Forceps.....	337	Hammer, Buck Neurological.....	436	Hemostats, Plastic, Sterile.....	123
Green Spatula.....	327	Hammer, Buck Neurological, Merit.....	116	Hemostats, Coller.....	44
Greene Uterine Curette.....	177	Hammer, Rabiner Neurological.....	436	Hemostats, Crile, Mid-Grade.....	37
Gritman Wax Spatula.....	419	Hammer, Taylor Percussion.....	436	Hemostats, Crile, OR Grade.....	37
Groovelok, Miller.....	415	Hammer, Taylor Percussion, Merit.....	116	Hemostats, Delicate Crile, Premium.....	37
Gross Hook and Spoon.....	266	Hand Sanitizer, Sklar.....	487	Hemostats, Delicate Kelly, Premium.....	38
Gross Maier Uterine Dressing Forceps.....	168	Hand-Held Pocket Gauge.....	438	Hemostats, Halsted, Mid-Grade.....	37
Gruber Ear Speculum.....	260	Handle #3, Scalpel, Merit.....	116	Hemostats, Halsted, OR-Grade.....	37
Guides, Catheter.....	256	Handle #4, Scalpel, Merit.....	116	Hemostats, Hartmann Mosquito, Mid-Grade.....	39
Gum Scissors, Quimby.....	304	Handle, Scalpel, Sklar.....	319	Hemostats, Hartmann Mosquito, OR Grade.....	39
Gusberg Endocervical Curette.....	177	Handle For Specialty Blades.....	322	Hemostats, Kelly, Mid-Grade.....	38
Gusberg Hysterectomy Clamp.....	167	Handle, Laparoscopic Sklar "X".....	224	Hemostats, Kelly, OR Grade.....	38
Gutglass Cervix Forceps.....	167	Handle, Laparoscopic Sklar "XC" Carbon.....	224	Hemostats, Rankin.....	45
Guthrie Double Hook.....	74,295,366	Handle, Laparoscopic Sklar "Y".....	224	Hemostats, Sklarlite Crile, Premium.....	37,81
Guthrie Double Hook, Laser.....	378	Handle, Laparoscopic Sklar "YC" Carbon.....	224	Hemostats, Sklarlite Kelly, Premium.....	38,81
Guthrie Fixation Hook.....	328	Handle, Lipo-Suction.....	315	Hemostats, Sterile, Hartmann, Floor-Grade.....	39
Gynecology Disposables.....	453-459	Handle, Suction.....	315		
Gynecology Instruments Disposable.....	234-242	Handles, Fiberoptic.....	428	Henly Vascular Surgery Retractor.....	71
Gynecology Instruments General.....	143-198	Hank Uterine Dilator.....	175	Hennig Plaster Spreader.....	403
Gynecology Instruments Laparoscopic.....	218-233	Hard Wire Cutter.....	424	Henrotin Vulsellum Forceps.....	164
Gynecology Instruments		Harms Tying Forceps.....	338	Henrotin Weighted Vaginal Speculum.....	151
Sklar Black - Laser.....	210-217	Hartman Mosher Tonsil Punches.....	288	Hercules Utility Scissors.....	32,406
Gynecology Instruments		Hartmann Alligator Forceps, Merit.....	116	Heyman Nasal Scissors.....	301
Sklar Blue - Electrosurgery.....	199-207	Hartmann Alligator Grasping Forceps.....	262	Heymann Septum Forceps.....	273
		Hartmann Mosquito Hemostats, Sterile, Floor-Grade.....	39	Hi Level Sklar Bandage Scissors.....	31
		Hartmann Mosquito Hemostats Sklarlite Premium.....	39,82	Hill Scissors.....	306,352
		Hartmann Mosquito Hemostats, Mid-Grade.....	39	Hirschman Anoscope.....	246,252,462
		Hartmann Mosquito Hemostats, OR Grade.....	39	Hoff Towel Clamp.....	47
		Hartmann Nasal Forceps.....	272	Hoffman Ear Forceps.....	263
		Hartmann Nasal Forceps.....	272	Hohmann Bone Elevator.....	400
		Hartmann Punch Forceps.....	262,264	Holden Uterine Curette.....	177
		Hartmann-Herzfeld Forceps.....	265	Hollenback Carver.....	417
		Hasson Trocar.....	226	Hollenback Condenser.....	412
		Head Mirror.....	282	Holman-Mathieu Cannula.....	177
		Headband, Jefferson Leather.....	282	Holzheimer Cross-Action Retractor.....	70,290,365,404
		Healy Suture Forceps.....	363	Hook and Spatula, McReynolds.....	328
		Heaney Forceps.....	169	Hook and Spoon, Gross.....	266
		Heaney Needle Holder, OR Grade.....	193	Hook Scissors, Laparoscopic.....	218
		Heaney Needle Holder, T-C Premium.....	96,193	Hook Scissors, Mini Laparoscopic.....	229
		Heaney Uterine Curette.....	177		
		Heaney-Ballentine Forceps.....	168		
		Heaney-Bozeman Needle Holder, T-C Premium.....	97,194		
		Heaney-Kanter Forceps.....	168		
		Heath Chalazion Curette.....	333		
		Heath Chalazion Forceps.....	334		
		Heath Scissors.....	304		
		Hegar Uterine Dilator.....	175		
		Heinlein Expressor.....	376		
		Hemorrhoidal Ligator Set, Mcgivney.....	244		
		Hemorrhoidal Ligator, Rudd.....	243		
		Hemorrhoidal Forceps, Baron Alligator.....	248		

H

Hajak Septum Chisels.....	279
Hajak-Ballenger Septum Elevator.....	274
Halle Nasal Scissors.....	301
Halle Nasal Speculum.....	271
Halle-Tieck Nasal Speculum.....	271

Halsey Needle Holders

Halsey Needle Holder, Merit.....	113
Halsey Needle Holder, Mid-Grade.....	65
Halsey Needle Holder, OR Grade.....	65,370
Halsey Needle Holder, Sklargrip, Premium.....	65
Halsey Needle Holder, Sklarlite, Premium.....	65,86
Halsey Needle Holder, Sterile, Floor-Grade.....	65
Halsey Needle Holder, T-C, Premium.....	65,94
Halsey Needle Holder, T-C, Surgi OR.....	104

Halsted Hemostats

Halsted Debakey Mosquito Forceps.....	361
Halsted Mosquito Forceps, Delicate, Premium.....	36
Halsted Mosquito Forceps, Econo, Floor-Grade.....	142
Halsted Mosquito Forceps, Heavy Pattern.....	36
Halsted Mosquito Forceps, Merit.....	111
Halsted Mosquito Forceps, Mid-Grade.....	36
Halsted Mosquito Forceps, OR Grade.....	36
Halsted Mosquito Forceps, Sklarlite, Premium.....	36,81
Halsted Mosquito Forceps, Sterile Floor-Grade.....	36

Hemostats

Hemostat, Dandy Scalp.....	361
Hemostats, Plastic.....	122

Henly Vascular Surgery Retractor.....	71
Hennig Plaster Spreader.....	403
Henrotin Vulsellum Forceps.....	164
Henrotin Weighted Vaginal Speculum.....	151
Hercules Utility Scissors.....	32,406
Heyman Nasal Scissors.....	301
Heymann Septum Forceps.....	273
Hi Level Sklar Bandage Scissors.....	31
Hill Scissors.....	306,352
Hirschman Anoscope.....	246,252,462
Hoff Towel Clamp.....	47
Hoffman Ear Forceps.....	263
Hohmann Bone Elevator.....	400
Holden Uterine Curette.....	177
Hollenback Carver.....	417
Hollenback Condenser.....	412
Holman-Mathieu Cannula.....	177
Holzheimer Cross-Action Retractor.....	70,290,365,404
Hook and Spatula, McReynolds.....	328
Hook and Spoon, Gross.....	266
Hook Scissors, Laparoscopic.....	218
Hook Scissors, Mini Laparoscopic.....	229

Hooks

Hook, Barr Crypt.....	250
Hook, Day Ear.....	266
Hook, Emmett.....	74,171
Hook, Emmett, Iris.....	171,172,173
Hook, Emmett, Iris, Laser.....	171,172,174,214
Hook, Emmett, Iris, Sklar Blue.....	171,172,173,205
Hook, Frazier Micro.....	295
Hook, Frazier Tissue.....	74,368
Hook, Gillies Skin.....	295,366
Hook, Graefe Strabismus.....	328
Hook, Guthrie Double.....	74,295,367
Hook, Guthrie Fixation.....	328
Hook, Jamison Strabismus.....	328

Hook, Joseph Skin.....	74,295,367
Hook, Laser Frazier Tissue	378
Hook, Laser Gillies Skin	378
Hook, Laser Guthrie Double	378
Hook, Laser Joseph Skin.....	378
Hook, Laser Tyrell Iris.....	378
Hook, O'Connor Skin.....	368
Hook, Pratt Crypt.....	250
Hook, Stevens Tenotomy	328
Hook, Tyrell Iris.....	295,328
Hook, Weiner Scleral.....	328,368
Hypoallergenic Soap, Sklar	487
Hypodermic Needles, Supersoft.....	448
Hysterectomy Clamp	167,169
Hysterosalpingogram Basic Tray.....	134

I

ID Roll Tape, Sklar	475
ID Sheet Tape, Sklar	474
ID Tags, Instrument.....	475
Incision & Drainage Tray W/ Econo Instruments	127
Incision & Drainage Tray W/ Plastic Instruments	127
Incision & Drainage Tray W/O Instruments.....	127
Indicator Labels.....	476
Indicator Pen, Steam.....	476
Indicator Strips	476
Indicator Tapes	476
Infant Ear Curette, Weisman.....	261
Infant Lachrymal Dilator	329
Infectious Waste Products	450
Inge Lamina Retractor.....	396,404
Ingrown Nail Cutter, Baker.....	386
Ingrown Nail Shaver.....	386
Instru-Guard 1 Step Cleaner/Lube	482
Instru-Guard Lube.....	2,481,486
Instrument Care	477-488
Instrument Cleaning Brush.....	443,481
Instrument Detergent	480,486
Instrument Detergent, Low Foam.....	480,485
Instrument ID Tags.....	475
Instrument Lubricant.....	481,486
Instrument Polish, Sklar.....	481,486
Instrument Processing.....	476
Instrument Protectors, Sklartip, Non-vented.....	473
Instrument Protectors, Sklartip, Vented.....	472
Instrument Soak	478,484
Instrument Trays.....	441,442,443
Insufflation Tubing W/ Filter.....	233
Insufflation, Infiltube.....	141
Insulin Syringes	444
Intra-Uterine Sound, Disposable	173,239,455
Iodine Cup	439

Iowa Membrane Forceps.....	197
Iowa State Fixation Forceps.....	335
Iris Dressing/Tissue Forceps, Merit.....	112
Iris Emmett Hook, Laser.....	171,172,214
Iris Emmett Hook, Sklar Blue.....	171,172,205
Iris Forceps, Chandler	336
Iris Forceps, Econo, Floor-Grade	142
Iris Forceps, Gill.....	335
Iris Forceps, Graefe.....	363
Iris Hook, Tyrell.....	295,328,368
Iris Micro-Miniature Scissors	330
Iris Retractors, McGannon.....	293

Iris Scissors

Iris Scissors, Angular	305
Iris Scissors, Angular, Probe Point.....	353
Iris Scissors, Barraquer-Dewecker	331
Iris Scissors, Bonn Miniature	307
Iris Scissors, Delicate, Premium.....	20
Iris Scissors, Econo, Floor-Grade.....	142
Iris Scissors, Merit.....	111
Iris Scissors, Mid-Grade	20
Iris Scissors, OR Grade.....	20
Iris Scissors, Ribbon.....	308,357
Iris Scissors, Sklar Edge T-C, Premium	21,91
Iris Scissors, Sklarcut, Premium.....	21,89
Iris Scissors, Sklarhone, Premium.....	21,93
Iris Scissors, Sklarlite, Premium	20,78
Iris Scissors, Sklarlite, Sklarcut, Premium.....	21,78,89
Iris Scissors, Sterile, Floor-Grade.....	20
Iris Scissors, T-C, Surgi OR	102
Iris Scissors, Knapp.....	305,352
Iris Scissors, McClure.....	331

Iris Suturing Forceps, McPherson Micro	338
IUD Extractor.....	177
IV Catheter Dressing Tray.....	130
IV Start Tray	130
Ives Rectal Speculum.....	243,244,246

J

Jackson Alligator Grasping Forceps.....	248
Jackson Retractor, Laser.....	217
Jackson Vaginal Retractor, Laser.....	152
Jacobs Vulsellum Forceps.....	164
Jacobson Mosquito Forceps.....	44,361
Jacobson Needle Holder, T-C, Premium.....	342
Jacobson Spring Handle Scissors.....	360
Jaeger Lid Retractor	325,369
Jameson Scissors, Sklarhone, Premium.....	93
Jamison Strabismus Hook.....	328
Jansen Retractor	71
Jansen-Middleton Septum Forceps.....	276

Jar, Dressing, With Cover.....	440
Jar, Forceps.....	440
Jar, Ointment, With Cover	440
Jarabak Plier.....	426
Jarcho Tenaculum Forceps.....	159
Javerts Placenta Forceps.....	197
Jefferson Leather Headband.....	282
Jelly, Lubrication.....	242,464
Jennings Mouth Gag	281
Jewelers Style Forceps	58,364
Johns Hopkins Mosquito Forceps	45
Jones Cross Action Towel Clamp.....	47
Joseph Bone Saw.....	276
Joseph Button End Knife.....	277
Joseph Knife.....	277
Joseph Periosteal Elevator.....	275
Joseph Rasp.....	280,390
Joseph Scissors	302,356,357
Joseph Skin Hook.....	74,295,367
Joseph Skin Hook, Laser.....	378

K

Kahn Dissecting Scissors.....	302
Kantrowitz Tissue Forceps	170
Kaye Face Lift Scissors, Sklarcut, Premium.....	311
Kaye Ribbon Undermining Scissors.....	352
Kelly Delicate Scissors, Sklarcut Premium.....	311
Kelly Extra Heavy Forceps	256

Kelly Hemostats

Kelly Hemostats, Econo, Floor-Grade.....	142
Kelly Hemostats, Merit.....	111
Kelly Hemostats, Delicate, Premium	38
Kelly Hemostats, Heavy Pattern.....	38
Kelly Hemostats, Mid-Grade.....	38
Kelly Hemostats, OR Grade	38
Kelly Hemostats, Sklarlite, Premium	38,81
Kelly Hemostats, Sterile Floor-Grade	38

Kelly Placenta Forceps.....	197
Kelly-Adson Scissors.....	188,258,356
Kelly-Sims Vaginal Retractor.....	152
Kelman-McPherson Tying Forceps	340
Kerrison Rongeurs.....	278
Kevorkian Biopsy Forcep, Micro-Cut, Premium.....	183
Kevorkian-Younger Biopsy Forcep.....	184
Kevorkian-Younger Endocervical Curette.....	178
Keyes Cutaneous Punch.....	375
Keyes Finger Ring Cutter	375
Keyes Vulvar/Dermal Punch.....	174
Killian Nasal Speculum.....	271
Kirkland Gingivectomy Knife.....	409
Kirschner Wires.....	400



OR Quality Instruments



OR Premium™ Instruments



Mid-Grade Instruments

Kit, Sklar Splinter Removal.....	59,362	Lahey Metz Scissors, SklarEdge T-C, Premium	17	Laparoscopic Maxi Fundus Grasping Forceps	220
Kleegman Dilator	176	Lahey Metz Scissors, Sklarlite Sklarcut Premium 17,77,89		Laparoscopic Metzenbaum Scissors	218,230
Kleinert-Kutz Bone Cutting Forceps	392	Lahey Metz Scissors, SklarEdge T-C, Premium	91	Laparoscopic Microscissors	218
Kleinert-Kutz Tenotomy Scissors	304	Lahey Metz Scissors, Sterile, Floor-Grade	16	Laparoscopic Mixer Forceps	219,222
Knapp Iris Scissors.....	305,352	Lahey Metz Scissors, Delicate, Premium	16	Laparoscopic Needle Holder	225
Knife, Atkins Tonsil.....	287	Lahey Metz Scissors, Mid-Grade	16	Laparoscopic Needles/Probe	229
Knife, Barkan Goniotomy.....	327	Lahey Metz Scissors, OR Grade	16	Laparoscopic Operating Scissors	218
Knife, Buck Gingivectomy.....	409	Lahey Metz Scissors, Sklarcut, Premium	17,89	Laparoscopic Peritoneal Scissors	218
Knife, Dean Tonsil	287	Lahey Metz Scissors, Sklarhone, Premium.....	17,93	Laparoscopic Pointed Grasping Forceps	220
Knife, Douglas Tonsil.....	287	Lahey Metz Scissors, Sklarlite, Premium	16,77	Laparoscopic Probe Excision Punch	219,230
Knife, Fisher Tonsil.....	287	Lahey Retractor.....	368	Laparoscopic Sharp Traumatic Grasping Forceps.....	221
Knife, Freer Septum	274	Lahey Traction Forceps.....	170	Laparoscopic Spoon Forceps.....	222,231
Knife, Gerzog Sexton Ear.....	266	Lambert Chalazion Forceps	333	Laparoscopic Strong Atraumatic Clamp	223
Knife, Gill Corneal.....	327	Lambotte Osteotomes	278	Laparoscopic Suction/Irrigation	228
Knife, Goldman-Fox.....	417	Lamina Retractor, Inge.....	396	Laparoscopic Tapered Grasping Forceps	220
Knife, Joseph.....	277	Lamps, Conventional Laryngoscope	432	Laparoscopic Trocars	226,232
Knife, Kirkland Gingivectomy.....	409	Lamps, Halogen Fiber Optic Laryngoscope	432	Laparoscopic Wave Grasping Forceps	221
Knife, Lothrop Tonsil.....	288	Lamps, Xenon Fiber Optic Laryngoscope	432		
Knife, Murphy Plaster	403	Lancaster Eye Speculum.....	324	Laparotomy Ring	170
Knife, Orban Gingivectomy.....	409	Lane Elevator	398	Larry Rectal Probe.....	250
Knife, Soft Corn	388	Langenbeck Elevator	398	Laryngeal Mirror, Everclear	282
Knife, Tooke Corneal.....	327			Laryngeal Mirror, Regular	282
Knife, Tyding Tonsil.....	287			Laryngoscopes	428-432
Knife, Wax and Spoon, Akers.....	411			Laryngoscopes, Handles/Blades, Lamps	428-432
Knife, Wax and Spoon, Evans.....	411				
Knight Nasal Scissors.....	301				
Knight Septum Forceps	272				
Knowles Bandage Scissors, Mid-Grade	31				
Knowles Bandage Scissors, OR Grade.....	31				
Knowles Bandage Scissors, Sterile Floor-Grade	31				
Kogan Endocervical Speculum.....	154				
Kogan Endospeculum, Laser	156,213				
Kogan Endospeculum, Sklar Blue	155,204				
Kratz-Barraquer Wire Eye Speculum	323				
Kratz-Barraquer Blade Eye Speculum.....	323				
Krause Ear Snare.....	267				
Krause Nasal Snare	274				
Kyle Applicator.....	269				

Laparoscopy Sklartech 4000

Laparoscopic "X" Handle, Sklar.....	224
Laparoscopic "XC" Carbon Handle, Sklar	224,232
Laparoscopic "Y" Handle, Sklar.....	224
Laparoscopic "YC" Carbon Handle, Sklar	224,232
Laparoscopic Alligator Grasping Forceps.....	221
Laparoscopic Allis T-C Forceps.....	221,223
Laparoscopic Atraumatic Grasping Forceps, Dissector	220,231
Laparoscopic Babcock Forceps	223
Laparoscopic Babcock-Debakey Forceps	223
Laparoscopic Blunt Grasping Forceps	220
Laparoscopic Claw Forceps	219,222
Laparoscopic Cobra Grasping Forceps.....	221,231
Laparoscopic Debakey Allis Forceps	223
Laparoscopic Debakey Forceps	221,223
Laparoscopic Dissecting Forceps.....	219
Laparoscopic Dolphin Forceps W/ Spoon	219
Laparoscopic Duck Nose Forceps.....	231
Laparoscopic Electrodes/Control Valves.....	227,232
Laparoscopic Electrosurgical Cable	232
Laparoscopic Endo Clinch Grasping Forceps	221
Laparoscopic Endoscope	232
Laparoscopic Fenestrated Forceps	219
Laparoscopic Fenestrated Grasping Forceps	220,231
Laparoscopic Grasping Forceps.....	220,231
Laparoscopic Grasping Forceps W/ Spoon.....	220
Laparoscopic Hook Scissors	218,230
Laparoscopic Insulated Cannula	224
Laparoscopic Kelly Forceps	219,231
Laparoscopic Kocher Forceps.....	222
Laparoscopic Maryland Dissector	219,222,231

Sklar Black™ LASER

Laser Adson Dressing Forceps	216
Laser Adson Tissue Forceps.....	379
Laser Adson-Brown Forceps.....	379
Laser Allis Forceps	160,216,251,379
Laser Auvard Vaginal Speculum	150,212
Laser Babcock Forceps.....	166,215,251
Laser Babcock Forceps, Premium	43
Laser Bozeman Forceps	157,215
Laser Champion Grasping Forceps.....	215,
Laser Champion Uterine Forceps.....	163,217
Laser Collin Vaginal Speculum.....	148,212
Laser Cottle Speculum	271
Laser De Lee Uterine Forceps	216
Laser Debakey Atraumatic Tissue Forceps.....	216,379
Laser Depth Ruler	214
Laser Dermal Retractor	378
Laser Desmarres Lid Retractor	378
Laser Dressing Forceps	379
Laser Emmett Hook, Iris.....	171,172,214
Laser Frazier Tissue Hook	378
Laser Freeway Graves Speculum	147,148,211
Laser Gerald Forceps.....	379
Laser Gillies Skin Hook	378
Laser Graves Speculum.....	143,144,210,211
Laser Graves Wide View Speculum.....	211
Laser Guthrie Double Hook	378

L

La Force Adenotome.....	286
Labels, Indicator	476
Lachrymal Dilator, Castroviejo.....	267,329
Lachrymal Dilator, Infant.....	329
Lachrymal Dilator, Muldoon.....	329
Lachrymal Dilator, Ruedemann	329
Lachrymal Dilator, Wilder	329
Lachrymal Dilator/Probe, Bowman	329
Lachrymal Dilator/Probe, Williams.....	329
Lachrymal Sac Retractor, Meller	324
Lachrymal Probes, French Pattern.....	267
Ladmore	414
Laforce Foreign Body Spud.....	326

Laser Jackson Retractor.....	217
Laser Jackson Vaginal Retractor.....	152
Laser Joseph Skin Hook.....	378
Laser Kogan Endospeculum.....	156,213
Laser Lateral Vaginal Retractor.....	149,212
Laser Laufe Uterine Polyp Forceps.....	163,217
Laser Pederson Speculum.....	145,146
Laser Potts-Smith Forceps.....	216,251,379
Laser Schroeder Tenaculum Forceps.....	158,215
Laser Schroeder Vulsellum Forceps.....	215
Laser Schweizer Uterine Forceps.....	162,217
Laser Senn Retractor.....	378
Laser Steiner-Auvard Vaginal Speculum.....	150,212
Laser Tissue Forceps.....	379
Laser Tuttle Forceps.....	251
Laser Tuttle/Singley Forceps.....	216
Laser Tyrell Iris Hook.....	378
Lateral Vaginal Retractor, Laser.....	149,212
Lateral Vaginal Retractor, Sklar Blue.....	149,202
Latex Exam Gloves.....	451
Latex Surgical Gloves.....	452
Laufe Divergent Obstetrical Forceps.....	196
Laufe Uterine Polyp Forceps, Laser.....	163,217
Laufe Uterine Polyp Forceps, Sklar Blue.....	163
Laufe-Piper Obstetrical Forceps.....	196
Lawton Forceps.....	168
Le Cron Carver.....	418
Leather Headband, Jefferson.....	282
Leff Stethoscope for Fetal Heart.....	435
Left Heart Cath Tray W/ Econo Instruments.....	137
Lempert Elevator.....	274,275
Lempert Endaural Curette.....	275
Lempert Rongeur.....	393
Lens Loop, Lewis.....	327
Lens Loop, New Orleans.....	327
Lens Loop, Wilder.....	327
Lens Scoop, Knapp.....	327
Lester Conjunctival Forceps.....	336,363
Lever, Cottle Bone.....	278
Lewis Lens Loop.....	327
Lewis Nasal Rasp.....	279
Lid Retractor, Desmarres.....	294,325,369
Lid Retractor, Jaeger.....	325,369
Ligator Set, McGivney Hemorrhoidal.....	244
Ligator Set, Rudd Clinic.....	243
Ligator, Hemorrhoid Suction.....	245
Ligature & Pin Cutter.....	423,424
Ligature Forming Plier.....	423
Lilly Dissecting Scissors.....	302
Lip Retractor, Columbia.....	284
Lipo-Suction.....	312-318
Lipo-Suction Cannula.....	312,313,314,316
Lipo-Suction Cannula, Disposable.....	317
Lipo-Suction Handle.....	315
Lipo-Suction Tubing, Disposable.....	318

Liquid Cleaner.....	480,487
Liquid Cleaner, Low Foam.....	480,486
Lister Bandage Scissors	
Lister Bandage Scissors, Delicate, Premium.....	30
Lister Bandage Scissors, Heavy Pattern.....	30
Lister Bandage Scissors, Large Ring.....	31
Lister Bandage Scissors, Merit.....	111
Lister Bandage Scissors, Mid-Grade.....	30
Lister Bandage Scissors, OR Grade.....	30
Lister Bandage Scissors, Sklarlite, Premium.....	30,79
Lister Bandage Scissors, Sterile, Floor-Grade.....	30
Liston Bone Cutting Forceps.....	392
Liston-Ruskin Bone Cutting Forceps.....	392,395
Litegrip Bishop-Harmon Forceps.....	335
Litegrip Eye Dressing Forceps.....	336
Litegrip Eye Tissue Forceps.....	336
Litegrip Sklar Adson Forceps, Premium.....	55
Litegrip Sklar Adson-Brown Forceps, Premium.....	55
Litegrip Sklar T-C Adson-Brown Forcep Premium.....	55
Litegrip T-C Adson-Brown Tissue/Suture Forceps.....	99
Littauer Cutting Forceps.....	380
Littauer Cutting Forceps, Merit.....	115
Littauer Cutting Forceps, Sklar-Taper.....	381
Littauer Cutting Forceps, Sklarlite, Premium.....	380
Littauer Ear Forceps.....	262
Littauer Nasal Forceps.....	273
Littauer Stitch Scissors, Delicate, Premium.....	25
Littauer Stitch Scissors, Mid-Grade.....	25
Littauer Stitch Scissors, OR Grade.....	25
Littauer Stitch Scissors, Sklarlite, Premium.....	25
Littauer Stitch Scissors, Sterile Floor-Grade.....	25
Littauer Suture Scissors, Plastic.....	122
Littauer Suture Scissors, Plastic, Sterile.....	123
Littler Suture Carrying Scissors.....	306
Lletz Ball Electrodes.....	236,459
Lletz Electrosurgery Tray.....	134
Lletz Loop Electrodes.....	236,459
Lletz Square Electrodes.....	236,459
Locator/Nerve Stimulator.....	209,298
Locke Elevator.....	388
Locke Phalangeal Forceps.....	396
Long Forceps.....	168
Long Stitch Scissors.....	302
Loop Forming Plier.....	423,424
Loop Tie Back Plier.....	424
Loop, Billeau Ear.....	261
Loops, Silicone.....	462
Lorna Edna Towel Clamp, Mid-Grade.....	47
Lorna Edna Towel Clamp, OR Grade.....	47
Lorna Edna Towel Clamp, Sterile, Floor-Grade.....	47
Lothrop Tonsil Knife.....	288

Lothrop Uvula Retractor.....	284
Lounsbury Placenta Curette.....	178
Love Uvula Retractors.....	293,294
Lube, Instru-Guard.....	481,487
Lube/Cleaner, Instru-Guard 1 Step.....	482
Lubrication Jelly.....	242,464
Lucae Bayonet Forceps.....	56,265
Lucae Ear Forceps, Merit.....	114
Luer-lock Adapter.....	315
Luethy Beck Needle Holder, T-C Premium.....	97,194
Lugol's Solution.....	237,458
Luikart Obstetrical Forceps.....	195
Lung Forceps, Collin Duval.....	49

M

Magill Catheter Forceps, Mid-Grade.....	46
Magill Catheter Forceps, OR Grade.....	46
Magill Catheter Forceps, Sterile, Floor-Grade.....	46
Magnetic Probe, Eye & Foreign Body Loop.....	325
Major Laceration Tray W/ Econo Instruments.....	127
Mallet, Gerzog Bone.....	402
Maltz Rasp.....	280,390
Marquette Black Plugger.....	417
Martin Scissors.....	306
Martini Curette.....	373
Maryland Dissector, Laparoscopic.....	219,222,230
Mathieu Needle Holder, OR Grade.....	194,371
Mathieu Needle Holder, T-C Premium.....	97,194
Mathieu Pliers.....	425
Mathieu Retractor.....	72,293,367

Mayo Scissors

Mayo Scissors, Delicate, Premium.....	14
Mayo Scissors, Heavy Pattern.....	14
Mayo Scissors, Merit.....	111
Mayo Scissors, Mid-Grade.....	14
Mayo Scissors, OR Grade.....	14
Mayo Scissors, Sklarcut, Premium.....	15,88
Mayo Scissors, Sklarhone, Premium.....	15,93
Mayo Scissors, Sklarlite, Premium.....	14,77
Mayo Scissors, Sterile Floor-Grade.....	14
Mayo Scissors, T-C, Surgi OR.....	102
Mayo Scissors, Sklar Edge T-C, Premium.....	15
Mayo Scissors, Sklarlite, Sklarcut, Premium.....	15,77,88
Mayo-Stille Dissecting Scissors.....	92,188

Mayo Tray.....	443
Mayo-Adams Retractor.....	71

Mayo-Hegar Needle Holder

Mayo-Hegar Needle Holder, Merit.....	113
Mayo-Hegar Needle Holder, Mid-Grade.....	64,191
Mayo-Hegar Needle Holder, OR Grade.....	64,191



OR Quality Instruments



OR Premium™ Instruments



Mid-Grade Instruments

Mayo-Hegar Needle Holder, Sklargrip, Premium ...64,191
 Mayo-Hegar Needle Holder, Sklarlite, Premium.....64,86
 Mayo-Hegar Needle Holder, Sterile Floor-Grade ...64,191
 Mayo-Hegar Needle Holder, T-C, Premium ..64,69,95,191
 Mayo-Hegar Needle Holder, T-C, Surgi OR.....104
 McCalls Finishing Curettes.....409
 McClure Iris Scissors.....331
 McClure Spring Handle Scissors.....359
 McCullough Utility Forceps.....57,339
 McGannon Iris Retractor293
 McGivney Hemorrhoidal Ligator Set.....244
 McGlamry Elevator.....397
 McGuire Corneal Scissors.....332
 McIndoe Bone Cutting Forceps.....393
 McKenty Septum Elevator.....275
 McLane-Tucker Obstetrical Forceps196
 McLane-Tucker-Luikhart Obstetrical Forceps195
 McPherson Micro Iris Suturing Forceps338
 McPherson-Vannas Scissors300,309,331,360
 Mead Rongeur.....394
 Medicine Cup.....440
 Mediflector.....432
 Meller Lachrymal Sac Retractor324
 Mellinger Eye Speculum.....323
 Mercurial Sphygmomanometer437
 Meriam Pliers.....415

MERIT

Instruments

Merit Adson Dressing/Tissue Forceps.....112
 Merit Adson-Brown Tissue Forceps112
 Merit Allis Tissue Forceps112
 Merit Alm Retractor.....113
 Merit Backhaus Towel Clamp.....112
 Merit Baumgartner Needle Holder.....113
 Merit Buck Ear Curette114
 Merit Buck Neuro Hammer116
 Merit Crile Hemostats111
 Merit Crile-Wood Needle Holder.....113
 Merit Curette Excavator.....115
 Merit Derf Needle Holder.....113
 Merit Dressing/Tissue Forceps.....112
 Merit Ear Syringe.....114
 Merit Foerster Sponge Forceps.....112
 Merit Fox Dermal Curette115
 Merit Gelpi Retractor113
 Merit Graves Speculum.....114
 Merit Halsey Needle Holder.....113
 Merit Halsted Mosquito Forceps.....111
 Merit Hartmann Alligator Forceps.....116
 Merit Iris Dressing/Tissue Forceps.....112

Merit Iris Scissors111
 Merit Kelly Hemostats.....111
 Merit Lister Bandage Scissors.....111
 Merit Littauer Cutting Forceps115
 Merit Lucae Ear Forceps114
 Merit Mayo Scissors111
 Merit Mayo-Hegar Needle Holder.....113
 Merit Metal Ear Syringe.....114
 Merit Metzenbaum Scissors111
 Merit Multi-Cut Utility Scissors.....116
 Merit Nail Nipper.....115
 Merit Nail Splitting Forceps.....115
 Merit Operating Scissors111
 Merit Pederson Speculum114
 Merit Plain Splinter Forceps112
 Merit Presbyterian Tube Occluding Clamp.....112
 Merit Probe and Excavator.....115
 Merit Scalpel Handle #3, #4116
 Merit Schroeder Tenaculum114
 Merit Simpson Uterine Sound.....114
 Merit Spencer Stitch Scissors.....116
 Merit Taylor Percussion Hammer116
 Merit Tissue Nipper115
 Merit Vienna Nasal Speculum114
 Merit Wartenberg Pinwheel116
 Merit Webster Needle Holder113
 Merit Weitlaner Retractor.....113
 Merit Wilde Ear Forceps.....114
 Merit Wire Cutting Scissors116

Metal Ear Syringe, Merit.....114
 Metatarsal Spreader, Schink404

Metzenbaum Scissors

Metzenbaum Lahey Scissors, Sklar Edge T-C Prem91
 Metzenbaum Lahey Scissors, Delicate, Premium16
 Metzenbaum Lahey Scissors, Mid-Grade16
 Metzenbaum Lahey Scissors, OR Grade.....16
 Metzenbaum Lahey Scissors, Sklarcut, Premium17,89
 Metzenbaum Lahey Scissors, Sklarhone, Premium..17,93
 Metzenbaum Lahey Scissors, Sklarlite, Premium16,77
 Metzenbaum Scissors, Laparoscopic.....218
 Metzenbaum Scissors, Merit111
 Metzenbaum Scissors, Mid-Grade18
 Metzenbaum Scissors, OR Grade.....18
 Metzenbaum Scissors, Mini Laparoscopic229
 Metzenbaum Scissors, Sklar Edge T-C, Premium19
 Metzenbaum Scissors, Sklarcut, Premium19
 Metzenbaum Scissors, Sklarhone, Premium.....19
 Metzenbaum Scissors, Sklarlite, Premium18
 Metzenbaum Scissors, Sklarlite, Sklarcut78,89,91
 Metzenbaum Scissors, Sterile, Floor-Grade.....18
 Metzenbaum Scissors, T-C, Surgi OR102
 Meyerding Skin Hook and Retractor.....74,367

Meyhoefer Chalazion Curette.....333,372
 Micro Adson Forceps, OR Grade55,363
 Micro Alligator Ear Forceps265
 Micro Ear Scissors, Bellucci265
 Micro Hook, Frazier295
 Micro Iris Suturing Forceps, McPherson338
 Micro Mosquito Forceps46,361
Microsurgery.....346-351
 Micro Surgery Scissors.....300,309
 Micro Suture Tying Forceps363
 Micro Suturing Forceps, Bonn338

SKLARHONE MICRO - CUT

Micro-Cut Iris Scissors.....21
 Micro-Cut Jameson Scissors.....93
 Micro-Cut Mayo Scissors.....15,93
 Micro-Cut Metzenbaum Scissors.....19
 Micro-Cut Metzenbaum Lahey Scissors.....17
 Micro-Cut Operating Scissors.....11,13,93

Microscissors, Laparoscopic218
 Microsurgery Forceps.....346
 Microsurgery Forceps, Rhoton351
 Microsurgery Needle Holder.....347,350
 Microsurgery Scissors348,349,350,351

Mid-Grade Instruments

Mid-Grade Adson Forceps52,53
 Mid-Grade Adson-Brown Forceps54
 Mid-Grade Allis Tissue Forceps42,160
 Mid-Grade Babcock Forceps.....43,166
 Mid-Grade Backhaus Towel Clamp.....48
 Mid-Grade Baumgartner Needle Holder.....66
 Mid-Grade Bozeman Forceps157
 Mid-Grade Crile Hemostats37
 Mid-Grade Derf Needle Holder.....63
 Mid-Grade Dressing Forceps50
 Mid-Grade Dunaway Circumcision Forceps.....44,161,198,259
 Mid-Grade Fine Point Splinter Forceps59
 Mid-Grade Foerster Sponge Forceps.....48
 Mid-Grade Graves Speculum143
 Mid-Grade Halsey Needle Holder.....65
 Mid-Grade Halsted Mosquito Hemostats.....36
 Mid-Grade Hartmann Mosquito Hemostats39
 Mid-Grade Iris Scissors20
 Mid-Grade Kelly Hemostats.....38
 Mid-Grade Knowles Bandage Scissors.....31
 Mid-Grade Lister Bandage Scissors.....30
 Mid-Grade Littauer Stitch Scissors.....25
 Mid-Grade Lorna Edna Towel Clamp.....47
 Mid-Grade Magill Catheter Forceps46
 Mid-Grade Mayo Scissors14
 Mid-Grade Mayo-Hegar Needle Holder.....64,191

Mid-Grade Metzenbaum Scissors	18
Mid-Grade Metzenbaum Lahey Scissors	16
Mid-Grade Multi-Cut Utility Scissors	33
Mid-Grade Operating Scissors	10,12
Mid-Grade Pederson Speculum	145
Mid-Grade Rochester-Ochsner Forceps	40
Mid-Grade Rochester-Pean Forceps.....	41
Mid-Grade Schroeder Tenaculum Forceps	158
Mid-Grade Spencer Stitch Scissors.....	24
Mid-Grade Strabismus Scissors.....	22
Mid-Grade Tissue Forceps.....	51
Mid-Grade Tube Occluding Forceps	49
Mid-Grade Webster Needle Holder	62,190
Mid-Grade Wire Cutting Scissors	29
Miller Dissecting Scissors.....	306
Miller Groovelok.....	415
Miller Rectal Scissors	250
Miller-Senn Retractor.....	72,367
Mini Blumenthal Rongeur	393
Mini Colposcopy Set.....	187
Mini Dilator/Os Finder Set, Sklar	174
Mini Endocervical Curette, Sklar	178
Mini Hohmann Bone Elevator.....	400
Minor Dressing Tray W/ Econo Instruments.....	129
Minor Dressing Tray W/ Plastic Instruments	129
Minor Laceration Tray A W/ Econo Instruments.....	128
Minor Laceration Tray B W/ Econo Instruments.....	128
Minor Laceration Tray W/ Plastic Instruments.....	128
Minor Laceration Tray W/O Instruments.....	128
Minor Prep Tray.....	126
Minor Procedure Fenestrated Drape	141
Minor Surgery Tray W/ Econo Instruments	131
Mirror, Head.....	282
Mirror, Laryngeal, Everclear	282
Mirror, Laryngeal, Regular.....	282
Mirror, Sklar Disposable	427
Mixing/Solution Bowl	439
Mixer Forceps.....	45,256
Mixer Forceps, Laparoscopic	219,222
Mixer Forceps, Sklarlite, Premium.....	83
Mogen Circumcision Clamp.....	198,257
Moleskin, Material/Bandage Scissors.....	32,385,405
Molluscum Curette.....	373
Molt Mouth Gag.....	422
Monsef's Paste	237,458
Morrison-Hurd/Pillar Retractor.....	283

Mosquito Hemostats

Mosquito Forceps, Debakey Halsted.....	361
Mosquito Forceps, Delicate Halsted, Premium	36
Mosquito Forceps, Halsted, Econo, Floor-Grade	142
Mosquito Forceps, Halsted, Merit.....	111
Mosquito Forceps, Halsted, Mid-Grade.....	36

Mosquito Forceps, Halsted, OR Grade	36
Mosquito Forceps, Sterile Halsted Floor-Grade	36
Mosquito Forceps, Jacobson.....	44,361
Mosquito Forceps, Johns Hopkins	45
Mosquito Forceps, Micro	46,361
Mosquito Forceps, Thomson.....	45
Mosquito Forceps, Sklarlite Hartmann, Premium	82
Mosquito Forceps, Delicate Hartmann Premium.....	39
Mosquito Forceps, Hartmann, Mid-Grade	39
Mosquito Forceps, Hartmann, OR Grade.....	39
Mouth Gag, Doyen-jansen.....	281
Mouth Gag, Jennings	281
Mouth Gag, Molt.....	422
Mouth Gag, Wesson.....	281
Muldoon Lachrymal Dilator.....	329
Multi-Cut Utility Scissors, Sterile Floor-Grade	33
Multi-Cut Utility Scissors, Merit.....	116
Multi-Cut Utility Scissors, Mid-Grade.....	33
Multi-Cut Utility Scissors, OR Grade	33
Murphy Plaster Knife	403
Muscle Forceps, Prince.....	296,337
Mycotic Nail Nipper.....	383
Myringotome, Buck	266

N

Nail and Bone File	388,389
Nail and Cuticle Scissors.....	385
Nail Cutter, Baker Ingrown	386
Nail Drill, Sklar	375
Nail Nipper.....	381,382,383
Nail Nipper, Merit.....	115
Nail Nipper, Mycotic.....	383
Nail Pulling Forceps, Platypus.....	384
Nail Shaver, Ingrown	386
Nail Splitter, Sklar	382,388
Nail Splitting Forceps.....	385
Nail Splitting Forceps, Merit.....	115
Nail Splitting Scissors.....	385
Nail Tray	133,391
Nasal Bone Saw, Joseph	276
Nasal Chisels, Fomon	278
Nasal Forceps, Blakesley Wilde	273
Nasal Forceps, Hartmann.....	272
Nasal Forceps, Jansen Bayonet.....	56,273
Nasal Forceps, Littauer	273
Nasal Forceps, Wilde	273
Nasal Osteotome, Cottle	278
Nasal Rasp, Lewis.....	279
Nasal Scissors, Cottle	301
Nasal Scissors, Fomon.....	303
Nasal Scissors, Halle.....	301
Nasal Scissors, Heyman	301

Nasal Scissors, Knight.....	301
Nasal Snare, Krause	274
Nasal Speculum, Beckman	272
Nasal Speculum, Cottle.....	271
Nasal Speculum, Disposable.....	271,463
Nasal Speculum, Gerzog.....	272
Nasal Speculum, Halle	271
Nasal Speculum, Killian.....	271
Nasal Speculum, Sonnenschein.....	272
Nasal Speculum, Thudichum.....	272
Nasal Speculum, Tieck-Halle	271
Nasal Speculum, Vienna	271
Nasal Speculum, Vienna, Merit.....	114
Needle and Spud, Dix.....	325
Needle Extenders, Disposable	238,457
Needle Extenders, Reusable.....	238,457
Needle For Injection & Irrigation	228

Needle Holders

Needle Holder, Baumgartner Sterile Floor-Grade	66
Needle Holder, Baumgartner, Econo Floor-Grade	142
Needle Holder, Baumgartner, Merit.....	113
Needle Holder, Baumgartner, Mid-Grade.....	66
Needle Holder, Baumgartner, OR Grade	66,370
Needle Holder, Baumgartner, Sklarlite Premium.....	87
Needle Holder, Brown	69
Needle Holder, Carroll.....	371
Needle Holder, Castroviejo, OR Grade	68,343
Needle Holder, Castroviejo-Kalt	299,343
Needle Holder, Cohan.....	342
Needle Holder, Collier	69
Needle Holder, Converse	299,370
Needle Holder, Crile-Murray, OR Grade	67,87
Needle Holder, Crile-Wood Sterile Floor-Grade	192
Needle Holder, Crile-Wood, Merit.....	113
Needle Holder, Crile-Wood, OR Grade	67,192
Needle Holder, Crile-Wood, Sklarlite, Premium	87
Needle Holder, Derf, Merit.....	113
Needle Holder, Derf, Mid-Grade.....	63
Needle Holder, Derf, OR Grade	63,370
Needle Holder, Derf, Sklarlite, Premium.....	86
Needle Holder, Derf, Sterile, Floor-Grade	63
Needle Holder, Finochietto, OR Grade.....	192
Needle Holder, Gillies.....	299
Needle Holder, Halsey, Merit.....	113
Needle Holder, Halsey, Mid-Grade.....	65
Needle Holder, Halsey, OR Grade	65,370
Needle Holder, Halsey, Sklarlite, Premium	86
Needle Holder, Halsey, Sterile, Floor-Grade	65
Needle Holder, Heaney, OR Grade.....	193
Needle Holder, Laparoscopic	225
Needle Holder, Mathieu, OR Grade	194,371
Needle Holder, Mayo-Hegar Sterile Floor-Grade	64,191
Needle Holder, Mayo-Hegar, Merit.....	113



**OR Quality
Instruments**



**OR Premium™
Instruments**



Mid-Grade Instruments

Needle Holder, Mayo-Hegar, Mid-Grade.....	64,191
Needle Holder, Mayo-Hegar, OR Grade.....	64,191
Needle Holder, Mayo-Hegar, Sklarlite, Premium.....	86
Needle Holder, Microsurgery.....	347,350
Needle Holder, Neivert.....	299,342,370
Needle Holder, New Orleans.....	69
Needle Holder, Olsen-Hegar, OR Grade.....	68,192
Needle Holder, Olsen-Hegar, Sklarlite Premium.....	87
Needle Holder, Paton.....	300,309
Needle Holder, Sarot.....	69
Needle Holder, Stevens.....	342
Needle Holder, Stratte, OR Grade.....	193
Needle Holder, Webster, Sklarlite, Premium.....	62

SKLAR T-C
TUNGSTEN CARBIDE

Needle Holder, T-C Baumgartner, Premium.....	66,94
Needle Holder, T-C Baumgartner, Surgi OR.....	104
Needle Holder, T-C Bozeman-Heaney, Premium.....	97,194
Needle Holder, T-C Castroviejo, Premium.....	68,343,350
Needle Holder, T-C Crile-Murray, Premium.....	67,94
Needle Holder, T-C Crile-Wood, Surgi OR.....	104
Needle Holder, T-C Crile-Wood, Premium.....	67,69,94,192
Needle Holder, T-C Derf, Premium.....	63,94
Needle Holder, T-C Derf, Surgi OR.....	104
Needle Holder, T-C Finochietto, Premium.....	96,192
Needle Holder, T-C Halsey, Premium.....	65,94
Needle Holder, T-C Halsey, Surgi OR.....	104
Needle Holder, T-C Heaney, Premium.....	96,193
Needle Holder, T-C Jacobson, Premium.....	342
Needle Holder, T-C Luethy Beck, Premium.....	97,194
Needle Holder, T-C Mathieu, Premium.....	97,194
Needle Holder, T-C Mayo-Hegar, Premium.....	64,69,95,191
Needle Holder, T-C Mayo-Hegar, Surgi OR.....	104
Needle Holder, T-C Neivert, Premium.....	97
Needle Holder, T-C New Orleans, Premium.....	95
Needle Holder, T-C Olsen-hegar, Premium.....	68,95,192
Needle Holder, T-C Ryder, Premium.....	95
Needle Holder, T-C Sarot, Premium.....	96
Needle Holder, T-C Stratte, Premium.....	96,193
Needle Holder, T-C Webster, Premium.....	62,94,190
Needle Holder, T-C Webster, Surgi OR.....	104

Needle Holder, Webster, Econo, Floor-Grade.....	142
Needle Holder, Webster, Merit.....	113
Needle Holder, Webster, Mid-Grade.....	62,190
Needle Holder, Webster, OR Grade.....	62,190,370
Needle Holder, Webster, Sterile, Floor-Grade.....	62
Needle With Stopcock, Verres.....	228
Needles, Cervical Block.....	238,457
Needles, Foreign Body.....	326
Needles, Supersoft Hypodermic.....	448
Neivert Knife Guide and Retractor.....	293

Neivert Needle Holder.....	299,342,370
Neivert Needle Holder, T-C Premium.....	97
Nerve Stimulator/Locator.....	209,298
Nerve/Vein Retractor, Cushing.....	284
Neuro Hammer, Buck, Merit.....	116
Neuro Sponges.....	468
Neurological Hammer, Buck.....	436
Neurological Hammer, Rabiner.....	436
Neurological Pinwheel, Wartenberg.....	436
Neurological Pinwheel, Disposable.....	463
Never Break Explorer.....	417
New Orleans Lens Loop.....	327
New Orleans Needle Holder.....	69
New Orleans Needle Holder, T-C Premium.....	95
New's Suture Scissors.....	303
Newborn Stethoscope.....	434
Nipper, Nail.....	381,382,383,384
Nipper, Nail, Merit.....	115
Nitrile Surgical Gloves, Sklartouch.....	452
Nitrile Exam Gloves, Sklartouch.....	451
Nose Clip, Plastic.....	122
Nose Clip, Plastic, Sterile.....	123
Novak Endometrial Curette.....	176
Noyes Alligator Forceps.....	266,273
Nugent Utility Forceps.....	339
Nurse Stethoscope.....	433
Nurses' Bandage Scissors.....	32

O

O'Brien Stitch Scissors.....	307,358
O'Brien-Elschnig Forceps.....	337
O'Connor Hook.....	328,368
O'Connor-O'Sullivan Vaginal Retractor.....	152
Ob-View Speculum, Graves.....	147
Ob-View Speculum, Graves, Sklar Blue.....	147
Obstetrical Forceps, De Lee.....	195
Obstetrical Forceps, Laufe Divergent.....	196
Obstetrical Forceps, Laufe-Piper.....	196
Obstetrical Forceps, Luikart.....	195
Obstetrical Forceps, McLane-Tucker.....	196
Obstetrical Forceps, McLane-Tucker-Luikart.....	195
Obstetrical Forceps, Simpson.....	195
Obstetrical Forceps, Simpson-Luikart.....	195
Obstetrical Stethoscope, Delee-Hillis.....	435
Occluding Clamp, Presbyterian Tube, Merit.....	112
Occluding Clamp, Sterile, Tube, Floor-Grade.....	49
Occluding Clamp, Tube, Mid-Grade.....	49
Occluding Clamp, Tube, OR Grade.....	49
Ohl Elevator.....	399
Ointment Jar With Cover.....	440
Olsen-Hegar Needle Holder, OR Grade.....	68,192
Olsen-Hegar Needle Holder, Sklarlite, Premium.....	68,87
Olsen-Hegar Needle Holder, T-C, Premium.....	68,95,192

Operating Scissors

Operating Scissors, Delicate, Premium.....	10,12
Operating Scissors, Heavy Pattern.....	10
Operating Scissors, Econo, Floor-Grade.....	142
Operating Scissors, Merit.....	111
Operating Scissors, Mid-Grade.....	10,12
Operating Scissors, OR Grade.....	10,12
Operating Scissors, Sklar Edge T-C, Premium.....	11,13,91
Operating Scissors, Sklarcut, Premium.....	11,13,88
Operating Scissors, Sklarhone, Premium.....	11,13,93
Operating Scissors, Sklarlite, Premium.....	10,12,76
Operating Scissors, Sterile, Floor-Grade.....	10,12
Operating Scissors, T-C, Surgi OR.....	101

Ophthalmology.....323-345

Optical Plier.....	424
OR Basin, Sterile.....	141
OR Towels, Sterile.....	139
Oral Swab, Sklardent Disposable.....	427
Orban Gingivectomy Knife.....	409
Orthopedic.....392-406	
Os Dilator Set, Teflon.....	174,239,455
Os Dilator, Disposable.....	239
Os Finder/Mini Dilator Set, Sklar.....	174
Osteotome, Cinelli.....	277
Osteotome, Cottle Nasal.....	278
Osteotome, Silver.....	277
Osteotome, Lambotte.....	278
Otis Bougie A Boule.....	254
Otis/Dittel Urethral Sound.....	254
Otoscope.....	260,435
Ovum Forceps, Bierer.....	198
Ovum Forceps, Corey.....	197

P

P and A Forceps.....	392
Pacemaker Tray.....	137
Packer and Excavator.....	387
Packer and Probe.....	386
Packer and Spatula.....	386
Panties, Surgical, Disposable.....	318
Pap Brush, Sklar Standard.....	240,454
Pap Brush, Sklar Cervix.....	240
Paparella Weitlaner Retractor.....	291
Paste, Monsel's.....	237,458
Paton Needle Holder.....	300,309
Paul Retractor.....	369
Peanut Sponge Forceps.....	49
Peanut Sponges.....	470

Pederson Speculum

Pederson Speculum, Laser.....	145
-------------------------------	-----

Pederson Speculum, Merit.....	114
Pederson Speculum, Mid-Grade.....	145
Pederson Speculum, OR Grade.....	145
Pederson Speculum, Sklar Blue.....	145
Pederson Speculum, Sterile, Floor-Grade.....	145
Pediatric Stethoscope.....	434
Pedo Extracting Forceps.....	421
Pen Light.....	209,298
Pen, Steam Indicator.....	476
Pencil, Electrosurgical.....	208,297
Penis Clamp, Stockman Zipser.....	256
Penis Clamp, Strauss.....	256
Percussion Hammer, Taylor.....	436
Percussion Hammer, Taylor, Merit.....	116
Perell Fetoscope.....	435
Perforator, Politzer Tympanum.....	266
Perforator, Royce Tympanum.....	266
Periosteal Elevator, Cottle.....	275
Periosteal Elevator, Joseph.....	275
Periosteal Elevator, Sedillot.....	399
Peritoneal Scissors, Laparoscopic.....	218
Perkins Endaural Retractor.....	291
Perry Pliers.....	415
Phalangeal Forceps, Locke.....	396
Phaneuf Forceps.....	167
Physicians Splinter Forceps.....	362
Piffard Curette.....	373
Pin & Fine Wire Cutter.....	424
Pin & Ligature Cutter.....	423
Pin Cutter, Diamond.....	401
Pin/Wire Extractor, Snap Lock.....	401
Pins, Safety.....	140
Pins, Steinmann.....	400
Pinwheel, Wartenberg Neurological.....	436
Pinwheel, Wartenberg, Merit.....	116
Pinwheel, Disposable.....	463
Piper-Laufe Obstetrical Forceps.....	196
Pitcher/Beaker.....	439
PK Thomas Wax Placer.....	418
Placenta Curette, Lounsbury.....	178
Placenta Forceps, Javerts.....	197
Placenta Forceps, Kelly.....	197
Plaster Knife, Murphy.....	403
Plaster Saw, Oscillating.....	403
Plaster Shears, Bruns.....	406
Plaster Shears, Esmarch.....	32,406
Plaster Shears, Seutin.....	406
Plaster Spreader, Hennig.....	403
Plaster Spreader, Walton.....	403
Plastic Dressing Forceps.....	122
Plastic Dressing Forceps, Sterile.....	123
Plastic Hemostat.....	122
Plastic Hemostat, Sterile.....	123

Plastic Instruments

Plastic Littauer Suture Scissors.....	122
Plastic Littauer Suture Scissors, Sterile.....	123
Plastic Nose Clip.....	122
Plastic Nose Clip, Sterile.....	123
Plastic Rulers, Sterile.....	140
Plastic Sponge Forceps.....	122
Plastic Sponge Forceps, Sterile.....	123
Plastic Surgical Prep Razor.....	122
Plastic Surgical Prep Razor, Sterile.....	123
Plastic Towel Clamp.....	122
Plastic Towel Clamp, Sterile.....	123
Plastic Tubing Clamp.....	122
Plastic Tubing Clamp, Sterile.....	123
Plastic Utility Forceps.....	122
Plastic Utility Forceps, Sterile.....	123
Plastic Yankauer Suction Tube.....	75
Plastic Surgery Retractor.....	73,295,368
Plastic Surgery Scissors.....	304,352
Plastic Surgery Scissors, Sklarcut, Premium.....	310
Plastic Surgery Scissors, Sklarhone, Premium.....	93
Plate Bending Forceps.....	401
Platypus Nail Pulling Forceps.....	384

Pliers, Orthodontic

Plier, Adams.....	424
Plier, Adjusting.....	423,426
Plier, Arch Forming.....	424
Plier, Baade Crown.....	416
Plier, Band Crimping.....	426
Plier, Band Removing.....	426
Plier, Bayonet Bending.....	424
Plier, Bending.....	425
Plier, Bernard Facebow.....	426
Plier, Clasp Adjusting.....	416
Plier, College.....	415
Plier, College, Non-pinch.....	415
Plier, College, Self-locking.....	415
Plier, Double Action, Parallel.....	401
Plier, Flat Nose.....	402
Plier, Forming.....	426
Plier, Forming & Closing.....	423
Plier, Gordon.....	416
Plier, Goslee Contouring.....	416
Plier, How.....	416
Plier, How-Style 110.....	425
Plier, Jarabak.....	426
Plier, Ligature Forming.....	423
Plier, Loop Forming.....	423,424
Plier, Loop Tie Back.....	424

Plier, Mathieu.....	425
Plier, Meriam.....	415
Plier, Optical.....	424
Plier, Perry.....	415
Plier, Removing.....	425,426
Plier, Retainer Forming.....	423,425
Plier, Step Bending.....	424
Plier, Stop.....	423
Plier, Three Jaw Offset.....	426
Plier, Torquing.....	425
Plier, Weingart Utility.....	425
Plier, Wire Bending.....	416
Plier, Wire Forming.....	423

Plugger, Black.....	412
Plugger, Marquette Black.....	417
Pocket Gauge, Hand-held.....	438
Podiatry.....	380-391
Polish, Sklar Instrument.....	481,487
Politzer Tympanum Perforator.....	266
Polokoff Rasp.....	389
Polyp Forceps, Laufe Uterine, Laser.....	163,217
Polyp Forceps, Laufe Uterine, Sklar Blue.....	163,207
Pomeroy Ear Syringe.....	268
Postauricular Retractor, Schuknecht.....	291
Potts-Smith Dressing Forceps, T-C Premium.....	98
Potts-Smith Forceps.....	56
Potts-Smith Forceps, Laser.....	216,251,379
Potts-Smith Forceps, Sklar Blue.....	206
Potts-Smith Vascular Scissors.....	350
Pouches, Sklar Sterile.....	443,476
Pratt Crypt Hook.....	250
Pratt Forceps.....	46
Pratt Rectal Speculum.....	247
Pratt T-shaped Clamp.....	257
Pratt Uterine Dilator.....	175
Precision Scissors, Sklar.....	27
Precision Scissors, Sklarlite, Premium.....	27,80

Sklar Premium™ Instruments

PREMIUM DELICATE

Premium Delicate, Adson Forceps.....	52,53
Premium Delicate, Adson-Brown Forceps.....	54
Premium Delicate, Allis Tissue Forceps.....	42,160
Premium Delicate, Crile Hemostats.....	37
Premium Delicate, Cushing Brain Forceps.....	57
Premium Delicate, Dressing Forceps.....	50
Premium Delicate, Halsted Mosquito Hemostats.....	36
Premium Delicate, Hartmann Mosquito Hemostats.....	39
Premium Delicate, Iris Scissors.....	20
Premium Delicate, Kelly Hemostats.....	38
Premium Delicate, Lister Bandage Scissors.....	30



**OR Quality
Instruments**



**OR Premium™
Instruments**



Mid-Grade Instruments

Premium Delicate, Littauer Stitch Scissors.....25
 Premium Delicate, Mayo Dissecting Scissors14
 Premium Delicate, Metzenbaum Lahey Scissors16
 Premium Delicate, Metzenbaum Scissors.....18
 Premium Delicate, Operating Scissors.....10,12
 Premium Delicate, Rochester-Ochsner Forceps40
 Premium Delicate, Rochester-Pean Forceps41

SKLAR EDGE
TUNGSTEN CARBIDE

Premium Sklar Edge T-C Dissecting Scissors92
 Premium Sklar Edge T-C Iris Scissors21,91
 Premium Sklar Edge T-C Mayo Scissors15,91
 Premium Sklar Edge T-C Mayo-Stille Scissors92
 Premium Sklar Edge T-C Metzenbaum Scissors19,91
 Premium Sklar Edge T-C Metz-Lahey Scissors17,91
 Premium Sklar Edge T-C Operating Scissors11,13,91
 Premium Sklar Edge T-C Strabismus Scissors22,92
 Premium Sklar Edge T-C Wire Cutting Scissors.....29,92,405

SKLAR LITEGRIP™

Premium Sklar Litegrip Adson Forceps.....55
 Premium Sklar Litegrip Adson-Brown Forceps.....55
 Premium Sklar Litegrip T-C Adson-Brown Forcep55

SKLAR CUT
SERRATED BLADE

Premium Sklarcut Scissors, Castanares Face Lift311
 Premium Sklarcut Scissors, Cottle Dorsal.....310
 Premium Sklarcut Scissors, Fomon Lateral310
 Premium Sklarcut Scissors, Goldman-Fox.....311
 Premium Sklarcut Scissors, Gorney Face Lift.....311
 Premium Sklarcut Scissors, Gorney Plastic Surgery...311
 Premium Sklarcut Scissors, Iris.....21,89
 Premium Sklarcut Scissors, Kaye Face Lift.....311
 Premium Sklarcut Scissors, Kelly, Delicate.....311
 Premium Sklarcut Scissors, Mayo Dissecting15,88
 Premium Sklarcut Scissors, Metzenbaum Lahey17,89
 Premium Sklarcut Scissors, Metzenbaum.....19,89
 Premium Sklarcut Scissors, Operating.....11,13,88
 Premium Sklarcut Scissors, Plastic Surgery310
 Premium Sklarcut Scissors, Ragnell Dissecting.....90
 Premium Sklarcut Scissors, Rhytidectomy.....311
 Premium Sklarcut Scissors, Wagner.....90

SKLARHONE
MICRO - CUT

Premium Sklarhone Scissors, Iris.....21,93
 Premium Sklarhone Scissors, Jameson.....93
 Premium Sklarhone Scissors, Mayo Dissecting.....15,93
 Premium Sklarhone Scissors, Metzenbaum Lahey...17,93
 Premium Sklarhone Scissors, Metzenbaum.....19,93

Premium Sklarhone Scissors, Operating.....11,13,93
 Premium Sklarhone Scissors, Plastic Surgery.....93

SKLARLITE
THE LIGHT TOUCH

Premium Sklarlite Adson Forceps52,53,84
 Premium Sklarlite Adson-Brown Forceps.....54,85
 Premium Sklarlite Allis Tissue Forceps42,83,160
 Premium Sklarlite Baumgartner Needle Holder.....66,87
 Premium Sklarlite Crile Hemostats.....37,81
 Premium Sklarlite Crile-Wood Needle Holder67,87
 Premium Sklarlite Derf Needle Holder.....63,86
 Premium Sklarlite Dressing Forceps50,84
 Premium Sklarlite Halsey Needle Holder65,86
 Premium Sklarlite Halsted Mosquito Hemostats36,81
 Premium Sklarlite Hartmann Mosquito Hemostats.....39,82
 Premium Sklarlite Iris Scissors20,78
 Premium Sklarlite Kelly Hemostats38,81
 Premium Sklarlite Lister Bandage Scissors.....30,79
 Premium Sklarlite Littauer Stitch Scissors.....25,380
 Premium Sklarlite Mayo Dissecting Scissors14,77
 Premium Sklarlite Mayo-Hegar Needle Holder.....64,86
 Premium Sklarlite Metzenbaum Lahey Scissors16,77
 Premium Sklarlite Metzenbaum Scissors.....18
 Premium Sklarlite Mixer Forceps.....83
 Premium Sklarlite Nail Splitting Forceps385
 Premium Sklarlite Olsen-Hegar Needle Holder68,87
 Premium Sklarlite Operating Scissors10,12,76
 Premium Sklarlite Precision Scissors.....27,80
 Premium Sklarlite Rochester-Ochsner Forceps40,82
 Premium Sklarlite Rochester-Pean Forceps41,82
 Premium Sklarlite Spencer Stitch Scissors24,80
 Premium Sklarlite Stevens Tenotomy Scissors...23,79,354
 Premium Sklarlite Strabismus Scissors.....22,79,355
 Premium Sklarlite Suture Scissors26,80
 Premium Sklarlite Tissue Forceps.....51,84
 Premium Sklarlite Tissue Nipper384
 Premium Sklarlite Webster Needle Holder62,86
 Premium Sklarlite Sklarcut Iris Scissors21,78,89
 Premium Sklarlite Sklarcut Mayo Scissors.....15
 Premium Sklarlite Sklarcut Metz-Lahey Scissor.....17
 Premium Sklarlite Sklarcut Metzenbaum Scissor.....19
 Premium Sklarlite Sklarcut Operating Scissors11,13,76,88
 Premium Sklarlite Sklarcut Wagner Scissors80,90

SKLARLITE XD
EXTRA ▼ DELICATE

Premium Sklarlite XD Adson Forceps52,53,84,85
 Premium Sklarlite XD Adson-Brown Forceps.....54,85
 Premium Sklarlite XD Allis Tissue Forceps42,83,160
 Premium Sklarlite XD Baumgartner Needle Holder.....66
 Premium Sklarlite XD Crile Hemostats.....37,81

Premium Sklarlite XD Crile-Wood Needle Holder67,87
 Premium Sklarlite XD Derf Needle Holder.....63,86
 Premium Sklarlite XD Dressing Forceps50,84
 Premium Sklarlite XD Halsey Needle Holder65,86
 Premium Sklarlite XD Halsted Mosquito Forceps.....36,81
 Premium Sklarlite XD Hartmann Hemostats39,82

Premium Sklarlite XD Iris Scissors20,78
 Premium Sklarlite XD Kelly Hemostats38,81
 Premium Sklarlite XD Lister Bandage Scissors.....30,79
 Premium Sklarlite XD Littauer Stitch Scissors.....25
 Premium Sklarlite XD Mayo Dissecting Scissors14,77
 Premium Sklarlite XD Mayo-Hegar Needle Holder...64,86
 Premium Sklarlite XD Metz-Lahey Scissors.....16,77
 Premium Sklarlite XD Metzenbaum Scissors18
 Premium Sklarlite XD Mixer Forceps.....83
 Premium Sklarlite XD Olsen-Hegar Needle Holder...68,87
 Premium Sklarlite XD Operating Scissors.....10,12,76
 Premium Sklarlite XD Precision Scissors.....27,80
 Premium Sklarlite XD Rochester-Ochsner Forcep.....40
 Premium Sklarlite XD Rochester-Pean Forceps41,82
 Premium Sklarlite XD Spencer Stitch Scissors24,80
 Premium Sklarlite XD Stevens Tenotomy Scissor23,79,354
 Premium Sklarlite XD Strabismus Scissors.....22,79,355
 Premium Sklarlite XD Suture Scissors26,80
 Premium Sklarlite XD Tissue Forceps.....51,84
 Premium Sklarlite XD Webster Needle Holder62,86

SKLAR T-C
TUNGSTEN CARBIDE

Premium T-C Adson Forceps55,99
 Premium T-C Adson-Brown Forceps.....55,99
 Premium T-C Allis Forceps.....42,98
 Premium T-C Babcock Forceps43,98,166
 Premium T-C Baumgartner Needle Holder66,94
 Premium T-C Bozeman-Heaney Needle Holder97,194
 Premium T-C Castroviejo Needle Holder68,343,350
 Premium T-C Crile-Murray Needle Holder67,94
 Premium T-C Crile-Wood Needle Holder67,69,94
 Premium T-C Debaque Atraumatic Forceps.....98,170
 Premium T-C Derf Needle Holder63,94
 Premium T-C Dressing Forceps50,99
 Premium T-C Finochietto Needle Holder.....96,192
 Premium T-C Halsey Needle Holder65,94
 Premium T-C Heaney Needle Holder.....96,193
 Premium T-C Jacobson Needle Holder.....342
 Premium T-C Luethy Beck Needle Holder97,194
 Premium T-C Maltz Rasp390
 Premium T-C Mathieu Needle Holder97,194
 Premium T-C Mayo-Hegar Needle Holder ...64,69,95,191
 Premium T-C Nevert Needle Holder.....97
 Premium T-C New Orleans Needle Holder95
 Premium T-C Olsen-Hegar Needle Holder68,95,192

Premium T-C Pin Cutter401
 Premium T-C Potts-Smith Dressing Forceps98
 Premium T-C Ryder Needle Holder.....95
 Premium T-C Sarot Needle Holder.....96
 Premium T-C Stratte Needle Holder.....96,193
 Premium T-C Webster Needle Holder62,94,190
 Premium T-C Wire Puller.....402

Prep Pad, Alcohol.....444,445,446,447
 Prep Razor, Surgical, Plastic.....122
 Prep Razor, Surgical, Plastic, Sterile.....123
 Presbyterian Tube Occluding Clamp, Merit.....112
 Prince Muscle Forceps296,337
 Probe and Excavator.....387
 Probe and Excavator, Merit.....115
 Probe and Packer.....386
 Probe and Spatula.....387
 Probe, Barr Fistula.....250
 Probe/Dilator, Bowman Lachrymal.....329
 Probe/Dilator, Williams Lachrymal.....329
 Probes, French Pattern Lacrimal.....267

Procedure Trays, Surgical Disposable124-137
 Procedure Trays, Plastic443
 Prostatic Retractor, Young257
 Protection/Identification Of Instruments472-475
 Protectors, Instrument, Sklartip, Non-vented.....473
 Protectors, Instrument, Sklartip, Vented.....472
 Providence Hospital Forceps.....46
 Pryor-Pean Vaginal Retractor.....153
 PTCA Sidepack W/ Econo Instruments.....137
 Ptosis Forceps, Berke296,334
 Punch, Disposable Dermal Biopsy377,461
 Punch, Disposable Vulvar Biopsy.....241
 Punch, Gaylor Biopsy.....185
 Punch, Gelhorn Biopsy.....185
 Punch, Keyes Biopsy.....174
 Punch, Keyes Cutaneous.....375
 Punch, Rubber Dam.....416
 Punch, Vulvar/Dermal, Keyes.....174
 Punch, Yeoman Rectal Biopsy249
 Put Ups, Sterile140-141

Q

Quimby Gum Scissors304
 Quire Foreign Body Instrument.....266

R

Rabiner Neurological Hammer436
 Ragnell Dissecting Scissors302,352
 Ragnell Dissecting Scissors, Sklarcut Premium.....90
 Ragnell Retractor.....73,295,367
 Randall Endometrial Curette176

Rankin Hemostats45
 Rasp #10, Bone.....389
 Rasp and File, Fomon280,390
 Rasp, Cottle.....280,390
 Rasp, Joseph.....280,390
 Rasp, Lewis Nasal.....279
 Rasp, Maltz.....280,390
 Rasp, Polokoff389
 Rasp, T-C Maltz.....280,390
 Rasp, Aufrecht Glabellar.....279,280
 Razor, Surgical Prep, Plastic.....122
 Razor, Surgical Prep, Plastic, Sterile.....123
 Rectal Biopsy Punch, Yeoman.....249

Rectal Instruments.....243-252
 Rectal Probe, Larry.....250
 Rectal Retractor, Sawyer.....247
 Rectal Scissors, Miller250
 Rectal Snare, Weston.....248
 Rectal Speculum, Barr.....247
 Rectal Speculum, Bodenhammer Sims.....247
 Rectal Speculum, Ives.....243
 Rectal Speculum, Pratt.....247
 Rectal Speculum, Sims247
 Reeh Stitch Scissors308
 Rein Oval Curette.....373
 Rein Round Curette.....373
 Removing Plier425,426
 Retainer Forming Plier.....423,425

Retractors

Retractor, Adson Beckman.....71
 Retractor, Alm.....70,290,365,404
 Retractor, Alm, Merit.....113
 Retractor, Aufrecht.....272,290
 Retractor, Beckman-Eaton291
 Retractor, Blair Rollet366
 Retractor, Blount Double Prong.....397
 Retractor, Blount Single Prong.....397
 Retractor, Brantley-Turner, Vaginal.....153
 Retractor, Cheek284,415
 Retractor, Columbia Lip.....284
 Retractor, Colver Tonsil Examining.....283
 Retractor, Converse Alar292
 Retractor, Converse Blade.....293
 Retractor, Cottle292
 Retractor, Crile73
 Retractor, Cushing Decompression.....284
 Retractor, Cushing Nerve/Vein.....284
 Retractor, Delee153
 Retractor, Dermal366
 Retractor, Desmarres Lid73,294,325,369
 Retractor, Desmarres Lid, Laser325
 Retractor, Doyen153
 Retractor, Farabeuf73

Retractor, Fomon.....292,295,366
 Retractor, Gelpi71
 Retractor, Gelpi, Merit113
 Retractor, Goelet283
 Retractor, Goldstein.....70,290,324,365
 Retractor, Henly Vascular Surgery71
 Retractor, Holzheimer Cross-action70,290,365,404
 Retractor, Inge Lamina.....396,404
 Retractor, Jackson, Vaginal.....152,217
 Retractor, Jaeger Lid.....325
 Retractor, Jansen71
 Retractor, Lahey.....368
 Retractor, Laser Dermal378
 Retractor, Laser Desmarres Lid378
 Retractor, Laser Senn378
 Retractor, Lateral Vaginal, Laser.....149,212
 Retractor, Lateral Vaginal, Sklar Blue149,202
 Retractor, Lothrop Uvula284
 Retractor, Love294
 Retractor, Mathieu72,293,367
 Retractor, Mayo-Adams.....71
 Retractor, Meller Lachrymal Sac324
 Retractor, Meyerding.....74
 Retractor, Miller-Senn.....72,367
 Retractor, O'Sullivan-O'Connor, Vaginal152
 Retractor, Paparella Weitlaner291
 Retractor, Paul.....369
 Retractor, Perkins Endaural291
 Retractor, Pillar/Tonsil, Morrison-Hurd283
 Retractor, Plastic Surgery.....73,295,368
 Retractor, Pryor-Pean, Vaginal.....153
 Retractor, Ragnell.....73,295,367
 Retractor, Rigid Dermal366
 Retractor, S226
 Retractor, Sawyer Rectal.....247
 Retractor, Schuknecht Postauricular291
 Retractor, Scoville294
 Retractor, Self Retaining70,290,365
 Retractor, Self Retaining, Delicate324
 Retractor, Senn72,295,367
 Retractor, Sims Vaginal, Sklar Blue151,202
 Retractor, Sims-Kelly, Vaginal.....152
 Retractor, Sklar Lateral Vaginal.....149
 Retractor, Tracheal.....73
 Retractor, U.S. Army Pattern.....73
 Retractor, University of Minnesota Cheek.....284
 Retractor, Volkman (Ring Handle).....72
 Retractor, Volkman (USA).....72
 Retractor, Weitlaner.....70,404
 Retractor, Weitlaner, Merit.....113
 Retractor, Weitlaner-Beckman71,291
 Retractor, Wire Retaining70,290
 Retractor, Wullstein Endaural.....291
 Retractor, Young Prostatic257



**OR Quality
Instruments**



**OR Premium™
Instruments**



Mid-Grade Instruments

Retractor, Zalkind Ribbon.....	283
Reynolds Scissors.....	306
Rhoton Microsurgery Forceps.....	351
Rhytidectomy Scissors.....	302,358
Rhytidectomy Scissors, Sklarcut, Premium.....	311
Ribbon Retractor, Zalkind.....	283
Ribbon Scissors, Iris.....	308,357
Ribbon Scissors, Kaye Undermining.....	308,352
Ribbon Scissors, Stevens Tenotomy.....	28,308,357
Ribbon Scissors, Stitch.....	26,28,308,357
Ribbon Scissors, Strabismus.....	28,308,357
Ribbon Scissors, Utility.....	28,308,357
Rigid Cut Surgical Blades, Disposable.....	320,466
Rigid Dermal Retractor.....	366
Ring Cutter, Keyes Finger.....	375
Ring Cutter, Sklar Finger.....	375
Ring, Laparotomy.....	170
Roach Carver.....	418

Rochester Forceps

Rochester-Carmalt Forceps.....	45
Rochester-Ochsner Forceps, Sterile Floor-Grade.....	40
Rochester-Ochsner Forceps, Delicate, Premium.....	40
Rochester-Ochsner Forceps, Heavy Pattern.....	40
Rochester-Ochsner Forceps, Mid-Grade.....	40
Rochester-Ochsner Forceps, OR Grade.....	40
Rochester-Ochsner Forceps, Sklarlite, Premium.....	40,82
Rochester-Pean Forceps, Delicate, Premium.....	41
Rochester-Pean Forceps, Heavy Pattern.....	40
Rochester-Pean Forceps, Mid-Grade.....	41
Rochester-Pean Forceps, OR Grade.....	41
Rochester-Pean Forceps, Sklarlite, Premium.....	41,82
Rochester-Pean Forceps, Sterile, Floor-Grade.....	41
Roeder Towel Clamp.....	47
Roll Tape, ID, Sklar.....	475
Rollet Blair Retractor.....	366
Rongeur, Blumenthal.....	393,422
Rongeur, Mini Blumenthal.....	393
Rongeur, Cleveland.....	394
Rongeur, Friedman Bone.....	394
Rongeur, Lempert.....	393
Rongeur, Mead.....	394
Rongeur, Ruskin.....	394
Rongeur, Zaufel-Jansen.....	394
Rongeur, Citelli.....	278
Rongeur, Kerrison.....	278
Rosebud Sponges.....	470
Round Curette, Rein.....	373
Rowland Bone Forceps.....	393
Royce Tympanum Perforator.....	266
Rubber Bands, Sterile.....	140
Rubber Dam Punch.....	416

Rudd Clinic Ligator Set.....	243
Ruedemann Lachrymal Dilator.....	329
Ruler, Laser.....	214
Ruler, Steel.....	296,344
Ruler, Plastic.....	140
Ruskin Rongeur.....	394
Ruskin-Liston Bone Cutting Forceps.....	392,395
Russian Tissue Forceps.....	56
Ryder Needle Holder, T-C Premium.....	95

S

S-retractor.....	226
Saber Back Scissors, Fomon.....	303,357
Safety Pins, Sterile.....	140
Safety Syringe, Sklarsafe Protection.....	449
Safety Trocar.....	226
Sanitizer, Sklar Hand.....	487
Sarot Needle Holder.....	69
Sarot Needle Holder, T-C Premium.....	96
Sauer Eye Speculum.....	323
Saw, Joseph Nasal Bone.....	276
Saw, Oscillating Plaster.....	403
Sawtell Applicator.....	269
Sawtell Tonsil Forceps.....	289
Sawyer Rectal Retractor.....	247
Sayre Elevator.....	398
Scaler, Crane-Kaplan DE.....	407
Scaler, Jaquette DE.....	407
Scaler, Goldman-Fox.....	408
Scaler, Taylor DE.....	407
Scaler, Towner DE.....	407
Scaler, Universal.....	407
Scaler, Younger-Good DE.....	407
Scalp Hemostat, Dandy.....	361
Scalpel Handles, Sklar.....	319
Scalpel Handle #3, Merit.....	116
Scalpel Handle #4, Merit.....	116
Scalpels And Blades.....	319-322
Scalpels / Blades Disposable.....	465-467
Scalpels, Disposable Surgical.....	321,465
Scalpels, Sklarsafe Protective.....	467
Scalpels, Econo Disposable.....	467
Schamberg Comedone Extractor.....	376
Schink Metatarsal Spreader.....	404
Schiotz Tonometer.....	345
Schmeden Tonsil Punches.....	288
Schmidt Forceps.....	45
Schmidt Tonsil Forceps.....	289
Schroeder Tenaculum, Sterile Floor-Grade.....	158
Schroeder Tenaculum, Laser.....	158,215
Schroeder Tenaculum, Merit.....	114
Schroeder Tenaculum, Mid-Grade.....	158
Schroeder Tenaculum, OR Grade.....	158

Schroeder Tenaculum, Sklar Blue.....	158,206
Schroeder Vulsellum Forceps.....	165
Schroeder Vulsellum Forceps, Laser.....	215
Schubert-Van Doren Biopsy Punch.....	185
Schuknecht Postauricular Retractor.....	291
Schweizer Forceps.....	49,169
Schweizer Uterine Forceps, Laser.....	162,217
Schweizer Uterine Forceps, Sklar Blue.....	162,207

Scissors

Scissors, Aebli Corneal.....	332
Scissors, Angular Iris.....	305
Scissors, Angular Iris, Probe Point.....	353
Scissors, Aufricht Face Lift.....	303,357
Scissors, Bantam Bandage.....	31
Scissors, Barraquer-Dewecker Iris.....	331
Scissors, Bellucci Micro Ear.....	265
Scissors, Blepharoplasty.....	304
Scissors, Boettcher.....	358
Scissors, Boettcher Tonsil.....	307
Scissors, Bonn.....	352
Scissors, Bonn Miniature Iris.....	307
Scissors, Braun Episiotomy.....	189,198
Scissors, Brophy Sullivan.....	189,305
Scissors, Brown Dissecting.....	303
Scissors, Busch Umbilical.....	189
Scissors, Castroviejo.....	359
Scissors, Castroviejo Corneal.....	332
Scissors, Cottle Dorsal.....	301
Scissors, Cottle Nasal.....	301
Scissors, Crown & Collar Cutting.....	29,405
Scissors, Cuticle and Nail.....	385
Scissors, Dean Tonsil.....	307
Scissors, Deaver, Delicate.....	356
Scissors, Mayo-Stille.....	188
Scissors, Doyen.....	188,258
Scissors, Dura, Semi-Sharp.....	304,356
Scissors, Ellen's Utility.....	33
Scissors, Enterotome.....	258
Scissors, Enucleation.....	304
Scissors, Fine Stitch.....	331,358
Scissors, Fomon.....	358
Scissors, Fomon Nasal.....	303
Scissors, Fomon Saber Back.....	303,357
Scissors, Gauze, USA Pattern.....	32
Scissors, Gibbs-Gradle.....	353
Scissors, Goldman-Fox.....	304,306,353
Scissors, Gradle.....	332,353
Scissors, Halle Nasal.....	301
Scissors, Heath.....	304
Scissors, Heavy Duty Emergency.....	33
Scissors, Hercules Utility.....	32,406
Scissors, Heyman Nasal.....	301
Scissors, Hill.....	306,352

Iris

Scissors, Iris, Micro-Miniature330
 Scissors, Iris, Delicate, Premium.....20
 Scissors, Iris, Econo, Floor-Grade.....142
 Scissors, Iris, Merit111
 Scissors, Iris, Mid-Grade20
 Scissors, Iris, OR Grade.....20
 Scissors, Iris, Sklar Edge T-C, Premium21,91
 Scissors, Iris, Sklarcut, Premium.....21,89
 Scissors, Iris, Sklarhone, Premium.....21,93
 Scissors, Iris, Sklarlite, Premium.....20,78
 Scissors, Iris, Sklarlite, Sklarcut, Premium21,78,89
 Scissors, Iris, Sterile, Floor-Grade.....20

 Scissors, Jacobson Spring Handle.....360
 Scissors, Jameson, Sklarhone, Premium.....93
 Scissors, Joseph302,356,357
 Scissors, Kahn.....302
 Scissors, Kaye Undermining Ribbon.....308,352
 Scissors, Kelly-Adson.....188,258,356
 Scissors, Knapp Iris.....305,352
 Scissors, Knight Nasal.....301
 Scissors, Knowles Bandage Sterile Floor-Grade31
 Scissors, Knowles Bandage, Mid-Grade.....31
 Scissors, Knowles Bandage, OR Grade.....31
 Scissors, Lilly.....302

Lister

Scissors, Lister Bandage, Delicate, Premium30
 Scissors, Lister Bandage, Econo, Floor-Grade142
 Scissors, Lister Bandage, Large Ring31
 Scissors, Lister Bandage, Merit.....111
 Scissors, Lister Bandage, Mid-Grade.....30
 Scissors, Lister Bandage, OR Grade30
 Scissors, Lister Bandage, Sklarlite, Premium.....30,79
 Scissors, Lister Bandage, Sterile Floor-Grade30

Littauer

Scissors, Littauer Stitch, Sterile Floor-Grade25
 Scissors, Littauer Stitch, Delicate, Premium.....25
 Scissors, Littauer Stitch, Mid-Grade25
 Scissors, Littauer Stitch, OR Grade.....25
 Scissors, Littauer Stitch, Sklarlite, Premium.....25
 Scissors, Littauer Suture, Plastic.....122
 Scissors, Littauer Suture, Plastic, Sterile.....123

Scissors, Littler Suture Carrying.....306
 Scissors, Long Stitch302
 Scissors, Martin306
 Scissors, Material/Bandage, Moleskin.....32

Mayo

Scissors, Mayo, Sterile Floor-Grade.....14

Scissors, Mayo, Delicate, Premium.....14
 Scissors, Mayo, Merit111
 Scissors, Mayo, Mid-Grade14
 Scissors, Mayo, OR Grade.....14,188
 Scissors, Mayo, Sklarcut, Premium.....15,88
 Scissors, Mayo, Sklarhone, Premium.....15,93
 Scissors, Mayo, Sklarlite, Premium14,77
 Scissors, Mayo, Sklar Edge T-C, Premium15
 Scissors, Mayo, Sklarlite, Sklarcut, Premium15

 Scissors, McClure Iris.....331
 Scissors, McClure Spring Handle.....359
 Scissors, McGuire Corneal.....332
 Scissors, McPherson-Vannas300,309,331,360

Metzenbaum

Scissors, Metzenbaum Lahey, Delicate, Premium.....16
 Scissors, Metzenbaum Lahey, Mid-Grade16
 Scissors, Metzenbaum Lahey, OR Grade16
 Scissors, Metzenbaum Lahey, Sklarcut, Premium...17,89
 Scissors, Metzenbaum Lahey, Sklarhone Premium..17,93
 Scissors, Metzenbaum Lahey, Sklarlite Premium77
 Scissors, Metzenbaum, Mid-Grade18
 Scissors, Metzenbaum, OR Grade.....18
 Scissors, Metzenbaum, Delicate, Premium.....18
 Scissors, Metzenbaum, Merit111
 Scissors, Metzenbaum, Sklar Edge T-C, Premium19
 Scissors, Metzenbaum, Sklarcut, Premium.....19
 Scissors, Metzenbaum, Sklarhone, Premium.....19
 Scissors, Metzenbaum, Sklarlite, Premium18
 Scissors, Metzenbaum, Sterile, Floor-Grade.....18

Scissors, Micro Surgery.....300,309,348,351,360
 Scissors, Miller Rectal250
 Scissors, Moleskin.....385,405

Utility

Scissors, Multi-Cut Utility, Merit.....116
 Scissors, Multi-Cut Utility, Mid-Grade.....33
 Scissors, Multi-Cut Utility, OR Grade33

Scissors, Nail Splitting.....385
 Scissors, New's Suture.....303
 Scissors, Nurses' Bandage32
 Scissors, O'Brien Stitch.....307,358

Operating

Scissors, Operating, Delicate, Premium.....10,12
 Scissors, Operating, Econo, Floor-Grade.....142
 Scissors, Operating, Merit111
 Scissors, Operating, Mid-Grade10,12
 Scissors, Operating, OR Grade.....10,12
 Scissors, Operating, Sklar Edge T-C, Premium...11,13,91
 Scissors, Operating, Sklarcut, Premium.....11,13,88

Scissors, Operating, Sklarhone, Premium.....11,13,93
 Scissors, Operating, Sklarlite, Premium10,12,76
 Scissors, Operating, Sterile, Floor-Grade.....10,12

Scissors, Plastic Surgery.....304,352
 Scissors, Plastic Surgery, Sklarhone, Premium93
 Scissors, Potts-Smith Vascular350
 Scissors, Precision, Sklarlite, Premium27,80
 Scissors, Quimby Gum.....304
 Scissors, Ragnell Dissecting302,353
 Scissors, Ragnell Dissecting Sklarcut Premium.....90
 Scissors, Reeh Stitch308
 Scissors, Reynolds306
 Scissors, Rhytidectomy302,358
 Scissors, Ribbon Iris.....308,357
 Scissors, Ribbon Stitch.....28,308,357
 Scissors, Ribbon Stitch, OR Grade26
 Scissors, Ribbon Strabismus.....28,308,357
 Scissors, Ribbon Utility.....28,308,357
 Scissors, Sealy Dissecting303,353
 Scissors, Seiler Turbinate.....301
 Scissors, Sims189,258
 Scissors, Sklar Angular305,353
 Scissors, Sklar Hi Level Bandage31
 Scissors, Sklar Precision27
 Scissors, Sklar Stitch, OR Grade26
 Scissors, Sklarcut Cottle Dorsal, Premium.....310
 Scissors, Sklarcut Fomon Lateral, Premium310
 Scissors, Sklarcut Goldman-Fox, Premium.....311
 Scissors, Sklarcut Gorney Face Lift, Premium.....311
 Scissors, Sklarcut Kaye Face Lift, Premium.....311
 Scissors, Sklarcut Plastic Surgery, Premium310
 Scissors, Sklarcut Rhytidectomy, Premium.....311
 Scissors, Spencer Stitch, Delicate, Premium24
 Scissors, Spencer Stitch, Merit.....116
 Scissors, Spencer Stitch, Mid-Grade.....24
 Scissors, Spencer Stitch, OR Grade24
 Scissors, Spencer Stitch, Sklarlite, Premium24,80
 Scissors, Spencer Stitch, Sterile Floor-Grade24

Stevens/Strabismus

Scissors, Stevens Tenotomy, Delicate, Premium.....23
 Scissors, Stevens Tenotomy, OR Grade.....23,354
 Scissors, Stevens Tenotomy, Sklarlite Premium.....23,79
 Scissors, Stevens Tenotomy, Ribbon.....28,308,357
 Scissors, Strabismus, Delicate, Premium.....22
 Scissors, Strabismus, Mid-Grade22
 Scissors, Strabismus, OR Grade.....22,355
 Scissors, Strabismus, Sklar Edge T-C, Premium.....22,92
 Scissors, Strabismus, Sklarlite, Premium.....22,79
 Scissors, Strabismus, Sterile, Floor-Grade22

 Scissors, Suture Wire Cutting.....29,405
 Scissors, Suture, Delicate, Premium26



**OR Quality
Instruments**



**OR Premium™
Instruments**



Mid-Grade Instruments

Scissors, Suture, OR Grade	26
Scissors, Suture, Sklarlite, Premium	26,80
Scissors, Taylor Dural	305
Scissors, U.S. Army Pattern Gauze	385,405
Scissors, Umbilical	189,198
Scissors, Vannas	331,360
Scissors, Wagner	303,356
Scissors, Wagner, Sklarcut, Premium	90
Scissors, Westcott Tenotomy	300,309,330,359
Scissors, Wilmer	305,353

Wire

Scissors, Wire Cutting Sklar Edge T-C Premium	29,92
Scissors, Wire Cutting, Merit	116
Scissors, Wire Cutting, Mid-Grade	29
Scissors, Wire Cutting, OR Grade	29
Scissors, Wire Cutting, Sterile, Floor-Grade	29

Scissors, Wullstein Ear	265
Scleral Hook, Weiner	328,368
Scoop, Knapp Lens	327
Scoville Retractor	294
Sealy Dissecting Scissors	303,353
Sedillot Periosteal Elevator	399
Segond Collin Forceps	164
Segond Vaginal Spatula	153
Seiler Turbinate Scissors	301
Seizing Forceps, Craig Tonsil	289
Seizing Forceps, Tivnen Tonsil	289
Seizing Forceps, Tyding Tonsil	289
Seldin Elevator	399,422
Semkin Dressing/Tissue Forceps	56
Senn Retractor	72,295,367
Senn-Miller Retractor	367
Septum Chisels, Hajek	279
Septum Elevator, Freer	274
Septum Elevator, Hajek-Ballenger	274
Septum Elevator, McKenty	275
Septum Forceps, Heymann	273
Septum Forceps, Jansen-Middleton	276
Septum Forceps, Knight	272
Septum Knife, Freer	274
Septum Straightening Forceps, Asch	276
Septum Straightening Forceps, Walsham	276
Sesamoid Clamp	396
Seutin Plaster Shears	406
Sexton Gerzog Ear Knife	266
Shapleigh Ear Curettes	261
Sharps Containers, Sklar	450
Shave Prep Tray	133
Shea Speculum Holder	260
Shears, Bruns Plaster	406
Shears, Commander Utility	32,406
Shears, Esmarch Plaster	32,406

Shears, Heavy Duty Emergency	406
Shears, Seutin Plaster	406
Sheet Holder, Bethea	198
Shield, Eye, Disposable	463
Shield, Fox Aluminum Eye	344
Silicone Loops	462
Silver Osteotome	277
Simcoe Irrigating/Aspirating Cannula	341
Simcoe Nucleus Delivery Cannula	341
Simpson Obstetrical Forceps	195
Simpson Uterine Sound, Malleable	173
Simpson Uterine Sound, Merit	114
Simpson-Luikhart Obstetrical Forceps	195
Sims Bodenhammer Rectal Speculum	247
Sims-Kelly Vaginal Retractor	152
Sims Rectal Speculum	247
Sims Retractor, Sklar Blue	151,202
Sims Scissors	189,258
Sims Uterine Curettes	178
Sims Uterine Sound, Malleable	173
Sims Uterine Sound, Disposable	239
Sims Vaginal Retractor	151
Singley/Tuttle Forceps	57
Singley/Tuttle Forceps, Laser	216
Singley/Tuttle Forceps, Sklar Blue	207
Skeele Chalazion Curette	333,372
Skene Uterine Curette	177
Skin Hook and Retractor, Meyerding	74,367
Skin Hook, Gillies	295,366
Skin Hook, Joseph	74,295,367
Skin Hook, Laser Gillies	378
Skin Hook, Laser Joseph	378
Skin Hook, O'Connor	368
Skin Marker	463

**Sklar Blue™
ELECTROSURGICAL**

Sklar Blue Adson Forceps	206
Sklar Blue Allis Tissue Forceps	160,207
Sklar Blue Auvard Vaginal Speculum	150,203
Sklar Blue Babcock Forceps	166,207
Sklar Blue Bozeman Forceps	157,206
Sklar Blue Clemetson Uterine Forceps	162
Sklar Blue Cusco Vaginal Speculum	149,202
Sklar Blue Dressing Forceps	206
Sklar Blue Emmett Hook, Iris	171,172,173,205
Sklar Blue Freeway Graves Speculum	147
Sklar Blue Graves Ob-View Speculum	147,201
Sklar Blue Graves Speculum	143,144,200
Sklar Blue Graves Speculum, Wide View	201
Sklar Blue Kogan Endospeculum	155,204
Sklar Blue Lateral Vaginal Retractor	149,202

Sklar Blue Laufe Uterine Polyp Forceps	163,207
Sklar Blue Pederson Speculum	145,199
Sklar Blue Potts-Smith Forceps	206
Sklar Blue Schroeder Tenaculum Forceps	158,206
Sklar Blue Schweizer Uterine Forceps	162,207
Sklar Blue Sims Retractor	151,202
Sklar Blue Steiner-Auvard Vaginal Speculum	150,203
Sklar Blue Tuttle/Singley Forceps	207

**SKLAR EDGE
TUNGSTEN CARBIDE**

Sklar Edge T-C Dissecting Scissors, Premium	92
Sklar Edge T-C Iris Scissors, Premium	21,91
Sklar Edge T-C Mayo-Stille Scissors	92
Sklar Edge T-C Metzenbaum Scissors, Premium	91
Sklar Edge T-C Metz-Lahey Scissors, Premium	17,91
Sklar Edge T-C Operating Scissors, Premium	11,13,91
Sklar Edge T-C Strabismus Scissors, Premium	22,92
Sklar Edge T-C Wire Cutting Scissors, Premium	29,92,405
Sklar Edge T-C Mayo Scissors, Premium	15,91
Sklar Edge T-C Metzenbaum Scissors, Premium	19

Sklar Kleen Detergent	480,485,486
Sklar Kleen, Low Foam Detergent	480,485
Sklar Soak, Non-Glutaraldehyde Decontaminant	478,484
Sklar-Zyme Enzymatic Detergent	479,485

**SKLARCUT
SERRATED BLADE**

Sklarcut Scissors, Castanares Face Lift, Premium	311
Sklarcut Scissors, Cottle Dorsal, Premium	310
Sklarcut Scissors, Fomon Lateral, Premium	310
Sklarcut Scissors, Goldman-Fox, Premium	311
Sklarcut Scissors, Gorney Face Lift, Premium	311
Sklarcut Scissors, Iris, Premium	21,89
Sklarcut Scissors, Iris, Sklarlite, Premium	21,78,89
Sklarcut Scissors, Kaye Face Lift, Premium	311
Sklarcut Scissors, Kelly, Delicate, Premium	311
Sklarcut Scissors, Mayo Dissecting, Premium	15,88
Sklarcut Scissors, Metz-Lahey, Sklarlite Premium	17
Sklarcut Scissors, Metzenbaum Lahey, Premium	17,89
Sklarcut Scissors, Metzenbaum Lahey, Sklarlite	77,89
Sklarcut Scissors, Metzenbaum, Sklarlite Premium	19
Sklarcut Scissors, Metzenbaum, Premium	19
Sklarcut Scissors, Operating, Premium	13,88
Sklarcut Scissors, Plastic Surgery, Premium	310
Sklarcut Scissors, Ragnell Dissecting, Premium	90
Sklarcut Scissors, Rhytidectomy, Premium	311
Sklarcut Scissors, Wagner, Sklarlite, Premium	80,90
Sklarcut Scissors, Mayo, Sklarlite, Premium	15

**SKLARHONE
MICRO - CUT**

Sklarhone Scissors, Iris, Premium	21,93
---	-------

Sklarhone Scissors, Jameson, Premium.....	93
Sklarhone Scissors, Mayo, Premium.....	15,93
Sklarhone Scissors, Metzenbaum, Premium.....	19,93
Sklarhone Scissors, Operating, Premium.....	11,13,93
Sklarhone Scissors, Plastic Surgery, Premium	93
Sklarhone Scissors, Metzenbaum Lahey, Premium..	17,93

SKLARLITE
THE LIGHT TOUCH

Sklarlite Adson Forceps, Premium	52,84
Sklarlite Adson-Brown Forceps, Premium.....	54,85
Sklarlite Allis Tissue Forceps, Premium	42,83,160
Sklarlite Baumgartner Needle Holder, Premium.....	66,87
Sklarlite Crile Hemostats, Premium.....	37,81
Sklarlite Crile-Wood Needle Holder, Premium	67,87
Sklarlite Derf Needle Holder, Premium.....	63,86
Sklarlite Dressing Forceps, Premium	50,84
Sklarlite Halsey Needle Holder, Premium	65,86
Sklarlite Halsted Mosquito Forceps, Premium.....	36,81
Sklarlite Hartmann Mosquito Hemostats Premium....	39,82
Sklarlite Iris Scissors, Premium	20,78
Sklarlite Kelly Hemostats, Premium	38,81
Sklarlite Lister Bandage Scissors, Premium.....	30,79
Sklarlite Littauer Cutting Forceps, Premium	380
Sklarlite Littauer Stitch Scissors, Premium	25
Sklarlite Mayo Scissors, Premium	14,77
Sklarlite Mayo-Hegar Needle Holder, Premium.....	64,86
Sklarlite Metzenbaum Lahey Scissors, Premium	16,77
Sklarlite Metzenbaum Scissors, Premium	18,78
Sklarlite Mixer Forceps, Premium.....	83
Sklarlite Nail Splitting Forceps, Premium	385
Sklarlite Olsen-Hegar Needle Holder, Premium.....	68,87
Sklarlite Operating Scissors, Premium	10,12,76
Sklarlite Precision Scissors, Premium	27,80
Sklarlite Rochester-Ochsner Forceps, Premium	40,82
Sklarlite Rochester-Pean Forceps, Premium	41,82
Sklarlite Stevens Tenotomy Scissors, Premium.....	23,79,354
Sklarlite Strabismus Scissors, Premium.....	22,79,355
Sklarlite Suture Scissors, Premium	26,80
Sklarlite Tissue Forceps, Premium.....	51,84
Sklarlite Webster Needle Holder, Premium	62,86
Sklarmold, Moldable Silicone Compound.....	391
Sklartip Instrument Protectors, Non-vented.....	473
Sklartip Instrument Protectors, Vented.....	472
Sklartouch Latex Surgical Gloves.....	452
Sklartouch Nitrile Surgical Gloves	452
Sklartouch Latex Exam Gloves	451
Sklartouch Nitrile Exam Gloves	451
Sklarview Lighted Stilette	431
Smith Special.....	413
Smoke Evacuation Tubing, Disposable.....	201,211
Snare Wire, Cut And Bent	285
Snare, Eves Tonsil	285

Snare, Krause Ear	267
Snare, Krause Nasal	274
Snare, Tyding Tonsil.....	285
Snare, Weston Rectal.....	248
Soap, Sklar Hypoallergenic	487
Sof-Rol™, Sterile.....	138
Soft Corn Knife	388
Solution Basin.....	439
Solution/Mixing Bowl	439
Sonnenschein Nasal Speculum.....	272

Sounds

Sound, Dittel Urethral	254
Sound, Otis/Dittel Urethral.....	254
Sound, Simpson Uterine, Malleable	173
Sound, Simpson Uterine, Merit.....	114
Sound, Sims Uterine, Malleable	173
Sound, Sklar Intra-uterine.....	239,455
Sound, Disposable	239
Sound, Van Buren Urethral	253
Spatula	387
Spatula and Hook, McReynolds	328
Spatula and Packer	386
Spatula and Probe.....	387
Spatula, Castroviejo Cycloclodialysis.....	328
Spatula, Cement.....	419
Spatula, Green	327
Spatula, Gritman Wax	419
Spatula, Segond, Vaginal	153
Spatula, Tauber, Vaginal.....	153
Spatula, Wax	419
Special, Smith.....	413
Specialist™, Sterile	138
Specialty Blades.....	322
Specialty Blades Handle.....	322

Speculum

Speculum Holder, Shea.....	260
Speculum, Auvard Vaginal, Laser	150,212
Speculum, Auvard Vaginal, Sklar Blue.....	150,203
Speculum, Auvard Vaginal, Weighted.....	150
Speculum, Barr Rectal.....	247
Speculum, Barraquer Wire	323
Speculum, Beckman Nasal	272
Speculum, Berling-Auvard Weighted, Vaginal.....	151
Speculum, Bodenhammer Sims Rectal.....	247
Speculum, Boucheron Ear.....	260
Speculum, Brinckerhoff	246
Speculum, Castroviejo.....	324
Speculum, Chelsea Eaton Anal.....	246
Speculum, Collin Vaginal.....	148
Speculum, Collin Vaginal, Laser.....	148,212
Speculum, Cook Eye	323

Speculum, Cottle Nasal	271
Speculum, Cusco Vaginal	149
Speculum, Cusco Vaginal, Non-sterile, Plastic.....	149,234,453
Speculum, Cusco Vaginal, Sterile, Plastic.....	149,234,453
Speculum, Cusco Vaginal, Sklar Blue	149,202
Speculum, Freeway Graves	147,48
Speculum, Freeway Graves, Laser	147,211
Speculum, Freeway Graves, Sklar Blue.....	147,201
Speculum, Garrigue Weighted, Vaginal	151
Speculum, Gerzog Nasal.....	272
Speculum, Graves Ob-View	147
Speculum, Graves Ob-View, Sklar Blue.....	147,201
Speculum, Graves Wide View	147,201
Speculum, Graves Wide View, Sklar Blue.....	147,201
Speculum, Graves, Laser	143,210
Speculum, Graves, Merit.....	114
Speculum, Graves, Mid-Grade	143
Speculum, Graves, OR Grade.....	143
Speculum, Graves, Sklar Blue.....	143
Speculum, Graves, Sterile, Plastic	143
Speculum, Graves, Non-sterile, Plastic.....	143,234,453
Speculum, Gruber Ear.....	260
Speculum, Halle Nasal	271
Speculum, Henrotin Weighted, Vaginal.....	151
Speculum, Hinkle-James.....	246
Speculum, Ives Rectal.....	243,244
Speculum, Killian Nasal.....	271
Speculum, Kogan Endocervical.....	154
Speculum, Kratz-Barraquer Wire Eye	323
Speculum, Lancaster Eye.....	324
Speculum, Mellinger Eye.....	323
Speculum, Nasal, Disposable.....	271,463
Speculum, Pederson, Laser	145,210
Speculum, Pederson, Merit	114
Speculum, Pederson, Mid-Grade	145
Speculum, Pederson, OR Grade.....	145
Speculum, Pederson, Sklar Blue.....	145,199
Speculum, Plain Wire	323
Speculum, Pratt Rectal.....	247
Speculum, Sauer Eye.....	323
Speculum, Sims Rectal	247
Speculum, Sonnenschein Nasal.....	272
Speculum, Steiner-Auvard, Vaginal, Laser.....	150,212
Speculum, Thudichum Nasal.....	272
Speculum, Tieck-Halle Nasal	271
Speculum, Toynbee Ear.....	260
Speculum, Vaginal, De Vilbiss.....	148
Speculum, Vienna Nasal	271
Speculum, Vienna Nasal, Merit.....	114
Speculum, Weeks Eye	324
Speculum, Williams	324
Spencer Chalazion Forceps	334
Spencer Ear Probe, Buck	267

Stitch Scissors, Ribbon.....	28,308,357
Stitch Scissors, Ribbon, OR Grade.....	26
Stitch Scissors, Spencer, Delicate, Premium.....	24
Stitch Scissors, Spencer, Merit.....	116
Stitch Scissors, Spencer, Mid-Grade.....	24
Stitch Scissors, Spencer, OR Grade.....	24
Stitch Scissors, Spencer, Sklarlite, Premium.....	24,80
Stitch Scissors, Spencer, Sterile Floor-Grade.....	24
Stockman Zipser Penis Clamp.....	256
Stop Plier.....	423
Storage Container.....	439
Strabismus Hook, Graefe.....	328
Strabismus Hook, Jamison.....	328
Strabismus Scissors.....	22,355
Strabismus Scissors, Delicate, Premium.....	22,355
Strabismus Scissors, Mid-Grade.....	22
Strabismus Scissors, OR Grade.....	22
Strabismus Scissors, Ribbon.....	28,308,357
Strabismus Scissors, Sklar Edge T-C, Premium.....	22,92
Strabismus Scissors, Sklarlite, Premium.....	22,79,355
Strabismus Scissors, Sterile, Floor-Grade.....	22
Strabismus Scissors, T-C, Surgi OR.....	102
Stratte Needle Holder, OR Grade.....	193
Stratte Needle Holder, T-C Premium.....	96,193
Strauss Penis Clamp.....	256
Strips, Indicator.....	476
Struempel Ear Forceps.....	263
Struycken Cutting Forceps.....	273
Suction Tube, Adson.....	267
Suction Tube, Baron.....	75
Suction Tube, Buie.....	249
Suction Tube, Ear.....	294
Suction Tube, Frazier.....	75
Suction Tube, Plastic Yankauer.....	75
Suction Tube, Sterile Yankauer, Floor-Grade.....	75
Suction Tube, Yankauer.....	75



Mid-Grade Instruments

Surgi OR Adson Forceps.....	105
Surgi OR Allis Tissue Forceps.....	108
Surgi OR Babcock Forceps.....	108
Surgi OR Backhaus Towel Clamp.....	106
Surgi OR Baumgartner Needle Holder.....	104
Surgi OR Bozeman Uterine Dressing Forceps.....	109
Surgi OR Crile Hemostats.....	106
Surgi OR Derf Needle Holder.....	104
Surgi OR Dressing Forceps.....	105
Surgi OR Foerster Sponge Forceps.....	106
Surgi OR Graves Vaginal Speculum.....	109
Surgi OR Halsey Needle Holder.....	104

Surgi OR Hartmann Hemostats.....	107
Surgi OR Iris Scissors.....	102
Surgi OR Kelly Hemostats.....	107
Surgi OR Knowles Bandage Scissors.....	103
Surgi OR Lister Bandage Scissors.....	101
Surgi OR Littauer Stitch Scissors.....	103
Surgi OR Lorna Edna Towel Clamp.....	106
Surgi OR Magill Catheter Forceps.....	108
Surgi OR Mayo Dissecting Scissors.....	102
Surgi OR Mayo-Hegar Needle Holder.....	104
Surgi OR Metzenbaum Scissors.....	102
Surgi OR Mosquito Hemostats.....	106
Surgi OR Multi-Cut Utility Shears.....	101
Surgi OR Operating Scissors.....	101
Surgi OR Pederson Vaginal Speculum.....	109
Surgi OR Presbyterian Tube Occluding Clamp.....	108
Surgi OR Rankin-Kelly Hemostats.....	106
Surgi OR Rochester-Ochsner Forceps.....	107
Surgi OR Rochester-Pean Forceps.....	107
Surgi OR Schroeder Tenaculum Forceps.....	109
Surgi OR Spencer Stitch Scissors.....	103
Surgi OR Splinter Forceps.....	105
Surgi OR Strabismus Scissors.....	102
Surgi OR Tissue Forceps.....	105
Surgi OR Webster Needle Holder.....	104
Surgi OR Wire Scissors.....	103
Surgi OR T-C Baumgartner Needle Holder.....	104
Surgi OR T-C Crile-Wood Needle Holder.....	104
Surgi OR T-C Derf Needle Holder.....	104
Surgi OR T-C Halsey Needle Holder.....	104
Surgi OR T-C Iris Scissors.....	102
Surgi OR T-C Mayo Dissecting Scissors.....	102
Surgi OR T-C Mayo-Hegar Needle Holder.....	104
Surgi OR T-C Metzenbaum Scissors.....	102
Surgi OR T-C Operating Scissors.....	101
Surgi OR T-C Strabismus Scissors.....	102
Surgi OR T-C Webster Needle Holder.....	104
Surgi OR T-C Wire Scissors.....	103

Surgical Blades, Disposable.....	320,466
Surgical Gloves, Latex, Sklartouch.....	452
Surgical Gloves, Nitrile, Sklartouch.....	452
Surgical Light.....	209,298
Surgical Panties, Disposable.....	318
Surgical Prep Razor, Plastic.....	122
Surgical Prep Razor, Plastic, Sterile.....	123
Surgical Scalpels, Disposable.....	321,465

Suture Products

Suture Carrying Scissors, Littler.....	306
Suture Forceps, Castroviejo.....	338
Suture Forceps, Healy.....	363
Suture Forceps, Manhattan Eye and Ear.....	339
Suture Forceps, Rhoton Microsurgery.....	351

Suture Removal Instrument, Sterile Floor-Grade.....	27
Suture Removal Instrument, Stainless Steel.....	27
Suture Removal Tray "A" W/ Econo Instruments.....	125
Suture Removal Tray "B" W/ Econo Instruments.....	125
Suture Removal Tray "C" W/ Econo Instruments.....	125
Suture Removal Tray "D" W/ Econo Instruments.....	125
Suture Removal Tray "E" W/ Plastic Instruments.....	125
Suture Removal Tray "F" W/ Plastic Instruments.....	125
Suture Scissors, Delicate, Premium.....	26
Suture Scissors, Littauer, Plastic.....	122
Suture Scissors, Littauer, Plastic, Sterile.....	123
Suture Scissors, New's.....	303
Suture Scissors, OR Grade.....	26
Suture Scissors, Sklarlite, Premium.....	26,80
Suture Tray.....	126
Suture Tying Forceps, Micro.....	363
Suture Wire Cutting Scissors.....	29,405

Sutureless Vasectomy Set, Standard.....	255
Sutureless Vasectomy Set, Wilson.....	255
Syringe, Infiltration, Disposable.....	318
Syringe, Metal Ear, Merit.....	114
Syringe, Pomeroy Ear.....	268
Syringe, Sklar-safe, Protective.....	449
Syringes.....	444-449

T

SKLAR T-C
TUNGSTEN CARBIDE

T-C Adson Forceps, Premium.....	55,99
T-C Adson-Brown Forceps, Premium.....	55,99
T-C Allis Forceps, Premium.....	42,98
T-C Babcock Forceps, Premium.....	43,98,166
T-C Baumgartner Needle Holder, Premium.....	66,94,104
T-C Bozeman-Heaney Needle Holder, Premium.....	97,194
T-C Castroviejo Needle Holder, Premium.....	68,343,350
T-C Crile-Murray Needle Holder, Premium.....	67,94
T-C Crile-Wood Needle Holder, Premium.....	67,69,94,192
T-C Debakey Atraumatic Forceps, Premium.....	98,170
T-C Derf Needle Holder, Premium.....	63,94,104
T-C Dissecting Scissors Sklar Edge Premium.....	92
T-C Dressing Forceps, Premium.....	50,99
T-C Finocchio Needle Holder, Premium.....	96,192
T-C Halsey Needle Holder, Premium.....	65,94
T-C Heaney Needle Holder, Premium.....	96,193
T-C Iris Scissors, Sklar Edge, Premium.....	21,91
T-C Jacobson Needle Holder, Premium.....	342
T-C Luethy Beck Needle Holder, Premium.....	97,194
T-C Maltz Rasp.....	280,390
T-C Mathieu Needle Holder, Premium.....	97,194
T-C Mayo Scissors, Sklar Edge, Premium.....	15,91
T-C Mayo-Hegar Needle Holder, Premium.....	64,69,95,191
T-C Mayo-Stille Scissors, Sklar Edge.....	92



**OR Quality
Instruments**



**OR Premium™
Instruments**



Mid-Grade Instruments

T-C Metz-Lahey Scissors, Sklar Edge, Premium	17,91	Thoms-Allis Forceps.....	44	Towel Clamp, Backhaus, Mid-Grade.....	48	
T-C Metzenbaum Scissors, Sklar Edge, Premium	19	Thoms-Gaylor Biopsy Forceps.....	250	Towel Clamp, Backhaus, OR Grade	48	
T-C Neivert Needle Holder, Premium.....	97	Thomson Mosquito Forceps	45	Towel Clamp, Sterile, Backhaus, Floor-Grade	48	
T-C New Orleans Needle Holder, Premium	95	Thorpe Caliper.....	296,344	Towel Clamp, Hoff.....	47	
T-C Olsen-Hegar Needle Holder, Premium.....	68,95,192	Thorpe Corneoscleral Forceps.....	339	Towel Clamp, Jones Cross Action.....	47	
T-C Operating Scissors, Sklar Edge, Premium	11,13,91	Three Jaw Offset Plier.....	426	Towel Clamp, Sterile, Lorna Edna, Floor-Grade	47	
T-C Pin Cutter, Premium	401	Thudichum Nasal Speculum.....	272	Towel Clamp, Lorna Edna, Mid-Grade	47	
T-C Potts-Smith Dressing Forceps, Premium	98	Tieck-Halle Nasal Speculum	271	Towel Clamp, Lorna Edna, OR Grade.....	47	
T-C Ryder Needle Holder, Premium.....	95	Tischler Cervical Biopsy Forcep.....	179,180	Towel Clamp, Plastic.....	122	
T-C Sarot Needle Holder, Premium.....	96	Tischler Oval Biopsy Forcep.....	182	Towel Clamp, Plastic, Sterile.....	123	
T-C Strabismus Scissors, Sklar Edge, Premium	22,92	Tissue Forceps			Towel Clamp, Roeder.....	47
T-C Stratte Needle Holder, Premium.....	96,193	Tissue Forceps, Heavy Pattern	51	Towels, Absorbent, Sterile.....	139	
T-C Webster Needle Holder, Premium.....	62,94,190	Tissue Forceps, Mid-Grade	51	Towels, OR, Sterile.....	139	
T-C Wire Cutting Scissors, Sklar Edge Premium.....	29,92,405	Tissue Forceps, OR Grade.....	51	Toynbee Ear Speculum	260	
T-C Wire Puller, Premium.....	402	Tissue Forceps, Sklarlite, Premium.....	51,84	Trach Care Tray	135	
Tags, Instrument ID	475	Tissue Forceps, Sterile, Floor Grade.....	51	Tracheal Retractor.....	73	
Takahashi Forceps	273	Tissue Forceps, Thumb, Econo, Floor-Grade	142	Traction Forceps, Lahey.....	170	
Tape, ID Roll, Sklar	475	Tissue Hook, Frazier	74,368	Tray, Catheter.....	442	
Tape, Sklar ID Sheet	474	Tissue Nipper	384	Tray, Instrument	441,442	
Tapes, Indicator.....	476	Tissue Nipper, Merit	115	Tray, Mayo.....	443	
Tauber Vaginal Spatula	153	Tissue Nipper, Sklarlite, Premium	384	Tray, Plastic Procedure	443	
Taylor Dural Scissors	305	Tissue Scissors, Fine Tip	352	Tray, Sterilization.....	441	
Taylor Percussion Hammer.....	436	Tivnen Tonsil Seizing Forceps	289	Trocar & Cannula, Standard Trap Door.....	226	
Taylor Percussion Hammer, Merit.....	116	Tongue Depressor, Wieder	281	Trocar & Trumpet Valve Cannula, Standard	226	
Teale Vulsellum Forceps.....	161	Tonometer Sterilizing Stand	345	Trocar Cannula Seals.....	226	
Tegaderm™ Dressing Change Tray.....	130	Tonometer, Schiotz	345	Trocar Set, Miniature, Reusable.....	232	
Tegaderm™ IV Start Tray	130	Tonsil Examining Retractor, Colver.....	283	Trocar, Hasson.....	226	
Tenaculum						
Tenaculum, Schroeder, Sterile Floor-Grade.....	158	Tonsil Forceps, Colver-Coakley	289	Trocar, Replacement.....	226	
Tenaculum, Schroeder, Laser	158,215	Tonsil Forceps, Sawtell	289	Trocar, Safety.....	226	
Tenaculum, Schroeder, Merit	114	Tonsil Forceps, Schnidt.....	289	Troutman-Barraquer Corneal Utility Forceps.....	335	
Tenaculum, Schroeder, Mid-Grade	158	Tonsil Forceps, White.....	289	Tru-Punch, Sklar.....	174	
Tenaculum, Schroeder, OR Grade.....	158	Tonsil Knife, Atkins.....	287	Trumpet Valve Cannula & Trocar, Standard	226	
Tenaculum, Schroeder, Sklar Blue.....	158,206	Tonsil Knife, Dean.....	287	Trumpet Valve Suction-Irrigation Tube.....	249	
Tenaculum, Adair Breast.....	159	Tonsil Knife, Douglas.....	287	Tube Occluding Forceps, Presbyterian, Merit	112	
Tenaculum, Barrett.....	159	Tonsil Knife, Fisher.....	287	Tube Occluding Forceps, Mid-Grade	49	
Tenaculum, Duplay.....	159	Tonsil Knife, Lothrop.....	288	Tube Occluding Forceps, OR Grade.....	49	
Tenaculum, Jarcho.....	159	Tonsil Knife, Tyding.....	287	Tube Occluding Forceps, Sterile, Floor-Grade.....	49	
Tenaculum, Staude	159	Tonsil Punches, Hartman Mosher	288	Tubing Clamp, Plastic.....	122	
Tenaculum Hooks, Emmett, Laser	214	Tonsil Punches, Schmeden.....	288	Tubing Clamp, Plastic, Sterile	123	
Tennant Tying Forceps.....	340	Tonsil Scissors, Boettcher.....	307	Tubing W/ Filter, Insufflation.....	233	
Tenotomy Hook, Stevens	328	Tonsil Scissors, Dean.....	307	Tubing, Infiltration, Disposable	318	
Tenotomy Scissors, Delicate Stevens, Premium.....	354	Tonsil Seizing Forceps, Craig.....	289	Tubing, Smoke Evacuation, Disposable.....	201	
Tenotomy Scissors, Ribbon Stevens.....	28,308,357	Tonsil Seizing Forceps, Tivnen	289	Tumblers.....	441	
Tenotomy Scissors, Stevens.....	354	Tonsil Seizing Forceps, Tyding	289	SKLAR T-C TUNGSTEN CARBIDE		
Tenotomy Scissors, Stevens, Delicate, Premium.....	23	Tonsil Snare, Eves	285	Tungsten Carbide Adson Forceps.....	55,99	
Tenotomy Scissors, Stevens, OR Grade.....	23	Tonsil Snare, Tyding.....	285	Tungsten Carbide Adson-Brown Forceps	55,99	
Tenotomy Scissors, Stevens, Sklarlite Premium.....	23,79	Tonsil Sponges.....	471	Tungsten Carbide Allis Forceps	42,98	
Tenotomy Scissors, Stevens, Westcott.....	300,309,330,359	Tooke Corneal Knife.....	327	Tungsten Carbide Babcock Forceps	43,98,166	
Textor Vasectomy Clamp	256	Toothbrush, Sklar Disposable	427	Tungsten Carbide Baumgartner Needle Holder	66,94	
Thomas Uterine Curettes	178	Torquing Plier	425	Tungsten Carbide Bozeman-Heaney Needle Holder	97,194	
Towel Clamp						
		Towel Clamp, Backhaus, Merit.....	112	Tungsten Carbide Castroviejo Needle Holder	68,343,350	

Tungsten Carbide Crile-Murray Needle Holder	67,94
Tungsten Carbide Crile-Wood Needle Holder.....	67,69,94,192
Tungsten Carbide Debakey Atraumatic Forceps.....	98,170
Tungsten Carbide Derf Needle Holder	63,94
Tungsten Carbide Dissecting Scissors.....	92
Tungsten Carbide Dressing Forceps.....	50,99
Tungsten Carbide Finochietto Needle Holder	96,192
Tungsten Carbide Halsey Needle Holder	65,94
Tungsten Carbide Heaney Needle Holder.....	96,193
Tungsten Carbide Iris Scissors.....	21,91
Tungsten Carbide Jacobson Needle Holder.....	342
Tungsten Carbide Luethy Beck Needle Holder	97,194
Tungsten Carbide Maltz Rasp	280,390
Tungsten Carbide Mathieu Needle Holder	97,194
Tungsten Carbide Mayo Dissecting Scissors	15,91
Tungsten Carbide Mayo-Hegar Needle Holder	64,69,95,191
Tungsten Carbide Mayo-Stille Scissors.....	92
Tungsten Carbide Metzenbaum Lahey Scissors.....	17,91
Tungsten Carbide Metzenbaum Scissors.....	19,91
Tungsten Carbide Neivert Needle Holder.....	97
Tungsten Carbide New Orleans Needle Holder	95
Tungsten Carbide Olsen-Hegar Needle Holder.....	68,95,192
Tungsten Carbide Operating Scissors.....	11,13,91
Tungsten Carbide Pin Cutter	401
Tungsten Carbide Potts-Smith Dressing Forceps	98
Tungsten Carbide Ring Handle Wire Extractor	402
Tungsten Carbide Ryder Needle Holder	95
Tungsten Carbide Sarot Needle Holder	96
Tungsten Carbide Strabismus Scissors	22,92
Tungsten Carbide Stratte Needle Holder	96,193
Tungsten Carbide Webster Needle Holder.....	62,94,190
Tungsten Carbide Wire Cutting Scissors.....	29,92,405
Tungsten Carbide Wire Puller	402
Tuning Fork Set	268
Turbinate Scissors, Seiler.....	301
Tuttle Forceps, Laser.....	251
Tuttle/Singley Forceps.....	57
Tuttle/Singley Forceps, Laser	216
Tuttle/Singley Forceps, Sklar Blue	207
Tyding Tonsil Knife	287
Tyding Tonsil Seizing Forceps	289
Tyding Tonsil Snare.....	285
Tying Forceps, Becherf-McPherson	340
Tying Forceps, Bonn	338
Tying Forceps, Harms	338
Tying Forceps, Kelman-McPherson	340
Tying Forceps, McPherson.....	338
Tying Forceps, Micro Suture	363
Tying Forceps, Tennant.....	340
Tympanum Perforator, Politzer.....	266
Tympanum Perforator, Royce	266
Tyrell Iris Hook.....	295,328,368

U

U.S. Army Pattern Gauze Scissors	385,405
U.S. Army Pattern Retractor.....	73
Ultrasound Tray.....	135
Umbilical Scissors	189,198
Undermining Ribbon Scissors, Kaye	308,352
Universal Biopsy Instrument, Cervical.....	186
Unna Comedone Extractor	376
Urethral Sound, Dittel	254
Urethral Sound, Otis/Dittel.....	254
Urethral Sound, Van Buren	253
Urological Drain Bags.....	140,259
Urology.....	253-259
USA Pattern Gauze Scissors	32
Uterine Curette, Greene	177
Uterine Curette, Heaney.....	177
Uterine Curette, Holden.....	177
Uterine Curette, Skene	177
Uterine Curette, Sims	178
Uterine Curette, Thomas	178
Uterine Dilator, Goodell	176
Uterine Dilator, Hank	175
Uterine Dilator, Hegar.....	175
Uterine Dilator, Pratt.....	175
Uterine Dilator, Wylie.....	176
Uterine Forceps, Campion, Laser.....	163
Uterine Forceps, Clemetson, Laser.....	162
Uterine Forceps, Clemetson, Sklar Blue	162
Uterine Forceps, Delee, Laser.....	216
Uterine Forceps, Delee.....	163
Uterine Forceps, Maier Gross	168
Uterine Forceps, Schweizer, Laser	162
Uterine Forceps, Schweizer, Sklar Blue.....	162
Uterine Manipulator, Cohen.....	159
Uterine Manipulator/Injector, Disposable.....	159,240,454
Uterine Polyp Forceps, Laufe, Laser	163,217
Uterine Polyp Forceps, Laufe, Sklar Blue.....	163,207
Uterine Sound, Simpson, Malleable	173
Uterine Sound, Simpson, Merit.....	114
Uterine Sound, Sims, Malleable	173
Utility Forceps, Girard Corneal	337
Utility Forceps, McCullough.....	57,339
Utility Forceps, Nugent	339
Utility Forceps, Plastic	122
Utility Forceps, Plastic, Sterile	123
Utility Forceps, Troutman-Barrquer Corneal.....	335
Utility Forceps, Wills Hospital	339

Utility Scissors

Utility Scissors, Multi-Cut, Sterile Floor-Grade	33
Utility Scissors, Multi-Cut, Merit.....	116
Utility Scissors, Multi-Cut, Mid-Grade.....	33
Utility Scissors, Multi-Cut, OR Grade	33

Utility Scissors, Ellen's.....	33
Utility Scissors, Hercules	32,406
Utility Scissors, Ribbon.....	28,308,357
Utility Scissors, Small, Econo, Floor-Grade.....	142
Utility Shears, Commander.....	32,406
Uvula Retractor, Lothrop	284
Uvula Retractor, Love.....	293

V

Vaginal Retractor, Brantley-Turner	153
Vaginal Retractor, Jackson, Laser.....	152
Vaginal Retractor, Lateral, Laser.....	149,212
Vaginal Retractor, Lateral, Sklar Blue	149,202
Vaginal Retractor, O'Sullivan-O'Connor	152
Vaginal Retractor, Pryor-Pean.....	153
Vaginal Retractor, Sims.....	151,152
Vaginal Retractor, Sims, Sklar Blue	151
Vaginal Retractor, Sims-Kelly.....	152

Vaginal Speculum

Vaginal Speculum, Auvard, Weighted	150
Vaginal Speculum, Auvard, Laser	150,212
Vaginal Speculum, Auvard, Sklar Blue.....	150,203
Vaginal Speculum, Berlind-Auvard Weighted.....	151
Vaginal Speculum, Collin.....	148
Vaginal Speculum, Collin, Laser.....	148,212
Vaginal Speculum, Cusco	149
Vaginal Speculum, Cusco, Non-Sterile, Plastic.....	234,453
Vaginal Speculum, Cusco, Sterile, Plastic.....	234,453
Vaginal Speculum, Cusco, Sklar Blue	149,202
Vaginal Speculum, De Vilbiss.....	148
Vaginal Speculum, Freeway Graves, Laser	211
Vaginal Speculum, Freeway Graves, Sklar Blue.....	201
Vaginal Speculum, Garrigue, Weighted	151
Vaginal Speculum, Graves Ob-View, Sklar Blue.....	201
Vaginal Speculum, Graves Wide View Sklar Blue.....	201
Vaginal Speculum, Graves Wide View, Laser.....	211
Vaginal Speculum, Graves, Sklar Blue.....	199,200
Vaginal Speculum, Graves, Laser	210,211
Vaginal Speculum, Graves, Non-sterile Plastic.....	234,453
Vaginal Speculum, Graves, Sterile, Plastic	234,453
Vaginal Speculum, Henrotin, Weighted.....	151
Vaginal Speculum, Pederson, Laser	210,211
Vaginal Speculum, Pederson, Sklar Blue.....	199,200
Vaginal Speculum, Steiner-Auvard, Laser.....	150,212
Vaginal Speculum, Steiner-Auvard, Sklar Blue	150,203
Vaginal Speculum, Steiner-Auvard, Weighted	150

Van Buren Urethral Sound	253
Van Doren-Schubert Biopsy Punch.....	185
Vanguard Splinter Pick	362
Vannas Scissors.....	331,360



OR Quality Instruments

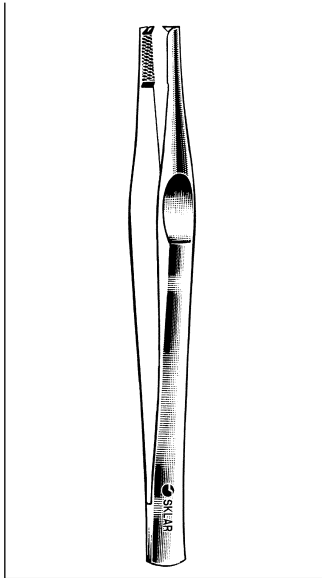


OR Premium™ Instruments



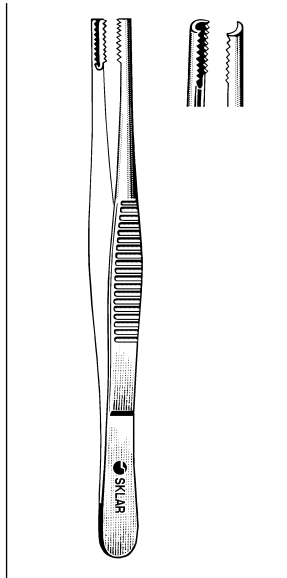
Mid-Grade Instruments

Vannas-McPherson Scissors	300,309,331	Weighted Vaginal Speculum, Berling-Auvar.....	151	Wire/Pin Extractor, Snap Lock.....	401
Vascular Scissors, Potts-Smith	350	Weighted Vaginal Speculum, Garrigue	151	Wires, Kirschner	400
Vasectomy Cautery	209,298	Weighted Vaginal Speculum, Henrotin.....	151	Wires, Snare, Cut and Bent.....	285
Vasectomy Clamp, Textor	256	Weighted Vaginal Speculum, Steiner Auvar.....	150	Wittner Uterine Biopsy Forcep, Micro-Cut.....	184
Vasectomy Set, Standard Sutureless.....	255	Weiner Scleral Hook.....	328	Wittner Uterine Biopsy Forcep.....	184
Vasectomy Set, Wilson Sutureless.....	255	Weingart Utility Plier	425	Wolfe-Boehler Cast Breaker.....	403
Vehe Carver	418	Weingartner Ear Forceps	265	Woodson	413
Vein/Nerve Retractor, Cushing.....	284	Weis Chalazion Forceps.....	334	Wound Closure Tray W/ Econo Instruments.....	124
Verres Needle With Stopcock.....	228	Weisman Infant Ear Curette	261	Wound Closure Tray W/ Plastic Instruments.....	124
Veruca Curette.....	374,386	Weitlaner Retractor.....	70,404	Wound Closure Tray W/O Instruments.....	124
Vienna Nasal Speculum	271	Weitlaner Retractor, Merit.....	113	Wrap, CSR Disposable.....	476
Vienna Nasal Speculum, Merit.....	114	Weitlaner Retractor, Paparella	291	Wullstein Ear Scissors.....	265
Vienna Nasal Speculum, Disposable	463	Weitlaner-Beckman Retractor	71,291	Wullstein Endaural Retractor.....	291
Virtus Splinter Forceps	362	Wesson Mouth Gag.....	281	Wylie Uterine Dilator.....	176
Vogel Adenoid Curette	286	West Bone Gouge	279		
Volkman Retractor (Ring Handle)	72	Westcott Tenotomy Scissors	300,309,330,359	X	
Volkman Retractor (USA).....	72	Weston Rectal Snare.....	248	Y	
Vulsellum Forceps, Doyen	164	Wieder Tongue Depressor	281	Xenon Fiber Optic Laryngoscope Lamps	432
Vulsellum Forceps, Henrotin.....	164	Wiener Scleral Hook.....	368		
Vulsellum Forceps, Jacobs	164	Wilde Blakesley Nasal Forceps.....	273		
Vulsellum Forceps, Schroeder.....	165	Wilde Ear Forceps.....	265		
Vulsellum Forceps, Schroeder, Laser	215	Wilde Ear Forceps, Merit.....	114	Yankauer Suction Tube	75
Vulsellum Forceps, Teale.....	161	Wilde Nasal Forceps	273	Yankauer Suction Tube, Plastic	75
Vulvar Biopsy Punch, Disposable	241	Wilder Lachrymal Dilator	329	Yankauer Suction Tube, Sterile, Floor-Grade	75
		Wilder Lens Loop.....	327	Yeoman Rectal Biopsy Punch	249
W		Williams Lachrymal Dilators/Probes	267,329	Young Prostatic Retractor	257
Wagner Scissors	303,356	Williams Probe.....	410		
Wagner Scissors, Sklarcut, Premium.....	90	Williams Speculum	324	Z	
Walls Carvers	411	Williams Stieglitz Splinter Forceps	363	Zalkind Ribbon Retractor.....	283
Walsham Septum Straightening Forceps.....	276	Williger Curette	374	Zaufel-Jansen Rongeur	394
Walther Dilator-Catheters	258	Williger Elevator.....	397	Ziegler Cilia Forceps.....	57
Walton Plaster Spreader	403	Wills Hospital Utility Forceps	339	Zipser Stockman Penis Clamp	256
Ward Carver	411	Wilmer Scissors.....	305,353		
Wartenberg Neurological Pinwheel	436	Wilson Sutureless Vasectomy Set.....	255		
Wartenberg Pinwheel, Merit	116	Wire Bending Plier.....	416		
Wax Knife and Spoon, Akers.....	411				
Wax Knife and Spoon, Evans.....	411	Wire Cutting Scissors			
Wax Spatula	419	Wire Cutting Scissors, Heavy Pattern	29		
Webril™, Sterile.....	138	Wire Cutting Scissors, Merit	116		
		Wire Cutting Scissors, Mid-Grade	29		
Webster Needle Holder		Wire Cutting Scissors, OR Grade.....	29		
Webster Needle Holder, Econo, Floor-Grade.....	142	Wire Cutting Scissors, Sklar Edge T-C Premium	29,92		
Webster Needle Holder, Heavy Pattern	62	Wire Cutting Scissors, Sterile, Floor-Grade.....	29		
Webster Needle Holder, Merit.....	113	Wire Cutting Scissors, Suture.....	29,405		
Webster Needle Holder, Mid-Grade	62,190	Wire Cutting Scissors, T-C Sklar Edge Premium	405		
Webster Needle Holder, OR Grade.....	62,190,370	Wire Extractor, T-C Ring Handle, Premium.....	402		
Webster Needle Holder, Sklargrip, Premium.....	62	Wire Eye Speculum, Kratz-Barraquer	323		
Webster Needle Holder, Sklarlite, Premium	62,86	Wire Forming Plier.....	423		
Webster Needle Holder, Sterile, Floor-Grade.....	62,190	Wire Puller, T-C, Premium.....	402		
Webster Needle Holder, T-C, Premium.....	62,94,190	Wire Retaining Retractor	70,290		
Weeks Eye Speculum	324	Wire Scissors, T-C, Surgi OR.....	103		
Weighted Vaginal Speculum, Auvar.....	150	Wire Speculum, Barraquer	323		
		Wire Speculum, Plain	323		



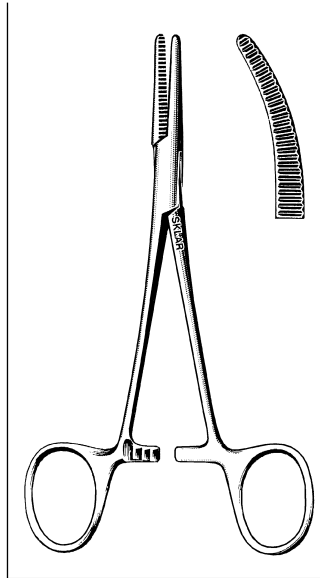
LANE TISSUE FORCEPS

Straight
 19-1955 5½" 1 x 2
 19-1975 7½" 1 x 2



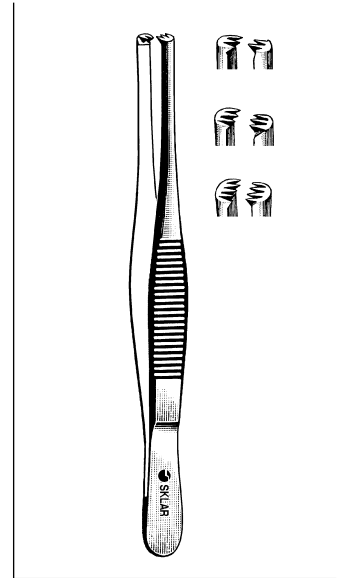
BROWN TISSUE FORCEPS

Side Grasping
 19-2860 6"
 19-2880 8"
 19-2910 10"



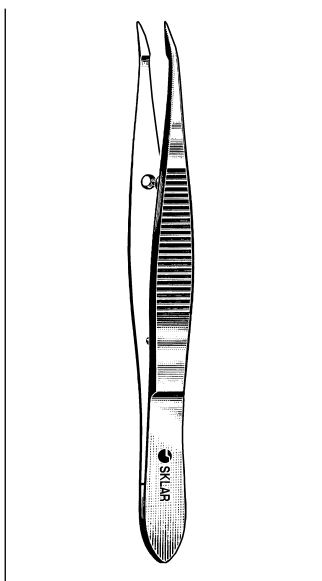
LAHEY FORCEPS

17-3255 5½" Straight
 17-3355 5½" Curved



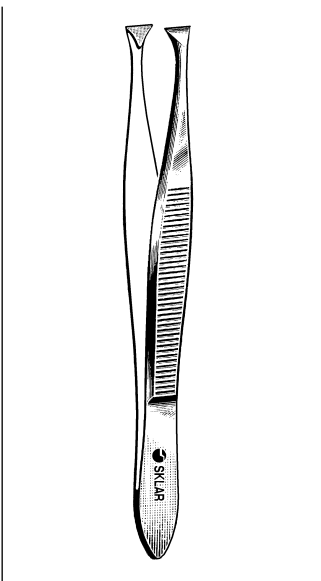
TISSUE FORCEPS

2 x 3	3 x 4
19-1450 5"	19-1655 5½"
19-1455 5½"	19-1660 6"
19-1460 6"	
19-1480 8"	4 x 5
19-1510 10"	19-1855 5½"
19-1512 12"	19-1910 10"



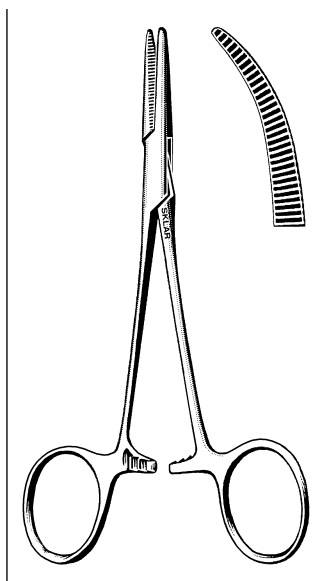
BARRAQUER CILIA FORCEPS

66-1742 4¼"



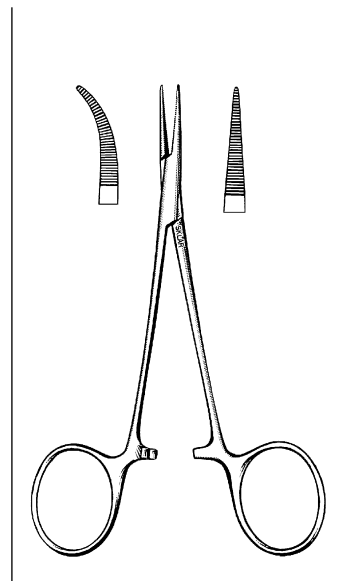
LITTAUER CILIA FORCEPS

66-1735 3½"



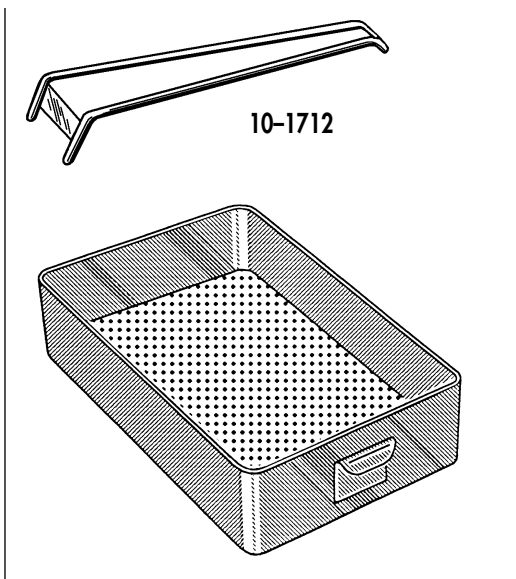
JONES FORCEPS

17-1255 5½" Straight
 17-1355 5½" Curved



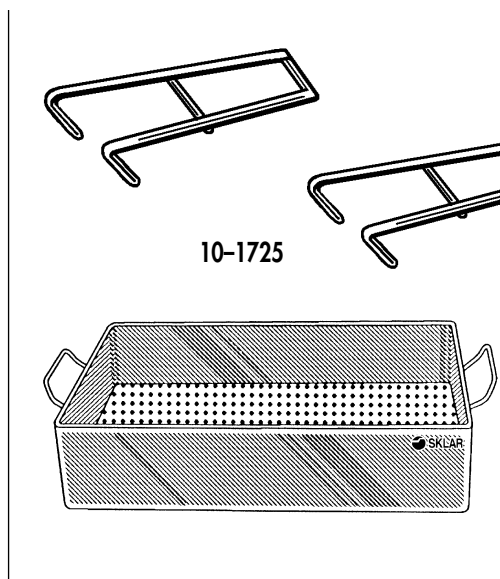
JACOBSON MOSQUITO FORCEPS DELICATE

98-2050 5" Straight
 98-2051 5" Curved



FLASH STERILIZATION INSTRUMENT TRAY

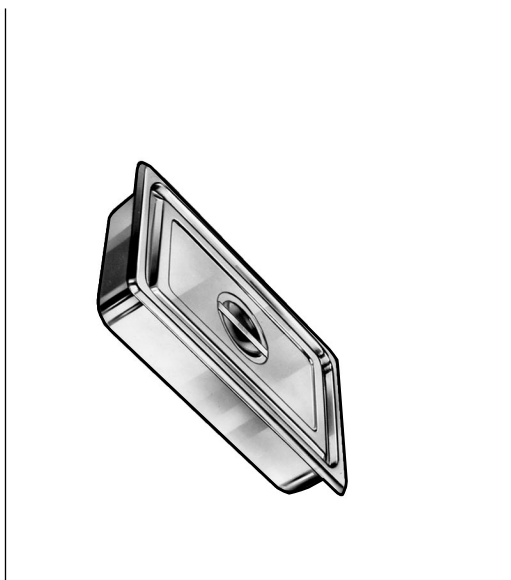
- 10-1711 10" x 6½" x 2"
 10-1712 Handle Only



INSTRUMENT STERILIZING TRAY

With Loop Handles—Outside Dimensions

- 10-1705 6¾" x 3¾" x 1¾"
 10-1710 10" x 6½" x 2½"
 10-1714 15" x 10½" x 3½"
 10-1720 20" x 10½" x 3½"
 10-1725 Handles for Lifting Sold in Pairs



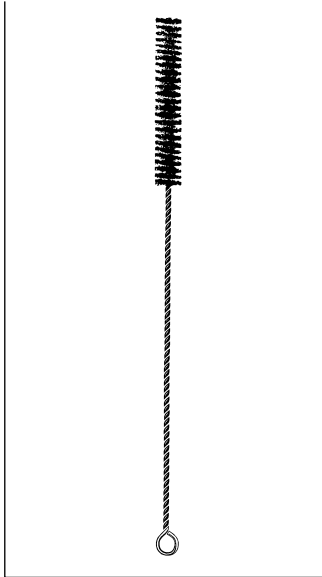
STERILIZING PANS & COVERS

- 10-1850 Solid 12¾" x 10½" x 2½"
 10-1852 Perf 12¾" x 10½" x 2½"
 10-1860 Solid 12¾" x 10½" x 4"
 10-1862 Perf 12¾" x 10½" x 4"
 10-1864 Cover for All Above



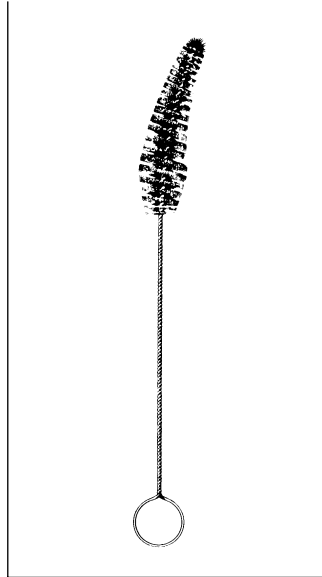
CLEANING BASKET

- Folding Handles
 10-1729 4½" x 7¼" x 2"
 10-1731 6" x 9" x 3"
 10-1732 8½" x 12½" x 3½"
 10-1733 9½" x 16" x 4"
 10-1734 12" x 21" x 5"
 10-1736 14" x 20" x 5"



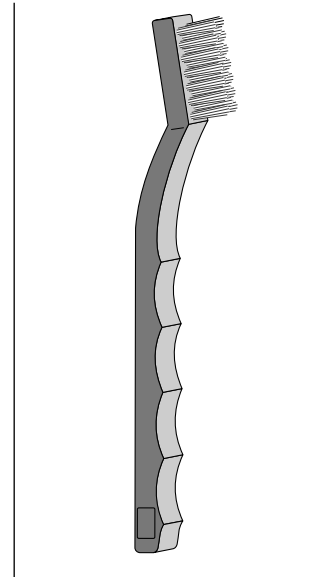
INSTRUMENT CLEANING BRUSHES - BRISTLE END

- 10-1660 2 1/4" x 1/8" x 12" Long Pack of 3
- 10-1661 2 1/4" x 1/8" x 12" Long Pack of 12
- 10-1664 2 1/2" x 3/8" x 15" Long Pack of 3
- 10-1665 2 1/2" x 3/8" x 15" Long Pack of 12
- 10-1668 3 1/2" x 1" x 15" Long Pack of 3
- 10-1669 3 1/2" x 1" x 15" Long Pack of 12



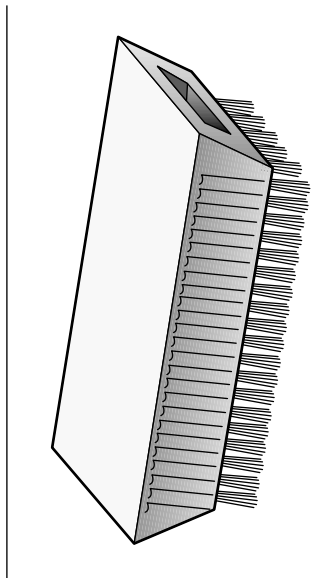
CLEANING BRUSH, TRACH TUBE

- Pack of 6
- 78-2821 Small 6" x 1/2" Dia.
- 78-2822 Med. 7" x 5/8" Dia.
- 78-2823 Large 7 1/2" x 3/4" Dia.
- 78-2813 Package of 3: Small, Medium, Large



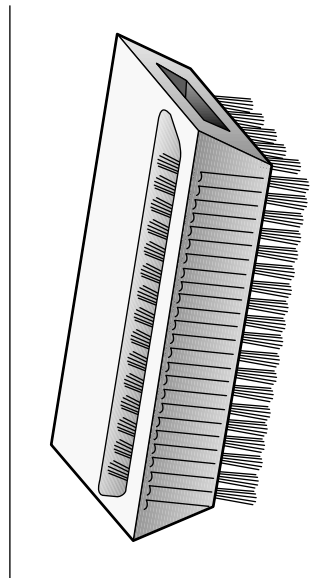
INSTRUMENT CLEANING BRUSH

- 10-1650 Stainless Steel Bristles Pack. of 3
- 10-1651 Nylon Bristles Pack. of 3
- 10-1652 Stainless Steel Bristles Pack. of 12
- 10-1657 Nylon Bristles Pack. of 12



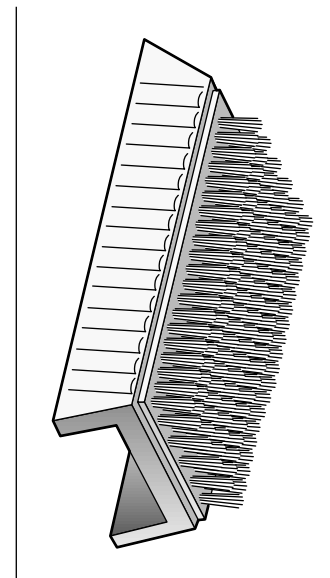
SURGEONS BRUSH

- 06-2881 Standard
- 06-2872 Pack of 12



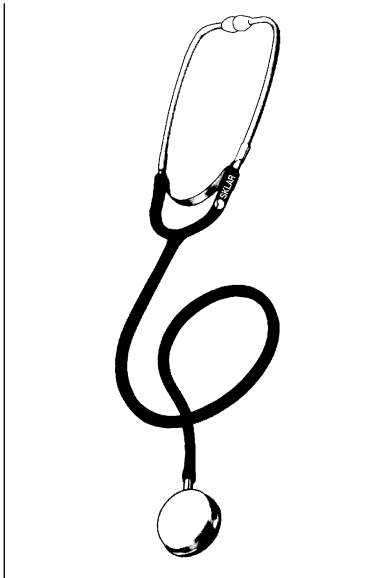
SURGEONS BRUSH

- 06-2882 With Nail Scrubber
- 06-2873 Pack of 12



SURGEONS BRUSH

- 06-2880 Channel Back
- 06-2870 Pack of 12



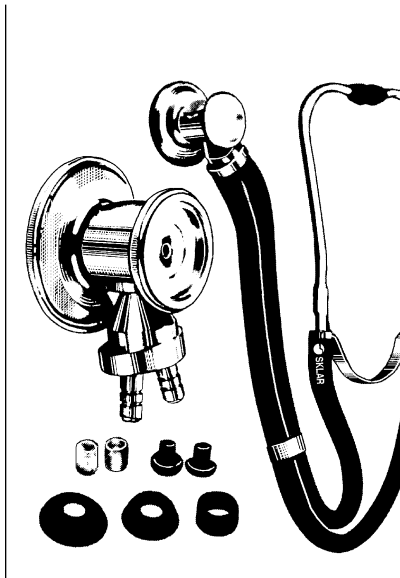
NURSE'S STETHOSCOPE LIGHTWEIGHT

With Vinyl Pouch

06-1004

06-2606 Standard Soft Rubber Ear Tips/Pair

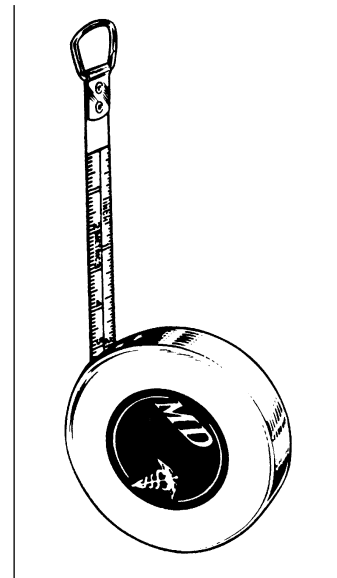
06-2607 Standard Plastic Ear Tips/Pair



SPRAGUE-RAPPAPORT STETHOSCOPE

Complete with 5 Chestpieces and
Large & Small Earpieces

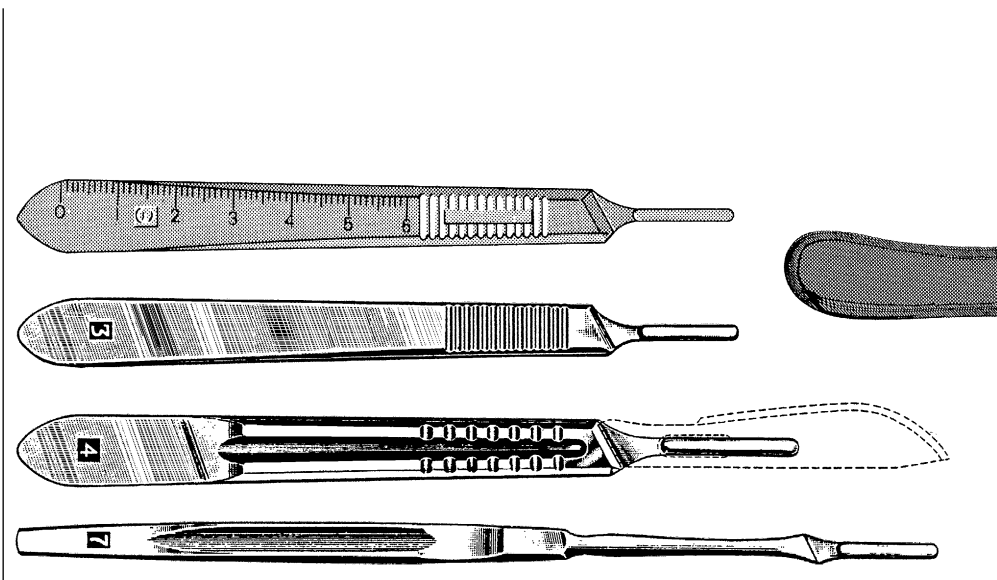
06-1935 Complete



TAPE MEASURE RETRACTABLE

MD Scale

06-2852



SCALPEL HANDLES

06-2910 Scalpel Handle #3 w/metric scale

06-2903 Scalpel Handle #3 fits Blade #10, 11, 12, 15

06-2904 Scalpel Handle #4 fits Blade #20, 21, 22, 23

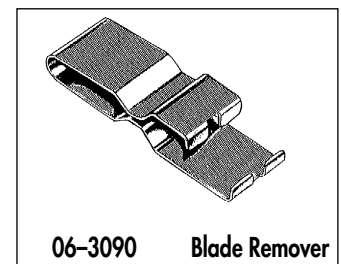
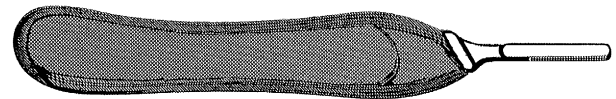
06-2907 Scalpel Handle #7 fits Blade #10, 11, 12, 15

06-2915 Scalpel Handle #3L

06-2920 Scalpel Handle #4L

06-2925 Large Lab Type Handle #3

06-2930 Large Lab Type Handle #4



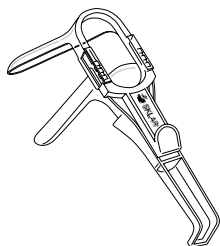
06-3090 Blade Remover

New Sterile Products from Sklar.

Sklar now has over 985 new sterile products for you to order.

Sterile products for Gynecology

1. Disposable Speculum
2. Lube Jelly
3. Monsel's and Lugol's
4. Biopsy Cannula



1. see page 234



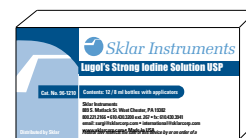
2. see page 242



4. see page 235



3. see page 237



Sterile products for Dermatology, ENT/Plastic Surgery

1. Biopsy Punch
2. Lipo Suction
3. Dermal Curette
4. Ear Curette

1. see page 241



2. see pages 312-322



3. see page 377



4. see page 261



Sterile products for General Surgery

1. General Purpose Tray
2. Minor Laceration Tray
3. Minor Surgery Tray
4. LLETZ Electrosurgery Tray



1. see page 124



2. see page 128



3. see page 131



4. see page 134



For more information call Sklar at 800.221.2166
or visit our website at www.sklarcorp.com

CLICK HERE TO SEE THIS WEEK'S SPECIALS - www.sklarcorp.com

NEW! Sklar Sterile

Sterile Instruments and Procedure Trays



Featuring Econo Floor Grade Instruments

GENERAL PURPOSE TRAY

96-1700 – CS/25



The Tradition Continues

*Visit our website at
www.sklarcorp.com*



Sklar Instruments
889 South Matlack Street
West Chester, PA 19382

800.221.2166—for customer service
610.696.9007—for fast fax quote

phone: 610.430.3200
international phone: +1.610.430.3200
international fax: +1.610.430.3941
e-mail: surgi@sklarcorp.com
website: www.sklarcorp.com

SECTION 4 - REACTIVITY HAZARD DATA

STABILITY

- Stable
 Unstable

Conditions
To Avoid

Avoid temperatures above 120°F and evaporation of water.

Incompatibility
(Materials to Avoid)

Acids and alkalines will neutralize active ingredient.

Hazardous
Decomposition Products

Oxides of carbon

HAZARDOUS POLYMERIZATION

- May Occur
 Will Not Occur

Conditions
To Avoid

Avoid temperatures above 120°F and evaporation of water.

SECTION 5 - HEALTH HAZARD DATA

PRIMARY ROUTES OF ENTRY

- Inhalation
 Skin Absorption
 Eyes
 Not Hazardous

CARCINOGEN LISTED IN

- NTP
 IARC Monograph
 OSHA
 Not Listed

HEALTH HAZARDS

Acute
N/A

Chronic
N/A

Signs and Symptoms
of Exposure

N/A

Medical Conditions

Generally Aggravated by Exposure N/A

EMERGENCY FIRST AID PROCEDURES -

Eye Contact

Flush eyes with water for 15 minutes. If irritation persists, seek medical attention.

Skin Contact

Wash skin with soap and water

Inhalation

Remove to fresh air. If symptoms persist, seek medical attention.

Ingestion

Do not induce vomiting. Give large amounts of water. Seek medical attention.

SECTION 6 - CONTROL AND PROTECTIVE MEASURES

Respiratory Protection
(Specify Type)

Use in well ventilated area.

Protective Gloves

Not required when used as directed.

Eye Protection

Not required when used as directed.

VENTILATION TO BE USED

- Local Exhaust Adequate ventilation
to maintain recommended exposure limit
 Mechanical (general)
Should be sufficient.
 Special
 Other (specify)

Other Protective
Clothing and Equipment

N/A

Hygienic Work
Practices

Handle in accordance with good personal hygiene and safety practices. These practices include avoiding unnecessary exposure.

SECTION 7 - PRECAUTIONS FOR SAFE HANDLING AND USE/LEAK PROCEDURES

Steps to be Taken If Material
Is Spilled Or Released

Ventilate area. Wipe up or rinse with tap water.

Waste Disposal
Methods

Flush thoroughly with water into sewage disposal system in accordance with local, state and federal regulations.

Do not reuse empty container. Wrap container and put in trash.

Precautions to be Taken
in Handling and Storage

Store Product in original sealed container at room temperature.

Other Precautions and/or Special Hazards

Keep out of reach of children. Do not ingest. Avoid skin and eye contact. Avoid contamination of food.

NFPA Rating* **N/A** Health ___ Flammability ___ Reactivity ___ Special ___

HMIS Rating* 4-Severe; 3-Serious; 2-Moderate; 1-Slight; 0-Minimum
Health 1 Flammability 2 Reactivity 0 Personal Protection N/A

Optional*

SECTION 4 - REACTIVITY HAZARD DATA

STABILITY

- Stable
 Unstable

Conditions
To Avoid

N/A

Incompatibility
(Materials to Avoid)

Do not mix with other products.

Hazardous
Decomposition Products

None

HAZARDOUS POLYMERIZATION

- May Occur
 Will Not Occur

Conditions
To Avoid

N/A

SECTION 5 - HEALTH HAZARD DATA

PRIMARY ROUTES OF ENTRY

- Inhalation
 Skin Absorption
 Eyes
 Ingestion

CARCINOGEN LISTED IN

- NTP
 IARC Monograph
 OSHA
 Not Listed

HEALTH HAZARDS

Acute

Not Known to have any acute effects.

Chronic

Not Known to have had any chronic effects.

Signs and Symptoms
of Exposure

Burning eyes when concentrate has been splashed into them.

Medical Conditions

Generally Aggravated by Exposure Persons with hypersensitive skin (under a physician's care) will generally aggravate condition upon exposure.

EMERGENCY FIRST AID PROCEDURES -

Eye Contact

Flush eyes with large amounts of water for at least 15 minutes holding lids apart to ensure flushing of the entire surface. Washing eyes within one minute is essential to achieve maximum effectiveness. Seek medical attention immediately.

Skin Contact

Wash skin with soap and water.

Inhalation

Remove to fresh air. If symptoms persist, seek medical attention.

Ingestion

Never give anything by mouth to an unconscious person. If swallowed, do not induce vomiting. Give large quantities of water. If available, give several glasses of milk. If vomiting occurs spontaneously, keep airway clear. Seek medical attention immediately.

SECTION 6 - CONTROL AND PROTECTIVE MEASURES

Respiratory Protection
(Specify Type)

N/A

Protective Gloves

N/A

Eye Protection

N/A

VENTILATION TO BE USED

- Local Exhaust
 Mechanical (general)
 Special
 Other (specify)

Other Protective
Clothing and Equipment

N/A

Hygienic Work
Practices

Good industrial hygiene practices should be adhered to when handling and storing this product.

SECTION 7 - PRECAUTIONS FOR SAFE HANDLING AND USE/LEAK PROCEDURES

Steps to be Taken If Material
Is Spilled Or Released

Using appropriate protection (impervious gloves, coveralls, boots, goggles, etc.) contain spill.

Remove as much as possible and reuse if possible.

Waste Disposal
Methods

Due to widespread variance in disposal regulations, consult federal, state, and local regulatory agencies for proper disposal of this product.

Precautions to be Taken
in Handling and Storage

Good industrial hygiene practices should be adhered to when handling and storing this product.

Other Precautions and/or Special Hazards

N/A

NFPA Rating* Health N/A Flammability Reactivity Special

HMS Rating* 4-Severe; 3-Serious; 2-Moderate; 1-Slight; 0-Minimum
Health 2 Flammability 0 Reactivity 0 Personal Protection N/A

Optional*

Material Safety Data Sheet

SKLAR FRESH

Sklar Instruments

Distributor

889 South Matlack Street

Address

West Chester, PA 19382

(610) 430-3200

Phone Number (For Information)

KeyDen™ Enterprises, L.L.C.

(888) 853-9336

Emergency Phone Number

Telex*

Identity (Trade Name As Used On Label)

N/D

MSDS Number*

N/A

CAS Number*

April 1, 1998

Date Prepared

Sklar Instruments

Prepared By:

Note: Blank spaces are not permitted. If any item is not applicable, or no information is available, the space must be marked to indicate that.

SECTION 1 - MATERIAL IDENTIFICATION AND INFORMATION

COMPONENTS—Chemical Name & Common Names (Hazardous Components 1% or greater; Carcinogens 0.1% or greater)	%*	OSHA PEL	ACGIH TLV	OTHER LIMITS RECOMMENDATIONS
None of the ingredients in Sklar Fresh are listed as hazardous				
Non-Hazardous Ingredients	0			
Total	100			

SECTION 2 - PHYSICAL/CHEMICAL CHARACTERISTICS

Boiling Point	212 F°.	Specific Gravity (H ₂ O = 1)	1.0
Vapor Pressure (mm Hg and Temperature)	At 20C degrees:17.7	Melting Point	N/D
Vapor Density (Air = 1)	N/D	Evaporation Rate (Butyl Acetate = 1)	N/D
Solubility in Water	Miscible	Water Reactive	N/D
Appearance and Odor	Clear liquid with citrus floral odor.		

SECTION 3 - FIRE AND EXPLOSION HAZARD DATA

Flash Point and Method Used	Will not flash	Auto-Ignition Temperature		Flammability Limits in Air % by Volume	None	LEL	N/D	UEL	N/D
Extinguisher Media	N/A								
Special Fire Fighting Procedures	N/A								
Unusual Fire and Explosion Hazards	N/A								

*Optional

SECTION 4 - REACTIVITY HAZARD DATA

STABILITY

- Stable
 Unstable

Conditions
To Avoid**High Temperature**Incompatibility
(Materials to Avoid)**N/E**Hazardous
Decomposition Products**N/E****HAZARDOUS POLYMERIZATION**

- May Occur
 Will Not Occur

Conditions
To Avoid**None**

SECTION 5 - HEALTH HAZARD DATA

**PRIMARY ROUTES
OF ENTRY**

- Inhalation
 Skin Absorption
 Ingestion
 Not Hazardous

**CARCINOGEN
LISTED IN**

- NTP
 IARC Monograph
 OSHA
 Not Listed

HEALTH HAZARDS

Acute

None anticipated

Chronic

None anticipatedSigns and Symptoms
of Exposure**May irritate eyes. Prolonged contact with skin may cause dryness.**Medical Conditions
Generally Aggravated by Exposure**N/E****EMERGENCY FIRST AID PROCEDURES** - Seek medical assistance for further treatment, observation and support if necessary.

Eye Contact

Flush eyes with water for at least 15 minutes.

Skin Contact

Wash affected area with copious amounts of water.

Inhalation

Remove to fresh air. Give oxygen or artificial respiration, as needed.

Ingestion

Call physician. Seek medical treatment if discomfort persists.

SECTION 6 - CONTROL AND PROTECTIVE MEASURES

Respiratory Protection
(Specify Type)**None**

Protective Gloves

Rubber if needed.

Eye Protection

N/A**VENTILATION
TO BE USED**

- Local Exhaust
 Mechanical (general)
 Special
 Other (specify)

Other Protective
Clothing and Equipment**Safety Shower and Eye Bath**Hygienic Work
Practices**None**

SECTION 7 - PRECAUTIONS FOR SAFE HANDLING AND USE/LEAK PROCEDURES

Steps to be Taken If Material
Is Spilled Or Released**Not hazardous. Not a RCRA hazardous waste.**Waste Disposal
Methods**N/D**Precautions to be Taken
in Handling and Storage**Store material at 25C. Keep storage container tightly closed. Avoid contact with skin and eyes. Do not inhale. Wash thoroughly after handling.**

Other Precautions and/or Special Hazards

NoneNFPA **N/A**
Rating* Health ___ Flammability ___ Reactivity ___ Special ___HMIS **N/A**
Rating* Health ___ Flammability ___ Reactivity ___ Personal Protection ___

Optional*

N/A = Not Applicable**N/E = Not Established****N/D = No Data**

SECTION 4 - REACTIVITY HAZARD DATA

STABILITY

- Stable
 Unstable

Conditions
To Avoid

Open flames and sparks, oxidizing agents

Incompatibility
(Materials to Avoid)

Oxidizing agents

Hazardous
Decomposition Products

CO2

HAZARDOUS POLYMERIZATION

- May Occur
 Will Not Occur

Conditions
To Avoid

N/A

SECTION 5 - HEALTH HAZARD DATA

PRIMARY ROUTES OF ENTRY

- Inhalation
 Skin Absorption
 Ingestion
 Not Hazardous

CARCINOGEN LISTED IN

- NTP
 IARC Monograph
 OSHA
 Not Listed

HEALTH HAZARDS

Acute

N/A

Chronic

N/A

Signs and Symptoms
of Exposure

Eyes: Will cause irritation. Ingestion: May cause gastrointestinal discomfort.

Medical Conditions
Generally Aggravated by Exposure

None

EMERGENCY FIRST AID PROCEDURES -

Eye Contact

Flush eyes with water for 15 minutes, if irritation persists, get medical attention.

Skin Contact

N/A

Inhalation

Remove to fresh air. If symptoms persist, call a physician.

Ingestion

Get medical attention.

SECTION 6 - CONTROL AND PROTECTIVE MEASURES

Respiratory Protection
(Specify Type)

N/A

Protective Gloves

Not required under normal use.

Eye Protection

Not required under normal use.

VENTILATION TO BE USED

- Local Exhaust
 Mechanical (general)
 Special
 Other (specify)

Other Protective
Clothing and Equipment

None

Hygienic Work
Practices

Wash hands before eating. Do not smoke while using.

SECTION 7 - PRECAUTIONS FOR SAFE HANDLING AND USE/LEAK PROCEDURES

Steps to be Taken If Material
Is Spilled Or Released

Use absorbent material to collect and contain.

Waste Disposal
Methods

Dispose of in accordance with Local, State and Federal regulation.

Precautions to be Taken
in Handling and Storage

Keep away from heat, flames and sparks. Keep container closed.

Other Precautions and/or Special Hazards

Read Label before using.

NFPA **N/A**
Rating* Health ___ Flammability ___ Reactivity ___ Special ___

HMIS **N/A**
Rating* Health ___ Flammability ___ Reactivity ___ Personal Protection ___

Optional*

SECTION 4 - REACTIVITY HAZARD DATA

STABILITY

- Stable
 Unstable

Conditions
To Avoid

Open flames and sparks, oxidizing agents

Incompatibility
(Materials to Avoid)

None Known

Hazardous
Decomposition Products

None Known

HAZARDOUS POLYMERIZATION

- May Occur
 Will Not Occur

Conditions
To Avoid

None Known

SECTION 5 - HEALTH HAZARD DATA

PRIMARY ROUTES OF ENTRY

- Inhalation
 Skin Absorption
 Ingestion
 Not Hazardous

CARCINOGEN LISTED IN

- NTP
 IARC Monograph
 OSHA
 Not Listed

HEALTH HAZARDS

Acute
N/A

Chronic
N/A

Signs and Symptoms
of Exposure

Skin: May cause irritation of the skin. Repeated or prolonged contact may cause drying and defatting of the skin. Eyes: May cause irritation and redness. Inhalation is unlikely due to low vapor pressure. Inhalation of mists may cause respiratory irritation. Product has low order of toxicity. Ingestion of concentrated product may cause digestive irritation and nausea.

Medical Conditions

Generally Aggravated by Exposure None Known

EMERGENCY FIRST AID PROCEDURES -

Eye Contact

Flush eyes with clean water for 15 minutes.

Skin Contact

Rinse thoroughly with water after use.

Inhalation

Remove to fresh air. If symptoms persist, call a physician.

Ingestion

Product has low order of oral toxicity. Ingestion of concentrated product may cause digestive irritation and nausea.

SECTION 6 - CONTROL AND PROTECTIVE MEASURES

Respiratory Protection
(Specify Type)

Not required when used as directed.

Protective Gloves

Not required when used as directed.

Eye Protection

Not required when used as directed.

VENTILATION TO BE USED

- Local Exhaust
 Mechanical (general)
 Special
 Other (specify) Not required when used as directed.

Other Protective
Clothing and Equipment

Not required when used as directed.

Hygienic Work
Practices

N/A

SECTION 7 - PRECAUTIONS FOR SAFE HANDLING AND USE/LEAK PROCEDURES

Steps to be Taken If Material
Is Spilled Or Released

Small spills can be rinsed with water. Large quantities (more than 5 gallons) should be absorbed with sawdust, clay or suitable material and discarded.

Waste Disposal
Methods

Dispose of in accordance with State and Federal regulations.

Precautions to be Taken
in Handling and Storage

Full containers should be stored in a cool, dry, well ventilated area. Keep this and all other chemical materials in closed, properly labeled containers and out of reach of small children.

Other Precautions and/or Special Hazards

N/A

NFPA N/A
Rating* Health ___ Flammability ___ Reactivity ___ Special ___

HMIS N/A
Rating* Health ___ Flammability ___ Reactivity ___ Personal Protection ___

Optional*

SECTION 4 - REACTIVITY HAZARD DATA

STABILITY

- Stable
 Unstable

Conditions
To Avoid

N/A

Incompatibility
(Materials to Avoid)

Oxidizing material can cause a reaction.

Hazardous
Decomposition Products

Silicon Dioxide, Carbon Dioxide and traces of incompletely burned carbon products.

HAZARDOUS POLYMERIZATION

- May Occur
 Will Not Occur

SECTION 5 - HEALTH HAZARD DATA

PRIMARY ROUTES OF ENTRY

- Eye
 Skin Absorption
 Inhalation
 Ingestion

CARCINOGEN LISTED IN

- NTP
 IARC Monograph
 OSHA
 Not Listed

HEALTH HAZARDS

Acute
None Known.

Chronic
None Known.

Signs and Symptoms
of Exposure

Eyes: May cause temporary discomfort. Skin: No known adverse effects. Inhalation: No effects except very slight irritation to the eyes or respiratory passages. Oral: Amounts transferred to the mouth by fingers, ect., during normal operations should not cause injury.

Medical Conditions
Generally Aggravated by Exposure

None Known.

EMERGENCY FIRST AID PROCEDURES - Seek medical assistance for further treatment, observation and support if necessary.

Eye Contact

Flush with water.

Skin Contact

Flush with water.

Inhalation

No Problem.

Ingestion

No Problem.

SECTION 6 - CONTROL AND PROTECTIVE MEASURES

Respiratory Protection
(Specify Type)

No personal protective equipment needed.

Protective Gloves

N/A

Eye Protection

Avoid splashing product in eyes.

VENTILATION TO BE USED

- Local Exhaust
 Mechanical (general)
 Special
 Other (specify)

Other Protective
Clothing and Equipment

N/A

Hygienic Work
Practices

Use in adjunct to appropriate cleaning and sterilizing techniques.

SECTION 7 - PRECAUTIONS FOR SAFE HANDLING AND USE/LEAK PROCEDURES

Steps to be Taken If Material
Is Spilled Or Released

Use absorbent material to collect and contain for salvage and disposal.

Waste Disposal
Methods

Dispose of or flush to sewage disposal system in accordance with all regulatory guidelines.

Precautions to be Taken
in Handling and Storage

Shake Instru-Guard concentrate well before using. Cover prepared diluted solution when not in use.

Other Precautions and/or Special Hazards

Make fresh solution every week. See container label for directions.

NFPA N/A
Rating* Health ___ Flammability ___ Reactivity ___ Special ___

HMIS N/A
Rating* Health ___ Flammability ___ Reactivity ___ Personal Protection ___

Optional*

Material Safety Data Sheet

SKLAR INSTRU-GUARD ONE STEP

Identity (Trade Name As Used On Label)

Sklar Instruments

Distributor

889 South Matlack Street

Address

West Chester, PA 19382

(800) 221-2166

Phone Number (For Information)

1-800-955-7334

Emergency Phone Number

Telex*

MSDS 835

MSDS Number*

N/A

CAS Number*

February 10, 2000

Date Prepared

Sklar Instruments

Prepared By:

Note: Blank spaces are not permitted. If any item is not applicable, or no information is available, the space must be marked to indicate that.

SECTION 1 - MATERIAL IDENTIFICATION AND INFORMATION

COMPONENTS—Chemical Name & Common Names (Hazardous Components 1% or greater; Carcinogens 0.1% or greater)	%*	OSHA PEL	ACGIH TLV	OTHER LIMITS RECOMMENDATIONS
Sodium Metasilicate Pentahydrate (CAS #6834-92-0)	0.25	15 MG/M3 ³	10 MG/M3 ³	N/A
Potassium Hydroxide (CAS #1310-58-3)	2	2 MG/M3 ³ Ceiling	2 MG/M3 ³ Ceiling	N/A
Propylene Glycol (CAS 57-55-6)	2	None	None	10 MG/M3 ³ (Aerosol) Manufacturer
Methanol (CAS #67-56-1)	0.21	200 ppm	200 ppm	N/A
Alcohols, C8-10, Ethoxylated Propoxylated (CAS #68603-25-8) This material contains Oxirane at < 0.0002%	3.5	N/A	N/A	N/A
Oxirane (see above) (CAS #75-21-8)	< 0.1ppm	1 ppm Action Level 0.5 ppm	N/A	N/A
Tetrasodium EDTA, 39% Active (CAS #64-02-8)	2	N/A	N/A	N/A
Tetrasodium EDTA contains a component which is listed as a potential carcinogen for hazard communications purposes under OSHA Standard 20 CFR 1910.1200. Component listed by NTP is nitrilotriacetic acid (NTA). Very small amounts of the trisodium salt of nitrilotriacetic acid (trisodium nitrilotriacetic, CAS - 005064-31-3) are present in this product. Large dietary doses of NTA have caused urinary tumors in laboratory animals.				
Total				

SECTION 2 - PHYSICAL/CHEMICAL CHARACTERISTICS

Boiling Point	195°F	Specific Gravity (H2O = 1)	1.031
Vapor Pressure (mm Hg and Temperature)	N/A	Melting Point	N/A
Vapor Density (Air = 1)	Heavier than air	Evaporation Rate (_____ = 1)	< 1
Solubility in Water	Complete	Water Reactive	N/A
Appearance and Odor	Green Liquid	pH	N/A

SECTION 3 - FIRE AND EXPLOSION HAZARD DATA

Flash Point and Method Used	Unknown	Auto-Ignition Temperature	N/A	Flammability Limits in Air % by Volume	N/A	LEL	N/A	UEL	N/A
Extinguisher Media	Use media appropriate for the source of the fire.								
Special Fire Fighting Procedures	Wear self contained breathing apparatus.								
Unusual Fire and Explosion Hazards	Thermal decomposition may produce carbon monoxide, carbon dioxide, ammonia and nitrogen oxides.								

*Optional

SECTION 4 - REACTIVITY HAZARD DATA

STABILITY

- Stable
 Unstable

Conditions
To Avoid

Unknown

Incompatibility
(Materials to Avoid)

Strong oxidizing agents or strong mineral acids.

Hazardous
Decomposition Products

N/A

HAZARDOUS POLYMERIZATION

- May Occur
 Will Not Occur

Conditions
To Avoid

Unknown

SECTION 5 - HEALTH HAZARD DATA

PRIMARY ROUTES OF ENTRY

- Inhalation
 Skin Absorption
- Ingestion
 Not Hazardous

CARCINOGEN LISTED IN

- NTP
 IARC Monograph
 Not Listed

HEALTH HAZARDS

Acute Regardless of concentration, the severity of damage and extent of its irreversibility increases with length of contact time. Prolonged contact with even dilute potassium hydroxide solution (2.0%) can cause a high degree of tissue destruction. Mist may cause damage to the respiratory tract. Destructive to eye tissue on contact. Swallowing can cause severe burns of the mouth, throat, esophagus and stomach. The effect of local skin exposure may consist of areas of superficial destruction or of primary irritant dermatitis. Potassium Hydroxide Acute Oral LD 50 (rat) 365 mg/kg.

Chronic

Signs and Symptoms
of Exposure

Corrosive to all body tissue with which it comes in contact.

Medical Conditions

Generally Aggravated by Exposure Unknown

EMERGENCY FIRST AID PROCEDURES

Eye Contact

Immediately flush eyes with large amounts of water for at least 15 minutes, holding lids apart to ensure flushing of entire surface.

Seek Medical attention.

Skin Contact

Immediately wash contaminated areas with plenty of water for 15 minutes. Remove contaminated clothing and footwear and wash before reuse.

Seek medical attention.

Inhalation

Remove to fresh air; if breathing is difficult, have trained person administer oxygen. If respiration stops, give mouth-to-mouth resuscitation.

Seek medical attention.

Ingestion

Never give anything by mouth to an unconscious person. If swallowed, DO NOT INDUCE VOMITING. Give large quantities of milk or water.

If vomiting occurs spontaneously, keep airway clear. Seek medical attention.

SECTION 6 - CONTROL AND PROTECTIVE MEASURES

Respiratory Protection
(Specify Type)

None required under usual conditions of use.

Protective Gloves

Impervious gloves should be worn.

Eye Protection

Wear chemical safety goggles.

VENTILATION TO BE USED

- Local Exhaust Adequate
 Mechanical (general)
 Special
- Other (specify)

Other Protective
Clothing and Equipment

Impervious clothing should be worn to minimize contact.

Hygienic Work
Practices

Avoid contamination of food.

SECTION 7 - PRECAUTIONS FOR SAFE HANDLING AND USE/LEAK PROCEDURES

Steps to be Taken If Material
Is Spilled Or Released

Absorb with inert material and collect for disposal.

Waste Disposal
Methods

Dispose of in accordance with local, state and federal regulation.

Precautions to be Taken
in Handling and Storage

Storage between 40°F and 100°F is recommended. Avoid freezing.

Other Precautions and/or Special Hazards

Keep out of reach of children. Do not ingest. Avoid contact with skin. Do not get into eyes.

NFPA Rating* N/A Health ___ Flammability ___ Reactivity ___ Special ___

HMIS Rating* N/A Health ___ Flammability ___ Reactivity ___ Personal Protection ___

Optional*

SECTION 4 - REACTIVITY HAZARD DATA

STABILITY

- Stable
 Unstable

Conditions
To Avoid

N/A

Incompatibility
(Materials to Avoid)

Do not mix with other products.

Hazardous
Decomposition Products

None

HAZARDOUS POLYMERIZATION

- May Occur
 Will Not Occur

Conditions
To Avoid

N/A

SECTION 5 - HEALTH HAZARD DATA

PRIMARY ROUTES OF ENTRY

- Inhalation
 Skin Absorption
 Eyes
 Ingestion

CARCINOGEN LISTED IN

- NTP
 IARC Monograph
 OSHA
 Not Listed

HEALTH HAZARDS

Acute

Not Known to have any acute effects.

Chronic

Not Known to have had any chronic effects.

Signs and Symptoms
of Exposure

Burning eyes when concentrate has been splashed into them.

Medical Conditions

Generally Aggravated by Exposure Persons with hypersensitive skin (under a physician's care) will generally aggravate condition upon exposure.

EMERGENCY FIRST AID PROCEDURES -

Eye Contact

Immediately Flush eyes with large amounts of water for at least 15 minutes holding lids apart to ensure flushing of the entire surface.

Washing eyes within one minute is essential to achieve maximum effectiveness. Seek medical attention immediately.

Skin Contact

N/A

Inhalation

N/A

Ingestion

Never give anything by mouth to an unconscious person. If swallowed, do not induce vomiting. Give large quantities of water. If available, give several glasses of milk. If vomiting occurs spontaneously, keep airway clear. Seek medical attention immediately.

SECTION 6 - CONTROL AND PROTECTIVE MEASURES

Respiratory Protection
(Specify Type)

N/A

Protective Gloves

N/A

Eye Protection

N/A

VENTILATION TO BE USED

- Local Exhaust
 Mechanical (general)
 Special
 Other (specify)

Other Protective
Clothing and Equipment

N/A

Hygienic Work
Practices

Good industrial hygiene practices should be adhered to when handling and storing this product.

SECTION 7 - PRECAUTIONS FOR SAFE HANDLING AND USE/LEAK PROCEDURES

Steps to be Taken If Material
Is Spilled Or Released

Using appropriate protection (impervious gloves, coveralls, boots, goggles, etc.) contain spill.

Remove as much as possible and reuse if possible.

Waste Disposal
Methods

Due to widespread variance in disposal regulations, consult federal, state, and local regulatory agencies for proper disposal of this product.

Precautions to be Taken
in Handling and Storage

Good industrial hygiene practices should be adhered to when handling and storing this product.

Other Precautions and/or Special Hazards

N/A

NFPA Rating* Health N/A Flammability Reactivity Special

HMS Rating* 4-Severe; 3-Serious; 2-Moderate; 1-Slight; 0-Minimum
Health 2 Flammability 0 Reactivity 0 Personal Protection N/A

Optional*

SECTION 4 - REACTIVITY HAZARD DATA

STABILITY

- Stable
 Unstable

Conditions
To Avoid

N/A

Incompatibility
(Materials to Avoid)

Do not mix with acidic products.

Hazardous
Decomposition Products

None

HAZARDOUS POLYMERIZATION

- May Occur
 Will Not Occur

Conditions
To Avoid

N/A

SECTION 5 - HEALTH HAZARD DATA

PRIMARY ROUTES OF ENTRY

- Inhalation
 Skin Absorption

- Eyes
 Ingestion

CARCINOGEN LISTED IN

None

- NTP
 IARC Monograph
- OSHA
 Not Listed

HEALTH HAZARDS

Acute

Burns skin, eye (possible permanent corneal damage), mucous membranes of the respiratory tract, mouth, throat, esophagus and stomach.

Chronic

Local effect may consist of multiple areas of superficial destruction of the skin or of primary irritant dermatitis.

Signs and Symptoms
of Exposure

Burning eyes, redness of skin.

Medical Conditions

Generally Aggravated by Exposure Sensitive skin

EMERGENCY FIRST AID PROCEDURES -

Eye Contact

Immediately Flush eyes with large amounts of water for at least 15 minutes holding lids apart to ensure flushing of the entire surface.

Washing eyes within one minute is essential to achieve maximum effectiveness. Seek medical attention immediately.

Skin Contact

Wash with plenty of water for fifteen minutes. Remove contaminated clothing and wash before reuse. Footwear should be decontaminated

before reuse. Seek medical attention if symptoms are present.

Inhalation

N/A

Ingestion

Never give anything by mouth to an unconscious person. If swallowed, do not induce vomiting. Give large quantities of water. If available, give several glasses of milk. If vomiting occurs spontaneously, keep airway clear. Seek medical attention immediately.

SECTION 6 - CONTROL AND PROTECTIVE MEASURES

Respiratory Protection
(Specify Type)

Where required use only NIOSH/MSHA approved respirator following manufactures recommendation where or spray of concentrate may be generated.

Protective Gloves

Gloves coated with rubber, synthetic elastomers, PVC, or other impervious material should be worn.

Eye Protection

Chemical splash goggles and face shield should be worn when working with this product.

VENTILATION TO BE USED

- Local Exhaust
 Mechanical (general)
 Special
 Other (specify)

Other Protective
Clothing and Equipment

Standard work clothes should be worn. Wash soiled clothing in soap and water and dry before reuse. Eyewash facilities should be accessible.

Hygienic Work
Practices

N/A

SECTION 7 - PRECAUTIONS FOR SAFE HANDLING AND USE/LEAK PROCEDURES

Steps to be Taken If Material
Is Spilled Or Released

Using appropriate protection (impervious gloves, coveralls, boots, goggles, etc.) contain spill.

Remove as much as possible and reuse if possible. Neutralize remaining traces with dilute mineral acids to a pH of 6-8.

Waste Disposal
Methods

Due to widespread variance in disposal regulations, consult federal, state, and local regulatory agencies for proper disposal of this product.

Precautions to be Taken
in Handling and Storage

Good industrial hygiene practices should be adhered to when handling and storing this product.

Avoid contact with undiluted product.

Other Precautions and/or Special Hazards

N/A

NFPA Rating* **N/A** Health ___ Flammability ___ Reactivity ___ Special ___

HMS Rating* 4-Severe; 3-Serious; 2-Moderate; 1-Slight; 0-Minimum
Health 1 Flammability 0 Reactivity 0 Personal Protection N/A

Optional*

SECTION 4 - REACTIVITY HAZARD DATA

STABILITY

- Stable
 Unstable

Conditions
To Avoid

N/A

Incompatibility
(Materials to Avoid)

Contact with strong acids. Do not mix with bleach. Do not expose to high heat.

Hazardous
Decomposition Products

Irritating of toxic substances may be emitted upon thermal decomposition. Carbon Dioxide gas could be toxic component.

HAZARDOUS POLYMERIZATION

- May Occur
 Will Not Occur

Conditions
To Avoid

N/A

SECTION 5 - HEALTH HAZARD DATA

PRIMARY ROUTES OF ENTRY

- Inhalation
 Skin Absorption

- Eyes
 Ingestion

CARCINOGEN LISTED IN

- NTP
 IARC Monograph
- OSHA
 Not Listed

HEALTH HAZARDS

Acute

Respiratory irritation/distress; eye irritation.

Chronic

None

Signs and Symptoms
of Exposure

N/A

Medical Conditions

Generally Aggravated by Exposure N/A

EMERGENCY FIRST AID PROCEDURES -

Eye Contact

Immediately Flush eyes with large amounts of water for at least 15 minutes holding lids apart to ensure flushing of the entire surface of eye and lids. Do not attempt to neutralize with chemical agents. Obtain medical attention.

Skin Contact

Wipe or brush off as much as possible. Wash with running water. Seek medical attention if irritation occurs.

Inhalation

Remove to fresh air.

Ingestion

Do not induce vomiting. Drink large quantities of water. If vomiting does occur, give fluids again. Seek medical attention. Never give anything to an unconscious or convulsing person.

SECTION 6 - CONTROL AND PROTECTIVE MEASURES

Respiratory Protection
(Specify Type)

Wear dust respirator

Protective Gloves

Use general rubber gloves.

Eye Protection

Chemical goggles or safety glasses.

VENTILATION TO BE USED

- Local Exhaust
 Mechanical (general)
 Special

Other (specify)
Normal room ventilation for regular use.

Other Protective
Clothing and Equipment

N/A

Hygienic Work
Practices

N/A

SECTION 7 - PRECAUTIONS FOR SAFE HANDLING AND USE/LEAK PROCEDURES

Steps to be Taken If Material
Is Spilled Or Released

Sweep up spilled material being careful not to create dust. Place in a chemical waste container for disposal.

Waste Disposal
Methods

In accordance with federal, state, and local regulations.

Precautions to be Taken
in Handling and Storage

Store in a cool dry place. Do not store in a hot environment.

Other Precautions and/or Special Hazards

N/A

NFPA Rating* Health N/A Flammability Reactivity Special

HMIS Rating* 4-Severe; 3-Serious; 2-Moderate; 1-Slight; 0-Minimum
Health N/A Flammability N/A Reactivity N/A Personal Protection N/A

Optional*

SECTION 4 - REACTIVITY HAZARD DATA

STABILITY

- Stable
 Unstable

Conditions
To Avoid

Incompatibility
(Materials to Avoid)

Ammonia, Reactive Metals and other Reducing Agents.

Hazardous
Decomposition Products

N/A

HAZARDOUS POLYMERIZATION

- May Occur
 Will Not Occur

Conditions
To Avoid

Incompatibles, Direct Light, Heat

SECTION 5 - HEALTH HAZARD DATA

PRIMARY ROUTES OF ENTRY

- Inhalation
 Skin Absorption
 Ingestion
 Not Hazardous

CARCINOGEN LISTED IN

- NTP
 IARC Monograph
 OSHA
 Not Listed

HEALTH HAZARDS

Acute

May Cause Mild Irritation and Brown Staining.

Chronic

May Cause Nose and Throat Irritation.

Signs and Symptoms
of Exposure

May Cause "Red Eye" with Tearing, Headaches, Rash.

Medical Conditions

Generally Aggravated by Exposure **Might Aggravate Lung and Heart Disease.**

EMERGENCY FIRST AID PROCEDURES - Seek medical assistance for further treatment, observation and support if necessary.

Eye Contact

Flush with Water for at Least 15 Minutes. Seek Medical Assistance.

Skin Contact

Flush with Soap and Water. If Available Rinse with a 5% Sodium Thiosulfate Solution. Seek Medical Assistance.

Inhalation

Remove to Fresh Air. If Breathing is Difficult, Administer Oxygen. Use Artificial Respiration if not Breathing.

Ingestion

Do Not Induce Vomiting. Seek Medical Assistance.

SECTION 6 - CONTROL AND PROTECTIVE MEASURES

Respiratory Protection
(Specify Type)

Cartridge or Can Vapor Respirator, Supplied Air, Self-Contained.

Protective Gloves

Rubber or Neoprene

Eye Protection

Splash Goggles as Necessary.

VENTILATION TO BE USED

- Local Exhaust
 Mechanical (general)
 Special
 Other (specify)

Other Protective
Clothing and Equipment

Wear Protective Clothing Adequate to Completely Cover Skin.

Hygienic Work
Practices

SECTION 7 - PRECAUTIONS FOR SAFE HANDLING AND USE/LEAK PROCEDURES

Steps to be Taken If Material
Is Spilled Or Released

Absorb with Sand or Inert Material.

Waste Disposal
Methods

Sweep or Scoop into Disposable Container.

Precautions to be Taken
in Handling and Storage

Store in Cool, Dry, Well-Ventilated Area, away from Incompatible Materials. Keep Out of Bright Light.

Other Precautions and/or Special Hazards

NFPA
Rating* Health ____ Flammability ____ Reactivity ____ Special ____

HMIS
Rating* Health 2 Flammability 0 Reactivity 1 Personal Protection C

Optional*

SECTION 4 - REACTIVITY HAZARD DATA

STABILITY

- Stable
 Unstable

Conditions
To Avoid

Freezes At Cool Temperature; Light Sensitive

Incompatibility
(Materials to Avoid)

N/A

Hazardous
Decomposition Products

Thermal Decomposition or Burning May Produce SO₂.

HAZARDOUS POLYMERIZATION

- May Occur
 Will Not Occur

Conditions
To Avoid

SECTION 5 - HEALTH HAZARD DATA

PRIMARY ROUTES OF ENTRY

- Inhalation
 Skin Absorption
 Ingestion
 Not Hazardous

CARCINOGEN LISTED IN

- NTP
 IARC Monograph
 OSHA
 Not Listed

HEALTH HAZARDS

Acute

No Relevant Data Known.

Chronic

No Information Found.

Signs and Symptoms
of Exposure

Medical Conditions

Generally Aggravated by Exposure Possibly Skin, Eye, Liver, Kidney or Respiratory Problems.

EMERGENCY FIRST AID PROCEDURES - Seek medical assistance for further treatment, observation and support if necessary.

Eye Contact

Wash Eyes With Plenty of Water for at Least 15 Minutes. If Irritation Develops, get Medical Attention.

Skin Contact

Wash Exposed Area with Soap and Water. Get Medical Advice if Irritation Develops.

Inhalation

Not Applicable.

Ingestion

Induce Vomiting By Giving Two Glasses of Water and Sticking Finger Down Throat, Call Physician.

SECTION 6 - CONTROL AND PROTECTIVE MEASURES

Respiratory Protection
(Specify Type)

N/A

Protective Gloves

Yes

Eye Protection

Goggles

VENTILATION TO BE USED

- Local Exhaust
 Mechanical (general)
 Special
 Other (specify)

Other Protective
Clothing and Equipment

Access to Eye Wash Equipment.

Hygienic Work
Practices

Change Clothing if Contaminated with the Product. Wash after Handling.

SECTION 7 - PRECAUTIONS FOR SAFE HANDLING AND USE/LEAK PROCEDURES

Steps to be Taken If Material
Is Spilled Or Released

Cover With Vermiculite or Absorbent and Dispose (Preferably in A Metal Container) with Waste Going to Approved Facilities.

Waste Disposal
Methods

As Permitted Under Appropriate Federal, State, and Local Regulations.

Precautions to be Taken
in Handling and Storage

Keep Tightly Closed and Protected from Light. Store in A Moderately Warm Place (Above 20°C). Wash Thoroughly after Handling.

Other Precautions and/or Special Hazards

Crystallization Might Occur at Low Temperatures. The Crystals will Redissolve Upon Warming The Solution.

NFPA
Rating* Health ___ Flammability ___ Reactivity ___ Special ___

HMIS
Rating* Health 1 Flammability 0 Reactivity 0 Personal Protection C

Optional*

Material Safety Data Sheet

SKLAR POLISH

Identity (Trade Name As Used On Label)

Sklar Instruments

Distributor

889 South Matlack Street

Address

West Chester, PA 19382

(610) 430-3200

Phone Number (For Information)

Chem-Trec 1-800-424-9300

Emergency Phone Number

Telex*

N/A

MSDS Number*

N/A

CAS Number*

October 1, 1999

Date Prepared

Sklar Instruments

Prepared By:

Note: Blank spaces are not permitted. If any item is not applicable, or no information is available, the space must be marked to indicate that.

SECTION 1 - MATERIAL IDENTIFICATION AND INFORMATION

COMPONENTS—Chemical Name & Common Names (Hazardous Components 1% or greater; Carcinogens 0.1% or greater)	%*	OSHA PEL	ACGIH TLV	OTHER LIMITS RECOMMENDATIONS
Citric Acid (CAS #77-92-9)	<15	N/E	N/E	
*Unidentified ingredients are not considered hazardous under the Federal Hazard Communication Standard (29 CFR 1910,1200).				
Non-Hazardous Ingredients				
Total	100			

SECTION 2 - PHYSICAL/CHEMICAL CHARACTERISTICS

Boiling Point	N/A	Specific Gravity (H ₂ O = 1)	Unknown
Vapor Pressure (mm Hg and Temperature)	N/A	Melting Point	N/A
Vapor Density (Air = 1)	N/A	Evaporation Rate (_____ = 1)	N/A
Solubility in Water	Slight	Water Reactive	N/A
		pH	5% solution <2.2
Appearance and Odor	Blue Powder, Odorless		

SECTION 3 - FIRE AND EXPLOSION HAZARD DATA

Flash Point and Method Used	N/A	Auto-Ignition Temperature	None	Flammability Limits in Air % by Volume		LEL	N/A	UEL	N/A
Extinguisher Media	Water or as for primary cause of fire.								
Special Fire Fighting Procedures	No special procedures required.								
Unusual Fire and Explosion Hazards	None Known.								

*Optional

SECTION 4 - REACTIVITY HAZARD DATA

STABILITY

- Stable
 Unstable

Conditions
To Avoid

None Known

Incompatibility
(Materials to Avoid)

Usual incompatibilities of organic acids.

Hazardous
Decomposition Products

None Known

HAZARDOUS POLYMERIZATION

- May Occur
 Will Not Occur

Conditions
To Avoid

None Known

SECTION 5 - HEALTH HAZARD DATA

PRIMARY ROUTES OF ENTRY

- Inhalation
 Skin Absorption
 Ingestion
 Not Hazardous

CARCINOGEN LISTED IN

- NTP
 IARC Monograph
 OSHA
 Not Listed

HEALTH HAZARDS

Acute
None Known

Chronic
None Known

Signs and Symptoms
of Exposure

Can cause minor skin and eye irritation. Inhalation of dust can cause irritation of nose, throat and respiratory tract.

Medical Conditions
Generally Aggravated by Exposure

N/A

EMERGENCY FIRST AID PROCEDURES - Seek medical assistance for further treatment, observation and support if necessary.

Eye Contact

Flush eyes with water. If irritation develops, get medical attention.

Skin Contact

Flush with water. If irritation develops, get medical attention.

Inhalation

Remove to fresh air.

Ingestion

Do not induce vomiting. Give large amounts of water to dilute material.

SECTION 6 - CONTROL AND PROTECTIVE MEASURES

Respiratory Protection
(Specify Type)

NIOSH approved dust mask.

Protective Gloves

Rubber or plastic.

Eye Protection

Safety goggles.

VENTILATION TO BE USED

- Local Exhaust
 Mechanical (general)
 Special
 Other (specify)

Other Protective
Clothing and Equipment

As required to minimize skin contact.

Hygienic Work
Practices

N/A

SECTION 7 - PRECAUTIONS FOR SAFE HANDLING AND USE/LEAK PROCEDURES

Steps to be Taken If Material
Is Spilled Or Released

Recover by vacuum or broom and shovel. Flush area with water to remove final traces.

Waste Disposal
Methods

Dispose of in approved landfill or neutralize and flush to drain. Any disposal method must comply with all applicable federal, state and local regulations.

Precautions to be Taken
in Handling and Storage

Store container in a cool, dry area. Keep container closed when not in use. Aqueous solutions can, if in contact with reactive metal (iron, zinc, aluminum), form hydrogen which may form explosive mixtures.

Other Precautions and/or Special Hazards

None

NFPA **N/A**
Rating* Health ___ Flammability ___ Reactivity ___ Special ___

HMIS **N/A**
Rating* Health ___ Flammability ___ Reactivity ___ Personal Protection ___

Optional*

SECTION 4 - REACTIVITY HAZARD DATA

STABILITY

- Stable
 Unstable

Conditions
To Avoid

Avoid temperatures above 120°F and evaporation of water.

Incompatibility
(Materials to Avoid)

Acids and alkalines will neutralize active ingredient.

Hazardous
Decomposition Products

Oxides of carbon

HAZARDOUS POLYMERIZATION

- May Occur
 Will Not Occur

SECTION 5 - HEALTH HAZARD DATA

PRIMARY ROUTES OF ENTRY

- Eye
 Skin Absorption
 Inhalation
 Ingestion

CARCINOGEN LISTED IN

- No
 NTP
 IARC Monograph
 OSHA
 Not Listed

HEALTH HAZARDS

Acute
None Known.

Chronic
None Known.

Signs and Symptoms
of Exposure

See Above Health Hazards.

Medical Conditions
Generally Aggravated by Exposure

None Known.

EMERGENCY FIRST AID PROCEDURES - Seek medical assistance for further treatment, observation and support if necessary.

Eye Contact

Flush with water for 15 minutes. If irritation persists, seek medical attention.

Skin Contact

Wash skin with soap and water.

Inhalation

Remove to fresh air. If irritation persists, seek medical attention.

Ingestion

Do not induce vomiting. Give large amounts of water. Seek medical attention.

SECTION 6 - CONTROL AND PROTECTIVE MEASURES

Respiratory Protection
(Specify Type)

Use in a well ventilated area.

Protective Gloves

Not required if used as directed.

Eye Protection

Not required if used as directed.

VENTILATION TO BE USED

- Local Exhaust
 Mechanical (general)
 Special
 Other (specify)

Other Protective
Clothing and Equipment

Gloves if sensitive.

Hygienic Work
Practices

Handle in accordance with good personal hygiene and safety practices. These practices include avoiding unnecessary exposure.

SECTION 7 - PRECAUTIONS FOR SAFE HANDLING AND USE/LEAK PROCEDURES

Steps to be Taken If Material
Is Spilled Or Released

Ventilate area. Wipe up or rinse with tap water.

Waste Disposal
Methods

Flush thoroughly with water into sewage disposal system in accordance with federal, state, and local regulations.

Do not reuse empty container. Wrap container and put in trash.

Precautions to be Taken
in Handling and Storage

Store product in original sealed container at room temperature.

Other Precautions and/or Special Hazards

Keep out of reach of children. Do not ingest. Avoid skin and eye contact. Avoid contamination of food.

NFPA **N/A**
Rating* Health ___ Flammability ___ Reactivity ___ Special ___

HMIS Index: 4-Severe Hazard; 3-Serious Hazard; 2-Moderate Hazard; 1-Slight Hazard
Rating* Health 1 Flammability 2 Reactivity 0 Personal Protection N/A

Optional*

Material Safety Data Sheet

SKLAR ZYME

Identity (Trade Name As Used On Label)

Sklar Instruments

Distributor

889 South Matlack Street

Address

West Chester, PA 19382

(610) 430-3200

Phone Number (For Information)

(604) 940-9955

Emergency Phone Number

Telex*

N/A

MSDS Number*

N/A

CAS Number*

December 10, 1999

Date Prepared

Sklar Instruments

Prepared By:

Note: Blank spaces are not permitted. If any item is not applicable, or no information is available, the space must be marked to indicate that.

SECTION 1 - MATERIAL IDENTIFICATION AND INFORMATION

COMPONENTS—Chemical Name & Common Names (Hazardous Components 1% or greater; Carcinogens 0.1% or greater)	%*	OSHA PEL	ACGIH TLV	OTHER LIMITS RECOMMENDATIONS
No Hazardous Material				
*Unidentified ingredients are not considered hazardous under the Federal Hazard Communication Standard (29 CFR 1910,1200).				
Non-Hazardous Ingredients				
Total				

SECTION 2 - PHYSICAL/CHEMICAL CHARACTERISTICS

Boiling Point	100 d.C.	Specific Gravity (H2O = 1)	1.05
Vapor Pressure (mm Hg and Temperature)	N/A	Melting Point	N/A
Vapor Density (Air = 1)	N/A	Evaporation Rate (_____ = 1)	N/A
Solubility in Water	N/A	Water Reactive	N/A
Appearance and Odor	Liquid, Blue in color, sea spray fragrance		
		pH	N/A

SECTION 3 - FIRE AND EXPLOSION HAZARD DATA

Flash Point and Method Used	N/A	Auto-Ignition Temperature	N/A	Flammability Limits in Air % by Volume	N/A	LEL	N/A	UEL	N/A
Extinguisher Media	N/A								
Special Fire Fighting Procedures	N/A								
Unusual Fire and Explosion Hazards	None								

*Optional

SECTION 4 - REACTIVITY HAZARD DATA

STABILITY

- Stable
 Unstable

Conditions
To Avoid

N/A

Incompatibility
(Materials to Avoid)

None

Hazardous
Decomposition Products

N/A

HAZARDOUS POLYMERIZATION

- May Occur
 Will Not Occur

Conditions
To Avoid

N/A

SECTION 5 - HEALTH HAZARD DATA

PRIMARY ROUTES OF ENTRY

- Inhalation
 Skin Absorption
 Ingestion
 Not Hazardous

CARCINOGEN LISTED IN

- NTP
 IARC Monograph
 OSHA
 Not Listed

HEALTH HAZARDS

Acute
None Known

Chronic
None Known

Signs and Symptoms
of Exposure

None Known

Medical Conditions
Generally Aggravated by Exposure

None Known

EMERGENCY FIRST AID PROCEDURES -

Eye Contact

Flush with plenty of water

Skin Contact

Inhalation

Ingestion

Ingestion of larger amounts may cause diarrhea

SECTION 6 - CONTROL AND PROTECTIVE MEASURES

Respiratory Protection
(Specify Type)

Not required

Protective Gloves

Not required

Eye Protection

Not required but avoid exposure.

VENTILATION TO BE USED

- Local Exhaust
 Mechanical (general)
 Special
 Other (specify)

No special ventilation required.

Other Protective
Clothing and Equipment

Not required

Hygienic Work
Practices

Normal

SECTION 7 - PRECAUTIONS FOR SAFE HANDLING AND USE/LEAK PROCEDURES

Steps to be Taken If Material
Is Spilled Or Released

Rinse area with water to avoid slippery surface hazard.

Waste Disposal
Methods

Flush with water. No special action required. Can be dischard down sewer line.

Precautions to be Taken
in Handling and Storage

Store in dry cool area. Protect from freezing.

Other Precautions and/or Special Hazards

None required

NFPA **N/A**
Rating* Health ___ Flammability ___ Reactivity ___ Special ___

HMIS **N/A**
Rating* Health ___ Flammability ___ Reactivity ___ Personal Protection ___

Optional*

SklarZyme

Multi Enzyme Based Instrument Presoak & Cleaner

Low PH

Sklarzymes low PH formula insures its safe use on all surfaces including fiber optic equipment, rubber, plastic, stainless steel.

Pleasant Fragrance and Color

Sklarzyme is a clean blue with a pleasant sea spray fragrance.

High Active Formula

Sklarzyme is not a single or dual enzyme. It is a multi enzyme formula with a high percentage of actives allowing Sklarzyme to serve as a presoak for manual decontamination, ultrasonics and scope washers.

Economical

Sklarzyme is a one ounce per gallon dilution and is packaged in 4 liter containers that contain 5% more product than U.S. gallons.

Low Foaming

Sklarzymes low foaming formula has made it the number one choice for use by major hospitals in their scope washers and ultrasonics. Low foam insures proper dilutions can be used for proper cleaning.

Cleans Quickly and Completely

Sklarzymes unique multi enzyme formula quickly dissolves and suspends all organic soils, even in crevices and hard to reach areas such as lumens and channels and is effective in cold water and temperatures up to 130 degrees fahrenheit.

Environmentally Safe

Sklarzyme is a proprietary blend of amino acid enzymes and is not a hazardous material. Used solutions may be safely disposed down the drain. The container has been classified as a 2 within the chasing arrows identifying high density polyethylene, a plastic that can be recycled.

Effective and Safe on

Flexible and Rigid Endoscopes,
all Accessories with Lumens and
Medical Instruments.