



Plastic Surgery Instruments



800.221.2166 | www.sklarcorp.com



TABLE OF CONTENTS

Terms and Conditions	3	Mouth Gags	129-131
Cannulas-Suction	4-12	Punches	132-133
Raspatories	13-15	Probes	134-137
Elevators	16-21	Drills	138
Dissectors.....	22-26	Cutting Instruments	139-146
Chisels-Tamps-Levers	27-29	Suturing	147-151
Osteotomes	30-33	Microsurgery	152-172
Gouges	34-35	Electrosurgery	173-184
Mallets	36-39	Disposables	185-189
Ronguers	40-41	ID	190-191
Bone Holding Forceps	42	Care and Cleaning	192-206
Bone Cutters.....	43-44		
Saws	45		
Curettes	46-48		
Retractors	49-56		
Hooks	57-69		
Forceps	70-83		
Scissors	84-92		
Needleholders	93-97		
Rhinoplasty	98-120		
Mammoplasty.....	121-125		
Cleft Palate	126-128		



© Copyright 2015.
 Sklar Corporation, West Chester, PA. All rights reserved. No portion of this catalog may be reproduced without written permission of Sklar.

DISCLAIMERS:

Sklar offers a full line of quality surgical products and services to meet your needs.

Product information within this catalog is intended to provide general information about Sklar, its products and services and makes no representation either expressed or implied to the contrary. It is not meant to provide specialist advice or instructions concerning the products available from Sklar. For additional information and special inquiries concerning our products and services, please contact Sklar directly.

In an effort to continually improve our product line, Sklar reserves the right to change patterns without notice. Contact your sales representative to verify availability.

In no event is Sklar liable for any incidental, special or exemplary damages or loss of profits in connection with the use of a Sklar Instrument or Product.

Convenience Kits (FDA recognized term) illustrated in this catalog are representative of Sklar's assembly capability. The final design and approval of the kit is the responsibility of the customer and will be managed in accordance with the Sklar Design and Development process.

Sklar Corporation
889 S. Matlack Street
West Chester, PA 19382

Phone: 800.221.2166
Fax: 610.696.9007
Email: Surgi@sklarcorp.com

ORDERS

- Sklar's full line of Instrument Products are available through any authorized Sklar Distributor. Contact our Customer Service Department at 800.221.2166 to locate a Sales Representative in your area.
- Customers with established accounts and in good standing are subject to Net 30 days from date of invoice. Poor credit conditions can result in denial, delay or cancellation of orders.

SHIPMENTS

- Pricing is FOB West Chester PA unless otherwise noted and may be subject to change. Shipping schedules are approximate and subject to change without notice. Same day shipping is available. Standard orders will be shipped via the carrier of Sklar's choice. Special shipping requests will be accepted but additional handling charges are applicable.
- All Sklar instruments and product are carefully inspected prior to shipment. Customers shall inspect all items upon receipt and file a claim within (10) days of receipt of shipment.

WARRANTY

- Instruments and Products are recommended for their intended use only, and require continuous and proper care. Misuse can damage instruments and products and void the warranty.
- All Sklar instruments are guaranteed to be free from defect in material and workmanship. Defective instruments may be returned for repair or replacement at no charge. Repair or replacement is at the discretion of Sklar. Warranty is void on any instrument serviced by any company other than Sklar Instrument Repair Services.
- Sklar offers a variety of supplementary surgical products. These products are held to high standards for material and craftsmanship and some are subject to a limited warranty (vary by product).

RETURNS

- Unused instruments returned in the original packaging will be accepted within 30 days of purchase. Standard sterile kits may be returned within 30 days provided sterility of the inner packs have not been compromised, package is unopened and resalable. Most cleaning products are non-returnable.
- Product that was special (engraved/etched) or custom ordered, discontinued, marked or altered in any way, including product or package labeling, will not be accepted for return or credit.
- A Returned Goods Authorization (RGA) number must be obtained prior to returning products. Contact Customer Service at 800.221.2166 for authorization. Credit, repair and/or replacement are at Sklar's discretion. See www.sklarcorp.com for complete return policy and procedures.



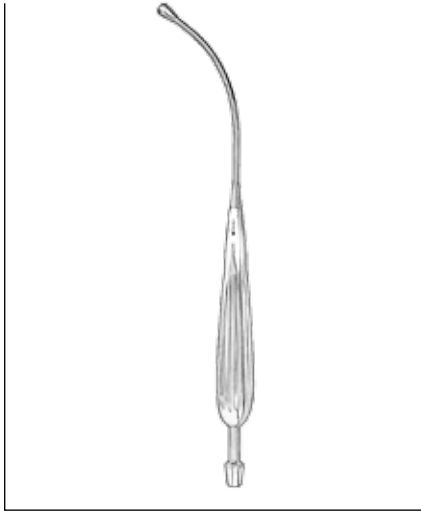

**ANDREWS-PYNCHON
SUCTION TUBE**

22-6590 10" Suction Tube
22-6591 Replacement Tip Only

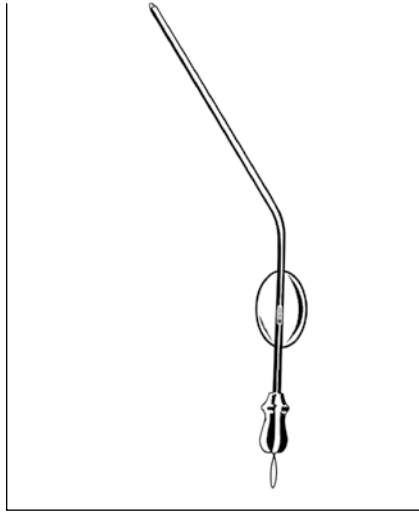

BARON SUCTION TUBES

50-1953 5½" 3 French
50-1955 5½" 5 French
50-1957 5½" 7 French

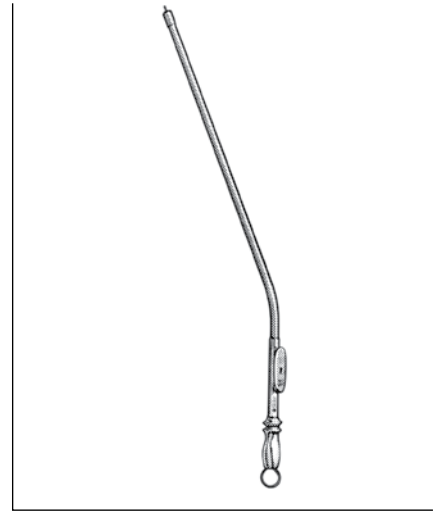

RHOTON-MERZ SUCTION TUBES

50-1870 3" 3 French
50-1871 3" 5 French
50-1872 3" 7 French
50-1873 3" 10 French
50-1874 4" 3 French
50-1875 4" 5 French
50-1876 4" 7 French
50-1877 4" 10 French
50-1878 4" 12 French
50-1879 5" 5 French
50-1880 5" 7 French
50-1881 5" 10 French

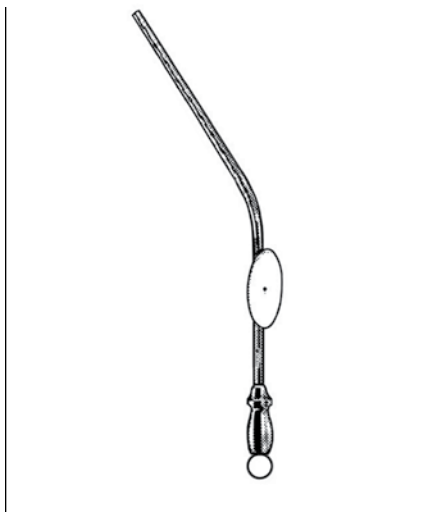

SCHUKNECHT SUCTION TUBES

50-1940 5" 20 Gauge
50-1941 5" 24 Gauge



NIJMEGAN SUCTION TUBES

50-1840 1.5mm
50-1841 2mm
50-1842 2.5mm
50-1843 3mm
50-1844 4mm

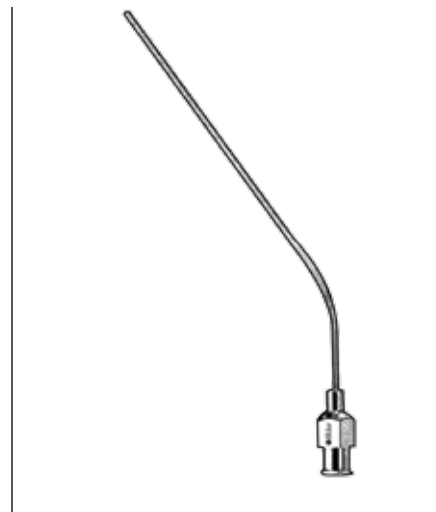

VERHOEVEN SUCTION TUBES

50-2320 4" 16 Gauge
50-2321 4" 18 Gauge
50-2322 4" 20 Gauge
50-2323 4" 22 Gauge
50-2324 4" 24 Gauge

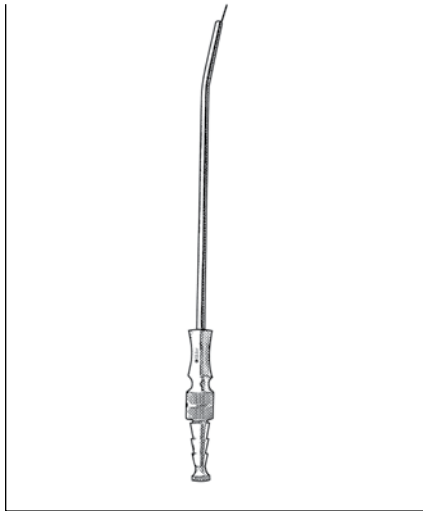

ADSON SUCTION TUBES

50-1982 6" 12 French
50-1985 7½" 15 French

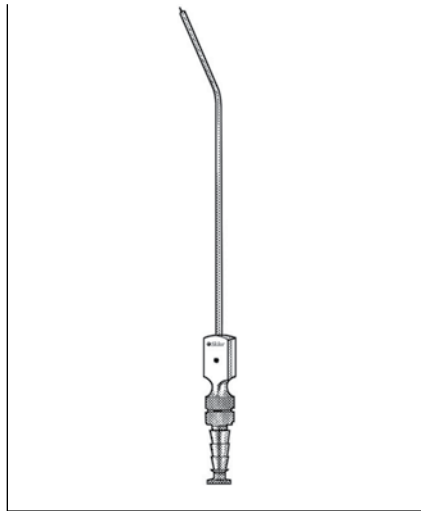

PLESTER SUCTION TUBES

50-1850 7½" 1.5mm
50-1851 7½" 2mm
50-1852 7½" 2.5mm
50-1853 7½" 3mm

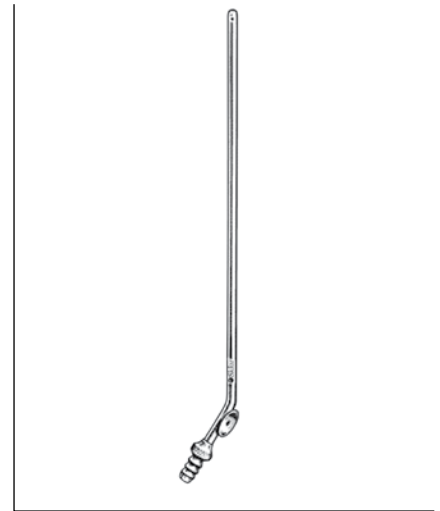

BUIE SUCTION TUBES

80-2715 16" With Valve 15 French
80-2815 16" Without Valve 15 French

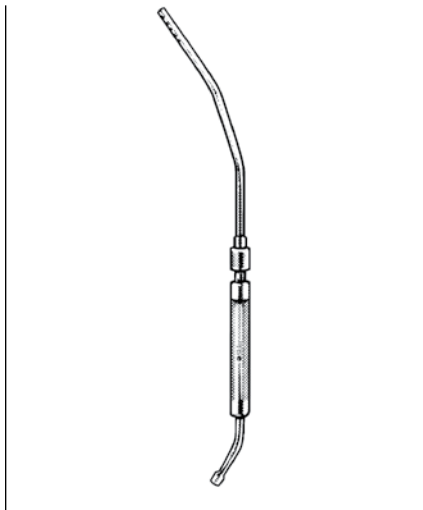

COOLEY SUCTION TUBE

07-1850 13¼" 24 French

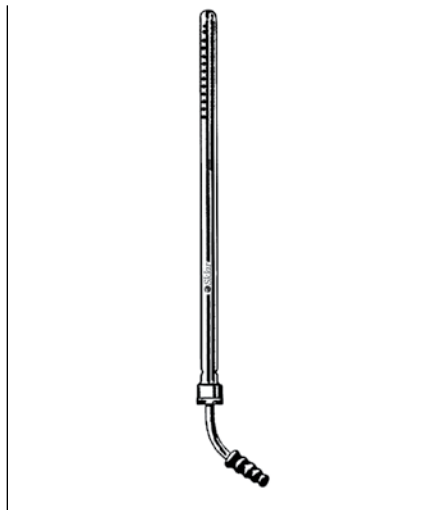

POOLE SUCTION TUBES

22-6577 7¾" 17 French
34-2023 9¼" 23 French

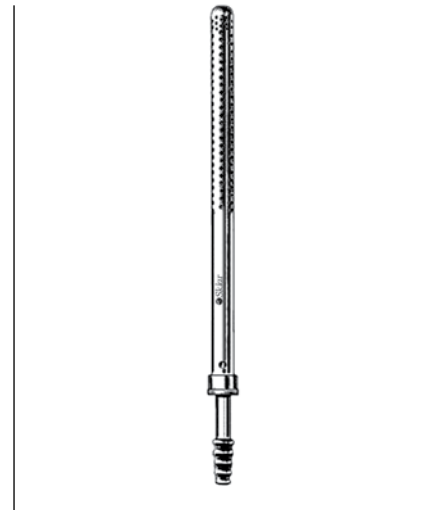

POOLE SUCTION TUBES

STRAIGHT
34-2230 8½" 30 French with Slip on End
34-2232 12" 32 French with Slip on End

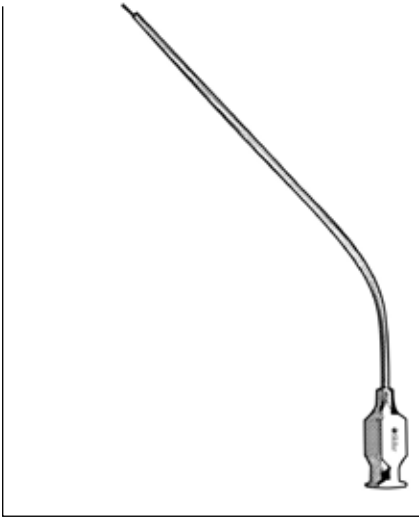

ROSEN SUCTION TUBES

50-1813	2½"	13 Gauge
50-1814	2½"	14 Gauge
50-1815	2½"	15 Gauge
50-1816	2½"	16 Gauge
50-1817	2½"	17 Gauge
50-1818	2½"	18 Gauge
50-1819	2½"	19 Gauge
50-1820	2½"	20 Gauge
50-1821	2½"	21 Gauge
50-1822	2½"	22 Gauge
50-1823	2½"	23 Gauge

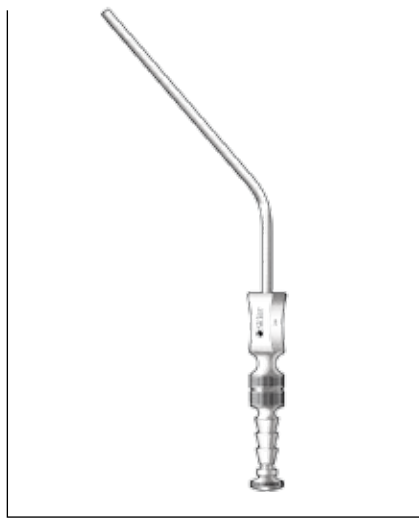

FRAZIER SUCTION TUBES

50-2006	6 French	50-2011	11 French
50-2007	7 French	50-2012	12 French
50-2008	8 French	50-2014	14 French
50-2009	9 French	50-2015	15 French
50-2010	10 French		



FRAZIER SUCTION TUBES

STRAIGHT WITH THUMB CONTROL

50-2106	6 French
50-2108	8 French
50-2109	9 French
50-2110	10 French
50-2112	12 French



FRAZIER SUCTION TUBES

90 DEGREE ANGLE, 5" WORKING LENGTH

50-2206	6 French
50-2207	7 French
50-2208	8 French
50-2210	10 French
50-2212	12 French

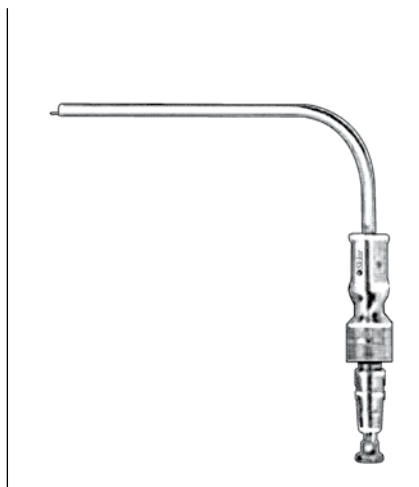

FERGUSSON SUCTION TUBES

50-2330	5 French
50-2331	6 French
50-2332	7 French
50-2333	8 French
50-2334	9 French
50-2335	10 French
50-2336	12 French

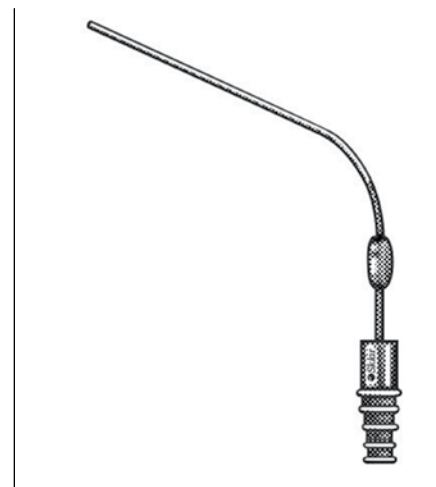

BARNES SUCTION TUBES

ANGLED

07-1830	2"	1.5mm
07-1831	2"	1.7mm
07-1832	2"	2mm

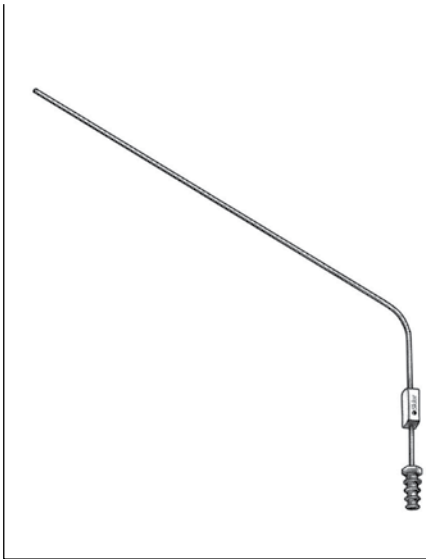

JAKO LARYNGEAL SUCTION TUBE

50-1977 8½" 7 French

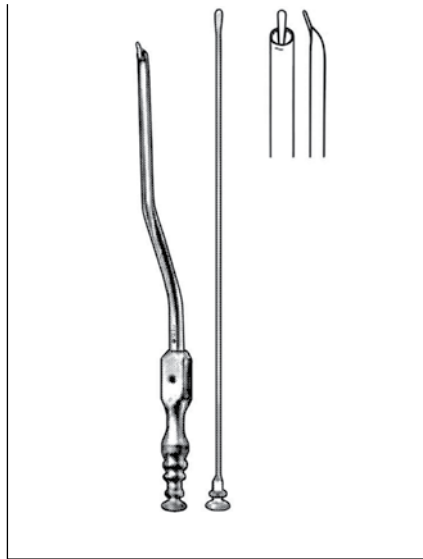

GUILLEN SUCTION TUBE

50-1995 7¾"

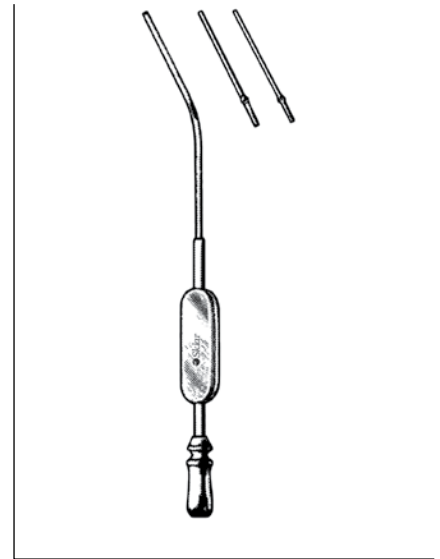

ZOELLNER EAR SUCTION TUBES

50-1950 With two Interchangeable Tips, 20 Gauge and 22 Gauge
 50-1948 20 Gauge Replacement Tip Only
 50-1949 22 Gauge Replacement Tip Only



YASARGIL SUCTION TUBES

50-2350	5"	1.5mm	50-2359	6"	2.5mm
50-2351	6"	1.5mm	50-2360	7"	2.5mm
50-2352	7"	1.5mm	50-2361	8¾"	2.5mm
50-2353	8¾"	1.5mm	50-2362	5"	3.5mm
50-2354	5"	2mm	50-2363	6"	3.5mm
50-2355	6"	2mm	50-2364	7"	3.5mm
50-2356	7"	2mm	50-2365	8¾"	3.5mm
50-2357	8¾"	2mm	50-2366	7"	4.5mm
50-2358	5"	2.5mm			

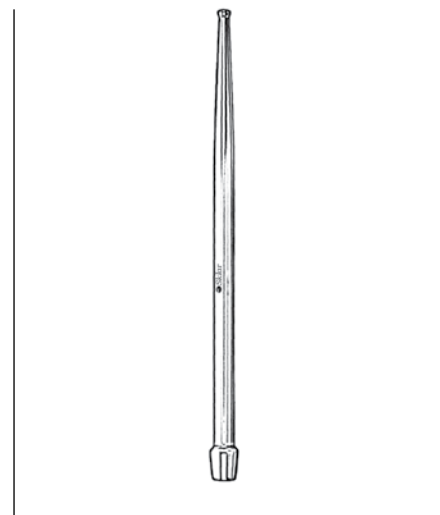

ANTHONY MASTOID SUCTION TUBES

50-2830	6½"	2mm	Lumen
50-2831	6½"	3mm	Lumen

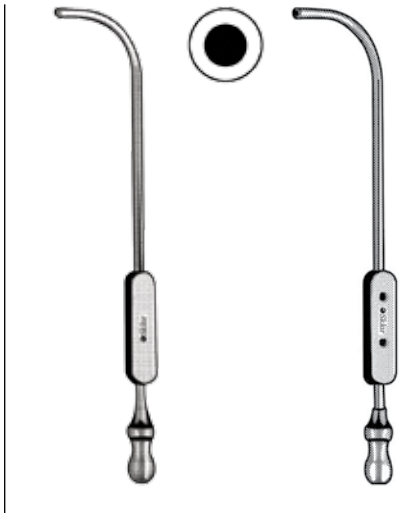

EICKEN IRRIGATING TUBES

WITH RECORD CONE

- 50-2230 6" 3mm
- 50-2232 6" 3mm, 2 Cut Off Holes

WITH LUER CONE

- 50-2231 6" 3mm
- 50-2233 6" 3mm, 2 Cut Off Holes
- 50-2234 6" 2mm
- 50-2235 6" 2mm, 45 Degree Angle
2 Cut Off Holes

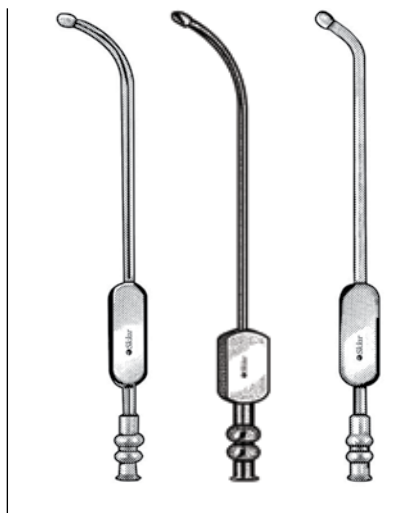

EICKEN IRRIGATING TUBES

SHORT CURVE

- 50-2236 6" 2.5mm
- 50-2237 6" 3mm
- 50-2238 6" 4mm

SHORT CURVE, WITH FINGER CUT OFF

- 50-2244 6" 2.5mm
- 50-2245 6" 3mm
- 50-2246 6" 4mm

LONG CURVE

- 50-2239 6" 2.5mm
- 50-2240 6" 3mm
- 50-2241 6" 4mm

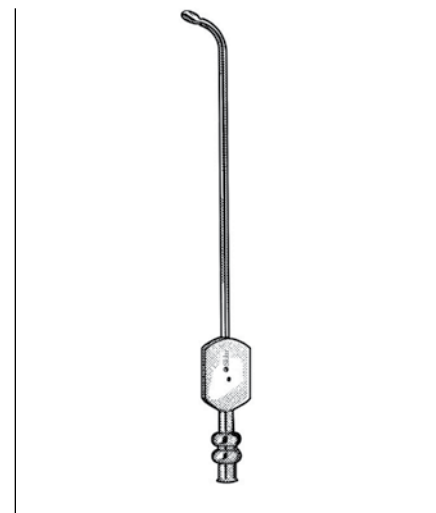

EICKEN IRRIGATING TUBES

LONG CURVE, WITH FINGER CUT OFF

- 50-2247 6" 2.5mm
- 50-2224 6" 3mm
- 50-2248 6" 4mm

LONG CURVE, WITH FINGER CUT OFF, MALLEABLE

- 50-2220 6" 2.5mm
- 50-2242 6" 3mm
- 50-2243 6" 4mm



BYRD CANNULAS

- 50-2260 8½" 1.5mm
- 50-2260 8½" 2.5mm
- 50-2260 8½" 3.5mm



NUBOER CANNULAS

- 50-2272 8¼" 6mm, Round Opening
- 50-2273 8¼" 6mm, Oval Opening

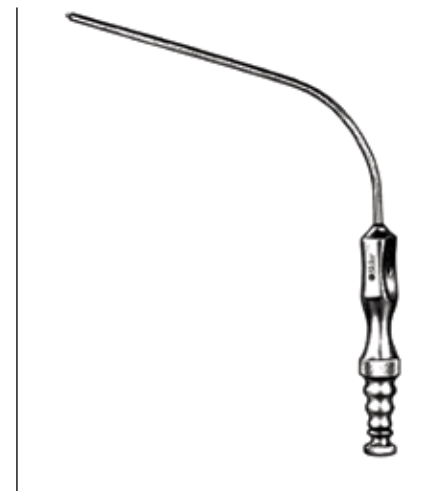

POPPEN CANNULAS

- 50-2274 6" 6 French
- 50-2275 6" 8 French
- 50-2276 6" 10 French
- 50-2277 6" 12 French

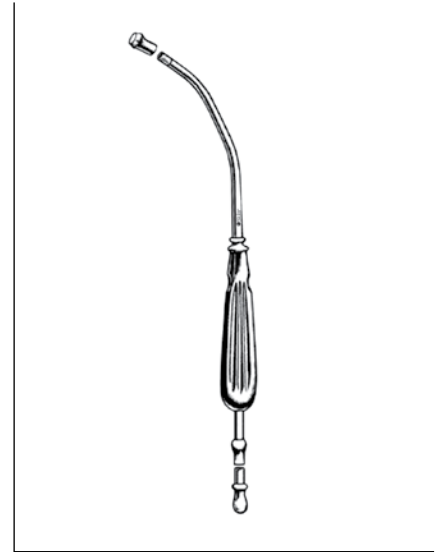
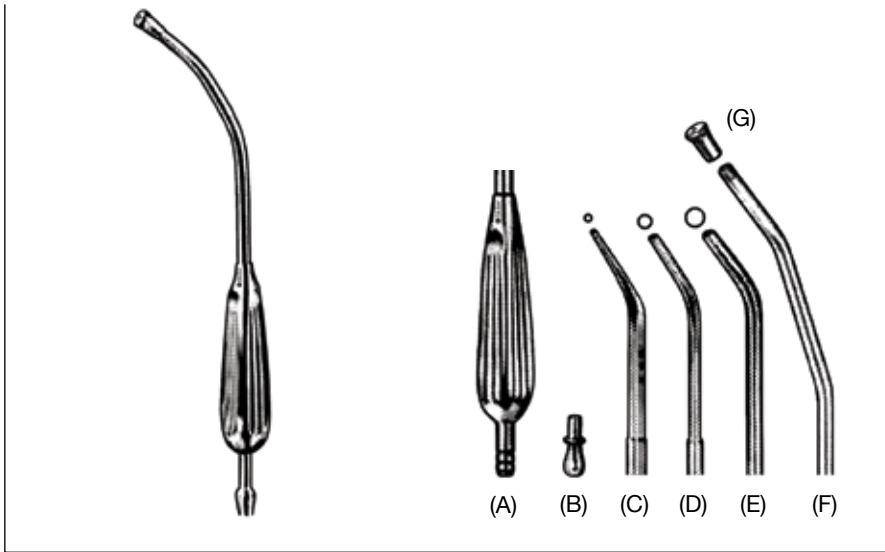

YANKAUER SUCTION CANNULAS

- 50-2292 11¼" 4.5mm Cannula Only
- 50-2293 11¼" 2mm Cannula Only
- 50-2295 12" 2mm Cannula, Suction Tip and Adaptor

- 50-2300 6" Handle (A)
- 50-2302 1" Adaptor Only (B)
- 50-2296 4" Tip, 1.3mm Hole (C)
- 50-2297 4" Tip, 2.3mm Hole (D)
- 50-2298 4" Tip, 3.3mm Hole (E)
- 50-2299 4" Tip, 6mm Hole (F)
- 50-2301 Suction Tip Replacement (G)
- 50-2294 Complete Set: Handle, 4 Tubes, 2mm Suction Tip and Adaptor

YANKAUER SUCTION CANNULAS

- HOLE 3.5MM**
- 07-1805 11" Cannula
 - 07-1806 Tip Only
 - 07-1807 15" Cannula
 - 22-6585 8½" Pediatric Cannula
 - 22-6586 Pediatric Tip Only
 - 07-1801 11" Chrome Cannula
 - 07-1802 Chrome Tip Only



KILLIAN WASH CANNULAS

- RECORD CONE**
- 50-2271 7", 2mm

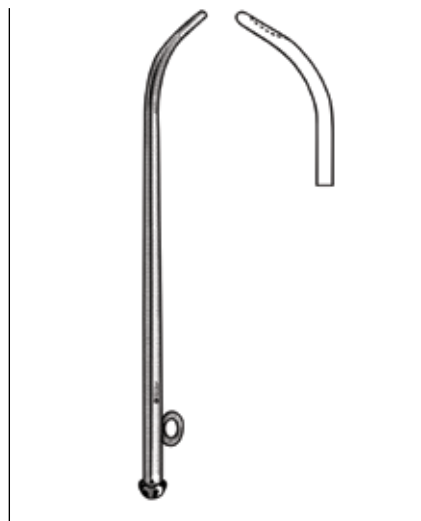

SIEBENMANN WASH CANNULAS

- SIDE PORT TOP**
- 50-2278 5" 2.5mm
 - 50-2279 5" 3mm
- SIDE PORT BOTTOM**
- 50-2280 5" 2.5mm
 - 50-2281 5" 3mm

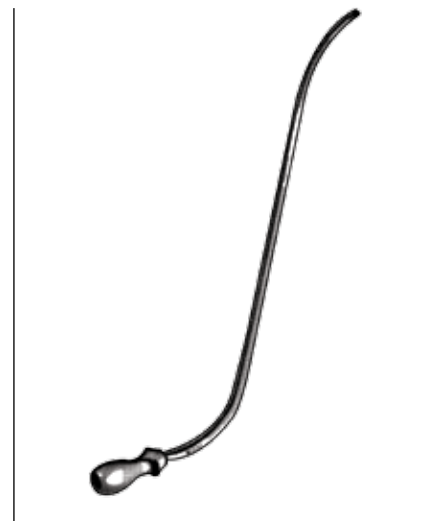

HARTMANN SINUS CANNULAS

- RECORD CONE**
- 50-2265 #1, Right Side
 - 50-2266 #2, Left Side

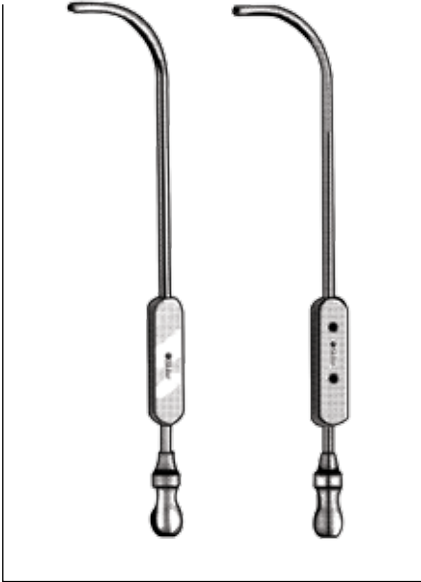

KILLIAN ANTRUM CANNULA

- 50-2267 6" 3mm
- 50-2268 6" 3.5mm
- 50-2269 6" #1, 2 Cut Off Holes
- 50-2270 6" #2, 2 Cut Off Holes

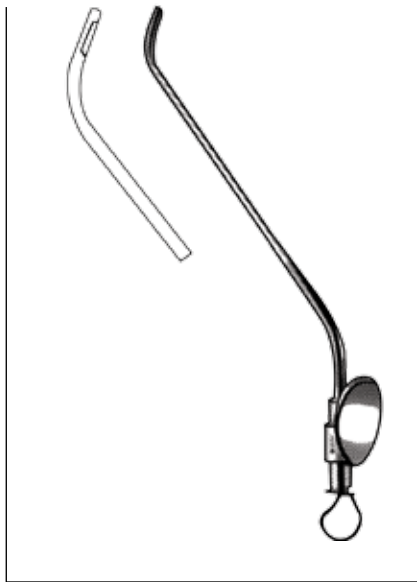

VAN ALYEA ANTRUM CANNULA

LUER LOCK

- 50-2284 4 3/4" #1
- 50-2285 4 3/4" #2



ANTRUM CANNULA

MALLEABLE, LUER LOCK, CURVED TIP

- 50-2306 6" 2.5mm
- 50-2307 6" 3mm
- 50-2308 6" 4mm

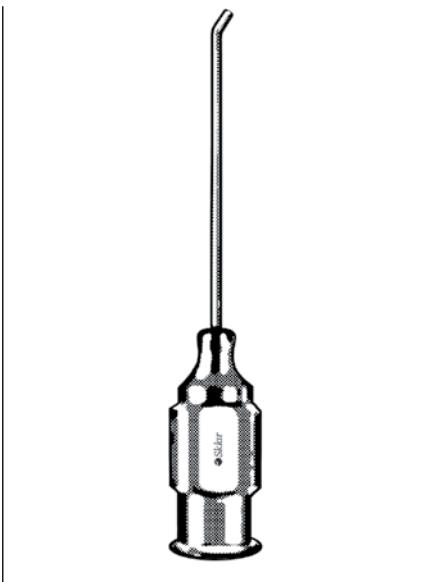

KNOLLE IRRIGATING CANNULA

- 66-6967 23 Gauge
- 66-6969 30 Gauge

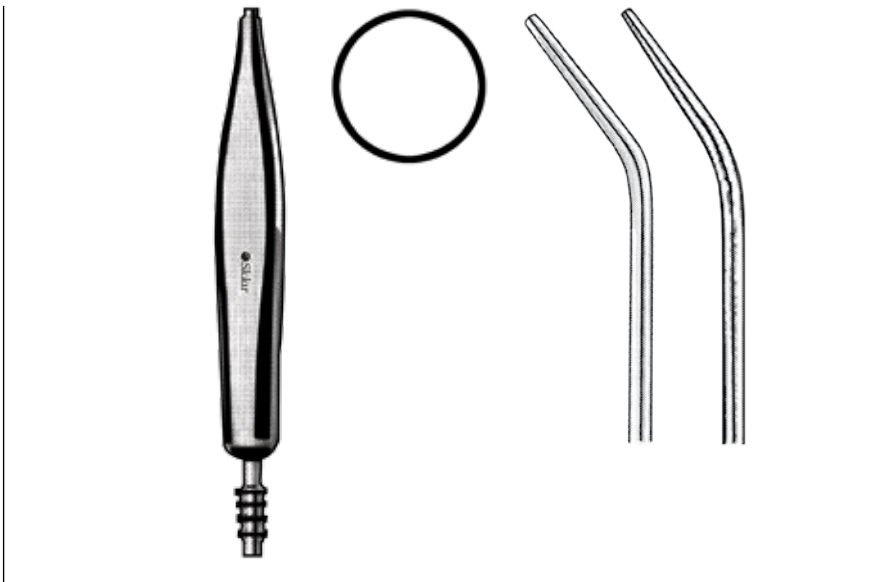

COUPLAND CANNULA

- 50-2250 4" 1.5mm
- 50-2251 4" 2mm
- 50-2252 4" 2.5mm
- 50-2253 4" 3.5mm
- 50-2254 4" 1.5mm with hole
- 50-2255 4" 2mm with hole
- 50-2256 4" 2.5mm with hole
- 50-2257 4" 3.5mm with hole
- 50-2825 6 1/2" Two Interchangeable Tips
- 50-2259 6 3/4" Suction Handle with Tube Connector

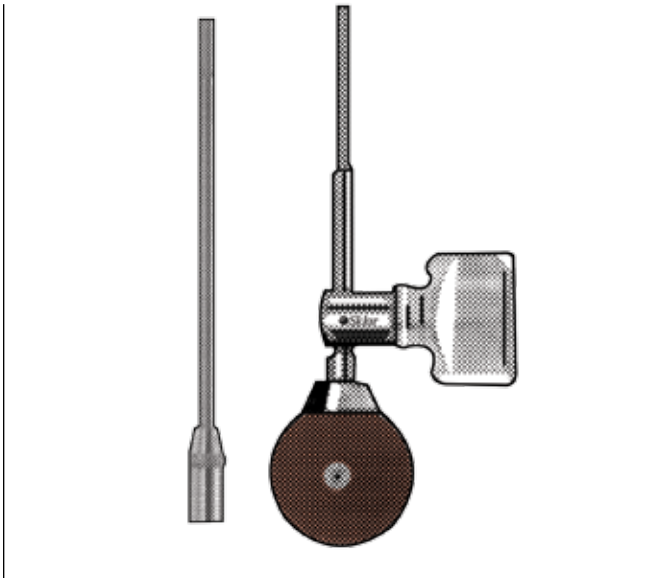

NASAL CANNULA

50-2305 4½", Straight



ASPIRATION TUBE SET

50-1920 Includes Handle and 8 Cannulas

HANDLE ONLY

50-1921 For Use with 50-1920

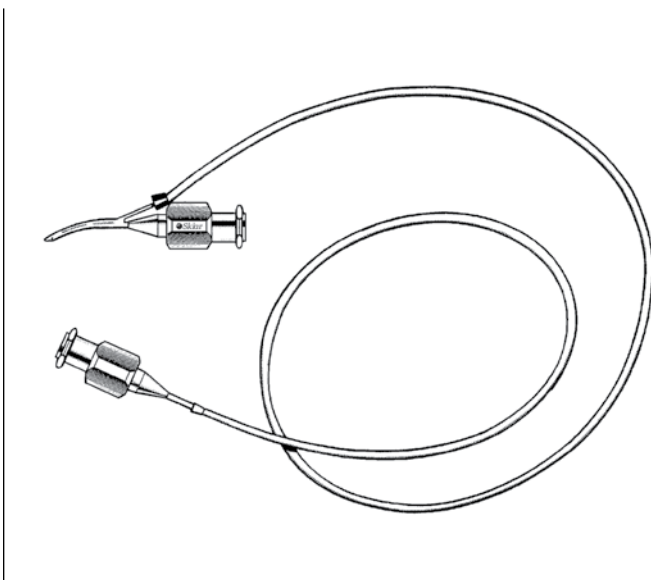

SIMCOE IRRIGATING/ASPIRATING CANNULA

REVERSE 15MM LONG

66-6930 23 Gauge T.W. x 23 gauge T.W. aspirating port facing into curve, aspiration on needle hub, irrigation in tubing hub

SIMCOE CANNULA

23 GAUGE THIN WALL

66-6932 Double barreled irrigating-aspirating

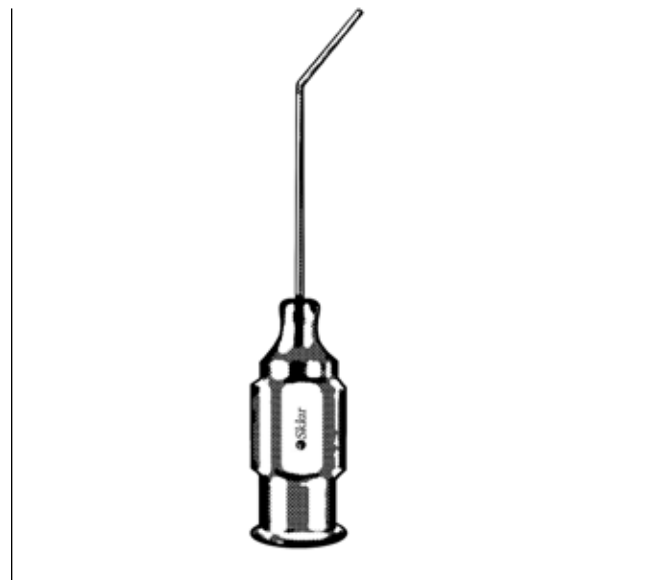

RAININ AIR INJECTION CANNULA

66-6903 27 Gauge

66-6901 30 Gauge

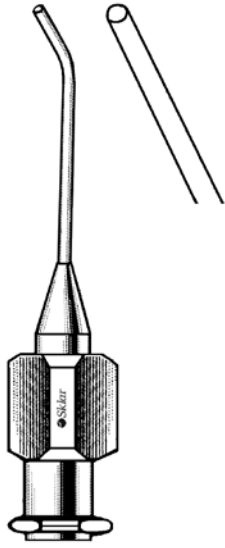

AIR INJECTION CANNULA

66-6900 27 Gauge
66-6902 30 Gauge

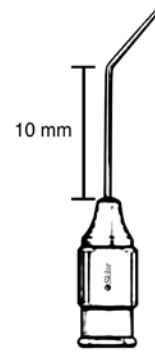
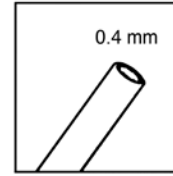

PIERCE HYDRODISSECTION CANNULA

66-6960 27 Gauge



SAUTER HYDRODISSECTION CANNULA

66-6965 27 Gauge

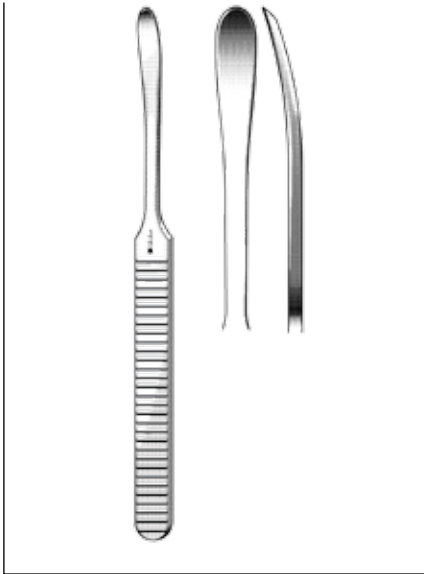

WILLIGER RASPATORY

SHARP, CURVED

40-7155 6¼"

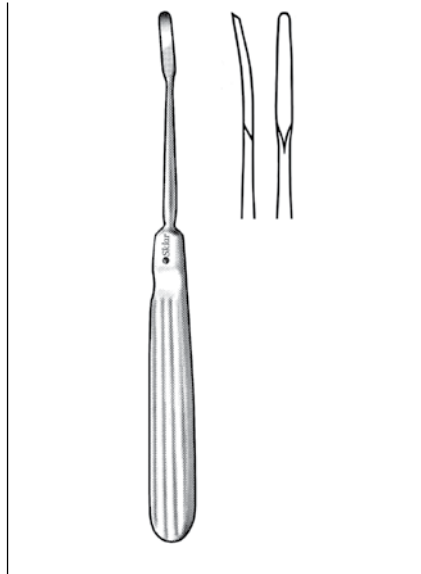

LEMPERT RASPATORIES

SHARP, SHORT BLADE, DELICATE

40-9054 6¾" 3.5mm

SHARP, DELICATE

40-9050 6¾" 2mm

40-9051 6¾" 3mm

40-9052 6¾" 4mm

40-9053 6¾" 5mm

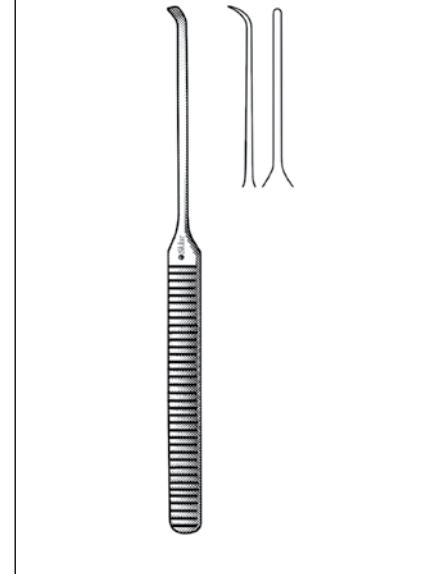

STEINHAUSER ORBITAL FLOOR RASPATORY

40-9872 6¾" 9mmx4mm

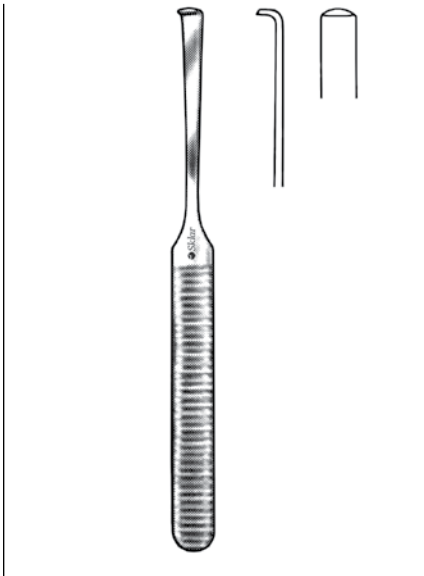

RASPATORIES

RIGHT ANGLED TIP

40-9900 6¼" 5mm

40-9901 6¼" 6mm

40-9902 6¼" 7mm

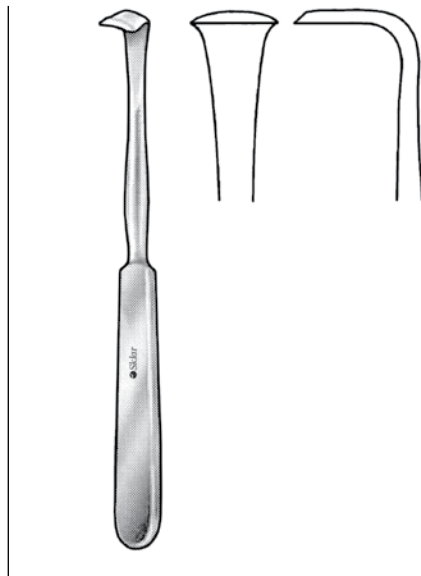

LANGENBECK RASPATORY

40-9068 7" Angled 90°

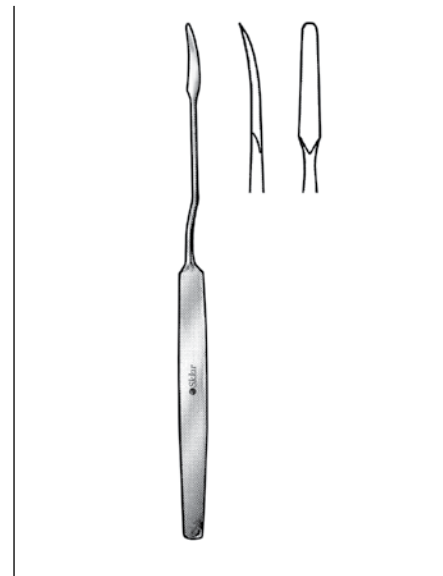

JOSEPH MASING SEPTUM RASPATORY

SHARP

40-9064 8¾" 4mm

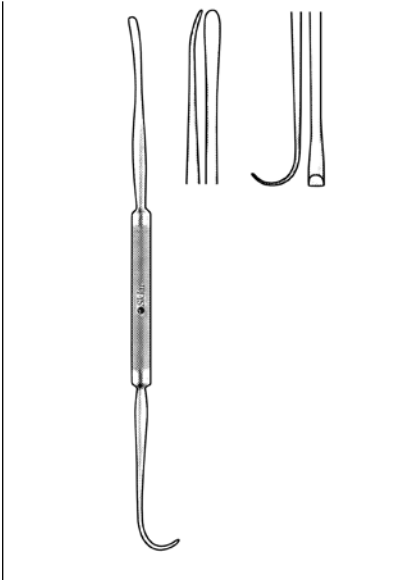

OBWEGESER FREER PERIOSTEAL ELEVATOR/RASPATORY

40-9849 8¼" Sharp/Blunt

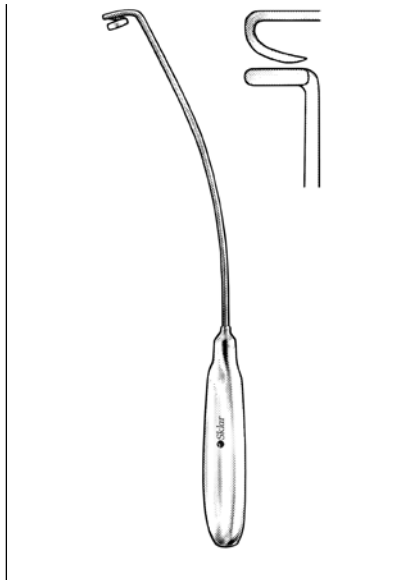

OBWEGESER RIB RASPATORIES

40-9860 11¾" Left
40-9861 11¾" Right

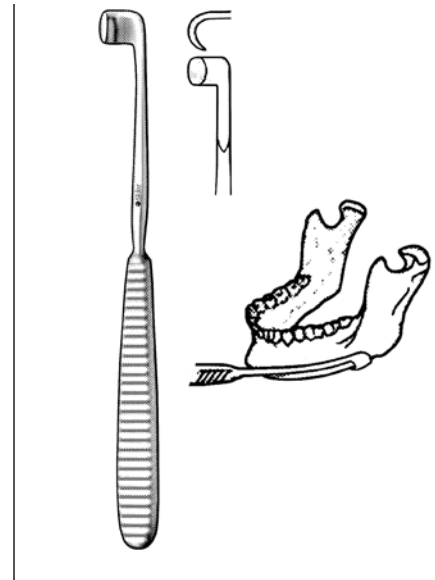

OBWEGESER MANDIBULAR RIM STRIPPERS

40-9862 7½" Left 8mm
40-9863 7½" Right 8mm

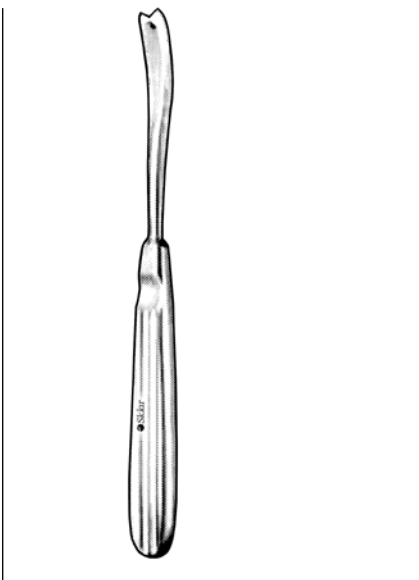

OBWEGESER PERIOSTEAL ELEVATOR/RASPATORY V NOTCH

40-9864 6¾" 9mm

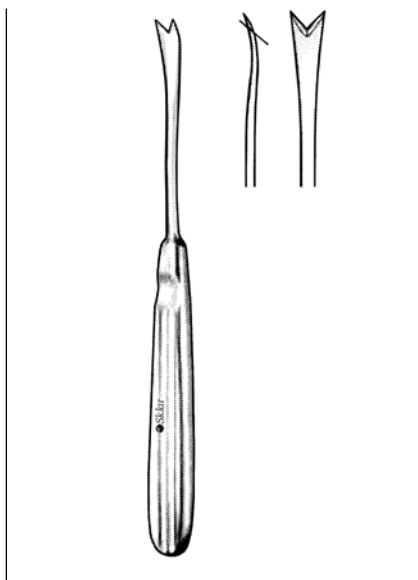

OBWEGESER SWALLOW-TAIL STRIPPER RASPATORIES

40-9865 6¾" 7mm
40-9866 6¾" 11mm

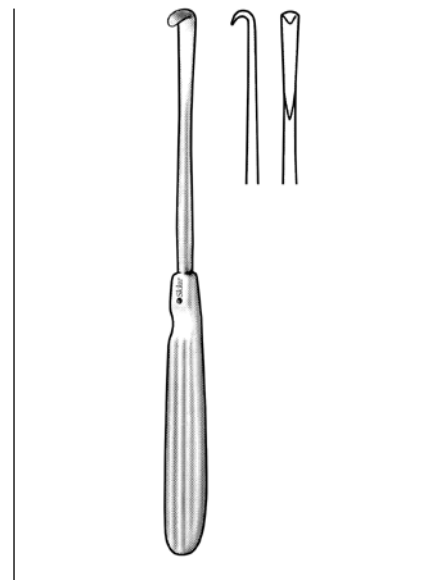

OBWEGESER PERIOSTEAL ELEVATORS/RASPATORIES CURVED SHARP

40-9867 7¾" 7mmx5mm
40-9868 7¾" 10mmx7mm
40-9869 7¾" 11mmx9mm



DINGMAN PERIOSTEAL ELEVATOR/RASPATORY
DOUBLE END

40-9844 7" 4mm/7mm



MCKENTY RASPATORY
DOUBLE END

40-7427 8¾" 4mm, Sharp



FREER ELEVATORS

47-2378 7½", Sharp, 4mm
47-2379 7½", Blunt, 4mm

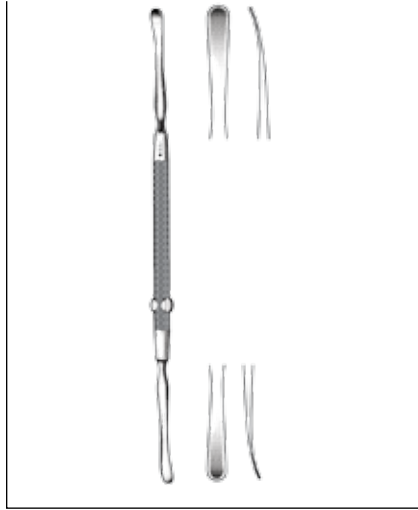

FREER ELEVATORS

DOUBLE END
47-2380 7", Sharp/Blunt, 5mm
47-2382 7¾", Sharp/Blunt, 4mm

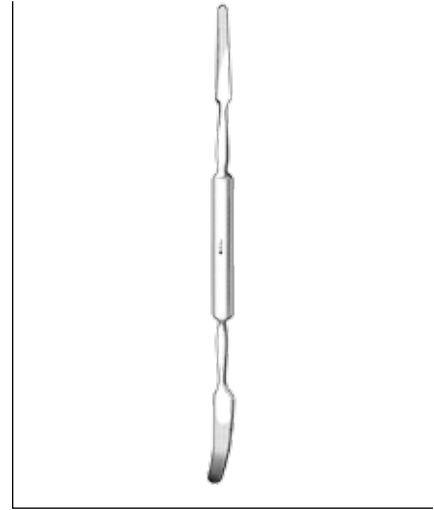

MCDONALD ELEVATOR

DOUBLE END
40-9280 7½"

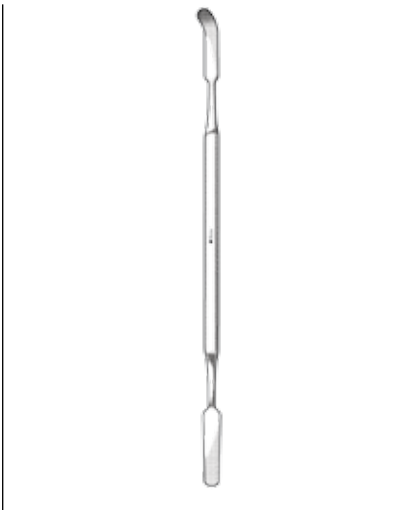

COHEN ELEVATOR

DOUBLE END
40-7609 9½", 6mm Blade, Round and Squared End

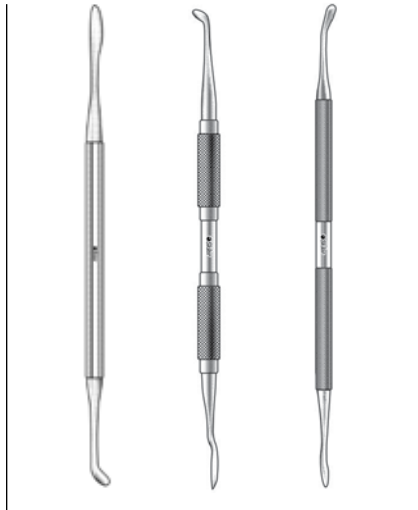

WOODSON ELEVATORS

#1
47-2355 7"
LARGE HANDLE
47-2357 7½"
FINE, STRAIGHT
47-2358 7"

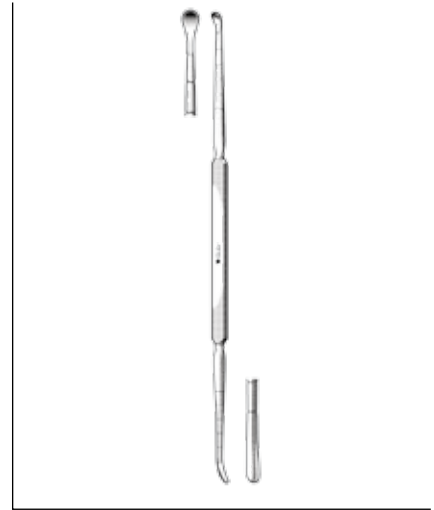

COTTLE ELEVATOR

DOUBLE END
41-1235 9", Graduation Marks



ALDERDYCE ELEVATOR
DOUBLE END, SEMI-SHARP/BLUNT
 40-2370 8½", 8mm



LANE ELEVATORS
BLUNT
 40-8375 7½", 6mm, Narrow
 40-8275 7½", 10mm, Wide

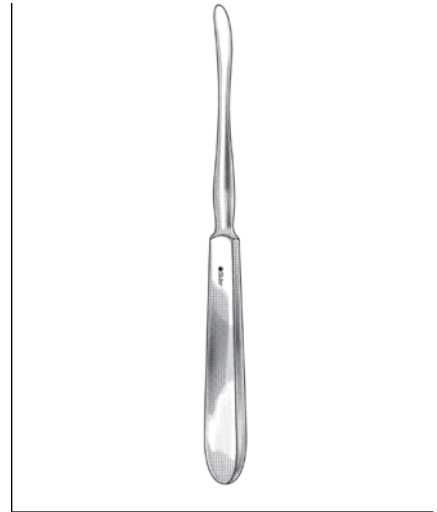

QUERVAIN ELEVATOR
6MM BLADE
 47-2398 8½", Curved

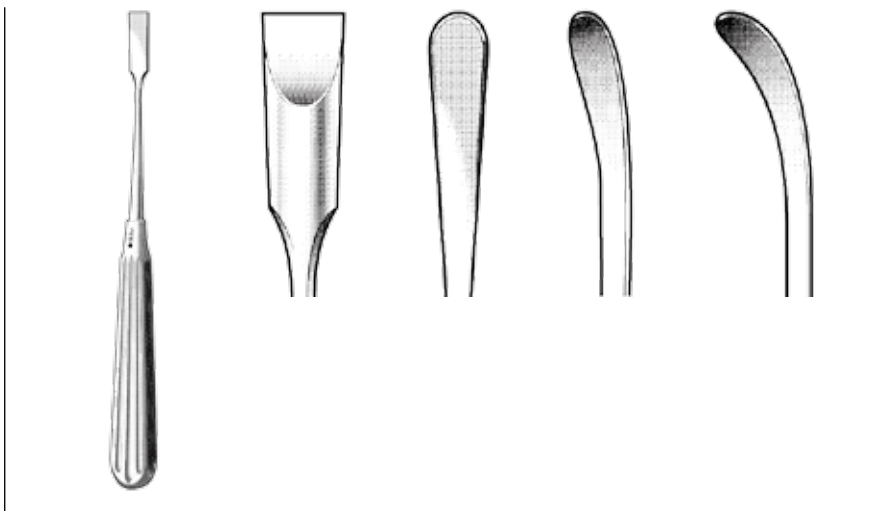

ADSON ELEVATORS
SQUARE END, 6¼"
 40-8270 8mm, Straight

ROUND END, 6¼"
 40-8272 7mm, Straight
 40-8273 7mm, Slight Curve
 40-8274 7mm, Curved

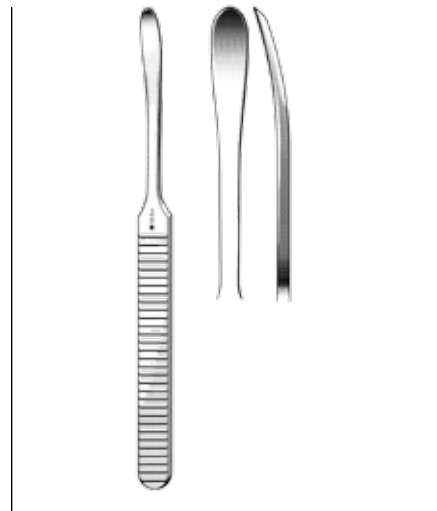

WILLIGER ELEVATORS
ROUND END, CURVED
 40-7153 5"
 40-7155 6¼"



DINGMAN ZYGOMA ELEVATOR
40-7615 8", 5mm

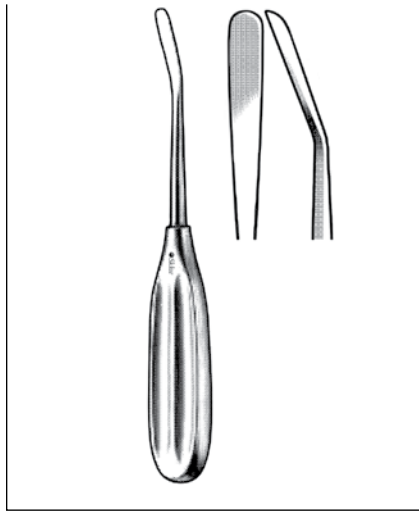

**GILLIES MALAR ELEVATOR
FOR ZYGOMATIC ARCH**
41-1225 8", Large Hand

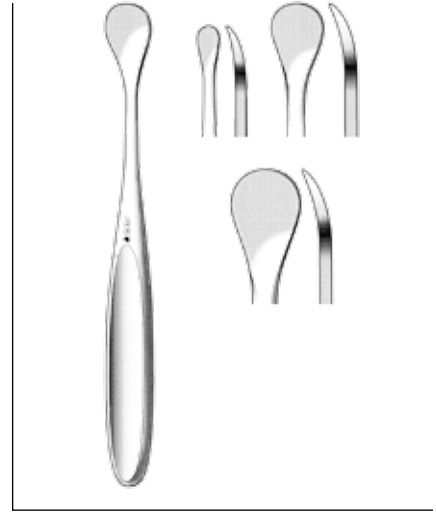

HOEN ELEVATORS
40-8340 7¼", 7mm
40-8343 7¼", 15mm
40-8344 7¼", 20mm

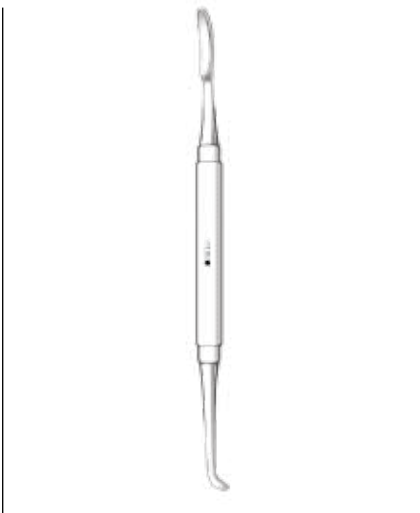

BENNET BONE ELEVATOR
47-2359 #12S 6¾", Sharp/Blunt



**COTTLE
PERIOSTEAL ELEVATOR**
41-1250 7½", 9mm,
Slight Curve

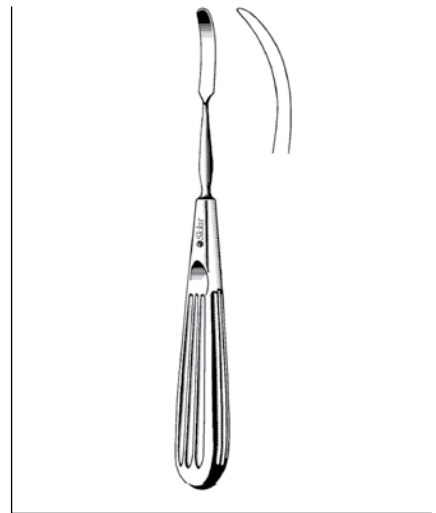

**JOSEPH
PERIOSTEAL ELEVATORS**
41-1245 6¼", 4.5mm
41-1240 7", 6.5mm

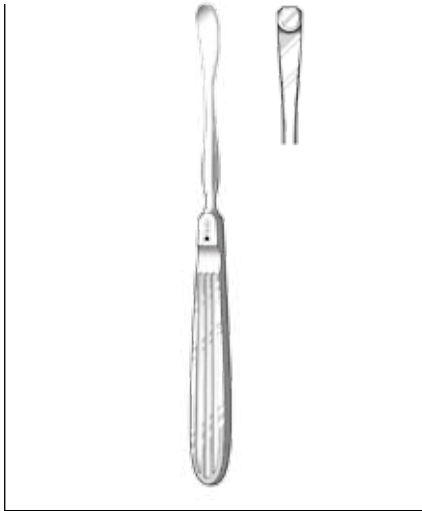

OBWEGESER PERIOSTEAL ELEVATORS

FLAT TIP

- 40-9306 7", 6mm
- 40-9307 7", 7mm
- 40-9309 7", 9mm
- 40-9311 7", 11mm

CURVED TIP

- 40-7075 8", 5mm
- 40-7077 8", 7mm
- 40-7079 8", 9mm

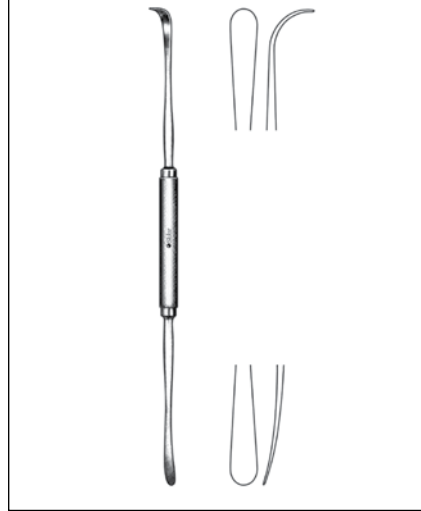

OBWEGESER PERIOSTEAL ELEVATORS

DOUBLE END, CURVED

- 40-9300 8", Blunt/Blunt
- 40-9301 8", Blunt/Sharp

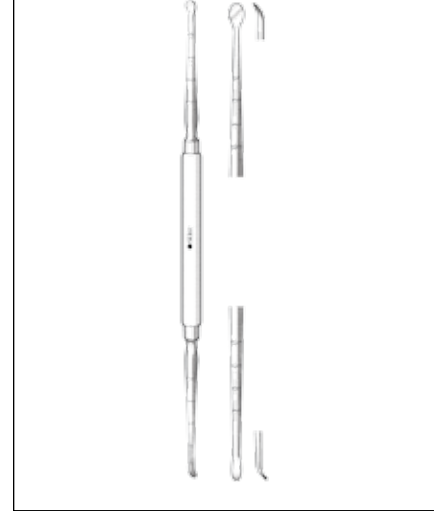

MASING PERIOSTEAL ELEVATORS

- 40-6951 7 3/4", 3mm/2mm

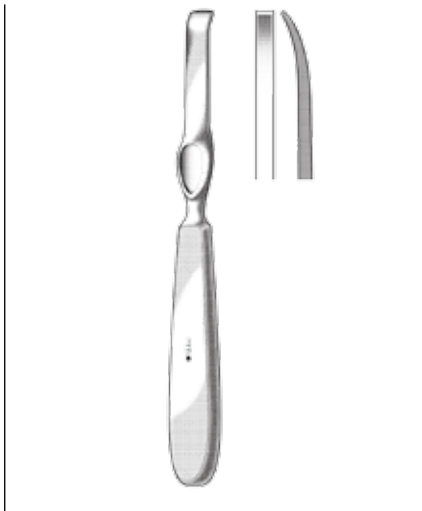

LAMBOTTE PERIOSTEAL ELEVATORS

8 1/4"

- 40-8780 5mm
- 40-8781 10mm
- 40-8782 15mm
- 40-8783 20mm
- 40-8784 25mm

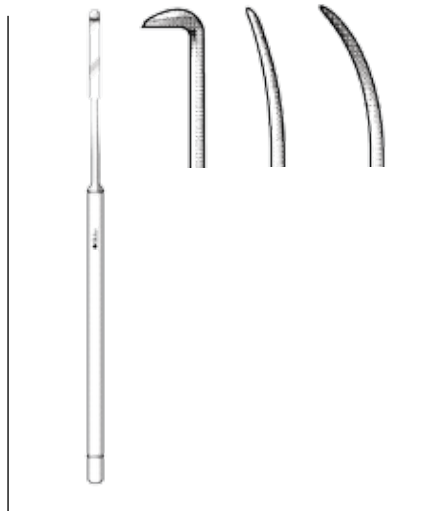

SALYER PERIOSTEAL ELEVATORS

7"

- 40-9340 Diamond Shape
- 40-9341 Slight Curve
- 40-9342 Strong Curve

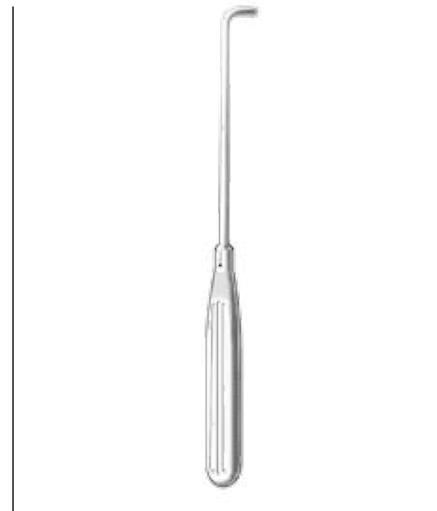

BLAIR CLEFT ELEVATORS

RIGHT ANGLE

- 40-7602 8", 5mm
- 40-7601 9", 5mm

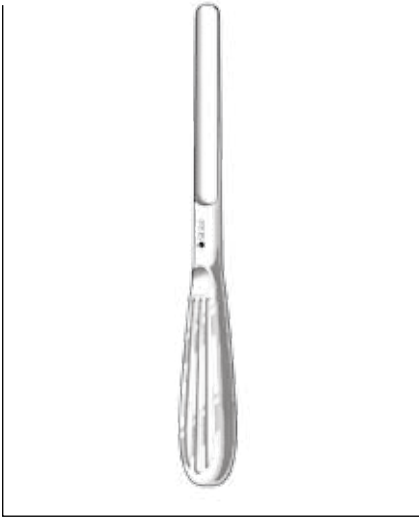

**BOIES
SEPTUM ELEVATOR**
40-9367 7½", 9mm

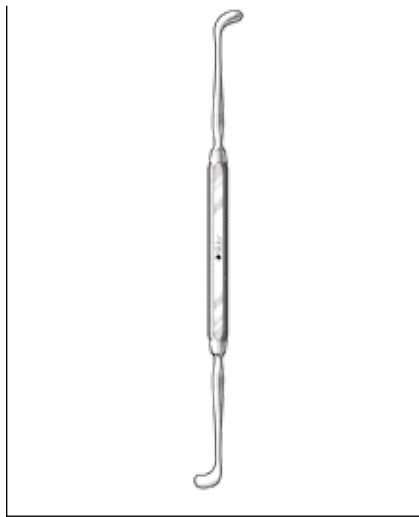

**PENNINGTON
SEPTUM ELEVATOR
DOUBLE END**
47-2372 8½", 4mm/4mm

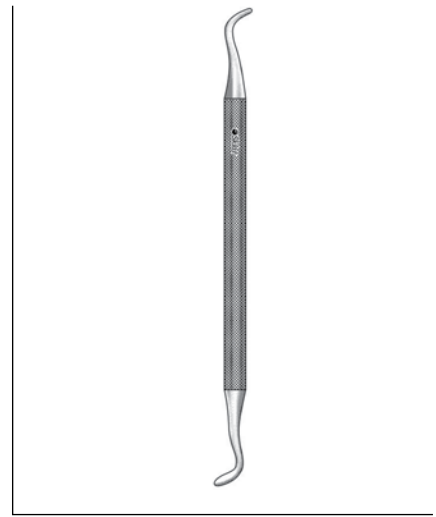

**NAGATA AURICULAR
SEPTUM ELEVATOR
DOUBLE END**
47-2393 5¼", 5mm
47-2394 6½", 5mm

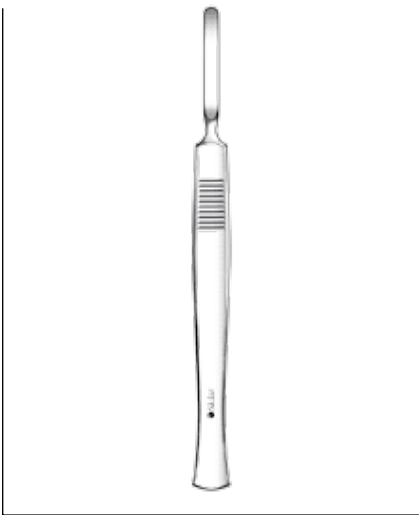

**MACKENTY SEPTUM ELEVATOR
FLAT, CURVED BLADE**
47-2385 6", 4mm
47-2388 6", 5mm

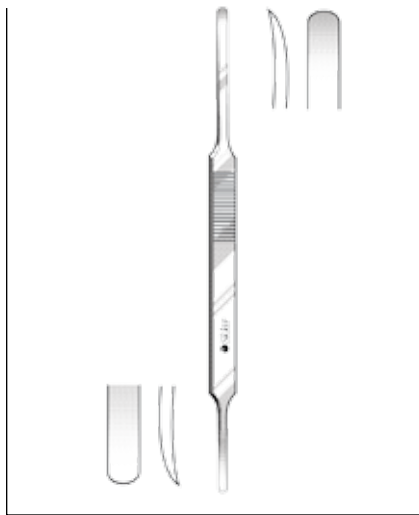

**MACKENTY SEPTUM ELEVATOR
DOUBLE END**
47-2390 8¾"

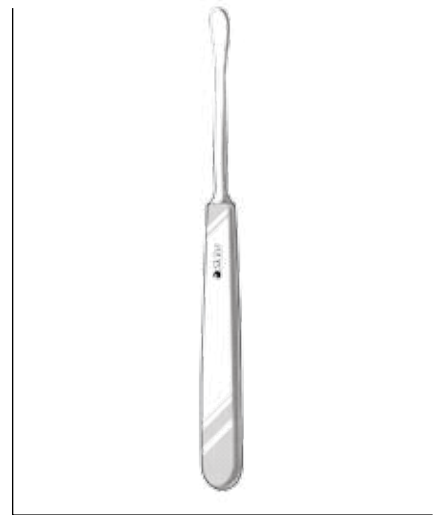

**YANKAUER SEPTUM ELEVATOR
BLUNT**
40-9359 6¾", 6mm



PIERCE SEPTUM ELEVATOR
DOUBLE END
 40-2379 8½", Right/Left Blades



COTTLE SEPTUM ELEVATOR
DOUBLE END
 47-2389 9"



KILLIAN SEPTUM ELEVATORS
DOUBLE END
 40-9360 7", 4mm
 40-9361 9", 4.5mm



GORNEY SUCTION ELEVATOR
ROUND END
 40-9368 8¼"

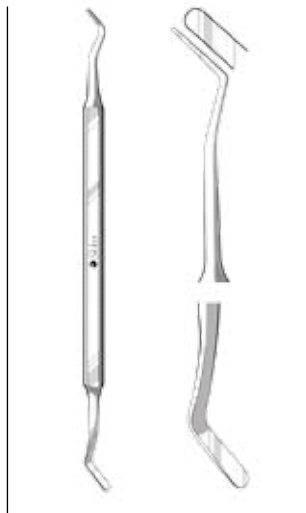

WOODSON ELEVATOR AND SPATULA
DOUBLE END
 47-2350 7" 3mm, Blunt
 47-2351 10" 3mm, Blunt

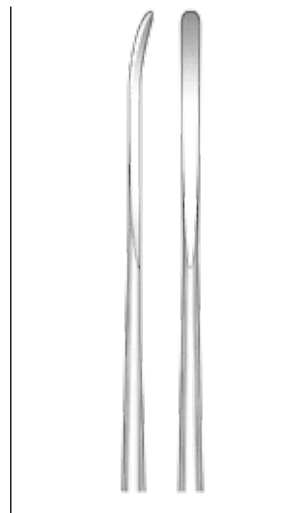

MICRO LARYNGEAL ELEVATOR
FOR USE WITH HANDLE 78-3546
 78-3543 9½"

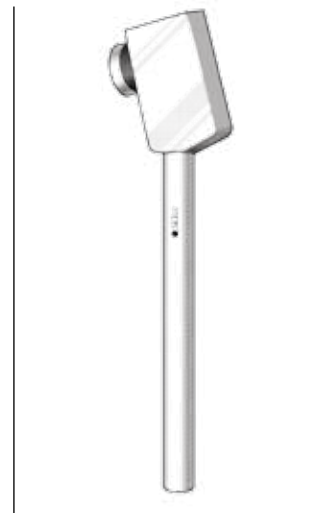

MICRO LARYNGEAL HANDLE
 78-3546



PENFIELD DISSECTORS

DOUBLE END WITH TAMPER

- 47-2255 6¾" #1 Sharp Curve
- 47-2256 7¾" #2 Slight Curve
- 47-2257 7¾" #3 Full Curve
- 47-2259 7¼" #5 Slight Curve

SINGLE END

- 47-2258 8½" #4 Slight Curve



LOPEZ-REINKE SUCTION DISSECTOR

- 75-6378 9¼" 7-9mm



GORNEY SUCTION DISSECTOR

- 40-9368 8¼" 4mm

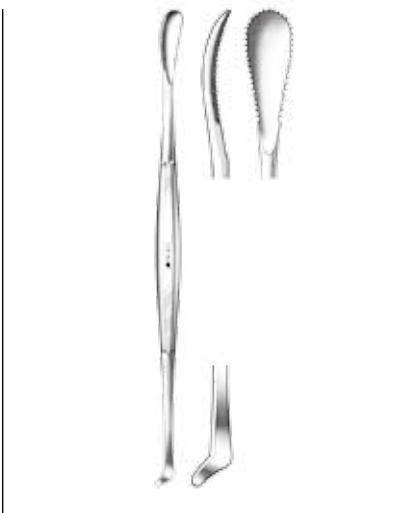

HENKE DISSECTOR AND RETRACTORS

- 75-6376 9" 5mm / 12mm
- 75-6377 9" 5mm / 17mm

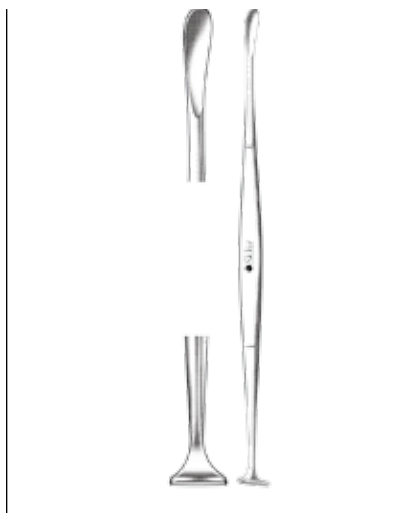

HURD TONSIL DISSECTORS

- 75-6386 8½" 6mm / 15mm
- 75-6387 8¾" 9mm / 13mm
- 75-6388 8½" 9mm / 14mm

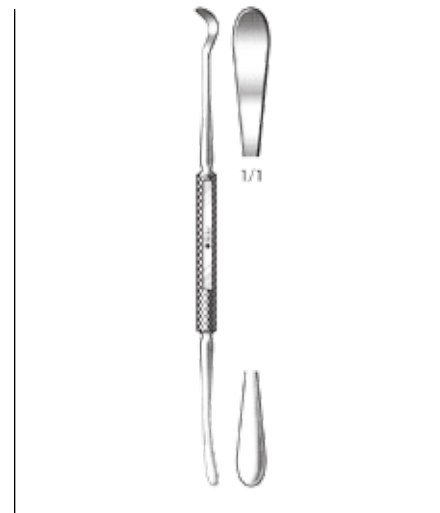

CARPENTER TONSIL DISSECTORS

STRAIGHT / ANGLED

- 75-6375 9" #1 5mm / 9mm

STRAIGHT / CURVED

- 75-6374 9" #2 5mm / 8mm

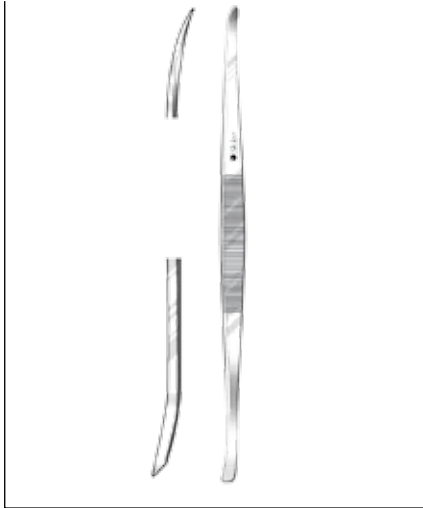

**GWYNNE-EVANS
TONSIL DISSECTORS**

DOUBLE END

75-6370 9" 6mm
75-6371 7¾" 8mm

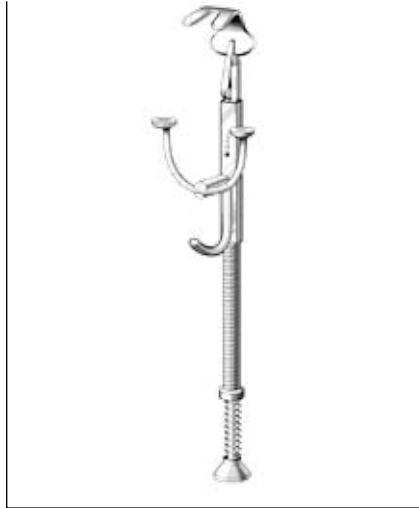

**HASLINGER
TONSIL DISSECTOR**

STRAIGHT

75-6380 6¾"

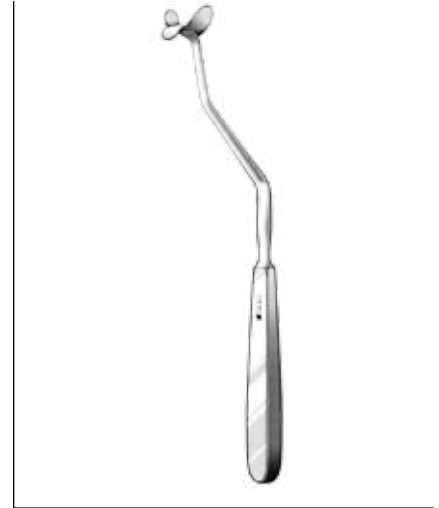

HOFER TONSIL DISSECTOR

BENT SHAFT

75-6381 9½"

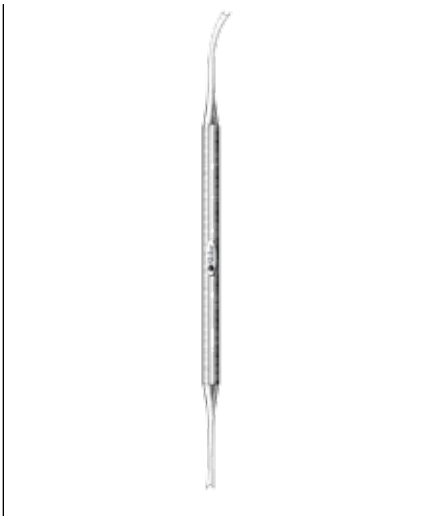

**LUNIATSCHEK TONSIL
GAUZE PACKER**

75-6379 7½"



**HAJEK-BALLENGER
SEPTUM ELEVATOR**

DOUBLE END

70-7185 8½" Sharp / Blunt

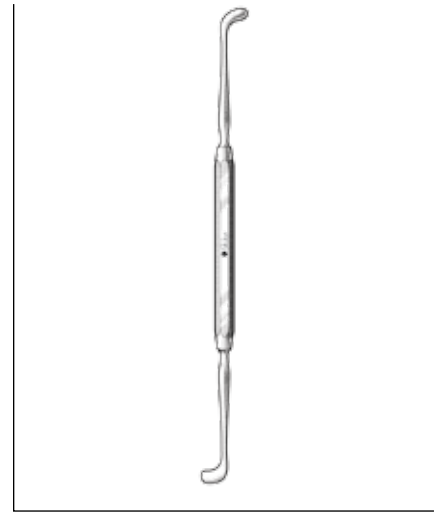

**PENNINGTON
SEPTUM ELEVATOR**

DOUBLE END

47-2372 8½" 4mm



PIERCE SEPTUM ELEVATOR
RIGHT AND LEFT BLADES
40-2379 8½"



**OLIVECRONA DURA
DISSECTOR**
DOUBLE END
50-4510 9½"

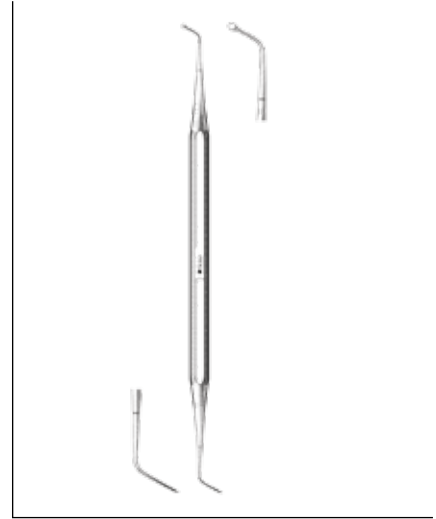

BONE PACKER DISSECTOR
DOUBLE END
40-7376 6¾" Ball End

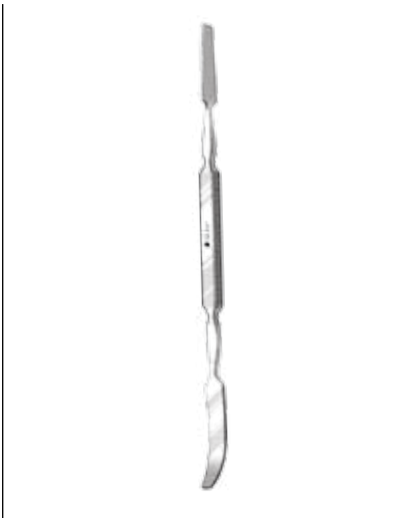

MACDONALD DISSECTOR
DOUBLE END
47-2370 7¼" Blunt / Blunt

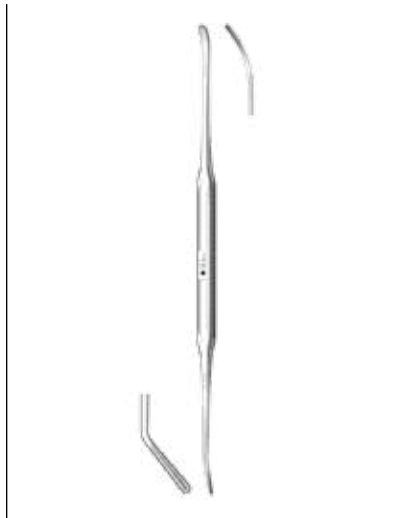

PENNYPACKER DISSECTOR
DOUBLE END
47-2269 9"

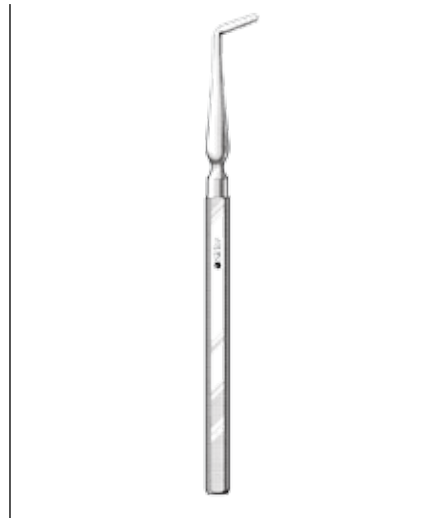

FRAZIER BLUNT DISSECTOR
47-2360 6" Angled

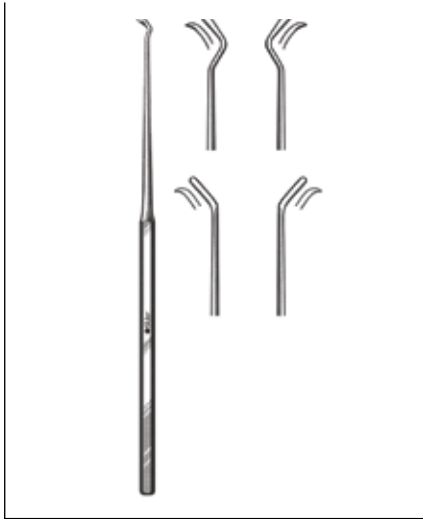

FISCH MICRO DISSECTORS

47-2272	6"	Angled to Right
47-2270	6"	Double Angled to Right
47-2273	6"	Angled to Left
47-2271	6"	Double Angled to Left

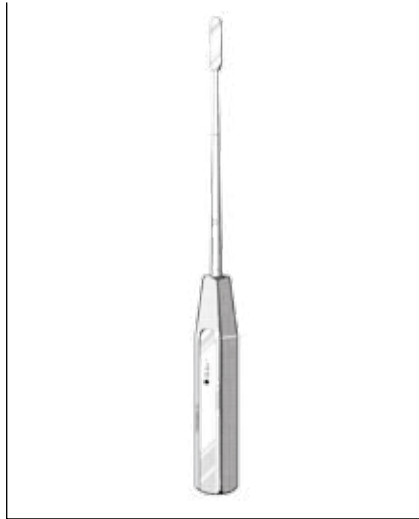

ENDO FACELIFT DISSECTORS

PHENOLIC HANDLE, BLUNT			
50-7010	10"	Straight	6mm
50-7011	10"	Curved	6mm

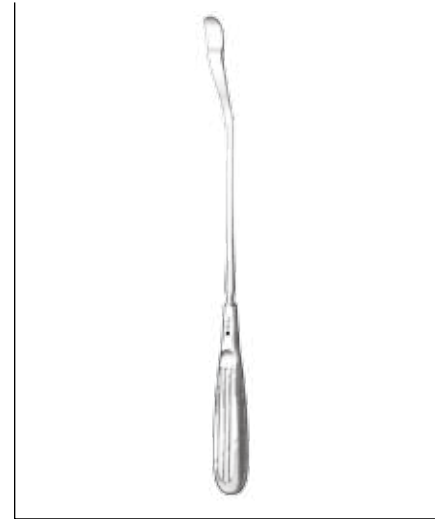

FACELIFT DISSECTORS

S-CURVE		
50-7001	10¾"	9mm
50-7002	10¾"	11mm

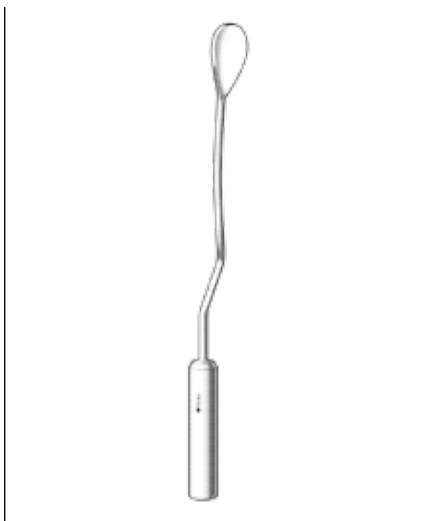

McCOLLUM-DINGMAN BREAST DISSECTORS

40-7624	11¾"
40-7625	16⅛"

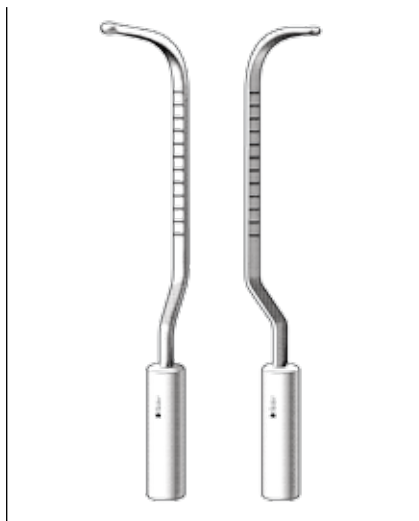

AGRIS-DINGMAN BREAST DISSECTORS

40-7620	14"	Set of 2, Left and Right
---------	-----	--------------------------

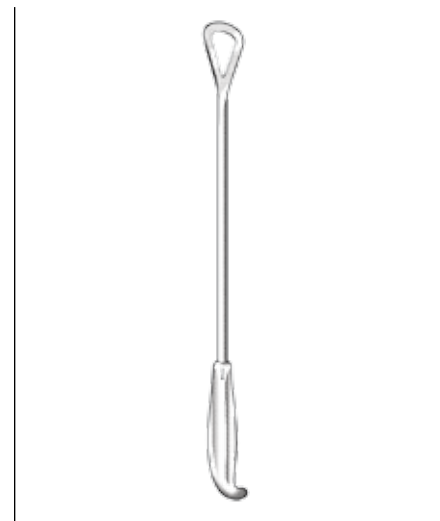

REYNOLDS TRANSAXILLARY BREAST DISSECTORS

40-7660	13"	1½" Tip
40-7661	16"	1½" Tip



**SILVERSTEIN
BREAST DISSECTOR**

40-7628 14"

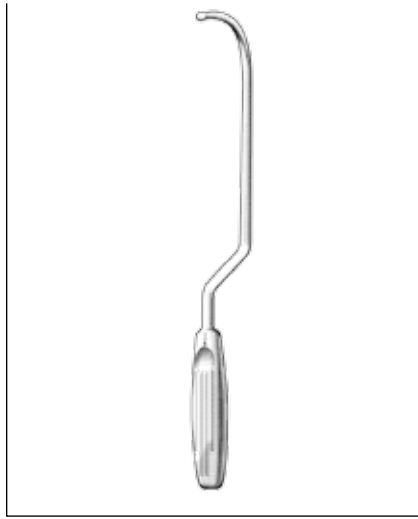

**SOLZ ATRAUMATIC
BREAST DISSECTORS**

40-7630 13¼"
47-2535 14"
40-7632 14½"



SPATULA BREAST DISSECTORS

40-7650 13"
40-7651 16½"
40-7652 13" Malleable
40-7653 16½" Malleable



BREAST HOOK DISSECTORS

40-7654 13"
40-7655 16½"
40-7656 13" Malleable
40-7657 16½" Malleable



MCCABE FACIAL NERVE DISSECTOR

CURVED
50-1250 5½" 25mm

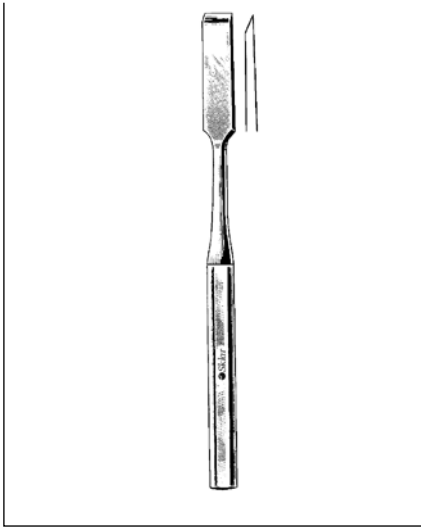

HIBBS CHISELS

STRAIGHT, 9½"		CURVED, 9½"	
40-6701	6mm	40-6731	6mm
40-6711	10mm	40-6732	10mm
40-6715	13mm	40-6733	13mm
40-6716	16mm	40-6734	16mm
40-6717	19mm	40-6735	19mm
40-6723	22mm	40-6736	22mm
40-6724	25mm	40-6737	25mm
40-6725	28mm	40-6738	28mm
40-6726	32mm	40-6739	32mm
40-6728	38mm	40-6740	38mm

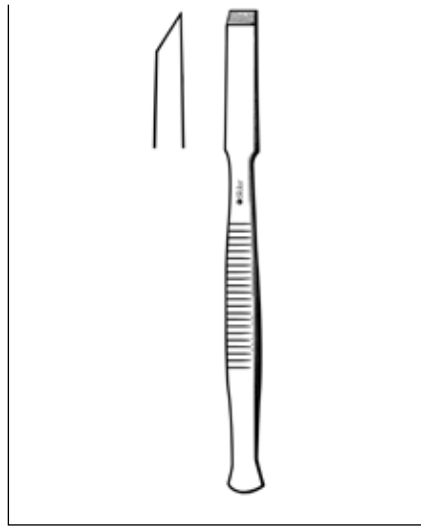

CHISELS

5¼"	
40-6170	8mm
40-6171	10mm
40-6172	12mm
40-6173	14mm
40-6174	16mm

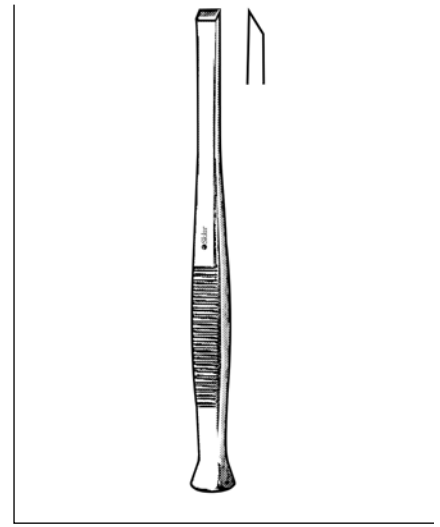

PARTSCH CHISELS

5¼"		6½"	
40-6232	2mm	40-6252	2mm
40-6233	3mm	40-6253	3mm
40-6234	4mm	40-6254	4mm
40-6235	5mm	40-6255	5mm
40-6236	6mm	40-6256	6mm
40-6237	7mm	40-6257	7mm
40-6238	8mm	40-6258	8mm

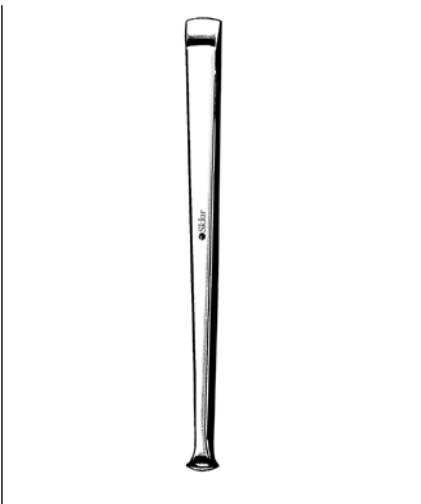

ALEXANDER CHISELS

7"	
67-4604	4mm
67-4606	6mm
67-4608	8mm
67-4610	10mm
67-4612	12mm
67-4614	14mm

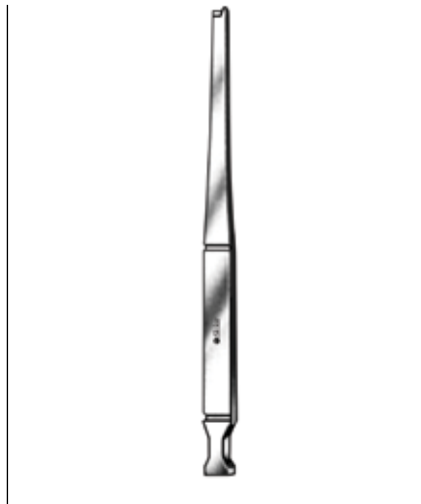

CONVERSE CHISELS

7½"	
70-7160	
70-7161	Right
70-7162	Left

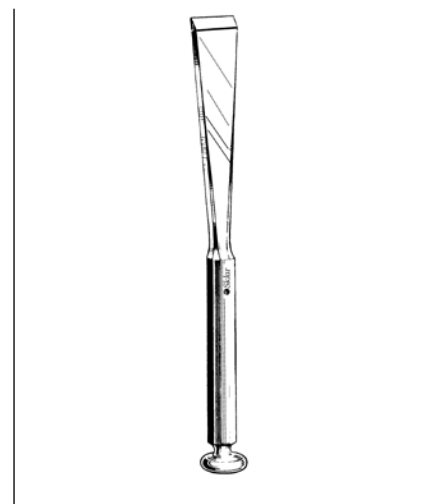

STILLÉ CHISELS

8"			
40-6379	6mm	40-6340	18mm
40-6380	8mm	40-6375	20mm
40-6338	10mm	40-6341	22mm
40-6343	12mm	40-6376	25mm
40-6339	14mm	40-6377	30mm
40-6374	15mm		

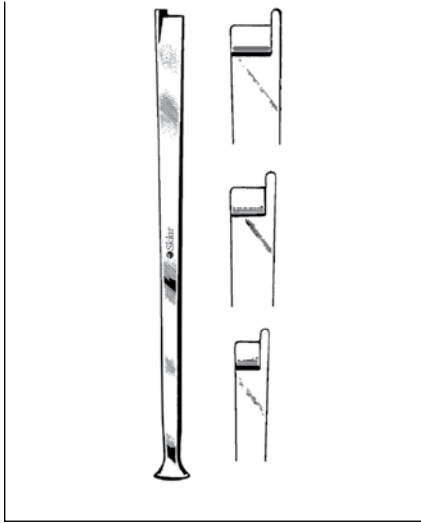

FOMON CHISELS

GUARDED POINT, 5¾"

- 41-1366 5mm
- 41-1367 7mm
- 41-1368 8mm

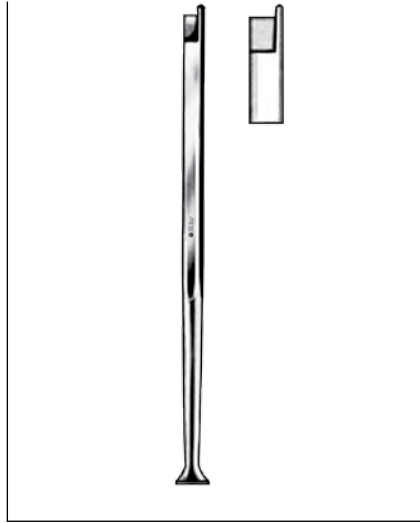

FOMON CHISELS

GUARDED POINT, 6¾"

- 41-1364 4mm
- 41-1369 6mm

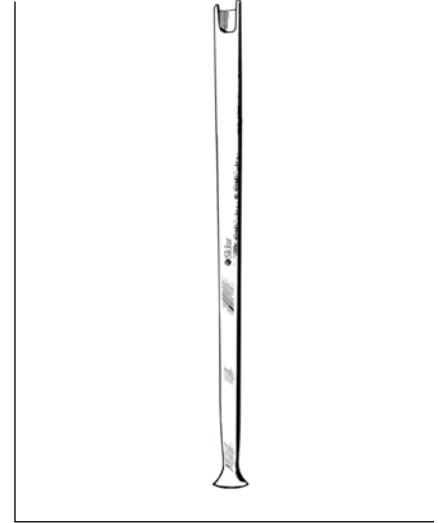

MOBERG CHISELS

GUARDED POINT, 7"

- 40-6140 10mm
- 40-6141 12mm
- 40-6142 14mm
- 40-6143 16mm

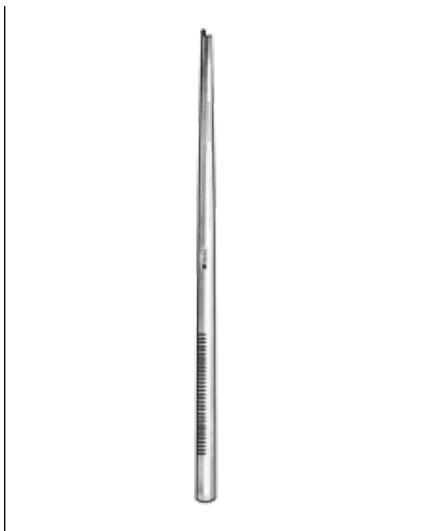

NEIVERT CHISELS

STRAIGHT

- 70-7158 8"

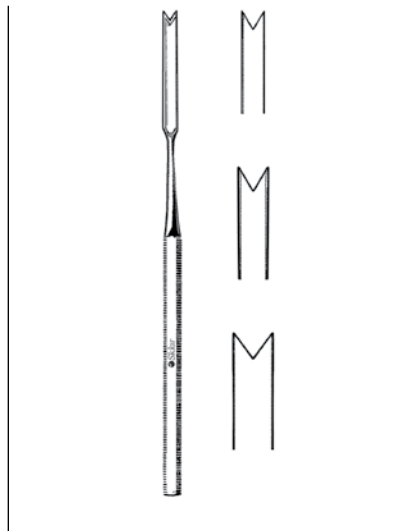

HAJEK SEPTUM CHISELS

6"

- 41-1359 2mm
- 41-1361 4mm
- 41-1362 6mm
- 41-1363 8mm

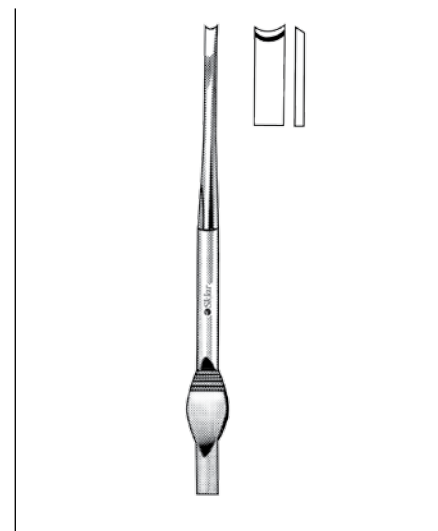

WALTER CHISEL

7½"

- 70-4405 3mm
- 70-4407 4.5mm



WEST LACRIMAL SAC CHISEL

7½"

70-4200 6mm

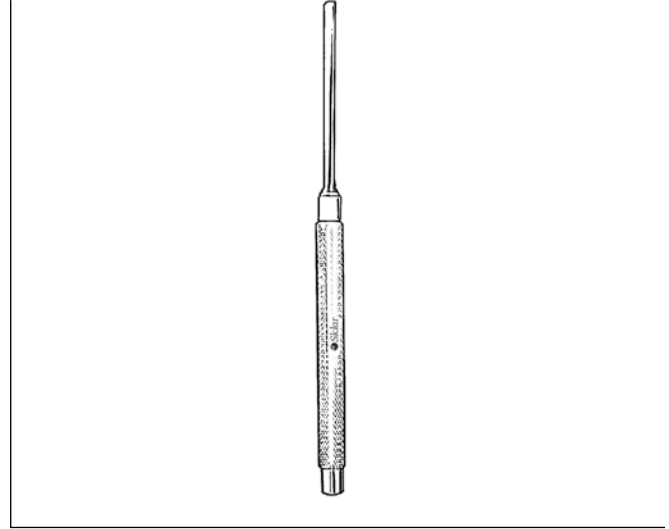

LUCAS CHISELS

6¼"

40-6400 6" 4mm

40-6401 6" 6mm



LEXER CHISELS

STRAIGHT, PHENOLIC HANDLE, 8½"

- 40-6040 5mm
- 40-6041 7mm
- 40-6042 10mm
- 40-6043 15mm
- 40-6044 20mm
- 40-6045 25mm
- 40-6046 30mm

CURVED, PHENOLIC HANDLE, 10¾"

- 40-6048 10mm
- 40-6049 15mm



MINI-LEXER CHISELS

STRAIGHT, PHENOLIC HANDLE, 7"

- 40-6020 4mm
- 40-6022 6mm
- 40-6024 8mm
- 40-6026 10mm
- 40-6028 12mm

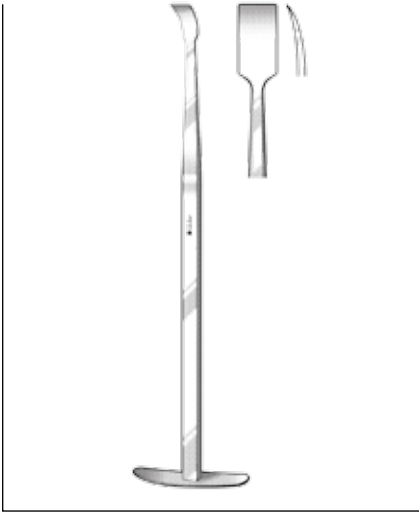

**DUNN-DAUTREY
OSTEOTOMES**

6½"

40-6427	4mm	Straight
40-6428	6mm	Straight
40-6429	8mm	Straight
40-6430	6mm	Slight Curve
40-6431	6mm	Strong Curve

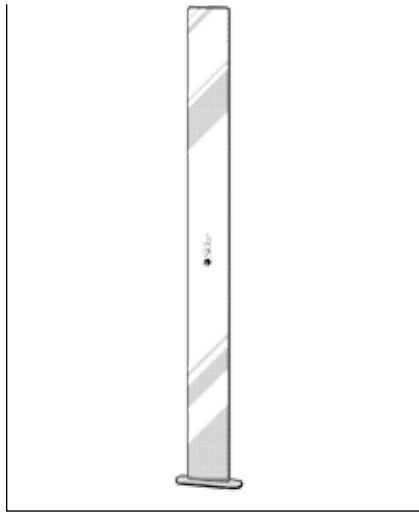

**DAUTREY-MUNRO
OSTEOTOMES**

STRAIGHT, 6¼"

40-7570	4mm
40-7571	6mm
40-7572	8mm
40-7573	10mm
40-7574	12mm
40-7575	14mm
40-7576	16mm

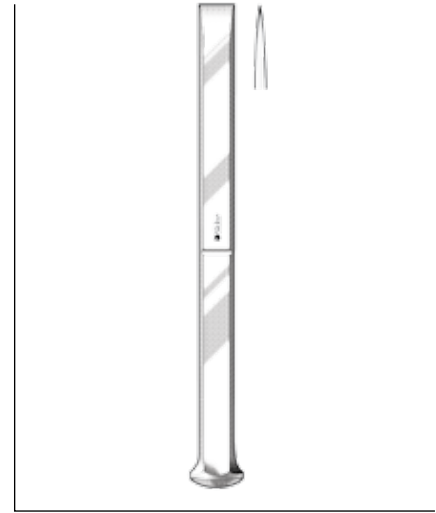

ARMY OSTEOTOMES

STRAIGHT, 6½"

40-6206	6mm
40-6212	12mm
40-6218	18mm

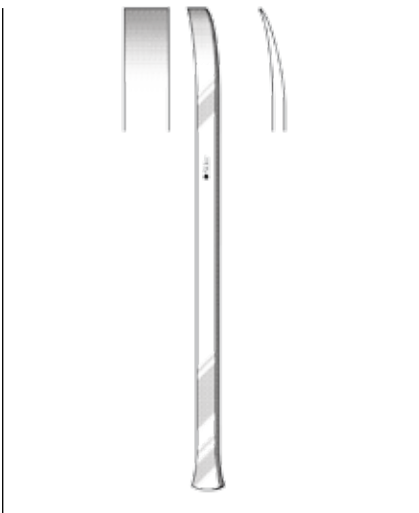

**OBWEGESER PTERYGOID
OSTEOTOMES**

CURVED, 9¼"

40-6480	8mm	Child
40-6481	11mm	Adult

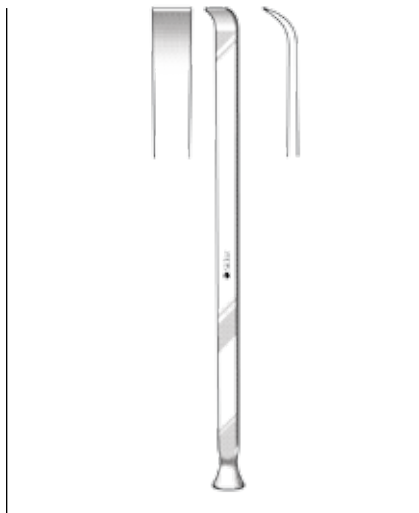

**HARGIS PTERYGOID
OSTEOTOME**

8½"

40-6460	10mm	Curved
---------	------	--------

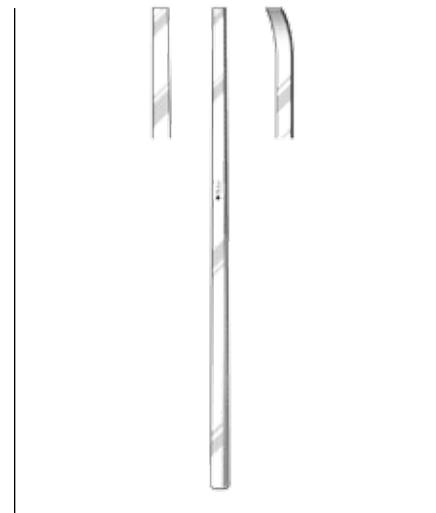

CHERRY OSTEOTOMES

STRAIGHT		CURVED	
70-7001	3mm	70-7006	3mm
70-7002	4mm	70-7007	4mm
70-7003	5mm	70-7008	5mm
70-7004	6mm	70-7009	6mm
70-7005	7mm	70-7010	7mm

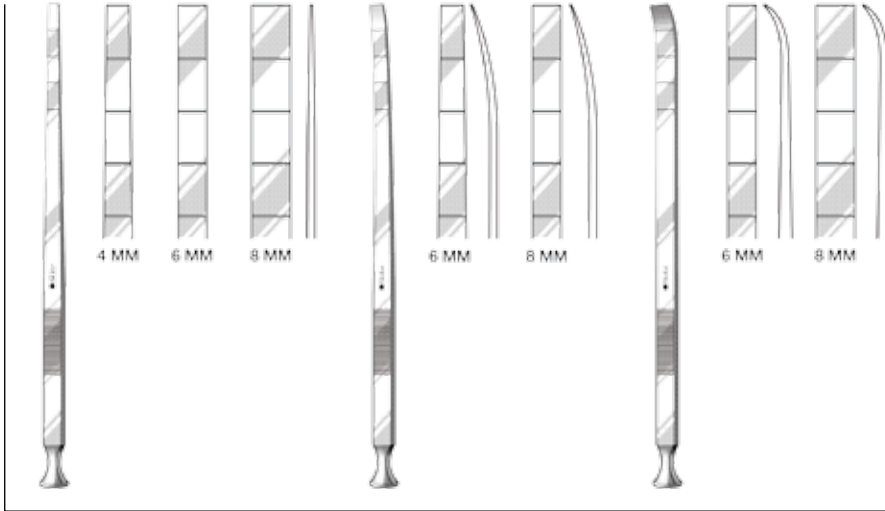

EPKER OSTEOTOMES

STRAIGHT, 7"

- 40-6450 4mm
- 40-6452 6mm
- 40-6455 8mm

SLIGHT CURVE, 7"

- 40-6451 6mm
- 40-6453 8mm

STRONG CURVE, 7"

- 40-6454 6mm
- 40-6456 8mm

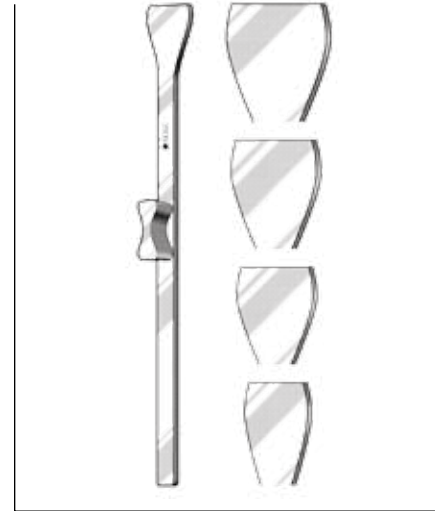

RUBIN OSTEOTOMES

STRAIGHT WITH STABILIZER, 7 1/4"

- 40-6370 10mm
- 40-6371 12mm
- 40-6372 14mm
- 40-6373 16mm

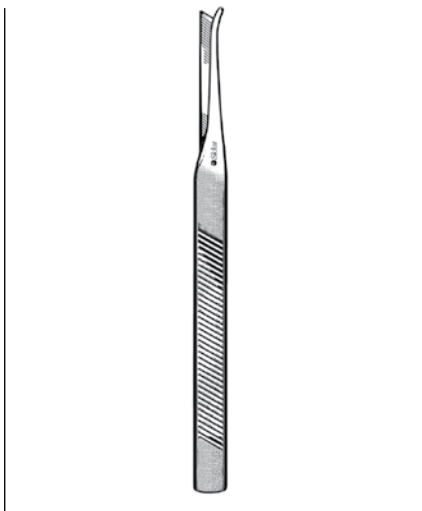

SILVER OSTEOTOMES

SINGLE GUARDED TIP, 7"

- 41-1350 5mm Straight
- 41-1355 5mm Curved Right
- 41-1360 5mm Curved Left

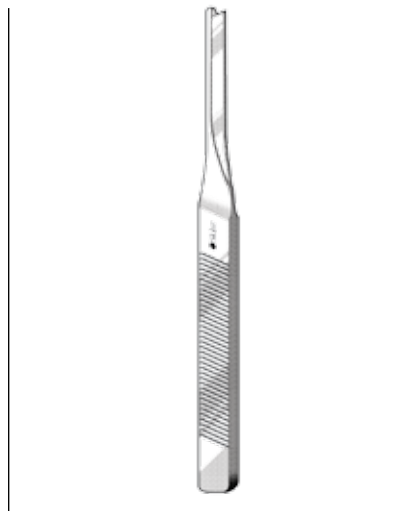

PARKES OSTEOTOME

DOUBLE GUARDED TIP, 7"

- 40-6515 6.5mm Straight

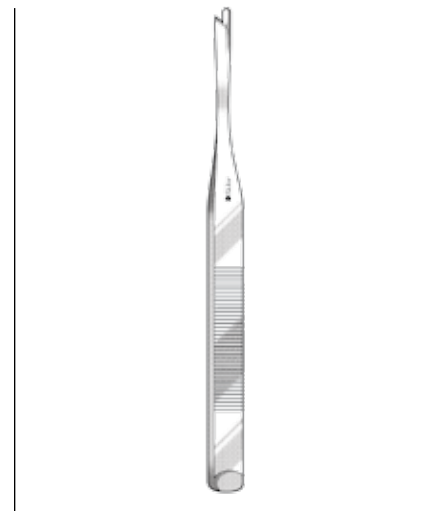

TESSIER NASAL OSTEOTOME

RIGHT GUARDED, 7 1/4"

- 40-7527 Straight

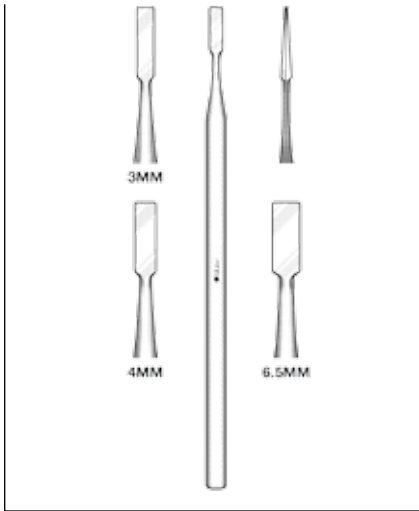

OBWEGESER ALVEOLAR OSTEOTOMES

STRAIGHT, 6"

- 40-6470 3mm
- 40-6471 4mm
- 40-6472 6.5mm

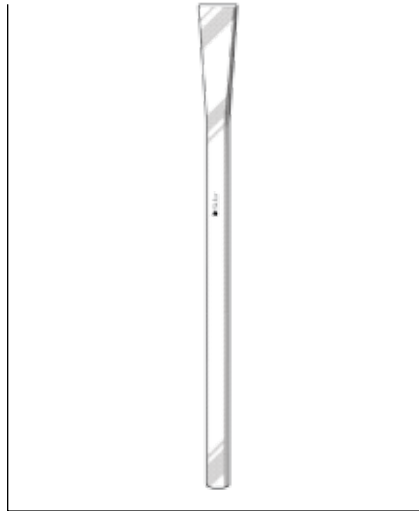

SHEEHAN OSTEOTOMES

STRAIGHT, 6 1/4"

- | | | | |
|---------|-----|---------|------|
| 67-4619 | 1mm | 67-4627 | 9mm |
| 67-4620 | 2mm | 67-4628 | 10mm |
| 67-4621 | 3mm | 67-4629 | 11mm |
| 67-4622 | 4mm | 67-4630 | 12mm |
| 67-4623 | 5mm | 67-4632 | 15mm |
| 67-4624 | 6mm | 67-4634 | 18mm |
| 67-4625 | 7mm | 67-4636 | 20mm |
| 67-4626 | 8mm | | |

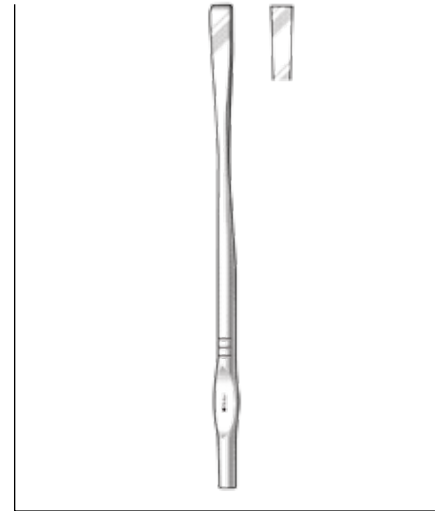

WALTER OSTEOTOMES

STRAIGHT, 7 1/2"

- 40-7540 3mm
- 40-7541 4mm
- 40-7542 7mm
- 40-7543 9mm
- 40-7544 12mm

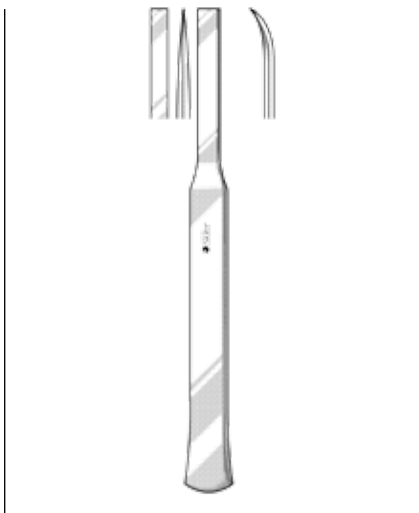

TESSIER CRANIOMAXILLOFACIAL SURGERY OSTEOTOMES

FLAT HANDLE

- | STRAIGHT, 6 1/4" | | CURVED, 6 1/4" | |
|-------------------------|-------------------|-----------------------|------|
| 40-7505 | 2mm | 40-7512 | 5mm |
| 40-7506 | 3.5mm | 40-7513 | 7mm |
| 40-7507 | 5mm | 40-7514 | 10mm |
| 40-7508 | 7mm | | |
| 40-7509 | 10mm | | |
| 40-7510 | 14mm | | |
| 40-7511 | 16mm | | |
| 40-7515 | 18mm, Bevel Blade | | |

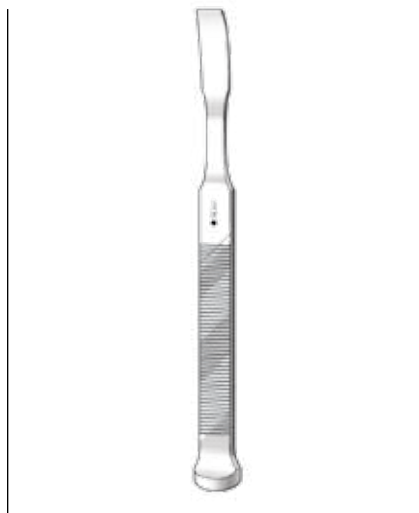

TESSIER CRANIOMAXILLOFACIAL SURGERY OSTEOTOME

CURVED, 7", MUSHROOM HANDLE

- 40-7516 10mm

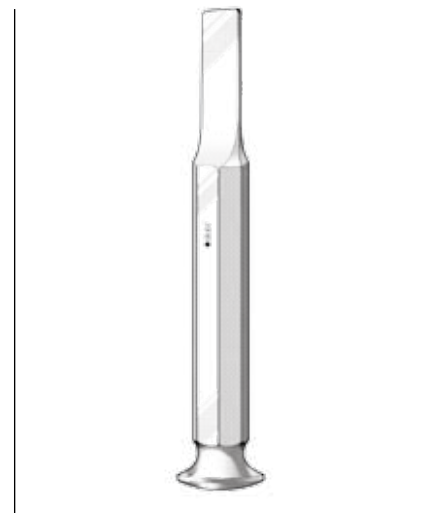

TESSIER CRANIOMAXILLOFACIAL SURGERY OSTEOTOMES

FOR GRAFTS FROM CRANIUM, 6 1/4"

- 40-7523 10mm, Straight
- 40-7525 10mm, Curved
- 40-7524 15mm, Straight
- 40-7526 15mm, Curved

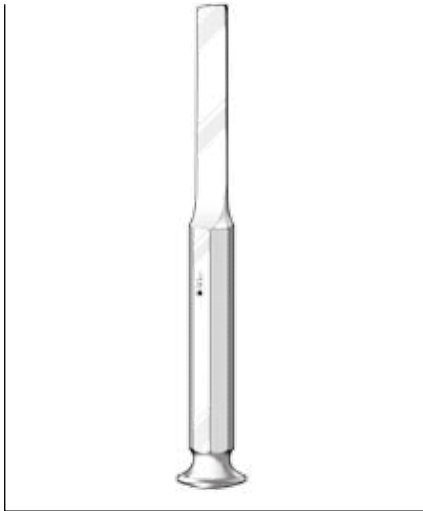

**TESSIER
CRANIOMAXILLOFACIAL
SURGERY OSTEOTOMES**

FOR GRAFTS FROM ILIUM AND TIBIA, 8"

40-7517	10mm	Straight
40-7521	10mm	Curved
40-7518	15mm	Straight
40-7522	15mm	Curved
40-7519	20mm	Straight
40-7520	30mm	Straight

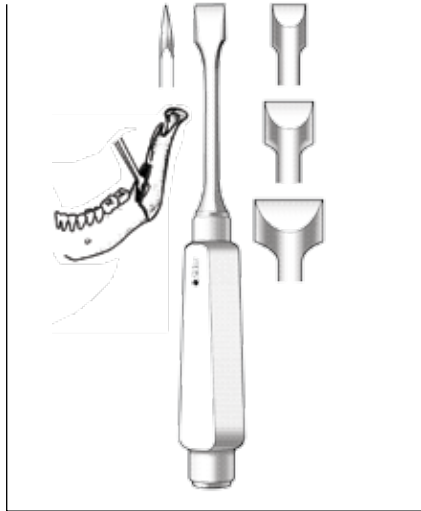

**OBWEGESER WEDGE
OSTEOTOMES**

STRAIGHT, 8 3/4"

40-6495	8mm
40-6496	12mm
40-6497	16mm

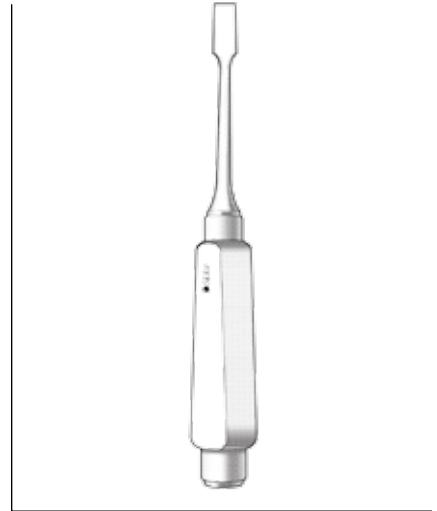

**OBWEGESER SPLITTING
OSTEOTOMES**

40-6488	7mm	8 3/4"
40-6489	10mm	8 3/4"

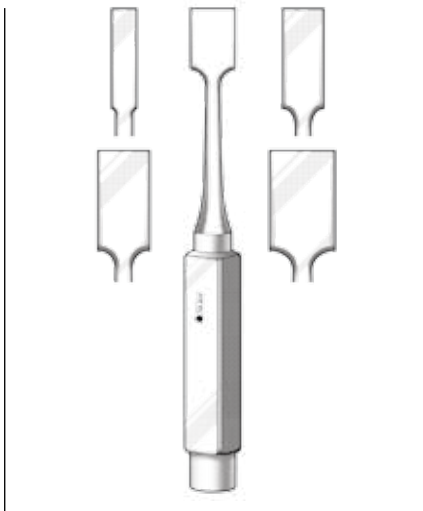

**OBWEGESER BLADE
OSTEOTOMES**

40-6490	8mm	8 3/4"
40-6491	12mm	8 3/4"
40-6492	16mm	8 3/4"
40-6493	20mm	8 3/4"

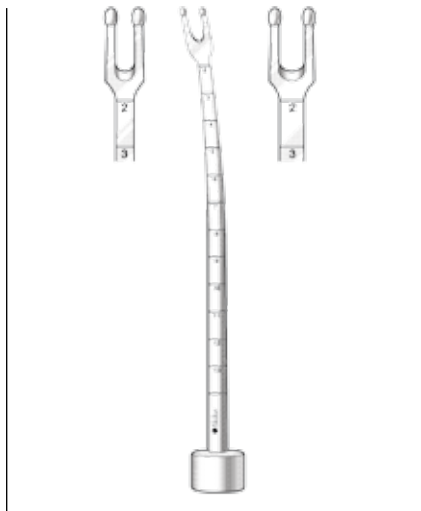

**OBWEGESER SEPTUM
OSTEOTOMES**

CURVED, GRADUATED, 7 1/4"

40-6475	4mm
40-6476	6mm
40-6477	8mm

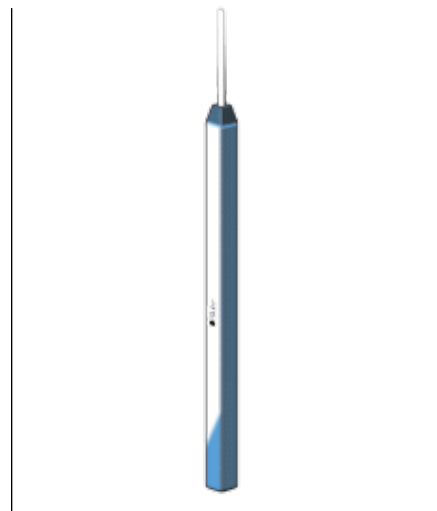

**REES NASAL OSTEOTOME
WITH BLUE HANDLE 8"**

40-6660	3mm
---------	-----

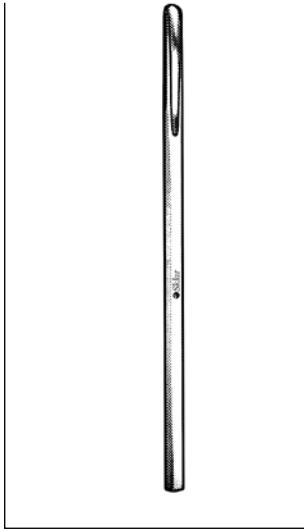

SHEEHAN GOUGES

6¼"

40-3252	2mm
40-3253	3mm
40-3254	4mm
40-3256	6mm

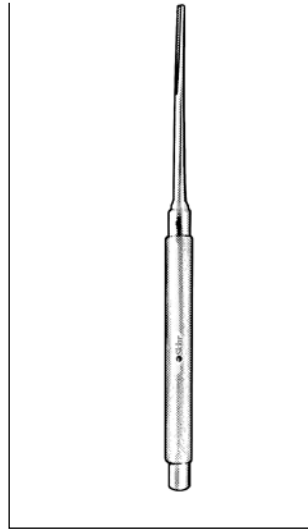

LUCAS GOUGES

40-6017	6¼"	3mm
40-6018	6¼"	5mm

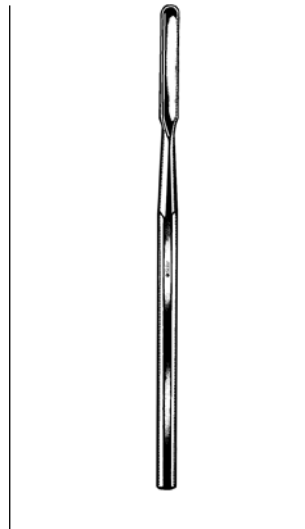

FREER GOUGE

STRAIGHT

41-1335	6"	6mm
---------	----	-----

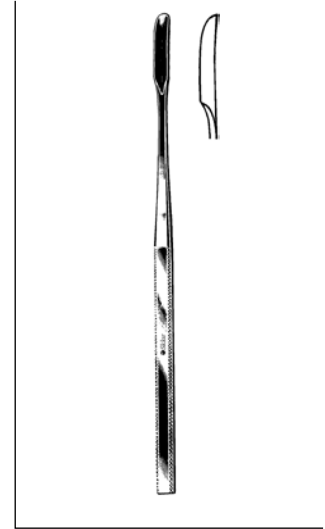

WEST BONE GOUGES

6¼"

40-6870	4mm	Straight
40-6871	4mm	Curved

7½"

41-1338	6mm	Straight
---------	-----	----------

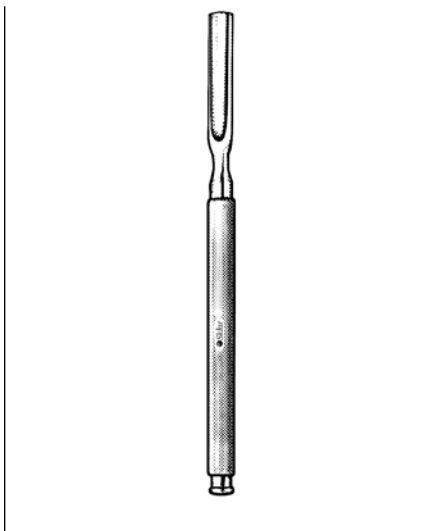

BRUENINGS BONE GOUGES

6¼"

40-6392	4mm
40-6393	6mm
40-6394	8mm
40-6395	10mm

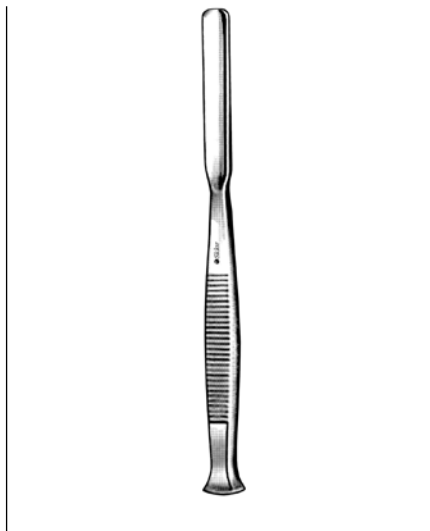

GOUGES

5½"

40-6900	3mm
40-6901	4mm
40-6902	5mm
40-6903	6mm
40-6904	8mm
40-6905	10mm
40-6906	12mm

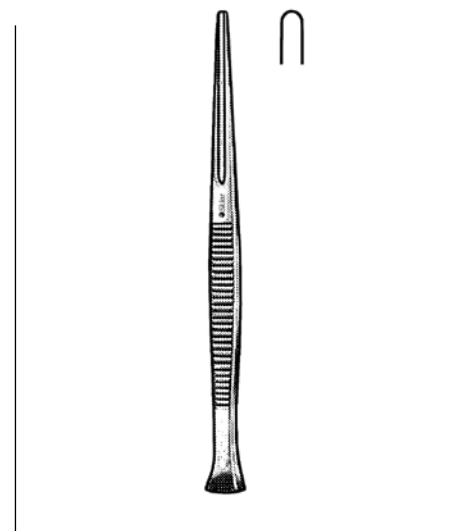

PARTSCH GOUGES

5¼"	6½"		
40-3232	2mm	40-3242	2mm
40-3233	3mm	40-3243	3mm
40-3234	4mm	40-3244	4mm
40-3235	5mm	40-3245	5mm
40-3236	6mm	40-3246	6mm
40-3237	7mm	40-3247	7mm
40-3238	8mm	40-3248	8mm

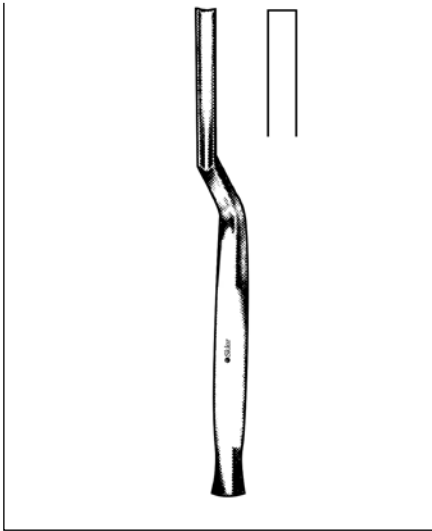

KILLIAN GOUGE

40-6818 6¾" Hollow

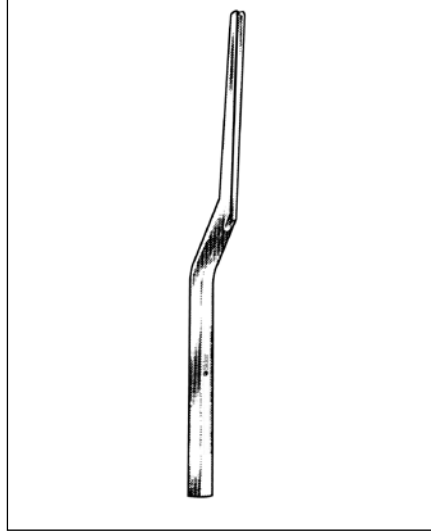

KILLIAN-CLAUS GOUGE

40-6821 6¾" 5mm

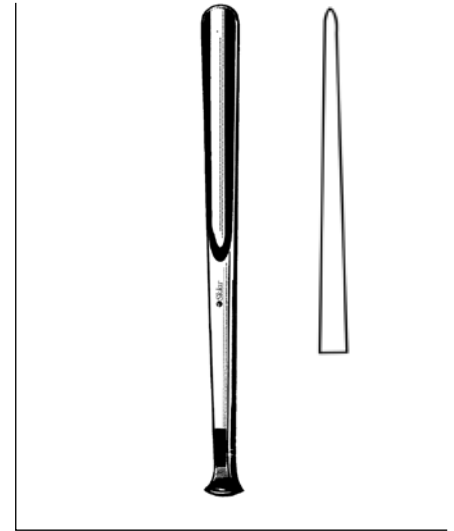

ALEXANDER GOUGES

STRAIGHT, 7"

67-4504	4mm	67-4509	9mm
67-4505	5mm	67-4510	10mm
67-4506	6mm	67-4511	11mm
67-4507	7mm	67-4512	12mm
67-4508	8mm	67-4514	14mm

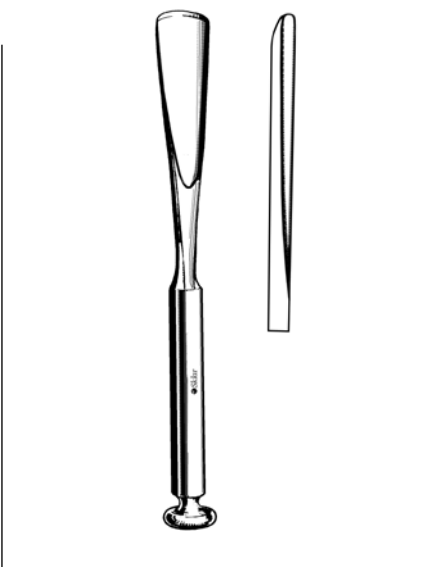

STILLE BONE GOUGES

STRAIGHT, 6¼"

40-6382	6mm
40-6383	8mm
40-6384	10mm
40-6385	12mm
40-6386	15mm

STRAIGHT, 8"

40-6304	6mm
40-6319	8mm
40-6334	10mm
40-6335	14mm
40-6344	15mm
40-6336	18mm
40-6346	20mm

CURVED, 7¾"

40-6389	15mm
40-6390	20mm
40-6391	25mm

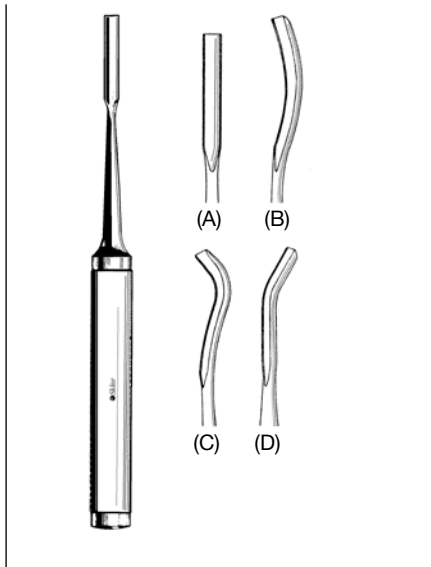

COBB TYPE SPINAL GOUGES

ROUND KNURLED HANDLE, 11"

40-6920	4mm	Straight (A)
40-6921	4mm	Slight Curve (B)
40-6922	4mm	Strong Curve (C)
40-6923	4mm	Reverse Curve (D)

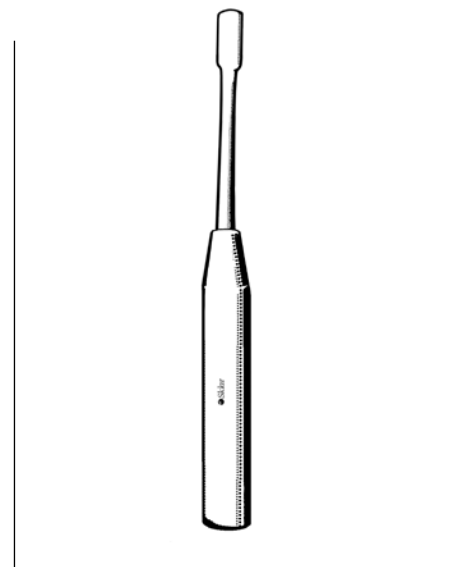

MINI-LEXER GOUGES

PLASTIC HANDLE, AUTOCLAVABLE

STRAIGHT, 7"

40-6100	4mm
40-6101	6mm
40-6102	8mm
40-6103	10mm
40-6104	12mm
40-6073	15mm
40-6075	20mm



COTTLE Mallet
40-5678 7¼" 30mm 12 oz.



RUSH (CRANE) Mallet
40-5665 7" 35mm 18 oz.



STRAND Mallet
40-5716 7½" 22mm 5.8 oz.



OMBREDANNE Mallet
STAINLESS STEEL HEAD, ALUMINIUM HANDLE
40-5696 9½" 40mm 1lb 9 oz.



GERZOG Mallet
LEAD FILLED HEAD
40-5765 7½" 25mm 14 oz.



WILLIGER MALLETS
LEAD FILLED, 9½"
40-5787 26mm 10.75 oz.
40-5788 28mm 12 oz.
40-5789 30mm 14.25 oz.



THIESS MALLETS

LEAD FILLED

40-5778 6½" 20mm 5 oz.

SOLID BRASS

40-5779 6½" 20mm 5 oz.



PARTSCH MALLET

STAINLESS STEEL

40-5700 7" 22mm 6 oz.

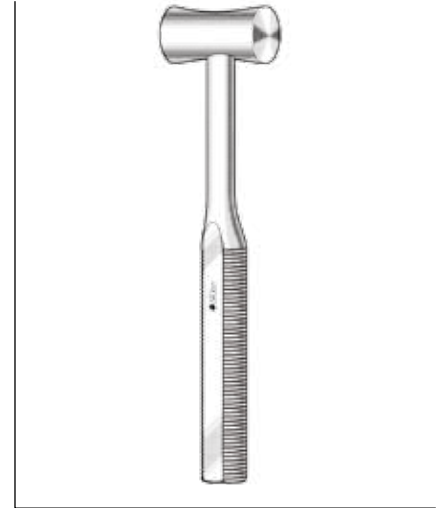

BERGMANN MALLETS

40-5560 9½" 30mm 15 oz.

40-5561 9½" 45mm 17 oz.

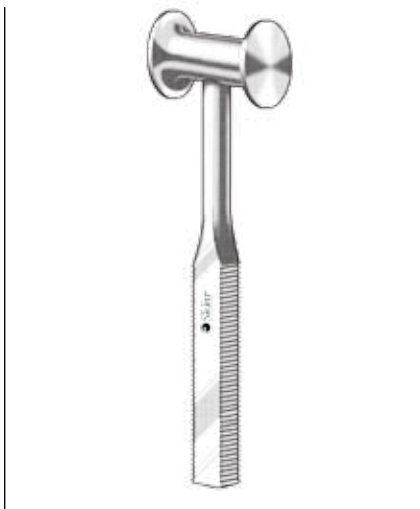

BERGMANN HIBBS MALLET

40-5562 8¾" 40mm 19 oz.

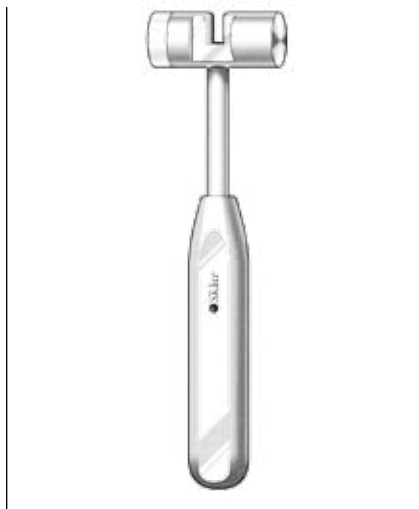

HERBERT MALLET

40-5774 7½" 25mm 10.5 oz.



HAJEK MALLET

40-5780 8" 27mm 7 oz.



KIRK Mallet

40-5672 8" 38mm 26 oz.



LUCAE MALLETS

SOLID STAINLESS STEEL

40-5874 7½" 19mm 7 oz.
 40-5875 7½" 25mm 8 oz.
 40-5876 8" 25mm 8 oz.



COLLIN Mallet

40-5674 8" 30mm 8 oz.



DOYEN MALLETS

40-5770 8" 25mm 4.25 oz.
 40-5771 8¼" 30mm 6.25 oz.
 40-5772 8¼" 35mm 9.25 oz.



FEROZELL Mallet

40-5797 9½" 30mm 4.25 oz.



FEROZELL Mallet

TWO REPLACEABLE PLASTIC ENDS

40-5798 7" 25mm 12.75 oz.
 40-5799 Replacement Ends

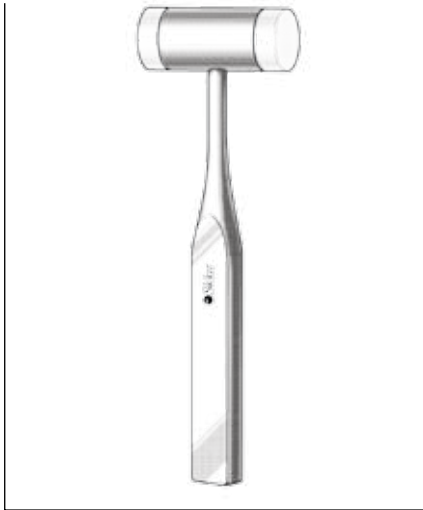

MALLET

TWO REPLACEABLE PLASTIC ENDS

- 40-5925 7¼" 25mm 8 oz.
- 40-5926 Replacement Ends

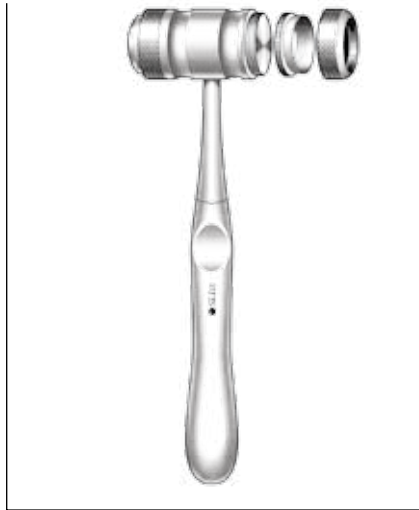

MEAD MALLET

TWO REPLACEABLE PLASTIC ENDS

- 40-5870 7½" 20mm 6 oz.
- 40-5871 Replacement Ends

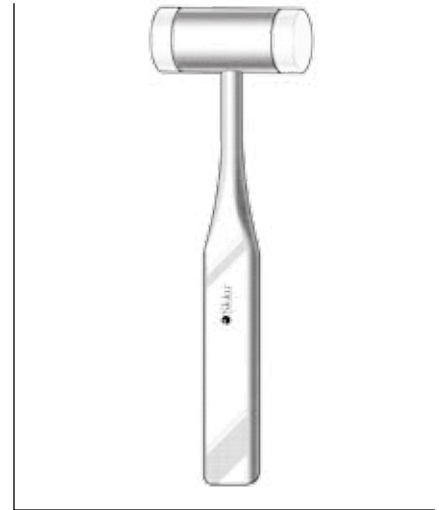

VICKERS MALLET

TWO REPLACEABLE PLASTIC ENDS

- 40-5781 7" 25mm 10.5 oz.
- 40-5782 Replacement Ends

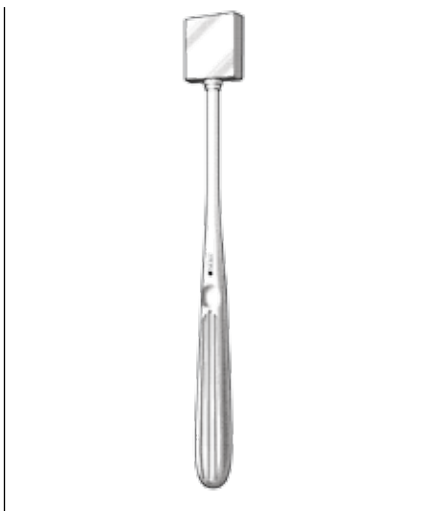

HEERMANN METAL HAMMER

- 70-7120 7¼" 195mm
- 70-7121 Handle Only

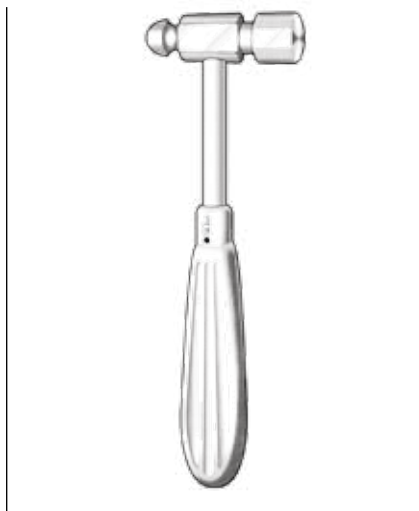

CLOWARD STYLE BALL PEEN HAMMERS

- 40-5722 7½" 11mm and 20mm 8 oz.
- 40-5724 9¼" 22mm and 25mm 13 oz.

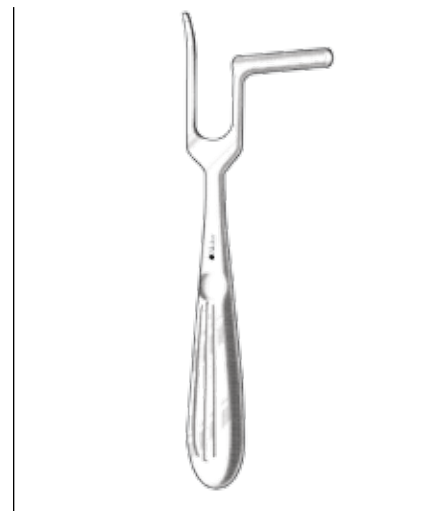

QUISLING INTRANASAL HAMMER

- 40-5775 6¾"

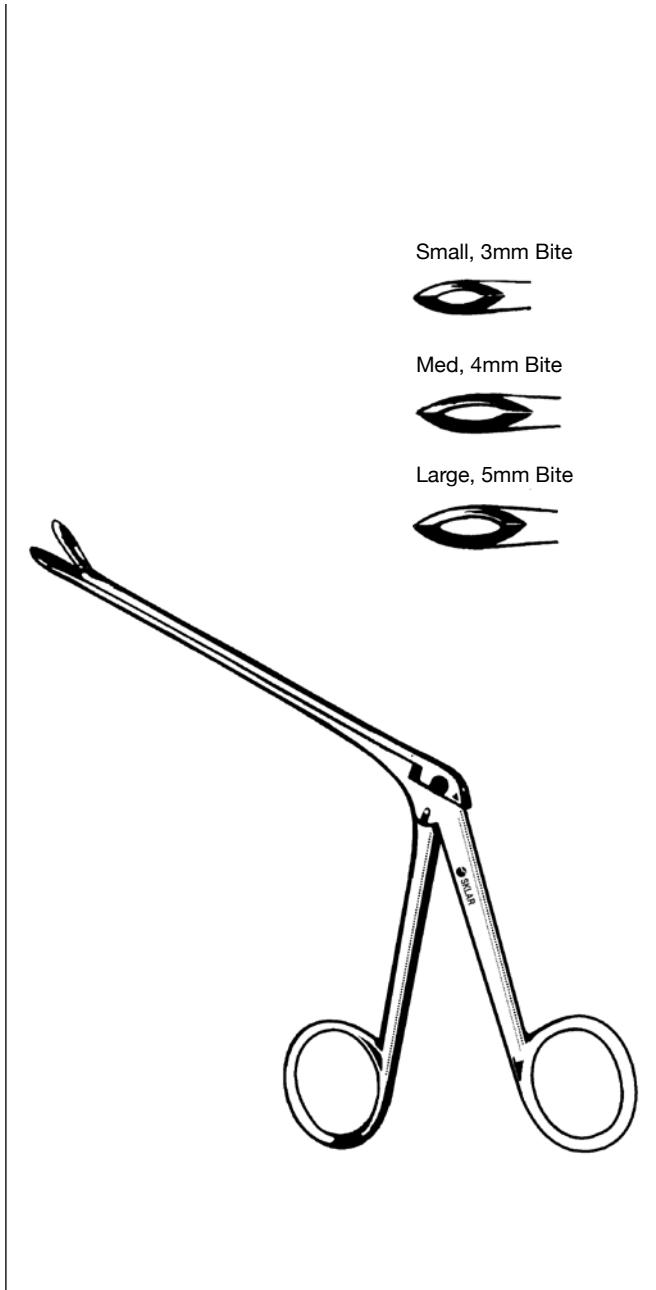

Small, 3mm Bite



Med, 4mm Bite



Large, 5mm Bite

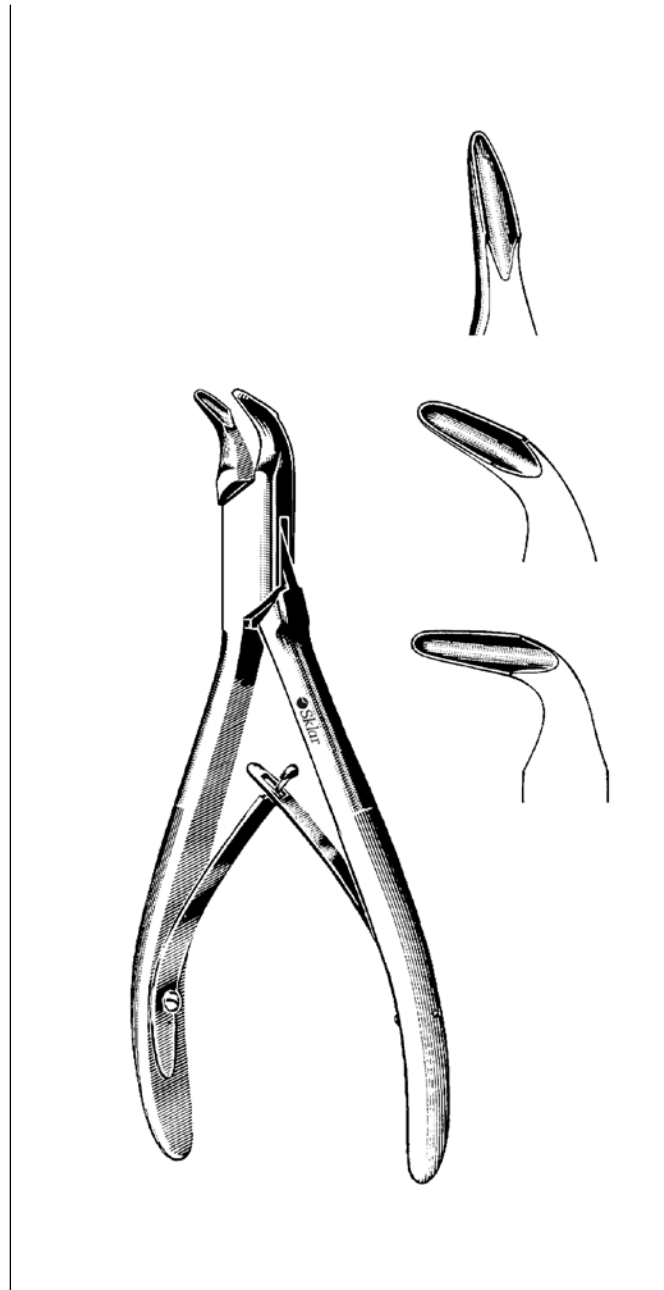

WILDE INTERVERTEBRAL RONGEURS

FENESTRATED JAWS

70-5420	5½"	3mm Bite	Small
70-5421	5½"	4mm Bite	Medium
70-5422	5½"	5mm Bite	Large

BLUMENTHAL RONGEURS

ANGLED

67-5990	6"	30 Degrees
67-5991	7"	30 Degrees
67-5992	6"	45 Degrees
67-5994	6"	90 Degrees



BANE RONGEUR
67-5175 7" Curved 3x16mm Bite



HARTMAN RONGEUR
67-5458 5 3/4" Full Curve



REINER RONGEUR
BROAD JAW
67-5770 7"



KERRISON RONGEURS
65-7400 3" Shaft 3mm
65-7401 4 1/2" Shaft 4mm
65-7402 4 1/2" Shaft 5mm
65-7403 4 1/2" Shaft 6mm

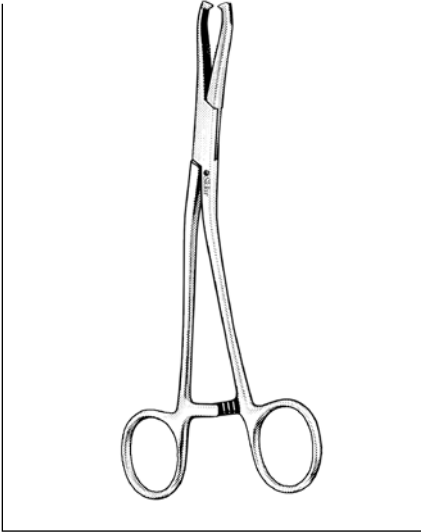

DINGMAN BONE HOLDING CLAMP

SERRATED, 2X2 TEETH
40-2660 7½" 4mm

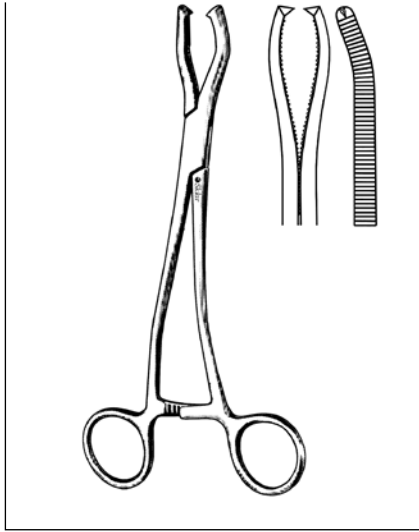

JETER-VAN SICKLES BONE HOLDING FORCEPS

67-1460 7" Light
67-1461 7" Heavy

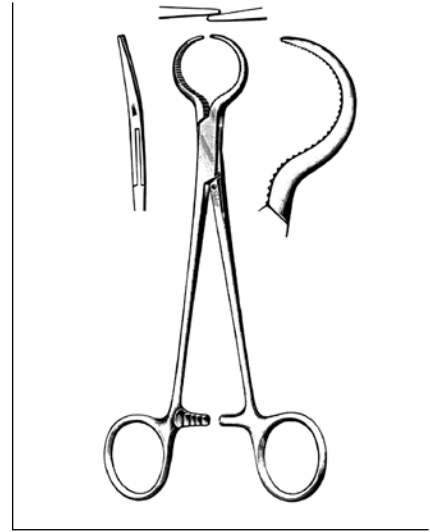

LEWIN BONE FORCEPS

40-2670 7" Serrated

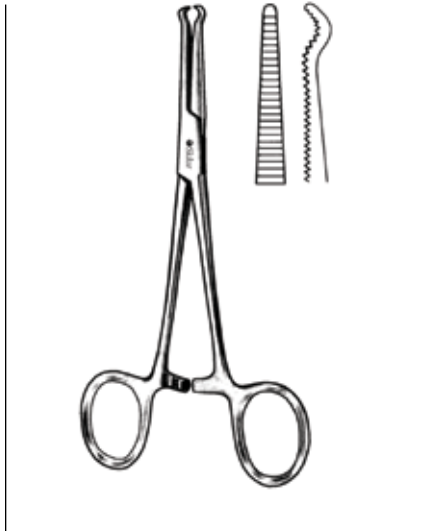

BONE HOLDING FORCEPS

40-2676 5½" Serrated

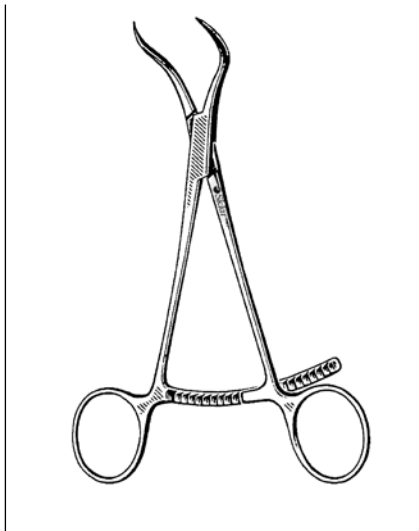

BONE HOLDING FORCEPS

40-2675 5½" Long Ratchet,
Pointed Tips



BONE HOLDING FORCEPS

40-2672 4¾" One Pointed Tip,
One Foot Plate

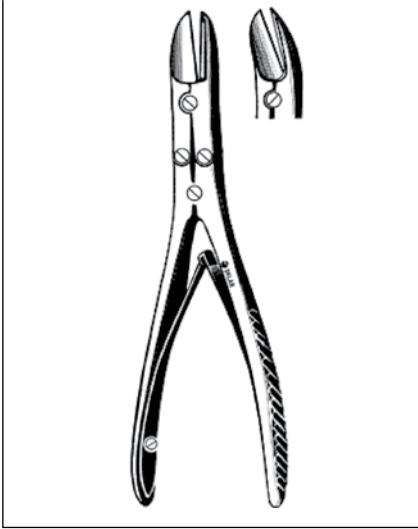

RUSKIN-LISTON BONE FORCEPS

40-4572 7¼" Straight
40-4575 7¼" Angled

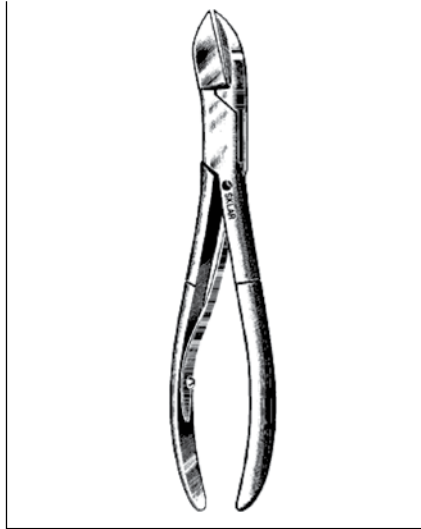

LISTON BONE FORCEPS

ANGLED
40-3155 5½"
40-3177 7¾"
40-3187 8¾"

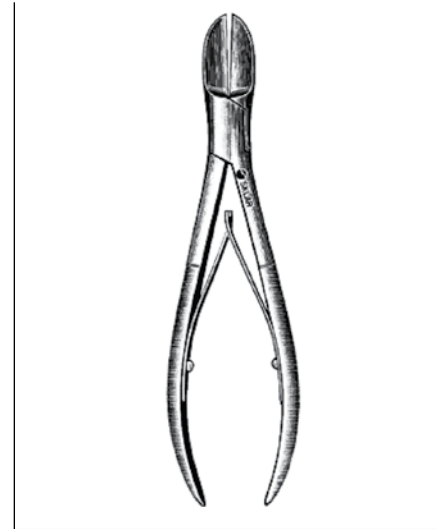

LISTON BONE FORCEPS

STRAIGHT
40-3055 5½"
40-3077 7¾"
40-3087 8¾"

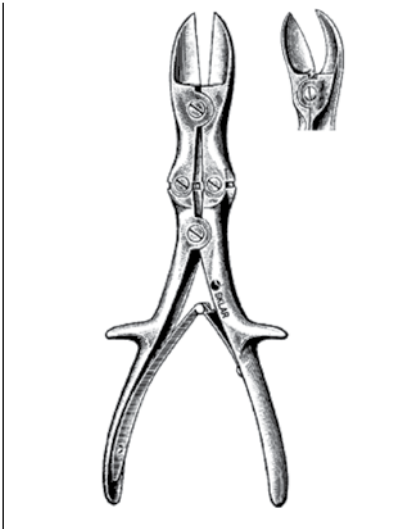

STILLE-LISTON BONE FORCEPS

40-3710 10½" Straight
40-3810 10½" Curved

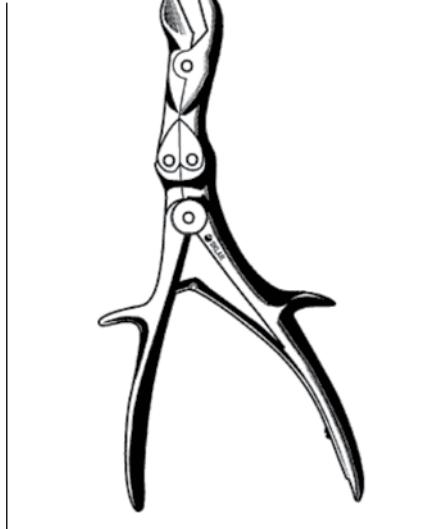

STILLE-HORSLEY BONE FORCEP

40-3910 10½"

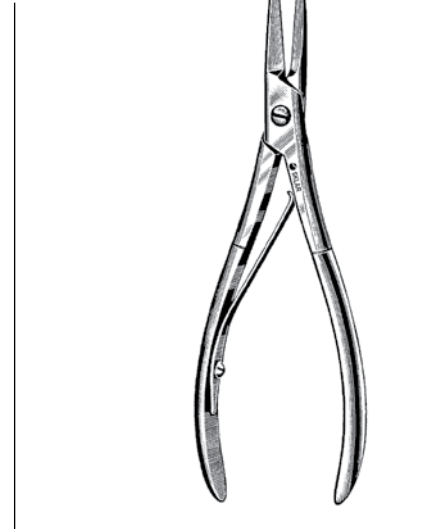

KAZANJIAN BONE CUTTING FORCEP

70-4275 7½"



ROWLAND BONE FORCEP

DOUBLE ACTION

41-1175 7" Narrow Jaws

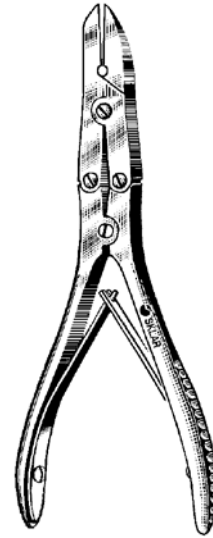

KLEINERT-KUTZ BONE CUTTING FORCEPS

DOUBLE ACTION

40-4560 6" Straight
40-4562 6" Straight, Delicate

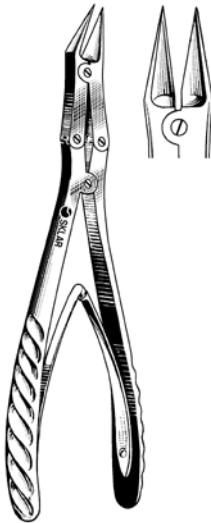

McINDOE BONE CUTTING FORCEP

DOUBLE ACTION

40-1170 7½" Slight Angle

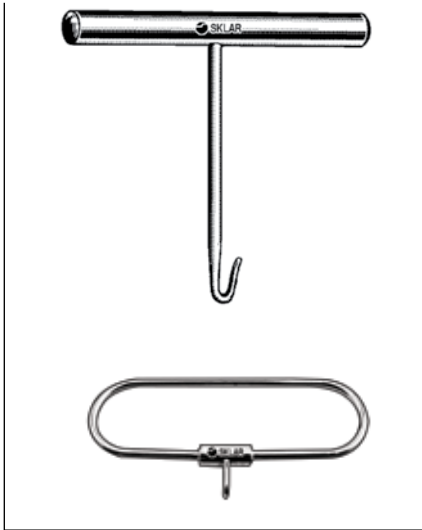

GIGLI SAW HANDLES

- 40-5520 T-Shaped
- 40-5535 Wire Loop

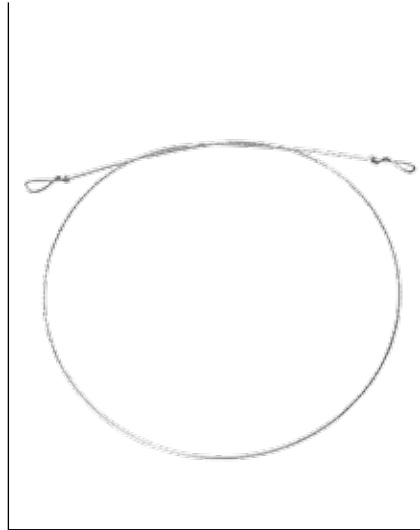

GIGLI SAW WIRES

- 40-5540 9"
- 40-5542 12"
- 40-5543 16"
- 40-5544 20"
- 40-5546 30"



JOSEPH SAW GUIDE

- 41-1320 4mm Curved



JOSEPH NASAL SAWS

- 70-7805 7½" Straight
- 70-7801 7½" Right Bayonet
- 70-7802 7½" Left Bayonet



JOSEPH NASAL SAWS

- 70-7821 Angled to Right
- 70-7822 Angled to Left

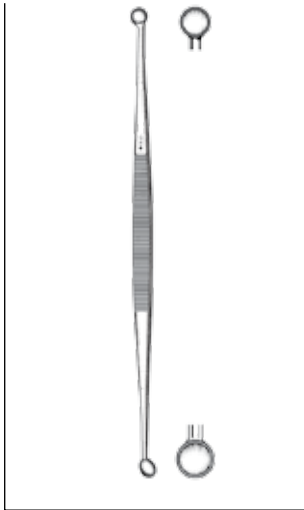

MARTINI BONE CURETTES

DOUBLE END, 5½"

- 40-7282 2.5mm & 3.5mm
- 40-7283 3.5mm & 4.5mm
- 40-7284 4mm & 5mm

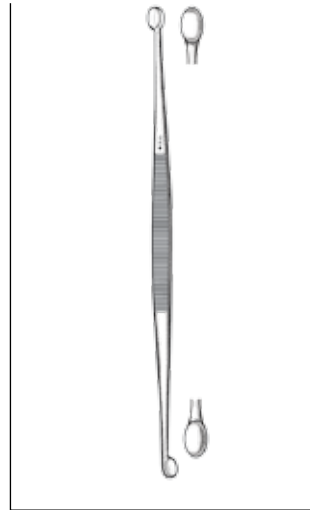

WILLIGER BONE CURETTES

DOUBLE END, OVAL, 5½"

- 40-7285 #00/0 2mm & 2.5mm
- 40-7287 #0/1 2.5mm & 3mm
- 40-7286 #1/2 3mm & 4mm

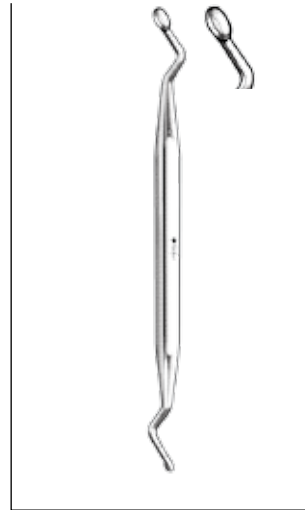

JANSEN BONE CURETTES

DOUBLE END, 6½"

- 41-1977 Round, 3mm & 5mm
Straight tips
- 41-1978 Oval, 3mm & 4mm
Angled tips

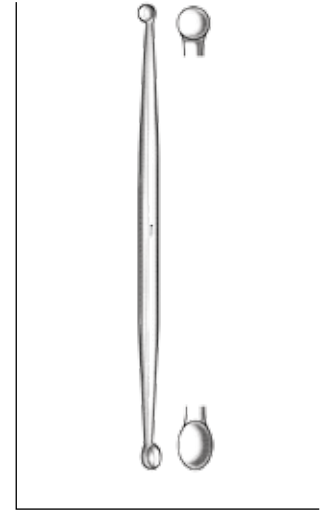

BONE CURETTE

OVAL/ROUND, 8¼"

40-7310 6mm Oval x 7mm Round

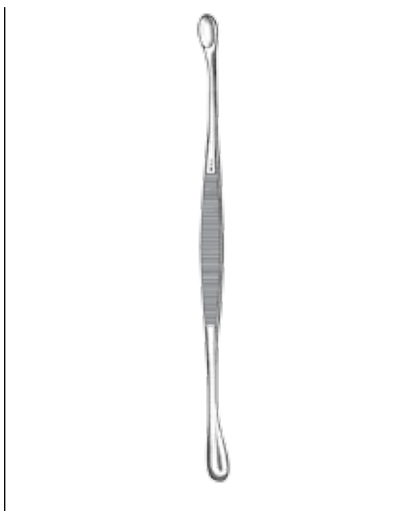

VOLKMAN CURETTES

DOUBLE END, OVAL / OVAL

- 40-7164 5"
- 40-7163 5½"
- 40-7165 6½"
- 40-7166 8"

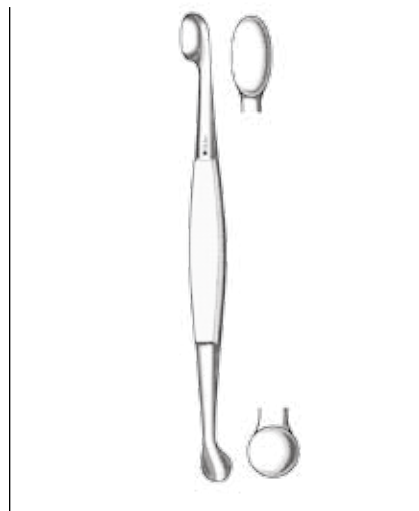

VOLKMAN BONE CURETTES

DOUBLE END, OVAL / ROUND

- 40-7250 5" Oval Cup 6mm x 10mm
Round Cup 7mm
- 40-7265 6½" Oval Cup 8mm x 14mm
Round Cup 10mm
- 40-7280 8" Oval Cup 9mm x 18mm
Round Cup 11mm

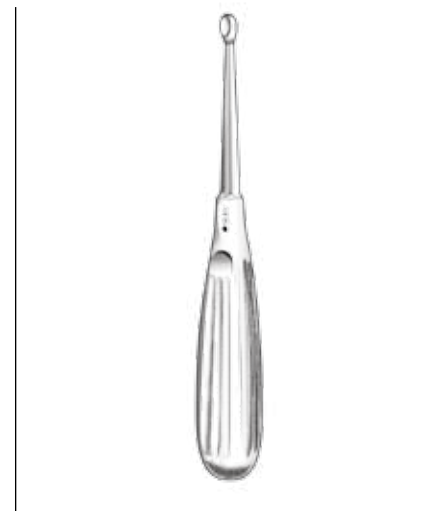

VOLKMAN BONE CURETTES

STRAIGHT, 6¾"

- | | |
|---------------|------------|
| 40-7140 #0000 | 40-7145 #2 |
| 40-7141 #000 | 40-7146 #3 |
| 40-7142 #00 | 40-7147 #4 |
| 40-7143 #0 | 40-7148 #5 |
| 40-7144 #1 | 40-7149 #6 |

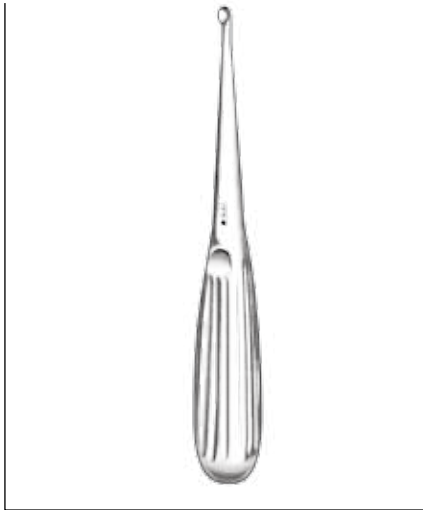

BRUNS CURETTES

STRAIGHT, ROUND, 6 $\frac{3}{4}$ "

41-1701	#000	41-1706	#3
41-1702	#00	41-1707	#4
41-1703	#0	41-1708	#5
41-1704	#1	41-1709	#6
41-1705	#2		

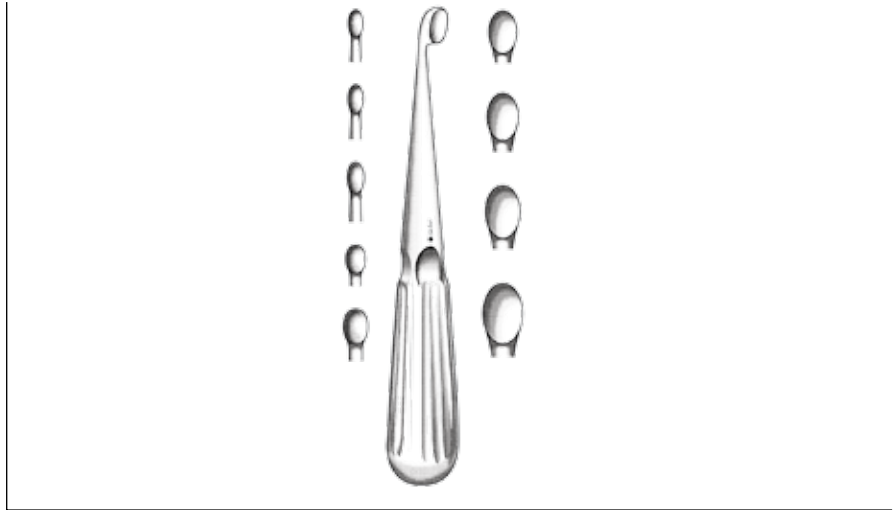

BRUNS CURETTES

STRAIGHT, OVAL
6 $\frac{3}{4}$ "

40-7118	#00000	40-7112	#2
40-7120	#0000	40-7113	#3
40-7000	#000	40-7114	#4
40-7100	#00	40-7115	#5
40-7110	#0	40-7116	#6
40-7111	#1		

9"

40-7199	#000000	40-7205	#1
40-7200	#00000	40-7206	#2
40-7201	#0000	40-7207	#3
40-7202	#000	40-7208	#4
40-7203	#00	40-7209	#5
40-7204	#0	40-7210	#6

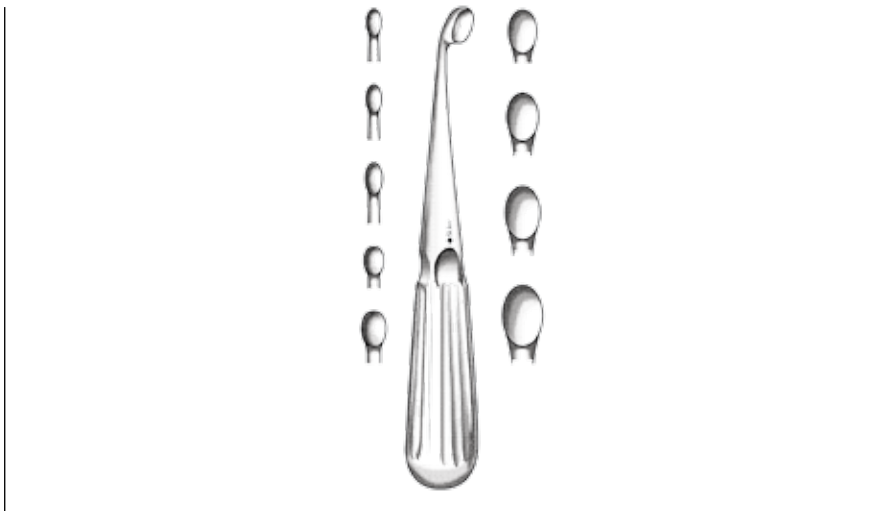

BRUNS CURETTES

ANGLED, OVAL

6 $\frac{1}{2}$ "				9"			
41-1710	#00000	41-1716	#2	40-7219	#000000	40-7225	#1
41-1711	#0000	41-1717	#3	40-7220	#00000	40-7226	#2
41-1712	#000	41-1718	#4	40-7221	#0000	40-7227	#3
41-1713	#00	41-1719	#5	40-7222	#000	40-7228	#4
41-1714	#0	41-1720	#6	40-7223	#00	40-7229	#5
41-1715	#1			40-7224	#0	40-7230	#6

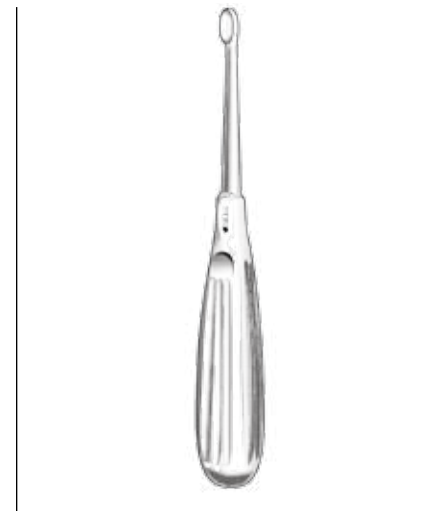

SCHIDE BONE CURETTES

OVAL, HOLLOW SHAFT, 6 $\frac{3}{4}$ "

41-1922	#000	41-1926	#2
41-1923	#00	41-1927	#3
41-1924	#0	41-1928	#4
41-1925	#1		



BRUNS CURETTES

OVAL, HEXAGONAL HANDLE, 9"

STRAIGHT

40-7330 #000	40-7335 #3
40-7331 #00	40-7336 #4
40-7332 #0	40-7337 #5
40-7333 #1	40-7338 #6
40-7334 #2	

ANGLED

40-7350 #000	40-7355 #3
40-7351 #00	40-7356 #4
40-7352 #0	40-7357 #5
40-7353 #1	40-7358 #6
40-7354 #2	

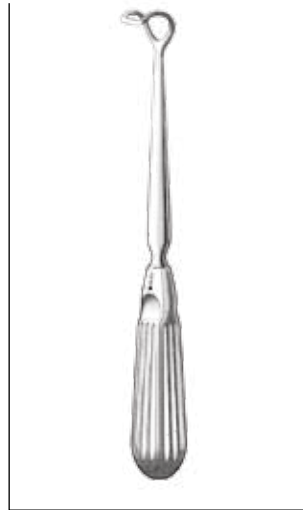

BARNHILL ADENOID CURETTES

8¼"

70-9200	#0
70-9201	#1
70-9202	#2
70-9203	#3
70-9204	#4

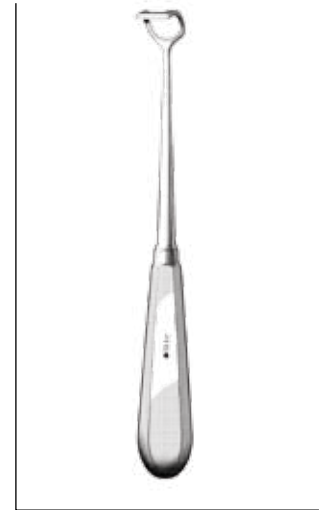

BECKMANN ADENOID CURETTES

8½"

70-9220	#1
70-9221	#2
70-9222	#3
70-9223	#4
70-9224	#5
70-9225	#6



RAY HYPOPHYSEAL CURETTE

7½"

41-1909	4mm	Round
---------	-----	-------



RAY PITUITARY CURETTES

ROUND, VERTICAL ANGLE, 7½"

41-1910	45°	3mm
41-1911	45°	4mm
41-1912	45°	5mm
41-1913	90°	3mm
41-1914	90°	4mm
41-1915	90°	5mm

ROUND, HORIZONTAL ANGLE, 7½"

41-1916	45°	3mm
41-1917	45°	4mm
41-1918	45°	5mm
41-1919	90°	3mm
41-1920	90°	4mm
41-1921	90°	5mm

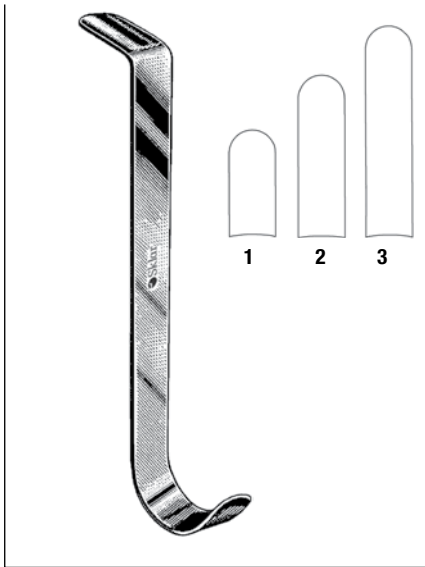

CONVERSE BLADE RETRACTORS

DOUBLE END

41-1401	#1	9x20mm	3¼"
41-1402	#2	13x28mm	3¼"
41-1403	#3	13x41mm	3¼"

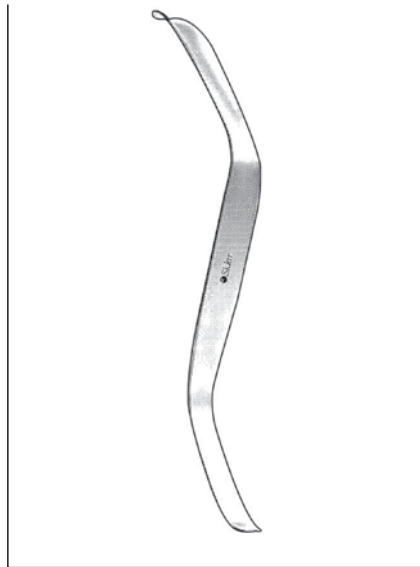

FISCHL "SHOE HORN" RETRACTOR

DOUBLE END

57-1440	5½"	16mm
---------	-----	------

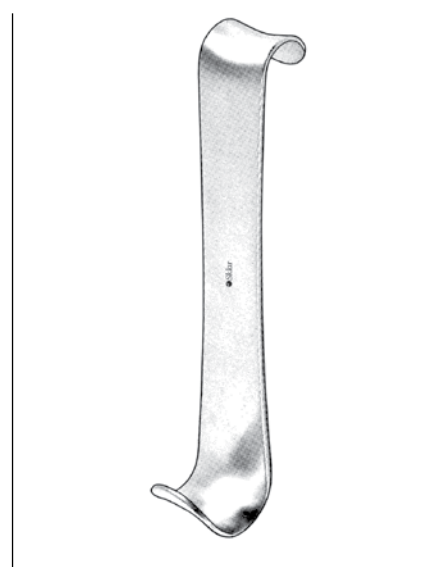

SHEARER RETRACTOR

DOUBLE END

75-1125	6"
---------	----

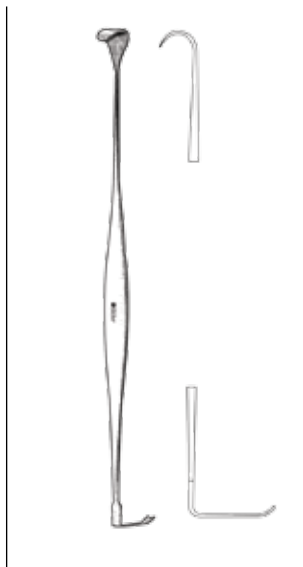

WALTER COPE RETRACTOR

DOUBLE END

60-6170	6¾"	Delicate
---------	-----	----------

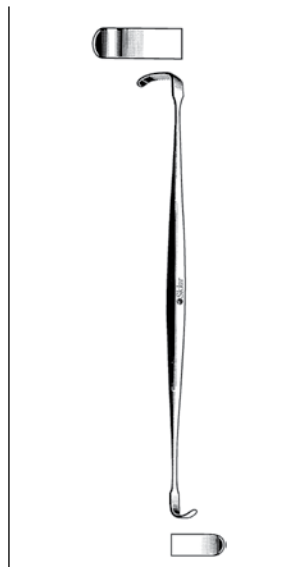

RAGNELL RETRACTOR

DOUBLE END

22-8560	5½"
---------	-----

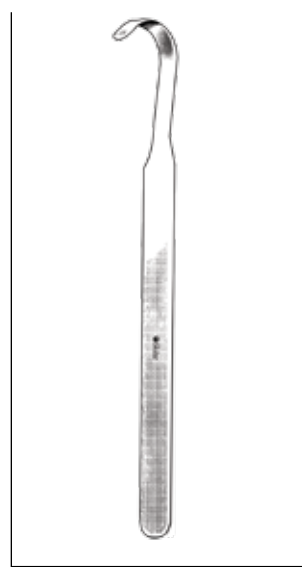

SHEEN RETRACTOR

41-2101	6"	Curved, 6.5mm
---------	----	---------------



BENICKE RETRACTORS

S-SHAPED TIP, DELICATE

47-6001	7½"	Sharp, 8mm
47-6002	7½"	Blunt, 8mm



MANNERFELT RETRACTORS

1 PRONG

47-2608	6"	Blunt	Narrow Tip
47-2614	6"	Blunt	Wide Tip
47-2600	5¼"	Sharp	
47-2601	6"	Sharp	
47-2605	6"	Sharp	Narrow Tip
47-2611	6"	Sharp	Wide Tip

2 PRONGS

47-2609	6"	Blunt	Narrow Tip
47-2615	6"	Blunt	
47-2602	6"	Sharp	Wide Tip
47-2606	6"	Sharp	Narrow Tip
47-2612	6"	Sharp	Wide Tip
47-2603	6"	Sharp	Short

3 PRONGS

47-2604	6"	Long	
47-2610	6"	Blunt	
47-2616	6"	Blunt	Wide Tip
47-2607	6"	Sharp	Narrow Tip
47-2613	6"	Sharp	Wide Tip
47-2617	6"	Sharp	Flexible Shaft

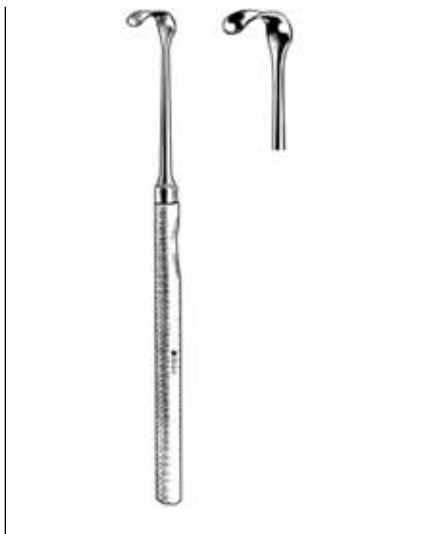

**MANNERFELT RETRACTOR
SADDLE GROOVED**

47-2618	6"	16x6mm
---------	----	--------

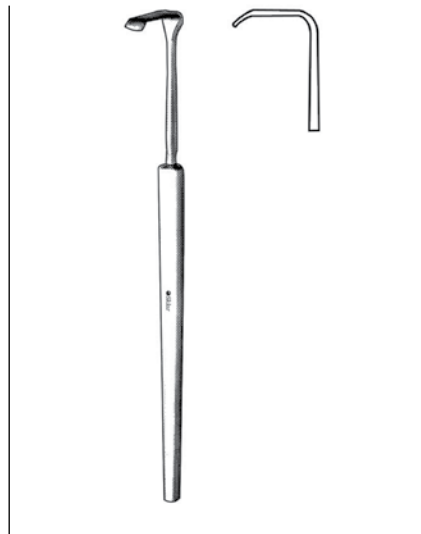

**SENN GREEN RETRACTORS
DELICATE**

60-6160	5½"	6x10mm
60-6161	5½"	6x20mm

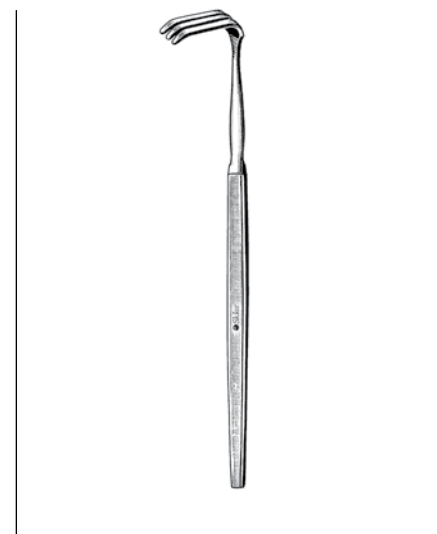

**PAUL RETRACTOR
3 PRONG**

47-2647	4¾"	Blunt
---------	-----	-------

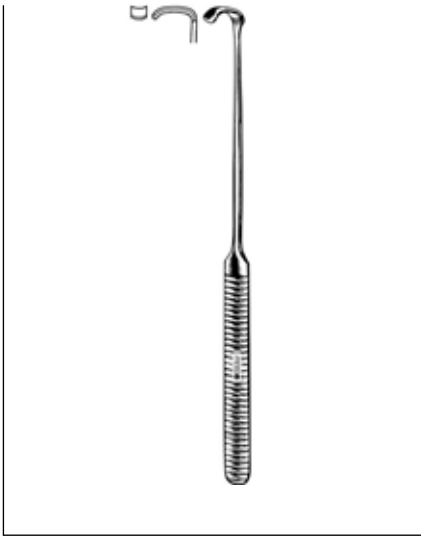

**STRANDELL-STILLE
RETRACTOR**

60-6172 7½" 20x6mm

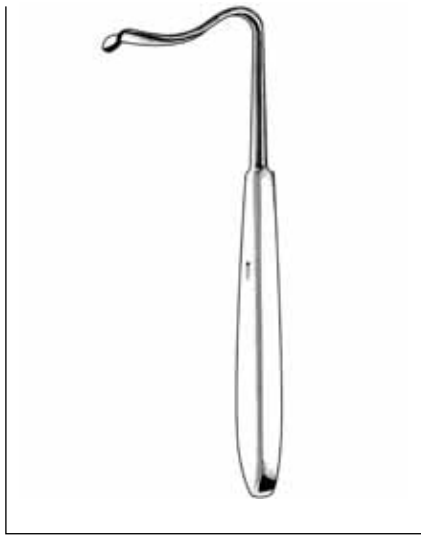

**BOWDLER-HENRY'S
RAKE RETRACTOR**

75-1155 6½"

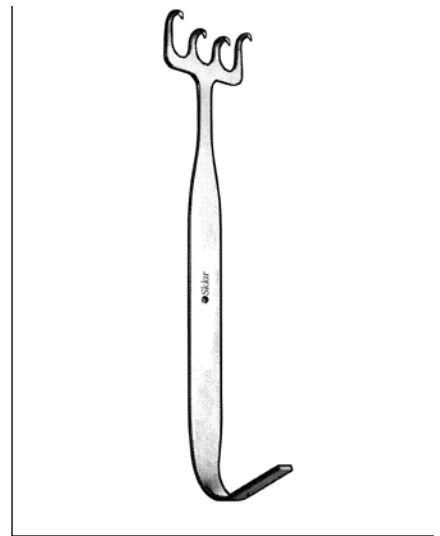

FREEMAN RETRACTOR

4 PRONG, SHARP
60-2033 7¼" Offset

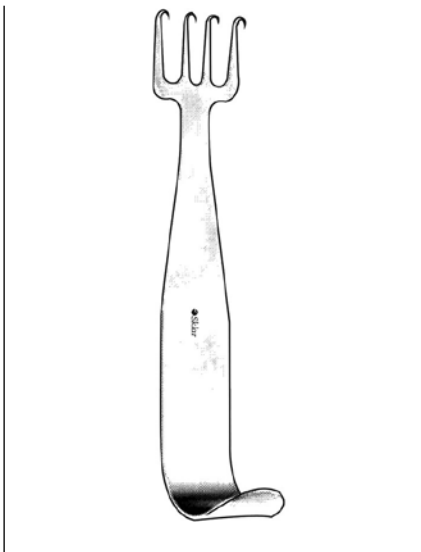

MAXWELL FLAP RETRACTORS

60-4101 4" 22mm
60-4102 4" 38mm

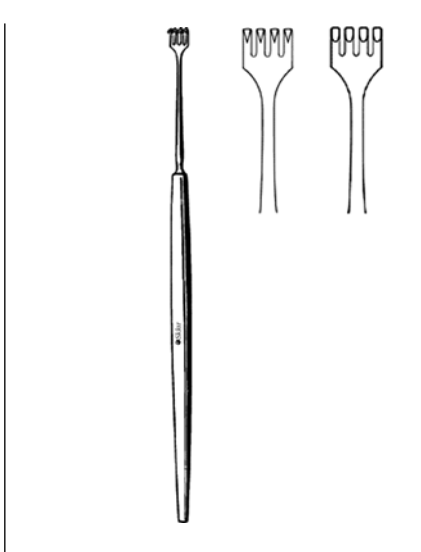

BLAIR-ROLL RETRACTORS

4 PRONG, DELICATE
47-2655 5½" Sharp
47-2752 5½" Blunt

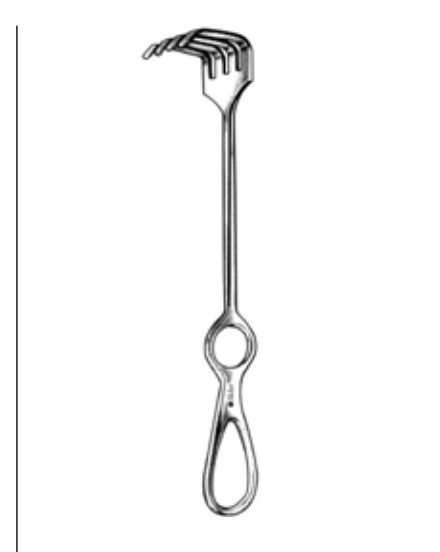

BILLROTH RETRACTORS

60-6110 9¾" 35x40mm
60-6111 9¾" 43x35mm
60-6112 9¾" 45x50mm



HOESEL RETRACTORS

60-1963	9¾"	60x20mm
60-1964	9¾"	80x30mm
60-1965	9¾"	100x30mm
60-1966	9¾"	120x30mm
60-1967	9¾"	140x30mm
60-1968	9¾"	140x40mm

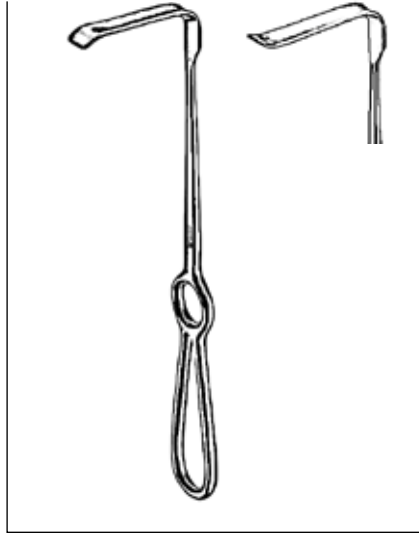

OBWEGESER RETRACTORS

CURVED DOWN		CURVED UP	
41-1450	7x25mm	41-1460	7x25mm
41-1451	10x35mm	41-1461	10x35mm
41-1452	10x42mm	41-1462	10x42mm
41-1453	12x55mm	41-1463	12x55mm
41-1454	14x70mm	41-1464	14x70mm
41-1455	16x80mm	41-1465	16x80mm

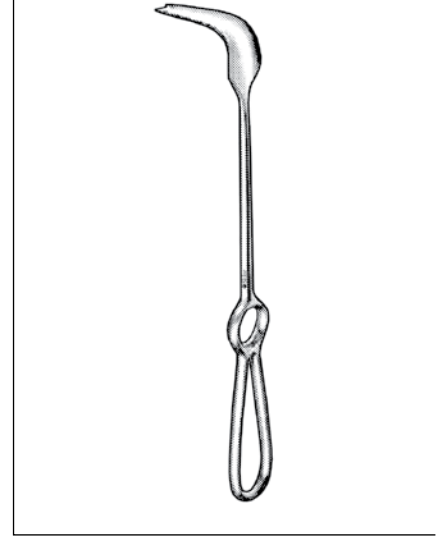

OBWEGESER RAMUS RETRACTORS

41-1435	22x70mm
---------	---------



MUNRO LATERAL VERTICAL RAMOS RETRACTOR

75-2221	6¼"	20mm
75-2222	6¼"	25mm
75-2223	6¼"	30mm
75-2224	6¼"	35mm

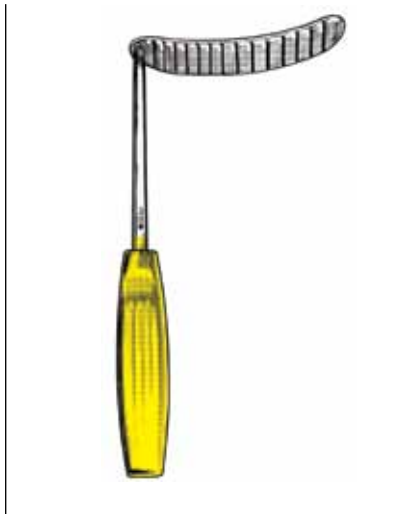

MARX BREAST RETRACTORS

60-8120	125x30mm
60-8122	140x30mm

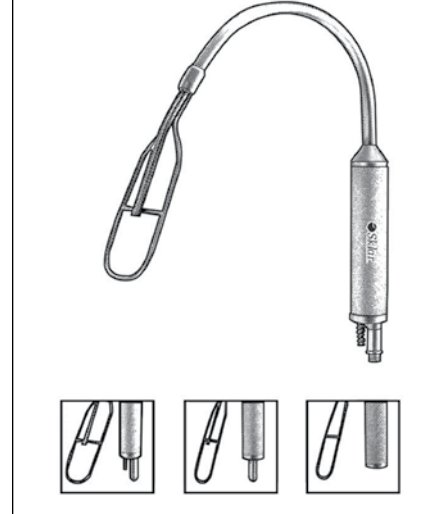

BIGGS MAMMOPLASTY RETRACTORS

WITHOUT FIBER OPTIC AND SUCTION TUBE

60-8100	30mm
60-8101	50mm

WITH FIBER OPTIC AND SUCTION TUBE

60-8102	30mm
60-8103	50mm

WITH FIBER OPTIC

60-8104	30mm
60-8105	50mm

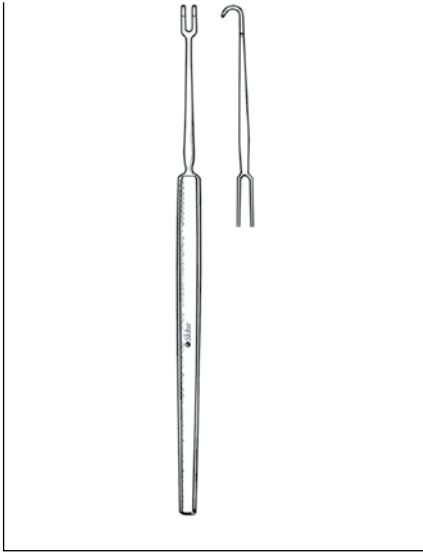

DERMAL RETRACTORS

2 PRONGS

- 47-2514 5¼" Sharp
- 47-2516 5¼" Blunt

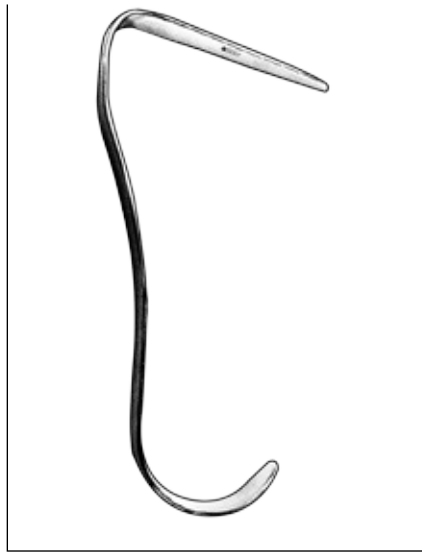

CONVERSE NASAL RETRACTOR

41-1407 4¼"

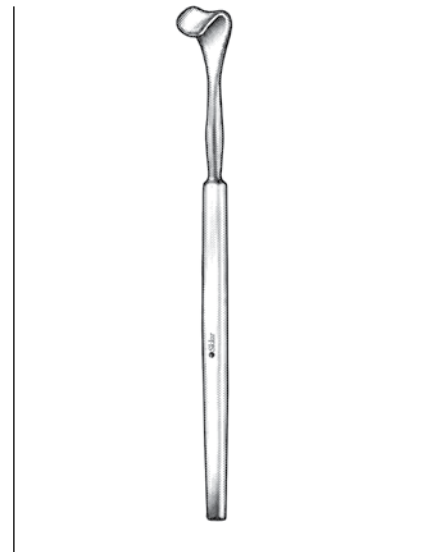

COTTLE NASAL RETRACTOR

41-1408 6" 10x12mm

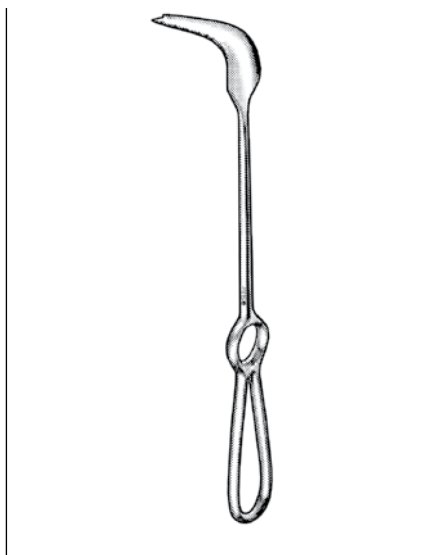

OBWEGESER NASAL RETRACTOR

41-1430 23x40mm

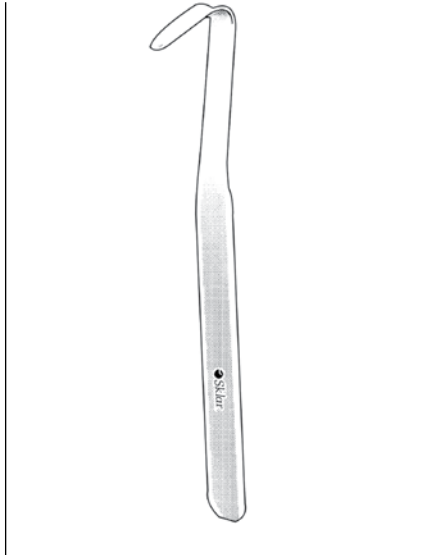

SHEEN NASAL RETRACTOR

41-2100 6¼" Angled, 10mm

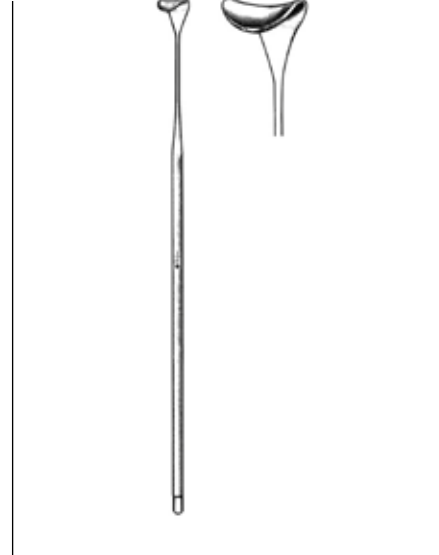

GIL-VERNET SINUS RETRACTORS

- 33-1708 9½" 8mm
- 33-1711 9½" 11mm
- 33-1715 9½" 13mm
- 33-1717 9½" 15mm
- 33-1720 9½" 18mm
- 33-1723 9½" 25mm

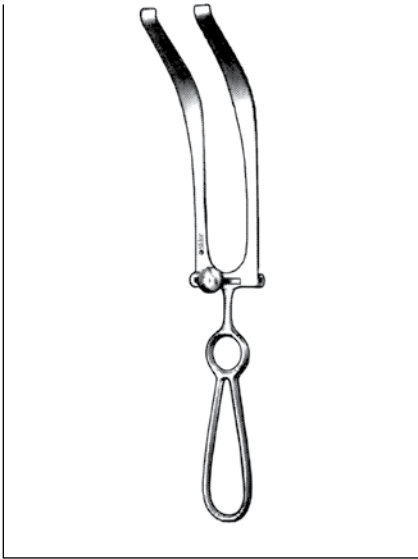

BURTON DOUBLE PALATAL RETRACTOR

ADJUSTABLE

75-2211 11"

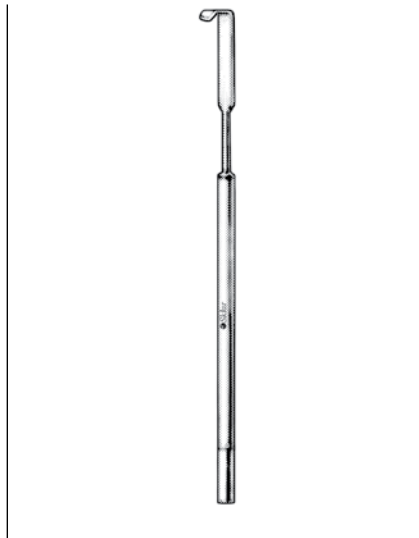

SALYER CLEFT PALATE RETRACTORS

41-1470	7"	Short
41-1471	7"	Long



LOGAN BOW RETRACTORS

DELICATE FOR CLEFT PALATE

75-1135	25mm
75-1136	32mm
75-1137	35mm



DUNN-DAUTREY TMJ RETRACTORS

75-2181	6½"	6.5x50mm	Posterior
75-2182	6½"	6.5x60mm	Anterior
75-2183	6½"	8x50mm	Superior
75-2184	6½"	6.5x50mm	Superior

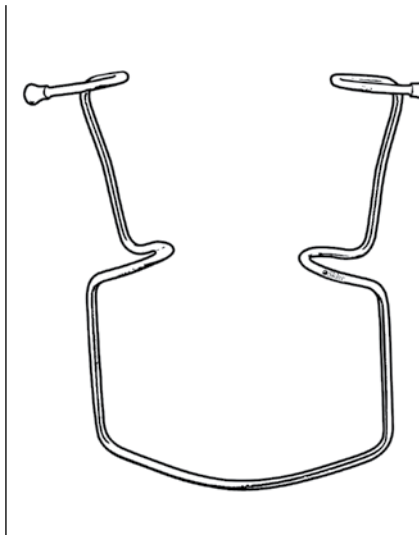

ORINGER LIP RETRACTORS

75-1145	3¾"	50mm
75-1146	3¾"	65mm
75-1147	3¾"	70mm
75-1148	3¾"	75mm
SET OF 3		
75-1149	3¾"	65mm, 70mm, 75mm

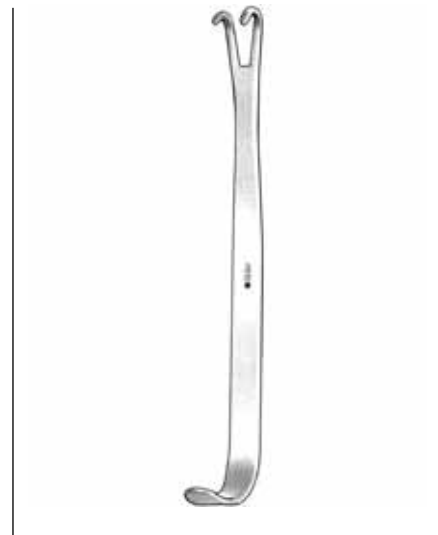

CRONIN LIP/NOSTRIL RETRACTOR

75-1128 6" 14mm

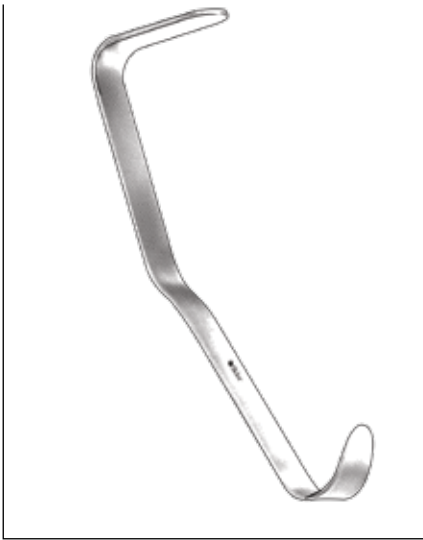

CRONIN CHEEK RETRACTOR

75-1127 6" 19mm

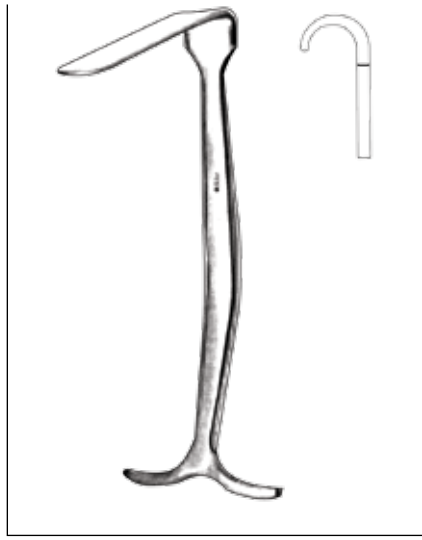

SMITH NERVE ROOT RETRACTOR

50-1325 7" 6x3mm

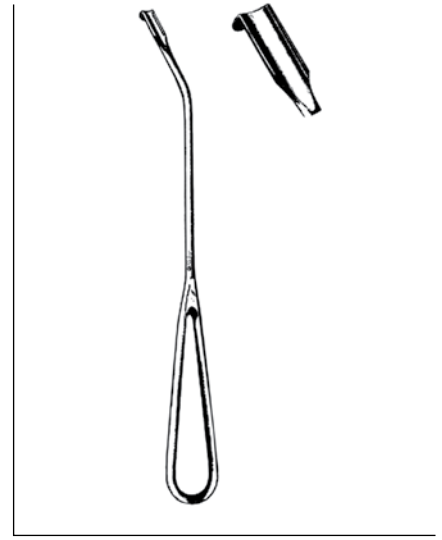

HOLSCHER NERVE RETRACTOR

50-1297 9½" 9mm Blunt

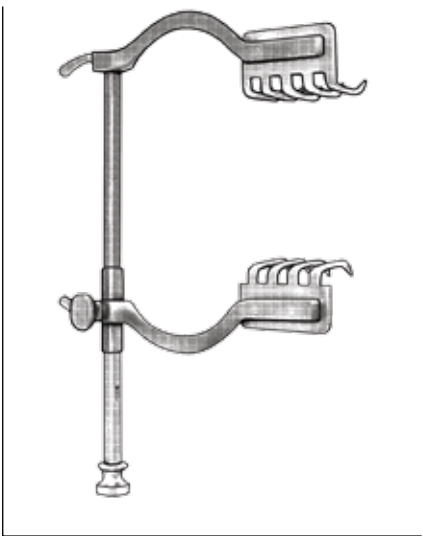

THEIS VEIN RETRACTOR

SELF-RETAINING

60-6315 3½" 4x5 Sharp Prongs

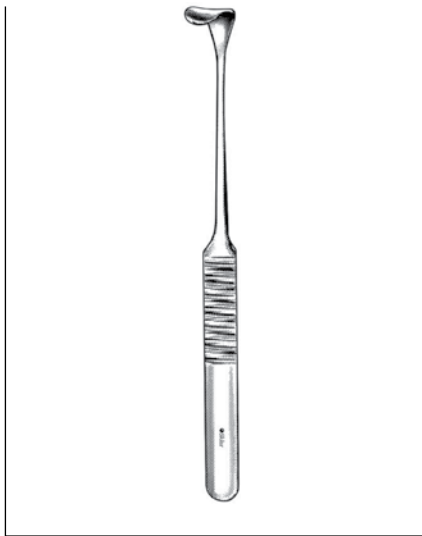

KOENIG VEIN RETRACTORS

47-2518 6¾" 13x16mm

47-2519 6¾" 13x13mm

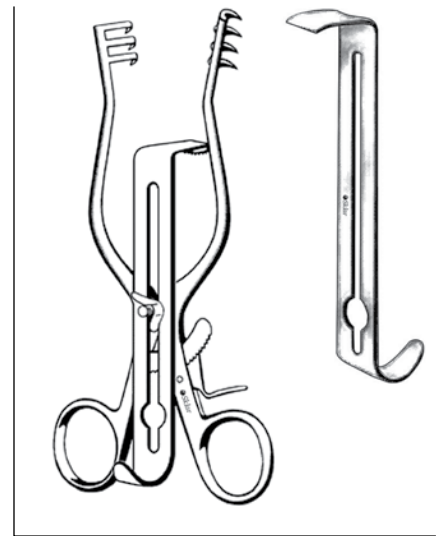

HENLEY RETRACTORS

55-7340 6½" 3x4 Sharp

55-7341 6½" 3x4 Blunt

HENLEY RETRACTOR BLADES

55-7342 16x19mm

55-7344 16x25mm

55-7345 16x32mm

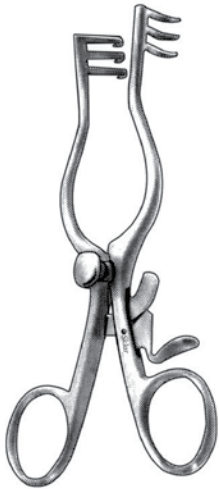

MILLIGAN RETRACTORS

SELF-RETAINING

42-1810	5"	Blunt
42-1811	5"	Sharp



JANSEN RETRACTORS

3" SPREAD

47-2832	4"	3x3 Prongs	Blunt
47-2834	4"	3x3 Prongs	Sharp
47-2836	4½"	4x4 Prongs	Blunt
47-2838	4½"	4x4 Prongs	Sharp

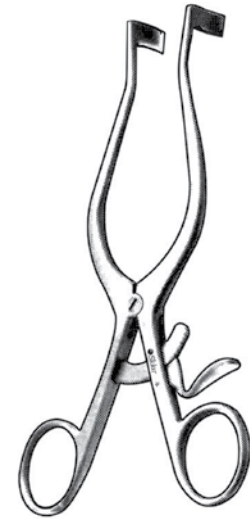

TÜBINGER MODELL RETRACTORS

SELF-RETAINING

42-1560	6½"
42-1561	7"



PARSONNET RETRACTORS

SELF-RETAINING

22-8845	1¼"	4x3 Sharp Prongs
22-8846	1½"	5x3 Sharp Prongs
22-8847	2"	3x3 Sharp Prongs

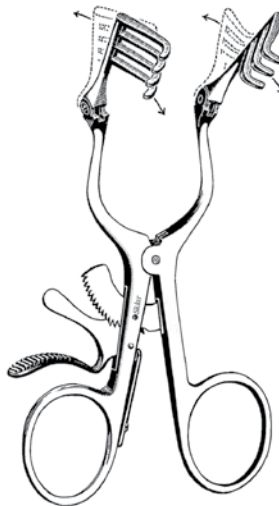

WEITLANER BECKMAN RETRACTORS

HINGED BLADES WITH 3X4 PRONGS

BLUNT		SHARP	
42-1654	5½"	42-1764	5½"
42-1655	6½"	42-1765	6½"
42-1656	9"	42-1766	9"
42-1657	10¼"	42-1767	10¼"

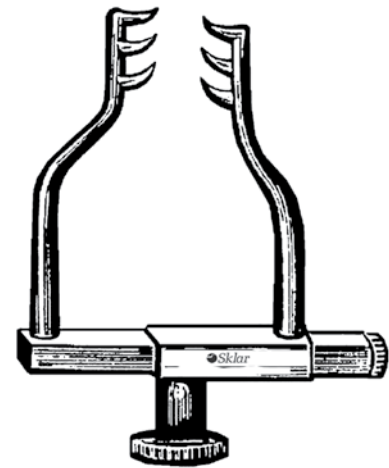

GOLDSTEIN RETRACTORS

SHARP

47-2913	1½"	3x3
---------	-----	-----

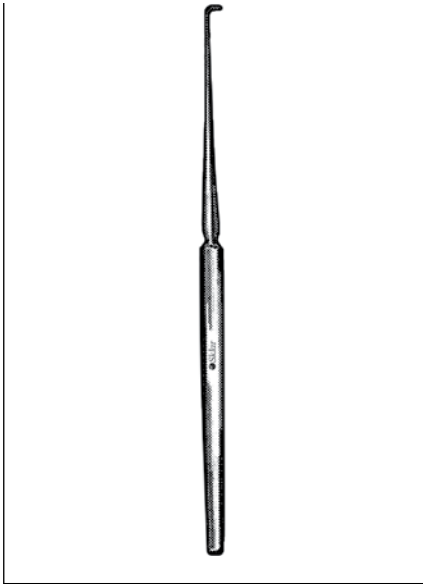

ADSON HOOKS

50-1685 8" Sharp
50-1585 8" Blunt

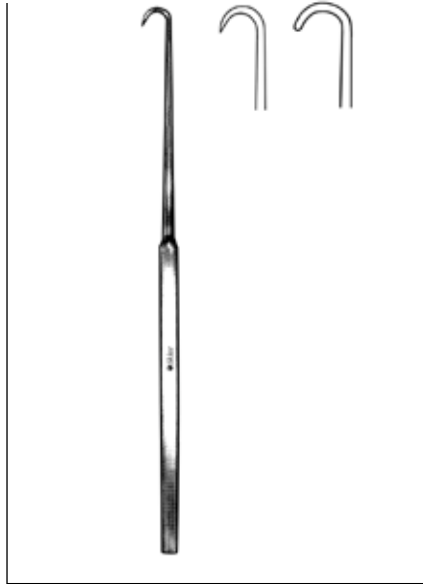

ITERSON HOOKS

78-3522 6¾" Sharp
78-3523 6¾" Blunt

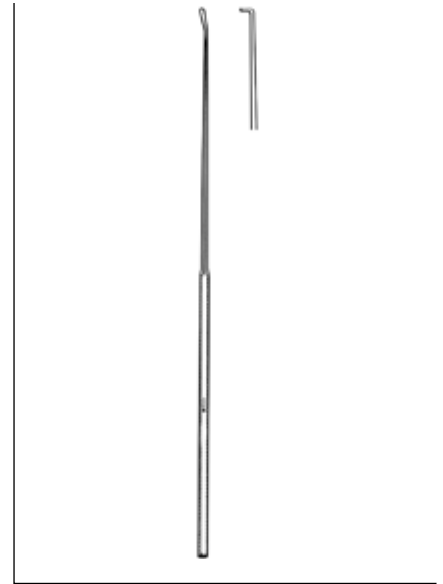

RHOTON HOOKS

98-7321 7½" #9
98-7322 7½" #10
98-7323 7½" #11

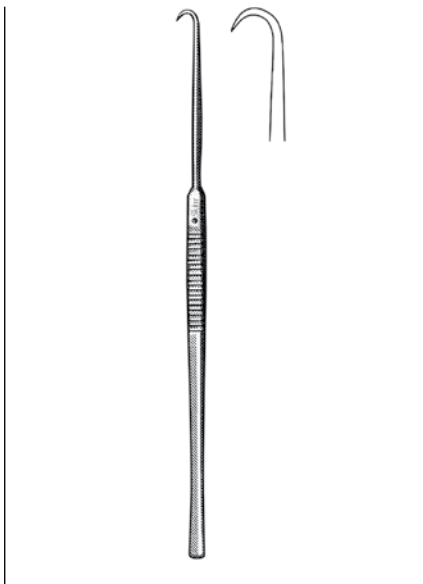

BERGMAN HOOK

47-2302 5½" Sharp

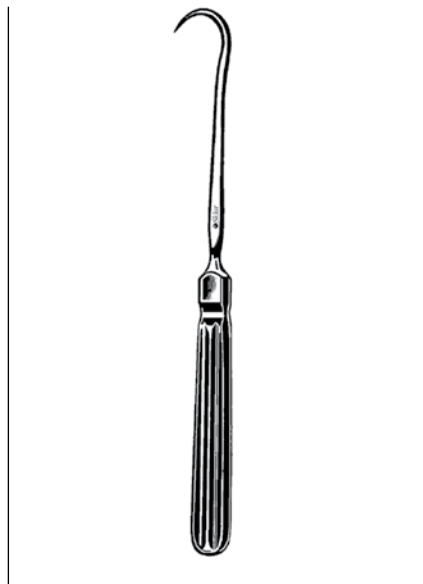

SKLAR HOOK

60-6280 8" Heavy

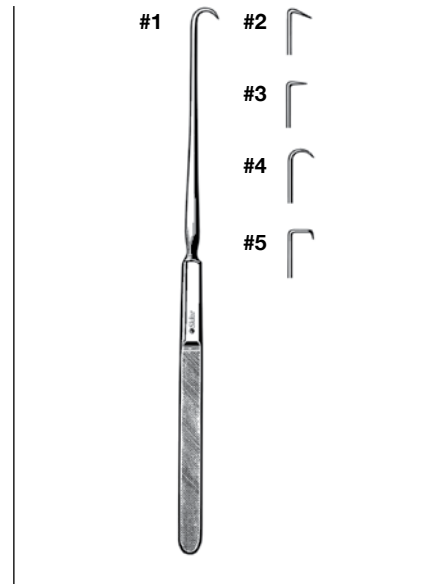

EMMETT HOOKS

90-8301 9" #1
90-8302 9" #2
90-8303 9" #3
90-8304 9" #4
90-8305 9" #5
90-8306 9" Set of 5

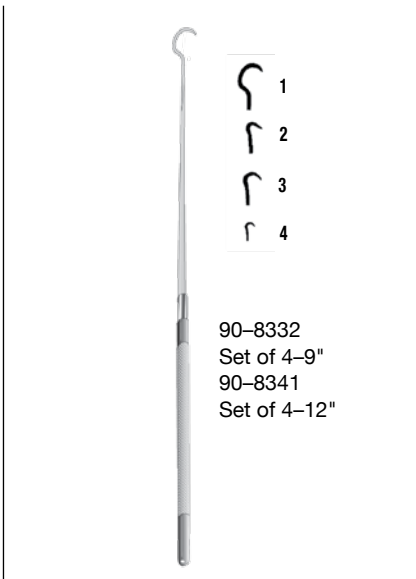

90-8332
Set of 4-9"
90-8341
Set of 4-12"

IRIS HOOKS

QUICK RELEASE

90-8333	9"	6mm Tip	Style 1
90-8342	12"	6mm Tip	Style 1
90-8334	9"	4mm Tip	Style 2
90-8344	12"	4mm Tip	Style 2
90-8335	9"	3mm Tip	Style 3
90-8346	12"	3mm Tip	Style 3
90-8336	9"	1mm Tip	Style 4
90-8348	12"	1mm Tip	Style 4

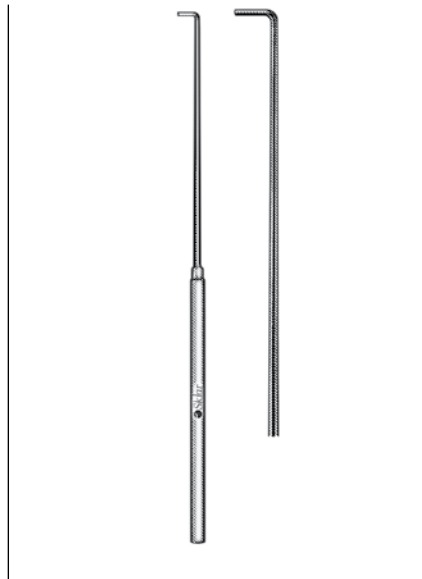

CRILE HOOK

50-1792 8" 7mm

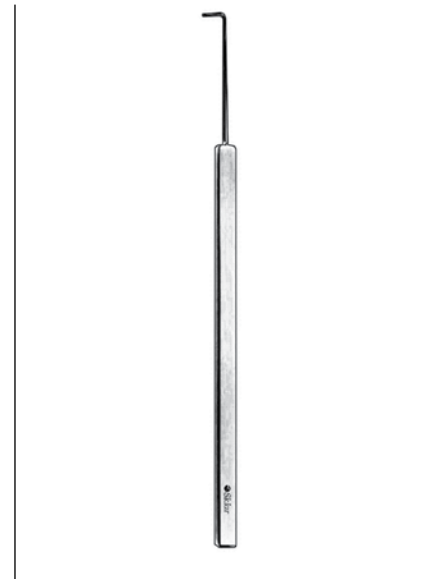

HELVESTON TEASER HOOK

65-3210 6mm, Blunt

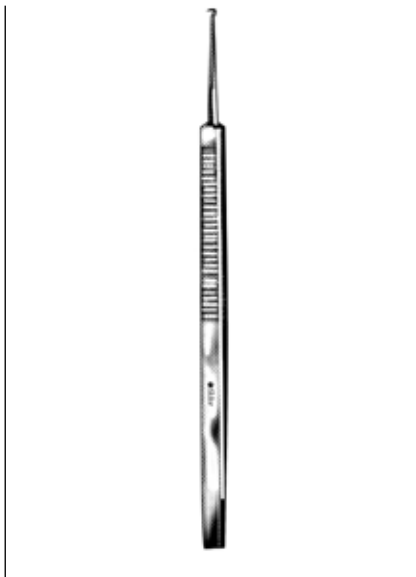

GRAEFE HOOKS

DELICATE

47-2557	5"	Sharp
47-2558	5"	Blunt

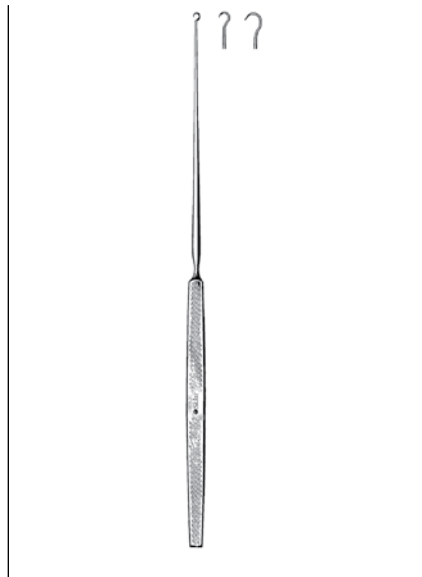

GILLIES HOOKS

SHARP

47-2570	7"	3mm
47-2572	7"	4mm

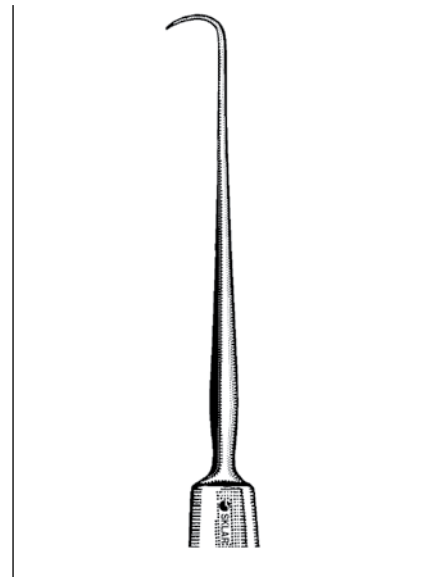

WIENER SCLERAL HOOK

65-3250 5"

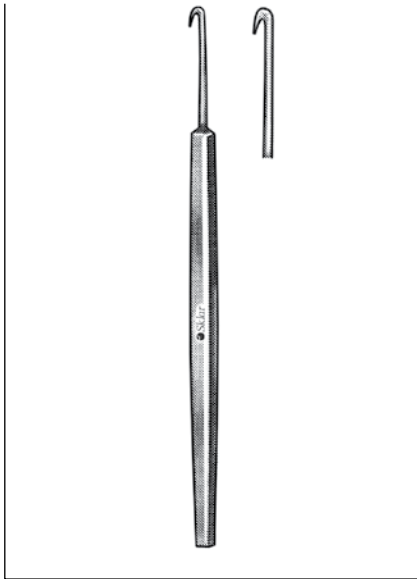

MOLDESTAD DELICATE HOOK

SHARP

47-2330 5" Fine



JOSEPH HOOKS

SHARP

47-2500	6¼"	1 Prong
47-2502	6¼"	2 Prongs, 2mm Spread
47-2505	6¼"	2 Prongs, 5mm Spread
47-2507	6¼"	2 Prongs, 7mm Spread
47-2510	6¼"	2 Prongs, 10mm Spread
47-2512	7¼"	2 Prongs, 12mm Spread

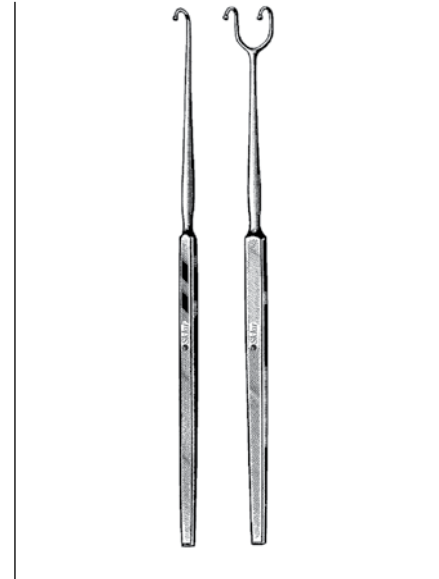

FOMON HOOKS

41-1395	6¼"	
41-1396	6¼"	2 Prongs

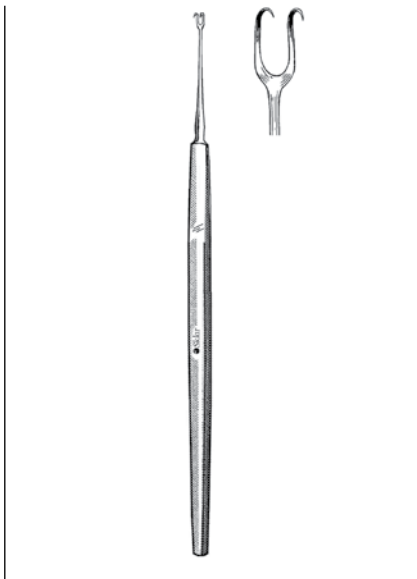

GUTHRIE DOUBLE HOOKS

SHARP

47-2651	5"	2mm	2 Small Prongs
47-2650	5"	3.5mm	2 Large Prongs

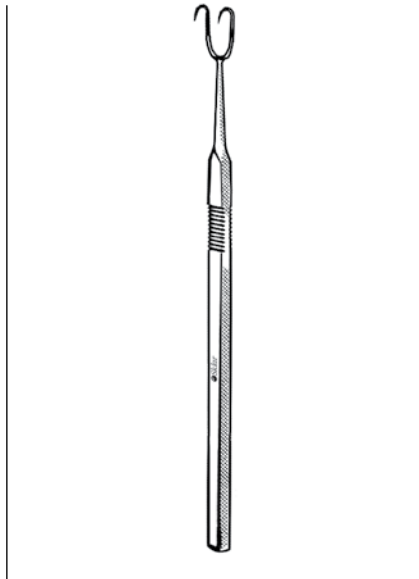

COTTLE DOUBLE HOOK

2 PRONGS

47-2646 5½" 12mm

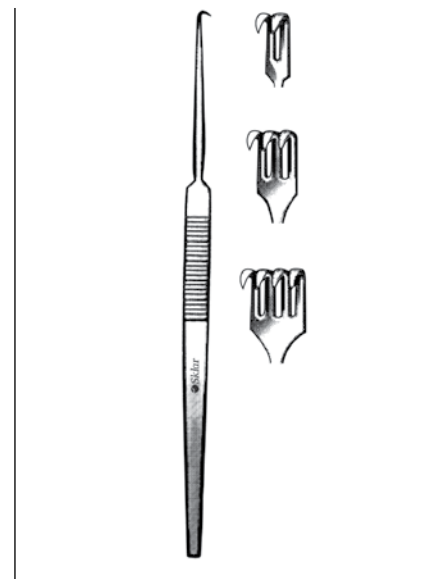

DELICATE HOOKS

SHARP

47-2551	6¼"	1 Prong
47-2552	6¼"	2 Prongs
47-2553	6¼"	3 Prongs
47-2554	6¼"	4 Prongs

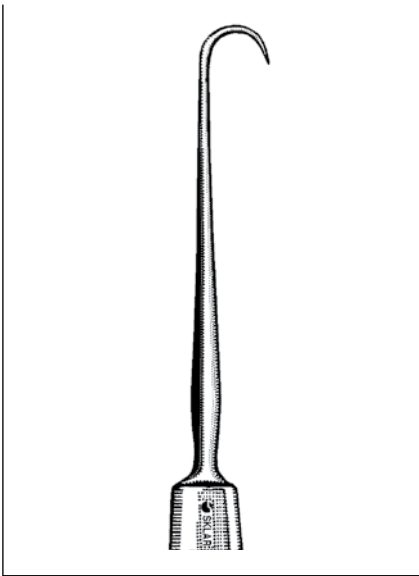

O'CONNOR HOOK
SHARP
65-3265 5"

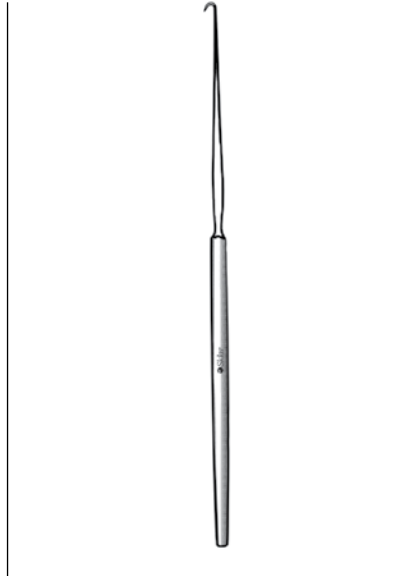

CUSHING DURA HOOK
47-2656 6½" Blunt

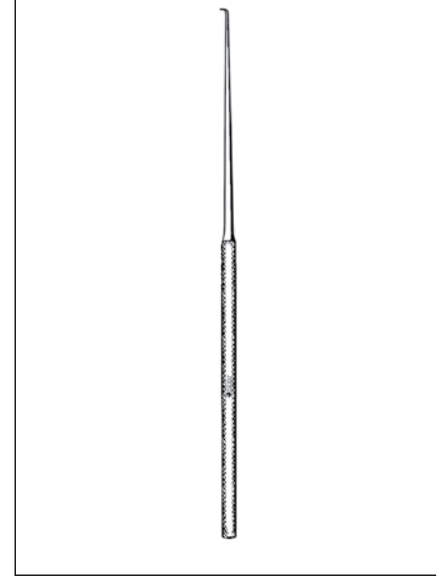

FISCH DURA HOOK
47-2660 7½"

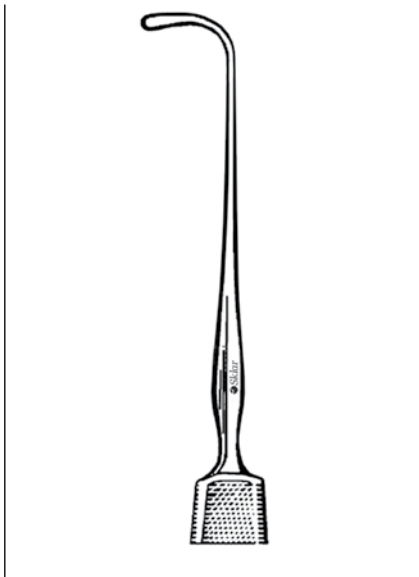

STEVENS TENOTOMY HOOK
BLUNT
65-3191 4¾" 4mm

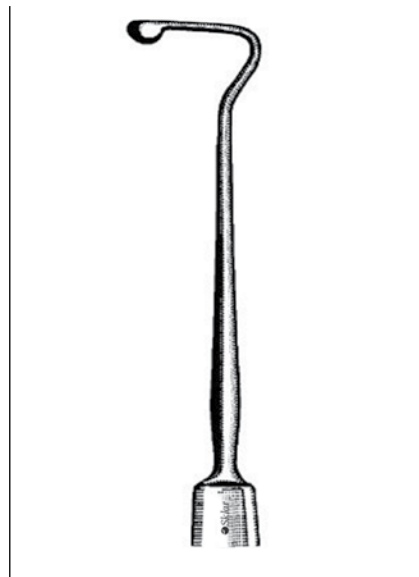

JAMESON STRABISMUS HOOK
65-3195 5" 10mm

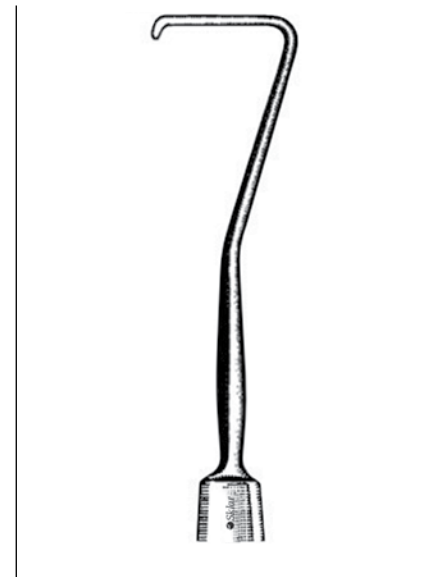

GREEN STRABISMUS HOOK
SHARP
65-3200 5" 7mm

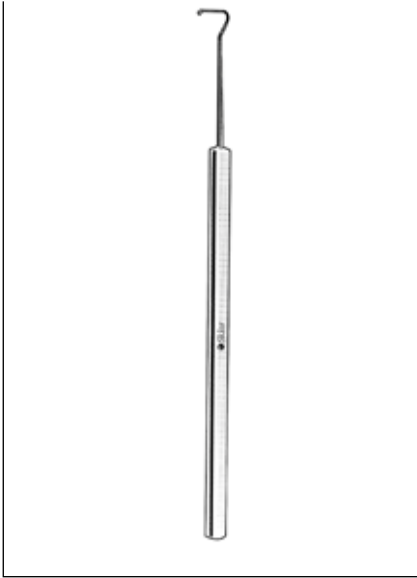

HELVESTON STRABISMUS HOOK

65-3201	8mm
65-3202	10mm
65-3203	12mm

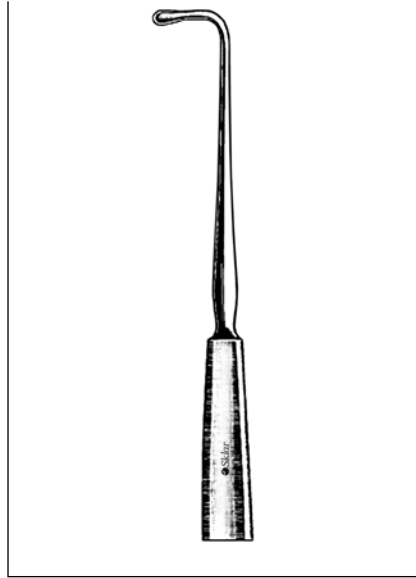

GRAEFE STRABISMUS HOOK

65-3215	5¼"	Small	7mm
65-3216	5½"	Medium	8mm
65-3217	5¾"	Large	10mm

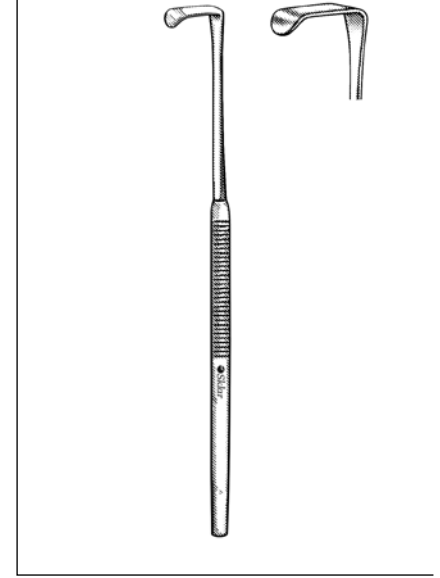

MINI-LANGENBECK DELICATE HOOKS

60-1882	6¼"	10x6mm
60-1883	6¼"	17x5mm
60-1884	6¼"	20x6mm
60-1885	6¼"	22x8mm

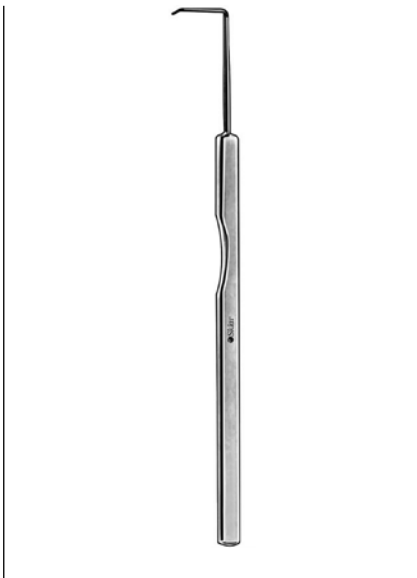

HELVESTON HOOKS

65-3236	8mm	Small
65-3235	12mm	Large

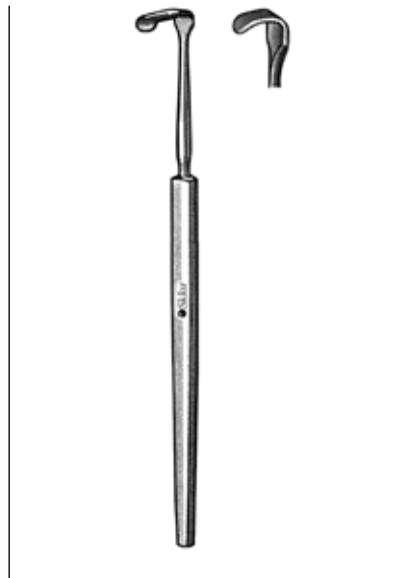

SENN-GREEN DELICATE HOOKS

60-6160	5½"	10x6mm
60-6161	5½"	6x20mm
60-6166	6"	10x6mm
60-6168	6"	22x8mm

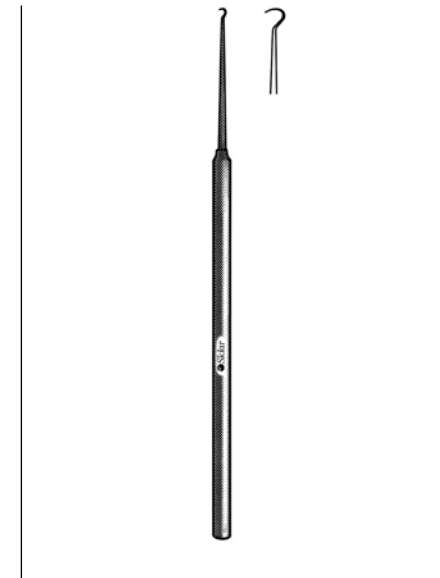

NIRO SKIN HOOKS

47-2586	6¼"	#1
47-2587	6¼"	#2
47-2588	6¼"	#3
47-2589	6¼"	#4

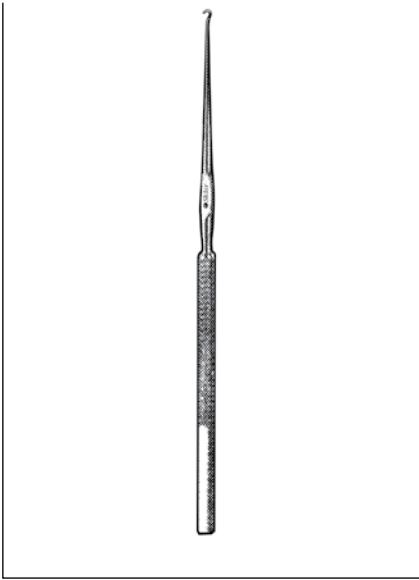

KILNER SKIN HOOK

47-2575 5¾"

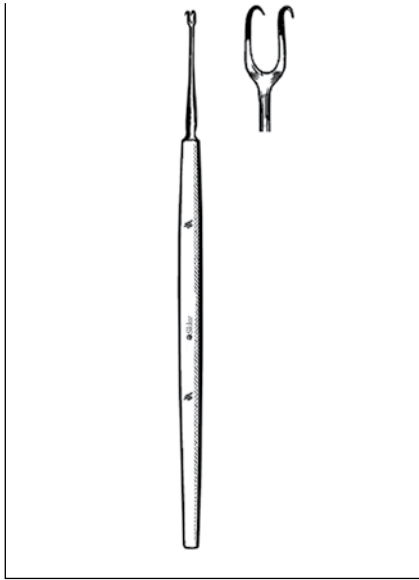

FREER SKIN HOOKS

2 PRONGS
47-2758 6" Blunt, 2.5mm
47-2760 6" Sharp, 2.5mm

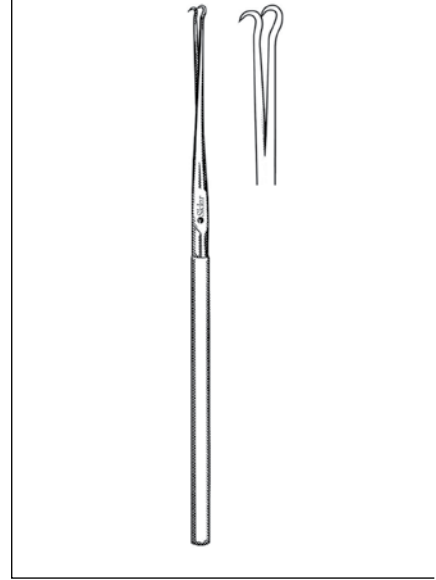

BARSKY SKIN HOOK

2 PRONGS
47-2300 6" Sharp

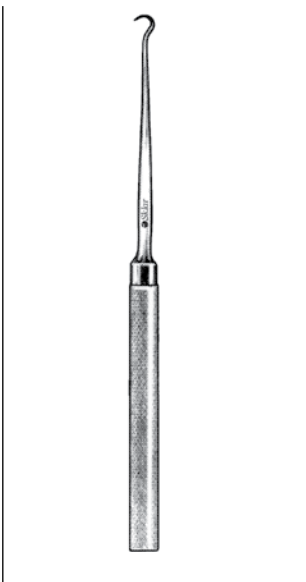

KLEINERT-KUTZ SKIN HOOK

47-2542 5" 7mm

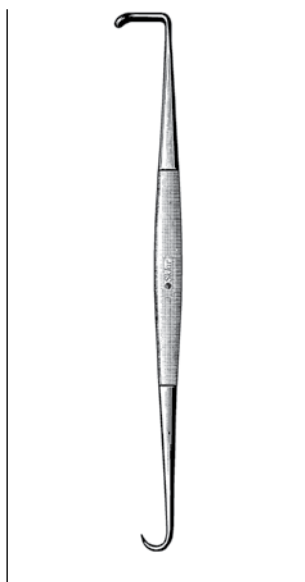

MEYERDING SKIN HOOK

DOUBLE END
47-2462 6½" 10mm/15mm

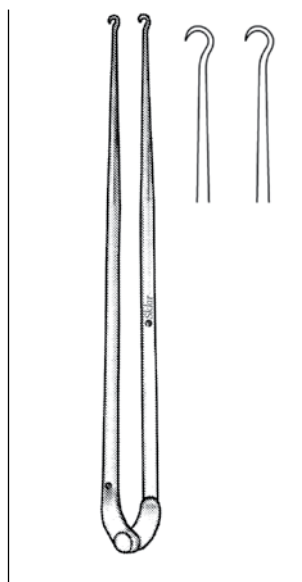

HUMBY SWIVEL SKIN HOOK

2 PRONGS
47-2312 4½"

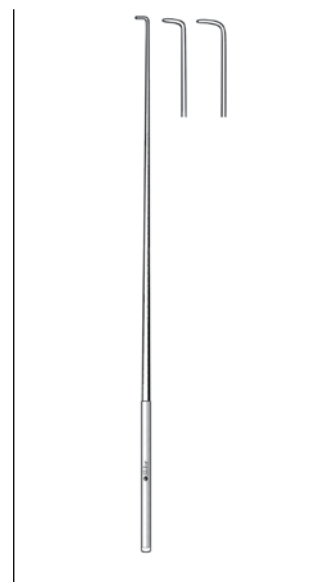

DAY EAR HOOKS

67-2550 6½" Small
67-2552 6½" Large

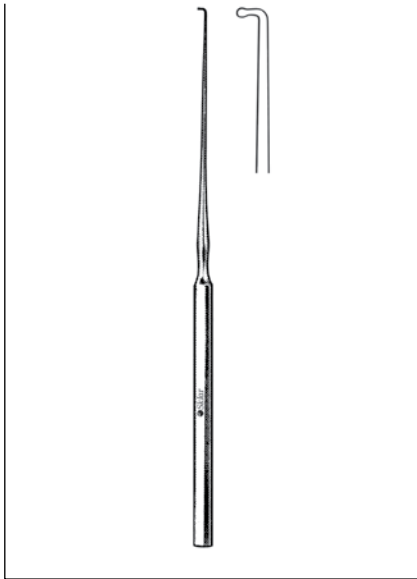

LUCAE EAR HOOKS

- 67-2545 5½" Small
- 67-2546 5½" Medium
- 67-2547 5½" Large

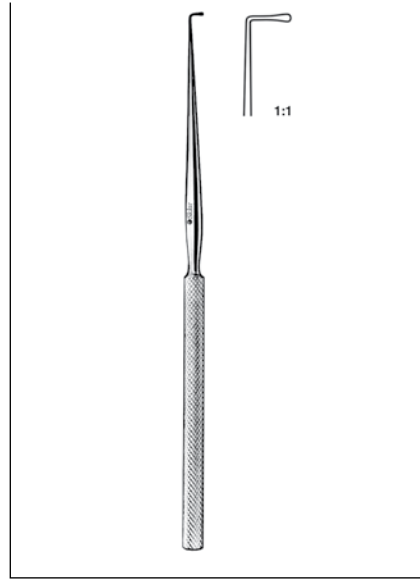

WAGENER EAR HOOKS

- WITH PROBE TIP**
- 67-2555 #1
 - 67-2556 #2
 - 67-2557 #3
 - 67-2558 #4
 - 67-2561 #5
 - 67-2562 #6
 - 67-2563 #7

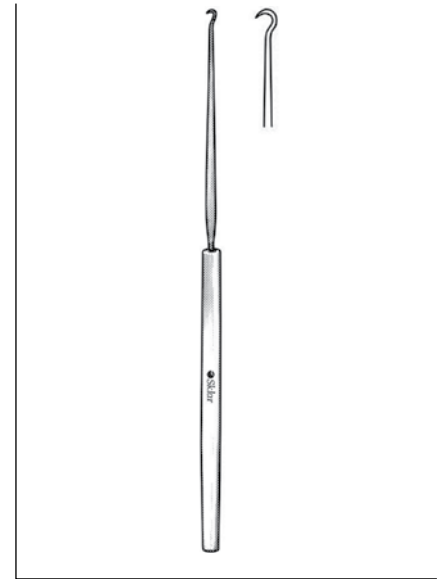

HARTMANN FOREIGN BODY EAR HOOK

- 67-2542 6¼"

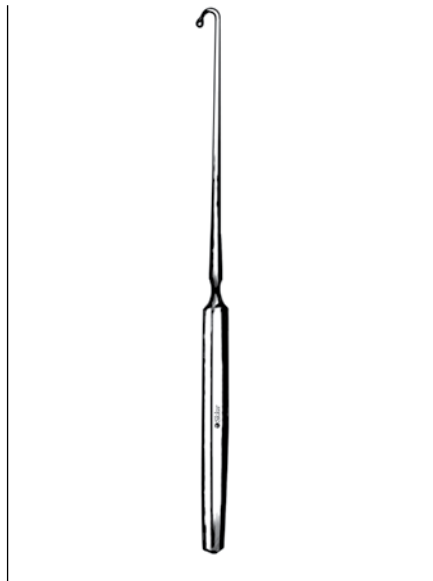

LANGE NASAL HOOK

- 47-2590 9" With Probe

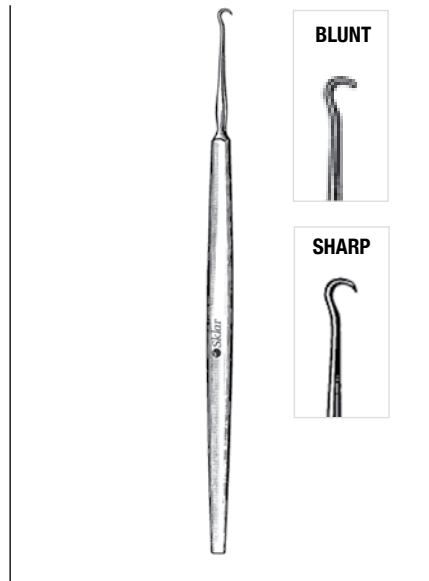

FRAZIER TISSUE HOOKS

- EXTRA DELICATE**
- 47-2555 5" Sharp
 - 47-2556 5" Blunt

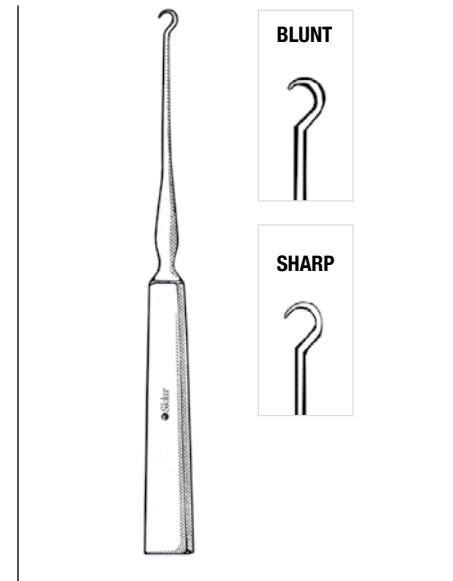

TYRELL IRIS HOOKS

- 65-3205 5" Blunt
- 65-3206 5" Sharp

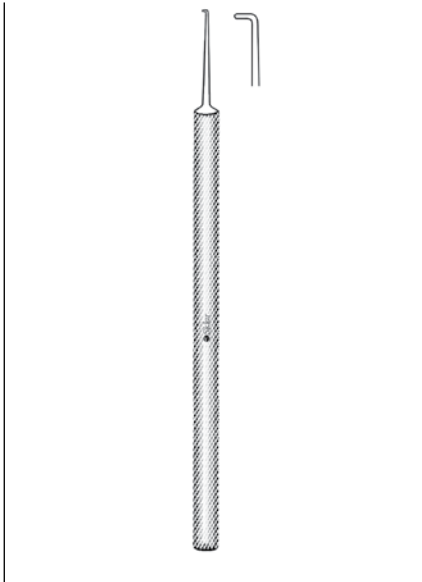

SINSKY MICRO IRIS HOOKS

66-7710 5" Blunt, Straight
66-7712 5" Angled, 45 Degree

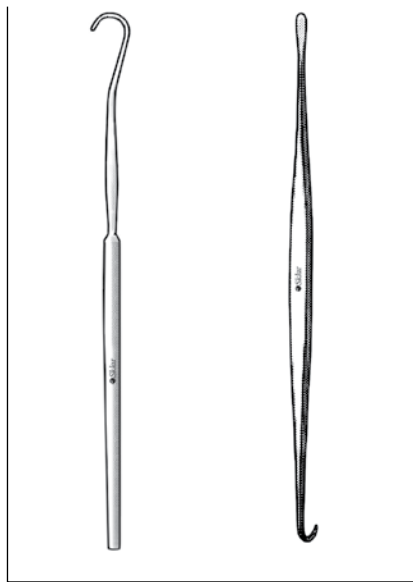

SMITHWICK NERVE HOOKS

47-2560 6½" Blunt, 10mm
50-1912 11½" Double End

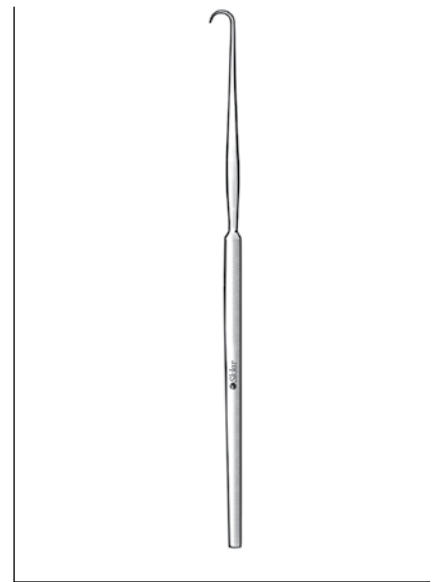

GRAHAM NERVE HOOKS

47-2580 7" Blunt, 6mm
47-2564 8¼" Blunt, 10mm

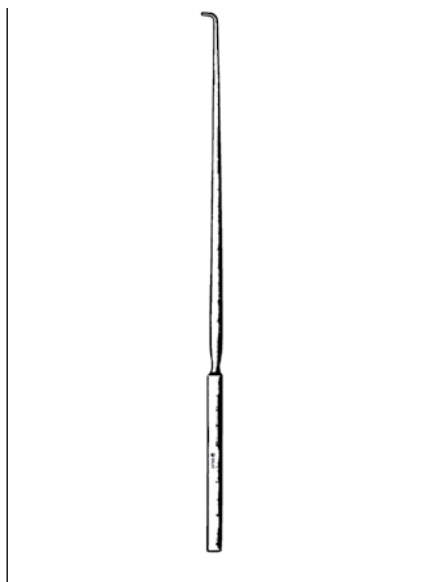

DANDY NERVE HOOK

50-1790 8" Straight 5mm

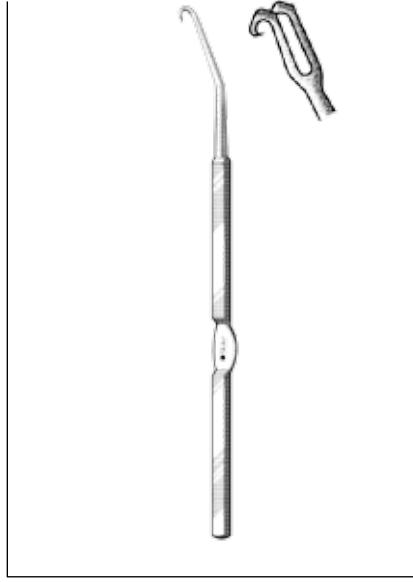

BLOCKSMANN CLEFT PALATE HOOKS

75-1231 7" 1 Prong
75-1232 7" 2 Prongs

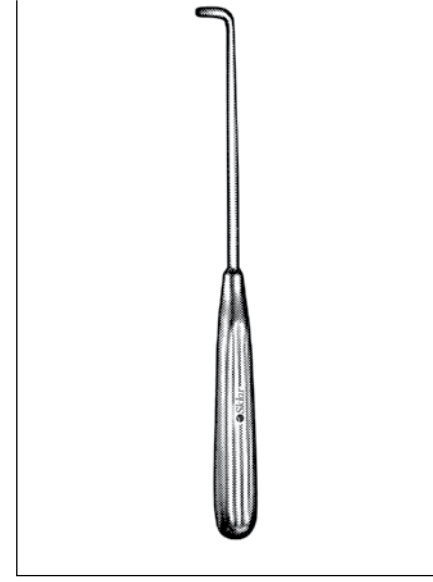

BLAIR CLEFT PALATE HOOK

40-7602 8" 5mm

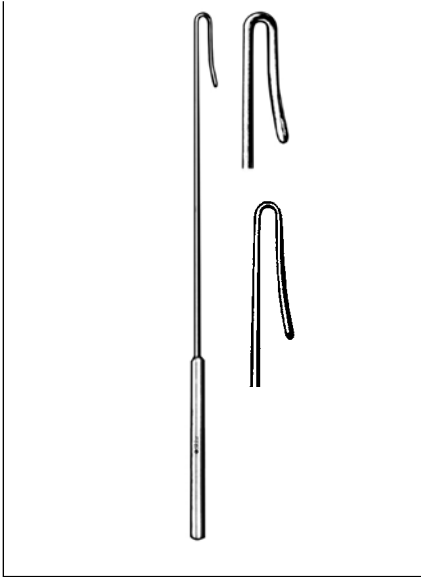

PRATT CRYPT HOOKS

- 80-3085 8½" Long
- 80-3185 8½" Short
- 80-3285 8½" Narrow

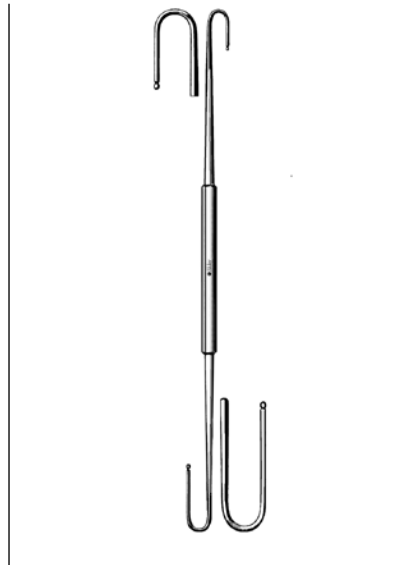

BARR CRYPT HOOK

- 80-3510 10" Double End

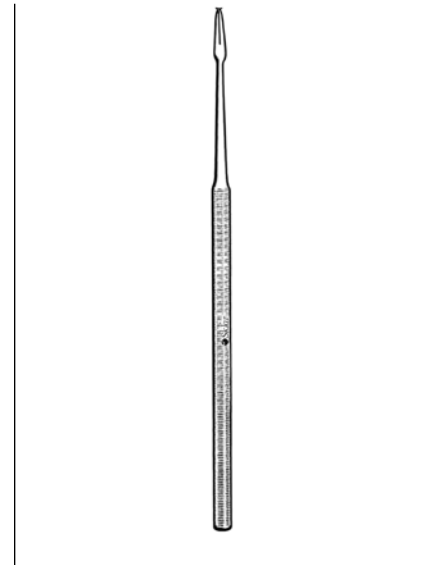

TISSUE TWIST HOOK

- 47-2670 5½"

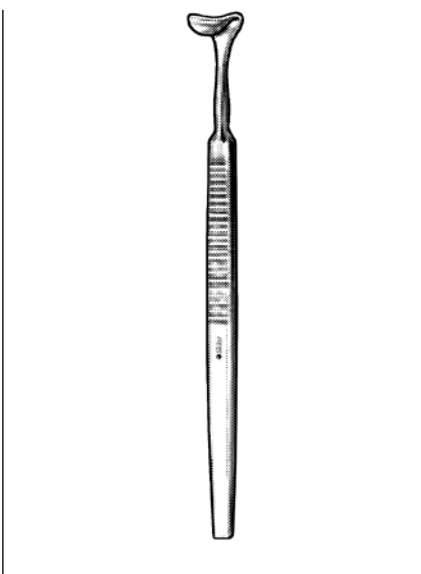

DESMARRES LID HOOKS

- 65-1839 6½" 8mm
- 65-1840 6½" 10mm
- 65-1841 6½" 12mm
- 65-1842 6½" 14mm
- 65-1843 6½" 16mm
- 65-1844 6½" 18mm

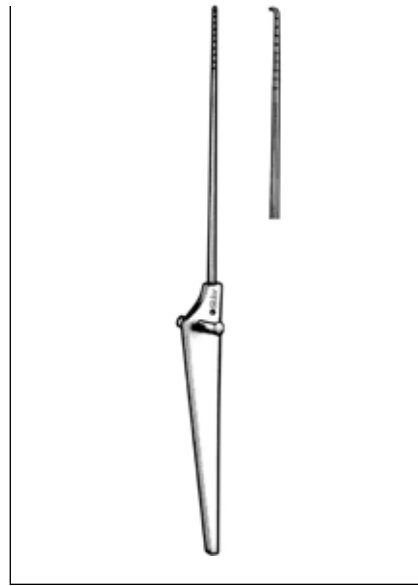

EXPLORING HOOK

- 45-6237 3.5mm, Sharp

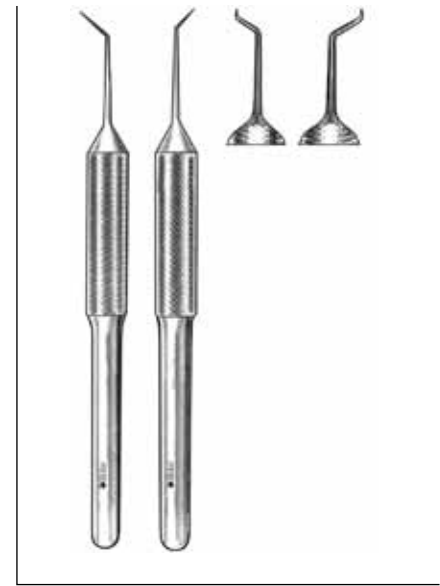

RAMELET HOOKS

- SET OF 2**
- 06-4172 4" Fine/Medium, Right
- SET OF 2**
- 06-4175 4" Fine/Medium, Left



OSHER "Y" HOOK
66-7705 5"



RAGNELL HOOK
DOUBLE END
22-8560 5½"

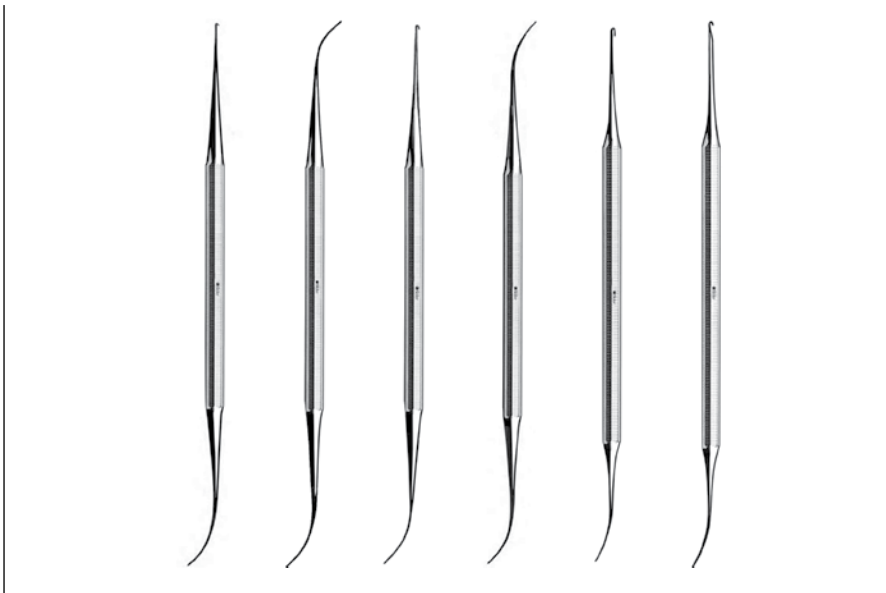

VARADY PHLEBECTOMY MICRO HOOKS

- 55-8410 6¾" Micro Hook and Spatula
- 55-8411 6¾" Spatula
- 55-8412 6¾" Small Hook and Spatula
- 55-8413 6¾" Dissecting Spatula
- 55-8414 7" Hook with Ball Tip and Spatula
- 55-8415 7" Hook and Spatula

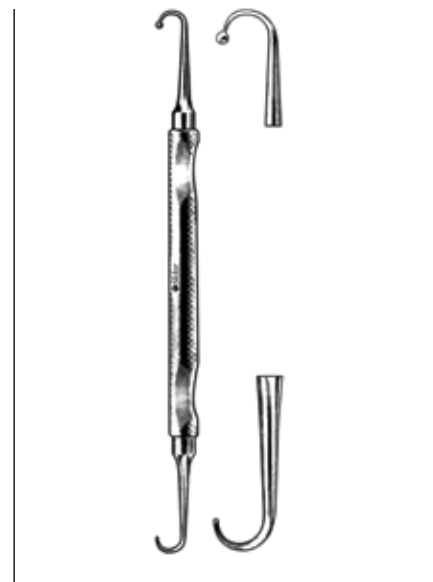

MANNERFELT TENDON HOOK
47-3540 6" Double End

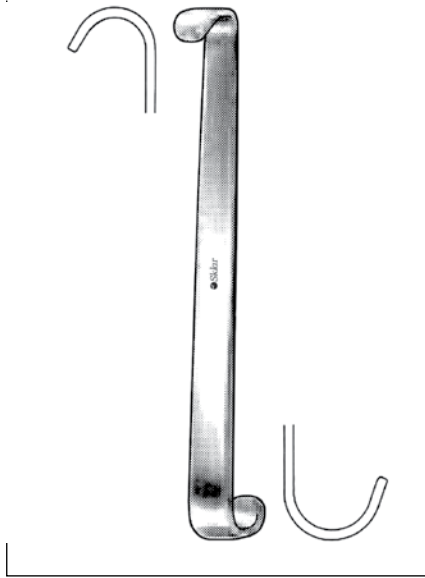

LEUR HOOK

78-3525 4½" Curved, Thin

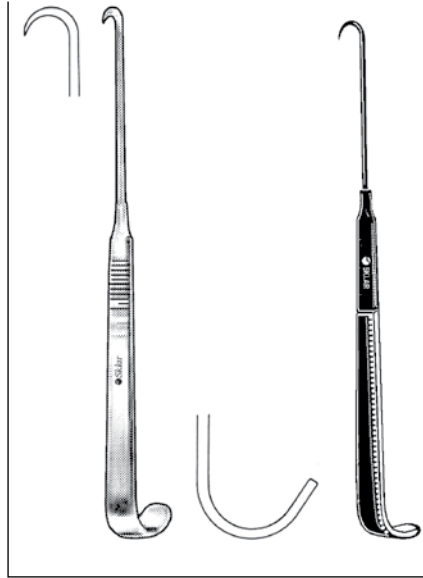

NEWS HOOKS

78-3526 6" Serrated Handle
78-3545 6"

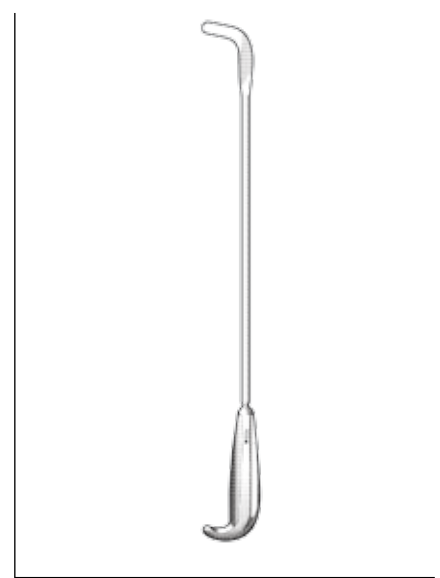

HOOK DISSECTORS

40-7654 13"
40-7655 16½"
40-7656 13" Malleable
40-7657 16½" Malleable



DINGMAN ZYGOMA HOOKS

40-7613 7½" 10mm
40-7614 8" 20mm



ROSE HOOK

78-3524 5¼" Smooth

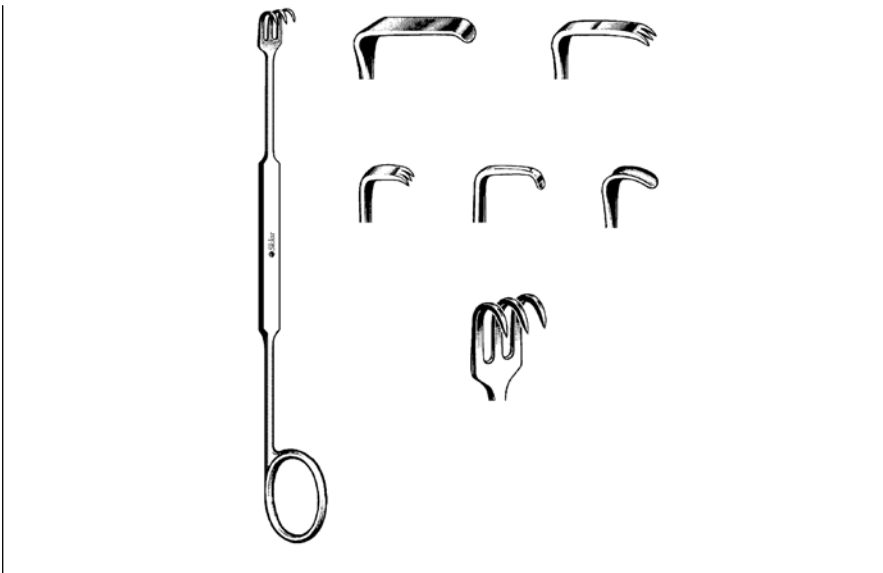

MEYERDING HOOKS

18X7MM, ANGLED

22-8210 7" 1 Long Blade

16X5MM, ANGLED

22-8211 7" 1 Long Blade with 3 Teeth

7X4MM, ANGLED

22-8212 7" 1 Short Blade with 3 Teeth

10X3MM, ANGLED

22-8213 7" 1 Short Blade, Blunt

7X47MM, ANGLED

22-8214 7" 2 Saddle Blade, Blunt

4X10MM, ANGLED

22-8215 7" 3 Prongs, Sharp

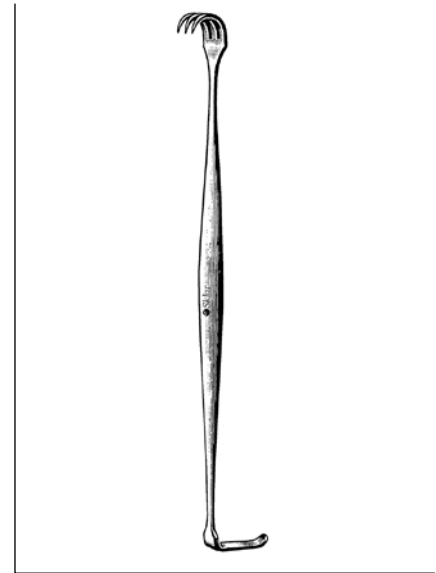

MILLER-SENN HOOKS

3 PRONGS

22-8360 6" 5x18mm, Sharp

22-8460 6" 5x18mm, Blunt

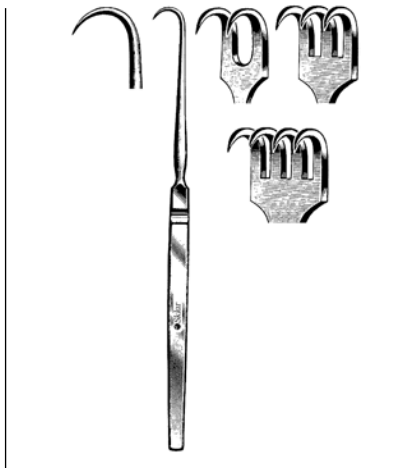

RIGID DERMAL HOOKS

22-9122 6" 1 Prong, Sharp

22-9124 6" 2 Prong, Sharp

22-9126 6" 3 Prong, Sharp

22-9128 6" 4 Prong, Sharp

22-9123 6" 1 Prong, Blunt

22-9125 6" 2 Prong, Blunt

22-9127 6" 3 Prong, Blunt

22-9129 6" 4 Prong, Blunt

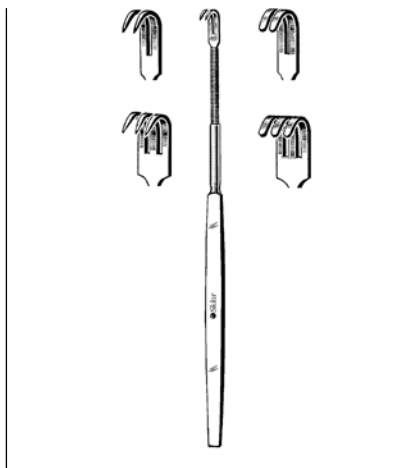

PLASTIC SURGERY HOOKS

22-9132 6" 2 Prongs, Sharp, Flexible

22-9133 6" 3 Prongs, Sharp, Flexible

22-9142 6" 2 Prongs, Blunt, Flexible

22-9143 6" 3 Prongs, Blunt, Flexible



SENN HOOKS

3 PRONGS

60-6162 6 1/4" Sharp

60-6164 6 1/4" Blunt

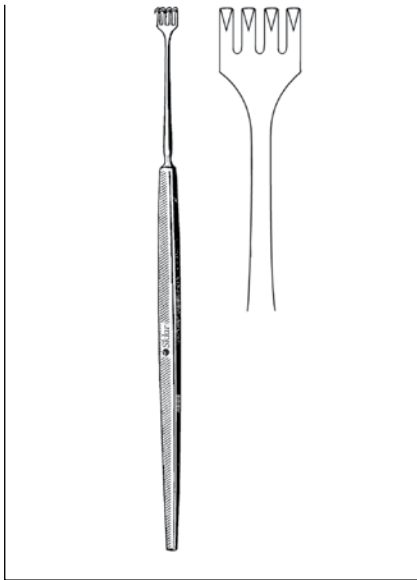

BLAIR-ROLLET HOOK
4 PRONGS
47-2655 5½" Delicate

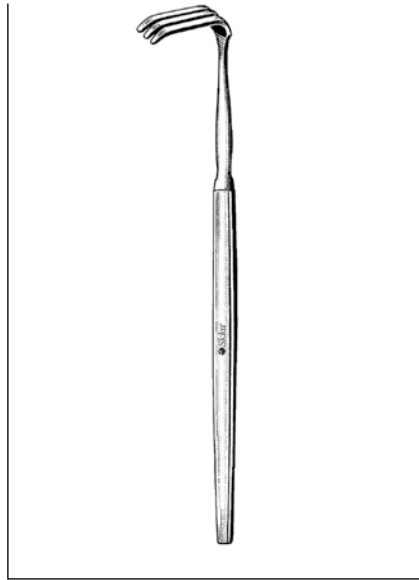

PAUL LACRIMAL SAC HOOK
3 PRONGS
47-2647 4¾" 11x8mm

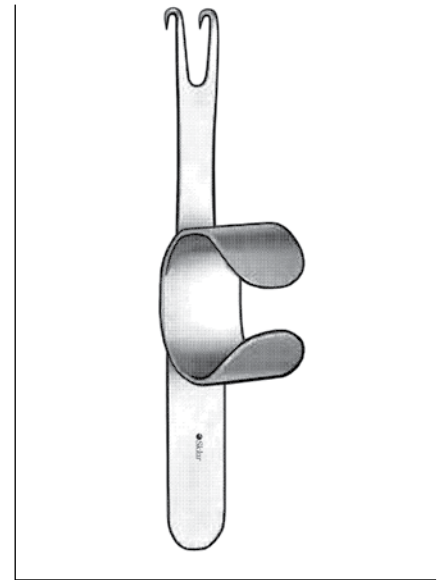

KAYE-MILLARD THIMBLE HOOK
47-2530 4½"

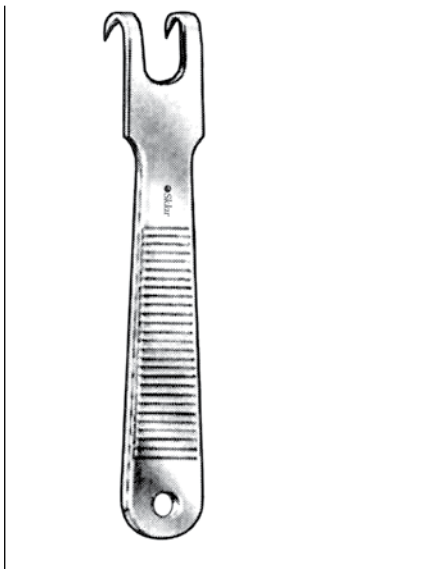

KILNER ALAR HOOK
47-2520 3¼"

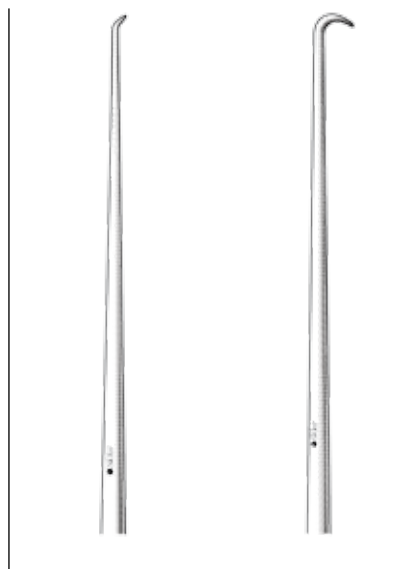

MICRO LARYNGEAL HOOKS
78-3541 9½" 70°
78-3542 9½" 110°



MICRO LARYNGEAL HANDLE
78-3546 For Hooks 78-3541 and 78-3542

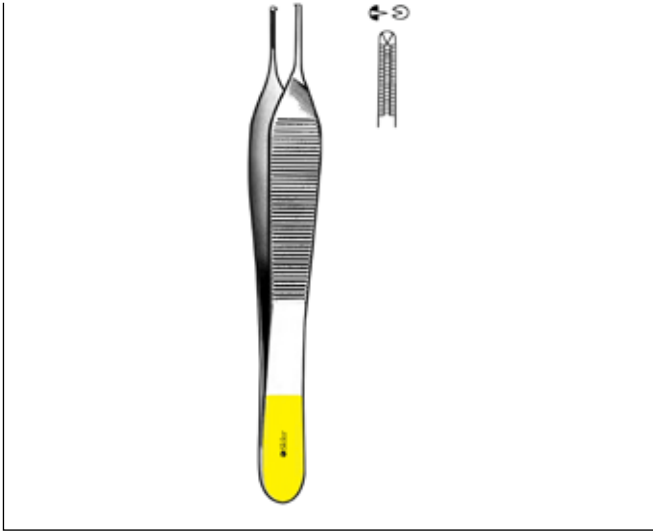

TC ADSON FORCEPS

- 1X2 TEETH**
51-3449 4 3/4"
51-3450 6"



TC OEHLER TISSUE FORCEPS

- STRAIGHT, 1X2 TEETH**
51-3030 5 1/2"
51-3031 6 1/4"
51-3032 7"
51-3033 8"



SKLARLITE XD™ ADSON FORCEPS

- STRAIGHT**
23-2604 4 3/4" Serrated
- TISSUE**
23-2606 4 3/4" 1x2 Teeth
- ADSON-BROWN**
23-2608 4 3/4" Side Grasping



ADSON FORCEPS DELICATE

- DRESSING**
47-2147 4 3/4" Serrated
- TISSUE**
47-2047 4 3/4" 1x2 Teeth
47-2049 4 3/4" 2x3 Teeth
- ADSON-BROWN**
47-2447 4 3/4" Side Grasping
47-1450 4 3/4" Angled

LiteGrip™ Fenestrated Handles
For Firm Secure Grip



SKLAR LITEGRIP™ ADSON-BROWN FORCEPS
47-1448 4¾" 7x7 Teeth Side Grasping



SKLAR LITEGRIP™ ADSON FORCEPS
50-3148 Serrated 4¾"
50-3050 1x2 Teeth 4¾"
50-3052 1x2 Teeth 4¾" with Tying Platform



SKLAR LITEGRIP™ BISHOP-HARMON FORCEPS
66-4034 3½" Serrated
66-4134 3½" 1x2 Teeth

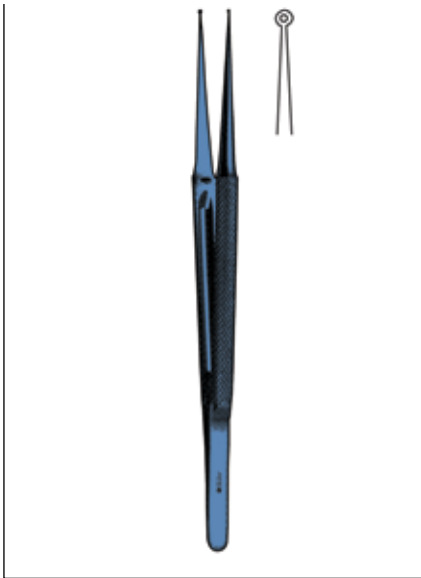

**TITANIUM MICRO RING
FORCEPS**

STRAIGHT

98-3230T	6"	2x1mm
98-3231T	7"	2x1mm
98-3232T	8¼"	2x1mm
98-3233T	9"	2x1mm
98-4250T	6"	1x.5mm
98-4251T	7"	1x.5mm
98-4252T	8¼"	1x.5mm
98-4253T	9"	1x.5mm

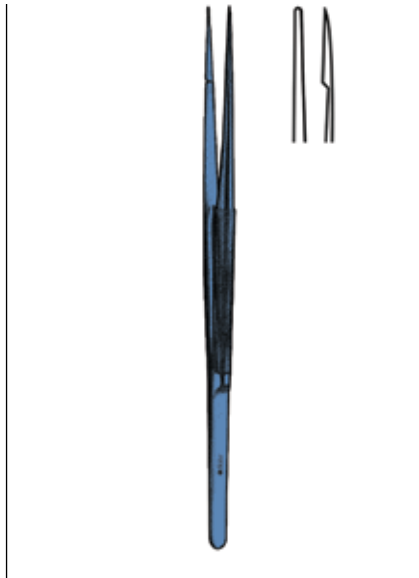

**TITANIUM MICRO FORCEPS
STRAIGHT**

98-4362T	6"	6x.4mm
98-4363T	7"	6x.4mm
98-4366T	6"	6x.7mm
98-4367T	7"	6x.7mm
98-4368T	8¼"	6x.7mm

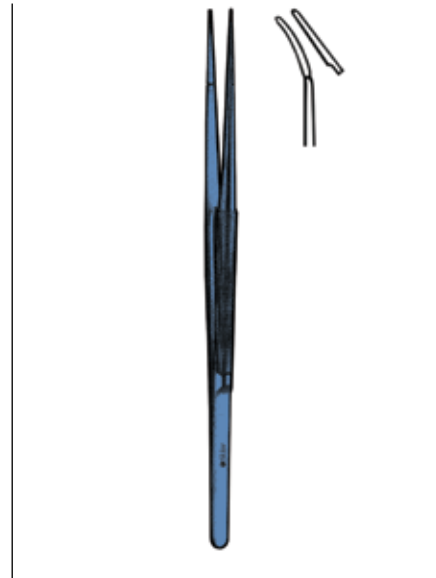

**TITANIUM MICRO FORCEPS
CURVED**

98-4364T	6"	6x.4mm
98-4365T	7"	6x.4mm
98-4370T	6"	6x.7mm
98-4371T	7"	6x.7mm
98-4372T	8¼"	6x.7mm

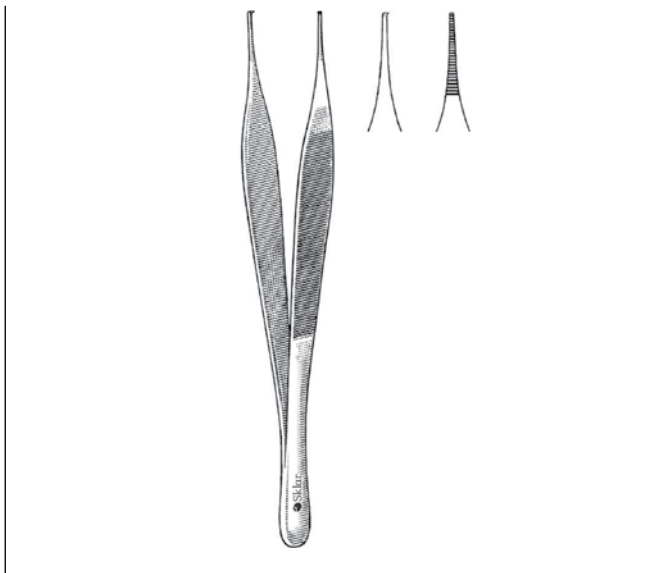

ADSON MICRO TISSUE FORCEPS

1X2 TEETH

98-2057	7"
---------	----

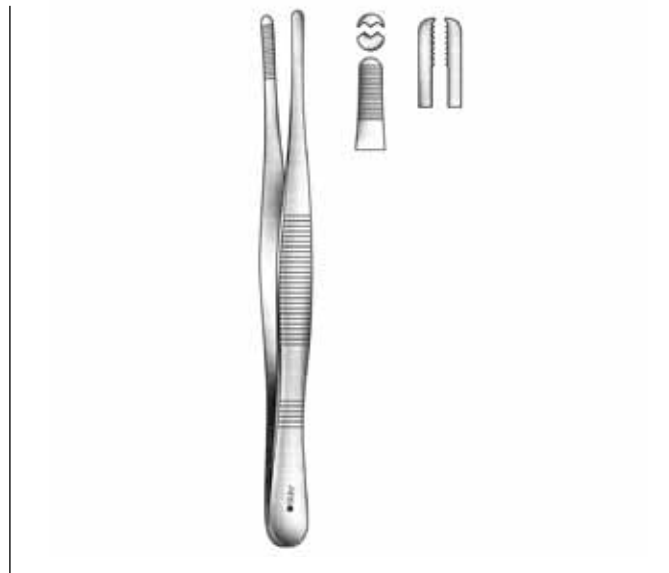

ADLERKREUTZ TISSUE FORCEPS

STRAIGHT, 2X3 TEETH

19-1915	6"
19-1916	8"

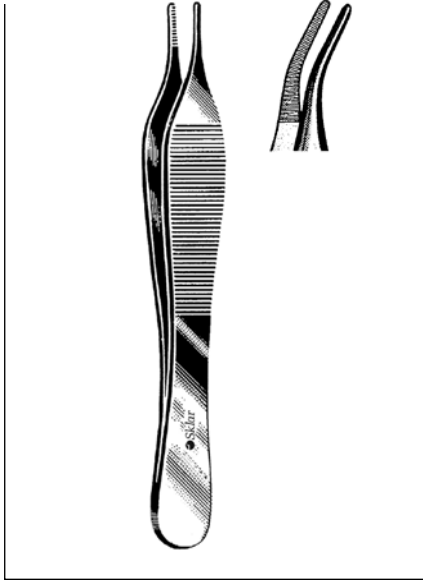

ADSON DRESSING FORCEPS
DELICATE
47-2148 4¾" Angled

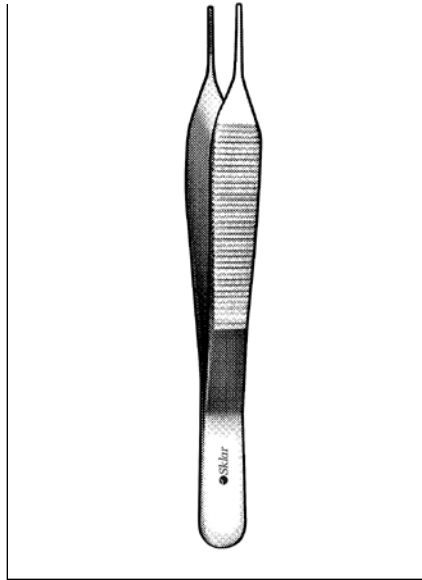

ADSON DRESSING FORCEPS
50-3071 7" Serrated

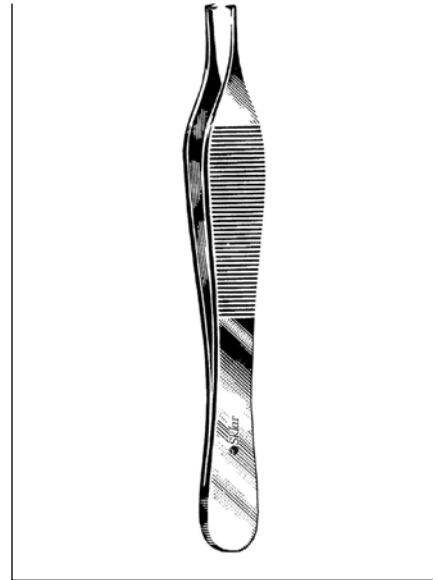

ADSON TISSUE FORCEPS
50-3170 6" 1x2 Teeth
50-3171 7" 1x2 Teeth

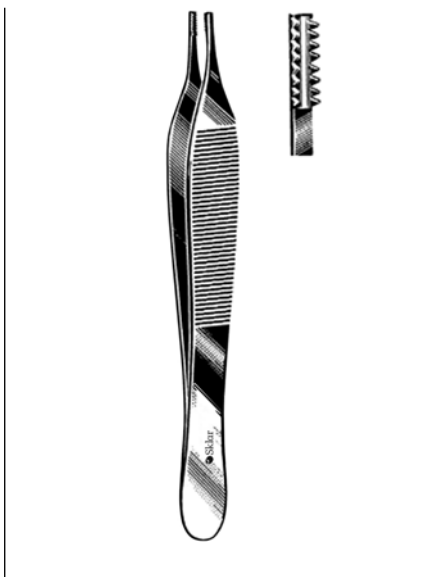

ADSON-BROWN TISSUE FORCEPS
SIDE-GRASPING
47-1447 4¾" 9x9 Teeth

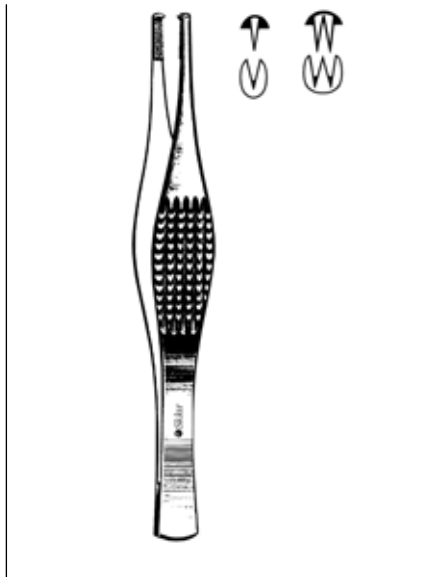

FERRIS-SMITH TISSUE FORCEPS
STRAIGHT
47-1470 7" 1x2 Teeth
52-3970 7" 2x3 Teeth

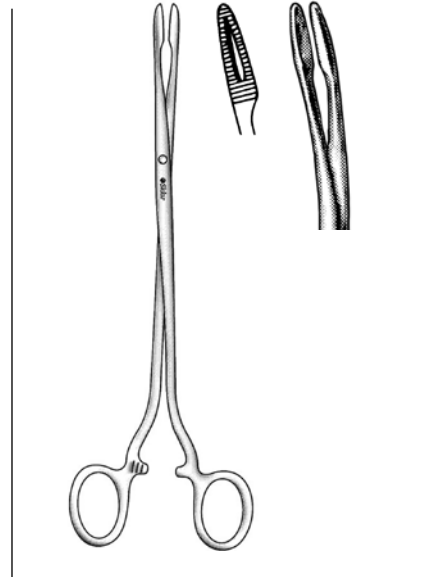

DUPLAY DRESSING FORCEPS
19-1030 8" Straight
19-1031 8" Curved

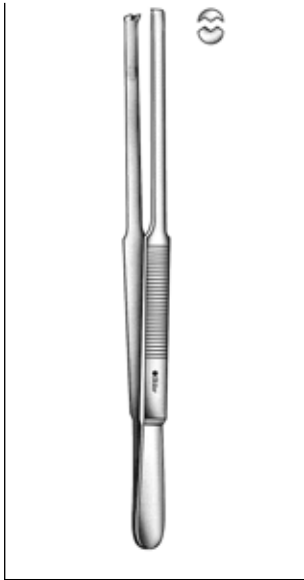

DUEHRSEN TISSUE FORCEPS

STRAIGHT

- 40-4246 8" 1x2 Teeth
- 40-4247 8" 2x3 Teeth

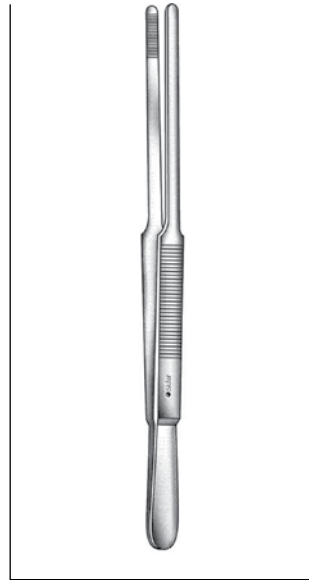

DUEHRSEN DRESSING FORCEPS

40-4245 8"

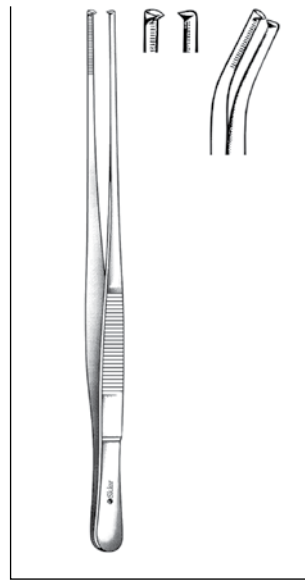

BROPHY TISSUE FORCEPS

- 19-1922 8" Straight 1x2 Teeth
- 19-1923 8" Curved 1x2 Teeth

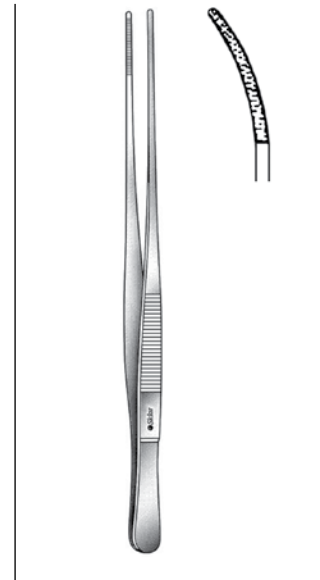

BROPHY DRESSING FORCEPS

- 19-1920 8" Straight
- 19-1921 8" Curved

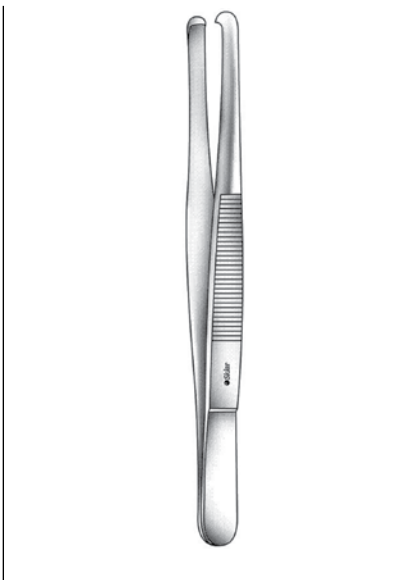

DURANTE GRASPING FORCEPS

STRAIGHT

- 47-1130 5¾"
- 47-1131 6¼"
- 47-1132 8"

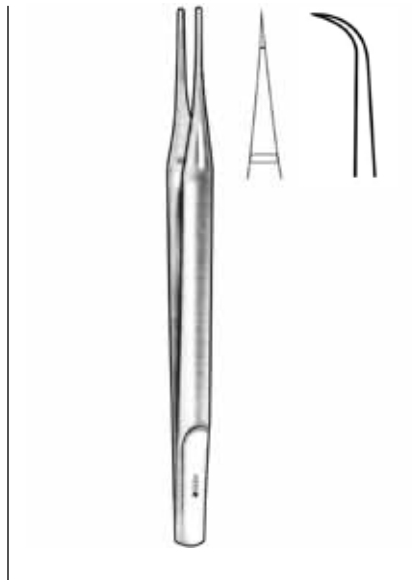

SUTURE TYING FORCEPS

SMOOTH, ROUND HANDLE, WITH PLATFORM

- 98-2078 4¾" .3mm Tip, Straight
- 98-2079 4¾" .3mm Tip, Curved
- 98-2082 7" .3mm Tip, Straight
- 98-2083 7" .3mm Tip, Curved

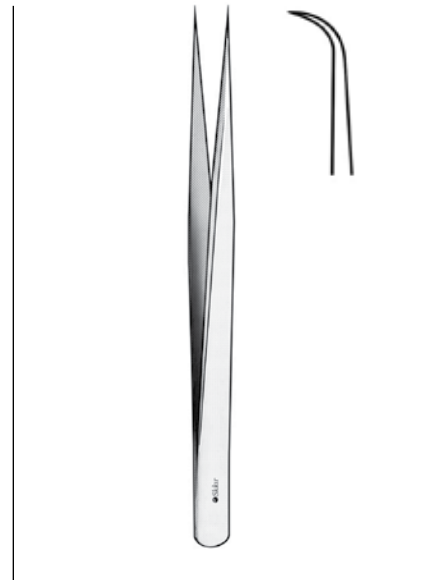

VISE SUTURE TYING FORCEPS

WITH PLATFORM

- 98-2090 5¼" .3mm Tip, Straight
- 98-2091 5¼" .3mm Tip, Curved

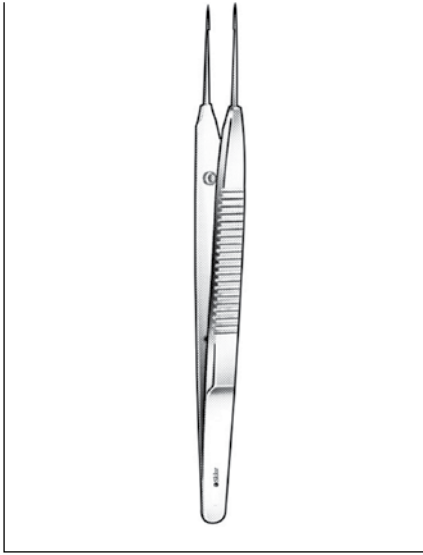

AUSTIN SUTURE FORCEPS WITH PLATFORM

98-2088	5½"	.8mm Tip
98-2089	7"	.8mm Tip

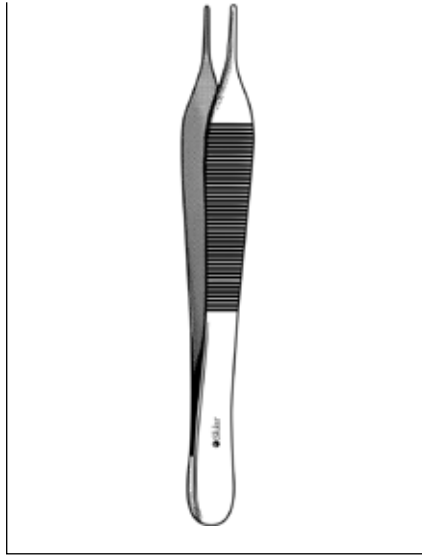

MUSTARDE SUTURE REMOVAL FORCEPS

LONGITUDINALLY SERRATED TIPS

66-6147	5"
---------	----



MICRO RING FORCEPS WITH DIAMOND JAWS, STRAIGHT

98-3230	6"	2x1mm
98-3231	7"	2x1mm
98-3232	8¼"	2x1mm
98-3233	9"	2x1mm

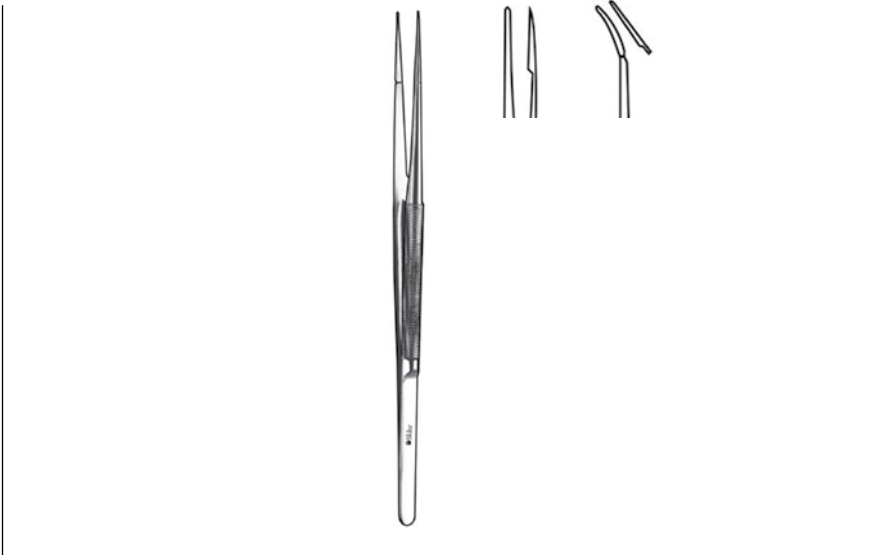

MICRO FORCEPS WITH DIAMOND JAWS, STRAIGHT

98-4350	6"	6x.4mm
98-4351	7"	6x.4mm
98-4354	6"	6x.7mm
98-4355	7"	6x.7mm
98-4356	8¼"	6x.7mm
98-4357	9"	6x.7mm

WITH DIAMOND JAWS, CURVED

98-4352	6"	6x.4mm
98-4353	7"	6x.4mm
98-4358	6"	6x.7mm
98-4359	7"	6x.7mm
98-4360	8¼"	6x.7mm
98-4361	9"	6x.7mm

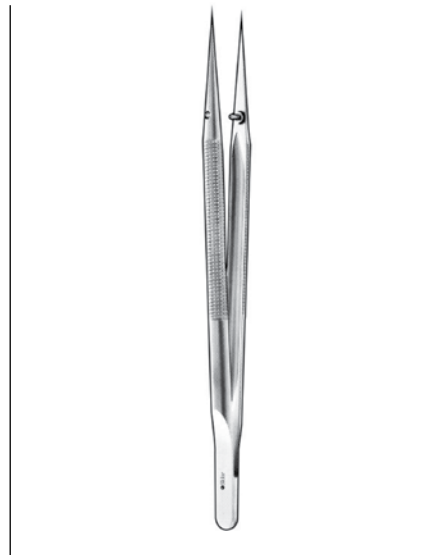

PIERCE MICRO TISSUE FORCEPS .3MM DIAMETER HOLE, ROUND HANDLE, STRAIGHT

98-2085	6"	Straight
98-2086	7"	Curved

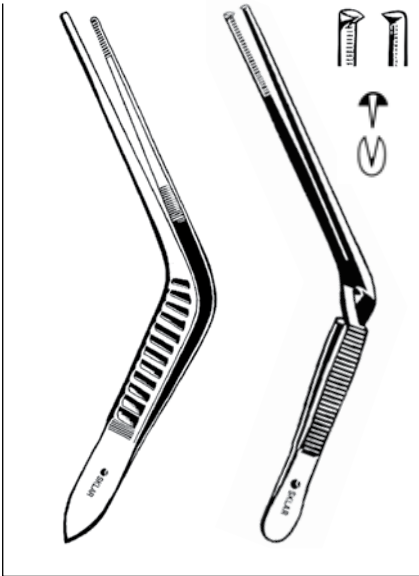

WILDE EAR FORCEPS

- | | | |
|---------|-----|-------------------------|
| 67-1249 | 4½" | Angled, Serrated |
| 67-1349 | 4½" | Cross Action, Serrated |
| 67-1150 | 5" | Angled, Serrated |
| 67-1151 | 5" | Angled, 1x2 Teeth |
| 67-1153 | 6" | Angled, Serrated |
| 67-1250 | 5" | Mouse Teeth |
| 67-1350 | 5" | Cross Action, Serrated |
| 67-1450 | 5" | Cross Action, 1x2 Teeth |
| 70-4470 | 7" | Angled, Serrated |

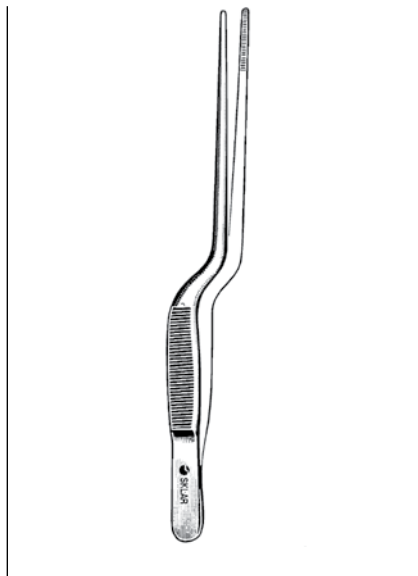

JANSEN NASAL FORCEPS
BAYONET SERRATED

- | | |
|---------|-----|
| 67-1465 | 6½" |
| 70-4375 | 7½" |
| 70-4385 | 8½" |

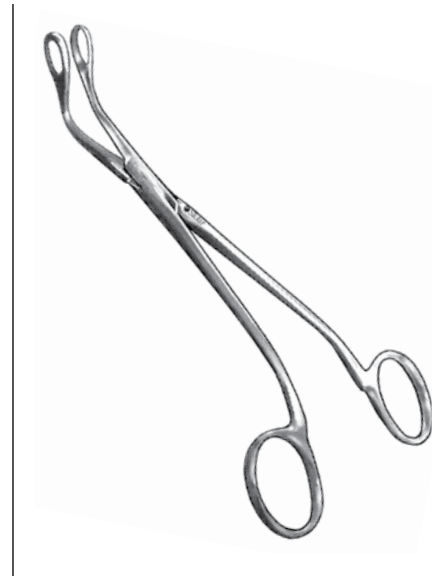

**ST CLAIR-THOMSON ADENOID
FORCEPS**

- | | |
|---------|----|
| 70-5697 | 7" |
|---------|----|

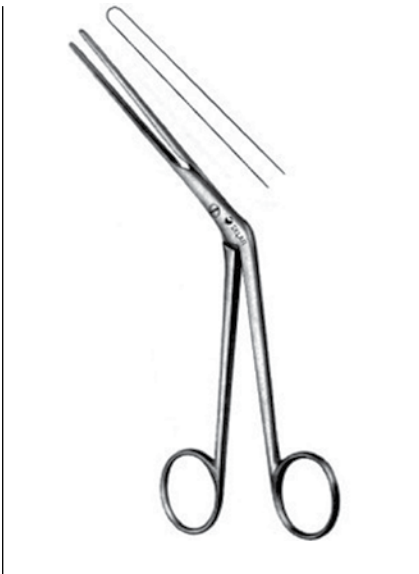

FERRIS-SMITH NASAL FORCEPS

- | | |
|---------|----|
| 70-5340 | 5" |
|---------|----|

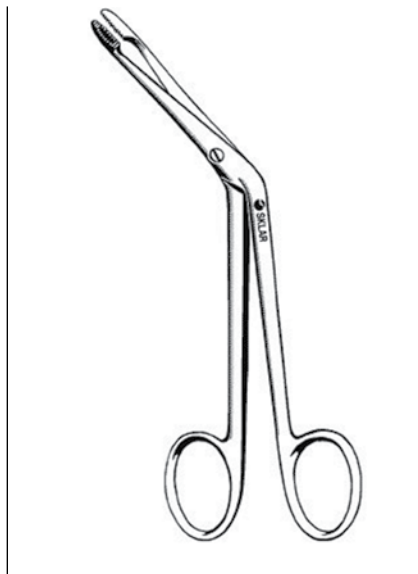

HARTMANN NASAL FORCEPS

- | | |
|---------|----|
| 70-4160 | 6" |
|---------|----|

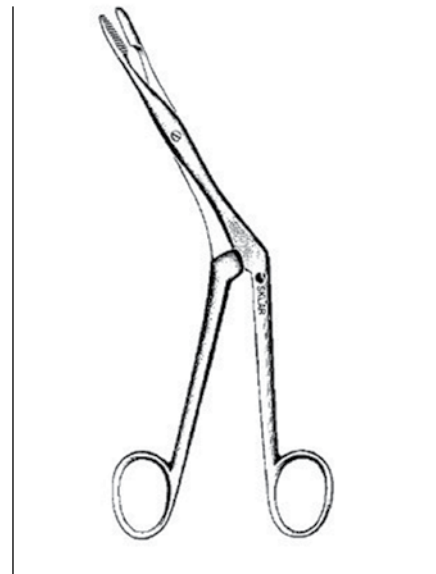

**HEYMANN-KNIGHT NASAL
FORCEPS**

- | | | |
|---------|----|----------|
| 70-4075 | 7" | Serrated |
|---------|----|----------|

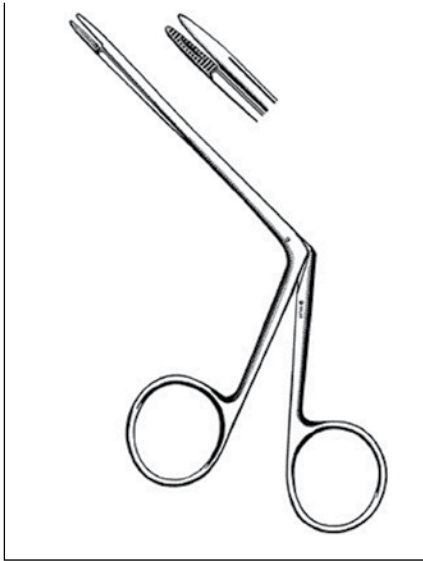

LITTAUER FORCEPS

67-1052	3"	Serrated
70-4170	4"	Serrated

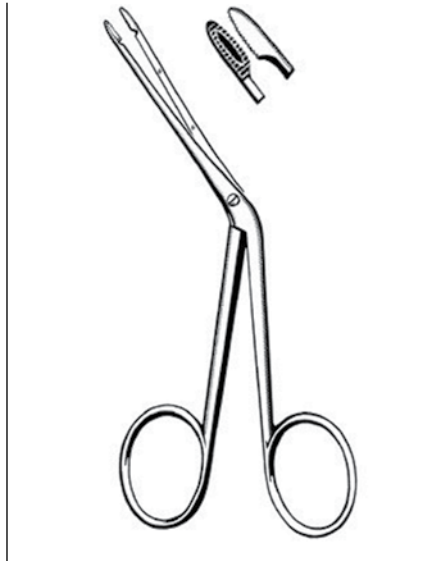

HARTMAN GRASPING FORCEPS

67-1045	Standard Serrated
67-1050	Fine Serrated

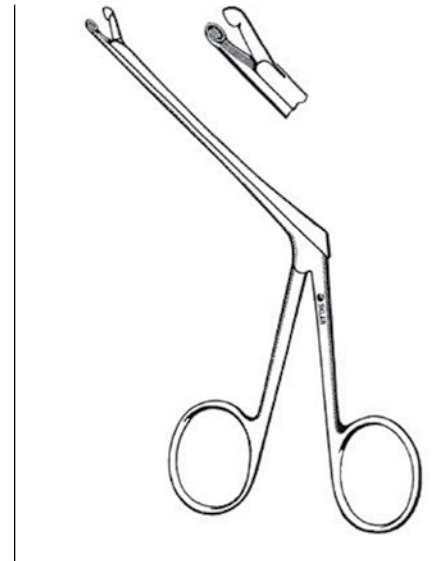

HARTMAN PUNCH FORCEPS

SPOON SHAPED JAWS		
67-1020	Standard	3mm
67-1021	Delicate	3mm
67-1030	Jaws Curved Up	3mm

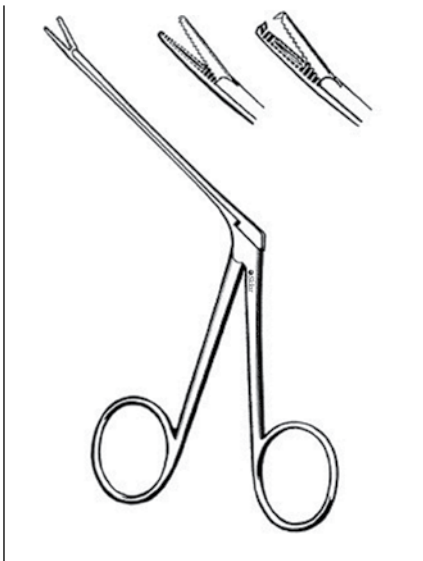

HARTMAN ALLIGATOR GRASPING FORCEPS

67-1035	3½"	Serrated
67-1036	3½"	Serrated, Extra Delicate
67-1040	3½"	Serrated, 1x2 Teeth
67-1038	5½"	Serrated
67-1039	6½"	Serrated

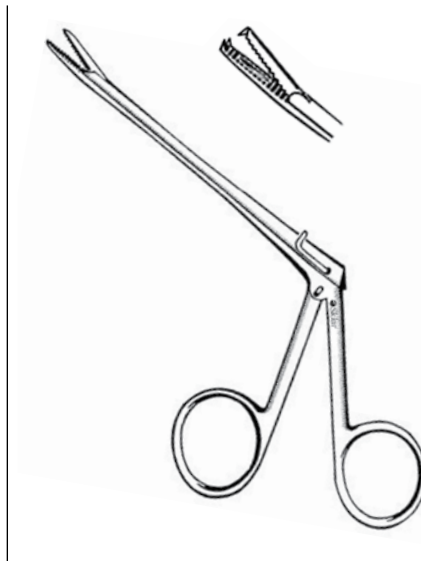

NOYES ALLIGATOR FORCEPS

70-5332	¾"	Serrated
70-5335	5½"	Serrated
70-5336	6½"	Serrated
70-5232	¾"	1x2 Teeth
70-5235	5½"	1x2 Teeth



DELICATE ALLIGATOR FORCEPS

67-8000	¾"	7mm, Serrated
67-8006	¾"	4mm, Serrated
67-8008	¾"	Curved Right, 4mm, Serrated
67-8010	¾"	Curved Left, 4mm, Serrated
67-8024	¾"	Curved Down, Smooth

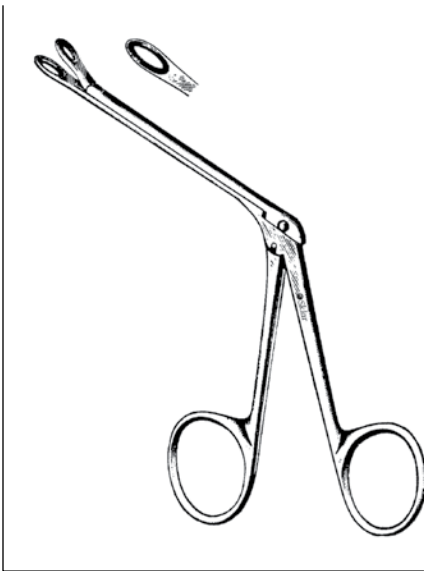

STRUEMPEL EAR FORCEPS
67-1032 3¼" Oval Jaws

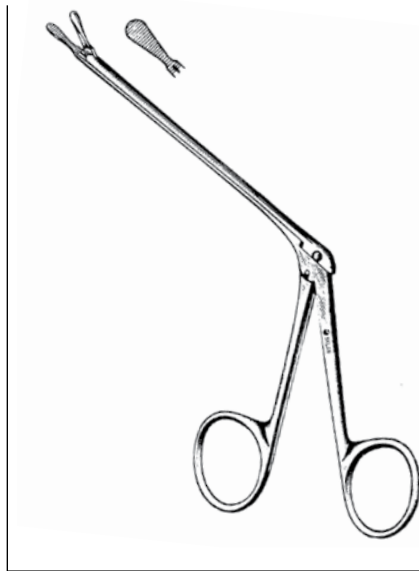

DUCKBILL EAR FORCEPS
67-1033 5½" Serrated

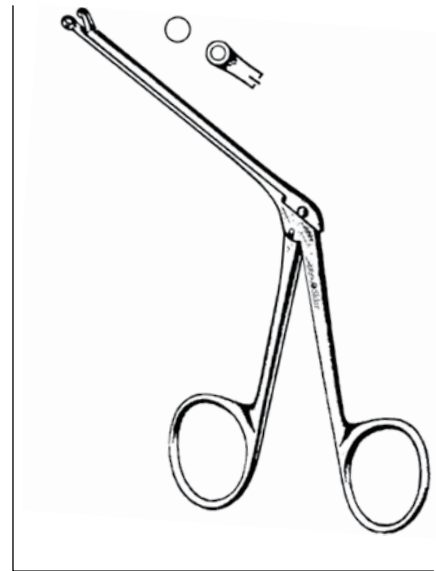

HOFFMAN EAR FORCEPS
67-1034 3¼" Through Cut Round Jaws

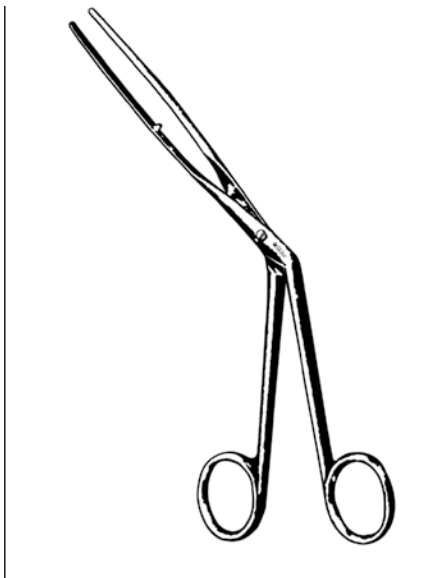

LUBET BARBON NASAL FORCEPS
70-4080 8"

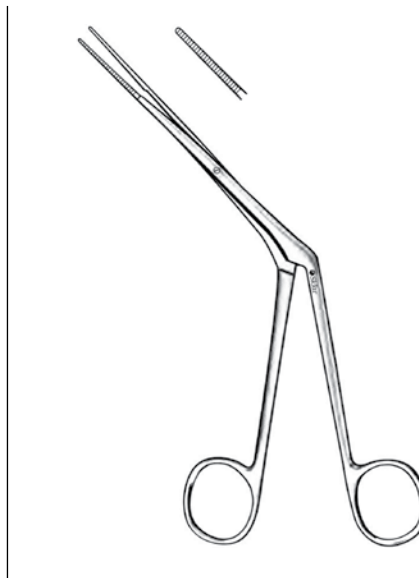

**MUSEHOLDT NASAL DRESSING
FORCEPS**
70-4207 8" Slender Blades

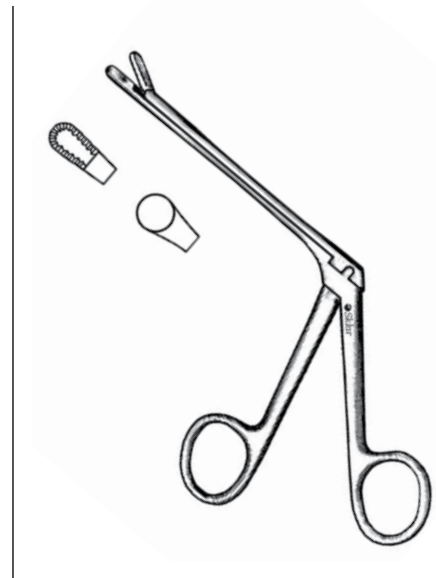

**WATSON-WILLIAMS NASAL
CUTTING FORCEPS**
70-5180 7½" Upturned Jaws

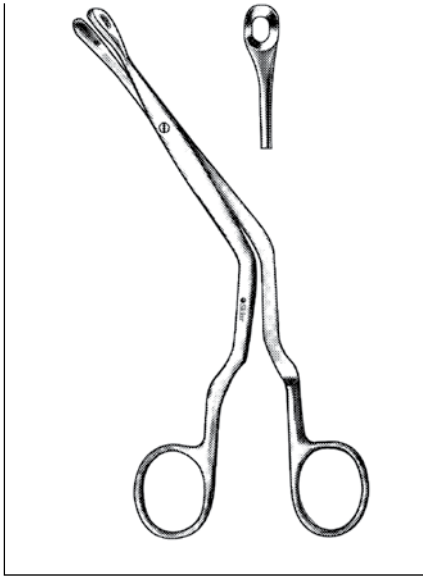

LUC NASAL CUTTING FORCEPS

OVAL, FENESTRATED JAW

70-4276 7½" Small
70-4277 7½" Large

SOLID CUP JAWS JAW

70-4280 7½" Large



CRAIG DOMNICK SEPTUM FORCEPS

40-4240 7¾" Curved Right
40-4241 7¾" Curved Left

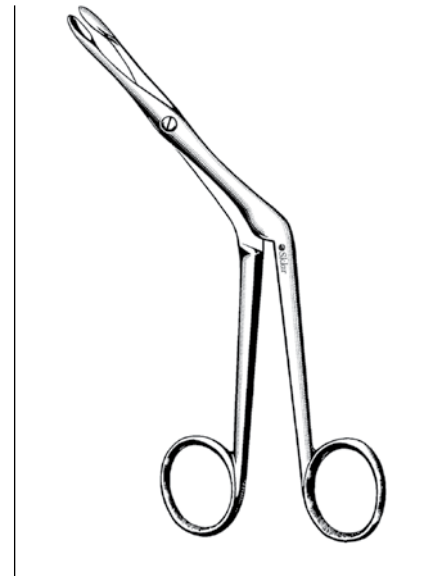

HEYMAN SEPTUM FORCEPS

70-4270 7"

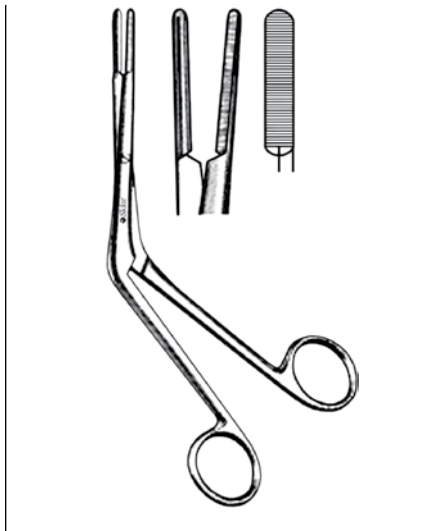

KILLIAN SEPTUM FORCEPS

70-4373 7¾" Serrated

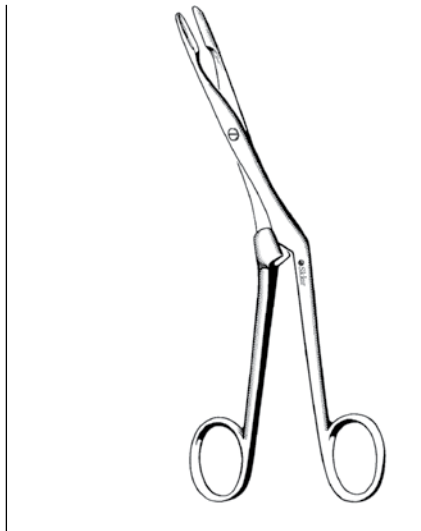

KNIGHT SEPTUM FORCEPS

70-5170 7"

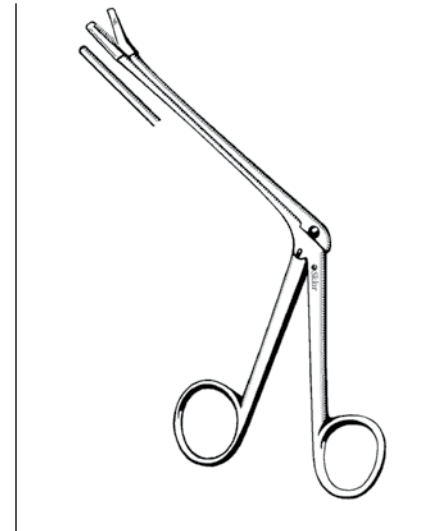

STRUYCKEN NASAL CUTTING FORCEPS

70-5176 7½"

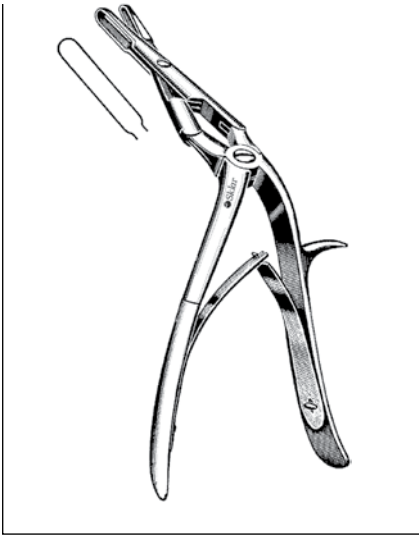

JANSEN-MIDDLETON SEPTUM CUTTING FORCEPS

70-5673 7½" Double Action
70-5674 7½" Cupped Jaws



RUBIN SEPTUM FORCEPS

70-5680 8¼"

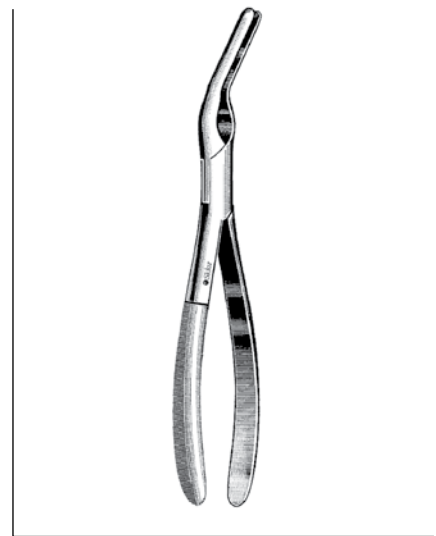

ASH SEPTUM STRAIGHTENING FORCEPS

70-5190 9"



LISTER SINUS FORCEPS

70-4180 7"

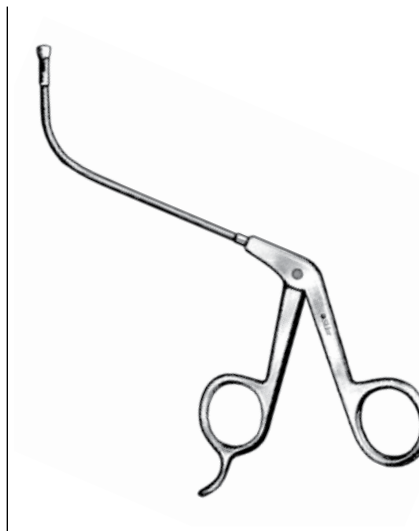

SINUSCOPY FORCEPS

70-5510 Upcutting, 3mm
70-5514 Downcutting, 3mm



CARREL ARTERY FORCEPS

17-1228 3½"

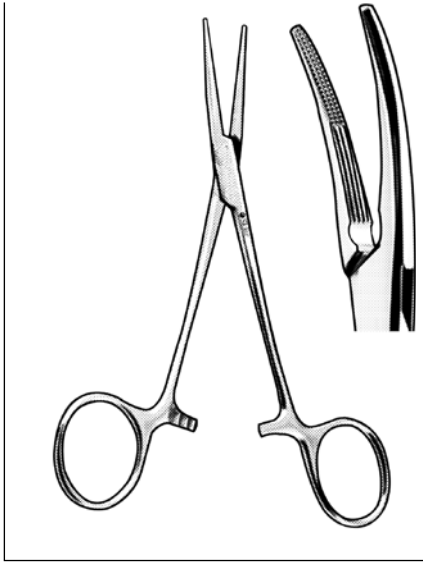

GRAY-TURNER ARTERY FORCEPS

98-5255 6" Serrated, .6mm Tip

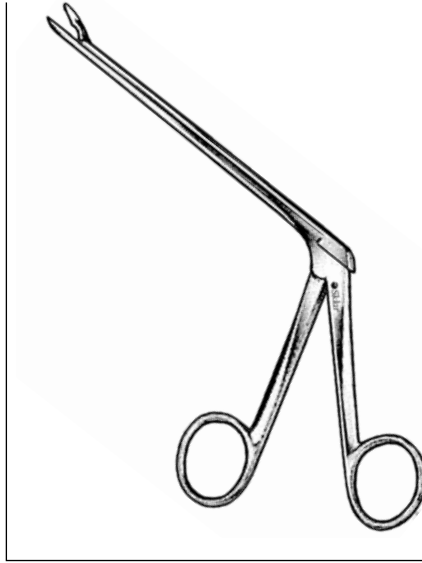

MACKAY-GRUENWALD ETHMOID FORCEPS

STRAIGHT

70-5460 5¼" Small 8x3mm
70-5461 5¼" Large 11.5x3.5mm

45 DEGREES

70-5462 5¼" Small 8x3mm
70-5463 5¼" Large 11.5x3.5mm

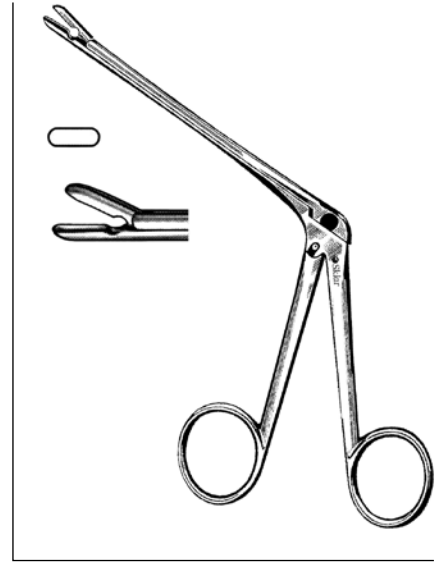

TAKAHASHI ETHMOID FORCEPS

70-5090 7½" 2x10mm



BERNHARD TOWEL FORCEPS

47-2965 4"
47-2966 4¾"
47-2967 5½"
47-2968 6½"
47-2969 7"



TOHOKU TOWEL FORCEPS

ANGLED BALL POINT TIP

47-2974 4"
47-2975 5"

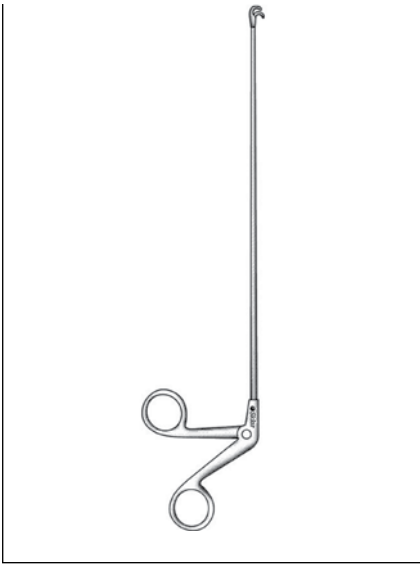

ARNOLD LARYNGEAL VOCAL CORD HOLDING FORCEPS
DOUBLE ACTION

75-1225	9"	Right
75-1226	9"	Left

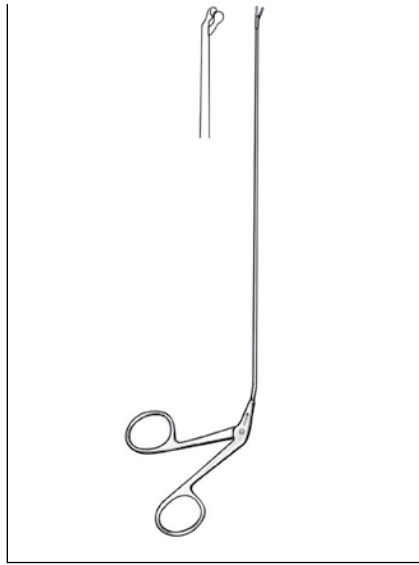

ENDOLARYNGEAL CUP FORCEPS

98-2175	9¾"	Curved Up, 2mm
98-2176	9¾"	Curved Right, 2mm
98-2177	9¾"	Curved Left, 2mm

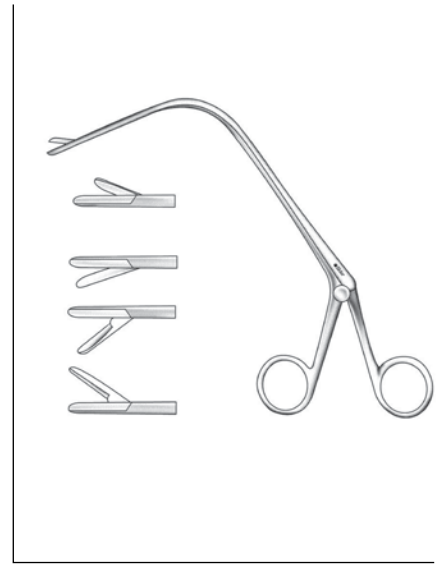

JURASZ LARYNGEAL FORCEPS

CURVED, OVAL CUP JAWS, GLIDING SHAFT		
75-1244	9"	Opening Upward
75-1245	9"	Opening Down
75-1246	9"	Opening Right
75-1247	9"	Opening Left

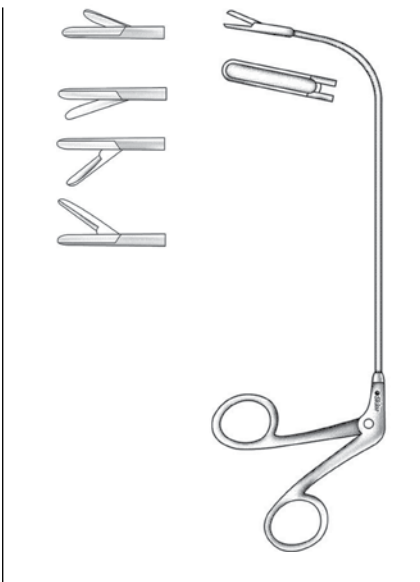

JURASZ LARYNGEAL POLYP FORCEPS

CURVED, OVAL CUP JAWS, TUBULAR SHAFT		
75-1240	9"	Opening Upward
75-1241	9"	Opening Down
75-1242	9"	Opening Right
75-1243	9"	Opening Left

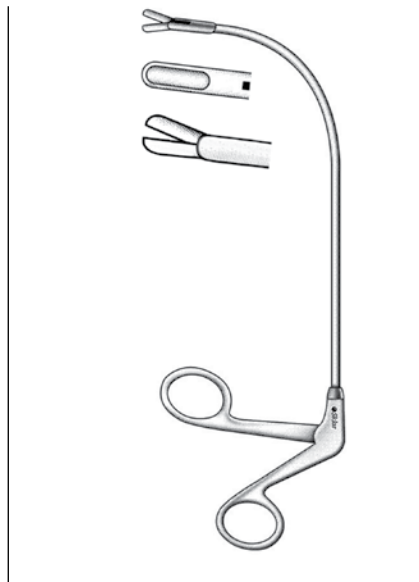

FRAENKEL LARYNGEAL POLYP FORCEPS

75-1228	6¾"	Oval Cup
75-1229	7"	Curved

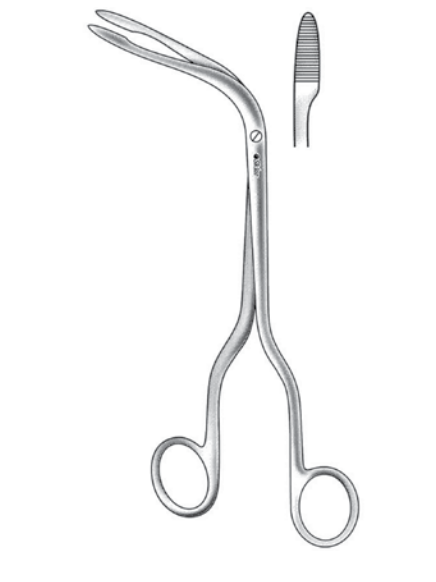

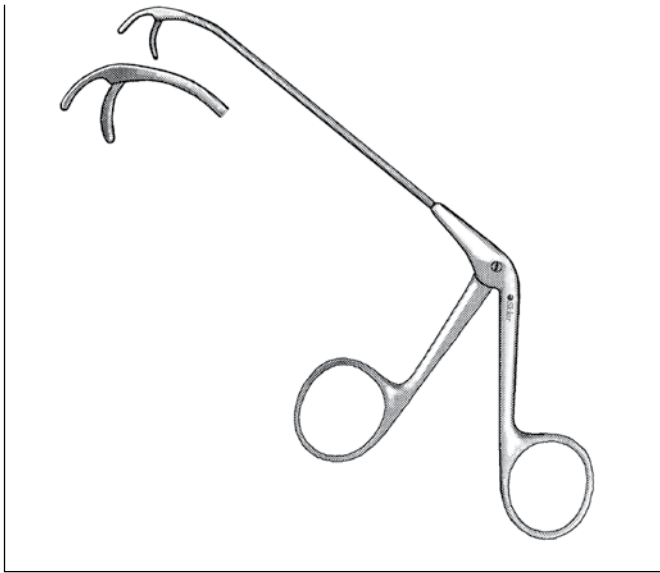

HEUWIESER ANTRUM FORCEPS
70-5100 Down Angled 90°



MYERSON BRONCHIAL ESOPHAGEAL BIOPSY FORCEPS
75-1235 18½" Delicate



KLEINERT KUTZ TENDON FORCEPS
47-3515 8"



COTTLE CLUMELLA FORCEPS
66-1040 4½" 1mm Wide Jaw



**SKLAR EDGE™
TC FRIEDLAND SCISSORS**
ONE SERRATED BLADE, SABER-BACK BLADES

16-3410	6¾"	Straight
16-3411	6¾"	Curved
16-3412	9"	Straight
16-3413	9"	Curved

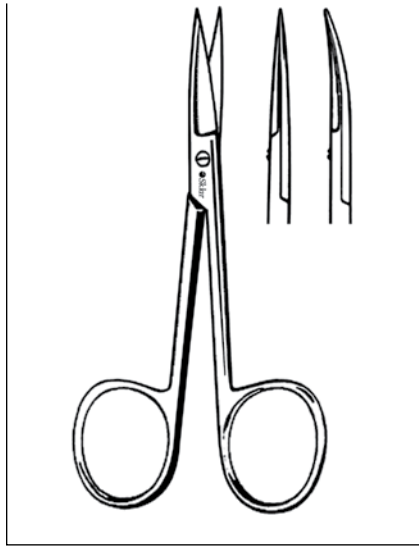

**SKLAR TISSUE SCISSORS
HEAVY**

47-1044	4¾"	Straight
47-1045	4¾"	Curved

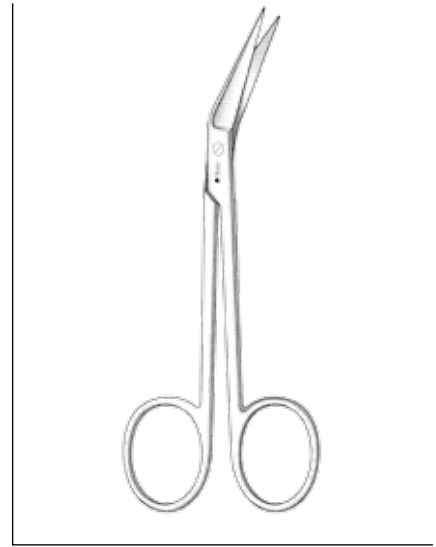

**SKLAR ANGULAR SCISSORS
SHARP/SHARP**

47-1080	4¾"	Smooth
47-1081	4¾"	Serrated

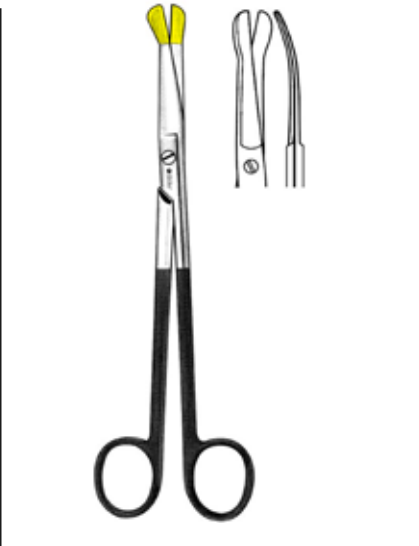

**SOLZ "GOLD TIP" SUPERCUT
SCISSORS**
CURVED, 1 RAZOR EDGE, 1 MICRO-SERRATED EDGE

15-9303	8"	Slight Bevel
15-9302	8"	Strong Bevel

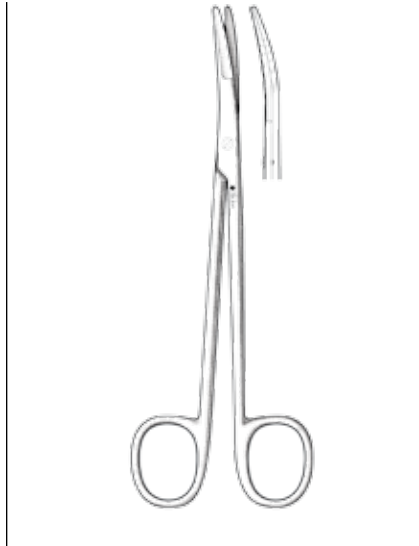

**GLASSMAN THIN POINT
DISSECTING SCISSORS**
SLIGHTLY CURVED TIPS

41-1047	7"
---------	----

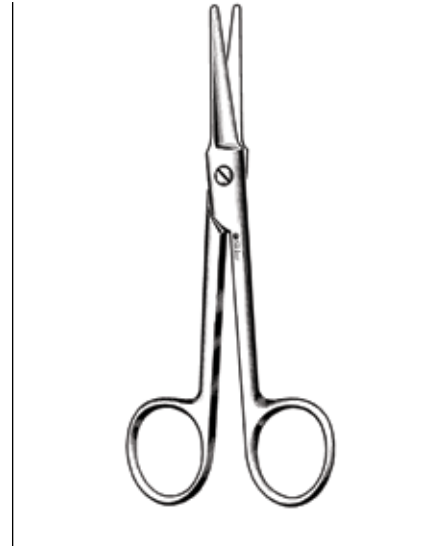

BROWN DISSECTING SCISSORS

41-1078	5½"	Straight
41-1079	5½"	Curved



MILLER DISSECTING SCISSORS
SERRATED
 41-1125 5"

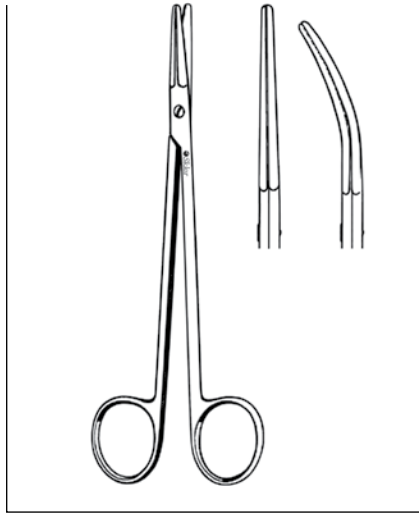

KAHN DISSECTING SCISSORS
STRAIGHT
 41-1132 5½"
 41-1136 7"
CURVED
 41-1134 5½"
 41-1138 7"



KILNER DISSECTING SCISSORS
CURVED
 47-1043 5¾"

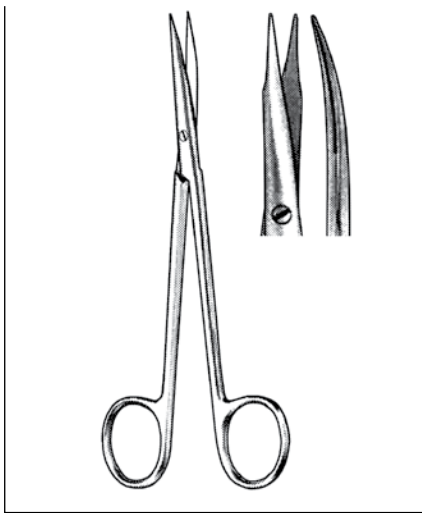

JAMESON DISSECTING SCISSORS
 47-1350 6" Curved
 47-1351 7" Curved

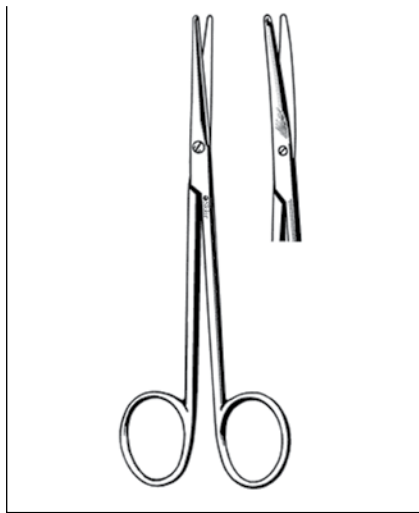

METZENBAUM-LAHEY DISSECTING SCISSORS
 47-1360 5¾" Curved

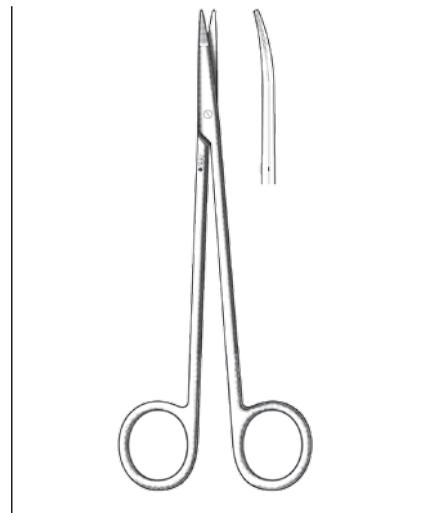

KAYE FACELIFT SCISSORS
CURVED
 47-1086 6"

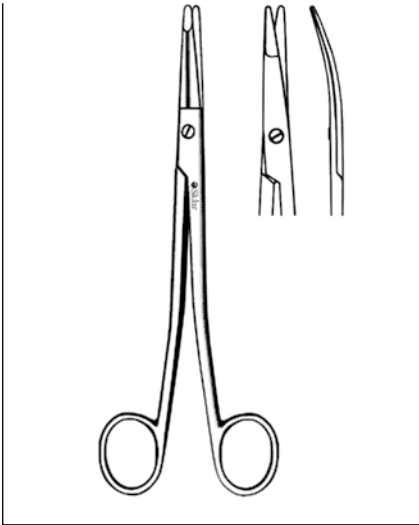

GORNEY FACELIFT SCISSORS
STRAIGHT

47-1088 5"
47-1090 7½"
47-1091 9"

CURVED

47-1089 6½" Curved



AUFRICHT FACELIFT SCISSORS
CURVED

41-1167 5¾"

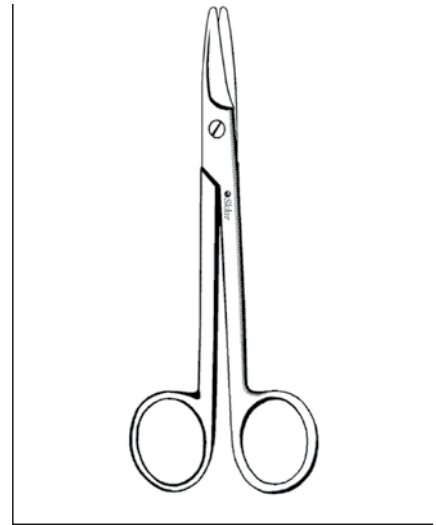

CASTANERES FACELIFT SCISSORS

41-1077 6¼"

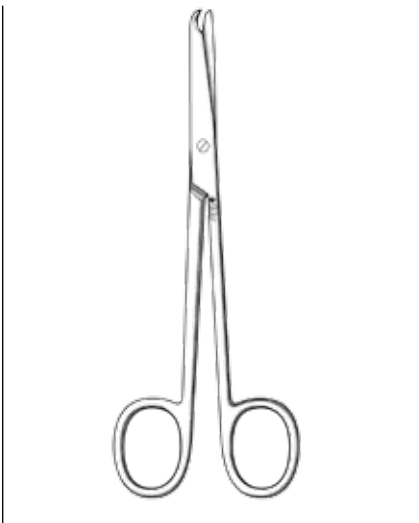

BUCK SUTURE SCISSORS

15-1359 7"

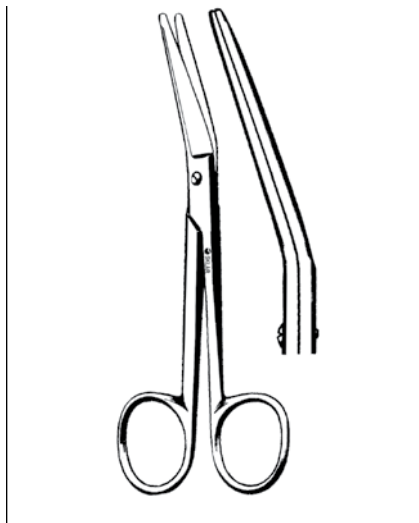

NEW'S SUTURE SCISSORS
ANGLED FLAT

41-1163 5½"

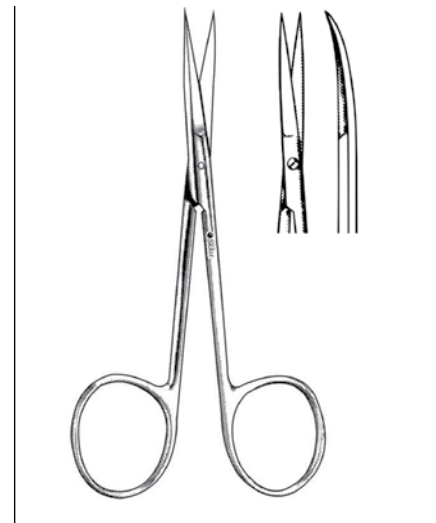

DAHLGREN IRIS SCISSORS

SHARP

47-1268 4" Straight
47-1269 4" Curved

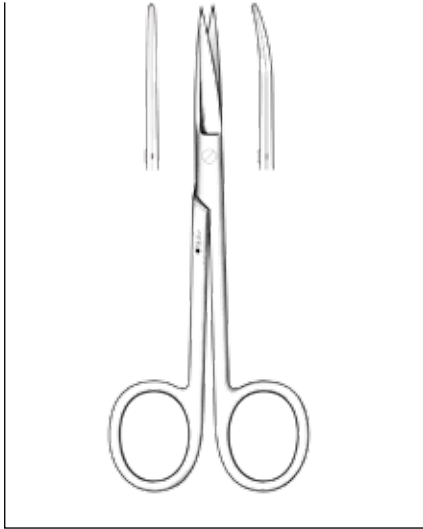

JOSEPH SCISSORS

41-1050 5¾" Straight
41-1054 5¾" Curved

DOUBLE EDGE

41-1058 5¾" Straight
41-1060 5¾" Curved

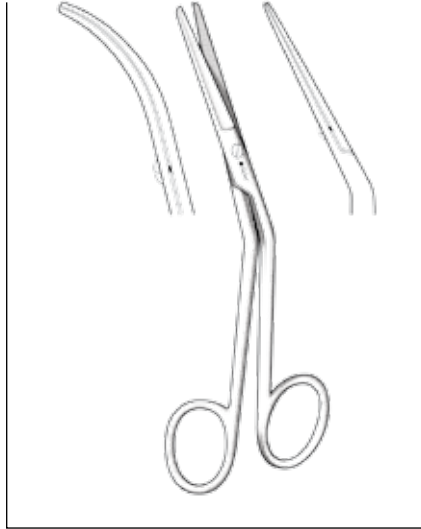

FOMON SABER BACK SCISSORS

41-1076 5½" Curved

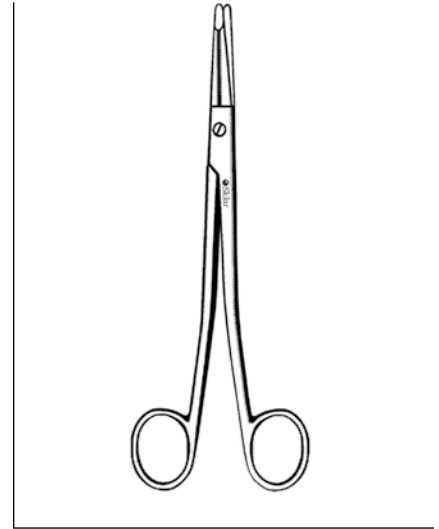

CASTANARES SHORT SCISSORS

41-1088 Straight, Blunt

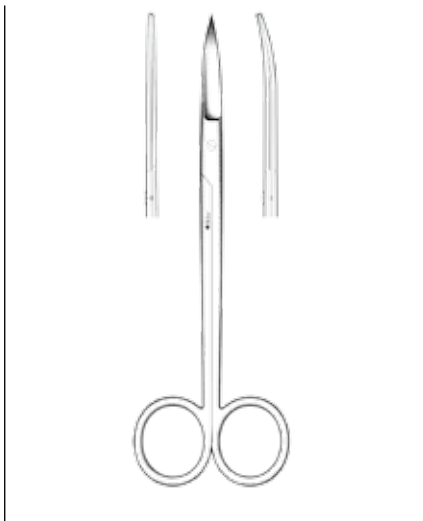

RHYTIDECTOMY SCISSORS

DOUBLE EDGE

41-1100 6½" Straight
41-1105 6½" Curved

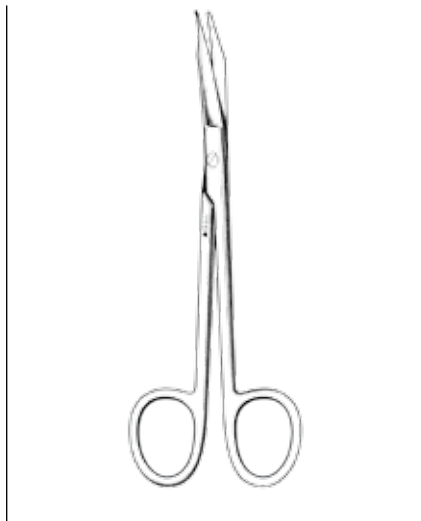

MARTIN SCISSORS

HEAVY

41-1120 8" Curved, Serrated

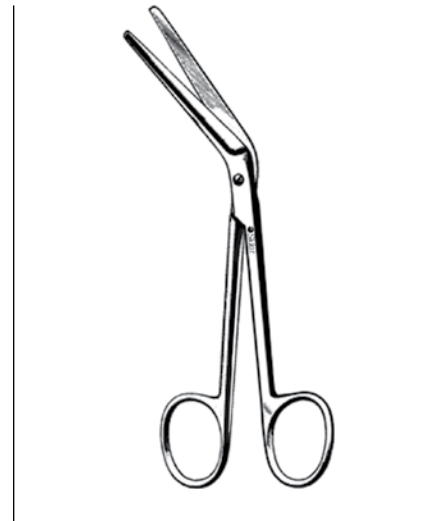

SEILER TURBINATE SCISSORS

ANGLED ON SIDE

41-1165 6¼"

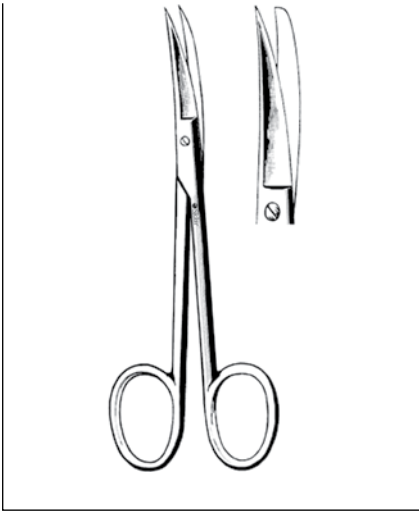

**WAGNER OPERATING
SCISSORS**

CURVED

- 47-1068 4½" Smooth
- 47-1069 4½" Serrated



KAYE UNDERMINING SCISSORS

STRAIGHT

- 47-1084 4¼"

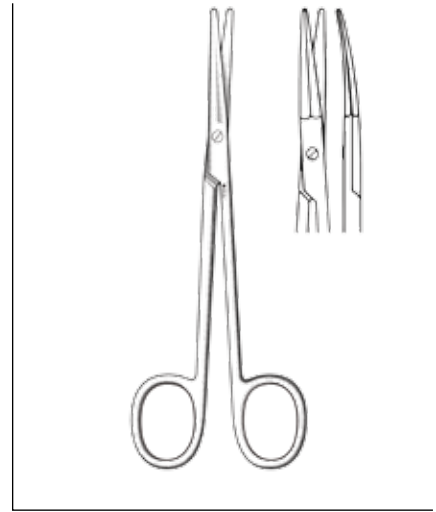

JOSEPH PECK SCISSORS

SHARP

- 47-1095 5¼" Straight
- 47-1096 5¼" Curved

BLUNT

- 47-1097 5¼" Straight
- 47-1098 5¼" Curved



**KAYE BLEPHAROPLASTY
SCISSORS**

SERRATED

- 47-1150 4½" Curved

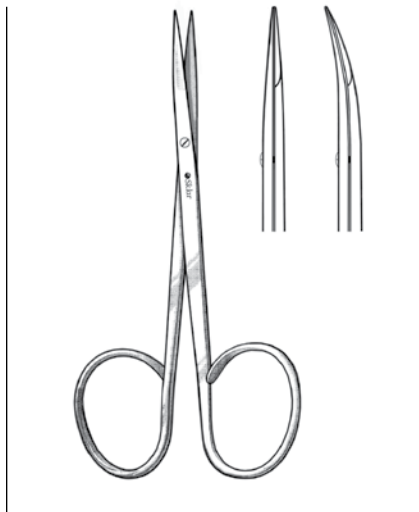

BLEPHAROPLASTY SCISSORS

RIBBON-TYPE

- 47-1152 4¼" Straight
- 47-1153 4¼" Curved

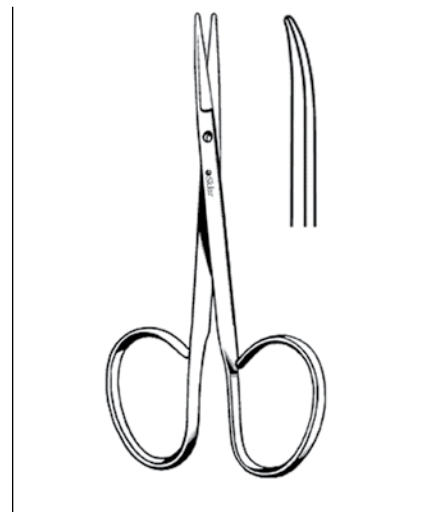

UTILITY RIBBON SCISSORS

CURVED, BLUNT/BLUNT

- 47-1247 4"



SHEA SCISSORS
THIN TIPS
 47-1257 4¾" Curved

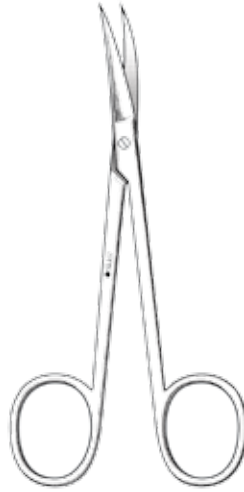

PLASTIC SURGERY SCISSORS
 47-1345 4½" Curved

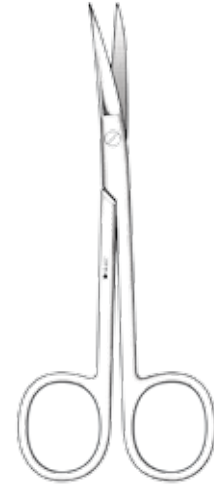

CINELLI LOWER LATERAL SCISSORS
 70-4348 4¼"

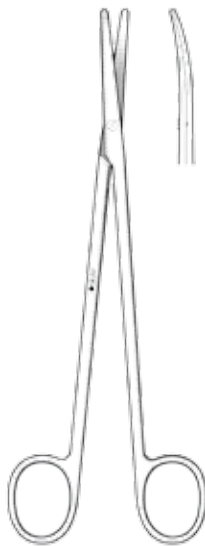

HALLE NASAL SCISSORS
 70-4265 7½" Curved



COTTLE NASAL SCISSORS
CURVED
 41-1168 4½"



CONVERSE NASAL SCISSORS
ANGLED
 70-4260 4¼" Blunt
 70-4261 4¼" Sharp

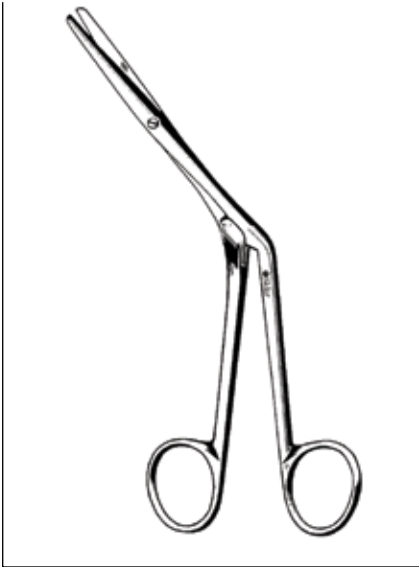

KNIGHT NASAL SCISSORS

70-4262 6¼" Blunt

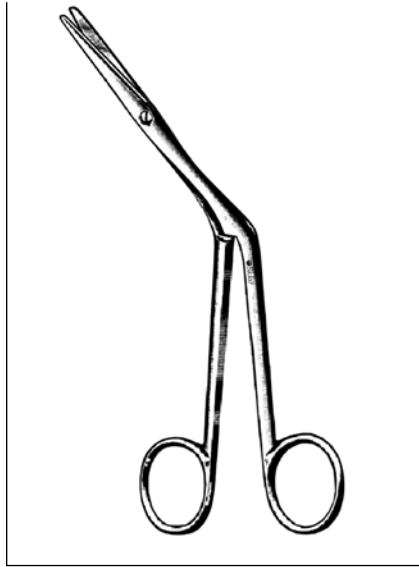

HEYMANN NASAL SCISSORS

70-4268 7"

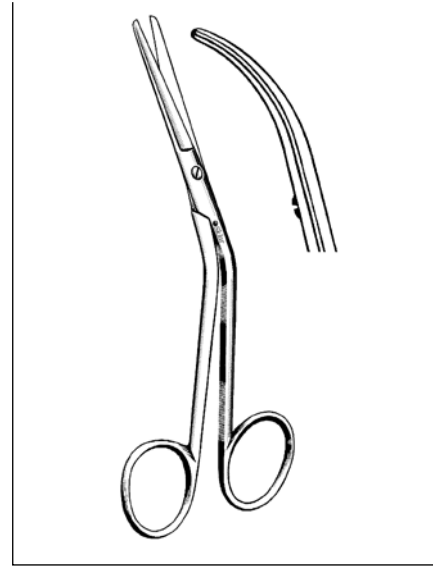

FOMON NASAL SCISSORS

70-4352 5¼" Curved

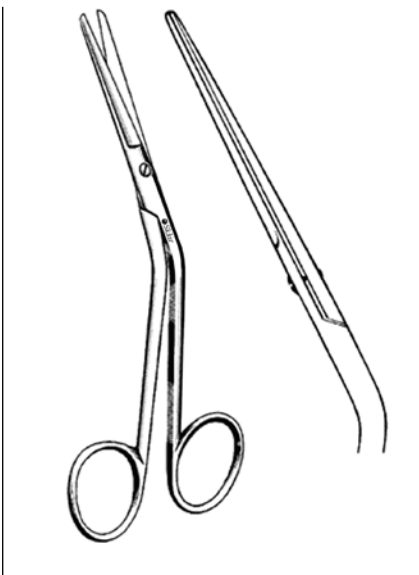

FOMON DORSAL SCISSORS

70-4350 5½" Angled

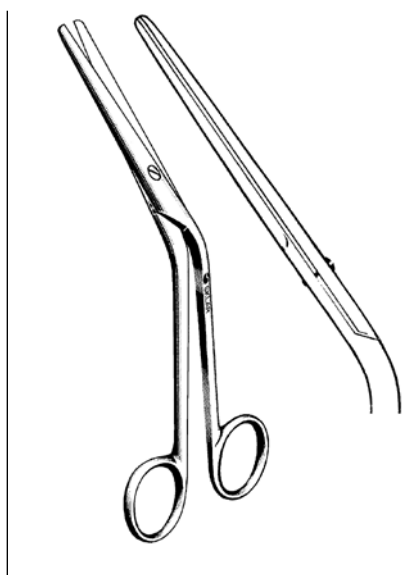

**COTTLE DORSAL
SCISSORS**

ANGLED
41-1169 6"

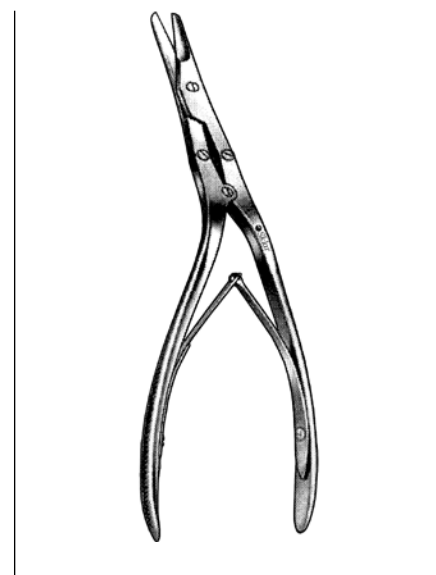

**CAPLAN DORSAL
SCISSORS**

SERRATED
41-1145 7½"

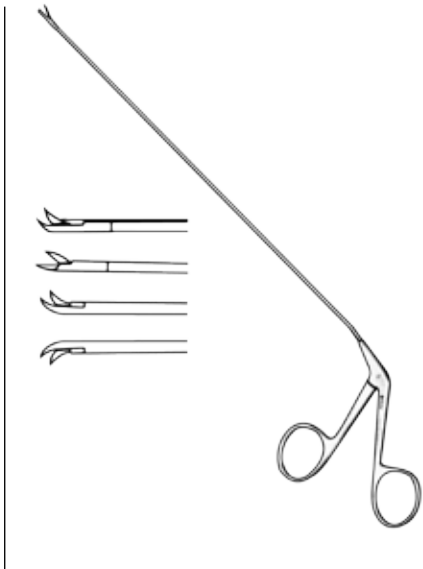

ENDOLARYNGEAL MICRO SCISSORS

2MM

- 98-2180 9¾" Left Curved
- 98-2181 9¾" Straight
- 98-2182 9¾" Curved Up
- 98-2183 9¾" Right Curved

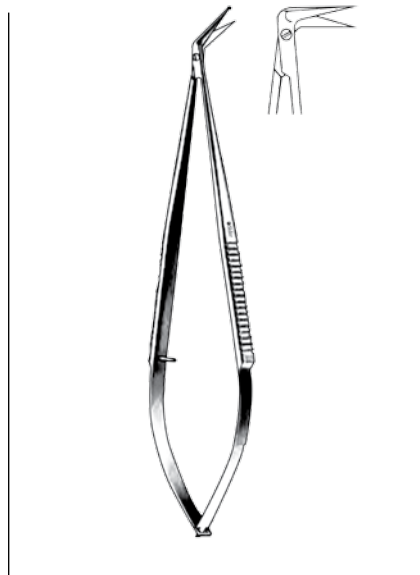

POTTS-SMITH VASCULAR SCISSORS

- 98-1079 7" 90 Degree Angle
- 98-1080 7" 120 Degree Angle

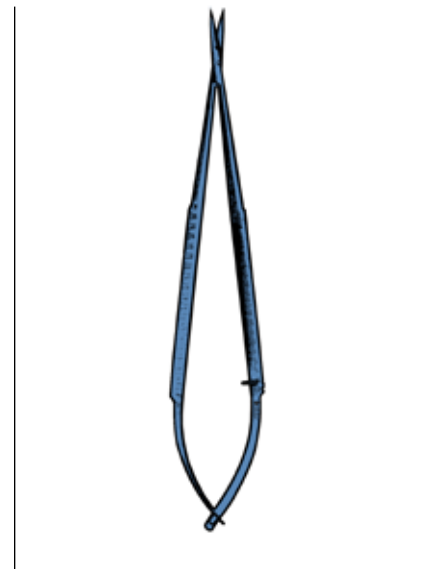

TITANIUM MICRO SCISSORS

- 98-4340T 6" Straight
- 98-4341T 6" Curved
- 98-4342T 7" Straight
- 98-4343T 7" Curved
- 98-4344T 8¼" Straight
- 98-4345T 8¼" Curved

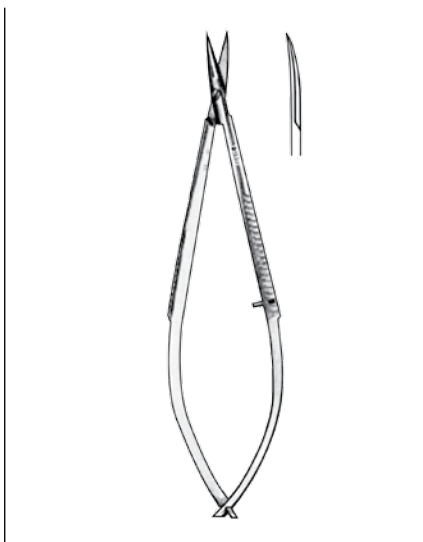

MICRO DISSECTING SCISSORS

FLAT HANDLE

- 98-7807 4¼" 14mm **ROUND HANDLE**
- 98-7808 6" 14mm 98-7818 6"
- 98-7809 6" 19mm 98-7819 7"

FLAT HANDLE WITH SAW EDGE

- 98-7811 6" 19mm
- 98-7813 7" 20mm

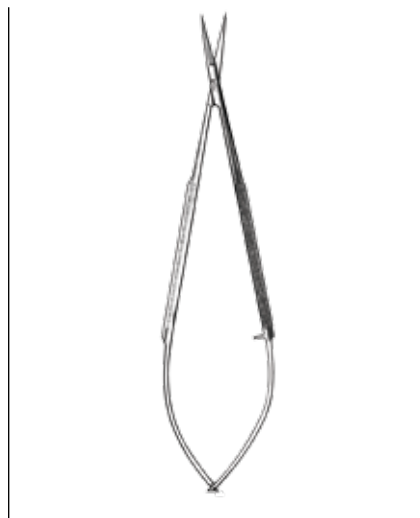

MICRO SCISSORS

- 98-7837 7" Long Blades

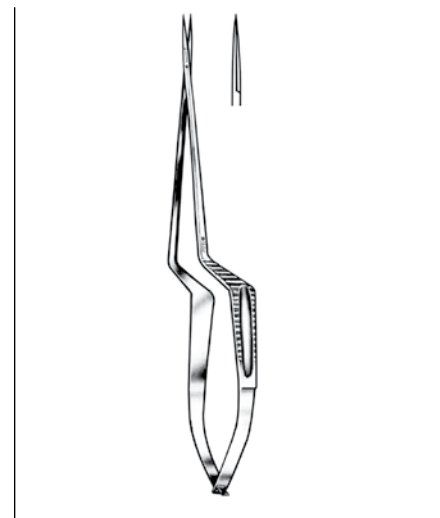

MICRO VESSEL SCISSORS

STRAIGHT

- 98-7821 7½" Straight
- 98-7823 7½" Curved
- 98-7825 7½" Straight
- 98-7827 7½" Curved

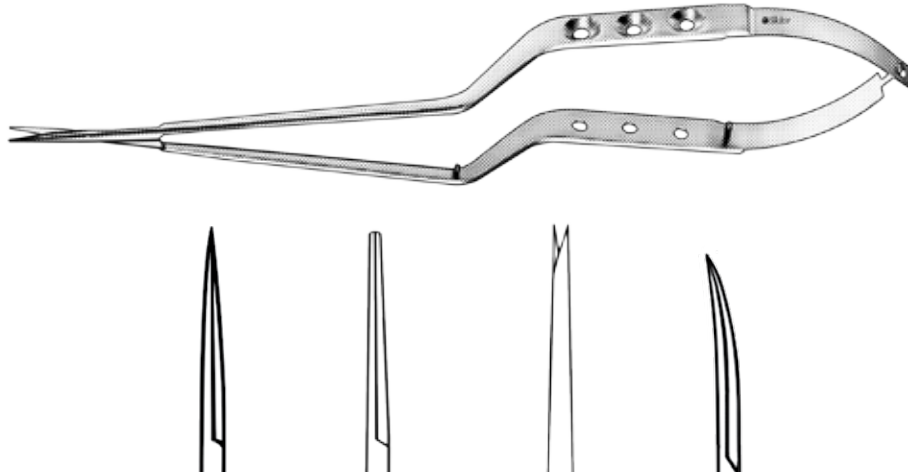

YASARGIL SCISSORS

BAYONET, FLAT, STRAIGHT

98-2101	6¼"	Sharp/Sharp
98-2102	6¼"	Blunt/Blunt
98-2103	7¾"	Sharp/Sharp
98-2104	7¾"	Blunt/Blunt
98-2105	8¾"	Sharp/Sharp
98-2106	8¾"	Blunt/Blunt

BAYONET, NOTCHED TIP, STRAIGHT

98-2112	6¼"	Sharp/Sharp
98-2113	7¾"	Sharp/Sharp
98-2114	8¾"	Sharp/Sharp

BAYONET, FLAT, CURVED

98-2107	6¼"	Blunt/Blunt
98-2108	7¾"	Sharp/Sharp
98-2109	7¾"	Blunt/Blunt
98-2110	8¾"	Sharp/Sharp
98-2111	8¾"	Blunt/Blunt

BAYONET, NOTCHED TIP, CURVED

98-2115	6¼"	Sharp/Sharp
98-2116	7¾"	Sharp/Sharp
98-2117	8¾"	Sharp/Sharp

**KILLS 99% OF GERMS
IN LESS THAN 15 SECONDS!**

SKLAR STAT™

Instant Foam Hand Sanitizer

SKLAR-STAT Instant Foam Hand Sanitizer, based on the active ingredient Benzalkonium Chloride, is a unique formulation featuring exceptional skin feel, conditioning and moisturizing properties. The efficacy of this product has been confirmed to reduce *S. Aureus* 99.999% and *S. Aureus* MRSA 99.9% in as little as 15 seconds.

Automatic Foam Dispenser

Motion activated battery powered and wall-mounted, Sklar's Automatic Foam Dispenser allows for easy access and reduced risk of cross contamination.

PRODUCT NUMBER	FEATURES	QUANTITIES
10-2856	Wall Mount Dispenser	1 Each
10-2854	1000ml Refill Bottles	6/case
10-2858	(2) Cases 1000ml Refill Bottles plus Free Wall Mount Dispenser	1 Set

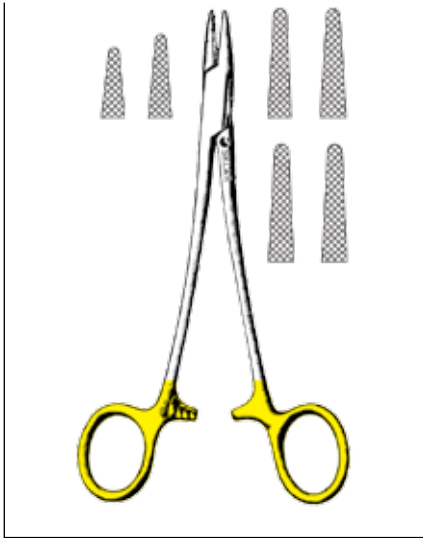

**TC MAYO-HEGAR
NEEDLE HOLDERS**

SERRATED

- | | | | |
|---------|--------------|---------|------|
| 21-8030 | 5½" | 21-8033 | 8" |
| 21-8031 | 6" | 21-8051 | 9½" |
| 21-8032 | 7" | 21-8034 | 10½" |
| 21-2570 | 7" Broad Jaw | 21-8035 | 12" |

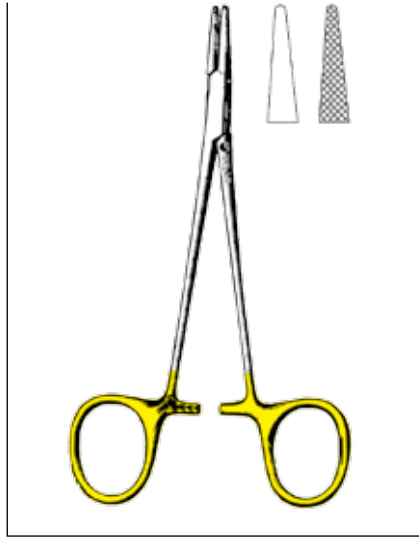

TC HALSEY NEEDLE HOLDERS

- | | | |
|---------|-----|----------|
| 21-8000 | 5¼" | Smooth |
| 21-8001 | 5¼" | Serrated |

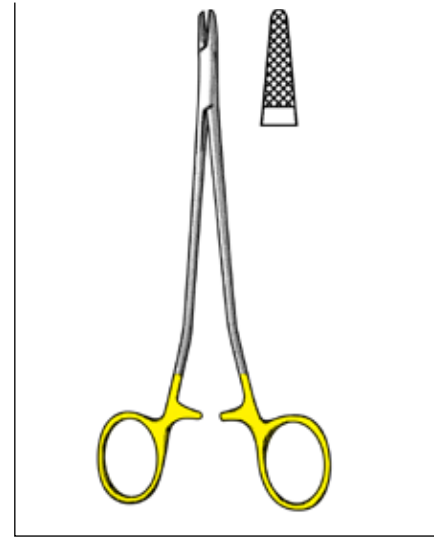

TC SENNING NEEDLE HOLDERS

SERRATED

- | | |
|---------|-----|
| 20-2311 | 6" |
| 20-2313 | 6¾" |
| 20-2315 | 8" |

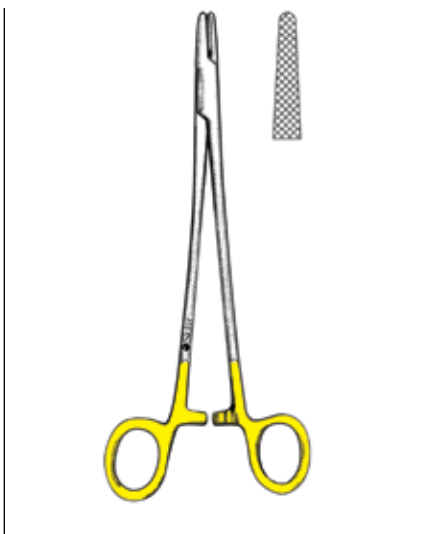

TC CAROLL NEEDLE HOLDER

- | | | |
|---------|----|----------|
| 21-3110 | 6" | Straight |
|---------|----|----------|

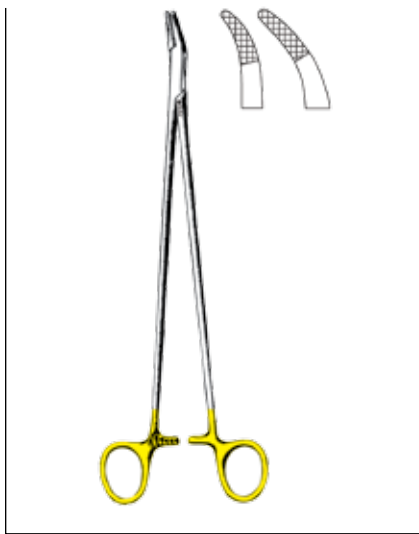

**TC FINOCHIETTO
NEEDLE HOLDERS**

SERRATED

- | | | |
|---------|------|--------|
| 21-8038 | 8" | |
| 21-8039 | 10½" | Angled |



TC GILLIES NEEDLE HOLDERS

- | | |
|---------|-----|
| 21-2660 | 4¾" |
| 21-2662 | 6" |
| 21-2664 | 5" |

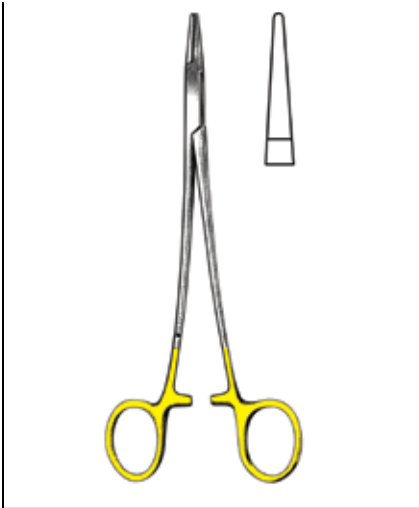

**TC EUPHRATE-PASQUE
NEEDLE HOLDERS**

SMOOTH

- 21-4960 5½"
- 21-4962 7"
- 21-4963 8"
- 21-4964 9"

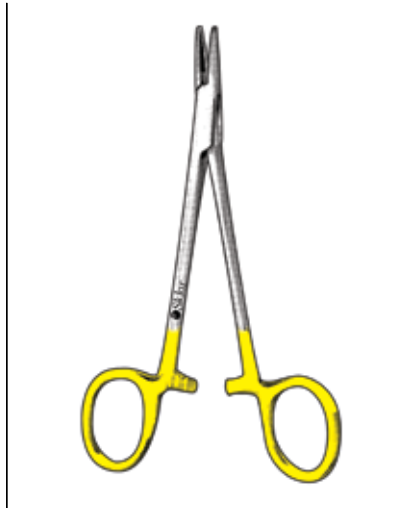

**TC WRIGHT DERF NEEDLE
HOLDER**

21-1549 5" Serrated

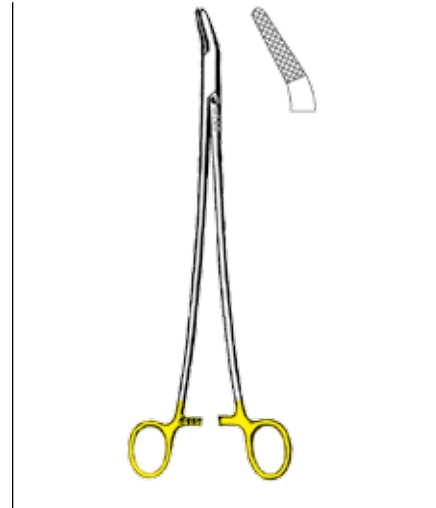

TC HEANEY NEEDLE HOLDERS

SERRATED, CURVED

- 21-8060 8¼"
- 21-8061 10"

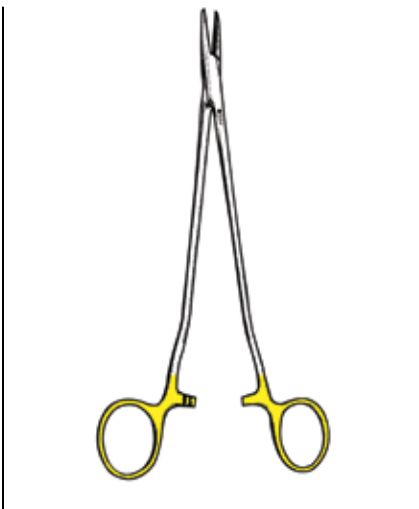

**TC COOLEY MICROVASCULAR
NEEDLE HOLDERS**

- 21-4950 6¾"
- 21-4951 8"

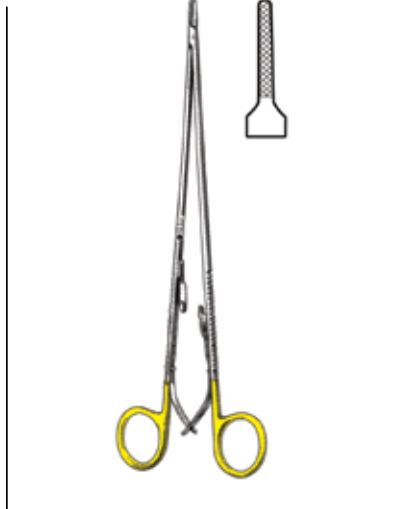

**TC DIETRICH MICRO NEEDLE
HOLDERS**

- 21-5000 6¼"
- 21-5001 7"
- 21-5002 8"
- 21-5003 9"
- 21-5004 10½"



**TC THOMPSON WALKER
BOZEMAN NEEDLE HOLDER**

21-2175 8¼" S-Shape



**TC DEBAKEY CARDIOVASCULAR
NEEDLE HOLDERS**

SERRATED

21-8087 7"

SERRATED, FENESTRATED

21-8088 8"

21-8089 9"

21-8090 10"

21-8092 12"

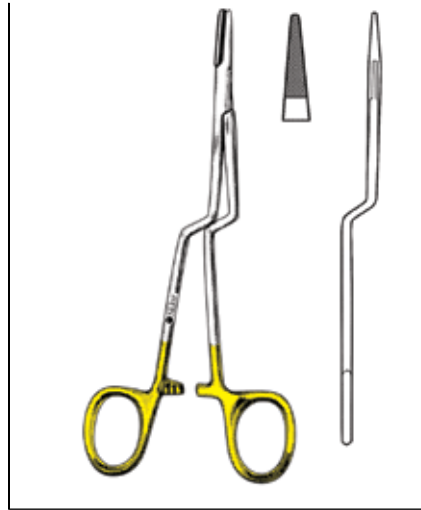

JACOBSON NEEDLE HOLDER

21-8049 7" Angled

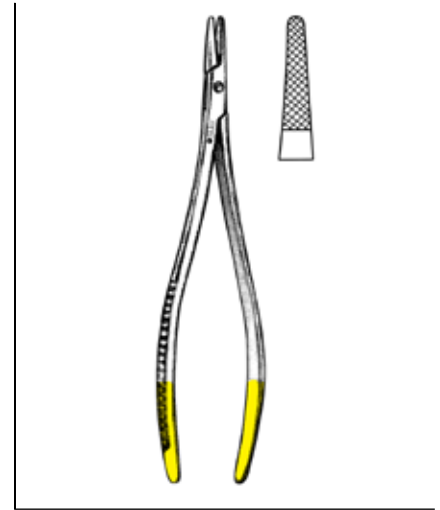

**TC LANGENBECK
NEEDLE HOLDERS**

DELICATE

21-8081 7" Straight

21-8083 7" Fine

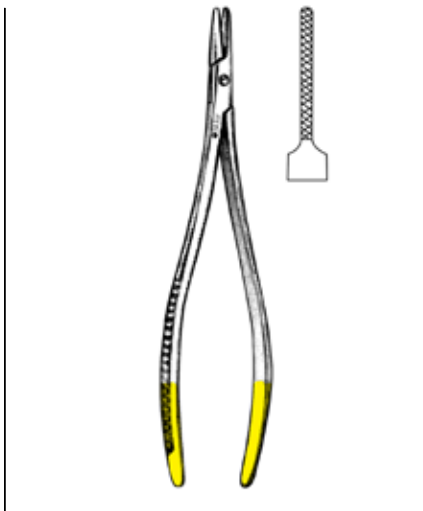

**TC LANGENBECK-RYDER
NEEDLE HOLDER**

21-8085 8" Fine

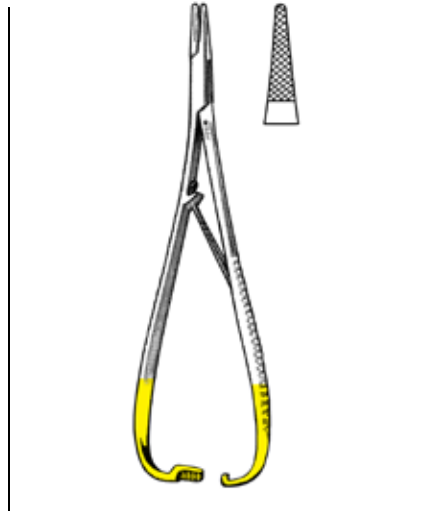

TC MATHIEU NEEDLE HOLDERS

DELICATE

21-8077 6¾"

21-8078 8"

21-8076 5½"

21-8074 9½"

21-8073 5½" Curved

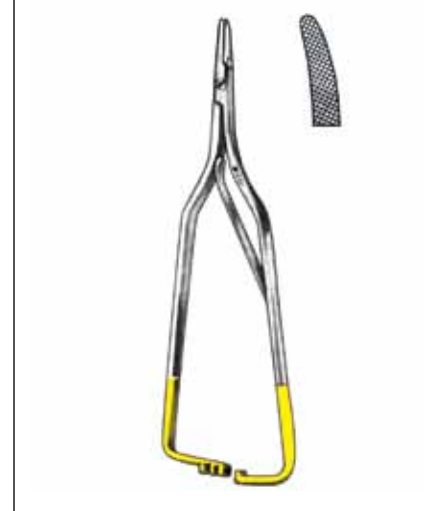

TC ARRUGA NEEDLE HOLDERS

21-3100 6¼" Straight

21-3101 6¼" Curved

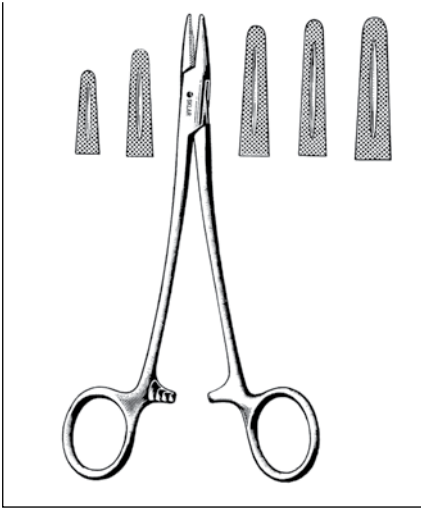

MAYO-HEGAR NEEDLE HOLDERS

SERRATED

20-2052	5¼"	20-2480	8"
20-2060	6"	20-2490	9½"
20-2070	7"	20-2910	10½" Masson
20-2270	7" Broad Jaw	20-2911	11½" Masson



CAROLL NEEDLE HOLDER

20-3110 6" Straight



SENNING NEEDLE HOLDER

20-2309 6¾" Delicate

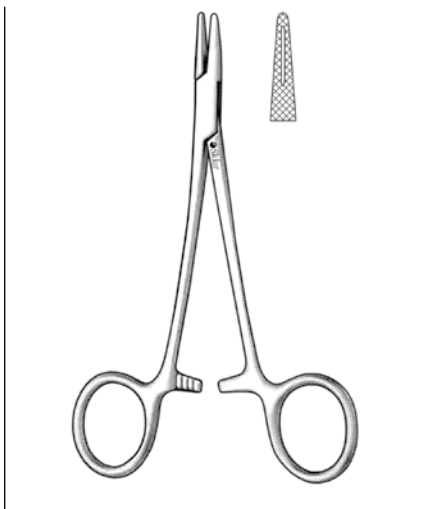

WRIGHT DERF NEEDLE HOLDER

20-1549 5"

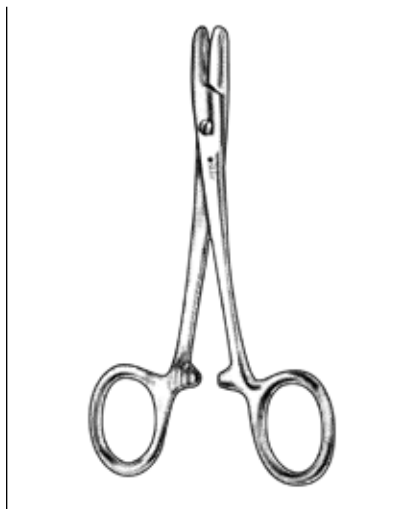

DOYEN NEEDLE HOLDER

20-3113 5"

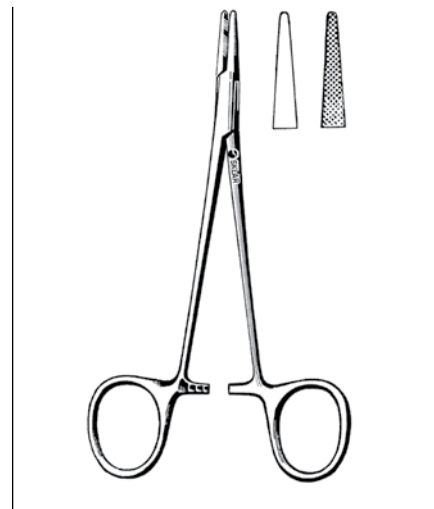

HALSEY NEEDLE HOLDERS

20-1750 5¼" Smooth
20-1751 5¼" Serrated



GILLIES NEEDLE HOLDER

20-2662 6" Serrated



LANGENBECK NEEDLE HOLDERS

21-8067 7" Smooth

21-8068 8" Smooth



ARRUGA NEEDLE HOLDERS

20-3100 6¼" Straight

20-3101 6¼" Curved



REILL MICRO NEEDLE HOLDERS

WITH PEN-TYPE HANDLE

20-1550 6" Straight

20-1551 6" Curved

20-1552 6" Straight with Ratchet

20-1553 6" Curved with Ratchet

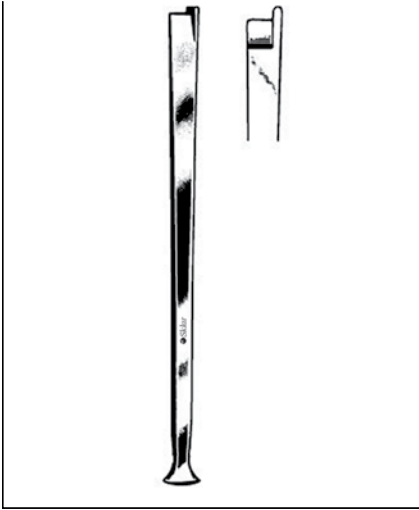

FOMON CHISELS

WITH GUARDED TIP

41-1366	5¾"	5mm
41-1367	5¾"	7mm
41-1368	5¾"	8mm

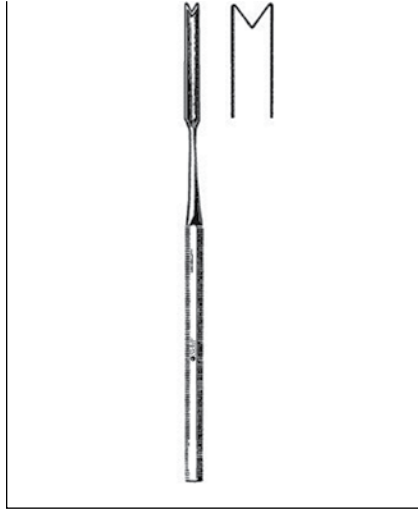

HAJEK SEPTUM CHISELS

V-SHAPED CUTTING EDGE

41-1361	6"	4mm
41-1362	6"	6mm
41-1363	6"	8mm

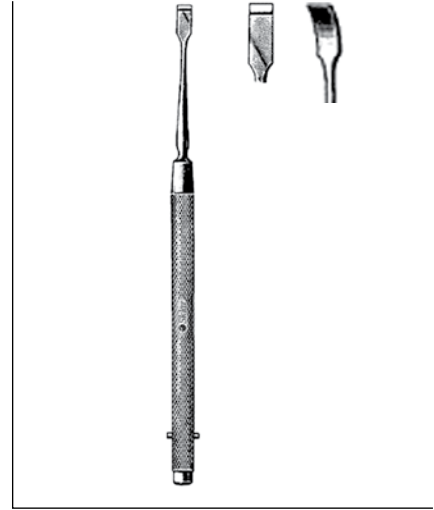

FREER SEPTUM CHISELS

41-1330	6½"	Straight	4mm
41-1332	6½"	Curved	4mm

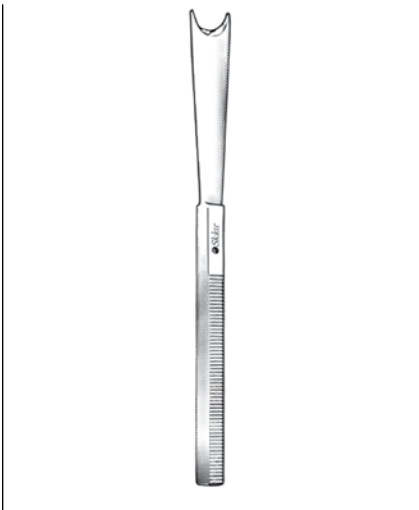

MCINDOE NASAL CHISELS

40-6130	5½"	9mm
40-6132	5½"	11mm
40-6133	5½"	13mm
40-6134	5½"	15mm

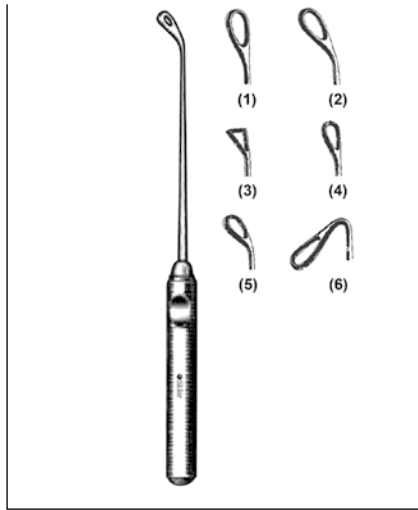

COAKLEY CURETTES

6¼"			
70-9301	(1)	30°	Large
70-9302	(2)	60°	Large
70-9303	(3)	30°	Triangular
70-9304	(4)	30°	Small
70-9305	(5)	60°	Small
70-9306	(6)	120°	Small

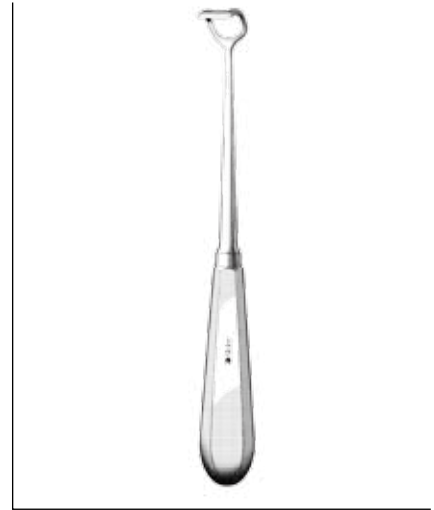

BECKMANN ADENOID CURETTES

70-9220	8½"	#1
70-9221	8½"	#2
70-9222	8½"	#3
70-9223	8½"	#4
70-9224	8½"	#5
70-9225	8½"	#6



BARNHILL ADENOID CURETTES

70-9200	8¼"	#0
70-9201	8¼"	#1
70-9202	8¼"	#2
70-9203	8¼"	#3
70-9204	8¼"	#4

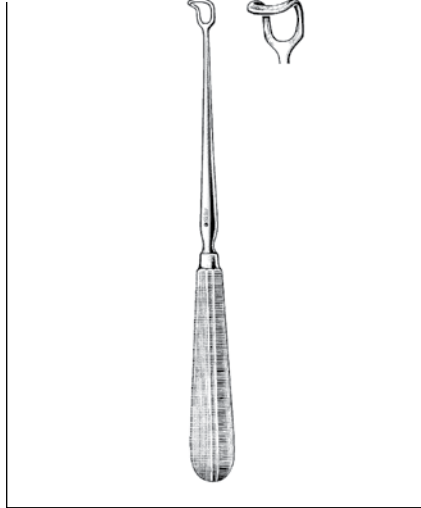

VOGEL ADENOID CURETTES

INFANT		
70-9210	8½"	Infant

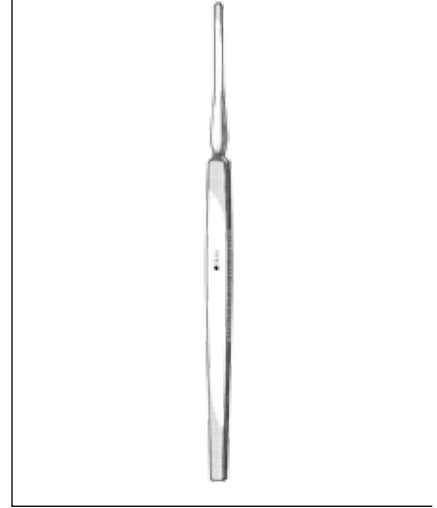

LEMPERT ELEVATORS

40-7470	6¼"	2mm
40-7472	6¼"	3mm
40-7474	6¼"	4mm
40-7476	6¼"	7mm



PIERCE ELEVATOR

DOUBLE ENDED

40-2379	8½"
---------	-----

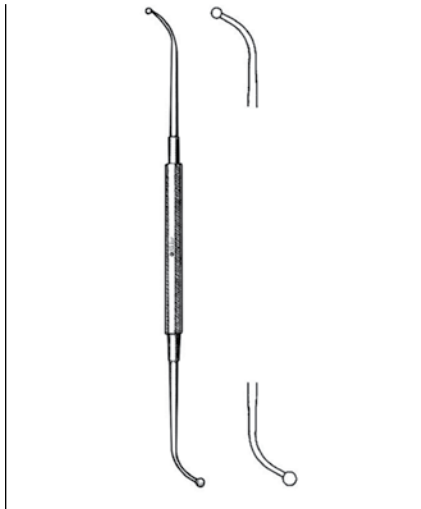

OSTIUM SEEKER BALL END ELEVATOR

DOUBLE ENDED

47-2399	7½"	2x2.5mm
---------	-----	---------

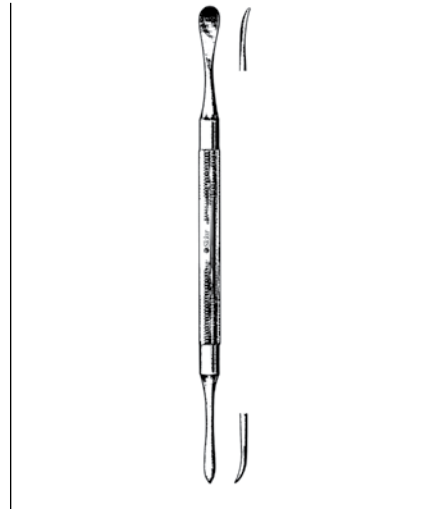

MOLT PERIOSTEAL ELEVATOR

DOUBLE ENDED

97-0530	7¼"	#9
---------	-----	----

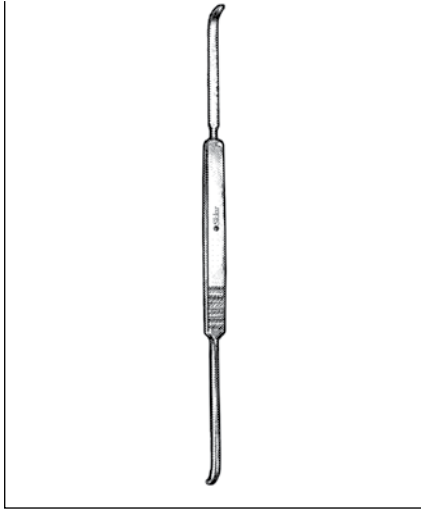

COTTLE SEPTUM ELEVATOR
DOUBLE ENDED
47-2389 9"

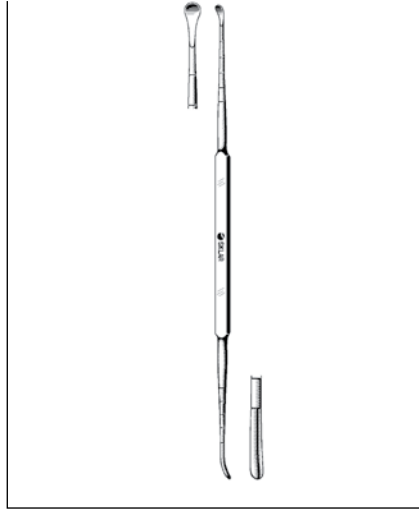

COTTLE SEPTUM ELEVATOR
DOUBLE ENDED
41-1235 9" Graduated

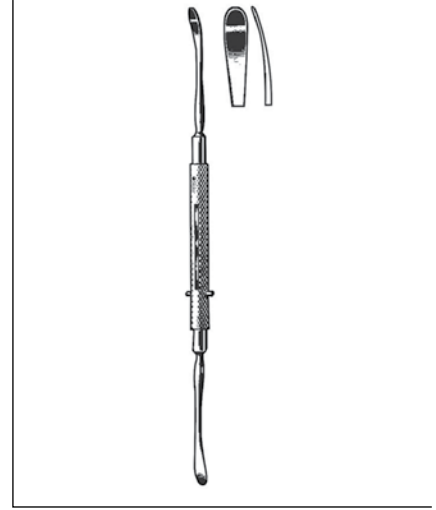

FREER SEPTUM ELEVATOR
DOUBLE ENDED
47-2380 7 1/4" Sharp/Blunt

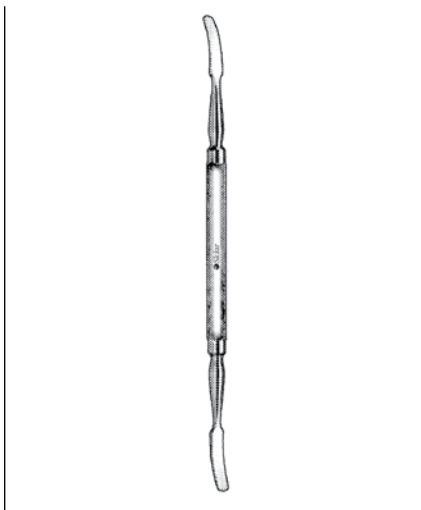

KILLIAN SEPTUM ELEVATOR
DOUBLE ENDED
40-9360 7" 4mm

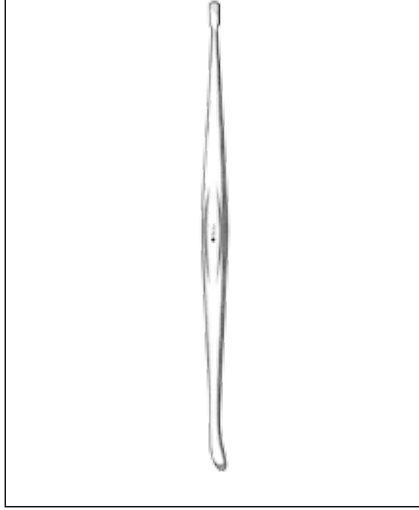

HOWARTH SEPTUM ELEVATOR
DOUBLE ENDED
40-8260 8 1/2" Sharp/Blunt

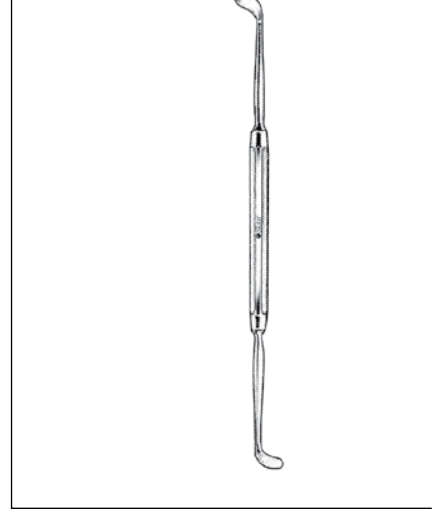

PENNINGTON SEPTUM ELEVATOR
DOUBLE ENDED
47-2372 8 1/2"

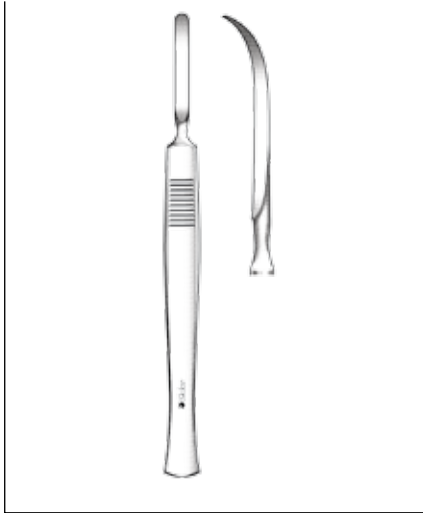

MCKENTY SEPTUM ELEVATORS

47-2385 6" 4mm
47-2388 6" 5mm

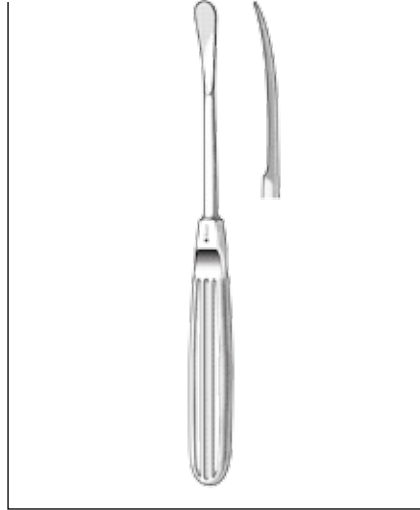

COTTLE ELEVATOR

SLIGHT CURVE
41-1250 7½", 9mm

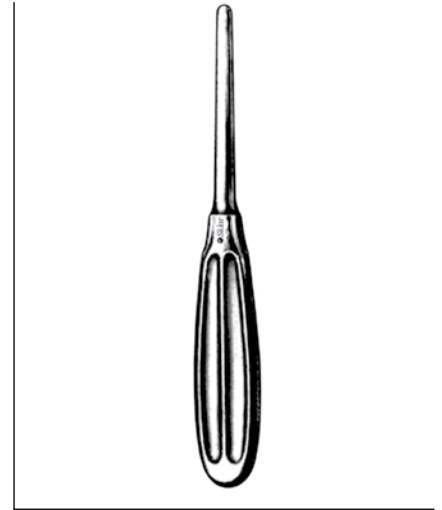

GOLDMAN SEPTUM ELEVATOR

41-1230 8¼"

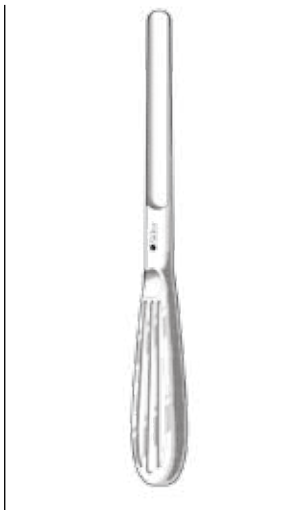

BOIES NASAL FRACTURE ELEVATOR

40-9367 7½" 9mm

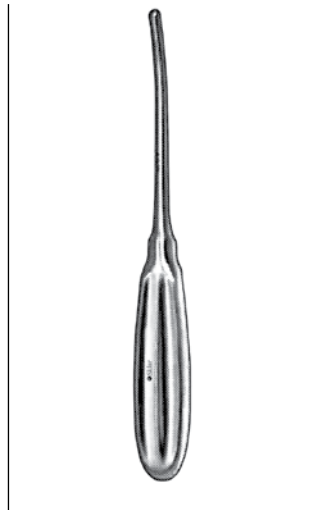

DINGMAN ZYGOMA ELEVATOR

ROUNDED BLADE
40-7615 8" 5mm



GILLIES MALAR ELEVATOR

41-1225 8"

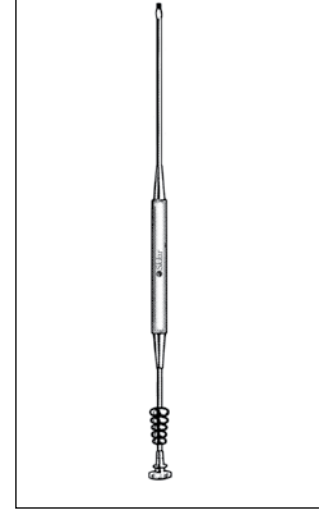

GORNEY SUCTION ELEVATOR

40-9368 8¼"

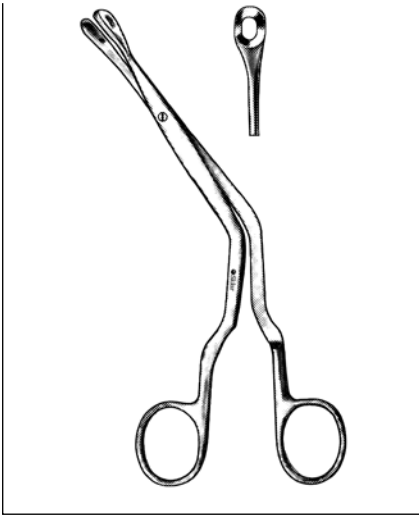

LUC NASAL CUTTING FORCEPS
OVAL, FENESTRATED JAW
 70-4276 7½" Small
 70-4277 7½" Large

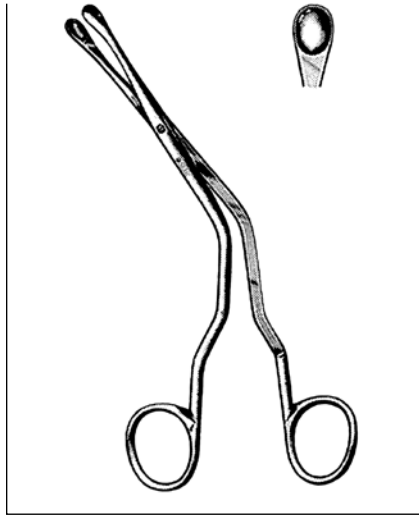

LUC NASAL CUTTING FORCEPS
SOLID CUP JAWS
 70-4280 7½" Large

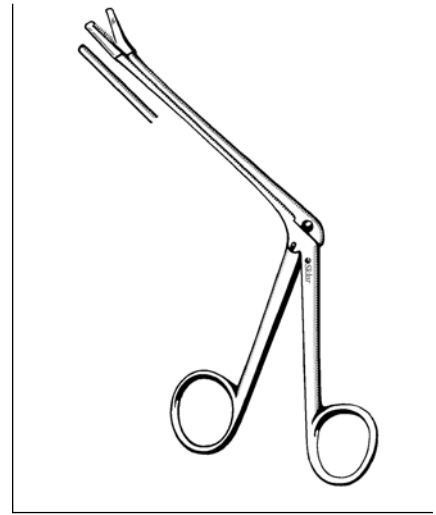

STRUYCKEN CUTTING FORCEPS
 70-5176 5" Shaft

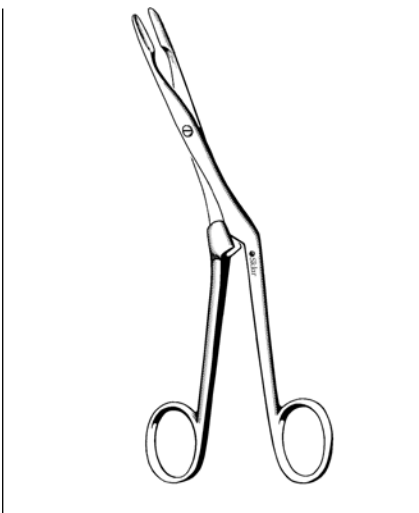

KNIGHT SEPTUM FORCEPS
 70-5170 7" Cupped Jaws

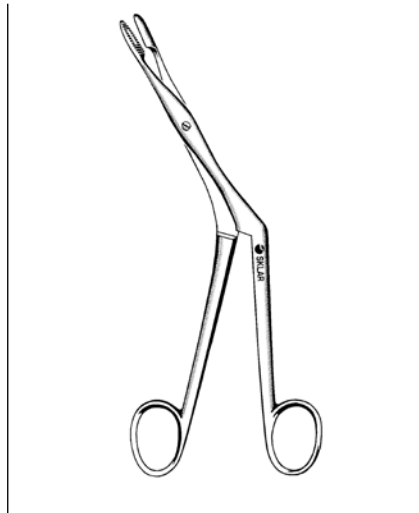

HEYMANN-KNIGHT NASAL FORCEPS
ANGLED, SERRATED
 70-4075 7"

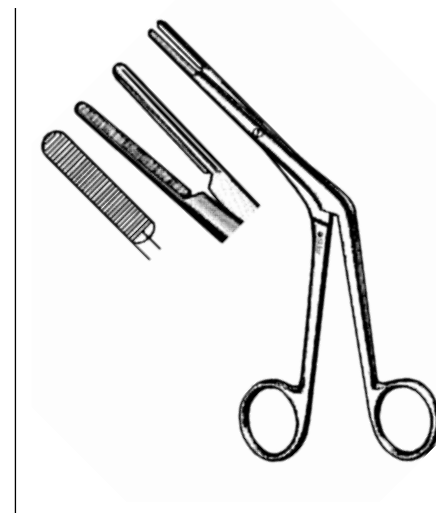

KILLIAN SEPTUM FORCEPS
SERRATED
 70-4373 6¾"

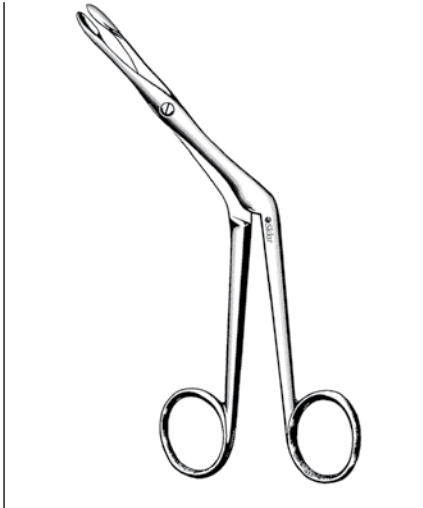

HEYMANN SEPTUM FORCEPS
70-4270 7"

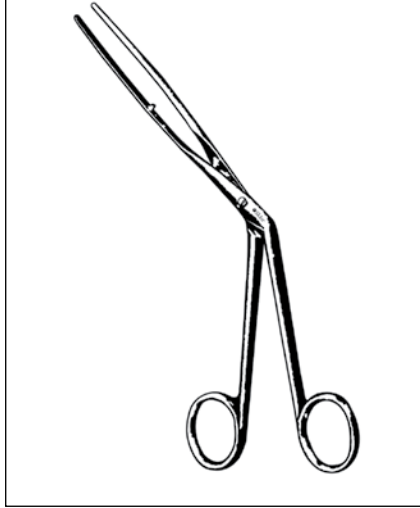

LUBET BARBON NASAL FORCEPS
70-4080 8"

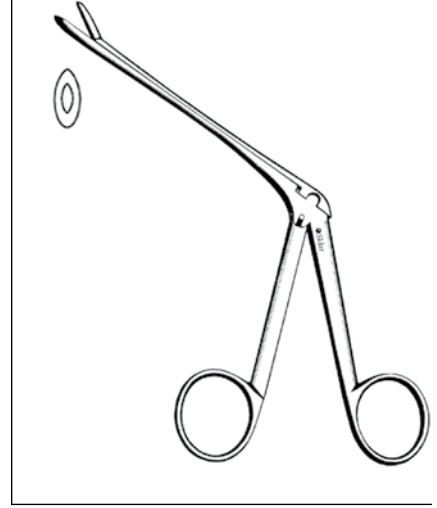

BLAKESLY NASAL FORCEP
70-5410 7½" Small

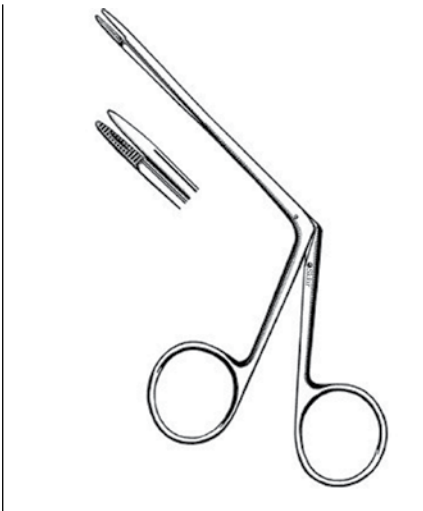

LITTAUER NASAL FORCEPS
70-4170 7"

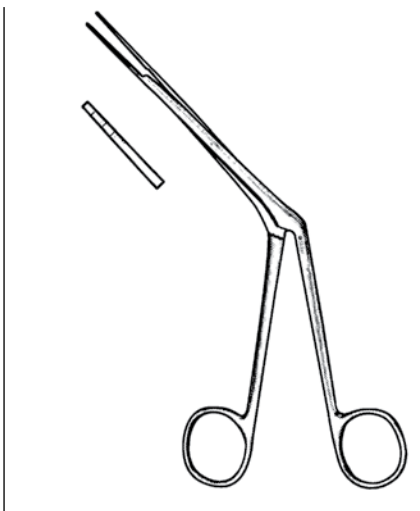

MUSEHOLDT NASAL DRESSING FORCEPS
70-4207 8" Slender Blades

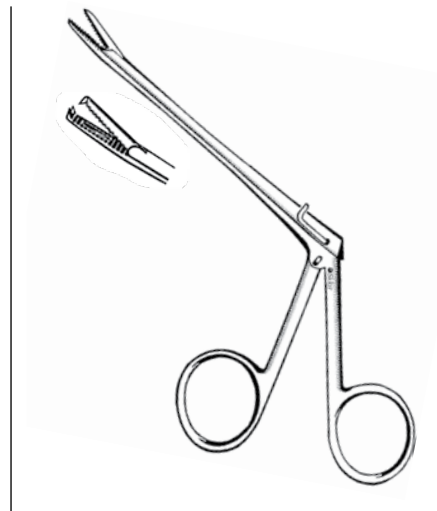

NOYES ALLIGATOR FORCEPS
70-5335 5½" Serrated
70-5235 5½" 1x2 Teeth

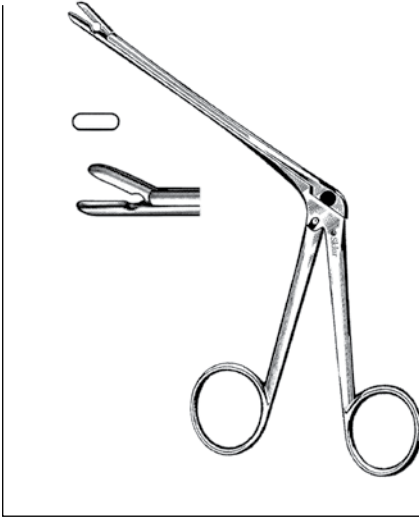

TAKAHASHI ETHMOID BONE FORCEPS

NARROW, 2x10MM

70-5090 7½" 120mm Shaft

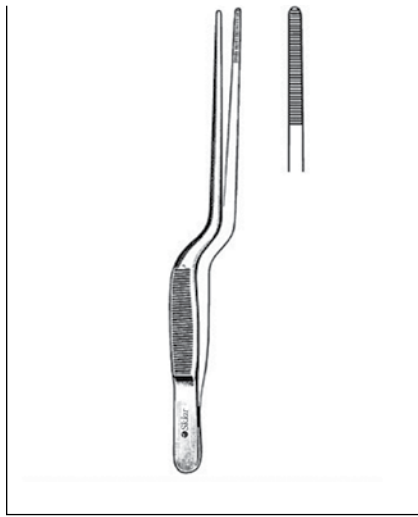

JANSEN NASAL FORCEPS

BAYONET, SERRATED TIP

67-1465 6½"
70-4375 7½"
70-4385 8½"

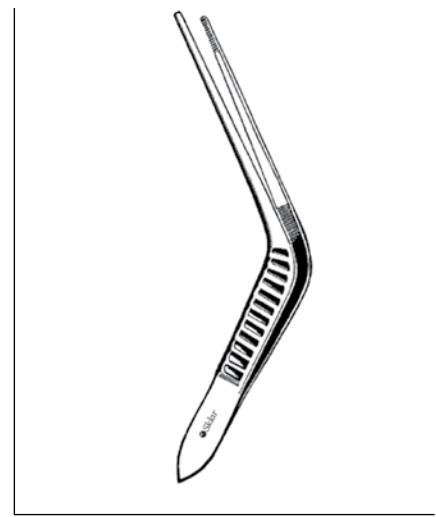

WILDE NASAL FORCEPS

ANGLED, SERRATED

70-4470 7"



TROELTSCH (WILDE) FORCEPS

ANGLED, WITH SERRATED TIPS

67-1350 5"

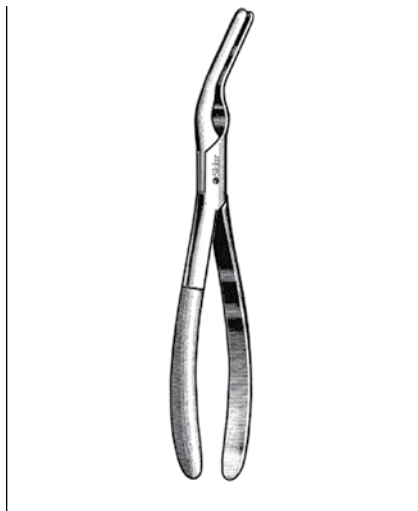

ASCH SEPTUM STRAIGHTENING FORCEPS

70-5190 9"

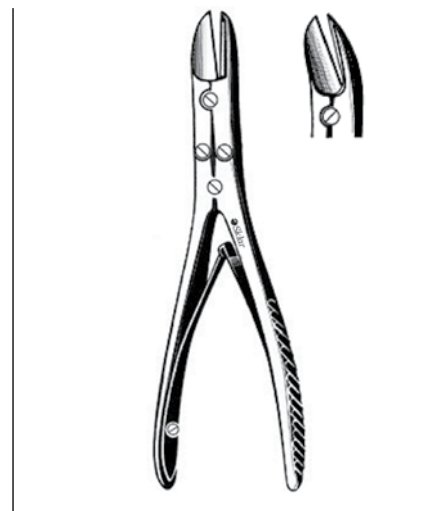

RUSKIN-LISTON BONE FORCEPS

WIDE

40-4572 7¼" Straight
40-4575 7¼" Curved

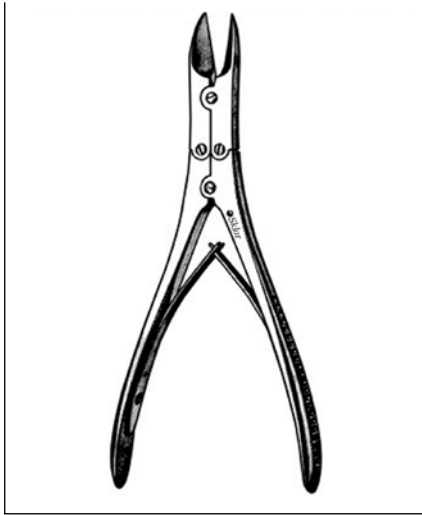

**RUSKIN-ROWLAND
BONE CUTTING FORCEPS**
DOUBLE ACTION, NARROW
41-1175 7"
41-1176 7¼" Angled on Flat

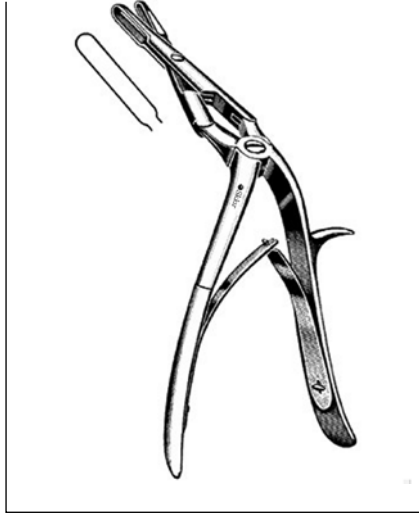

**JANSEN-MIDDLETON SEPTUM
CUTTING FORCEPS**
70-5673 7½" Double Action
70-5674 7½" Cupped Jaws

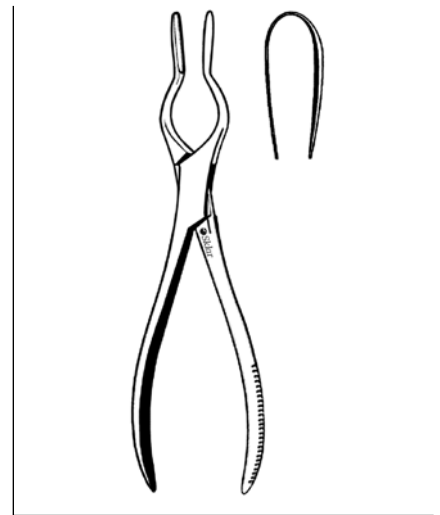

**WALSHAM SEPTUM
STRAIGHTENING FORCEPS**
70-5294 9" Right
70-5292 9" Left
70-5290 9" Straight

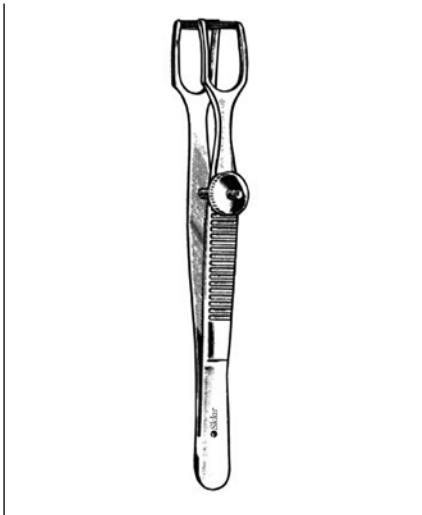

COTTLE CLUMELLA FORCEPS
66-1040 4½" 1mm Wide Jaw

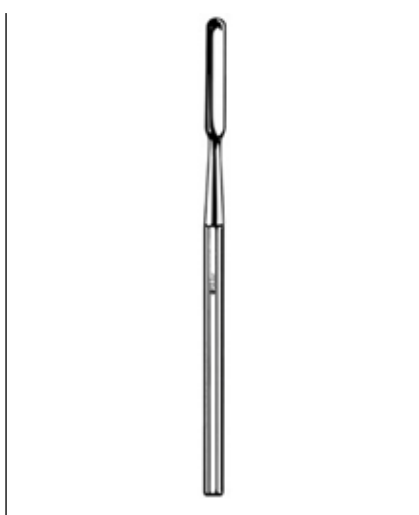

FREER SEPTUM GOUGE
STRAIGHT
41-1335 6" 6mm

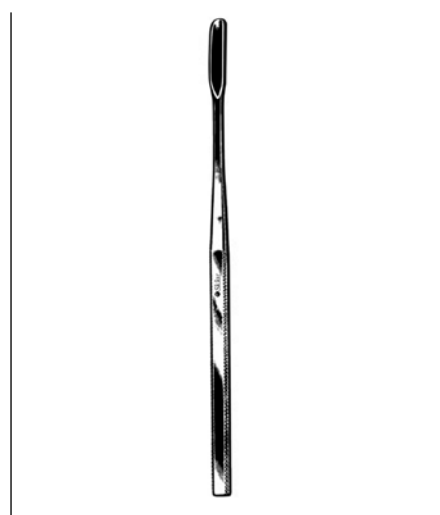

WEST BONE GOUGE
STRAIGHT
41-1338 7½" 6mm



KILLIAN-CLAUS SEPTUM GOUGE
BAYONET
 40-6821 6¾" 5mm

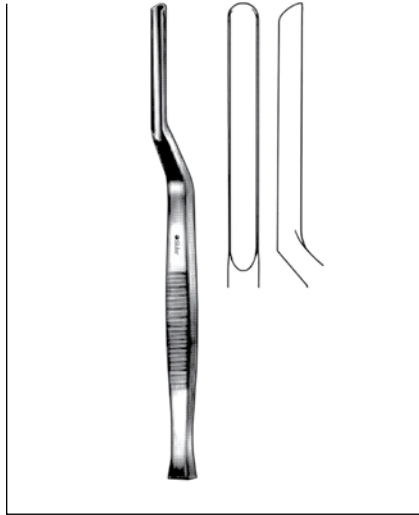

KILLIAN SEPTUM GOUGE
ROUND EDGE
 40-6820 6¾" 5mm

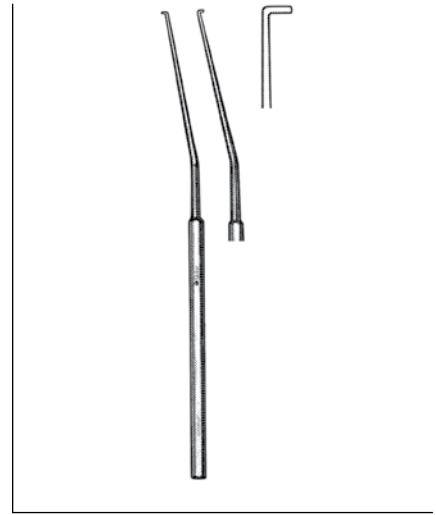

HOUSE HOOKS
ANGLED
 66-7786 Right
 66-7785 Left

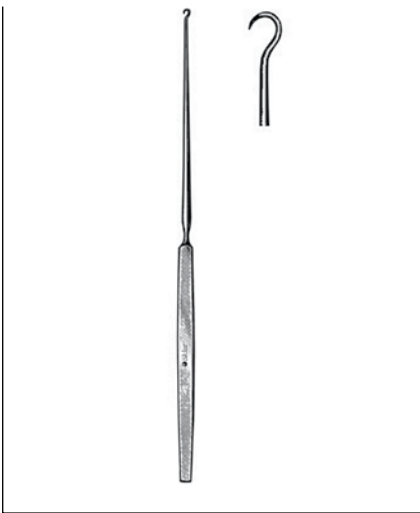

GILLIES SKIN HOOKS
 47-2570 7" 3mm
 47-2572 7" 4mm

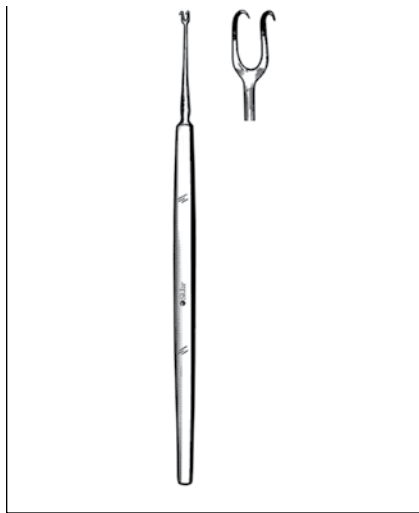

FREER HOOK
 47-2760 6" Sharp 2.5mm
 47-2758 6" Blunt 2.5mm

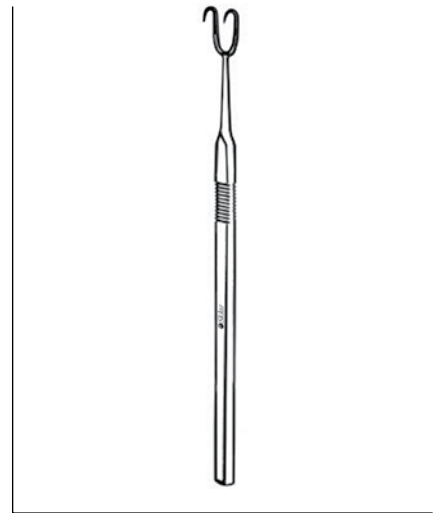

COTTLE DOUBLE HOOK
 47-2646 5½" 12mm

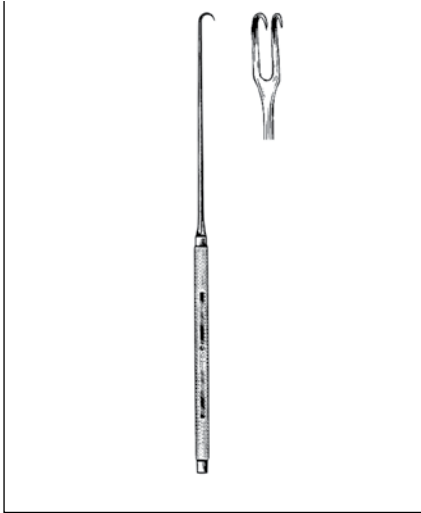

JOSEPH MUCOUS HOOKS

1 PRONG

47-2500 6¼"

2 PRONGS

47-2502 6¼" 2mm

47-2505 6¼" 5mm

47-2507 6¼" 7mm

47-2510 6¼" 10mm

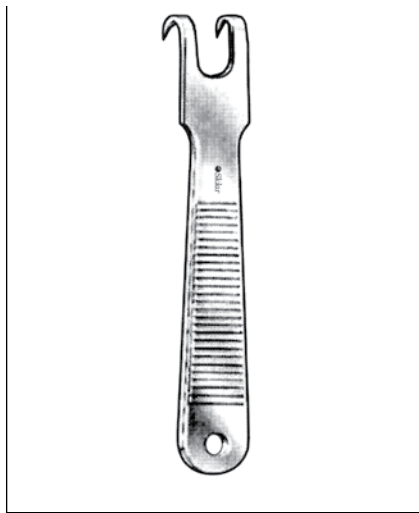

KILNER HOOK

47-2520 3¼" Sharp

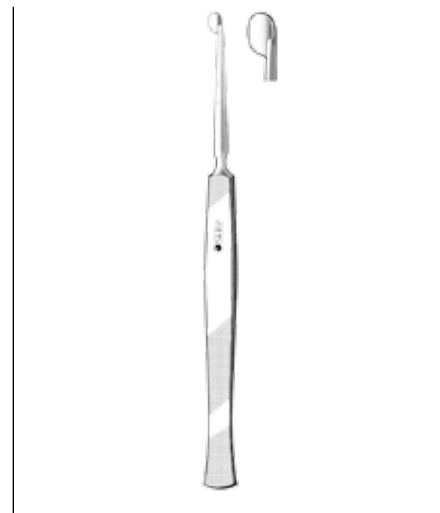

FREER SEPTUM KNIFE

70-7062 6¼"

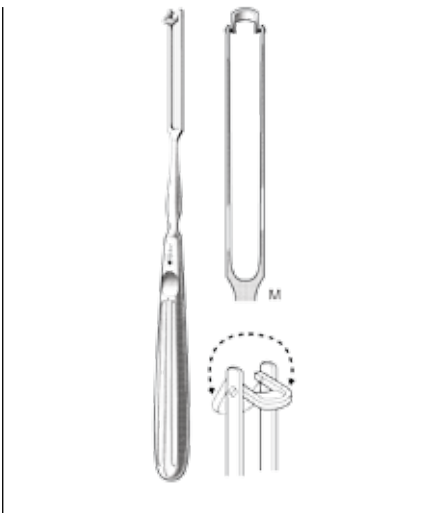

BALLENGER SEPTUM SWIVEL KNIVES

70-7503 8" 3mm

70-7504 8" 4mm

70-7505 8" 5mm



FOMON KNIFE

DOUBLE EDGE

41-1318 6½"

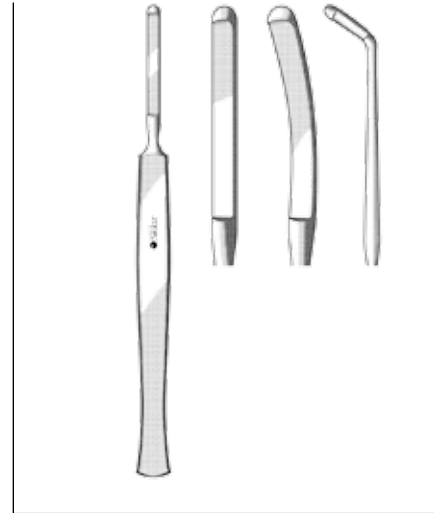

JOSEPH BUTTON END KNIVES

41-1300 6" Straight

41-1305 6" Angled



GERZOG MALLET
40-5765 7½" 14oz

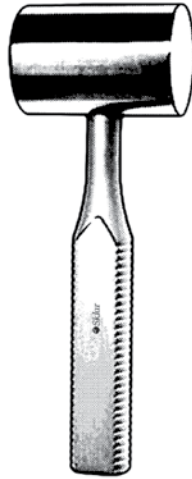

HEATH MALLET
40-5684 7½" 11lb 15oz



COTTLE MALLET
40-5678 7¼" 12oz

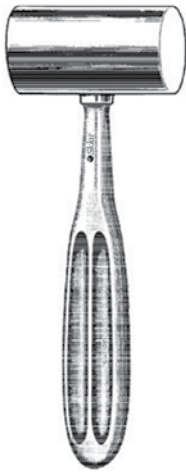

KIRK MALLET
40-5672 8" 26oz

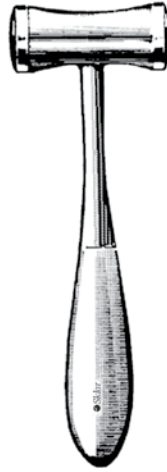

LUCAE MALLET
40-5874 7½" 7oz



MICHEL RHINOSCOPIC MIRRORS

COMPLETE		
73-1371	9¾"	12mm
73-1372	9¾"	14mm
73-1373	9¾"	16mm
73-1374	9¾"	18mm
MIRROR ONLY		
73-1375	9¾"	12mm
73-1376	9¾"	14mm
73-1377	9¾"	16mm
73-1378	9¾"	18mm

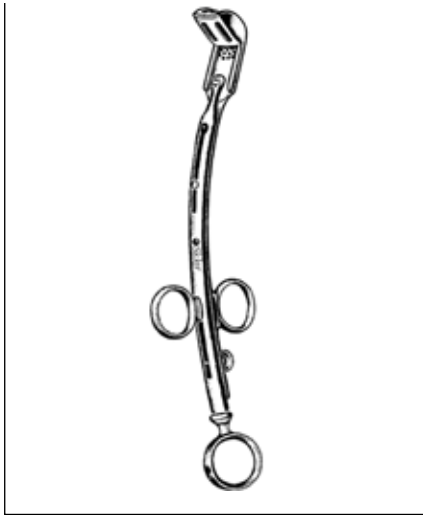

LA FORCE ADENOTOMES

70-9001 10" #1
 70-9002 10" #2
 70-9003 10" #3

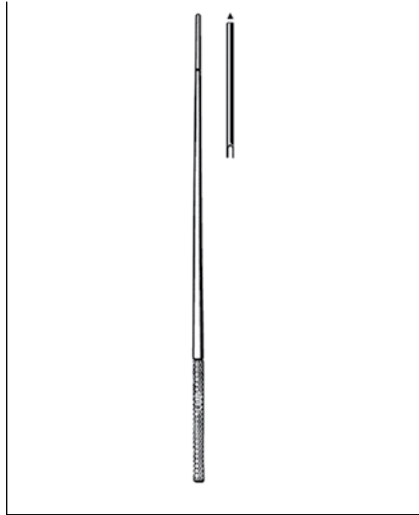

FARRELL APPLICATORS

68-1865 6½" Triangle End
 68-1765 6½" Twist End

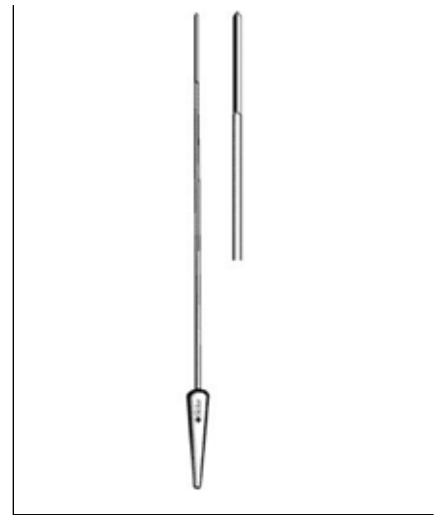

BROWN APPLICATOR

68-1257 5¾" Triangle End

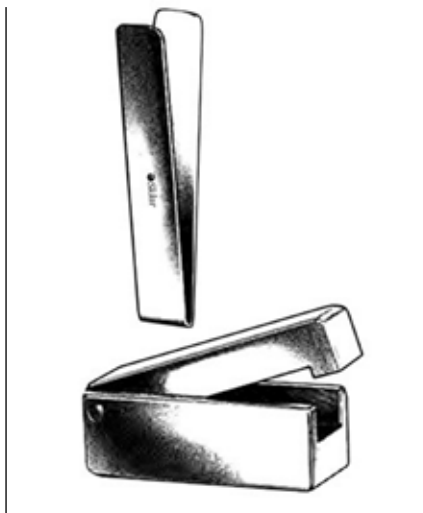

COTTLE CARTILAGE CRUSHER

40-5990 2½"

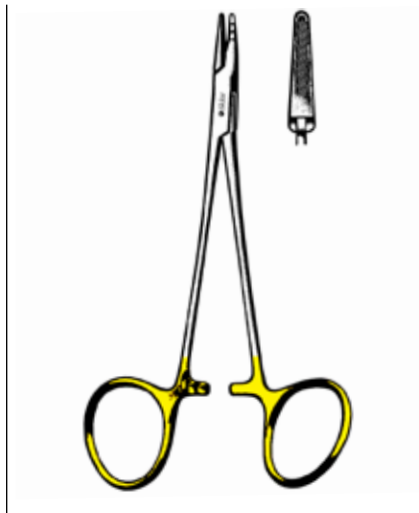

TC NEIVERT NEEDLE HOLDER

21-8086 5" Serrated



NEIVERT NEEDLE HOLDER

20-1760 5" Smooth with Groove

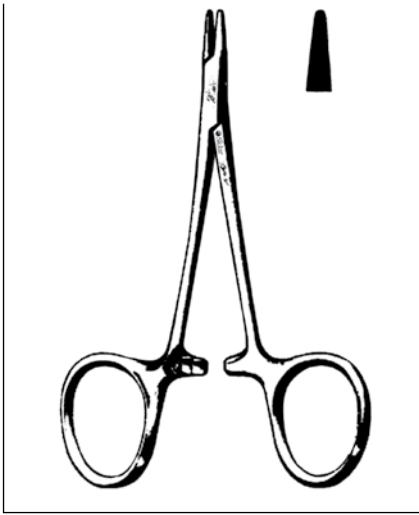

CONVERSE NEEDLE HOLDER
LONGITUDINALLY SERRATED
20-3350 5"

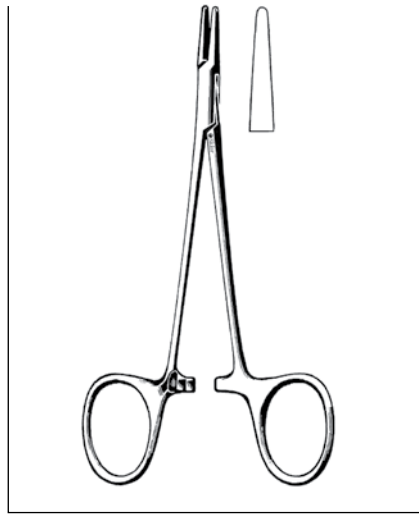

WEBSTER NEEDLE HOLDER
SMOOTH JAWS
20-1350 5¼"

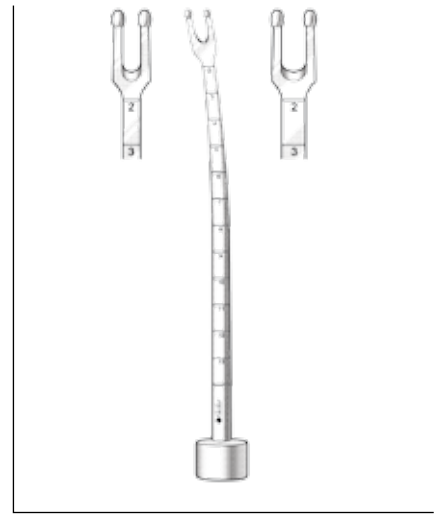

**OBWEGESER NASAL SEPTUM
OSTEOTOMES**
40-6475 7¼" 4mm
40-6476 7¼" 4mm
40-6477 7¼" 4mm



REES NASAL OSTEOTOME
40-6660 8" Blue Handle, 3mm

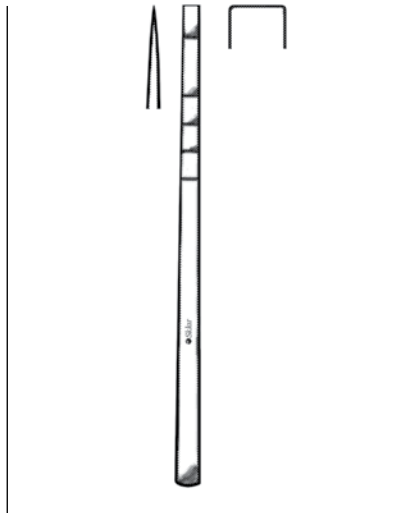

COTTLE OSTEOTOMES
GRADUATED
41-1284 7" 4mm
41-1287 7" 7mm
41-1289 7" 9mm
41-1292 7" 12mm

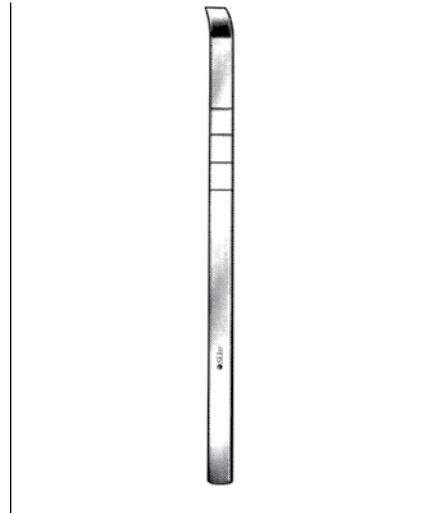

COTTLE OSTEOTOME
41-1511 7" 6mm, Curved

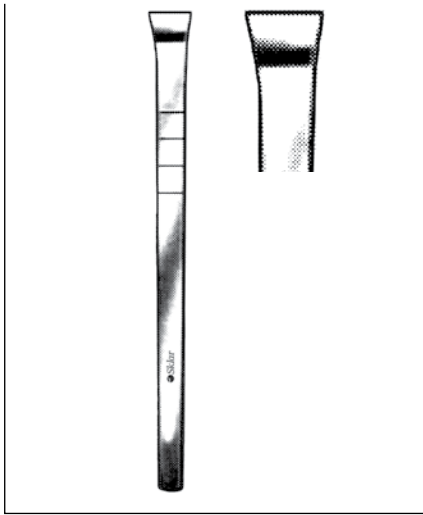

COTTLE OSTEOOTOME
FISHTAIL TIP WITH DEPTH MARKINGS
 41-1515 7" 16mm

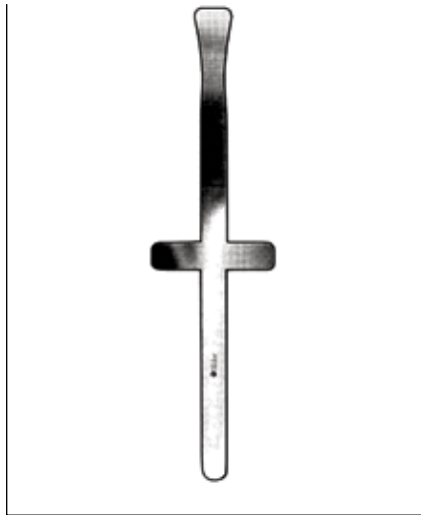

COTTLE CROSSBAR
OSTEOOTOMES
WITH DEPTH MARKINGS

41-1501	7¼"	4mm
41-1502	7¼"	7mm
41-1503	7¼"	9mm
41-1504	7¼"	12mm
41-1505	7¼"	18mm

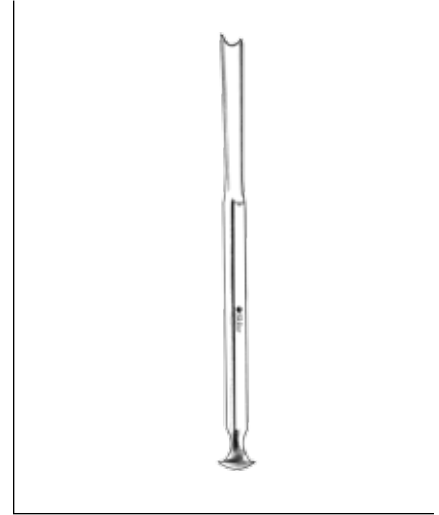

COTTLE OSTEOOTOME
CROSSBAR HANDLE
 41-1510 7" 6mm

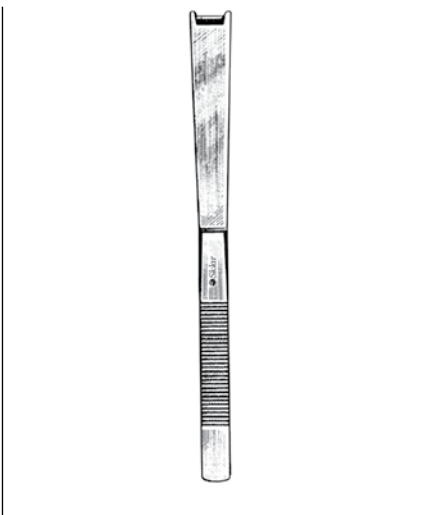

CINELLI OSTEOOTOMES
GUARDED ON BOTH SIDES

41-1370	6¼"	10mm
41-1372	6¼"	12mm
41-1374	6¼"	14mm
41-1376	6¼"	16mm

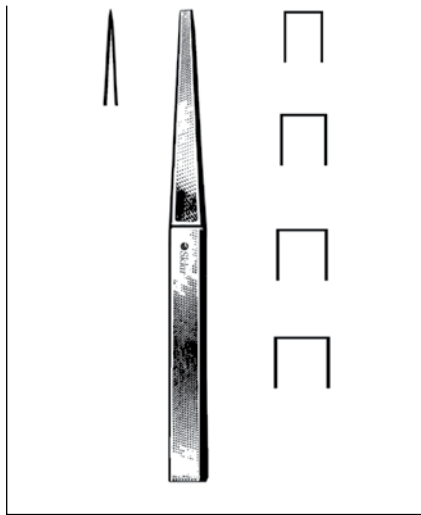

CONVERSE OSTEOOTOMES
STRAIGHT

40-6412	7"	2mm
40-6414	7"	4mm
40-6416	7"	6mm
40-6418	7"	8mm
40-6420	7"	10mm
40-6422	7"	12mm
40-6424	7"	14mm

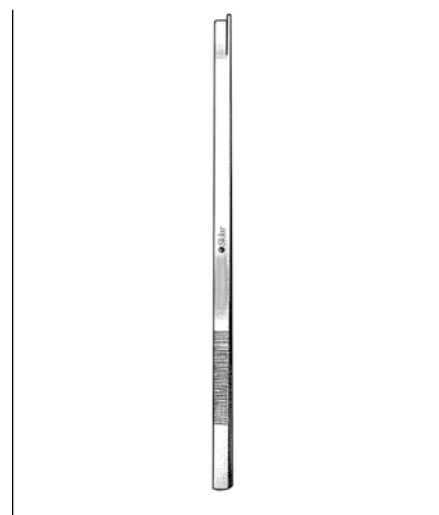

ANDERSON-NEIVERT
OSTEOOTOMES
GUARDED

40-5962	8"	Straight, 7mm
40-5961	8"	Curved Left, 7mm
40-5960	8"	Curved Right, 7mm

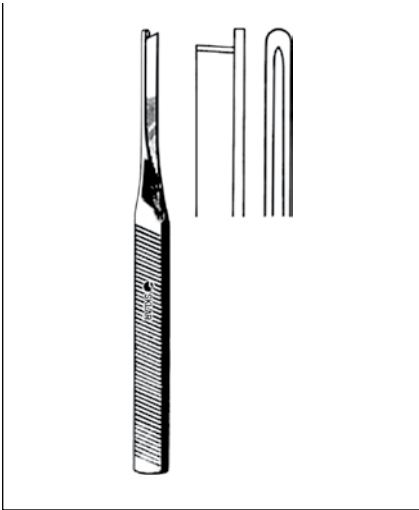

PARKES OSTEOTOME

GUARDED
40-6515 7" 6.5mm

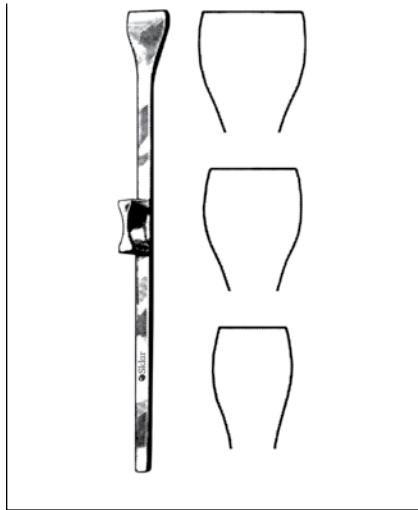

RUBIN OSTEOTOMES

WITH STABILIZER
40-6370 7¼" 10mm
40-6371 7¼" 12mm
40-6372 7¼" 14mm

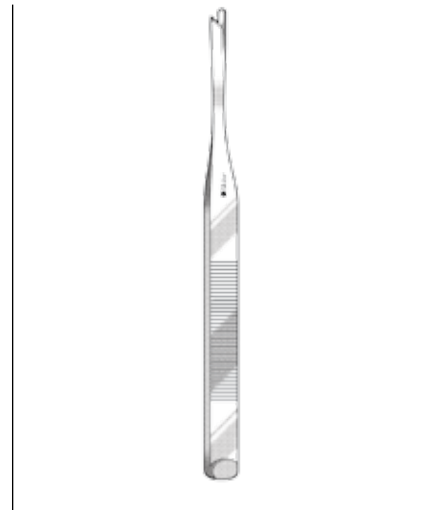

TESSIER NASAL OSTEOTOME

RIGHT GUARDED
40-7527 7¼" Straight

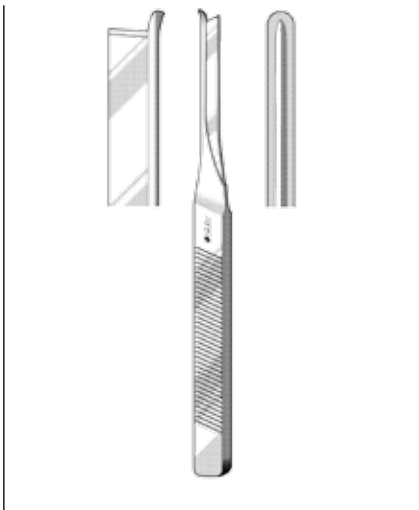

SILVER OSTEOTOMES

41-1350 7" 5mm, Straight
41-1360 7" 5mm, Left
41-1355 7" 5mm, Right

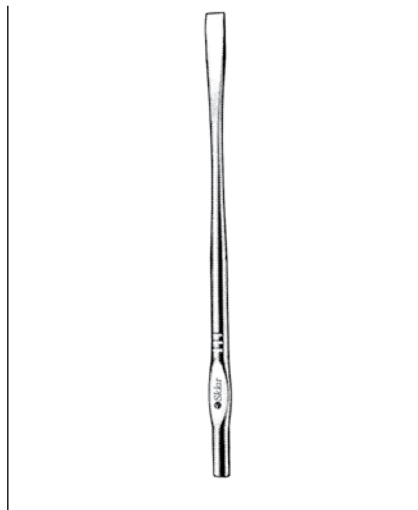

WALTER OSTEOTOME

40-7540 7½" 3mm
40-7541 7½" 4mm
40-7542 7½" 7mm
40-7543 7½" 9mm
40-7544 7½" 12mm

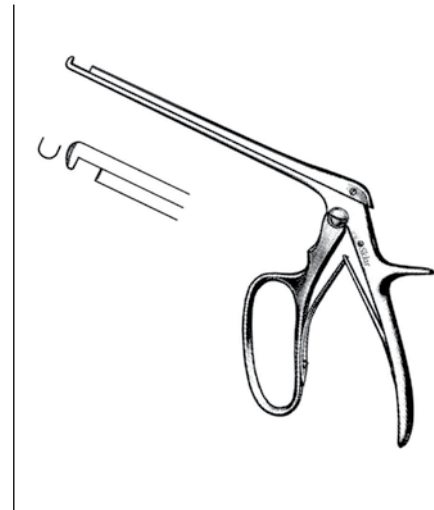

FERRIS-SMITH-KERRISON PUNCHES

3X3MM
65-7426 7" Upwards
65-7427 7" Downwards
5X5MM
65-7428 7" Upwards
65-7429 7" Downwards

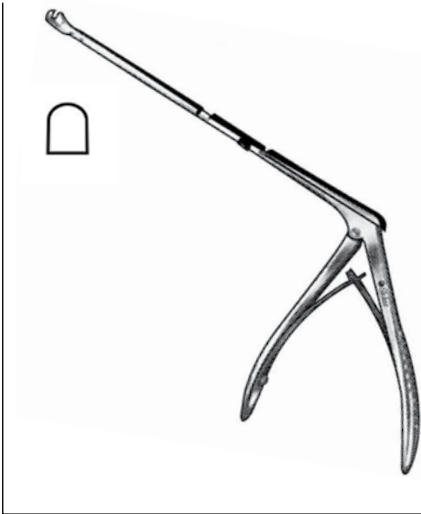

HAJEK-KOFLER SPHENOID PUNCHES

65-7414	5½"	Backwards
65-7416	5½"	Downwards
65-7417	5½"	Upwards
65-7418	5½"	Downwards

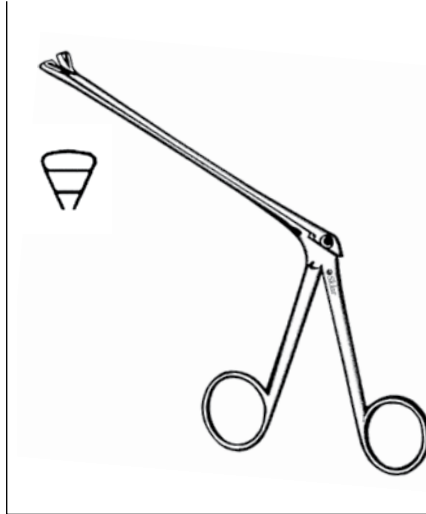

SCHMEDEN (MELTZER) ADENOID PUNCHES

TRIANGULAR		
75-9601	5½"	#1
75-9602	5½"	#2
75-9603	5½"	#3

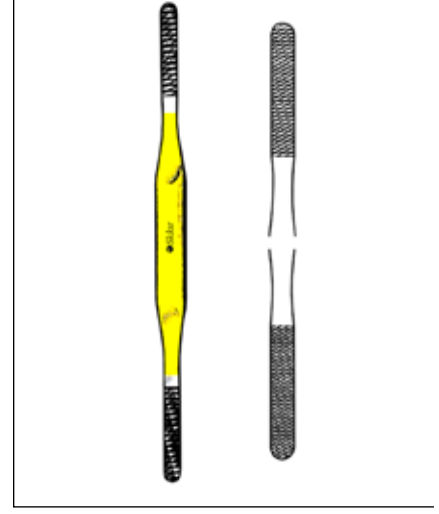

TC FOMON NASAL RASPS

DOUBLE END		
97-1510	8"	#1/#2
97-1511	8"	#3/#4
97-1512	8"	#5/#6
97-1513	8"	#7/#8
97-1514	8"	#9/#10



PEET (COTTLE) NASAL RASPS

DIAMOND COATED		
97-1520	7½"	Straight
97-1521	7½"	Curved

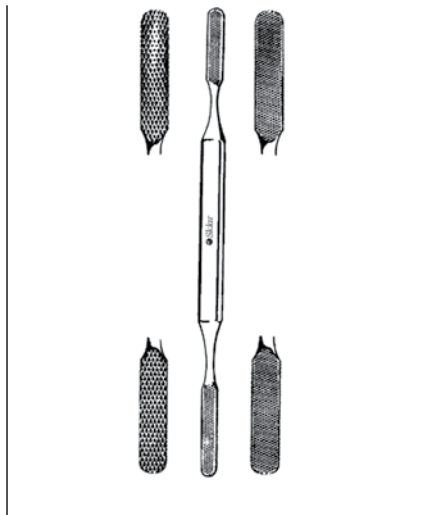

FOMON NASAL RASPS

DIAMOND COATED		
40-9692	8¼"	Two Sides, Fine
40-9688	8¼"	Four Sides, Fine Coarse

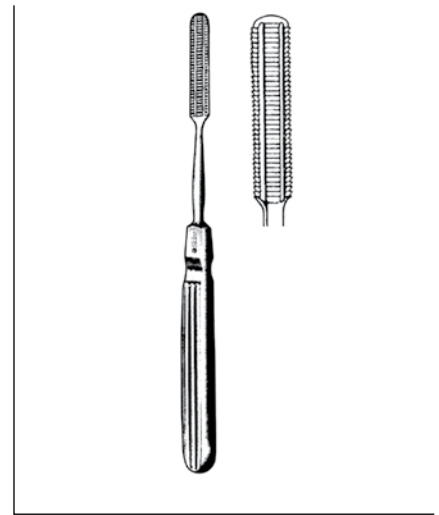

MALTZ NASAL RASP

40-9815	7"	Backward Cutting
---------	----	------------------

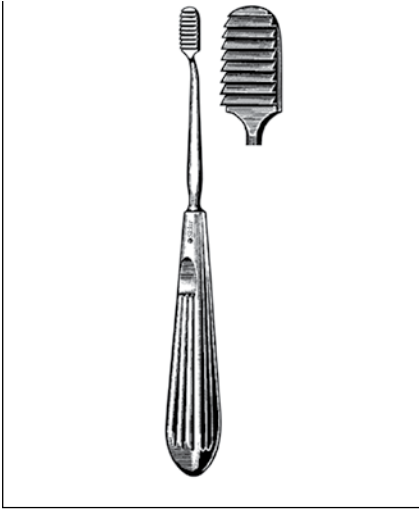

LEWIS NASAL RASPS

DIAMOND COATED

- 70-2292 7" Fine
- 70-2293 7" Course

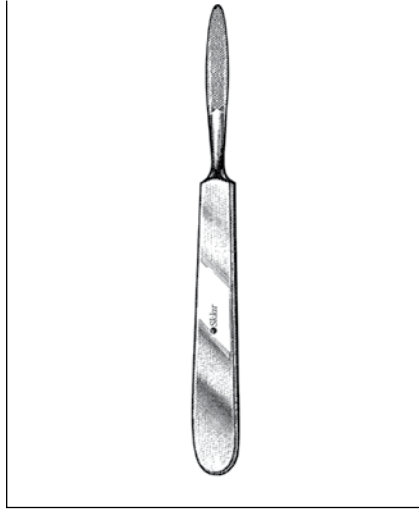

JOSEPH NASAL RASP

- 40-9825 6¼" Cross Serrated

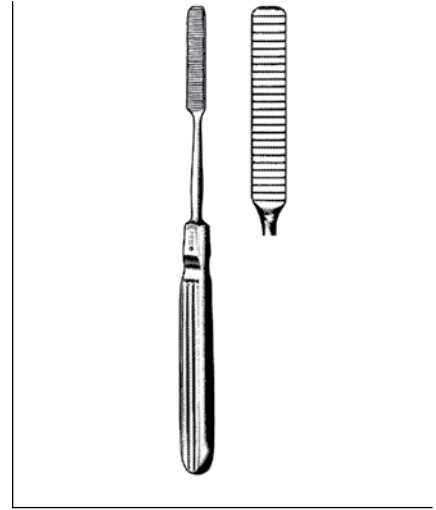

COTTLE NASAL RASP

- 40-9820 8" Backward Cutting

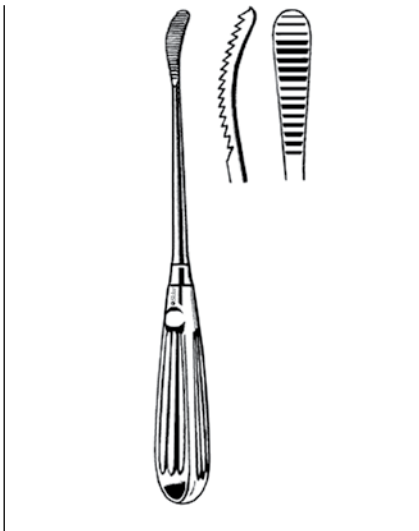

AUFRICHT GLABELLAR RASPS

- 40-9841 8" Backward Cutting
- 40-9840 8" Forward Cutting

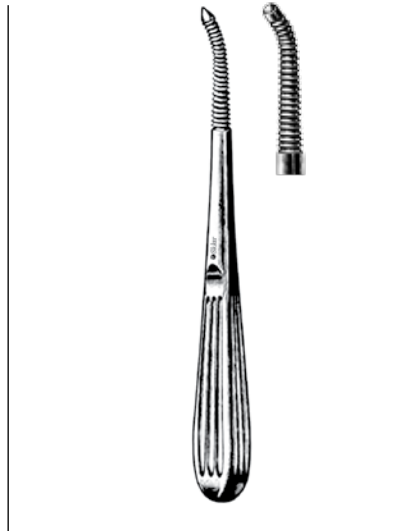

WIENER ANTRUM RASPS

- 70-2280 7" Round Tip
- 70-2281 7" Round Tip

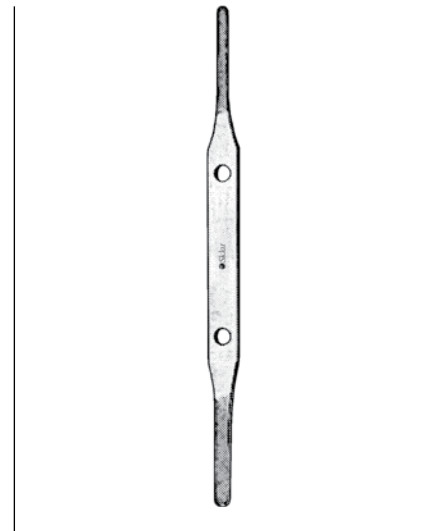

MASING NASAL FILE

- 40-9680 8½" Fine
- 40-9681 8½" Coarse

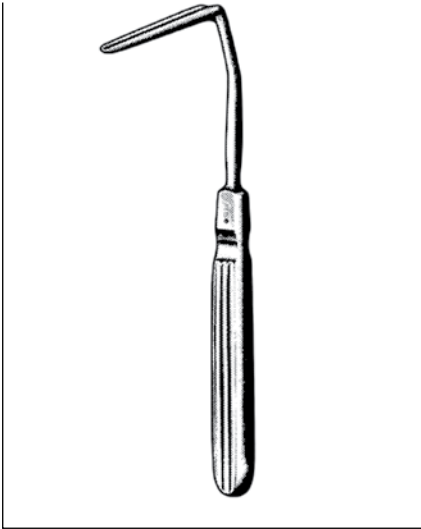

AUFRICHT NASAL RETRACTOR

41-1410 6¼" Solid Blade

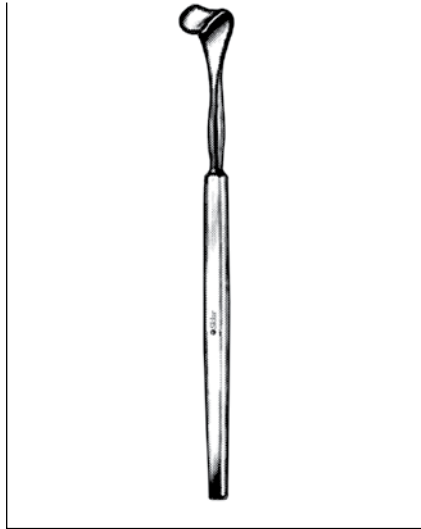

COTTLE NASAL RETRACTOR

41-1408 6" 10x12mm

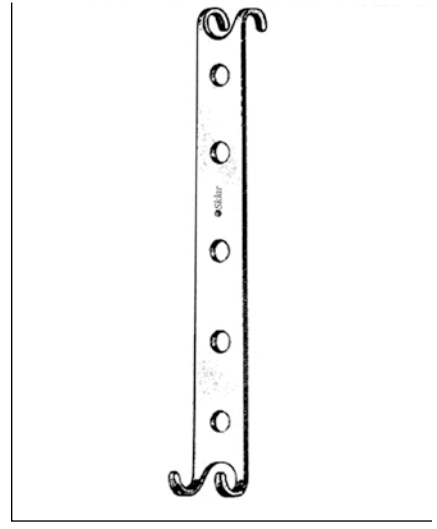

CONVERSE ALAR RETRACTOR

41-1398 4½" Double End

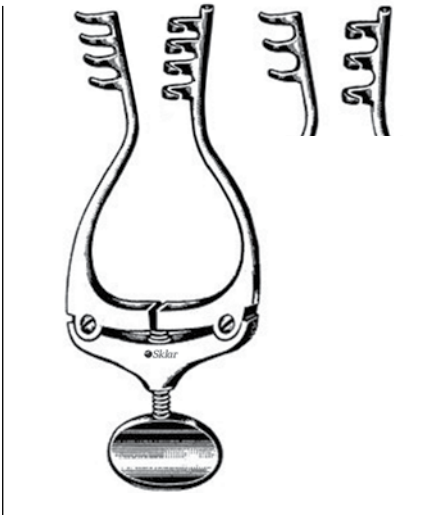

JANSEN RETRACTORS

47-2838 4½" 4x4 Sharp Prongs
 47-2836 4½" 4x4 Blunt Prongs
 47-2834 4½" 3x3 Sharp Prongs
 47-2832 4½" 3x3 Blunt Prongs

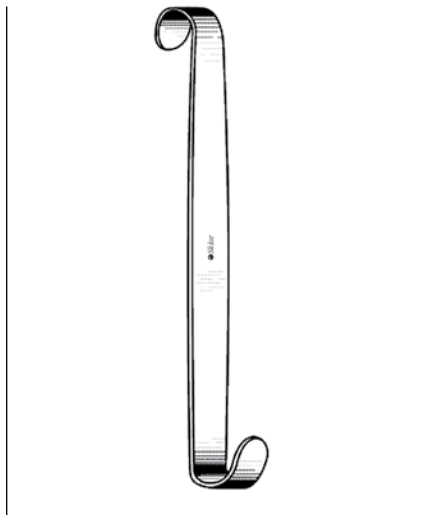

LUER RETRACTOR

22-8565 5½" Double End

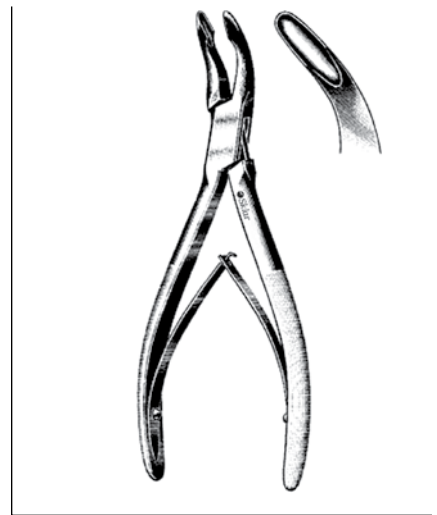

DEAN BONE RONGUER

47-2455 5½" Curved



LEMPERT RONGUERS

- 47-2467 6¼" Straight
- 47-2468 6¼" Curved
- 47-2465 7½" Straight
- 47-2466 7½" Curved

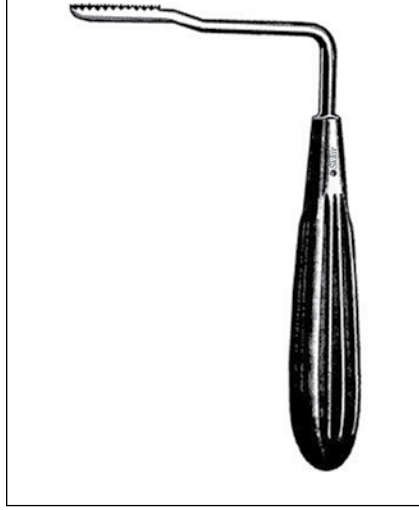

JOSEPH NASAL SAWS

- 70-7822 Angled Left
- 70-7821 Angled Right

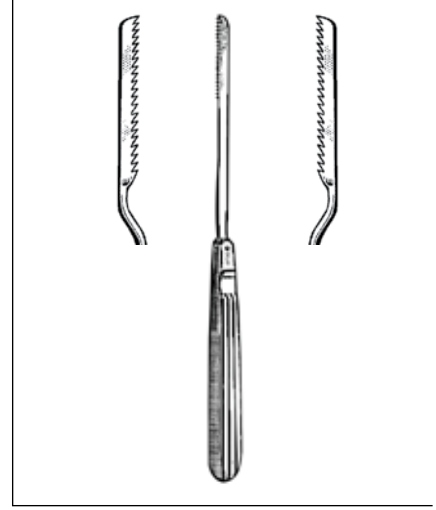

JOSEPH NASAL SAWS

- 70-7805 7½" Straight
- 70-7802 7½" Left
- 70-7801 7½" Right

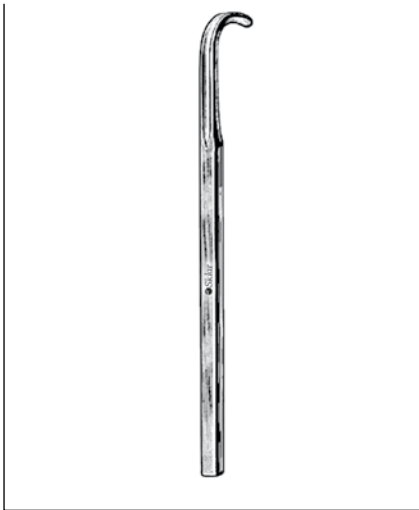

JOSEPH SAW GUIDE

- 41-1320 4mm

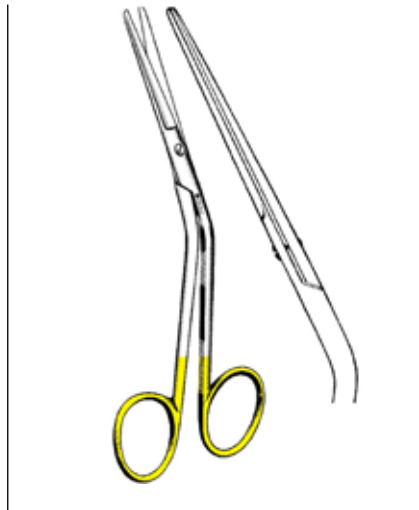

TC FOMON DORSAL SCISSORS

- 16-3632 5½" Angled

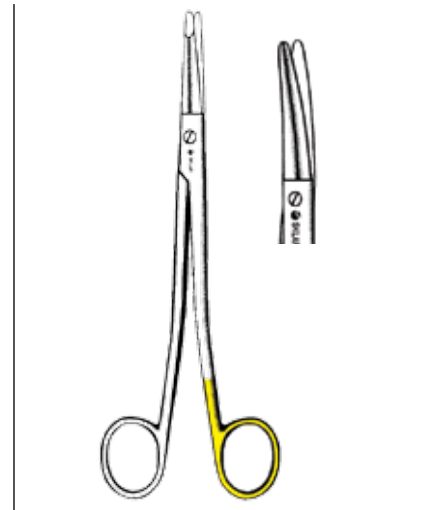

SKLARCUT™ GORNEY FACE LIFT SCISSORS

SEMI-SHARP OUTER EDGES

- 15-3583 7½" Straight Flat Tapered Tip
- 15-3584 7½" Curved Flat Tapered Tip
- 15-3577 7¼" Straight Bevelled Blades
- 15-3578 7¼" Curved Bevelled Blades

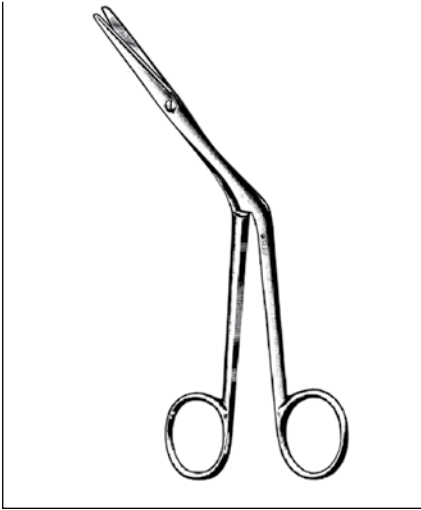

HEYMANN NASAL SCISSORS
70-4268 7"

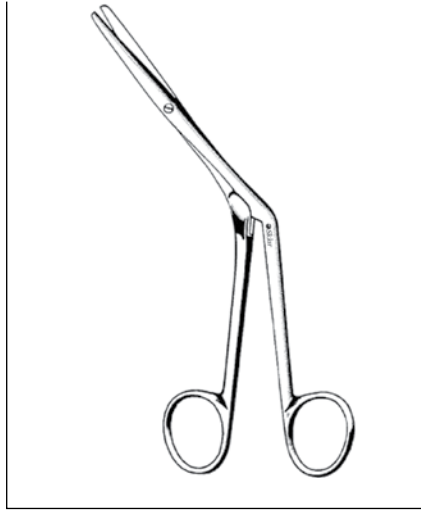

KNIGHT NASAL SCISSORS
70-4262 6¼"



COTTLE NASAL SCISSORS
41-1168 4½" Curved

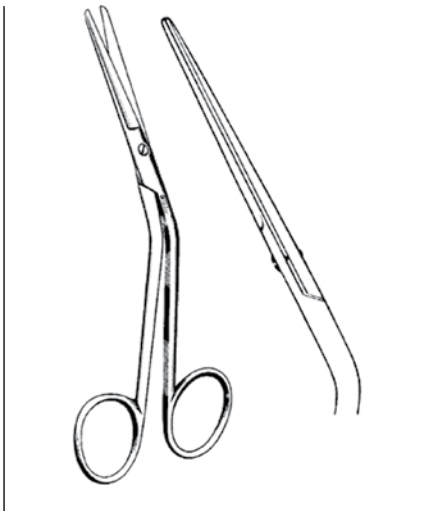

FOMON DORSAL SCISSORS
70-4350 5½" Angled

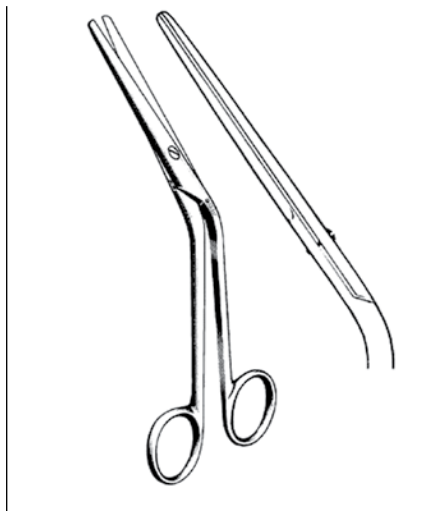

COTTLE DORSAL SCISSORS
41-1169 6" Angled

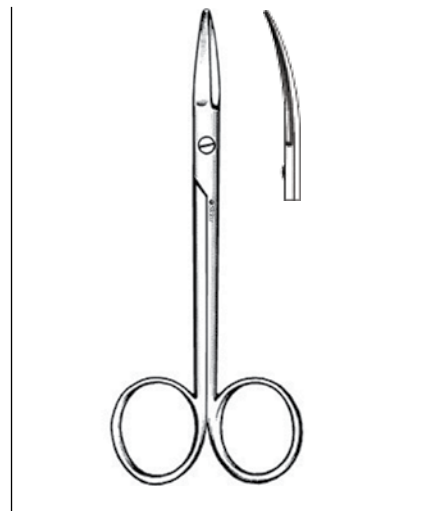

JOSEPH SCISSORS
DOUBLE EDGE
41-1058 5¾" Straight
41-1060 5¾" Curved

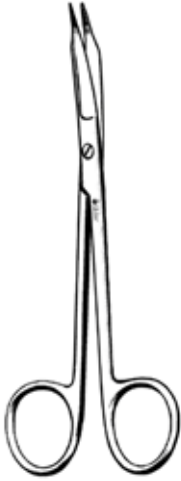

MARTIN SCISSORS
41-1120 8" Heavy Serrated, Curved



LITTLER SUTURE CARRYING SCISSORS
22-2645 4½" Curved

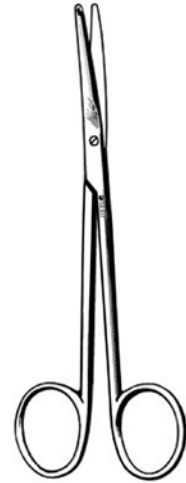

METZENBAUM-LAHEY DISSECTING SCISSORS
47-1360 5¾" Curved



SELLER TURBINATE SCISSORS
41-1165 6¼" Angled

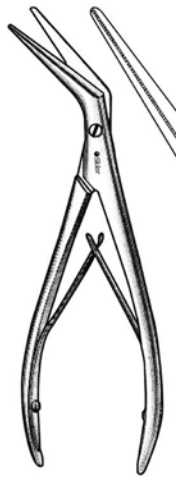

JACKSON NASAL BONE SCISSORS
41-1143 7¾"



CAPLAN NASAL SEPTUM SCISSORS
41-1145 7½" Serrated

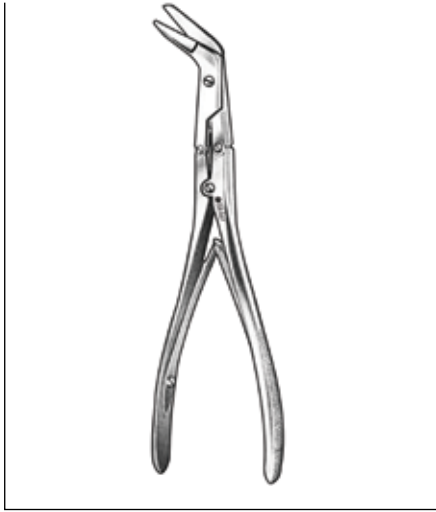

KILLIAN SEPTUM SCISSORS
70-4267 8" Serrated

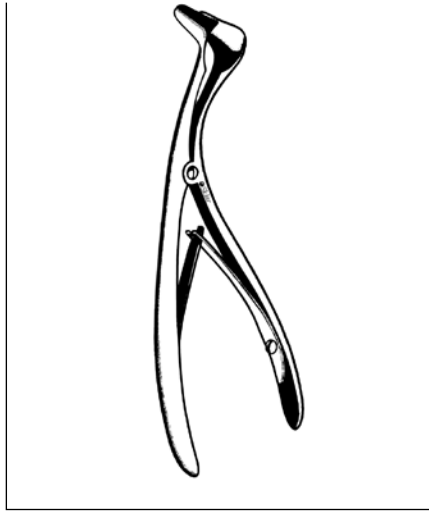

BECKMAN NASAL SPECULUM
70-1092 5¾"
70-1091 5" Pediatric



**KILLIAN NASAL SPECULUM
WITHOUT SET SCREW**
70-1063 1¼"
70-1064 2"
70-1065 2½"
70-1066 3"
70-1067 3½"

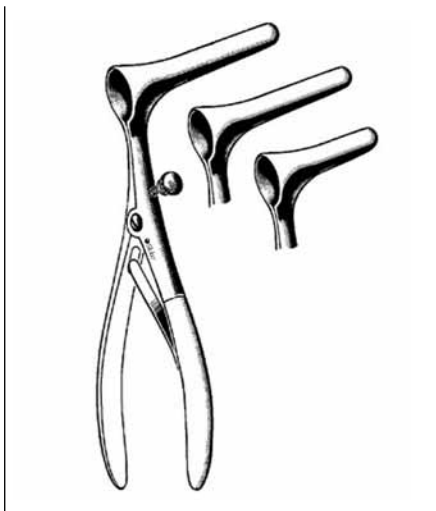

**KILLIAN NASAL SPECULUM
WITH SET SCREW**
70-1020 2" 35mm
70-1030 3" 50mm
70-1035 3½" 35mm

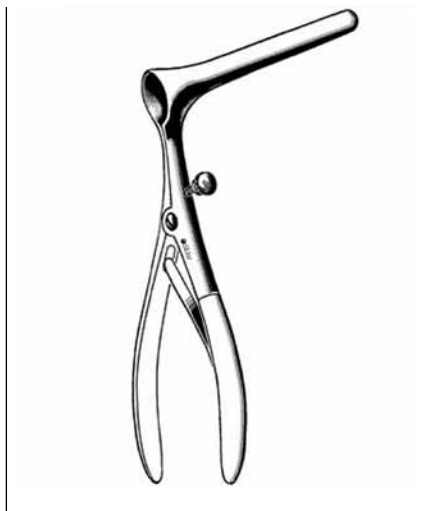

**COTTLE NASAL SPECULUM
WITH SCREW**
41-1190 1½"
41-1192 2"
41-1194 2½"
41-1196 3"

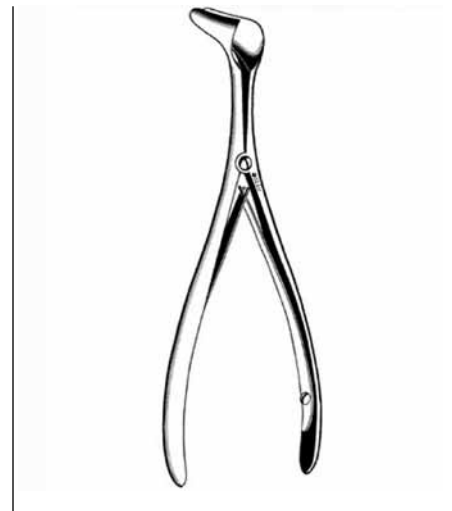

**SONNENSCHN NASAL
SPECULUM**
70-1096 6"



VIENNA NASAL SPECULA

70-1070	5½"	Pediatric
70-1071	5½"	Medium
70-1072	5½"	Large

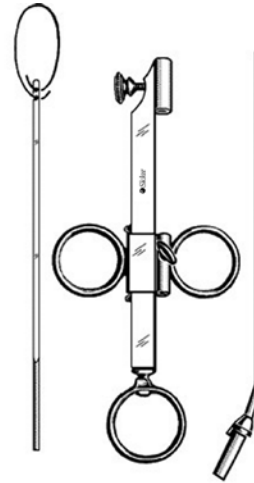

KRAUSE-VOSS NASAL SNARE

70-6165	With Wires
---------	------------

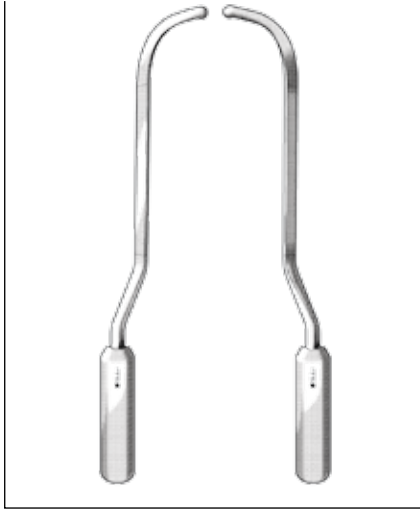

AGRIS-DIGNMAN BREAST DISSECTORS

14¼"
 40-7634 Right
 40-7636 Left



SPATULA BREAST DISSECTORS

40-7650 13"
 40-7651 16½"
 40-7652 13" Malleable
 40-7653 16½" Malleable



SILVERSTEIN BREAST DISSECTOR

40-7628 14"

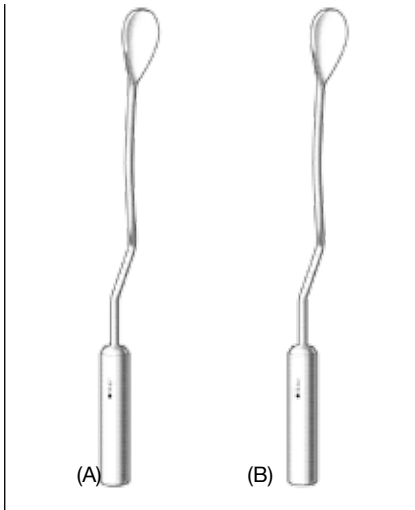

McCULLUM-DINGMAN DISSECTORS

40-7624 11¾" (A) Submammary
 40-7625 16" (B) Breast

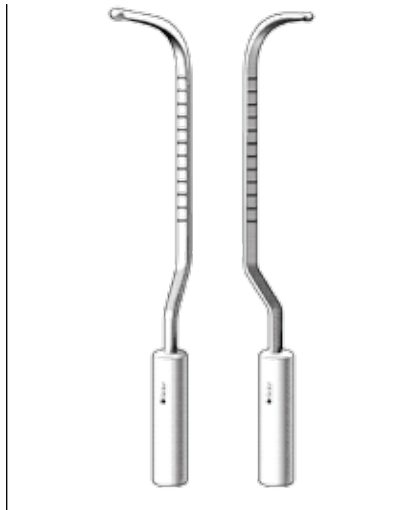

ARGIS-DINGMAN SUBMAMMARY DISSECTOR SET OF 2, LEFT AND RIGHT PATTERNS

40-7620 14"

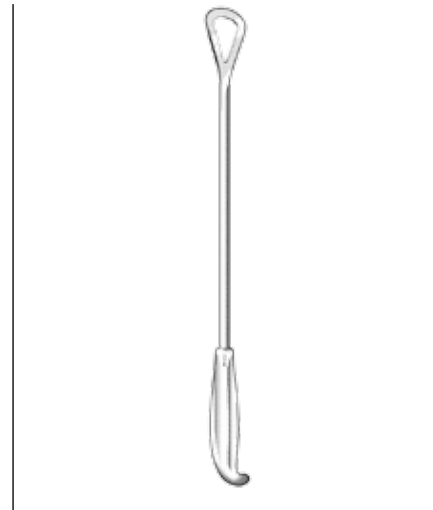

REYNOLDS TRANSAXILLARY BREAST DISSECTORS

1½" TIP
 40-7660 13"
 40-7661 16"

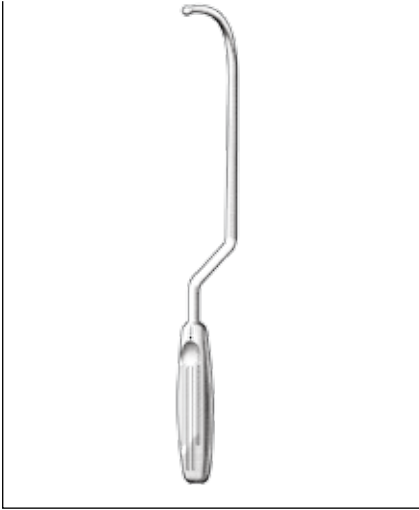

SOLZ ATRAUMATIC BREAST DISSECTORS

40-7630 13¼"
40-7632 14½"

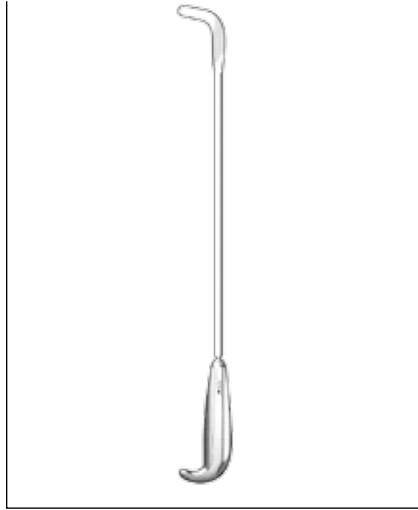

HOOK DISSECTORS

40-7654 13"
40-7655 16½"
40-7656 13" Malleable
40-7657 16½" Malleable

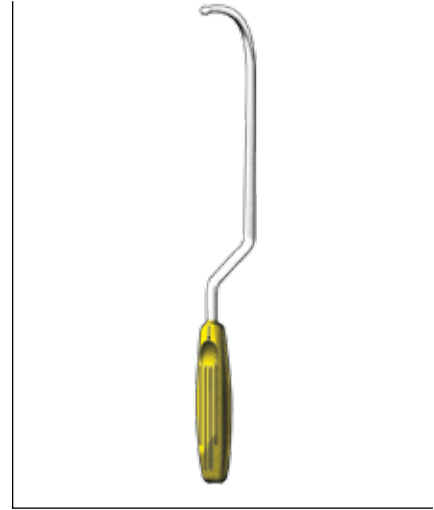

SOLZ HOOK DISSECTOR FOR FINE CONTOURING OF IMPLANT BED

47-2535 14¼" Curved Right



MARX BREAST RETRACTORS

10¼"
60-8120 30mm x 125mm
60-8122 30mm x 140mm



MAMMOPLASTY RETRACTORS

7", FOR USE WITH TELESCOPES
60-8835 25mm x 4mm
60-8836 25mm x 10mm



BIGGS MAMMAPLASTY RETRACTORS

WITHOUT FIBER OPTIC OR SUCTION TUBE		WITH FIBER OPTIC AND SUCTION TUBE		WITH FIBER OPTIC	
60-8100	30mm	60-8102	30mm	60-8104	30mm
60-8101	50mm	60-8103	50mm	60-8105	50mm

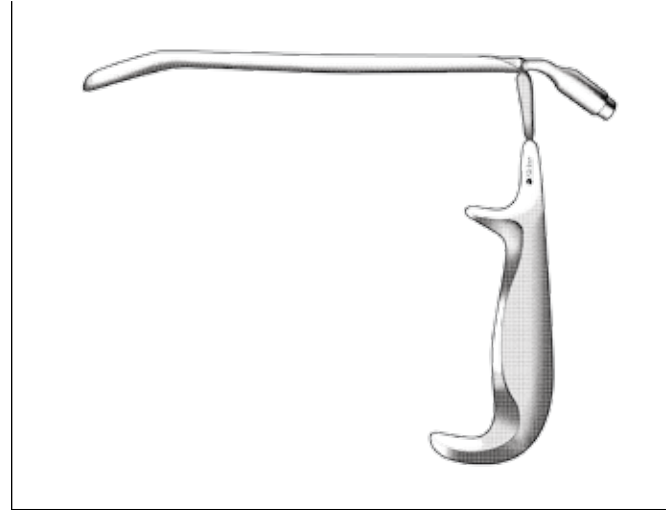

FERREIRA MAMMOPLASTY RETRACTORS

9" WITH FIBER-OPTIC	
60-8816	16mm x 80mm
60-8815	16mm x 150mm
60-8814	25mm x 90mm
60-8813	25mm x 150mm
60-8812	25mm x 180mm



FERREIRA MAMMOPLASTY RETRACTORS

9" WITH FIBER-OPTIC AND SMOKE EXCAVATION	
60-8801	16mm x 80mm
60-8802	16mm x 150mm
60-8803	25mm x 90mm
60-8804	25mm x 150mm
60-8805	25mm x 180mm



FREEMAN FLAP MAMMOPLASTY RETRACTORS

8" WITH FIBER-OPTIC	
40-7740	12mm
40-7742	25mm

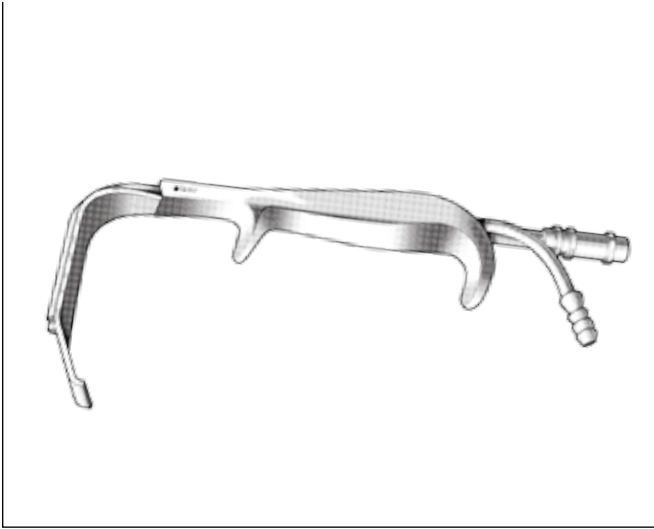

TEBETTS TOOTHED MAMMOPLASTY RETRACTORS

9" WITH FIBER-OPTIC		9" WITH FIBER-OPTIC AND SMOKE EXCAVATION	
60-8820	16mm x 80mm	60-8825	16mm x 80mm
60-8821	16mm x 150mm	60-8826	16mm x 150mm
60-8822	25mm x 90mm	60-8827	25mm x 90mm
60-8823	25mm x 150mm	60-8828	25mm x 150mm
60-8824	25mm x 180mm	60-8829	25mm x 180mm

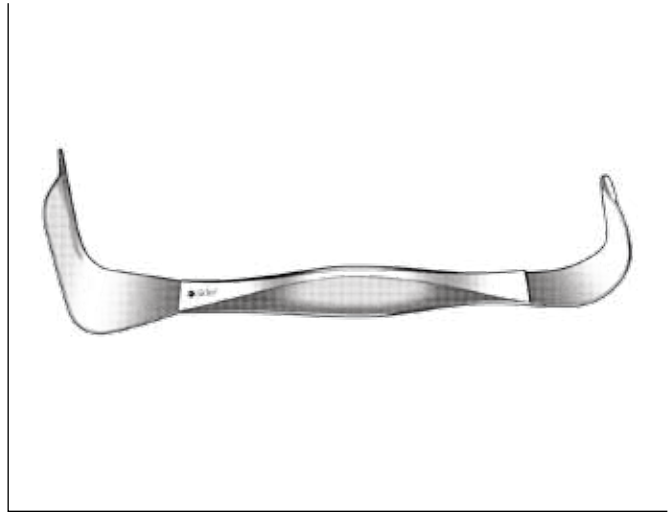

TEBETTS TOOTHED MAMMOPLASTY RETRACTOR

9" DOUBLE ENDED	
60-8830	37mm x 70mm and 22mm x 54mm

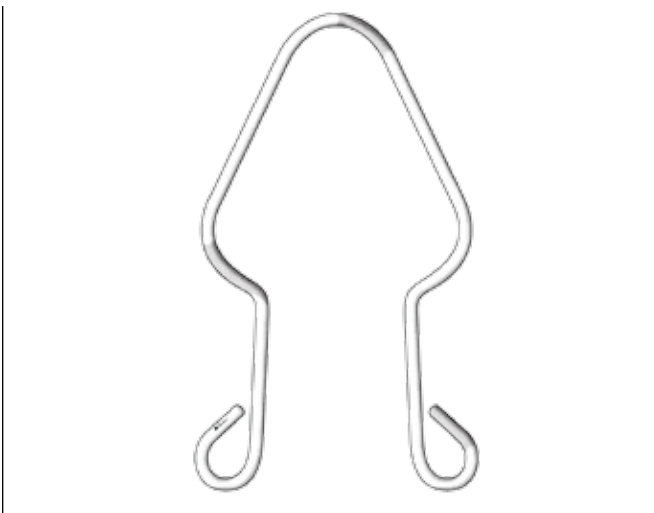

ACKERMANN AREOLA MARKERS

40-7768	5½"
40-7769	6¼"



McKISSOCK AREOLA MARKERS

KEYHOLE PATTERN WITH CM MARKS	
40-7754	38mm
40-7756	42mm
40-7758	45mm



GROSSMAN AREOLA MARKER

4 IN 1, ALUMINUM

40-7752 40mm, 44mm, 48mm, 52mm



FREEMAN AREOLA MARKERS

40-7718	38mm
40-7720	42mm
40-7722	45mm
40-7724	50mm



FREEMAN AREOLA MARKERS IMPROVED

40-7726	30mm	40-7734	42mm
40-7728	34mm	40-7736	45mm
40-7730	36mm	40-7738	50mm
40-7732	38mm		



FREEMAN AREOLA MARKERS

2 IN 1

40-7746	34mm / 36mm
40-7748	38mm / 42mm
40-7750	45mm / 50mm



SOLZ AREOLA MARKERS

BLUNT

40-7760	36mm
40-7762	40mm
40-7764	42mm
40-7766	45mm

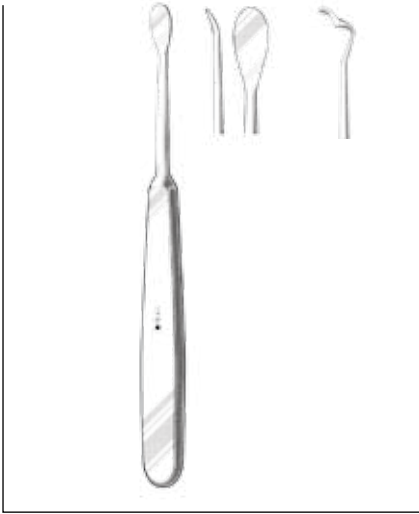

**WANG CLEFT
PALATE ELEVATORS**

- 40-8325 6" Straight
- 40-8326 7" Curved Right
- 40-8327 7" Curved Left
- 40-8328 7" Angled Right
- 40-8329 7" Angled Left

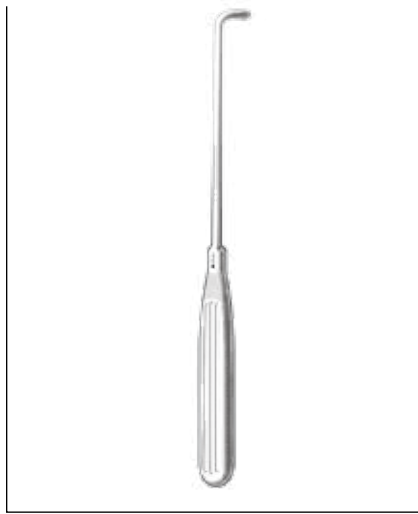

**BLAIR CLEFT
PALATE ELEVATORS**

- 5MM**
- 40-7602 8" Right Angle
 - 40-7601 9" Right Angle



**BLOCKSMA
CLEFT PALATE HOOKS**

- 75-1231 7" 1 Prong
- 75-1232 7" 2 Prong

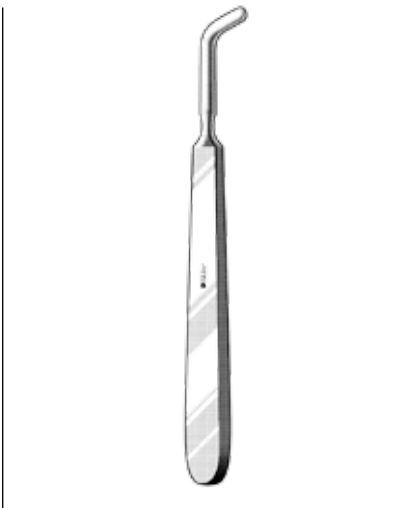

CLEFT PALATE RASPATORIES

- 75-1210 5½" Left
- 75-1211 5½" Right

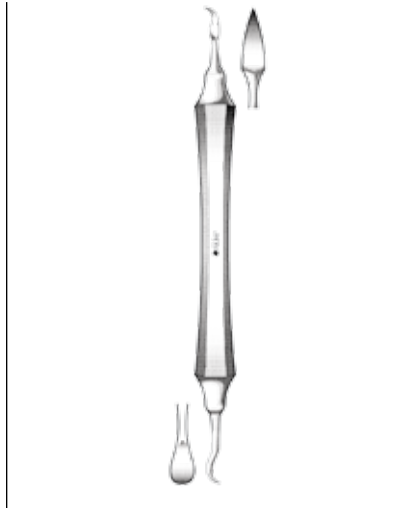

**KHARE CLEFT
PALATE RASPATORY**

- 75-1215 6¾" Double End

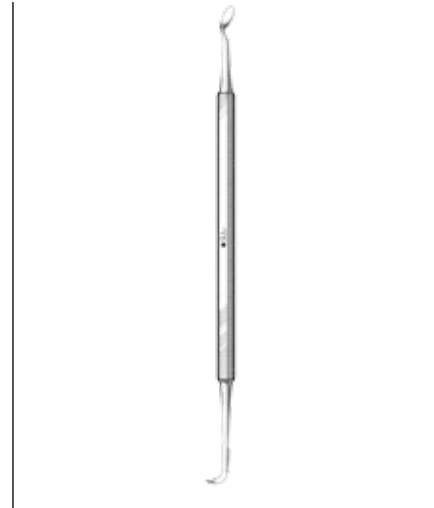

**McINDOE CLEFT
PALATE RASPATORY**

- 75-1220 6½" Double End



SALYER CLEFT PALATE RETRACTORS

- 41-1470 7" Short
- 41-1471 7" Long

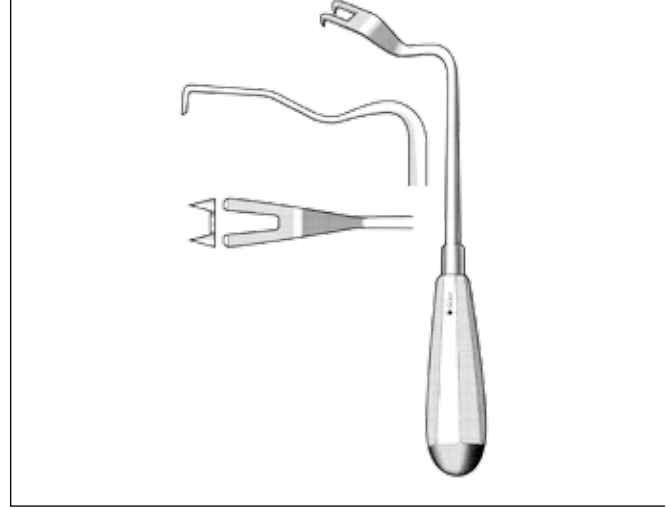

MUCO PERIOSTEAL RETRACTORS

- 40-9069 7½"
- 40-9281 7½" Small



MUCO PERIOSTEAL RETRACTORS

- 40-9283 7½" Large

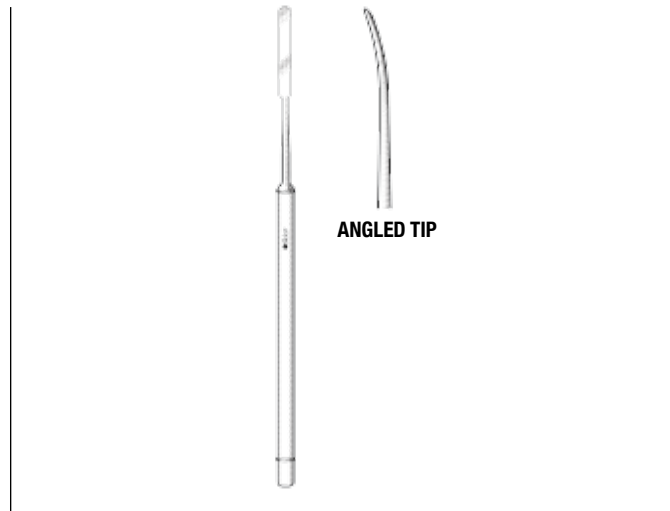

SALYER PERIOSTEAL ELEVATORS

- 40-9342 7" Right Angle Long
- 40-9341 7" Right Angle Short
- 40-9340 7" Slight Curve

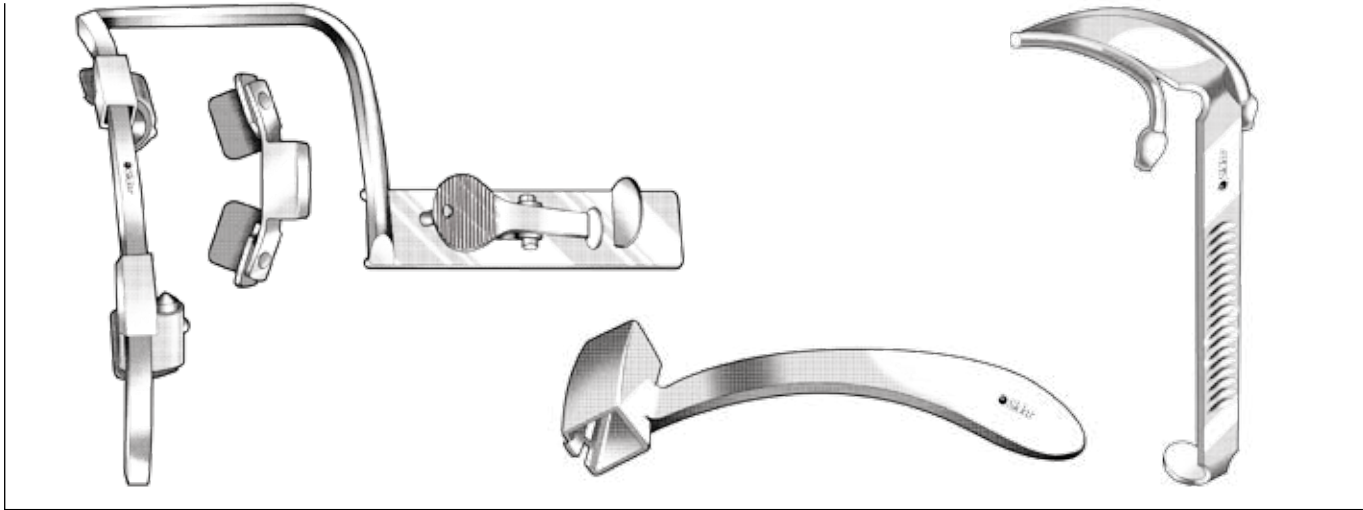

DAVIS-MEYER TONGUE DEPRESSORS

75-1090	Frame with 2 Single Bites / 1 Double Bite and Interchangeable Silicone Inserts				
75-1091	Silicone Insert				
75-1092	Palate Blade for Toothless Patients				
75-1093	Blade Only	29mm x 70mm	With Suction		
75-1094	Blade Only	30.5mm x 75mm	With Suction		
75-1095	Blade Only	31.5mm x 80mm	With Suction		
75-1096	Blade Only	32.5mm x 85mm	With Suction		
75-1097	Blade Only	33.5mm x 95mm	With Suction		
75-1098	Blade Only	33.8mm x 100mm	With Suction		
75-1099	Blade Only	34mm x 105mm	With Suction		



McIVOR MOUTH GAGS

5½"

75-1020	Complete with Interchangeable Blades #1-3
75-1021	Blade #1, 27mm x 95mm
75-1022	Blade #2, 22mm x 85mm
75-1023	Blade #3, 22mm x 70mm



LOGAN LIP TRACTION BOW

SHARP WITH TEETH		BLUNT WITHOUT TEETH	
75-1132	25mm	75-1135	25mm
75-1133	32mm	75-1136	32mm
75-1134	35mm	75-1137	35mm

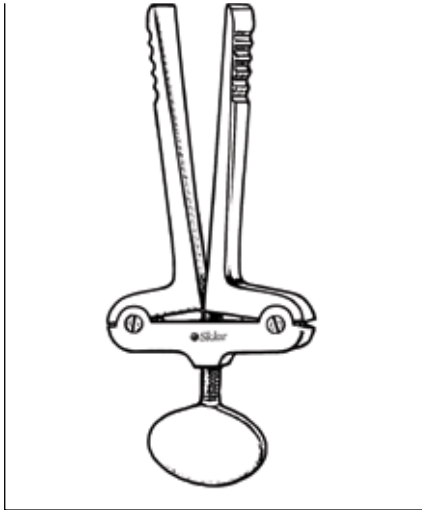

HEISTER MOUTH GAG

75-1008 5¼"

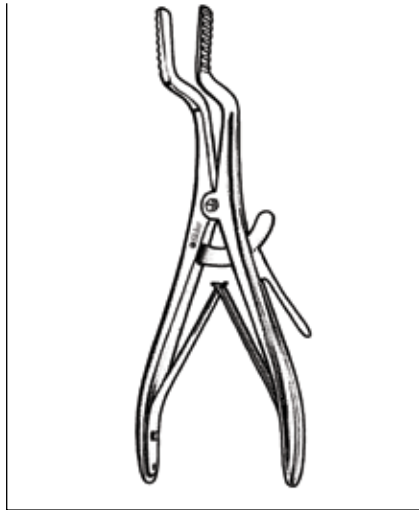

ROSER-KONIG MOUTH GAGS

75-1011 6¼"
75-1012 7½"

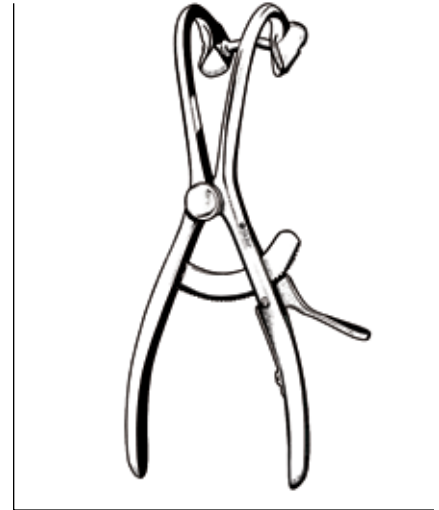

DENHARDT MOUTH GAG

75-1007 4¾"



MOLT (DOYEN JANSEN) MOUTH GAGS

22-8945 Child
75-1025 Adult

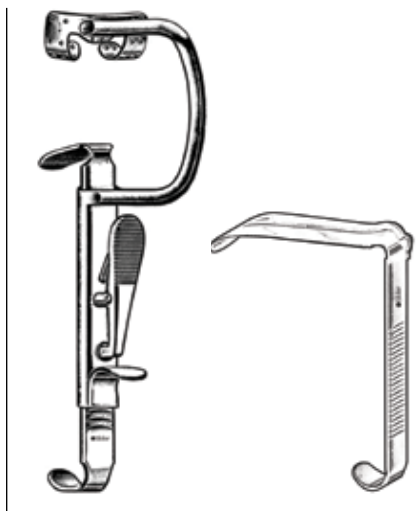

DAVIS-BOYLE MOUTH GAGS

75-1108 Complete with Left Frame and Blades, #1-5
75-1110 Right Frame Only
75-1111 Left Frame Only
REPLACEMENT BLADES WITH SUCTION
75-1112 #1 27mm x 105mm
75-1113 #2 25mm x 90mm
75-1114 #3 25mm x 75mm
75-1115 #4 22mm x 60mm
REPLACEMENT BLADES WITHOUT SUCTION
75-1116 #5 20mm x 25mm

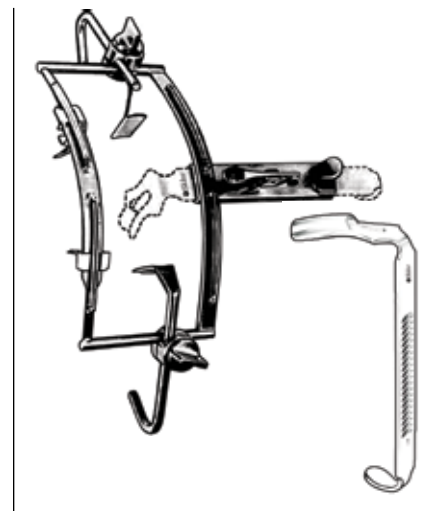

DINGMAN MOUTH GAGS

75-1040 Complete with Frame with 2 Hooks, 2 Lateral Retractors and 3 Tongue Depressors
5¼" FENESTRATED BLADE
75-1041 #1 25mm x 65mm
75-1042 #2 29mm x 70mm
75-1043 #3 32mm x 80mm

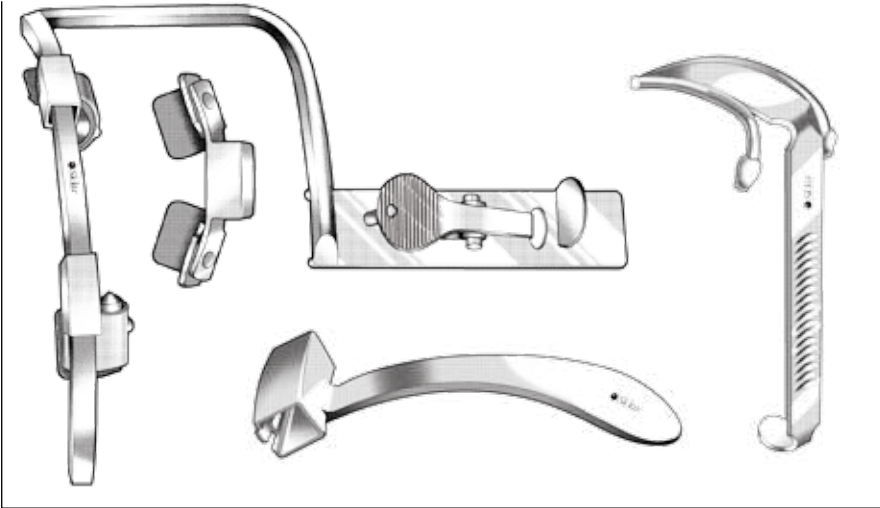

DAVIS-MEYER TONGUE DEPRESSOR

- 75-1090 Frame with 2 Single Bites / 1 Double Bite and Interchangeable Silicone Inserts
- 75-1091 Silicone Inserts
- 75-1092 Palate Blade for Toothless Patients

BLADE ONLY

- 75-1093 29mm x 70mm
- 75-1094 30.5mm x 75mm
- 75-1095 31.5mm x 80mm
- 75-1096 32.5mm x 85mm
- 75-1097 33.5mm x 95mm
- 75-1098 33.8mm x 100mm
- 75-1099 34mm x 105mm

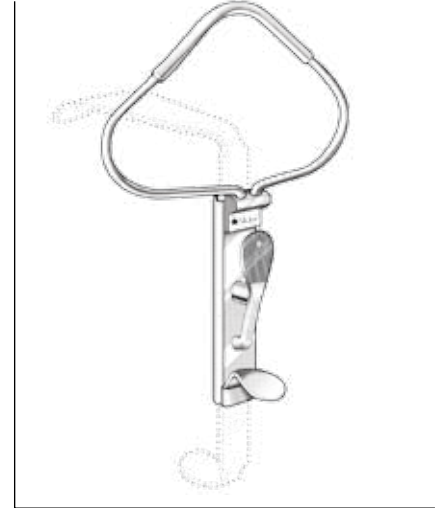

McIVOR MOUTH GAGS

- 75-1020 Complete with Frame and Blades #1-3
 - 75-1024 Frame Only
- REPLACEMENT BLADES**
- 75-1021 #1 27mm x 95mm
 - 75-1022 #2 22mm x 85mm
 - 75-1023 #3 22mm x 70mm



KILNER-DOUGHTY MOUTH GAGS

- 75-1005 Complete with Frame and Blades #1-3
 - 75-1004 Frame Only
- REPLACEMENT BLADES, FENESTRATED**
- 75-1001 #1 28mm x 65mm
 - 75-1002 #2 32mm x 75mm
 - 75-1003 #3 37mm x 80mm

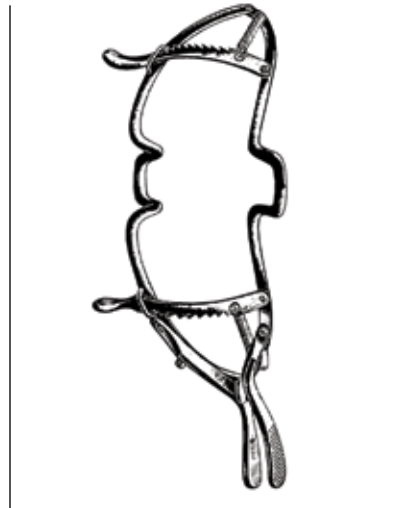

WHITEHEAD MOUTH GAGS WITHOUT TONGUE DEPRESSOR

- 75-1054 4 1/4"
- 75-1055 5"
- 75-1056 6"

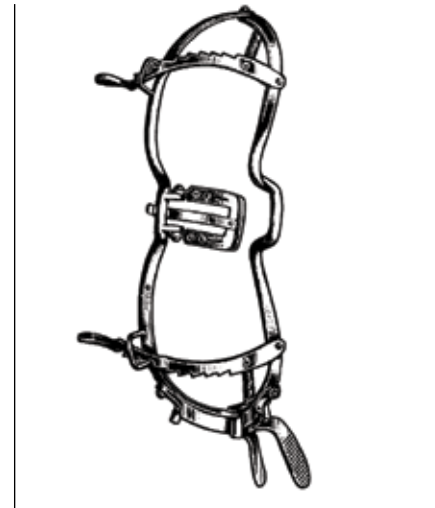

WHITEHEAD MOUTH GAGS WITH TONGUE DEPRESSOR

- 75-1057 4 1/4"
- 75-1058 5"
- 75-1059 6"

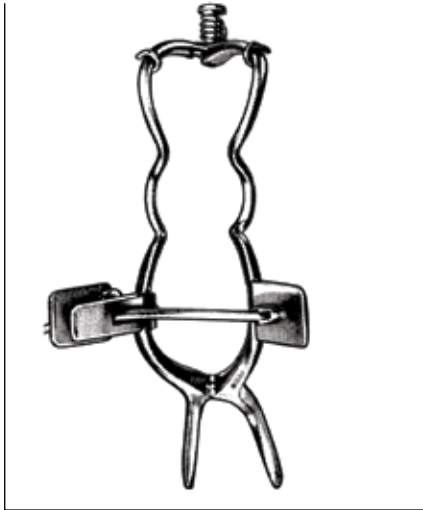

SEEMANN-SEIFFERT MOUTH GAGS

- 75-1050 3½"
- 75-1051 4¼"
- 75-1052 5"
- 75-1053 6"

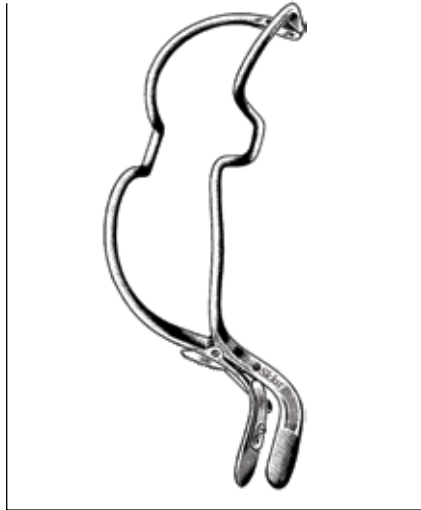

JENNINGS MOUTH GAGS

- 75-1015 3½"
- 75-1016 4¼"
- 75-1017 5"
- 75-1018 6"

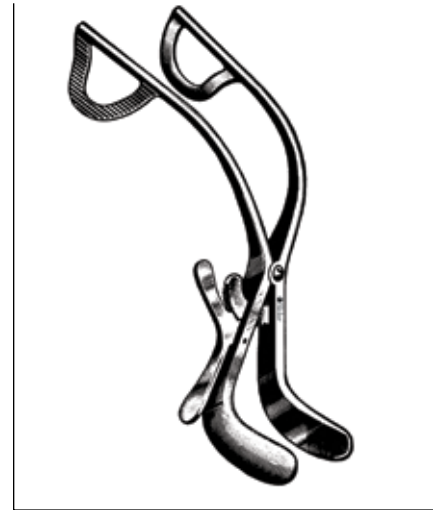

WESSON MOUTH GAG

- 75-1010 5¾"

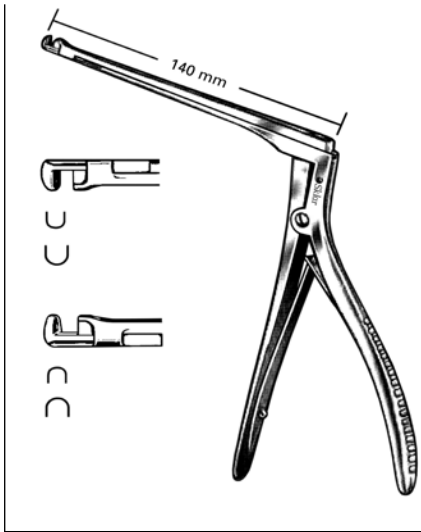

HAJEK-KOFLER SPHENOID PUNCHES

5½" SHAFT

- 65-7415 3.5mm x 3.5mm Bite, Up
- 65-7416 3.5mm x 3.5mm Bite, Down
- 65-7417 4mm x 4mm Bite, Up
- 65-7418 4mm x 4mm Bite, Down

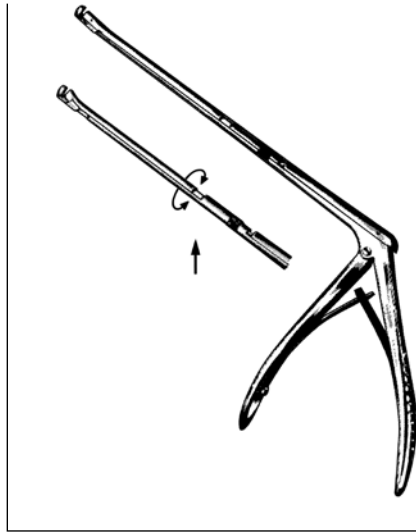

HAJEK-KOFLER SPHENOID PUNCH

6¼" SHAFT

- 65-7419 Rotatable, 360°
- 70-5516

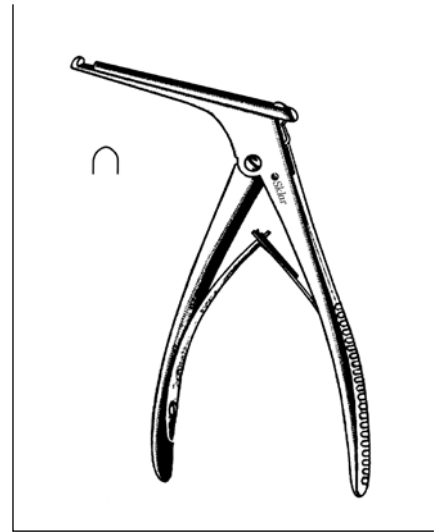

KERRISON RONGUERS

3½" SHAFT

- 65-7400 3mm
- 65-7401 4mm
- 65-7402 5mm
- 65-7403 6mm



CITELLI RONGUERS

2½" SHAFT

- 65-7409 1mm
- 65-7410 2mm
- 65-7411 3mm
- 65-7412 4mm

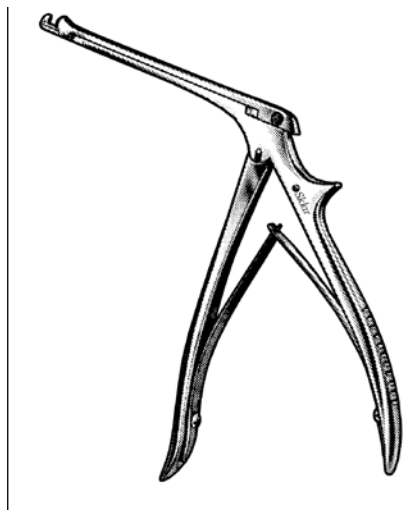

BEYER PUNCH

- 65-7408 3½" Shaft



HAJEK-CLAUS SPHENOID PUNCHES

- 65-7420 8", Up



FRONTAL SINUS PUNCH FORCEPS

7" SHAFT
75-9620 3mm Bite, 70°

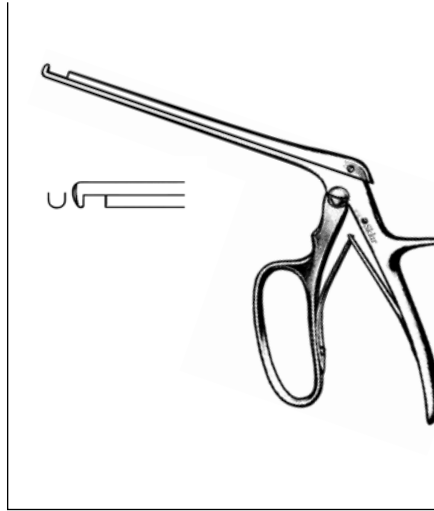

FERRIS-SMITH-KERRISON SPHENOID PUNCH

7" SHAFT
65-7426 3mm x 3mm Bite, Up
65-7427 3mm x 3mm Bite, Down
65-7428 5mm x 5mm Bite, Up
65-7429 5mm x 5mm Bite, Down
65-7430 3mm x 3mm, Forward
65-7431 5mm x 5mm, Forward

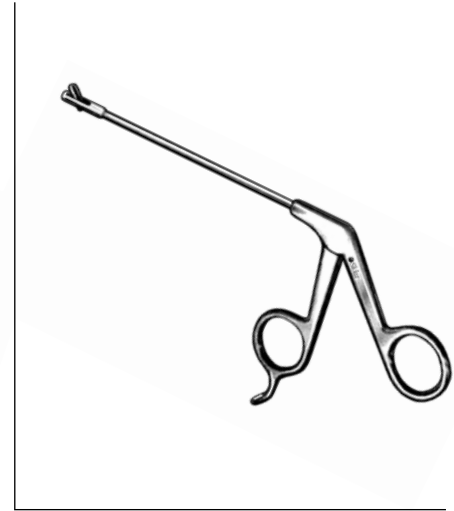

PUNCHES

4 3/4" SHAFT, HORIZONTAL CUTTING
75-9631 2.5mm x 6mm Bite, Straight
75-9632 2.5mm x 6mm Bite, 30°
75-9633 2.5mm x 6mm Bite, 45°
75-9634 2.5mm x 6mm Bite, 60°
75-9635 2.5mm x 6mm Bite, 70°



SCHMEDEN TONSIL PUNCHES

5 1/4" SHAFT, WITH TRIANGLE BASKET TIP
75-9601 Size 1
75-9602 Size 2
75-9603 Size 3

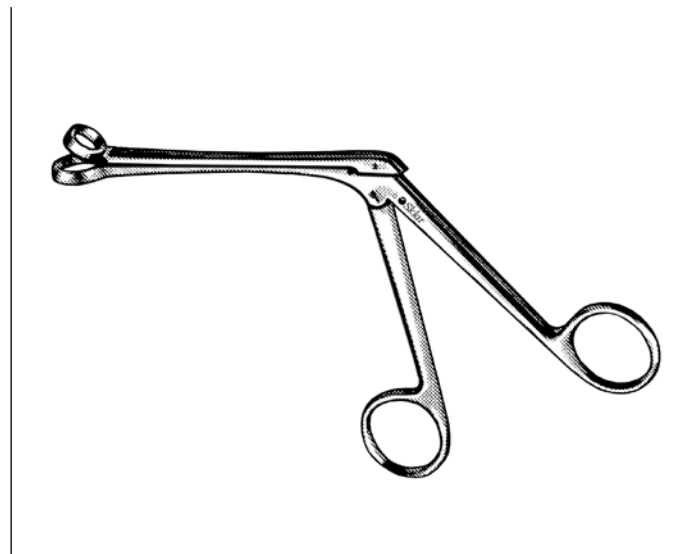

HARTMANN TONSIL PUNCHES

4 3/4" SHAFT
75-9605 13mm
75-9606 15mm
75-9607 17mm

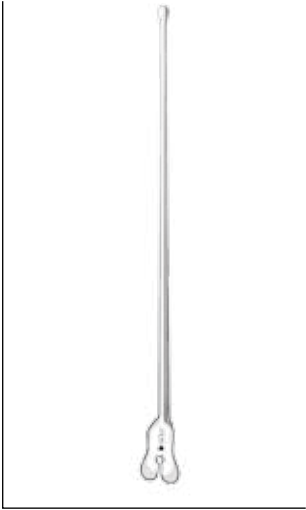

BRODIE PROBE

30-1230 8"

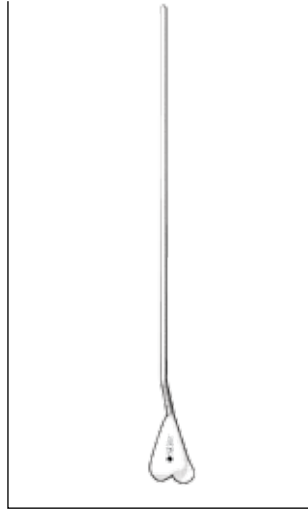

LOCKHART-MUMMERY PROBES

30-1211 Straight
 30-1212 Curved
 30-1213 Strong Curve, Large
 30-1214 Strong Curve, Small

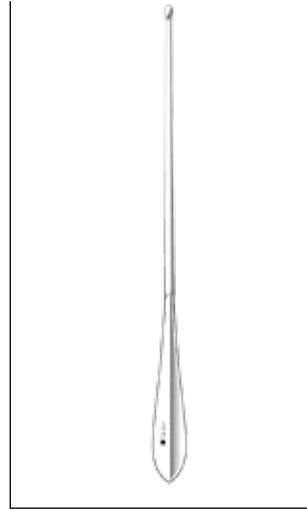

MYRTLE LEAF PROBES

30-1450 5"
 30-1455 5¾"
 30-1460 6¼"
 30-1470 7"
 30-1480 7¾"

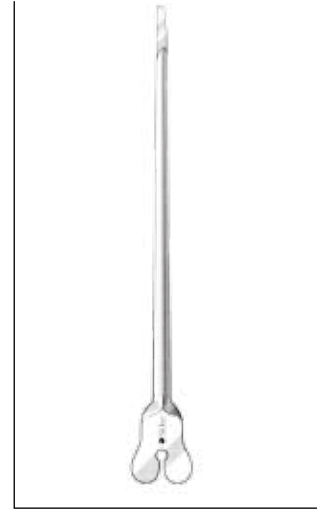

NELATON PROBE

30-1210 6¼" Grooved

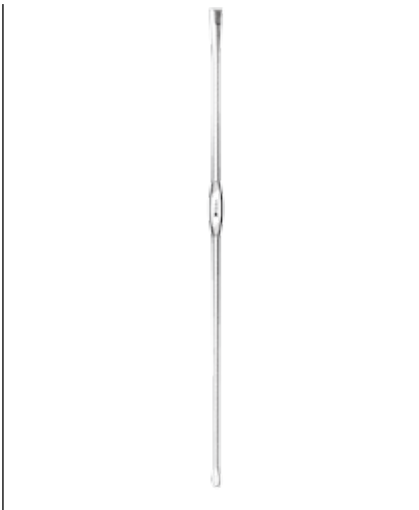

BUNNELL TENDON PASSER AND PROBES

MALLEABLE

47-3525 7"
 47-3526 9"

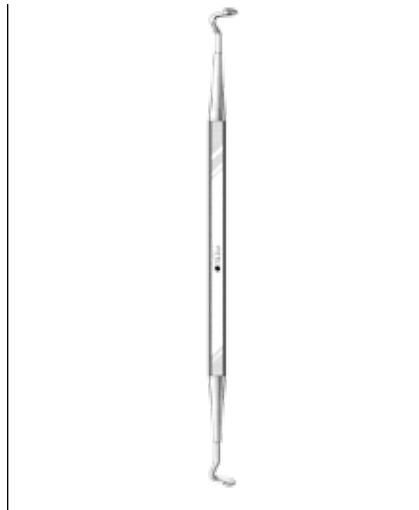

WORST PIGTAIL PROBES

41-1185 5½" Child
 41-1186 6¼" Adult



BUNNELL DISSECTING PROBE

47-3524 6½" Angled

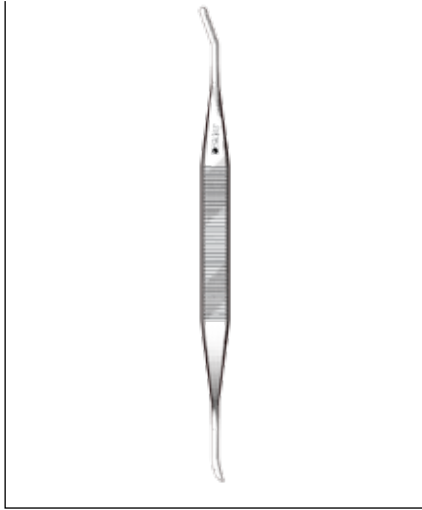

**WATSON-CHEYNE
DISSECTOR PROBES**

DOUBLE END

40-8350	5"
40-8352	7"

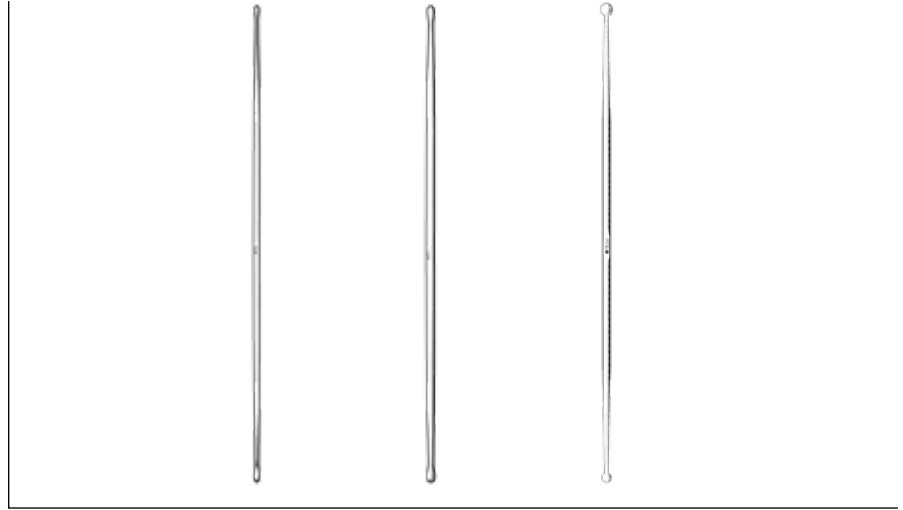

PROBES

DOUBLE END, 1MM

30-1502	4½"
30-1504	5"
30-1506	5½"
30-1508	6¼"
30-1510	7"
30-1512	8"
30-1514	9¾"

DOUBLE END, 1.5MM

30-1516	4¼"
30-1518	4½"
30-1520	5"
30-1522	5½"
30-1524	6¼"
30-1526	7"
30-1528	7¾"
30-1530	9¾"

DOUBLE END, 2MM

30-1532	4"
30-1545	4½"
30-1550	5"
30-1555	5½"
30-1560	6"
30-1570	7"
30-1580	8"
30-1610	10"
30-1612	12"

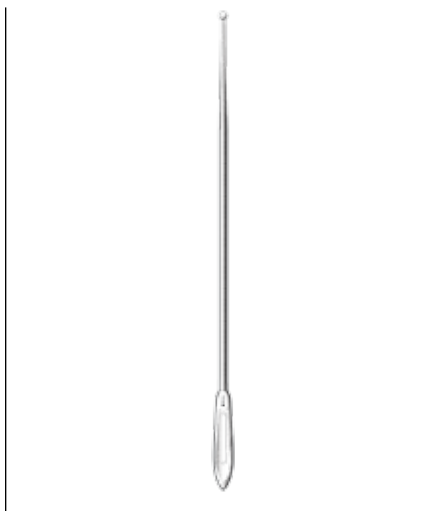

PROBES

WITH EYE, 2MM

30-1945	4½"
30-1950	5"
30-1955	5½"
30-1960	6"
30-1970	7"
30-1980	8"
30-2010	10"
30-2012	12"

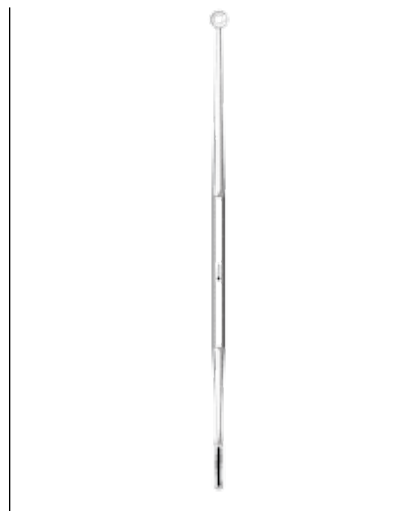

JOBSON-HORNE EAR PROBES

30-1020	4¾"
30-1021	7"

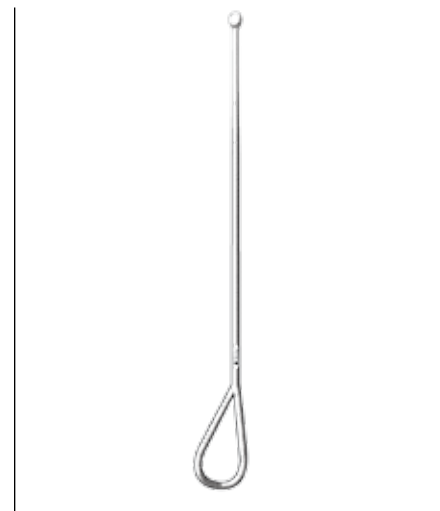

STACKE EAR PROBE

30-1040	4"
---------	----

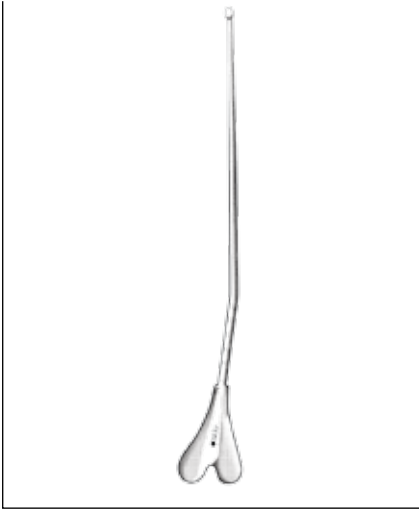

NASAL PROBE

30-2457 5 3/4" Angled



KISTNER NASAL PROBES AND ELEVATORS

DOUBLE ENDED

41-1201 6 3/4"
41-1202 6 3/4" Fine

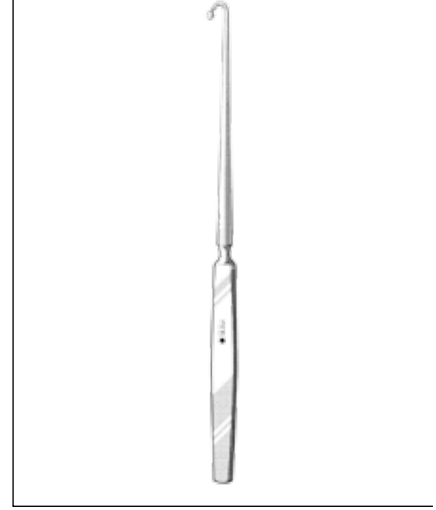

LANGE NASAL PROBE

41-1210 9" Choana Hook

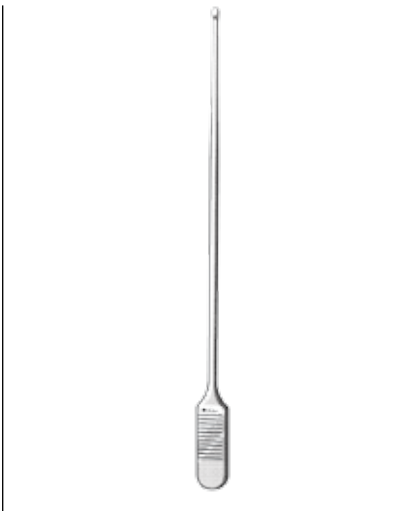

THEOBALD FISH SINUS PROBE

30-1240 6"

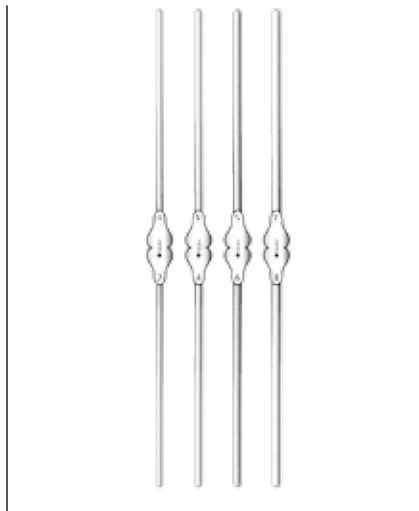

BOWMAN LACRIMAL PROBES

DOUBLE ENDED, MALLEABLE, 5"

65-4098 #0000 / 000
65-4099 #00 / 0
65-4101 #1 / 2
65-4103 #3 / 4
65-4105 #5 / 6
65-4107 #7 / 8

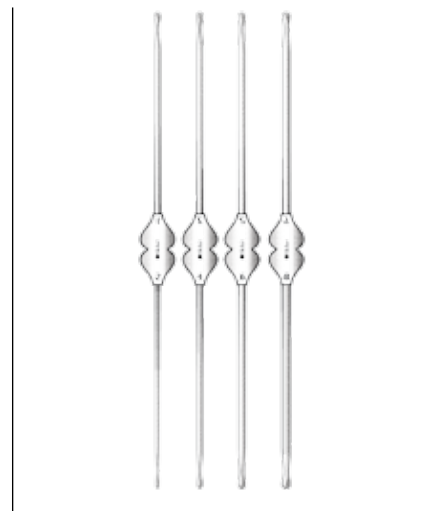

WILLIAMS LACRIMAL PROBES

DOUBLE END, MALLEABLE, BULBOUS TIPS, 5 1/2"

65-4129 #0000 / 000
65-4128 #00 / 0
65-4121 #1 / 2
65-4123 #3 / 4
65-4125 #5 / 6
65-4127 #7 / 8
65-4120 Set of 4 Includes sizes 1-8

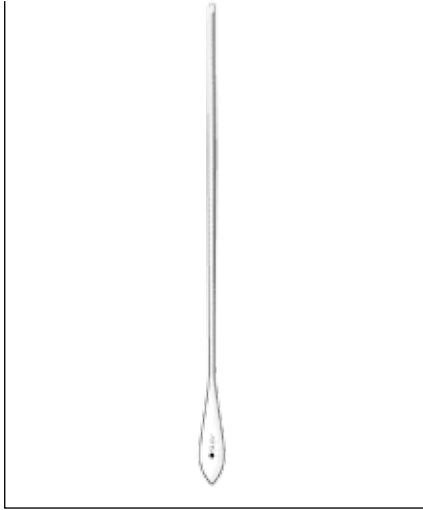

SEIFFERT SALIVARY DUCT PROBE
30-1410 7"

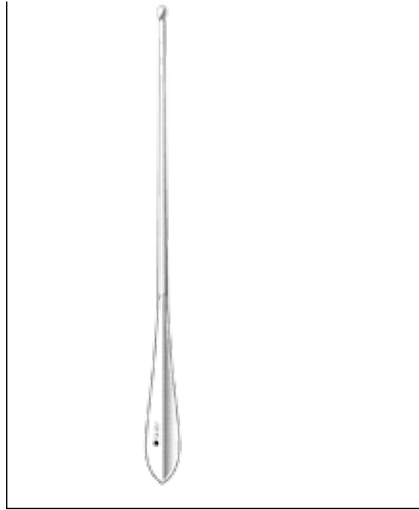

JAKO LARYNGEAL PROBE
12" OVERALL LENGTH
78-3595 8¾"



DOYEN GROOVED DIRECTOR
30-1260 5¾" Curved

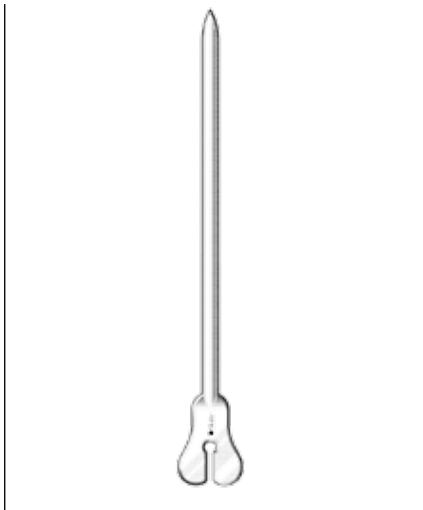

GROOVED DIRECTORS
30-1045 4½"
30-1050 5"
30-1055 5¾"
30-1060 6¼"
30-1070 7"
30-1080 7¾"

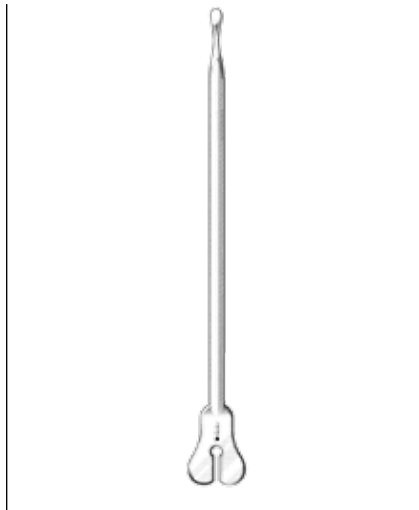

GROOVED DIRECTORS WITH PROBE
30-1145 4¼"
30-1150 5"
30-1155 5¾"
30-1160 6¼"
30-1170 7"
30-1180 7¾"

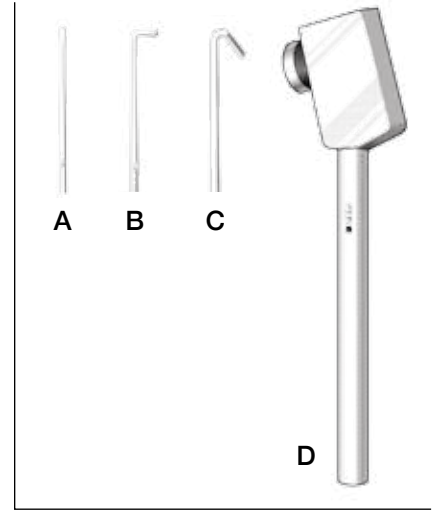

MICRO LARYNGEAL PROBES
9½"
78-3536 Straight (A)
78-3537 90° Angled Right (B)
78-3538 120° Angled Right (C)
78-3546 Handle (D)

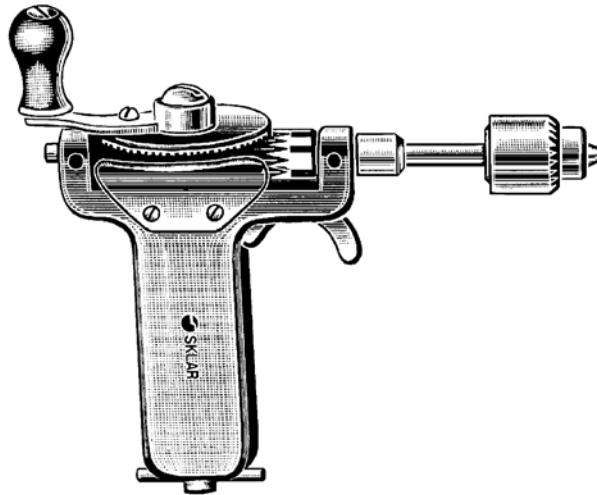

BUNNELL HAND DRILL
CANNULATED WITH JACOBS CHUCK

40-1475 6¼" For Twist Drills and Kirschner Wires
40-1478 Chuck Key Only

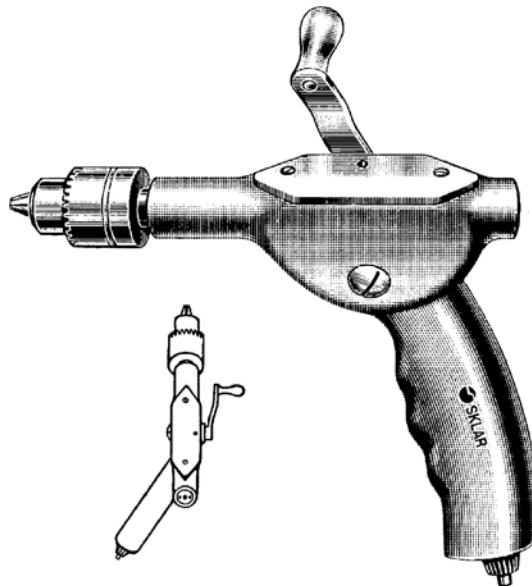

SKLAR BONE DRILL
OFFSET HANDLE WITH JACOBS CHUCK

40-1465 6" For Twist Drills and Kirschner Wires
40-1478 Chuck Key Only

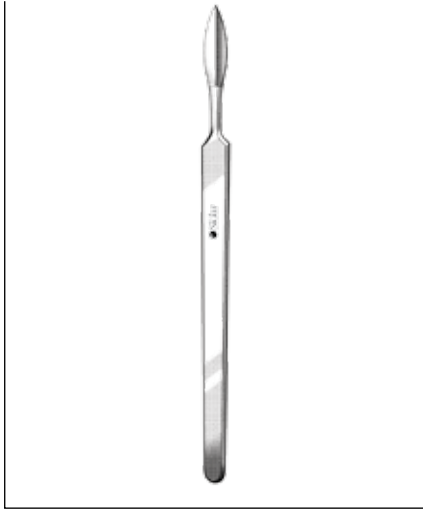

COTTLE DOUBLE-EDGED KNIFE STRAIGHT
41-1252 6" 6mmx24mm Blade



FOMON DOUBLE-EDGED KNIFE CURVED WITH BLUNT TIP
41-1318 6½"



MALTZ BUTTON END KNIFE
41-1319 6¾" 9mm Blade

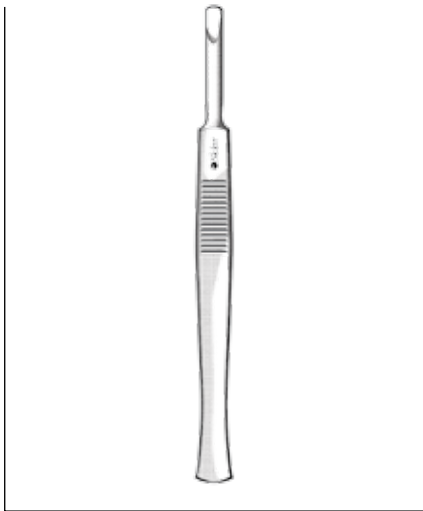

COTTLE NASAL KNIVES STRAIGHT
41-1253 6" Round
41-1255 5½" 4mm Blade

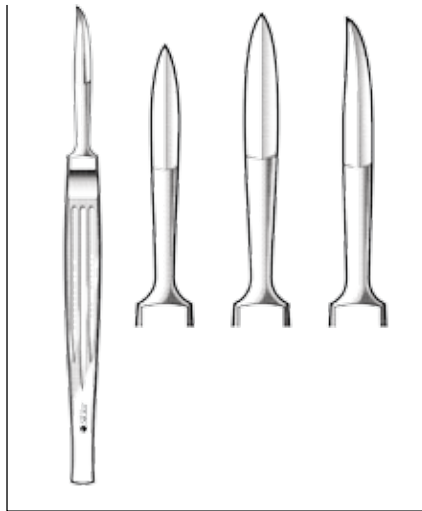

JOSEPH NASAL KNIVES
STRAIGHT, 6"
41-1260 4mmx23mm Blade, Sharp
41-1270 4mmx23mm Blade, Blunt
41-1262 6mmx23mm Blade, Sharp
41-1272 6mmx23mm Blade, Blunt
CURVED, 6"
41-1264 4mmx23mm Blade, Sharp
41-1266 4mmx23mm Blade, Blunt
41-1274 6mmx23mm Blade, Sharp
41-1276 6mmx23mm Blade, Blunt

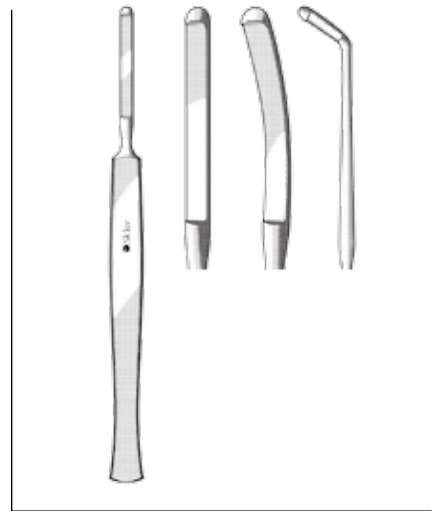

JOSEPH BUTTON-END KNIVES
41-1300 6" Straight
41-1305 6" Angled
41-1310 6" Curved

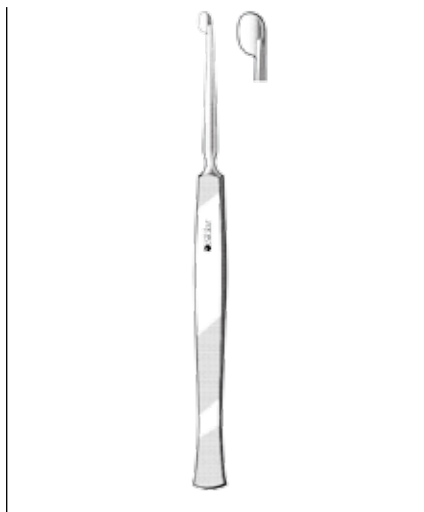

FREER SEPTUM KNIFE

70-7062 6¼"

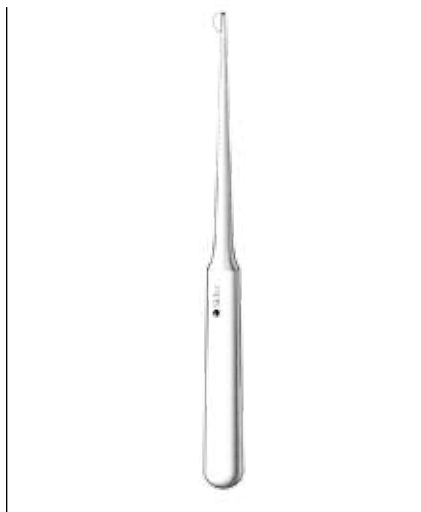

FREER SEPTUM KNIFE

70-7061 6"

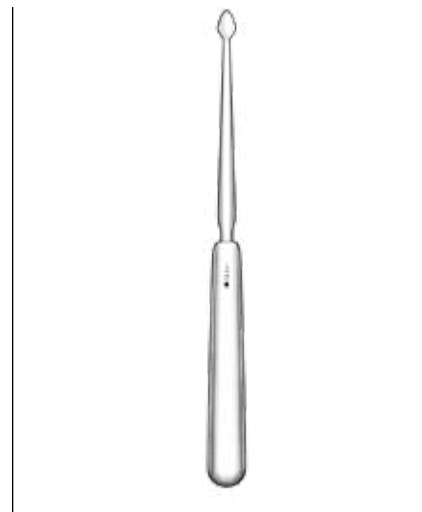

FREER SEPTUM KNIFE

70-7063 6" "E" Model



FREER SEPTUM KNIFE

70-7067 7¼"

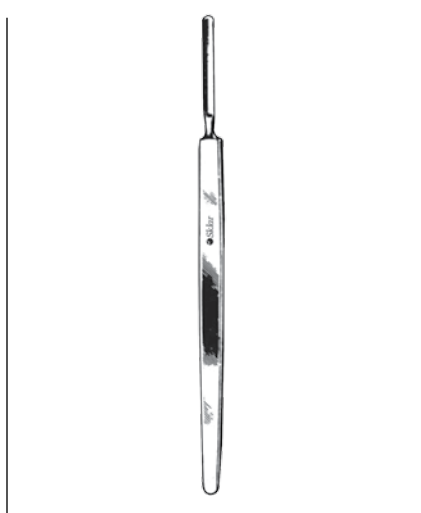

FREER SEPTUM KNIFE

STRAIGHT
41-1253 6" Round

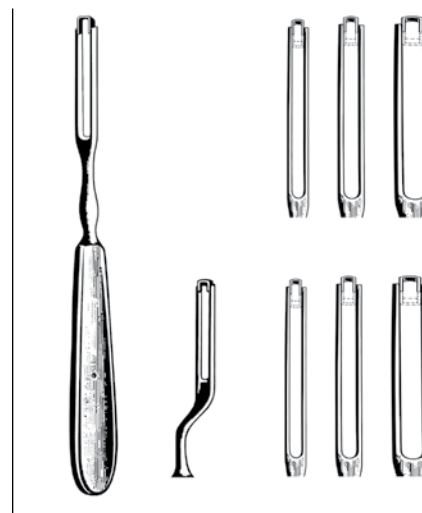

BALLENGER SEPTUM SWIVEL KNIVES

STRAIGHT
70-7503 8" 3mm
70-7504 8" 4mm
70-7505 8" 5mm
BAYONET
70-7506 8" 3mm
70-7507 8" 4mm
70-7508 8" 5mm

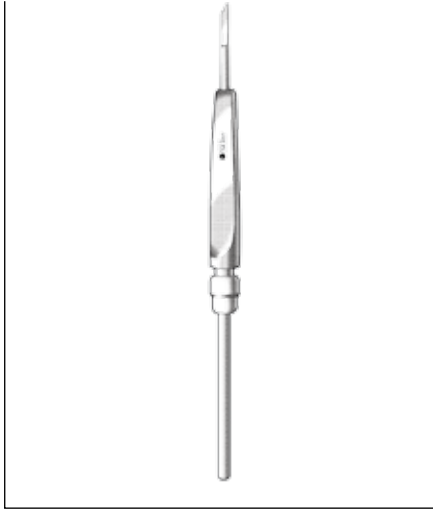

BRUENING KNIFE
41-1256 6¼"

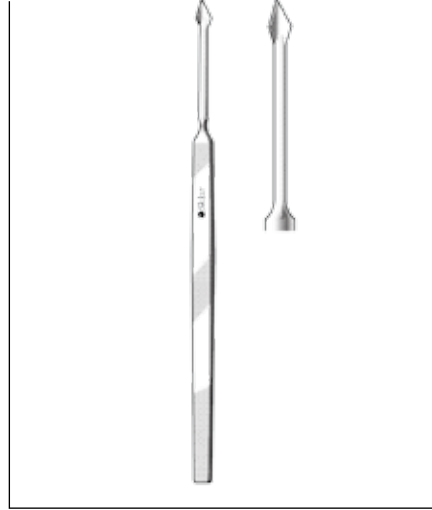

MASING CARTILAGE KNIFE
CURVED, POINTED
41-1258 5"



FISHER TONSIL KNIFE
SLIGHTLY CURVED BLADE
75-7590 8½"

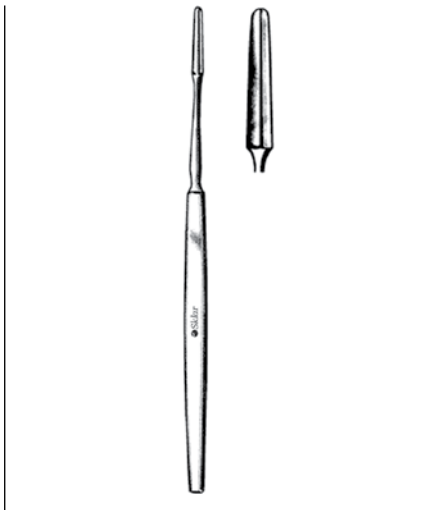

DEAN TONSIL KNIFE
DOUBLE EDGE
75-7492 7¼" Straight

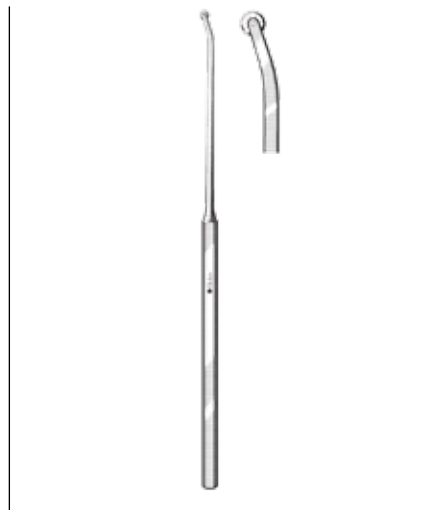

**SCHUKNECHT MICRO
EAR ROLLER KNIVES**
ROTARY KNIFE, ANGLED
67-2011 6" Vertical Blade
67-2012 6" Horizontal Blade

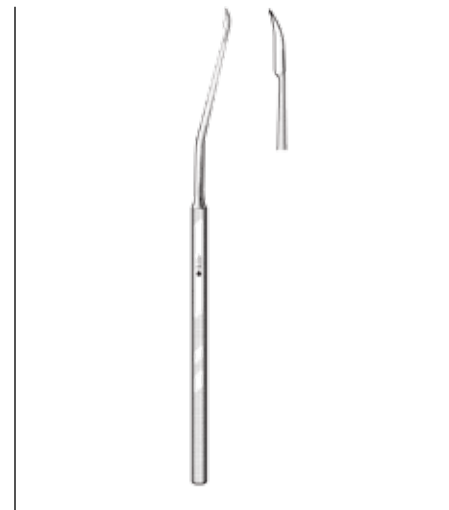

**SCHUKNECHT MICRO-
EAR KNIFE**
SICKLE KNIFE
67-2013 5¾" Straight with
Angled Shaft



TABB MICRO EAR KNIFE
MUCOSA KNIFE
07-2017 6" Curved Tip

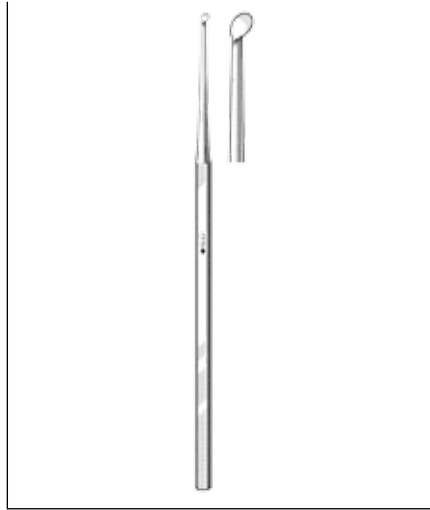

ROSEN MICRO EAR KNIFE
#4
65-3243 6" 2mm

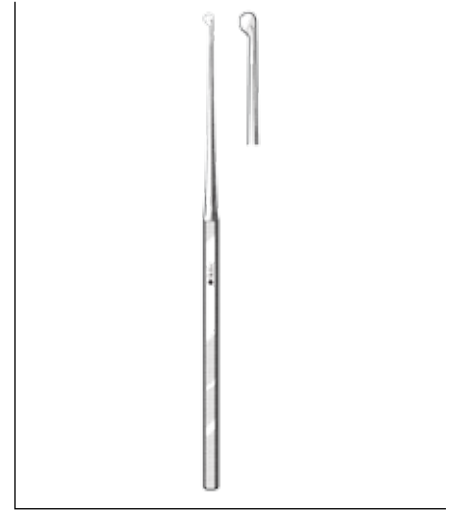

PLESTER MICRO FLAP KNIFE
67-2018 6" Straight



MICRO LARYNGEAL KNIFE
78-3530 9½" Curved



MICRO LARYNGEAL KNIFE
78-3531 9½" Straight

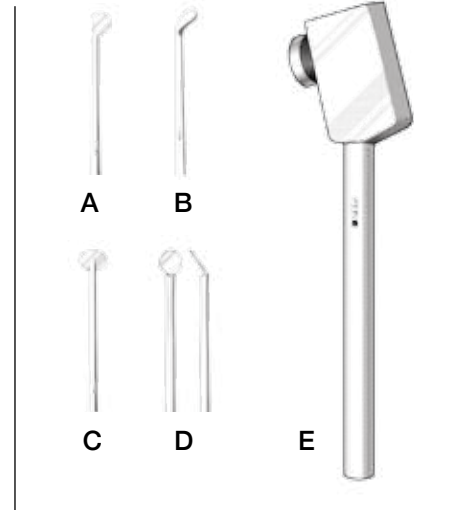

MICRO LARYNGEAL KNIVES
9½"
78-3532 Round Edge (A)
78-3533 Golf Club Style (B)
78-3534 Full Round Edge (C)
78-3535 Angled, Round Edge (D)
78-3546 Handle (E)

SCALPEL HANDLES

PRODUCT NUMBER	FEATURES
06-2910	#3 with metric scale



PRODUCT NUMBER	FEATURES
06-2903	#3 fits Blade #10, 11, 12, 15

06-2915	#3L
---------	-----

06-2916	#3XL
---------	------



PRODUCT NUMBER	FEATURES
06-2904	#4 fits Blade #20, 21, 22, 23

06-2920	#4L
---------	-----



PRODUCT NUMBER	FEATURES
06-2907	#7 fits Blade #10, 11, 12, 15



PRODUCT NUMBER	FEATURES
06-2911	#9 fits Blade #10, 11, 12, 15



PRODUCT NUMBER	FEATURES
06-2912	#8 fits Blade #60



PRODUCT NUMBER	FEATURES
06-2925	Large Lab Type Handle #3

06-2930	Large Lab Type Handle #4
---------	--------------------------



PRODUCT NUMBER	FEATURES
06-2908	Round Scalpel Handle, Straight #3R, fits Blade #10, 11, 12, 15

06-2909	Round Scalpel Handle, Angled Fits Blade #10, 11, 12, 15
---------	---



PRODUCT NUMBER	FEATURES
06-3090	Blade Remover

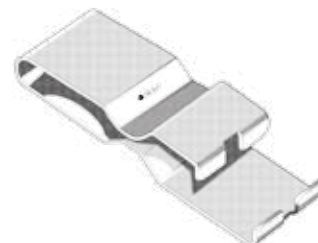

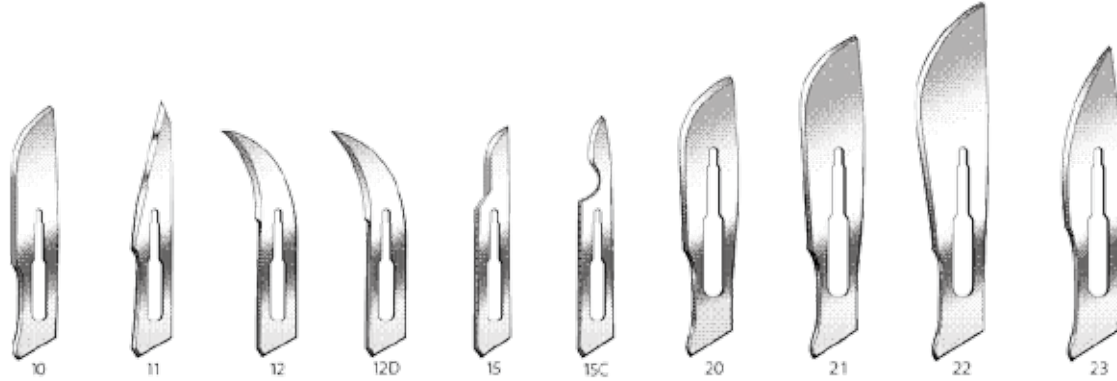

BLADES, STAINLESS STEEL

STERILE

PRODUCT NUMBER	FEATURES	QUANTITIES
06-3100	#10	100/box
06-3101	#11	100/box
06-3102	#12	100/box
06-3103	#15	100/box
06-3108	#15C	100/box
06-3104	#20	100/box
06-3105	#21	100/box
06-3106	#22	100/box
06-3107	#23	100/box

BLADES, STAINLESS STEEL

STERILE

PRODUCT NUMBER	FEATURES	QUANTITIES
06-3010	#10	100/box
06-3011	#11	100/box
06-3012	#12	100/box
06-3013	#12D	100/box
06-3015	#15	100/box
06-3016	#15C	100/box
06-3020	#20	100/box
06-3021	#21	100/box
06-3022	#22	100/box
06-3023	#23	100/box

SCALPELS, DISPOSABLE

STERILE

PRODUCT NUMBER	FEATURES	QUANTITIES
06-3110	#10	10/box
06-3111	#11	10/box
06-3112	#12	10/box
06-3115	#15	10/box
06-3120	#20	10/box
06-3121	#21	10/box
06-3122	#22	10/box
06-3123	#23	10/box





SKLARSAFE™ SAFETY SCALPELS



LATEX-FREE

- Protective, transparent sheath can be opened, closed, and locked with a single hand.
- Precision stainless steel blade made in England.
- Sturdy, “Sure-Grip” handle.
- Audible “click” when sheath advanced to locked position.
- OSHA Compliant.
- Individually sealed in sturdy film and Tyvek® pack.

STERILE

PRODUCT NUMBER	FEATURES	QUANTITIES
06-3094	#10	10/box
06-3095	#11	10/box
06-3096	#15	10/box

NON-STERILE

06-3130	#10	500/cs
06-3132	#11	500/cs
06-3134	#15	500/cs

SELF-LOCKING HANDLE

NON-STERILE

PRODUCT NUMBER	FEATURES	QUANTITIES
97-1445	#6	1 Each



CARBON P-M BLADE

NON-STERILE

PRODUCT NUMBER	FEATURES	QUANTITIES
06-3024	#60	50/box



MINI THUMB SCALPEL

NON-STERILE

PRODUCT NUMBER	FEATURES	QUANTITIES
06-7052	#11	1500/cs



STITCH CUTTER

STERILE

PRODUCT NUMBER	FEATURES	QUANTITIES
06-3030	Stainless Steel	100/box

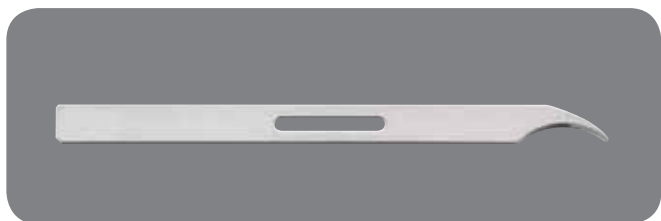

SPECIALTY BLADES

NON-STERILE

PRODUCT NUMBER	FEATURES	QUANTITIES
97-1400	#318, Curved Edge	12/box
97-1405	#312, Curved Edge	12/box
97-1410	#313, Curved Edge	12/box
97-1420	#316, Straight Edge	12/box



MINI PODIATRY HANDLE

NON-STERILE

PRODUCT NUMBER	FEATURES	QUANTITIES
97-1450	#3K	1 Each



MINI BLADES AND SCALPELS

STERILE

PRODUCT NUMBER	FEATURES	QUANTITIES
97-1822	#61	25/box
97-1821	#62	25/box
97-1820	#63	25/box
97-1826	#64	25/box
97-1825	#65	25/box
97-1824	#67	25/box
97-1823	#69	25/box



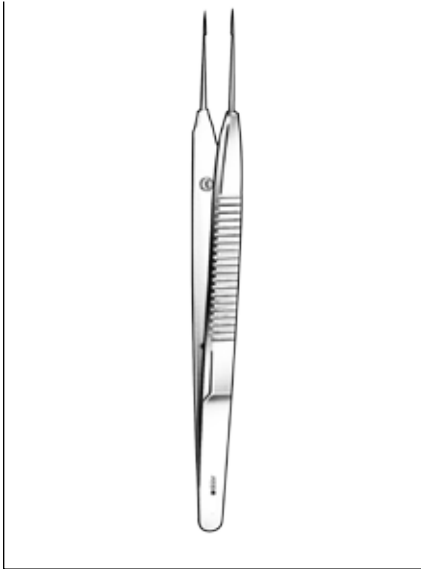

AUSTIN MICRO SUTURE TYING FORCEPS WITH PLATFORM

98-2088	5½"	.8mm
98-2089	7"	.8mm

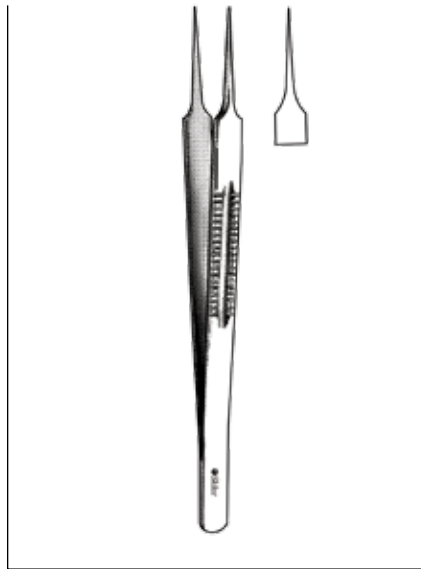

LAZAR MICRO SUTURE TYING FORCEPS

98-6100	6"	.5mm
98-6101	6"	.8mm

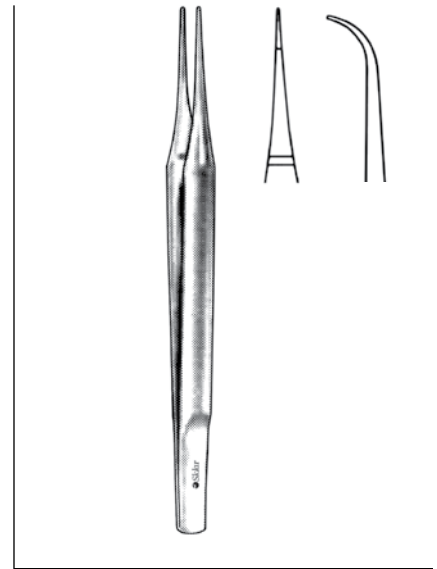

SUTURE TYING FORCEPS ROUND HANDLE WITH PLATFORM, SMOOTH

98-2078	4¾"	Straight	.3mm
98-2079	4¾"	Curved	.3mm
98-2080	6"	Straight	.3mm
98-2081	6"	Curved	.3mm
98-2082	7"	Straight	.3mm
98-2083	7"	Curved	.3mm

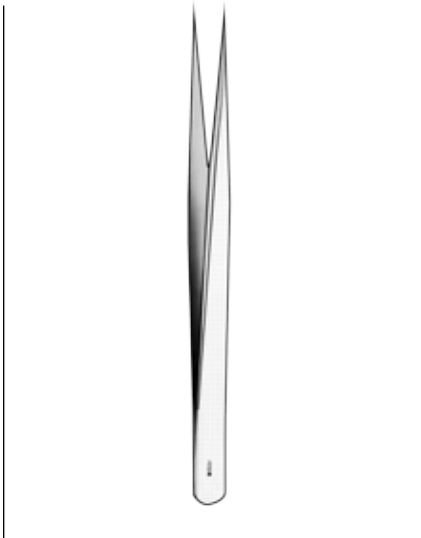

VICE SUTURE TYING FORCEPS WITH PLATFORM

98-2090	5¼"	Straight	.3mm
98-2091	5¼"	Curved	.3mm

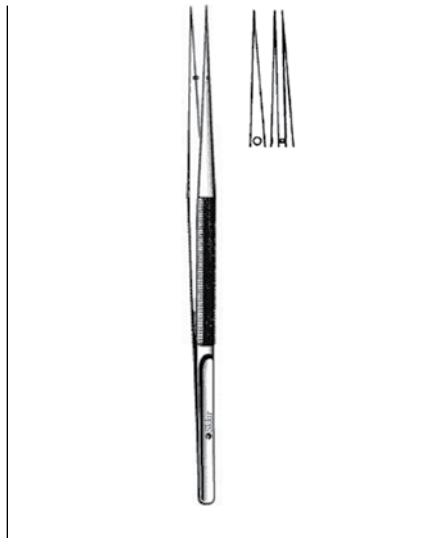

RHOTON SUTURE TYING FORCEPS ROUND HANDLE WITH PLATFORM

98-3056	7"	Straight	.6mm
---------	----	----------	------

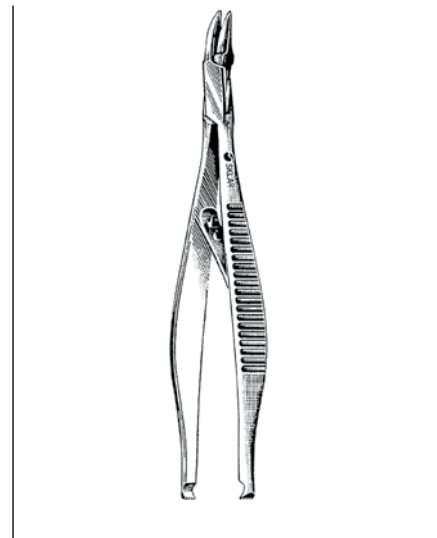

MICHEL CLIP APPLYING AND REMOVING FORCEPS DOUBLE ENDED

24-1250	5"
---------	----

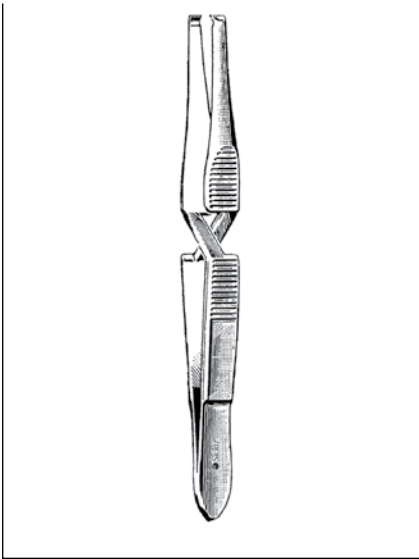

**HEGENBARTH CLIP
APPLYING FORCEPS**

24-1650 5"

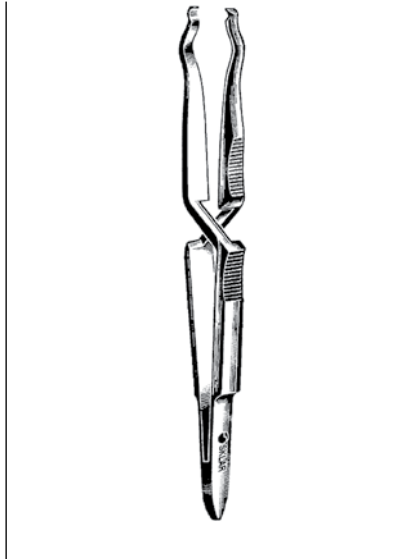

**WACHENFELDT CLIP
APPLYING AND REMOVING
FORCEPS**

24-1450 5" Cross Action

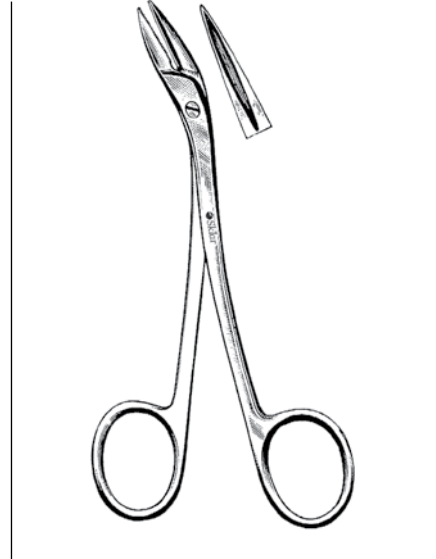

**RICHTER-HEATH
CLIP REMOVING FORCEPS**

24-2055 5½"

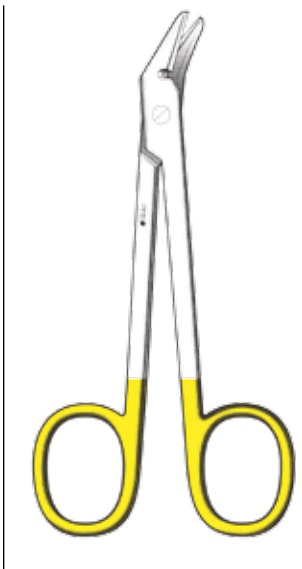

**TC SUTURE WIRE
CUTTING SCISSORS**

16-2800 4¾" Angled

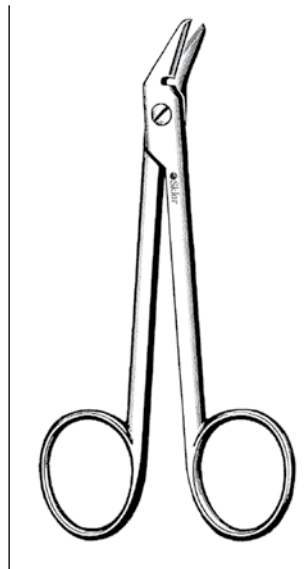

**SUTURE WIRE
CUTTING SCISSORS
ANGLED**

24-2342 4¾" Serrated

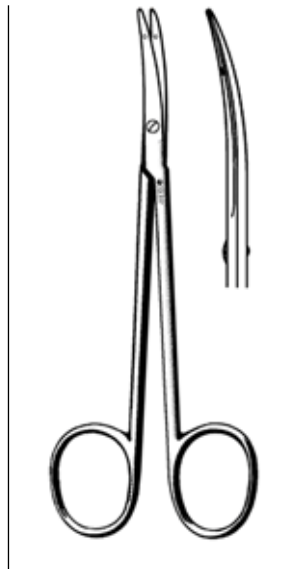

**LITTLER SUTURE
CARRYING SCISSORS**

22-2645 4½" Curved

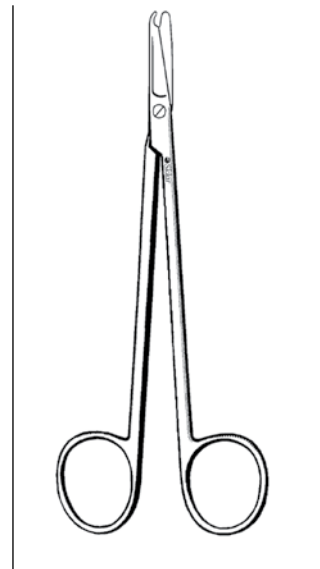

**LONG STITCH
SCISSORS**

15-1358 6¼"

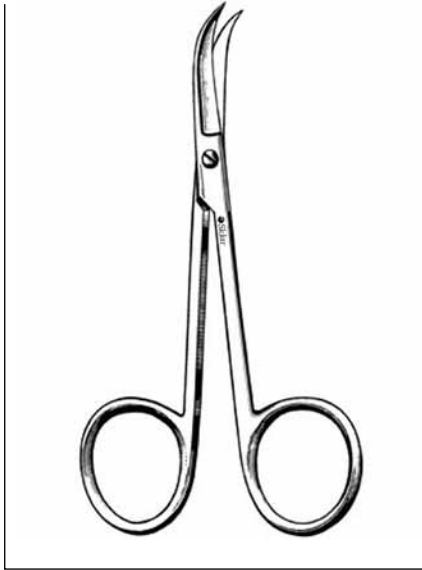

HILL STITCH SCISSORS

22-2955 4¾" Curved



SUTURE SCISSORS

- 22-2935 3½" Shortbent Hooked Blade
- 22-2934 3½" Shortbent, Delicate Hooked Blade
- 22-2947 4¾" Northbent

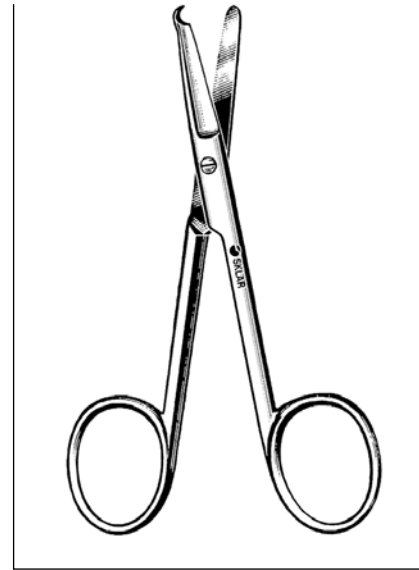

SPENCER(LITTAUER) STITCH SCISSORS

- 22-2835 3½" Hooked Blade
- 22-2845 4½" Hooked Blade
- 15-1355 5½" Hooked Blade

DELICATE

- 22-2834 3½" Hooked Blade
- 22-2844 4½" Hooked Blade
- 22-1354 5½" Hooked Blade

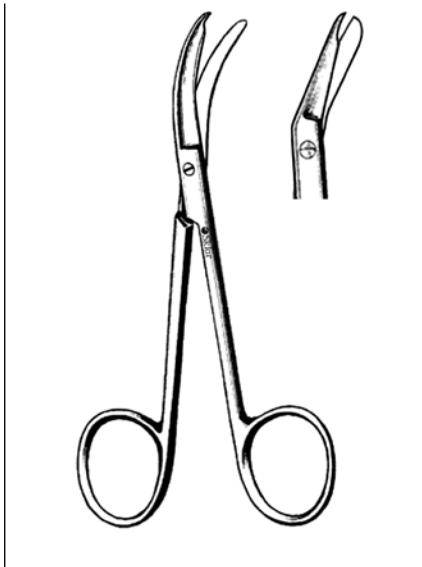

SKLAR STITCH SCISSORS

DELICATE HOOKED BLADE

- 15-3150 4½" Angled
- 22-2950 5" Curved

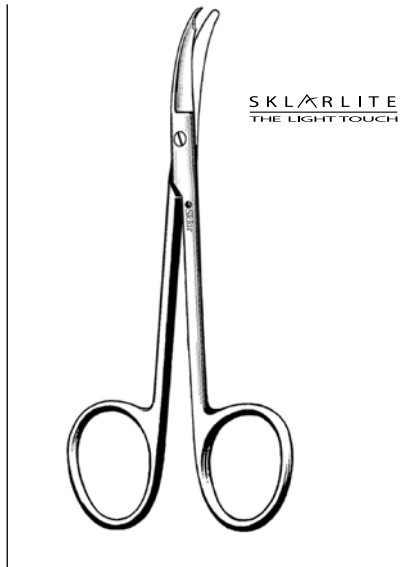

SKLARLITE™ XD SUTURE SCISSORS

- 23-1196 3½" Shortbent
- SKLARLITE™ SUTURE SCISSORS**
- 23-1191 3½" Shortbent

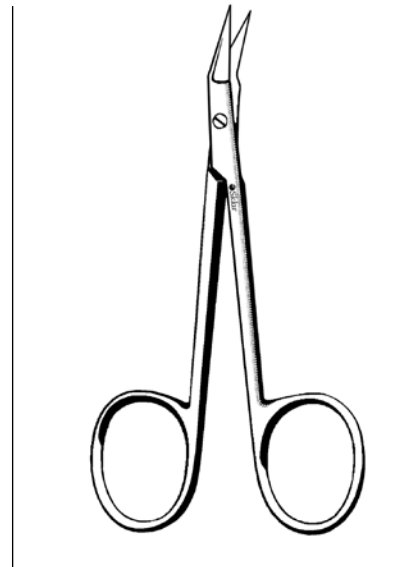

O'BRIEN STITCH SCISSORS

22-2837 3¾" Angled

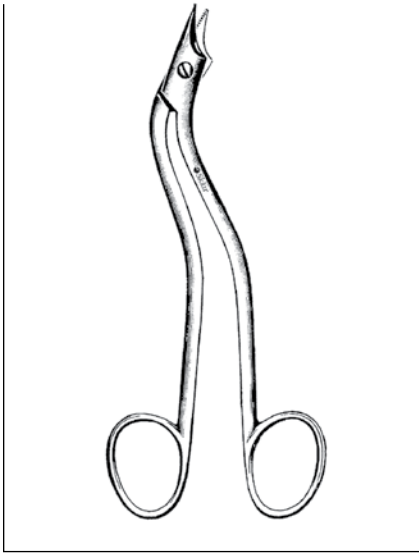

HEATH SCISSORS

24-1962 6¼" Serrated

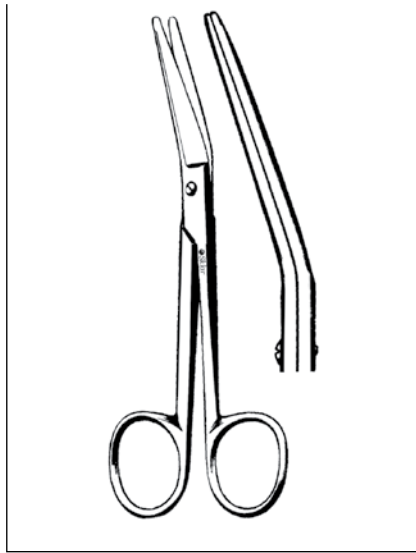

NEW'S SUTURE SCISSOR

41-1163 5½" Angled on Flat

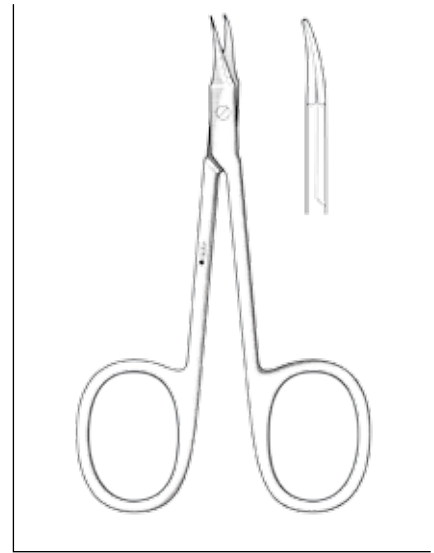

GRADLE SCISSORS

64-3280 3¾" Slight Curve



GRADLE STITCH SCISSORS

22-2957 3¾"

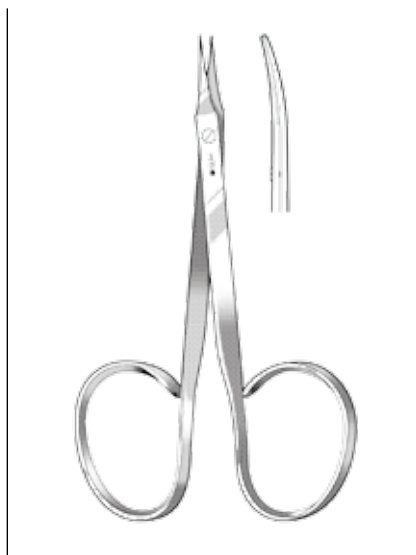

RIBBON STITCH SCISSORS

64-1345 4" Straight
64-1445 4" Curved

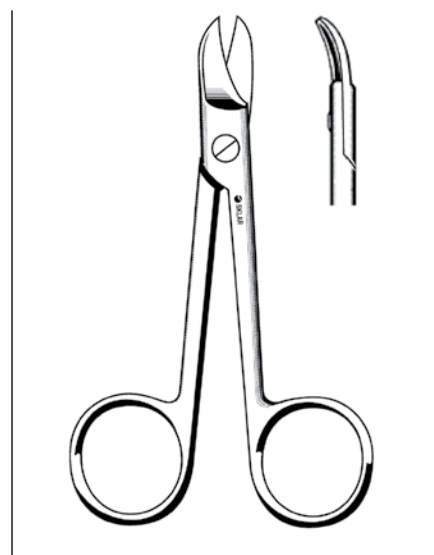

CROWN SCISSORS

24-2345 4" Straight, Smooth
24-2340 4" Straight, Serrated
24-2346 4" Curved, Smooth
24-2341 4" Curved, Serrated

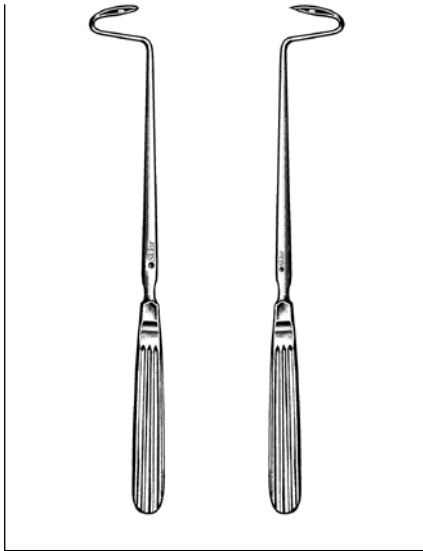

DESCHAMP NEEDLES

CURVED

26-1480	8"	Right, Sharp
26-1280	8"	Right, Blunt
26-1380	8"	Left, Blunt
26-1580	8"	Left, Sharp
26-1780	9½"	Right, Blunt
26-1680	9½"	Left, Blunt
26-1685	11"	Left, Blunt

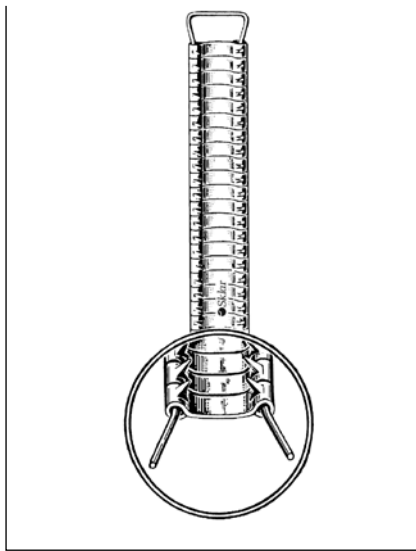

MICHEL CLIPS

PACK OF 1000

24-1007	7.5mm
24-1011	11mm
24-1012	12mm
24-1014	14mm
24-1016	16mm
24-1018	18mm
24-1020	20mm
24-1022	22mm

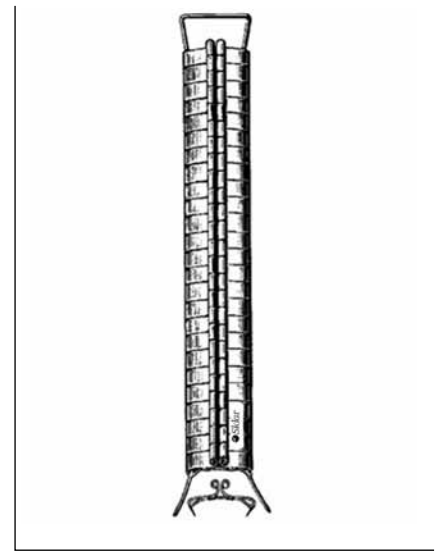

WACHENFELDT CLIPS

PACK OF 100

24-1116	16mm
---------	------

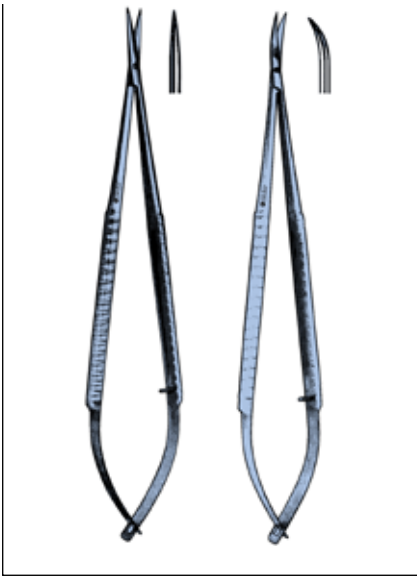

TITANIUM MICRO SCISSORS

ROUND HANDLE

98-4340T	6"	Straight
98-4341T	6"	Curved
98-4342T	7"	Straight
98-4343T	7"	Curved
98-4344T	8¼"	Straight
98-4345T	8¼"	Curved

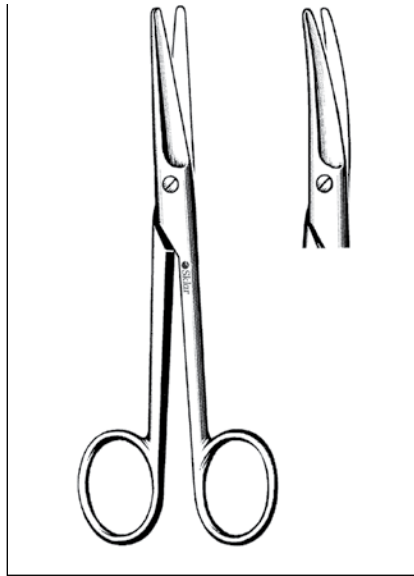

SKLARLITE XD MAYO DISSECTING SCISSORS

EXTRA DELICATE

23-1168	5½"	Straight
23-1170	5½"	Curved

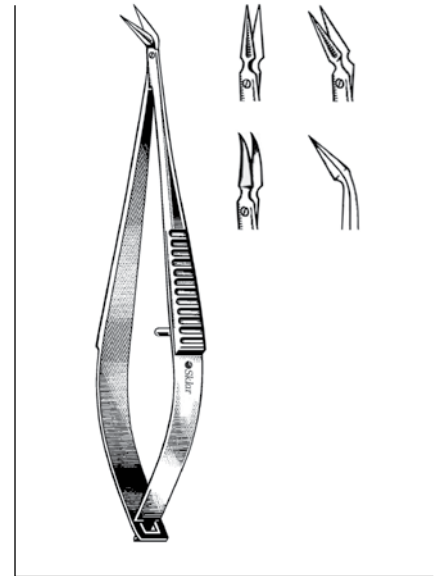

VANNAS MICRO SCISSORS

FLAT GROOVED HANDLE

64-1950	3"	Straight
64-1951	3"	Curved
64-1952	3"	Angled
64-1955	3"	Angled on Flat

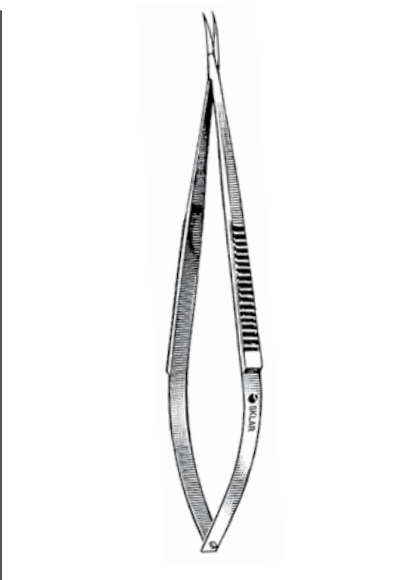

JACOBSON SCISSORS

98-1052	5¼"	Curved
98-1055	6¼"	Straight
98-1067	6¼"	Curved

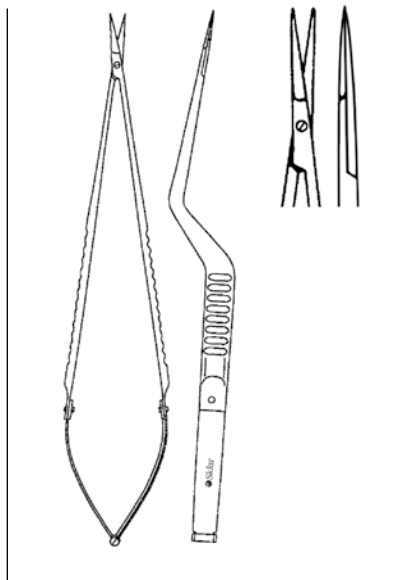

MICROSURGICAL SCISSORS

STRAIGHT, BAYONET HANDLE

98-7920	6½"
98-7924	9½"

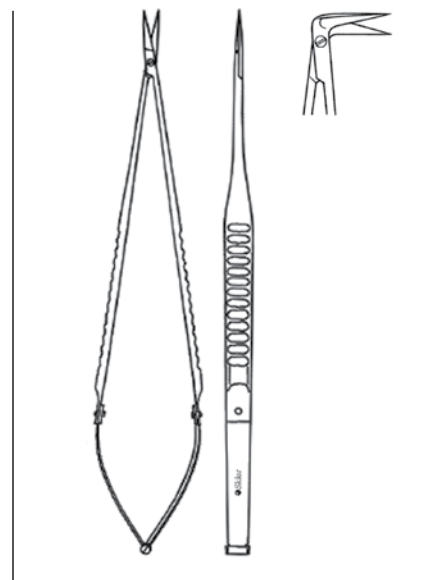

MICROSURGICAL SCISSORS

98-7910	7¼"	90 Degrees, Flat Handle
---------	-----	-------------------------

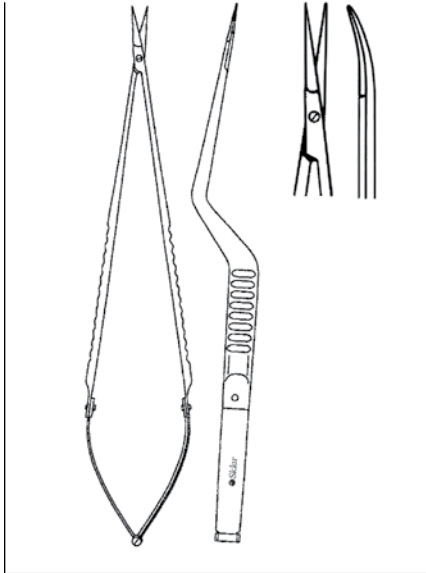

MICROSURGICAL SCISSORS

98-7918 7¾" Bayonet Handle, Curved



MICROSURGICAL SCISSORS

ROUND HANDLE

98-7815 6" Curved, 14mm
 98-7817 7" Curved, 14mm
 98-7837 7" Straight, 27mm

FLAT HANDLE

98-7810 6" Straight, 14mm
 98-7816 7" Straight, 14mm
 98-7814 6" Straight, 14mm

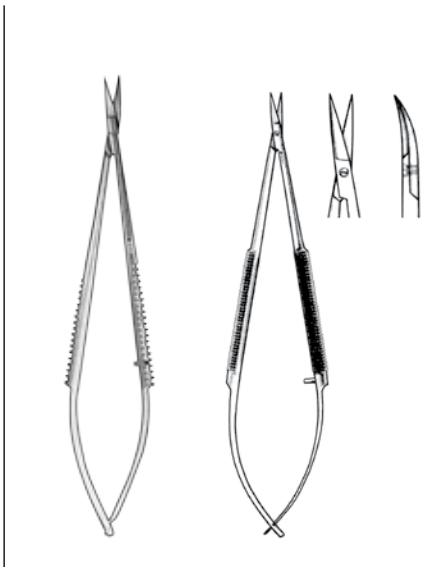

MICRO DISSECTION SCISSORS

ROUND HANDLE

98-7818 6" Curved, 14mm
 98-7819 7" Curved, 14mm

FLAT HANDLE

98-7807 4¼" Curved, 14mm
 98-7808 6" Curved, 14mm
 98-7809 6" Curved, 19mm
 98-7811 6" Curved, 19mm, Saw Edge

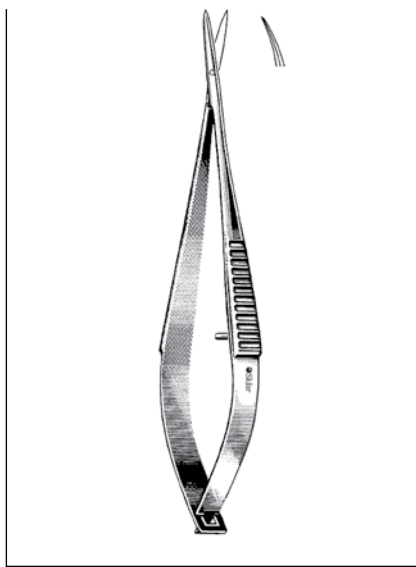

MCPHERSON VANNAS SCISSORS

STRAIGHT

64-1960 3"

CURVED

64-1961 3"

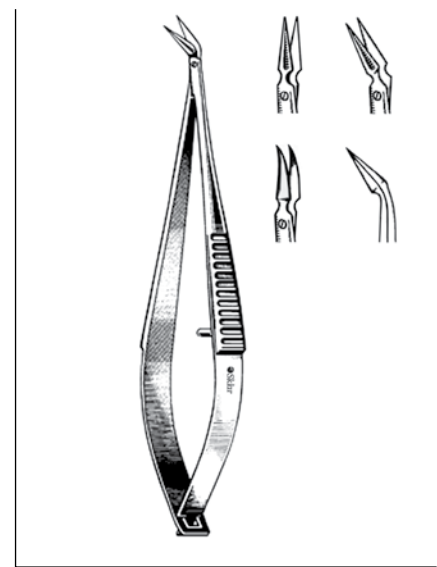

MICRO VANNAS SCISSORS

ULTRA FINE BLADES, 5MM

64-1850 3" Straight
 64-1851 3" Curved
 64-1852 3" Angled
 64-1853 3" Angled Flat

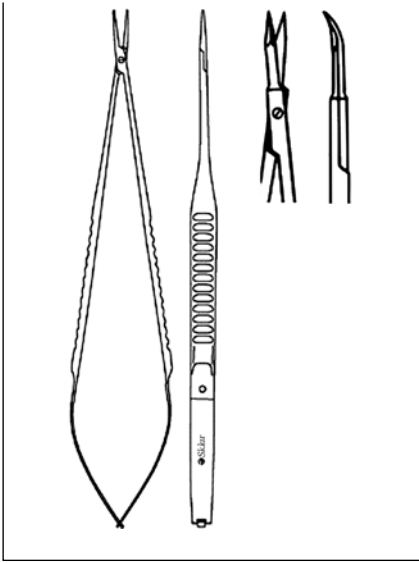

VANNAS MICROSURGICAL SCISSORS

98-7277	6¼"	Straight, Blunt
98-7278	8"	Straight, Blunt
98-7279	9½"	Straight

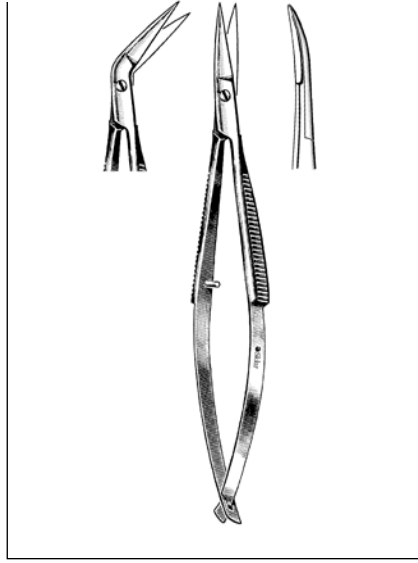

MCCLURE IRIS SCISSORS

64-1842	4¼"	Straight
64-1942	4¼"	Curved
64-1742	4¼"	Angled

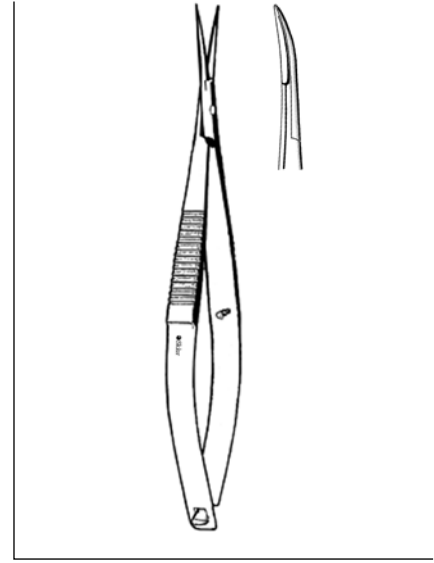

NOYES IRIS SCISSORS

STRAIGHT		
64-3211	4½"	Sharp/Blunt
64-3212	4½"	Sharp/Sharp
CURVED		
64-3215	4½"	Sharp/Sharp
64-3210	4½"	Blunt/Blunt

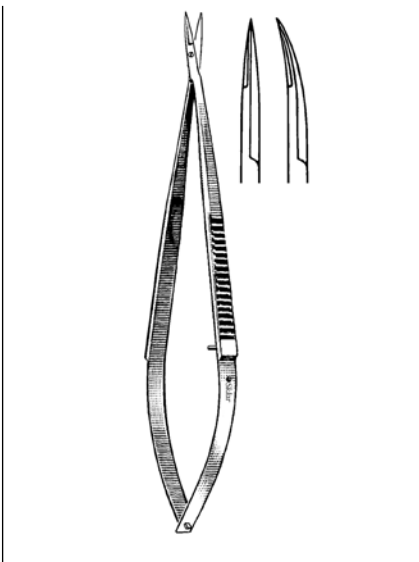

**MICRO IRIS SCISSORS
EXTRA DELICATE**

64-3050	4"	Straight
64-3052	4"	Curved

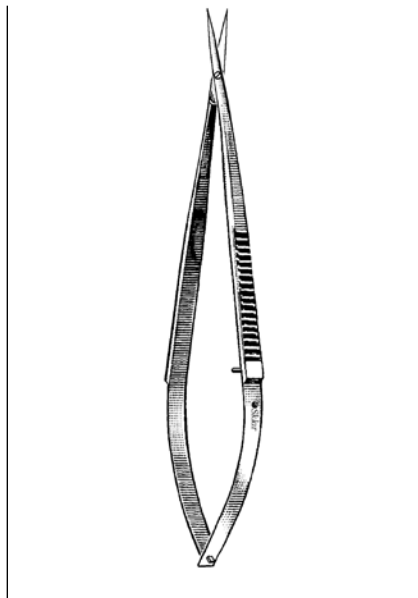

**FINE STITCH SCISSORS
DELICATE**

64-3260	4¼"	Sharp
---------	-----	-------

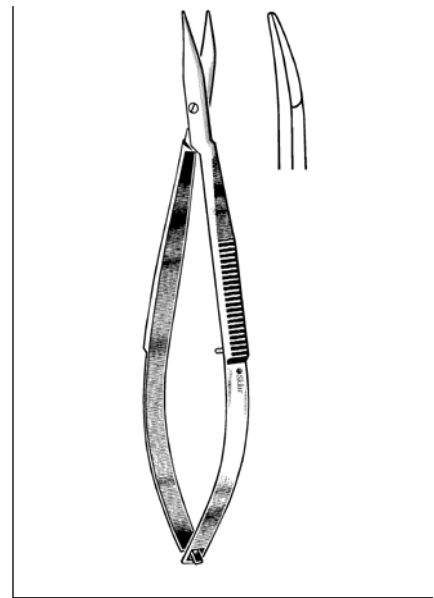

**WESTCOTT TENOTOMY SCISSORS
WITH SPRING HANDLE**

64-3146	4¼"	Curved	Blunt
64-3145	4¼"	Curved	Sharp
64-3142	5"	Right	Blunt
64-3144	5"	Left	Blunt



CASTROVIEJO CORNEAL SCISSORS

EXTRA DELICATE

64-2535	4"	Angled, Blunt
64-2442	4"	Curved, Blunt
64-2242	4 1/4"	Curved Right
64-2342	4 1/4"	Curved Left

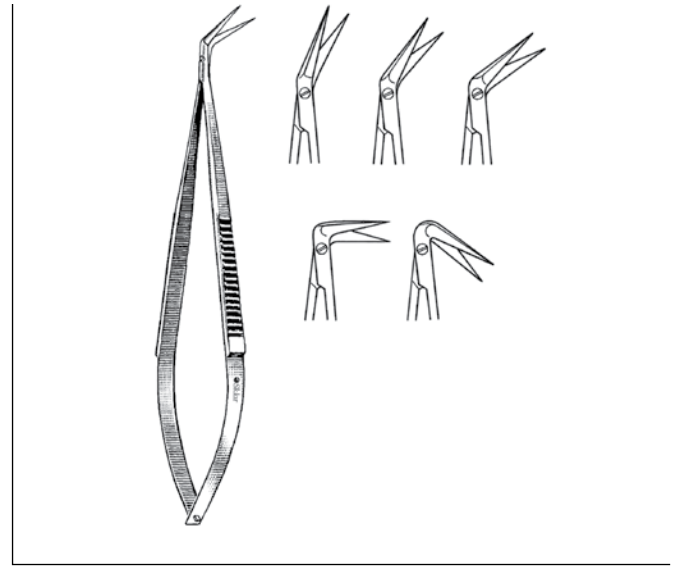

POTTS SMITH VASCULAR SCISSORS

9MM, SHARP, FLAT HANDLE

98-1075	7"	25 Degree Angle
98-1076	7"	45 Degree Angle
98-1077	7"	60 Degree Angle
98-1079	7"	90 Degree Angle
98-1080	7"	120 Degree Angle

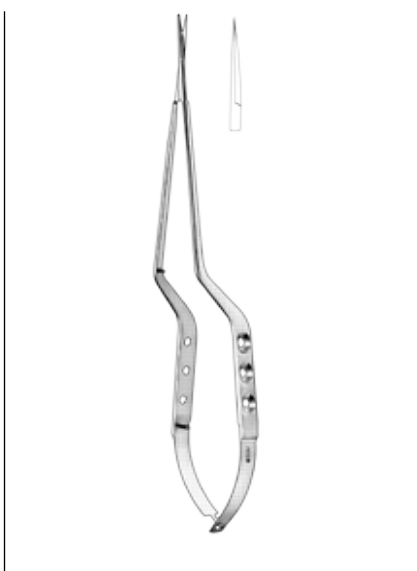

YASARGIL MICRO SCISSORS

STRAIGHT, FLAT BAYONET

98-2101	6 1/4"	Sharp/Sharp
98-2102	6 1/4"	Blunt/Blunt
98-2103	7 3/4"	Sharp/Sharp
98-2104	7 3/4"	Blunt/Blunt
98-2105	8 3/4"	Sharp/Sharp
98-2106	8 3/4"	Blunt/Blunt

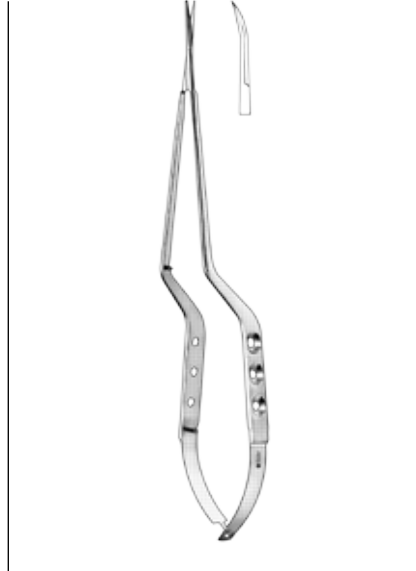

YASARGIL MICRO SCISSORS

CURVED, FLAT BAYONET

98-2107	6 1/4"	Sharp/Sharp
98-2108	7 3/4"	Sharp/Sharp
98-2109	7 3/4"	Blunt/Blunt
98-2110	8 3/4"	Sharp/Sharp
98-2111	8 3/4"	Blunt/Blunt

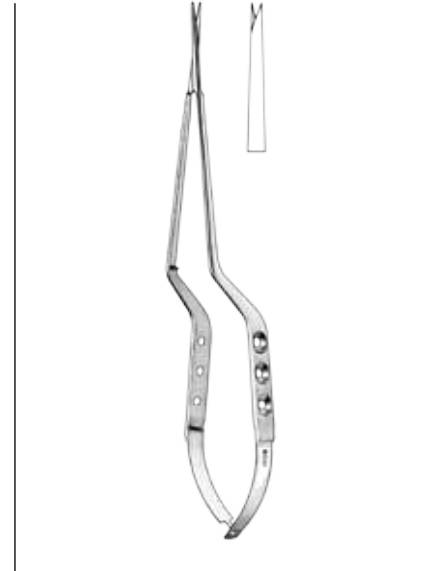

YASARGIL MICRO SCISSORS

SHARP/SHARP, BAYONET WITH KNOTCHED TIP

98-2112	6 1/4"	Straight
98-2115	6 1/4"	Curved
98-2113	7 3/4"	Straight
98-2116	7 3/4"	Curved
98-2114	8 3/4"	Straight
98-2117	8 3/4"	Curved

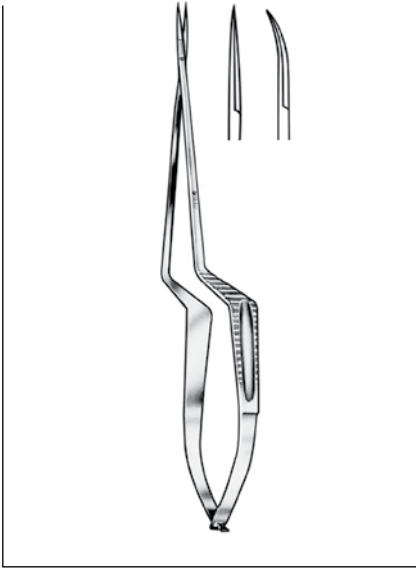

MICROSURGICAL VESSEL SCISSORS

FLAT BAYONET HANDLE

98-7821	7½"	Straight
98-7822	7½"	Curved
98-7823	7½"	Delicate, Straight
98-7824	7½"	Delicate, Curved

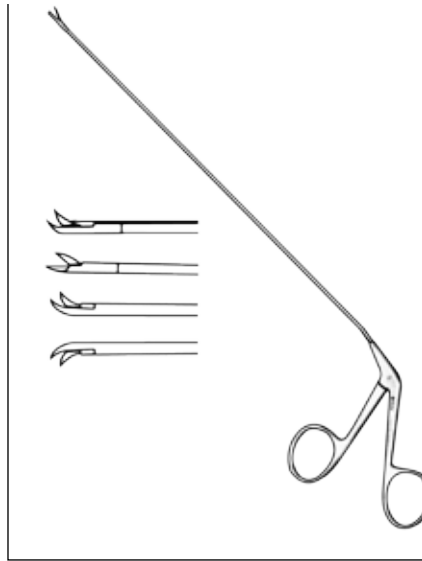

ENDOLARYNGEAL MICROSURGICAL SCISSORS

2MM

98-2180	9¾"	Left Curved
98-2181	9¾"	Straight
98-2182	9¾"	Curved Up
98-2183	9¾"	Right Curved

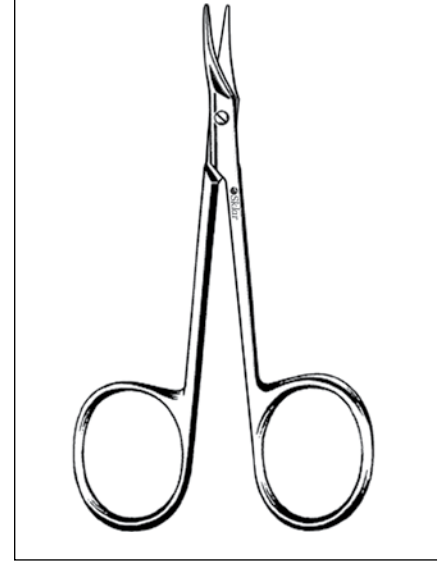

MCGUIRE CORNEAL SCISSORS

64-3298	4¼"	Left
64-3297	4¼"	Right

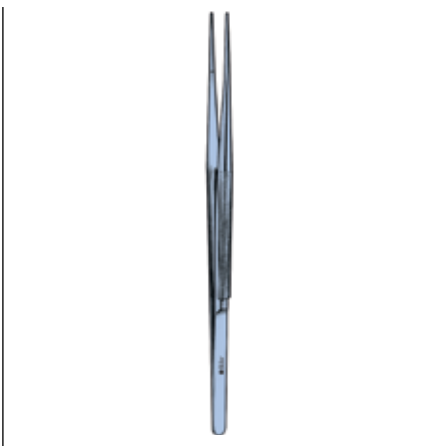

TITANIUM MICRO FORCEPS

STRAIGHT

98-4330T	6"	1x.5mm
98-4331T	7"	1x.5mm
98-4332T	8¼"	1x.5mm



TITANIUM MICRO RING FORCEPS

STRAIGHT

98-4250T	6"	1x.5mm
98-4251T	7"	1x.5mm
98-4252T	8¼"	1x.5mm
98-4253T	9"	1x.5mm
98-3230T	6"	2x1mm
98-3231T	7"	2x1mm
98-3232T	8¼"	2x1mm
98-3233T	9"	2x1mm

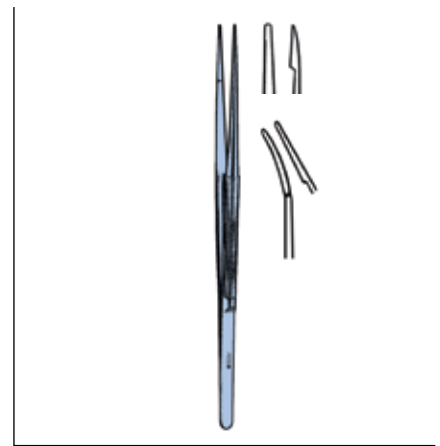

TITANIUM MICRO DRESSING FORCEPS

DIAMOND JAWS

98-4362T	6"	Straight,	6x.4mm Jaw
98-4363T	7"	Straight,	6x.4mm Jaw
98-4364T	6"	Curved,	6x.4mm Jaw
98-4365T	7"	Curved,	6x.4mm Jaw
98-4366T	6"	Straight,	6x.7mm Jaw
98-4367T	7"	Straight,	6x.7mm Jaw
98-4368T	8¼"	Straight,	6x.7mm Jaw
98-4370T	6"	Curved,	6x.7mm Jaw
98-4371T	7"	Curved,	6x.7mm Jaw
98-4372T	8¼"	Curved,	6x.7mm Jaw

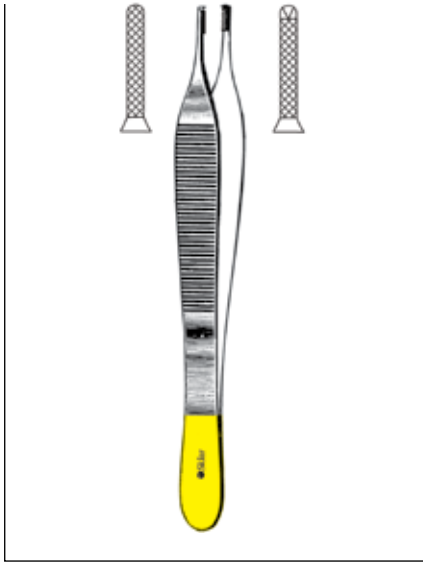
**TC ADSON
FORCEPS**

- 51-3447 4¾" Serrated
- 51-3448 6" Serrated
- 51-3449 4½" 1x2 Teeth
- 51-3450 6" 1x2 Teeth

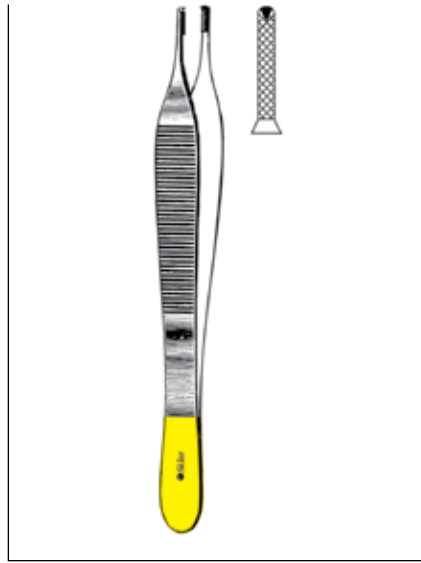
**TC MICRO ADSON
FORCEPS**

- 1X2 TEETH, WITH TYING PLATFORM**
- 51-3050 4¾" Smooth
 - 51-3049 4¾" Serrated
 - 51-3051 6" Serrated

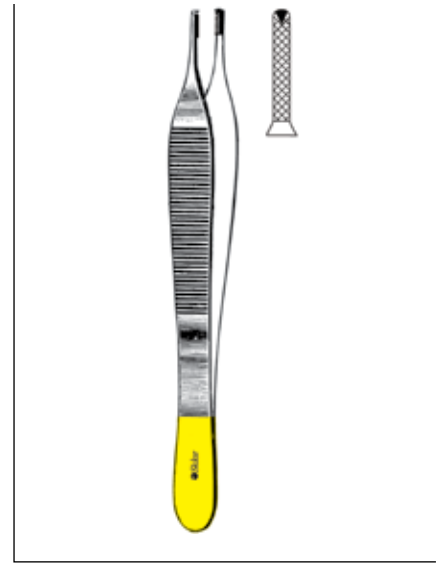
**TC SEMKEN TISSUE
FORCEPS**

- 1X2 TEETH**
- 51-4234 6¼"
 - 51-4235 7"

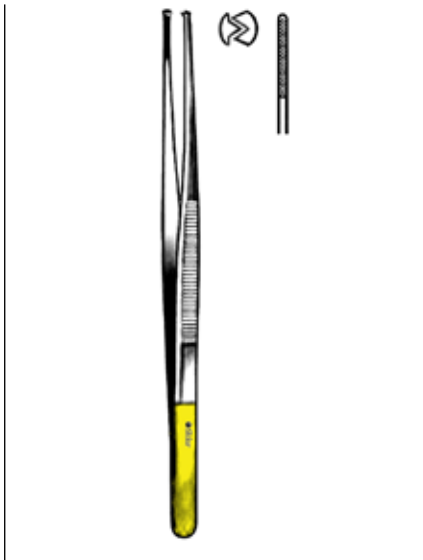
**TC MICRO SEMKEN
TISSUE FORCEPS**

- 51-4238 6"
- 51-4239 7"

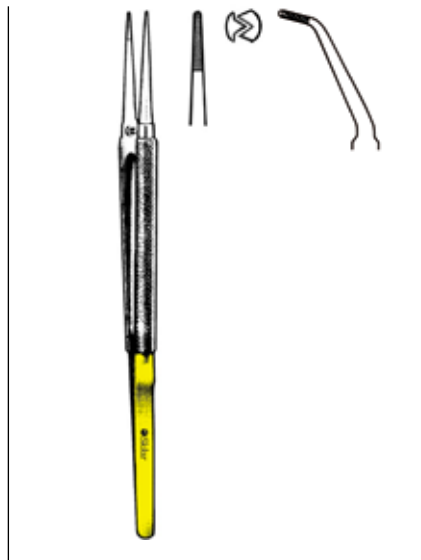
**TC JABOMA
MICRO TISSUE FORCEPS**

- 51-4240 7" Serrated
- 51-4242 7" Straight, 1x2 Teeth
- 51-4244 7" Angled, 1x2 Teeth

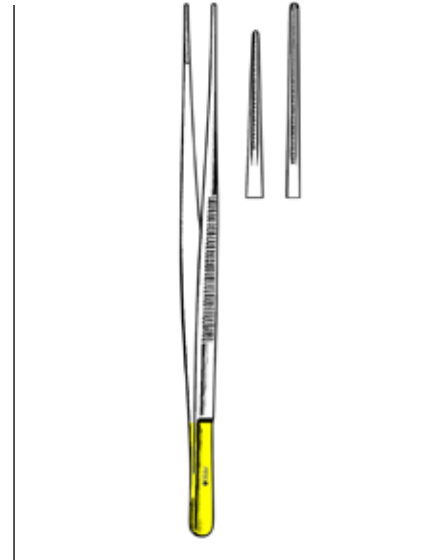
**TC DEBAKEY
ATRAUMATIC FORCEPS**

- ATRAUMATIC**
- 52-5062 6¼" 1.5mm Tip
 - 52-5077 7¾" 1.5mm Tip
 - 52-5095 9½" 1.5mm Tip
 - 52-5162 6¼" 2mm Tip
 - 52-5177 7¾" 2mm Tip
 - 52-5195 9½" 2mm Tip



VICKERS MICRO RING FORCEPS

DIAMOND JAW, STRAIGHT

98-2009	6"	1x.5mm
98-2010	7"	1x.5mm
98-2011	8¼"	1x.5mm
98-2012	9"	1x.5mm

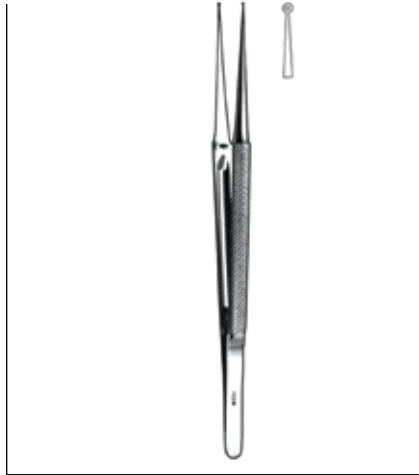

MICRO RING FORCEPS

DIAMOND JAW, STRAIGHT

98-3230	6"	2x1mm
98-3231	7"	2x1mm
98-3232	8¼"	2x1mm
98-3233	9"	2x1mm

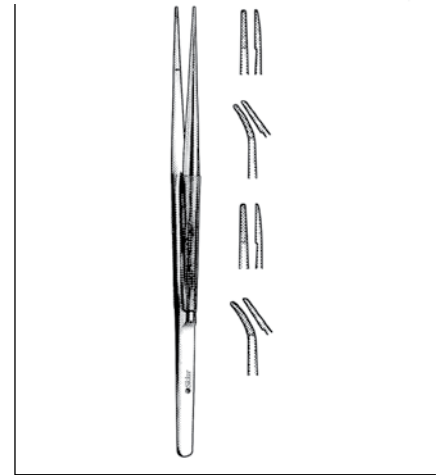

MICRO DRESSING FORCEPS

DIAMOND JAWS

98-4350	6"	Straight, 6x.4mm Jaw
98-4351	7"	Straight, 6x.4mm Jaw
98-4352	6"	Curved, 6x.4mm Jaw
98-4353	7"	Curved, 6x.4mm Jaw
98-4354	6"	Straight, 6x.7mm Jaw
98-4355	7"	Straight, 6x.7mm Jaw
98-4356	8¼"	Straight, 6x.7mm Jaw
98-4357	9"	Straight, 6x.7mm Jaw
98-4358	6"	Curved, 6x.7mm Jaw
98-4359	7"	Curved, 6x.7mm Jaw
98-4360	8¼"	Curved, 6x.7mm Jaw
98-4361	9"	Curved, 6x.7mm Jaw



SKLARLITE™ ADSON FORCEPS

DRESSING

23-2600	4¾"	Serrated
---------	-----	----------

TISSUE

23-2602	4¾"	1x2 Teeth
---------	-----	-----------

SKLARLITE XD™ ADSON FORCEPS

DRESSING

23-2604	4¾"	Serrated
---------	-----	----------

TISSUE

23-2606	4¾"	1x2 Teeth
---------	-----	-----------

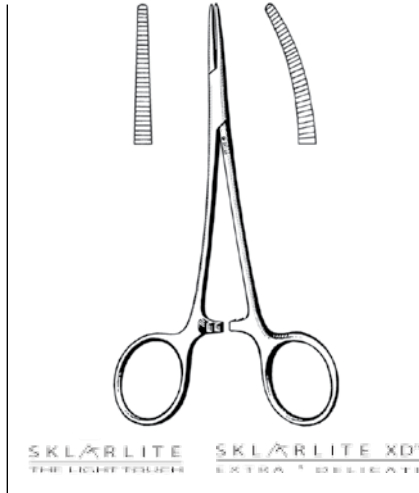

SKLARLITE™ HALSTED MOSQUITO FORCEPS

23-2105	5"	Straight
23-2106	5"	Curved

SKLARLITE XD™ HALSTED MOSQUITO FORCEPS

23-2505	5"	Straight
23-2506	5"	Curved



SKLARLITE™ MIXTER FORCEPS

RIGHT ANGLE

23-2516	5½"
23-2520	7"

SKLARLITE XD™ MIXTER FORCEPS

RIGHT ANGLE

23-2521	5½"
23-2525	7"

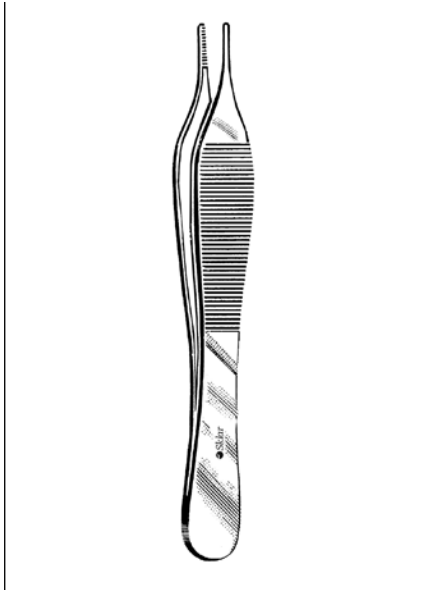

ADSON DRESSING FORCEPS
SERRATED

50-3147	4¾"	
47-2147	4¾"	Delicate
47-2148	4¾"	Angled
50-3070	6"	
50-3071	7"	

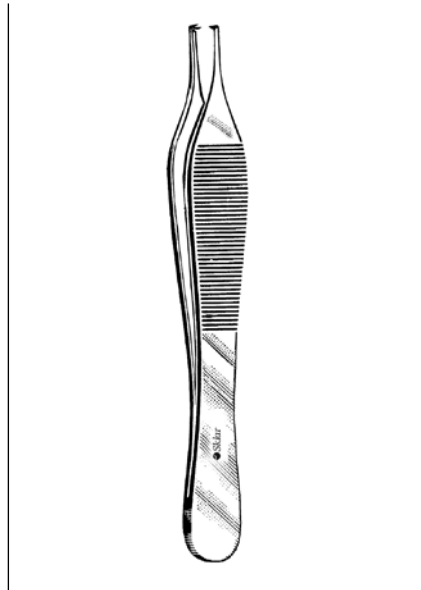

ADSON TISSUE FORCEPS

1X2 TEETH		
50-3047	4¾"	
47-2047	4¾"	Delicate
50-3046	4¾"	Angled
50-3170	6"	
50-3171	7"	
2X3 TEETH		
47-2049	4¾"	Delicate

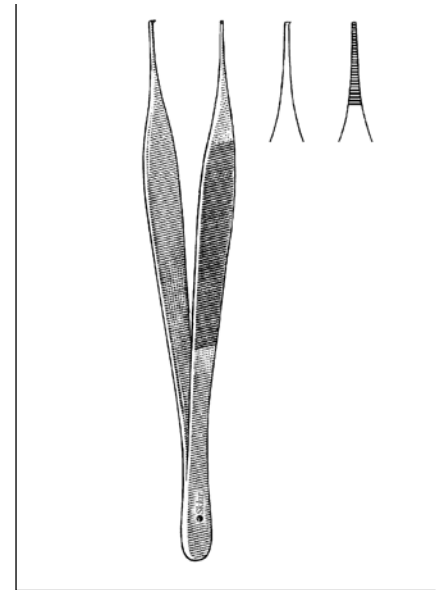

MICRO ADSON FORCEPS

SERRATED		
98-2048	4¾"	
98-2068	6"	
1X2 TEETH		
98-2047	4¾"	1x2 Teeth
98-2067	6"	1x2 Teeth
98-2057	7"	1x2 Teeth

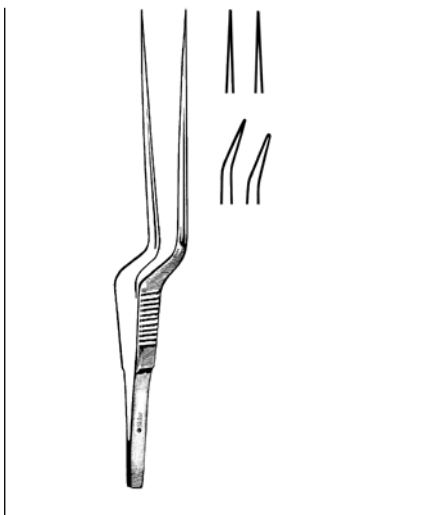

JACOBSON FORCEPS

FLAT BAYONET HANDLE		
98-2072	6¼"	Straight, Sharp
98-2075	7¼"	Straight, Blunt
98-2076	7¼"	Straight, Sharp
98-2077	7¼"	Angled, Blunt

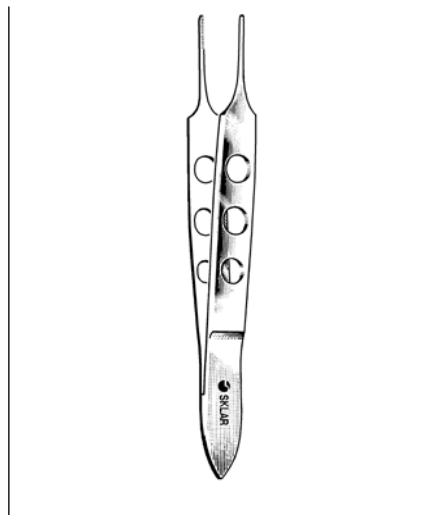

BISHOP-HARMON FORCEPS

66-4032	3½"	Serrated
66-4132	3½"	1x2
66-4230	3½"	1x2 Micro
66-4232	3½"	1x2 Delicate
66-4133	3½"	1x2 Extra Delicate

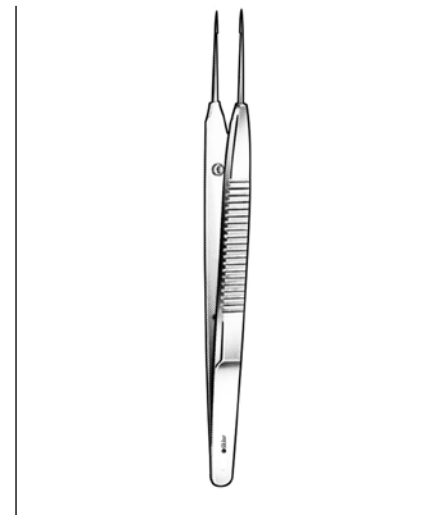

AUSTIN SUTURE TYING FORCEPS WITH PLATFORM

STRAIGHT		
98-2088	5½"	
98-2089	7"	

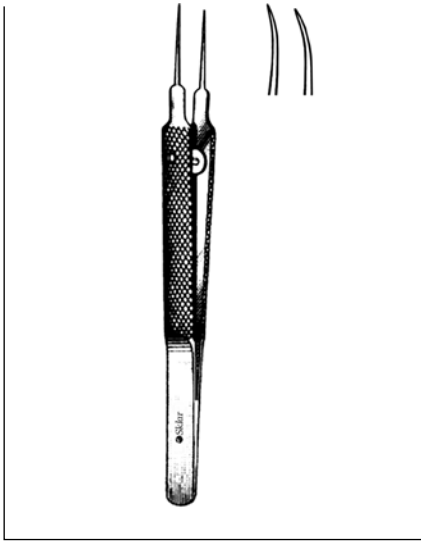

TENNANT TYING FORCEPS

EXTRA DELICATE

66-6194 Straight
66-6196 Curved

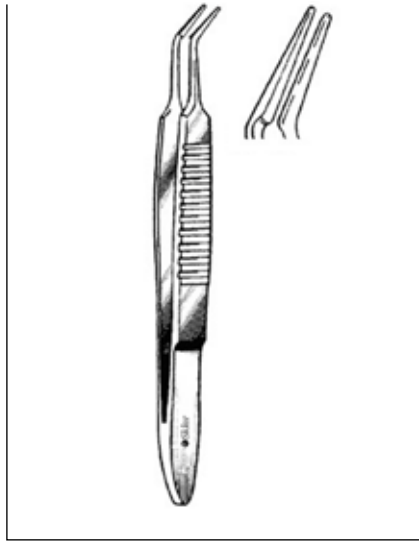

BECHERT-MCPHERSON TYING FORCEPS

66-6178 3¼" Angled

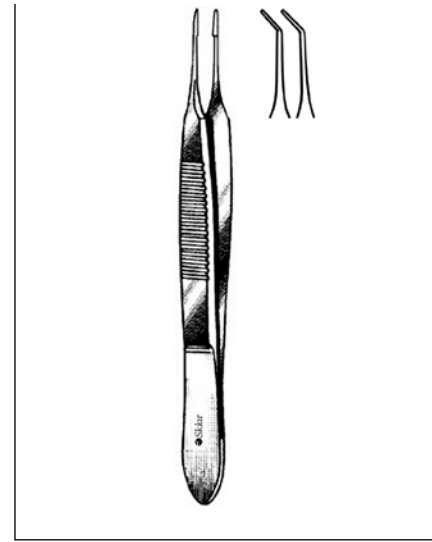

MCPHERSON TYING FORCEPS

STRAIGHT

66-6150 3¼"

ANGLED

66-6152 4"

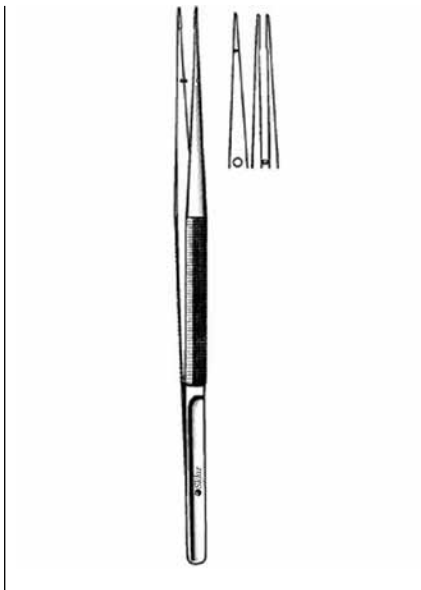

RHOTON-TYPE SUTURE TYING FORCEPS

WITH .6MM PLATFORM

98-3055 7" Straight

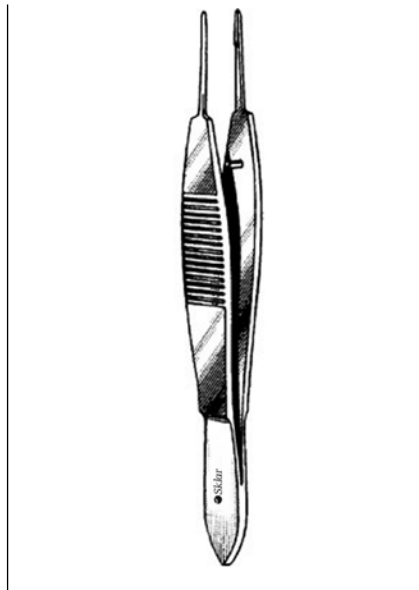

HARMS MICRO TYING FORCEPS WITH .6MM PLATFORM

66-6140 4" Curved
66-6142 4" Straight

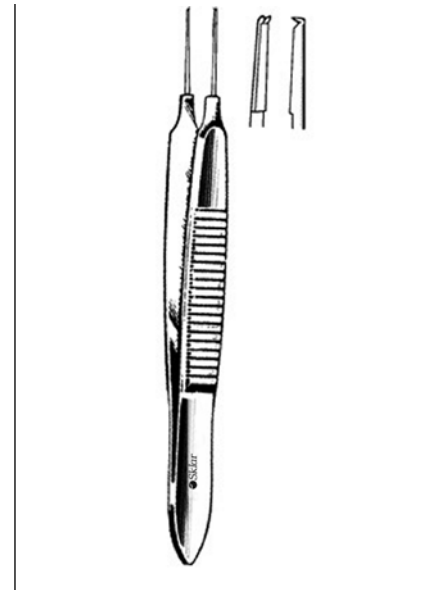

BONN MICRO SUTURING FORCEPS

STRAIGHT, 1X2 TEETH

66-6125 2¾" Straight, Sharp
66-6126 3¾" Straight, Blunt

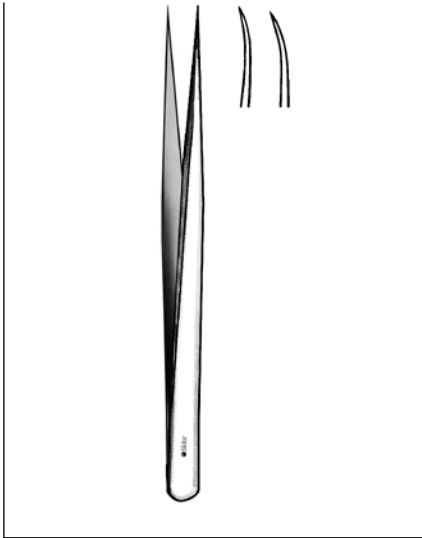

WISE SUTURE TYING FORCEPS

0.3MM TIP WITH TYING PLATFORM

- 98-2090 5¼" Straight
- 98-2091 5¼" Curved

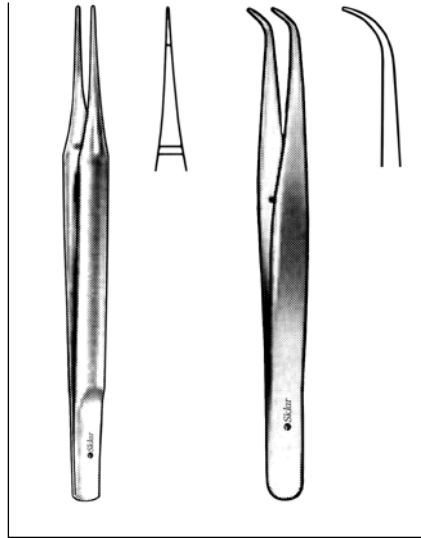

SUTURE TYING FORCEPS SMOOTH, 6MM TYING PLATFORM WITH ROUND HANDLE

- 98-2078 4¾" Straight, .3mm
- 98-2079 4¾" Curved, .3mm
- 98-2080 6" Straight, .3mm
- 98-2081 6" Curved, .3mm
- 98-2082 7" Straight, .3mm
- 98-2083 7" Curved, .3mm

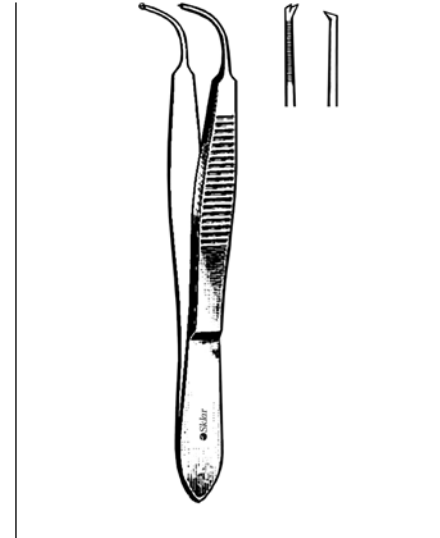

GRAEFE IRIS FORCEPS

STRAIGHT

- 66-4526 2¾" Serrated
- 66-4525 2¾" 1x2 Teeth

CURVED

- 66-4626 2¾" Serrated
- 66-4625 2¾" 1x2 Teeth

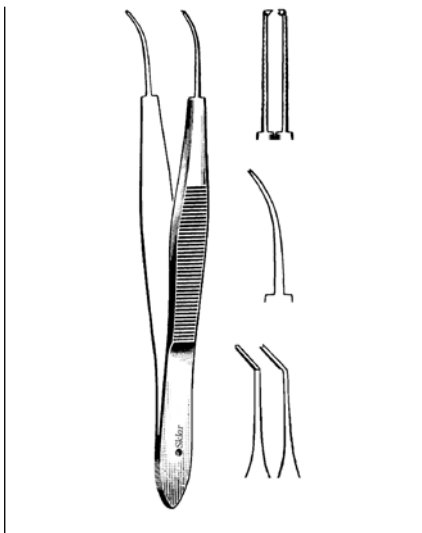

STEVEN IRIS FORCEPS

SERRATED, WITHOUT CATCH

- 66-4947 4" Straight
- 66-4948 4" Curved
- 66-4949 4" Angled

1X2 TEETH, WITHOUT CATCH

- 66-4950 4" Straight
- 66-4951 4" Curved
- 66-4955 4" Angled

WITH CATCH

- 66-4952 4¼" Straight

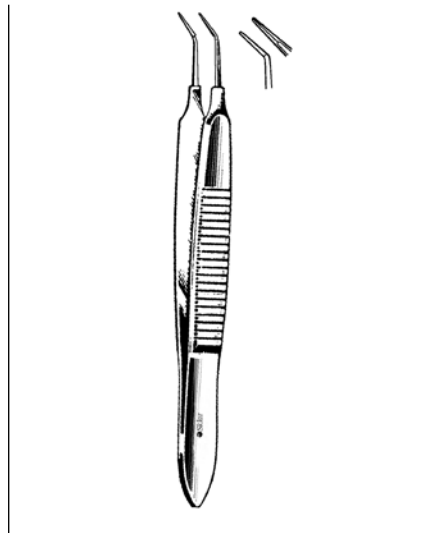

MCPHERSON IRIS MICRO FORCEPS

- 66-6164 3½" Straight
- 66-6166 3½" Curved

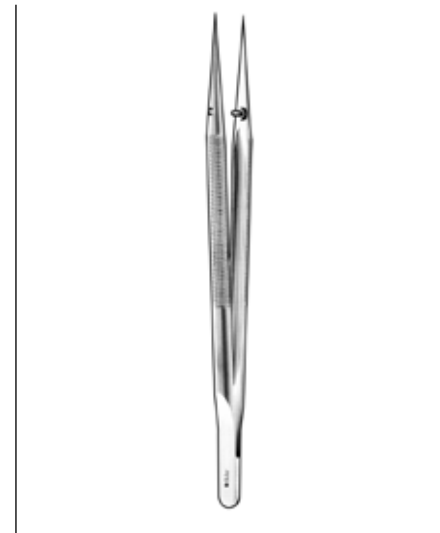

PIERSE MICRO TISSUE FORCEPS

WITH .3MM HOLE, ROUND HANDLE

- 98-2085 6"
- 98-2086 7"

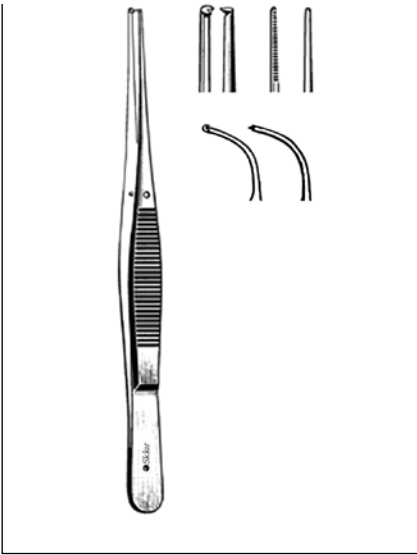

SEMKEN TISSUE FORCEPS

1X2 TEETH

- 22-4450 5" Delicate
- 22-4354 6" Straight
- 22-4352 5" Curved
- 22-4356 6" Curved

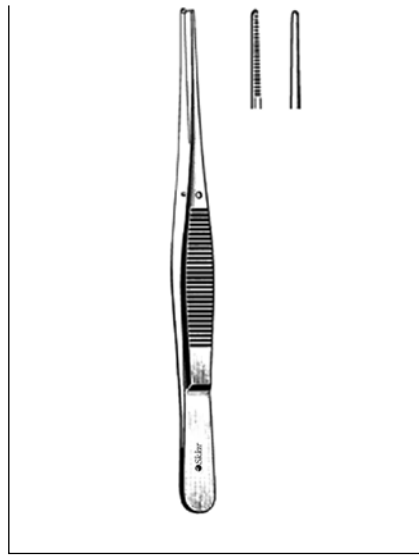

SEMKEN DRESSING FORCEPS

CURVED, SERRATED

- 22-4156 6" Serrated
- 22-4152 5" Serrated

SERRATED

- 22-4154 6" Straight

DELICATE

- 22-4250 6" Serrated

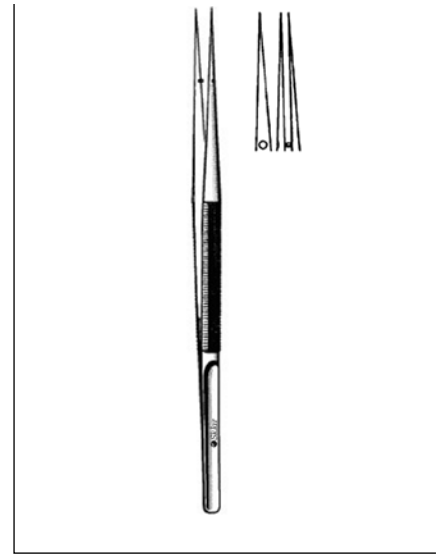

RHOTON MICRO FORCEPS

STRAIGHT, WITH TYING PLATFORM

- 98-3056 7" 0.5mm

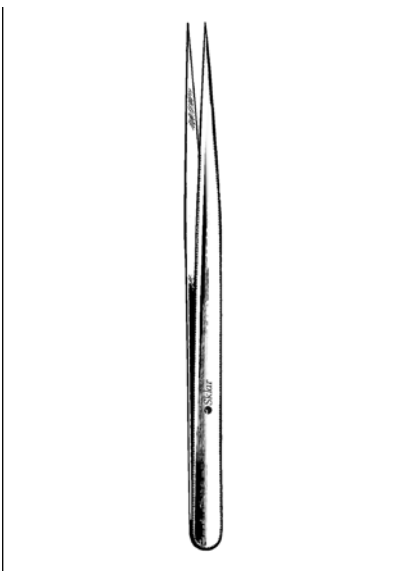

JEWELERS FORCEPS

EXTRA FINE TIP

- 66-7436 4½" #1
- 66-7438 4½" #1

FINE TIP

- 66-7440 4½" #2

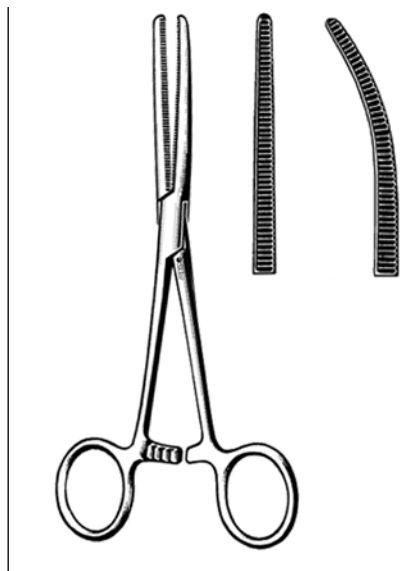

ROCHESTER-PEAN FORCEPS

STRAIGHT, DELICATE

- 22-3555 5½"

CURVED, DELICATE

- 22-3655 5½"
- 17-2362 6¼"
- 22-2272 7¼"
- 22-2280 8"

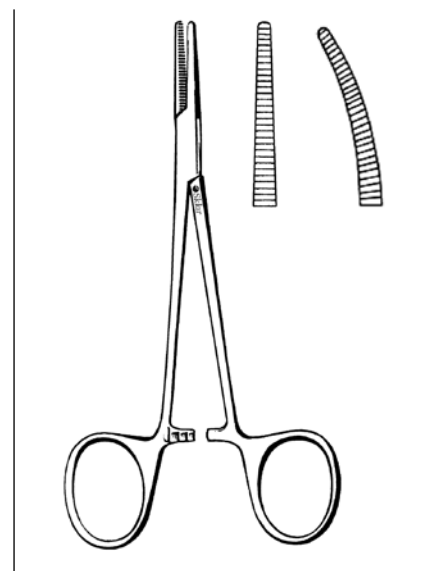

HALSTED MOSQUITO FORCEPS

DELICATE

- 18-1050 5" Straight
- 18-1150 5" Curved

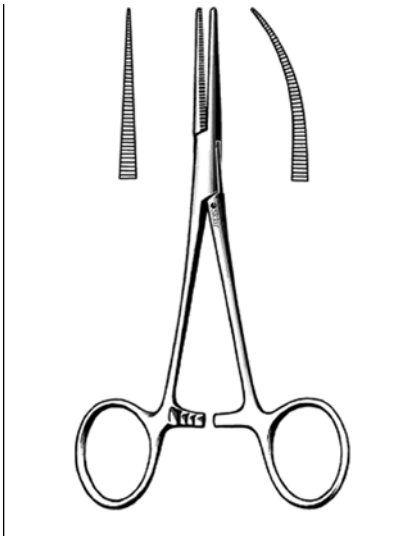

MICRO MOSQUITO FORCEPS

SERRATED

98-2030	4"	Straight
98-2031	4"	Curved
98-2032	4¾"	Straight
98-2033	4¾"	Curved

1X2

98-2034	4"	Straight
98-2035	4"	Curved
98-2036	4¾"	Straight
98-2037	4¾"	Curved

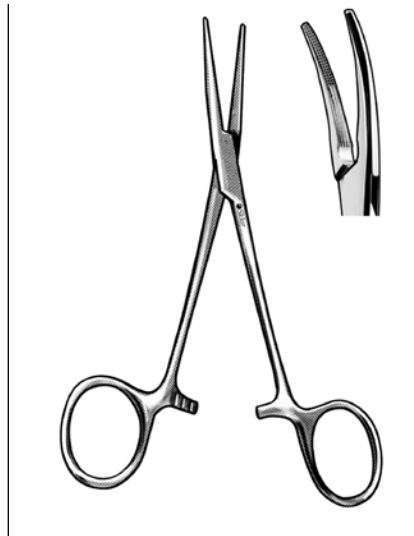

GRAY-TURNER ARTERY FORCEPS

SERRATED

98-5255	6"	0.6mm
---------	----	-------

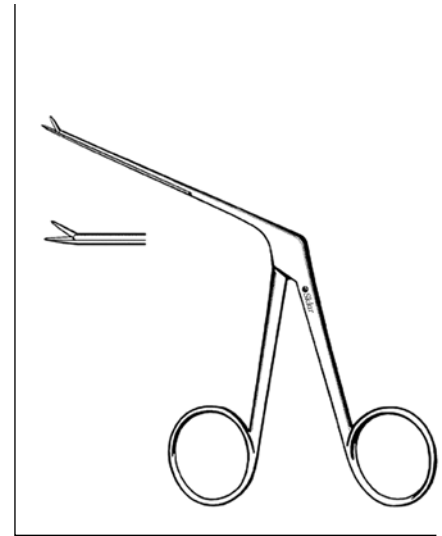

MICRO ALLIGATOR EAR FORCEPS

67-8173	¾"	Oval, .5mm
67-8177	¾"	Oval, Ebony, .5mm
67-8170	¾"	Serrated, .6mm
67-8172	¾"	Ebony, .6mm
67-8178	¾"	.8mm
67-8180	¾"	Oval, Ebony, .8mm
67-8175	¾"	Smooth, .8mm
67-8174	¾"	Serrated, .8mm
67-8176	¾"	Ebony, .8mm

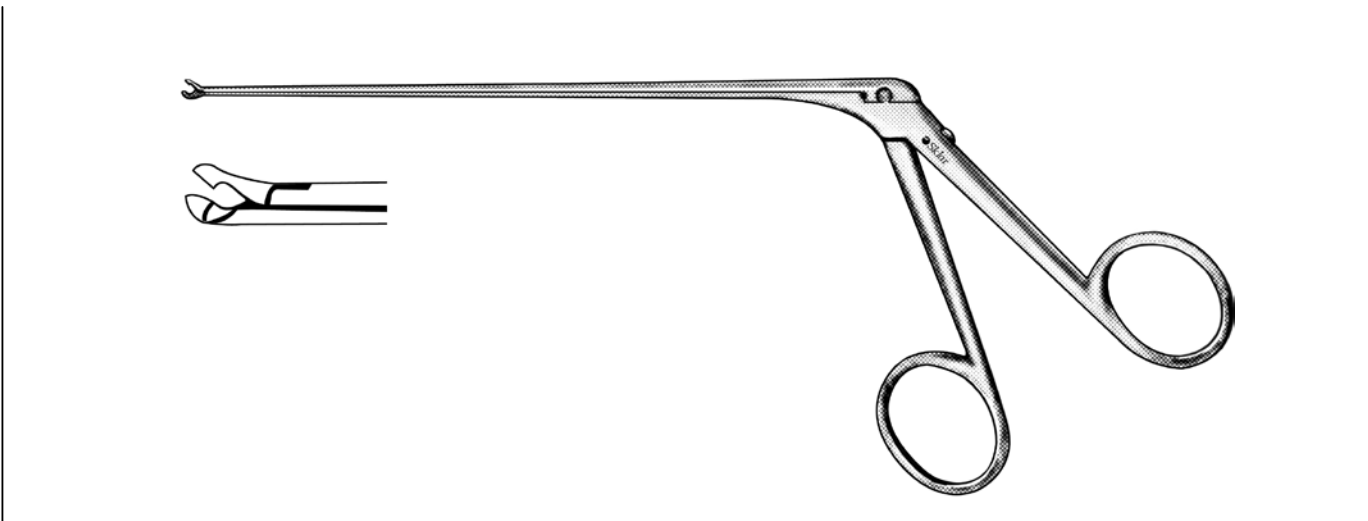

RHOTON MICRO ALLIGATOR FORCEPS

67-8182	6"	Right, 1mm
67-8183	6"	Left, 1mm
67-8184	6"	Straight, 2mm

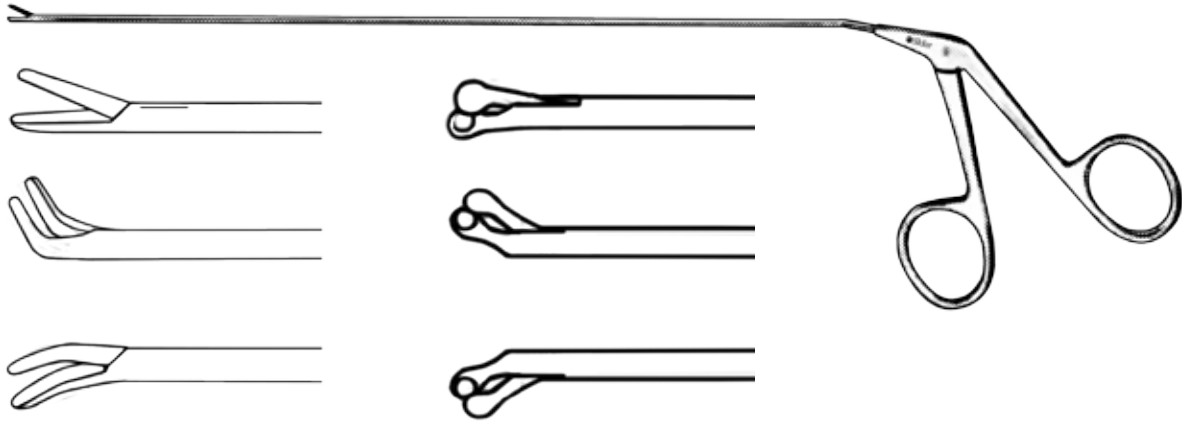

ENDOLARYNGEAL MICRO ALLIGATOR FORCEPS

2MM

98-2172	9¾"	Straight
98-2173	9¾"	Right Curved
98-2174	9¾"	Left Curved

ENDOLARYNGEAL MICRO CUP FORCEPS

2MM

98-2175	9¾"	Curved Upwards
98-2176	9¾"	Right Curved
98-2177	9¾"	Left Curved

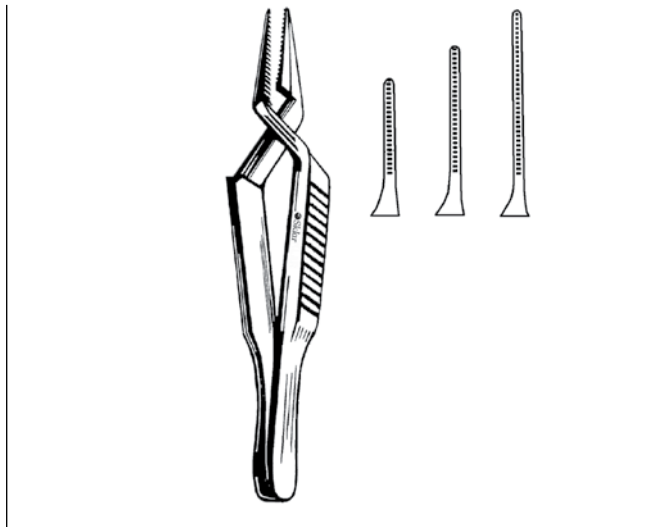

DEITHRICH BULLDOG CLAMPS

STRAIGHT

98-4008	8mm
98-4012	12mm
98-4020	20mm

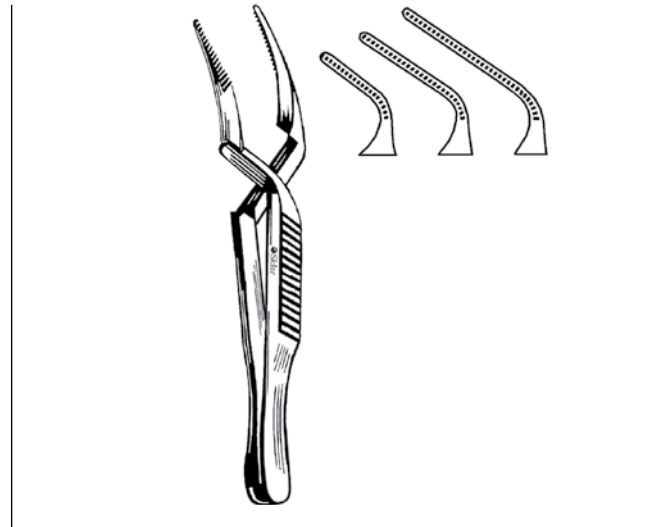

DEITHRICH BULLDOG CLAMPS

ANGLED

98-4108	8mm
98-4112	12mm
98-4120	20mm

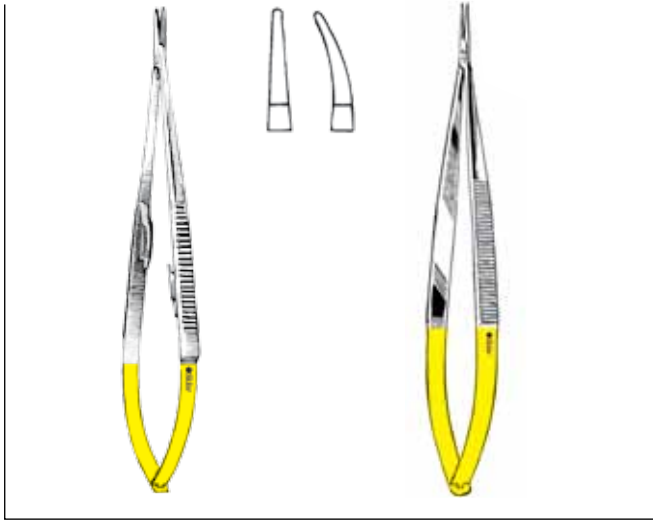

TC CASTROVIEJO MICRO NEEDLE HOLDERS

WITH LOCK, SMOOTH

- 21-8042 5½" Straight, Delicate
- 21-8043 5½" Curved, Delicate
- 21-8040 5½" Straight
- 21-8046 5½" Curved
- 21-8047 5½" Curved, Serrated

WITHOUT LOCK, SMOOTH

- 21-8044 5½" Straight
- 21-8045 5½" Curved

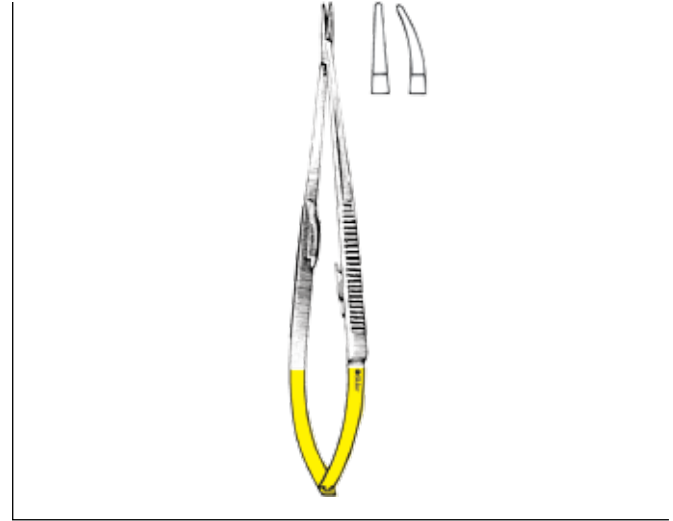

TC CASTROVIEJO NEEDLE HOLDERS WITH DIAMOND JAW

WITH LOCK, SERRATED

- 21-8130 5½" Straight
- 21-8131 6½" Curved

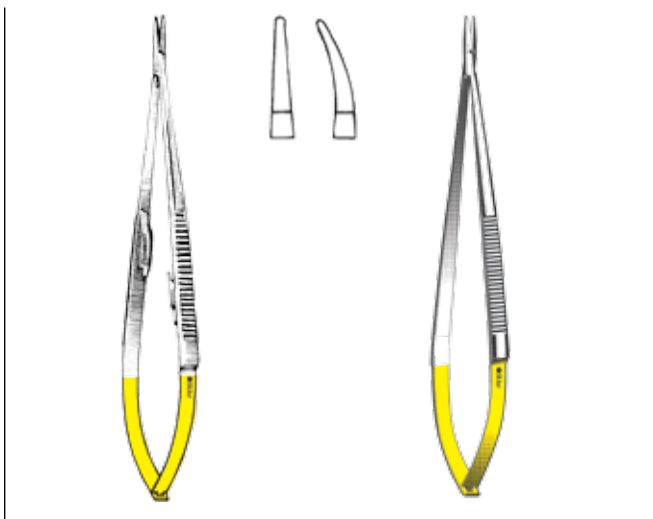

TC JACOBSON NEEDLE HOLDERS WITH DIAMOND JAW

WITH LOCK

- 21-8132 7" Straight
- 21-8133 7" Curved
- 21-8134 8½" Straight
- 21-8135 8½" Curved

WITHOUT LOCK

- 21-8136 5½" Straight
- 21-8137 6½" Curved
- 21-8138 7" Straight
- 21-8139 7" Curved
- 21-8140 8½" Straight
- 21-8141 8½" Curved

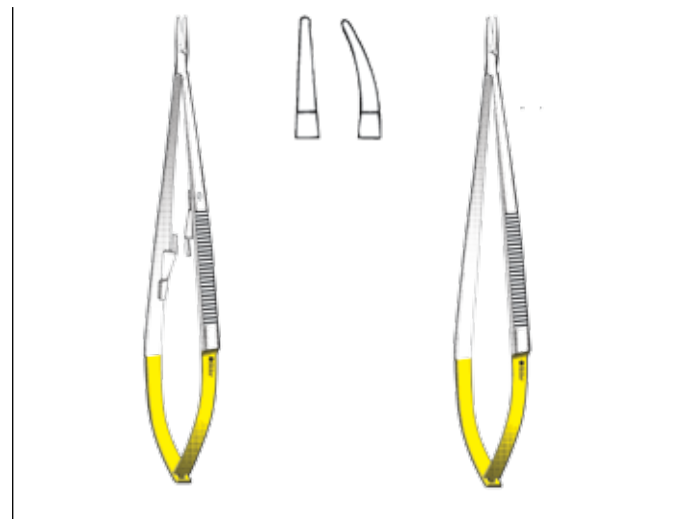

TC JACOBSON NEEDLE HOLDERS

WITH LOCK, SMOOTH

- 21-8053 7" Straight
- 21-8253 7" Curved
- 21-8055 8½" Straight
- 21-8057 9" Straight
- 21-8257 9" Curved
- 21-8059 9¼" Straight

WITHOUT LOCK, SMOOTH

- 21-8054 7" Straight
- 21-8254 7" Curved
- 21-8058 8½" Straight
- 21-8258 8½" Curved
- 21-8259 9" Curved

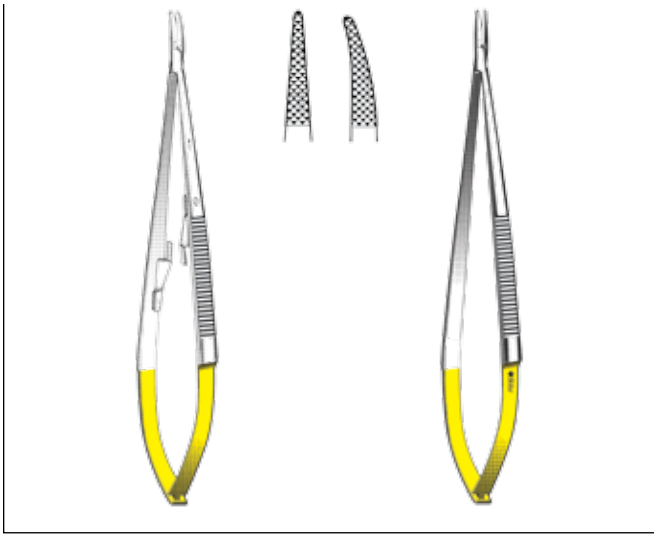

TC JACOBSON NEEDLE HOLDERS

SERRATED WITH LOCK

21-8250	7"	Straight
21-8251	7"	Curved
21-8052	8½"	Straight
21-8056	8½"	Curved
21-8157	9"	Straight
21-8158	9"	Curved

SERRATED WITHOUT LOCK

21-8150	7"	Straight
21-8151	7"	Curved
21-8152	8½"	Straight
21-8156	8½"	Curved
21-8159	9"	Straight
21-8160	9"	Curved



TC PAR DIAMOND-LITE NEEDLE HOLDERS

DELICATE, SERRATED

21-7012	4½"
21-7013	5"



TC WEBSTER NEEDLE HOLDERS

21-8080	5¼"	Serrated
21-8002	5¼"	Smooth
21-2240	4½"	Smooth



TC HEGAR VASCULAR NEEDLE HOLDER

20-4175	6¾"
20-4178	7¾"

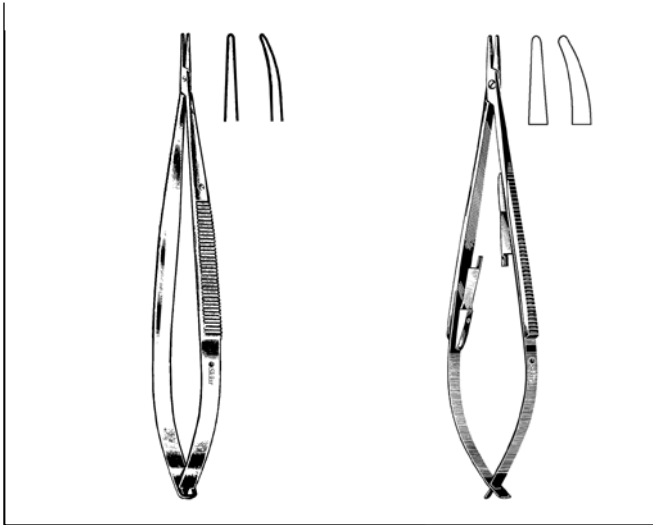

CASTROVIEJO MICRO NEEDLE HOLDERS

EXTRA DELICATE, WITHOUT LOCK

65-6350 5½" Straight
65-6351 5½" Curved

EXTRA DELICATE, WITH LOCK

65-6352 5½" Straight
65-6354 5½" Curved

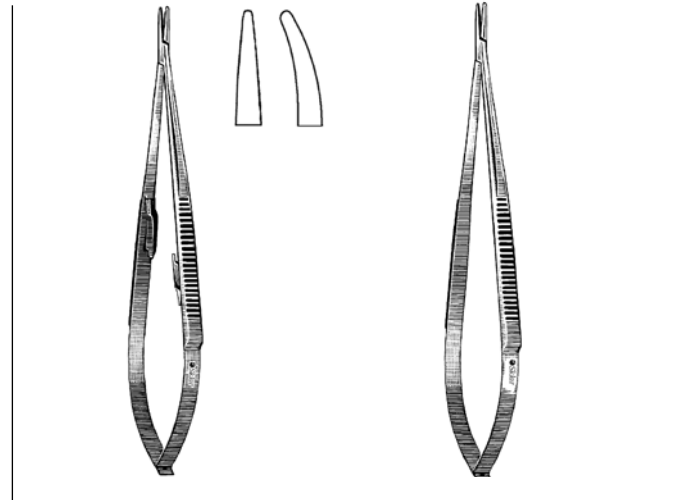

JACOBSON NEEDLE HOLDERS

FLAT HANDLE, WITH LOCK

98-3170 7" Straight
98-3171 7" Curved

FLAT HANDLE, WITHOUT LOCK

98-3070 7" Straight



MICROSURGICAL NEEDLE HOLDERS

.6MM JAW, WITHOUT LOCK

98-3182 6" Straight
98-3183 6" Curved

.6MM JAW, WITH LOCK

98-3184 6" Straight
98-3185 6" Curved

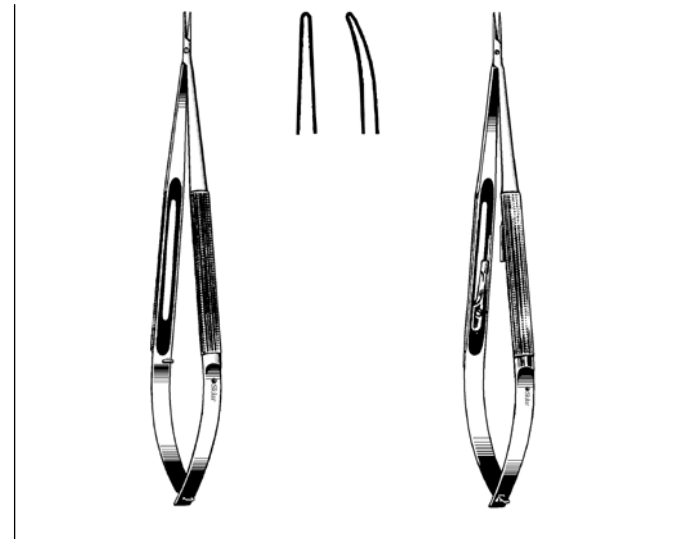

MICROSURGICAL NEEDLE HOLDERS

ROUND HANDLE, WITHOUT LOCK

98-3180 5¼" Curved
98-3186 7⅞" Straight
98-3188 7⅞" Curved

ROUND HANDLE, WITH LOCK

98-3190 7⅞" Straight With Lock
98-3192 7⅞" Curved With Lock

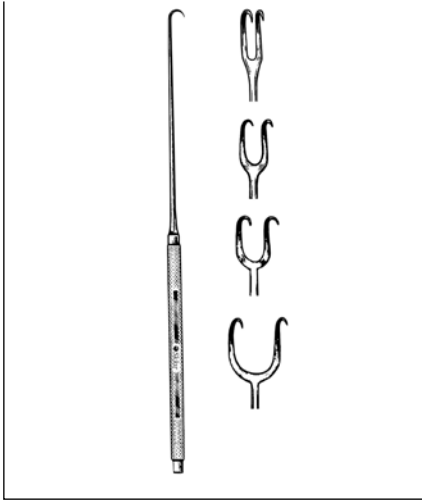

JOSEPH SKIN HOOKS

2 PRONG, SHARP

47-2502	6¼"	2mm
47-2505	6¼"	5mm
47-2507	6¼"	7mm
47-2510	6¼"	10mm

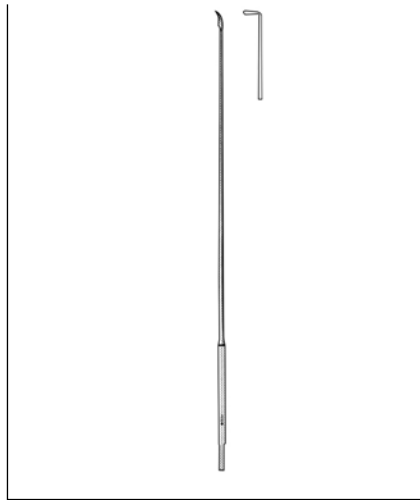

JAKO MICRO LARYNX HOOK

90° ANGLE

98-2092	8½"
---------	-----

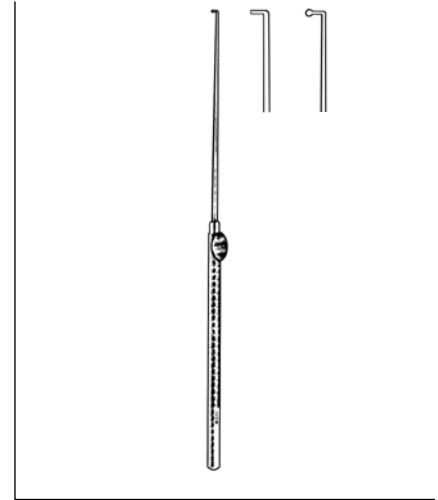

KRAYENBUEHL NERVE HOOKS

SMALL

47-2565	7¼"
---------	-----

LARGE

47-2566	7¼"
---------	-----

BALL TIP

47-2567	7¼"	Small
---------	-----	-------

BALL TIP

47-2568	7¼"	Large
---------	-----	-------

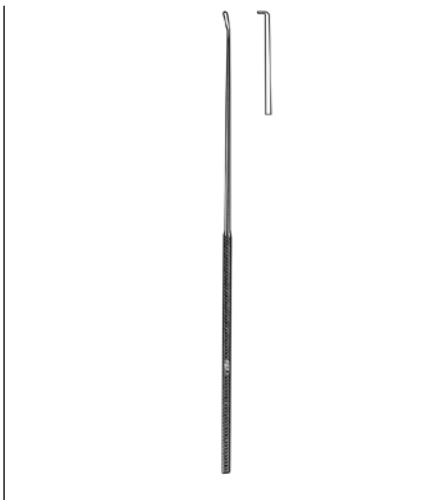

RHOTON-TYPE HOOKS

90° ANGLE

98-7321	7½"	#9, Semi-Sharp
98-7322	7½"	#10, Blunt

45° ANGLE

98-7323	7½"	#11, Semi-Sharp
---------	-----	-----------------

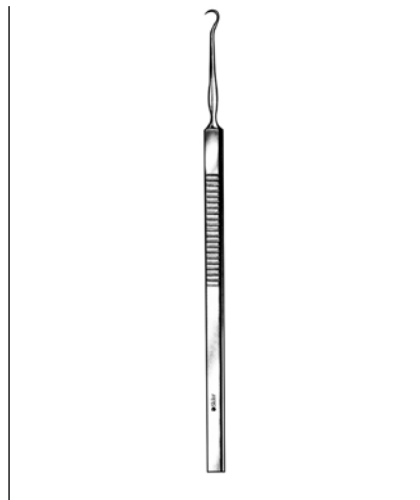

SINGLE-PRONG MICRO HOOKS

SMALL

47-2581	6¼"	Small, 5x3mm 31mm Shaft
47-2582	6¼"	Small, 5x3mm 32mm Shaft

LARGE

47-2583	6¼"	Large, 5x4mm 34mm Shaft
47-2584	6¼"	Large, 7x4mm 35mm Shaft

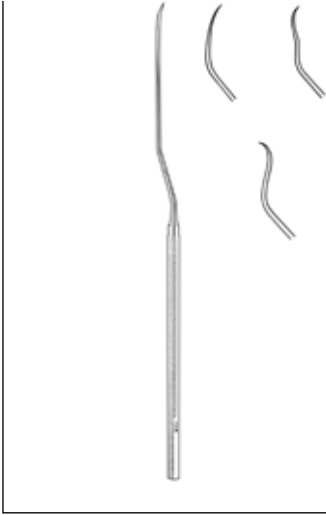

YASARGIL RASPATORY

ROUND HANDLE

- 98-2120 7¼" Light Curve
- 98-2121 7¼" Forward Cutting
- 98-2122 7¼" Backward Cutting

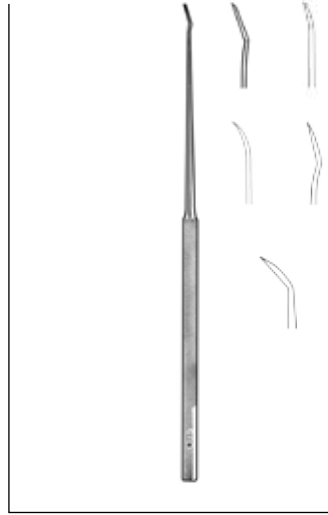

YASARGIL RASPATORY

- 98-2123 7½" Wide Blade, Angled
- 98-2124 7½" Narrow, Light Curve
- 98-2125 7½" Narrow, Strong Curve
- 98-2126 7½" Angled, Pointed
- 98-2127 7½" Angled, Round

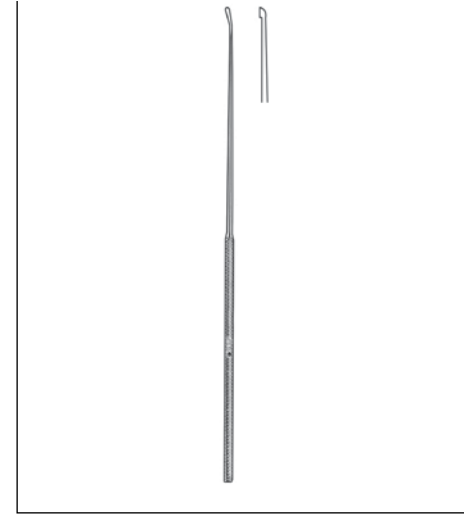

RHOTON-TYPE CURETTE

STRAIGHT

- 98-7302 7½" #13

ANGLED

- 98-7303 7½" #14

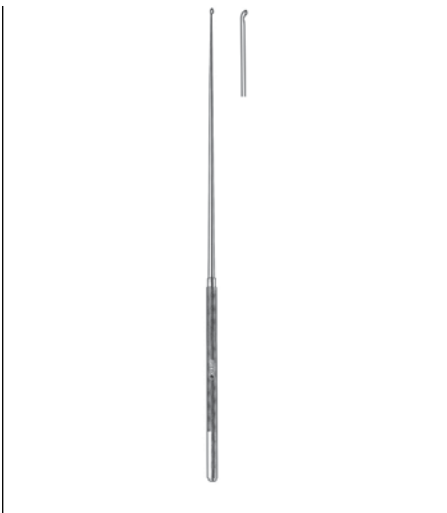

YASARGIL CURETTE

ROUND STRAIGHT HANDLE

- 98-7305 9" Straight
- 98-7306 9" Curved

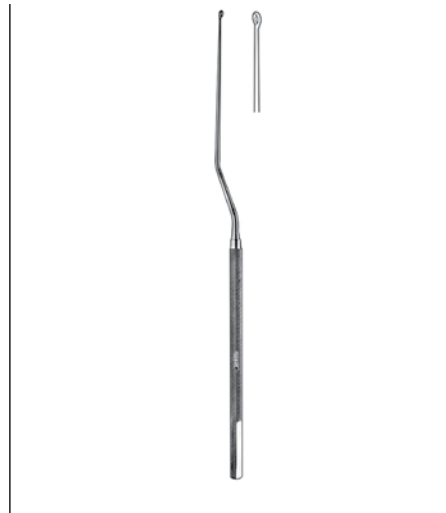

YASARGIL CURETTE

ROUND STRAIGHT HANDLE

- 98-7308 7¼" 1.5mm Tip

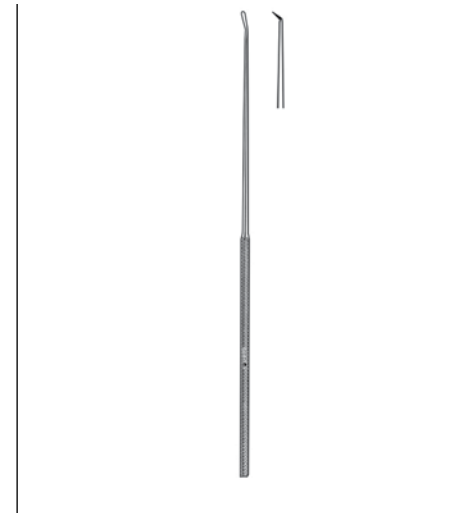

RHOTON-TYPE DISSECTOR

ROUND

- 98-7310 7½" #1, 1mm Blade
- 98-7311 7½" #2, 2mm Blade
- 98-7312 7½" #3, 3mm Blade
- 98-7313 7½" #16, 3mm Blade

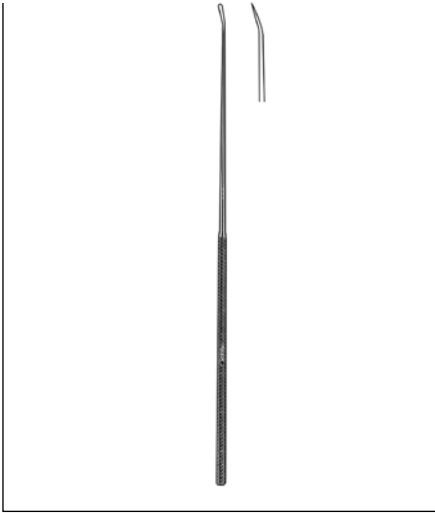

**RHOTON-TYPE
SPATULA DISSECTORS**

- 98-7317 7½" Small, #6
- 98-7318 7½" Medium, #7
- 98-7319 7½" Large, #8



RHOTON-TYPE ELEVATORS

- ANGLED**
- 98-7315 7½" #4
- CURVED**
- 98-7316 7½" #5

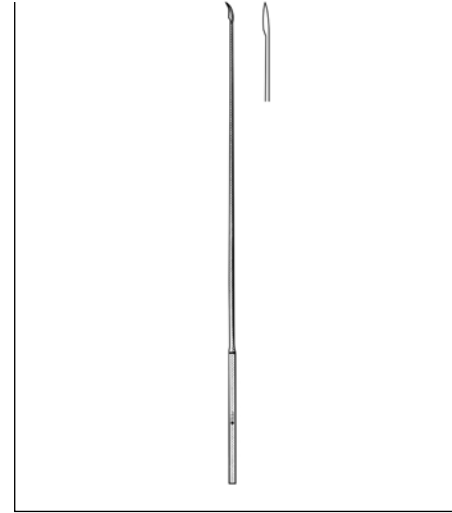

JAKO SEPTUM KNIVES

- 98-2094 8½" Straight
- 98-2095 8½" Curved

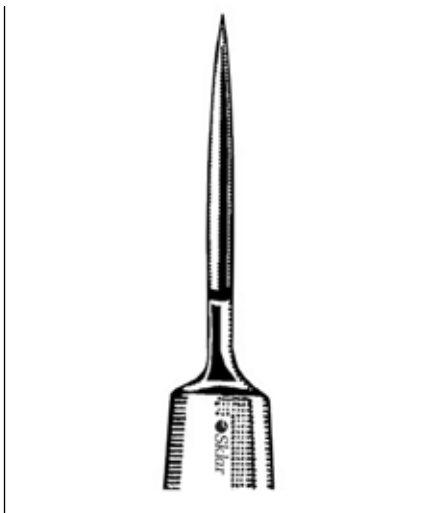

WHEELER DISCISSION KNIFE

- 65-3010 1mm

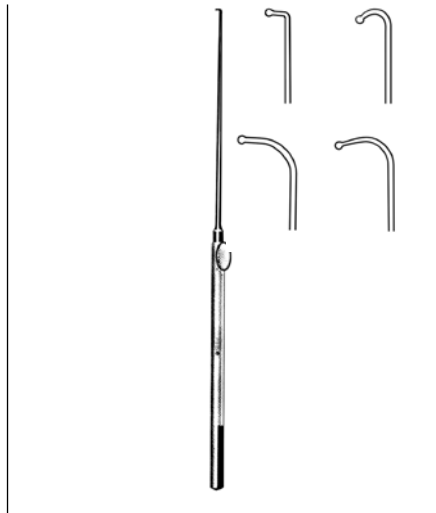

YASARGIL LIGATURE CARRIERS

- 47-2576 7¼" Right Angle
- 47-2577 7¼" Short Strong Curve
- 47-2578 7¼" Long Strong Curve
- 47-2579 7¼" Long Light Curve

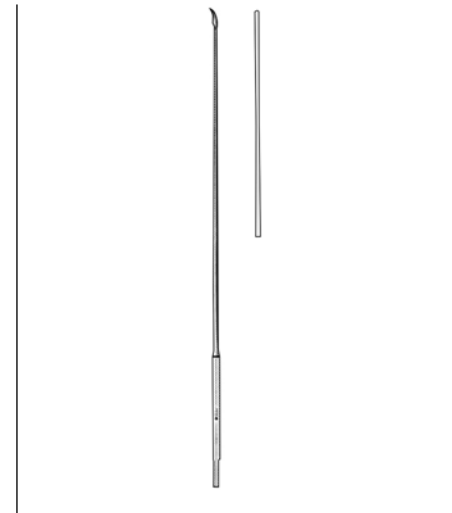

JAKO MICRO-LARYNX PROBE

- STRAIGHT**
- 98-2093 8½"

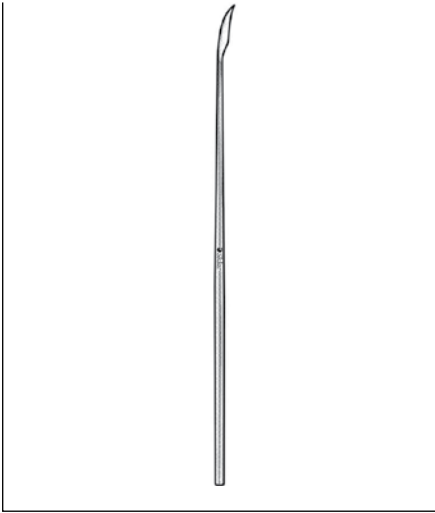

MICRO LARYNGEAL KNIFE
CURVED
78-3530 9½"



MICRO LARYNGEAL KNIFE
STRAIGHT
78-3531 9½"



MICRO LARYNGEAL KNIFE
ROUND EDGE
78-3532 9½"



MICRO LARYNGEAL KNIFE
GOLF CLUB STYLE
78-3533 9½"



MICRO LARYNGEAL KNIFE
FULL ROUND EDGE
78-3534 9½"

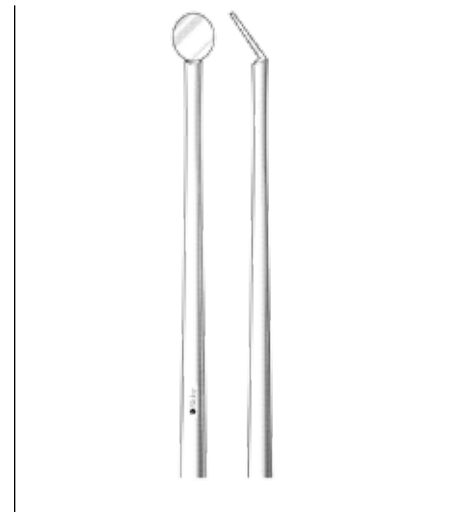

MICRO LARYNGEAL KNIFE
ANGLED, ROUND EDGE
78-3535 9½"

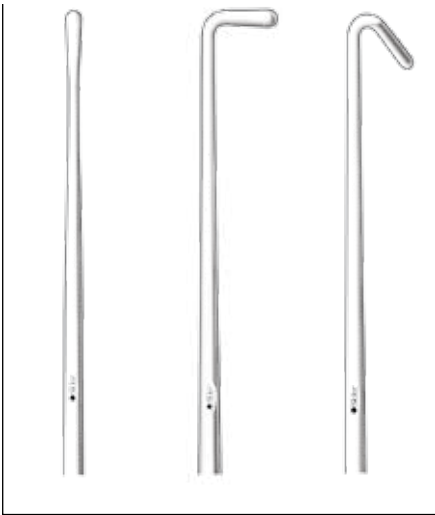

MICRO LARYNGEAL PROBES

STRAIGHT

78-3536 9½"

90° ANGLED RIGHT

78-3537 9½"

120° ANGLED RIGHT

78-3538 9½"



MICRO LARYNGEAL NEEDLES

CURVED RIGHT

78-3539 9½"

CURVED LEFT

78-3540 9½"



MICRO LARYNGEAL HOOKS

90 DEGREES

78-3541 9½"

120 DEGREES

78-3542 9½"

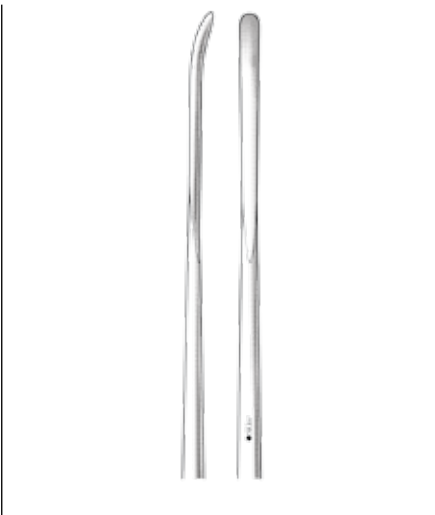

MICRO LARYNGEAL ELEVATOR

CURVED RIGHT

78-3543 9½"

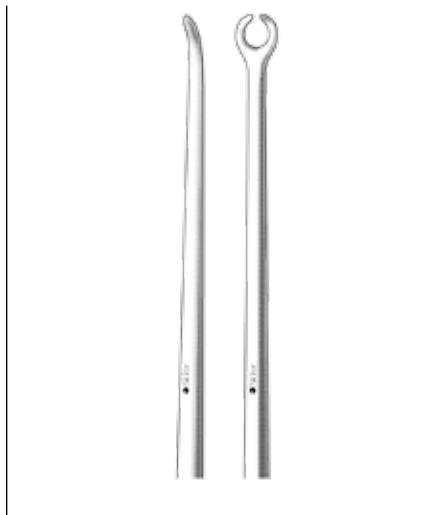

MICRO LARYNGEAL KNOT GUIDE

90 DEGREES

78-3544 9½"



MICRO LARYNGEAL HANDLE

HANDLE ONLY

78-3546 For use with
Micro laryngeal Instruments
78-3530 through 78-3544

Single Use / Sterile

Sklar Premium Electrosurgical Pencils are available in a push button, foot switch or rocker switch configuration. Sklar pencils are ergonomically designed to provide maximum balance and comfort for the surgeon. Each pencil features a removable 2.75" stainless steel blade electrode, with hex locking feature to provide stability during difficult surgical procedures.

Unsurpassed performance and design features, like sealed switching components, make the Sklar Premium Electrosurgical Pencil the right choice. Pencil tips are interchangeable with any of Sklar's electrodes and most other manufacturer's electrodes. Sklar Pencils come standard with a pre-attached 3 meter cord with a standard three prong plug. All Electrosurgical Pencils are provided in a single use, sterile pouch.

PUSH BUTTON SWITCH

PRODUCT NUMBER	FEATURES	ACCESSORIES	QUANTITIES
96-9601	2.75" Blade Electrode	-	50/Box
96-9602	2.75" Blade Electrode	-	50/bx, 2bx/cs, 100/cs
96-9603	2.75" Blade Electrode	Holster	50/Box
96-9604	2.75" Blade Electrode	Holster	50/bx, 2bx/cs, 100/cs
96-9605	2.75" Blade Electrode	Holster, Tip Cleaner	50/Box
96-9606	2.75" Blade Electrode	Holster, Tip Cleaner	50/bx, 2bx/cs, 100/cs
96-9607	2.75" Coated Blade Electrode	-	50/Box
96-9608	2.75" Coated Blade Electrode	-	50/bx, 2bx/cs, 100/cs
96-9609	2.75" Coated Blade Electrode	Holster	50/Box
96-9610	2.75" Coated Blade Electrode	Holster	50/bx, 2bx/cs, 100/cs



ROCKER SWITCH

PRODUCT NUMBER	FEATURES	ACCESSORIES	QUANTITIES
96-9611	2.75" Blade Electrode	-	50/Box
96-9612	2.75" Blade Electrode	-	50/bx, 2bx/cs, 100/cs
96-9613	2.75" Blade Electrode	Holster	50/Box
96-9614	2.75" Blade Electrode	Holster	50/bx, 2bx/cs, 100/cs
96-9615	2.75" Blade Electrode	Holster, Tip Cleaner	50/Box
96-9616	2.75" Blade Electrode	Holster, Tip Cleaner	50/bx, 2bx/cs, 100/cs
96-9617	2.75" Coated Blade Electrode	-	50/Box
96-9618	2.75" Coated Blade Electrode	-	50/bx, 2bx/cs, 100/cs
96-9619	2.75" Coated Blade Electrode	Holster	50/Box
96-9620	2.75" Coated Blade Electrode	Holster	50/bx, 2bx/cs, 100/cs



FOOT SWITCH

PRODUCT NUMBER	FEATURES	ACCESSORIES	QUANTITIES
96-9621	2.75" Blade Electrode	-	50/Box
96-9622	2.75" Blade Electrode	-	50/bx, 2bx/cs, 100/cs
96-9623	2.75" Blade Electrode	Holster	50/Box
96-9624	2.75" Blade Electrode	Holster	50/bx, 2bx/cs, 100/cs
96-9625	2.75" Blade Electrode	Holster, Tip Cleaner	50/Box
96-9626	2.75" Blade Electrode	Holster, Tip Cleaner	50/bx, 2bx/cs, 100/cs
96-9627	2.75" Coated Blade Electrode	-	50/Box
96-9628	2.75" Coated Blade Electrode	-	50/bx, 2bx/cs, 100/cs
96-9629	2.75" Coated Blade Electrode	Holster	50/Box
96-9630	2.75" Coated Blade Electrode	Holster	50/bx, 2bx/cs, 100/cs

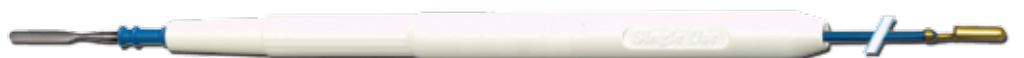

Single Use / Sterile

Sklar Premium Blade Electrodes feature a ribbed molded insulator, which allows the surgeon or technician easy removal of the electrode during procedures. They are available with a hex lock feature that assures stability and prohibits rotation of the blade during difficult procedures. They are also available coated with an anti-stick material that allows easy clean up of accumulated debris.

BLADE ELECTRODES

PRODUCT NUMBER	FEATURES	QUANTITIES
96-9632	Flex Tip Blade, 2.4"	10/Box
96-9633	Flex Tip Blade, 2.4"	10/bx, 10bx/cs, 100/cs
96-9634	Flex Tip Blade, Hex Lock Hub, 2.4"	10/Box
96-9635	Flex Tip Blade, Hex Lock Hub, 2.4"	10/bx, 10bx/cs, 100/cs
96-9636	Solid Steel Blade, 2.75"	10/Box
96-9637	Solid Steel Blade, 2.75"	10/bx, 10bx/cs, 100/cs
96-9638	Solid Steel Coated Blade, 2.75"	10/Box
96-9639	Solid Steel Coated Blade 2.75"	10/bx, 10bx/cs, 100/cs
96-9640	Solid Steel Blade, Hex Lock Hub, 2.75"	10/Box
96-9641	Solid Steel Blade, Hex Lock Hub, 2.75"	10/bx, 10bx/cs, 100/cs
96-9642	Solid Steel Coated Blade, Hex Lock Hub, 2.75"	10/Box
96-9643	Solid Steel Coated Blade, Hex Lock Hub, 2.75"	10/bx, 10bx/cs, 100/cs



PRODUCT NUMBER	FEATURES	QUANTITIES
96-9644	Solid Steel Blade, 6"	10/Box
96-9645	Solid Steel Blade, 6"	10/bx, 10bx/cs, 100/cs



PRODUCT NUMBER	FEATURES	QUANTITIES
96-9646	Solid Steel Coated Blade, 6"	10/Box
96-9647	Solid Steel Coated Blade, 6"	10/bx, 10bx/cs, 100/cs



PRODUCT NUMBER	FEATURES	QUANTITIES
96-9648	Solid Steel Blade, 10"	10/Box
96-9649	Solid Steel Blade, 10"	10/bx, 10bx/cs, 100/cs



PRODUCT NUMBER	FEATURES	QUANTITIES
96-9650	Solid Steel Coated Blade, 10"	10/Box
96-9651	Solid Steel Coated Blade, 10"	10/bx, 10bx/cs, 100/cs



Single Use / Sterile

Sklar Premium Loop Electrodes feature a strong and durable tungsten steel loop incorporated into a reinforced T-molded head for added stability during difficult and delicate surgical procedures. All electrodes are a standard five inches in length and feature an extended insulation covering to protect the surgeon and patient.

LOOP ELECTRODES

PRODUCT NUMBER	FEATURES	QUANTITIES
96-9652	Tungsten Loop, 10mm x 5mm, 5"	5/Box
96-9653	Tungsten Loop, 10mm x 5mm, 5"	5/bx, 10bx/cs, 50/cs
		
96-9654	Tungsten Loop, 10mm x 10mm, 5"	5/Box
96-9655	Tungsten Loop, 10mm x 10mm, 5"	5/bx, 10bx/cs, 50/cs
		
96-9656	Tungsten Loop, 15mm x 10mm, 5"	5/Box
96-9657	Tungsten Loop, 15mm x 10mm, 5"	5/bx, 10bx/cs, 50/cs
		
96-9658	Tungsten Loop, 15mm x 15mm, 5"	5/Box
96-9659	Tungsten Loop, 15mm x 15mm, 5"	5/bx, 10bx/cs, 50/cs
		
96-9660	Tungsten Loop, 20mm x 10mm, 5"	5/Box
96-9661	Tungsten Loop, 20mm x 10mm, 5"	5/bx, 10bx/cs, 50/cs
		
96-9662	Tungsten Loop, 20mm x 15mm, 5"	5/Box
96-9663	Tungsten Loop, 20mm x 15mm, 5"	5/bx, 10bx/cs, 50/cs
		

Single Use / Sterile

LLETZ BALL ELECTRODES

PRODUCT NUMBER	FEATURES	QUANTITIES
96-1040	3mm / 0.3cm	5/Box



LLETZ SQUARE ELECTRODES

PRODUCT NUMBER	FEATURES	QUANTITIES
96-1099	10 x 8mm / 1.0 x 0.8cm	5/Box

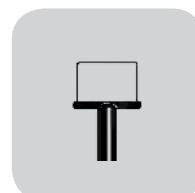

LLETZ LOOP ELECTRODES

PRODUCT NUMBER	FEATURES	QUANTITIES
96-1060	15 x 8mm / 1.5 x 0.8cm	5/Box
96-1075	20 x 8mm / 2.0 x 0.8cm	5/Box
96-1085	20 x 20mm / 2.0 x 2.0cm	5/Box

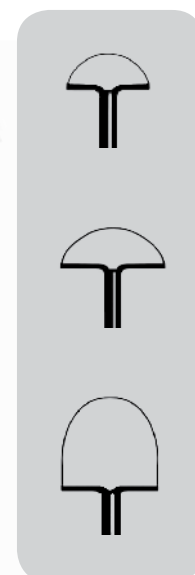

Single Use / Sterile

Sklar Premium Needle Electrodes feature a durable and ultra fine needle point for precise locations during the surgical procedure. All electrodes feature a ribbed molded insulation for easy removal and extended insulation to protect the surgeon and patient.

STRAIGHT NEEDLE ELECTRODES

PRODUCT NUMBER	FEATURES	QUANTITIES
96-9664	Solid Stainless Steel Needle, 2.8"	10/Box
96-9665	Solid Stainless Steel Needle, 2.8"	10/bx, 10bx/cs, 100/cs
96-9666	Solid Stainless Steel Coated Needle, 2.8"	10/Box
96-9667	Solid Stainless Steel Coated Needle, 2.8"	10/bx, 10bx/cs, 100/cs
96-9668	Solid Stainless Steel Needle, 6"	10/Box
96-9669	Solid Stainless Steel Needle, 6"	10/bx, 10bx/cs, 100/cs



96-9670	Solid Stainless Steel Coated Needle, 6"	10/Box
96-9671	Solid Stainless Steel Coated Needle, 6"	10/bx, 10bx/cs, 100/cs



96-9672	Solid Stainless Steel Needle, 10"	10/Box
96-9673	Solid Stainless Steel Needle, 10"	10/bx, 10bx/cs, 100/cs



96-9674	Solid Stainless Steel Coated Needle, 10"	10/Box
96-9675	Solid Stainless Steel Coated Needle, 10"	10/bx, 10bx/cs, 100/cs



Single Use / Sterile

Sklar Premium Straight Ball Electrodes feature our Hex Locking system to assure stability during difficult procedures. They also have our Ribbed Molded insulation for easy removal and extended insulation for protection of the surgeon and patient.

STRAIGHT BALL ELECTRODES

PRODUCT NUMBER	FEATURES	QUANTITIES
96-9676	Stainless Steel 4mm Ball, 2"	10/Box
96-9677	Stainless Steel 4mm Ball, 2"	10/bx, 10bx/cs, 100/cs
96-9678	Stainless Steel 4mm Coated Ball, 2"	10/Box
96-9679	Stainless Steel 4mm Coated Ball, 2"	10/bx, 10bx/cs, 100/cs
96-9680	Stainless Steel 5mm Ball, 2"	10/Box
96-9681	Stainless Steel 5mm Ball, 2"	10/bx, 10bx/cs, 100/cs
96-9682	Stainless Steel 5mm Coated Ball, 2"	10/Box
96-9683	Stainless Steel 5mm Coated Ball, 2"	10/bx, 10bx/cs, 100/cs

96-9684	Stainless Steel 5mm Ball, 5.3"	10/Box
96-9685	Stainless Steel 5mm Ball, 5.3"	10/bx, 10bx/cs, 100/cs

96-9686	Stainless Steel 5mm Coated Ball, 5.3"	10/Box
96-9687	Stainless Steel 5mm Coated Ball, 5.3"	10/bx, 10bx/cs, 100/cs



Single Use / Non-Sterile

Sklar Premium Patient Return Pads are manufactured using an advanced design hydro-gel adhesive that, incorporated with a gel overlay system, provide a much safer return pad for both the patient and surgeon. Sklar offers Patient Return Pads in five different configurations.

RETURN ELECTRODES / GROUNDING PADS

PRODUCT NUMBER	FEATURES	QUANTITIES
96-9688	Dual Element, 9' Cord Attached, Standard	50/cs
96-9690	Dual Element, Non-Corded, Standard	5/pk, 40pk/cs, 200/cs

96-9688 and 96-9690 are dual element return pads designed to be used with electrosurgical units that are equipped with REM or Neutral Electrode safety systems that continually monitor impedance levels. The 96-9688 comes with a pre-attached 9 foot cord with standard plug. The 96-9690 requires the use of a reusable cable, 96-9698, and come in a resealable foil pouch.

PRODUCT NUMBER	FEATURES	QUANTITIES
96-9692	Single Element, 9' Cord Attached, Standard	50/cs
96-9694	Single Element, Non-Corded, Standard	5/pk, 40pk/cs, 200/cs

96-9692 and 96-9694 are traditional single element return pads manufactured using the same hydro-gel technology. Both are designed for use with all electrosurgical generators. The 96-9692 comes with a pre-attached 9 foot cord, with standard connector. The 96-9694 requires the use of a reusable cable, 96-9698, and come in a resealable foil pouch.

PRODUCT NUMBER	FEATURES	QUANTITIES
96-9696	Dual Element, 9' Cord Attached, Pediatric / Infant	50/cs



CORDS AND CABLES

PRODUCT NUMBER	FEATURES	QUANTITIES
96-9698	Reusable Return Pad Cable For Use With Non-Corded Pads, 15' Non-Sterile	10/Box



PRODUCT NUMBER	FEATURES	QUANTITIES
96-9700	Single Use, Sterile, Bipolar Forceps Cord, Flying Lead, 12'	10/Box
96-9701	Single Use, Sterile, Bipolar Forceps Cord, Flying Lead, 12'	10/bx, 5bx/cs 50/cs



PRODUCT NUMBER	FEATURES	QUANTITIES
96-9702	Single Use, Sterile, Bipolar Forceps Cord, Solid Connector, 12'	10/Box
96-9703	Single Use, Sterile, Bipolar Forceps Cord, Solid Connector, 12'	10/bx, 5bx/cs 50/cs



TIP CLEANERS-DISPOSABLE

PRODUCT NUMBER	FEATURES	QUANTITIES
96-9704	Sterile	50/Box
96-9706	Non-Sterile	500/Box

42.5MM X 42.5MM
(1.7" X 1.7")



HOLSTERS-DISPOSABLE

PRODUCT NUMBER	FEATURES	QUANTITIES
96-9708	Sterile	100/Box
96-9710	Non-Sterile	500/Box



ADSON FORCEPS

PRODUCT NUMBER	FEATURES
91-6100	1mm, 4¾"



COAPTATION FORCEPS

PRODUCT NUMBER	FEATURES
91-6101	.5mm, 4"



CUSHING FORCEPS

PRODUCT NUMBER	FEATURES
91-6102	1mm, 6"



GERALD BAYONET FORCEPS

PRODUCT NUMBER	FEATURES
91-6103	1mm, 7"



GERALD FORCEPS

PRODUCT NUMBER	FEATURES
91-6104	1mm, 7"



HARDY BAYONET FORCEPS

PRODUCT NUMBER	FEATURES
91-6105	1mm, 8½"



JANSEN BAYONET FORCEPS

PRODUCT NUMBER	FEATURES
91-6106	1mm, 6"



JEWELER #5 FORCEPS

PRODUCT NUMBER	FEATURES
91-6107	.5mm 4½"



MALIS FORCEPS

PRODUCT NUMBER	FEATURES
91-6108	1mm, 7"



MCPHERSON FORCEPS

PRODUCT NUMBER	FEATURES
91-6109	.5mm, 3½" Curved



MCPHERSON FORCEPS

PRODUCT NUMBER	FEATURES
91-6110	.5mm, 3½" Straight



SEMKIN FORCEPS

PRODUCT NUMBER	FEATURES
91-6111	.5mm, 5½"



TENZEL FORCEPS

PRODUCT NUMBER	FEATURES
91-6112	.5mm, 4"



MCPHERSON NON-STICK FORCEPS

PRODUCT NUMBER	FEATURES
91-6130	Straight
91-6131	Curved



NON-STICK JEWELER FORCEPS

PRODUCT NUMBER	FEATURES
91-6132	#5



NON-STICK JEWELER FORCEPS

PRODUCT NUMBER	FEATURES
91-6133	#4



ADSON NON-STICK FORCEPS

PRODUCT NUMBER	FEATURES
91-6134	



SEMKIN NON-STICK FORCEPS

PRODUCT NUMBER	FEATURES
91-6135	



CUSHING NON-STICK FORCEPS

PRODUCT NUMBER	FEATURES
91-6136	6¼"
91-6137	7"



CUSHING IRRIGATION FORCEPS

PRODUCT NUMBER	FEATURES
91-6150	For use with 91-6160



GERALD IRRIGATION FORCEPS

PRODUCT NUMBER	FEATURES
91-6151	Bayonet, For use with 91-6160



JANSEN IRRIGATION FORCEPS

PRODUCT NUMBER	FEATURES
91-6152	Bayonet, For use with 91-6160



SCOVILLE-GREENWOOD IRRIGATION FORCEPS

PRODUCT NUMBER	FEATURES
91-6153	For use with 91-6160



HARDY IRRIGATION FORCEPS

PRODUCT NUMBER	FEATURES
91-6154	Bayonet, For use with 91-6160



REUSABLE SILICONE BIPOLAR CABLE

PRODUCT NUMBER	FEATURES
91-6113	10'
91-6160	Angled

2-Pin US Instrument Plug with 4mm Generator Plug.
Compatible with most US Generators



WARNING: STERILIZATION GUIDELINES

Follow manufacturer's recommendations and AAMI standards for sterilization.

STEAM: steam autoclave at 250°F / 121°C for 20 minutes.

FLASH: steam autoclave at 275°F / 134°C for 10 minutes.

GAS (ETO): follow manufacturer's guide for the unit which you are using.

SKLAR DISPOSABLE EAR CURETTES



NON-STERILE		
PRODUCT NUMBER	FEATURES	QUANTITIES
96-1001	Cup	50/bx
96-1006	Loop	50/bx
96-1031	Spoon	50/bx
96-1011	Medium Ring Tip	50/bx
96-1016	Large Ring Tip	50/bx
96-1021	Small Ring Tip	50/bx
96-1035	Assorted, 10 each (no Pedi Ring Tip)	50/bx

SKLAR DISPOSABLE DERMAL CURETTES

SURGICAL STEEL TIPS



STERILE		
PRODUCT NUMBER	FEATURES	QUANTITIES
96-1190	2 mm	25/bx
96-1192	3 mm	25/bx
96-1194	4 mm	25/bx
96-1196	5 mm	25/bx
96-1198	7 mm	25/bx
96-1199	Assorted, 5 each	25/bx

DISPOSABLE NASAL SPECULUMS

PRODUCT NUMBER	SIZE	FEATURES	QUANTITIES
96-0670	6¼"	Non-Sterile	48/box





LATEX FREE

SKLAR TRU-PUNCH™ DISPOSABLE VULVAR BIOPSY PUNCH

The Sklar Tru-Punch has a seamless steel tip carefully honed for a razor sharp incision and perfect sample. The ribbed and hollow handle permits tissue to be easily dislodged. Latex free.

STERILE		
PRODUCT NUMBER	DESCRIPTION	QUANTITY
96-0192	1mm	25/bx
96-1098	1.5mm	50/bx
96-1140	2mm	25/bx
96-0102	2.5mm	25/bx
96-1142	3mm	25/bx
96-1110	3.5mm	50/bx
96-1146	4mm	25/bx
96-1148	5mm	25/bx
96-1150	6mm	25/bx
96-1152	8mm	25/bx
96-1092	1mm	50/bx

STERILE		
PRODUCT NUMBER	DESCRIPTION	QUANTITY
96-1100	2mm	50/bx
96-1102	2.5mm	50/bx
96-1105	3mm	50/bx
96-1144	3.5mm	25/bx
96-1115	4mm	50/bx
96-1110	3.5mm	50/bx
96-1115	4mm	50/bx
96-1120	5mm	50/bx
96-1125	6mm	50/bx
96-1130	8mm	50/bx
96-1160	Assorted – 5 of each: 2, 3, 3.5, 4 & 5mm	25/bx
96-0160	Assorted – 5 of each: 2, 3, 3.5, 4 & 5mm	50/bx

SKLAR BLADES AND SCALPELS

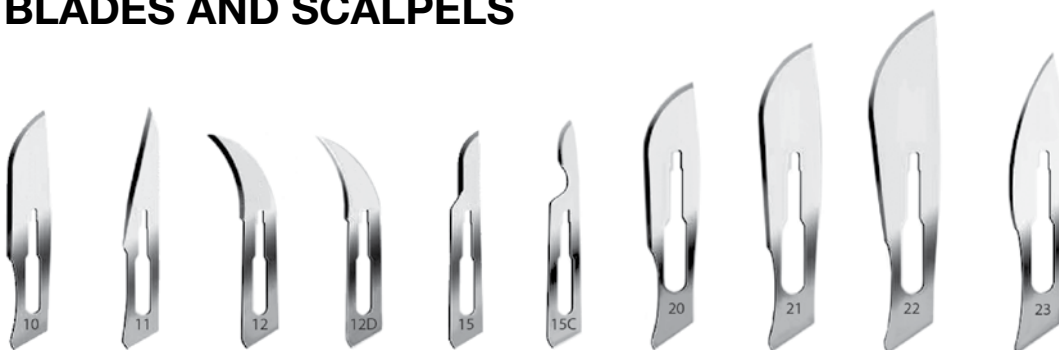

BLADES, CARBON STEEL

STERILE

PRODUCT NUMBER	FEATURES	QUANTITIES
06-3010	#10	100/box
06-3011	#11	100/box
06-3012	#12	100/box
06-3013	#12D	100/box
06-3015	#15	100/box
06-3016	#15C	100/box
06-3020	#20	100/box
06-3021	#21	100/box
06-3022	#22	100/box
06-3023	#23	100/box

BLADES, STAINLESS STEEL

STERILE

PRODUCT NUMBER	FEATURES	QUANTITIES
06-3100	#10	100/box
06-3101	#11	100/box
06-3102	#12	100/box
06-3103	#15	100/box
06-3108	#15C	100/box
06-3104	#20	100/box
06-3105	#21	100/box
06-3106	#22	100/box
06-3107	#23	100/box



LATEX FREE

SKLARSAFE™ SAFETY SCALPEL

- Protective, transparent sheath can be opened, closed, and locked with a single hand.
- Precision stainless steel blade made in England.
- Sturdy, "sure-grip" handle.
- Audible "click" when sheath advanced to locked position.
- OSHA compliant.
- Individually sealed in sturdy film and Tyvek® pack.

STERILE

PRODUCT NUMBER	FEATURES	QUANTITIES
06-3094	#10	10/bx
06-3130	#10	500/cs
06-3095	#11	10/bx
06-3132	#11	500/cs
06-3096	#15	10/bx
06-3134	#15	500/cs

SCALPELS, DISPOSABLE

STERILE

PRODUCT NUMBER	FEATURES	QUANTITIES
06-3110	#10	10/box
06-3111	#11	10/box
06-3112	#12	10/box
06-3115	#15	10/box
06-3120	#20	10/box
06-3121	#21	10/box
06-3122	#22	10/box
06-3123	#23	10/box



SKLAR SURGICAL SKIN MARKER

Sklar Surgical Skin markers are designed to allow the surgeon to conveniently demarcate selected sites prior to or during surgical procedures. Latex free.

Scrub resistant ink • Durable tip • Non-smearing

STERILE

PRODUCT NUMBER	FEATURES	QUANTITIES
10-1440	Fine/Regular Tip, Scrub Resistant	50/bx



BLADE REMOVER

STERILE

PRODUCT NUMBER	QUANTITIES
96-7460	100/cs



Sklar Instrument Protectors provide a convenient, color-coded means of protecting surgical instrument tips and edges. Autoclavable, steam and gas permeable, and available in a wide variety of shapes and sizes, SklarTip™ Instrument Protectors provide exceptional protection during handling and sterilization. Latex Free.



INSTRUMENT PROTECTORS - NON-VENTED

PRODUCT NUMBER	FEATURES	QUANTITIES
96-1510	19 x 1.5mm, 3/4" x 1/16"	White 100/pk
96-1508	19 x 2.0mm, 3/4" x 5/64"	Blue 100/pk
96-1506	19 x 3.0mm, 3/4" x 1/8"	Green 100/pk
96-1504	25 x 3.0mm, 1" x 1/8"	Red 100/pk
96-1502	25 x 5.0mm, 1" x 3/16"	Yellow 100/pk
96-1500	19 x 1.0mm, 3/4" x 3/64"	Maroon 100/pk
96-1516	25 x 1.5mm, 1" x 3/8" x 1/16"	Orange 100/pk
96-1514	25 x 2.0mm, 1" x 5/8" x 5/64"	Brown 100/pk
96-1512	25 x 3.0mm, 1" x 1" x 1/8"	Black 100/pk
96-1518	Assorted	100/pk

INSTRUMENT PROTECTORS - VENTED

PRODUCT NUMBER	FEATURES	QUANTITIES
96-1410	19 x 1.5mm, 3/4" x 1/16"	White 100/pk
96-1408	19 x 2.0mm, 3/4" x 5/64"	Blue 100/pk
96-1406	19 x 3.0mm, 3/4" x 1/8"	Green 100/pk
96-1404	25 x 3.0mm, 1" x 1/8"	Red 100/pk
96-1402	25 x 5.0mm, 1" x 3/16"	Yellow 100/pk
96-1400	19 x 1.0mm, 3/4" x 3/64"	Maroon 100/pk
96-1416	25 x 1.5mm, 1" x 3/8" x 1/16"	Orange 100/pk
96-1414	25 x 2.0mm, 1" x 5/8" x 5/64"	Brown 100/pk
96-1412	25 x 3.0mm, 1" x 1" x 1/8"	Black 100/pk
96-1418	Assorted	100/pk

OSTEOTOME GUARDS - VENTED

PRODUCT NUMBER	FEATURES	QUANTITIES
96-1440	3/4" x 1/4"	50/pk
96-1442	1" x 3/8"	50/pk
96-1444	1" x 1/2"	50/pk
96-1446	1 1/2" x 1 1/2"	50/pk

TIP GRIPS

PRODUCT NUMBER	FEATURES	QUANTITIES
96-1550	.062" Yellow	3pr/pk, 5pks
96-1552	.062" Yellow	5pr/pk, 5pks

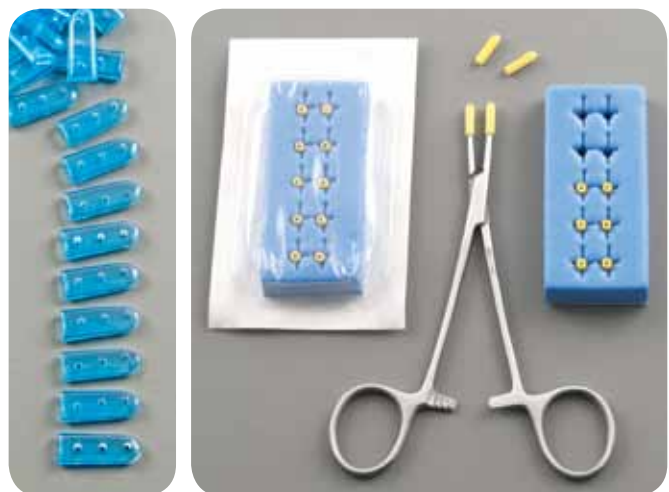



Instrument recognition is key to efficient processing in a busy clinical setting. SklarTip™ Instrument ID products offer a convenient color coded system for identifying instruments. Offered in various combinations including tape sheets, tape rolls and tags, products last through many autoclaving and gas sterilization processes. Latex Free.

ID SHEET TAPE

PRODUCT NUMBER	FEATURES	QUANTITIES
96-1845	Blue with White Stripes	1 Each
96-1846	Green with White Stripes	1 Each
96-1847	Red with White Stripes	1 Each
96-1848	Yellow with White Stripes	1 Each
96-1849	Orange with White Stripes	1 Each
96-1850	Brown with White Stripes	1 Each
96-1851	Lavender with White Stripes	1 Each
96-1852	Light Blue with White Stripes	1 Each
96-1853	Pink with White Stripes	1 Each



ID ROLL TAPE

PRODUCT NUMBER	FEATURES	QUANTITIES
96-1860	White 300" x 1/4"	1 Each
96-1862	Green 300" x 1/4"	1 Each
96-1864	Yellow 300" x 1/4"	1 Each
96-1866	Orange 300" x 1/4"	1 Each
96-1868	Black 300" x 1/4"	1 Each
96-1870	Purple 300" x 1/4"	1 Each
96-1872	Blue 300" x 1/4"	1 Each
96-1874	Red 300" x 1/4"	1 Each
96-1876	Brown 300" x 1/4"	1 Each



INSTRUMENT ID TAGS

PRODUCT NUMBER	FEATURES	QUANTITIES
96-1900	ID Repair Tags, Red	100/pk
96-1901	ID Repair Tags, Red	1000/pk
96-1903	Sklar Tags, White	100/pk
96-1905	ID Tags for Sharpen, Blue	100/pk
96-1906	ID Tags for Sharpen, Blue	1000/pk



Sklar is pleased to offer a full line of Care & Cleaning agents to disinfect, decontaminate, sterilize, lubricate and protect your stainless steel surgical instruments and equipment. For expert care of your surgical instruments at every stage of the cleaning process, trust Sklar to deliver the right cleaning agent for you.



3 EASY STEPS FOR THE CARE AND CLEANING OF YOUR INSTRUMENTS

1 DECONTAMINATION

2 MINUTE KILL TIME

Sklar Soak™ and Sklar Disinfectant are intended to safely decontaminate soiled surgical instruments immediately after use. These ready to use, non-toxic formulas are safe for use on medical and surgical equipment including stainless steel, chrome, glass, plastic, Plexiglas, baked on painted and other non-porous surfaces. Effective against H1N1, HIV-1, HSV, VRE, Rotaviruses, Hep B & C as well as TB, MRSA and A-Baumannii.



2 CLEANING

DETERGENTS AND ENZYMATICS

Choose from a wide selection of Sklar cleaning agents. First use Sklar Spray-Zyme™ foam pre-cleaner to coat instruments until ready to process. Next use Sklar Enzymatic™, a fast acting detergent specifically formulated for soaking/cleaning instruments heavily laden with organic debris. Finally, use Sklar Kleen™ as your neutral pH, non-corrosive detergent for manual, ultrasonic or automatic cleaning. Sklar detergents and enzymatics are effective in the cleaning process of surgical instruments, as well as metals, glassware, plastics and rubber.



3 LUBRICATION

SKLAR LUBRICANT

To guarantee the extended life and performance of your surgical instruments, lubrication should be a standard part of your instrument processing regimen. Easy to use Sklar Instru-Guard™ products improve function and contain rust inhibitors that protect against corrosion, rust and stains. Following lubrication, instruments should be sterilized according to the instrument manufacturer's instructions and/or stored until use.





SKLAR-CIDE™

HIGH LEVEL DISINFECTING/STERILIZING SOLUTION

Sporicidal • Bactericidal • Virucidal • Fungicidal

SKLAR-CIDE provides a safe and efficient means for the high-level disinfection or sterilization of medical, ophthalmic, dental and surgical devices including endoscopes and lensed instruments. It may be used as a standard soak solution or in automatic reprocessing units set at room temperature. Unlike other solutions, there is no need to increase the solution temperature to provide high-level disinfection in 25 minutes.

SKLAR-CIDE is a surfactant-free, activated glutaraldehyde liquid chemical sterilant and high-level disinfectant. Its active ingredient is glutaraldehyde in a nominal concentration of 3%. When the powdered activator is added, the solution turns green in color to indicate its readiness for use. In addition to the active ingredient, this ready-to-use solution contains buffers, wetting agents, and a rust and corrosion inhibitor and it has a pleasant fragrance.

SKLAR-CIDE produces high-level disinfection at room temperature in as little time as 25 minutes, and complete sterilization in 10 hours at room temperature.

- Reusable for 28 days instead of 14, safer and saves time and money.
- Surfactant free - Will not damage scope surfaces or cloud lenses.
- Can be used safely on reusable medical devices, including endoscopes. No need to stock several products.

PRODUCT NUMBER	FEATURES	QUANTITIES
10-1623	28 HLD 1 Gallon Bottles	4/case
10-1624	28 HLD 1 Gallon Bottle	1 bottle

GLUTARALDEHYDE STRIPS

PRODUCT NUMBER	FEATURES	QUANTITIES
96-4106	.5 - 2.5% MEC 100 Strips / Bottle	1 bottle



SKLAR SOAK™

INSTRUMENT PRE-SOAK & DECONTAMINANT

RUST INHIBITOR!

2 MINUTE KILL TIME

Immersing soiled instruments in SKLAR SOAK effectively pre-cleans and decontaminates, without fear of rusting!

SKLAR SOAK is an effective pre-cleaner that breaks down bio-burden, lifting blood and other organic debris from the surface, while penetrating box locks and crevices. The rust inhibitor protects the delicate chromium oxide layer of the instrument, thus defending against rust and corrosion. Using SKLAR SOAK™ as a pre-cleaner is the first line of defense against rust, prolonging the life of the instrument and therefore protecting your investment!

Soaking for only two minutes thoroughly decontaminates instruments, reducing the risk of exposure to pathogens such as H1N1, HIV-1, HSV, VRE, Rotaviruses, Hep B & C as well as TB, MRSA and A. Baumannii. However, because SKLAR SOAK™ contains a rust inhibitor, instruments may soak for several hours without fear of rusting! Employees are protected from cross contamination, and at the same time can enjoy the freedom to reprocess instruments when it's convenient!

SKLAR SOAK is ideal for use on all stainless steel instruments:

- PH balanced, designed specifically for stainless steel instruments.
- Intermediate level disinfectant with broad spectrum of efficacy.
- Rust inhibitor.
- Non-caustic.
- Ready to use.
- No special handling or disposal.
- Fragrant, no offensive odors.
- Non-glutaraldehyde.



PRODUCT NUMBER	FEATURES	QUANTITIES
10-1603	1 Gallon Bottles	4/case
10-1609	1 Gallon Bottle	1 bottle



SKLAR DISINFECTANT

READY-TO-USE SPRAY SURFACE
DISINFECTANT

2 MINUTE KILL TIME

- Ready to use, non-toxic formula.
- Specially formulated for the control of cross contamination.
- Effective against a broad range of pathogens including H1N1, HIV-1, HSV, VRE, Rotaviruses, Hep B & C as well as TB, MRSA and A. Baumannii.
- Safe for all areas of the facility including the NICU, operating rooms, isolation rooms, patient care areas and laboratories.
- Satisfies OSHA's Bloodborne Pathogen Standards.
- Non-irritating formula.
- EPA registered.

PRODUCT NUMBER	FEATURES	QUANTITIES
10-1643	24 oz. Spray Bottles	6/case
10-1642	24 oz. Spray Bottle	1 bottle
10-1653	1 Gallon Bottles	4/case
10-1654	1 Gallon Bottle	1 bottle
10-1644	2.5 Gallon Bottles	2/case



SKLAR DISINFECTANT SURFACE WIPES

READY-TO-USE, PRE-MOISTENED
TOWELETTES

Same Effective Formula as Sklar Disinfectant!

2 MINUTE KILL TIME

- Ready to use, non-toxic formula.
- Specially formulated for the control of cross contamination.
- Effective against a broad range of pathogens including H1N1, HIV-1, HSV, VRE, Rotaviruses, Hep B & C as well as TB, MRSA and A. Baumannii.
- Safe for all areas of the facility.
- Satisfies OSHA's Bloodborne Pathogen Standards.
- Destroys odor-causing bacteria.
- 7" x 10" non-woven, tear resistant towelette.
- Clean scent.
- EPA registered.

PRODUCT NUMBER	FEATURES	QUANTITIES
10-1617	100 Towelettes / Canister	12/case
10-1616	100 Towelettes / Canister	6/case



KILLS MRSA AND H1N1 VIRUS



SKLAR SPRAY-ZYME™

SURGICAL INSTRUMENT PRE-CLEANER

Multi-Enzyme Based Instrument Presoak & Foam Spray Cleaner

The newest product from Sklar for expert care of your surgical instruments. This multi-enzymatic spray creates a heavy foam which lasts for hours, keeping soiled instruments moist to avoid encrustation while also pre-cleaning prior to processing.

- Prevents Organic Encrustation - enzyme foam stops blood and bodily fluids from drying onto surgical instruments.
- No More Spills - messy spills between the operating room and central cleaning /processing department are eliminated.
- Neutral pH - safe and effective for stainless steel, tungsten carbide, aluminum and brass instruments.
- Bacteriostatic - microbiological control agents inhibit bacterial growth in the ready-to-use foam solution.
- Long Lasting Foam - saves time, foam lasts many hours after application.
- Multi-Enzymatic - contains a synergistic blend of lipase and protease enzymes.

PRODUCT NUMBER	FEATURES	QUANTITIES
10-2722	22 oz. Refillable Spray Bottles	12/case
10-2724	1 Gallon Bottles	4/case



SKLAR ENZYMATIC™ DETERGENT

MULTI-ENZYME DETERGENT CONCENTRATE

100% Biodegradable

SKLAR ENZYMATIC Detergent is a low-foaming, fast acting detergent specifically designed for use when instruments and/or cloth materials become soiled with organic debris.

SKLAR ENZYMATIC Detergent may be used as a manual instrument cleaner as well as a pre-soak for blood-contaminated linens, clothing and instruments. It is also used in ultrasonic units and in washer/sterilizer/decontaminators. When used as directed, the enzymatic pH neutral formula is safe for use on rubber, plastic, stainless steel instruments, and surgical equipment as well as cloth.

PRODUCT NUMBER	FEATURES	QUANTITIES
10-2777	1 Gallon Bottles	4/case
10-2775	1 Gallon Bottles	2/case
10-2776	1 Gallon Bottle	1 bottle





SKLAR KLEEN™

LOW FOAM LIQUID DETERGENT

The SKLAR KLEEN Low Foam Liquid is concentrated in order to provide a very cost-effective cleaning solution. It is especially formulated to maintain low foam, ensuring effective and trouble-free action in washer/ sterilizers and tunnel washers. Dispersing quickly, the SKLAR KLEEN Low Foam formula is also well suited for automatic injection systems.

- Safe for use in washer / sterilizers.
- Low, Non-Aggressive pH.
- Disperses quickly.
- Non-etching to glassware.
- Concentrated formula.
- Cost-effective solution.

PRODUCT NUMBER	FEATURES	QUANTITIES
10-2701	Low Foam 1 Gallon Bottles	4/case
10-2702	Low Foam 1 Gallon Bottle	1 bottle



SKLAR KLEEN™

LIQUID DETERGENT

The SKLAR KLEEN Liquid Detergent was specifically developed for manual and ultrasonic cleaning. It is an effective yet non-corrosive, non aggressive, phosphate free and biodegradable formula that will not etch glassware or attack instrument metals. It is moderately alkaline, affording optimum cleaning power.

- Ideal for manual and ultrasonic cleaning.
- Non-Corrosive.
- Phosphate free and biodegradable.
- Superior wetting power to penetrate locks, serrations, and crevices.
- Appropriate for stainless steel, metal, glassware, plastics, and rubber.

PRODUCT NUMBER	FEATURES	QUANTITIES
10-1612	Liquid 8 oz. Bottles	6/case
10-1614	Liquid 8 oz. Bottle	1 bottle
10-1613	Liquid 1 Gallon Bottles	4/case
10-1627	Liquid 1 Gallon Bottle	1 bottle





SKLAR KLEEN™ POWDERED DETERGENT

The SKLAR KLEEN Powdered Detergent is an excellent way to reduce or neutralize the effects of corrosive minerals that are inherent in virtually all community water supplies. SKLAR KLEEN Powdered Detergent is ideal for manual and ultrasonic cleaning. One economical 3½ lb. container can make in excess of 150 gallons of cleaning solution. It's non-corrosive, non aggressive, phosphate free formula will not etch glassware or attack your instrument metals.

- Economical and Convenient.
- For all manual and ultrasonic cleaning.
- Appropriate for stainless steel, metal glassware, plastics and rubber.
- Non-Corrosive.
- Easy to Handle.

PRODUCT NUMBER	FEATURES	QUANTITIES
10-1608	Powdered 5 lb. Containers	4/case
10-1607	Powdered 5 lb. Container	1 container
10-1630	Powdered 3.5 lb. Pitchers	6/case
10-2765	Powdered 3.5 lb. Pitcher	1 pitcher



SKLAR INSTRU-GUARD™ ONE STEP

A “ONE STEP” INSTRUMENT
CLEANER AND LUBRICANT

EXTENDS INSTRUMENT LIFE!

SKLAR INSTRU-GUARD ONE STEP contains a penetrating lubricant that protects and helps extend the life of surgical instruments. The detergents and emulsifiers quickly break up and remove organic soils from box locks and other hard to reach places.

SKLAR INSTRU-GUARD ONE STEP contains four rust inhibitors to control corrosion and eliminate scaling and spotting. It does not contain phosphates and can reduce the time and cost involved in processing your instruments by cleaning and lubricating in one easy step.

PRODUCT NUMBER	FEATURES	QUANTITIES
10-2800	1 Gallon Bottles	4/case
10-2801	1 Gallon Bottle	1 bottle





SKLAR INSTRU-GUARD™ LUBE

SURGICAL INSTRUMENT LUBRICANT / RUST INHIBITOR

- Increase the Life of Instruments.
- Protects all Surgical Instruments.

SKLAR INSTRU-GUARD LUBE is an easy-to-use, water soluble, lubricant and rust inhibitor. When used daily as a rinse after every cleaning it keeps moving parts operating smoothly and remains effective after autoclaving, but without leaving an oily residue.

Regular lubrication is essential no matter which cleaning method is employed (including ultrasonic). SKLAR INSTRU-GUARD LUBE is ideal for maintaining instrument quality and performance.

PRODUCT NUMBER	FEATURES	QUANTITIES
10-1635	1 Gallon Bottles Concentrated	4/case
10-1634	1 Gallon Bottle Concentrated	1 bottle
10-1636	8 oz. Spray Bottles	12/case
10-1637	8 oz. Spray Bottle	1 bottle



SKLAR POLISH™

INSTRUMENT STAIN REMOVER

SKLAR POLISH is an effective stain remover for use on all your metal surgical instruments, including stainless steel, chrome and brass. It will brighten instrument trays, basins and racks and may also be used on porcelain and tile surfaces.

- Non Abrasive.
- Removes corrosive stains.
- Extends instruments life.
- "Like New" results.

PRODUCT NUMBER	FEATURES	QUANTITIES
10-1626	8 oz. Jars	12/case
10-1629	8 oz. Jars	6/case
10-1927	8 oz. Jar	1 jar



INSTRUMENT CLEANING BRUSHES

PRODUCT NUMBER	FEATURES	QUANTITIES
10-1650	Stainless Steel Bristles	3/pk
10-1652	Stainless Steel Bristles	12/pk
10-1658	Stainless Steel Bristles	24/pk
10-1665	Stainless Steel Bristles	48/pk
10-1651	Nylon Bristles	3/pk
10-1657	Nylon Bristles	12/pk
10-1659	Nylon Bristles	24/pk
10-1656	Nylon Bristles	48/pk





SKLAR-SHEEN™

AUTOCLAVE AND INSTRUMENT CLEANER AND CONDITIONER

With an efficacious phosphoric acid cleaning agent, Sklar Sheen is a robust spot, stain and rust remover. Ideal for dissolving hard water deposits, use in autoclaves to quickly cut through steam sterilizer scale and deposits.

Versatile and effective, SKLAR SHEEN couples powerful stain and rust removers with corrosion inhibitors, making it tough on stains but gentle on instruments. Recondition instruments to restore them to nearly brand new working condition.

Use to clean and recondition any stainless steel surface to its original luster, including carts, trays and basins.

- Conditions for lasting protection.
- Dissolves hard water deposits.
- Frees up frozen box locks.
- Restores and extends surgical instrument life.

PRODUCT NUMBER	FEATURES	QUANTITIES
10-2738	22 oz. Spray Bottles	12/case
10-2736	22 oz. Spray Bottle	1 bottle



SKLAR INSTRUMENT CARE KIT

A TRIO OF SKLAR'S CARE AND CLEANING PRODUCTS TO KEEP INSTRUMENTS IN TIPTOP SHAPE

PRODUCT NUMBER	FEATURES	QUANTITIES
10-1625		
	Sklar Lube™ 8 oz. Spray Bottle	1 each
	Sklar Kleen™ Liquid 8 oz. Bottle	1 each
	Sklar Polish™ 8 oz. Jar	1 each
	Stainless Steel Bristle Cleaning Brush	1 each
	Nylon Bristle Cleaning Brush	1 each



TROUBLE SHOOTING

NO STEEL IS TRULY “STAINLESS”

It's a fact that so-called stainless steel is subject to both water-spotting and staining. However what many people identify as a “rust” problem usually turns out to be something else.

Most often the problem is actually a stain caused by a surface deposit. These deposits appear in a variety of colors depending upon the type of deposit involved. Once the cause is found and eliminated, most of the time the problem quickly diminishes or disappears completely.

As you probably know, stainless steel is ideally suited for the surgical suite because it is rust resistant, it can

be honed to an extremely sharp edge or fine point, and it can be hardened to maintain the delicate, yet precise, requirements of the surgeon. But it is this hardenable quality – the amount of carbon used during the manufacturing process – coupled with harsh chemicals and improper care that renders stainless steel susceptible to corrosion.

To protect your instrument investment, Sklar cleaning agents have been specifically formulated to provide cost effective instrument care solutions that help maintain the life and performance of your valuable stainless steel instruments.



**889 South Matlack Street
West Chester, PA 19382**

800.221.2166

610.430.3200

Fax: 610.696.9007

International Phone: 610.430.3200

International Fax: 610.430.3941

surgi@sklarcorp.com

international@sklarcorp.com

www.sklarcorp.com

DISTRIBUTED BY: