



SURGERY CENTER

# HOSPITAL CATALOG

GENERAL SURGERY  
EDITION



*Complete Guide to the Care and Cleaning of Surgical Instruments. See Pages 715-729*

# TABLE OF CONTENTS

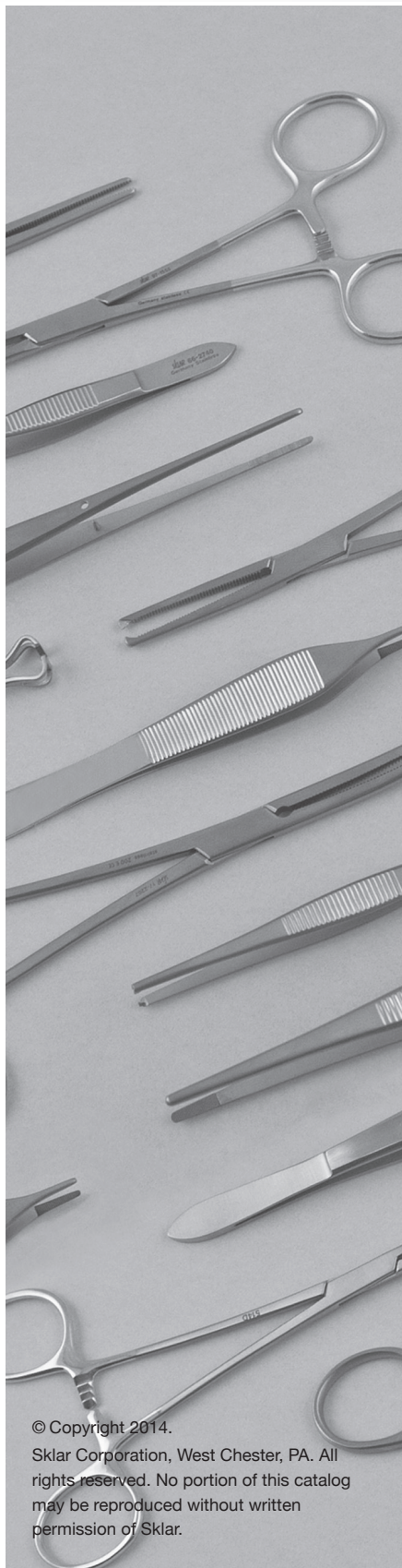

© Copyright 2014.  
Sklar Corporation, West Chester, PA. All rights reserved. No portion of this catalog may be reproduced without written permission of Sklar.

## TABLE OF CONTENTS

Care & Cleaning .....	3-17	Bariatric .....	459-463
Premium Instruments .....	18-46	Genito-Urinary Instruments .....	464-469
Scissors .....	47-77	Rectal Instruments .....	470-476
Forceps .....	78-127	Thoracic .....	477-494
Needle Holders .....	128-136	Cardiovascular .....	495-531
Retractors .....	137-153	Dermal .....	532-535
Suction & Aspiration .....	154-161	Instrument Sets .....	536-581
Trocars .....	162	Dental .....	582-614
Suture Instruments .....	163-171	Surgi-OR .....	615-622
Directors & Probes .....	172	Merit .....	623-633
Gall Bladder Instruments .....	173-175	Econo/Econo-Sterile .....	634-661
Kidney Instruments .....	176	Sterile Trays .....	662-666
ENT/Plastic Surgery .....	177-213	Blades/Scalpels .....	667-670
Ophthalmic .....	214-258	Diagnostic .....	671-679
Micro-Surgery .....	259-271	Stainless Steel .....	680-702
Orthopedic .....	272-317	Plastic Ware .....	703-706
Arthroscopy .....	318-321	ID .....	707-708
Podiatry .....	322-353	Brushes .....	709-714
OB/GYN .....	354-409	Care & Cleaning .....	715-729
Electrosurgery .....	410-419	Conversion Chart .....	730
Laparoscopic .....	420-449	Index .....	731-808
Disposables .....	450-458		





**DISCLAIMERS:**

Sklar offers a full line of quality surgical products and services to meet your needs. Product information within this catalog is intended to provide general information about Sklar, its products and services and makes no representation either expressed or implied to the contrary. It is not meant to provide specialist advice or instructions concerning the products available from Sklar. For additional information and special inquiries concerning our products and services, please contact Sklar directly. In an effort to continually improve our product line, Sklar reserves the right to change patterns without notice. Contact your sales representative to verify availability.

In no event is Sklar liable for any incidental, special or exemplary damages or loss of profits in connection with the use of a Sklar Instrument or Product.

Convenience Kits (FDA recognized term) illustrated in this catalog are representative of Sklar's assembly capability. The final design and approval of the kit is the responsibility of the customer and will be managed in accordance with the Sklar Design and Development process.

Sklar Corporation  
889 S. Matlack Street  
West Chester, PA 19382

Phone: 800.221.2166  
Fax: 610.696.9007  
Email: Surgi@sklarcorp.com

**ORDERS**

- Sklar's full line of Instrument Products are available through any authorized Sklar Distributor. Contact our Customer Service Department at 800.221.2166 to locate a Sales Representative in your area.
- Customers with established accounts and in good standing are subject to Net 30 days from date of invoice. Poor credit conditions can result in denial, delay or cancellation of orders.

**SHIPMENTS**

- Pricing is FOB West Chester PA unless otherwise noted and may be subject to change. Shipping schedules are approximate and subject to change without notice. Same day shipping is available. Standard orders will be shipped via the carrier of Sklar's choice. Special shipping requests will be accepted but additional handling charges are applicable.
- All Sklar instruments and product are carefully inspected prior to shipment. Customers shall inspect all items upon receipt and file a claim within (10) days of receipt of shipment.

**WARRANTY**

- Instruments and Products are recommended for their intended use only, and require continuous and proper care. Misuse can damage instruments and products and void the warranty.
- All Sklar instruments are guaranteed to be free from defect in material and workmanship. Defective instruments may be returned for repair or replacement at no charge. Repair or replacement is at the discretion of Sklar. Warranty is void on any instrument serviced by any company other than Sklar Instrument Repair Services.
- Sklar offers a variety of supplementary surgical products. These products are held to high standards for material and craftsmanship and some are subject to a limited warranty (vary by product).

**RETURNS**

- Unused instruments returned in the original packaging will be accepted within 30 days of purchase. Standard sterile kits may be returned within 30 days provided sterility of the inner packs have not been compromised, package is unopened and resalable. Most cleaning products are non-returnable.
- Product that was special (engraved/etched) or custom ordered, discontinued, marked or altered in any way, including product or package labeling, will not be accepted for return or credit.
- A Returned Goods Authorization (RGA) number must be obtained prior to returning products. Contact Customer Service at 800.221.2166 for authorization. Credit, repair and/or replacement are at Sklar's discretion. See [www.sklarcorp.com](http://www.sklarcorp.com) for complete return policy and procedures.





## CARE AND CLEANING

Sklar is pleased to offer a full line of Care & Cleaning agents to disinfect, decontaminate, sterilize, lubricate and protect your stainless steel surgical instruments and equipment. For expert care of your surgical instruments at every stage of the cleaning process, trust Sklar to deliver the right cleaning agent for you.



## 3 EASY STEPS FOR THE CARE AND CLEANING OF YOUR INSTRUMENTS

**1 DECONTAMINATION****2 MINUTE KILL TIME**

Sklar Soak™ and Sklar Disinfectant are intended to safely decontaminate soiled surgical instruments immediately after

use. These ready to use, non-toxic formulas are safe for use on medical and surgical equipment including stainless steel, chrome, glass, plastic, Plexiglas, baked on painted and other non-porous surfaces. Effective against H1N1, HIV-1, HSV, VRE, Rotaviruses, Hep B & C as well as TB, MRSA and A-Baumannii.

**2 CLEANING****DETERGENTS AND ENZYMATICS**

Choose from a wide selection of Sklar cleaning agents. First use Sklar Spray-Zyme™ foam pre-cleaner to coat instruments until ready to process.

Next use Sklar Enzymatic™, a fast acting detergent specifically formulated for soaking/cleaning instruments heavily laden with organic debris. Finally, use Sklar Kleen™ as your neutral pH, non-corrosive detergent for manual, ultrasonic or automatic cleaning. Sklar detergents and enzymatics are effective in the cleaning process of surgical instruments, as well as metals, glassware, plastics and rubber.

**3 LUBRICATION****SKLAR LUBRICANT**

To guarantee the extended life and performance of your surgical instruments, lubrication should be a standard part of your instrument processing regimen. Easy to use Sklar Instru-Guard™ products improve function and contain rust inhibitors that protect against corrosion, rust and stains. Following lubrication, instruments should be sterilized according to the instrument manufacturer's instructions and/or stored until use.



# SKLAR-CIDE™

## HIGH LEVEL DISINFECTING/STERILIZING SOLUTION

**Sporicidal • Bactericidal • Virucidal • Fungicidal**

SKLAR-CIDE provides a safe and efficient means for the high-level disinfection or sterilization of medical, ophthalmic, dental and surgical devices including endoscopes and lensed instruments. It may be used as a standard soak solution or in automatic reprocessing units set at room temperature. Unlike other solutions, there is no need to increase the solution temperature to provide high-level disinfection in 25 minutes.

SKLAR-CIDE is a surfactant-free, activated glutaraldehyde liquid chemical sterilant and high-level disinfectant. Its active ingredient is glutaraldehyde in a nominal concentration of 3%. When the powdered activator is added, the solution turns green in color to indicate its readiness for use. In addition to the active ingredient, this ready-to-use solution contains buffers, wetting agents, and a rust and corrosion inhibitor and it has a pleasant fragrance.

SKLAR-CIDE produces high-level disinfection at room temperature in as little time as 25 minutes, and complete sterilization in 10 hours at room temperature.

- Reusable for 28 days instead of 14, safer and saves time and money.
- Surfactant free - Will not damage scope surfaces or cloud lenses.
- Can be used safely on all devices, including instruments and endoscopes. No need to stock several products.



PRODUCT NUMBER	FEATURES	QUANTITIES
10-1623	28 HLD 1 Gallon Bottles	4/case
10-1624	28 HLD 1 Gallon Bottle	1 bottle

### GLUTARALDEHYDE STRIPS

PRODUCT NUMBER	FEATURES	QUANTITIES
96-4106	.5 - 2.5% MEC 100 Strips / Bottle	1 bottle



# SKLAR SOAK™

## INSTRUMENT PRE-SOAK & DECONTAMINANT RUST RESISTANT!

Immersing soiled instruments in SKLAR SOAK effectively pre-cleans and decontaminates, without fear of rusting!

SKLAR SOAK is an effective pre-cleaner that breaks down bio-burden, lifting blood and other organic debris from the surface, while penetrating box locks and crevices.

The rust inhibitor protects the delicate chromium oxide layer of the instrument, thus defending against rust and corrosion. Using SKLAR SOAK as a pre-cleaner is the first line of defense against rust, prolonging the life of the instrument and therefore protecting your investment!

Soaking for only two minutes thoroughly decontaminates instruments, reducing the risk of exposure to pathogens such as H1N1, HIV-1, HSV, VRE, Rotaviruses, Hep B & C as well as TB, MRSA and A. Baumannii. However, because SKLAR SOAK contains a rust inhibitor, instruments may soak for several hours without fear of rusting! Employees are protected from cross contamination, and at the same time can enjoy the freedom to reprocess instruments when it's convenient!

SKLAR SOAK is ideal for use on all stainless steel instruments:

- PH balanced, designed specifically for stainless steel instruments.
- Intermediate level disinfectant with broad spectrum of efficacy.
- Rust resistant.
- Non-caustic.
- Ready to use.
- No special handling or disposal.
- Fragrant, no offensive odors.
- Non-glutaraldehyde.

PRODUCT NUMBER	FEATURES	QUANTITIES
10-1603	1 Gallon Bottles	4/case
10-1609	1 Gallon Bottle	1 bottle



# SKLAR DISINFECTANT™

## 2 MINUTE KILL TIME

### READY-TO-USE SPRAY SURFACE DISINFECTANT

- Ready to use, non-toxic formula.
- Specially formulated for the control of cross contamination.
- Effective against a broad range of pathogens including H1N1, HIV-1, HSV, VRE, Rotaviruses, Hep B & C as well as TB, MRSA and A. Baumannii.
- Safe for all areas of the facility including the NICU, operating rooms, isolation rooms, patient care areas and laboratories.
- Satisfies OSHA's Bloodborne Pathogen Standards.
- Non-irritating formula.
- EPA registered.

PRODUCT NUMBER	FEATURES	QUANTITIES
10-1643	24 oz. Spray Bottles	6/case
10-1642	24 oz. Spray Bottle	1 bottle
10-1653	1 Gallon Bottles	4/case
10-1654	1 Gallon Bottle	1 bottle
10-1644	2.5 Gallon Bottles	2/case





# SKLAR DISINFECTANT™ SURFACE WIPES

READY-TO-USE, PRE-MOISTENED  
TOWELETTES

SAME EFFECTIVE FORMULA AS  
SKLAR DISINFECTANT!

## 2 MINUTE KILL TIME

- Ready to use, non-toxic formula.
- Specially formulated for the control of cross contamination.
- Effective against a broad range of pathogens including H1N1, HIV-1, HSV, VRE, Rotaviruses, Hep B & C as well as TB, MRSA and A. Baumannii.
- Safe for all areas of the facility.
- Satisfies OSHA's Bloodborne Pathogen Standards.
- Destroys odor-causing bacteria.
- 7" x 10" non-woven, tear resistant towelette.
- Clean scent.
- EPA registered.

PRODUCT NUMBER	FEATURES	QUANTITIES
10-1616	100 Towelettes / Canister	6/case
10-1617	100 Towelettes / Canister	12/case





# SKLAR SPRAY-ZYME™

## SURGICAL INSTRUMENT PRE-CLEANER

### Multi-Enzyme Based Foam Spray Instrument Cleaner

Processing soiled instruments immediately after use is key to preventing damage caused by dried organic fluids. If rinsing is not immediately available, it is best to pre-treat instruments with a neutral pH/enzymatic solution at point of service. Sklar SPRAY-ZYME is a multi-enzymatic spray that creates a long lasting, heavy foam, coating soiled instruments and scopes for hours after application. Encrustation is avoided and instruments are pre-cleaned and remain moist until ready for processing.

- Enzyme foam stops blood and bodily fluids from drying on surgical instruments.
- Foam consistency prevents messy spills during transportation.
- Neutral pH formula is safe for use on stainless steel, tungsten carbide, aluminum and brass instruments.
- Microbiological control agents inhibit bacterial growth.
- Ready-to-use formula is cost effective and saves time.

PRODUCT NUMBER	FEATURES	QUANTITIES
10-2722	22 oz. Refillable Spray Bottles	12/case
10-2724	1 Gallon Bottles	4/case





# SKLAR ENZYMATIC™ DETERGENT

## MULTI-ENZYME DETERGENT CONCENTRATE

### 100% Biodegradable

SKLAR ENZYMATIC Detergent is a low-foaming, fast acting detergent specifically designed for use when instruments and/or cloth materials become soiled with organic debris.

SKLAR ENZYMATIC Detergent may be used as a manual instrument cleaner as well as a pre-soak for blood-contaminated linens, clothing and instruments. It is also used in ultrasonic units and in washer/sterilizer/decontaminators. When used as directed, the enzymatic pH neutral formula is safe for use on rubber, plastic, stainless steel instruments, and surgical equipment as well as cloth.

PRODUCT NUMBER	FEATURES	QUANTITIES
10-2777	1 Gallon Bottles	4/case
10-2775	1 Gallon Bottles	2/case
10-2776	1 Gallon Bottle	1 bottle



# SKLAR KLEEN™

## LIQUID DETERGENT

### Regular Formula for Manual and Ultrasonic Cleaning

The SKLAR KLEEN Liquid Detergent was specifically developed for manual and ultrasonic cleaning. It is an effective yet non-corrosive, non-aggressive, phosphate-free and biodegradable formula that will not etch glassware or attack instrument metals. It is moderately alkaline, affording optimum cleaning power. Appropriate for stainless steel, metal, glassware, plastics and rubber.

### Low Foam Formula for Automatic Cleaning

The SKLAR KLEEN Low Foam Liquid is concentrated in order to provide a very cost-effective cleaning solution. It is especially formulated to maintain low foam, ensuring effective and trouble-free action in washer/sterilizers and tunnel washers. Dispersing quickly, the SKLAR KLEEN Low Foam formula is also well suited for automatic injection systems.

PRODUCT NUMBER	FEATURES	QUANTITIES
10-1612	Liquid 8 oz. Bottles	6/case
10-1614	Liquid 8 oz. Bottle	1 bottle
10-1613	Liquid 1 Gallon Bottles	4/case
10-1627	Liquid 1 Gallon Bottle	1 bottle
10-2701	Low Foam 1 Gallon Bottles	4/case
10-2702	Low Foam 1 Gallon Bottle	1 bottle





# SKLAR KLEEN™

## POWDERED DETERGENT

The SKLAR KLEEN Powdered Detergent is an excellent way to reduce or neutralize the effects of corrosive minerals that are inherent in virtually all community water supplies. SKLAR KLEEN Powdered Detergent is ideal for manual and ultrasonic cleaning. One economical 3½ lb. container can make in excess of 150 gallons of cleaning solution. It's non-corrosive, non aggressive, phosphate free formula will not etch glassware or attack your instrument metals.

- Economical and Convenient.
- For all manual and ultrasonic cleaning.
- Appropriate for stainless steel, metal glassware, plastics and rubber.
- Non-Corrosive.
- Easy to Handle.

PRODUCT NUMBER	FEATURES	QUANTITIES
10-1608	Powdered 5 lb. Containers	4/case
10-1607	Powdered 5 lb. Container	1 container
10-1630	Powdered 3.5 lb. Pitchers	6/case
10-2765	Powdered 3.5 lb. Pitcher	1 pitcher



# SKLAR INSTRU-GUARD™ ONE STEP

## A “ONE STEP” INSTRUMENT CLEANER AND LUBRICANT

### EXTENDS INSTRUMENT LIFE!

SKLAR INSTRU-GUARD ONE STEP contains a penetrating lubricant that protects and helps extend the life of surgical instruments. The detergents and emulsifiers quickly break up and remove organic soils from box locks and other hard to reach places.

SKLAR INSTRU-GUARD ONE STEP contains four rust inhibitors to control corrosion and eliminate scaling and spotting. It does not contain phosphates and can reduce the time and cost involved in processing your instruments by cleaning and lubricating in one easy step.

PRODUCT NUMBER	FEATURES	QUANTITIES
10-2800	1 Gallon Bottles	4/case
10-2801	1 Gallon Bottle	1 bottle





# SKLAR INSTRU-GUARD™ LUBE

## SURGICAL INSTRUMENT LUBRICANT / RUST INHIBITOR

- Extend the Life of Instruments.
- Protects all Surgical Instruments.

SKLAR INSTRU-GUARD LUBE is an easy-to-use, water soluble, lubricant and rust inhibitor. When used daily as a rinse after every cleaning it keeps moving parts operating smoothly and remains effective after autoclaving, but without leaving an oily residue.

Regular lubrication is essential no matter which cleaning method is employed (including ultrasonic). SKLAR INSTRU-GUARD LUBE is ideal for maintaining instrument quality and performance.

PRODUCT NUMBER	FEATURES	QUANTITIES
10-1635	1 Gallon Containers Concentrated	4/case
10-1634	1 Gallon Container Concentrated	1 container
10-1636	8 oz. Spray Bottles	12/case
10-1637	8 oz. Spray Bottle	1 bottle



# SKLAR POLISH™

## INSTRUMENT STAIN REMOVER

SKLAR POLISH is an effective stain remover for use on all your metal surgical instruments, including stainless steel, chrome and brass. It will brighten instrument trays, basins and racks and may also be used on porcelain and tile surfaces.

- Non Abrasive.
- Removes corrosive stains.
- Extends instruments life.
- "Like New" results.

PRODUCT NUMBER	FEATURES	QUANTITIES
10-1626	8 oz. Jars	12/case
10-1629	8 oz. Jars	6/case
10-1927	8 oz. Jar	1 jar



## INSTRUMENT CLEANING BRUSHES (STAINLESS BRISTLES)

PRODUCT NUMBER	FEATURES	QUANTITIES
10-1650	Stainless Steel Bristles	3/pk
10-1652	Stainless Steel Bristles	12/pk
10-1658	Stainless Steel Bristles	24/pk
10-1665	Stainless Steel Bristles	48/pk



## INSTRUMENT CLEANING BRUSHES (NYLON BRISTLES)

PRODUCT NUMBER	FEATURES	QUANTITIES
10-1651	Nylon Bristles	3/pk
10-1657	Nylon Bristles	12/pk
10-1659	Nylon Bristles	24/pk
10-1656	Nylon Bristles	48/pk



### DISPOSABLE (PICTURE ON WEB)

10-1465	Nylon Bristles, Disposable	12/pk
10-1468	Nylon Bristles, Disposable	24/pk



# SKLAR-SHEEN™

## AUTOCLAVE AND INSTRUMENT CLEANER AND CONDITIONER

With an efficacious phosphoric acid cleaning agent, SKLAR SHEEN is a robust spot, stain and rust remover. Ideal for dissolving hard water deposits, use in autoclaves to quickly cut through steam sterilizer scale and deposits.

Versatile and effective, SKLAR SHEEN combines powerful stain and rust removers with corrosion inhibitors, making it tough on stains but gentle on instruments. Recondition instruments to restore them to nearly brand new working condition.

Use to clean and recondition any stainless steel surface to its original luster, including carts, trays and basins.

- Conditions for lasting protection.
- Dissolves hard water deposits.
- Frees up frozen box locks.
- Restores and extends surgical instrument life.

PRODUCT NUMBER	FEATURES	QUANTITIES
10-2738	Spray Foam Autoclave Cleaner & Conditioner	12/case
10-2736	Spray Foam Autoclave Cleaner & Conditioner	22oz. bottle





# SKLAR INSTRUMENT CARE KIT

A Trio of Sklar's Care and Cleaning products to keep instruments in tiptop shape.

PRODUCT NUMBER	FEATURES	QUANTITIES
10-1625		
	Sklar Lube™ 8 oz. Spray Bottle	1 each
	Sklar Kleen™ Liquid 8 oz. Bottle	1 each
	Sklar Polish™ 8 oz. Jar	1 each
	Stainless Steel Bristle Cleaning Brush	1 each
	Nylon Bristle Cleaning Brush	1 each



## TROUBLE SHOOTING

### NO STEEL IS TRULY “STAINLESS”

It's a fact that so-called stainless steel is subject to both water-spotting and staining. However what many people identify as a “rust” problem usually turns out to be something else.

Most often the problem is actually a stain caused by a surface deposit. These deposits appear in a variety of colors depending upon the type of deposit involved. Once the cause is found and eliminated, most of the time the problem quickly diminishes or disappears completely.

As you probably know, stainless steel is ideally suited for the surgical suite because it is rust resistant, it can be honed to an extremely sharp edge or fine point,

and it can be hardened to maintain the delicate, yet precise, requirements of the surgeon. But it is this hardenable quality – the amount of carbon used during the manufacturing process – coupled with harsh chemicals and improper care that renders stainless steel susceptible to corrosion.

To protect your instrument investment, Sklar cleaning agents have been specifically formulated to provide cost effective instrument care solutions that help maintain the life and performance of your valuable stainless steel instruments.



## TROUBLE SHOOTING

### CORROSION

- Problem:** Debris and residue in box locks, serrations and ratchets.
- Solution:** Serrations, box locks and ratchets should be carefully cleaned and rinsed. A soft bristle brush is effective in these difficult areas.
- Problem:** Moisture remaining on the instruments within the sterile wrapped packs; excessive moisture in autoclave during sterilization and termination of cycle.
- Solution:** Preheat autoclave, drying time cannot be accelerated, open autoclave door slightly. Routinely inspect valves. Malfunctioning valves can precipitate corrosion.
- Problem:** Some local water supplies contain excessive quantities of alkali. This can manifest itself by depositing corrosive matter on the instruments.
- Solution:** It is generally accepted that cold distilled or demineralized water be used during sterilization. An alternative is to use the local water supply, while instituting a program of preventive maintenance. Carefully clean surfaces with SKLAR KLEEN™, using SKLAR POLISH™ to remove difficult stains and SKLAR LUBE™ for proper lubrication.

### PITTING

- Problem:** Instruments are inevitably exposed to chemical compounds that initiate pitting. The most common are saline solutions and blood.
- Solution:** It is essential that instruments be rinsed with distilled or demineralized water and then cleaned routinely.
- Problem:** Some Non-Sklar detergents contain a chloride or have an acid base. If rinsing is not thorough, the residual detergent can precipitate pitting. Hydrochloric acid can be formed by the combination of chloride in the cleaner and steam, causing the instrument to pit.
- Solution:** Evaluate detergents without a chloride base. SKLAR KLEEN™ is recommended.
- Problem:** Instruments may be pitted when the detergent used has an excessively high pH. If instruments are not rinsed thoroughly and then autoclaved, the heat increases the effect of the solution on the instruments.
- Solution:** Use only detergents specifically developed for instrument cleaning. SKLAR KLEEN™ products are pH balanced.

### BROWNISH STAIN

- Problem:** This stain is more obvious on dull finish instruments. Most likely, it is a deposit of chromium oxide. The thin hard layer protects stainless steel from corrosion precipitated by the atmosphere. The brownish film (sometimes dull blue) occurs naturally when stainless is heated. Occasionally this stain can be traced to the sterilizer. Improper cleaning compounds could contain poly phosphates that cause the copper components in the sterilizer to be deposited by electrolytic action on the stainless steel instruments.
- Solution:** Water supply to autoclave should be cold and demineralized. Use the correct amount of SKLAR KLEEN™ as recommended for best results.

### BLUISH GRAY STAINS

- Problem:** Cold sterilizing solutions.
- Solution:** In the preparation of the solution make certain the manufacturer's directions are followed accurately. To minimize discoloration use distilled water and add a rust inhibitor. Using the solution beyond recommended time limitations will cause the solution to become corrosive.

### RUST DEPOSIT

- Problem:** Sterilizing instruments of different metals in the same cycle will cause rusting. An electrolytic action carries the carbon particles from the exposed metal and deposits them on the stainless steel instruments. The rapid oxidation of molecules results in a surface film of rust.
- Solution:** The ideal technique would be to sterilize the two types of instruments separately. It is recommended that chrome plated instruments that indicate signs of peeling or flaking be replaced with stainless steel instruments.
- Problem:** The rust film on the surface of stainless steel instruments can be caused by chemicals in the detergent. Excess amounts of iron or other minerals from the local water supply may cause the rust deposits.
- Solution:** It is recommended that instruments be rinsed with distilled or demineralized water. Surface rust can be removed by light buffing or an application of SKLAR POLISH™.

### LIGHT AND DARK COLORED SPOTS

- Problem:** Spotting caused by slow evaporation of water drops identified with the mineral content of the water.
- Solution:** Eliminate water droplets by adhering to autoclave manufacturer's operating instructions. Autoclave door should not be opened until steam has been completely vented.

Sklar is proud to offer a full line of Premium instruments that have been customized to meet the needs of clinicians for specific procedures. Choose from a wide variety of the most popular patterns within each premium line.

### Tungsten Carbide

Tungsten carbide is an extremely hard alloy that provides an exceptionally strong and positive holding power beyond that of any standard instrument. Sklar TC instruments improve control and reduce trauma. Using the special non-slip tissue gripping profile, users can apply exact pressure for proper tissue handling and suture tying. These precision ground instruments are readily identified by the gold handles.

### Sklar Edge™ Tungsten Carbide

Sklar Edge scissors are manufactured using a Sklar exclusive edging process that permanently bonds Tungsten Carbide to the scissor blades, resulting in a stronger, sharper edge. These perfectly balanced scissors are readily identified by the dual gold finger rings and maintain a 5-year guarantee on durability.

### Sklar Edge™ Tungsten Carbide Supercut SklarHone™

Sklar Edge™ Tungsten Carbide Supercut SklarHone™ Scissors combine all the advantages of durable Tungsten Carbide with the precision performance of Supercut SklarHone™ blades. Easily identify these instruments with one gold handle and one black handle.

### Supercut SklarHone™

Designed to cut through tissue effortlessly, SklarHone™ Scissors feature the razor-like edge of a surgical knife on the upper blade. The opposing blade is available as Supercut, with micro-serrations to hold tissue and prevent slippage, or as a standard, smooth edge. Both patterns are ideal for delicate surgeries and specially crafted to cut cleanly without catching or leaving minute tags. SklarHone™ scissors are distinctly identified by their dual black handles.

### SklarCut™

SklarCut™ improves the design and function of your most frequently used surgical instruments with the addition of ultra-fine serrations on one blade. This premium feature provides additional surgical control by holding the tissue while cutting more cleanly and with greater precision. SklarCut™ scissors are easily identified by the gold finger ring on the serrated blade handle.

### SklarLite™ / SklarLite XD™

SklarLite™ premium scissors provide the clinician a lighter pattern, minimizing fatigue during prolonged procedures. A comfortable instrument that withstands the rigors of frequent use while retaining its structural integrity. SklarLite XD™ extra delicate scissors provide the most sensitive surgical tool as well as our lightest pattern with surprising strength. SklarLite™ and SklarLite XD™ are fully guaranteed for a lifetime of dependable use.

### Sklar LiteGrip™

Sklar LiteGrip™ instruments offer fenestrated handles to allow for a firm secure grip in a lighter pattern and are ideal for extended procedures.





**SKLAR EDGE™ TC OPERATING SCISSORS**

**STRAIGHT**

16-1055	5½"	Sharp/Sharp
16-1056	5½"	Sharp/Blunt
16-1057	5½"	Blunt/Blunt

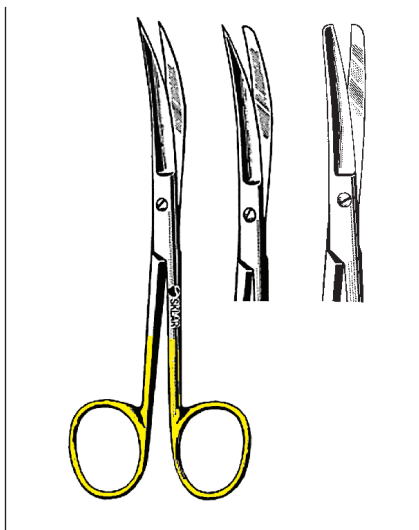

**SKLAR EDGE™ TC OPERATING SCISSORS**

**CURVED**

16-1155	5½"	Sharp/Sharp
16-1156	5½"	Sharp/Blunt
16-1157	5½"	Blunt/Blunt

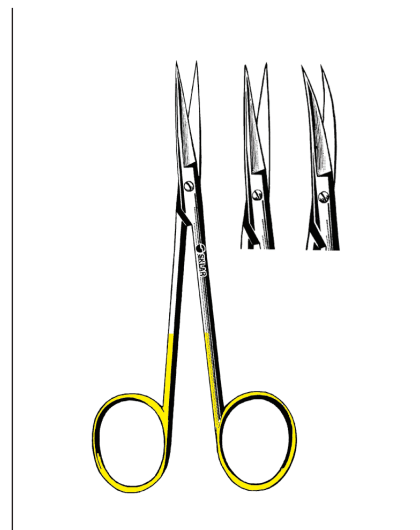

**SKLAR EDGE™ TC IRIS SCISSORS**

**SHARP/SHARP**

16-2405	4½"	Straight
16-2505	4½"	Curved

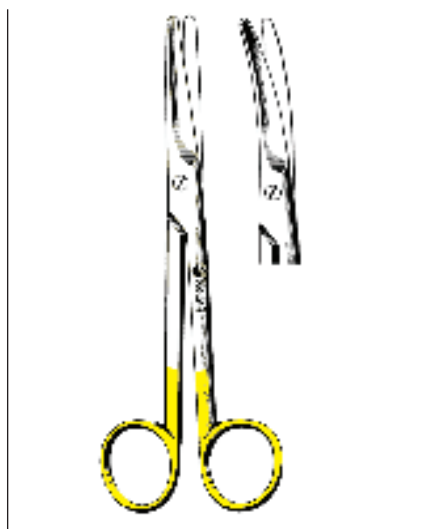

**SKLAR EDGE™ TC MAYO DISSECTING SCISSORS**

**BLUNT/BLUNT**

16-1505	5½"	Straight
16-1605	5½"	Curved
16-1510	6¾"	Straight
16-1610	6¾"	Curved
16-1515	9"	Straight
16-1615	9"	Curved

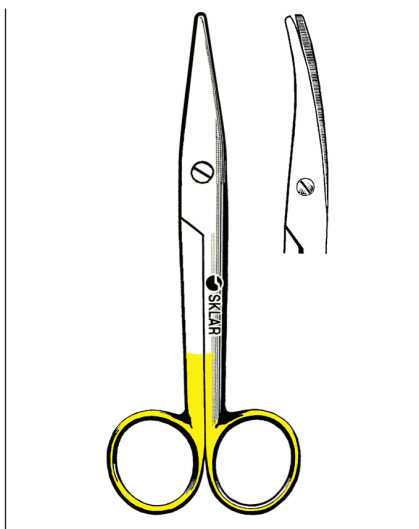

**SKLAR EDGE™ TC MAYO-STILLE DISSECTING SCISSORS**

**BLUNT/BLUNT**

16-3552	5½"	Straight
16-3562	5½"	Curved
16-3557	6¾"	Straight
16-3567	6¾"	Curved



**SKLAR EDGE™ TC METZENBAUM SCISSORS (LAHEY)**

**BLUNT/BLUNT**

16-1810	5¾"	Straight	
16-1910	5¾"	Curved	
16-1805	5¾"	Straight	Delicate
16-1905	5¾"	Curved	Delicate

**SHARP/SHARP**

16-1815	5¾"	Straight
16-1915	5¾"	Curved

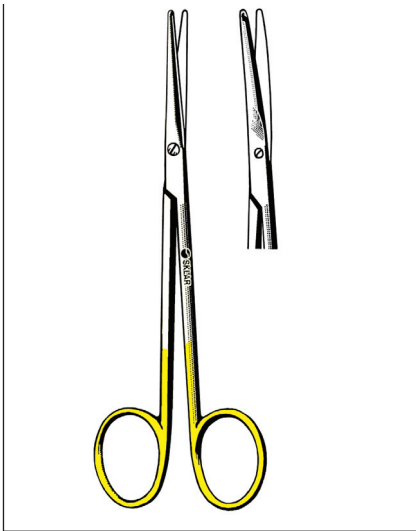

**SKLAR EDGE™ TC  
METZENBAUM SCISSORS**

**STRAIGHT, BLUNT/BLUNT**

- 16-2010 7" Delicate
- 16-2005 7" (Nelson)
- 16-2210 9" Delicate (Nelson)
- 16-2205 9" Delicate (Nelson)

**STRAIGHT, SHARP/SHARP**

- 16-2015 7" Delicate

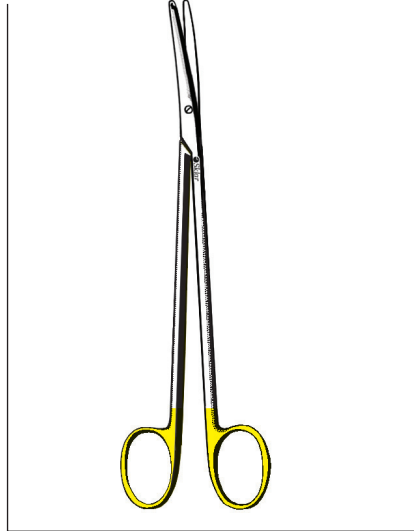

**SKLAR EDGE™ TC  
METZENBAUM SCISSORS**

**CURVED, BLUNT/BLUNT**

- 16-2110 7" Delicate
- 16-2105 7" Delicate
- 16-2215 8" Delicate
- 16-2310 9" Delicate
- 16-2305 9" Delicate (Nelson)
- 16-2211 10" Delicate (Nelson)
- 16-2311 11" (Nelson)
- 16-2312 12" (Nelson)

**CURVED, SHARP/SHARP**

- 16-2115 7" Delicate

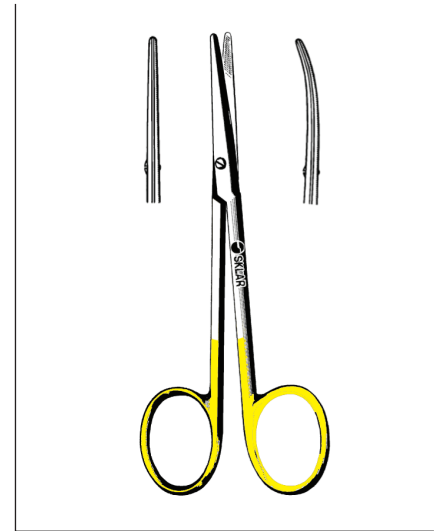

**SKLAR EDGE™ TC STRABISMUS  
SCISSORS**

- 16-2605 4½" Straight
- 16-2705 4½" Curved

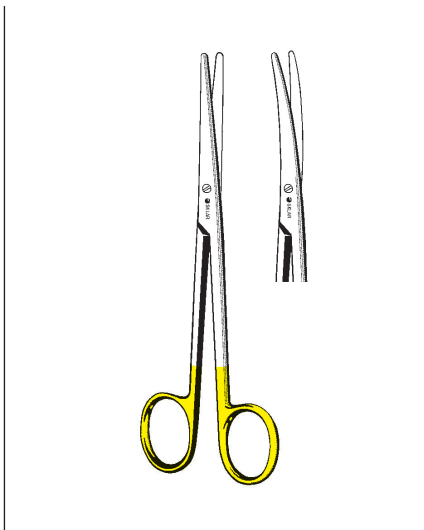

**SKLAR EDGE™ TC LEXER  
SCISSORS**

- 16-2436 6¼" Curved
- 16-2428 8¼" Straight
- 16-2438 8¼" Curved

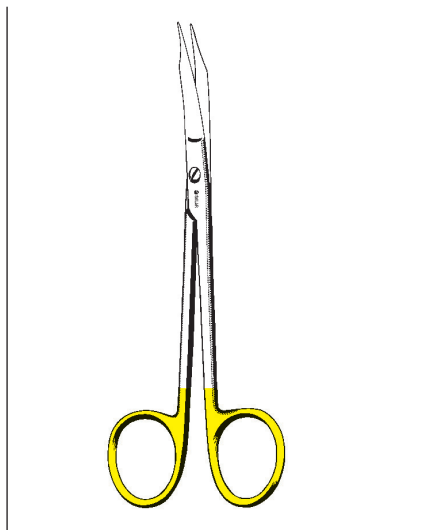

**SKLAR EDGE™ TC  
GOLDMAN-FOX SCISSORS**

**ONE SERRATED BLADE**

- 16-3614 5" Straight Blunt
- 16-3615 5" Curved Blunt
- 16-2610 5" Curved Sharp

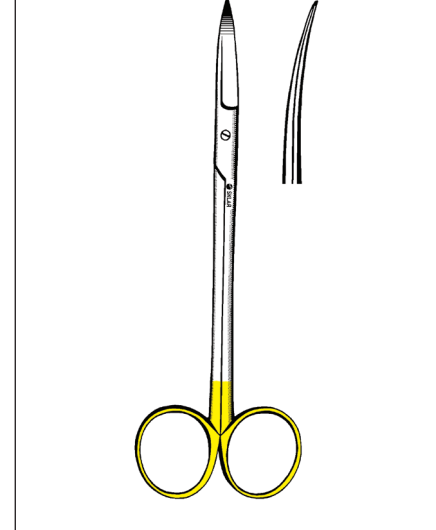

**SKLAR EDGE™ TC KAYE  
RHYTIDECTOMY &  
DISSECTING SCISSOR**

- 16-3620 5¾" Curved

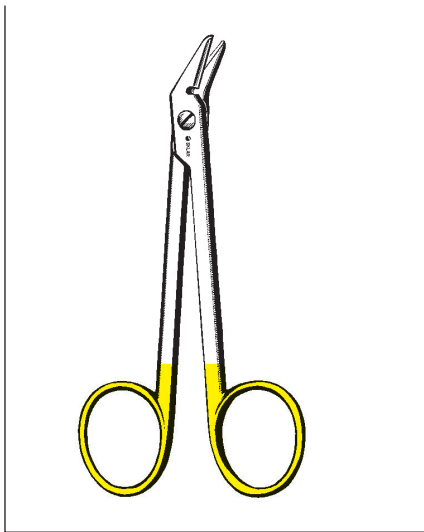

**SKLAR EDGE™ TC WIRE CUTTING SCISSOR**

16-2800 4¾" Serrated Angled



**SKLAR EDGE™ TC BLEPHAROPLASTY & DISSECTING SCISSOR**

47-1148 4½" Curved

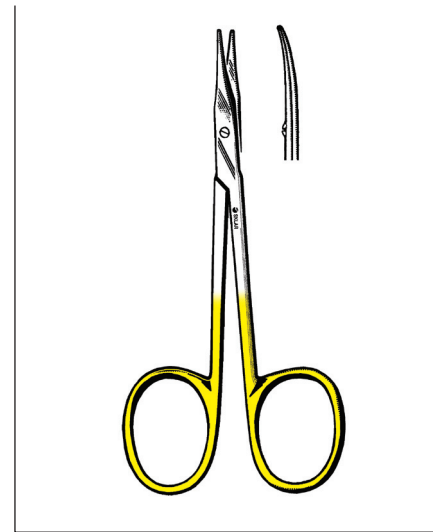

**SKLAR EDGE™ TC STEVENS TENOTOMY SCISSORS**

16-2730 4½" Straight Blunt/Bunt  
16-2731 4½" Curved Blunt/Blunt

## Z-TYPE SCISSORS

Sklar's Z-Type Hysterectomy/Parametrium Scissors are specifically designed to ideally meet the surgeon's needs during abdominal procedures. Manufactured from German grade stainless steel and under the highest quality standards, these specialized instruments provide uncompromised balance, feel and performance. With solid Tungsten Carbide inserts, Z-Type Scissors have extremely sharp, strong and precise cutting edges with lasting durability, and are specifically formed to cut tissue laterally.

PRODUCT NUMBER	DESCRIPTION
16-4000	9" Z-Type Parametrium Scissors Slight Curve
16-4001	9" Z-Type Parametrium Scissors Curved
16-4002	9" Z-Type Parametrium Scissors Full Curve
16-4004	10½" Z-Type Parametrium Scissors Slight Curve
16-4005	10½" Z-Type Parametrium Scissors Curved
16-4006	10½" Z-Type Parametrium Scissors Full Curve
16-4008	12" Z-Type Parametrium Scissors Slight Curve
16-4009	12" Z-Type Parametrium Scissors Curved
16-4010	12" Z-Type Parametrium Scissors Full Curve
16-4012	14" Z-Type Parametrium Scissors Slight Curve
16-4013	14" Z-Type Parametrium Scissors Curved
16-4014	14" Z-Type Parametrium Scissors Full Curve



**SUPER-CUT SKLAR EDGE™ TUNGSTEN CARBIDE SKLARHONE™** scissors combine all the advantages of durable tungsten carbide with the precision performance of SUPER-CUT SklarHone™ blades, featuring the razor sharp cutting edge of a knife on one blade and micro-serrations on the other. Easily identified with one gold handle and one black handle.

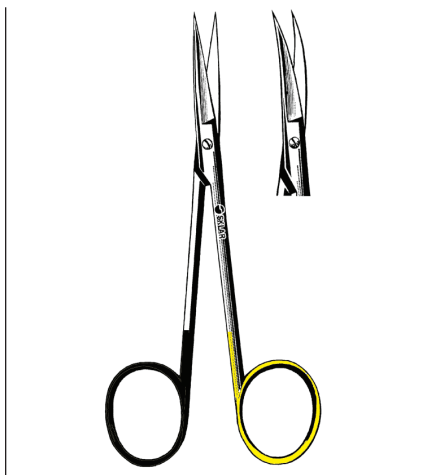

**SUPER-CUT TC SKLARHONE™  
IRIS SCISSORS**

- 16-3545 4½" Straight
- 16-3546 4½" Curved

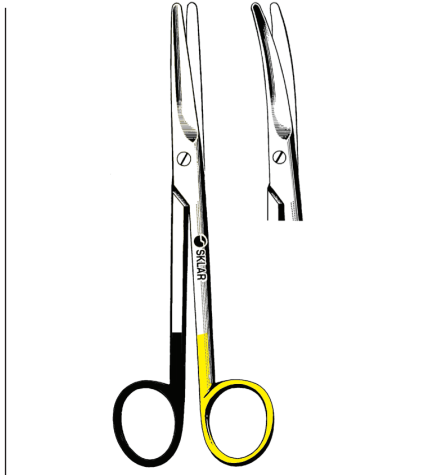

**SUPER-CUT TC SKLARHONE™  
MAYO SCISSORS**

- 16-3530 5½" Straight
- 16-3531 5½" Curved
- 16-3532 6¾" Straight
- 16-3533 6¾" Curved

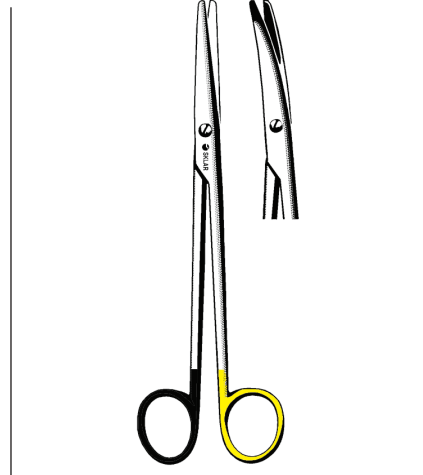

**SUPER-CUT TC SKLARHONE™  
MAYO-STILLE SCISSORS**

- 16-3572 6" Straight
- 16-3582 6" Curved
- 16-3577 6¾" Straight
- 16-3587 6¾" Curved

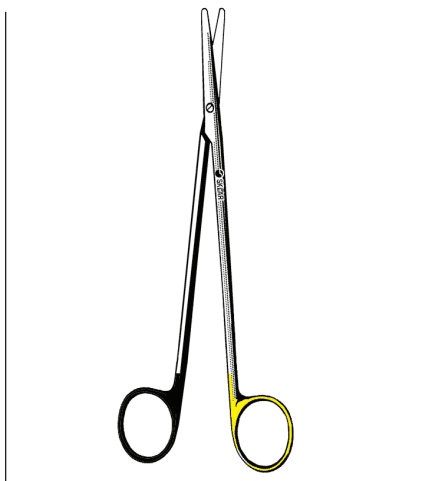

**SUPER-CUT TC SKLARHONE™  
METZENBAUM SCISSORS**

- STRAIGHT, BLUNT/BLUNT TIPS**
- 16-3503 5¾" (Lahey)
  - 16-3513 5¾" Delicate (Lahey)
  - 16-3504 7"
  - 16-3514 7" Delicate
  - 16-3505 8"
  - 16-3515 8" Delicate

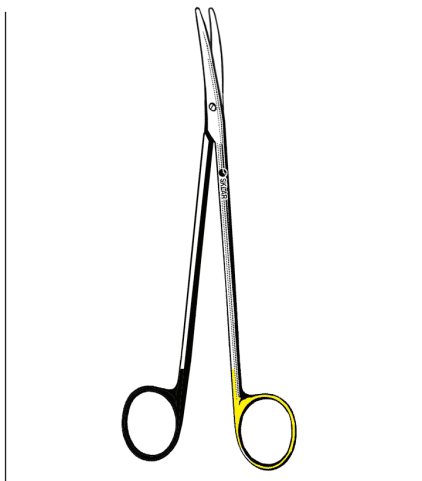

**SUPER-CUT TC SKLARHONE™  
METZENBAUM SCISSORS**

- CURVED, BLUNT/BLUNT TIPS**
- 16-3506 5¾" (Lahey)
  - 16-3526 5¾" Delicate (Lahey)
  - 16-3507 7"
  - 16-3527 7" Delicate
  - 16-3508 8"
  - 16-3528 8" Delicate
  - 16-3509 9" (Nelson)
  - 16-3510 10" (Nelson)
  - 16-3511 11" (Nelson)

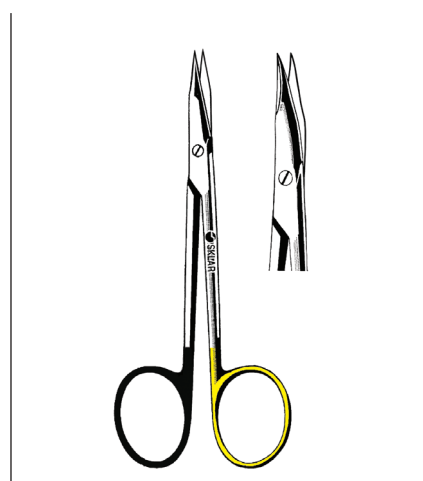

**SUPER-CUT TC SKLARHONE™  
STEVENS TENOTOMY SCISSORS**

- POINTED, SHARP/SHARP**
- 16-3540 4½" Straight
  - 16-3541 4½" Curved

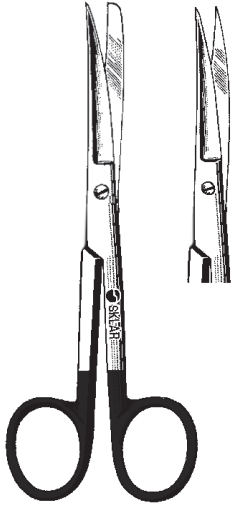

SKLARHONE™  
**SKLARHONE™  
OPERATING SCISSORS**  
**STRAIGHT, SMOOTH**  
15-3343 5½" Sharp/Blunt  
15-3342 5½" Sharp/Sharp

SUPER-CUT  
SKLARHONE™  
**SUPER-CUT SKLARHONE™  
OPERATING SCISSORS**  
**STRAIGHT, SERRATED**  
15-3443 5½" Sharp/Blunt  
15-3442 5½" Sharp/Sharp

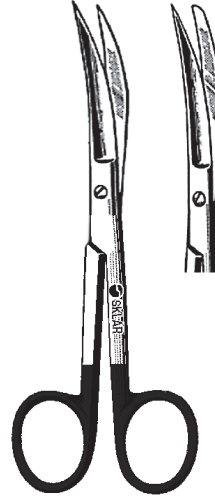

SKLARHONE™  
**SKLARHONE™  
OPERATING SCISSORS**  
**CURVED, SMOOTH**  
15-3349 5½" Sharp/Blunt  
15-3348 5½" Sharp/Sharp

SUPER-CUT  
SKLARHONE™  
**SUPER-CUT SKLARHONE™  
OPERATING SCISSORS**  
**CURVED, SERRATED**  
15-3449 5½" Sharp/Blunt  
15-3448 5½" Sharp/Sharp



SKLARHONE™  
**SKLARHONE™  
IRIS SCISSORS**  
**SMOOTH**  
15-3352 4½" Straight  
15-3357 4½" Curved

SUPER-CUT  
SKLARHONE™  
**SUPER-CUT SKLARHONE™  
IRIS SCISSORS**  
**SERRATED**  
15-3452 4½" Straight  
15-3457 4½" Curved

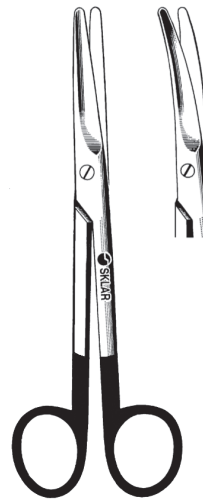

SKLARHONE™  
**SKLARHONE™  
MAYO SCISSORS**  
**SMOOTH**  
15-3325 5½" Straight  
15-3330 5½" Curved  
15-3326 6¾" Straight  
15-3331 6¾" Curved

SUPER-CUT  
SKLARHONE™  
**SUPER-CUT SKLARHONE™  
MAYO SCISSORS**  
**SERRATED**  
15-3429 5½" Straight  
15-3430 5½" Curved  
15-3426 6¾" Straight  
15-3427 6¾" Curved  
15-3434 9" Straight  
15-3435 9" Curved



SKLARHONE™

**SKLARHONE™  
METZENBAUM SCISSORS**

**SMOOTH**

15-3305	5¾"	Straight	(Lahey)
15-3306	5¾"	Curved	(Lahey)
15-3507	7"	Straight	
15-3310	7"	Curved	
15-3508	8"	Straight	
15-3311	8"	Curved	
15-3509	9"	Straight	(Nelson)
15-3315	9"	Curved	(Nelson)

**SUPER-CUT  
SKLARHONE™**

**SUPER-CUT SKLARHONE™  
METZENBAUM SCISSORS**

**SERRATED**

15-3405	5¾"	Straight	(Lahey)
15-3406	5¾"	Curved	(Lahey)
15-3407	7"	Straight	
15-3410	7"	Curved	
15-3408	8"	Straight	
15-3411	8"	Curved	
15-3409	9"	Straight	(Nelson)
15-3412	9"	Curved	(Nelson)

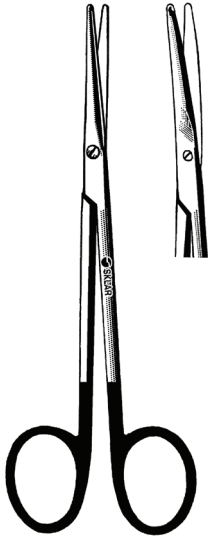

SKLARHONE™

**SKLARHONE™ SKLARLITE™  
METZENBAUM SCISSORS**

**SMOOTH**

15-9107	7"	Straight	
15-9117	7"	Curved	
15-9108	8"	Straight	
15-9118	8"	Curved	
15-9109	9"	Straight	(Nelson)
15-9119	9"	Curved	(Nelson)

**SKLARLITE™  
THE LIGHT TOUCH**

**SUPER-CUT  
SKLARHONE™**

**SUPER-CUT SKLARHONE™  
SKLARLITE™  
METZENBAUM SCISSORS**

**SERRATED**

15-3307	7"	Straight	
15-3317	7"	Curved	
15-3308	8"	Straight	
15-3318	8"	Curved	
15-3309	9"	Straight	(Nelson)
15-3319	9"	Curved	(Nelson)

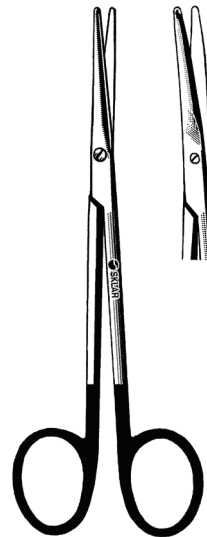

SKLARHONE™

**SKLARHONE™  
RAGNELL SCISSOR**

**SMOOTH**

15-3336	5"	Curved	
---------	----	--------	--

**SUPER-CUT  
SKLARHONE™**

**SUPER-CUT SKLARHONE™  
RAGNELL SCISSORS**

**SERRATED**

15-3335	5"	Curved	
---------	----	--------	--

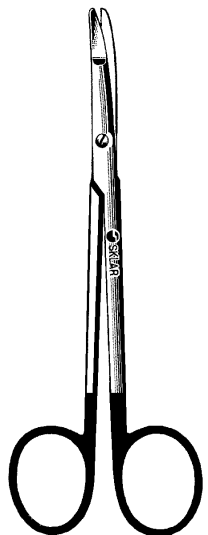

SKLARHONE™

**SKLARHONE™  
PLASTIC SURGERY SCISSORS**

**SMOOTH**

15-3460	4¾"	Straight	
15-3461	4¾"	Curved	

**SUPER-CUT  
SKLARHONE™**

**SUPER-CUT SKLARHONE™  
PLASTIC SURGERY SCISSORS**

15-3360	4¾"	Straight	
15-3361	4¾"	Curved	

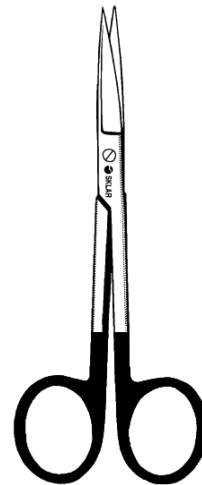

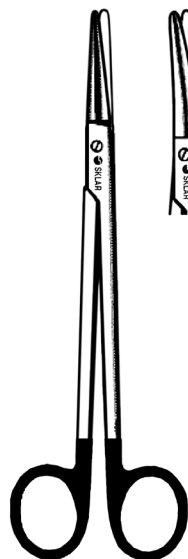

**SUPER-CUT**  
SKLARHONE™

**SUPER-CUT SKLARHONE™**  
**GORNEY PLASTIC SURGERY**  
**SCISSORS**

**SERRATED**

15-3450	7¼"	Straight
15-3451	7¼"	Curved

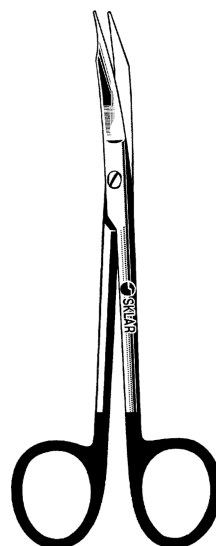

**SUPER-CUT**  
SKLARHONE™

**SUPER-CUT SKLARHONE™**  
**GOLDMAN-FOX SCISSOR**

**SERRATED**

15-3340	5"	Curved
---------	----	--------

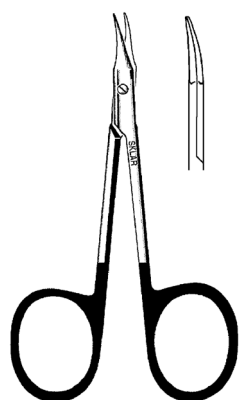

**SUPER-CUT**  
SKLARHONE™

**SUPER-CUT SKLARHONE™**  
**GRADLE SCISSOR**

**SERRATED**

15-3444	3¾"	Slight Curve
---------	-----	--------------

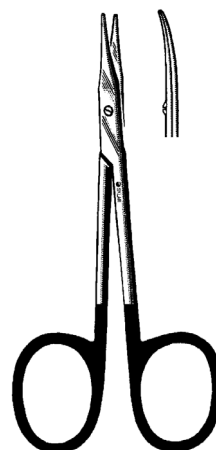

**SUPER-CUT**  
SKLARHONE™

**SUPER-CUT SKLARHONE™**  
**STEVENS TENOTOMY**  
**SCISSORS**

**SERRATED**

15-1242	4½"	Straight	Blunt
15-1243	4½"	Straight	Sharp
15-1342	4½"	Curved	Blunt
15-1343	4½"	Curved	Sharp

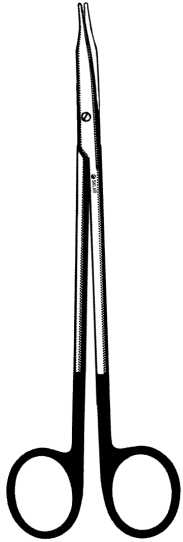

SUPER-CUT  
SKLARHONE™

**SUPER-CUT SKLARHONE™  
JAMESON SCISSOR**

**SERRATED**  
15-7032 7" Curved

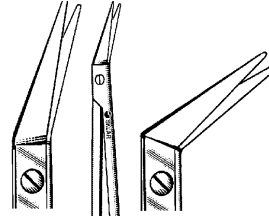

SKLARHONE™

**SKLARHONE™  
POTTS-SMITH SCISSORS**

**SMOOTH**  
15-3464 7" 25° Angle  
15-3466 7" 45° Angle  
15-3468 7" 60° Angle

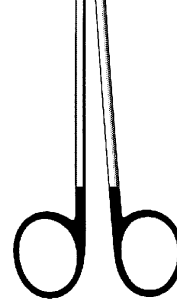

SUPER-CUT  
SKLARHONE™

**SUPER-CUT SKLARHONE™  
POTTS-SMITH SCISSORS**

**SERRATED**  
15-3364 7" 25° Angle  
15-3366 7" 45° Angle  
15-3368 7" 60° Angle

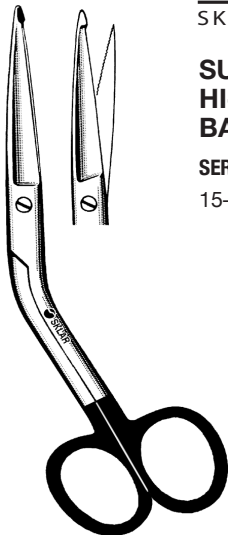

SUPER-CUT  
SKLARHONE™

**SUPER-CUT SKLARHONE™  
HI-LEVEL  
BANDAGE SCISSOR**

**SERRATED**  
15-3354 5½"

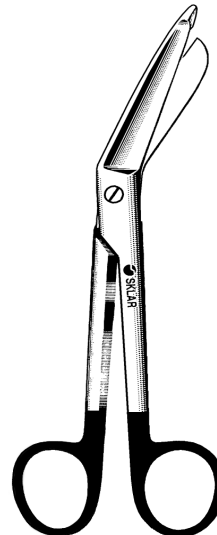

SUPER-CUT  
SKLARHONE™

**SUPER-CUT SKLARHONE™  
LISTER SCISSORS**

**SERRATED**  
15-3355 5½"  
15-3356 7¼"  
15-3358 8"



**SKLARCUT™ OPERATING SCISSORS**

15-3505	5½"	Straight	Sharp/Blunt
15-3500	5½"	Straight	Sharp/Sharp
15-3515	5½"	Curved	Sharp/Blunt
15-3510	5½"	Curved	Sharp/Sharp



**SKLARLITE™ SKLARCUT™ OPERATING SCISSORS**

23-1262	5½"	Straight	Sharp/Blunt
23-1260	5½"	Straight	Sharp/Sharp
23-1266	5½"	Curved	Sharp/Blunt
23-1264	5½"	Curved	Sharp/Sharp

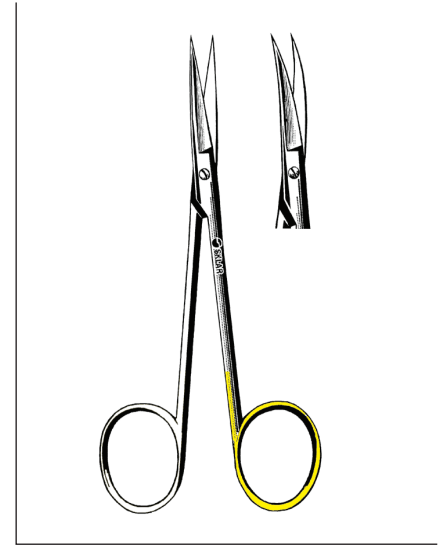

**SKLARCUT™ IRIS SCISSORS**

15-3585	4½"	Straight
15-3590	4½"	Curved



**SKLARLITE™ SKLARCUT™ IRIS SCISSORS**

23-1268	4½"	Straight
23-1270	4½"	Curved

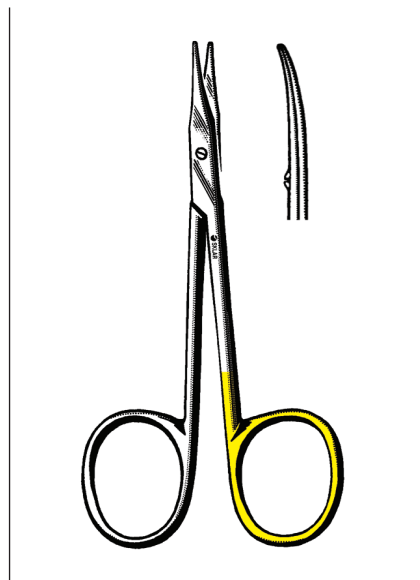

**SKLARCUT™ STEVENS TENOTOMY SCISSORS**

<b>BLUNT/BLUNT</b>		
15-3372	4½"	Straight
15-3370	4½"	Curved

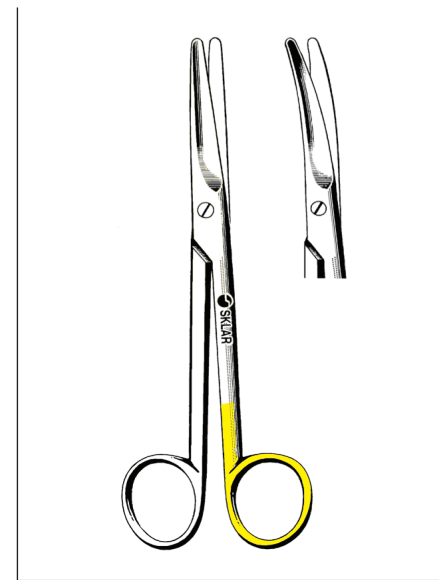

**SKLARCUT™ MAYO SCISSORS**

15-3550	5½"	Straight
15-3560	5½"	Curved
15-3555	6¾"	Straight
15-3565	6¾"	Curved
15-3566	9"	Straight
15-3568	9"	Curved

**SKLARCUT™**  
SERRATED BLADE



**SKLARLITE™ SKLARCUT™  
MAYO SCISSORS**

23-1274 6¾" Straight  
23-1278 6¾" Curved

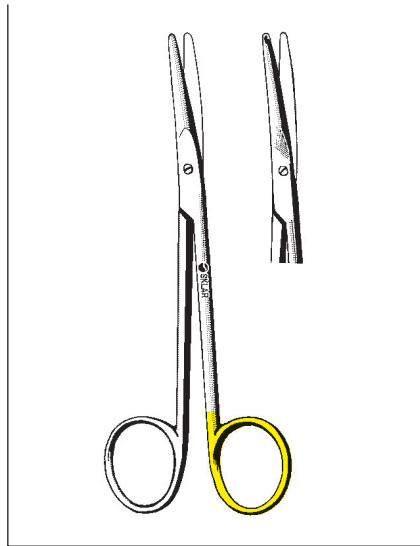

**SKLARCUT™ METZENBAUM  
SCISSORS (LAHEY)**

15-3569 4½" Straight  
15-3571 4½" Curved  
15-3567 5¾" Straight  
15-3570 5¾" Curved

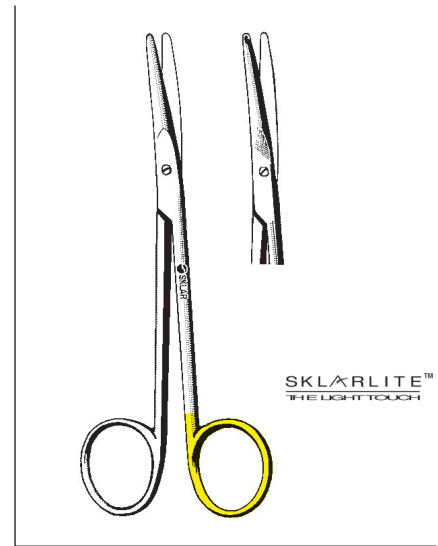

**SKLARLITE™ SKLARCUT™  
METZENBAUM SCISSORS**

23-1280 5¾" Curved (Lahey)  
23-1267 7" Curved

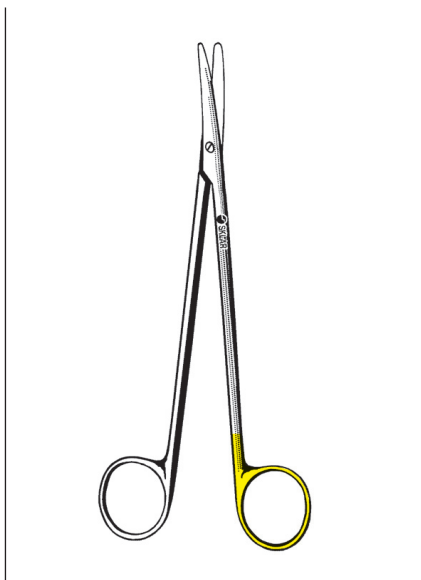

**SKLARCUT™ METZENBAUM  
SCISSORS**

**BLUNT/BLUNT**

15-3575 7" Curved  
15-3586 7" Straight  
15-3574 9" Curved

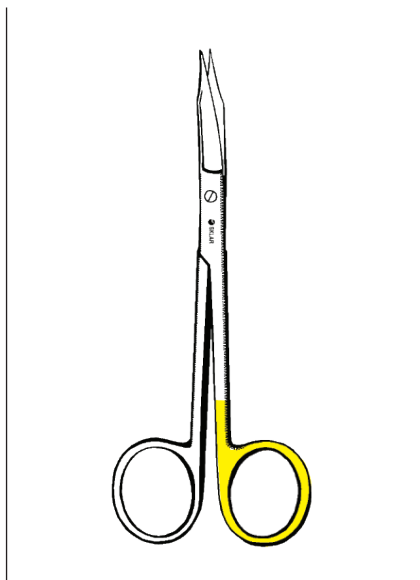

**SKLARCUT™ GOLDMAN-FOX  
SCISSOR**

15-3536 5" Delicate

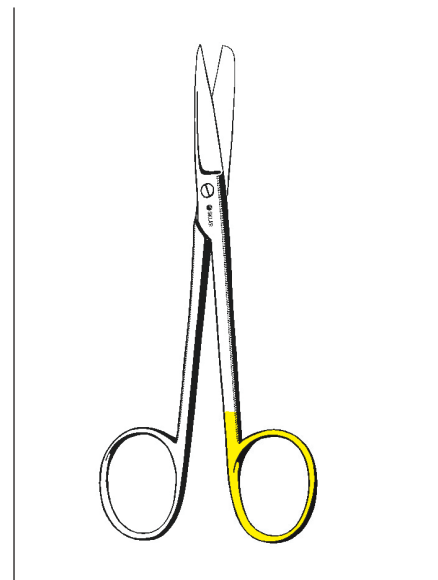

**SKLARCUT™ WAGNER  
SCISSOR**

15-3542 4½" Straight Sharp/Blunt

**SKLARCUT**  
SERRATED BLADE

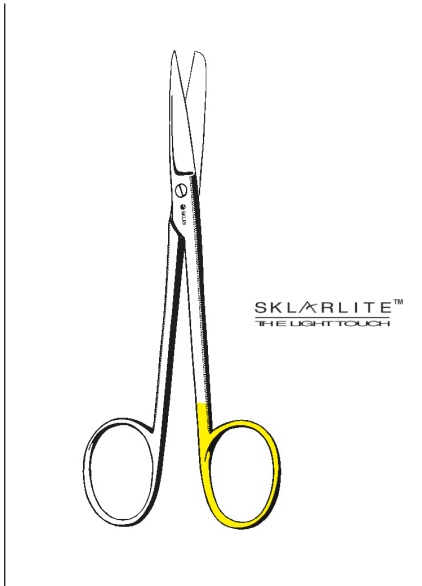

**SKLARLITE™ SKLARCUT™  
WAGNER SCISSOR**

23-1254 4½" Straight Sharp/Blunt

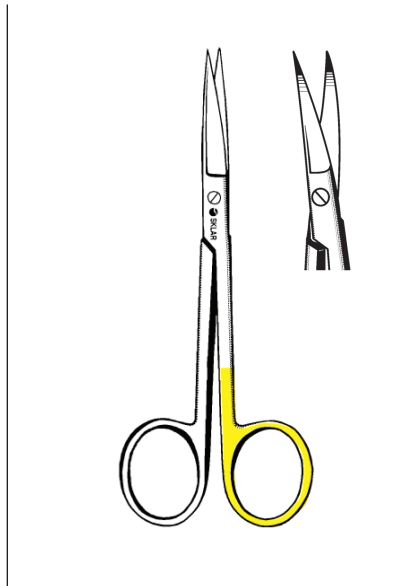

**SKLARCUT™ PLASTIC  
SURGERY SCISSORS**

15-3520 4½" Straight  
15-3525 4½" Curved  
15-3535 4½" Curved Delicate

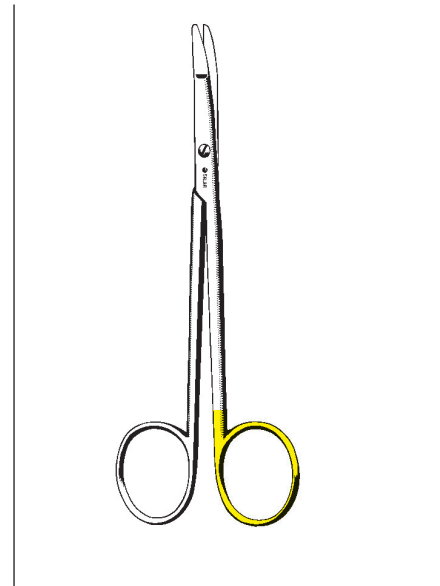

**SKLARCUT™ RAGNELL  
SCISSOR**

15-3320 5" Curved

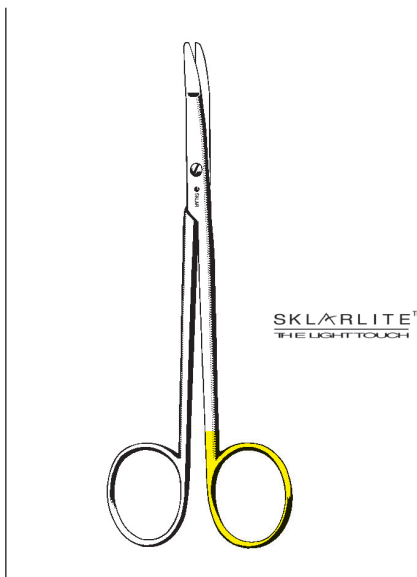

**SKLARLITE™ SKLARCUT™  
RAGNELL SCISSOR**

23-1250 5" Curved

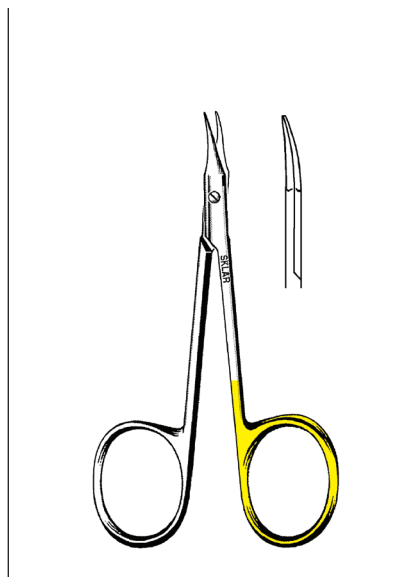

**SKLARCUT™ GRADLE  
SCISSOR**

15-3244 3¾" Curved

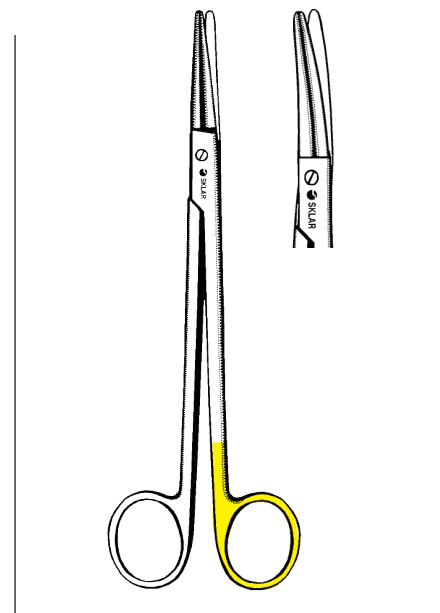

**SKLARCUT™ GORNEY PLASTIC  
SURGERY SCISSORS**

15-3577 7¼" Straight  
15-3578 7¼" Curved

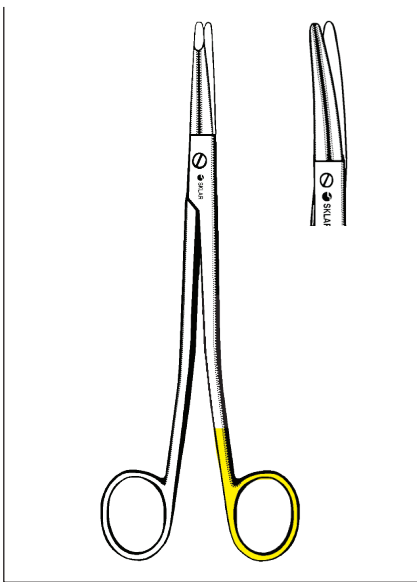

**SKLARCUT™ GORNEY  
FACE LIFT SCISSORS**

SEMI-SHARP OUTER EDGES

- 15-3583 7½" Straight Flat Tapered Tip
- 15-3584 7½" Curved Flat Tapered Tip
- 15-3577 7¼" Straight Bevelled Blades
- 15-3578 7¼" Curved Bevelled Blades

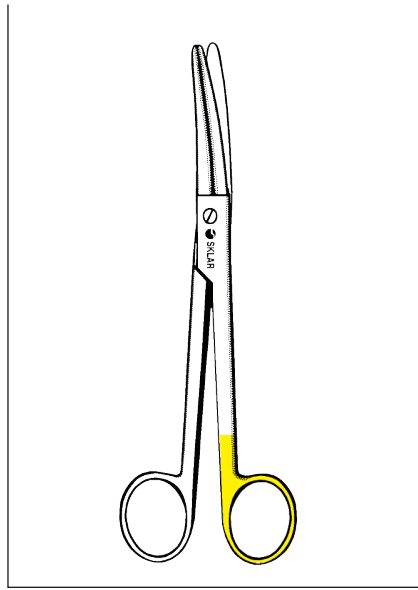

**SKLARCUT™ KAYE  
FACE LIFT SCISSORS**

- 15-3579 6" Curved
- 15-3580 7½" Curved

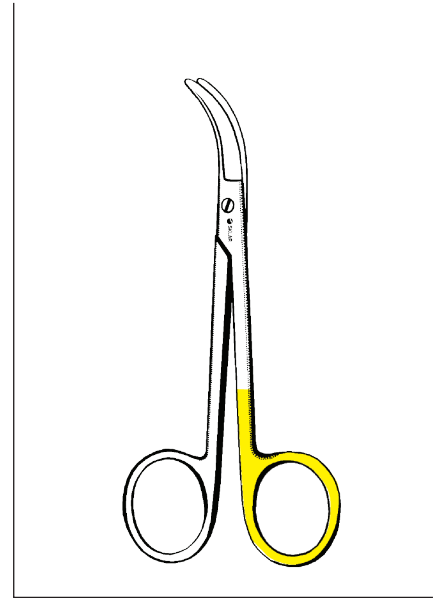

**SKLARCUT™ FOMON  
LATERAL SCISSOR**

- 15-3548 5" Curved

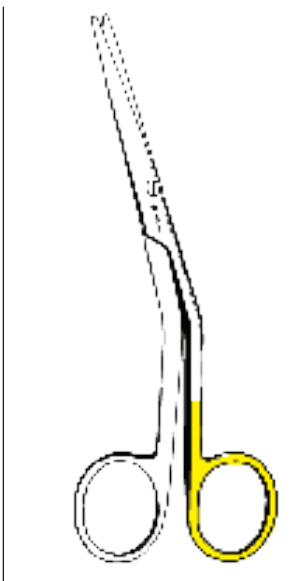

**SKLARCUT™ COTTLE  
DORSAL SCISSOR**

- 15-3547 6½" Angled on Flat

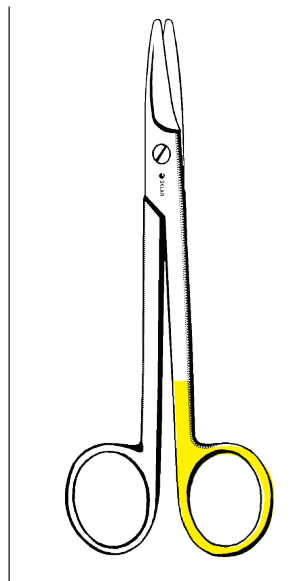

**SKLARCUT™ CASTANARES FACE  
LIFT SCISSOR**

- 15-3549 6¼" Straight

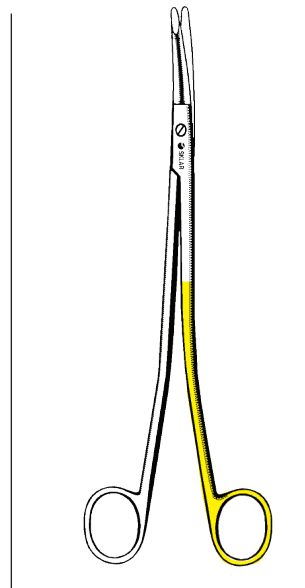

**SKLARCUT™ KELLY  
PLASTIC SURGERY  
SCISSOR**

- 15-3572 9" Curved

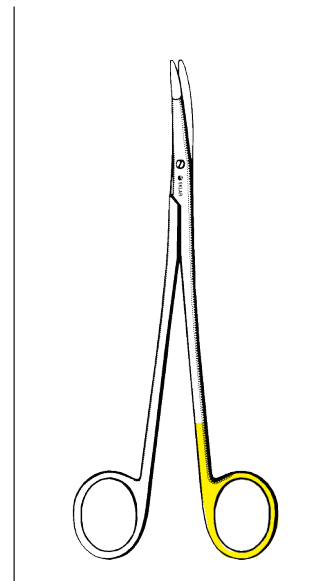

**SKLARCUT™ RHYTIDECTOMY  
SCISSOR**

- 15-3576 6½" Curved

**SKLARCUT**  
SERRATED BLADE

SKLARLITE  
THE LIGHT TOUCH

SKLARLITE™ OPERATING  
SCISSORS

STRAIGHT

23-1104	4½"	Sharp/Blunt
23-1100	4½"	Sharp/Sharp
23-1105	5"	Sharp/Blunt
23-1101	5"	Sharp/Sharp
23-1106	5½"	Sharp/Blunt
23-1102	5½"	Sharp/Sharp

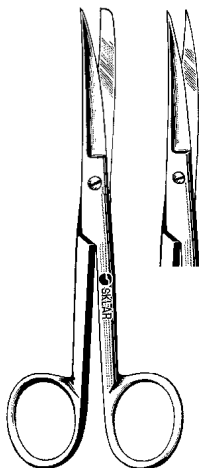

SKLARLITE XD  
EXTRA DELICATE

SKLARLITE XD™ OPERATING  
SCISSORS

STRAIGHT

23-1116	4½"	Sharp/Blunt
23-1112	4½"	Sharp/Sharp
23-1117	5"	Sharp/Blunt
23-1113	5"	Sharp/Sharp
23-1118	5½"	Sharp/Blunt
23-1114	5½"	Sharp/Sharp

SKLARLITE  
THE LIGHT TOUCH

SKLARLITE™ OPERATING  
SCISSORS

CURVED

23-1128	4½"	Sharp/Blunt
23-1124	4½"	Sharp/Sharp
23-1130	5½"	Sharp/Blunt
23-1126	5½"	Sharp/Sharp

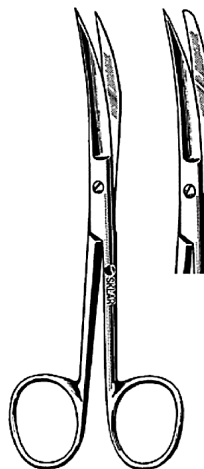

SKLARLITE XD  
EXTRA DELICATE

SKLARLITE XD™ OPERATING  
SCISSORS

CURVED

23-1140	4½"	Sharp/Blunt
23-1136	4½"	Sharp/Sharp
23-1142	5½"	Sharp/Blunt
23-1138	5½"	Sharp/Sharp

SKLARLITE  
THE LIGHT TOUCH

SKLARLITE™ MAYO  
DISSECTING SCISSORS

23-1164	5½"	Straight
23-1166	5½"	Curved
23-1165	6¾"	Straight
23-1167	6¾"	Curved

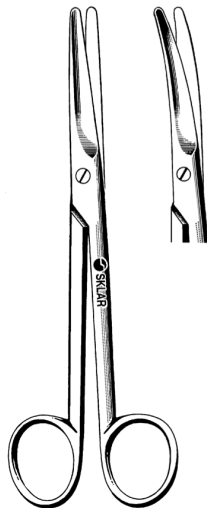

SKLARLITE XD  
EXTRA DELICATE

SKLARLITE XD™ MAYO  
DISSECTING SCISSORS

23-1168	5½"	Straight
23-1170	5½"	Curved
23-1169	6¾"	Straight
23-1171	6¾"	Curved

SKLARLITE  
THE LIGHT TOUCH

SKLARLITE™ METZENBAUM  
SCISSORS (LAHEY)

23-1172	4½"	Straight
23-1174	4½"	Curved
23-1173	5¾"	Straight
23-1175	5¾"	Curved

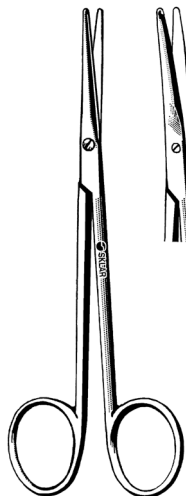

SKLARLITE XD  
EXTRA DELICATE

SKLARLITE XD™ METZENBAUM  
SCISSORS (LAHEY)

23-1176	4½"	Straight
23-1178	4½"	Curved
23-1177	5¾"	Straight
23-1179	5¾"	Curved



SKLARLITE  
THE LIGHT TOUCH

SKLARLITE™ METZENBAUM  
SCISSORS

- 23-1180 7" Straight
- 23-1182 7" Curved



SKLARLITE XD  
EXTRA DELICATE

SKLARLITE XD™ METZENBAUM  
SCISSORS

- 23-1184 7" Straight
- 23-1186 7" Curved

SKLARLITE  
THE LIGHT TOUCH

SKLARLITE™ IRIS SCISSORS

SHARP/SHARP

- 23-1148 3½" Straight
- 23-1149 4½" Straight
- 23-1150 3½" Curved
- 23-1151 4½" Curved

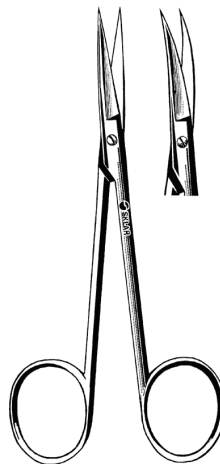

SKLARLITE XD  
EXTRA DELICATE

SKLARLITE XD™ IRIS SCISSORS

SHARP/SHARP

- 23-1152 3½" Straight
- 23-1153 4½" Straight
- 23-1154 3½" Curved
- 23-1155 4½" Curved

SKLARLITE  
THE LIGHT TOUCH

SKLARLITE™ STEVENS  
SCISSORS

- 23-1156 4½" Straight Blunt/Blunt
- 23-1157 4½" Curved Blunt/Blunt

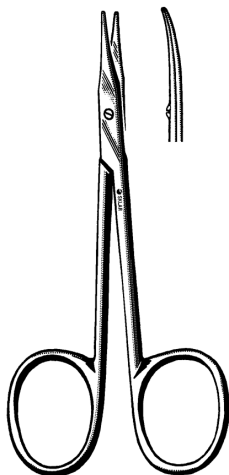

SKLARLITE XD  
EXTRA DELICATE

SKLARLITE XD™ STEVENS  
SCISSORS

BLUNT/BLUNT

- 23-1160 4½" Straight Blunt/Blunt
- 23-1161 4½" Curved Blunt/Blunt

SKLARLITE  
THE LIGHT TOUCH

SKLARLITE™ STRABISMUS  
SCISSORS

- 23-1158 4½" Straight
- 23-1159 4½" Curved

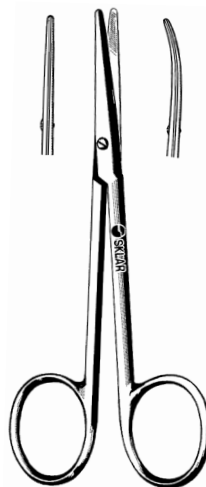

SKLARLITE XD  
EXTRA DELICATE

SKLARLITE XD™ STRABISMUS  
SCISSORS

- 23-1162 4½" Straight
- 23-1163 4½" Curved

SKLARLITE  
THE LIGHT TOUCH

**SKLARLITE™ STITCH  
SCISSORS**

- 23-1188 3½" Spencer
- 23-1189 4½" Spencer
- 23-1190 5½" Littauer

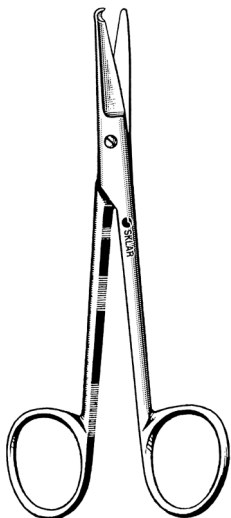

SKLARLITE XD  
EXTRA DELICATE

**SKLARLITE XD™  
STITCH SCISSORS**

- 23-1193 3½" Spencer
- 23-1194 4½" Spencer
- 23-1195 5½" Littauer

SKLARLITE  
THE LIGHT TOUCH

**SKLARLITE™ SHORTBENT  
SUTURE SCISSORS**

- 23-1191 3½"

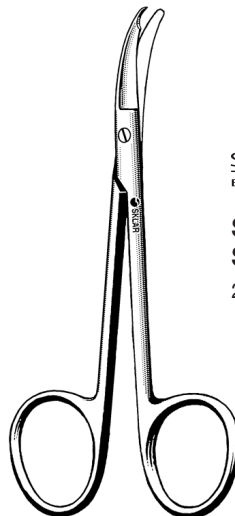

SKLARLITE XD  
EXTRA DELICATE

**SKLARLITE XD™ SHORTBENT  
SUTURE SCISSOR**

- 23-1196 3½"

SKLARLITE  
THE LIGHT TOUCH

**SKLARLITE™ PRECISION  
SUTURE SCISSORS**

- 23-1290 3½" Straight
- 23-1292 3½" Curved
- 23-1294 4½" Straight
- 23-1296 4½" Curved

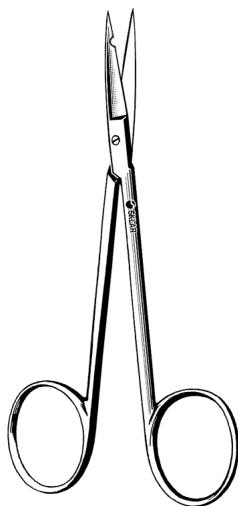

SKLARLITE XD™  
EXTRA DELICATE

**SKLARLITE XD™ PRECISION  
SUTURE SCISSORS**

- 23-1300 3½" Straight
- 23-1302 3½" Curved
- 23-1304 4½" Straight
- 23-1306 4½" Curved

SKLARLITE  
THE LIGHT TOUCH

**SKLARLITE™ LISTER  
BANDAGE SCISSORS**

- 23-1199 5½"
- 23-1200 7¼"

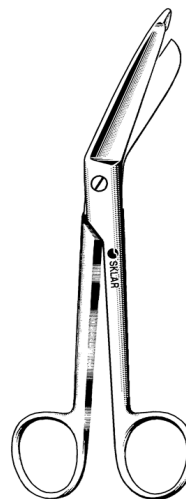

SKLARLITE XD  
EXTRA DELICATE

**SKLARLITE XD™ LISTER  
BANDAGE SCISSORS**

- 23-1202 5½"
- 23-1203 7¼"

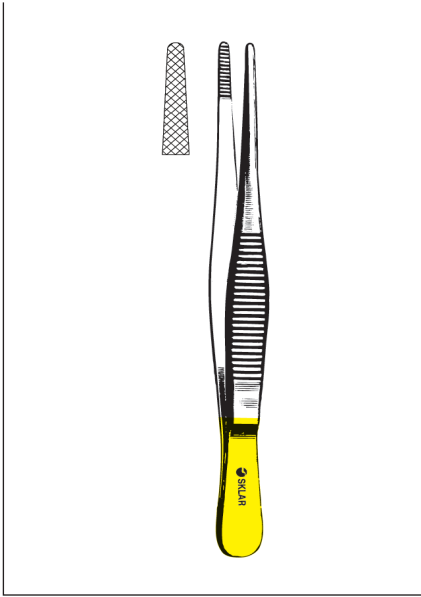

**TC DRESSING FORCEPS**

**SERRATED**

- 51-3460 6"
- 51-3480 8"

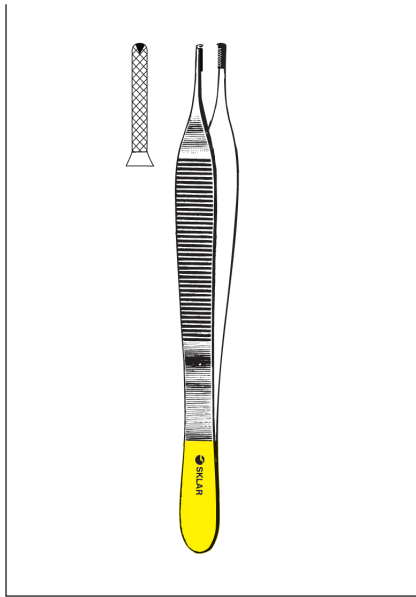

**TC ADSON DRESSING FORCEPS**

**SERRATED**

- 51-3447 4¾"
- 51-3448 6"

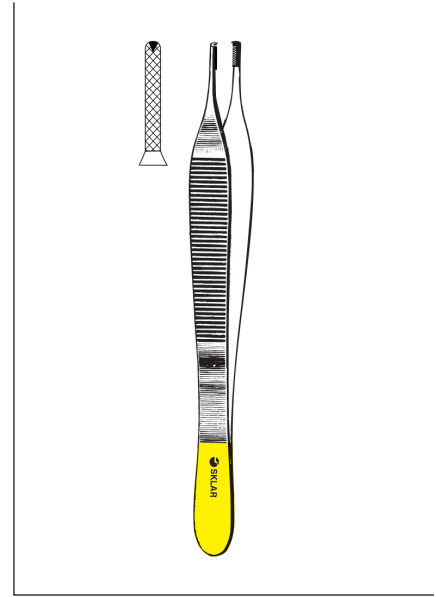

**TC ADSON TISSUE FORCEPS**

**1X2 TEETH, WITH TYING PLATFORM**

- 51-3049 4¾" Serrated
- 51-3050 4¾" Smooth, Gorney-Adson
- 51-3051 6" Serrated

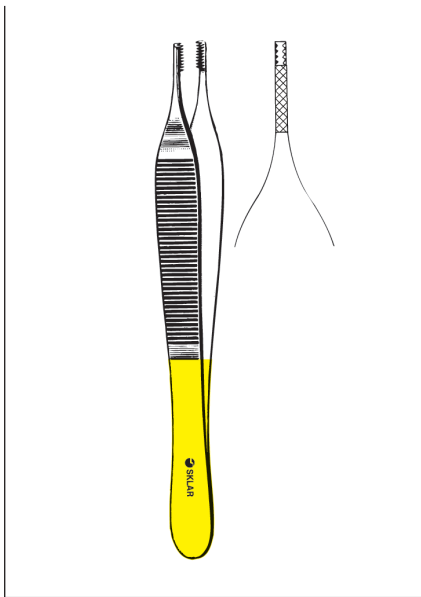

**TC ADSON-BROWN FORCEPS**

**SIDE GRASPING**

- 51-1446 4¾" 4x4 Teeth
- 51-1447 4¾" 7x7 Teeth

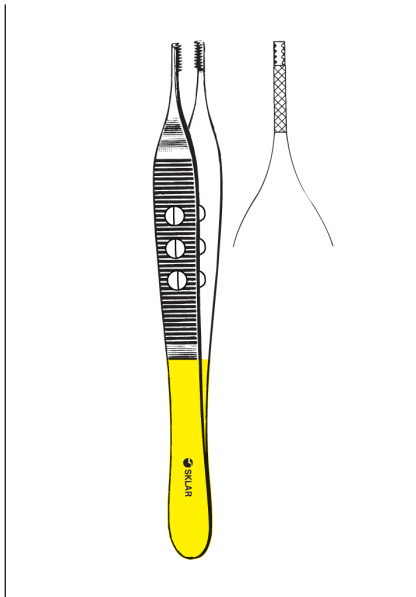

**TC LITEGRIP™ ADSON-BROWN FORCEPS**

**SIDE GRASPING**

- 51-1448 4¾" 7x7 Teeth

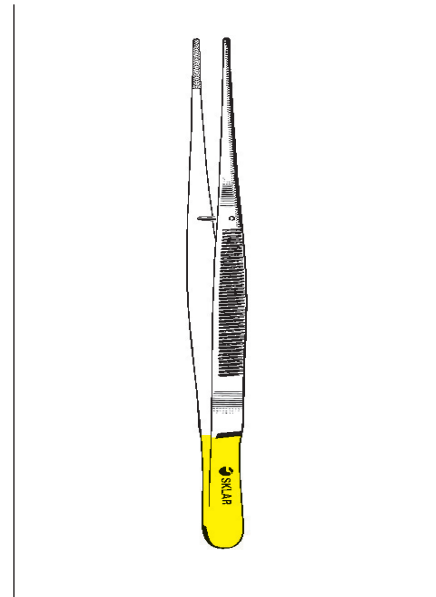

**TC POTTS-SMITH DRESSING FORCEPS**

**SERRATED**

- 51-4360 6"
- 51-4370 7"
- 51-4382 8¼"
- 51-4395 9½"

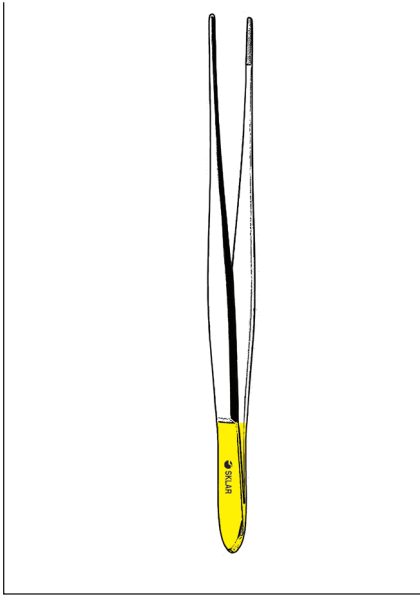

**TC CUSHING DRESSING  
FORCEPS**

**GUTCH HANDLE**

51-4398 7" Serrated

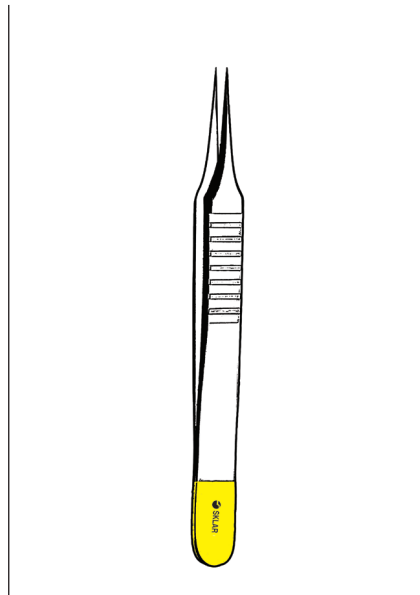

**TC JEWELER'S FORCEPS**

**DIAMOND DUST TIPS**

51-4450 4" #4  
51-4451 4¼" #5A

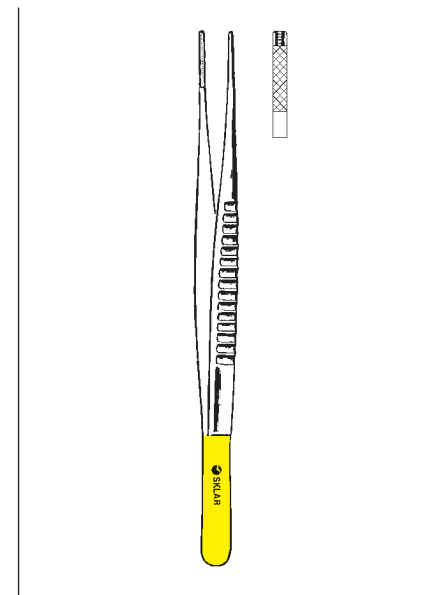

**TC DEBAKEY ATRAUMATIC  
FORCEPS**

97-1530 6" 2mm  
97-1531 6" 2.7mm  
97-1540 8" 2mm  
97-1541 8" 2.7mm

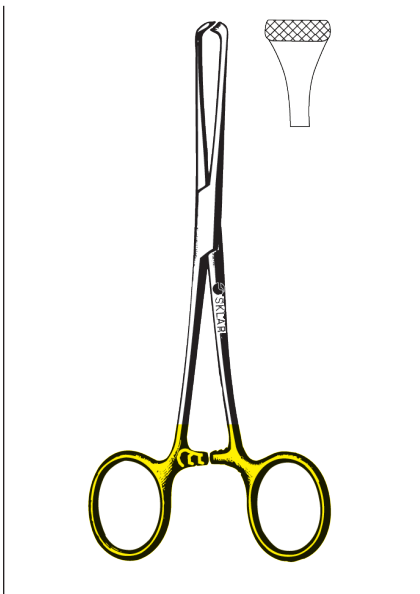

**TC ALLIS TISSUE FORCEPS**

**ATRAUMATIC**

97-1555 6"  
97-1560 7½"

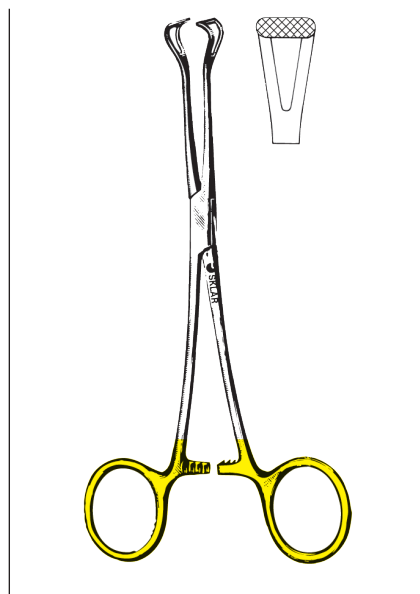

**TC BABCOCK FORCEPS**

**ATRAUMATIC**

97-1565 6¼"  
97-1570 8"

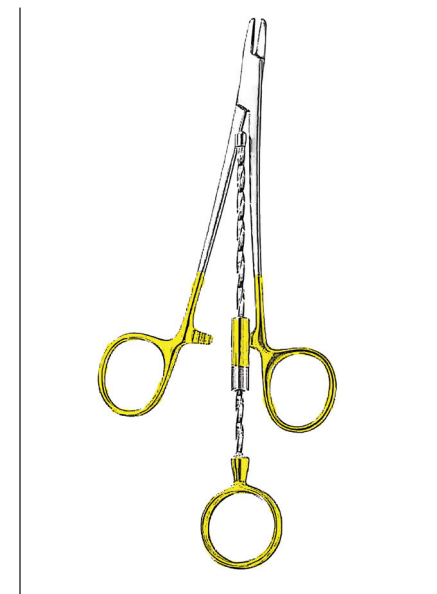

**TC CORWIN WIRE TWISTER  
FORCEPS**

**SERRATED**

21-9050 6" Flat  
21-9051 6" Round  
21-9052 6½" Round, Narrow

SKLARLITE  
THE LIGHT TOUCH

SKLARLITE XD  
EXTRA DELICATE

SKLARLITE™ AND SKLARLITE XD™  
PROVIDE LIGHTNESS  
AND DURABILITY

In response to industry demands for lighter pattern instruments, Sklar has established the SklarLite line of premium operating room instruments. Through a unique manufacturing technique, we are able to provide a noticeably lighter instrument that maintains the strength and durability of a standard pattern. These extremely sensitive instruments give the surgeon maximum control and precision while comfortably withstanding the daily rigors of frequent use.

Sklarlite™ and Sklarlite XD™ premium instruments are our lightest and most sensitive instruments. These surprisingly strong instruments carry the same day-in and day-out reliability that you have come to expect from all Sklar instruments and are fully guaranteed for a lifetime of dependable use.



SKLARLITE  
THE LIGHT TOUCH

SKLARLITE™ DRESSING  
FORCEPS

SERRATED

23-2824	4½"
23-2826	5"
23-2828	5½"
23-2830	6"

SKLARLITE XD™  
EXTRA DELICATE

SKLARLITE XD™  
DRESSING FORCEPS

SERRATED

23-2834	4½"
23-2836	5"
23-2838	5½"
23-2840	6"

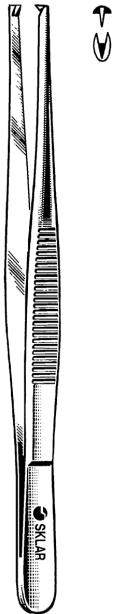

SKLARLITE  
THE LIGHT TOUCH

SKLARLITE™ TISSUE  
FORCEPS

23-2809	4½"	1x2 Teeth
23-2811	5½"	1x2 Teeth

SKLARLITE XD™  
EXTRA DELICATE

SKLARLITE XD™  
TISSUE FORCEPS

23-2819	5½"	1x2 Teeth
---------	-----	-----------

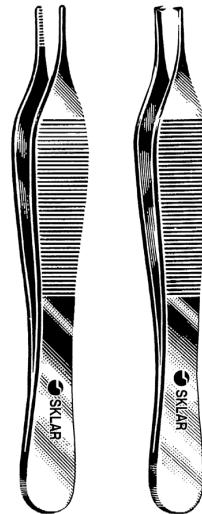

SKLARLITE  
THE LIGHT TOUCH

SKLARLITE™ ADSON  
FORCEPS

DRESSING

23-2600	4¾"	Serrated
---------	-----	----------

TISSUE

23-2602	4¾"	1x2 Teeth
---------	-----	-----------

ADSON-BROWN

23-2603	4¾"	Side Grasping
---------	-----	---------------

SKLARLITE XD™  
EXTRA DELICATE

SKLARLITE XD™  
ADSON FORCEPS

DRESSING

23-2604	4¾"	Serrated
---------	-----	----------

TISSUE

23-2606	4¾"	1x2 Teeth
---------	-----	-----------

ADSON-BROWN

23-2608	4¾"	Side Grasping
---------	-----	---------------

**SKLARLITE**  
THE LIGHT TOUCH

**SKLARLITE™ HARTMANN MOSQUITO FORCEPS**

**SERRATED**

23-2100	3½"	Straight
23-2101	3½"	Curved

**SKLARLITE XD™**  
EXTRA DELICATE

**SKLARLITE XD™ HARTMANN MOSQUITO FORCEPS**

**SERRATED**

23-2500	3½"	Straight
23-2501	3½"	Curved

**SKLARLITE**  
THE LIGHT TOUCH

**SKLARLITE™ HALSTED MOSQUITO FORCEPS**

23-2105	5"	Straight
23-2106	5"	Curved

**SKLARLITE XD™**  
EXTRA DELICATE

**SKLARLITE XD™ HALSTED MOSQUITO FORCEPS**

23-2505	5"	Straight
23-2506	5"	Curved

**SKLARLITE**  
THE LIGHT TOUCH

**SKLARLITE™ KELLY HEMOSTATIC FORCEPS**

23-2107	5½"	Straight
23-2108	5½"	Curved

**SKLARLITE XD™**  
EXTRA DELICATE

**SKLARLITE XD™ KELLY HEMOSTATIC FORCEPS**

23-2507	5½"	Straight
23-2508	5½"	Curved

**SKLARLITE**  
THE LIGHT TOUCH

**SKLARLITE™ CRILE HEMOSTATIC FORCEPS**

23-2110	5½"	Straight
23-2113	5½"	Curved
23-2111	7½"	Straight
23-2112	7½"	Curved

**SKLARLITE XD™**  
EXTRA DELICATE

**SKLARLITE XD™ CRILE HEMOSTATIC FORCEPS**

23-2510	5½"	Straight
23-2513	5½"	Curved

SKLARLITE  
THE LIGHT TOUCH

SKLARLITE™  
ROCHESTER-PEAN  
FORCEPS

23-2532	6 1/4"	Straight
23-2538	6 1/4"	Curved
23-2534	7 1/4"	Straight
23-2542	7 1/4"	Curved

SKLARLITE XD™  
EXTRA DELICATE

SKLARLITE XD™  
ROCHESTER-PEAN  
FORCEPS

23-2552	6 1/4"	Straight
23-2561	6 1/4"	Curved
23-2554	7 1/4"	Straight
23-2563	7 1/4"	Curved



SKLARLITE  
THE LIGHT TOUCH

SKLARLITE™  
ROCHESTER-OGHSNER  
FORCEPS

1X2 TEETH

23-2560	6 1/4"	Straight
23-2568	6 1/4"	Curved

SKLARLITE XD™  
EXTRA DELICATE

SKLARLITE XD™  
ROCHESTER-OGHSNER  
FORCEPS

1X2 TEETH

23-2577	6 1/4"	Straight
23-2585	6 1/4"	Curved

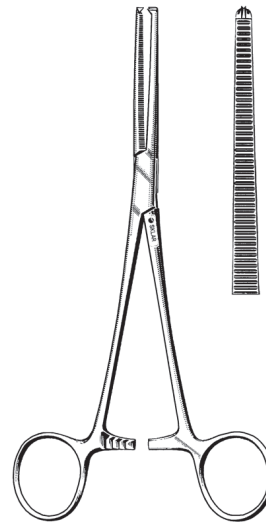

SKLARLITE  
THE LIGHT TOUCH

SKLARLITE™  
MIXTER FORCEPS

RIGHT ANGLE

23-2516	5 1/2"
23-2520	7 1/4"

SKLARLITE XD™  
EXTRA DELICATE

SKLARLITE XD™  
MIXTER FORCEPS

RIGHT ANGLE

23-2521	5 1/2"
23-2525	7 1/4"

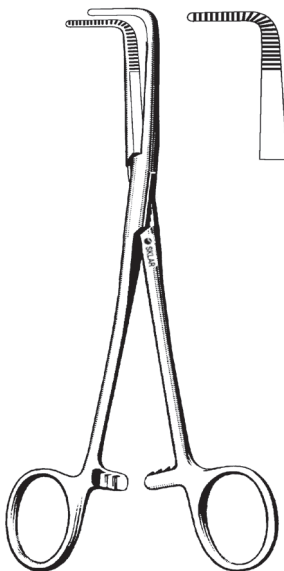

SKLARLITE  
THE LIGHT TOUCH

SKLARLITE™ ALLIS  
TISSUE FORCEPS

23-2851	6"	4x5 Teeth
23-2852	6"	5x6 Teeth

SKLARLITE XD™  
EXTRA DELICATE

SKLARLITE XD™  
ALLIS TISSUE FORCEPS

23-2861	5"	4x5 Teeth
23-2862	5 1/2"	4x5 Teeth
23-2864	6"	4x5 Teeth
23-2865	6"	5x6 Teeth



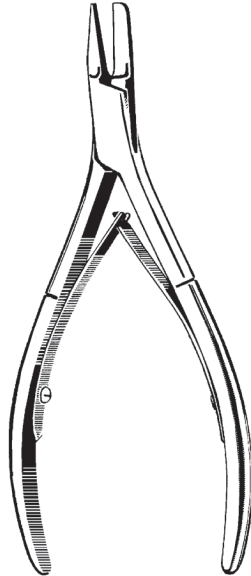

SKLARLITE  
THE LIGHT TOUCH

**SKLARLITE™  
NAIL SPLITTING  
FORCEPS**

ENGLISH ANVIL PATTERN  
23-9250 5"



SKLARLITE  
THE LIGHT TOUCH

**SKLARLITE™  
LITTAUER CUTTING  
FORCEPS**

**STRAIGHT BACK**

- 23-9251 4"
- 23-9255 4½"
- 23-9259 5"

**CURVED BACK**

- 23-9273 4½"
- 23-9275 5"
- 23-9276 6"

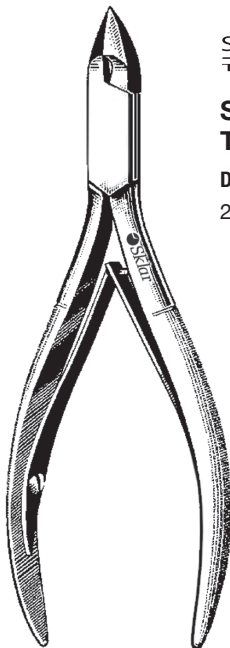

SKLARLITE  
THE LIGHT TOUCH

**SKLARLITE™  
TISSUE NIPPER**

DOUBLE SPRING CONVEX BLADES  
23-9292 4½" 11mm

**SKLAR DISPOSABLE SCALPELS**

PRODUCT NUMBER	FEATURES	QUANTITIES
06-3110	#10	10/box
06-3111	#11	10/box
06-3112	#12	10/box
06-3115	#15	10/box
06-3120	#20	10/box
06-3121	#21	10/box
06-3122	#22	10/box
06-3123	#23	10/box

**FEATURING:  
SURGICAL STEEL  
BLADES**



LATEX FREE



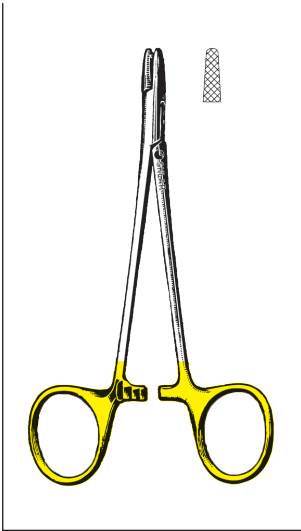

**TC DERF  
NEEDLE HOLDER**

**SERRATED**  
21-8004 4¾"

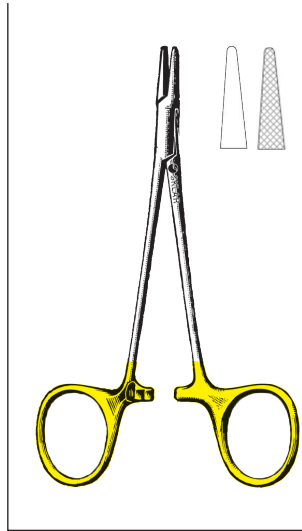

**TC WEBSTER  
NEEDLE HOLDERS**

21-2240 4¼" Smooth  
21-8002 5¼" Smooth  
21-8080 5¼" Serrated

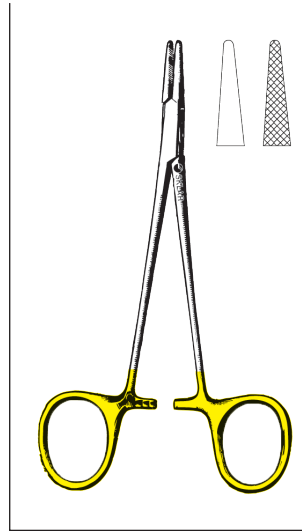

**TC HALSEY  
NEEDLE HOLDERS**

21-8000 5¼" Smooth  
21-8001 5¼" Serrated

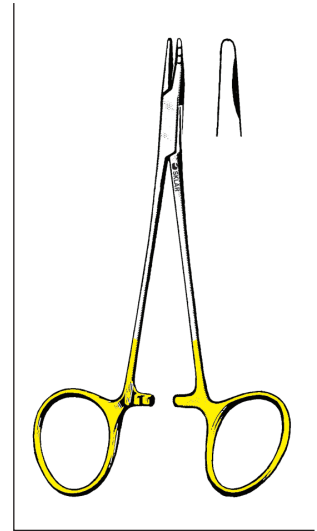

**TC NEIVERT  
NEEDLE HOLDER**

**SERRATED**  
21-8086 5" One Offset Ring

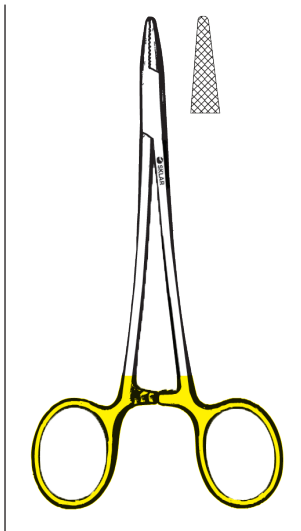

**TC BAUMGARTNER  
NEEDLE HOLDER**

**SERRATED**  
21-8005 5¼"

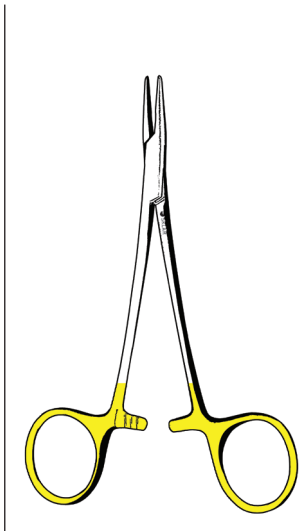

**TC PAR  
NEEDLE HOLDERS**

**DELICATE, SERRATED**  
21-7012 4½"  
21-7013 5"

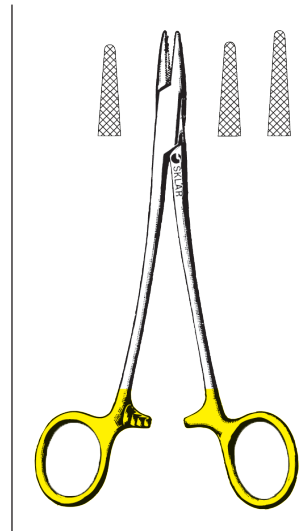

**TC CRILE-WOOD  
NEEDLE HOLDERS**

21-8003 6" Smooth  
21-8006 6" Serrated  
21-8007 7" Serrated  
21-8008 8" Serrated  
21-8009 9" Serrated  
21-8010 10½" Serrated  
21-8011 12" Serrated

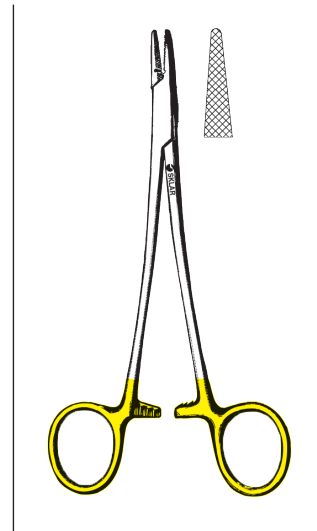

**TC CRILE-MURRAY  
NEEDLE HOLDER**

**SERRATED**  
21-8075 6"

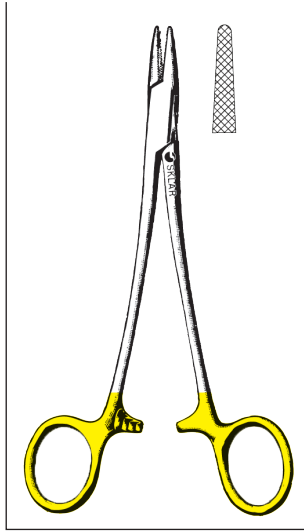

**TC MAYO-HEGAR  
NEEDLE HOLDERS**

**SERRATED**

- 21-8030 5½"
- 21-8031 6"
- 21-8032 7"
- 21-8033 8"
- 21-8051 9½"
- 21-8034 10½"
- 21-8035 12"

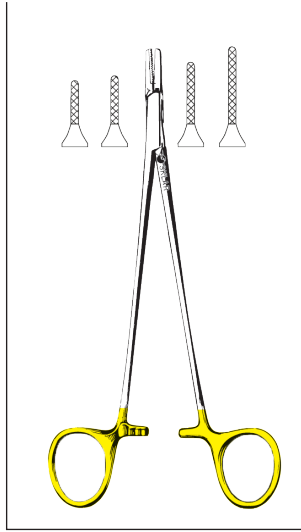

**TC RYDER  
NEEDLE HOLDERS**

**MICRO SERRATED**

- 21-8012 5"
- 21-8013 6"
- 21-8014 7"
- 21-8016 9"

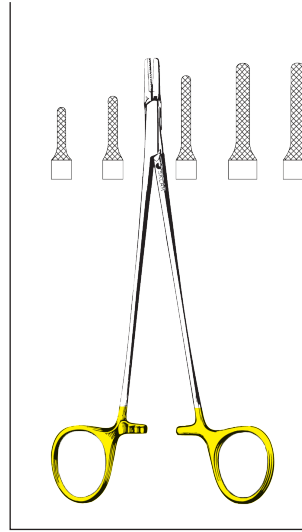

**TC RYDER  
NEEDLE HOLDERS**

**SERRATED**

- 21-8019 5"
- 21-8020 6"
- 21-8021 7"
- 21-8022 8"
- 21-8023 9"
- 21-8024 10¼"

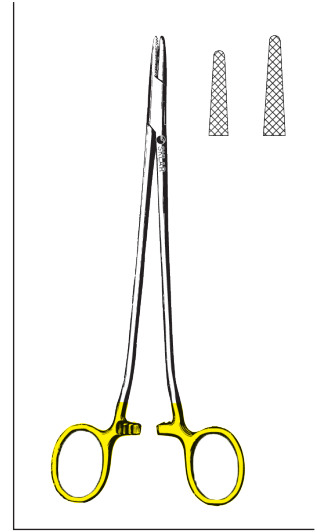

**TC SAROT  
NEEDLE HOLDERS**

**SERRATED**

- 21-8036 7⅞"
- 21-8037 10½"



**TC NEW ORLEANS  
NEEDLE HOLDER**

**SERRATED**

- 21-8082 7"

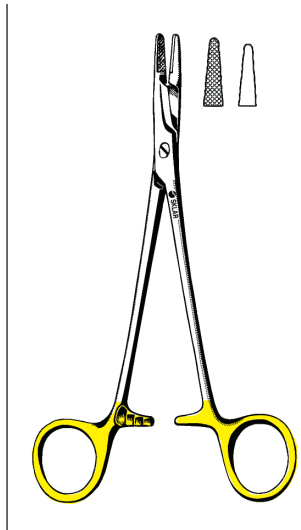

**TC OLSEN-HEGAR  
NEEDLE HOLDERS**

- 21-8026 4¾" Smooth Delicate
- 21-8025 4¾" Serrated Delicate
- 21-8027 5½" Serrated
- 21-8028 6½" Serrated
- 21-8029 7½" Serrated

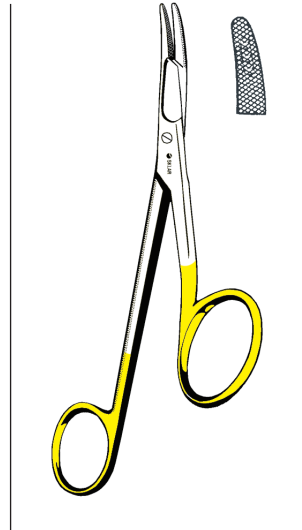

**TC GILLIES  
NEEDLE HOLDERS**

**SERRATED**

- 21-2660 4¼"
- 21-2664 5"
- 21-2662 6"

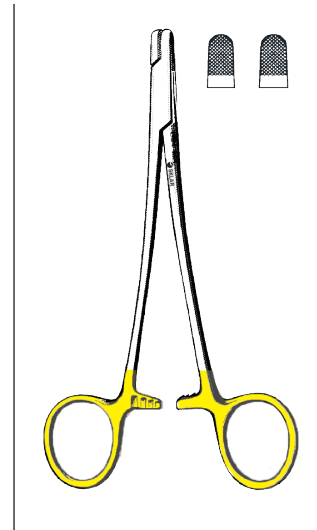

**TC STERNAL WIRE  
TWISTERS**

- 21-9060 5"
- 21-9065 7"

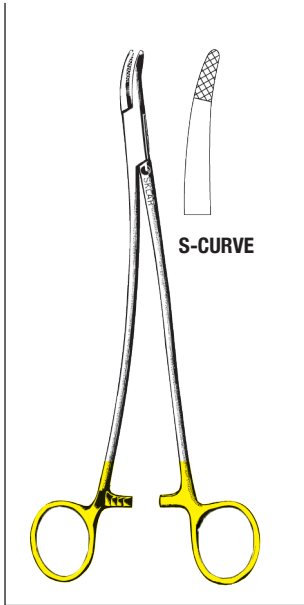

**TC STRATTE  
NEEDLE HOLDER**  
SERRATED, S-CURVE  
21-8065 9"

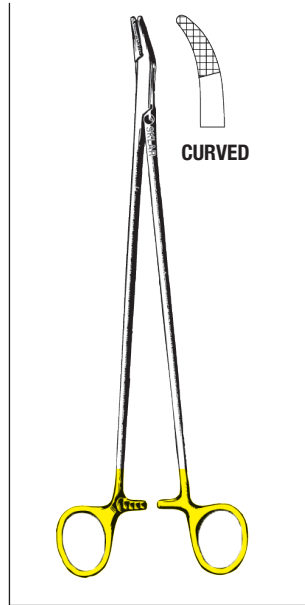

**TC HEANEY  
NEEDLE HOLDERS**  
SERRATED, CURVED  
21-8060 8¼"  
21-8061 10"

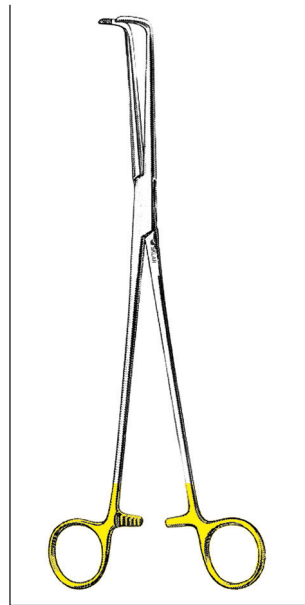

**TC BIHRLE  
NEEDLE HOLDER**  
SMOOTH/ SERRATED TIPS  
21-8079 11"

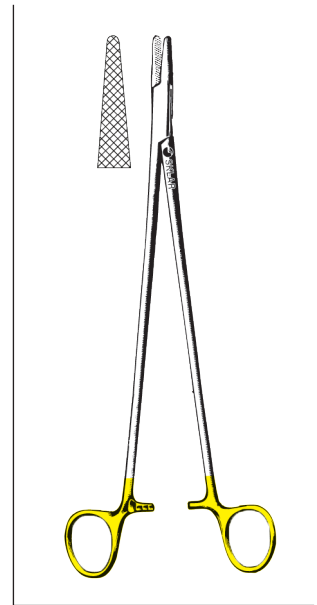

**TC WANGENSTEEN  
NEEDLE HOLDER**  
SERRATED  
21-3510 10½"

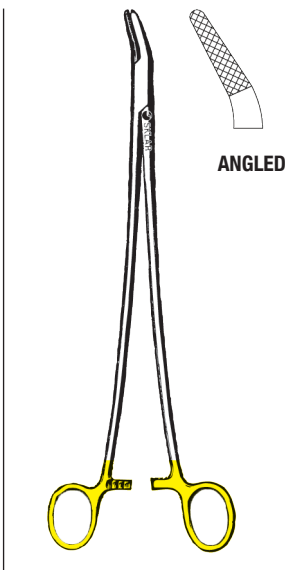

**TC FINOCHIETTO  
NEEDLE HOLDER**  
SERRATED, ANGLED  
21-8039 10½"

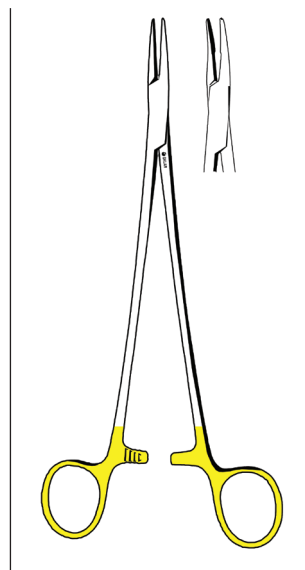

**TC JULIAN PATTERN  
NEEDLE HOLDER**  
SERRATED  
21-8096 8¼" Curved

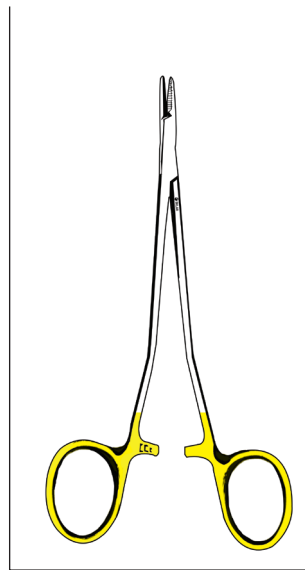

**TC SWEDISH  
NEEDLE HOLDER**  
SERRATED  
21-8097 6"

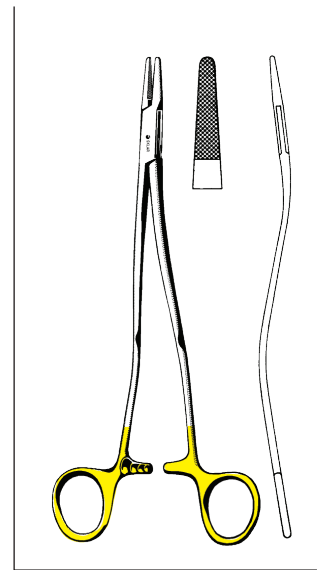

**TC BOZEMAN HEANEY  
NEEDLE HOLDERS**  
S-CURVE  
21-2180 8"  
21-2195 9½"  
21-8062 10½"



## ***Sklar's Left-Handed Needle Holders***

Now there's a ring-handled needle holder created for the needs of left-handed surgeons.

Sklar's left-handed needle holder features a unique ratchet design that makes it possible for surgeons to easily control the needle holder with their left hand. As a result surgeons experience less fatigue and hand strain than ever before.

Suitable for left hand use.

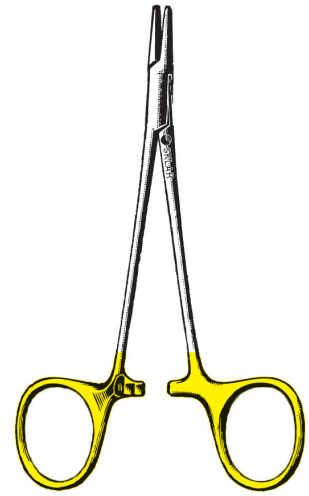

**TC WEBSTER NEEDLE HOLDER**

**SMOOTH**

21-9012 5"

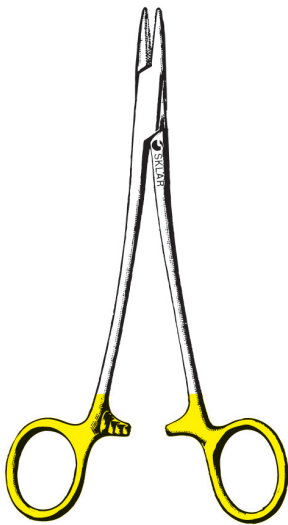

**TC CRILE-WOOD  
NEEDLE HOLDERS**

**SERRATED**

21-9030 6"  
21-9035 7"

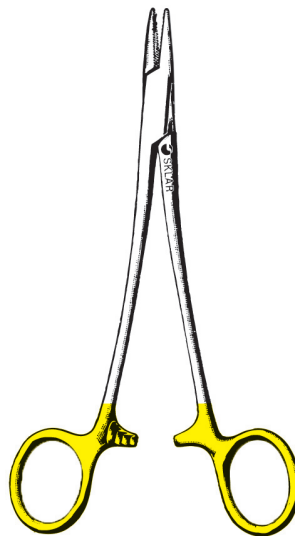

**TC MAYO-HEGAR  
NEEDLE HOLDERS**

**SERRATED**

21-9016 6"  
21-9018 7"



**TC RYDER NEEDLE HOLDER**

**SERRATED**

21-9045 6"

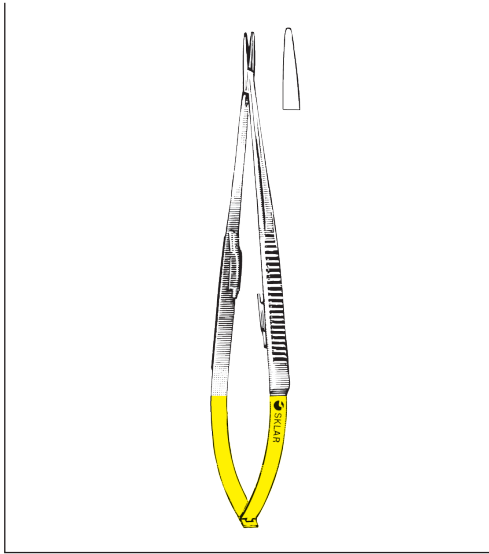

**TC JACOBSON MICROVASCULAR  
NEEDLE HOLDERS**

**SMOOTH**

**WITH LOCK**

- 21-8053 7" Straight
- 21-8253 7" Curved
- 21-8055 8¼" Straight
- 21-8255 8½" Curved
- 21-8057 9" Straight
- 21-8257 9" Curved

**WITHOUT LOCK**

- 21-8054 7" Straight
- 21-8254 7" Curved
- 21-8058 8¼" Straight
- 21-8258 8½" Curved
- 21-8059 9" Straight
- 21-8259 9" Curved

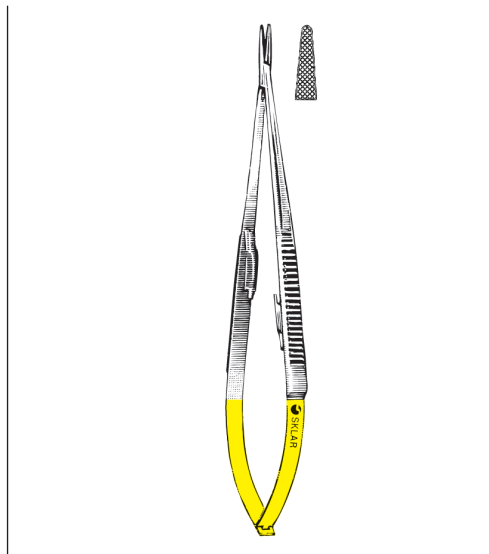

**TC JACOBSON MICROVASCULAR  
NEEDLE HOLDERS**

**SERRATED**

**WITH LOCK**

- 21-8250 7" Straight
- 21-8251 7" Curved
- 21-8052 8½" Straight
- 21-8056 8¼" Curved
- 21-8157 9" Straight
- 21-8158 9" Curved

**WITHOUT LOCK**

- 21-8150 7" Straight
- 21-8151 7" Curved
- 21-8152 8½" Straight
- 21-8156 8¼" Curved
- 21-8159 9" Straight
- 21-8160 9" Curved

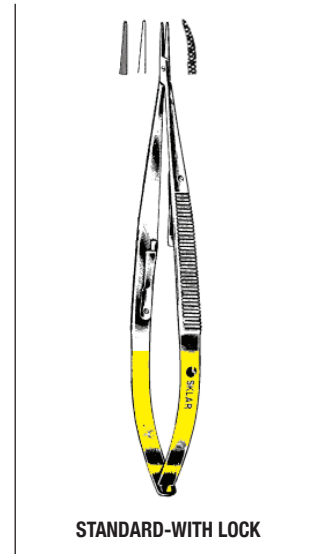

STANDARD-WITH LOCK

**TC CASTROVIEJO  
NEEDLE HOLDERS**

- 21-8040 5½" Smooth Straight
- 21-8046 5½" Serrated Straight
- 21-8047 5½" Serrated Curved

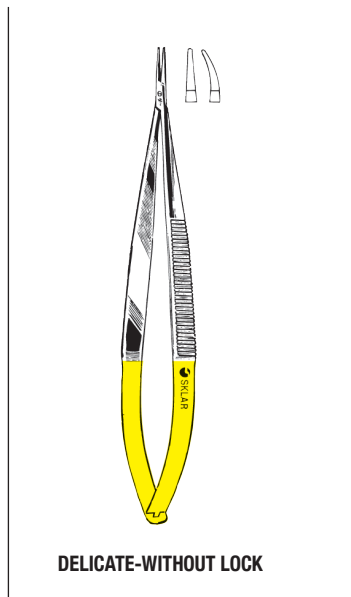

DELICATE-WITHOUT LOCK

**TC CASTROVIEJO  
NEEDLE HOLDERS**

- 21-8044 5½" Smooth Straight
- 21-8045 5½" Smooth Curved

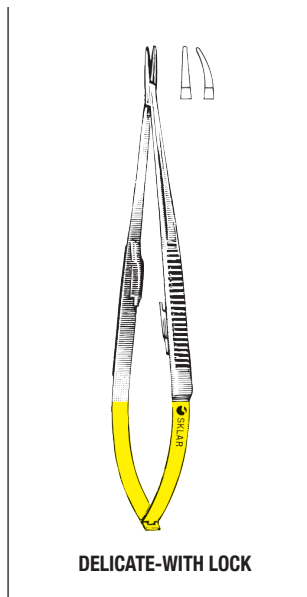

DELICATE-WITH LOCK

**TC CASTROVIEJO  
NEEDLE HOLDERS**

- 21-8042 5½" Smooth Straight
- 21-8043 5½" Smooth Curved

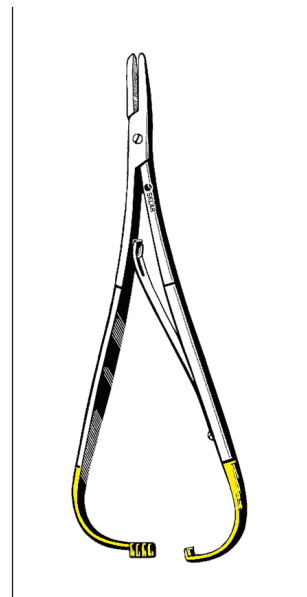

**TC MATHIEU  
NEEDLE HOLDERS**

- 21-8070 5½"
- 21-8071 6¾" Narrow Jaw
- 21-8072 7½"

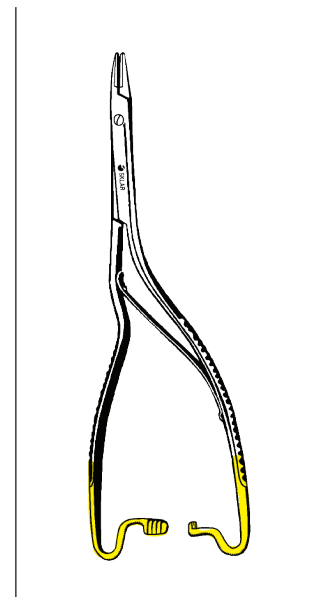

**TC LUETHY BECK  
NEEDLE HOLDER**

- 21-8064 8"

SKLARLITE  
THE LIGHT TOUCH

SKLARLITE XD  
EXTRA DELICATE

SKLARLITE™ AND SKLARLITE XD™  
PROVIDE LIGHTNESS  
AND DURABILITY

In response to industry demands for lighter pattern instruments, Sklar has established the SklarLite line of premium operating room instruments. Through a unique manufacturing technique, we are able to provide a noticeably lighter instrument that maintains the strength and durability of a standard pattern. These extremely sensitive instruments give the surgeon maximum control and precision while comfortably withstanding the daily rigors of frequent use.

SklarLite™ and SklarLite XD™ premium instruments are our lightest and most sensitive instruments. These surprisingly strong instruments carry the same day-in and day-out reliability that you have come to expect from all Sklar instruments and are fully guaranteed for a lifetime of dependable use.

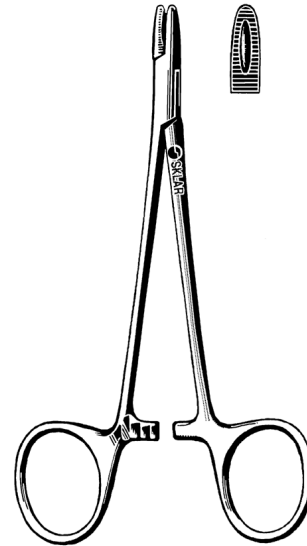

SKLARLITE  
THE LIGHT TOUCH

SKLARLITE™  
DERF NEEDLE HOLDER

23-2124 4¾" Serrated

SKLARLITE XD  
EXTRA DELICATE

SKLARLITE XD™  
DERF NEEDLE HOLDER

23-2224 4¾" Serrated

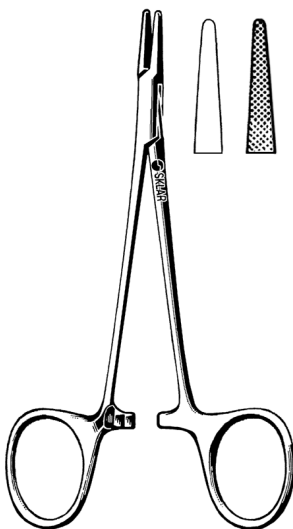

SKLARLITE  
THE LIGHT TOUCH

SKLARLITE™  
WEBSTER  
NEEDLE HOLDERS

23-2125 5¼" Smooth  
23-2120 5¼" Serrated

SKLARLITE XD  
EXTRA DELICATE

SKLARLITE XD™  
WEBSTER  
NEEDLE HOLDERS

23-2225 5¼" Smooth  
23-2220 5¼" Serrated

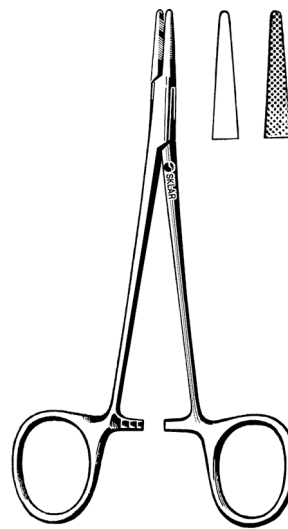

SKLARLITE  
THE LIGHT TOUCH

SKLARLITE™  
HALSEY  
NEEDLE HOLDERS

23-2135 5¼" Smooth  
23-2130 5¼" Serrated

SKLARLITE XD  
EXTRA DELICATE

SKLARLITE XD™  
HALSEY  
NEEDLE HOLDERS

23-2235 5¼" Smooth  
23-2230 5¼" Serrated

SKLARLITE  
THE LIGHT TOUCH

**SKLARLITE™  
BAUMGARTNER  
NEEDLE HOLDER**

23-2132 5¼" Serrated

SKLARLITE XD  
EXTRA \* DELICATE

**SKLARLITE XD™  
BAUMGARTNER  
NEEDLE HOLDER**

23-2232 5¼" Serrated

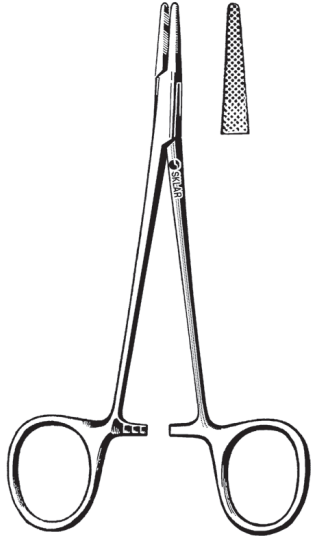

SKLARLITE  
THE LIGHT TOUCH

**SKLARLITE™  
CRILE-WOOD  
NEEDLE HOLDER**

23-2134 6" Serrated

SKLARLITE XD  
EXTRA \* DELICATE

**SKLARLITE XD™  
CRILE-WOOD  
NEEDLE HOLDER**

23-2234 6" Serrated



SKLARLITE  
THE LIGHT TOUCH

**SKLARLITE™  
MAYO-HEGAR  
NEEDLE HOLDER**

23-2128 7" Serrated

SKLARLITE XD  
EXTRA \* DELICATE

**SKLARLITE XD™  
MAYO-HEGAR  
NEEDLE HOLDER**

23-2228 7" Serrated

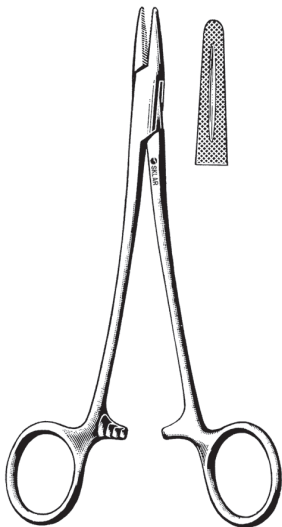

SKLARLITE  
THE LIGHT TOUCH

**SKLARLITE™  
OLSEN-HEGAR  
NEEDLE HOLDER**

23-2136 5½" Serrated

SKLARLITE XD  
EXTRA \* DELICATE

**SKLARLITE XD™  
OLSEN-HEGAR  
NEEDLE HOLDER**

23-2236 5½" Serrated

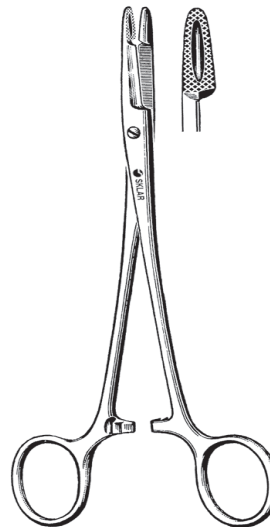

SCISSORS

GENERAL



**OPERATING SCISSORS**

**STRAIGHT**

SHARP/SHARP		SHARP/BLUNT		BLUNT/BLUNT	
13-1045	4½"	14-1045	4½"	15-1045	4½"
13-1050	5"	14-1050	5"	15-1050	5"
13-1055	5½"	14-1055	5½"	15-1055	5½"
13-1060	6"	14-1060	6"	15-1060	6"
13-1065	6½"	14-1065	6½"	15-1065	6½"
13-1072	7¼"	14-1072	7¼"		



SKLARLITE™  
THE LIGHT TOUCH

**SKLARLITE™ OPERATING SCISSORS**

**STRAIGHT**

SHARP/SHARP		SHARP/BLUNT	
23-1100	4½"	23-1104	4½"
23-1101	5"	23-1105	5"
23-1102	5½"	23-1106	5½"



**OPERATING SCISSORS**

**DELICATE, STRAIGHT**

SHARP/SHARP		SHARP/BLUNT		BLUNT/BLUNT	
22-1145	4½"	22-1245	4½"	22-1345	4½"
22-1150	5"	22-1250	5"	22-1350	5"
22-1155	5½"	22-1255	5½"	22-1355	5½"



SKLARLITE XD™  
EXTRA DELICATE

**SKLARLITE XD™ OPERATING SCISSORS**

**STRAIGHT**

SHARP/SHARP		SHARP/BLUNT	
23-1112	4½"	23-1116	4½"
23-1113	5"	23-1117	5"
23-1114	5½"	23-1118	5½"





**OPERATING SCISSORS**

**CURVED**

**SHARP/SHARP**

13-2045	4½"
13-2050	5"
13-2055	5½"
13-2060	6"
13-2065	6½"
13-2072	7¼"

**SHARP/BLUNT**

14-2045	4½"
14-2050	5"
14-2055	5½"
14-2060	6"
14-2065	6½"
14-2072	7¼"

**BLUNT/BLUNT**

15-2045	4½"
15-2050	5"
15-2055	5½"
15-2060	6"
15-2065	6½"



SKLARLITE™  
THE LIGHT TOUCH

**SKLARLITE™ OPERATING SCISSORS**

**CURVED**

**SHARP/SHARP**

23-1124	4½"
23-1126	5½"

**SHARP/BLUNT**

23-1128	4½"
23-1130	5½"



**OPERATING SCISSORS**

**DELICATE, CURVED**

**SHARP/SHARP**

22-1445	4½"
22-1450	5"
22-1455	5½"

**SHARP/BLUNT**

22-1545	4½"
22-1550	5"
22-1555	5½"

**BLUNT/BLUNT**

22-1645	4½"
22-1650	5"
22-1655	5½"



SKLARLITE XD™  
EXTRA DELICATE

**SKLARLITE XD™ OPERATING SCISSORS**

**CURVED**

**SHARP/SHARP**

23-1136	4½"
23-1138	5½"

**SHARP/BLUNT**

23-1140	4½"
23-1142	5½"

SCISSORS

GENERAL

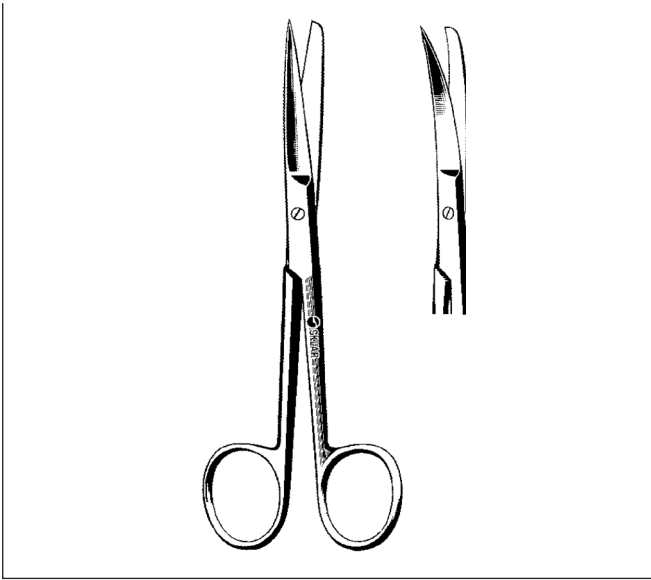

**DEAVER SCISSORS**

**DELICATE**

**STRAIGHT**

13-1155	5½"	Sharp/Sharp
14-1155	5½"	Sharp/Blunt
15-1155	5½"	Blunt/Blunt

**CURVED**

13-2155	5½"	Sharp/Sharp
14-2155	5½"	Sharp/Blunt



**SKLAR ANGULAR SCISSORS**

**SHARP/SHARP**

47-1080	4¾"	Smooth
47-1081	4¾"	Serrated



**WAGNER SCISSORS**

**STRAIGHT**

**SMOOTH**

47-1047	4½"	Sharp/Sharp
47-1048	4½"	Sharp/Blunt
47-1070	4½"	Blunt/Blunt

**SERRATED**

47-1049	4½"	Sharp/Sharp
47-1060	4½"	Sharp/Blunt
47-1071	4½"	Blunt/Blunt



**WAGNER SCISSORS**

**CURVED**

**SMOOTH**

47-1058	4½"	Sharp/Sharp
47-1068	4½"	Sharp/Blunt
47-1075	4½"	Blunt/Blunt

**SERRATED**

47-1059	4½"	Sharp/Sharp
47-1069	4½"	Sharp/Blunt
47-1072	4½"	Blunt/Blunt

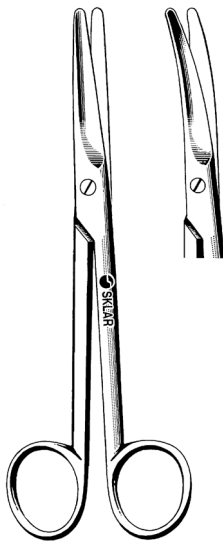

**MAYO DISSECTING SCISSORS**

STRAIGHT		CURVED	
15-1555	5½"	15-2555	5½"
15-1567	6¾"	15-2567	6¾"
90-1590	9"	90-1690	9"
55-8711	11" Harrington	55-8611	11" Harrington

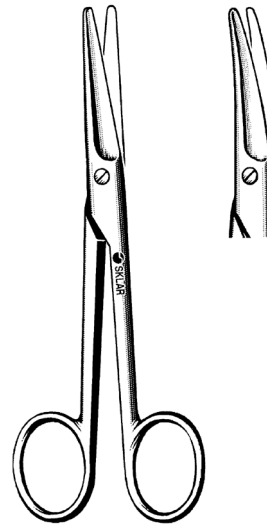

SKLARLITE™  
THE LIGHT TOUCH

**SKLARLITE™ MAYO DISSECTING SCISSORS**

STRAIGHT		CURVED	
23-1164	5½"	23-1166	5½"
23-1165	6¾"	23-1167	6¾"

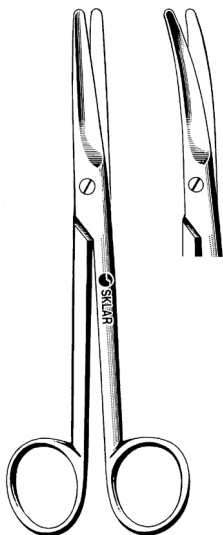

**MAYO DISSECTING SCISSORS**

DELICATE		CURVED	
STRAIGHT			
22-1556	5½"	22-2555	5½"
22-1567	6¾"	22-2567	6¾"

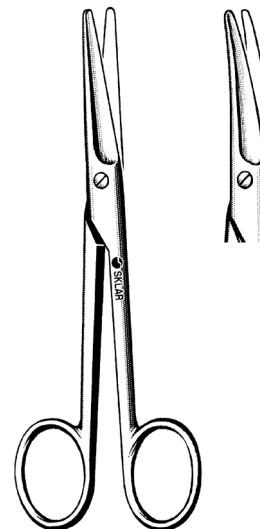

SKLARLITE XD™  
EXTRA DELICATE

**SKLARLITE XD™ MAYO DISSECTING SCISSORS**

STRAIGHT		CURVED	
23-1168	5½"	23-1170	5½"
23-1169	6¾"	23-1171	6¾"



**SCISSORS**

**GENERAL**



**METZENBAUM (LAHEY) SCISSORS**

STRAIGHT		CURVED	
22-2550	4½"	22-2545	4½"
75-5460	5¾"	47-1360	5¾"



**SKLARLITE™ METZENBAUM (LAHEY) SCISSORS**

STRAIGHT		CURVED	
23-1172	4½"	23-1174	4½"
23-1173	5¾"	23-1175	5¾"



**METZENBAUM (LAHEY) SCISSORS**

DELICATE			
STRAIGHT		CURVED	
22-2450	4½"	22-2650	4½"
22-2460	5¾"	22-1057	5¾"



**SKLARLITE XD™ METZENBAUM (LAHEY) SCISSORS**

STRAIGHT		CURVED	
23-1176	4½"	23-1178	4½"
23-1177	5¾"	23-1179	5¾"



**METZENBAUM DISSECTING SCISSORS**

STRAIGHT			CURVED		
75-5570	7"		75-5670	7"	
55-9180	8"	(Nelson)	55-9080	8"	(Nelson)
55-9190	9"	(Nelson)	55-9090	9"	(Nelson)
55-9310	10"	(Nelson)	55-9210	10"	(Nelson)
55-9311	11"	(Nelson)	55-9411	11"	(Nelson)
55-9312	12"	(Nelson)	55-9612	12"	(Nelson)
55-9314	14"	(Nelson)	55-9614	14"	(Nelson)



**SKLARLITE™ METZENBAUM DISSECTING SCISSORS**

STRAIGHT			CURVED		
23-1180	7"		23-1182	7"	



**METZENBAUM DISSECTING SCISSORS**

DELICATE			CURVED		
STRAIGHT					
22-1071	7"		22-1070	7"	
55-9184	8"	(Nelson)	55-9084	8"	(Nelson)
55-9194	9"	(Nelson)	55-9094	9"	(Nelson)
			55-9414	11"	(Nelson)



**SKLARLITE XD™ METZENBAUM DISSECTING SCISSORS**

STRAIGHT			CURVED		
23-1184	7"		23-1186	7"	

SCISSORS

GENERAL

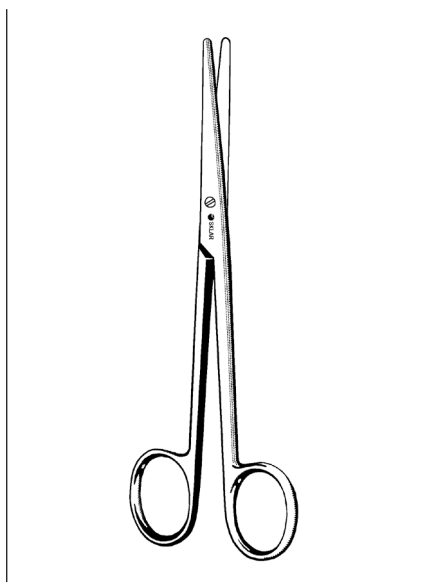

**LEXER SCISSORS**

15-2426	6¼"	Straight
15-2436	6¼"	Curved
15-2428	8¼"	Straight
15-2438	8¼"	Curved

**BABY LEXER**

22-1040	4"	Straight
22-1042	4"	Curved

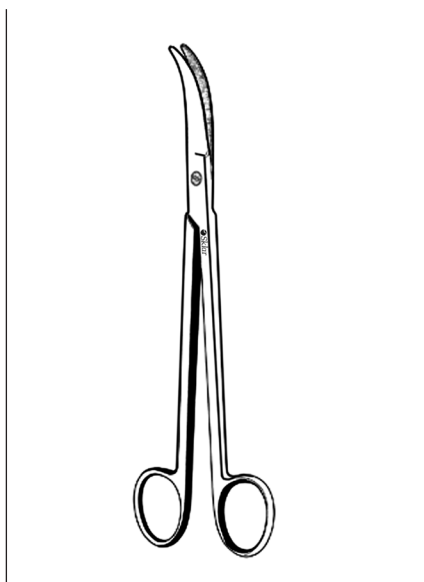

**JORGENSON SCISSORS**

**STRONG CURVE**

52-2970	9"
52-2979	12"
52-2980	14"
61-0011	16"
61-1011	18"
61-2011	20"

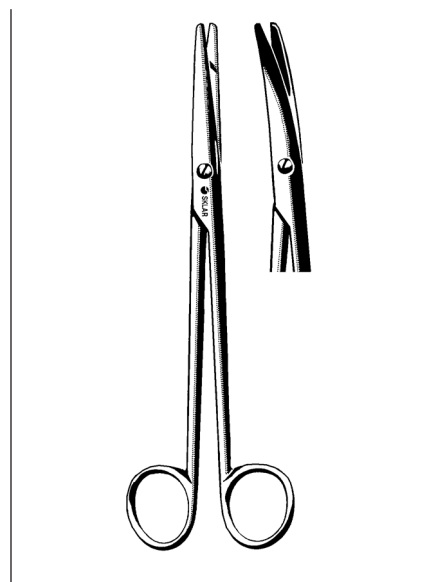

**MAYO-STILLE DISSECTING SCISSORS**

**ROUNDED BLADES**

**STRAIGHT**

15-1655	5½"
15-1667	6¾"

**CURVED**

15-2655	5½"
15-2667	6¾"

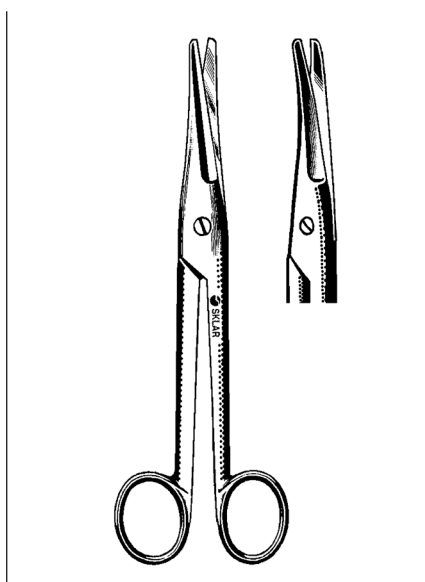

**MAYO-NOBLE DISSECTING SCISSORS**

**BEVELED BLADE**

**STRAIGHT**

15-1762	6½"
---------	-----

**CURVED**

5-2762	6½"
--------	-----

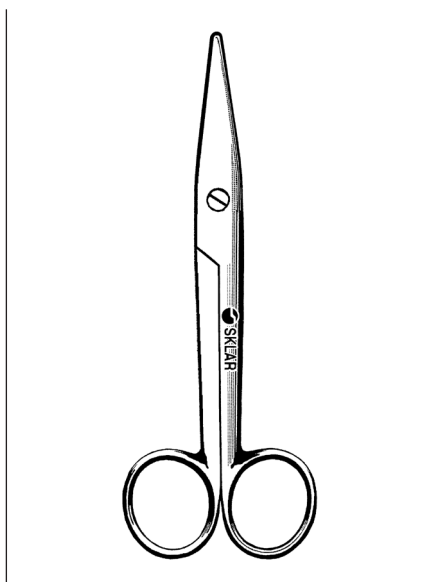

**MAYO-NOBLE-STILLE DISSECTING SCISSORS**

**STRAIGHT**

15-1862	6½"
---------	-----

**CURVED**

15-2862	6½"
---------	-----



**DOYEN SCISSORS**

**STRAIGHT**

15-1307	7"	Smooth
15-1308	7"	Serrated

**CURVED**

15-2307	7"	Smooth
15-2308	7"	Serrated

# SCISSORS

## GENERAL



### KELLY-ADSON SCISSORS

#### STRAIGHT

50-4562 6¼" Smooth  
50-4563 6¼" Serrated

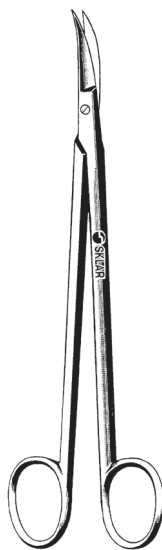

### KELLY-ADSON SCISSORS

#### CURVED

50-4662 6¼" Smooth

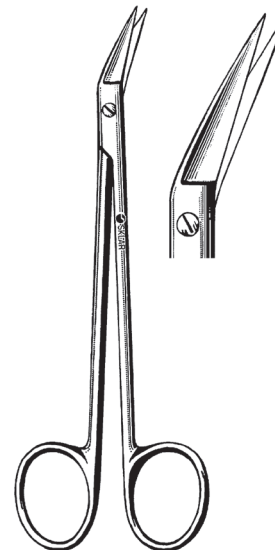

### KELLY-ADSON SCISSORS

#### ANGULAR

50-4462 6¼" Smooth

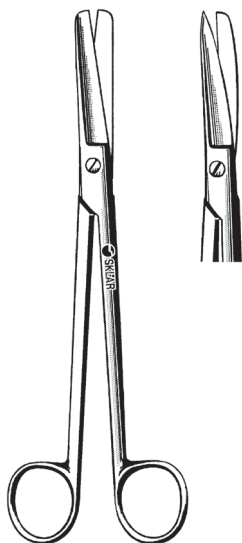

### SIMS SCISSORS

#### STRAIGHT

90-1280 8" Sharp/Sharp  
90-1180 8" Sharp/Blunt  
90-1080 8" Blunt/Blunt

#### CURVED

90-1580 8" Sharp/Sharp  
90-1480 8" Sharp/Blunt  
90-1380 8" Blunt/Blunt



### PLASTIC SURGERY SCISSORS

#### SHARP/SHARP

CURVED  
47-1345 4½"

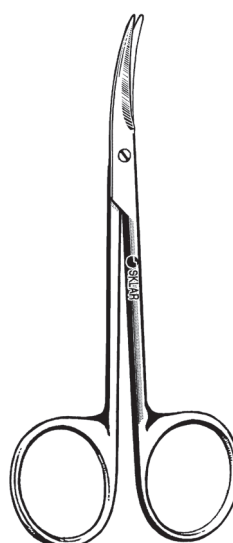

### DURA SCISSORS

#### SEMI-SHARP

CURVED  
22-2742 4¼"

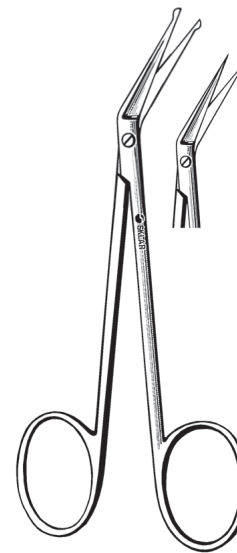

### IRIS SCISSORS

64-2142 4½" Angled  
64-2143 4½" Curved, Sideways  
64-2042 4¼" Angled, Probe Point

SCISSORS

GENERAL



SKLARLITE  
THE LIGHT TOUCH

SKLARLITE™  
OFFERS THE SURGEON  
EXQUISITE CONTROL

We recognize the need for scissors that maintain the strength and durability of a standard instrument but afford a lighter pattern. In response to industry demands for these lighter instruments, Sklar established the SklarLite line of premium operating room scissors.

Through a unique manufacturing technique, we are able to yield a noticeably lighter instrument that maintains the structural integrity of the original instrument. These extremely sensitive scissors give the surgeon maximum control and precision while comfortably withstanding the daily rigors of frequent use.

Sklarlite™ Scissors are ideal for prolonged procedures, minimizing fatigue and providing exquisite control. These surprisingly strong instruments carry the same day-in and day-out reliability that you have come to expect from all Sklar instruments and are fully guaranteed for a lifetime of dependable use.

*Sklar Exclusive!*



IRIS SCISSORS

STRAIGHT

47-1135	3½"	S/S
47-1140	3½"	B/B
47-1143	4"	S/S
47-1441	4"	S/S, Heavy
47-1145	4½"	S/S
47-1144	4½"	B/B

CURVED

47-1235	3½"	S/S
47-1240	3½"	B/B
47-1243	4"	S/S
47-1442	4"	S/S, Heavy
47-1245	4½"	S/S
47-1244	4½"	B/B



SKLARLITE™  
THE LIGHT TOUCH

SKLARLITE™ IRIS SCISSORS

SHARP/SHARP

STRAIGHT

23-1148	3½"
23-1149	4½"

CURVED

23-1150	3½"
23-1151	4½"



**SKLARLITE XD**  
EXTRA DELICATE

**SKLARLITE XD™  
DELIVERS THE ULTIMATE  
IN PRECISION**

Sklar has surpassed industry standards by offering an extra delicate pattern operating room scissor, giving the surgeon one of the lightest general surgery scissors on the market today.

Through a unique manufacturing technique, we are able to produce our lightest pattern scissor, furnishing strength and integrity equal to that of the original instrument. These extra delicate scissors are our most sensitive surgical tool and allow the surgeon the ultimate in precision and control.

Sklarlite XD™ Scissors are ideal for prolonged procedures, comfortably withstanding the daily rigors of frequent use. They carry the same day-in and day-out reliability that you have come to expect from all Sklar instruments and are guaranteed for a lifetime of dependable use.

For the surgeon who demands the finest in OR scissors, SklarLite XD is the ultimate choice.

***Sklar Exclusive!***



**IRIS SCISSORS DELICATE**

**SHARP/SHARP**

**STRAIGHT**

22-1135 3½"

47-1440 4"

47-1246 4½"

**CURVED**

22-1235 3½"

47-1340 4"

47-1248 4½"



**SKLARLITE XD™**  
EXTRA DELICATE

**SKLARLITE XD™ IRIS SCISSORS**

**SHARP/SHARP**

**STRAIGHT**

23-1152 3½"

23-1153 4½"

**CURVED**

23-1154 3½"

23-1155 4½"



**SCISSORS**  
**GENERAL**



**STRABISMUS SCISSORS**

**STRAIGHT**

64-1442 4½"

**CURVED**

64-1542 4½"



**SKLARLITE™ STRABISMUS SCISSORS**

**STRAIGHT**

23-1158 4½"

**CURVED**

23-1159 4½"



**STRABISMUS SCISSORS**

**DELICATE**

**STRAIGHT**

22-1442 4½"

**CURVED**

22-1542 4½"



**SKLARLITE XD™ STRABISMUS SCISSORS**

**STRAIGHT**

23-1162 4½"

**CURVED**

23-1163 4½"



**STEVENS TENOTOMY SCISSORS**

**STRAIGHT**

64-1243 4½" S/S  
64-1242 4½" B/B

**CURVED**

64-1343 4½" S/S  
64-1342 4½" B/B

**STRAIGHT, DELICATE**

22-1240 4½" S/S  
22-1242 4½" B/B

**CURVED, DELICATE**

22-1241 4½" S/S  
22-1342 4½" B/B



**SKLARLITE™ STEVENS TENOTOMY SCISSORS**

**BLUNT/BLUNT**

**STRAIGHT**  
23-1156 4½"

**CURVED**  
23-1157 4½"

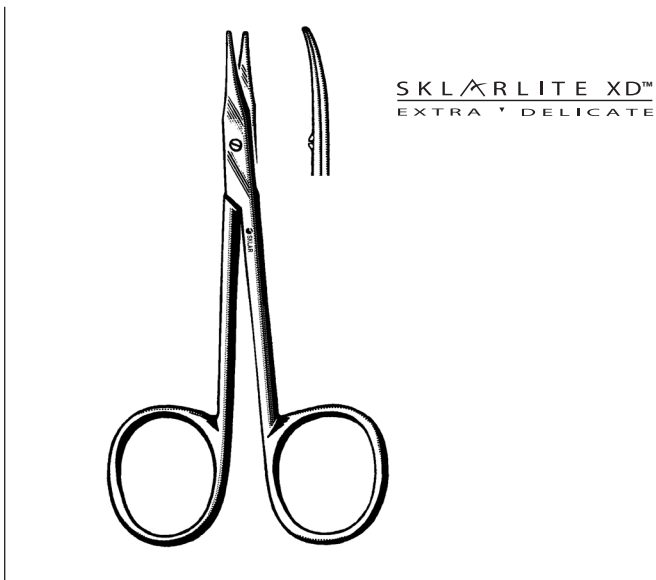

**SKLARLITE XD™ STEVENS TENOTOMY SCISSORS**

**BLUNT/BLUNT**

**STRAIGHT**  
23-1160 4½"

**CURVED**  
23-1161 4½"



**KAYE UNDERMINING SCISSOR**

**STRAIGHT**  
47-1084 4½"

SCISSORS

GENERAL

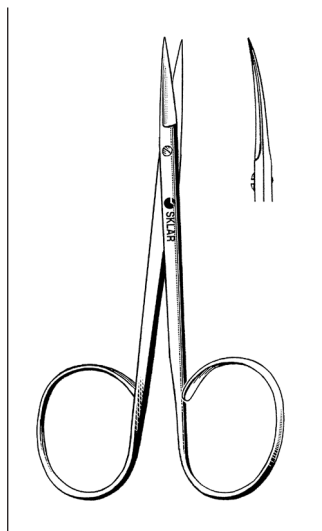

**RIBBON IRIS SCISSORS**  
STRAIGHT 47-1250 4" CURVED 47-1255 4"

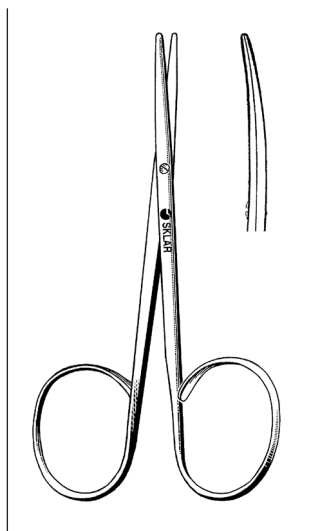

**RIBBON STRABISMUS SCISSORS**  
STRAIGHT 64-1240 4" CURVED 64-1340 4"

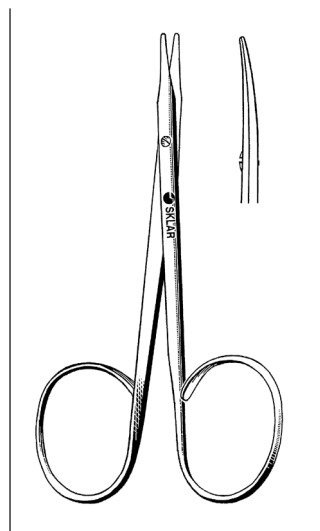

**RIBBON STEVENS TENOTOMY SCISSORS**  
STRAIGHT 64-1241 4" CURVED 64-1341 4"

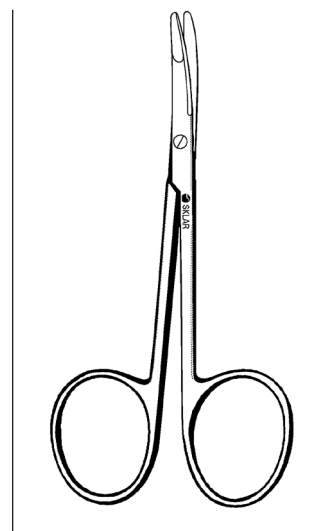

**BLEPHAROPLASTY DISSECTING SCISSOR**  
CURVED, SERRATED 47-1147 4 3/4"

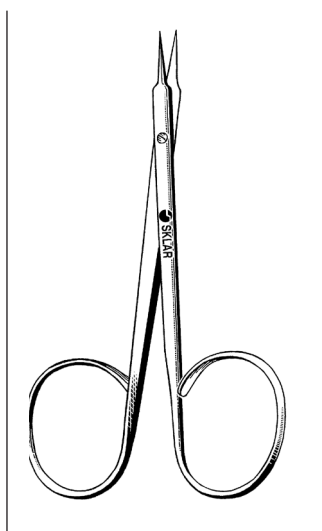

**RIBBON STITCH SCISSORS**  
STRAIGHT 64-1345 4" CURVED 64-1445 4"

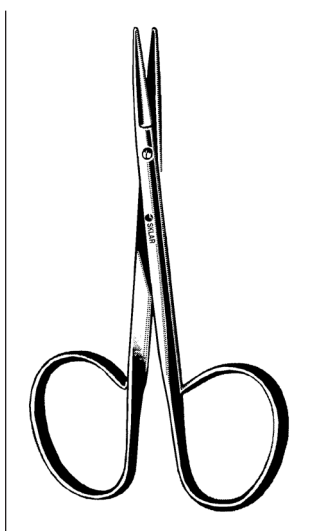

**UTILITY RIBBON SCISSORS**  
BLUNT/BLUNT 47-1146 4" CURVED 47-1247 4"

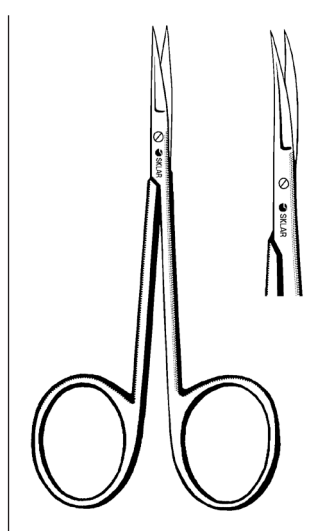

**BON MINI IRIS SCISSORS**  
STRAIGHT 64-2035 3 1/2" CURVED 64-2036 3 1/2"

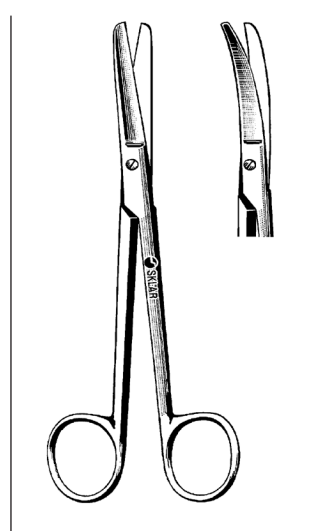

**MIXTER SCISSORS**  
STRAIGHT 15-1360 6 1/4" CURVED 15-1361 6 1/4"

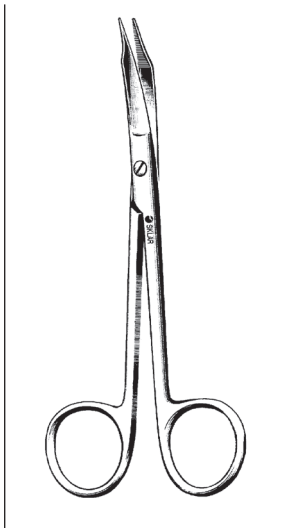

**MARTIN SCISSOR**  
CURVED  
41-1120 8" Heavy Serrated

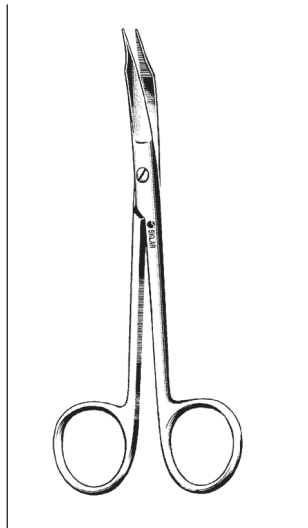

**MILLER DISSECTING SCISSOR**  
BACK EDGES SEMI-SHARP  
41-1125 5" Serrated

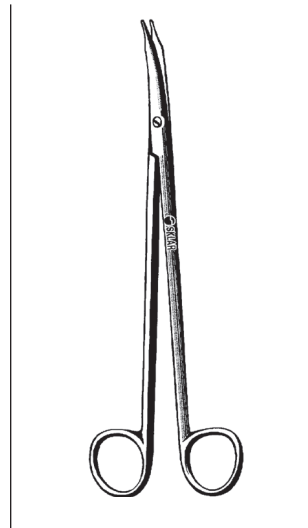

**REYNOLDS SCISSORS**  
NARROW TIP  
22-2758 6" Straight  
22-2759 6" Straight, Serrated  
22-2760 6" Curved  
22-2762 6" Curved, Serrated  
22-2772 7" Straight  
22-2768 7" Straight, Serrated  
22-2770 7" Curved  
22-2722 7" Curved, Serrated

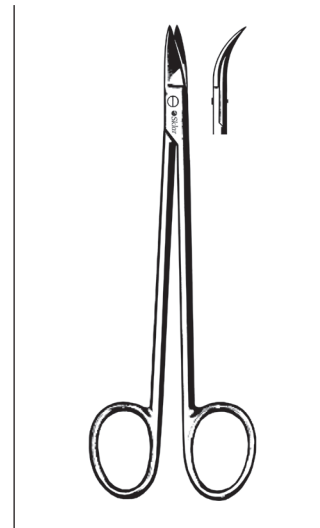

**QUIMBY GUM SCISSORS**  
22-2750 5" Straight  
22-2751 5" Curved

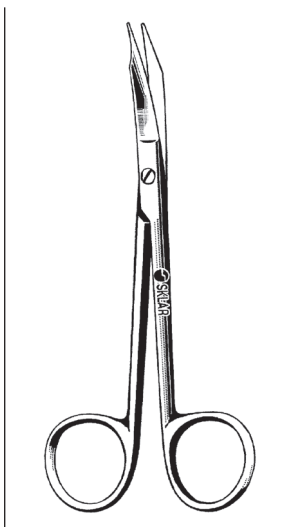

**GOLDMAN-FOX SCISSOR**  
CURVED  
22-2520 5" Serrated

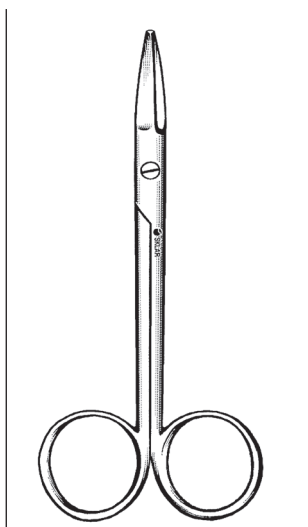

**JOSEPH SCISSORS**  
DOUBLE EDGE  
STRAIGHT CURVED  
41-1058 5 3/4" 41-1060 5 3/4"

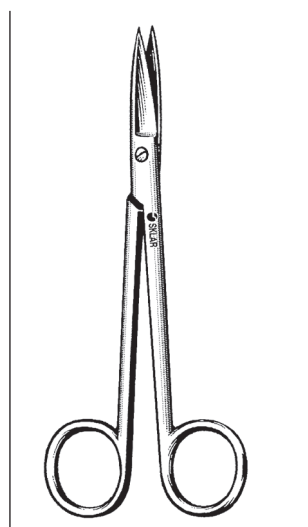

**JOSEPH SCISSORS**  
STRAIGHT CURVED  
41-1050 5 3/4" 41-1054 5 3/4"

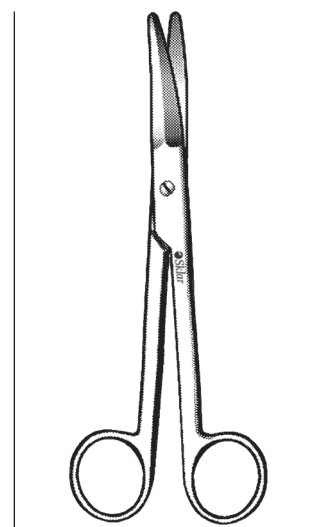

**KAYE FACELIFT SCISSORS**  
47-1086 6"  
47-1087 7 1/2"

SCISSORS

GENERAL

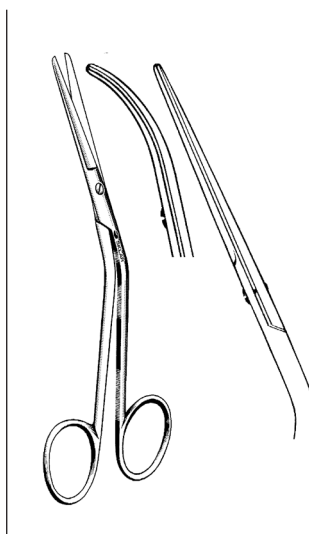

**FOMON SCISSORS**

- 70-4352 5¼" Curved
- 41-1076 5½" Curved,  
Saber Back
- 70-4350 5½" Angled

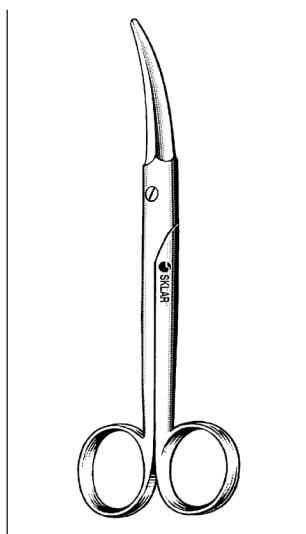

**AUFRICHT FACE LIFT  
SCISSOR**

- CURVED TRIANGULAR BLADES**  
41-1167 5¾"

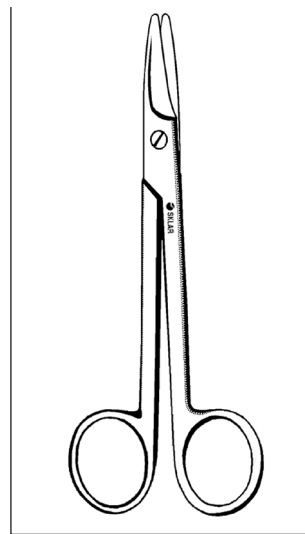

**CASTANARES  
FACE LIFT SCISSOR**

- 41-1077 6¼" Straight

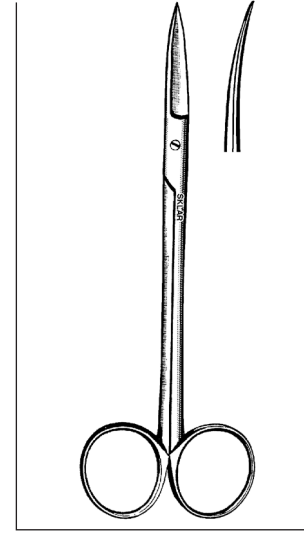

**RHYTIDECTOMY  
SCISSORS**

- DOUBLE EDGE**  
41-1100 6½" Straight  
41-1105 6½" Curved

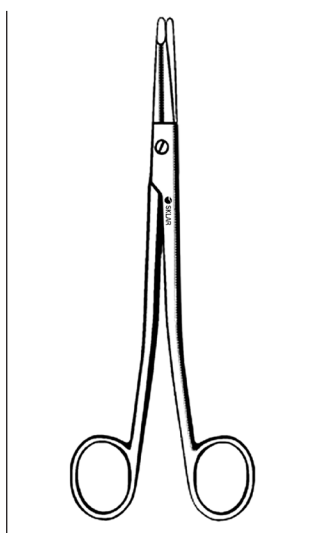

**GORNEY FACELIFT  
SCISSORS**

- 47-1088 5" Straight
- 47-1090 7½" Straight
- 47-1089 7½" Curved
- 47-1091 9" Straight

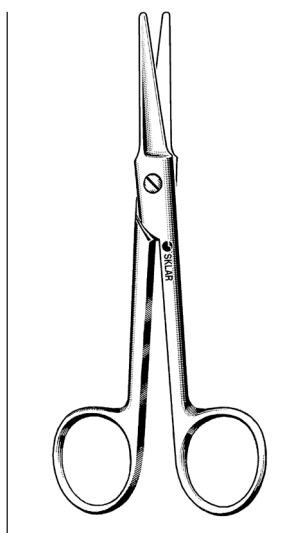

**BROWN DISSECTING  
SCISSORS**

- HEAVY PATTERN**  
41-1078 5½" Straight  
41-1079 5½" Curved

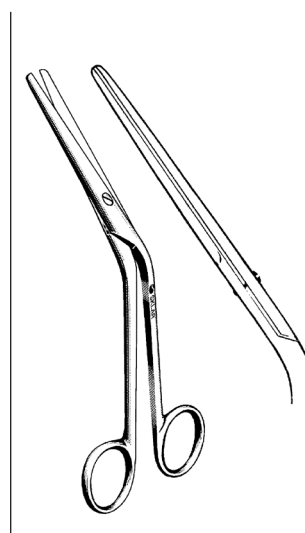

**COTTLE DORSAL  
SCISSOR**

- HEAVY ROUNDED BLADES**  
41-1169 6" Angular

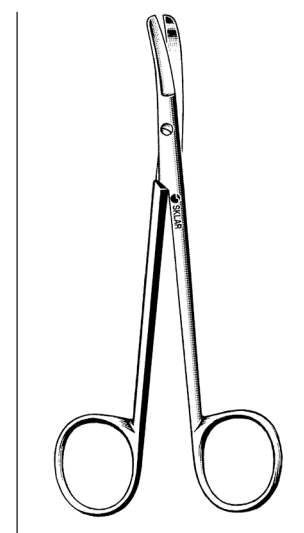

**COTTLE NASAL  
SCISSOR**

- STRONG SHORT BLADES**  
41-1168 4½" Curved

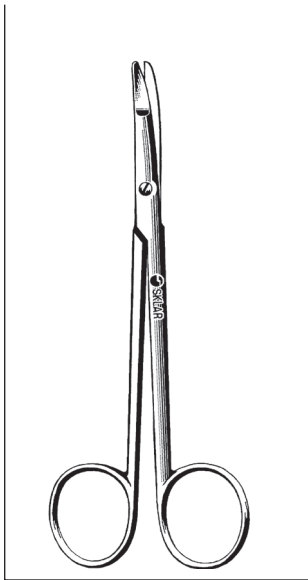

**RAGNELL DISSECTING SCISSORS (FLAT TIPS)**

<b>CURVED</b>	<b>STRAIGHT</b>
22-2652 5"	22-2653 5"
22-2657 7"	

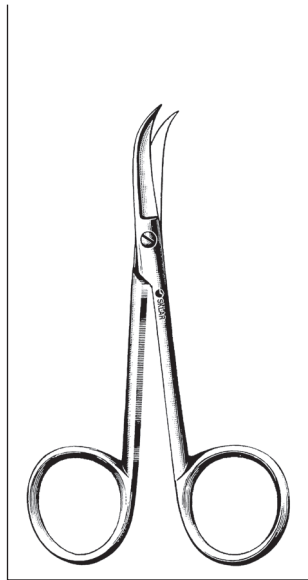

**HILL SCISSOR**  
SHARP POINTS CURVED SIDEWAYS

22-2955 4¾"

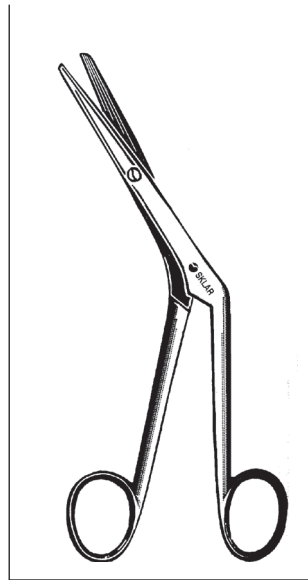

**KNIGHT NASAL SCISSOR**

70-4262 6¼"



**SEILER TURBINATE SCISSOR**

41-1165 6¼" Angled  
Sideways

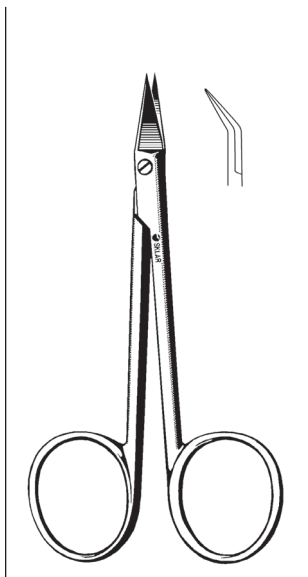

**WILMER IRIS SCISSOR**  
ANGLED ON FLAT

64-1735 4"

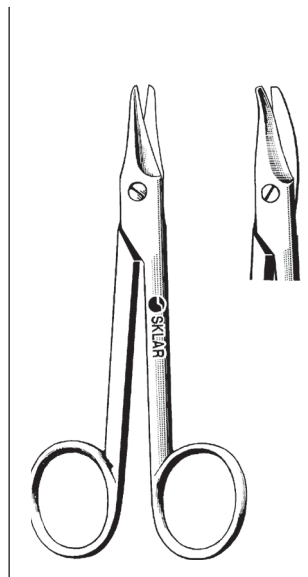

**SISTRUNK SCISSORS**

15-2445 5¾"	Straight
15-2455 5¾"	Curved

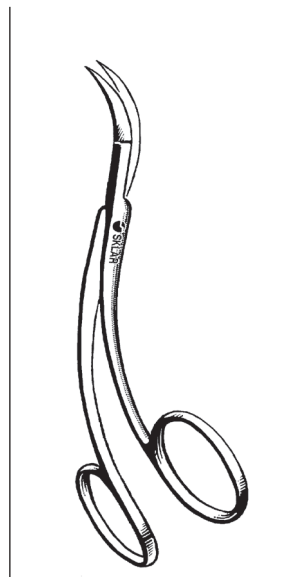

**LA GRANGE SCISSOR**  
S-SHAPED

22-2745 4½" Sharp/Sharp

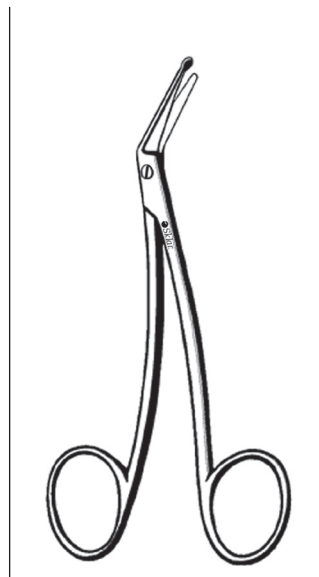

**TAYLOR DURAL SCISSOR**

50-4655 6½" Probe Tip

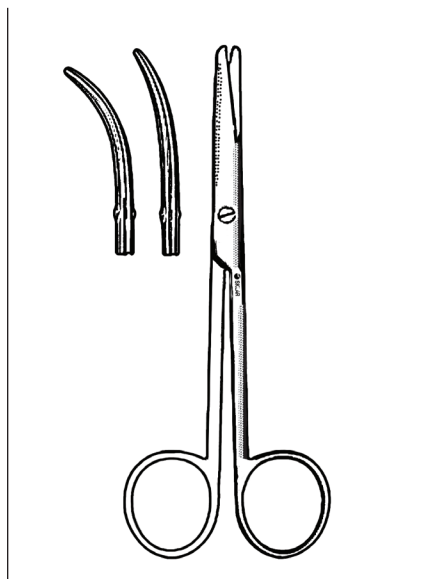

**ENUCLEATION SCISSORS**

- 64-1150 5" Light Curve
- 64-1151 5" Medium Curve
- 64-1152 5" Full Curve

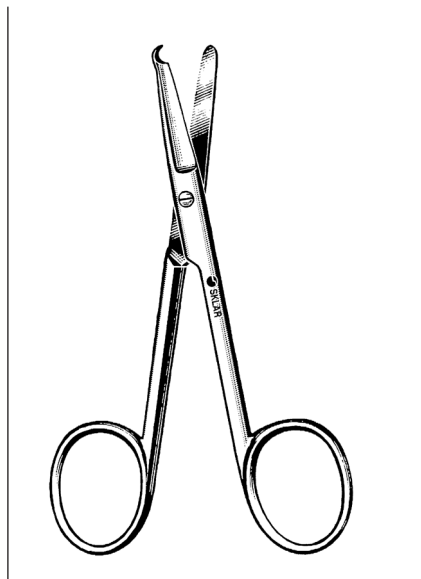

**SPENCER STITCH SCISSORS**

- 22-2835 3½"
- 22-2845 4½"
- 15-1355 5½" Littauer



**SKLARLITE™ SPENCER STITCH SCISSORS**

- 23-1188 3½"
- 23-1189 4½"
- 23-1190 5½" Littauer

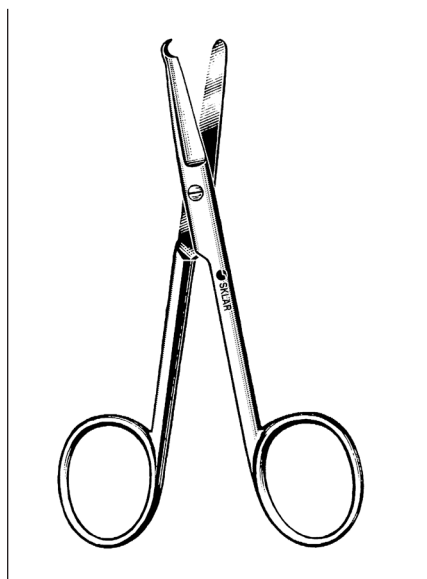

**SPENCER STITCH SCISSORS  
DELICATE**

- 22-2834 3½"
- 22-2844 4½"
- 22-1354 5½" Littauer



**SKLARLITE XD™ SPENCER  
STITCH SCISSORS**

- 23-1193 3½"
- 23-1194 4½"
- 23-1195 5½" Littauer

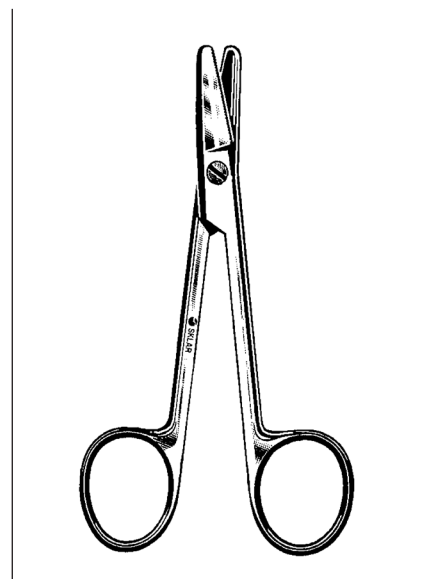

**SUTURE WIRE CUTTING  
SCISSOR**

- HEAVY**  
24-2347 4¾" Straight, Serrated



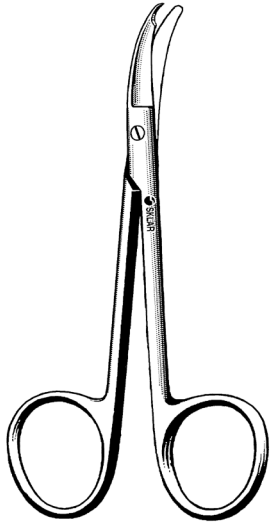

**SUTURE SCISSORS**

- 22-2935 3½" Shortbent
- 22-2934 3½" Shortbent Delicate
- 22-2947 4¾" Northbent

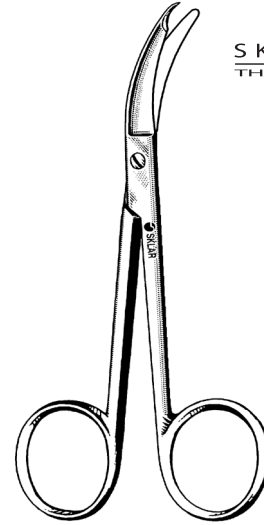

SKLARLITE™  
THE LIGHT TOUCH

**SKLARLITE™ SUTURE SCISSOR**

- 23-1191 3½" Shortbent

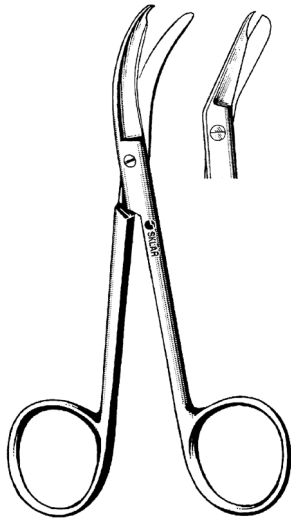

**SKLAR STITCH SCISSORS**

- 15-3150 4½" Angular
- 22-2950 5" Curved Sideways

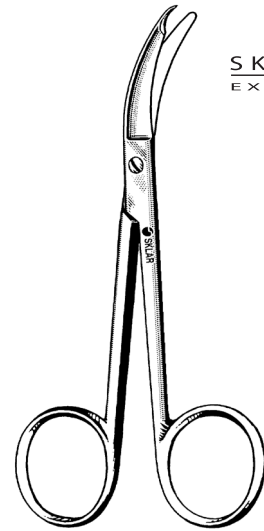

SKLARLITE XD™  
EXTRA DELICATE

**SKLARLITE XD™ SUTURE SCISSOR**

- 23-1196 3½" Shortbent

**SCISSORS  
SUTURE**



**SKLAR PRECISION  
COMBINATION IRIS AND  
SUTURE SCISSORS**

Similar to the very popular Iris Scissors, these specially designed scissors are ideal for use in extremely delicate surgery. The delicate blades are honed extremely fine and sharp. The upper blade has a fine serration to maintain grip and the lower blade is razor honed to give a smooth precision cut on tissue or suture. There is also a suture cutting notch near the tip of the blade for convenience during procedures.

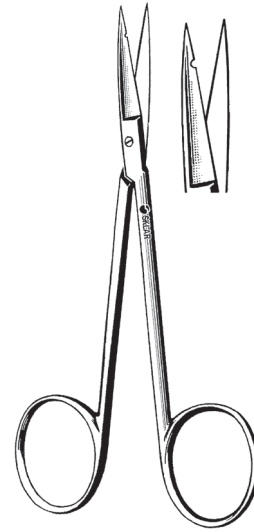

**SKLAR PRECISION SCISSORS**

STRAIGHT		CURVED	
22-2820	3½"	22-2822	3½"
22-2824	4½"	22-2825	4½"

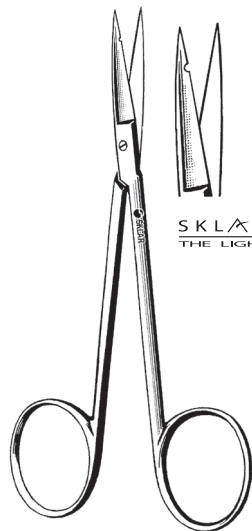

SKLARLITE™  
THE LIGHT TOUCH

**SKLARLITE™ PRECISION SCISSORS**

STRAIGHT		CURVED	
23-1290	3½"	23-1292	3½"
23-1294	4½"	23-1296	4½"

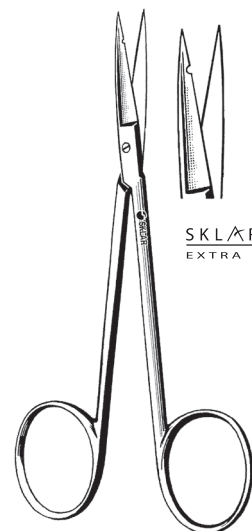

SKLARLITE XD™  
EXTRA DELICATE

**SKLARLITE XD™ PRECISION SCISSORS**

STRAIGHT		CURVED	
23-1300	3½"	23-1302	3½"
23-1304	4½"	23-1306	4½"

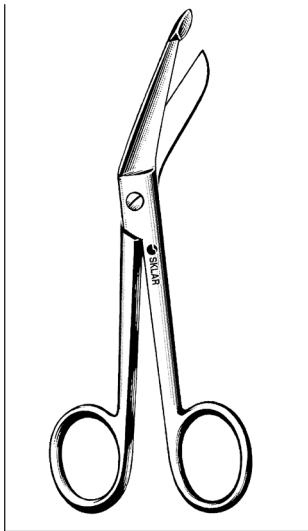

**LISTER BANDAGE  
SCISSORS**

- 11-1035 3½"
- 11-1045 4½"
- 11-1055 5½"
- 11-1055LFT 5½" Left Handed
- 11-1072 7¼"
- 11-1072LFT 7¼" Left Handed
- 11-1080 8"

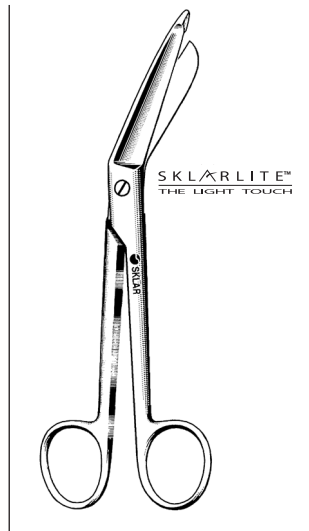

**SKLARLITE™ LISTER  
BANDAGE SCISSORS**

- 23-1199 5½"
- 23-1200 7¼"

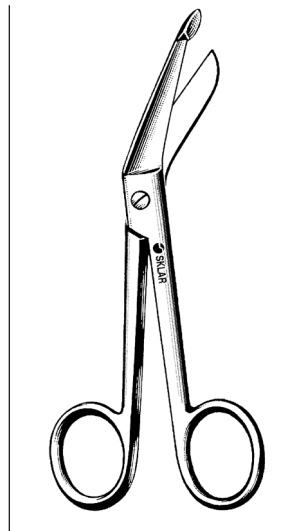

**LISTER BANDAGE  
SCISSORS**

- DELICATE**
- 22-1054 5½"
  - 22-1072 7¼"

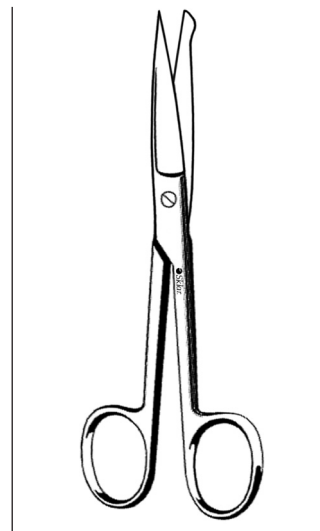

**INCISION SCISSOR  
WITH PROBE POINT**

- 14-1080 5½"



**SKLARLITE XD™ LISTER  
BANDAGE SCISSORS**

- 23-1202 5½"
- 23-1203 7¼"



**LISTER BANDAGE  
SCISSOR**

- LARGE RING**
- 11-1060 8"

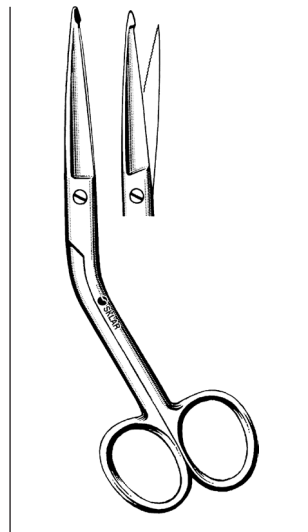

**SKLAR HI LEVEL  
BANDAGE SCISSOR**

- SERRATED**
- 11-1252 5½"

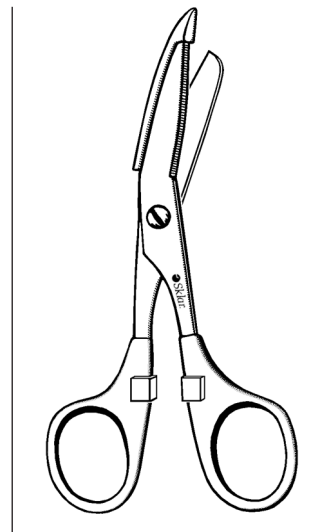

**NURSES BANDAGE  
SCISSORS**

- 11-1495 5½" Pink
- 11-1496 5½" Blue



**SCISSORS**  
**BANDAGE | UTILITY**

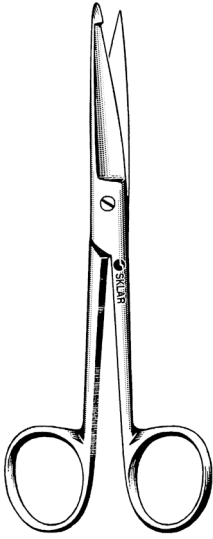

**KNOWLES BANDAGE SCISSOR**

11-1255 5½"

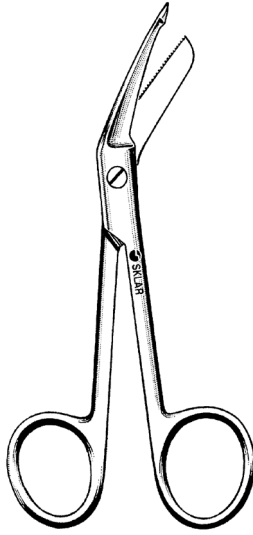

**BANTAM BANDAGE SCISSOR**

**SERRATED**  
11-1257 5¼"

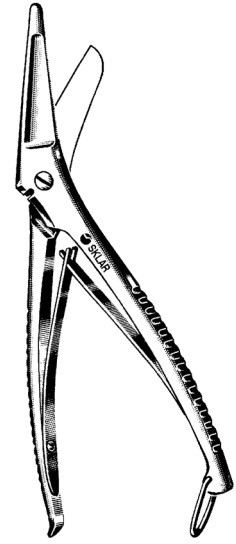

**COMMANDER UTILITY SHEAR**

**HEAVY DUTY WITH WIRE CUTTING NOTCH**  
11-1298 8½" Serrated

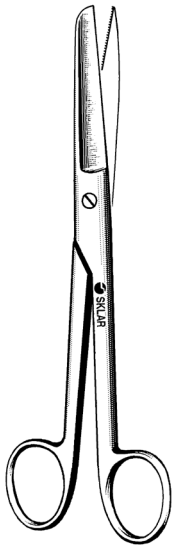

**MOLESKIN SCISSORS**

**SERRATED**  
97-1350 7½" Straight  
97-1351 7½" Curved

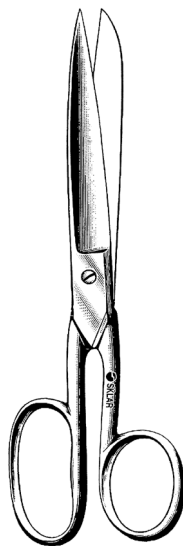

**USA PATTERN GAUZE SCISSOR**

11-1180 8"

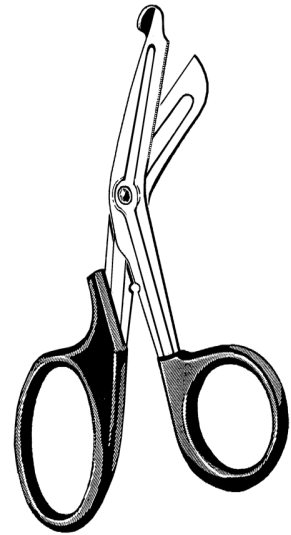

**UTILITY SCISSORS**

**SERRATED**  
11-1278 6" Blue  
11-1280 7½" Blue  
11-1281 7½" Black  
11-1282 7½" Green  
11-1283 7½" Red  
11-1284 7½" White  
11-1285 7½" Purple  
11-1286 7½" Orange  
11-1287 7½" Yellow

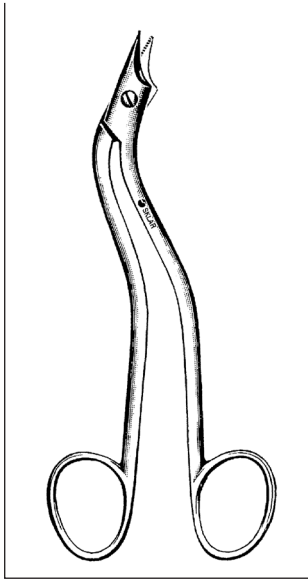

**HEATH SCISSOR**

**SERRATED**

24-1962 6¼"

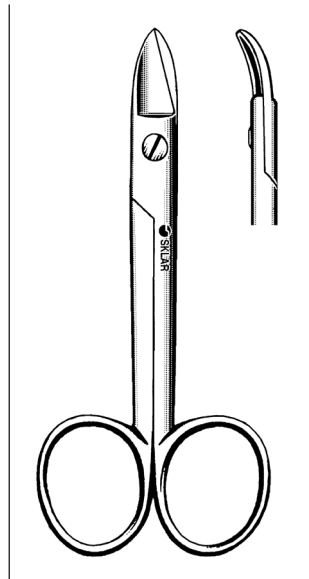

**CROWN & COLLAR SCISSORS**

**STRAIGHT**

24-2345 4"

24-2340 4" Serrated

**CURVED**

24-2346 4"

24-2341 4" Serrated

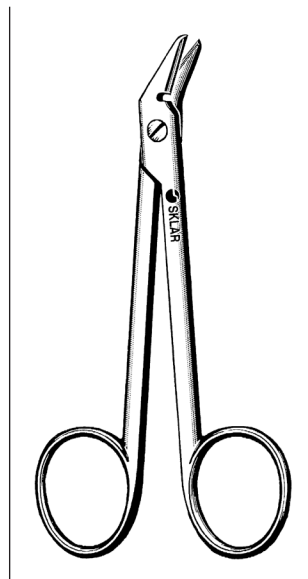

**SUTURE WIRE CUTTING SCISSOR**

**ANGLED, SERRATED**

24-2342 4¾"

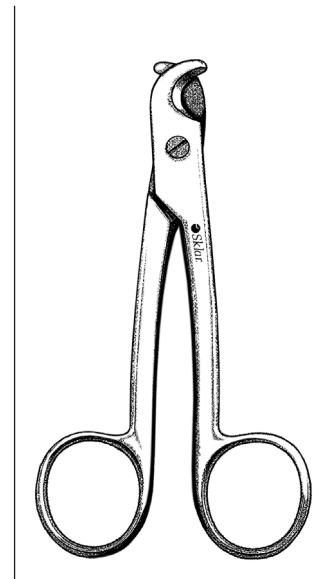

**SUTURE WIRE SCISSOR**

**DELICATE**

24-1965 4½"

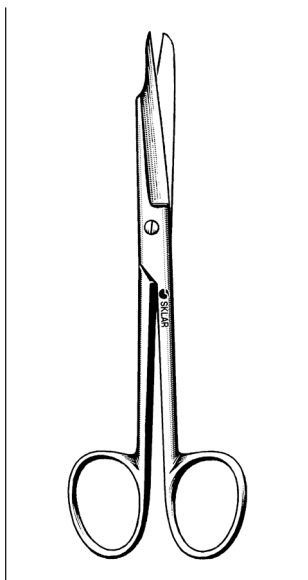

**NAIL SPLITTING SCISSOR**

**ONE POINTED BLADE**

97-0555 6" Serrated

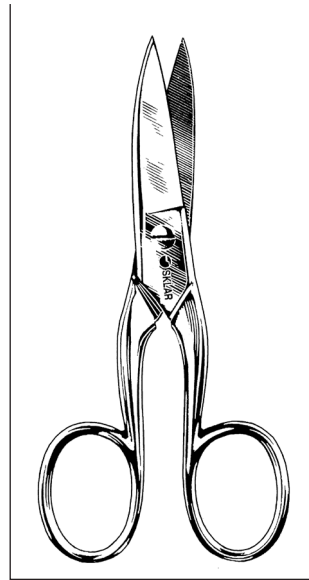

**SKLAR NAIL SCISSORS**

**RING HANDLE**

97-1235 3½" Straight

97-1245 4½" Curved

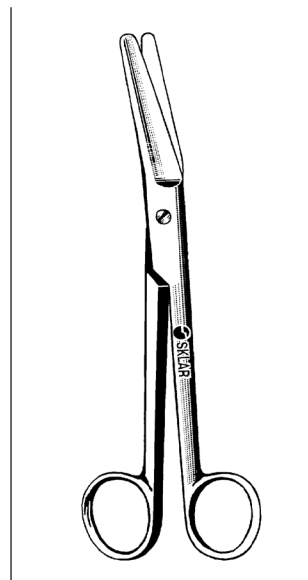

**FERGUSON SCISSOR**

**ANGLED ON FLAT**

15-3107 7"

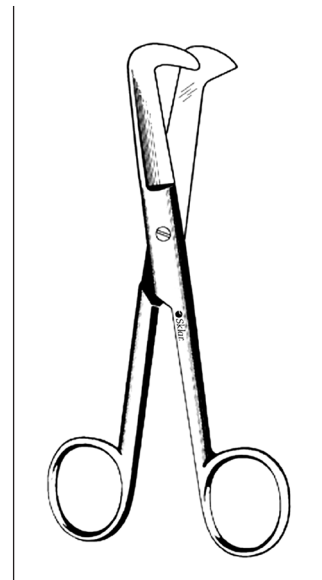

**SCHUMACHER UMBILICAL SCISSOR**

92-5560 6¼"

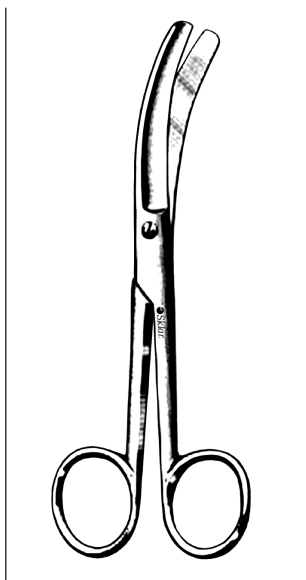

**BUSCH UMBILICAL  
SCISSOR**

92-5565 6½"

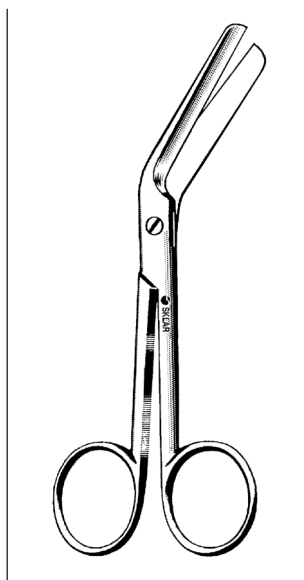

**BRAUN EPISIOTOMY  
SCISSORS**

ANGULAR, GUARDED BLADE

90-1755 5½"

90-1785 8½"

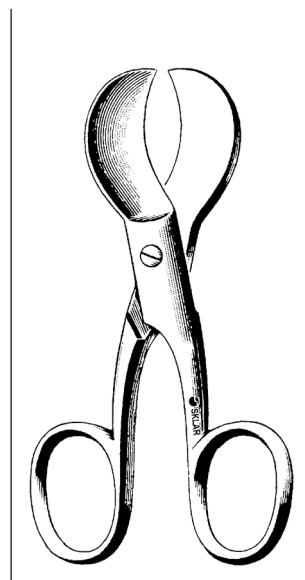

**UMBILICAL SCISSOR**

92-5540 4"

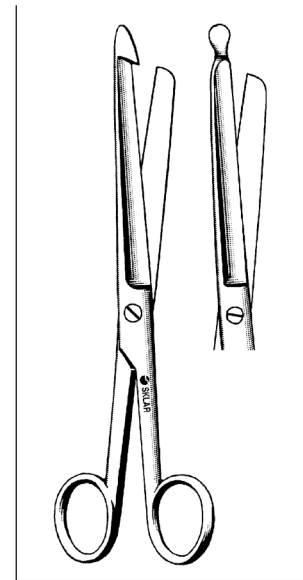

**ENTEROTOME  
SCISSORS**

HOOK POINT

15-1282 8¼"

PROBE POINT

15-1285 8¼"

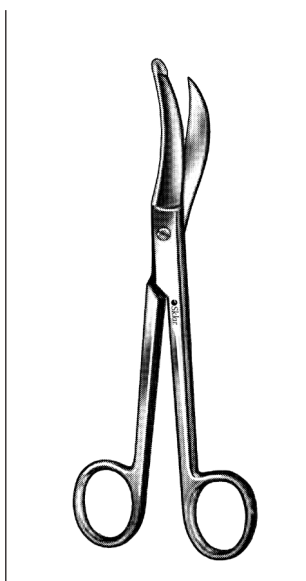

**WALDMANN  
EPISIOTOMY SCISSOR**

SERRATED

90-1770 7"

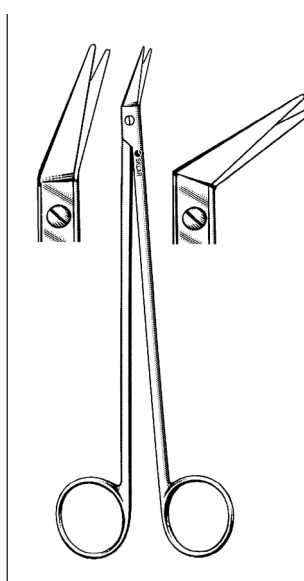

**POTTS-SMITH  
SCISSORS**

ANGLED

52-2825 7¼" 25°

52-2845 7¼" 45°

52-2860 7¼" 60°

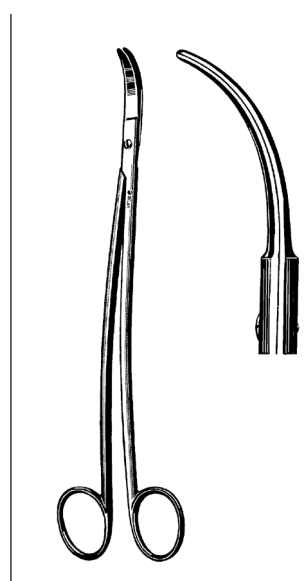

**SATINSKY SCISSOR**

DOUBLE CURVE

55-8495 9½"

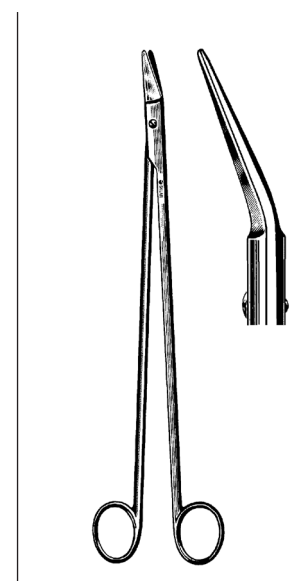

**FINOCHIETTO SCISSOR**

THORACIC SCISSORS, ANGULAR

55-8310 10¾"

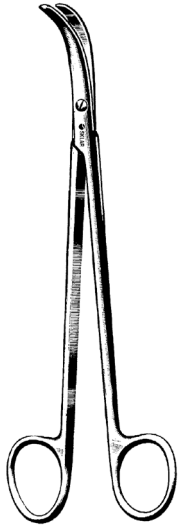

**THOREK SCISSORS**

**FULL CURVE**

15-3172 7¼"  
15-3210 10"

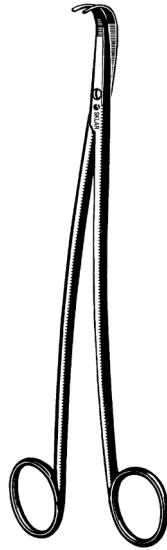

**HAIMOVICI SCISSOR**

**ARTERY SCISSORS, CURVED**

52-2985 10½"

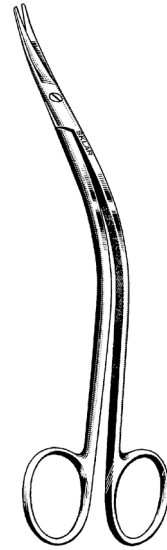

**MILLER SCISSOR**

**DOUBLE CURVE**

80-1565 6½" Serrated

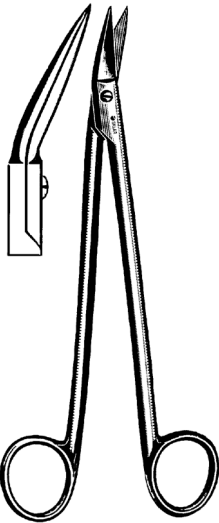

**DEAN SCISSOR**

**ANGULAR**

75-5267 6¾" Serrated

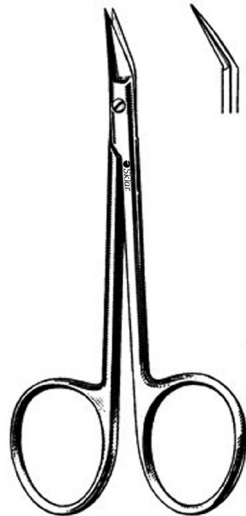

**BIRD DERMAL  
NAEVUS SCISSOR**

**DELICATE**

64-1740 4"

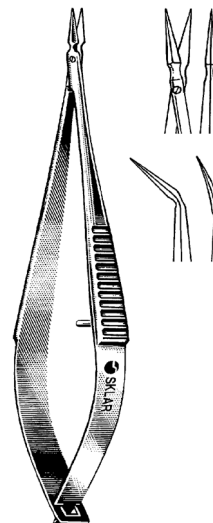

**VANNAS SPRING  
HANDLE SCISSORS**

**DELICATE, 8MM**

64-1950 3" Straight  
64-1951 3" Curved  
64-1952 3" Angled  
64-1955 3" Angled on Flat

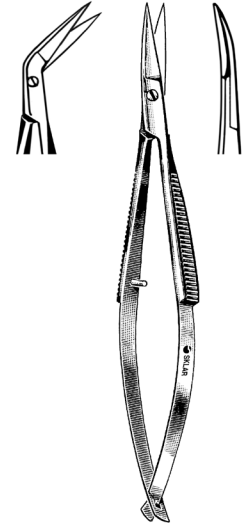

**McCLURE IRIS  
SCISSORS**

64-1742 4¼" Angled  
64-1842 4¼" Straight  
64-1942 4¼" Curved



**SCISSORS  
MICRO**

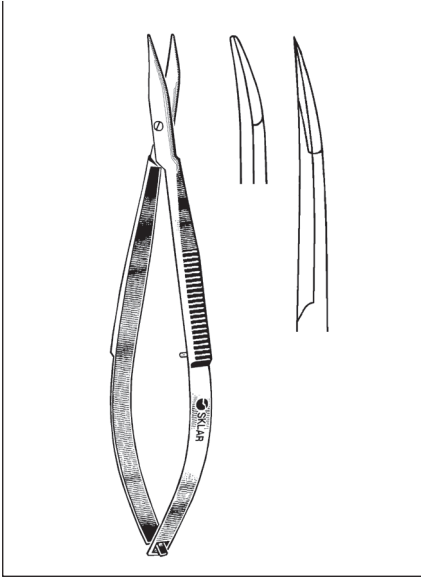

**WESTCOTT TENOTOMY  
SCISSORS**

**SPRING HANDLE**

64-3146	4 1/4"	Straight	Blunt
64-3145	4 1/4"	Straight	Sharp
64-3142	5"	Curved Right	Blunt
64-3144	5"	Curved Left	Blunt

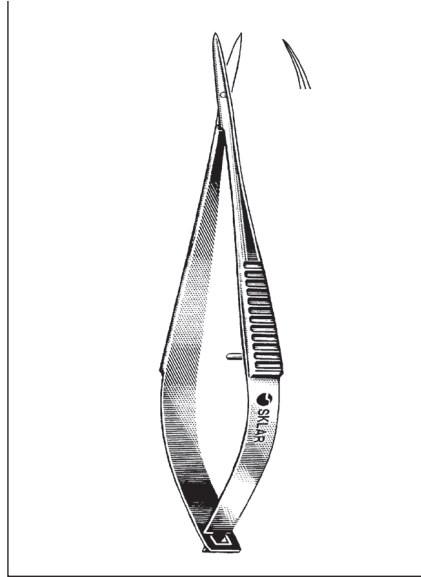

**MCPHERSON-VANNAS  
SCISSORS**

**VERY DELICATE**

64-1960	3"	Straight
64-1961	3"	Curved

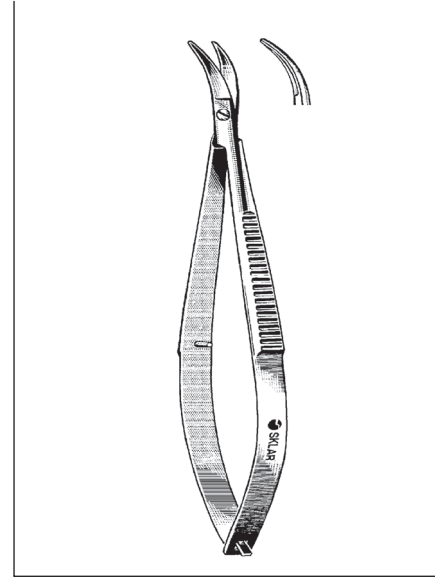

**CASTROVIEJO SCISSOR**

**BLUNT**

64-2442	4"	Curved
---------	----	--------



**CASTROVIEJO SCISSOR**

**ANGULAR**

64-2535	4"	Blunt
---------	----	-------



**JACOBSON SPRING HANDLE SCISSORS**

**STANDARD**

98-1055	6 1/4"	Straight
98-1052	5 1/4"	Curved
98-1067	6 1/4"	Curved



**SKLARCUT™**  
SERRATED BLADE

**SKLARCUT™**  
**GOLD-RING SCISSORS**  
**CUT CLEANLY AND**  
**PRECISELY**

Surgical scissors are your most frequently used instrument. SKLARCUT scissors improve the traditional design with ultra-fine serrations on one blade.

This special feature provides for smooth and less traumatic cutting of fine and coarse tissue. One blade of these extremely high tempered scissors is precision ground, while the other blade employs extremely fine serrations that help the scissors maintain grip and accuracy throughout the entire cut.

SKLARCUT scissors provide users with an exceptionally sensitive “feel” and help eliminate problems associated with tissue slippage during cutting.

For easy visual distinction from normal scissors, the finger ring of the serrated blade is gold-coated.

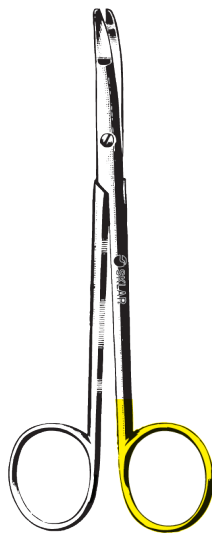

**SKLARCUT™ RAGNELL**  
**DISSECTING SCISSOR**

**CURVED**  
15-3320 5"

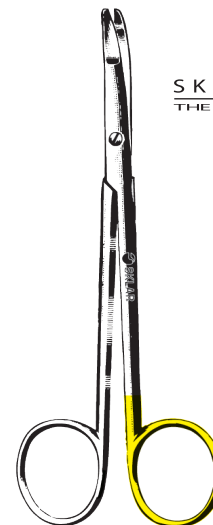

**SKLARLITE™**  
THE LIGHT TOUCH

**SKLARLITE™ SKLARCUT™**  
**RAGNELL DISSECTING**  
**SCISSOR**

**CURVED**  
23-1250 5"

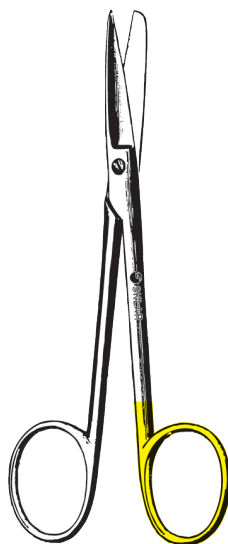

**SKLARCUT™**  
**WAGNER SCISSOR**

**STRAIGHT**  
15-3542 4½" Sharp/Blunt

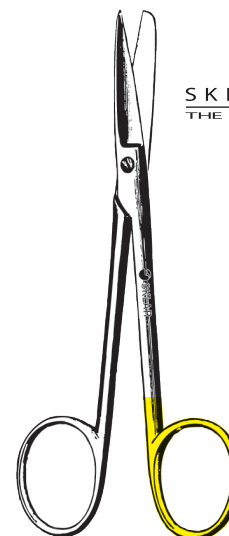

**SKLARLITE™**  
THE LIGHT TOUCH

**SKLARLITE™ SKLARCUT™**  
**WAGNER SCISSOR**

**STRAIGHT**  
23-1254 4½" Sharp/Blunt



**SKLARCUT™  
OPERATING SCISSORS**

**STRAIGHT**

15-3500 5½" Sharp/Sharp  
15-3505 5½" Sharp/Blunt

**CURVED**

15-3510 5½" Sharp/Sharp  
15-3515 5½" Sharp/Blunt

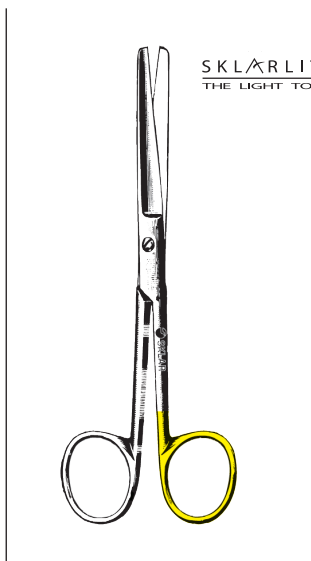

SKLARLITE™  
THE LIGHT TOUCH

**SKLARLITE™  
SKLARCUT™  
OPERATING SCISSORS**

**STRAIGHT**

23-1260 5½" Sharp/Sharp  
23-1262 5½" Sharp/Blunt

**CURVED**

23-1264 5½" Sharp/Sharp  
23-1266 5½" Sharp/Blunt



**SKLARCUT™  
IRIS SCISSORS**

**SHARP/SHARP**

**STRAIGHT**

15-3585 4½"

**CURVED**

15-3590 4½"

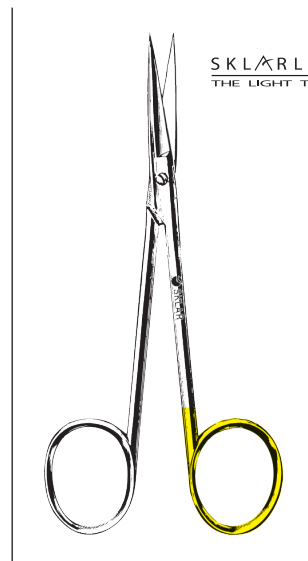

SKLARLITE™  
THE LIGHT TOUCH

**SKLARLITE™  
SKLARCUT™  
IRIS SCISSORS**

**STRAIGHT**

23-1268 4½"

**CURVED**

23-1270 4½"

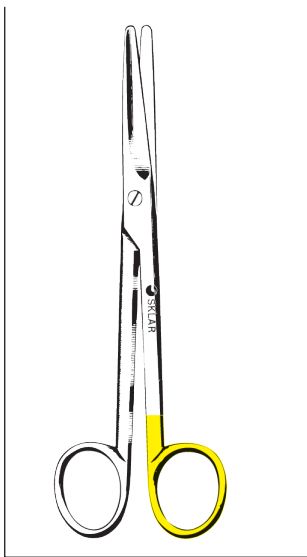

**SKLARCUT™ MAYO  
DISSECTING SCISSORS**

**STRAIGHT**

**CURVED**

15-3550 5½" 15-3560 5½"  
15-3555 6¾" 15-3565 6¾"  
15-3566 9" 15-3568 9"

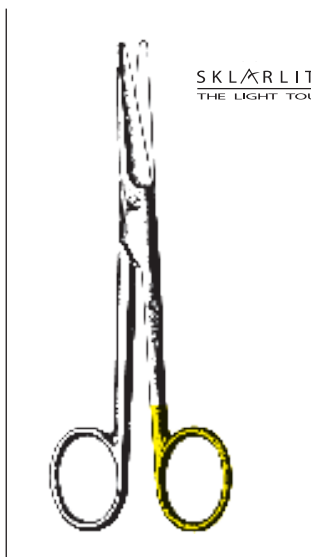

SKLARLITE™  
THE LIGHT TOUCH

**SKLARLITE™  
SKLARCUT™  
MAYO DISSECTING  
SCISSORS**

**STRAIGHT**

**CURVED**

23-1274 6¾" 23-1278 6¾"

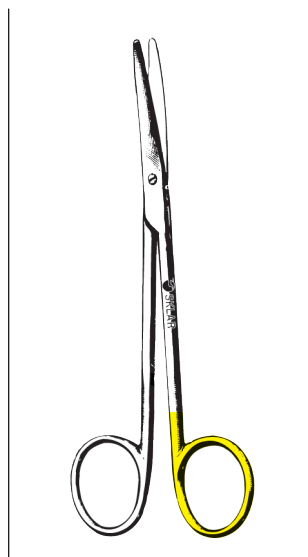

**SKLARCUT™  
METZENBAUM  
SCISSORS**

15-3569 4½" Straight Lahey  
15-3571 4½" Curved Lahey  
15-3567 5¾" Straight Lahey  
15-3570 5¾" Curved Lahey  
15-3575 7" Curved  
15-3574 9" Curved Nelson

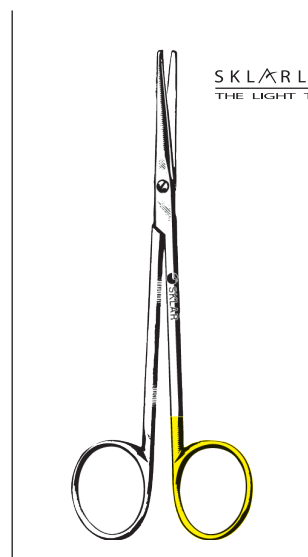

SKLARLITE™  
THE LIGHT TOUCH

**SKLARLITE™  
SKLARCUT™  
METZENBAUM  
(LAHEY) SCISSORS**

**CURVED-BLUNT**

23-1280 5¾" Lahey  
23-1267 7"

**SKLAR EDGE™**

TUNGSTEN CARBIDE

**SKLAR EDGE™  
TUNGSTEN CARBIDE  
SCISSORS  
GIVE YOU THE EDGE IN  
PERFORMANCE**

Tungsten carbide is one of the hardest alloys made. And it is tungsten carbide that gives SKLAR EDGE surgical scissors an exceptionally sharp and durable cutting edge – an edge that rarely needs sharpening.

SKLAR EDGE scissors are specially made to perform better and stay sharper for a significantly longer period of time when compared to non-TC scissors. The unique edging process permanently bonds the tungsten carbide to your scissors giving you smooth and controlled performance, a perfectly balanced “feel” of enhanced precision and an edge guaranteed to stay sharp for five full years.

All SKLAR EDGE scissors come with gold plated finger rings for easy identification.



**SKLAR EDGE™ TC OPERATING SCISSORS**

**STRAIGHT**

16-1055	5½"	S/S
16-1056	5½"	S/B
16-1057	5½"	B/B

**CURVED**

16-1155	5½"	S/S
16-1156	5½"	S/B
16-1157	5½"	B/B

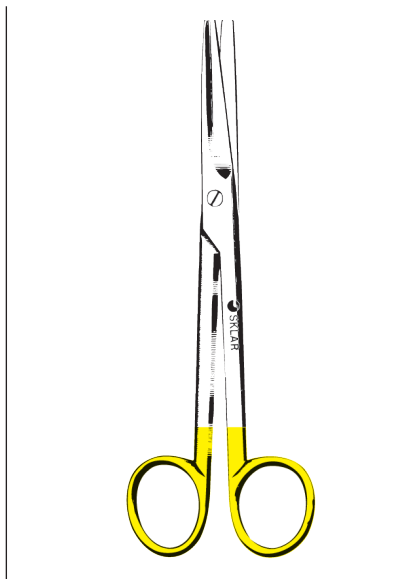

**SKLAR EDGE™ TC MAYO  
DISSECTING SCISSORS**

**BLUNT/BLUNT**

**STRAIGHT**

16-1505	5½"
16-1510	6¾"
16-1515	9"

**CURVED**

16-1605	5½"
16-1610	6¾"
16-1615	9"

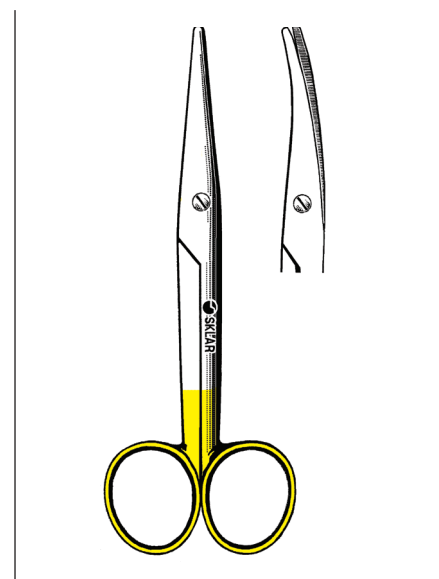

**SKLAR EDGE™ TC MAYO-STILLE  
DISSECTING SCISSORS**

**ROUNDED BLADES**

**STRAIGHT**

16-3552	5½"
16-3557	6¾"

**CURVED**

16-3562	5½"
16-3567	6¾"

SCISSORS

TUNGSTEN CARBIDE



**SKLAR EDGE™ TC  
METZENBAUM (LAHEY)  
SCISSORS**

**STRAIGHT**

- 16-1810 5¾"
- 16-1805 5¾" Delicate
- 16-1815 5¾" S/S

**CURVED**

- 16-1910 5¾"
- 16-1905 5¾" Delicate
- 16-1915 5¾" S/S



**SKLAR EDGE™ TC  
METZENBAUM  
SCISSORS**

**STRAIGHT, BLUNT/BLUNT**

- 16-2010 7"
- 16-2005 7" Delicate
- 16-2210 9"
- 16-2205 9" Delicate

**STRAIGHT, SHARP/SHARP**

- 16-2015 7" Delicate

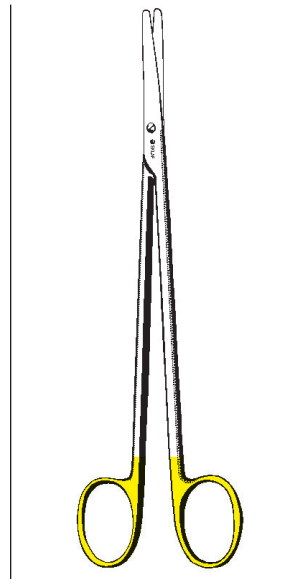

**SKLAR EDGE™ TC  
METZENBAUM  
SCISSORS**

**CURVED, BLUNT/BLUNT**

- 16-2110 7"
- 16-2105 7" Delicate
- 16-2215 8"
- 16-2310 9"
- 16-2305 9" Delicate
- 16-2211 10"
- 16-2311 11"
- 16-2312 12"

**CURVED, SHARP/SHARP**

- 16-2115 7" Delicate

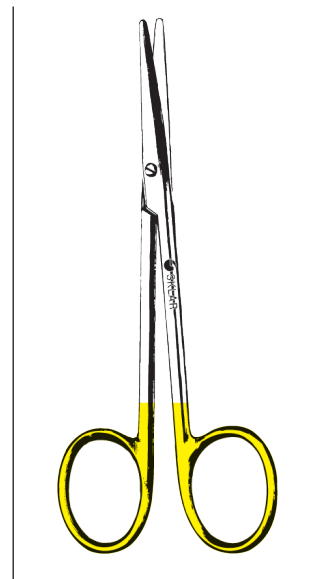

**SKLAR EDGE™ TC  
STRABISMUS  
SCISSORS**

**STRAIGHT, BLUNT/BLUNT**

- 16-2605 4½"
- 16-2705 4½"



**SKLAR EDGE™  
TC DISSECTING SCISSORS**

**CURVED**

- 16-2610 5"



**SKLAR EDGE™  
TC IRIS SCISSORS**

**SHARP/SHARP**

- |                 |     |               |     |
|-----------------|-----|---------------|-----|
| <b>STRAIGHT</b> |     | <b>CURVED</b> |     |
| 16-2405         | 4½" | 16-2505       | 4½" |



**SKLAR EDGE™  
TC WIRE CUTTING SCISSOR**

**SERRATED ANGULAR**

- 16-2800 4¾"

**SKLARHONE™ FOR KNIFE EDGE  
SHARPNESS WITH SCISSORS PRECISION**

With the addition of SKLARHONE premium operating room scissors, Sklar continues its effort to provide the surgeon with the most current technology and the largest selection of superior instruments. SKLARHONE scissors combine the razor sharp cutting edge of a knife, with the control and precision of scissors, in one instrument. One blade on the SKLARHONE scissors is crafted with the cutting geometry of a knife, while the opposing blade has a standard smooth, scissors edge for clean cutting action. When cutting thick tissue, SKLARCUT SKLARHONE scissors combine a serrated lower blade to hold tissue with, a knife-like upper blade, leaving the edges smooth and clean. For easy visual distinction from the normal scissors, these scissors come with dual black handles and shafts.

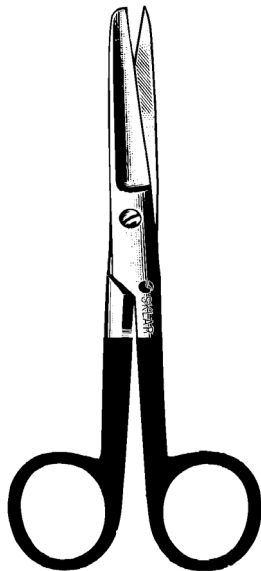

SKLARHONE™  
**SKLARHONE™  
OPERATING SCISSORS**  
STRAIGHT, SMOOTH  
15-3343 5½" Sharp/Blunt  
15-3342 5½" Sharp/Sharp

SUPER-CUT  
SKLARHONE™  
**SUPER-CUT SKLARHONE™  
OPERATING SCISSORS**  
STRAIGHT, SERRATED  
15-3443 5½" Sharp/Blunt  
15-3442 5½" Sharp/Sharp

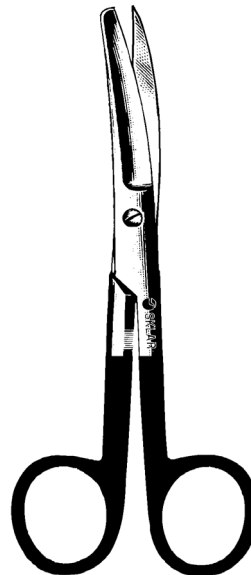

SKLARHONE™  
**SKLARHONE™  
OPERATING SCISSORS**  
CURVED, SMOOTH  
15-3349 5½" Sharp/Blunt  
15-3348 5½" Sharp/Sharp

SUPER-CUT  
SKLARHONE™  
**SUPER-CUT SKLARHONE™  
OPERATING SCISSORS**  
CURVED, SERRATED  
15-3449 5½" Sharp/Blunt  
15-3448 5½" Sharp/Sharp



**SKLARHONE™**  
**SKLARHONE™**  
**IRIS SCISSORS**

<b>SMOOTH</b>			
15-3352	4½"	Straight	
15-3357	4½"	Curved	

**SUPER-CUT**  
**SKLARHONE™**

**SUPER-CUT**  
**SKLARHONE™**  
**IRIS SCISSORS**

<b>SERRATED</b>			
15-3452	4½"	Straight	
15-3457	4½"	Curved	



**SKLARHONE™**  
**SKLARHONE™**  
**MAYO SCISSORS**

<b>SMOOTH</b>			
15-3325	5½"	Straight	
15-3330	5½"	Curved	
15-3326	6¾"	Straight	
15-3331	6¾"	Curved	

**SUPER-CUT**  
**SKLARHONE™**

**SUPER-CUT**  
**SKLARHONE™**  
**MAYO SCISSORS**

<b>SERRATED</b>			
15-3429	5½"	Straight	
15-3430	5½"	Curved	
15-3426	6¾"	Straight	
15-3427	6¾"	Curved	
15-3434	9"	Straight	
15-3435	9"	Curved	

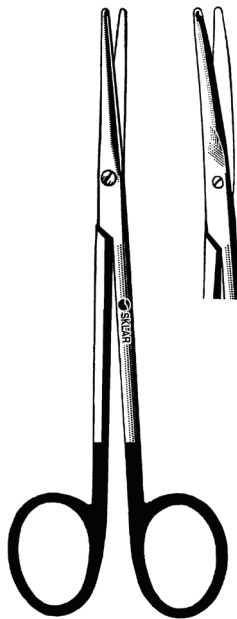

**SKLARHONE™**  
**SKLARHONE™**  
**METZENBAUM SCISSORS**

<b>SMOOTH</b>				
15-3305	5¾"	Straight	(Lahey)	
15-3306	5¾"	Curved	(Lahey)	
15-3507	7"	Straight		
15-3310	7"	Curved		
15-3508	8"	Straight		
15-3311	8"	Curved		
15-3509	9"	Straight	(Nelson)	
15-3315	9"	Curved	(Nelson)	

**SUPER-CUT**  
**SKLARHONE™**

**SUPER-CUT SKLARHONE™**  
**METZENBAUM SCISSORS**

<b>SERRATED</b>				
15-3405	5¾"	Straight	(Lahey)	
15-3406	5¾"	Curved	(Lahey)	
15-3407	7"	Straight		
15-3410	7"	Curved		
15-3408	8"	Straight		
15-3411	8"	Curved		
15-3409	9"	Straight	(Nelson)	
15-3412	9"	Curved	(Nelson)	

# Skarlite™ Forceps

## Provide Lightness And Durability

**SKLARLITE**

**THE LIGHT TOUCH**

To meet industry demands for lighter pattern instruments, Sklar developed the SklarLite line of premium operating room forceps. Through a unique manufacturing technique, we are able to deliver a noticeably lighter instrument that maintains the strength and durability of a standard instrument. These extremely sensitive forceps give the surgeon maximum control and precision while comfortably withstanding the daily rigors of prolonged surgery. Sklarlite Forceps minimize fatigue and provide the exquisite control and reliability you have come to expect from all Sklar instruments. Sklarlite Forceps are covered under the same warranty that guarantees all Sklar instruments for a lifetime of dependable use.

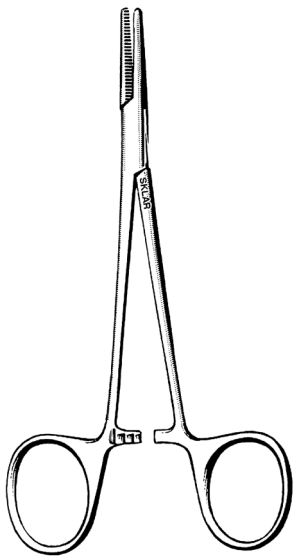

**HALSTED MOSQUITO HEMOSTATIC FORCEPS**

STRAIGHT		CURVED	
17-1450	5"	17-1550	5"
17-1650	5" 1x2	17-1750	5" 1x2
17-1455	5" Non-Magnetic	17-1555	5" Non-Magnetic

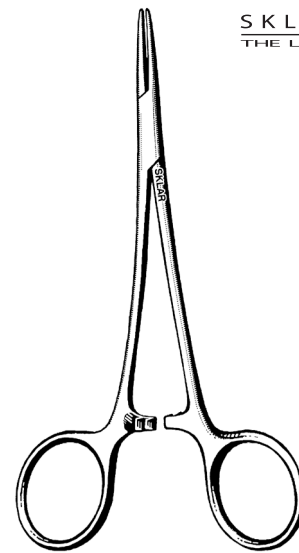

**SKLARLITE**  
**THE LIGHT TOUCH**

**SKLARLITE™ HALSTED MOSQUITO HEMOSTATIC FORCEPS**

STRAIGHT		CURVED	
23-2105	5"	23-2106	5"



# Sklarlite XD™

## Delivers The Ultimate In Precision

### SKLARLITE XD

EXTRA DELICATE Sklar has surpassed industry standards by developing extra delicate operating room forceps that offer the surgeon one of the lightest general surgery instruments on the market today. Through a unique manufacturing technique, we are able to produce the lightest pattern forceps, affording strength and integrity equal to that of the original instrument. These extra delicate forceps are our most sensitive surgical tool, giving the surgeon the ultimate in precision and control.

Sklarlite XD Forceps are ideal for prolonged procedures, comfortably withstanding the daily rigors of frequent use. They carry the same day-in and day-out reliability that you have come to expect from all Sklar instruments and are guaranteed for a lifetime of dependable use. For the surgeon who demands the finest in OR forceps, SklarLite XD is the best choice.

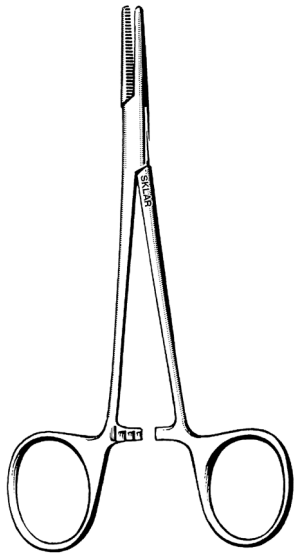

**HALSTED MOSQUITO HEMOSTATIC FORCEPS**

DELICATE

STRAIGHT

18-1050 5"

CURVED

18-1150 5"

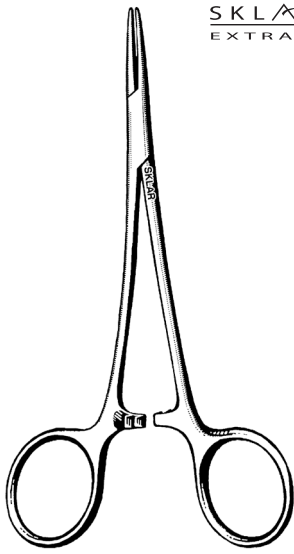

SKLARLITE XD™  
EXTRA DELICATE

**SKLARLITE XD™**

**HALSTED MOSQUITO HEMOSTATIC FORCEPS**

STRAIGHT

23-2505 5"

CURVED

23-2506 5"



**FORCEPS  
GENERAL**



**CRILE HEMOSTATIC FORCEPS**

STRAIGHT		CURVED	
17-3055	5½"	17-3155	5½"
17-3062	6¼"	17-3162	6¼"
17-3075	7½"	17-3168	6¼" Heavy
		17-3175	7½"



SKLARLITE  
THE LIGHT TOUCH

**SKLARLITE™ CRILE HEMOSTATIC FORCEPS**

STRAIGHT		CURVED	
23-2110	5½"	23-2113	5½"
23-2111	7½"	21-2112	7½"

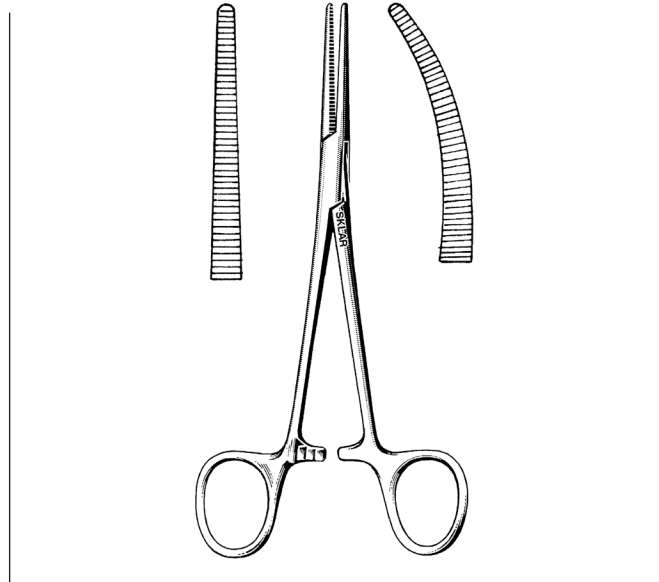

**CRILE HEMOSTATIC FORCEPS**

DELICATE			
STRAIGHT		CURVED	
18-1952	5½"	18-2052	5½"



SKLARLITE XD™  
EXTRA DELICATE

**SKLARLITE XD™ CRILE HEMOSTATIC FORCEPS**

STRAIGHT		CURVED	
23-2510	5½"	23-2513	5½"



**FORCEPS  
GENERAL**

SKLARLITE  
THE LIGHT TOUCH

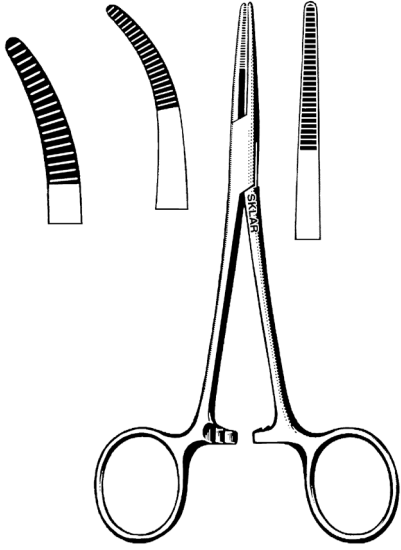

**KELLY HEMOSTATIC FORCEPS**

STRAIGHT		CURVED	
17-2055	5½"	17-2155	5½"
74-3260	7" Extra Heavy	74-3270	7" Extra Heavy

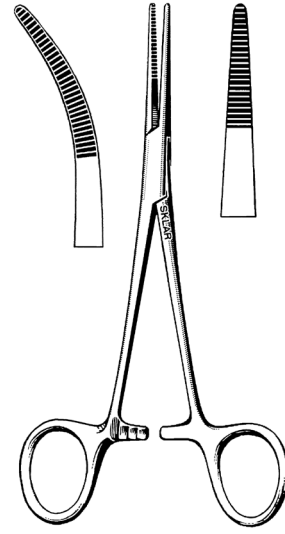

**SKLARLITE™ KELLY HEMOSTATIC FORCEPS**

STRAIGHT		CURVED	
23-2107	5½"	23-2108	5½"

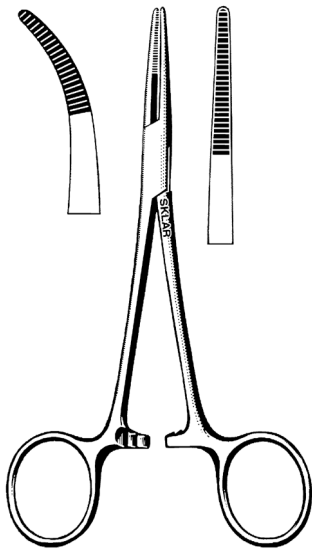

**KELLY HEMOSTATIC FORCEPS**

DELICATE		CURVED	
STRAIGHT			
18-1552	5½"	18-1652	5½"

SKLARLITE XD™  
EXTRA DELICATE

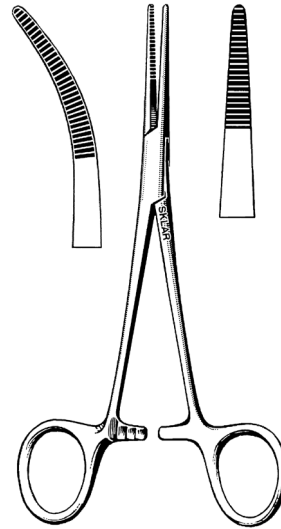

**SKLARLITE XD™ KELLY HEMOSTATIC FORCEPS**

STRAIGHT		CURVED	
23-2507	5½"	23-2508	5½"

**FORCEPS  
GENERAL**



**HARTMANN MOSQUITO HEMOSTATIC FORCEPS**  
**STRAIGHT** 17-1235 3½" Serrated  
**CURVED** 17-1335 3½" Serrated



**SKLARLITE™ HARTMANN MOSQUITO HEMOSTATIC FORCEPS**  
**STRAIGHT** 23-2100 3½"  
**CURVED** 23-2101 3½"



**HARTMANN MOSQUITO HEMOSTATIC FORCEPS**  
**DELICATE**  
**STRAIGHT** 17-1230 3½"  
**CURVED** 17-1232 3½"



**SKLARLITE XD™ HARTMANN MOSQUITO HEMOSTATIC FORCEPS**  
**STRAIGHT** 23-2500 3½"  
**CURVED** 23-2501 3½"



**FORCEPS  
GENERAL**



SKLARLITE  
THE LIGHT TOUCH

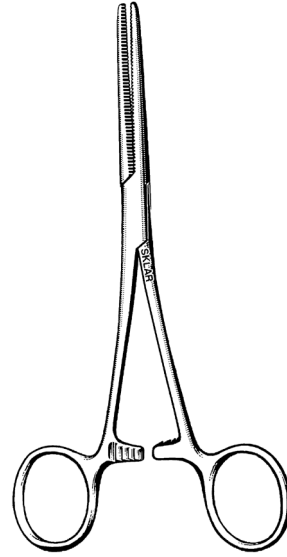

**ROCHESTER-PEAN FORCEPS**

STRAIGHT		CURVED	
17-2455	5½"	17-2255	5½"
17-2462	6¼"	17-2262	6¼"
17-2467	6¾" Heavy	17-2267	6¾" Heavy
17-2472	7¼"	17-2272	7¼"
17-2480	8"	17-2280	8"
36-2690	9"	36-2790	9"
36-2710	10¼"	36-2810	10¼"
36-2712	12"	36-2812	12"

**SKLARLITE™ ROCHESTER-PEAN FORCEPS**

STRAIGHT		CURVED	
23-2532	6¼"	23-2538	6¼"
23-2534	7¼"	23-2542	7¼"

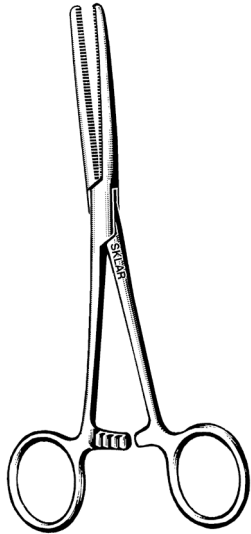

SKLARLITE XD™  
EXTRA DELICATE

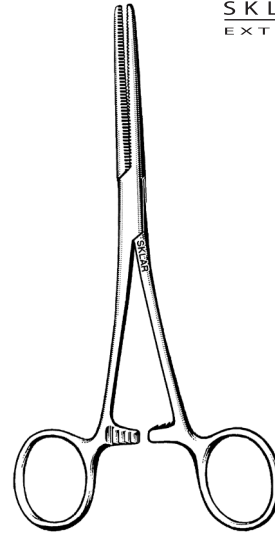

**ROCHESTER-PEAN FORCEPS**

DELICATE		CURVED	
<b>STRAIGHT</b>			
22-3555	5½"	22-3655	5½"
		17-2362	6¼"
		22-2272	7¼"
		22-2280	8"

**SKLARLITE XD™ ROCHESTER-PEAN FORCEPS**

STRAIGHT		CURVED	
23-2552	6¼"	23-2561	6¼"
23-2554	7¼"	23-2563	7¼"

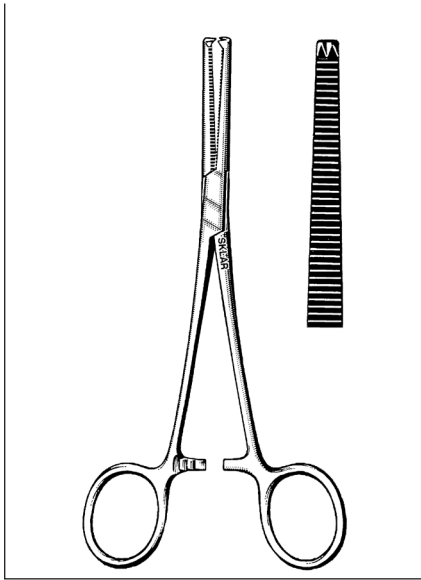

**ROCHESTER-OGHSNER  
FORCEPS**

STRAIGHT	1X2 TEETH	CURVED	1X2 TEETH
17-2855	5½" (Kocher)	17-2655	5½" (Kocher)
17-2862	6¼"	17-2662	6¼"
17-2872	7¼"	17-2672	7¼"
17-2880	8"	17-2680	8"
17-2885	9"	17-2685	9"
17-2890	10"	17-2690	10"

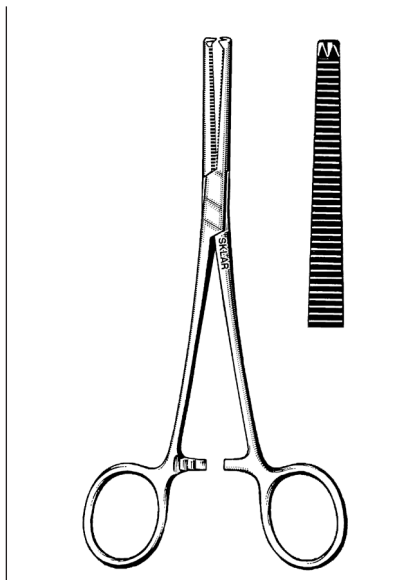

**ROCHESTER-OGHSNER  
FORCEPS**

STRAIGHT	1X2 TEETH	CURVED	1X2 TEETH
18-1752	5¼"	18-1852	5¼"
22-3755	5½"	22-3855	5½"
17-2962	6¼"	17-2762	6¼"

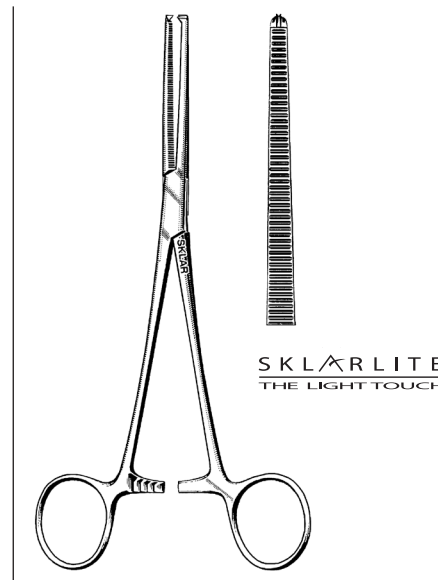

SKLARLITE  
THE LIGHT TOUCH

**SKLARLITE™  
ROCHESTER-OGHSNER  
FORCEPS**

STRAIGHT	1X2 TEETH
23-2560	6¼"
CURVED	1X2 TEETH
23-2568	6¼"

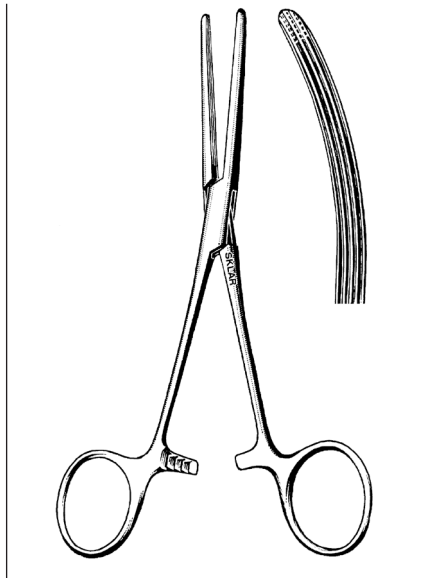

**ROCHESTER-CARMALT  
FORCEPS**

STRAIGHT	CURVED
17-1062	6¼"
17-1080	8"
17-1162	6¼"
17-1180	8"

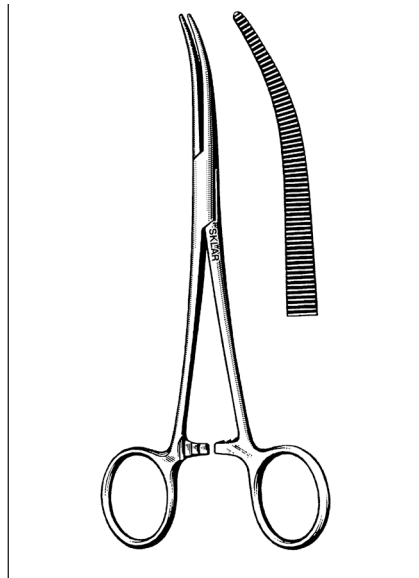

**COLLER HEMOSTATIC FORCEPS**

STRAIGHT	CURVED
17-3455	5½"
17-3265	6¼"
17-3275	7½"
17-3555	5½"
17-3365	6¼"
17-3375	7½"

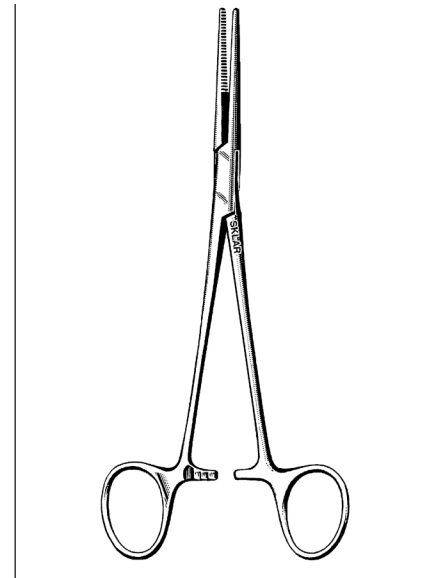

**RANKIN HEMOSTATIC FORCEPS**

17-1262	6¼"	Straight
17-1362	6¼"	Curved

**FORCEPS  
GENERAL**

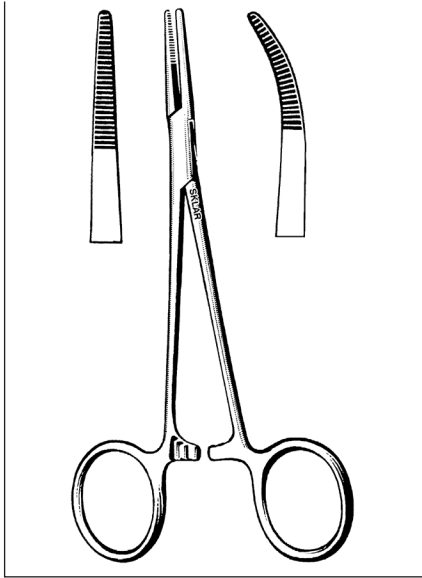

**PROVIDENCE HOSPITAL  
FORCEPS**

STRAIGHT		CURVED	
17-1855	5½"	17-1955	5½"
18-1352	5½"	18-1452	5½"
	Delicate		Delicate

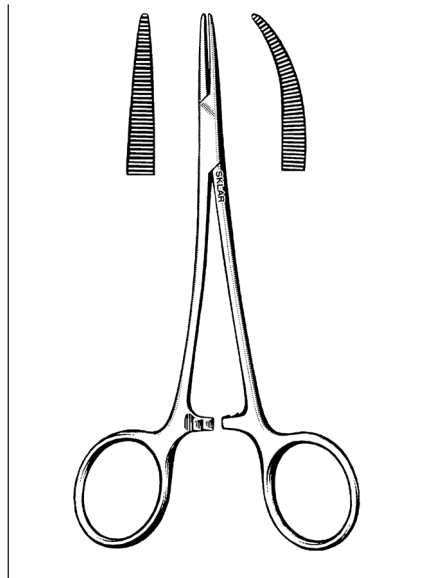

**THOMSON MOSQUITO FORCEPS  
PEDIATRIC**

22-3047	5"	Straight
22-3147	5"	Curved

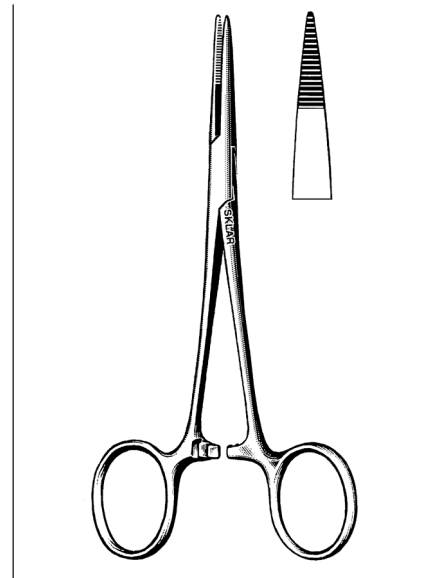

**JOHNS HOPKINS MOSQUITO  
FORCEPS**

17-1155	5½"	Straight
---------	-----	----------

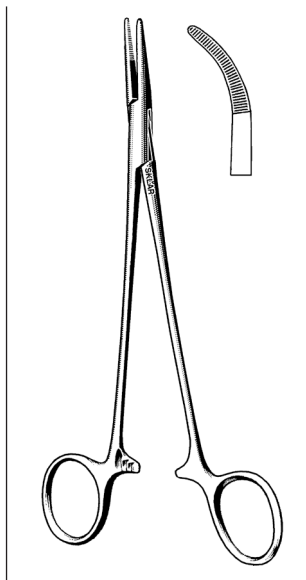

**ADSON FORCEPS**

SERRATED			
50-1574	7"	Straight	1x2
50-1372	7¼"	Straight	
50-1472	7¼"	Curved	

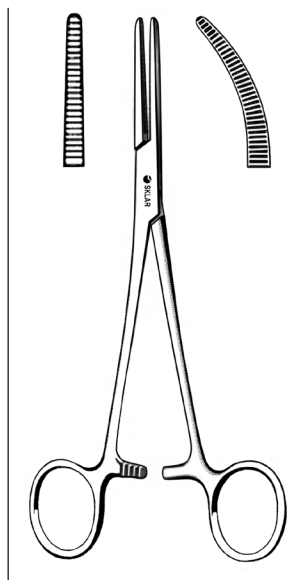

**SPENCER WELLS  
FORCEPS**

STRAIGHT		CURVED	
17-2550	5"	17-2650	5"
17-2570	7"	17-2660	6"
17-2580	8"	17-2670	7"
		17-2678	8"

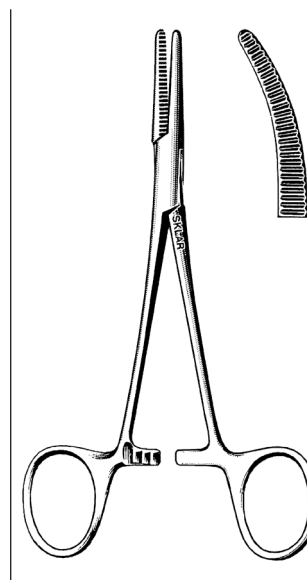

**LAHEY FORCEPS**

17-3255	5½"	Straight
17-3355	5½"	Curved

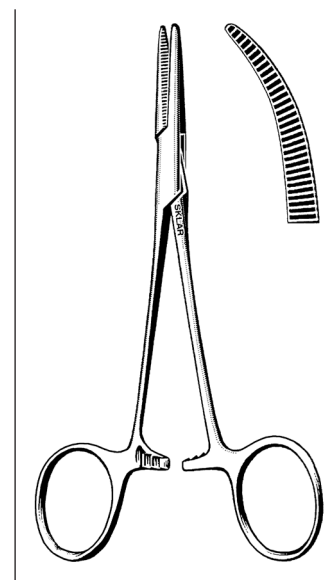

**JONES FORCEPS**

17-1255	5½"	Straight
17-1355	5½"	Curved

**FORCEPS  
GENERAL**



SKLARLITE  
THE LIGHT TOUCH

**MIXTER FORCEPS**

**RIGHT ANGLE**

18-1250	5½"		55-2892	9¼"	Heavy
17-1762	6¼"		55-2894	10½"	Longitudinal Serrations Heavy
17-1772	7¼"		55-3012	12"	Longitudinal Serrations Heavy
55-2893	9"	Longitudinal Serrations			

**SKLARLITE™ MIXTER FORCEPS**

**RIGHT ANGLE**

23-2516	5½"
23-2520	7¼"



SKLARLITE XD™  
EXTRA DELICATE

**MIXTER FORCEPS DELICATE**

**RIGHT ANGLE**

22-3255	5½"
22-3270	7"

**SKLARLITE XD™ MIXTER FORCEPS**

**RIGHT ANGLE**

23-2521	5½"
23-2525	7¼"

**FORCEPS  
GENERAL**

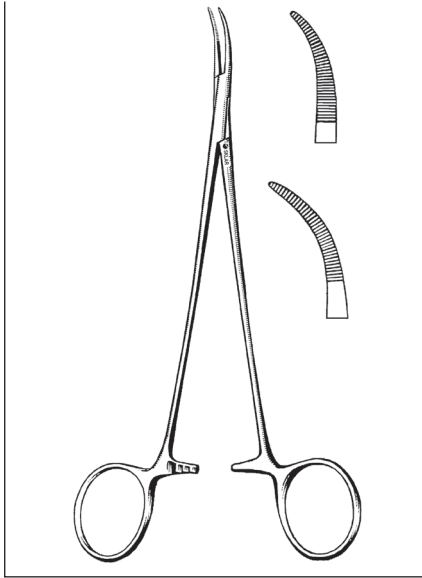

**JACOBSON MOSQUITO  
FORCEPS**  
**EXTRA DELICATE**  
98-2070 7" Slight Curve  
98-2071 7" Full Curve

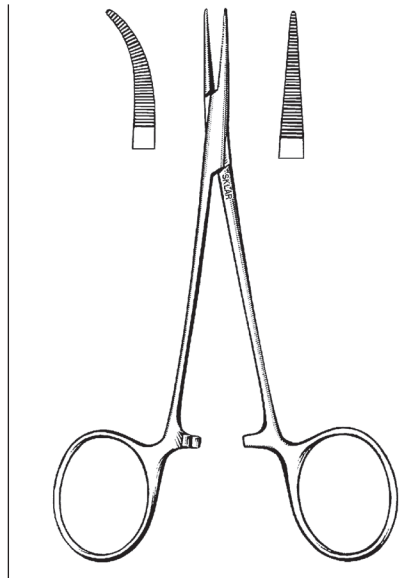

**JACOBSON MOSQUITO  
FORCEPS**  
**DELICATE**  
98-2050 5" Straight  
98-2051 5" Curved

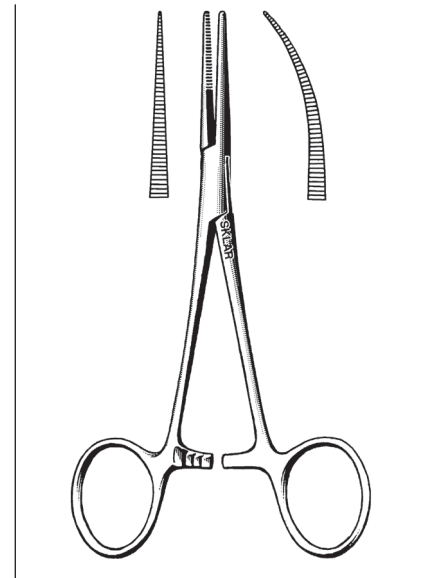

**MICRO MOSQUITO FORCEPS**  
17-1220 5" Straight  
17-1225 5" Curved

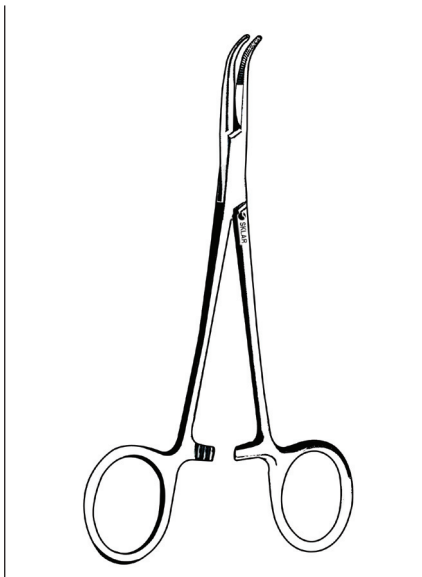

**BABY MIXTER FORCEPS**  
**PARTIALLY SERRATED**  
22-3452 5½" Curved  
22-3455 7" Curved

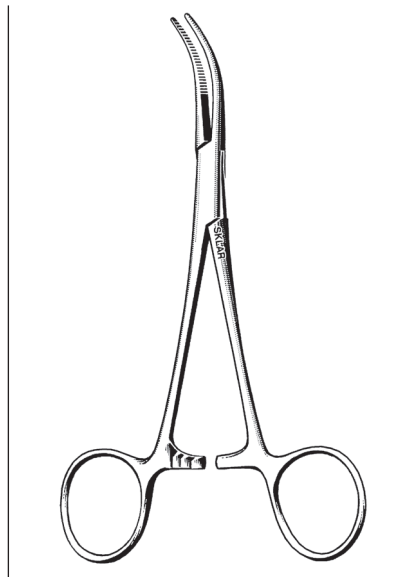

**DANDY SCALP HEMOSTATIC  
FORCEPS**  
**CURVED TO SIDE**  
50-1355 5½" Serrated  
50-1357 5½" Serrated 1x2 Teeth

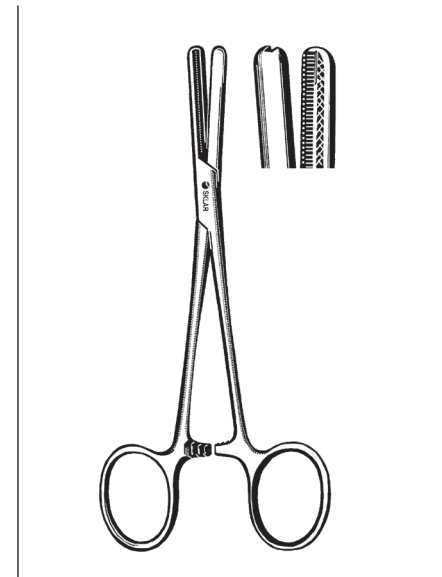

**FERGUSON ANGIOTRIBE  
FORCEPS**  
17-1260 6" Straight  
17-1360 6" Curved  
17-1250 7½" Straight  
17-1350 7½" Curved



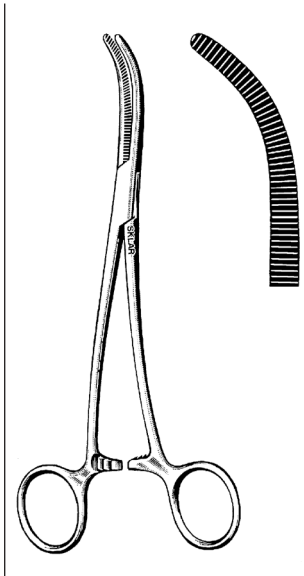

**SHALLCROSS  
FORCEPS**

32-2070 7" Double Curve

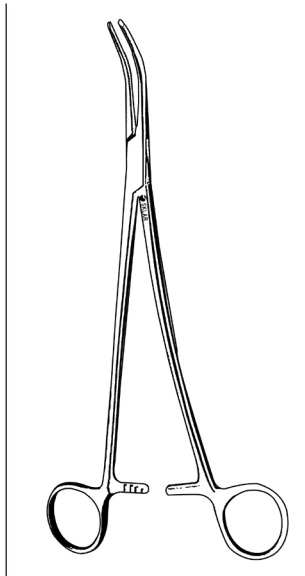

**GRAY CYSTIC DUCT  
FORCEPS**

SET OF 2  
32-2090 9" Serrated

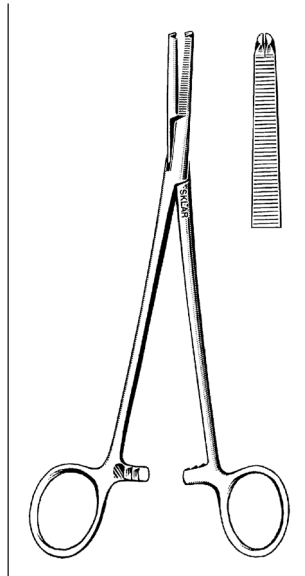

**O'HANLON  
INTESTINAL CLAMP**

36-4082 8¼"

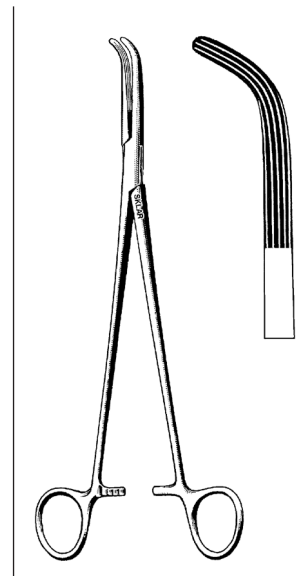

**LAHEY GALL DUCT  
FORCEPS**

32-1875 7½"  
32-1890 9"  
32-1990 9" Heavy

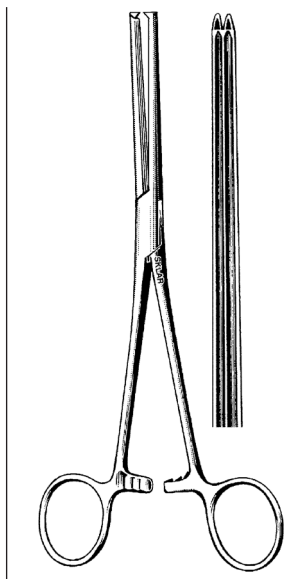

**ALLEN INTESTINAL  
CLAMPS**

LONGITUDINAL SERRATIONS  
STRAIGHT

22-6160 6" 1x2  
36-3180 8" 1x2  
36-3195 9½" 1x2

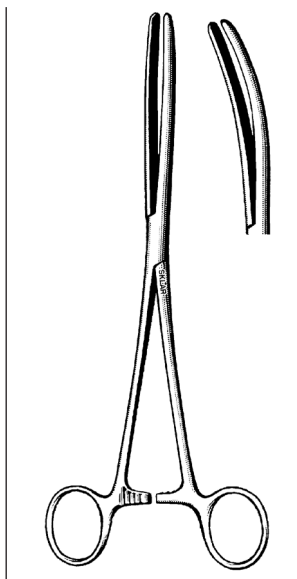

**PEAN  
GASTRO-INTESTINAL  
CLAMPS**

LONGITUDINAL SERRATIONS  
STRAIGHT CURVED

36-2890 9" 36-2990 9"  
36-2895 9½" 36-2995 9½"

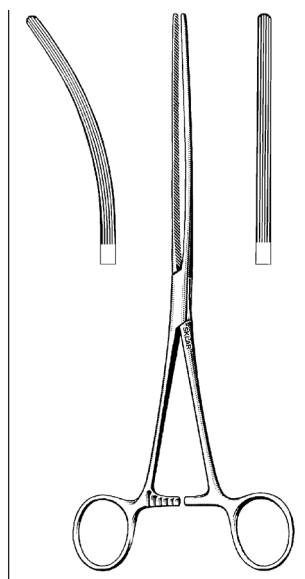

**DOYEN INTESTINAL  
FORCEPS**

36-3590 9" Straight  
36-3690 9" Curved

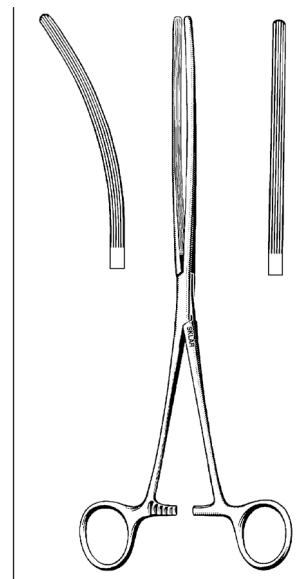

**MAYO-ROBSON  
INTESTINAL  
FORCEPS**

36-3210 10" Straight  
36-3310 10" Curved

**FORCEPS  
GENERAL**

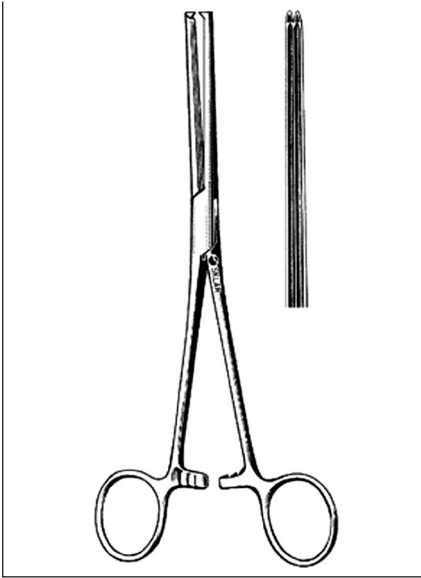

**LOCKWOOD ALLIS INTESTINAL  
FORCEPS**  
36-1362 6¼"

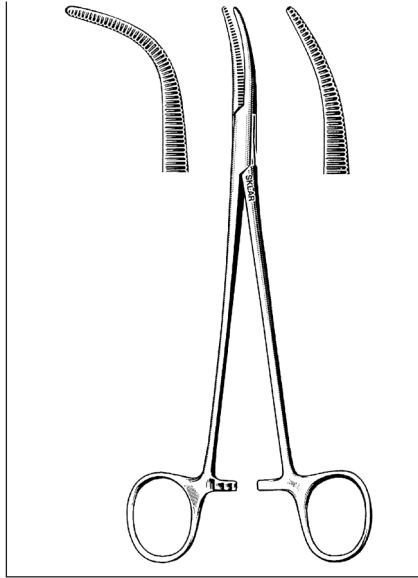

**VARCO FORCEPS**  
32-2075 7" Shallow Curve  
32-2175 7½" Full Curve

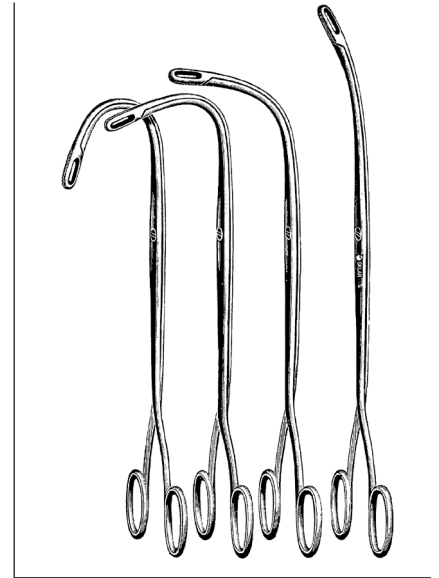

**RANDALL STONE FORCEPS**  
33-1001 9¼" ¼ Curve  
33-1002 8½" ½ Curve  
33-1003 7¾" ¾ Curve  
33-1004 7¾" Full Curve



**BLAKE GALLSTONE FORCEPS**  
32-2782 8" Curved  
32-2785 8" Straight



**MAYO-BLAKE GALLSTONE FORCEPS**  
32-2880 8" Straight  
32-2980 8" Curved

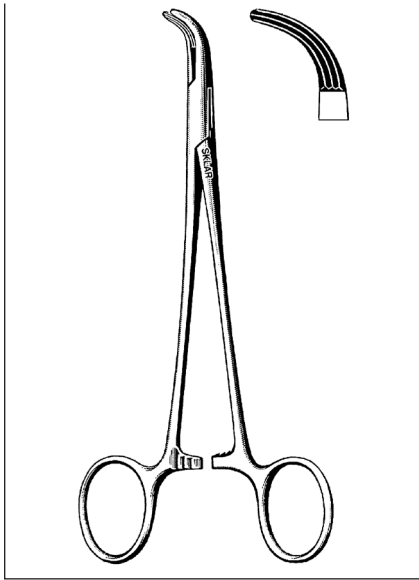

**LOWER GALL DUCT FORCEPS**

32-1870 7"

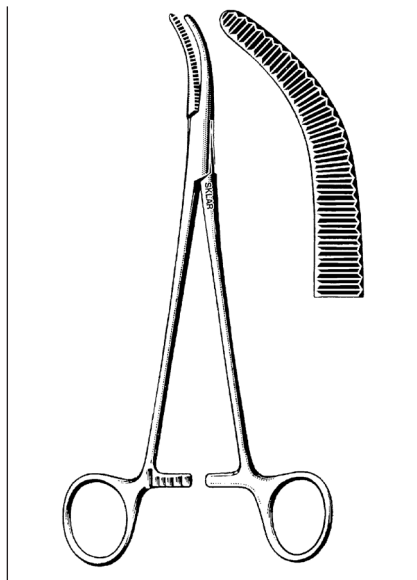

**MOYNIHAN FORCEPS**

32-1785 8½"

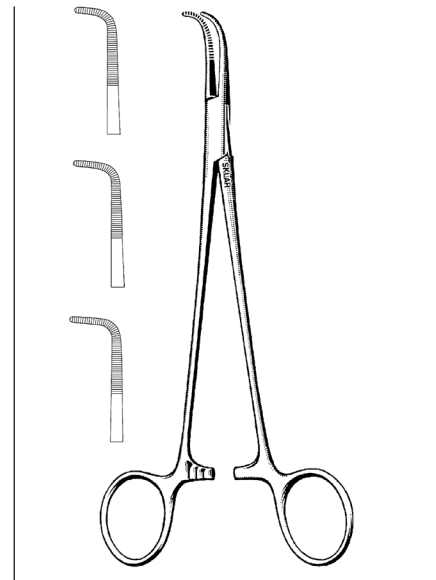

**KANTROWITZ CLAMPS**

55-2775 7½"  
55-2795 9½"  
55-2810 10½"



**GEMINI FORCEPS**

**DELICATE RIGHT ANGLE**

55-2855 5"  
55-2870 6¼"  
55-2880 8"  
55-2890 9"  
55-2898 11"



**PEMBERTON ANASTOMOSIS CLAMP**

**ANGIOTRIBE JAW**

36-4490 9"

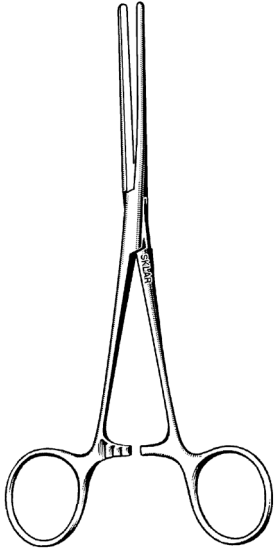

**SCUDDER INTESTINAL FORCEPS**

22-6260 6" Straight Smooth  
36-3510 9½" Straight Smooth

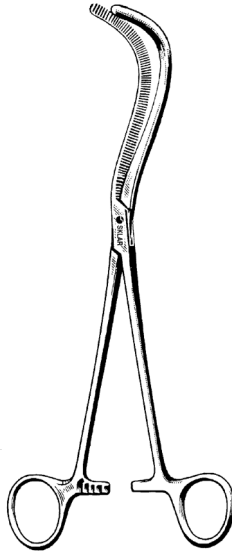

**MAYO-GUYON KIDNEY CLAMP**

33-1090 9"

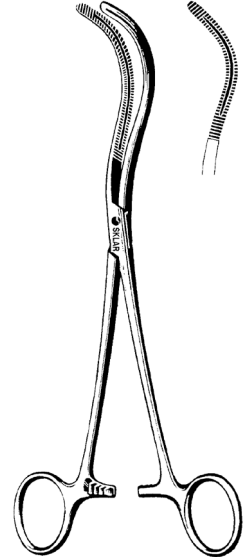

**STILLE KIDNEY CLAMP**

33-1190 9¼"

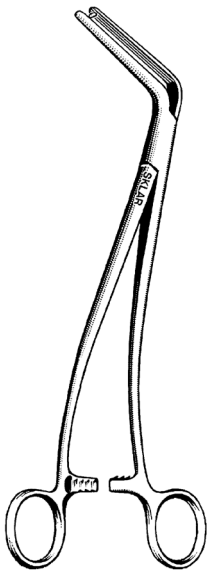

**FOSS INTESTINAL FORCEPS**

**ANGULAR**

36-4411 11½"

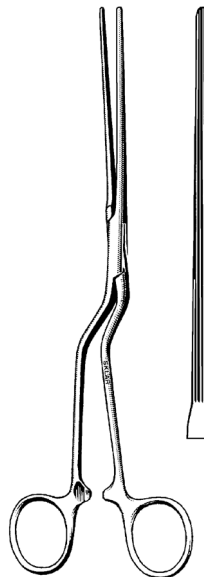

**GAVIN MILLER BAYONET  
FORCEPS**

36-4180 8"

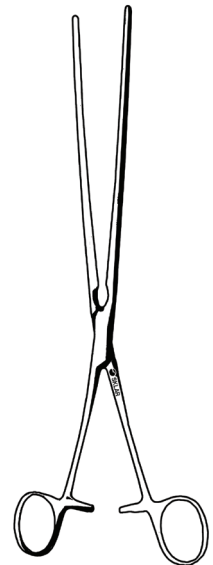

**KOCHER INTESTINAL  
FORCEPS**

**LONGITUDINAL SERRATIONS, ATRAUMATIC**

90-2574 10½" Straight

90-2576 10½" Curved



**PAYR PYLORUS CLAMPS**

22-6457	5¾"	Light
36-4280	8"	
36-4320	9"	No Pin
36-4311	11"	
36-4313	13"	



**SKLAR INTESTINAL FORCEPS**

<b>2½" JAW</b>		
36-7010	10"	Heavy



**WERTHEIM-CULLEN PEDICLE CLAMPS**

<b>2" JAW</b>		
33-1375	8½"	Right Angle
33-1376	9¾"	Curved



**BENSON PYLORUS SEPARATOR**

22-6557	5¾"	
---------	-----	--

**FORCEPS  
GENERAL**

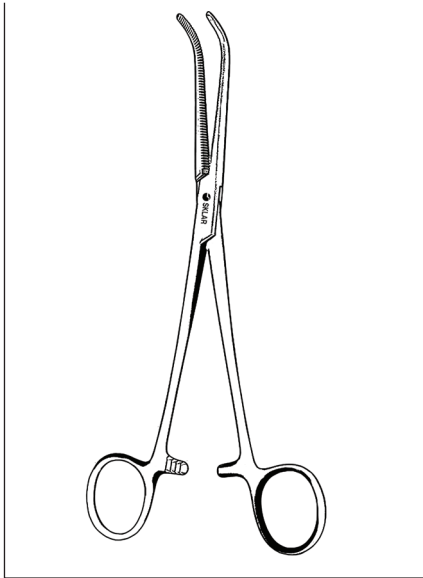

**JOHN HOPKINS GALL BLADDER  
FORCEPS**  
32-1850 8"

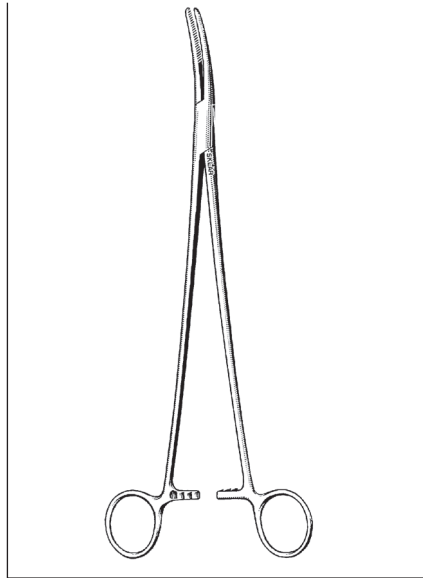

**SKLAR THORACIC CLAMPS**  
55-3080 7" Curved  
55-3110 10" Curved

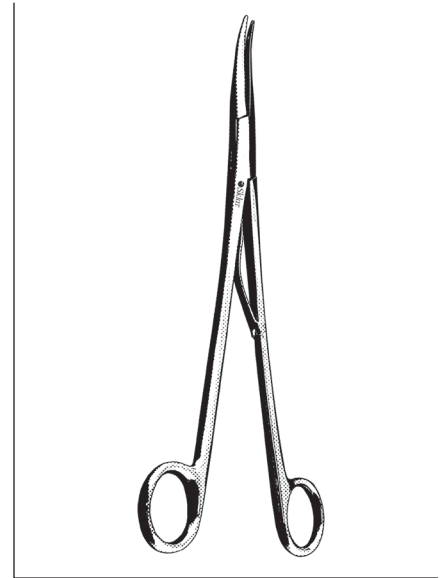

**SKLAR CLIP APPLYING  
FORCEPS**  
50-4292 9¼" Curved

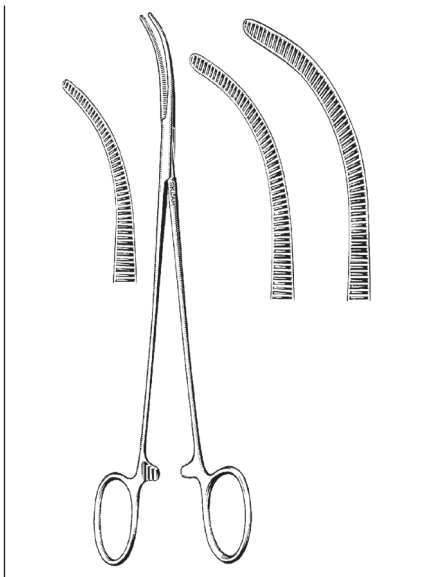

**OVERHOLT FORCEPS**  
55-2187 8¼" Small Jaw  
55-2190 8¼" Medium Jaw  
55-2195 8¼" Long Jaw

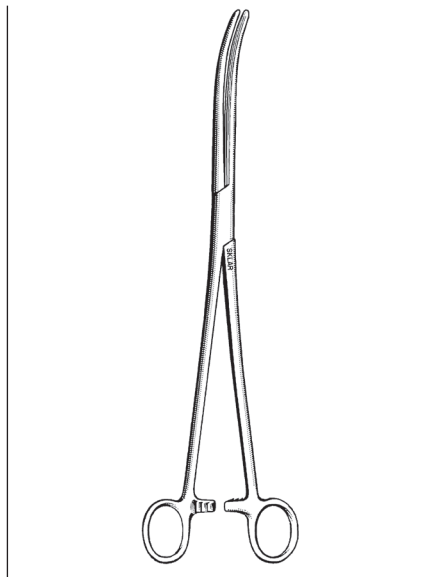

**HARRINGTON FORCEPS**  
55-2112 12" Curved Longitudinal  
Serrations

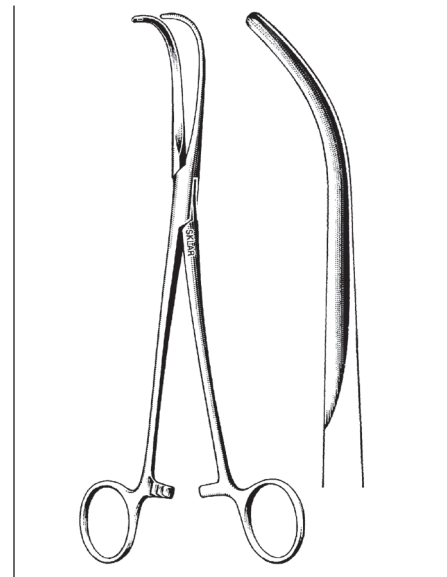

**SEMB DISSECTING FORCEPS**  
55-2395 9½" Shallow Curve

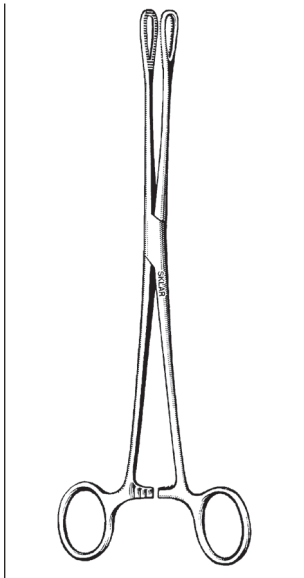

**SCHWEIZER FORCEPS**  
90-7995 9½" Straight

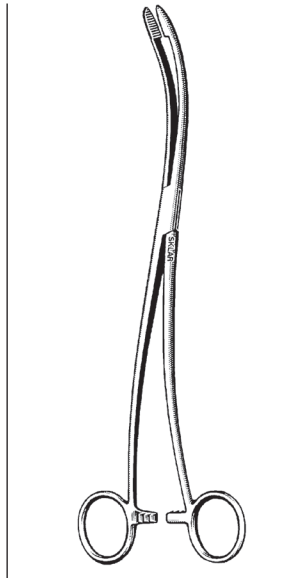

**DELEE UTERINE FORCEPS**  
90-8111 11" S-Curve



**MAIER-GROSS UTERINE DRESSING FORCEPS**

WITH RATCHET			WITHOUT RATCHET		
90-8070	7"	Straight	90-8120	7"	Straight
90-8072	7"	Curved	90-8122	7"	Curved
90-8080	8"	Straight	90-8130	8"	Straight
90-8082	8"	Curved	90-8132	8"	Curved
90-8110	10"	Straight	90-8140	10"	Straight
90-8112	10"	Curved	90-8142	10"	Curved

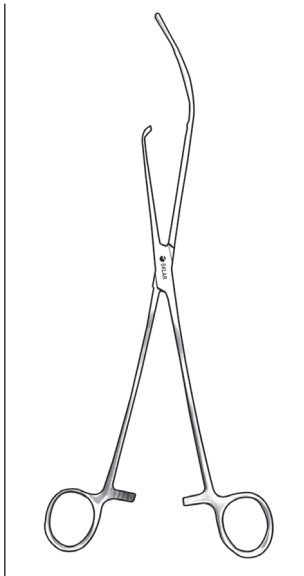

**HULKA TENACULUM FORCEPS**  
91-1280 11½"



**CLEMETSON FORCEPS**  
90-7895 9½" Straight

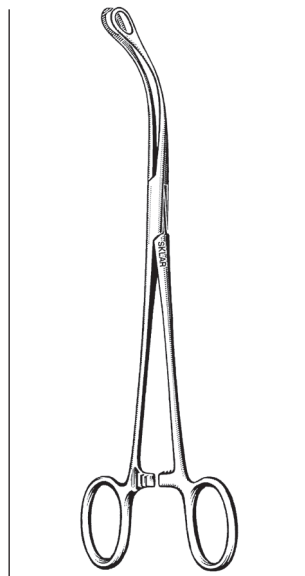

**LAUFE UTERINE POLYP FORCEPS**  
90-7977 7¾" Curved

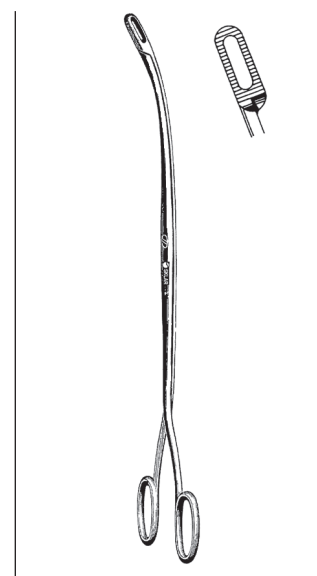

**CAMPION FORCEPS**  
90-7898 9¼" Curved

**FORCEPS  
GENERAL**

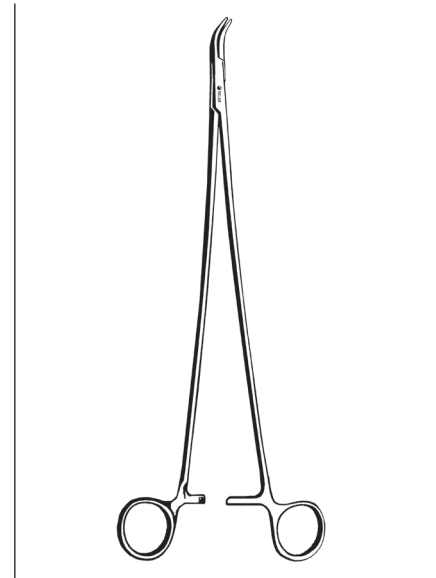
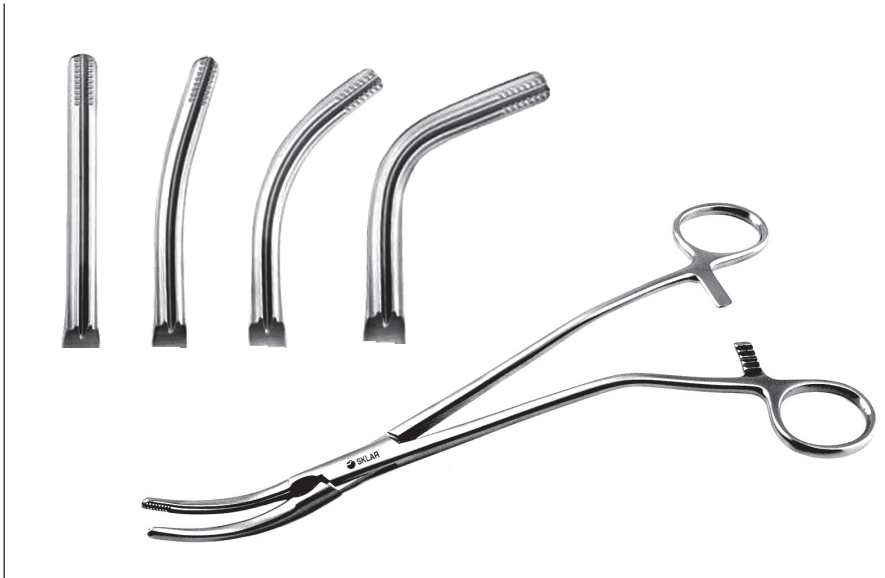

**Z-TYPE HYSTERECTOMY FORCEPS**

LONGITUDINAL GROOVES WITH TIP SERRATIONS AND OFFSET HANDLE

90-2785	8¼"	Straight	90-2796	12"	Straight
90-2786	8¼"	Slight Curve	90-2797	12"	Slight Curve
90-2787	8¼"	Full Curve	90-2798	12"	Full Curve
90-2788	8¼"	Angled	90-2799	12"	Angled
90-2790	9½"	Straight	90-2801	14"	Straight
90-2792	9½"	Slight Curve	90-2802	14"	Slight Curve
90-2793	9½"	Full Curve	90-2803	14"	Full Curve
90-2794	9½"	Angled	90-2804	14"	Angled

**CLARK CLAMP**

90-2354 8¼"

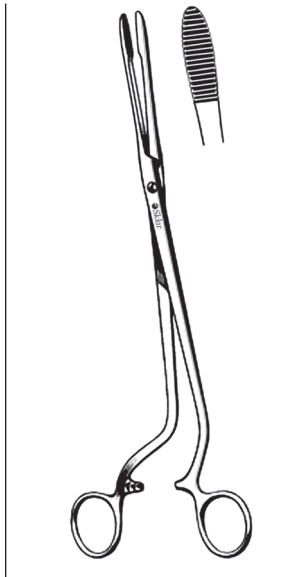

**CHERON UTERINE  
DRESSING FORCEPS**

SERRATED JAWS

90-7910 10½"

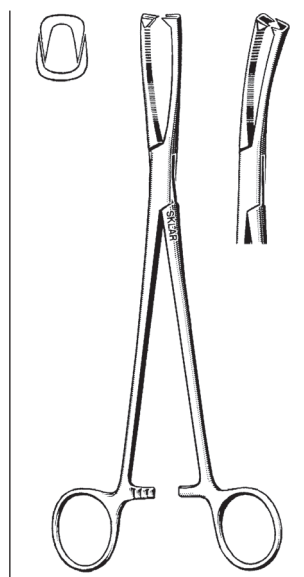

**JACOBS VULSELLUM  
FORCEPS**

SERRATED JAWS

91-2282 8¼" Straight

91-2382 8¼" Angular

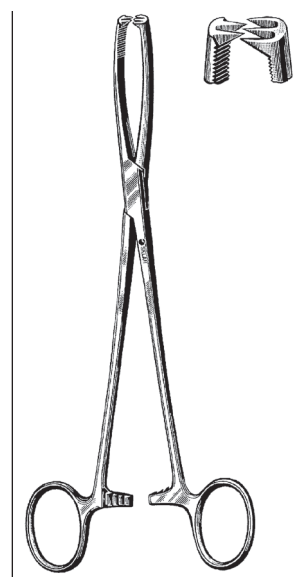

**HENROTIN VULSELLUM  
FORCEPS**

91-2585 8½" 2x3 Teeth

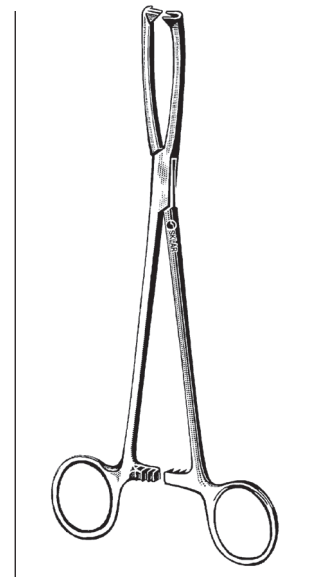

**DOYEN VULSELLUM  
FORCEPS**

91-2482 8½" 2x2 teeth



**FORCEPS  
GENERAL**

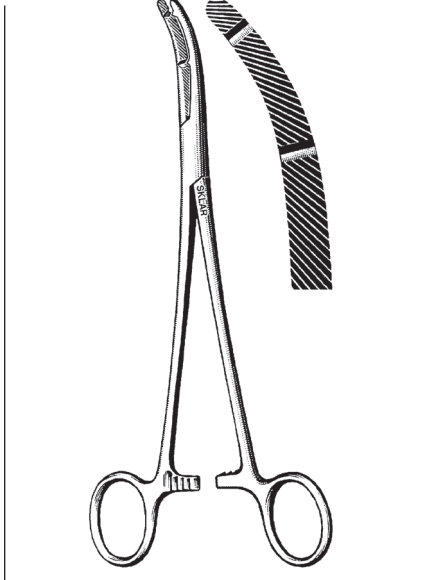

**GUTGLASS CERVIX FORCEPS**

90-8090 9½"

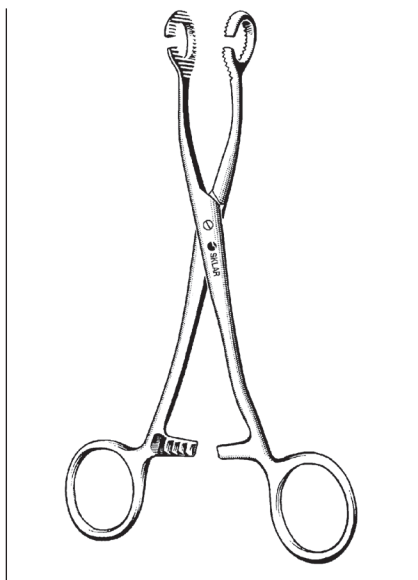

**HILDEBRANDT FORCEPS**

90-8065 6½"

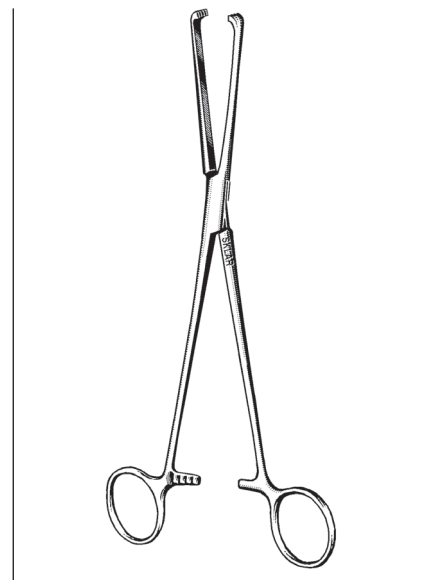

**ALLIS FORCEPS**

**ATRAUMATIC JAWS**

36-2298 6" Straight

36-2280 8" Straight

36-2385 10" Straight

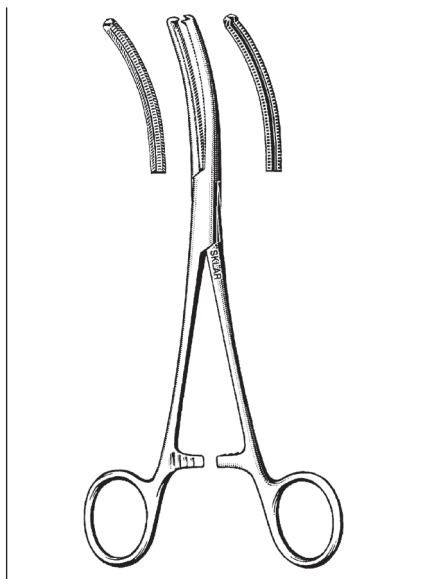

**GELPI-LOWRIE FORCEPS**

90-1885 8½"

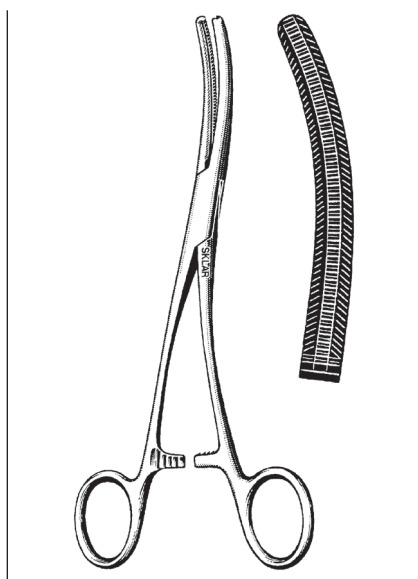

**DE ALVAREZ FORCEPS**

90-2782 7¾" Double Curve

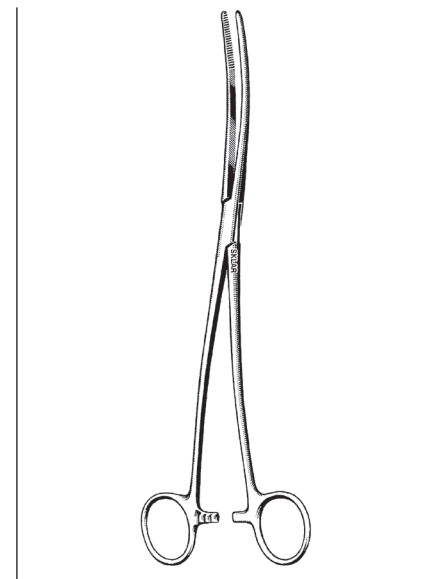

**BOZEMAN FORCEPS**

90-7610 10½" Straight

80-1410 10¼" Double Curve

**FORCEPS  
GENERAL**

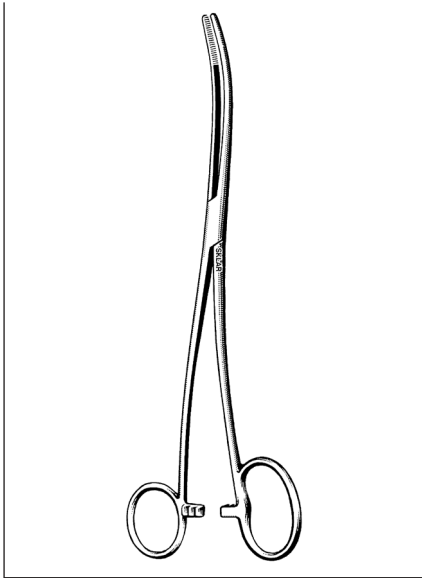

**BOZEMAN FORCEPS**  
ONE LARGE RING  
90-7710 10¼" Double Curved

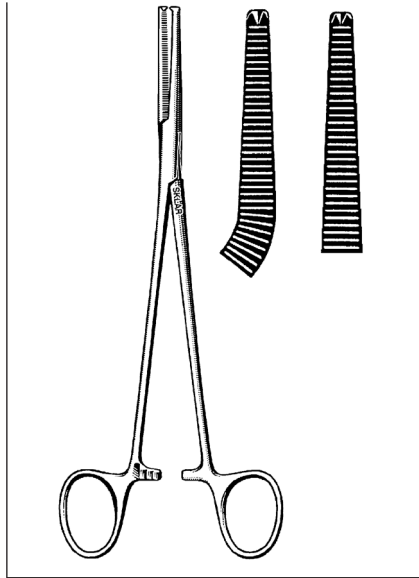

**PHANEUF FORCEPS**  
90-2680 8¼" Angular  
90-2682 8¼" Straight

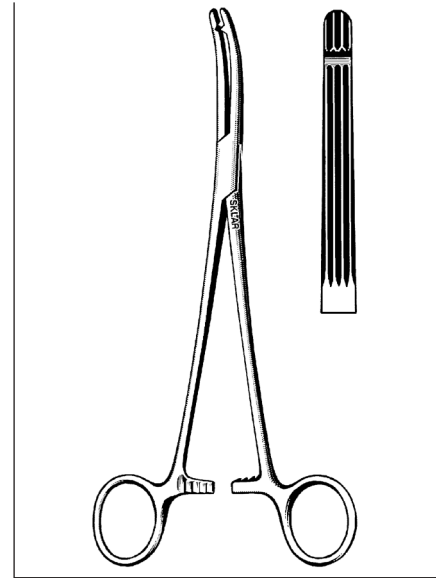

**HEANEY-BALLENTINE  
FORCEPS**  
90-2480 8" Straight  
90-2580 8" Curved

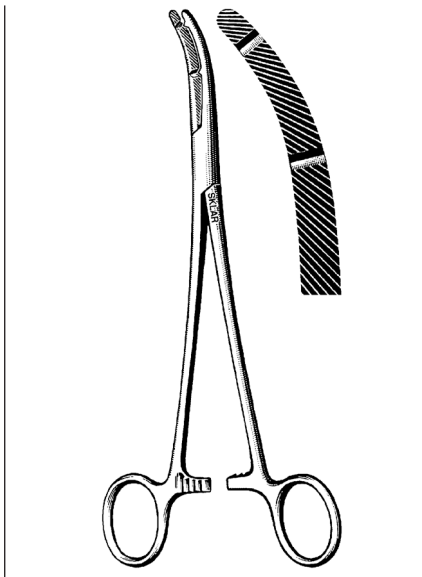

**HEANEY FORCEPS**  
HEAVY DOUBLE TOOTH  
90-2280 8"  
90-2387 8¾"

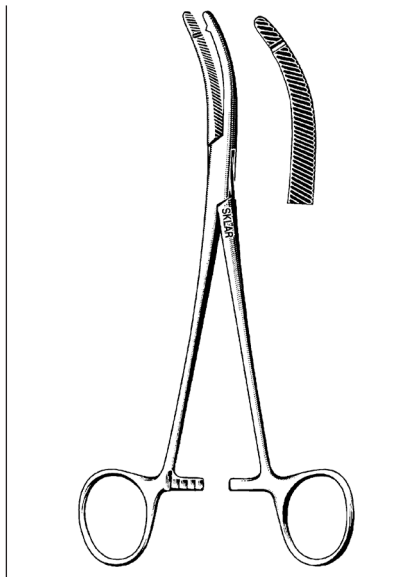

**HEANEY FORCEPS**  
SINGLE TOOTH  
90-1977 7¾" Light Model

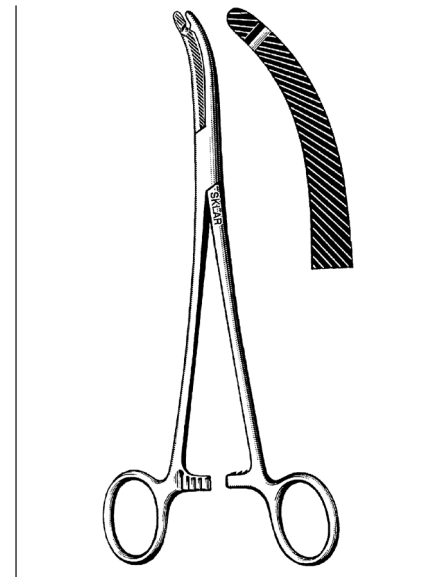

**HEANEY FORCEPS**  
SINGLE TOOTH  
90-2177 8¼" Heavy

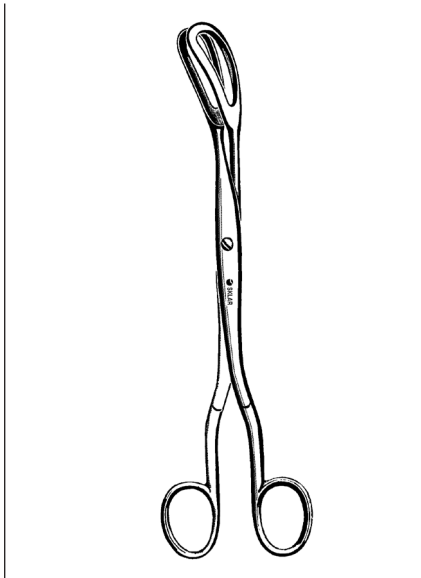

**COREY OVUM FORCEPS**

92-5295 9½"

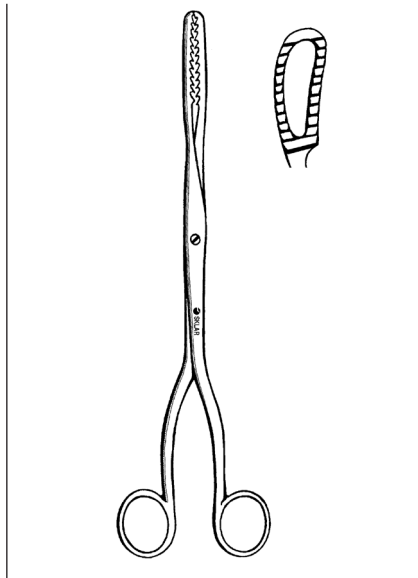

**BIERER OVUM FORCEPS**

91-3822 11" 16mm Serrated Jaw

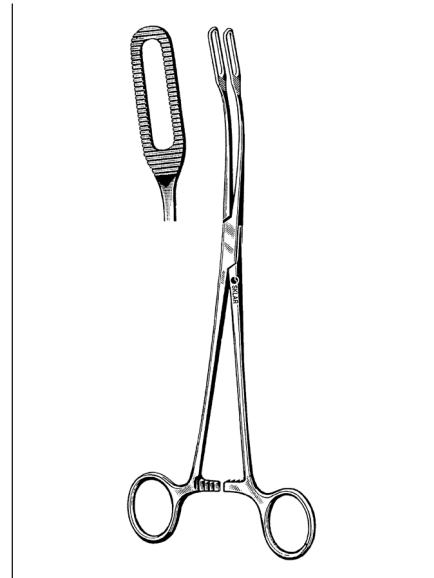

**JAVERTS PLACENTA FORCEPS**

92-5095 9½" Serrated  
92-5195 9½" Smooth  
(Long Island College)

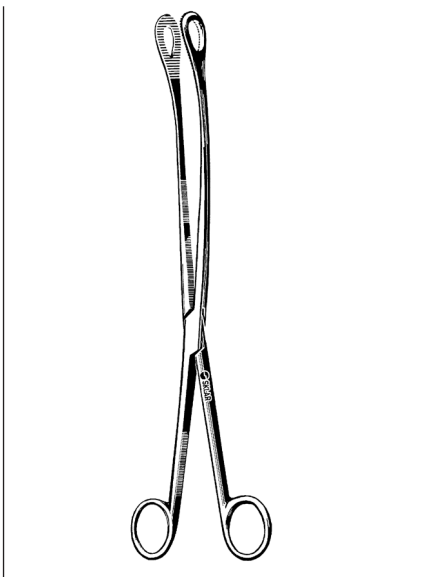

**KELLY PLACENTA FORCEPS**

**CURVED**  
92-5012 12"

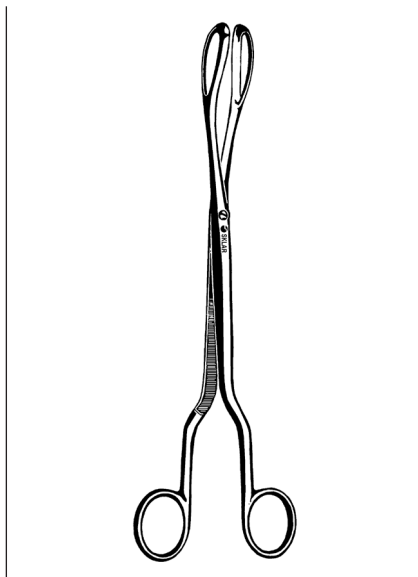

**BARRETT PLACENTA FORCEPS**

92-5310 10"

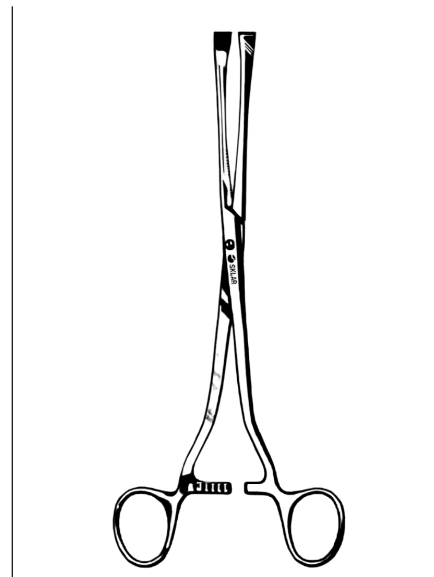

**GREEN ARMYTAGE FORCEPS**

90-5420 8¼" Straight  
90-5419 8¼" Curved

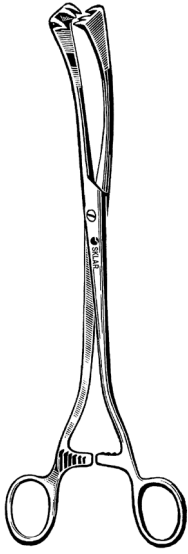

**SECOND (COLLIN) FORCEPS**

**4X4 TEETH**

91-3795 9½" Curved on flat

**3X3 TEETH**

91-3095 9½" Straight

91-3195 9½" Curved sideways



**IOWA MEMBRANE FORCEPS**

91-4310 10"

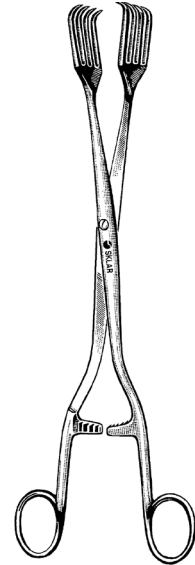

**BILLROTH FORCEPS**

91-3810 10¾" 4x4 Teeth

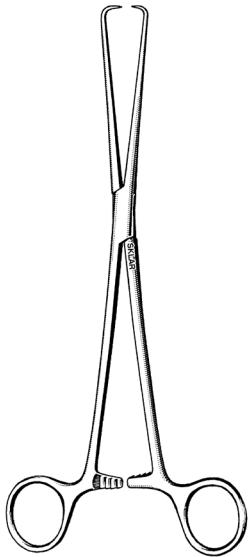

**SCHROEDER TENACULUM FORCEPS**

91-1290 10" Flat Tips (Braun)

91-1298 10" Rounded Tips (Pozzi)

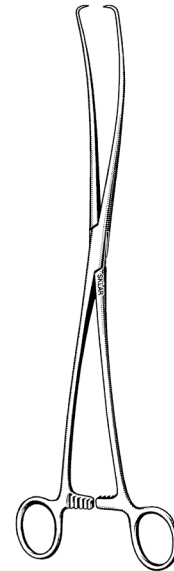

**DUPLAY TENACULUM FORCEPS**

91-1111 11" S-Curve

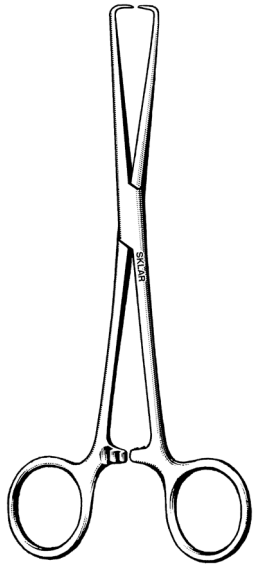

**BARRETT TENACULUM  
FORCEPS**

18-2257 6½" Delicate  
91-1070 7"

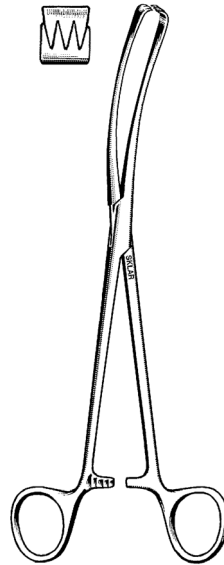

**TEALE VULSELLUM FORCEPS  
CURVED SIDEWAYS**

91-2695 9" 3x4 Teeth



**SKENE TENACULUM FORCEPS**

91-2595 9½"  
91-1390 9½" Side Curved



**SCHROEDER VULSELLUM FORCEPS**

**STRAIGHT**  
91-1590 9½"

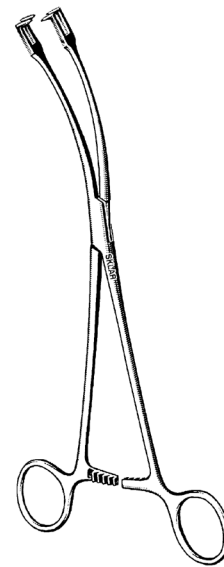

**SCHROEDER VULSELLUM FORCEPS**

91-1690 9" Curved on Flat  
91-1890 9½" Curved Sideways

**FORCEPS  
GENERAL**

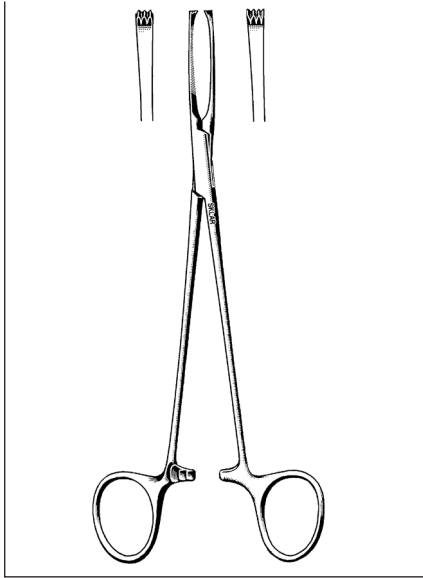

**SKLAR-ALLIS FORCEPS**  
36-1960 6" (Judd)  
36-1975 7½"

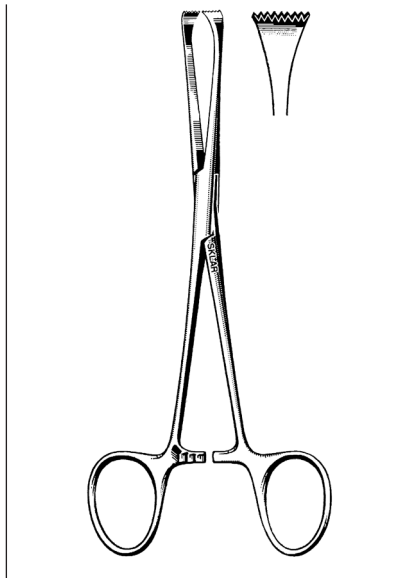

**ALLIS-ADAIR FORCEPS**  
36-1765 6½" 9x10 Teeth

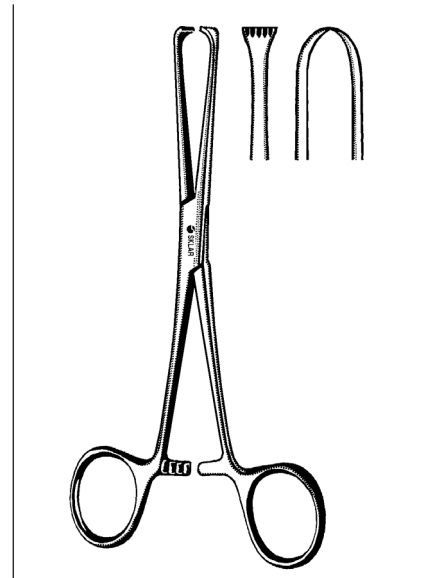

**BOYS-ALLIS TISSUE FORCEPS**  
36-1860 6" 5x6 Teeth Heavy Pattern

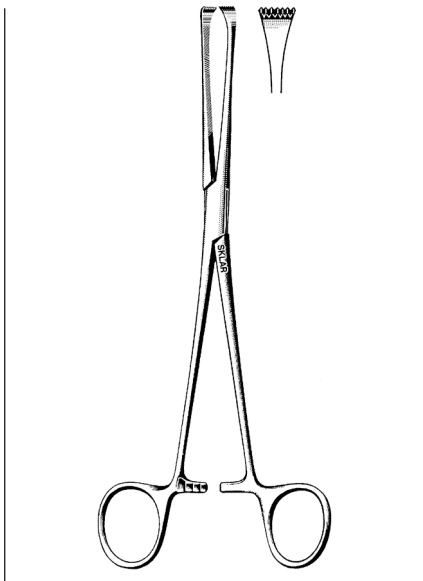

**ALLIS-THOMS FORCEPS**  
36-2380 8" 6x7 Teeth

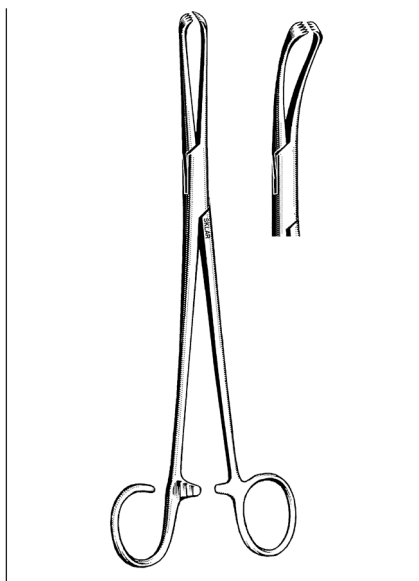

**COLVER-COAKLEY FORCEPS**  
74-2475 7½" Curved

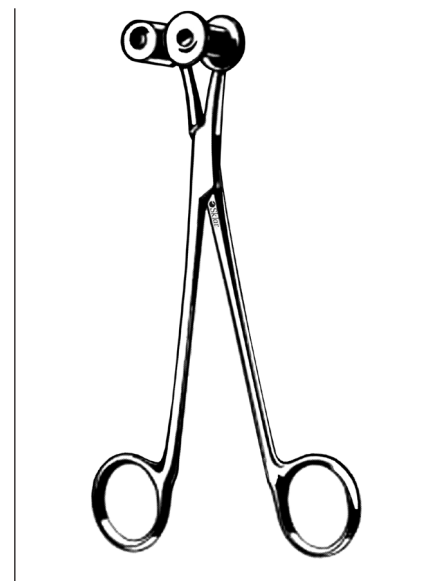

**GUNNER HEY ROLLER  
FORCEPS**  
17-3990 7¼"

# *Sklarlite™ Forceps*

## *Provide Lightness And Durability*

To meet industry demands for lighter pattern instruments, Sklar developed the SklarLite line of premium operating room forceps. Through a unique manufacturing technique, we are able to deliver a noticeably lighter instrument that maintains the strength and durability of a standard instrument. These extremely sensitive forceps give the surgeon maximum control and precision while comfortably withstanding the daily rigors of prolonged surgery. Sklarlite Forceps minimize fatigue and provide the exquisite control and reliability you have come to expect from all Sklar instruments. Sklarlite Forceps are covered under the same warranty that guarantees all Sklar instruments for a lifetime of dependable use.

*Sklar Exclusive!*

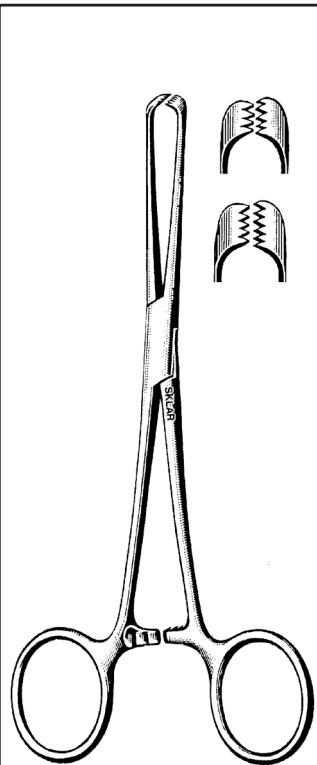

**ALLIS TISSUE  
FORCEPS**

- 36-2060 6" 3X4
- 36-2160 6" 4X5
- 36-2260 6" 5X6
- 36-2275 7½" 5X6

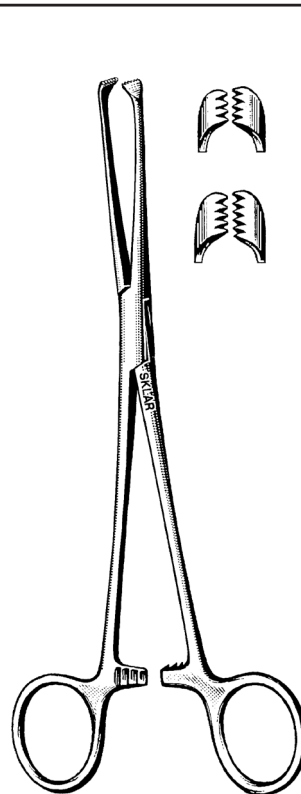

**SKLARLITE™  
ALLIS TISSUE  
FORCEPS**

- 23-2851 6" 4X5
- 23-2852 6" 5X6

SKLARLITE  
THE LIGHT TOUCH



# Sklarlite XD™

## Delivers The Ultimate In Precision

Sklar has surpassed industry standards by developing extra delicate operating room forceps that offer the surgeon one of the lightest general surgery instruments on the market today. Through a unique manufacturing technique, we are able to produce the lightest pattern forceps, affording strength and integrity equal to that of the original instrument. These extra delicate forceps are our most sensitive surgical tool, giving the surgeon the ultimate in precision and control.

Sklarlite XD Forceps are ideal for prolonged procedures, comfortably withstanding the daily rigors of frequent use. They carry the same day-in and day-out reliability that you have come to expect from all Sklar instruments and are guaranteed for a lifetime of dependable use. For the surgeon who demands the finest in OR forceps, SklarLite XD is the best choice.

### Sklar Exclusive!

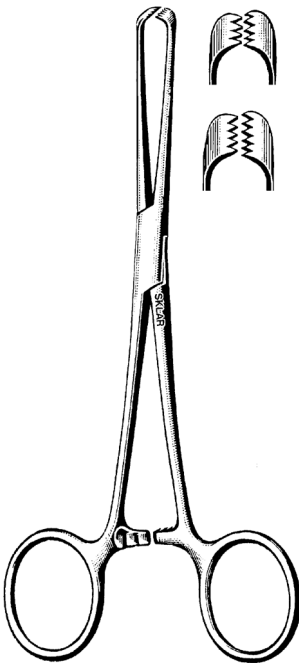
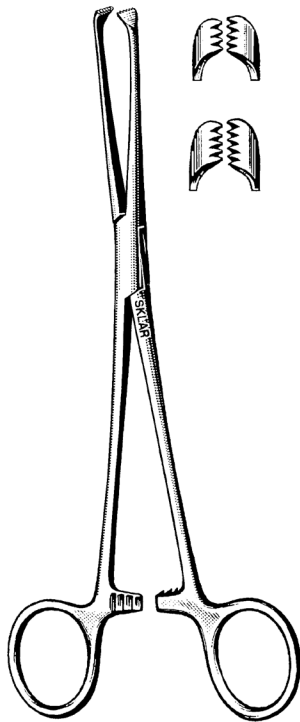
	<p><b>ALLIS TISSUE FORCEPS DELICATE</b></p> <table border="0"> <tr><td>18-2140</td><td>4"</td><td>4X5</td></tr> <tr><td>18-2155</td><td>5"</td><td>4X5</td></tr> <tr><td>22-6157</td><td>5½"</td><td>4X5</td></tr> <tr><td>18-2162</td><td>6"</td><td>4X5</td></tr> <tr><td>18-2164</td><td>6"</td><td>5X6</td></tr> <tr><td>36-2295</td><td>9½"</td><td>5X6</td></tr> </table>	18-2140	4"	4X5	18-2155	5"	4X5	22-6157	5½"	4X5	18-2162	6"	4X5	18-2164	6"	5X6	36-2295	9½"	5X6		<p><b>SKLARLITE XD™ ALLIS TISSUE FORCEPS</b></p> <table border="0"> <tr><td>23-2861</td><td>5"</td><td>4X5</td></tr> <tr><td>23-2862</td><td>5½"</td><td>4X5</td></tr> <tr><td>23-2864</td><td>6"</td><td>4X5</td></tr> <tr><td>23-2865</td><td>6"</td><td>5X6</td></tr> </table> <p>SKLARLITE XD™ EXTRA DELICATE</p>	23-2861	5"	4X5	23-2862	5½"	4X5	23-2864	6"	4X5	23-2865	6"	5X6
18-2140	4"	4X5																															
18-2155	5"	4X5																															
22-6157	5½"	4X5																															
18-2162	6"	4X5																															
18-2164	6"	5X6																															
36-2295	9½"	5X6																															
23-2861	5"	4X5																															
23-2862	5½"	4X5																															
23-2864	6"	4X5																															
23-2865	6"	5X6																															



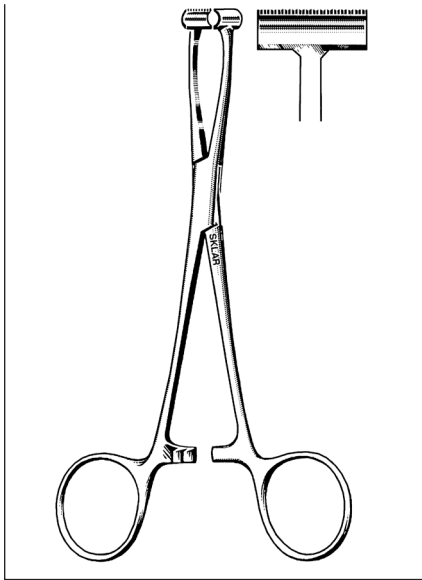

**PRATT FORCEPS**

T-SHAPE

17-1055 6"

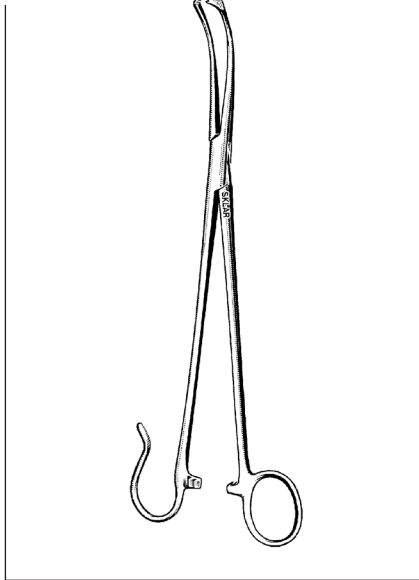

**WHITE FORCEPS**

OPEN RING

74-2575 7" Curved  
74-2590 9" Curved

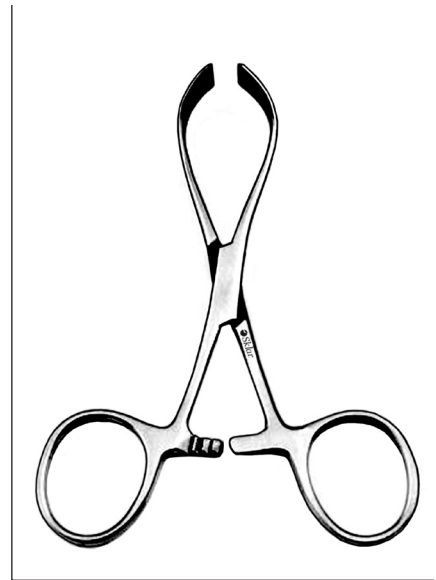

**SKLAR TOWEL CLAMP**

CROSS ACTION

87-1070 7"



**COLLINS FORCEPS**

22-6162	6¼"	A-Style	½" Jaw
36-2477	7¾"	A-Style	½" Jaw
36-2577	8"	A-Style	Duval 1" Jaw
36-2595	9½"	A-Style	Duval 1" Jaw
17-2957	6¼"	B-Style	Pennington ½" Jaw
17-2958	8"	B-Style	Pennington ½" Jaw

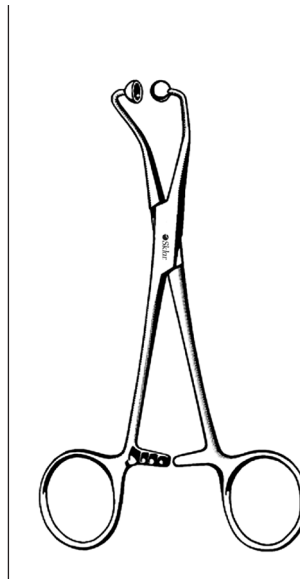

**BALL AND SOCKET  
TOWEL CLAMP**

47-3050 5"

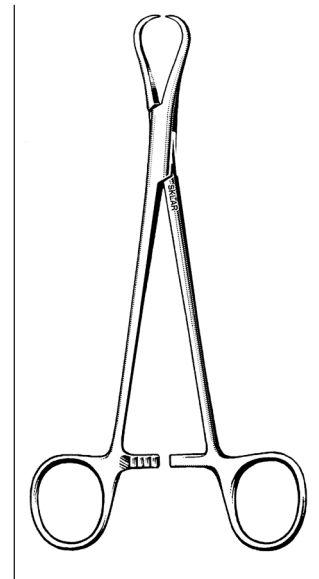

**ADAIR BREAST  
TENACULUM FORCEPS**

36-1865 6¼"

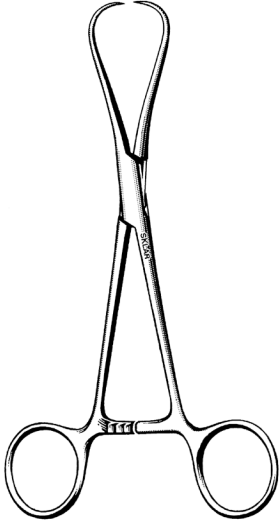

**STAUDE-MOORE TENACULUM  
FORCEPS**

91-1455 5½"  
91-1465 6½"

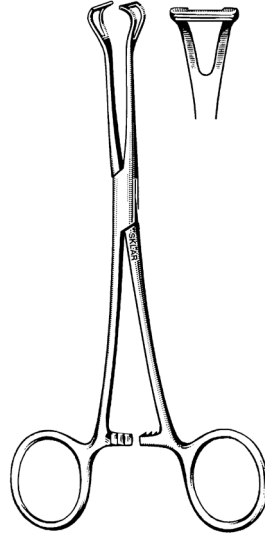

**BABCOCK FORCEPS**

22-6155 5½" 6mm Delicate  
36-1662 6¼" 9mm  
36-1677 8" 10mm  
36-1692 9½" 15mm

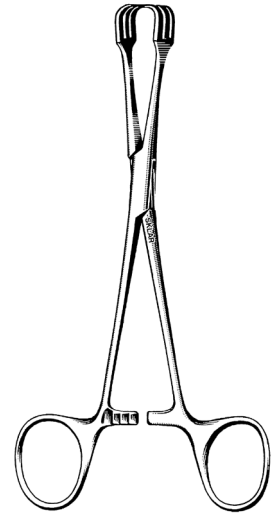

**LAHEY TRACTION FORCEPS**

17-3562 6¼"  
91-2080 8" (MGH)

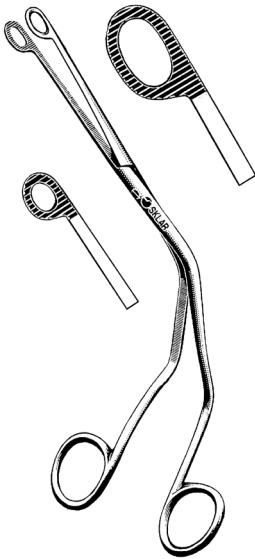

**MAGILL CATHETER FORCEPS**

07-1777 Infant 6½"  
07-1780 Child 8"  
07-1797 Adult 10"

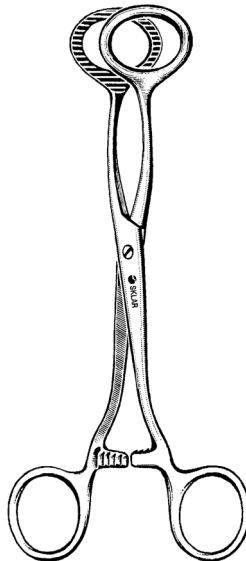

**COLLINS TONGUE  
SEIZING FORCEPS**

07-1565 6½"  
07-1570 7"

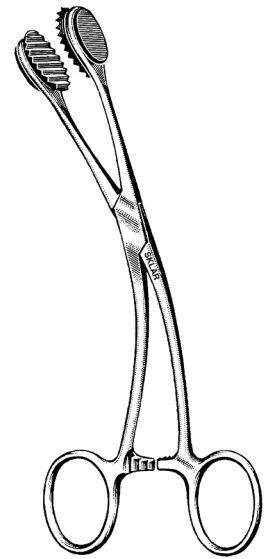

**YOUNG TONGUE  
SEIZING FORCEPS**

07-1562 6¼"  
07-1563 Jaw inserts only 2/pk

# Skarlite™ Forceps

## Provide Lightness And Durability

### SKLARLITE

#### THE LIGHT TOUCH

To meet industry demands for lighter pattern instruments, Sklar introduced the SklarLite line of premium operating room forceps. Through a unique manufacturing technique, we are able to deliver a noticeably lighter instrument that maintains the strength and durability of a standard instrument. These extremely sensitive forceps give the surgeon maximum control and precision while comfortably withstanding the daily rigors of prolonged surgery. Sklarlite Forceps minimize fatigue and provide the exquisite control and reliability you have come to expect from all Sklar instruments. Sklarlite Forceps are covered under the same warranty that guarantees all Sklar instruments for a lifetime of dependable use.



#### ADSON FORCEPS

##### DRESSING

- 50-3147 4¾" Serrated
- 50-3044 4¾" Smooth
- 47-2148 4¾" Angled

##### TISSUE

- 50-3046 4¾" Angled
- 50-3047 4¾" 1x2

##### ADSON-BROWN

- 47-1447 4¾" Side Grasping



#### SKLARLITE™ ADSON FORCEPS

##### DRESSING

- 23-2600 4¾" Serrated

##### TISSUE

- 23-2602 4¾" 1x2

##### ADSON-BROWN

- 23-2603 4¾" Side Grasping



# Sklarlite XD™

## Delivers The Ultimate In Precision

### SKLARLITE XD

**EXTRA \* DELICATE** Sklar has surpassed industry standards by developing extra delicate operating room forceps that offer the surgeon one of the lightest general surgery instruments on the market today. Through a unique manufacturing technique, we are able to produce our lightest pattern forceps, affording strength and integrity equal to that of the original instrument. These extra delicate forceps are our most sensitive surgical tool, giving the surgeon the ultimate in precision and control.

Sklarlite XD Forceps are ideal for prolonged procedures, comfortably withstanding the daily rigors of frequent use. They carry the same day-in and day-out reliability that you have come to expect from all Sklar instruments and are guaranteed for a lifetime of dependable use. For the surgeon who demands the finest in OR forceps, SklarLite XD is the best choice.



#### ADSON FORCEPS DELICATE

##### DRESSING

47-2147 4¾" Serrated

##### TISSUE

47-2047 4¾" 1x2

47-2049 4¾" 2x3

##### ADSON-BROWN

47-2447 4¾" Side Grasping

47-1450 4¾" Angled



SKLARLITE XD™  
EXTRA \* DELICATE

#### SKLARLITE XD™ ADSON FORCEPS

##### STRAIGHT

23-2604 4¾" Serrated

##### TISSUE

23-2606 4¾" 1x2

##### ADSON-BROWN

23-2608 4¾" Side Grasping

*LiteGrip™ Fenestrated Handles  
For Firm Secure Grip*



**SKLAR LITEGRIP™  
BISHOP-HARMON FORCEPS**

66-4034 3½" Serrated  
66-4134 3½" 1x2 Teeth



**SKLAR LITEGRIP™  
ADSON-BROWN FORCEPS**

47-1448 4¾" 7x7 Teeth Side Grasping



**SKLAR LITEGRIP™ ADSON  
FORCEPS**

50-3148 Serrated 4¾"  
50-3050 1x2 Teeth 4¾"  
50-3052 1x2 Teeth 4¾" with Tying Platform

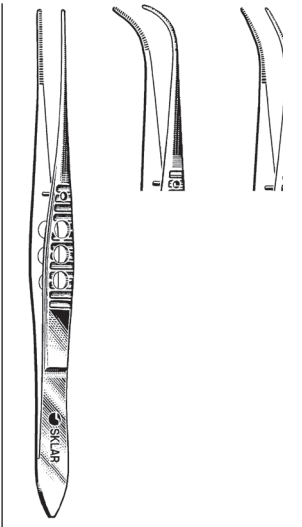

**SKLAR LITEGRIP™  
IRIS FORCEPS**

**SERRATED**  
66-2742 4" Straight  
66-2942 4" ½ Curve  
66-3142 4" Full Curve

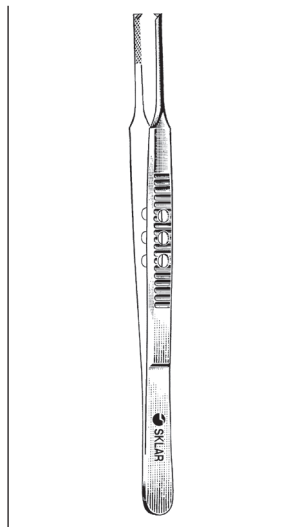

**SKLAR LITEGRIP™  
IRIS FORCEPS**

**1X2 TEETH**  
66-3342 4" Straight  
66-3542 4" ½ Curve  
66-3742 4" Full Curve

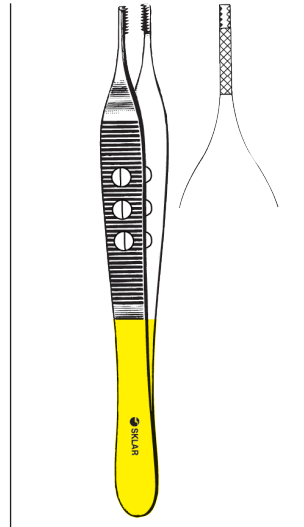

**SKLAR LITEGRIP™  
TC ADSON-BROWN  
TISSUE AND SUTURE  
FORCEPS**

51-1448 4¾" Side  
Grasping w/Tungsten Carbide  
insert 4¾"

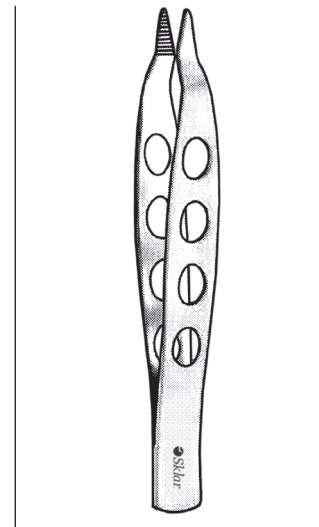

**SKLAR JEANS  
DISSECTING FORCEPS**

**SERRATED**  
19-2180 5½"  
19-2181 5½" 1x2 Teeth  
19-2182 5½" 2x3 Teeth

FORCEPS

THUMB



**ADSON FORCEPS**

- 50-3048 4¾" Serrated, 1x2
- 50-3049 4¾" 1x2 with Platform

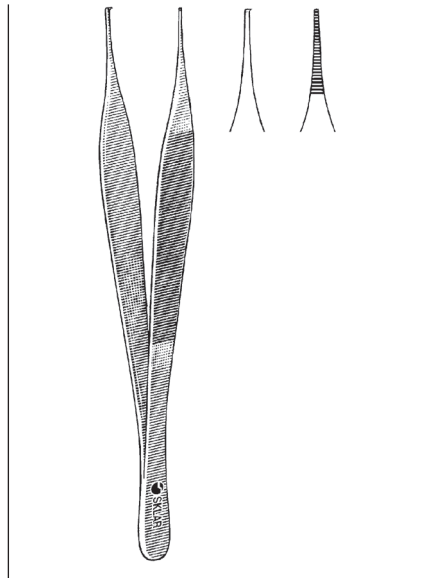

**MICRO ADSON FORCEPS**

- 98-2047 4¾" 1x2 Teeth
- 98-2048 4¾" Serrated

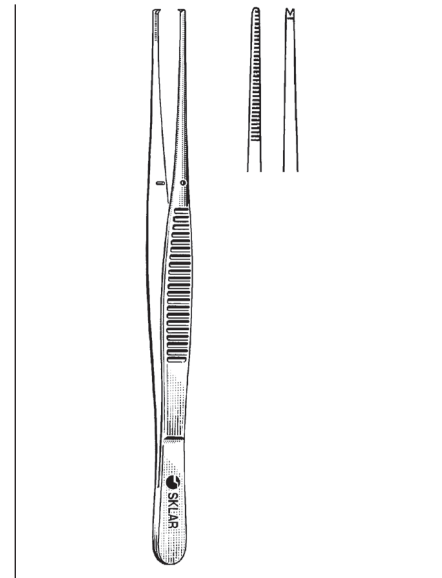

**CUSHING FORCEPS**

- DELICATE**
- 22-6770 7" Serrated
  - 22-6870 7" 1x2

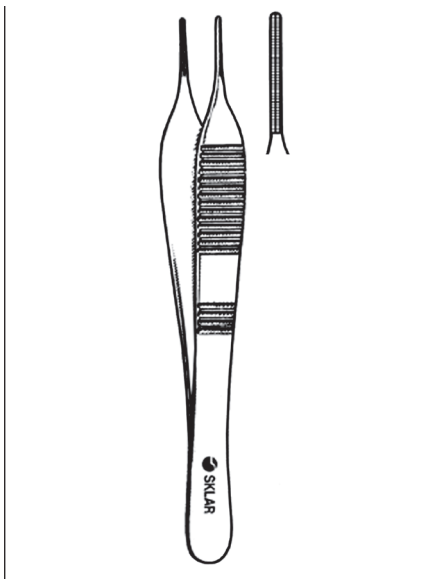

**ADSON -DEBAKEY DRESSING FORCEPS**

**ATRAUMATIC TIPS**

- 52-5362 4¾" 1.5mm

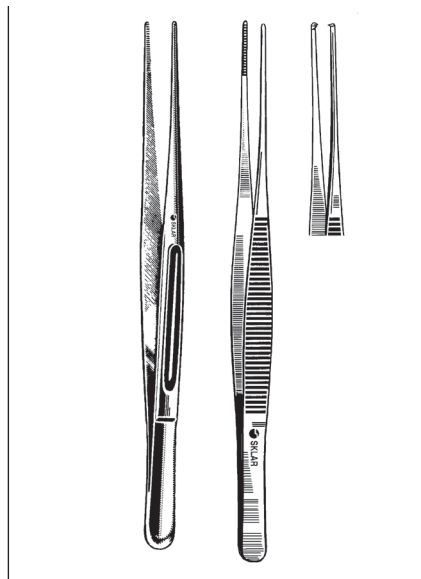

**CUSHING BRAIN FORCEPS**

**DELICATE**

- 50-2670 7" Serrated Gutch Handle
- 50-2870 7" 1x2 Gutch Handle
- 50-2970 7" 1x2 Serrated Handle

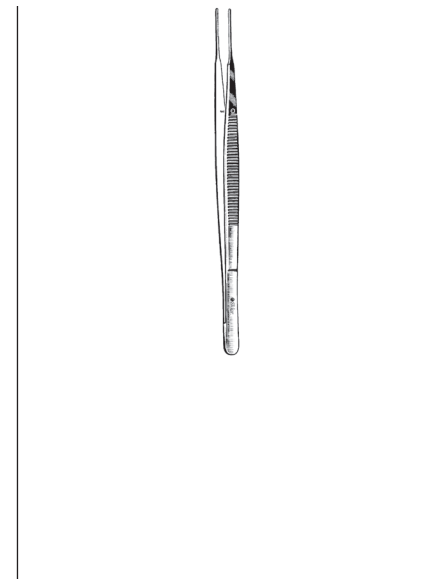

**GERALD FORCEPS**

**SERRATED**

- 47-1180 7" Straight
- 47-1175 7" Curved

**1X2**

- 47-1173 7" Straight
- 47-1186 7" Curved

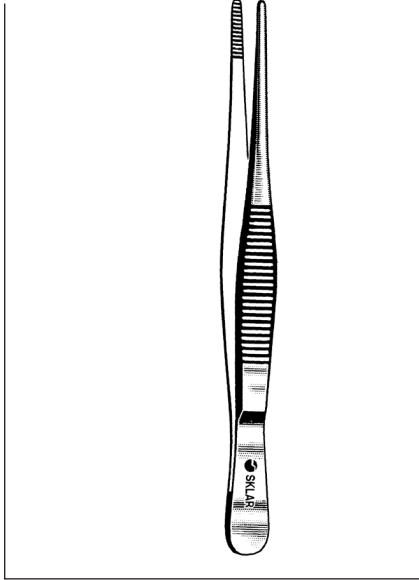

**DRESSING FORCEPS**

**SERRATED**

19-1045	4½"	19-1070	7"
19-1050	5"	19-1080	8"
19-1055	5½"	19-1110	10"
19-1060	6"	19-1112	12"

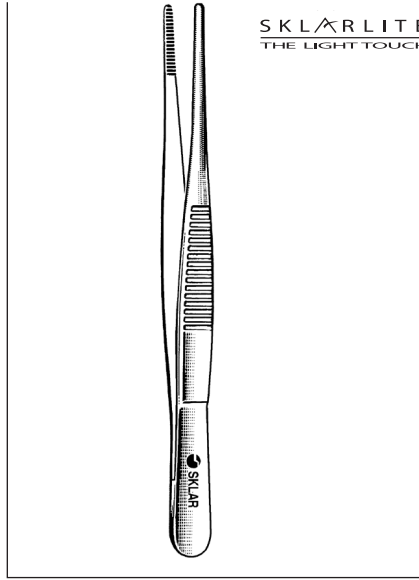

**SKLARLITE™ DRESSING FORCEPS**

**SERRATED**

23-2824	4½"	23-2828	5½"
23-2826	5"	23-2830	6"

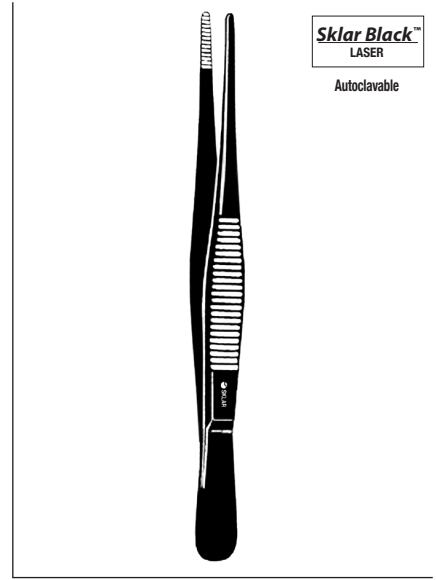

**SKLAR BLACK™ DRESSING FORCEPS**

**SERRATED**

90-1063	4½"	90-1065	5½"
90-1064	5"	90-1066	6"

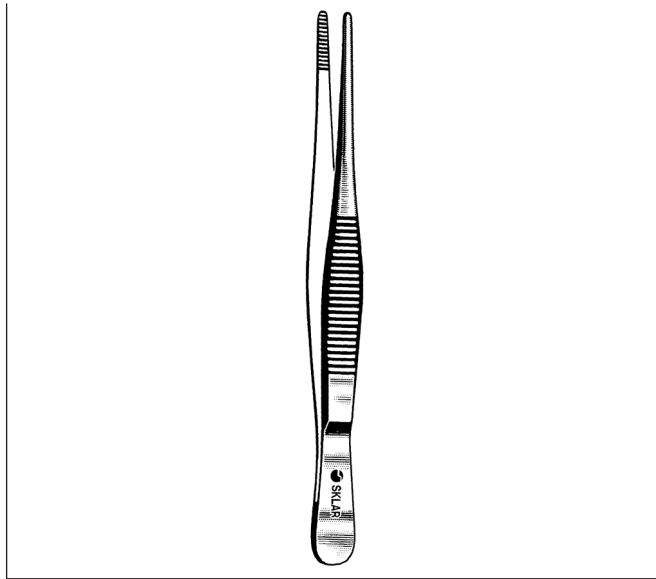

**DRESSING FORCEPS**

**DELICATE, SERRATED**

22-1161	4½"	22-1163	5½"
22-1162	5"	22-1164	6"



**SKLARLITE XD™ DRESSING FORCEPS**

23-2834	4½"	23-2838	5½"
23-2836	5"	23-2840	6"

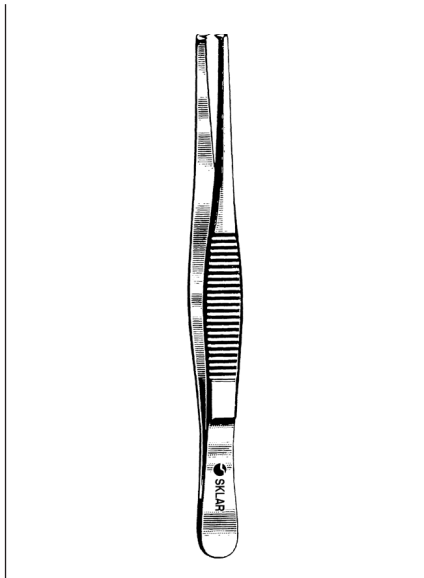

**TISSUE FORCEPS**

**1X2 TEETH**

19-1245	4½"	19-1280	8"
19-1250	5"	19-1310	10"
19-1255	5½"	19-1312	12"
19-1260	6"		
19-1270	7"		

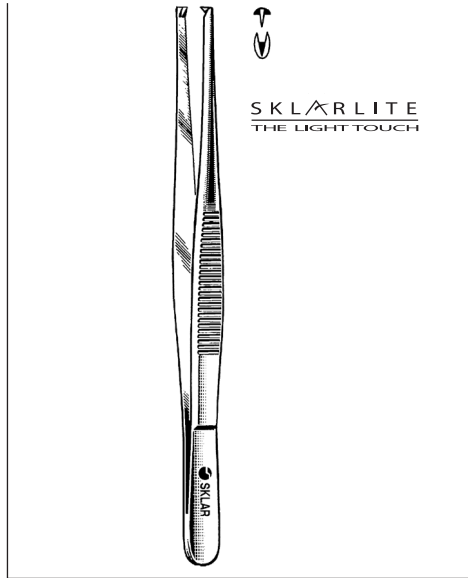

**SKLARLITE™ TISSUE FORCEPS**

**1X2 TEETH**

23-2809	4½"
23-2811	5½"

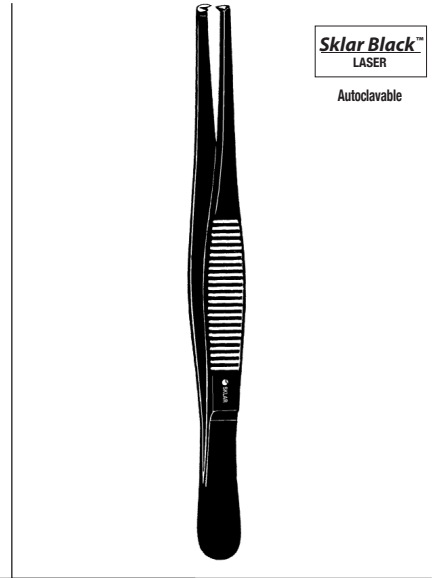

**SKLAR BLACK™ TISSUE FORCEPS**

**1X2 TEETH**

90-1020	4½"	90-1022	5½"
90-1021	5"	90-1023	6"



**TISSUE FORCEPS DELICATE**

**1X2 TEETH**

22-1061	4½"		
22-1047	4¾"	With Skin Hook	
22-1062	5"		
22-1063	5½"		
22-1064	6"		



**SKLARLITE XD™ TISSUE FORCEPS**

**1X2 TEETH**

23-2819	5½"
---------	-----



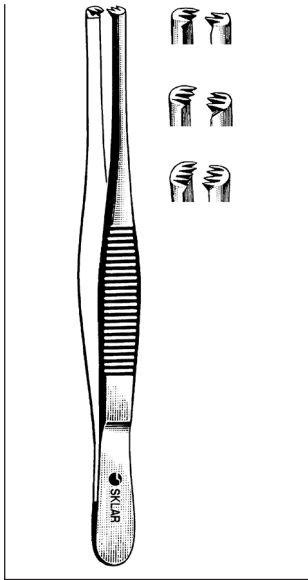

**TISSUE FORCEPS**

<b>2X3</b>		<b>3X4</b>	
19-1445	4½"	19-1650	5"
19-1450	5"	19-1655	5½"
19-1455	5½"	19-1660	6"
19-1460	6"	<b>4X5</b>	
19-1480	8"	19-1850	5"
19-1510	10"	19-1855	5½"
19-1512	12"	19-1905	6"
		19-1910	10"

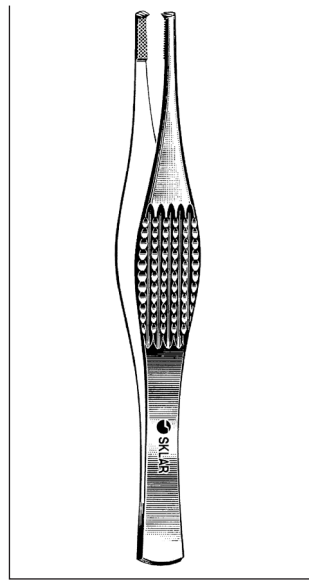

**FERRIS-SMITH  
FORCEPS**

47-1470	7"	1x2
52-3970	7"	2x3

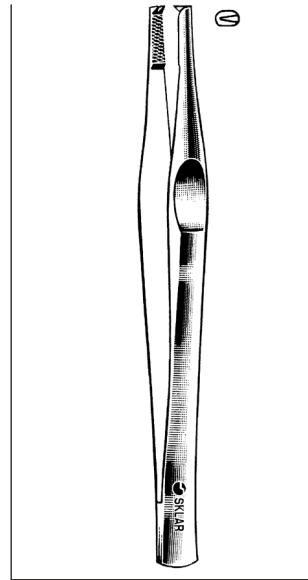

**LANE TISSUE  
FORCEPS**

<b>STRAIGHT</b>		
19-1955	5½"	1x2
19-1975	7½"	1x2

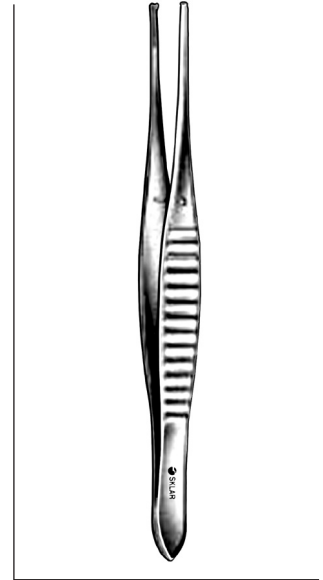

**GILLIES FORCEPS**

<b>1X2 TEETH, SERATED</b>	
19-2070	6"

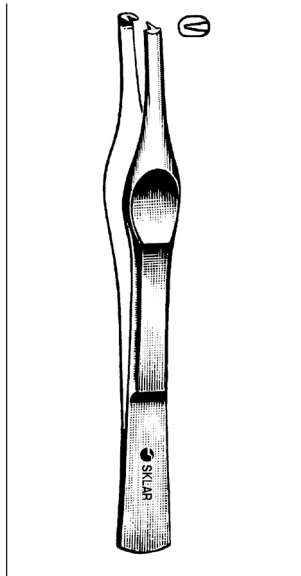

**MICHEL TISSUE  
FORCEPS**

<b>STRAIGHT</b>		
19-1950	5"	1x2

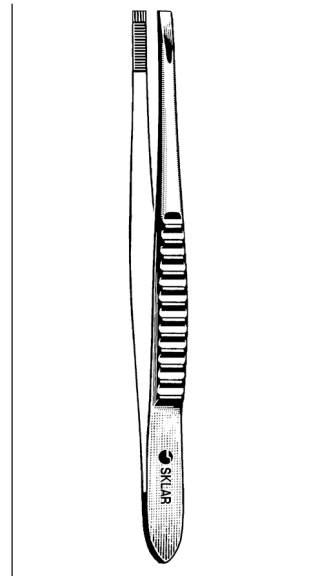

**STILLE TISSUE  
FORCEPS**

19-2050	5"	4x5
---------	----	-----

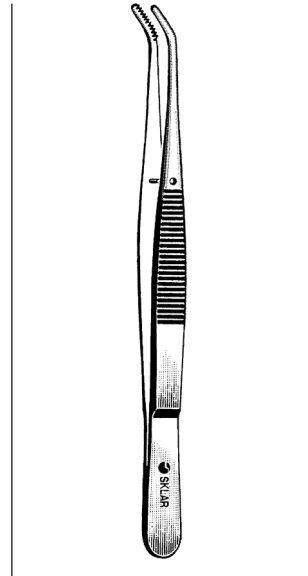

**ESSRIG TISSUE  
FORCEPS**

19-2460	6"	Angular
---------	----	---------

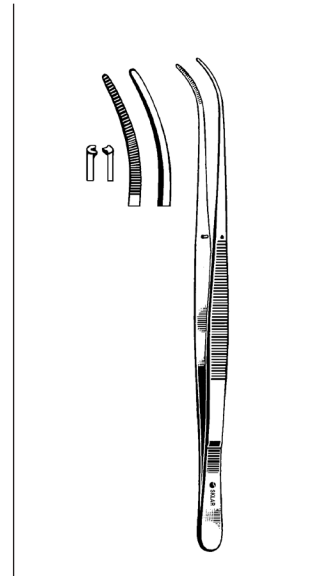

**KANTROWITZ FORCEPS**

<b>1X2 TEETH</b>		
52-3597	9¼"	Curved

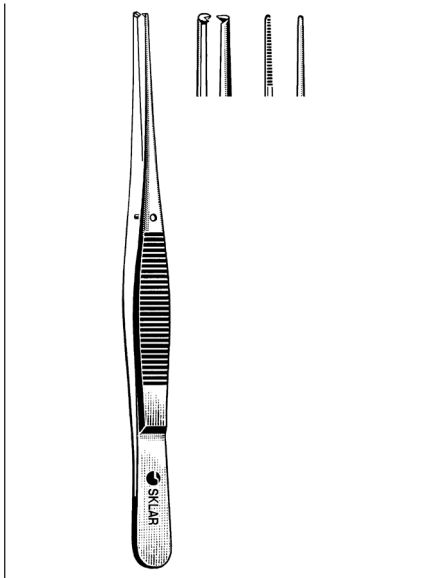

**SEMKIN DRESSING FORCEPS**

22-4150	5"	Narrow	Serrated
22-4250	5"	Delicate	Serrated
22-4350	5"	Narrow	1x2
22-4450	5"	Delicate	1x2
22-4550	5"	Narrow	2x3
22-4650	5"	Delicate	2x3

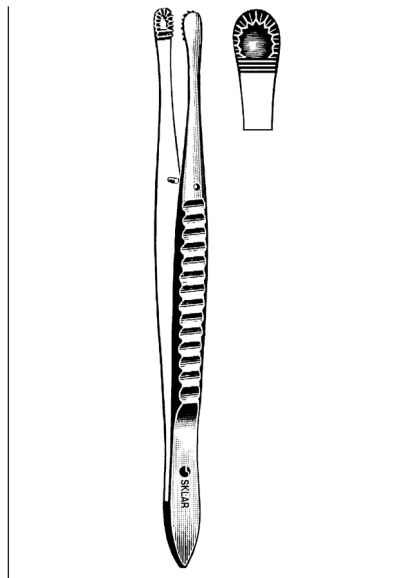

**RUSSIAN TISSUE FORCEPS**

19-2260	6"
19-2280	8"
19-2320	9"
19-2310	10"

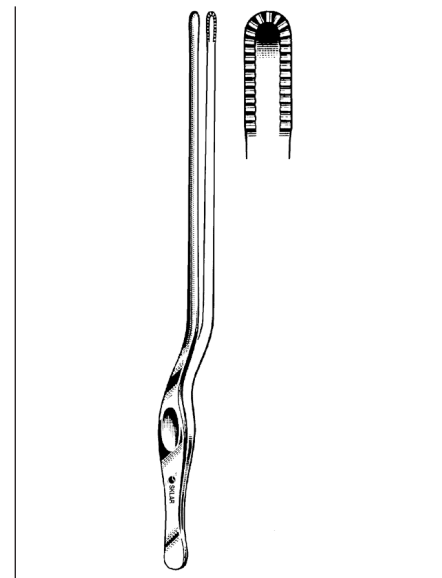

**HARRINGTON-MAYO BAYONET FORCEPS**

55-4114	14"
---------	-----

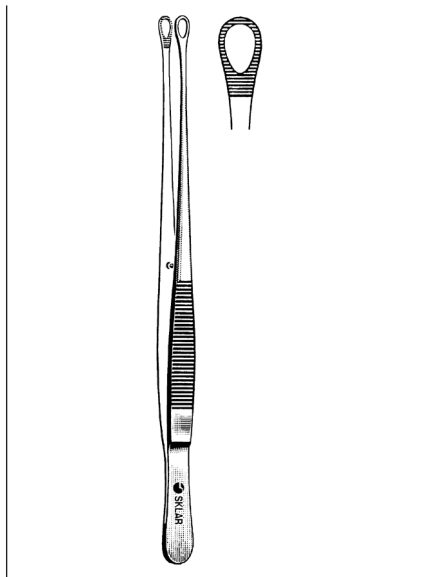

**TUTTLE/SINGLEY FORCEPS**

22-7470	7"	Tuttle
36-1290	9"	Singley

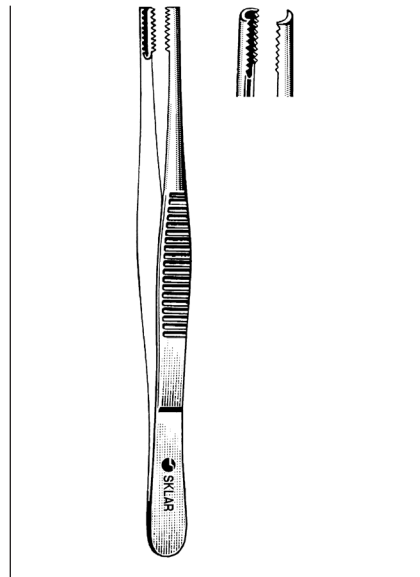

**BROWN TISSUE FORCEPS**

<b>SIDE GRASPING</b>	
19-2860	6"
19-2880	8"
19-2910	10"

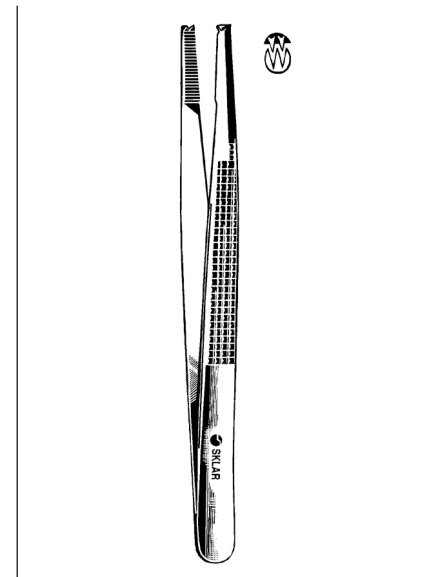

**BONNEY TISSUE FORCEPS**

<b>SERRATED</b>		
19-2170	7"	1x2
19-2172	7"	2x3



**POTTS-SMITH FORCEPS**

52-3270	7"	Serrated	52-3410	10"	1x2
52-3370	7"	1x2	52-3510	10"	1x2, Curved
52-3282	8¼"	Serrated	52-3312	12"	Serrated
52-3382	8¼"	1x2	52-3412	12"	1x2
52-3310	10"	Serrated			



**SELMAN TISSUE FORCEPS**

52-4260	6"
52-4310	10"

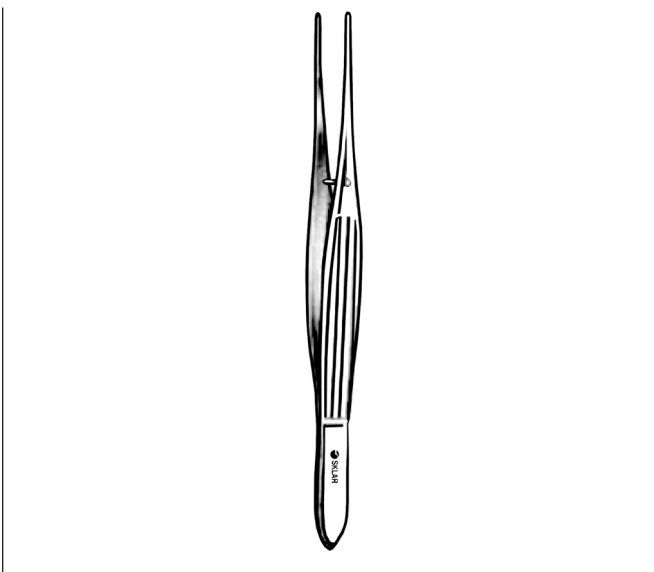

**MCINDOE FORCEPS**

19-1230	6"	Serrated
---------	----	----------

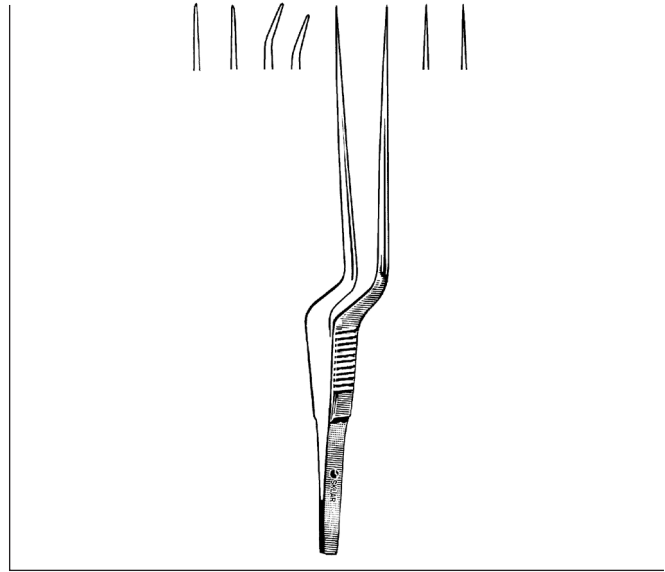

**JACOBSON MICRO FORCEPS**

98-2072	6¼"	Sharp	<b>ANGLED TIP</b>		
98-2075	7¼"	Blunt	98-2077	7¼"	Blunt
98-2076	7¼"	Sharp			

FORCEPS

THUMB

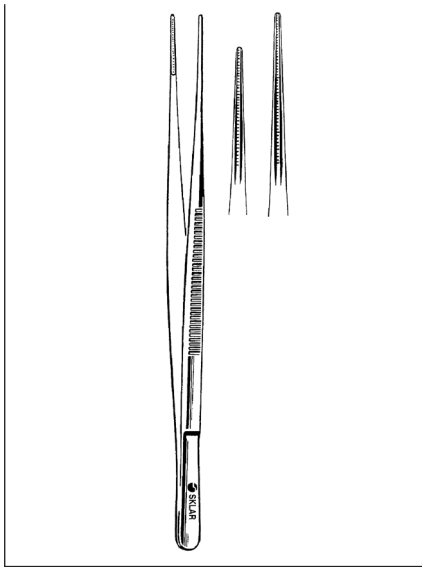

**DEBAKEY ATRAUMATIC TISSUE FORCEPS**

**1.5MM JAWS**

52-5062	6¼"
52-5077	7¾"
52-5095	9½"
52-5098	12"

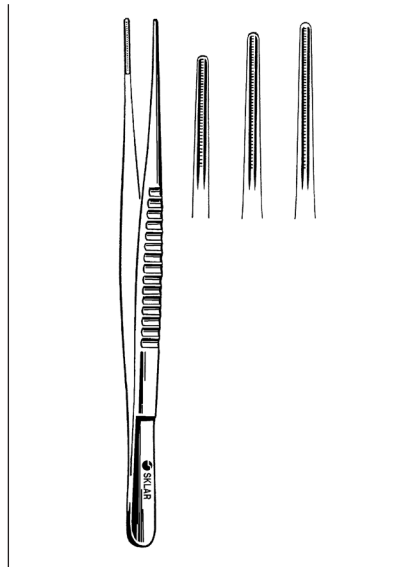

**DEBAKEY ATRAUMATIC TISSUE FORCEPS**

**2.0MM JAWS**

52-5162	6¼"
52-5177	7¾"
52-5195	9½"
52-5198	12"

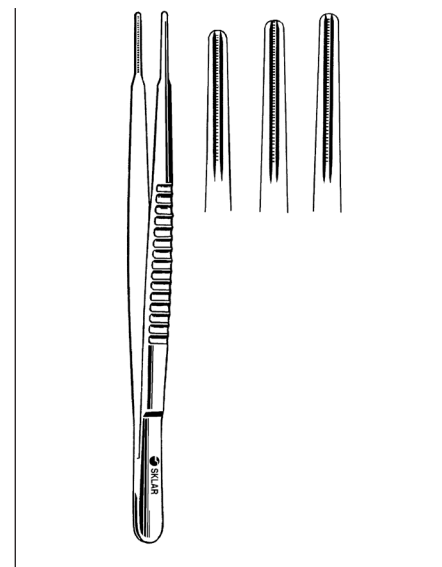

**DEBAKEY ATRAUMATIC TISSUE FORCEPS**

**3.5MM JAWS**

52-5262	6¼"
52-5277	7¾"
52-5295	9½"
52-5297	12"

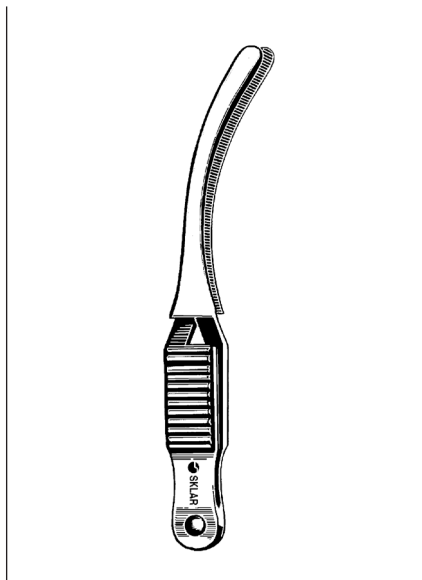

**JOHN HOPKINS BULLDOG CLAMPS**

**STRAIGHT**

52-1416	1½"
52-1421	2"
52-1423	2¼"
52-1426	2½"
52-1428	2¾"
52-1431	3"
52-1436	3½"

**CURVED**

52-1415	1½"
52-1420	2"
52-1422	2¼"
52-1425	2½"
52-1427	2¾"
52-1430	3"
52-1435	3½"

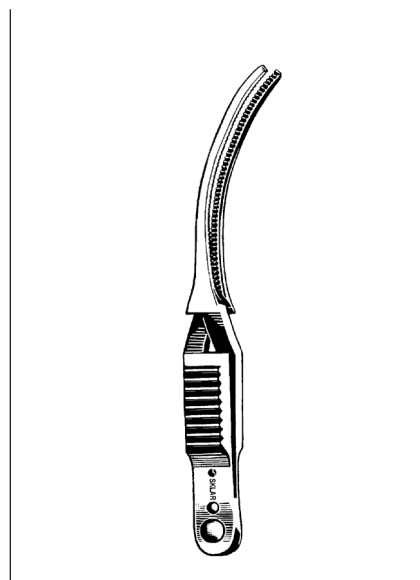

**DEBAKEY BULLDOG CLAMPS**

**STRAIGHT**

52-1530	3"	7.5cm
52-1531	3½"	8.5cm
52-1532	4¼"	10.5cm
52-1533	4¾"	12.0cm

**CURVED**

52-1540	2¾"	7.0cm
52-1541	3¼"	8.0cm
52-1542	4"	10.0cm
52-1543	4¾"	11.5cm

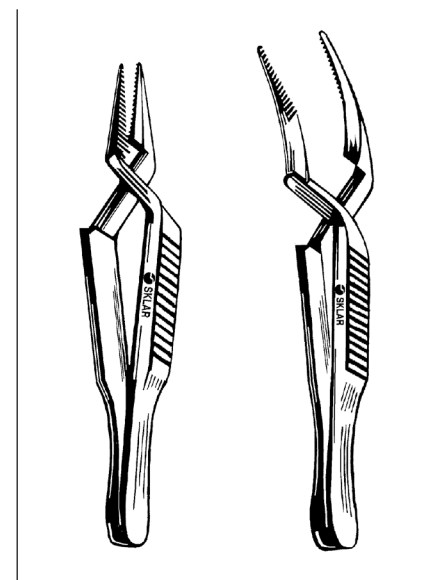

**DIETRICH MICROCORONARY BULLDOG CLAMPS**

98-4008	8mm	Straight
98-4012	12mm	Straight
98-4020	20mm	Straight
98-4108	8mm	Angled
98-4112	12mm	Angled
98-4120	20mm	Angled

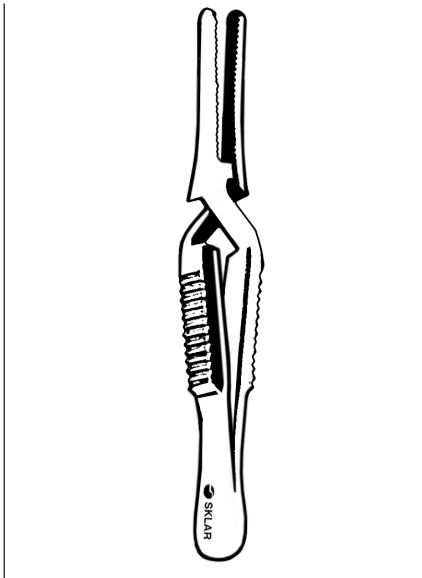

**DIEFFENBACH BULLDOG CLAMPS**

- 17-3815 1½" Straight
- 17-3915 1½" Curved
- 17-3817 2¼" Straight
- 17-3917 2¼" Curved

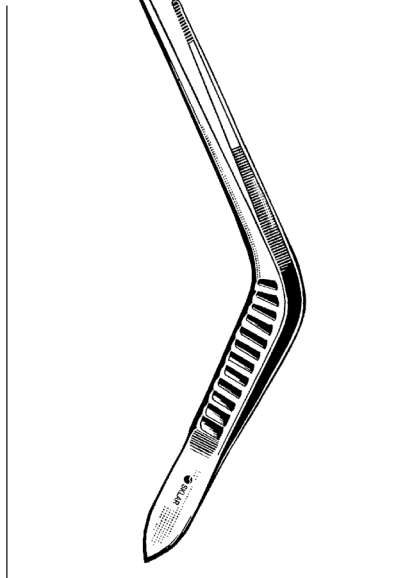

**WILDE EAR FORCEPS  
ANGLED**

- 67-1150 5" Serrated
- 67-1250 5" Mouse Teeth
- 70-4470 7" Serrated

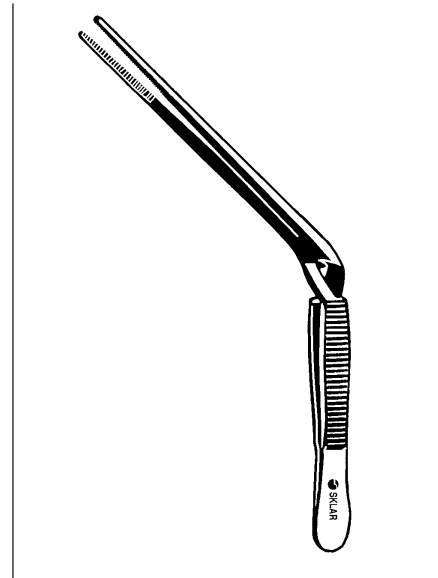

**WILDE EAR FORCEPS**

- 67-1350 5" Serrated Jaws, Cross Action
- 67-1450 5" 1x2 Teeth, Cross Action

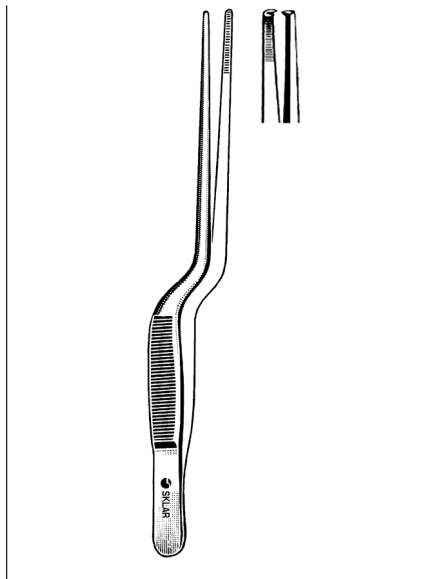

**LUCAE BAYONET FORCEPS**

- 67-1455 5½" Serrated
- 67-1555 5½" 1x2 Teeth

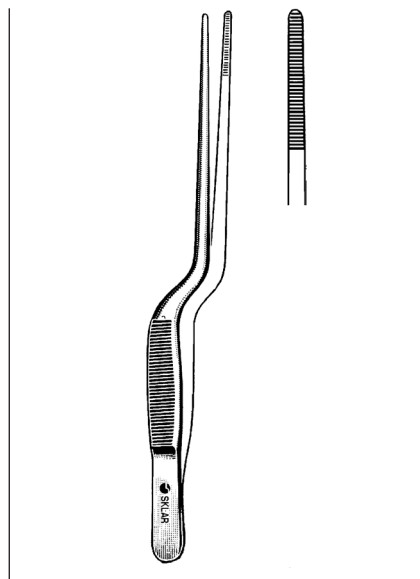

**JANSEN BAYONET FORCEPS**

- SERRATED**
- 67-1465 6½"
  - 70-4375 7½"
  - 70-4385 8½"

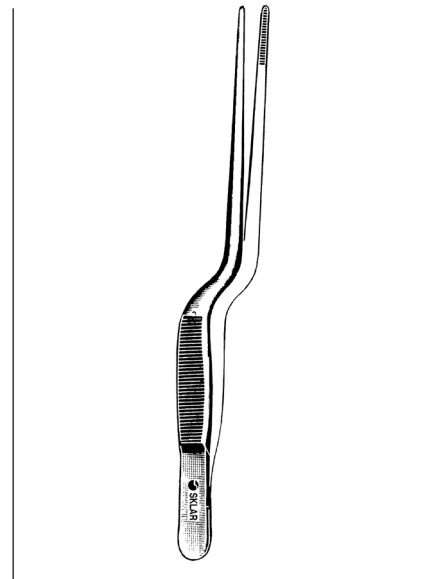

**ADSON BAYONET FORCEPS**

- 50-3371 7½" Delicate

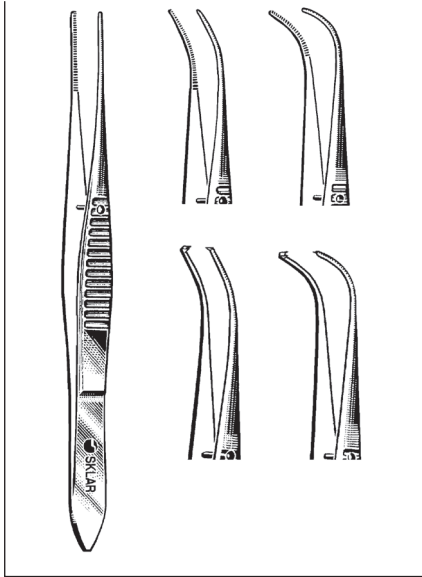

**EYE DRESSING FORCEPS**

4", SERRATED

66-2734	Straight	0.5mm Delicate
66-2736	Half Curve	0.5mm Delicate
66-2738	Full Curve	0.5mm Delicate
66-2740	Straight	0.8mm
66-2840	Straight	0.8mm Non-Magnetic
66-2940	Half Curve	0.8mm
66-3140	Full Curve	0.8mm

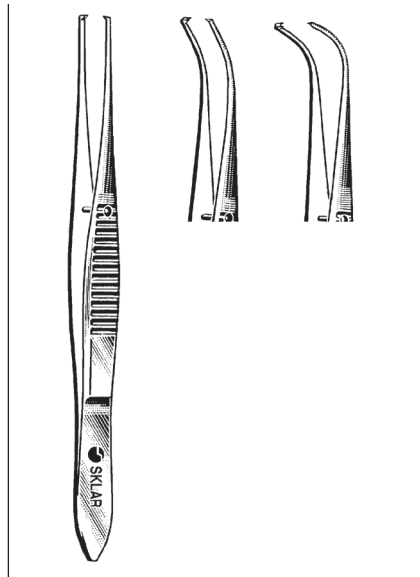

**EYE TISSUE FORCEPS**

1X2 TEETH, 4"

66-3340	Straight	0.8mm
66-3240	Straight	0.8mm, Non-Magnetic
66-3540	Half Curve	0.8mm
66-3740	Full Curve	0.8mm

1X2 TEETH, EXTRA DELICATE, 4"

66-3341	Straight	0.5mm
66-3541	Half Curve	0.5mm
66-3741	Full Curve	0.5mm

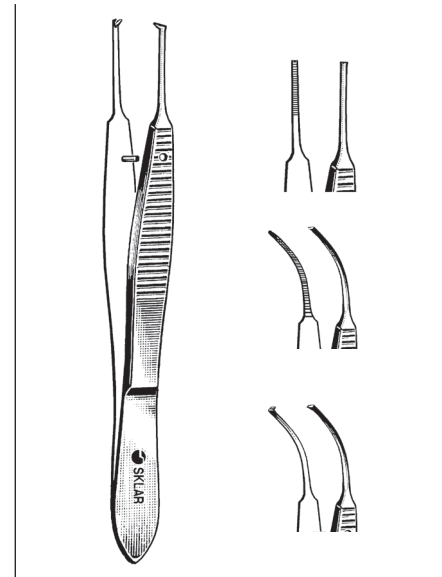

**GRAEFE IRIS FORCEPS**

STRAIGHT

66-4526	2 3/4"	Serrated
66-4525	2 3/4"	1x2 Teeth

CURVED

66-4626	2 3/4"	Serrated
66-4625	2 3/4"	1x2 Teeth



**THORPE CORNEOSCLERAL FORCEPS**

66-7347 4 3/4"

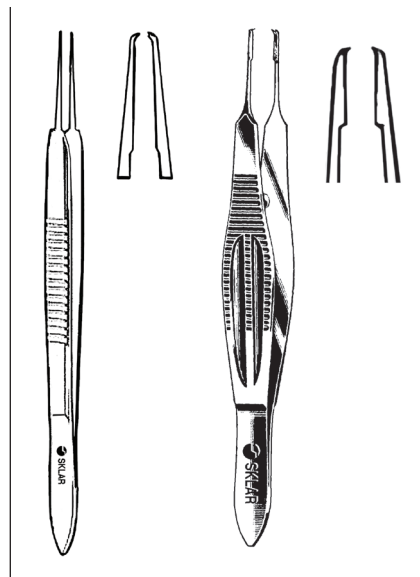

**CASTROVIEJO FORCEPS**

WITH PLATFORM

66-6119	4"	0.12mm
66-6103	4"	0.3mm
66-6105	4"	0.5mm
66-6109	4"	0.9mm
66-6115	4 1/4"	0.5mm Wide Handle
66-6118	4 1/4"	1.5mm Wide Handle

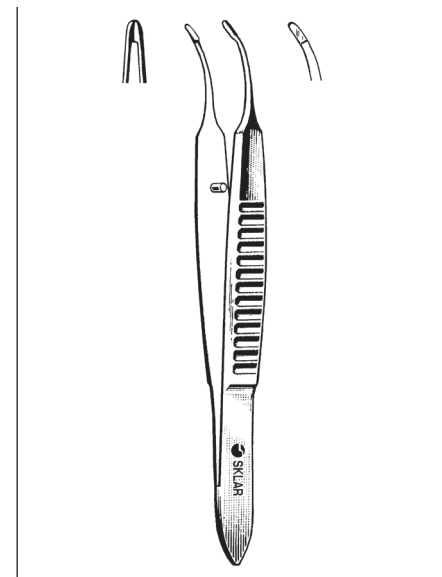

**CHANDLER IRIS FORCEPS**

66-3927 2 3/4" Curved with Platform

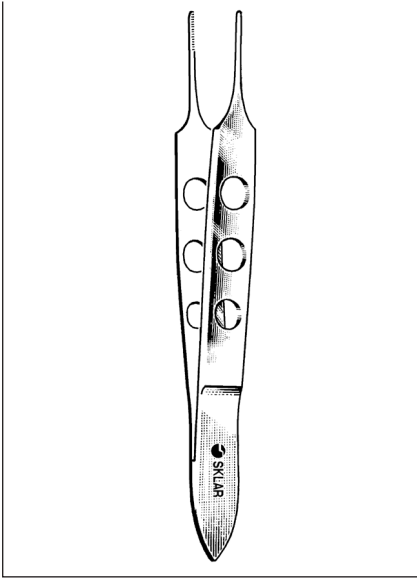

**BISHOP-HARMON FORCEPS**

- 66-4032 3½" Serrated
- 66-4132 3½" 1x2
- 66-4230 3½" 1x2 Micro
- 66-4232 3½" 1x2 Delicate
- 66-4133 3½" 1x2 Extra Delicate

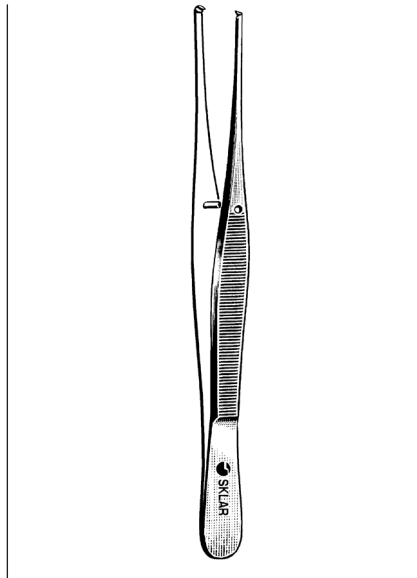

**STRABISMUS FORCEPS**

- 66-4840 4" Straight 1x2

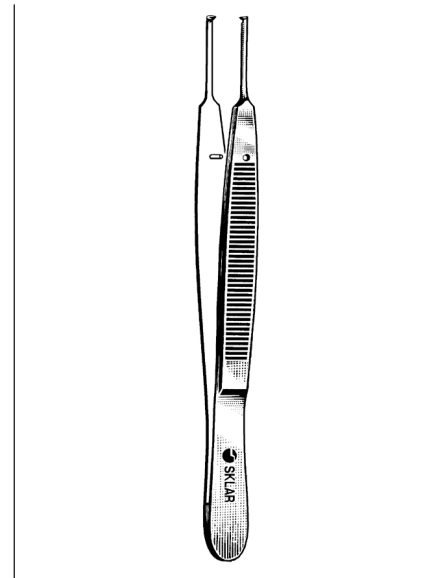

**LESTER CONJUNCTIVAL FORCEPS**

- DELICATE**
- 66-4237 3½" 1x2
  - 66-4238 3½" 2x3



**FOERSTER EYE DRESSING FORCEPS**

- 66-6036 3¾" Straight Serrated
- 66-6038 3¾" Straight 1x2 Teeth
- 66-6037 3¾" Full Curve Serrated
- 66-6039 3¾" Full Curve 1x2 Teeth

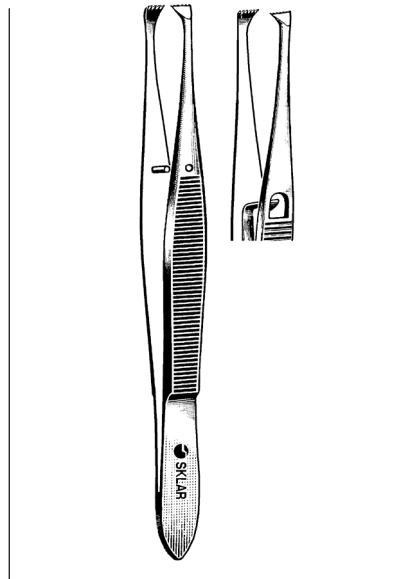

**GRAEFE FIXATION FORCEPS**

- 66-1940 4½" Without Lock
- 66-2140 4½" With Lock

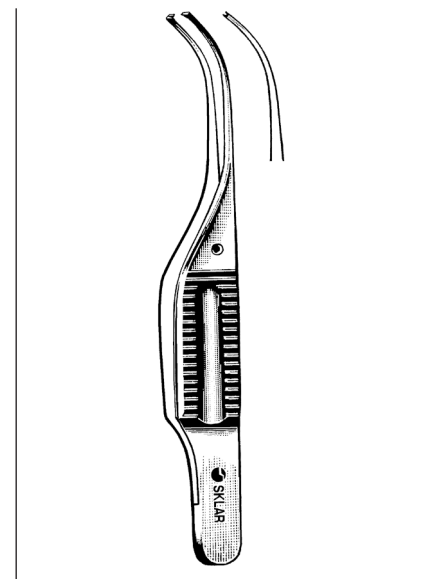

**GILL IRIS FORCEPS**

- 66-7130 3" Smooth Delicate
- 66-7230 3" Smooth Extra Delicate

FORCEPS

THUMB

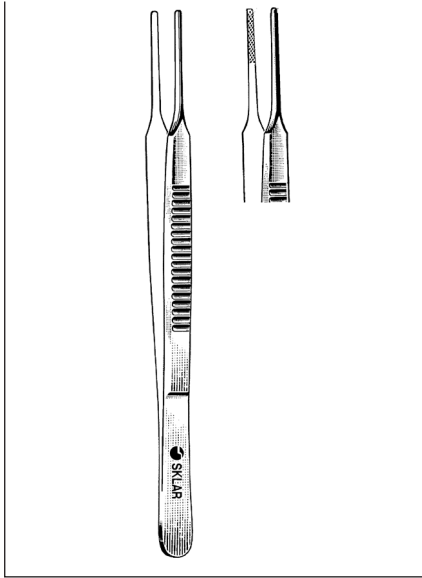

**MCCULLOUGH UTILITY FORCEPS**

- 66-6110 4" Serrated
- 66-6114 4" Serrated 1x2
- 66-6112 4" Smooth

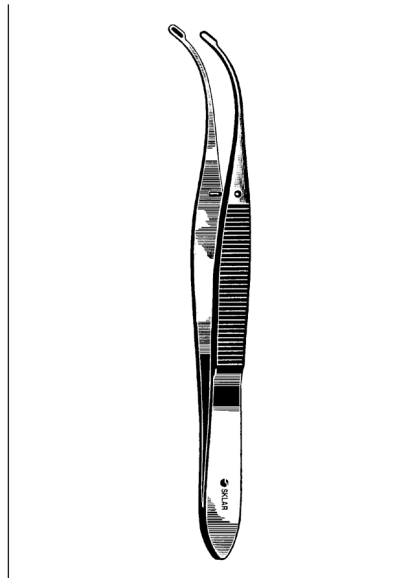

**ARRUGA CAPSULE FORCEPS**

66-5340 4"

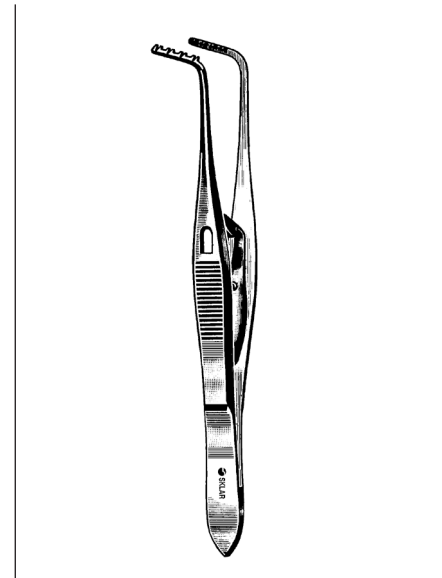

**PRINCE ADVANCEMENT FORCEPS**

66-5942 4" Left

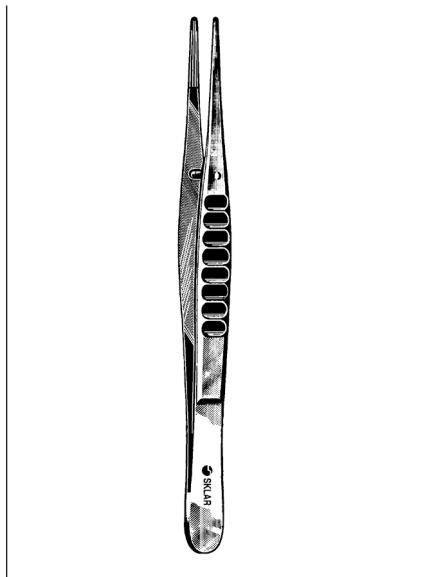

**BONACCOLTO FORCEPS**

**TAPERED TIP**

- 66-6340 4" 1.2mm
- 66-6338 4" 1.7mm

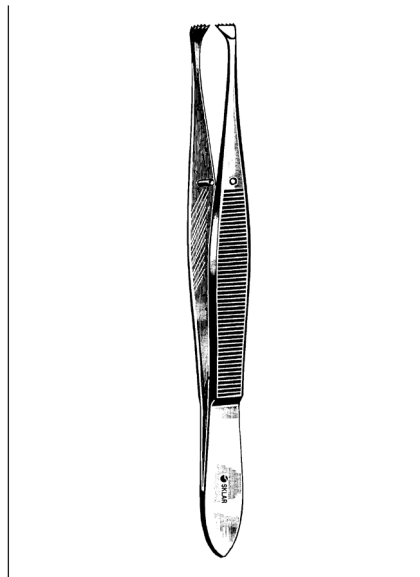

**FIXATION FORCEPS**

**WITH FINE TEETH**

- 66-2040 4 1/8" Straight Without Catch
- 66-2340 4 1/8" Curved With Catch

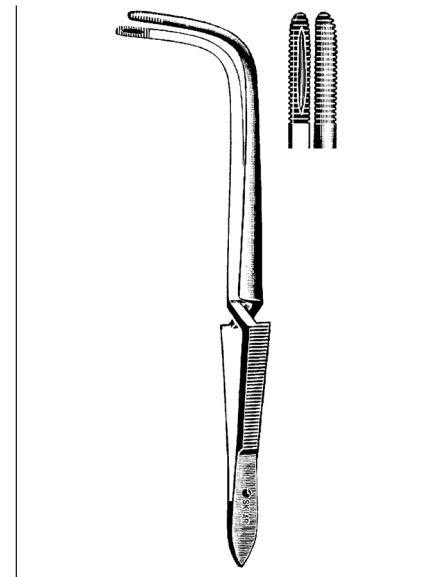

**JACKSON FORCEPS**

**CROSS ACTION, SERRATED**

- 76-1390 9"
- 76-1490 9" With Teeth



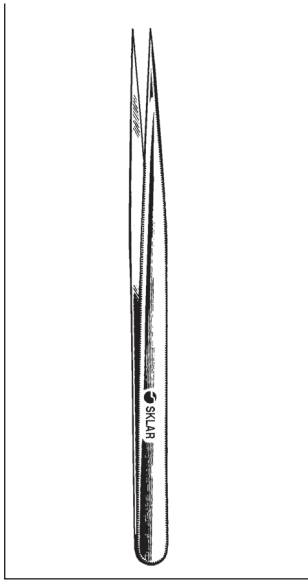

**JEWELERS FORCEPS**

66-7436 4½" With extra fine tips, Style 1

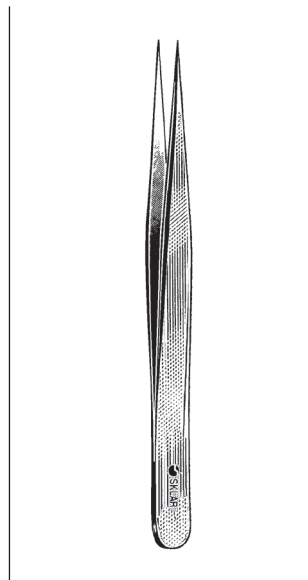

**JEWELERS FORCEPS**

66-7438 4½" With fine tips, Style 1

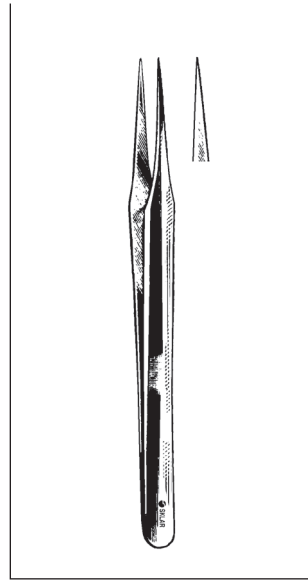

**JEWELERS FORCEPS**

66-7440 4½" With fine tips, Style 2

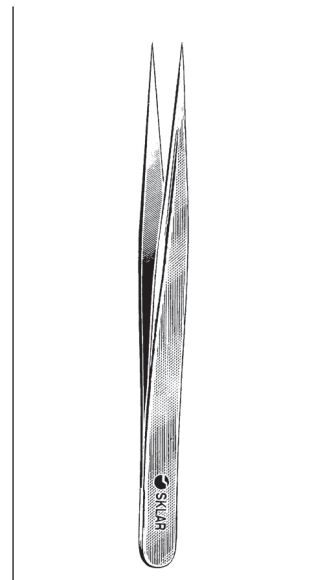

**JEWELERS STYLE FORCEPS**

66-7447 4½" #3 Straight  
66-7442 4½" #3C Straight Delicate  
66-7443 4¾" #3 Straight Micro-Fine



**JEWELERS STYLE FORCEPS**

DELICATE, STRAIGHT  
66-7542 4½" #4

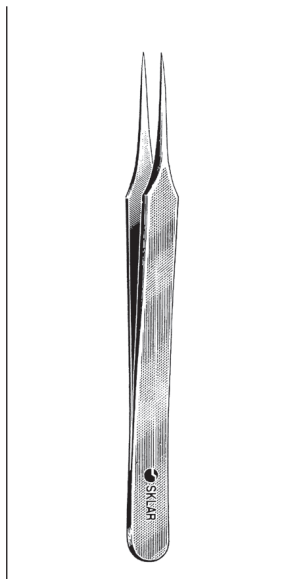

**JEWELERS STYLE FORCEPS**

STRAIGHT  
66-7642 4½" #5

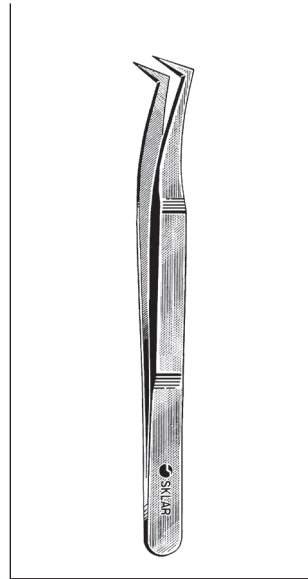

**JEWELERS STYLE FORCEPS**

ANGLED  
66-7645 4½" #5

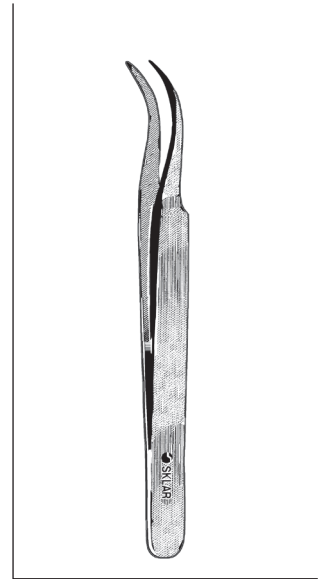

**JEWELERS STYLE FORCEPS**

CURVED  
66-7644 4½" #7

**FORCEPS  
SPLINTER**

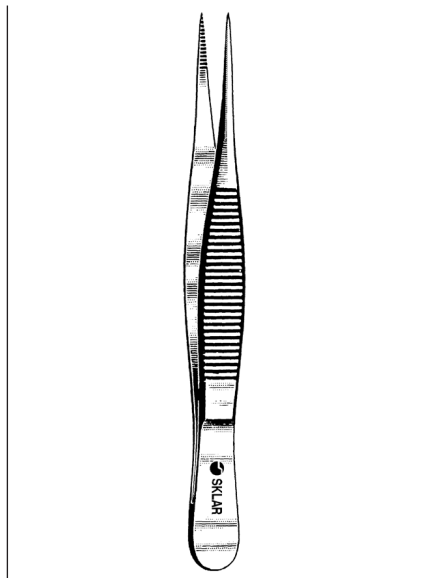

**FINE POINT SPLINTER  
FORCEPS**

**STRAIGHT**

- 19-3035 3½"
- 19-3040 4"
- 19-3045 4½"

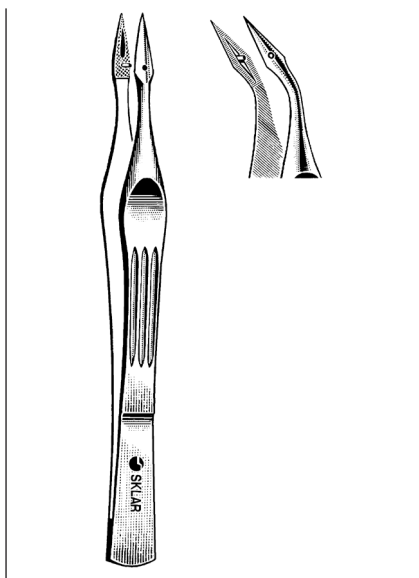

**CARMALT SPLINTER FORCEPS**

- 19-3240 4¼" Straight
- 19-3340 4¼" Curved

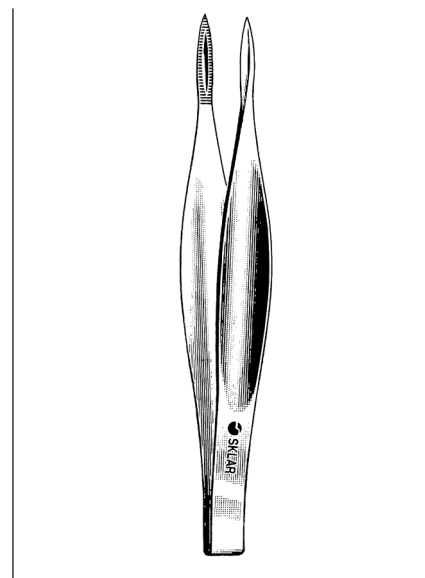

**FEILCHENFELD SPLINTER  
FORCEPS**

**STRAIGHT**

- 19-2930 3"
- 19-2945 4½"

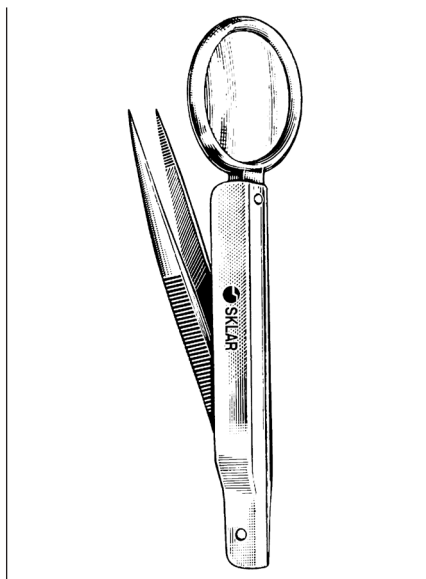

**PLAIN SPLINTER FORCEPS**

**WITH MAGNIFIER**

- 19-3030 3" Non-Autoclavable
- 94-7001 3" Floor Grade
- 21-708 3" Floor Grade, 12/box

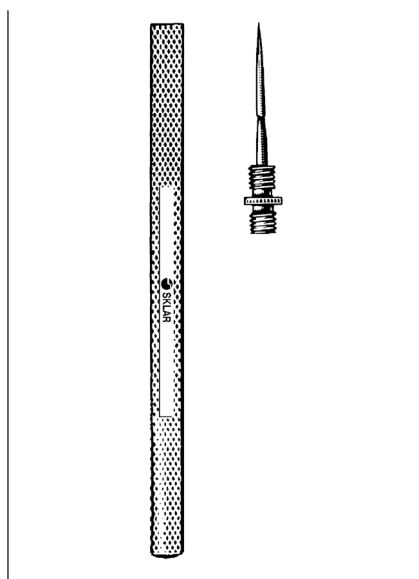

**VANGUARD SPLINTER PICK**

- 19-3350 Trocar Point

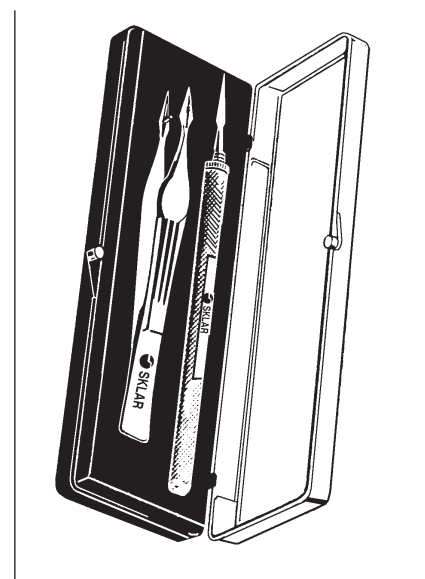

**SKLAR SPLINTER REMOVAL KIT**

- 19-3360 Containing one 19-3240 and one 19-3350 in a convenient storage case.

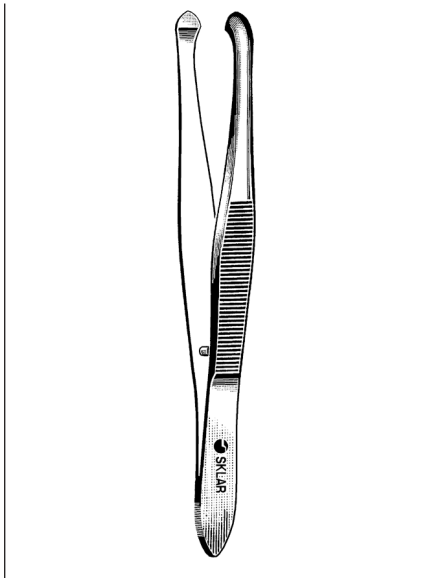

**ZIEGLER CILIA FORCEPS**

SMOOTH

66-1535 3½" 2mm

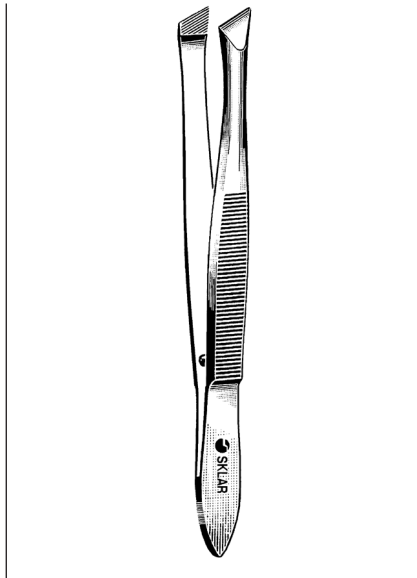

**BERGH CILIA FORCEPS**

66-1635 3½" 5mm

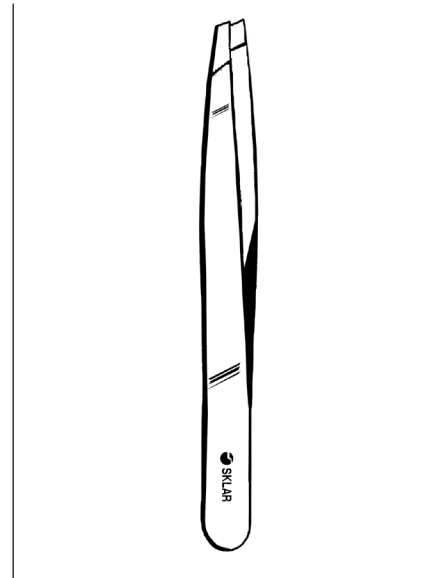

**SWISS CILIA FORCEPS**

DIAGONAL JAWS

66-1740 3¾" 3mm

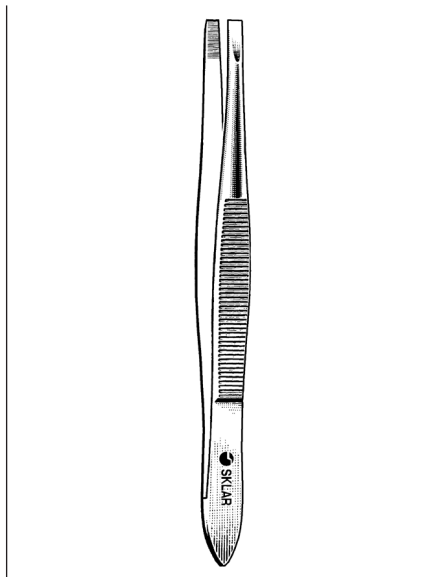

**DOUGLASS CILIA FORCEPS**

THIN TIPS

66-1830 3½" 2.5mm

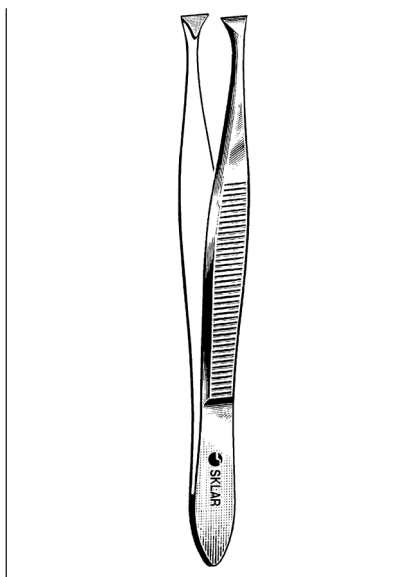

**LITTAUER CILIA FORCEPS**

66-1735 3½" 4mm

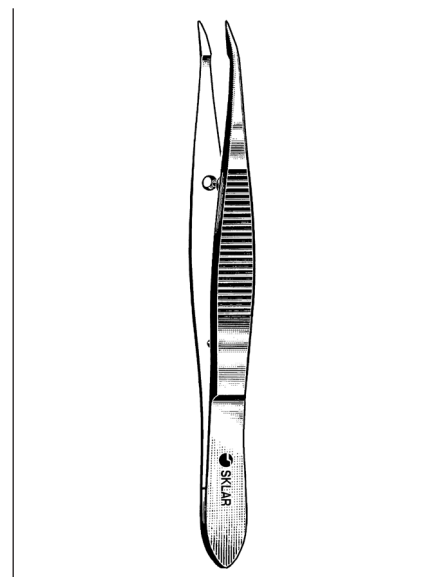

**BARRAQUER CILIA FORCEPS**

SMOOTH

66-1742 4¼" 5mm

FORCEPS

THUMB

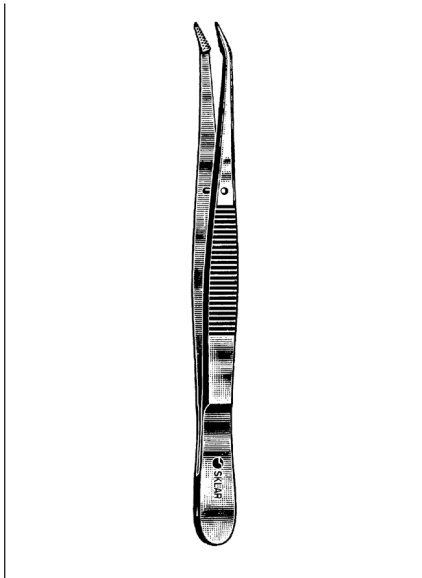

**HEALY SUTURE FORCEPS**

24-2155 5½"

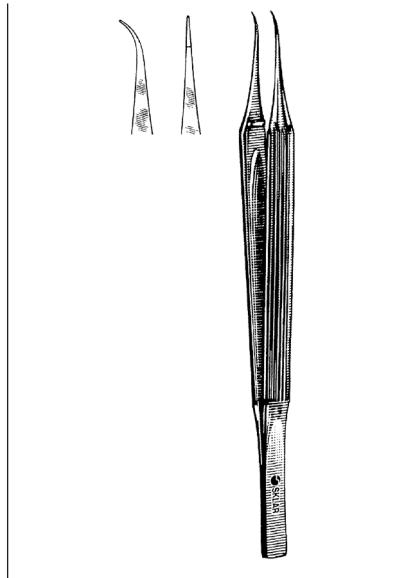

**MICRO SUTURE TYING FORCEPS**

98-2080 6" Straight  
98-2081 6" Curved

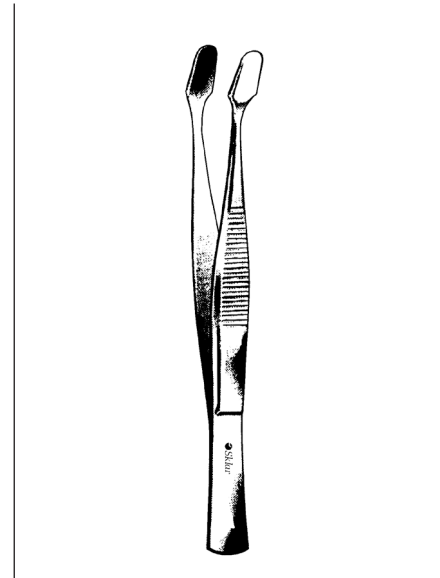

**KUEHNE COVER GLASS FORCEPS**

**ANGLED**  
19-3400 4"

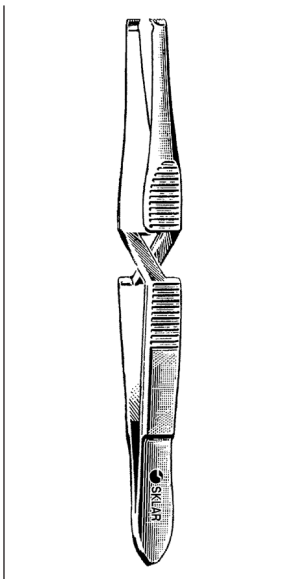

**HEGENBARTH CLIP FORCEPS**

**STRAIGHT**  
24-1650 5"

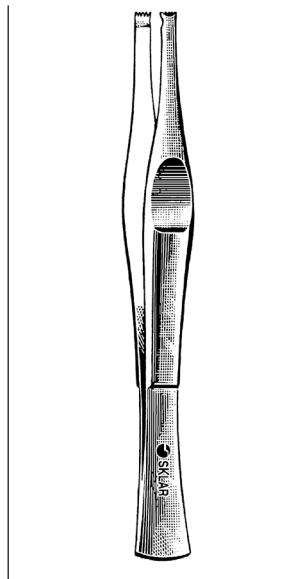

**MICHEL CLIP APPLYING FORCEPS**

24-1150 5"

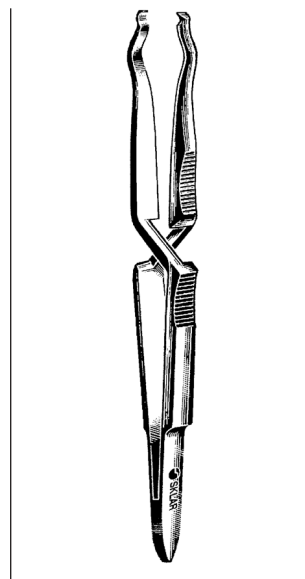

**WACHENFELDT CLIP FORCEPS**

**X-ACTION**  
24-1450 5"

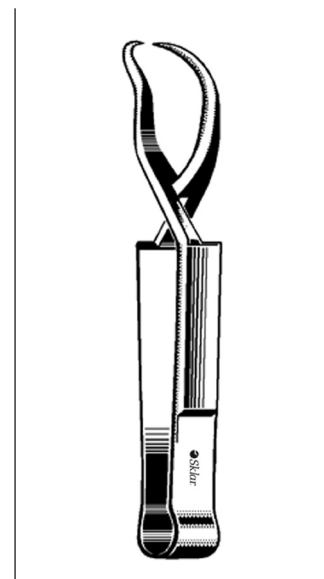

**SCHAEDEL TOWEL CLAMP**

47-2937 3½"

# *Sklar TC Insert Forceps*

## *Grip Vessels, Tissues And Sutures*

### *Firmly Yet Gently*

SKLAR TC INSERT forceps are designed to provide long-lasting, positive holding power. SKLAR TC INSERT forceps utilize a special non-slip tissue gripping profile, which enables the user to apply exactly the amount of pressure needed for proper tissue handling and suture tying with reduced trauma.

SKLAR TC INSERT forceps with durable tungsten-carbide inlays, exceptionally fine milled serrations, easy-find gold-plated handles, and a full 5-year performance guarantee make SKLAR TC INSERT forceps the surgeon's choice.

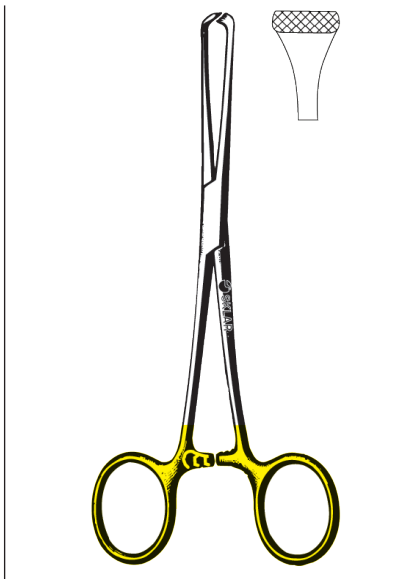

**TC ALLIS FORCEPS**

97-1555 6"  
97-1560 7½"

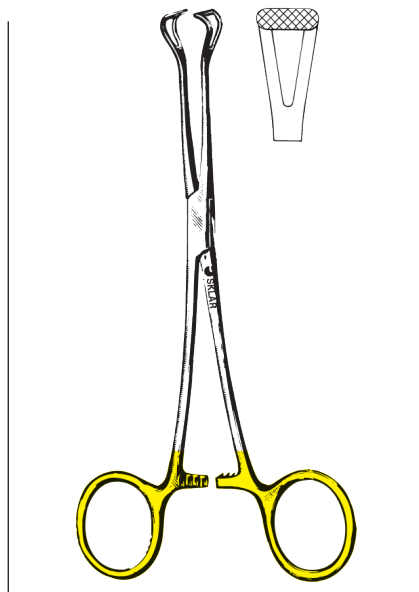

**TC BABCOCK FORCEPS**

97-1565 6¼"  
97-1570 8"

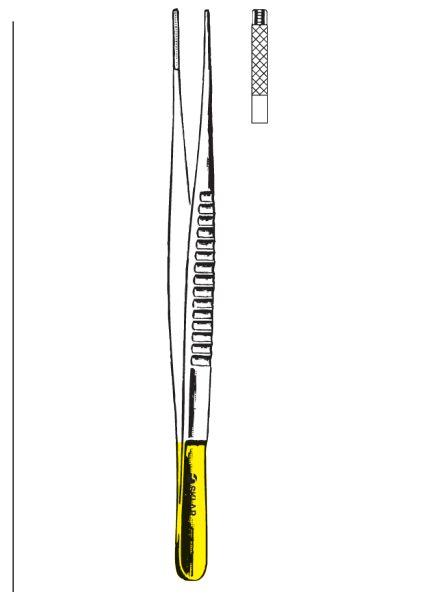

**TC DEBAKEY FORCEPS**

97-1530 6" 2.0mm Tips  
97-1531 6" 2.7mm Tips  
97-1540 8" 2.0mm Tips  
97-1541 8" 2.7mm Tips



**TC ADSON DRESSING FORCEPS**

**1X2 TEETH, WITH TYING PLATFORM**

- 51-3049 4¾" Cross-Serrations
- 51-3050 4¾" Smooth, Gorney Adson
- 51-3051 6" Cross-Serrations

**CROSS-SERRATIONS**

- 51-3447 4¾"
- 51-3448 6"

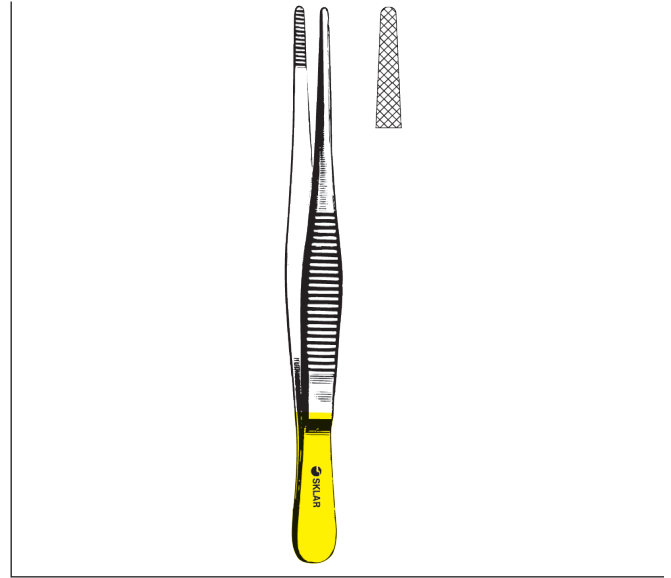

**TC DRESSING FORCEPS**

**SERRATED**

- 51-3460 6"
- 51-3480 8"



**TC POTTS-SMITH DRESSING FORCEPS**

**SERRATED**

- 51-4360 6"
- 51-4370 7"
- 51-4382 8¼"
- 51-4395 9½"

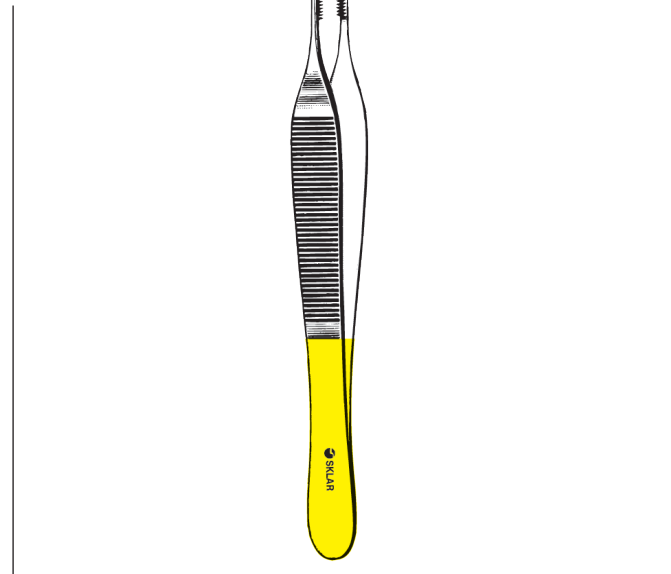

**TC ADSON BROWN FORCEPS**

- 51-1446 4¾" 4x4
- 51-1447 4¾" Side Grasping

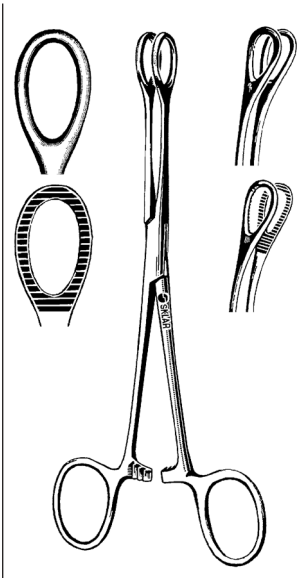

**BALLENGER SPONGE FORCEPS**

**STRAIGHT**

74-1370	7"	Smooth
74-1470	7"	Serrated

**CURVED**

74-1570	7"	Smooth
74-1670	7"	Serrated

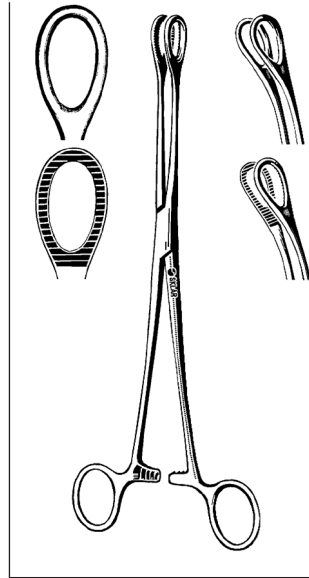

**FOERSTER SPONGE FORCEPS**

**STRAIGHT**

87-2095	9½"	Smooth
87-2195	9½"	Serrated

**CURVED**

87-2295	9½"	Smooth
87-2395	9½"	Serrated

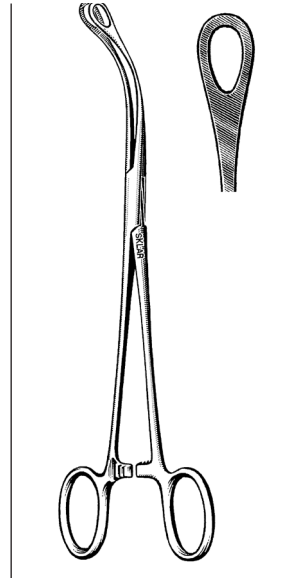

**PEANUT SPONGE FORCEPS**

**STRAIGHT**

22-9380	8"	Smooth
---------	----	--------

**CURVED**

22-9480	8"	Serrated
---------	----	----------

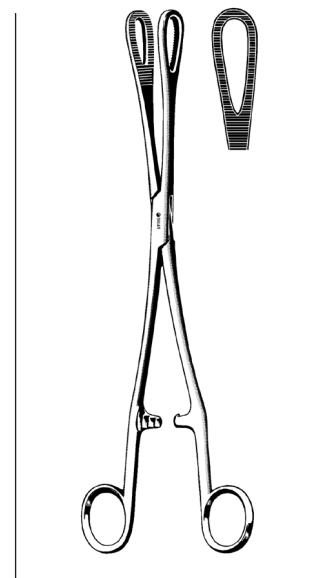

**RAMPLEY SPONGE FORCEPS**

87-2240	9¾"
---------	-----

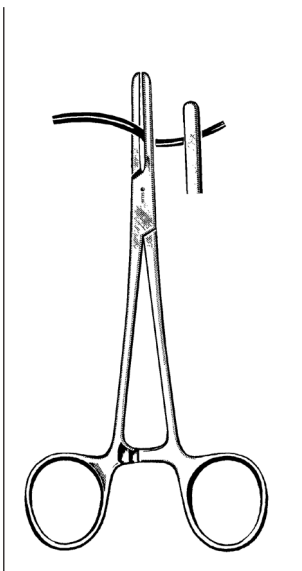

**TUBE OCCLUDING CLAMPS**

**SMOOTH JAW, STRAIGHT**

17-3995	5½"
17-3996	6½"
17-3997	7"

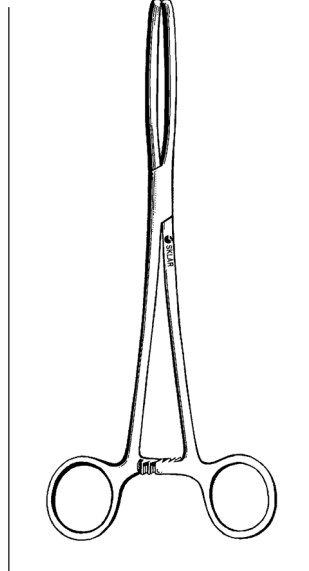

**MARCUSE TUBING FORCEPS**

**STRAIGHT**

17-3955	6"	Smooth
17-3965	6½"	Smooth
17-3980	8"	Smooth

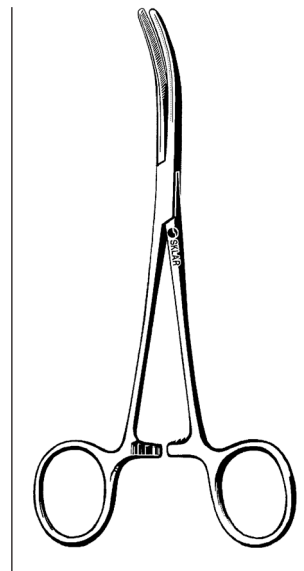

**ST. VINCENT TUBING FORCEPS**

**CURVED**

17-3962	6¼"	Standard
17-3970	7"	Heavy

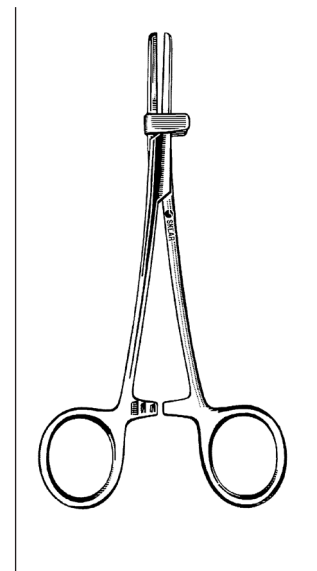

**VORSE TUBE OCCLUDING FORCEPS**

**STRAIGHT-SERRATED**

17-3956	6"	
17-3960	6"	With Guard



**JOHNS HOPKINS OCCLUDING FORCEPS**

**STRAIGHT**  
52-1080

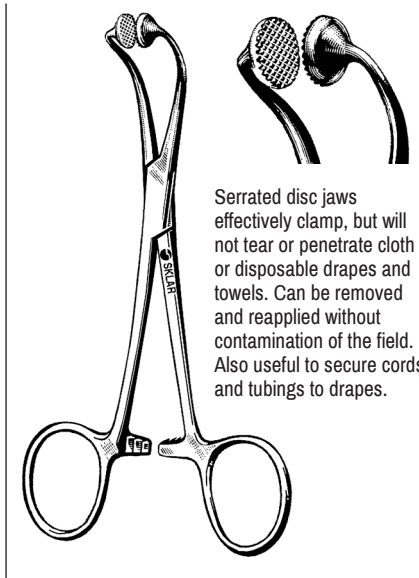

Serrated disc jaws effectively clamp, but will not tear or penetrate cloth or disposable drapes and towels. Can be removed and reapplied without contamination of the field. Also useful to secure cords and tubings to drapes.

**HOFF TOWEL CLAMPS**

**STAINLESS STEEL**  
47-3040 4"  
47-3057 6¼"

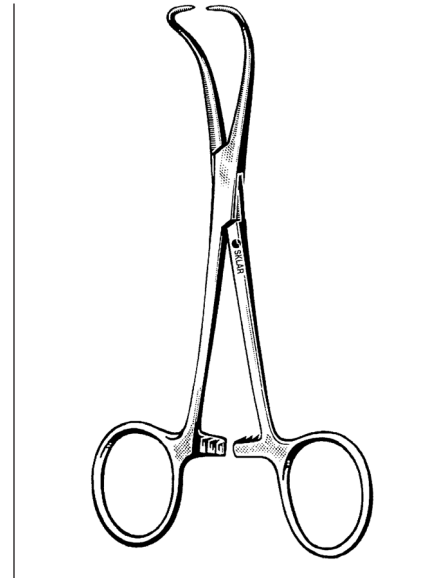

**BACKHAUS TOWEL CLAMPS**

47-2935 3½"  
47-2945 4½"  
47-2955 5¼"  
47-2960 6"

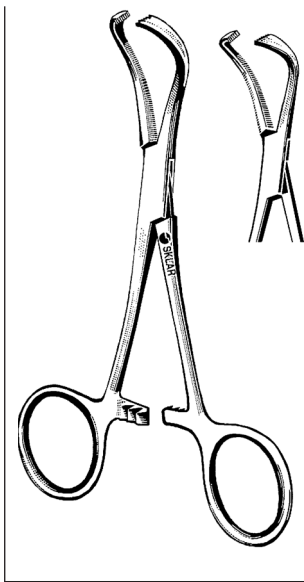

**LORNA (EDNA) TOWEL CLAMPS**

**NON-PERFORATING**  
47-2837 4"  
47-2852 5¼"

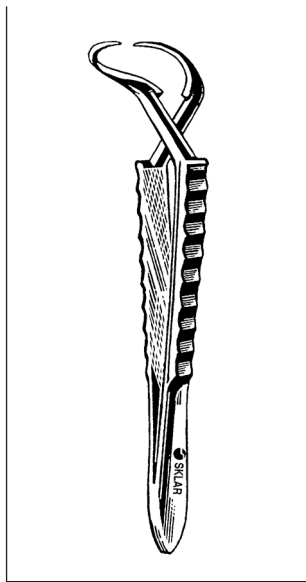

**JONES CROSS ACTION TOWEL CLAMPS**

47-2925 2¼" Delicate  
47-2927 3"  
47-2930 3½"

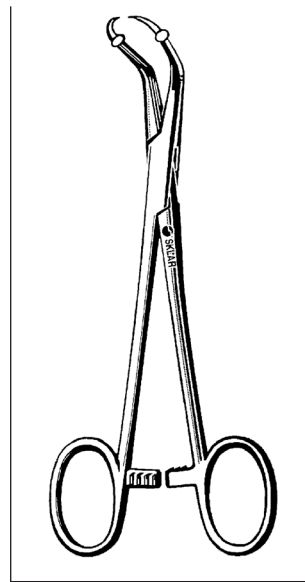

**ROEDER TOWEL CLAMP**

**WITH BALL STOPS**  
87-1052 5¼"

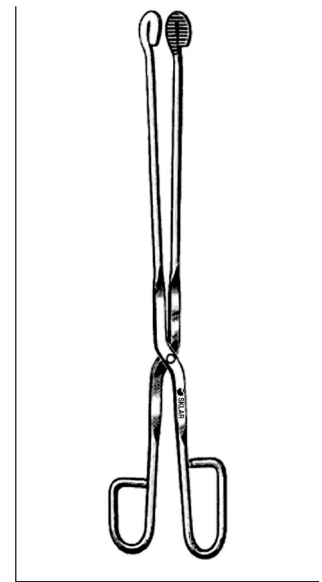

**STERILIZATION FORCEPS**

**STRAIGHT**  
10-1080 8"  
10-1111 11"  
**CURVED**  
10-1081 8"  
10-1211 11"



# NEEDLE HOLDERS

## GENERAL

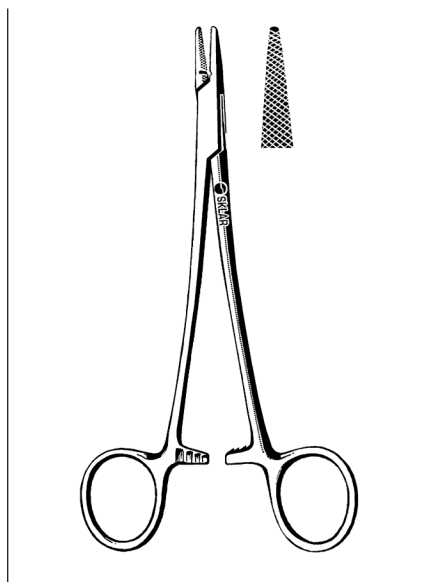

### CRILE-MURRAY NEEDLE HOLDER

20-1260 6" Serrated

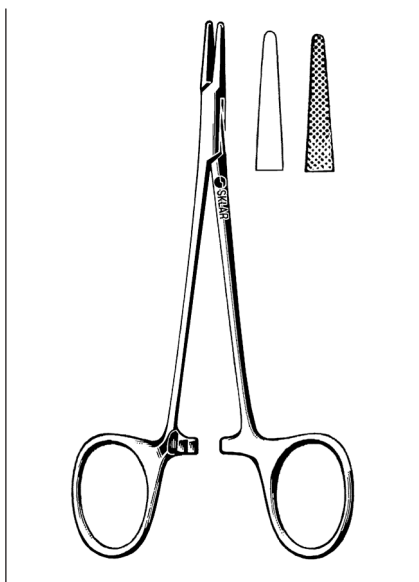

### WEBSTER NEEDLE HOLDERS

#### DELICATE

20-1350 5¼" Smooth

20-1352 5¼" Serrated

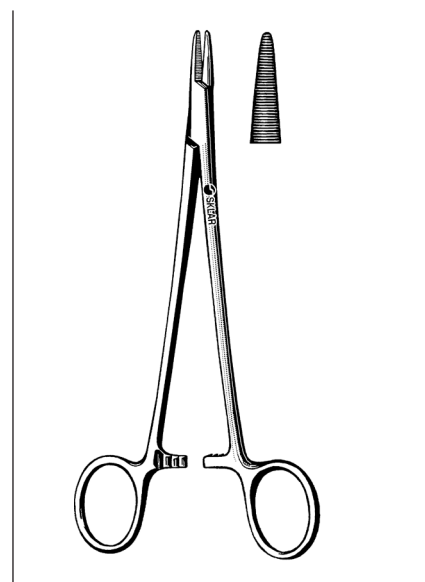

### BROWN NEEDLE HOLDERS

#### ROUNDED JAWS

20-4852 5¼"

20-4867 6¾"

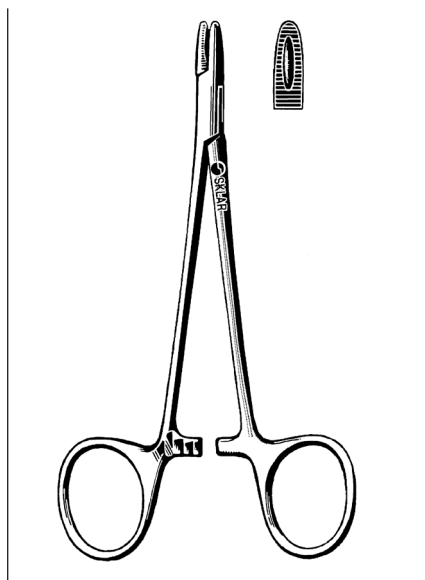

### DERF NEEDLE HOLDER

20-1547 4¾" Serrated

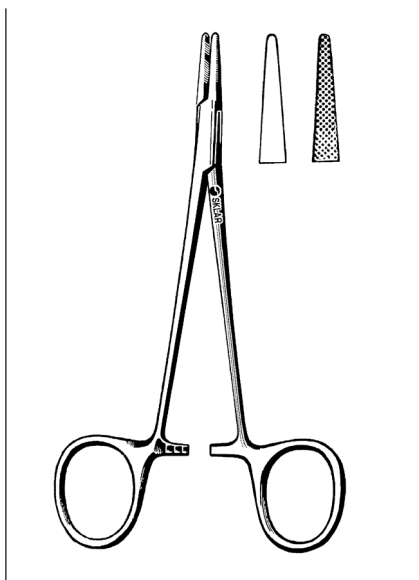

### HALSEY NEEDLE HOLDERS

20-1750 5¼" Smooth

20-1751 5¼" Serrated

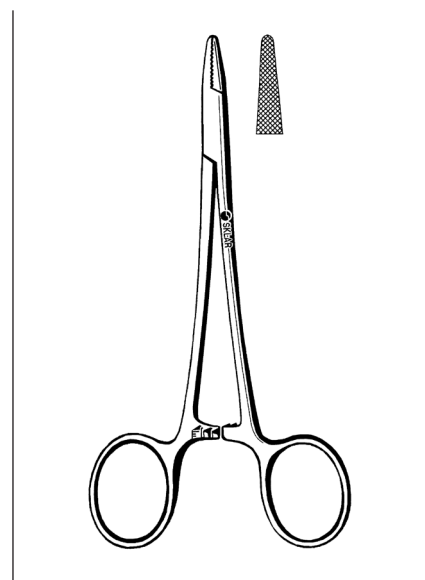

### BAUMGARTNER NEEDLE HOLDER

20-1450 5¼" Serrated

NEEDLE HOLDERS

GENERAL

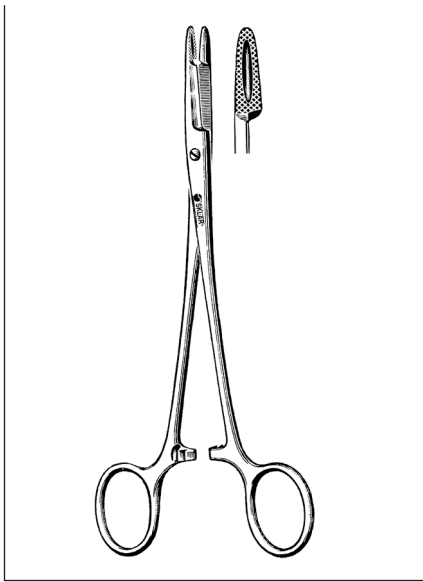

**OLSEN-HEGAR  
NEEDLE HOLDERS**

**SCISSORS COMBINATION**

20-2748	4¾"	Smooth, Delicate
20-2747	4¾"	Serrated, Delicate
20-2755	5½"	Serrated
20-2765	6½"	Serrated
20-2775	7"	Serrated

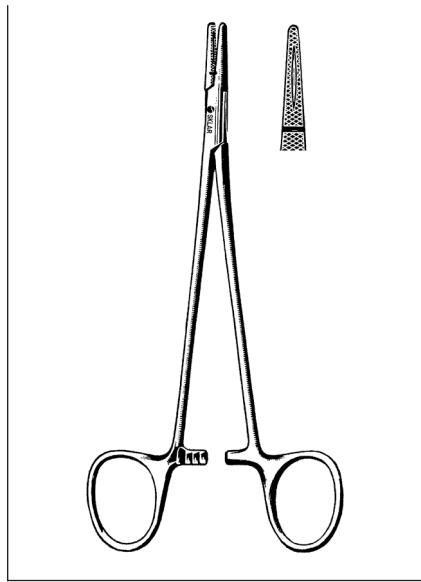

**CRILE-WOOD  
NEEDLE HOLDERS**

**SERRATED**

20-1265	6"	Narrow Jaws
20-1270	7"	DeBakey Type
20-1280	8"	DeBakey Type
20-1290	9"	DeBakey Type
20-1295	10½"	DeBakey Type

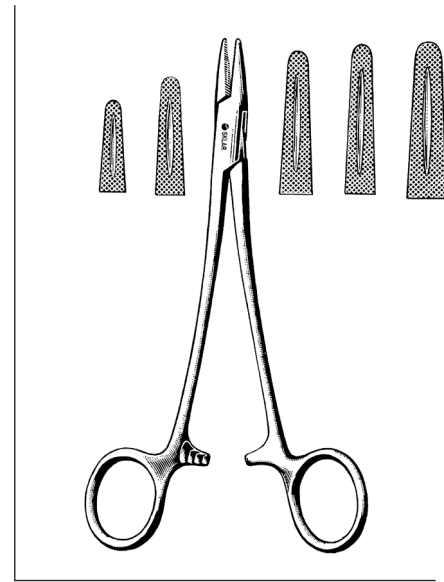

**MAYO-HEGAR NEEDLE HOLDERS**

**SERRATED**

20-2052	5¼"	20-2480	8"
20-2060	6"	20-2490	9½"
20-2070	7"	20-2910	10½" Masson
20-2270	7" Broad Jaw	20-2911	11½" Masson

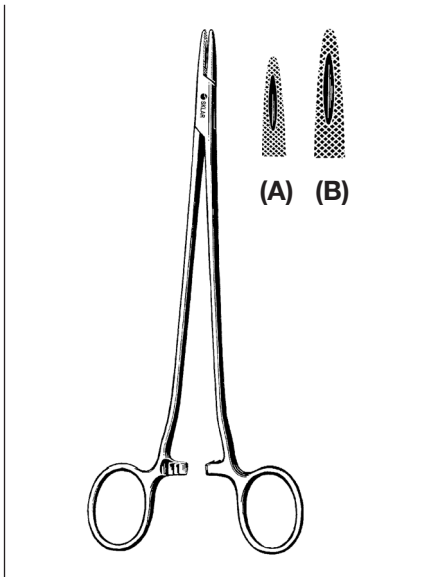

**SAROT NEEDLE HOLDERS**

**SERRATED**

22-5050	5"	A Jaw	Pediatric
20-4170	7½"	A Jaw	
20-3910	10¼"	B Jaw	

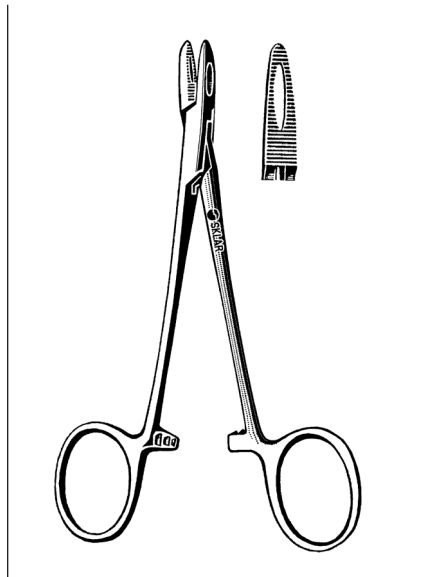

**COLLIER NEEDLE HOLDER**

**FENESTRATED JAW**

65-6550	5¼"	Serrated
---------	-----	----------

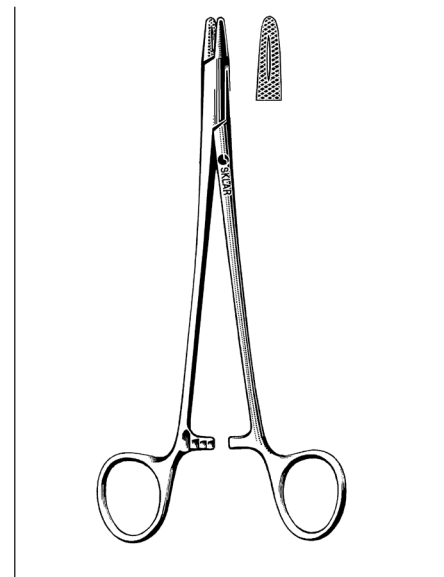

**NEW ORLEANS NEEDLE HOLDER**

20-1870	7"	Serrated
---------	----	----------

# NEEDLE HOLDERS

## GENERAL



**HEANEY NEEDLE HOLDER**  
20-4682 8¼" Serrated, Curved



**FINOCHIETTO NEEDLE HOLDER**  
20-4510 10¼" Serrated, Angular

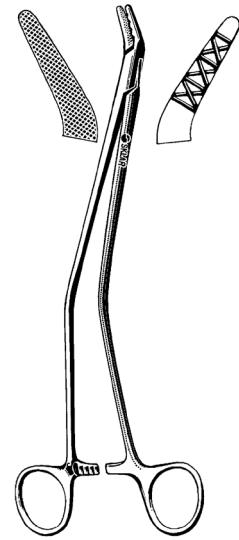

**JOHNSON NEEDLE HOLDER**  
20-4610 10¾"

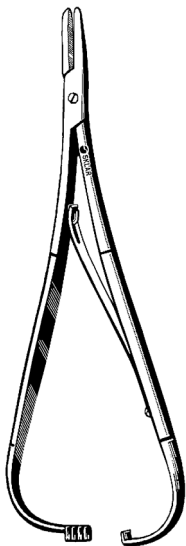

**MATHIEU NEEDLE HOLDERS**  
20-3055 5½" Serrated  
20-3075 7½" Serrated



**STEVENS NEEDLE HOLDER**  
65-6265 6"

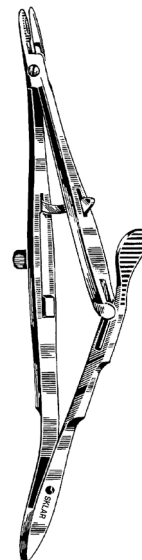

**CASTROVIEJO-KALT  
NEEDLE HOLDERS**  
65-6055 5½" Serrated  
65-6255 5½" With Suture Cutter



NEEDLE HOLDERS

MICRO



**CASTROVIEJO NEEDLE HOLDERS**

**WITH CATCH**

- 65-6357 5½" Straight
- 65-6358 5½" Curved



**BARRAQUER NEEDLE HOLDERS**

**WITHOUT CATCH**

- 65-6452 5¼" Curved
- 65-6454 5½" Straight
- 65-6455 5½" Curved
- 65-6456 7½" Straight
- 65-6457 7½" Curved

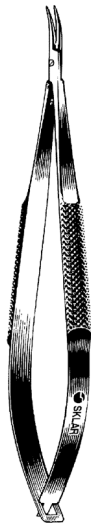

**STANGEL-BARRAQUER NEEDLE HOLDER**

- 65-6552 4½" Curved

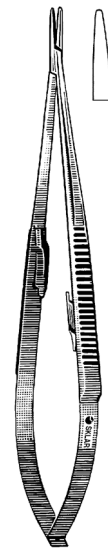
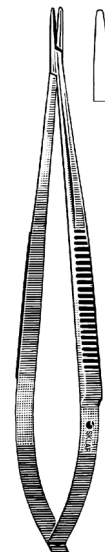

**JACOBSON MICRO NEEDLE HOLDERS**

**WITHOUT CATCH**

- 98-3070 7" Straight, Smooth
- 98-3085 8½" Straight, Smooth

**WITH CATCH**

- 98-3170 7" Straight, Smooth
- 98-3171 7" Curved, Smooth

## Sklar TC™ Needle Holders Are Unconditionally Guaranteed for Five Years

SKLAR TC needle holders are designed to hold suture needles far more securely and firmly than standard needle holders. They utilize solid tungsten-carbide inserts for the longest life possible. All inserts have a precisely ground, virtually indestructible, pyramid profile that is harder than the needles they hold. The pyramid profile retains its original shape much longer than other needle holders. This profile ensures firm needle holding capability and virtually eliminates needle rotation.

SKLAR TC needle holders feature graduated ratchet grips for safe, secure and exacting control over needle holding pressure, and gold plated rings for quick identification.

### 5 Year Warranty

SKLAR TC needle holder jaws with tungsten carbide inserts are warranted for five full years of normal use. During this warranty period, if any adjustments become necessary, SKLAR will repair or replace the SKLAR TC needle holders. A nominal charge will be made for repairs once the warranty period has expired. The non-TC portion of the instrument is guaranteed under Sklar's Lifetime Warranty.

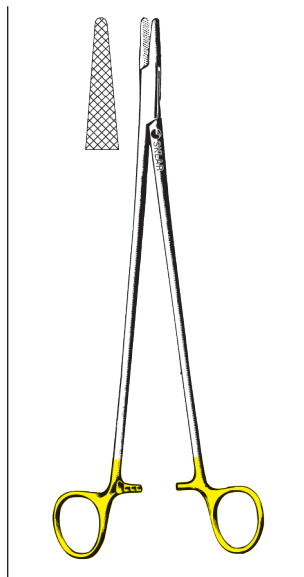

**TC WANGENSTEEN  
NEEDLE HOLDER**

**SERRATED**

21-3510 10½"

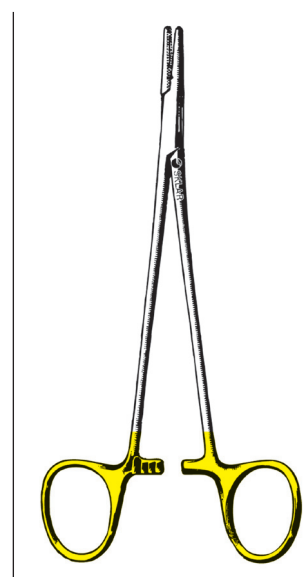

**TC DEBAKEY  
CARDIOVASCULAR  
NEEDLE HOLDERS**

**SERRATED**

21-8087 7"

**SERRATED, FENESTRATED**

21-8088 8"

21-8089 9"

21-8090 10"

21-8092 12"

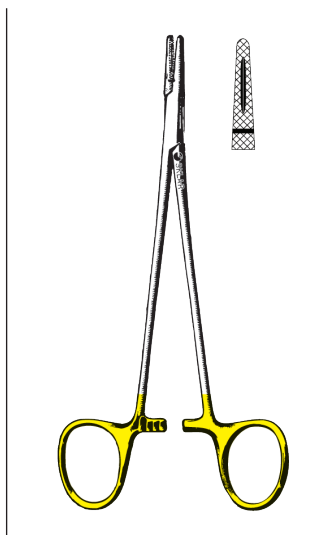

**TC DEBAKEY  
NEEDLE HOLDER**

**SERRATED**

21-5112 12"

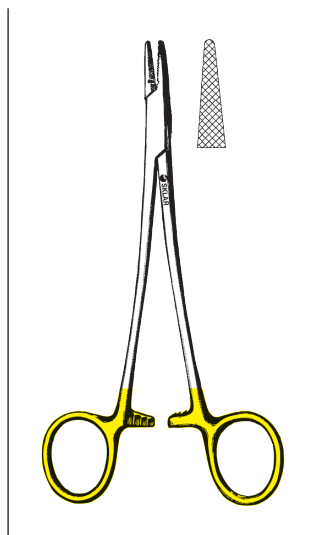

**TC CRILE-MURRAY  
NEEDLE HOLDER**

**SERRATED**

21-8075 6"

21-1260 6" SklarGrip

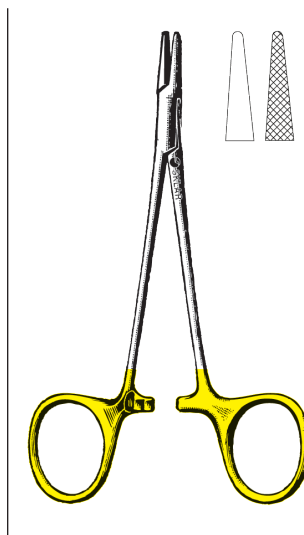

**TC WEBSTER  
NEEDLE HOLDERS**

21-8002 5¼" Smooth

21-8080 5¼" Serrated

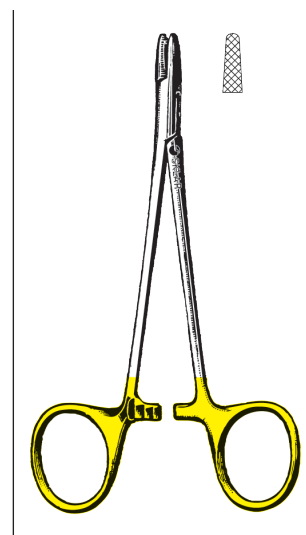

**TC DERF  
NEEDLE HOLDER**

**SERRATED**

21-8004 4¾"



**NEEDLE HOLDERS**  
**TUNGSTEN CARBIDE**

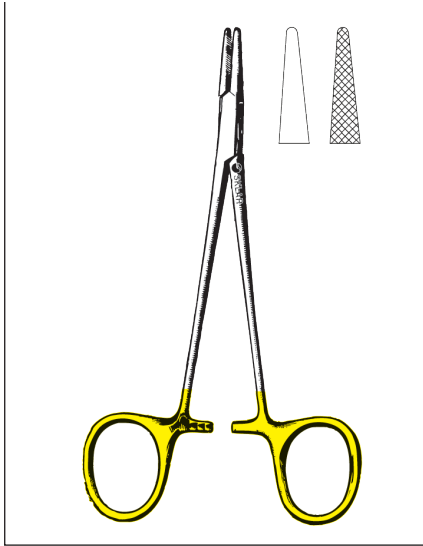

**TC HALSEY  
NEEDLE HOLDERS**

- 21-8000 5¼" Smooth
- 21-8001 5¼" Serrated

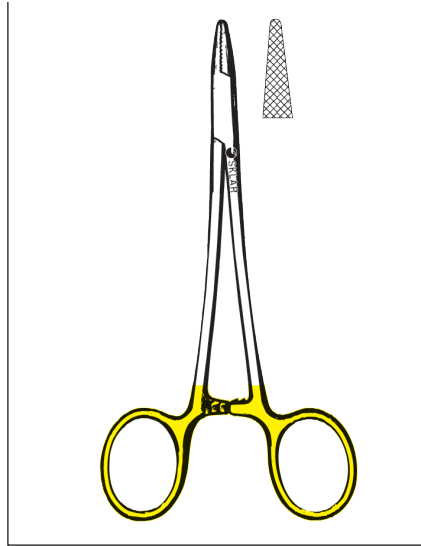

**TC BAUMGARTNER  
NEEDLE HOLDER**

- SERRATED**
- 21-8005 5¼"

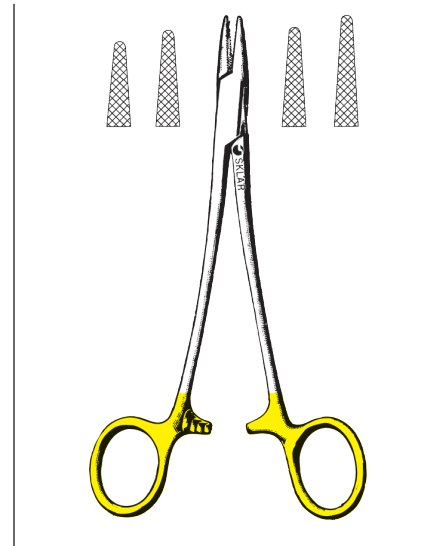

**TC CRILE-WOOD  
NEEDLE HOLDERS**

- SERRATED**
- 21-8006 6" Narrow
  - 21-8007 7" DeBakey
  - 21-8008 8" DeBakey
  - 21-8009 9" DeBakey
  - 21-8010 10½" DeBakey
  - 21-8011 12" DeBakey

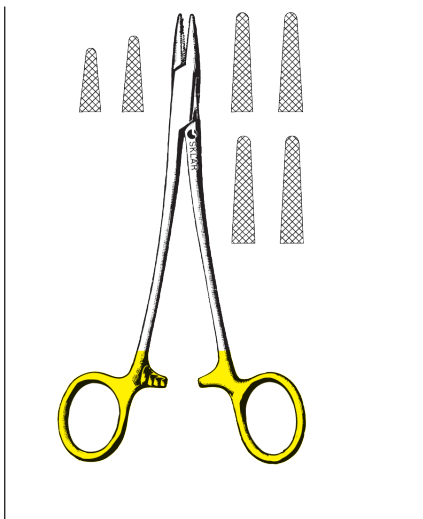

**TC MAYO-HEGAR  
NEEDLE HOLDERS**

- SERRATED**
- 21-8030 5½"
  - 21-8031 6"
  - 21-8032 7"
  - 21-2570 7" Broad Jaw
  - 21-8033 8"
  - 21-8051 9½"
  - 21-8034 10½"
  - 21-8035 12"

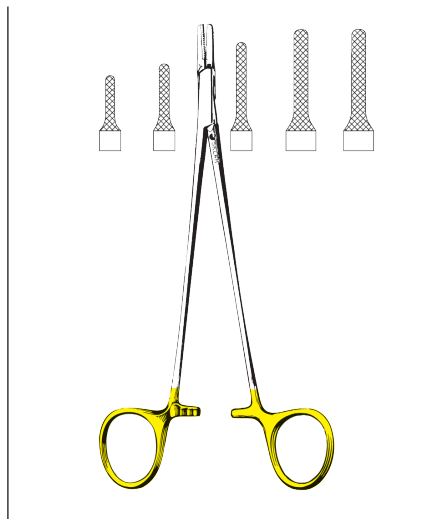

**TC RYDER NEEDLE HOLDERS**

- SERRATED**
- 21-8019 5"
  - 21-8020 6"
  - 21-8021 7"
  - 21-8022 8"
  - 21-8023 9"

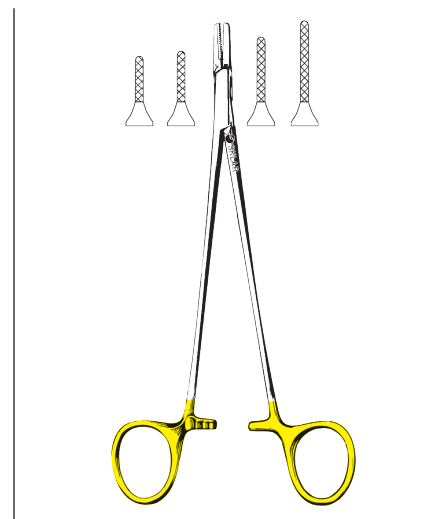

**TC RYDER NEEDLE HOLDERS**

- MICRO-SERRATED**
- 21-8012 5"
  - 21-8013 6"
  - 21-8014 7"
  - 21-8016 9"

# NEEDLE HOLDERS

## TUNGSTEN CARBIDE



**TC NEW ORLEANS  
NEEDLE HOLDER**

21-8082 7" Serrated

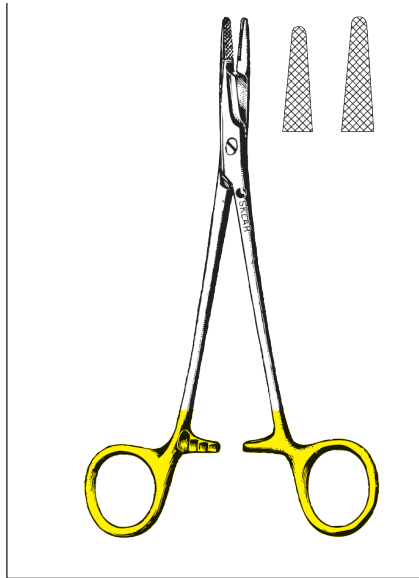

**TC OLSEN-HEGAR  
NEEDLE HOLDERS**

21-8025 4¾" Serrated, Delicate  
21-8026 4¾" Smooth, Delicate  
21-8027 5½" Serrated  
21-8028 6½" Serrated  
21-8029 7½" Serrated

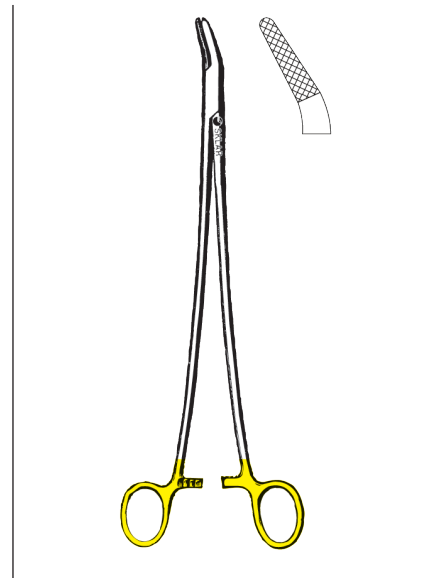

**TC HEANEY NEEDLE HOLDERS  
CURVED**

21-8060 8¼" Serrated  
21-8061 10" Serrated

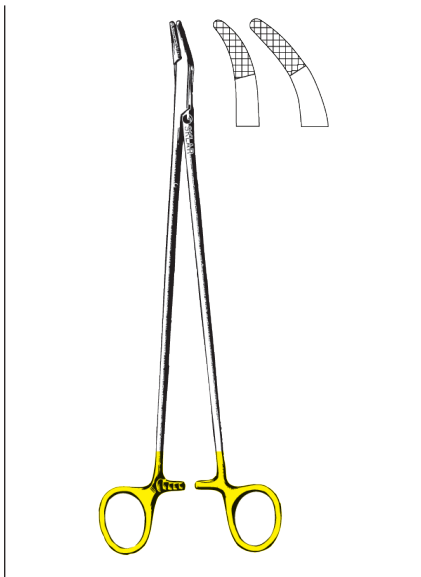

**TC FINOCHIETTO  
NEEDLE HOLDER**

**ANGULAR**

21-8039 10½" Serrated

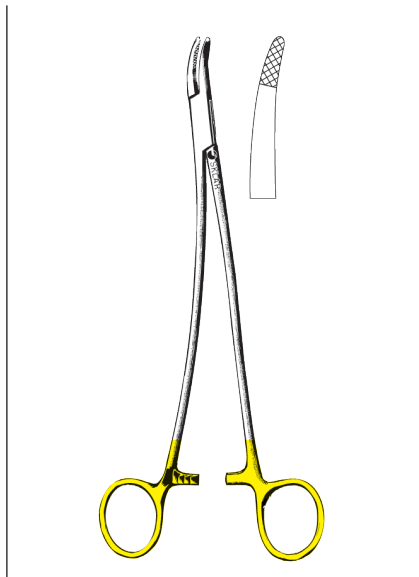

**TC STRATTE NEEDLE HOLDER**

**"S" SHAPED**

21-8065 9" Serrated

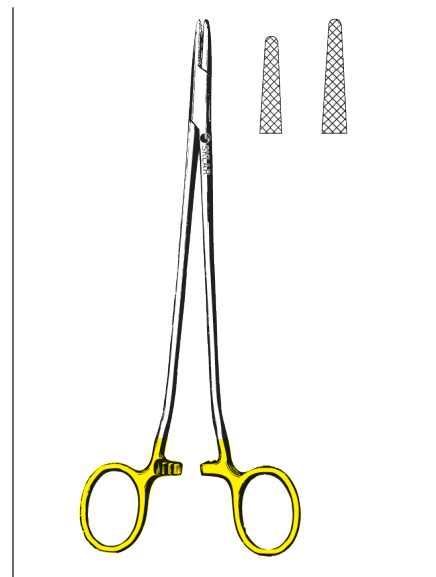

**TC SAROT NEEDLE HOLDERS**

21-8036 7⅞" Serrated  
21-8037 10½" Serrated



**NEEDLE HOLDERS**  
**TUNGSTEN CARBIDE**

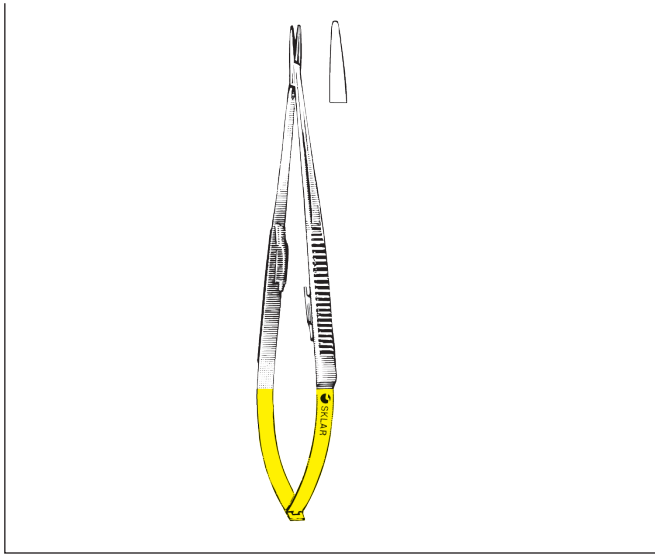

**TC JACOBSON MICROVASCULAR  
NEEDLE HOLDERS**

**SMOOTH**

**WITH LOCK**

21-8053	7"	Straight
21-8253	7"	Curved
21-8055	8¼"	Straight
21-8255	8½"	Curved
21-8057	9"	Straight
21-8257	9"	Curved

**WITHOUT LOCK**

21-8054	7"	Straight
21-8254	7"	Curved
21-8058	8¼"	Straight
21-8258	8½"	Curved
21-8059	9"	Straight
21-8259	9"	Curved

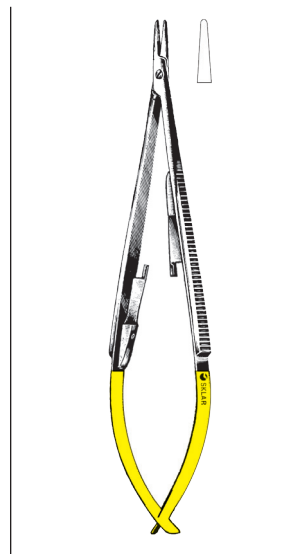

**TC CASTROVIEJO  
NEEDLE HOLDERS**

**STANDARD-WITH LOCK**

21-8040	5½"	Smooth, Straight
21-8046	5½"	Serrated, Straight
21-8047	5½"	Serrated, Curved

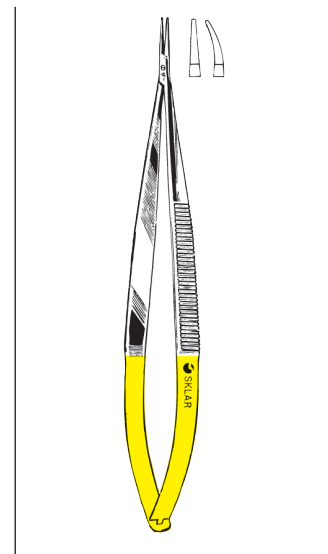

**TC CASTROVIEJO  
NEEDLE HOLDERS**

**EXTRA DELICATE-WITHOUT LOCK**

**SMOOTH**

21-8044	5½"	Straight
21-8045	5½"	Curved

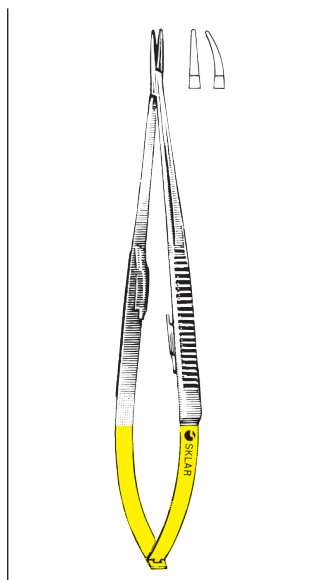

**TC CASTROVIEJO  
NEEDLE HOLDERS**

**EXTRA DELICATE-WITH LOCK**

**SMOOTH**

21-8042	5½"	Straight
21-8043	5½"	Curved

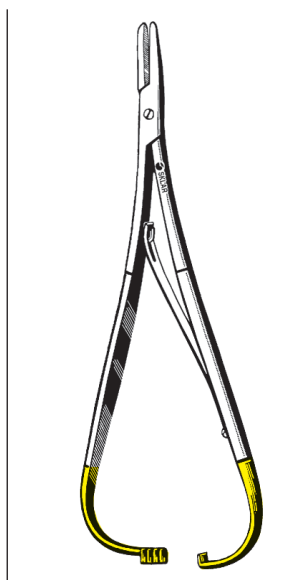

**TC MATHIEU  
NEEDLE HOLDERS**

21-8070	5½"	
21-8071	6¾"	Narrow Jaw

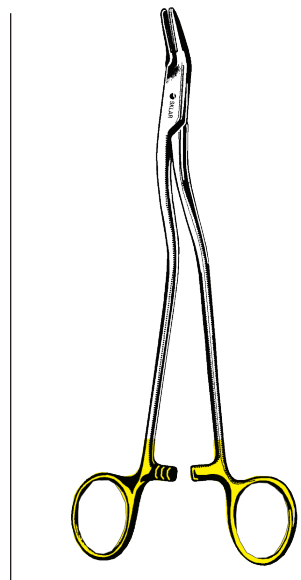

**TC BOZEMAN-  
HEANEY NEEDLE  
HOLDERS**

**S-CURVED**

21-2180	8"	
21-2195	9½"	
21-8062	10½"	

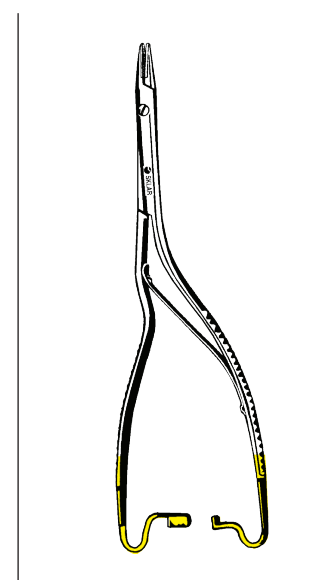

**TC LUETHY BECK  
NEEDLE HOLDER**

21-8064	8"	
---------	----	--





## Sklar's Left-Handed Needle Holders

Now there's a ring-handled needle holder created for the needs of left-handed surgeons.

Sklar's left-handed needle holder's features a unique ratchet design that makes it possible for surgeons to easily control the needle holder with their left hand. As a result surgeons experience less fatigue and hand strain than ever before.

Suitable for left hand use.

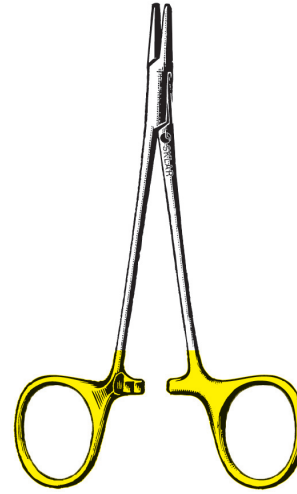

**TC WEBSTER NEEDLE HOLDER**

21-9012 5" Smooth

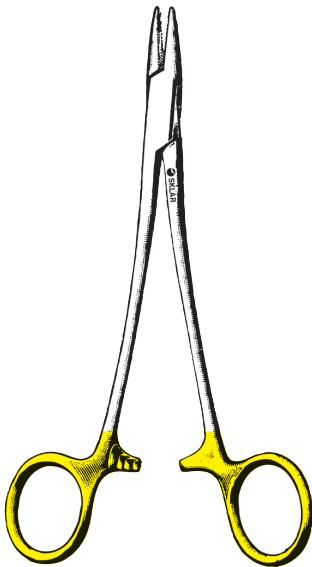

**TC MAYO-HEGAR NEEDLE HOLDERS**

**SERRATED (LEFT HANDED)**

21-9016 Mayo-Hegar 6"  
21-9018 Mayo-Hegar 7"



**TC RYDER NEEDLE HOLDER**

**SERRATED (LEFT HANDED)**

21-9045 Ryder French Eye 6"

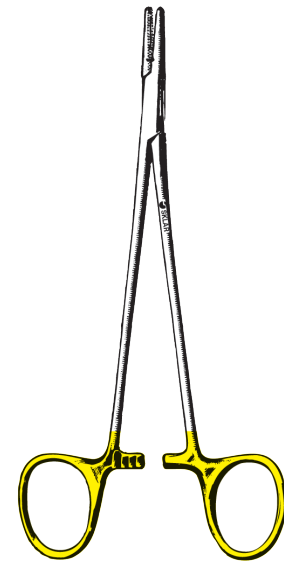

**TC CRILE-WOOD NEEDLE HOLDERS**

**SERRATED (LEFT HANDED)**

21-9030 Crile-Wood 6"  
21-9035 Crile-Wood 7"

RETRACTORS

GENERAL

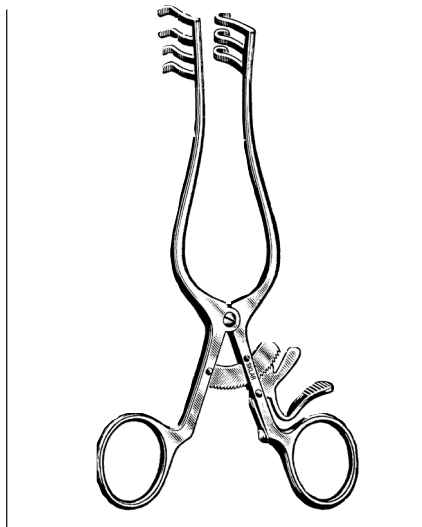

**WEITLANER SELF-RETAINING  
RETRACTORS**

**BLUNT**

22-8345	4½"	2x3 Teeth
22-8355	5½"	3x4 Teeth
42-1865	6½"	3x4 Teeth
42-1875	8"	3x4 Teeth
42-1895	9½"	3x4 Teeth

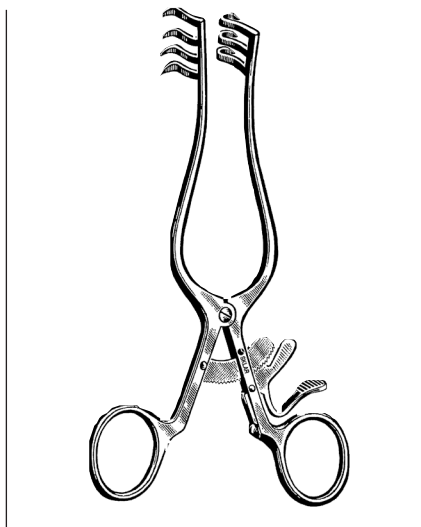

**WEITLANER SELF-RETAINING  
RETRACTORS**

**SHARP**

22-8245	4½"	2x3 Teeth
22-8255	5½"	3x4 Teeth
42-1965	6½"	3x4 Teeth
42-1975	8"	3x4 Teeth
42-1995	9½"	3x4 Teeth

**SOLID BLADES**

22-8760	5½"
---------	-----

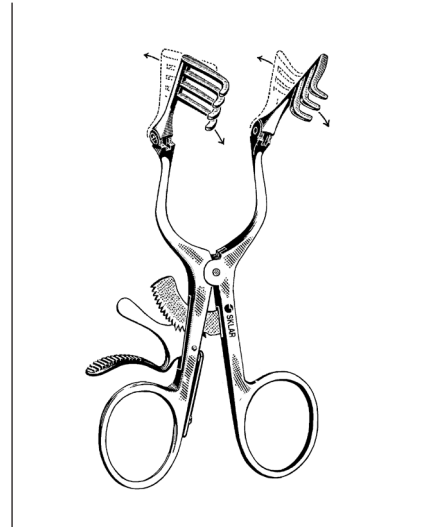

**WEITLANER BECKMAN  
RETRACTORS**

**HINGED BLADES WITH 3X4 PRONGS**

**BLUNT**

42-1654	5½"
42-1655	6½"
42-1656	9"
42-1657	10¼"

**SHARP**

42-1764	5½"
42-1765	6½"
42-1766	9"
42-1767	10¼"

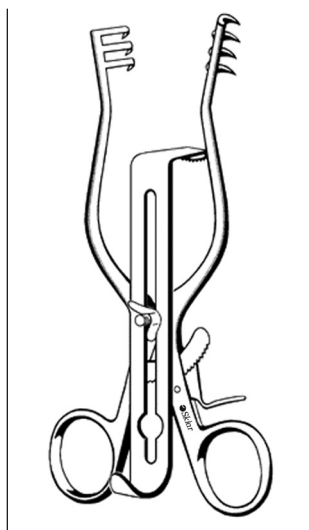

**HENLEY  
RETRACTORS**

**3X4 TEETH**

55-7340	6½"	Sharp
55-7341	6½"	Blunt

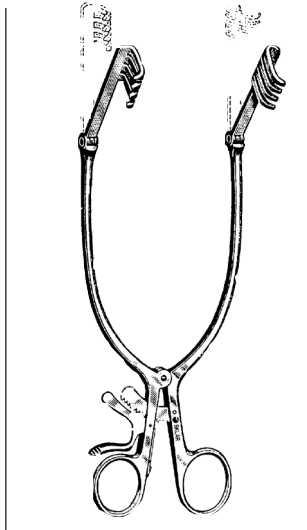

**ADSON-BECKMAN  
RETRACTORS**

**TRU-GRIP RATCHET**

42-1511	12"	Blunt
42-1611	12"	Sharp

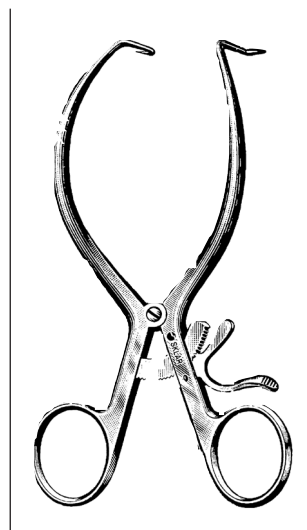

**GELPI RETRACTORS**

22-8850	3½"	
22-8853	5½"	
22-8855	6¼"	
60-6570	7"	
60-6580	7½"	With Stop

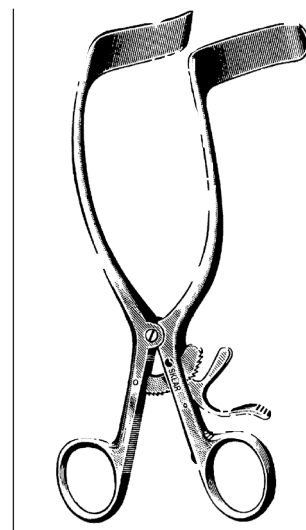

**RIGBY RETRACTOR**

**TRU-GRIP RATCHET**

60-6370	7"
---------	----

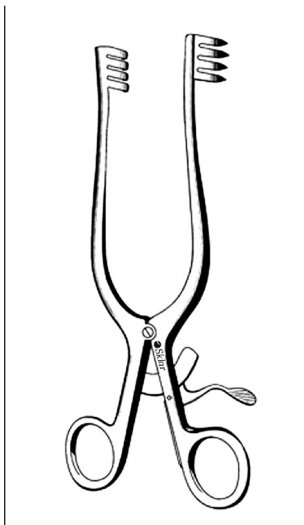

**ADSON RETRACTORS**

- SHARP**  
 42-1775 7½" 4x4 Teeth  
 42-1510 10½" 5x6 Teeth
- BLUNT**  
 42-1785 7½" 4x4 Teeth  
 42-1610 10½" 5x6 Teeth

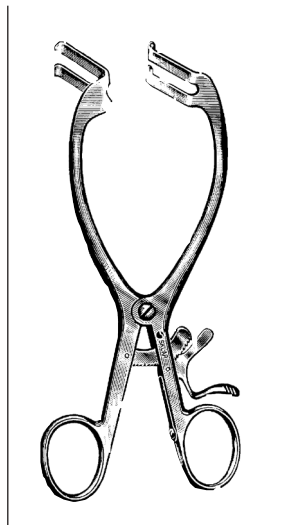

**MAYO-ADAMS  
RETRACTOR**

- 60-6467 6¼" 2 Blades

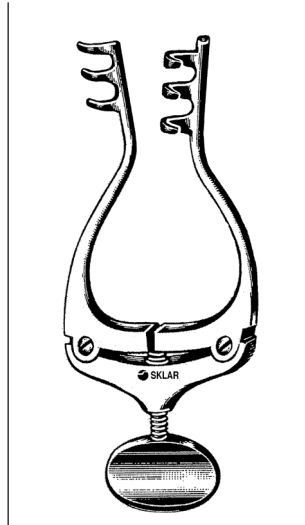

**JANSEN RETRACTORS**

- 3" SPREAD**  
**SHARP**  
 47-2834 4" 3x3 Prongs  
 47-2838 4½" 4x4 Prongs
- BLUNT**  
 47-2832 4" 3x3 Prongs  
 47-2836 4½" 4x4 Prongs

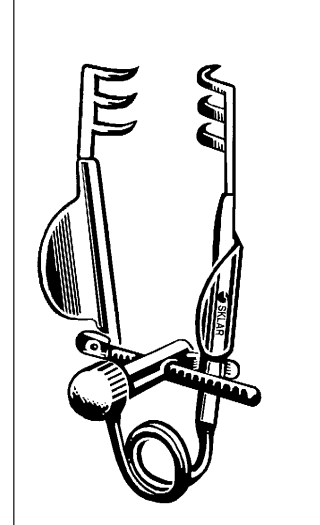

**MELLER RETRACTORS**

- 65-1815 1½" Sharp, 4mm  
 Deep, Delicate
- 65-1830 3" Blunt  
 3mm Deep

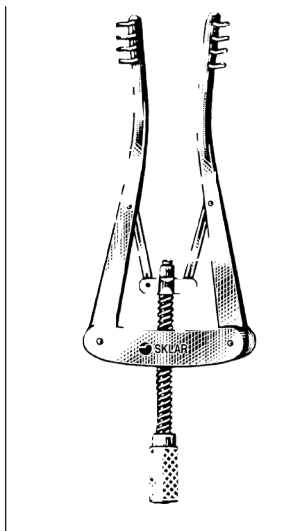

**ALM SELF-RETAINING  
RETRACTORS**

- SHARP**  
 22-9029 2¾" 4x4 Teeth  
 60-6342 4" 4x4 Teeth
- BLUNT**  
 22-9027 2¾" 4x4 Teeth  
 60-6340 4" 4x4 Teeth

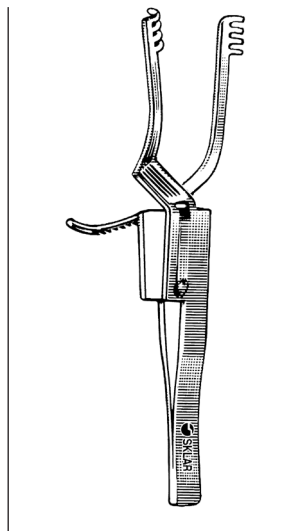

**HOLZHEIMER  
SELF-RETAINING  
RETRACTORS**

- SHARP**  
 22-8920 4" 4x4 Teeth
- BLUNT**  
 22-8940 4" 4x4 Teeth

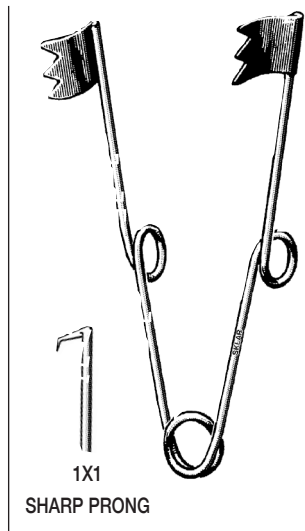

**WIRE RETAINING  
RETRACTORS**

- 22-8832 ¾" 3x3 Blade  
 22-8834 ¾" 1x1 Sharp Prong

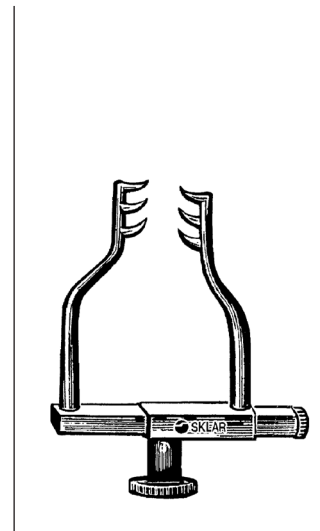

**GOLDSTEIN  
RETRACTOR**

- 47-2913 1½" Sharp  
 3x3 Prongs

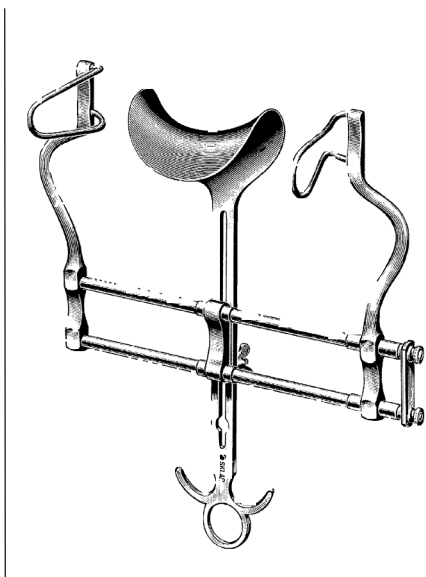

**BALFOUR RETRACTORS**

**2½" FENESTRATED SIDE BLADES**

60-6670 7" Spread 2" x 3" Center Blade

60-6710 10" Spread 2¾" x 3¼"

Center Blade

**1¼" FENESTRATED SIDE BLADES**

22-9030 3" Spread ¾" x ¾"

Center Blade



**BALFOUR RETRACTORS**

**RATCHET BAR WITH INTERCHANGABLE,  
FENESTRATED SIDE BLADES 2½" X 1¾"  
AND 3¼" X 2¾"**

60-7112 7" Spread 2¼" x 3½"  
Center Blade

60-7113 10" Spread 2¼" x 3½"  
Center Blade

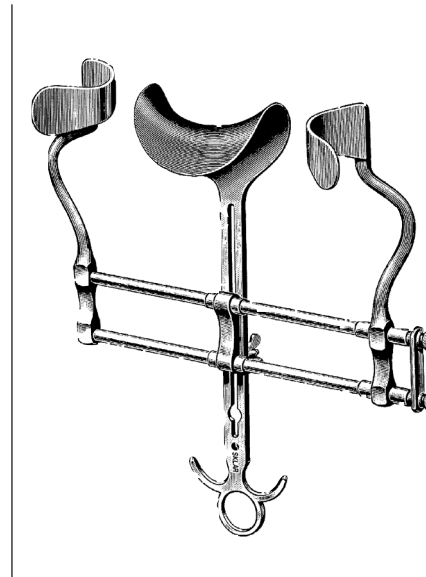

**BALFOUR RETRACTOR  
SOLID SIDE BLADES**

60-6870 2½" Deep 7" Spread

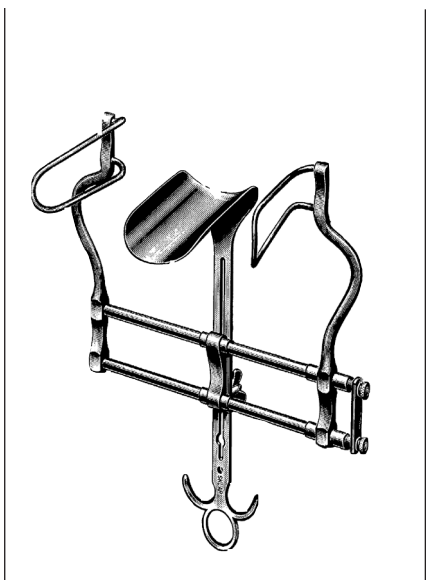

**BALFOUR RETRACTORS**

**4" FENESTRATED SIDE BLADES**

60-7070 7" Spread, 2½" x 4"

Center Blade

60-7110 10" Spread, 2½" x 4"

Center Blade

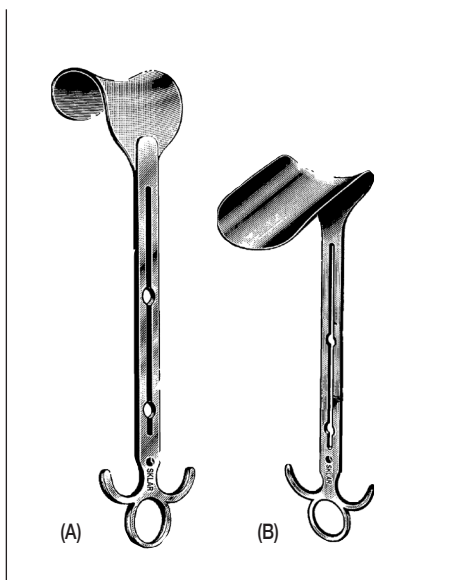

**BALFOUR CENTER BLADES**

60-7120 1¾" wide x 3" deep (A)

60-7125 2½" wide x 3" deep (A)

60-7115 3¼" wide x 3½" deep (A)

60-7130 2½" wide x 4" deep (B)

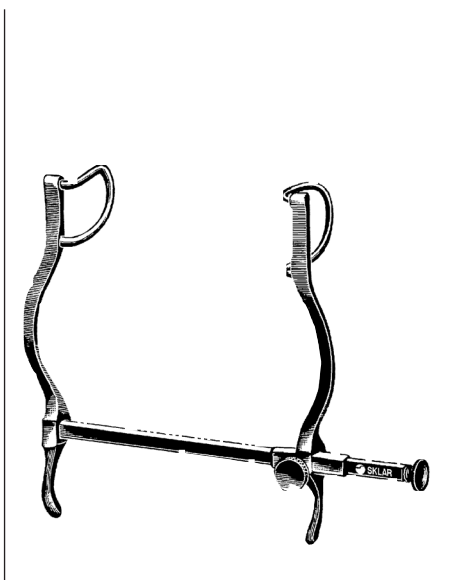

**NELSON RETRACTORS (GOSSET)  
SELF-RETAINING**

55-7355 1¼" x 2½" Blades 5½" Spread

60-6240 1" x 1½" Blades 4" Spread

# RETRACTORS

## RIB / ABDOMINAL SPREADERS

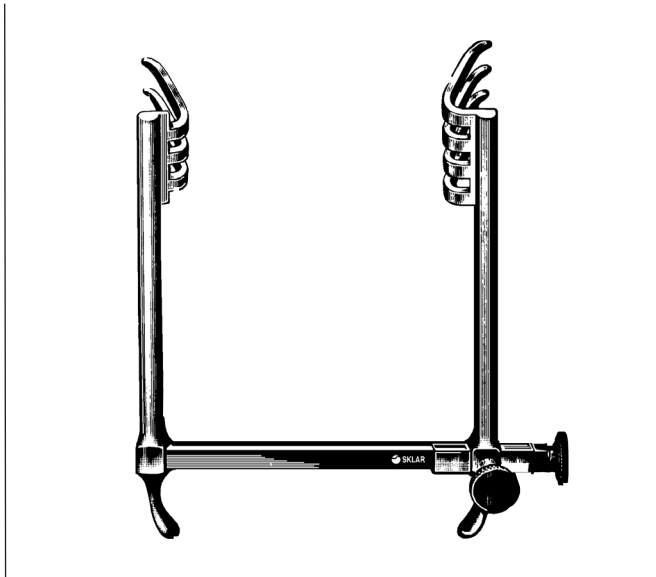

### TEMPLE-FAY RETRACTOR

TOTAL OPENING 4 3/4"

- 42-1247 4 Prong Blade 1 1/2" x 2"
- 3 Prong Blade 1" x 2"

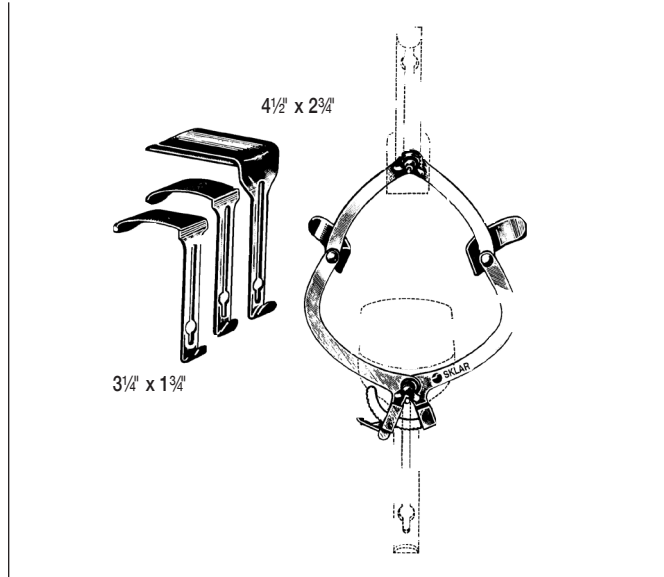

### O'SULLIVAN-O'CONNOR ABDOMINAL RETRACTOR

- 90-3025 With 3 interchangeable blades, 1 large, 2 small
- 90-3026 Center Blade, Convex 3 1/4" x 1 3/4"

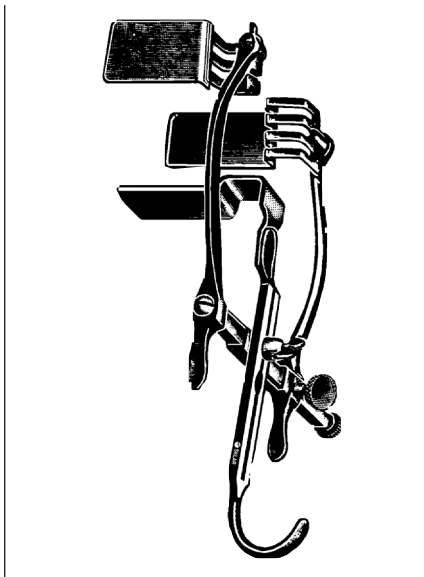

### JUDD-MASSON RETRACTOR

- 85-5350 Bladder and Suprapubic Retractor, with 2 blades



### HARKEN RIB SPREADER

- 55-7785 1 3/4" deep x 3" wide, solid scapula blades, 1 1/2" deep x 2" wide, total opening 10"



### BURFORD-FINOCHIETTO RIB SPREADER

- 2 SETS OF BLADES
- 55-7880 2 1/2" x 2 1/2" 8" Spread
- 1 1/2" x 2 1/2"

RETRACTORS

RIB SPREADERS

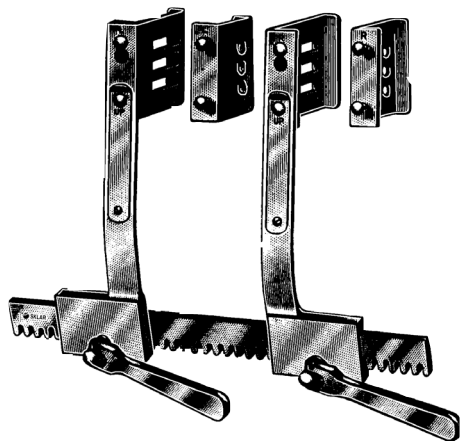

**BURFORD-FINOCHIETTO RIB SPREADER**

55-7980 With both arms movable and two sets of interchangeable blades, large, 2½" x 2½" (6.4 x 7cm), small, 1½" x 2½" (6.4 x 5.1cm), curved arms, total opening 8" (20.3cm)

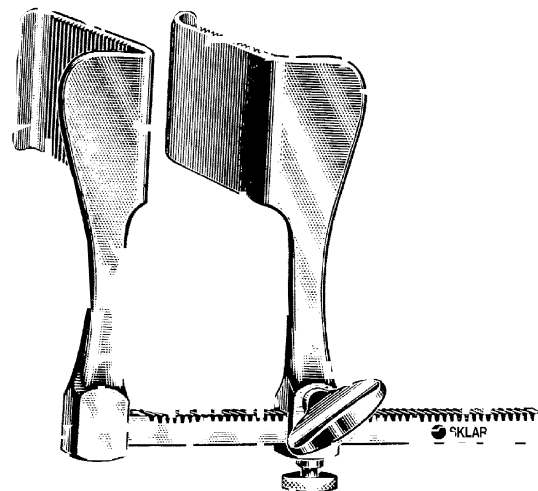

**TUFFIER RIB SPREADERS**

55-7445 2" x 2" 4½" Spread  
55-7465 2" x 2" 6½" Spread

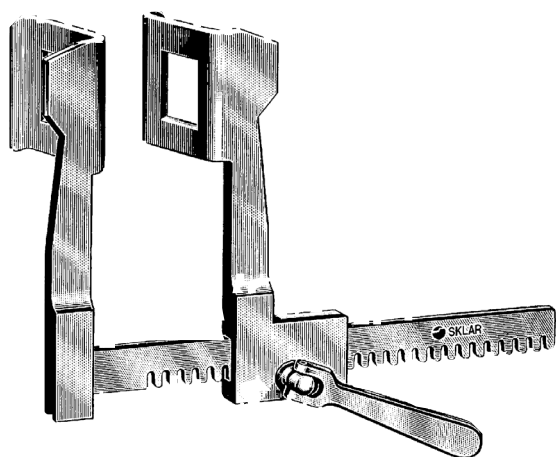

**FINOCHIETTO RIB SPREADERS**

55-7675 1¼" x 1¾" 6" Spread  
55-7685 1¼" x 2⅝" 6½" Spread

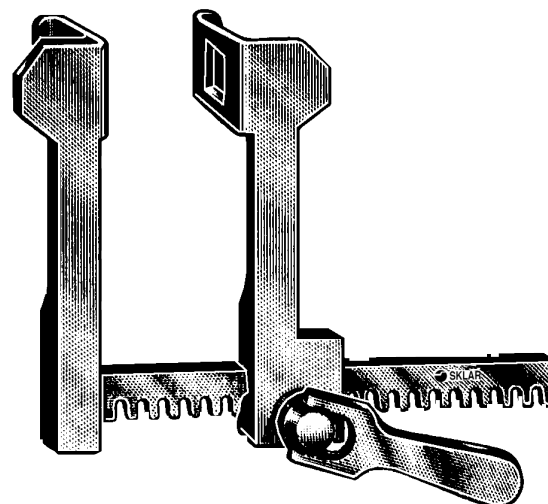

**HAIGHT-FINOCHIETTO RIB RETRACTOR**

22-7855 Total opening 3½"

# RETRACTORS

## GENERAL

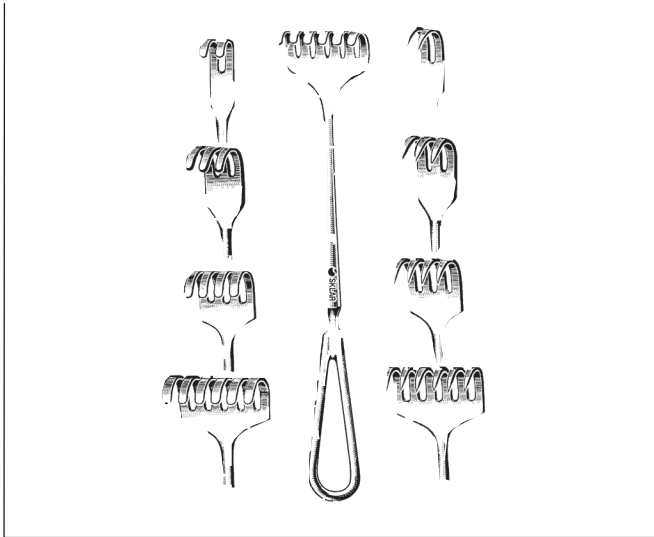

### VOLKMAN RETRACTORS (USA)

**8½" LENGTH**

**SHARP**

- 60-5602 2 Prongs
- 60-5603 3 Prongs
- 60-5604 4 Prongs
- 60-5606 6 Prongs

**BLUNT**

- 60-5502 2 Prongs
- 60-5503 3 Prongs
- 60-5504 4 Prongs
- 60-5506 6 Prongs

**4½" LENGTH**

**SHARP**

- 60-4242 2 Prongs
- 60-4243 3 Prongs
- 60-4244 4 Prongs
- 60-4246 6 Prongs

**BLUNT**

- 60-4252 2 Prongs
- 60-4253 3 Prongs
- 60-4254 4 Prongs
- 60-4256 6 Prongs

### VOLKMAN RETRACTORS (RING HANDLE)

**8½" LENGTH**

**SHARP**

- 60-5822 2 Prongs
- 60-5823 3 Prongs
- 60-5824 4 Prongs
- 60-5826 6 Prongs

**BLUNT**

- 60-5812 2 Prongs
- 60-5813 3 Prongs
- 60-5814 4 Prongs
- 60-5816 6 Prongs

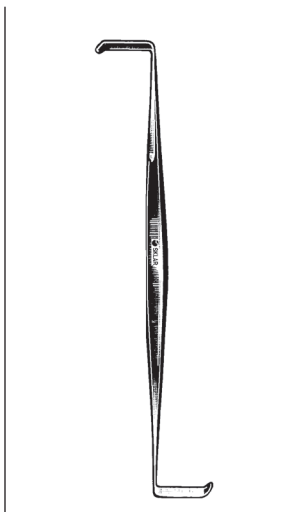

### HERNIA RETRACTOR DOUBLE ENDED

22-8860 6"

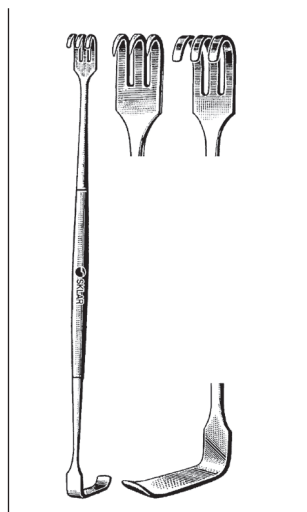

### SENN RETRACTORS DOUBLE ENDED

60-6162 6¼" Sharp  
60-6164 6¼" Blunt

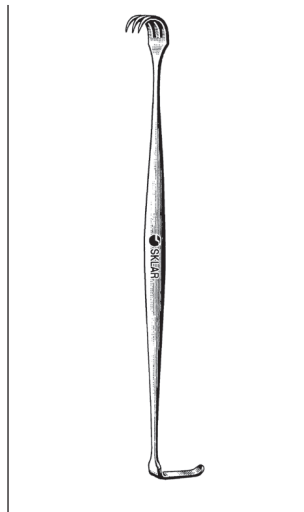

### MILLER-SENN RETRACTORS DOUBLE ENDED

22-8360 6" Sharp Solid End  
5mm x 18mm  
22-8460 6" Blunt Solid End  
5mm x 18mm

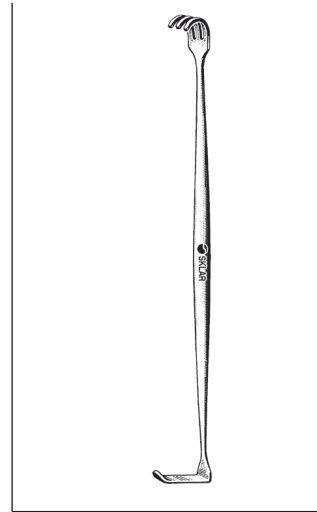

### MATHIEU RETRACTORS DOUBLE ENDED

60-6064 6¼" Sharp  
60-6062 6¼" Blunt

RETRACTORS

GENERAL

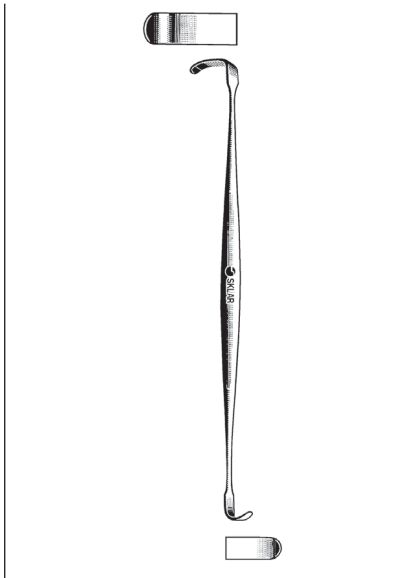

**RAGNELL RETRACTOR**  
DOUBLE END  
22-8560 5½"



**MEYERDING SKIN HOOK AND RETRACTOR**  
DOUBLE END  
47-2462 6¼"

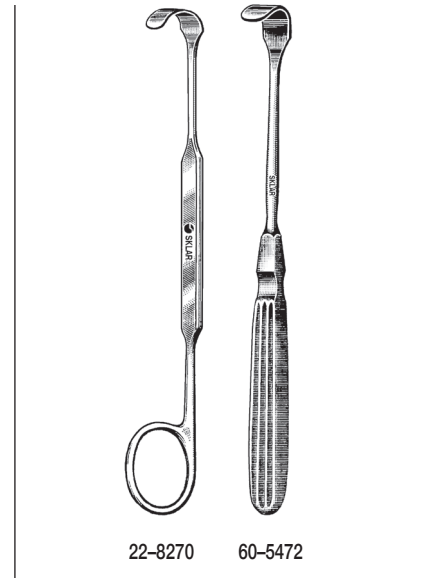

**LITTLE RETRACTORS**  
X-THIN BLADE  
22-8270 ½" x 7" Ring Handle  
60-5472 ½" x 7¼"



**McBURNAY RETRACTOR**  
FENESTRATED  
57-1475 5/16" x 7½"

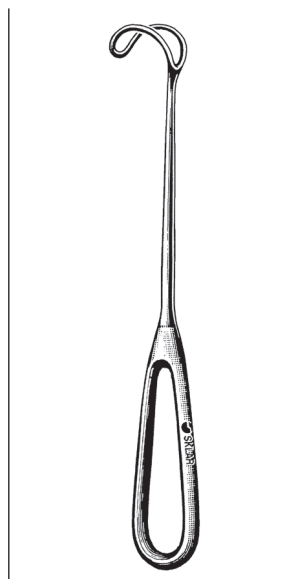

**GREEN RETRACTOR**  
FENESTRATED  
57-1485 5/8" x 8½"

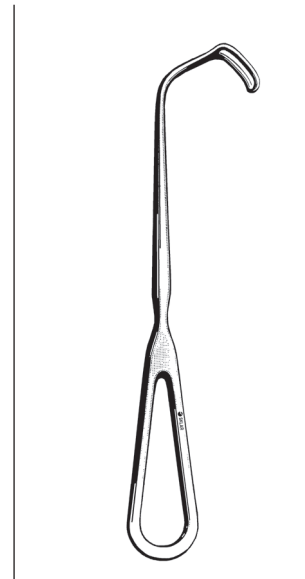

**CUSHING RETRACTOR**  
50-1280 8"

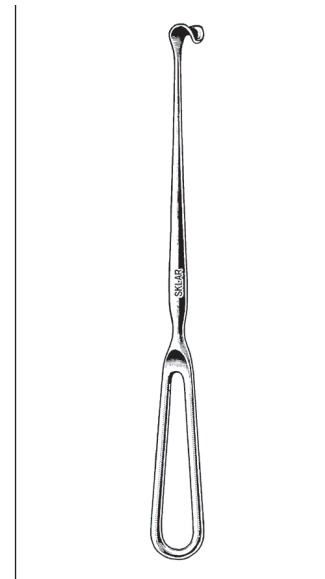

**CUSHING VEIN RETRACTOR**  
50-1290 9"



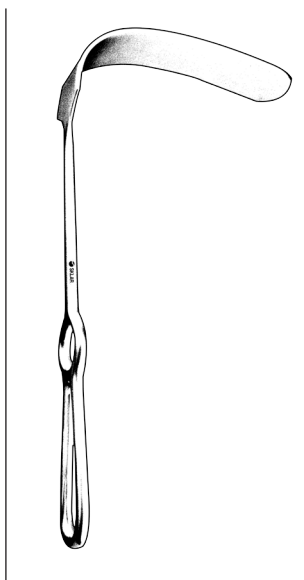

**KELLY RETRACTORS**  
10¼"

- 60-1800 160mm x 38mm
- 60-1802 160mm x 57mm
- 60-1801 190mm x 38mm
- 60-1803 190mm x 57mm

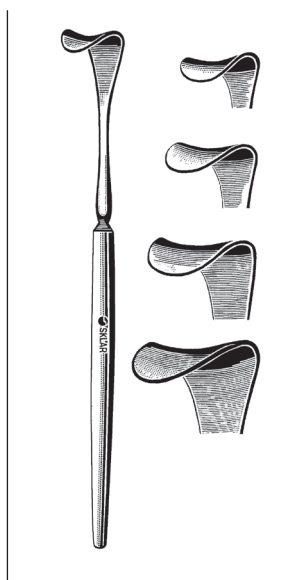

**DESMARRES LID RETRACTORS**

- 65-1841 #1 12mm
- 65-1842 #2 14mm
- 65-1843 #3 16mm
- 65-1844 #4 18mm

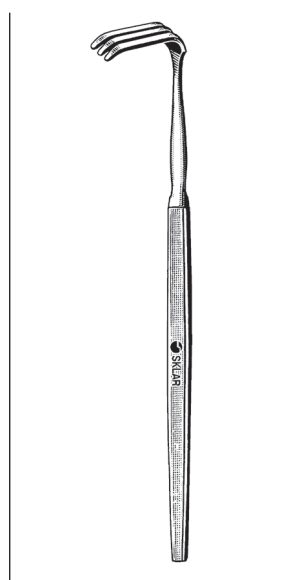

**PAUL RETRACTOR**

47-2647 4¾" 3 Prongs Blunt

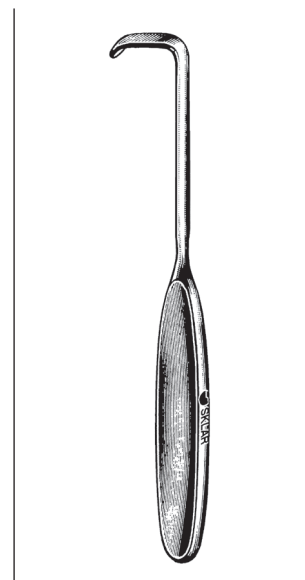

**LAHEY RETRACTOR**

52-1277 7"



**LANGENBECK RETRACTORS**

- 60-1891 ¾" x 1⅛" 9"
- 60-1892 ½" x 1⅛" 9"
- 60-1893 ⅝" x 1⅛" 9"
- 60-1894 ¾" x 1½" 9"
- 60-1895 ¾" x 2" 9"

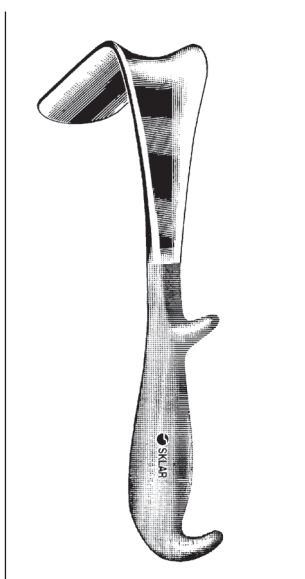

**YOUNG ANTERIOR RETRACTOR**

85-4780 8"

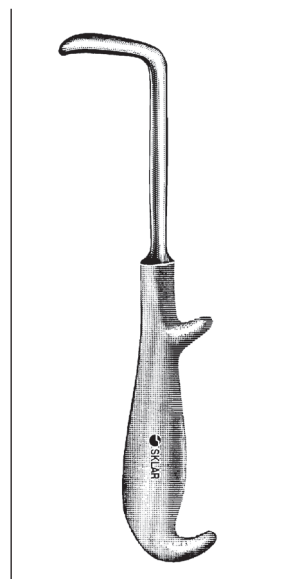

**YOUNG LATERAL RETRACTOR**

85-4697 8½"

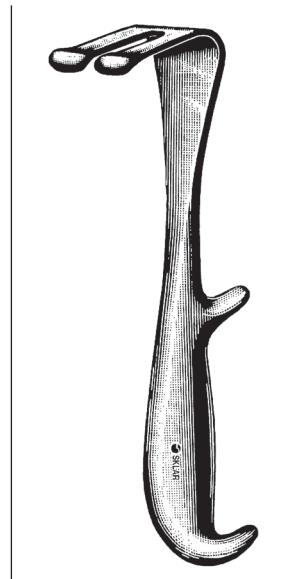

**YOUNG BIFURCATED RETRACTOR**

85-4970 8½"

RETRACTORS

GENERAL



**DEAVER RETRACTORS**

**WITHOUT HANDLE**

60-3070	#000	3/4" x 7"	60-3114	#2 1/2	1" x 14"
60-3085	#00	7/8" x 8 1/2"	60-3212	#3	1 1/2" x 12"
60-3090	#0	1" x 9"	60-3312	#4	2" x 12"
60-3112	#1	1" x 12"	60-3412	#5	3" x 12"
60-3113	#2	1" x 13"			

**PEDIATRIC**

22-8080	5/8" x 8"	22-8180	1" x 8"
---------	-----------	---------	---------



**DEAVER RETRACTORS**

**SKLAR-GRIP HANDLE**

60-2710	#0	1" x 10"	60-2812	#3	1 1/2" x 12"
60-2712	#1	1" x 12"	60-2912	#4	2" x 12"
60-2713	#2	1" x 13"	60-3012	#5	3" x 12"



**MEYERDING  
RETRACTORS**

42-2085	7 3/4" Small	2" x 5/8"
42-2092	8 3/4" Medium	3" x 1"
42-2095	9 1/2" Large	3 1/2" x 2"

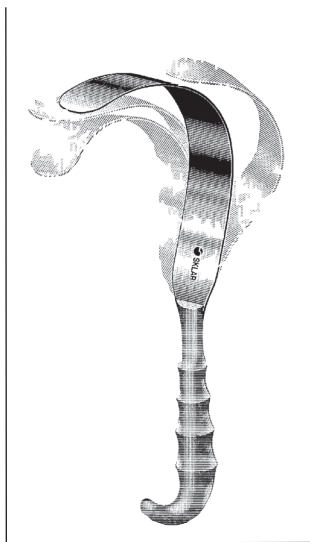

**ZALKIND LUNG  
RETRACTORS**

<b>MALLEABLE</b>	
55-7220	2" x 12"
55-7230	3" x 12"

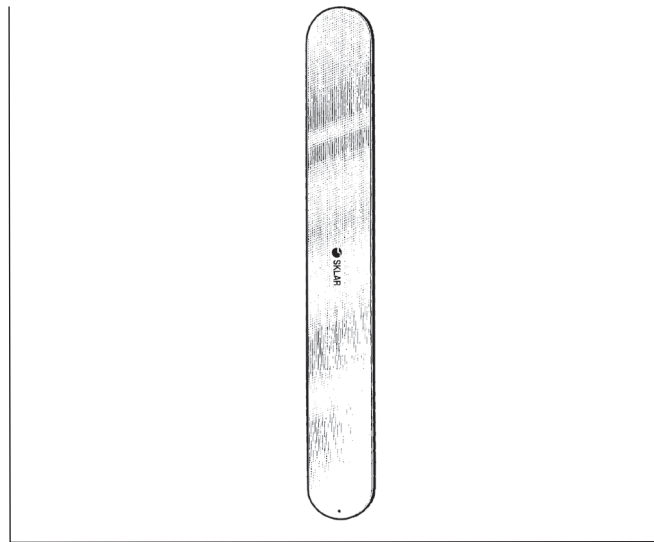

**ZALKIND (RIBBON) RETRACTORS**

**MALLEABLE**

60-3594	1/4" x 7 3/4"	60-3607	3/4" x 13"
60-3596	1/2" x 7 3/4"	60-3610	1" x 13"
22-8067	5/8" x 7 3/4"	60-3612	1 1/4" x 13"
60-3598	3/4" x 7 3/4"	60-3615	1 1/2" x 13"
22-8075	1" x 7 3/4"	60-3617	1 3/4" x 13"
		60-3620	2" x 13"
		60-3625	2 1/2" x 13"

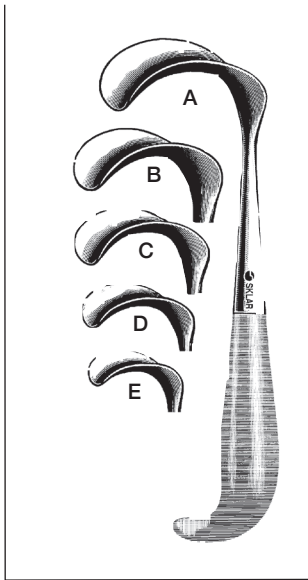

**BREWSTER  
RETRACTORS**

- 60-5431 Style A 2½" x 1⅞"
- 60-5432 Style B 2¼" x 1¾"
- 60-5433 Style C 2" x 1⅜"
- 60-5434 Style D 1¾" x 1"
- 60-5435 Style E ¾" x 1½"

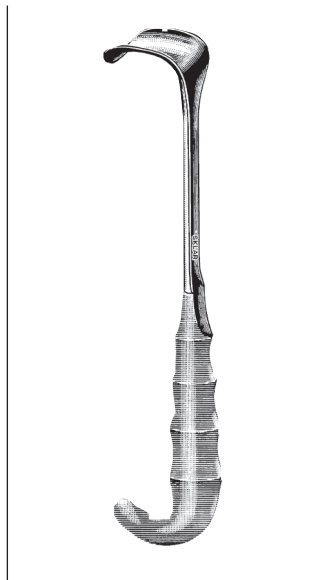

**RICHARDSON  
RETRACTORS**

- 60-1676 ¾" x 1" 9½"
- 60-1681 1" x 1¼" 9½"
- 60-1686 1½" x 1½" 9½"
- 60-1691 ¾" x 2" 9½"

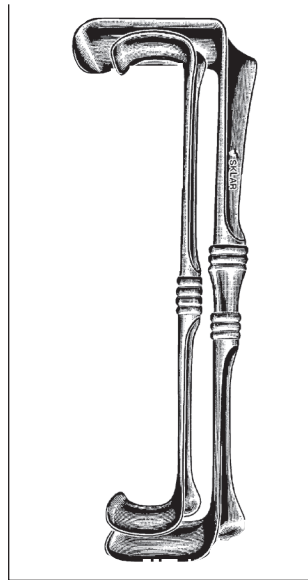

**RICHARDSON-  
EASTMAN  
RETRACTORS**

- DOUBLE END**
- 60-1697 1⅝" x 2½" 10¼"
  - 60-1699 ¾" x 1⅛" 9½"
  - 60-1695 1⅛" x 1½" 9½"
  - 60-1695 Set of 2 above

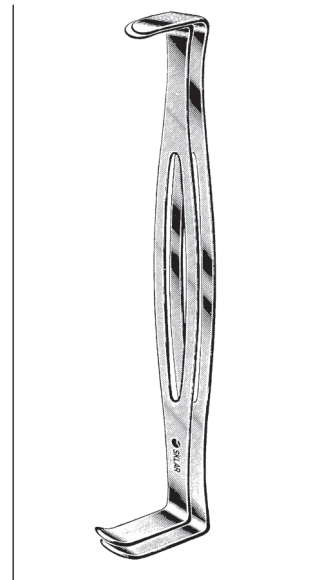

**U.S. ARMY PATTERN  
RETRACTOR**

- SET OF 2**  
60-1085 8¼"

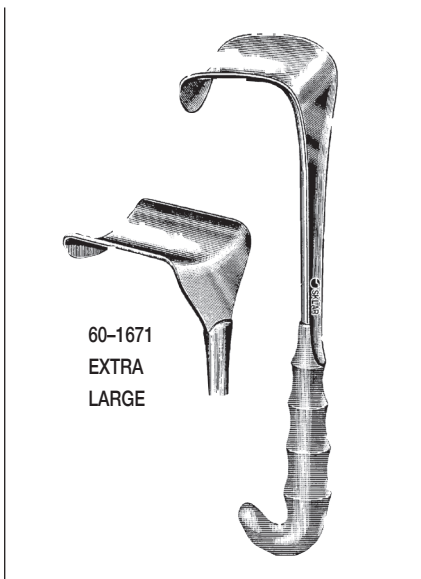

60-1671  
EXTRA  
LARGE

**KELLY RETRACTORS**

- 60-1656 9" 1½" x 2"
- 60-1661 9½" 2" x 2½"
- 60-1666 10" 2½" x 3"
- 60-1671 10½" 2¾" x 3¼" Extra Large



**HEANEY RETRACTORS**

- 60-1616 10½" Small Blade 1¾" x 1"
- 60-1617 10½" Medium Blade 3" x 1"
- 60-1618 10½" Large Blade 3¼" x 1⅛"

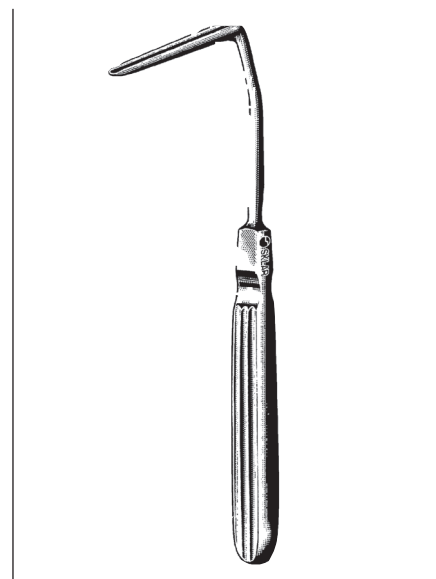

**AUFRICHT RETRACTOR**

- SOLID BLADE**  
41-1410 6½" x 1¾"

RETRACTORS

GENERAL



**PARKER RETRACTORS**

DOUBLE END SET OF 2

- 60-1350 5/8" x 5"
- 60-1370 1" x 7"



**GOELET RETRACTOR**

DOUBLE END

- 60-1075 7 1/2" Long 1 1/4" x 1 1/2"



**ROUX RETRACTORS**

DOUBLE END

- 60-1104 5" X-Small
- 60-1170 5 1/4" Small
- 60-1101 5 1/2" Small
- 60-1102 6" Medium
- 60-1103 6 3/4" Large
- 60-1100 Set of 60-1101, 60-1102 and 60-1103

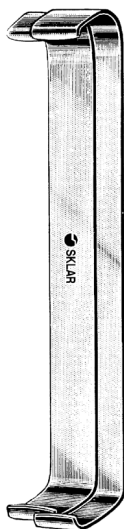

**FARABEU  
RETRACTOR**

DOUBLE END SET OF 2

- 60-1460 6" 5/8" x 7/8", 5/8" x 1"
- 60-1461 4 3/4" 1 1/4" x 1/2", 1 x 3/8"

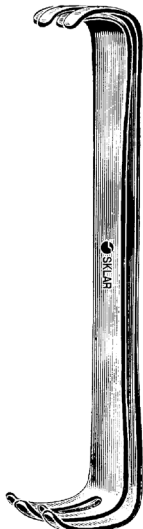

**MAYO-COLLINS  
RETRACTOR**

DOUBLE END SET OF 2

- 60-1160 6" 3/4" x 1 1/2"

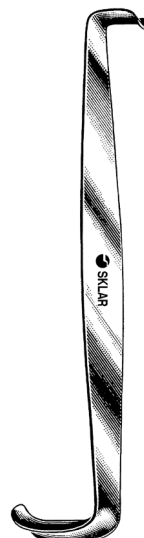

**CRILE RETRACTOR**

DOUBLE END

- 57-1445 4 1/2" Small

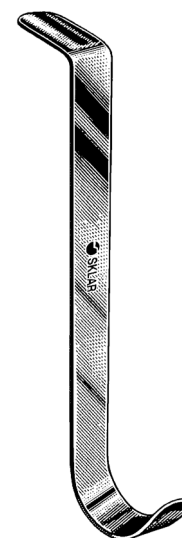

**CONVERSE  
RETRACTORS**

- 41-1402 3 3/4" #2 13 x 28mm
- 41-1403 3 3/4" #3 13 x 41mm

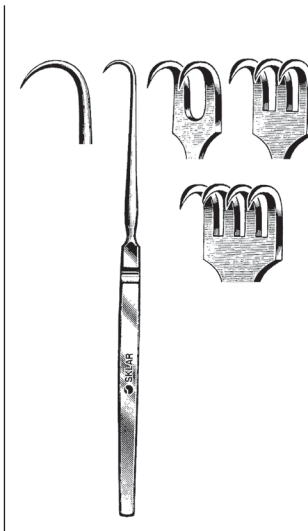

**RIGID DERMAL  
RETRACTORS**

**SHARP 6"**

- 22-9122 1 Prong
- 22-9124 2 Prongs
- 22-9126 3 Prongs
- 22-9128 4 Prongs

**BLUNT 6"**

- 22-9123 1 Prong
- 22-9125 2 Prongs
- 22-9127 3 Prongs
- 22-9129 4 Prongs

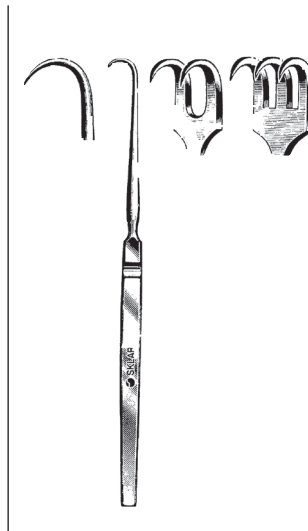

**TRACHEAL  
RETRACTORS**

**6½"**

- 78-1001 Sharp 1 Prong
- 78-1002 Sharp 2 Prongs
- 78-1003 Sharp 3 Prongs
- 78-1101 Blunt 1 Prong
- 78-1102 Blunt 2 Prongs
- 78-1103 Blunt 3 Prongs



**JACKSON TRACHEAL  
RETRACTOR**

**BLUNT DOUBLE PRONG**

- 78-3570 7"

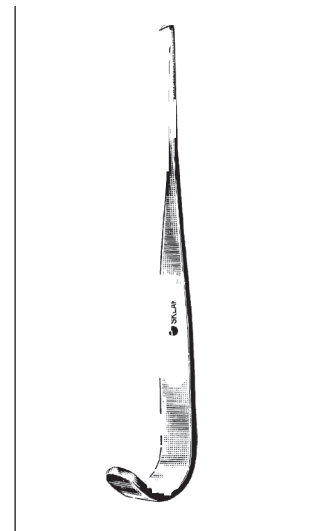

**JACKSON TENACULUM**

- 78-3550 5¾"

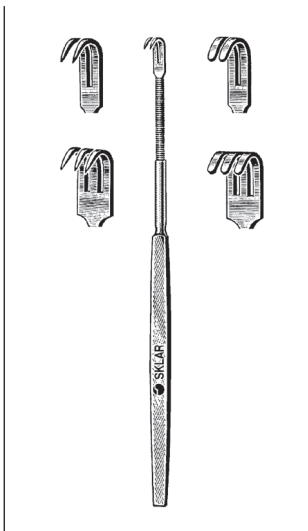

**PLASTIC SURGERY  
RETRACTORS**

**6" FLEXIBLE SHANK**

- 22-9144 Sharp 1 Prong
- 22-9132 Sharp 2 Prongs
- 22-9133 Sharp 3 Prongs
- 22-9141 Blunt 1 Prong
- 22-9142 Blunt 2 Prongs
- 22-9143 Blunt 3 Prongs

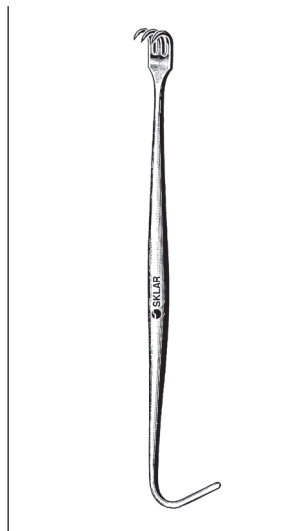

**HUPP TRACHEAL  
RETRACTOR**

**DOUBLE END**

- 78-1113 6" with 3 sharp prongs and blunt hook



**LAHEY RETRACTORS**

**4¾" SHARP**

- 78-1201 1 Prong
- 78-1202 2 Prongs
- 78-1203 3 Prongs



**NEWS HOOK**

- 78-3545 6"

RETRACTORS

HOOK

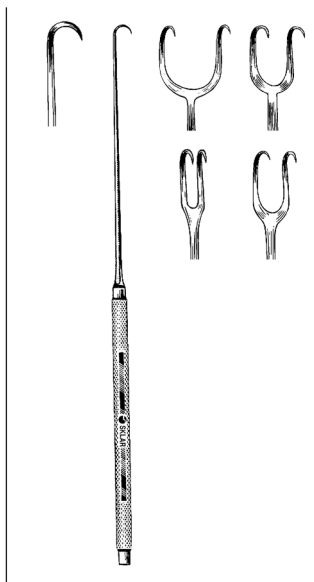

**JOSEPH SKIN HOOKS**  
SINGLE END, SHARP PRONGS, 6¼"

- 47-2500 1 Prong
- 47-2502 2 Prongs 2mm
- 47-2505 2 Prongs 5mm
- 47-2507 2 Prongs 7mm
- 47-2510 2 Prongs 10mm
- 47-2512 2 Prongs 12mm

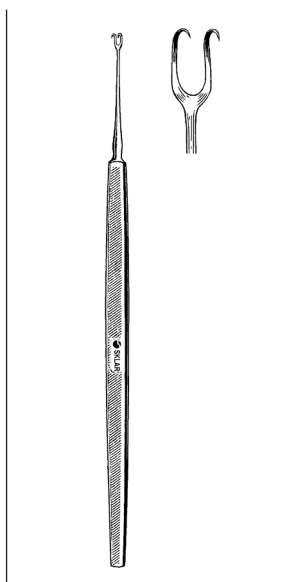

**GUTHRIE DOUBLE HOOKS**

- SHARP PRONGS
- 47-2651 2 Small
  - 47-2650 2 Large

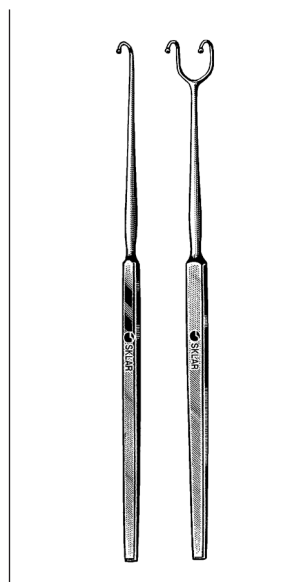

**FOMON RETRACTORS**  
BALL END

- 41-1395 6¾" Single
- 41-1396 6¼" Double

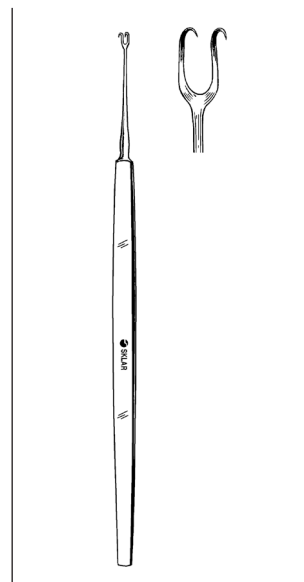

**FREER SKIN HOOKS**  
DOUBLE PRONG, 2.5MM

- 47-2760 6" Sharp
- 47-2758 6" Blunt

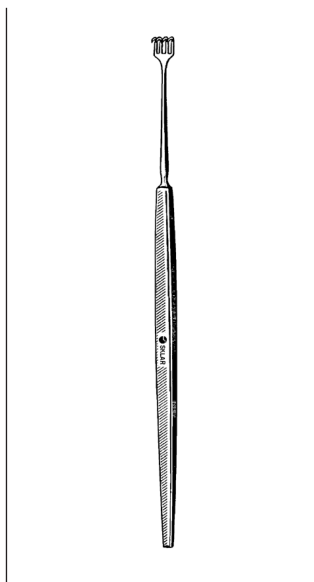

**BLAIR (ROLLET) RETRACTORS**  
4 PRONG-DELICATE

- 47-2655 5½" Sharp
- 47-2752 5½" Blunt

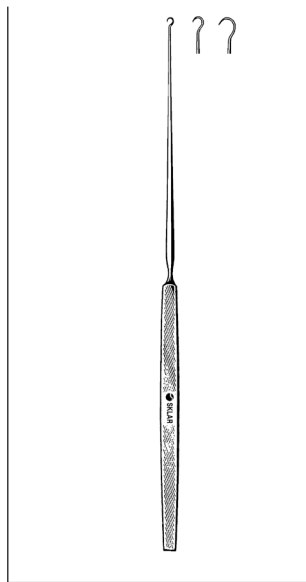

**GILLIES SKIN HOOKS**

- 47-2570 7" 3mm
- 47-2572 7" 4mm

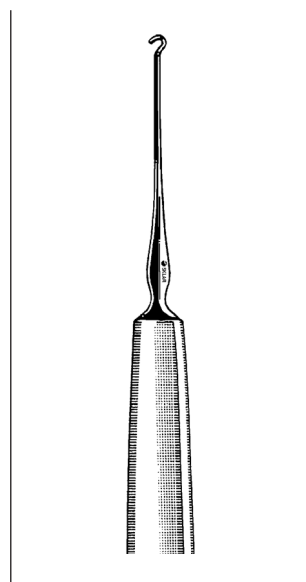

**TYRELL IRIS HOOKS**

- 65-3205 5" Blunt
- 65-3206 5" Sharp

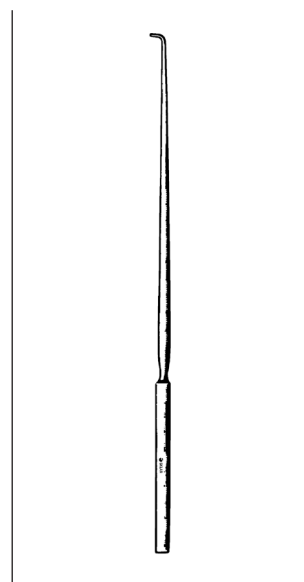

**DANDY NERVE HOOKS**

- 50-1790 8" 5mm

# RETRACTORS

## HOOK

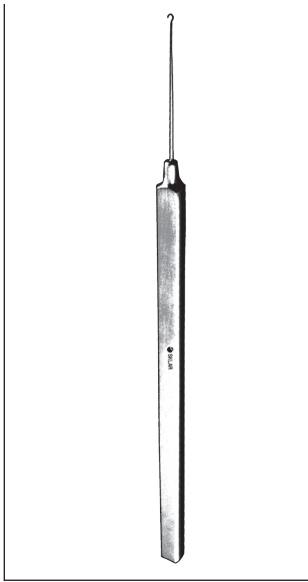

**SHEPARDS CROOK  
SKIN HOOK**

65-3267 5½"

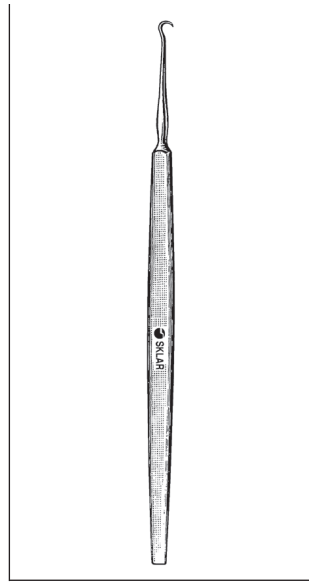

**FRAZIER TISSUE  
HOOKS**

**EXTRA DELICATE**

47-2555 5" Sharp  
47-2556 5" Blunt

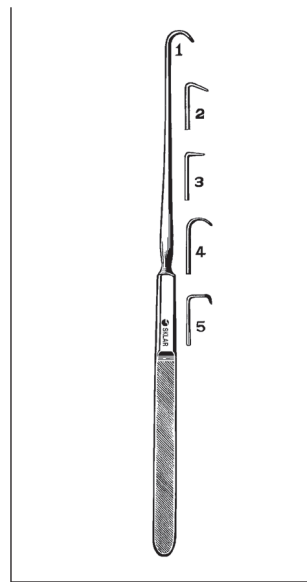

**EMMETT HOOKS 9"**

90-8301 Style 1  
90-8302 Style 2  
90-8303 Style 3  
90-8304 Style 4  
90-8305 Style 5  
90-8306 Set of 5

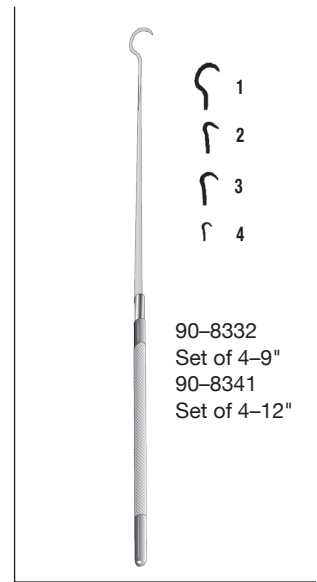

**IRIS HOOKS**

**QUICK RELEASE**

90-8333 9" 6mm Tip Style 1  
90-8342 12" 6mm Tip Style 1  
90-8334 9" 4mm Tip Style 2  
90-8344 12" 4mm Tip Style 2  
90-8335 9" 3mm Tip Style 3  
90-8346 12" 3mm Tip Style 3  
90-8336 9" 1mm Tip Style 4  
90-8348 12" 1mm Tip Style 4

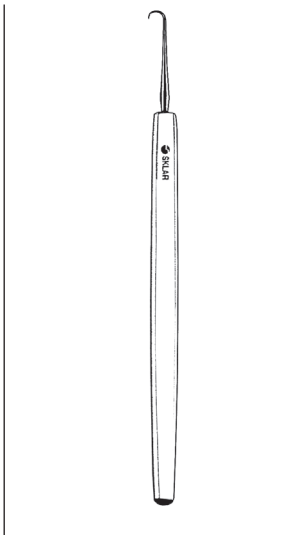

**SKIN HOOK**

**SHARP**

47-2550 4¾" 2mm

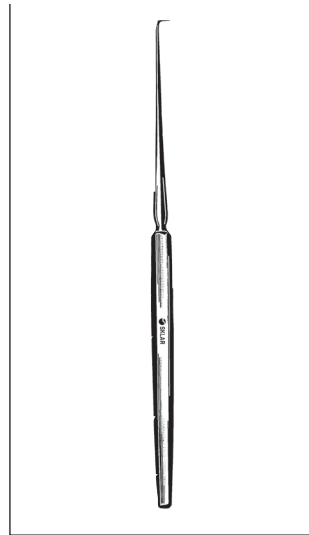

**ADSON HOOKS**

50-1585 8" Blunt  
50-1685 8" Sharp

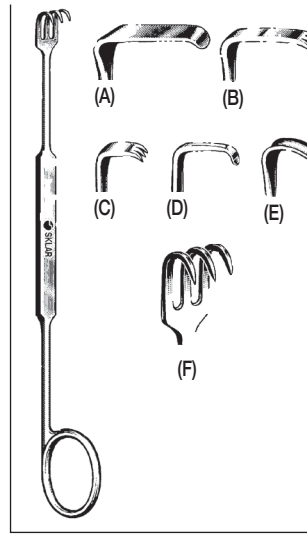

**MEYERING  
RETRACTORS**

**7" (17.8CM)**

22-8210 A 11/16" Deep  
22-8211 B 5/8" Deep  
22-8212 C 1/4" Deep  
22-8213 D 3/8" Deep  
22-8214 E 1/4" Deep  
22-8215 F 3 Prongs Sharp

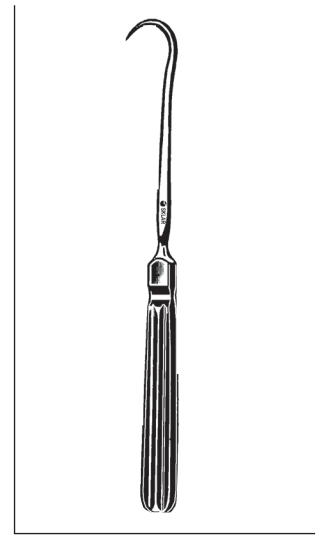

**SKLAR HOOK**

60-6280 8" Single Prong,  
Heavy 1" Tip

RETRACTORS

GENERAL

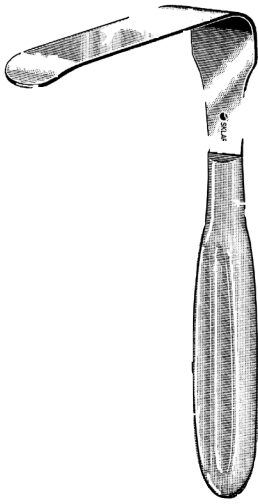

**BRANTLEY-TURNER  
RETRACTOR**

90-3470 4" x 1 1/4" 7"



**PRYOR-PEAN RETRACTOR**

90-3510 4 1/4" x 1" 10 1/4"

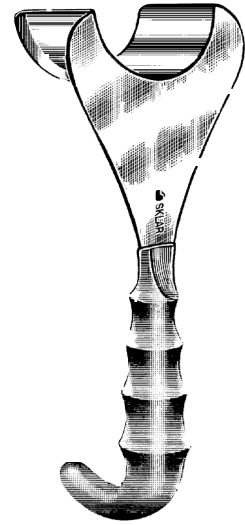

**DELEE RETRACTOR**

**UNIVERSAL**

90-3452 2 3/4" x 2"

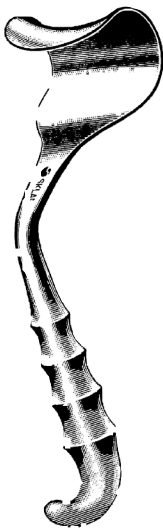

**MAYO ABDOMINAL  
RETRACTOR**

60-2110 2 3/4" x 10"

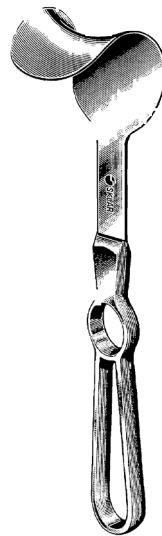

**FRITCH RETRACTOR**

60-2010 2 3/4" x 2" 9 1/4"

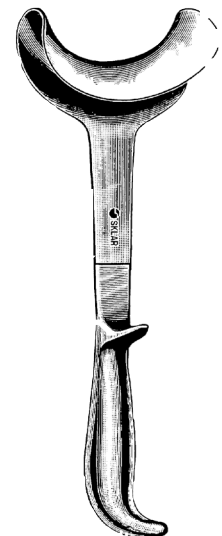

**DOYEN ABDOMINAL  
RETRACTOR**

**STRAIGHT**

60-1797 3 1/2" x 2" 9 3/4"



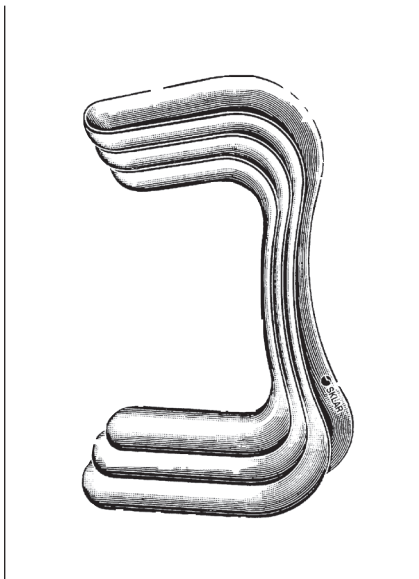

**SIMS RETRACTORS**

**DOUBLE END**

90-3150	7/8" x 2 1/2"	1" x 3"	#1
90-3151	1" x 2 1/2"	1 1/8" x 3"	#2
90-3152	1" x 3"	1 1/2" x 3 1/4"	#3
90-3153	1 1/4" x 3"	1 1/2" x 3 1/4"	#4
90-3154	1 1/4" x 3 1/4"	1 1/2" x 4"	#5
90-3155	1 1/4" x 3 1/4"	1 3/4" x 4"	#6

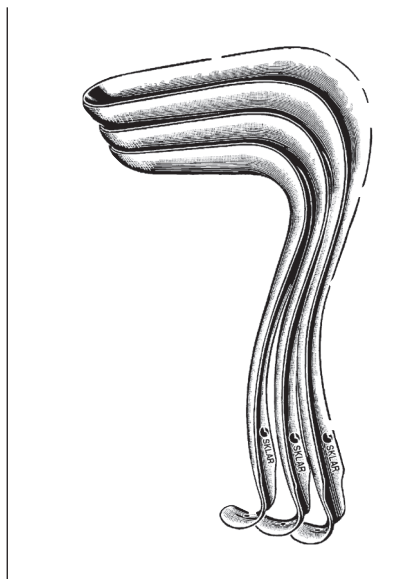

**SIMS RETRACTORS**

**SINGLE END**

90-3225	2 1/2" x 1"
90-3230	3" x 1 1/4"
90-3235	3 1/2" x 1 1/2"

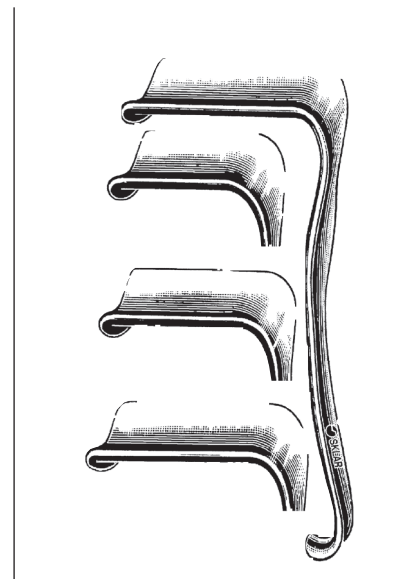

**EASTMAN RETRACTORS**

90-3030	3" x 1 1/2"	Small
90-3035	3 1/2" x 1 1/2"	Medium
90-3040	4" x 1 1/2"	Large

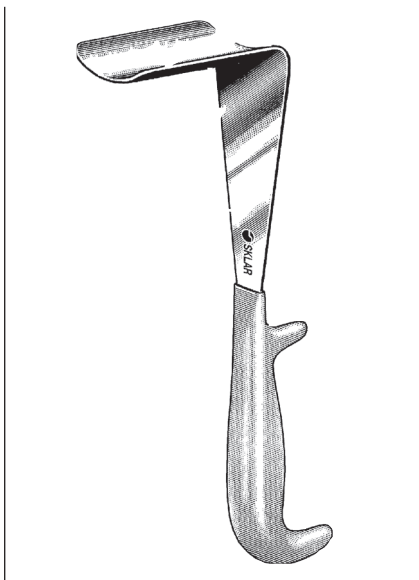

**DOYEN RETRACTORS**

60-2185	1 3/4" x 2 1/8"	9"
60-2190	1 3/4" x 3 1/4"	9"
60-2195	2 1/4" x 3 1/4"	9"

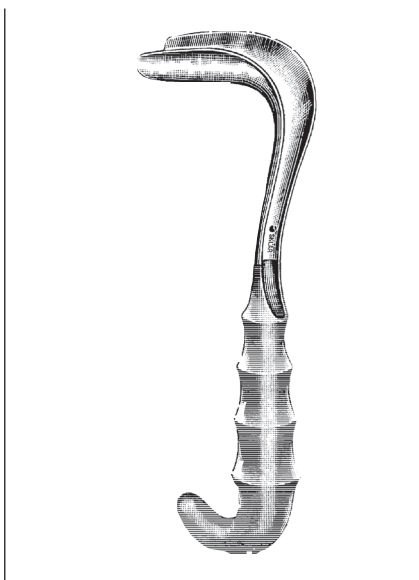

**SIMS-KELLY RETRACTORS**

**SKLAR-GRIP HANDLE**

90-3422	2 1/4" x 1"	Small
90-3427	2 3/4" x 1 1/4"	Medium
90-3430	3" x 1 1/2"	Large

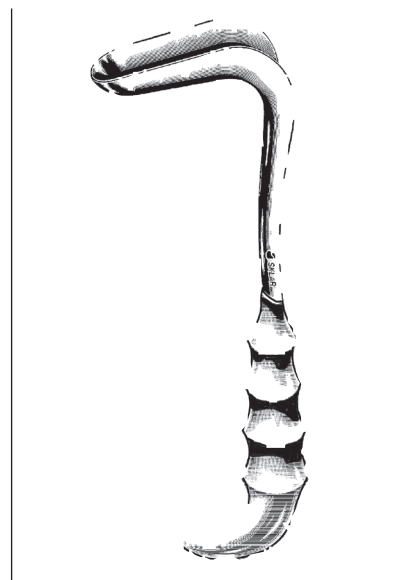

**SIMS RETRACTORS**

**SKLAR-GRIP HANDLE**

90-3327	2 3/4" x 1"	Small
90-3330	3" x 1 1/4"	Medium
90-3335	3 1/2" x 1 1/2"	Large

RETRACTORS

GENERAL

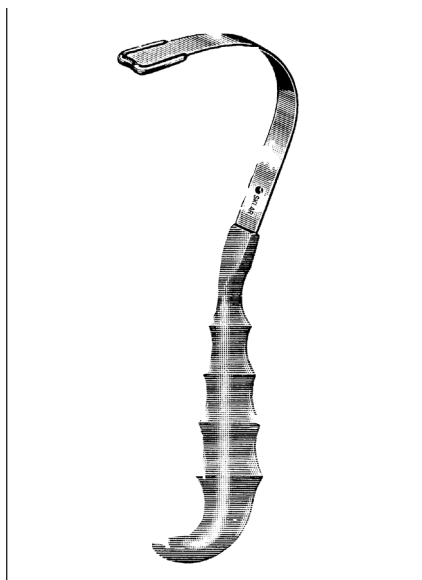

**HARRINGTON RETRACTOR**  
22-7795 1" x 10" Pediatric



**HARRINGTON THORACIC  
RETRACTORS**  
12½" LONG  
55-7115 1½" x 5" Blade Depth  
55-7125 2½" x 5" Blade Depth

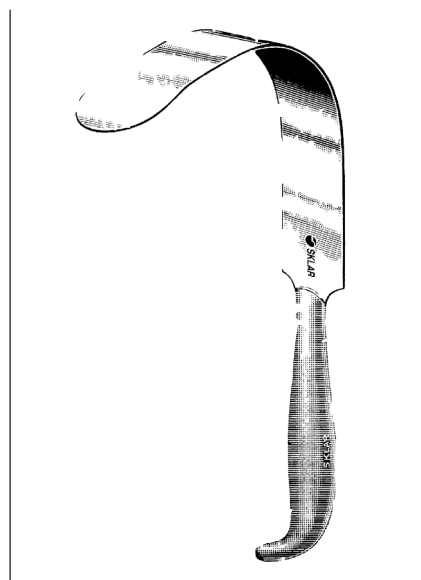

**FOSS BILIARY DUCT  
RETRACTOR**  
60-2395 1¾" x 9½"

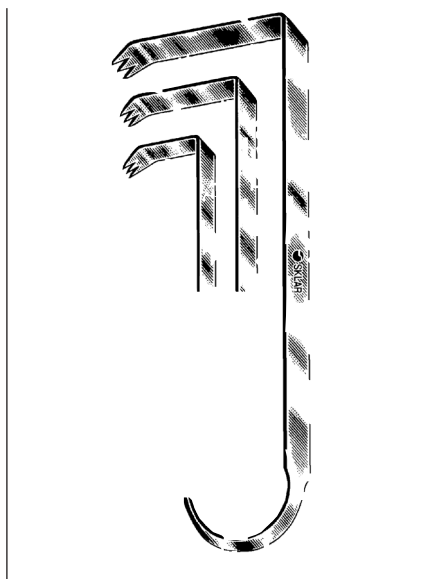

**HIBBS RETRACTORS**  
55-7167 ½" x 1¼" 6¾"  
55-7175 ⅝" x 2" 9"  
55-7192 1" x 3" 9½"

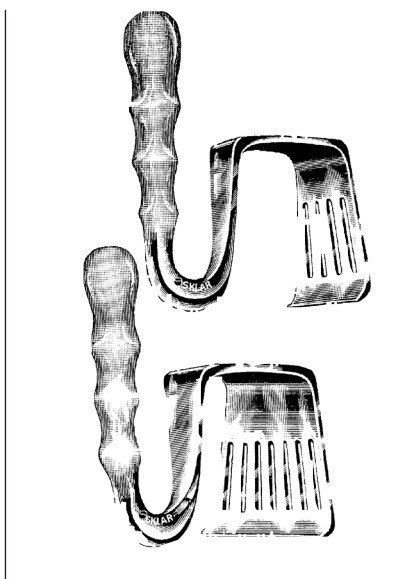

**DAVIDSON SCAPULA  
RETRACTORS**  
55-7195 Large 3" x 3½"  
55-7196 Small 3" x 2"

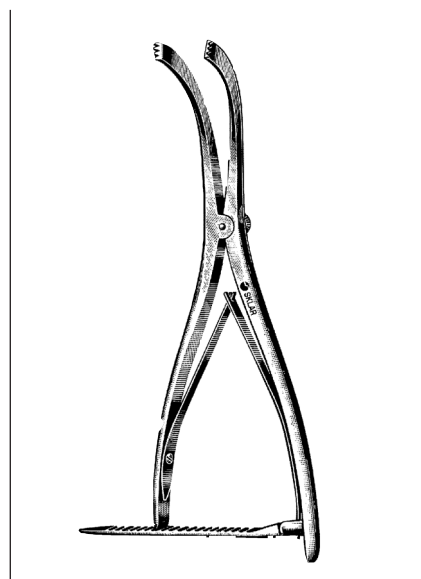

**INGE RETRACTORS**  
42-1420 6½"  
42-1425 10½"

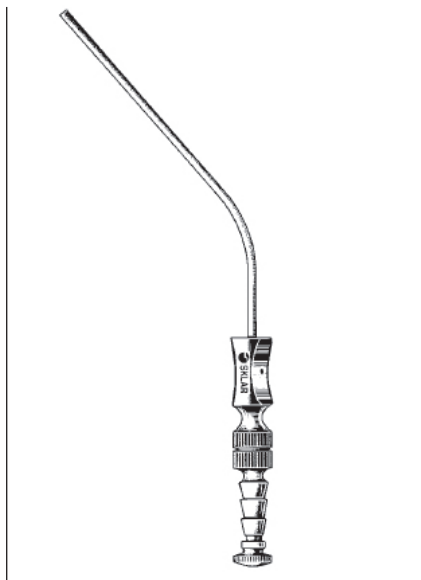

**FRAZIER SUCTION TUBES**

50-2006	6 French
50-2007	7 French
50-2008	8 French
50-2009	9 French
50-2010	10 French
50-2011	11 French
50-2012	12 French
50-2014	14 French



**FRAZIER SUCTION TUBES  
90 DEGREE**

50-2206	6 French
50-2207	7 French
50-2208	8 French
50-2210	10 French
50-2212	12 French

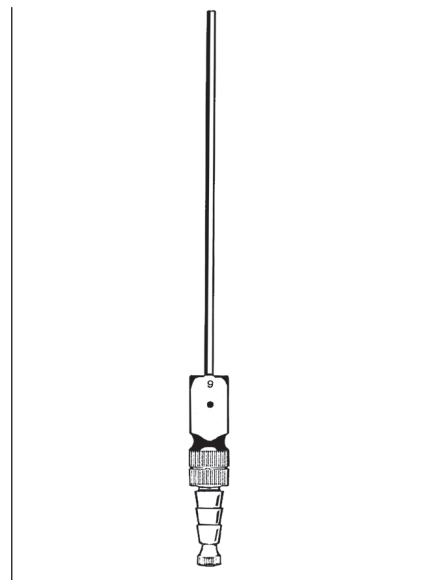

**FRAZIER FERGUSON  
SUCTION TUBES**

**STRAIGHT WITH THUMB CONTROL**

50-2106	6 French
50-2108	8 French
50-2109	9 French
50-2110	10 French
50-2112	12 French

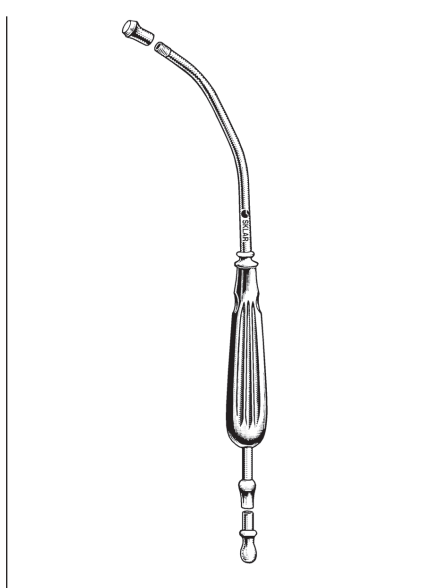

**YANKAUER SUCTION TUBES**

07-1801	11"	Chrome Plated
07-1805	11"	Stainless Steel
22-6585	8½"	Stainless Steel, Pediatric
07-1802	Tip	For use with 07-1801
07-1806	Tip	For use with 07-1805
22-6586	Tip	For use with 22-6585

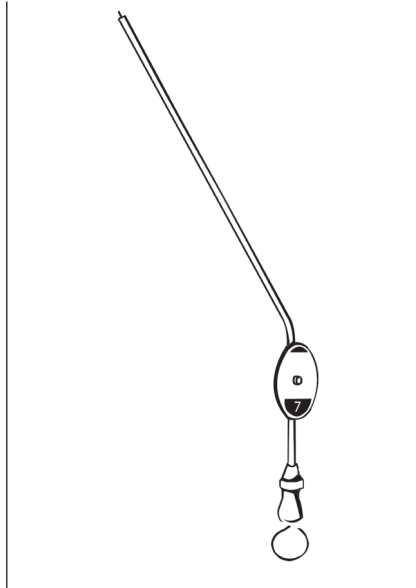

**BARON SUCTION TUBES**

50-1953	3 French	1.0mm
50-1955	5 French	1.6mm
50-1957	7 French	2.3mm

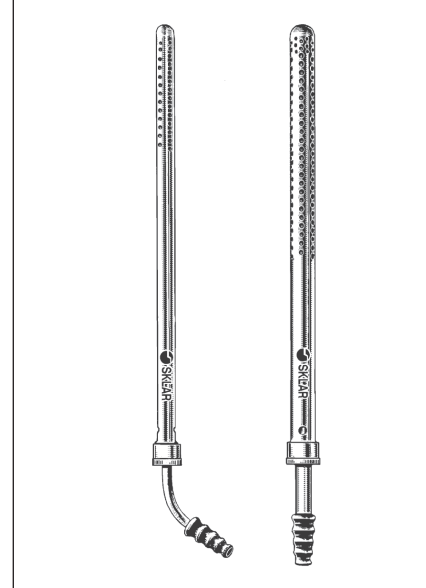

**POOLE SUCTION TUBES**

22-6577	7¾"	17 French
34-2023	9¼"	23 French
34-2230	8½"	30 French Slip On, Straight

# SUCTION & ASPIRATION SUCTION TUBES

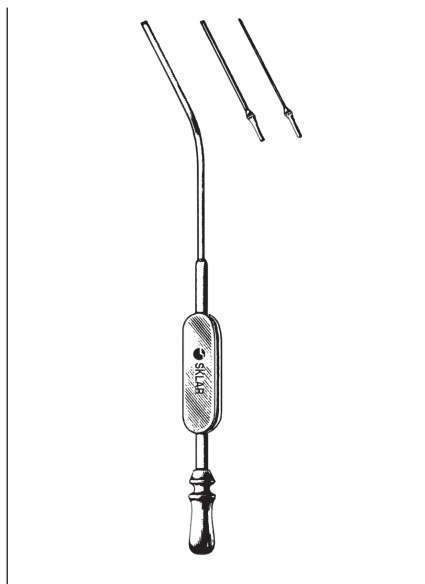

### EAR SUCTION TUBE

50-1950 7" With 2 tips  
20GA and 22GA

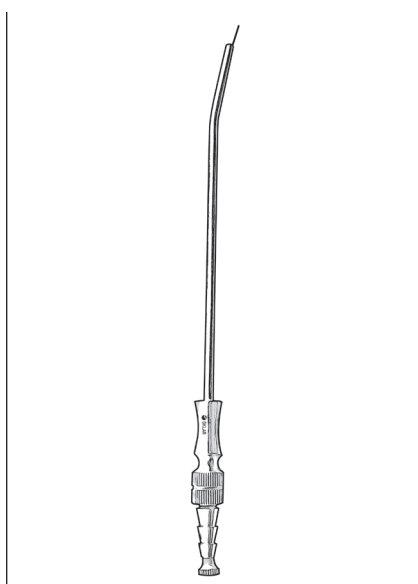

### ADSON SUCTION TUBES

50-1982 6" Shaft 12 French  
50-1985 7½" Shaft 15 French

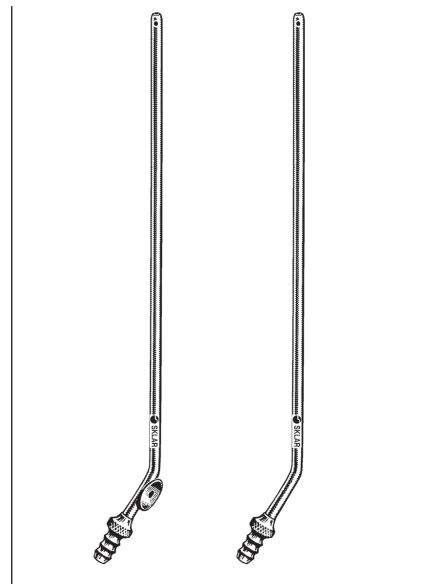

### BUIE SUCTION TUBES

80-2715 16" With Valve 15 French  
80-2815 16" Without Valve 15 French

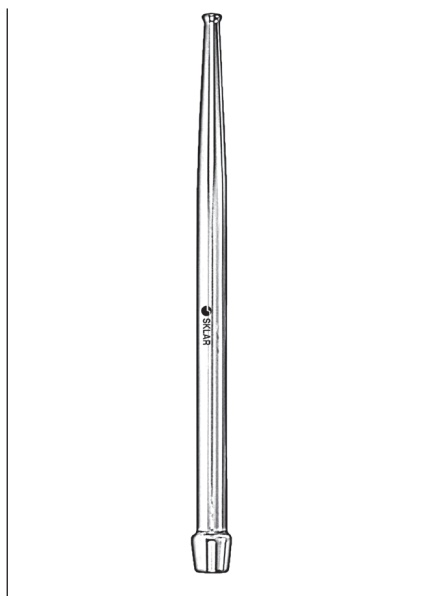

### ANTHONY MASTOID SUCTION TUBES

50-2830 6½" 2mm Lumen  
50-2831 6½" 3mm Lumen

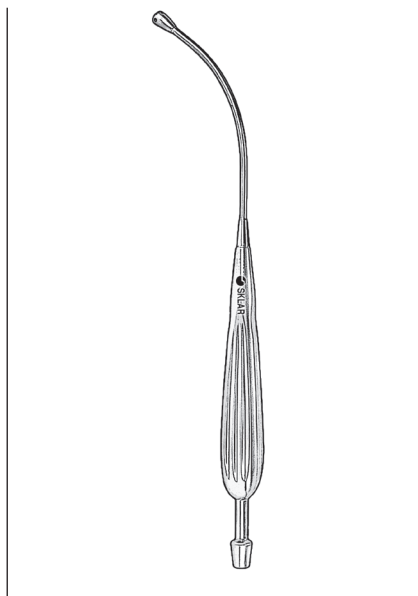

### ANDREWS-PYNCHON SUCTION TUBE

22-6590 10" Delicate Pattern  
22-6591 Tip For use with 22-6590

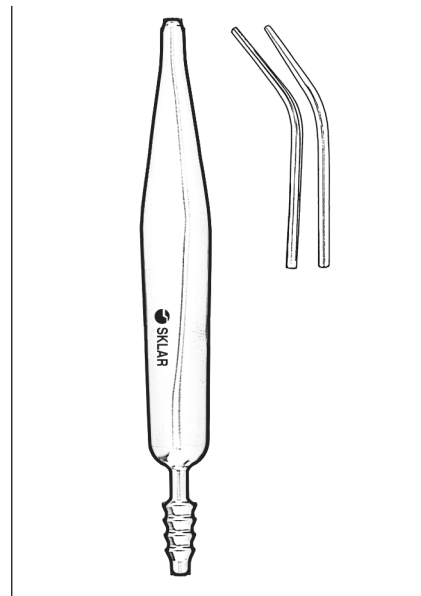

### COUPLAND SUCTION TUBE

50-2825 10" 2 Interchangeable Tips  
1.5mm and 2.0mm



**JACKSON ORIGINAL TRACHEOSTOMY TUBES**

**STAINLESS, REGULAR**

78-1700	#00	78-1715	#5
78-1710	#0	78-1716	#6
78-1711	#1	78-1717	#7
78-1712	#2	78-1718	#8
78-1713	#3	78-1719	#9
78-1714	#4	78-1720	#10



**JACKSON ORIGINAL TRACHEOSTOMY TUBES**

**STAINLESS, SHORT**

78-1300	#00	78-1315	#5
78-1310	#0	78-1316	#6
78-1311	#1	78-1317	#7
78-1312	#2	78-1318	#8
78-1313	#3	78-1319	#9
78-1314	#4	78-1320	#10

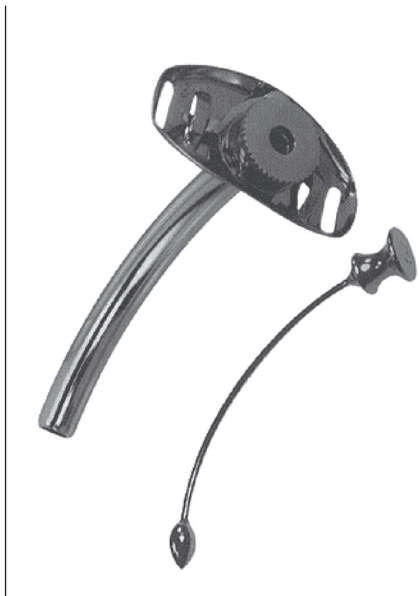

**JACKSON IMPROVED TRACHEOSTOMY TUBES**

**STAINLESS, REGULAR**

78-2000	#00	78-2015	#5
78-2010	#0	78-2016	#6
78-2011	#1	78-2017	#7
78-2012	#2	78-2018	#8
78-2013	#3	78-2019	#9
78-2014	#4	78-2020	#10



**JACKSON IMPROVED TRACHEOSTOMY TUBES**

**STAINLESS, SHORT LENGTH**

78-2100	#00	78-2115	#5
78-2110	#0	78-2116	#6
78-2111	#1	78-2117	#7
78-2112	#2	78-2118	#8
78-2113	#3	78-2119	#9
78-2114	#4	78-2120	#10



**JACKSON IMPROVED TRACHEOSTOMY TUBES**

**STAINLESS, EXTRA LONG**

78-2214	#4
78-2215	#5
78-2216	#6
78-2217	#7
78-2218	#8
78-2219	#9



## SUCTION & ASPIRATION TRACHEOSTOMY TUBES



### JACKSON IMPROVED TRACHEOSTOMY TUBES

STAINLESS, WITH ADAPTOR

78-2144	#4	78-2147	#7
78-2145	#5	78-2148	#8
78-2146	#6	78-2150	#10



### JACKSON IMPROVED TRACHEOSTOMY TUBES

FOUR PIECE SET

INCLUDES OUTER, INNER, 15MM ADAPTER AND OBTURATOR

78-2030	#00	78-2024	#4
78-2029	#0	78-2025	#5
78-2031	#1	78-2026	#6
78-2032	#2	78-2027	#7
78-2033	#3	78-2028	#8



### JACKSON IMPROVED LARYNGECTOMY TUBES

STAINLESS

78-2284	#4	78-2288	#8
78-2285	#5	78-2289	#9
78-2286	#6	78-2290	#10
78-2287	#7		



### JACKSON ORIGINAL LARYNGECTOMY TUBES

STAINLESS

78-2254	#4	78-2258	#8
78-2255	#5	78-2259	#9
78-2256	#6	78-2260	#10
78-2257	#7		

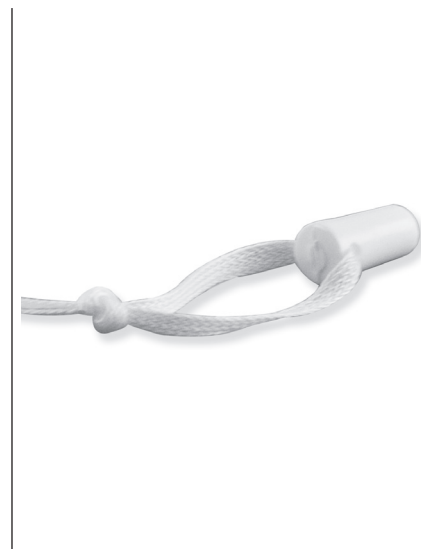

### SKLAR DECANNUATION STOPPERS

FULL SIZE

78-3130	#0	78-3135	#5
78-3131	#1	78-3136	#6
78-3132	#2	78-3137	#7
78-3133	#3	78-3138	#8
78-3134	#4	78-3139	#9



**FIBER OPTIC MILLER  
LARYNGOSCOPE BLADES**

**ENGLISH STYLE, 4MM**

07-1430	#00	Length 40mm
07-1431	#0	Length 50mm
07-1432	#1	Length 77mm
07-1433	#2	Length 128mm
07-1434	#3	Length 170mm
07-1435	#4	Length 178mm



**FIBER OPTIC MILLER  
LARYNGOSCOPE BLADES**

**AMERICAN STYLE**

07-1245	#00	
07-1246	#0	
07-1247	#1	
07-1248	#2	
07-1249	#3	
07-1250	#4	



**FIBER OPTIC MILLER  
LARYNGOSCOPE BLADES**

**INTEGRATED FIBER OPTIC BUNDLE**

07-1462	#00	Length 40mm
07-1263	#0	Length 52mm
07-1264	#1	Length 77mm
07-1265	#2	Length 127mm
07-1266	#3	Length 167mm
07-1267	#4	Length 183mm



**FIBER OPTIC MACINTOSH  
LARYNGOSCOPE BLADES**

**ENGLISH STYLE, 4MM**

07-1272	#0	Length 54mm
07-1268	#1	Length 67mm
07-1269	#2	Length 75mm
07-1273	#2L	Length 87mm
07-1270	#3	Length 113mm
07-1271	#4	Length 128mm



**FIBER OPTIC MACINTOSH  
LARYNGOSCOPE BLADES**

**ENGLISH STYLE, 4.5MM**

07-1440	#0	Length 57mm
07-1441	#1	Length 68mm
07-1442	#2	Length 90mm
07-1443	#3	Length 110mm
07-1444	#4	Length 130mm
07-1445	#5	Length 151mm



**FIBER OPTIC MACINTOSH  
LARYNGOSCOPE BLADES**

**INTEGRATED FIBER OPTIC BUNDLE**

07-1240	#0	
07-1241	#1	
07-1242	#2	
07-1243	#3	
07-1244	#4	

# SUCTION & ASPIRATION LARYNGOSCOPE BLADES



## FIBER OPTIC MACINTOSH FLEX TIP LARYNGOSCOPE BLADES

### ENGLISH STYLE, 4.5 MM

07-1447	#2	Length 75mm
07-1448	#3	Length 105mm
07-1449	#4	Length 130mm



## FIBER OPTIC WISCONSIN LARYNGOSCOPE BLADES

### ENGLISH STYLE, 4 MM

07-1257	#0	Length 50mm
07-1258	#1	Length 72mm
07-1259	#2	Length 110mm
07-1260	#3	Length 132mm
07-1261	#4	Length 175mm

### AMERICAN STYLE

07-1251	#0
07-1252	#1
07-1253	#2



## STANDARD MILLER LARYNGOSCOPE BLADES

### ENGLISH STYLE

07-1211	Size 00
07-1212	Size 0
07-1213	Size 1
07-1214	Size 2
07-1215	Size 3
07-1216	Size 4

### AMERICAN STYLE

07-1220	Size 00
07-1221	Size 0
07-1222	Size 1
07-1223	Size 2
07-1224	Size 3
07-1225	Size 4



## STANDARD MACINTOSH LARYNGOSCOPE BLADES

### ENGLISH STYLE

07-1219	Size 0
07-1200	Size 1
07-1201	Size 2
07-1202	Size 3
07-1203	Size 4
07-1218	Size 5

### AMERICAN STYLE

07-1205	Size 0
07-1206	Size 1
07-1207	Size 2
07-1208	Size 3
07-1210	Size 4



**SUCTION & ASPIRATION  
LARYNGOSCOPE HANDLES**



**FIBER OPTIC LARYNGOSCOPE HANDLE**

**HOOK-ON, 2.5V (BATTERIES NOT INCLUDED)**

- |         |                                      |         |                               |
|---------|--------------------------------------|---------|-------------------------------|
| 07-1400 | Medium, Requires (2) C Batteries     | 07-1172 | Replacement Lamp, Fiber Optic |
| 07-1401 | Pediatric, Requires (2) AA Batteries | 07-1175 | Rechargeable Battery, AA      |
| 07-1402 | Stubby, Requires (2) AA Batteries    | 07-1176 | Rechargeable Battery, C       |



**LED LARYNGOSCOPE HANDLE**

**HOOK ON, 2.5V (BATTERIES NOT INCLUDED)**

- |         |                                      |
|---------|--------------------------------------|
| 07-1478 | Medium, Requires (2) C Batteries     |
| 07-1479 | Pediatric, Requires (2) AA Batteries |
| 07-1171 | Replacement Lamp, LED                |
| 07-1175 | Rechargeable Battery, AA             |
| 07-1176 | Rechargeable Battery, C              |



**STANDARD LARYNGOSCOPE HANDLE**

**HOOK ON, 2.5V (BATTERIES NOT INCLUDED)**

- |         |                                      |
|---------|--------------------------------------|
| 07-1420 | Medium, Requires (2) C Batteries     |
| 07-1422 | Pediatric, Requires (2) AA Batteries |
| 07-1424 | Stubby, Requires (2) AA Batteries    |
| 07-1175 | Rechargeable Battery, AA             |
| 07-1176 | Rechargeable Battery, C              |



## SUCTION & ASPIRATION LARYNGOSCOPE SETS



### FIBER OPTIC MILLER LARYNGOSCOPE BLADE SET

SET OF 4 WITH MEDIUM HANDLE

07-1375 Blade Sizes 1-4



### FIBER OPTIC MACINTOSH LARYNGOSCOPE BLADE SET

SET OF 4 WITH MEDIUM HANDLE

07-1376 Blade Sizes 1-4



### DISPOSABLE FIBER OPTIC LARYNGOSCOPE SET

SET OF 7 WITH HANDLE

07-1374 Miller Blades, Sizes 0, 1, 2, 3  
Macintosh Blades, Sizes 2, 3, 4

# TROCARS

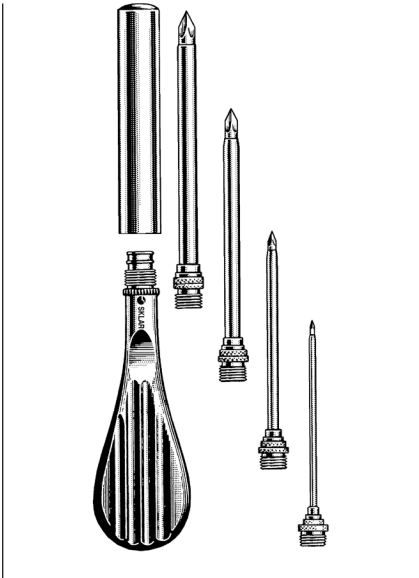

### TROCARS

SET OF FOUR

NESTED IN FLAT HANDLE

34-1014 5½" 6, 9, 13, 17 French

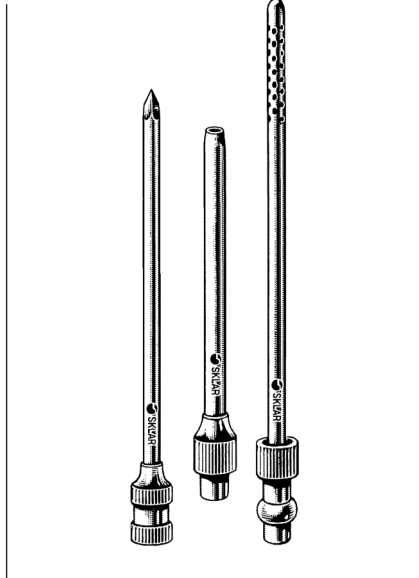

### DUKE IMPROVED TROCAR

PERFORATED CANNULA

34-1017 4¼" 17 French

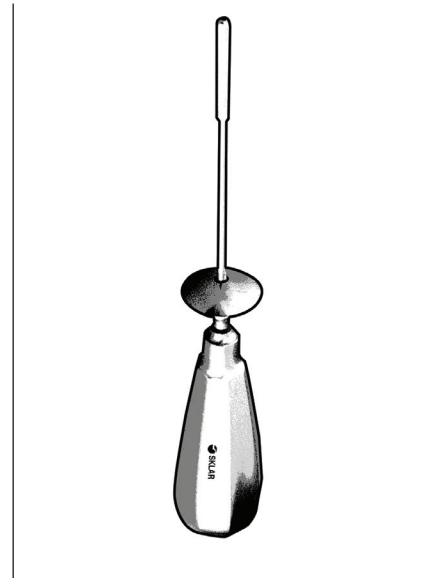

### THORACIC TROCARS

34-3620 3.5mm

34-3624 4mm

34-3626 4.5mm

34-3628 5mm

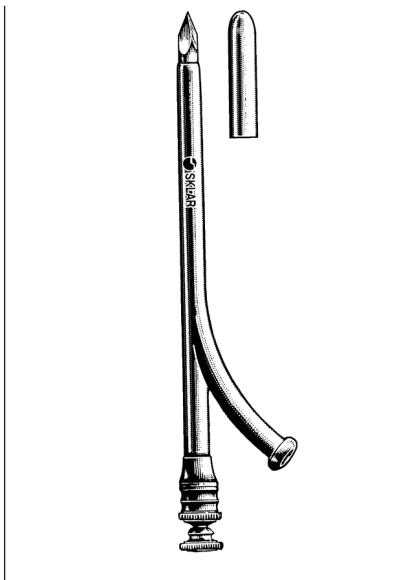

### OCHSNER TROCARS

34-1410 10 French for 6 Fr Catheter

34-1414 14 French for 10 Fr Catheter

34-1417 16 French for 12 Fr Catheter

34-1418 18 French for 14 Fr Catheter

34-1420 20 French for 16 Fr Catheter

34-1422 22 French for 18 Fr Catheter

34-1424 24 French for 20 Fr Catheter

34-1428 28 French for 22 Fr Catheter

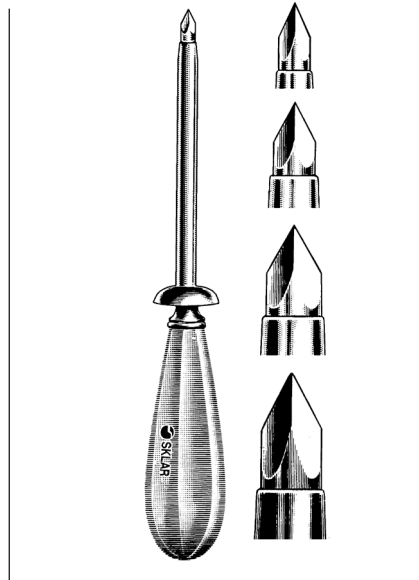

### NELSON TROCARS

34-2422 #1 8¼" 25 French

34-2428 #2 8¼" 30 French

34-2434 #3 8¼" 33 French

34-2438 #4 8¼" 35 French

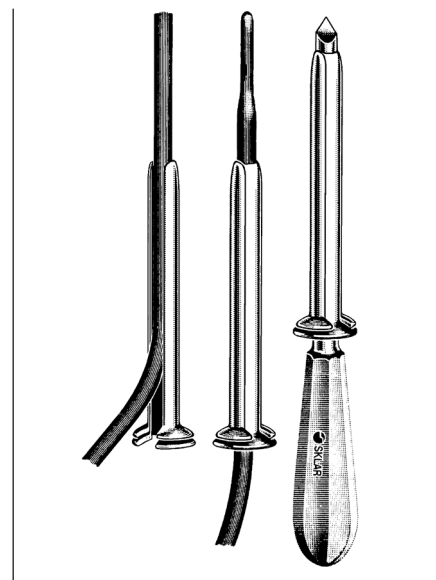

### HURWITZ TROCARS

34-2522 22 French

34-2526 26 French

34-2536 36 French

# SUTURE INSTRUMENTS



## NEEDLES

Sklar Surgical Needles are offered in multiple configurations. For wound and laceration care, the Reverse Cutting Needles are made with a sharp outer edge to allow for smooth and atraumatic penetration of tough skin and fascia. Tapered needles are used almost exclusively on soft, less dense tissue and when the smallest diameter hole is desired. All needles have Regular Surgeon Eyes unless otherwise specified.

All needles are sold Non-Sterile in packages of 12. When ordering simply add the corresponding needle size number to the end of the needle family product number, ie. needle size #4 would be 93-1760-4 or size #16 would be 93-1760-16. Needles are not shown to actual size.

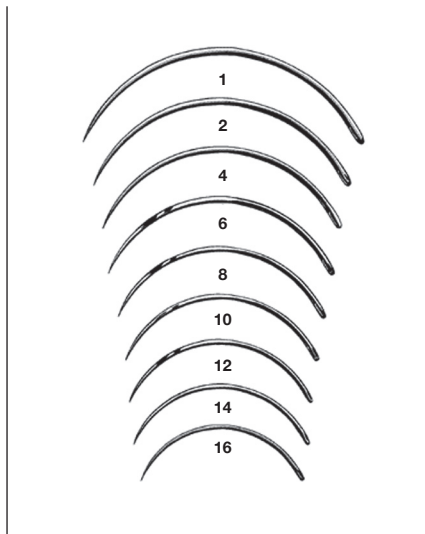

### REGULAR SURGEON NEEDLE

$\frac{3}{8}$  CIRCLE WITH SPRING EYE  
93-1760-# Cutting Edge

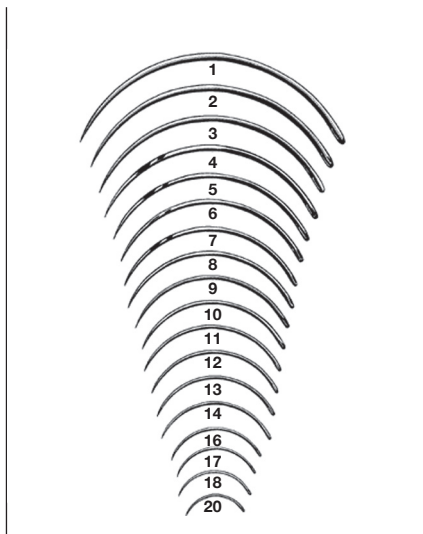

### REGULAR SURGEON NEEDLE

$\frac{3}{8}$  CIRCLE  
93-1762-# Reverse Cutting Edge

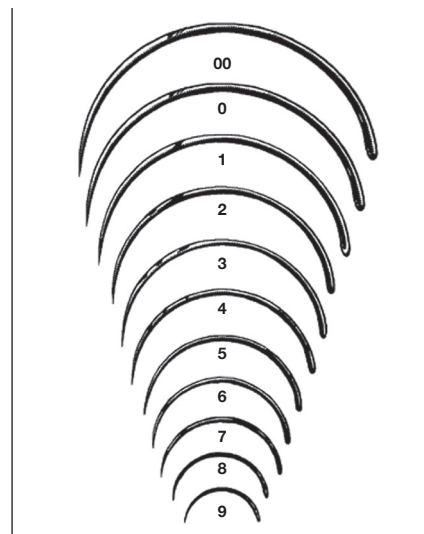

### REGULAR SURGEON NEEDLE

$\frac{1}{2}$  CIRCLE  
93-1770-# Cutting Edge

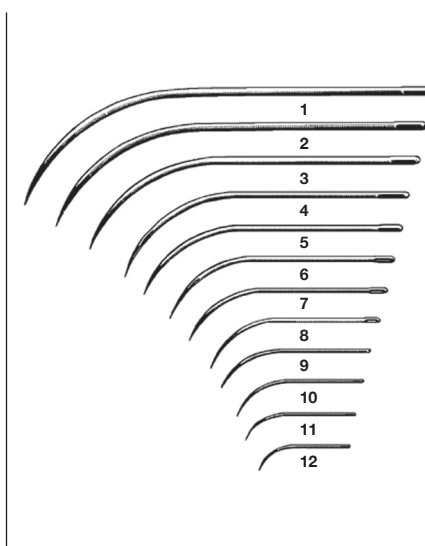

### REGULAR SURGEON NEEDLE

HALF CURVE  
93-1780-# Cutting Edge

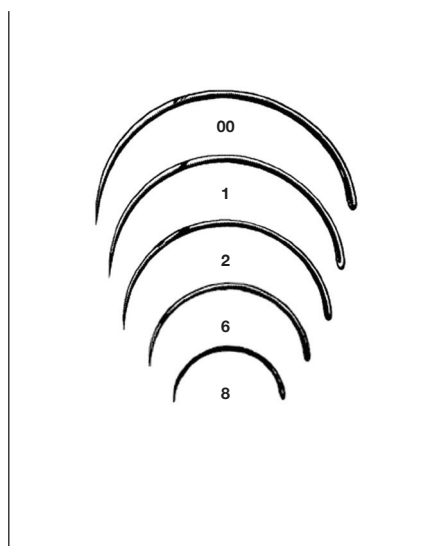

### FISTULA NEEDLE

$\frac{1}{2}$  CIRCLE  
93-1710-# Cutting Edge

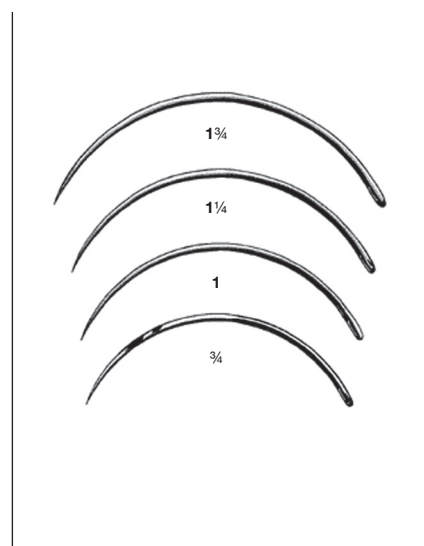

### MAYO INTESTINAL NEEDLE

$\frac{3}{8}$  CIRCLE  
93-1712-# Taper Point

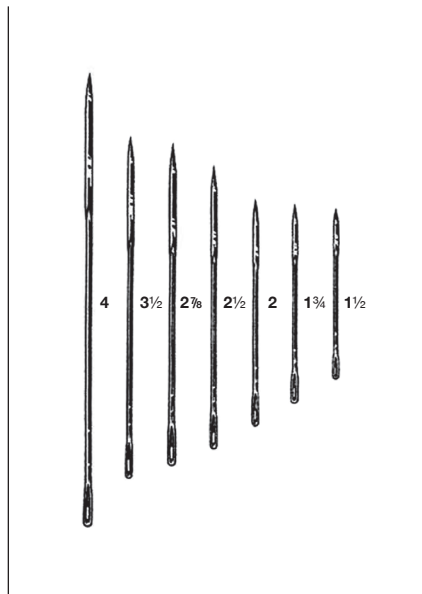

**KEITH ABDOMINAL NEEDLE**

STRAIGHT

93-1714-# Triangular Point

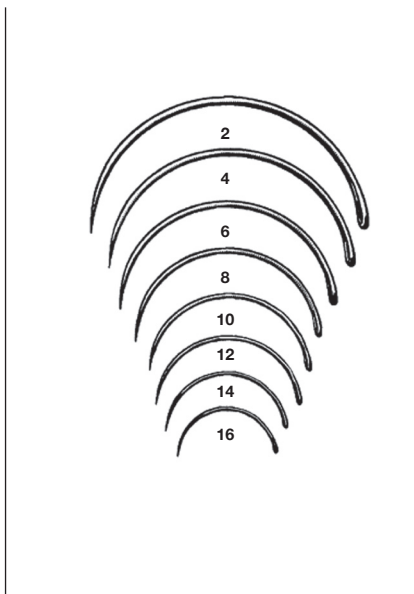

**FERGUSON NEEDLE**

1/2 CIRCLE

93-1716-# Taper Point

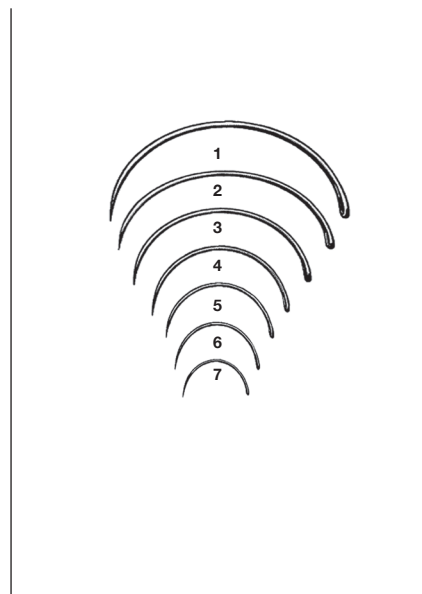

**MAYO CATGUT NEEDLE**

1/2 CIRCLE

93-1718-# Taper Point

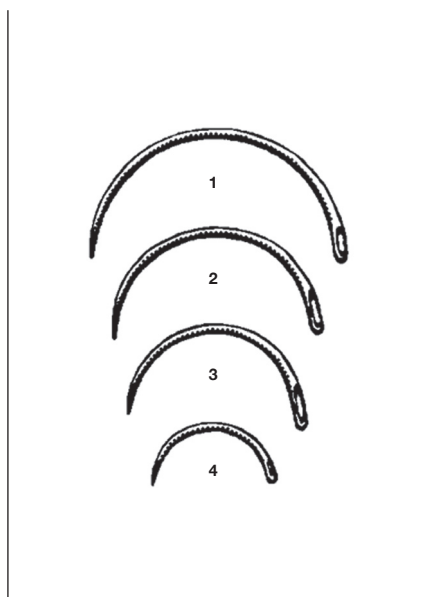

**MURPHY'S INTESTINAL NEEDLE**

1/2 CIRCLE

93-1720-# Taper Point

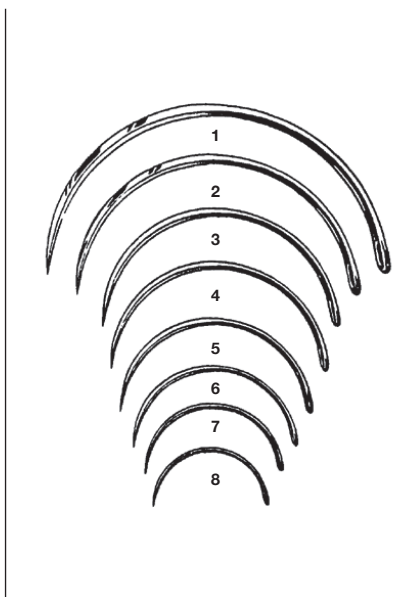

**MARTIN'S UTERINE NEEDLE**

1/2 CIRCLE

93-1722-# Cutting Edge



**POST MORTEM NEEDLE**

HALF CURVE

93-1730-# Cutting Edge



# SUTURE INSTRUMENTS

## NEEDLES

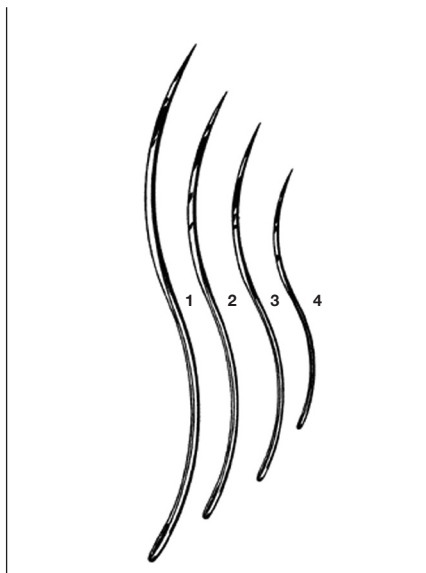

### POST MORTEM NEEDLE

DOUBLE CURVE

93-1731-# Cutting Edge

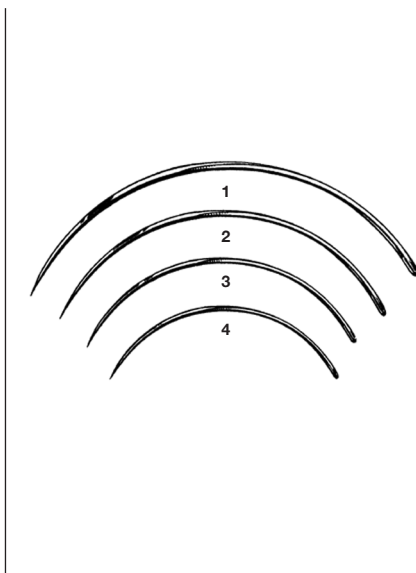

### VETERINARY NEEDLE

$\frac{3}{8}$  CIRCLE WITH SPRING EYE

93-1732-# Cutting Edge

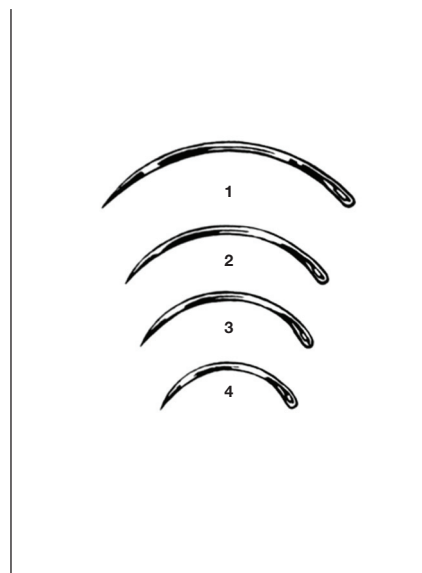

### EYE NEEDLE

$\frac{3}{8}$  CIRCLE

93-1740-# Cutting Edge

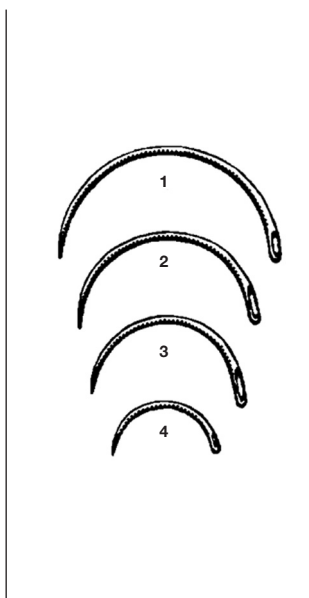

### EYE NEEDLE

$\frac{1}{2}$  CIRCLE

93-1741-# Cutting Edge

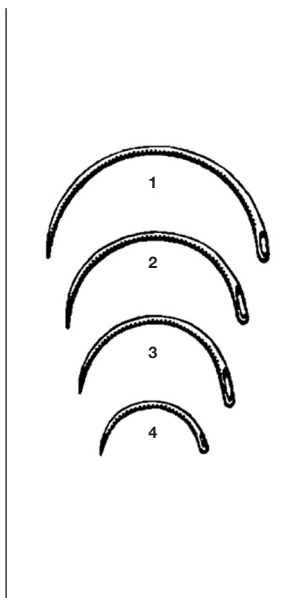

### EYE NEEDLE

$\frac{1}{2}$  CIRCLE

93-1742-# Taper Point

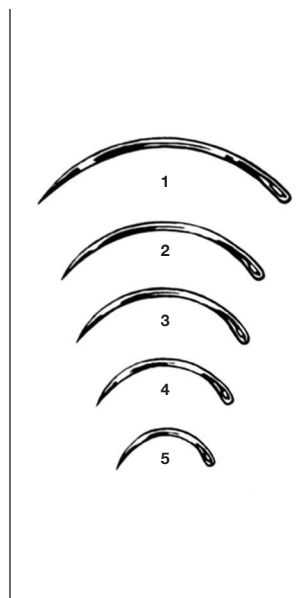

### LANE CLEFT PALATE NEEDLE

$\frac{3}{8}$  CIRCLE

93-1750-# Cutting Edge

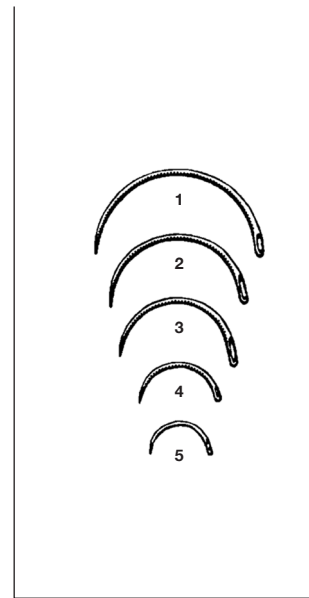

### LANE CLEFT PALATE NEEDLE

$\frac{1}{2}$  CIRCLE

93-1751-# Cutting Edge

All needles are sold Non-Sterile in packages of 12. When ordering simply add the corresponding needle size number to the end of the needle family product number, ie. needle size #4 would be 93-1760-4 or size #16 would be 93-1760-16. Needles are not shown to actual size.

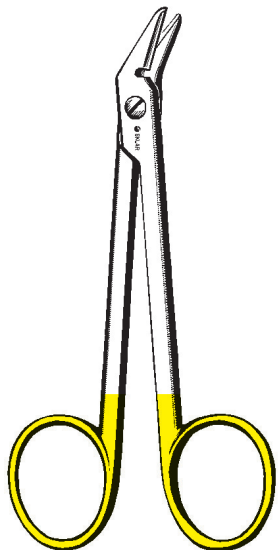

**SKLAR EDGE™ TC WIRE CUTTING SCISSOR**

16-2800 4¾" Angled, Serrated

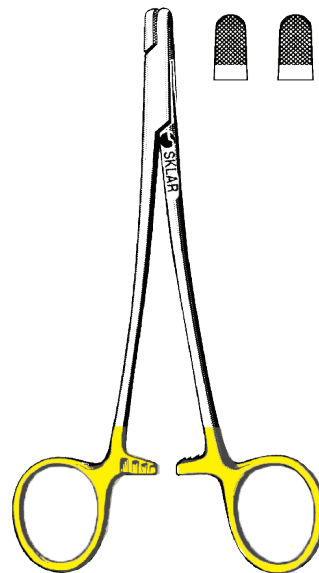

**TC STERNAL WIRE TWISTERS**

21-9060 5"  
21-9065 7"

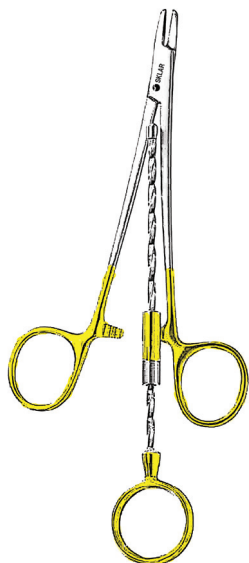

**TC CORWIN WIRE TWISTERS**

**SERRATED**

21-9050	6"	Flat
21-9051	6"	Round
21-9052	6½"	Round, Narrow

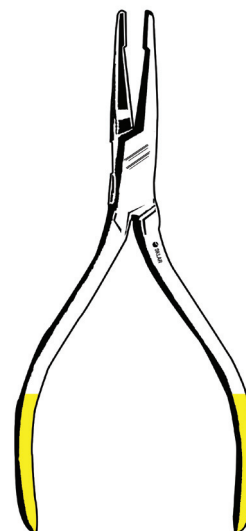

**TC PIN PULLER**

40-1740 5½"



# SUTURE INSTRUMENTS

## STITCH SCISSORS

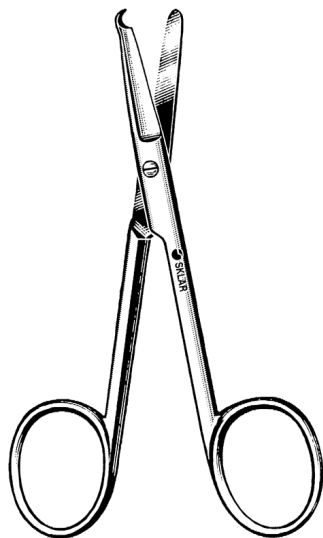

### STITCH SCISSORS

- 22-2835 3½" Spencer
- 22-2845 4½" Spencer
- 15-1355 5½" Littauer

### DELICATE

- 22-2834 3½" Spencer
- 22-2844 4½" Spencer
- 22-1354 5½" Littauer

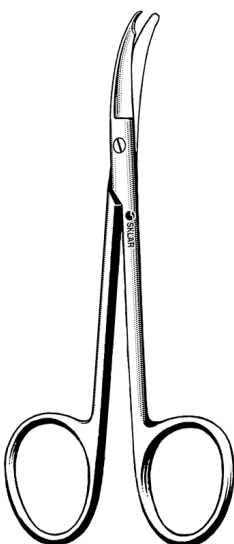

### SUTURE SCISSORS

- 22-2935 3½" Shortbent
- 22-2934 3½" Shortbent, Delicate
- 22-2947 4¾" Northbent



### SKLARLITE™ SUTURE SCISSOR

- 23-1191 3½" Shortbent

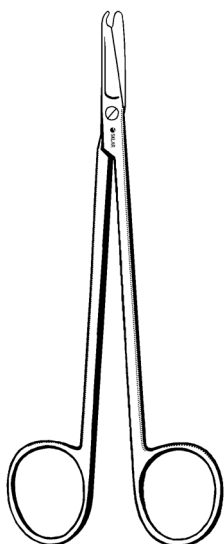

### LONG STITCH SCISSOR

- 15-1358 6¼"

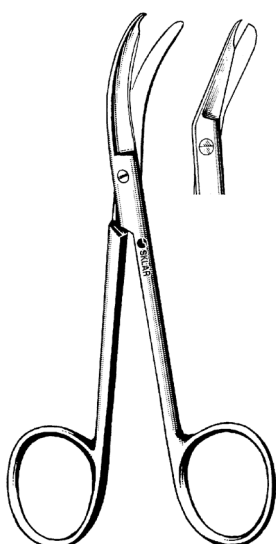

### SKLAR STITCH SCISSORS

- 15-3150 4½" Angled
- 22-2950 5" Curved

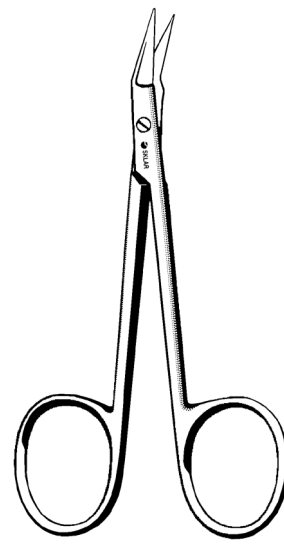

### O'BRIEN STITCH SCISSOR

- 22-2837 3¾" Angled



# SUTURE INSTRUMENTS

## STITCH SCISSORS

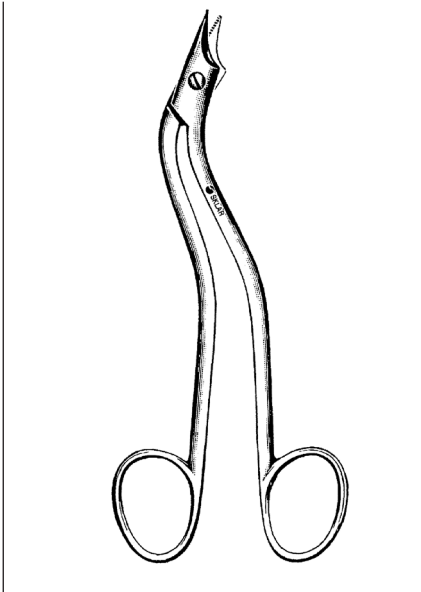

**HEATH SCISSOR**  
24-1962 6¼" Serrated

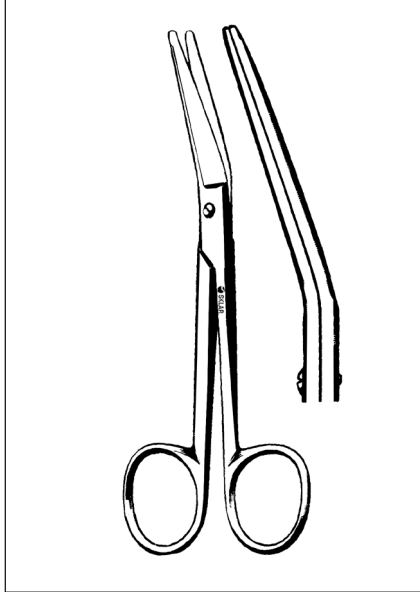

**NEW'S SUTURE SCISSOR**  
41-1163 5½" Angled on Flat

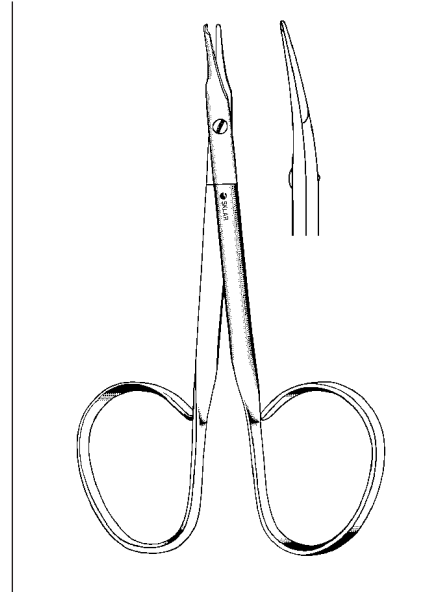

**REEH RIB STITCH SCISSOR**  
64-1348 3¾"

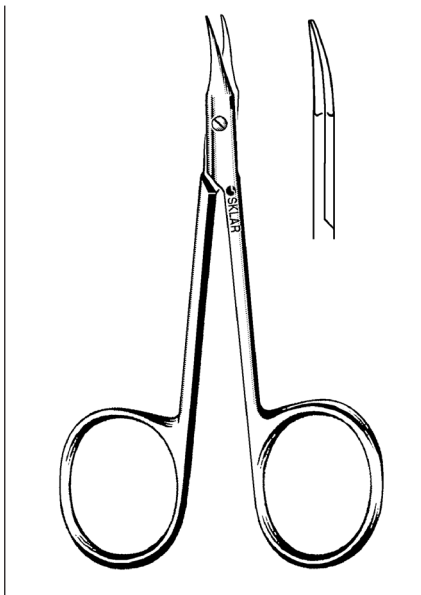

**GRADLE SCISSORS**  
64-3280 3¾" Slight Curve, Sharp  
22-2957 3¾" Ribbon Style

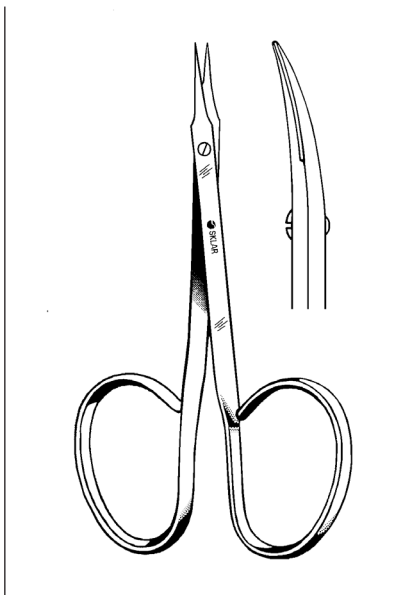

**RIBBON STITCH SCISSORS**  
64-1345 4" Straight  
64-1445 4" Curved

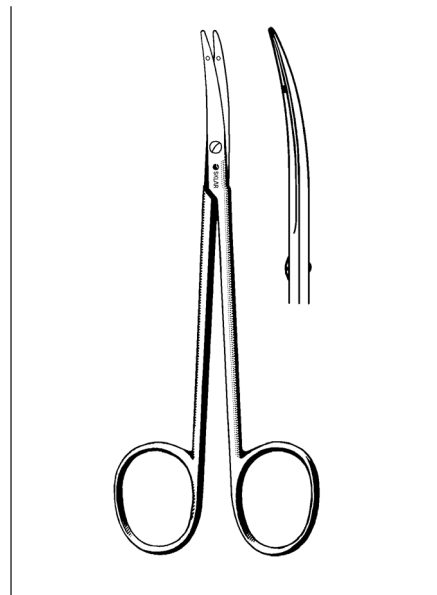

**LITTLER SUTURE  
CARRYING SCISSOR**  
22-2645 4½" Curved

# SUTURE INSTRUMENTS

## GENERAL



### CROWN SCISSORS

- 24-2345 4" Straight, Smooth
- 24-2340 4" Straight, Serrated
- 24-2346 4" Curved, Smooth
- 24-2341 4" Curved, Serrated

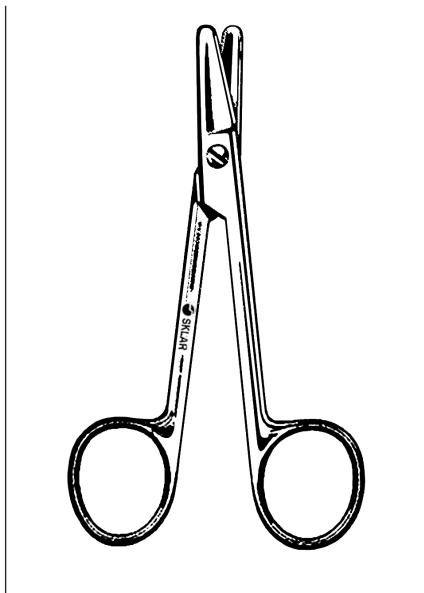

### SUTURE SCISSOR

- 24-2347 4 3/4" Straight, Heavy Serrations

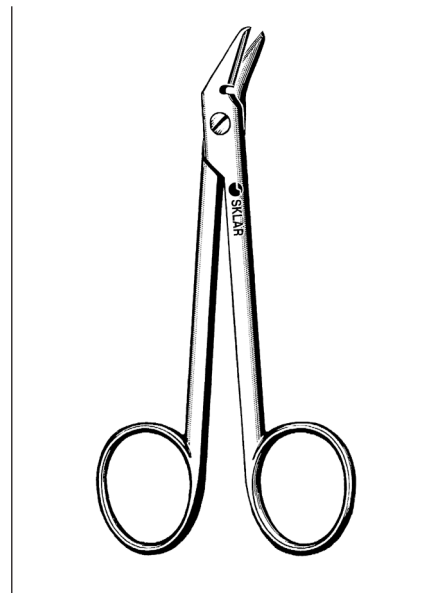

### SUTURE WIRE CUTTING SCISSOR

- 24-2342 4 3/4" Angled, Serrated

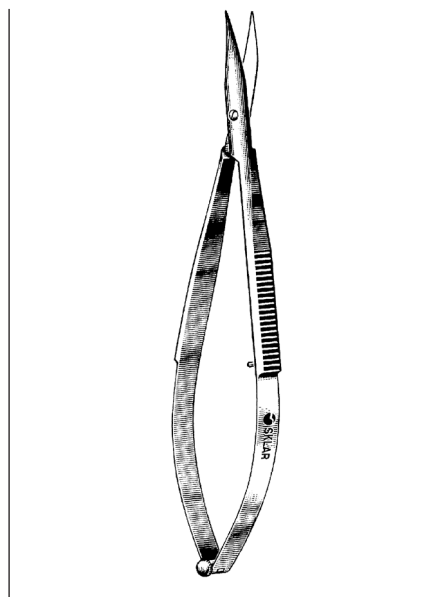

### WESTCOTT TENOTOMY SCISSORS

- 64-3146 4 1/4" Blunt
- 64-3145 4 1/4" Sharp
- 64-3142 5" Right
- 64-3144 5" Left

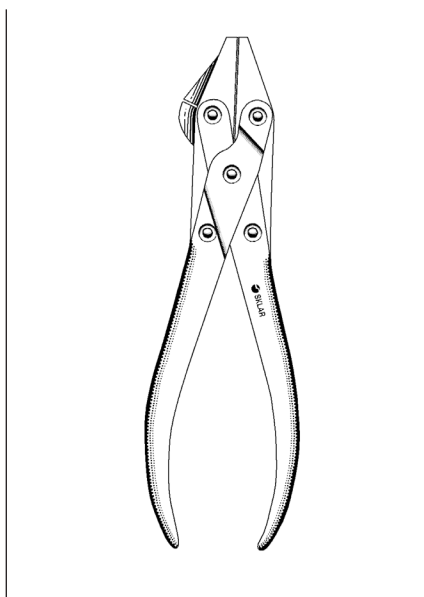

### DOUBLE ACTION PARALLEL PLIER SIDE WIRE CUTTER

- 40-1727 6 3/4"

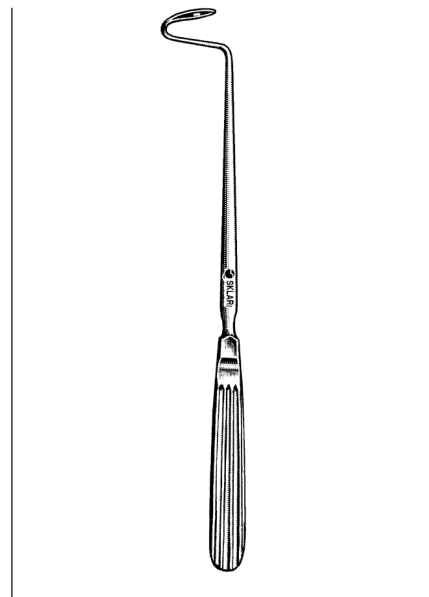

### DESCHAMP NEEDLES

#### CURVED

- 26-1280 8" Right, Blunt
- 26-1480 8" Right, Sharp
- 26-1380 8" Left, Blunt
- 26-1580 8" Left, Sharp

# SUTURE INSTRUMENTS

## GENERAL

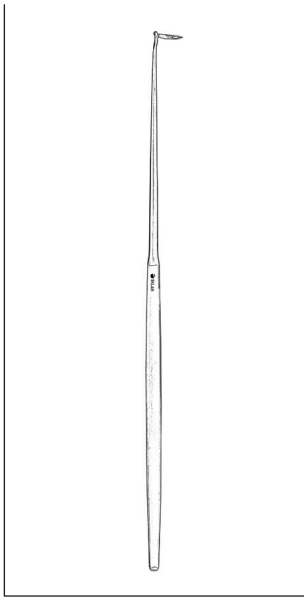

**DUPUYSS-WEISS  
LIGATURE CARRIERS**

26-1585 8½" Right  
26-1586 8½" Left

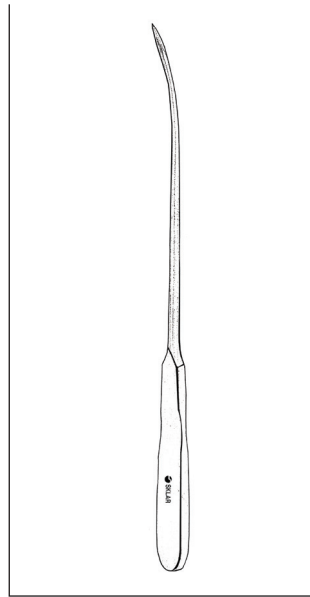

**OBWEGESER  
MANDIBULAR AWLS**

**FOR WIRE SUTURING, SLIGHT CURVE**  
26-2005 5"  
26-2006 6"  
26-2007 7"  
26-2009 9"

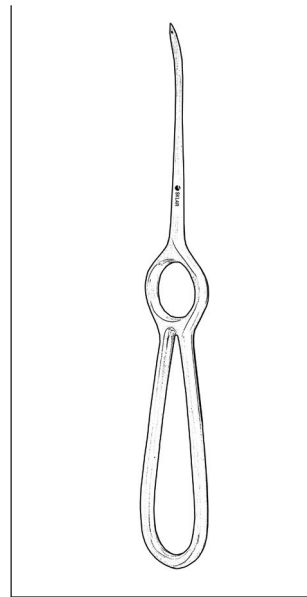

**OBWEGESER  
MAXILLARY AWL**

**FOR WIRE SUTURING,  
STRONG CURVE**  
26-2010 7"

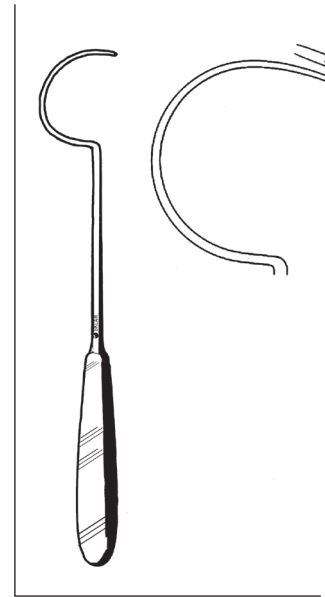

**DEMEL BONE  
WIRE GUIDES**

26-1031 10¾"  
26-1032 11¼"  
26-1033 12"

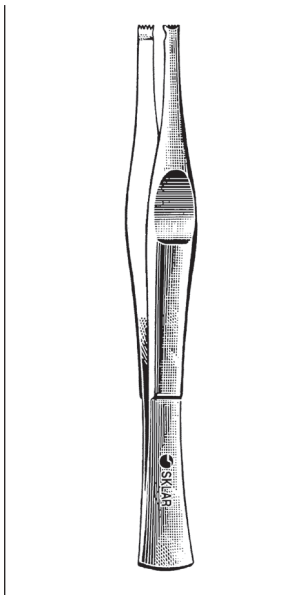

**MICHEL WOUND  
CLIP FORCEPS**

24-1150 5"

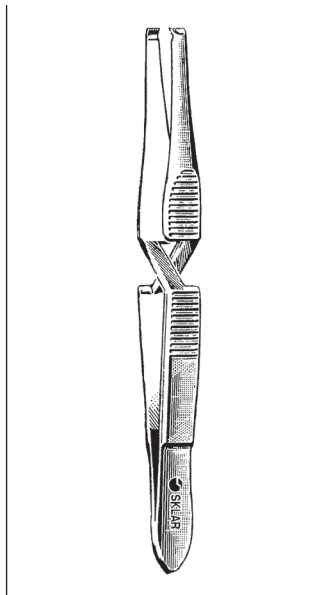

**HEGENBARTH CLIP  
APPLYING FORCEPS**

24-1650 5"

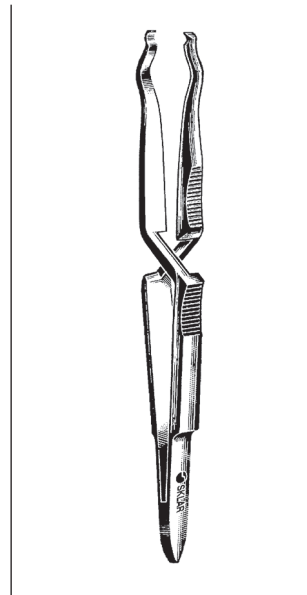

**WACHENFELDT CLIP  
APPLYING / REMOVING  
FORCEPS**

**CROSS ACTION**  
24-1450 5"

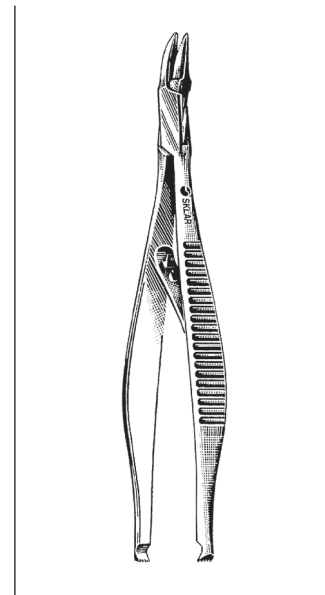

**MICHEL CLIP  
APPLYING / REMOVING  
FORCEPS**

24-1250 5"

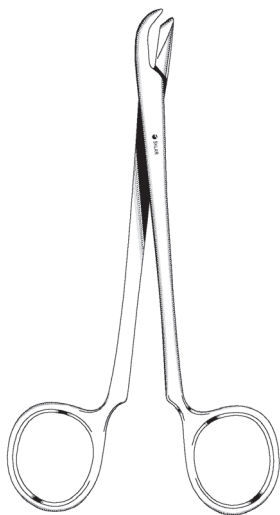

**WOUND CLIP REMOVER**

24-2047 5"

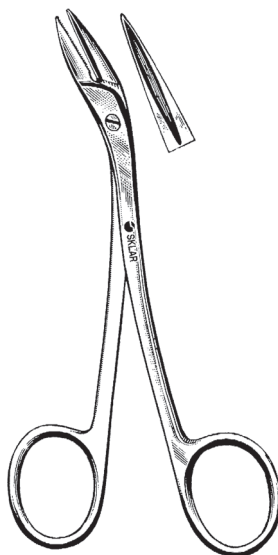

**MICHEL CLIP REMOVING FORCEPS**

24-2055 5½"

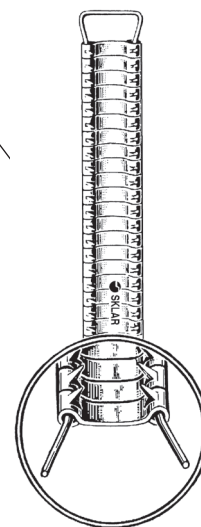

**MICHEL CLIPS**

**UNIT 1000**

24-1007	7.5mm	24-1016	16mm
24-1011	11mm	24-1018	18mm
24-1012	12mm	24-1020	20mm
24-1014	14mm	24-1022	22mm

**WACHENFELDT CLIPS**

**UNIT 100**

24-1116 7.5mm

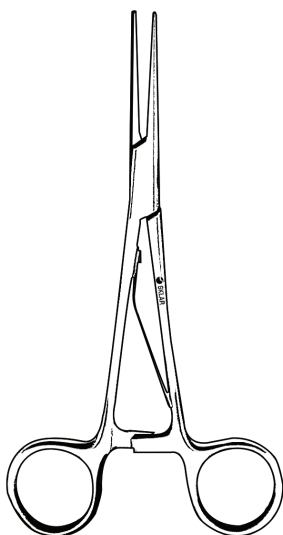

**MCKENZIE BRAIN CLIP FORCEPS**

50-4157 5¾"

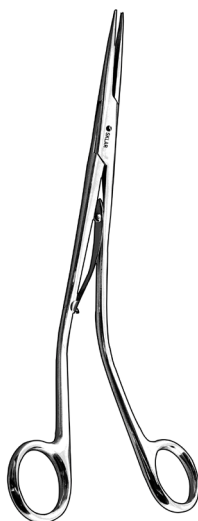

**SWEET CLIP FORCEPS  
FOR USE WITH MCKENZIE CLIPS**

50-4392 9¼"

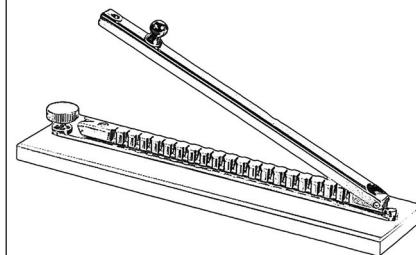

**MCKENZIE BRAIN CLIP HOLDING RACKS**

50-4200 For 20 clips  
50-4202 For 40 clips

**MCKENZIE BRAIN CLIPS**

50-4190 Vial of 100 Clips

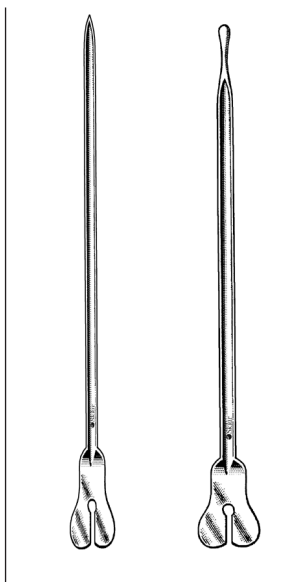

**DIRECTOR AND TONGUE TIES**

PLAIN END	PROBE END
30-1045 4½"	30-1145 4½"
30-1050 5"	30-1150 5"
30-1055 5½"	30-1155 5½"
30-1060 6"	30-1160 6"
30-1070 7"	30-1170 7"
30-1080 8"	30-1180 8"

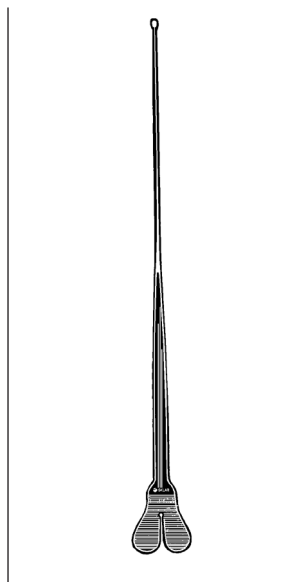

**LARRY PROBE**

80-2870 7"



**DOUBLE ENDED PROBES**

1MM		1.5MM		2.0MM	
30-1502	4½"	30-1518	4½"	30-1545	4½"
30-1504	5"	30-1520	5"	30-1550	5"
30-1506	5½"	30-1522	5½"	30-1555	5½"
30-1508	6"	30-1524	6"	30-1560	6"
30-1510	7"	30-1526	7"	30-1570	7"
30-1512	8"	30-1528	8"	30-1580	8"
30-1514	10"	30-1530	10"	30-1610	10"
				30-1612	12"

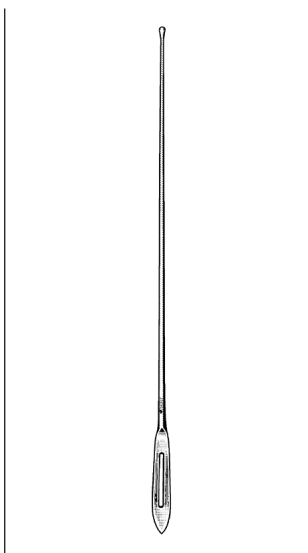

**PROBES WITH EYE**

30-1945	4½"
30-1950	5"
30-1955	5½"
30-1960	6"
30-1970	7"
30-1980	8"
30-2010	10"
30-2012	12"

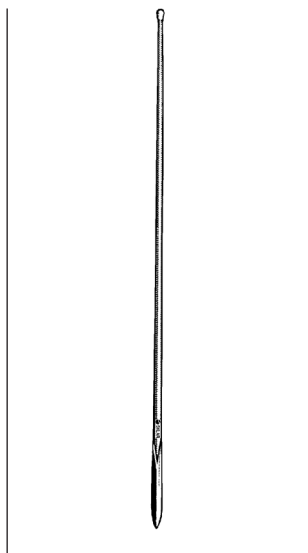

**SPEAR POINT PROBES**

30-2145	4½"
30-2150	5"
30-2155	5½"
30-2160	6"

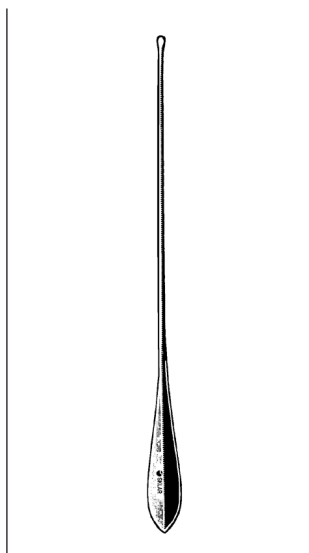

**MYRTLE LEAF PROBES**

STRAIGHT	
30-1450	5"
30-1455	5¾"
30-1460	6¼"
30-1470	7"
30-1480	8"

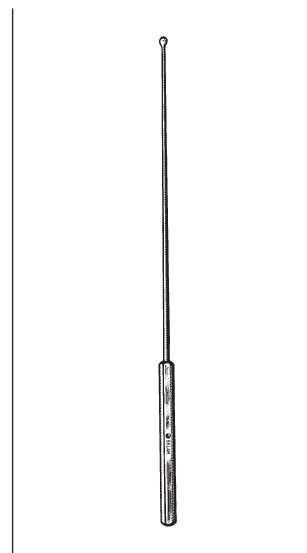

**BARR FISTULA PROBE**

WITH EYE, 11½" OVERALL  
80-2910 8" Sterling Shaft

# GALL BLADDER INSTRUMENTS

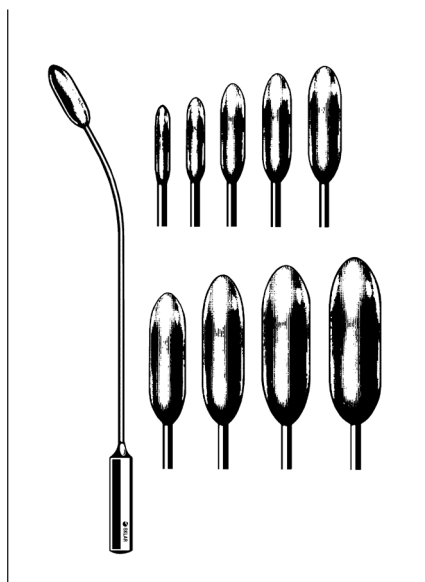

## BAKES DILATORS

### MALLEABLE SHAFT

32-1533	3mm	32-1538	8mm
32-1534	4mm	32-1539	9mm
32-1535	5mm	32-1610	10mm
32-1536	6mm	32-1611	11mm
32-1537	7mm	32-1530	Set of 9

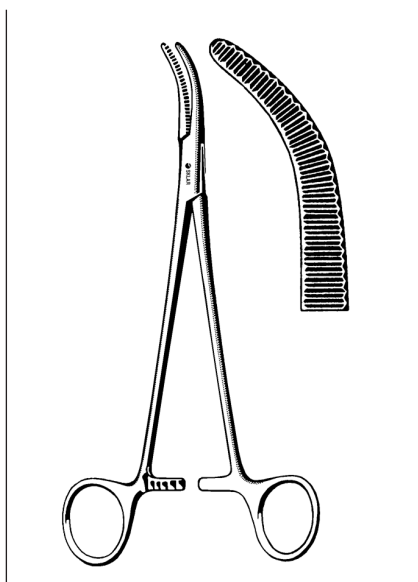

## MOYNIHAN GALL DUCT FORCEPS

32-1785 8½"

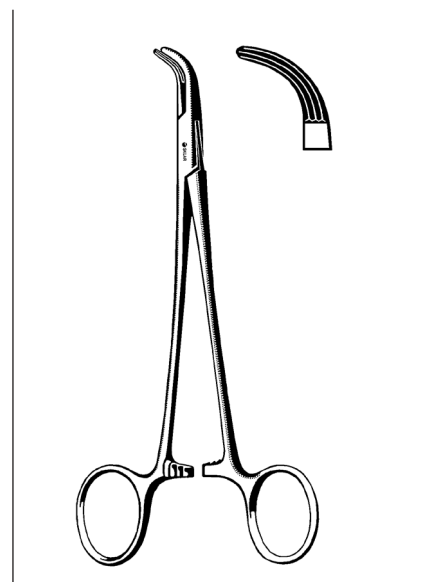

## LOWER GALL DUCT FORCEPS

32-1870 7"

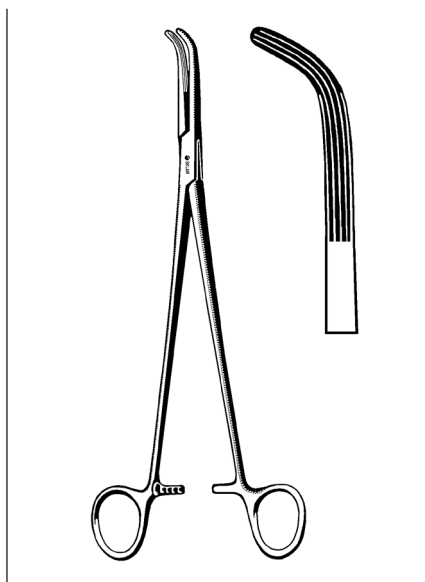

## LAHEY GALL DUCT FORCEPS

32-1875	7½"		
32-1890	9"		
32-1990	9"	Heavy	

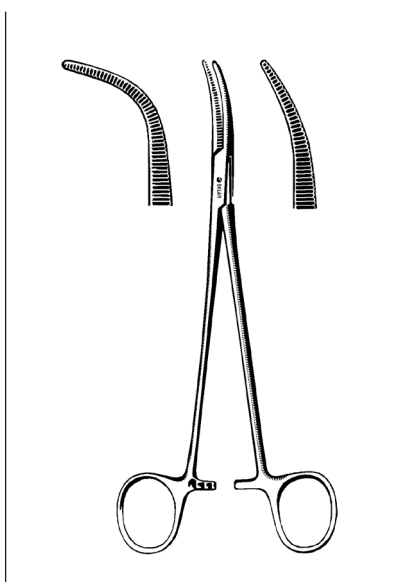

## VARCO GALL BLADDER FORCEPS

32-2075	7"	Shallow Curve
32-2175	7½"	Full Curve

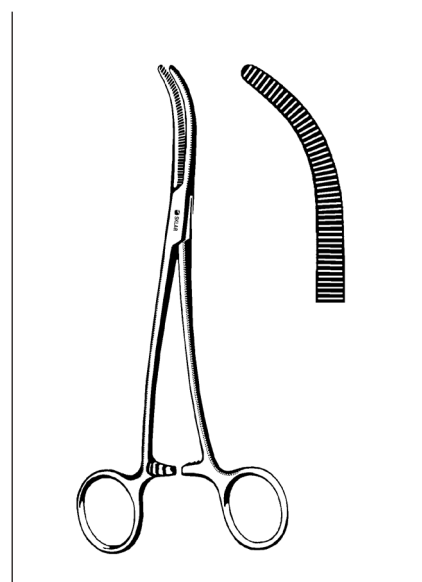

## SHALLCROSS FORCEPS

DOUBLE CURVE  
32-2070 7"

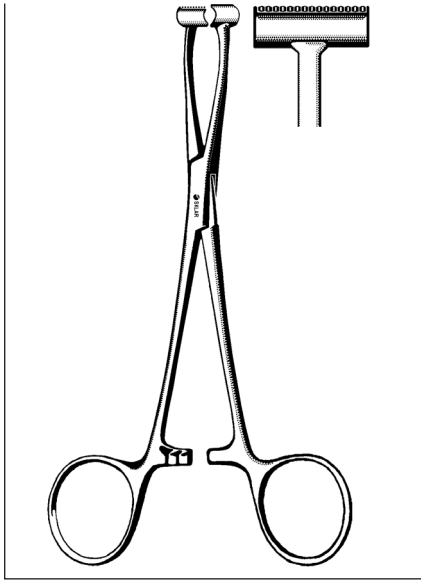

**PRATT T-SHAPE CLAMP**

17-1055 6"

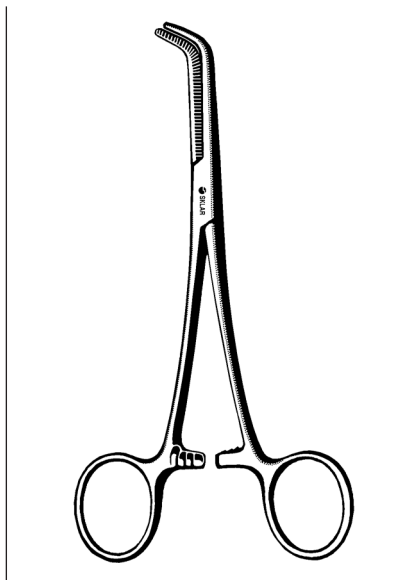

**MIXTER GALL DUCT FORCEPS**

**RIGHT ANGLE**

18-1250 5½"  
17-1762 6¼"  
17-1772 7¼"

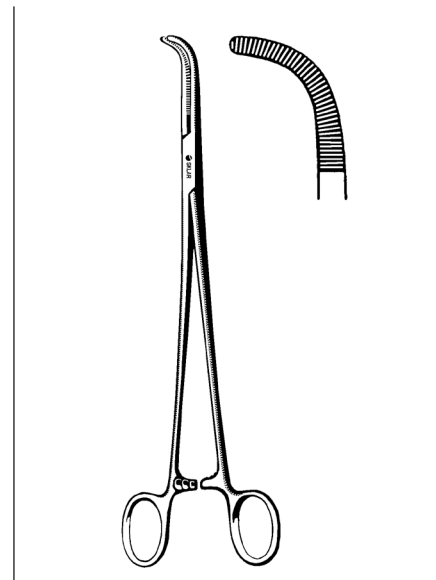

**MIXTER FORCEPS**

**RIGHT ANGLE, DELICATE**

22-3255 5½"  
22-3270 7"  
55-2890 9" Gemini  
55-2912 12" Harrington, Longitudinal  
Serrations

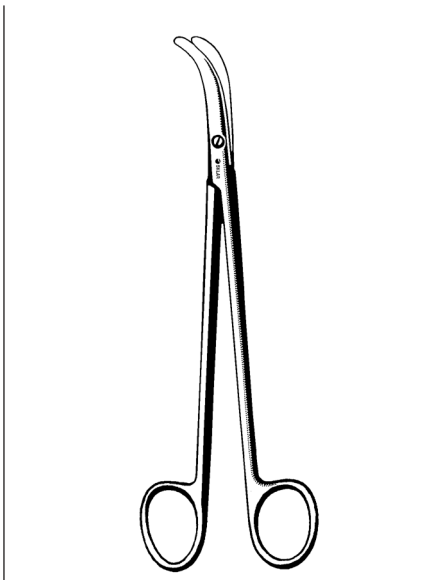

**THOREK SCISSORS**

**FULL CURVE**

15-3172 7¼"  
15-3210 10"

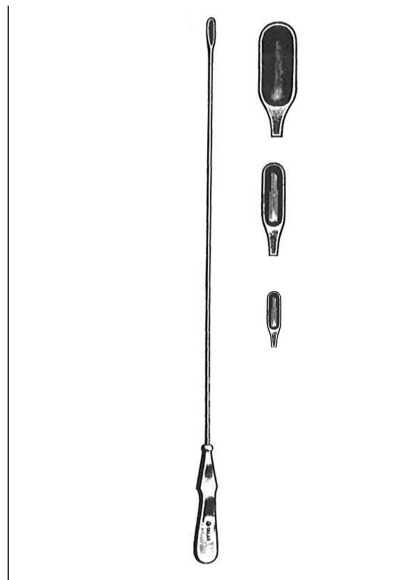

**MAYO COMMON DUCT SCOOPS**

**10½"**

32-1014 Small  
32-1015 Medium  
32-1016 Large

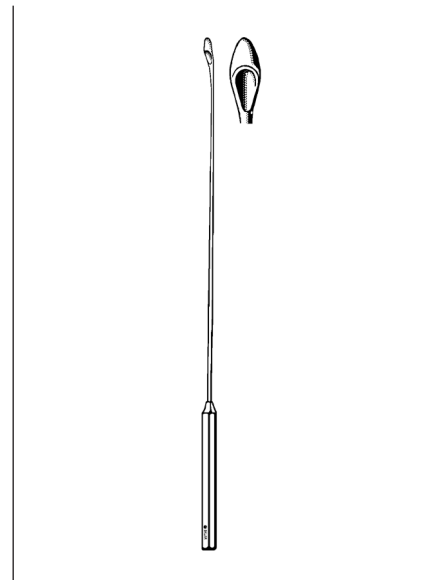

**DESJARDIN GALLSTONE  
SCOOPS**

32-3194 13 French  
32-3092 17 French  
32-3094 21 French  
32-3096 24 French  
32-3098 27 French

GALL BLADDER INSTRUMENTS

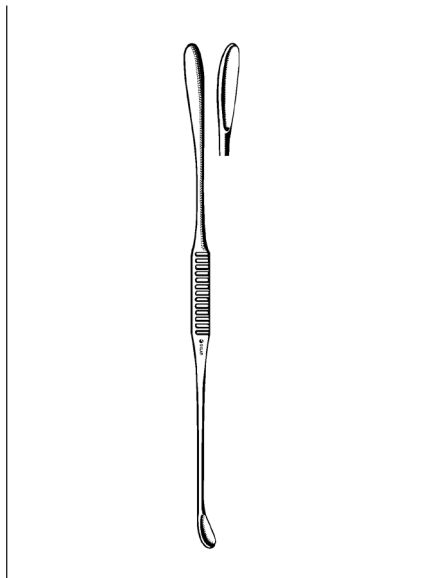

**MAYO GALLSTONE SCOOP**  
DOUBLE END  
32-1040 10¾"

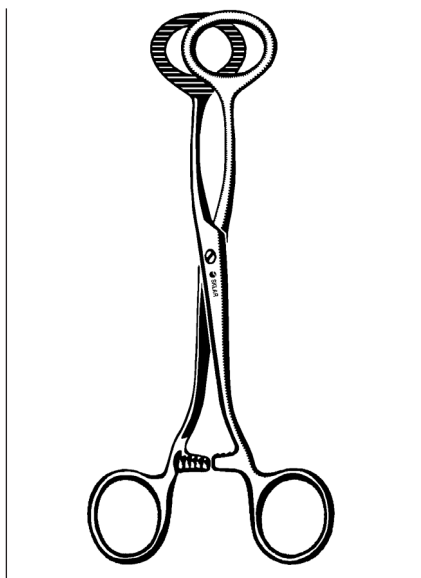

**JUDD MARTEL GALL BLADDER FORCEPS**  
32-2465 6½"

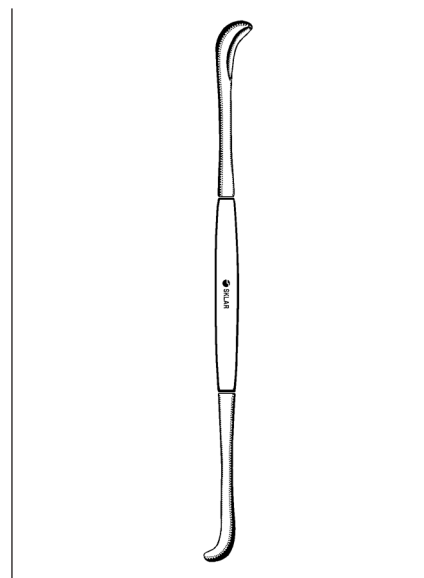

**FERGUSON SCOOP**  
DOUBLE END  
32-1037 9½"

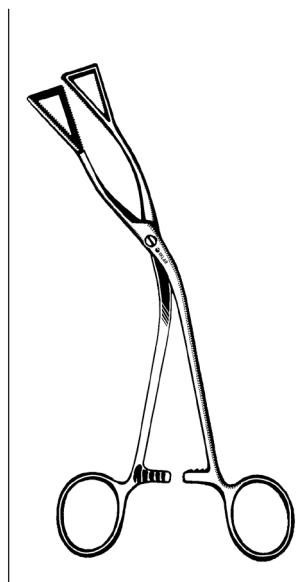

**LOVELACE GALL BLADDER TRACTION FORCEPS**  
ANGULAR  
32-2470 7"

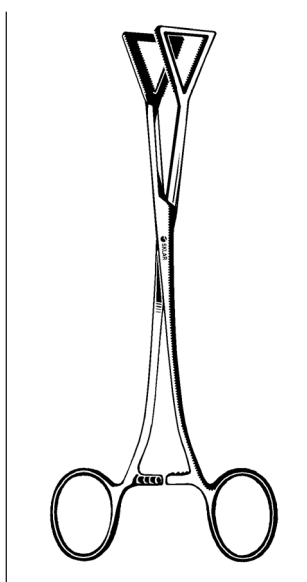

**LOVELACE GALL BLADDER TRACTION FORCEPS**  
STRAIGHT  
32-2477 8"

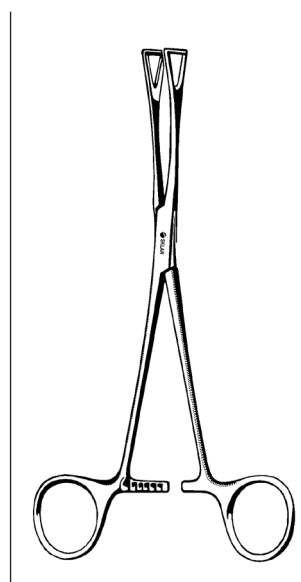

**DUVAL LUNG GRASPING FORCEPS**  
36-2577 1" Jaw Length 8"  
36-2595 1" Jaw Length 9½"

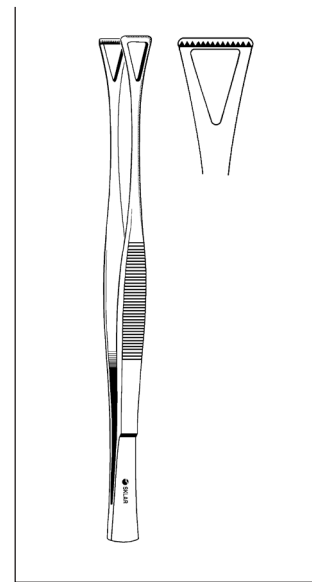

**COLLINS-DUVAL LUNG GRASPING FORCEPS**  
36-2607 1" Jaw Wide Length 8"





**RANDALL KIDNEY STONE FORCEPS**

- 33-1001 9¼" ¼ Curve
- 33-1002 8½" ½ Curve
- 33-1003 7¾" ¾ Curve
- 33-1004 7¾" Full Curve



**MAYO-GUYON KIDNEY CLAMP**

- 33-1090 9"

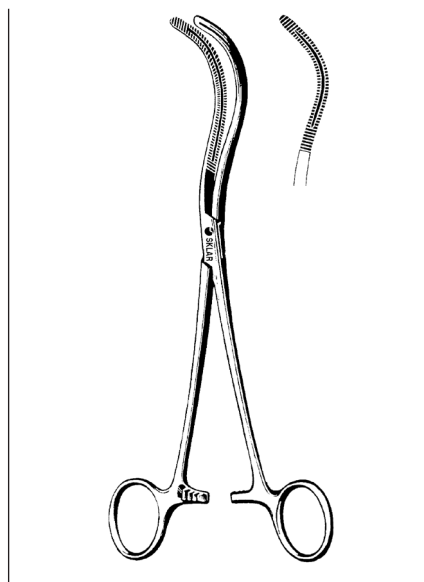

**STILLE KIDNEY CLAMPS**

- 33-1190 9¼" Light

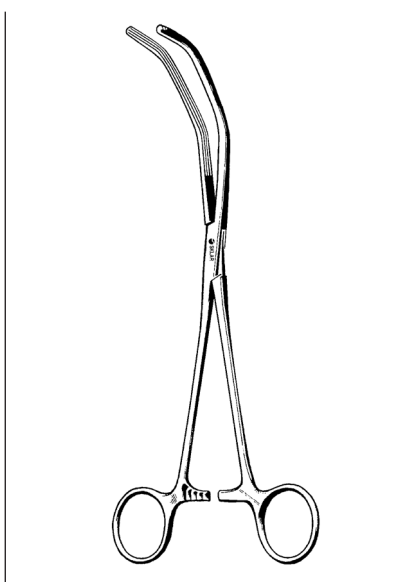

**HERRICK KIDNEY CLAMP**

- 33-1290 9" Light

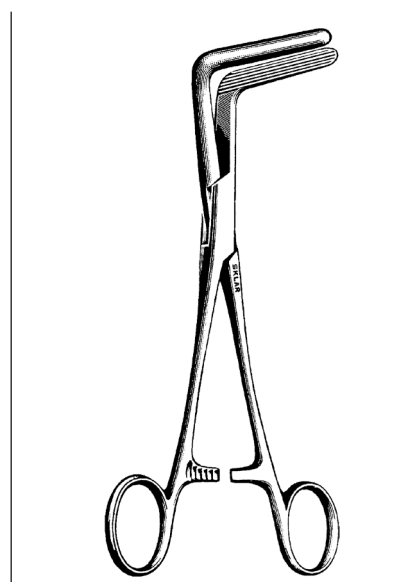

**WERTHEIM-CULLEN PEDICLE CLAMP**

- 33-1375 8½" 2¼" Jaws

ENT / PLASTIC SURGERY

SCOPES / SPECULUM



**OTOSCOPE  
WITH THREE SPECULA**

67-6250 The Sklar Otoscope employs a rheostat so that light intensity may be varied. Use alkaline battery size C.



**SKLAR DERMATOSCOPE  
10X MAGNIFICATION**

06-6250 Use alkaline battery Size C

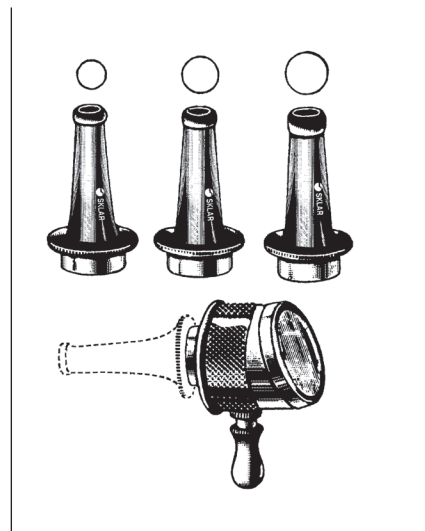

**BRUENING MAGNIFIER  
OTOSCOPE**

67-6200 Chrome with 3 specula Small, Medium and Large Complete with inflation bulb and tubing.

67-6202 Single Speculum Small  
67-6204 Single Speculum Medium  
67-6206 Single Speculum Large

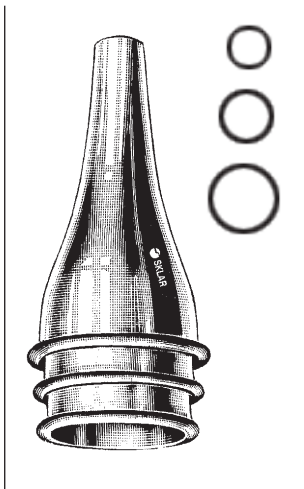

**GRUBER EAR  
SPECULUM**

CHROME

67-6025 Small  
67-6026 Medium  
67-6027 Large  
67-6020 Set of 3

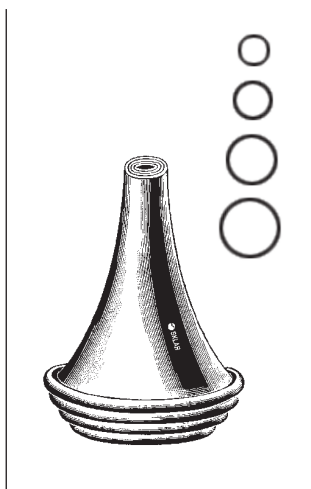

**BOUCHERON EAR  
SPECULUM**

CHROME

67-6011 5mm  
67-6012 6mm  
67-6013 7mm  
67-6014 8mm  
67-6010 Set of 4

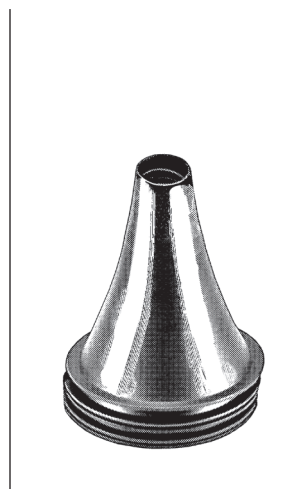

**FARRIOR EAR  
SPECULUMS**

BLACK, 36MM

67-6061 #1 5.5mm  
67-6062 #2 6.5mm  
67-6063 #3 7.5mm  
67-6064 #4 8.5mm  
67-6065 #5 9.5mm  
67-6066 #6 10.5mm  
67-6067 #7 11.5mm  
67-6042 Set #1-7

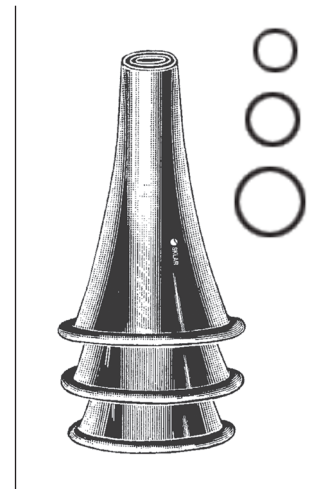

**TOYNBEE EAR  
SPECULUM**

CHROME

67-6031 Small  
67-6032 Medium  
67-6033 Large  
67-6030 Set of 3

For a complete listing of our Plastic Surgery product line, visit [www.sklarcorp.com](http://www.sklarcorp.com).



**SHEA SPECULUM HOLDER**

67-6050 30cm - Overall Length

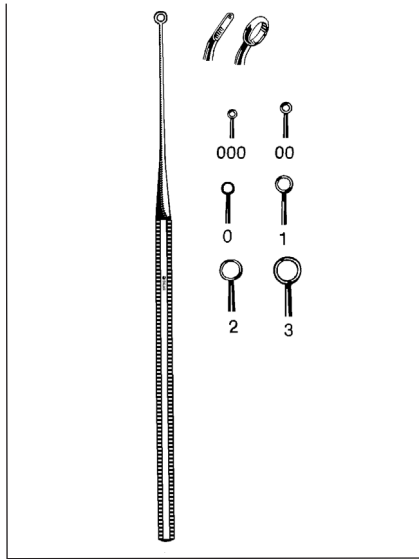

**BUCK EAR CURETTES**

**BLUNT**

**STRAIGHT**

67-2488 #000  
67-2489 #00  
67-2490 #0  
67-2491 #1  
67-2492 #2  
67-2493 #3

**ANGLED**

67-2508 #000  
67-2509 #00  
67-2510 #0  
67-2511 #1  
67-2512 #2  
67-2513 #3

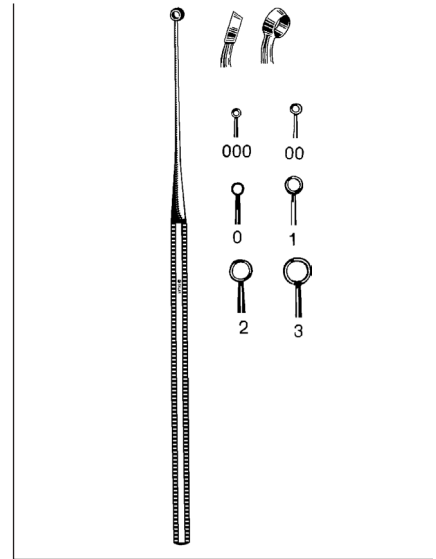

**BUCK EAR CURETTES**

**SHARP**

**STRAIGHT**

67-2519 #000  
67-2514 #00  
67-2515 #0  
67-2516 #1  
67-2517 #2  
67-2518 #3

**ANGLED**

67-2498 #000  
67-2499 #00  
67-2500 #0  
67-2501 #1  
67-2502 #2  
67-2503 #3

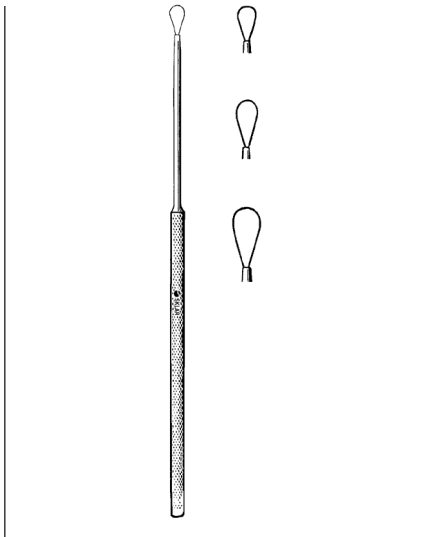

**BILLEAU EAR LOOPS**

67-2521 Small  
67-2522 Medium  
67-2523 Large

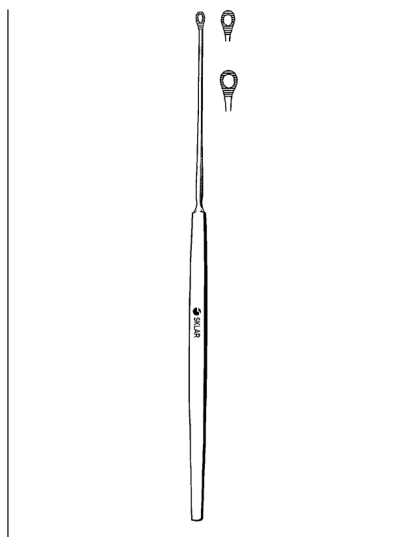

**SHAPLEIGH EAR CURETTES**

**6 1/4" SERRATED LOOP**

67-2525 Small Size 1  
67-2526 Large Size 2

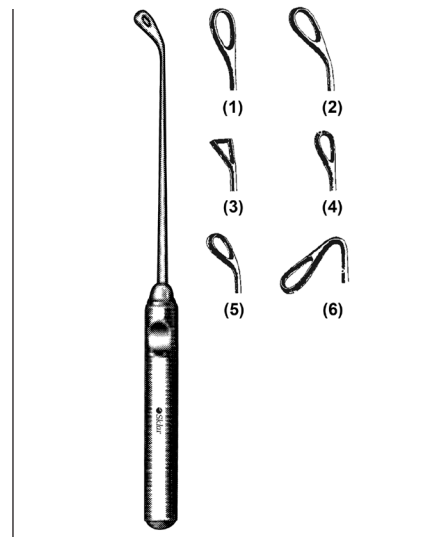

**COAKLEY CURETTES**

**6 3/4"**

70-9301 (1) 30° Large  
70-9302 (2) 60° Large  
70-9303 (3) 30° Triangular  
70-9304 (4) 30° Small  
70-9305 (5) 60° Small  
70-9306 (6) 120° Small

For a complete listing of our ENT product line, visit [www.sklarcorp.com](http://www.sklarcorp.com).



**LITTAUER FORCEPS**

67-1052 Serrated 3"  
70-4170 Serrated 4"

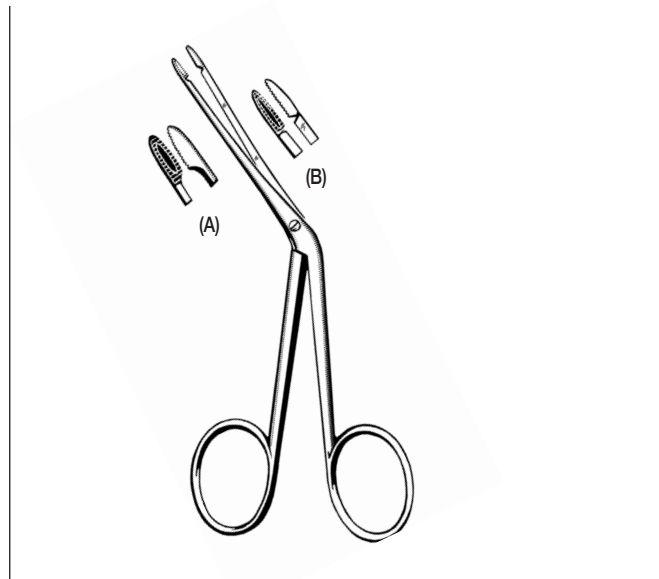

**HARTMANN GRASPING FORCEPS**

67-1045 Standard-Serrated (A)  
67-1050 Fine-Serrated (B)

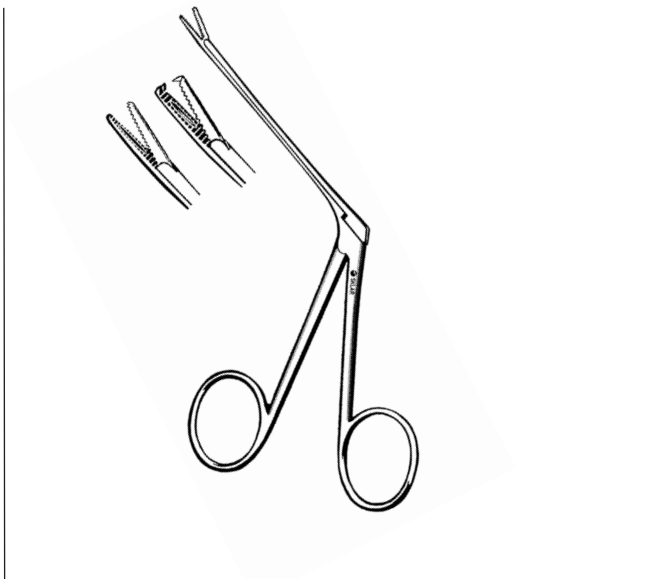

**HARTMANN ALLIGATOR GRASPING FORCEPS**

67-1035 3½" Serrated  
67-1036 3½" Serrated, Extra Delicate  
67-1040 3½" 1x2 Teeth  
67-1038 5½" Serrated  
67-1039 6½" Serrated



**HARTMANN PUNCH FORCEPS**

**SPOON SHAPED JAWS**  
67-1020 Standard  
67-1021 (Wullstein) Delicate

For a complete listing of our Plastic Surgery product line, visit [www.sklarcorp.com](http://www.sklarcorp.com).



**HARTMANN PUNCH FORCEPS**

67-1030 Jaws Curved Up

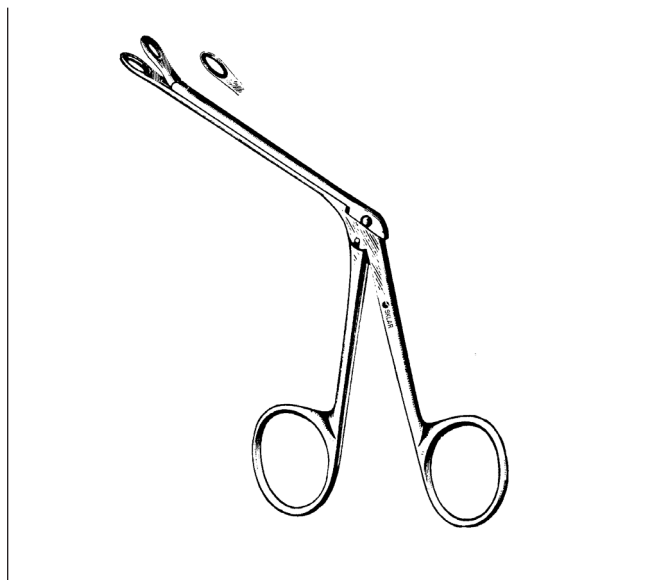

**STRUEMPEL EAR FORCEPS**

67-1032 Oval Spoon Jaws



**DUCKBILL EAR FORCEPS**

67-1033 Flat Serrated Jaws

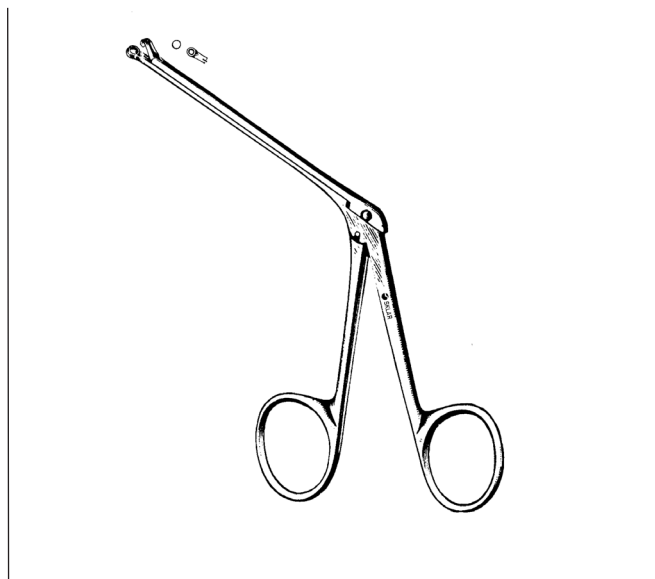

**HOFFMAN EAR FORCEPS**

67-1034 Round Jaws Thru-Cut

For a complete listing of our ENT product line, visit [www.sklarcorp.com](http://www.sklarcorp.com).

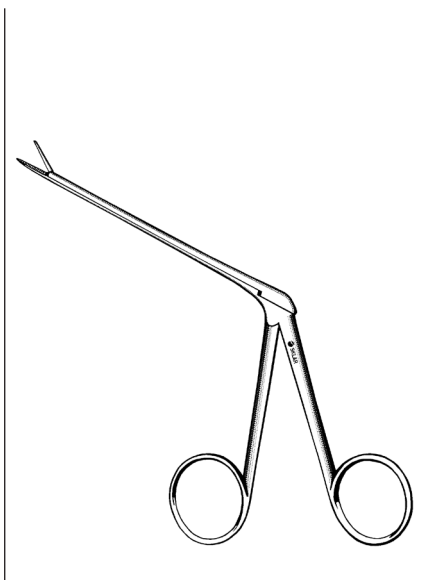

**DELICATE ALLIGATOR EAR  
FORCEPS**

67-8000 3/4" Straight Jaw, 7mm  
Serrated

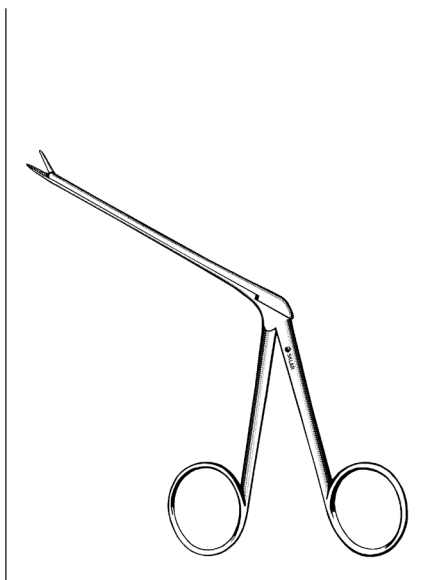

**DELICATE ALLIGATOR EAR  
FORCEPS**

67-8006 3/4" Straight Jaw, 4mm  
Serrated

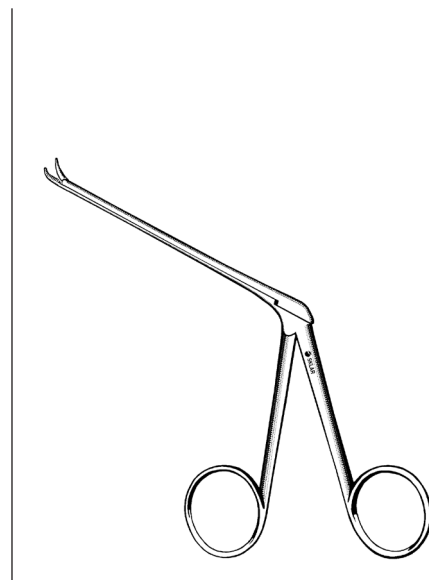

**DELICATE ALLIGATOR EAR  
FORCEPS**

67-8008 3/4" Jaw Curved Right  
Serrated, 4mm

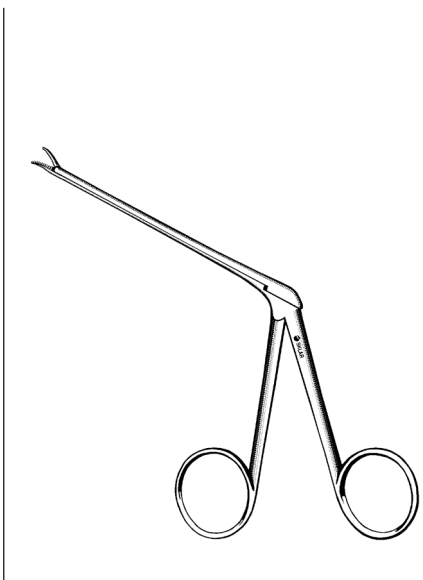

**DELICATE ALLIGATOR EAR  
FORCEPS**

67-8010 3/4" Jaw Curved Left  
Serrated, 4mm

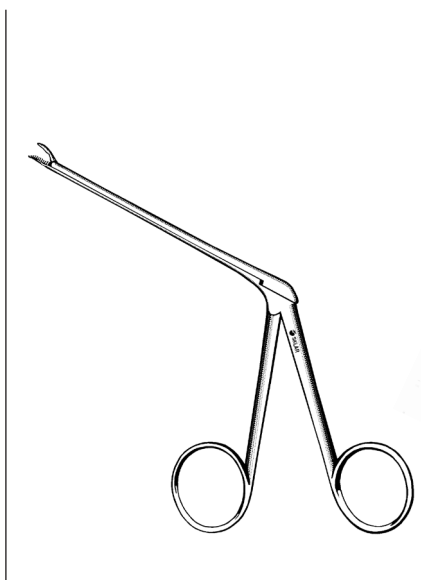

**DELICATE ALLIGATOR EAR  
FORCEPS**

67-8024 3/4" Top Jaw Curved  
Down, Smooth

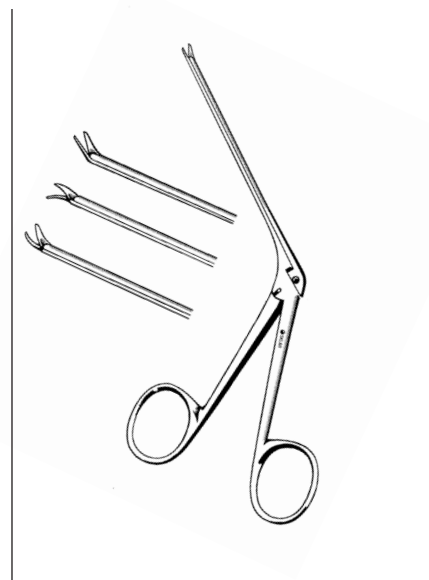

**DELICATE ALLIGATOR EAR  
SCISSORS**

67-8014 3/4" Straight  
67-8016 3/4" Angled Up  
67-8018 3/4" Curved Left  
67-8020 3/4" Curved Right

For a complete listing of our Plastic Surgery product line, visit [www.sklarcorp.com](http://www.sklarcorp.com).

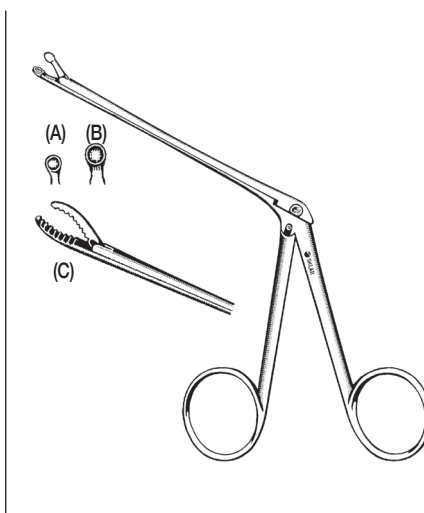

**HARTMANN-HERZFELD FORCEPS**

**ALLIGATOR TYPE CUP-SHAPE**

- 67-8150 3" shaft 2mm cup (A)
- 67-8152 3" shaft 3mm cup (B)

**WEINGARTNER EAR FORCEPS**

**ALLIGATOR TYPE CONCAVE SERRATED JAWS**

- 67-8155 3" shaft (C)

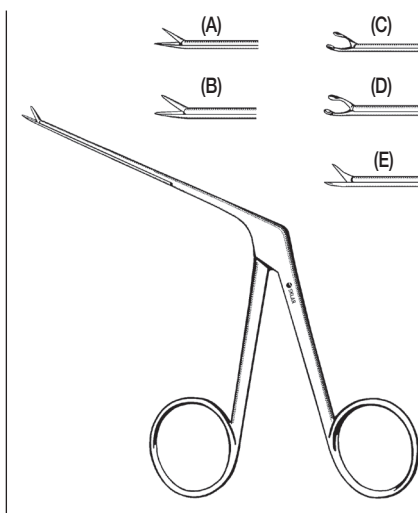

**MICRO ALLIGATOR EAR FORCEPS**

**3/4" SHAFT, SERRATED**

- 67-8170 0.6mm tip (A)
- 67-8172 0.6mm tip Ebony finish (A)
- 67-8174 0.8mm tip (B)
- 67-8176 0.8mm tip Ebony finish (B)

**3/4" SHAFT, OVAL CUP**

- 67-8173 0.5mm tip (C)
- 67-8177 0.5mm tip Ebony finish (C)
- 67-8178 0.8mm tip (D)
- 67-8180 0.8mm tip Ebony finish (D)
- 67-8175 0.8mm tip Smooth (D)



**BELLUCCI MICRO EAR SCISSORS**

- 67-8187 3" 4mm Straight
- 67-8188 3" 4mm Straight Ebony
- 67-8189 3" 4mm Curved Right
- 67-8191 3" 4mm Curved Left
- 67-8193 3" 4mm Curved Upward

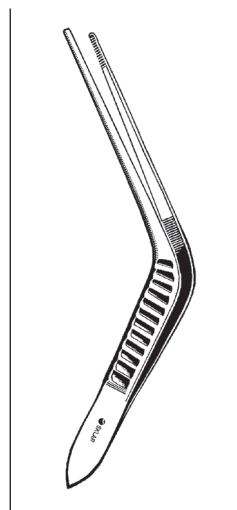

**WILDE EAR FORCEPS**

**ANGLED**

- 67-1150 5" Serrated
- 70-4470 7" Serrated
- 70-4472 7" 1x2 Teeth

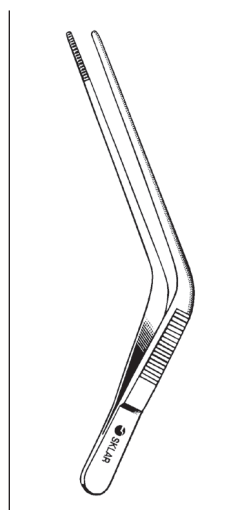

**BLAKE EAR FORCEPS**

**DELICATE**

- 67-1058 4 1/2" Angular Serrated

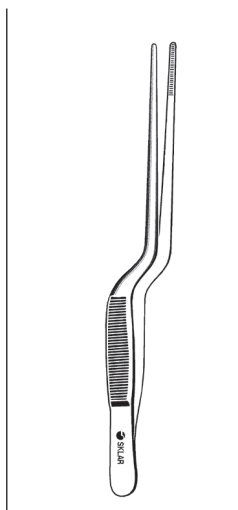

**LUCAE BAYONET FORCEPS**

- 67-1455 5 1/2" Serrated

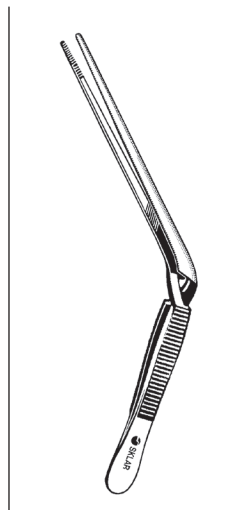

**WILDE EAR FORCEPS**

**CROSS ACTION**

- 67-1350 5" Serrated
- 67-1450 5" 1x2 Teeth

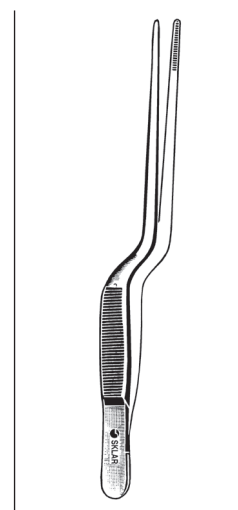

**ADSON BAYONET FORCEPS**

- 50-3371 7 1/2" Delicate

For a complete listing of our ENT product line, visit [www.sklarcorp.com](http://www.sklarcorp.com).

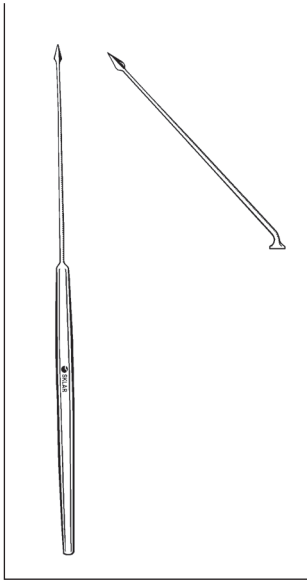

**POLITZER TYMPANUM PERFORATORS**

67-2005 Straight  
67-2007 Angular

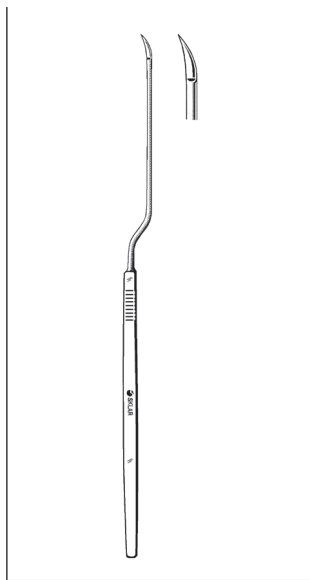

**ROYCE TYMPANUM PERFORATOR**

67-2145

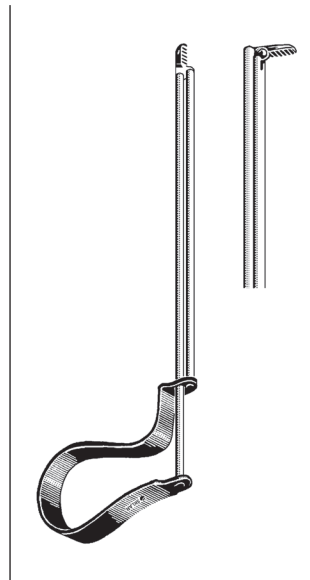

**QUIRE FOREIGN BODY INSTRUMENT**

SPRING HANDLE  
67-1732 4"

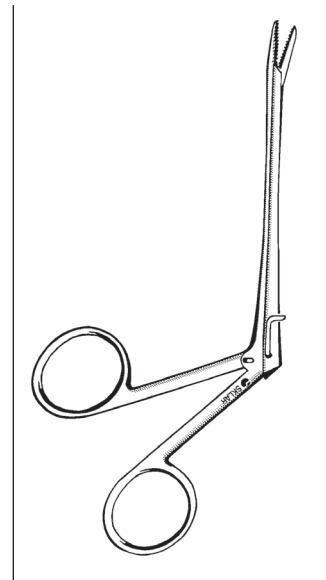

**NOYES ALLIGATOR FORCEPS**

RING HANDLE  
67-1734

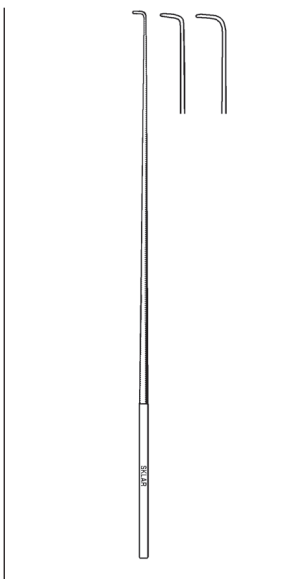

**DAY EAR HOOKS**

67-2550 6½" Small  
67-2552 6½" Large

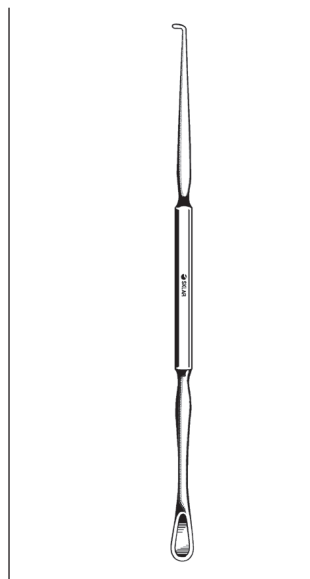

**GROSS HOOK AND SPOON**

DOUBLE ENDED  
67-2540 5¼"

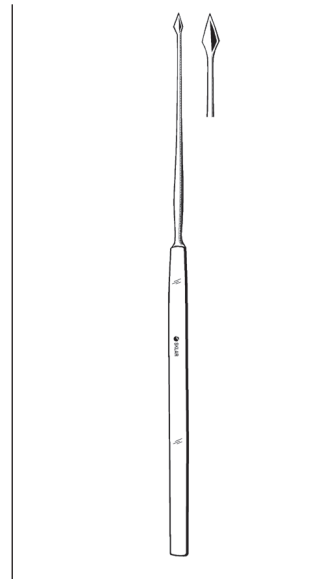

**BUCK MYRINGOTOME**

67-2115

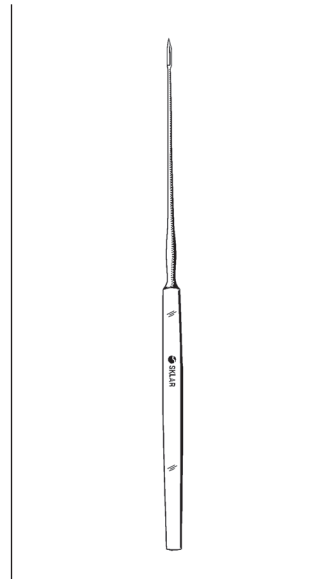

**GERZOG (SEXTON) EAR KNIVES**

67-2015 Straight  
67-2017 Angled

For a complete listing of our Plastic Surgery product line, visit [www.sklarcorp.com](http://www.sklarcorp.com).



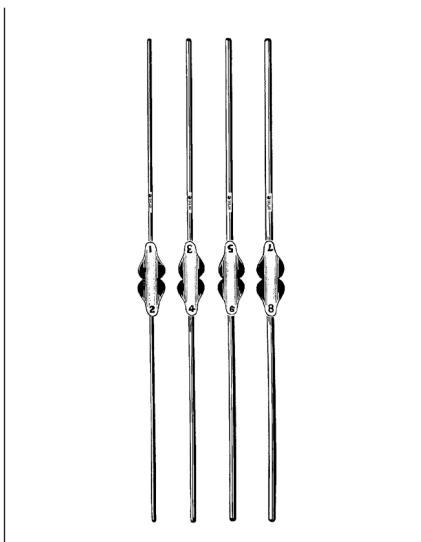

**BOWMAN LACHRYMAL  
DILATORS/PROBES**

**DOUBLE ENDED**

- 65-4098 #0000/000
- 65-4099 #00/0
- 65-4101 #1-2
- 65-4103 #3-4
- 65-4105 #5-6
- 65-4107 #7-8
- 65-4100 Set of 4 #1 thru #8

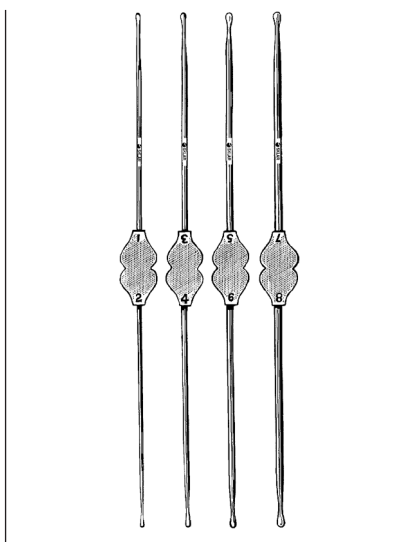

**WILLIAMS LACHRYMAL  
DILATORS/PROBES**

**DOUBLE ENDED STERLING SILVER**

- 65-4129 #0000-000
- 65-4128 #00
- 65-4121 #1-2
- 65-4123 #3-4
- 65-4125 #5-6
- 65-4127 #7-8
- 65-4120 Set of 4 #1 thru #8

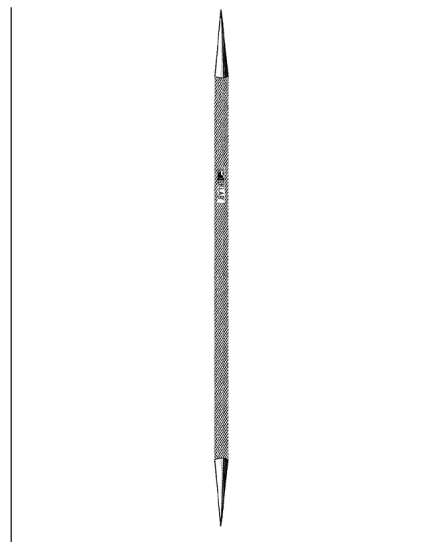

**CASTROVIEJO LACHRYMAL  
DILATOR**

- DOUBLE ENDED TAPERS, 4 3/4"**
- 65-6960

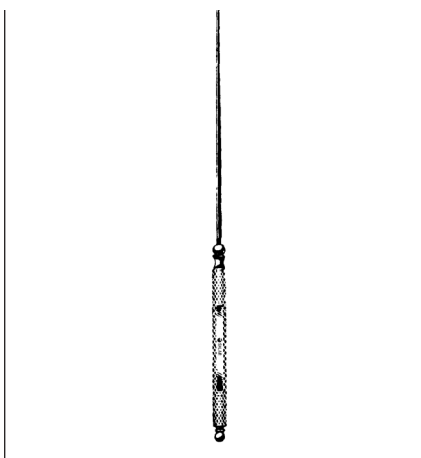

**BUCK EAR PROBE**

**STERLING SILVER SHAFT**

- 30-1030 5 1/2"

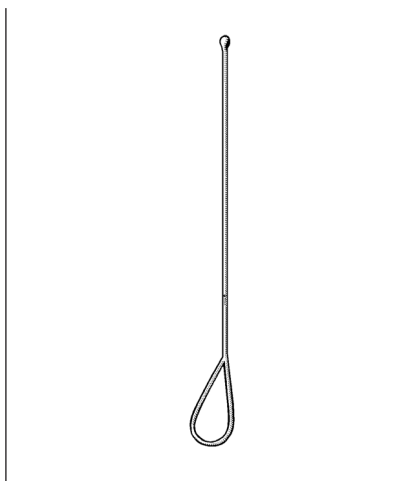

**STACKE EAR PROBE**

- 30-1040 4"

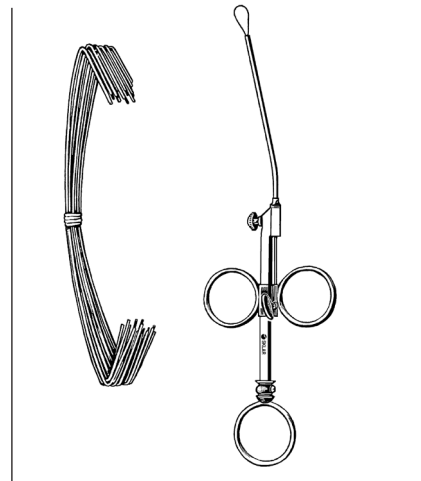

**KRAUSE EAR SNARES**

**WITH 1 DOZEN SNARE WIRES**

- 67-1750 Complete with 1 doz. Cut & Bent Wires
- 67-1753 #4 4" Cut & Bent Snare Wires, 1 doz.
- 67-1752 #4 4" Cut & Bent Snare Wires, 144/pk

For a complete listing of our ENT product line, visit [www.sklarcorp.com](http://www.sklarcorp.com).

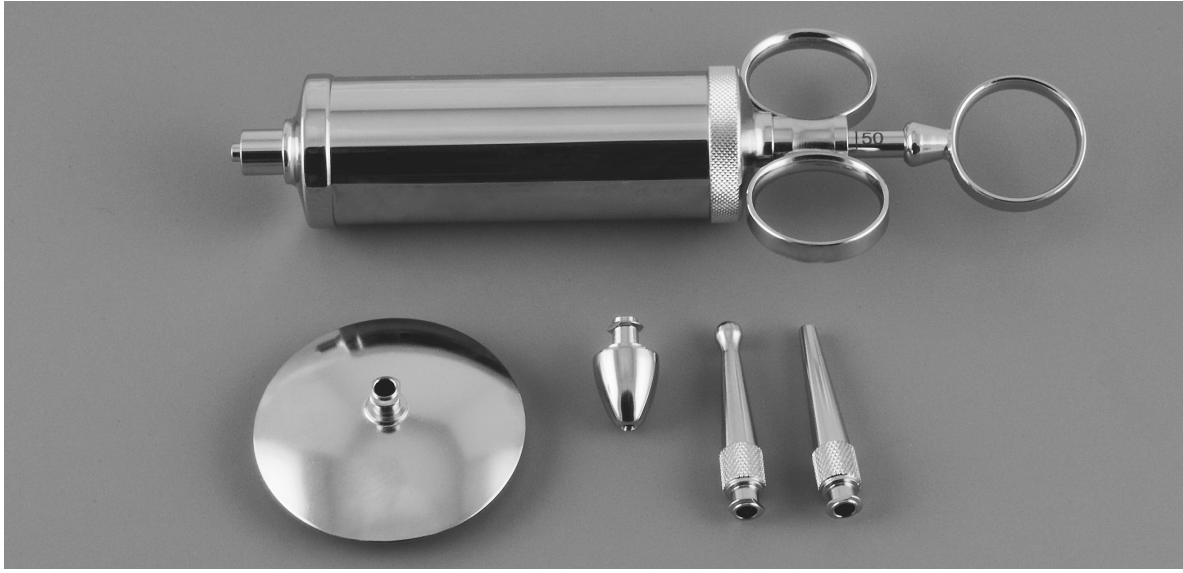

**POMEROY EAR SYRINGES**

**CHROME PLATED**

- 67-3402 Complete 2 oz. with Luer Lock
- 67-3404 Complete 4 oz. with Luer Lock
- 67-3424 Shield only for Ear Syringe
- 67-3418 Conical Tip with Luer Lock

- 67-3422 Conical Tip with Bulb with Luer Lock
- 67-3423 Squat Bulbous Tip with Luer Lock
- 67-3413 Replacement O'Rings

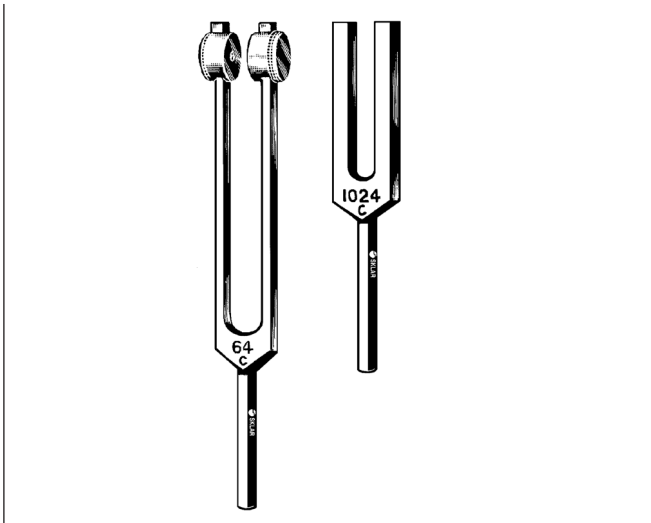

**ALUMINUM ALLOY TUNING FORKS**

- |         |       |         |        |
|---------|-------|---------|--------|
| 67-7064 | C-64  | 67-7524 | C-1024 |
| 67-7128 | C-128 | 67-7548 | C-2048 |
| 67-7256 | C-256 | 67-7596 | C-4096 |
| 67-7512 | C-512 |         |        |

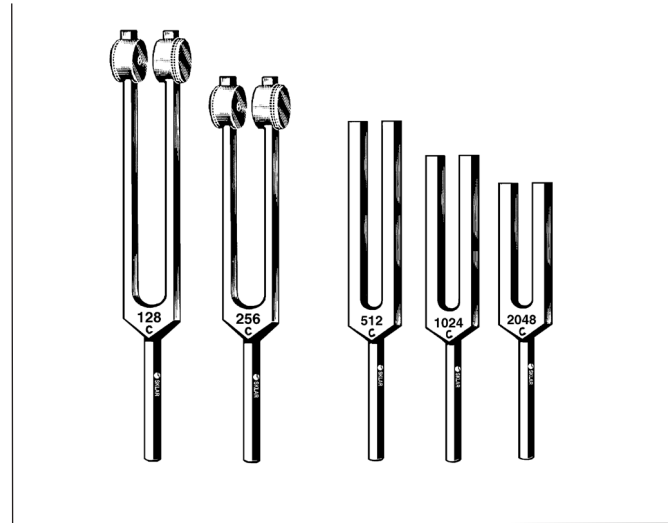

**TUNING FORK SET**

**ALUMINUM ALLOY**

- Set of 5
- 67-7605 Including C-128 C-1024  
C-256 C-2048  
C-512

**For a complete listing of our Plastic Surgery product line, visit [www.sklarcorp.com](http://www.sklarcorp.com).**

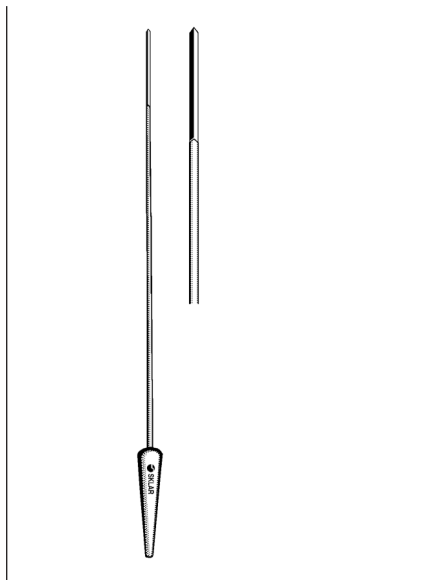

**BROWN APPLICATORS**

- 68-1257 5¾" Triangle
- 68-1357 5¾" Triangle Copper

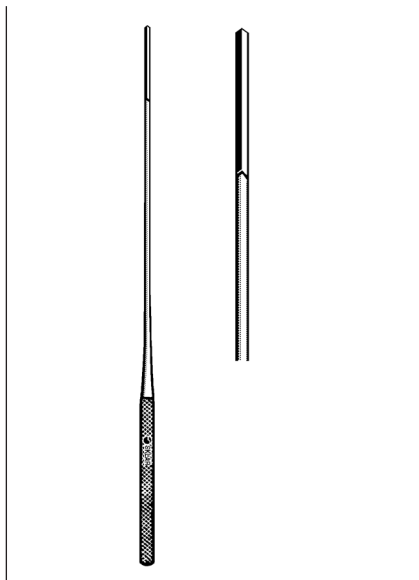

**KYLE APPLICATOR**

- 68-1557 5½" Triangle

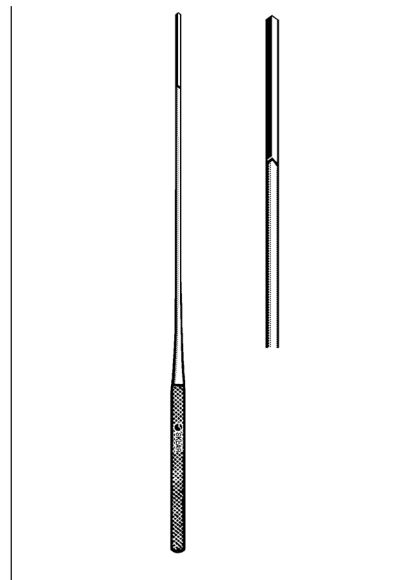

**SAWTELL APPLICATOR**

- 68-1665 6½" Triangle

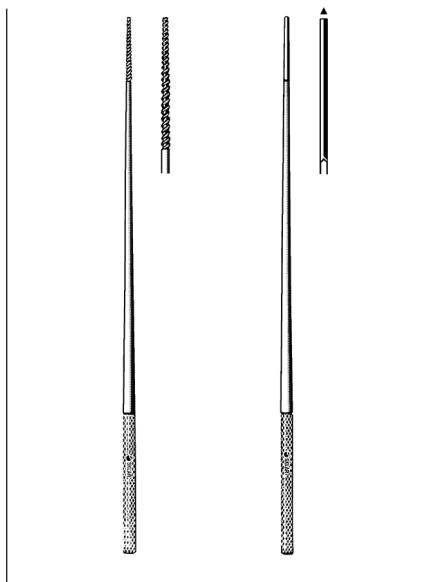

**FARRELL APPLICATORS**

- 68-1765 6½" Twist End
- 68-1865 6½" Triangle End
- 68-1890 9" Triangle End

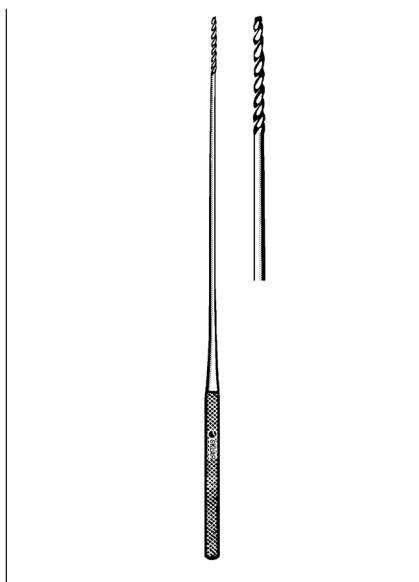

**BUCK APPLICATOR**

- 68-2175 7½" Twist End

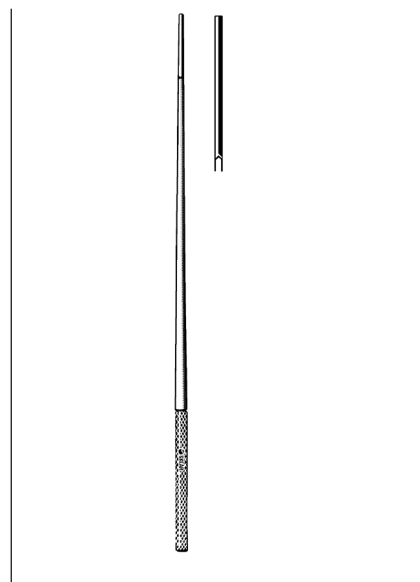

**BUCK APPLICATOR**

- 68-1050 5" Triangle

For a complete listing of our ENT product line, visit [www.sklarcorp.com](http://www.sklarcorp.com).

# ENT / PLASTIC SURGERY



## CURETTES

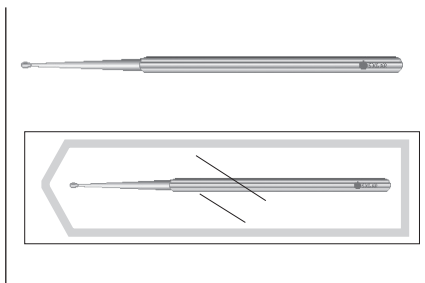

### SKLAR EAR CURETTES

#### CUP, DISPOSABLE

- 96-1000 12/Box Non-Sterile
- 96-1001 50/Box Non-Sterile
- 96-1002 50/Box Sterile

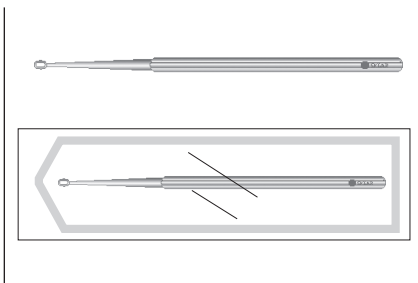

### SKLAR EAR CURETTES

#### LOOP, DISPOSABLE

- 96-1005 12/Box Non-Sterile
- 96-1006 50/Box Non-Sterile
- 96-1007 50/Box Sterile

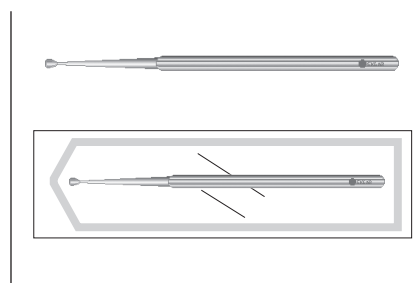

### SKLAR EAR CURETTES

#### SPOON, DISPOSABLE

- 96-1030 12/Box Non-Sterile
- 96-1031 50/Box Non-Sterile

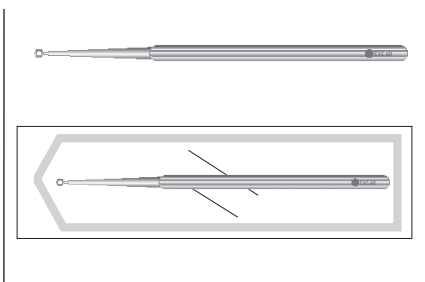

### SKLAR EAR CURETTES

#### PEDI-RING - SMALL, DISPOSABLE

- 96-1020 12/Box Non-Sterile
- 96-1021 50/Box Non-Sterile
- 96-1022 50/Box Sterile

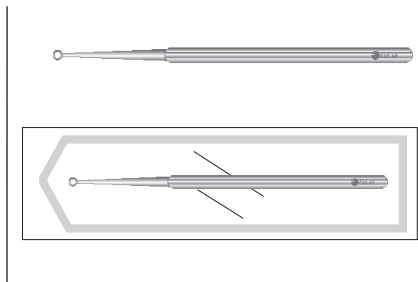

### SKLAR EAR CURETTES

#### CHILD RING-MEDIUM, DISPOSABLE

- 96-1010 12/Box Non-Sterile
- 96-1011 50/Box Non-Sterile
- 96-1012 50/Box Sterile

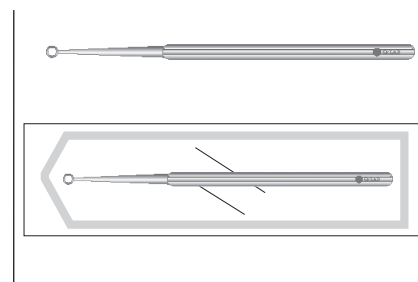

### SKLAR EAR CURETTES

#### ADULT RING - LARGE, DISPOSABLE

- 96-1015 12/Box Non-Sterile
- 96-1016 50/Box Non-Sterile
- 96-1017 50/Box Sterile



### ASSORTED EAR CURETTES

#### DISPOSABLE (NON-STERILE)

- 96-1035 50/Box, 10 Each of 96-1001, 96-1006, 96-1011, 96-1016, 96-1031

#### DISPOSABLE (STERILE)

- 96-1036 50/Box, 10 Each of 96-1002, 96-1007, 96-1012, 96-1017, 96-1022



### EAR TRAY

#### 96-1728 CASE OF 10

- |                     |                |
|---------------------|----------------|
| Contents:           |                |
| Bulb Syringe        | Calgiswab      |
| Ear Curette, Ring   | Ear Forcep     |
| 2 Gauze Sponges     | Deep Prep Tray |
| Sterilization Pouch | CSR Wrap       |

For a complete listing of our Plastic Surgery product line, visit [www.sklarcorp.com](http://www.sklarcorp.com).

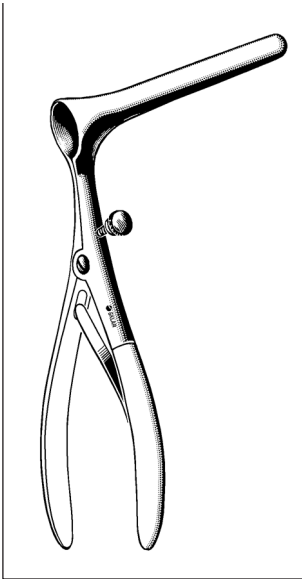

**COTTLE NASAL SPECULUMS**

WITH SET SCREW

- 41-1190 6" Long 1½" Blade
- 41-1192 6" Long 2" Blade
- 41-1194 6" Long 3" Blade
- 41-1196 6" Long 3½" Blade

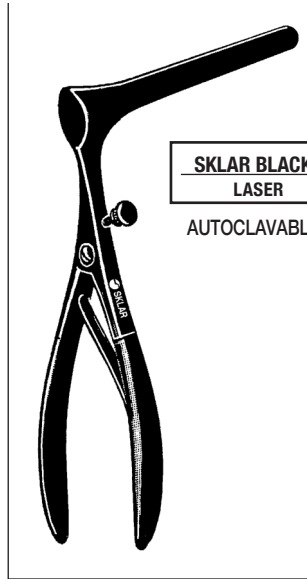

SKLAR BLACK™  
LASER  
AUTOCLAVABLE

**LASER COTTLE NASAL SPECULUMS**

WITH SET SCREW

- 41-1198 6" x 2"
- 41-1200 6" x 3"

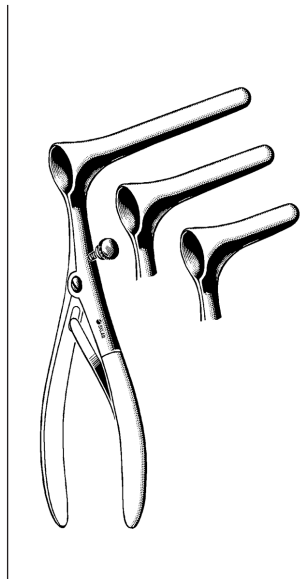

**KILLIAN NASAL SPECULUMS**

- |         |        |     |
|---------|--------|-----|
| 70-1020 | Small  | 2"  |
| 70-1030 | Medium | 3"  |
| 70-1035 | Large  | 3½" |

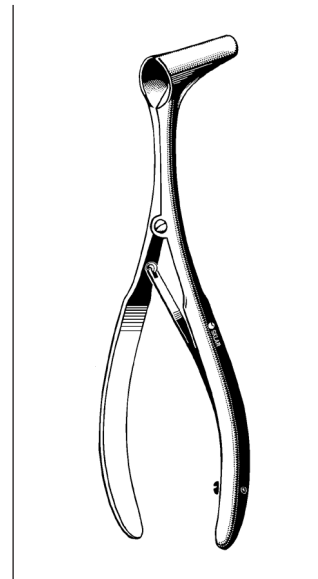

**HALLE NASAL SPECULUM**

70-1041 Adult

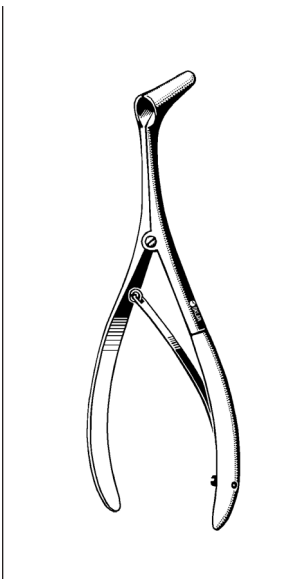

**TIECK-HALLE NASAL SPECULUM**

70-1040 Infant

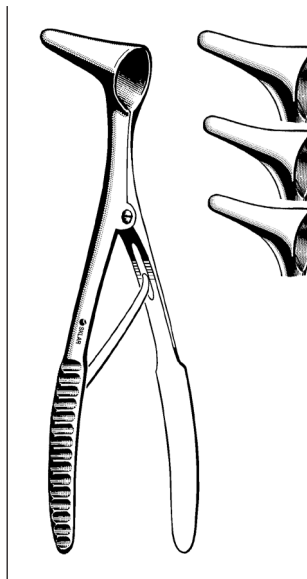

**VIENNA NASAL SPECULUMS**

- 70-1070 Infant
- 70-1071 Child
- 70-1072 Adult

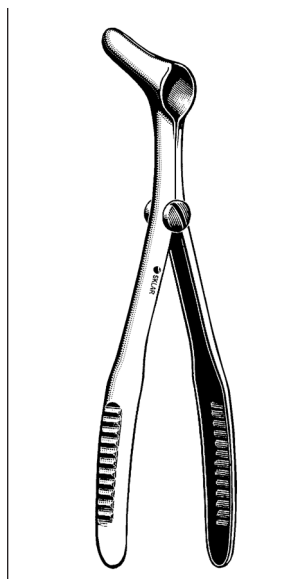

**VIENNA NASAL SPECULUM**

WROUGHT METAL-LIGHTWEIGHT  
70-1075 Adult

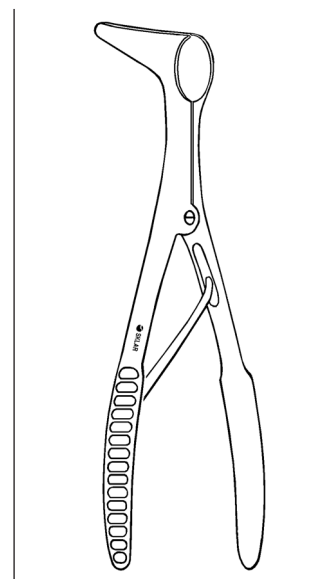

**NASAL SPECULUM, DISPOSABLE**

PACK/48, PLASTIC  
96-0670 6¼"

For a complete listing of our ENT product line, visit [www.sklarcorp.com](http://www.sklarcorp.com).

ENT / PLASTIC SURGERY

NASAL SPECULUM / FORCEPS



**BECKMAN NASAL SPECULUM**

70-1092 5¾"

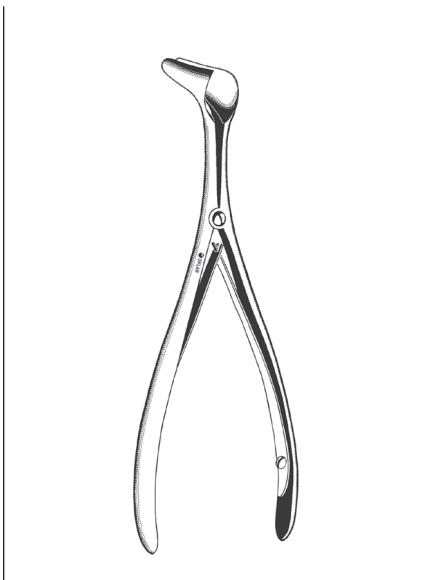

**SONNENSCHN NASAL SPECULUM**

70-1096 6"

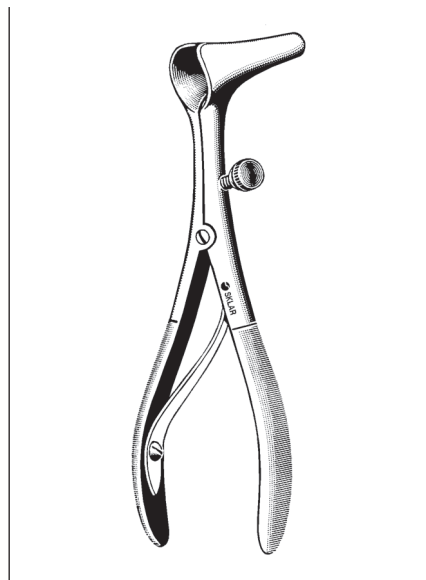

**GERZOG NASAL SPECULUM WITH SET SCREW**

70-1060 Adult

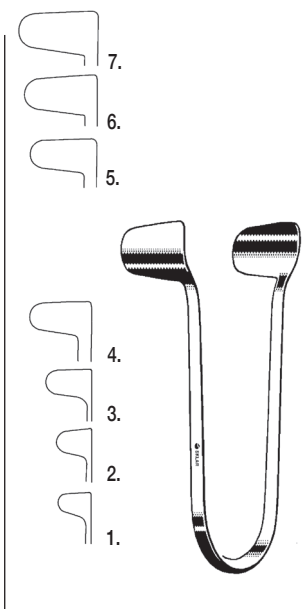

**THUDICHUM NASAL SPECULUMS**

70-1081 Fig. 1 70-1085 Fig. 5  
70-1082 Fig. 2 70-1086 Fig. 6  
70-1083 Fig. 3 70-1087 Fig. 7  
70-1084 Fig. 4

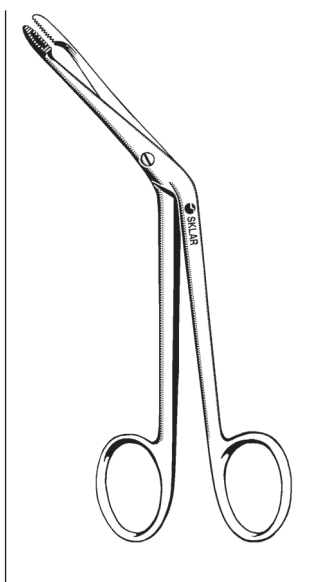

**HARTMANN NASAL FORCEPS**

70-4160 6" Serrated Jaw

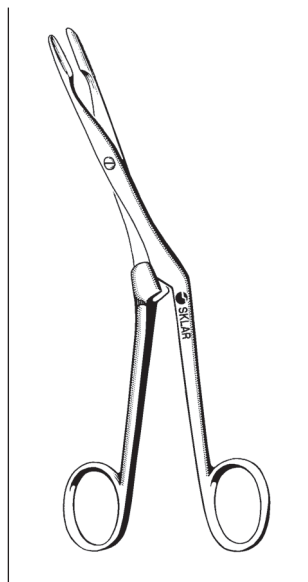

**KNIGHT SEPTUM FORCEPS**

**CUPPED JAWS, CUTTING**  
70-5170 7"

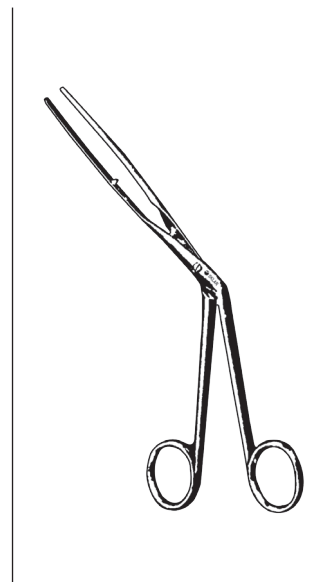

**LUBET BARBON NASAL POLYP FORCEPS**

70-4080 8"

For a complete listing of our Plastic Surgery product line, visit [www.sklarcorp.com](http://www.sklarcorp.com).

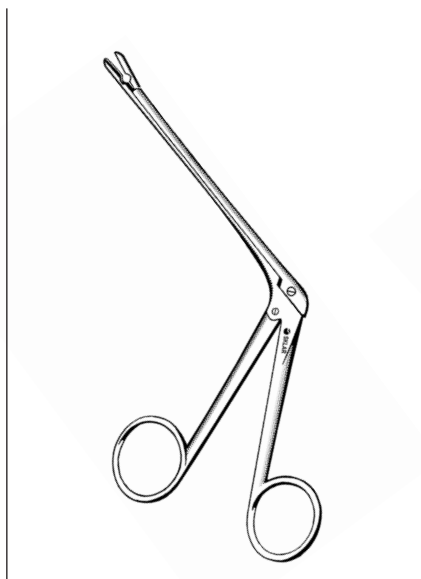

**TAKAHASHI FORCEPS**

70-5090 Slender Cup Jaws

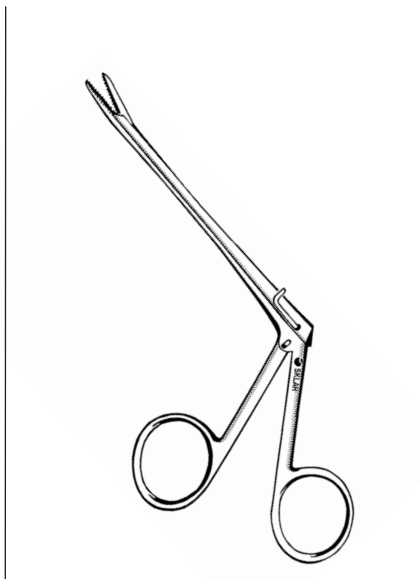

**NOYES ALLIGATOR FORCEPS**

- 70-5332 3¼" Serrated
- 70-5335 5½" Serrated
- 70-5336 6½" Serrated
- 70-5232 3¼" 1x2 Teeth
- 70-5235 5½" 1x2 Teeth

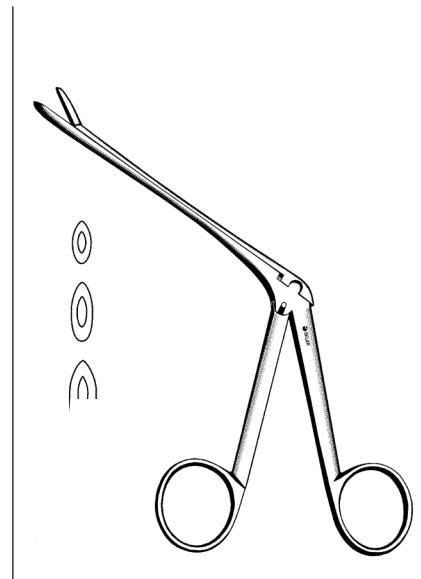

**BLAKESLEY NASAL FORCEPS (WILDE)**

- 70-5410 7½" Small
- 70-5411 7½" Standard

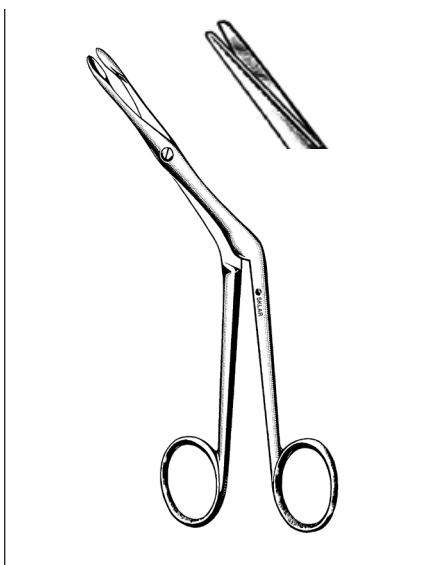

**HEYMANN SEPTUM FORCEPS**

- 70-4270 7" Cup Tips
- 70-4268 7" Straight Tips

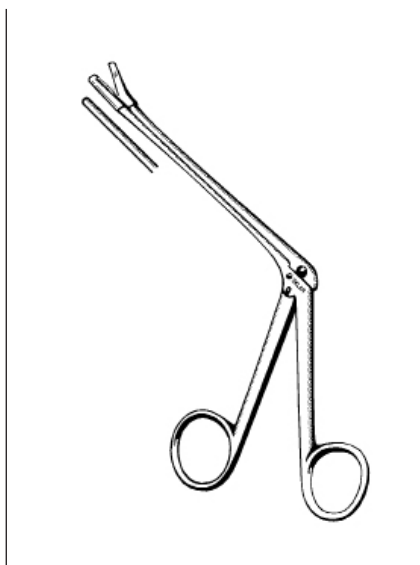

**STRUYCKEN CUTTING FORCEPS**

70-5176 5" Shaft

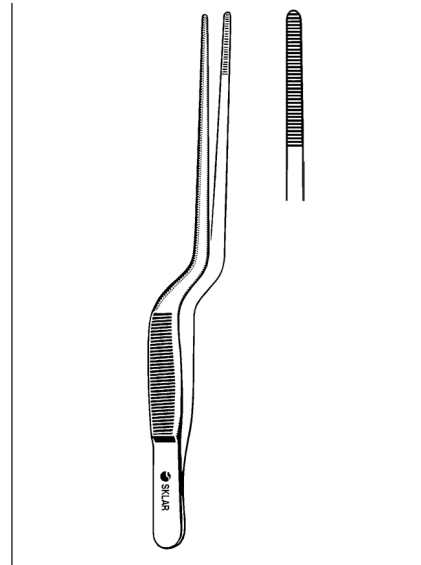

**JANSEN BAYONET NASAL FORCEPS**

- 67-1465 6½"
- 70-4375 7½"
- 70-4385 8½"

For a complete listing of our ENT product line, visit [www.sklarcorp.com](http://www.sklarcorp.com).

ENT / PLASTIC SURGERY

ELEVATORS

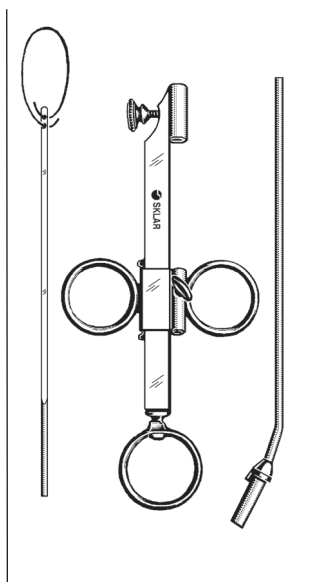

**KRAUSE NASAL  
SNARES**

70-6165 Complete with 1dz.  
Cut & Bent Wires  
70-6166 Stylet only for 70-6165  
70-6168 4" Cut & Bent Snare  
Wires #6, 144/pk

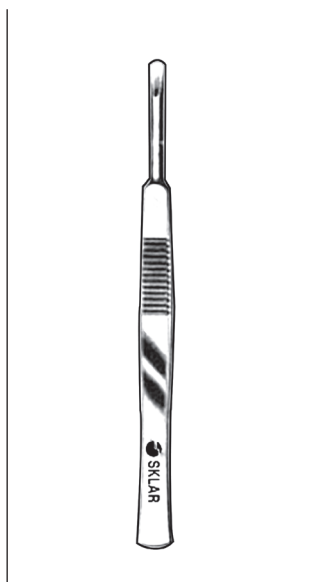

**COTTLE NASAL KNIFE**  
SHARP

41-1255 5½" 4mm

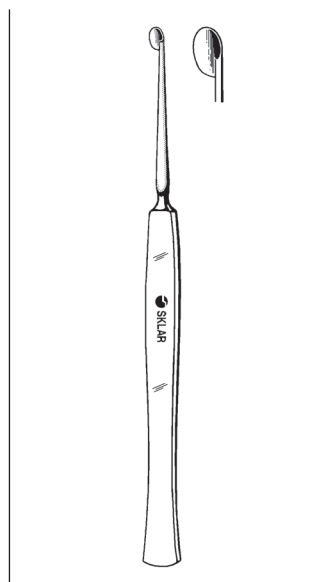

**FREER SEPTUM KNIFE**  
HALF ROUND BLADE

70-7062 6¼"

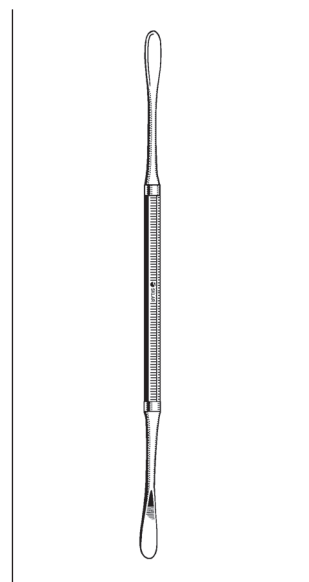

**HAJEK-BALLENGER  
SEPTUM ELEVATOR**  
DOUBLE ENDED

70-7185 8½" Sharp/Blunt

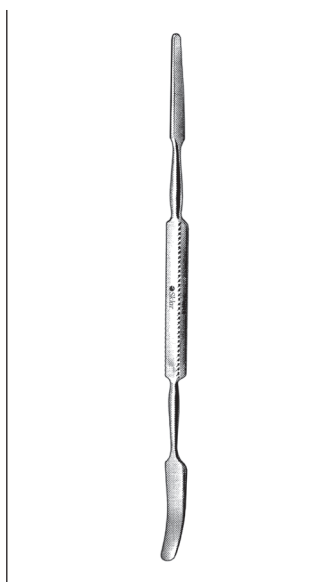

**MCDONALD ELEVATOR**  
DOUBLE END

40-9280 7½"

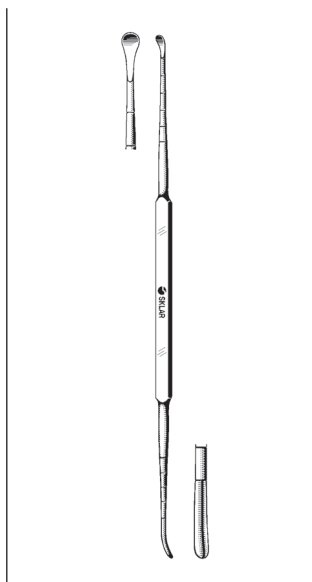

**COTTLE ELEVATOR**  
SHAFT GRADUATED IN CM

41-1235 9" Double End

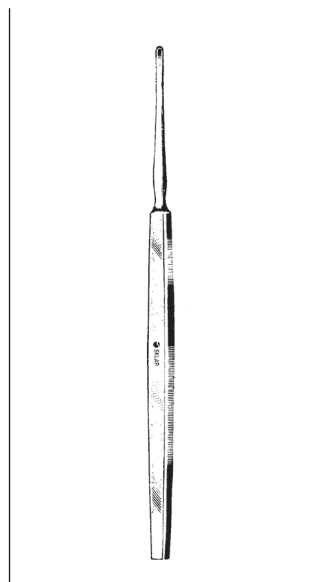

**LEMPERT ELEVATOR**  
STRAIGHT

40-7470 7¼" 2mm Blade

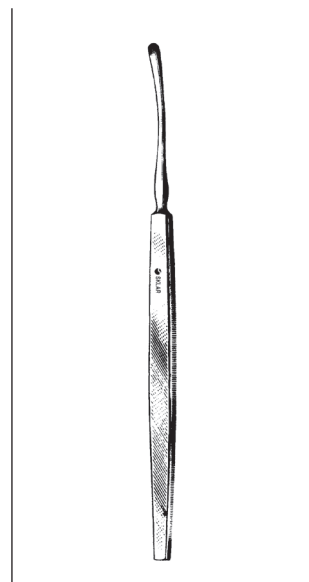

**LEMPERT ELEVATOR**  
CURVED

40-7472 7¼" 3mm Blade

For a complete listing of our Plastic Surgery product line, visit [www.sklarcorp.com](http://www.sklarcorp.com).





**McGLAMRY ELEVATORS**  
CURVED, 6½"

- 40-7478 9mm
- 40-7480 11mm
- 40-7482 13mm
- 40-7484 15mm
- 40-7486 17mm

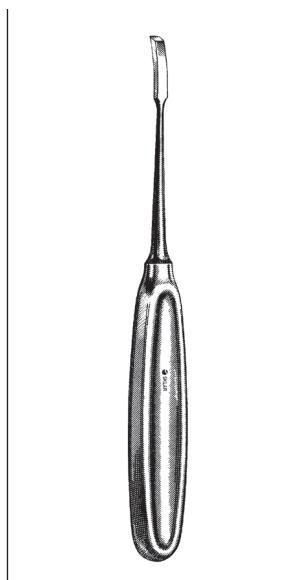

**LEMPERT ELEVATOR**  
CURVED

- 40-7474 7¼" 4mm Blade

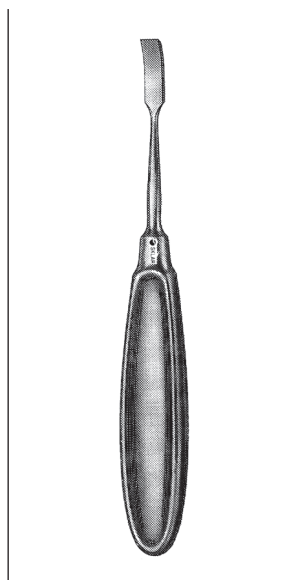

**LEMPERT ELEVATOR**  
CURVED

- 40-7476 7¼" 7mm Blade

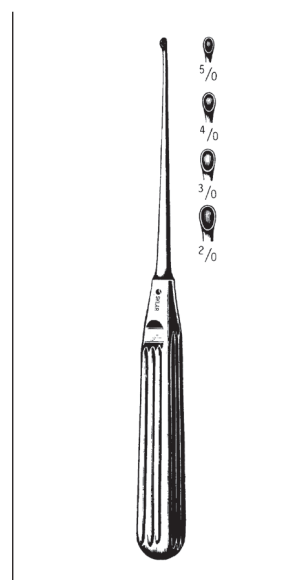

**LEMPERT ENDAURAL CURETTES**  
OVAL CUP

- 40-7380 8¼" Size 5/0
- 40-7381 8¼" Size 4/0
- 40-7382 8¼" Size 3/0
- 40-7383 8¼" Size 2/0

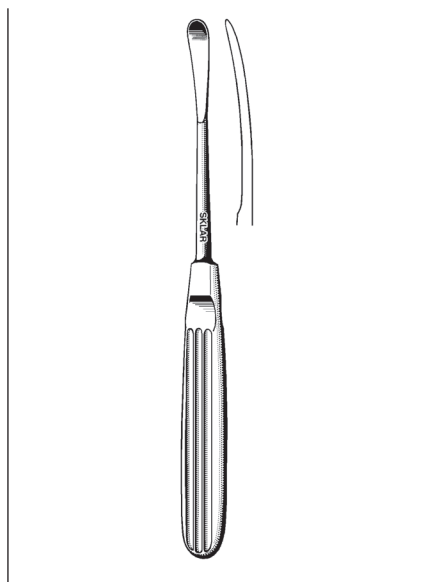

**COTTLE PERIOSTEAL ELEVATOR**

- SLIGHT CURVE
- 41-1250 7½" 9mm

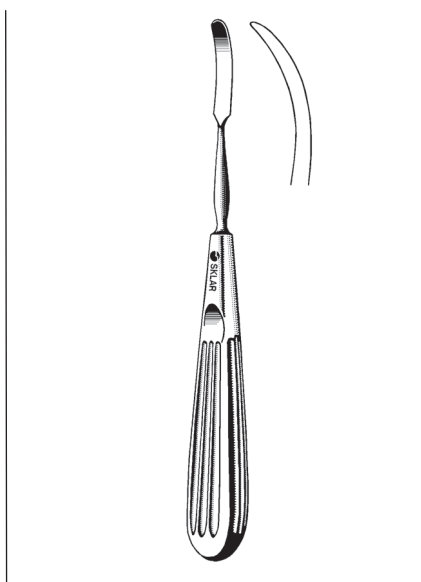

**JOSEPH PERIOSTEAL ELEVATORS**

- 41-1245 6¼" 4.5mm
- 41-1240 7" 6.5mm

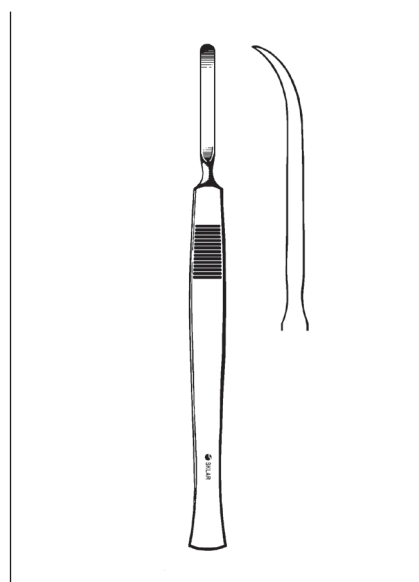

**MCKENTY SEPTUM ELEVATORS**

- CURVED
- 47-2385 6" 4mm
- 47-2388 6" 5mm

For a complete listing of our ENT product line, visit [www.sklarcorp.com](http://www.sklarcorp.com).

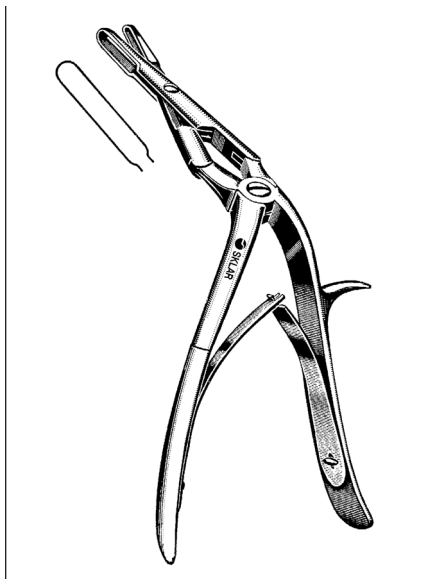

**JANSEN-MIDDLETON SEPTUM FORCEPS**

**DOUBLE ACTION**

70-5673 7½" Cutting

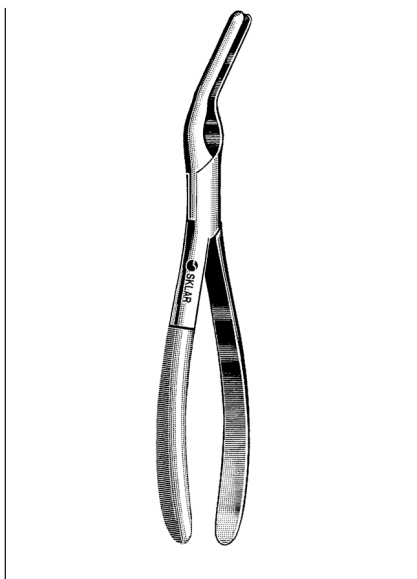

**ASH SEPTUM STRAIGHTENING FORCEPS**

70-5190 9"

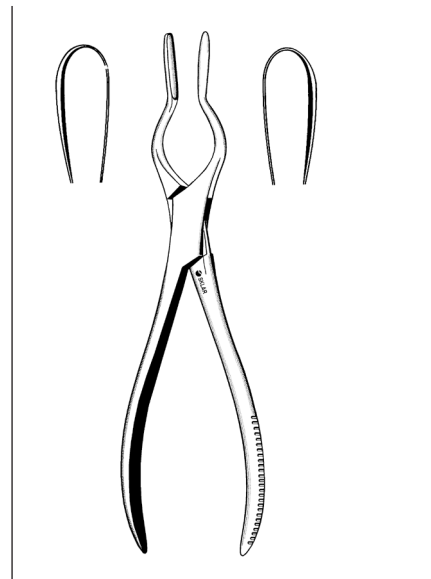

**WALSHAM SEPTUM STRAIGHTENING FORCEPS**

70-5290 9" Straight

70-5292 9" Left

70-5294 9" Right

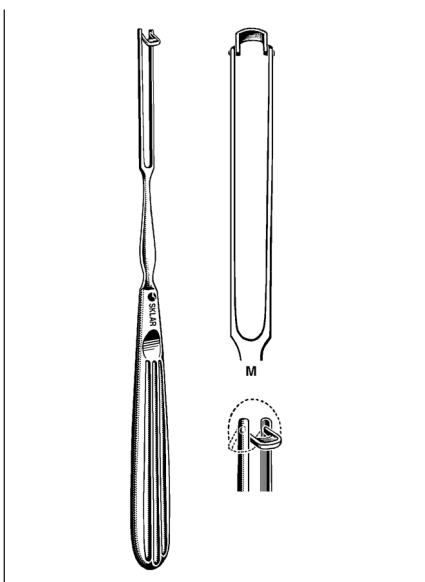

**BALLENGER SWIVEL KNIFE**

**BAYONET**

70-7503 7¾" 3mm

70-7504 7¾" 4mm

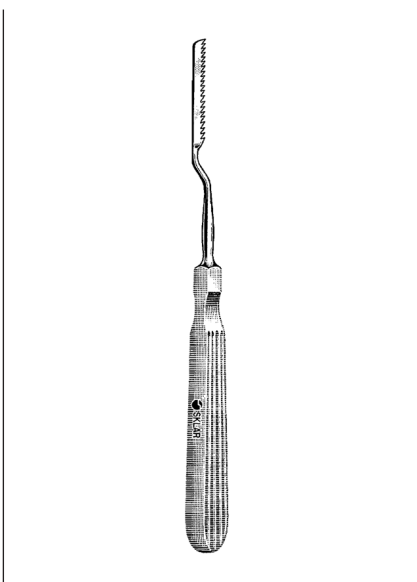

**JOSEPH BONE SAWS**

**BAYONET**

70-7801 7½" Right

70-7802 7½" Left

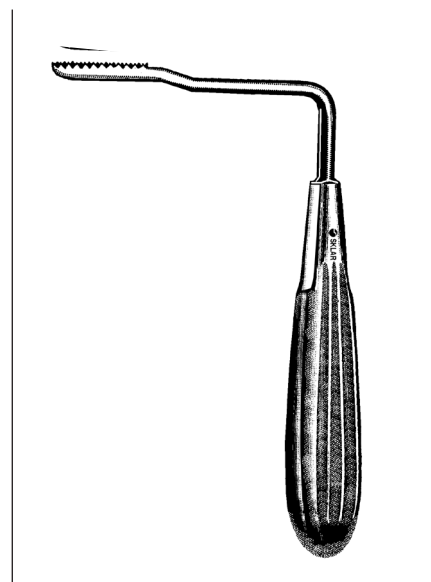

**JOSEPH NASAL BONE SAWS**

70-7821 Right Angle

70-7822 Left Angle

For a complete listing of our Plastic Surgery product line, visit [www.sklarcorp.com](http://www.sklarcorp.com).

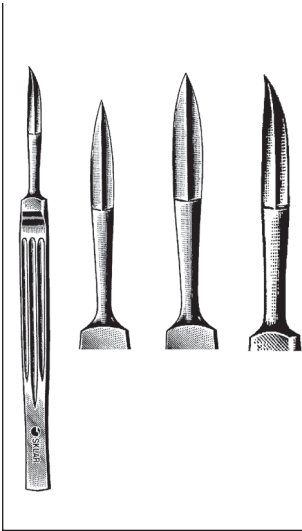

**JOSEPH KNIVES**  
SHARP POINT, 6"

41-1260	Small	Straight
41-1262	Large	Straight
41-1264	Small	Curved
41-1266	Large	Curved

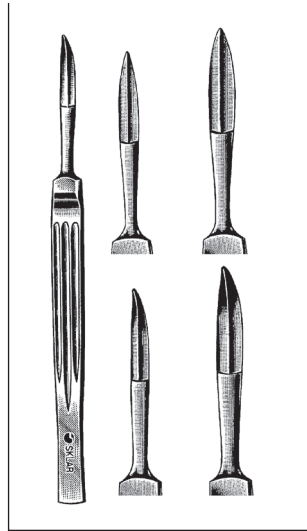

**JOSEPH KNIVES**  
BLUNT POINT, 6"

41-1270	Small	Straight
41-1272	Large	Straight
41-1274	Small	Curved
41-1276	Large	Curved

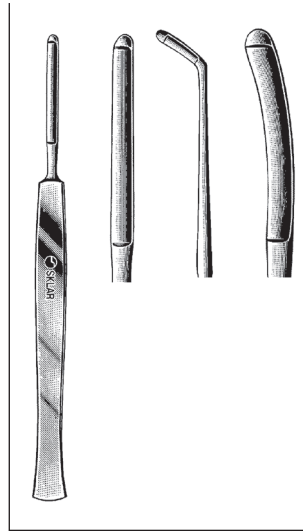

**JOSEPH BUTTON END  
KNIVES**

41-1300	6"	Straight
41-1305	6"	Angular
41-1310	6"	Curved

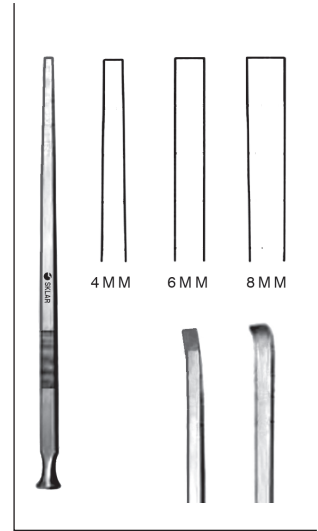

**EPKER OSTEOTOMES**

40-6450	4mm	Straight
40-6451	4mm	Slight Curve
40-6452	6mm	Straight
40-6453	6mm	Slight Curve
40-6454	6mm	Strong Curve
40-6455	8mm	Straight
40-6456	8mm	Strong Curve

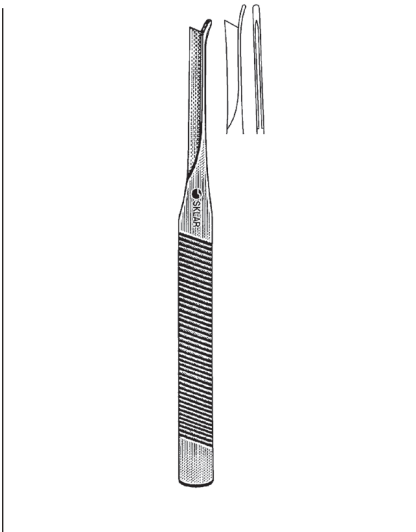

**SILVER OSTEOTOMES**  
GUARDED ONE SIDE

41-1350	7"	Straight
41-1355	7"	Guarded Right
41-1360	7"	Guarded Left

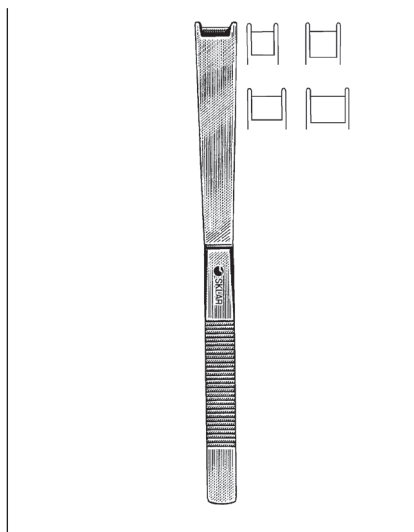

**CINELLI OSTEOTOMES**  
GUARDED BOTH SIDES

41-1370	6½" x 10mm	Straight
41-1372	6½" x 12mm	Straight
41-1374	6½" x 14mm	Straight
41-1376	6½" x 16mm	Straight

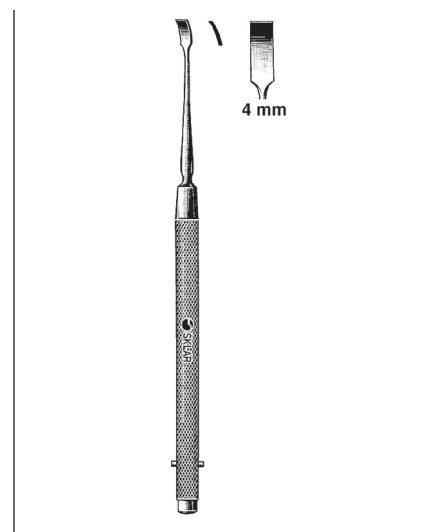

**FREER CHISELS**

41-1330	6½"	Straight	4mm
41-1332	6½"	Curved	4mm

For a complete listing of our ENT product line, visit [www.sklarcorp.com](http://www.sklarcorp.com).

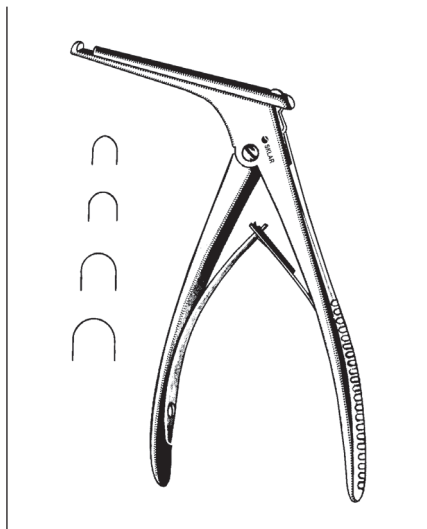

**KERRISON RONGEURS**

3.5" SHAFT

- 65-7400 Size 0 3mm
- 65-7401 Size 1 4mm
- 65-7402 Size 2 5mm
- 65-7403 Size 3 6mm



**CITELLI RONGEURS**

2½" SHAFT

- 65-7410 Size 1 2mm
- 65-7411 Size 2 3mm
- 65-7412 Size 3 4mm

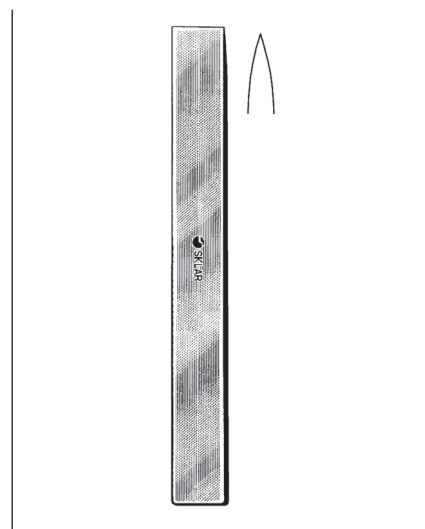

**LAMBOTTE OSTEOTOMES**

STRAIGHT, DELICATE, 5"

- 40-6532 2mm
- 40-6533 3mm
- 40-6534 4mm
- 40-6535 5mm
- 40-6536 6mm
- 40-6537 7mm
- 40-6538 8mm
- 40-6540 10mm
- 40-6542 12mm
- 40-6544 14mm
- 40-6545 15mm
- 40-6548 18mm
- 40-6549 19mm
- 40-6550 20mm
- 40-6552 Set of 9, Includes: 2, 4, 6, 8, 10, 12, 14, 18 and 20mm

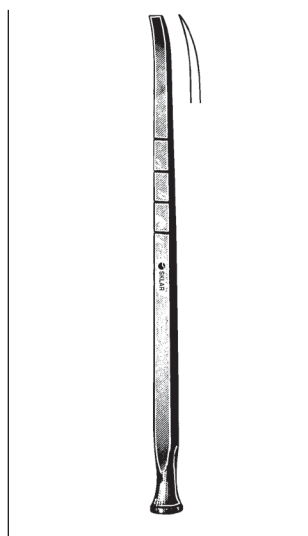

**COTTLE NASAL  
OSTEOTOME**

41-1340 6½" Curved

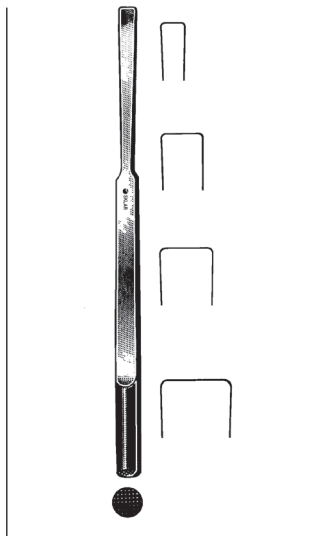

**COTTLE NASAL CHISELS  
7" WITH ROUNDED CORNERS**

- 41-1342 4mm
- 41-1344 7mm
- 41-1346 9mm
- 41-1348 12mm

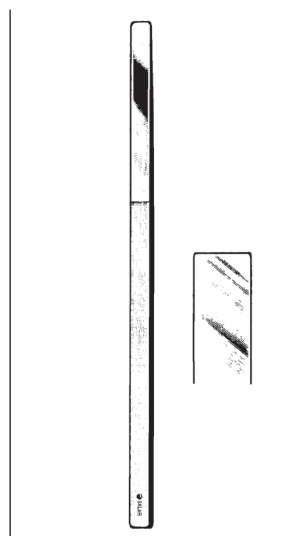

**COTTLE BONE LEVER**

41-1365 7⅛"

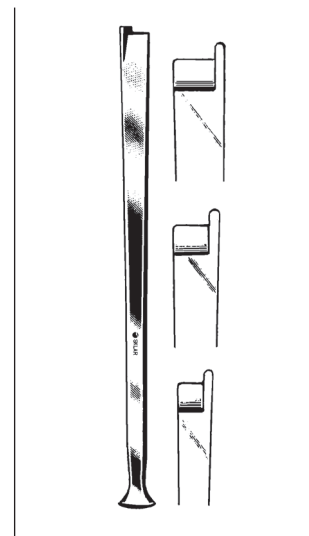

**FOMON NASAL  
CHISELS**

5¾" WITH GUARDED TIP

- 41-1366 5mm
- 41-1367 7mm
- 41-1368 8mm

For a complete listing of our Plastic Surgery product line, visit [www.sklarcorp.com](http://www.sklarcorp.com).



**AUFRICHT GLABELLAR RASPS**

- 40-9840 8" Forward Cutting
- 40-9841 8" Backward Cutting



**LEWIS NASAL RASPS**

- 70-2292 7" Fine
- 70-2293 7" Coarse

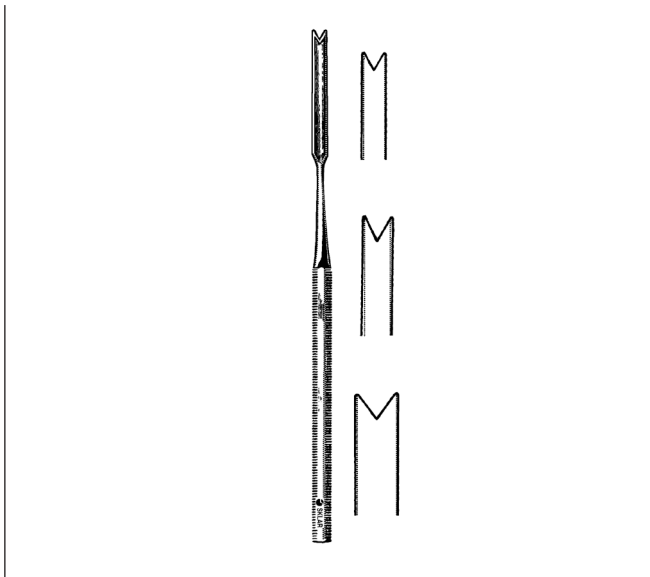

**HAJEK SEPTUM CHISELS**

**6" V-SHAPED CUTTING EDGE ENHANCED FORWARD CUTTING EFFECT**

- 41-1361 4mm Small
- 41-1362 6mm Medium
- 41-1363 8mm Large



**WEST BONE GOUGE**

- 41-1338 7½"

**For a complete listing of our ENT product line, visit [www.sklarcorp.com](http://www.sklarcorp.com).**

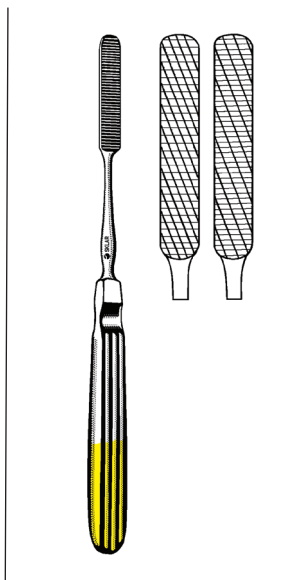

**TC MALTZ RASPS**

**SINGLE END**

97-1505 Fine  
97-1506 Medium

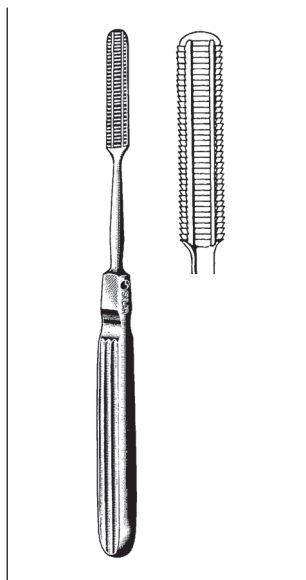

**MALTZ RASP**

40-9815 7" Backward Cutting

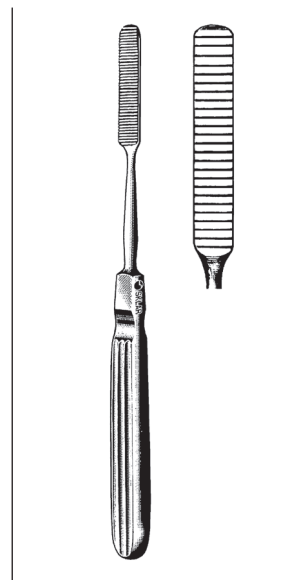

**COTTLE RASP**

40-9820 8" Backward Cutting

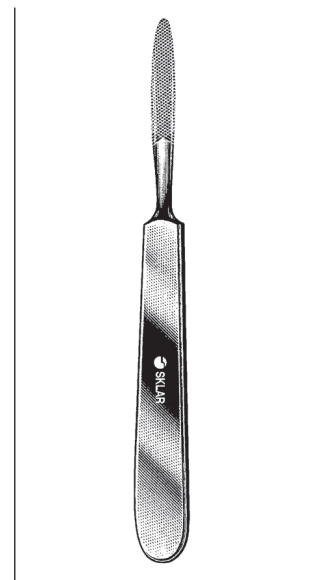

**JOSEPH RASP**

**STRAIGHT HANDLE**

40-9825 6 1/4" Fine Cross  
Serrations



**FOMON RASP AND FILE**

**DOUBLE END, FLAT AND CONVEX**

40-9686 8 1/4" 2 Sided, Coarse  
40-9688 8 1/2" 4 Sided, Coarse and Fine



**McIVOR MOUTH GAG**

75-1020 Complete with 3 Blades  
22mm x 70mm  
22mm x 85mm  
27mm x 95mm

For a complete listing of our Plastic Surgery product line, visit [www.sklarcorp.com](http://www.sklarcorp.com).

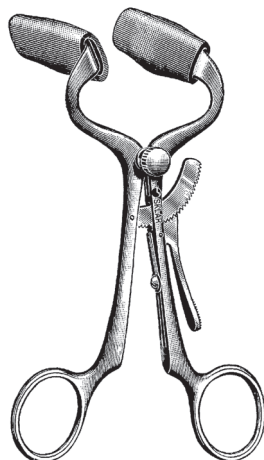

**DOYEN-JANSEN MOUTH GAGS (MOLT)**

**WITH CUSHIONS**

- |         |     |                                 |
|---------|-----|---------------------------------|
| 22-8945 | 4"  | Child, With Cushions            |
| 75-1025 | 5½" | Adult, With Cushions            |
| 75-1026 |     | Replacement Sleeves for 75-1025 |

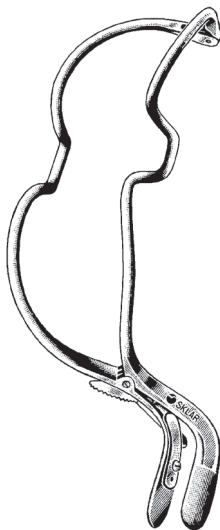

**JENNINGS MOUTH GAGS**

- |         |     |        |
|---------|-----|--------|
| 75-1015 | 3½" | Small  |
| 75-1016 | 4¼" | Medium |
| 75-1017 | 5¼" | Large  |

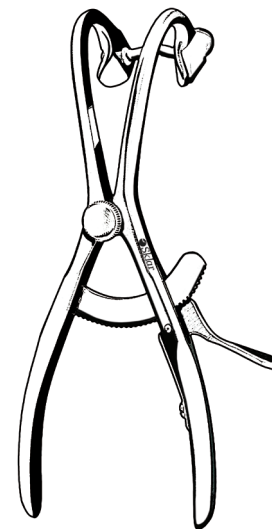

**DENHARDT MOUTH GAGS**

**WITH SILICONE GUARDS**

- |         |     |                    |
|---------|-----|--------------------|
| 75-1007 | 4¾" | Ratchet            |
| 75-1006 | 2pk | Replacement Guards |

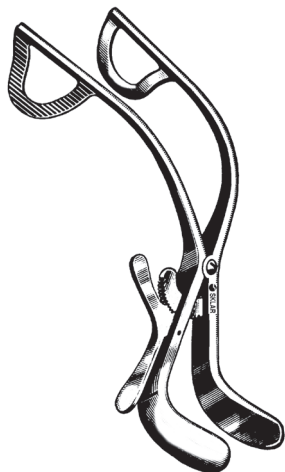

**WESSON MOUTH GAG TRU-GRIP RATCHET**

- 75-1010 With Finger Guard

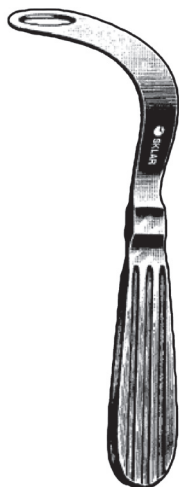

**BOGSWORTH TONGUE DEPRESSOR FENESTRATED END**

- 75-2175

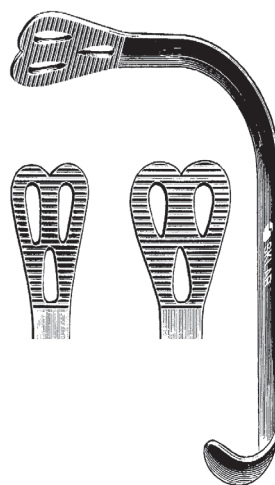

**WIEDER TONGUE DEPRESSORS FENESTRATED AND SERRATED BLADE**

- |         |       |
|---------|-------|
| 75-2160 | Small |
| 75-2161 | Large |

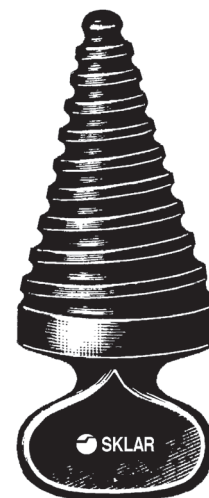

**ORAL SCREW, PLASTIC MOUTH OPENER**

- 75-1400

For a complete listing of our ENT product line, visit [www.sklarcorp.com](http://www.sklarcorp.com).

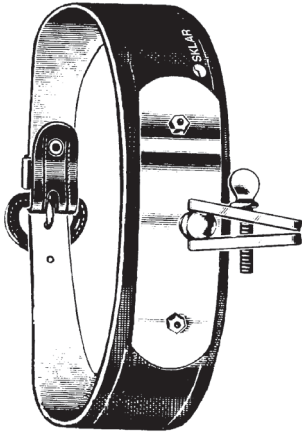

**JEFFERSON LEATHER  
HEADBAND**

73-1015 1½" With Pad

**PLASTIC HEADBAND**

73-1082



**BECK HEADBAND**

**ADJUSTABLE**

73-1075

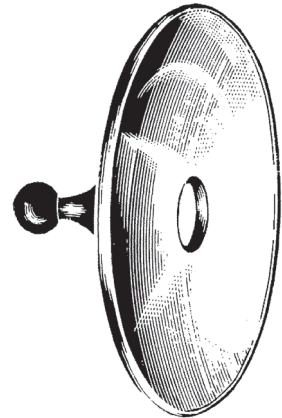

**HEAD MIRROR**

**BOILABLE, FOR USE WITH 73-1015 AND 73-1082**

73-1085 3½" ½" Hole Diameter

73-1086 3" 5/8" Hole Diameter,  
Stainless Black

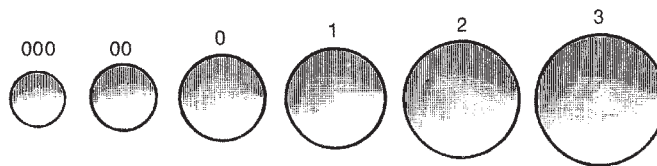

8mm 10mm 12mm 14mm 16mm 18mm

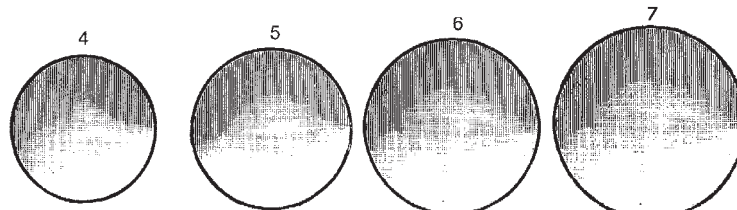

20mm 22mm 24mm 26mm

**LARYNGEAL MIRRORS, REGULAR**

**CHROME BACK MIRROR WITH STAINLESS STEEL HANDLE**

73-1188 #000	73-1190 #0	73-1192 #2	73-1194 #4	73-1196 #6
73-1189 #00	73-1191 #1	73-1193 #3	73-1195 #5	73-1197 #7

For a complete listing of our Plastic Surgery product line, visit [www.sklarcorp.com](http://www.sklarcorp.com).



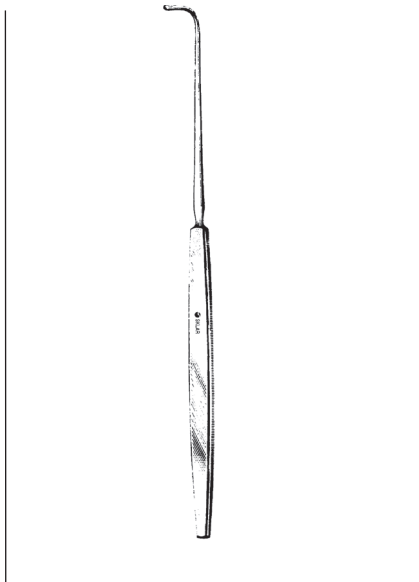

**COLVER TONSIL EXAMINING  
RETRACTOR**

74-1202 8" Blunt Tip

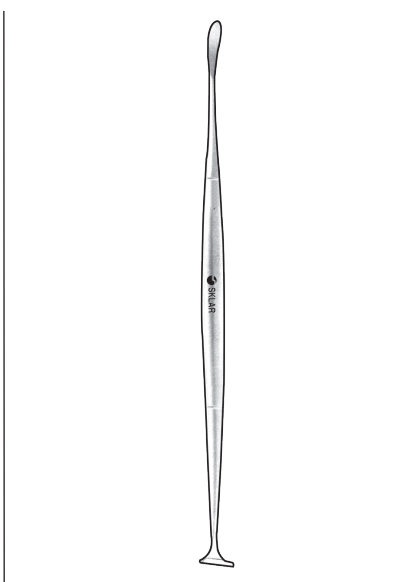

**HURD TONSIL DISSECTOR AND  
PILLAR RETRACTOR**

DOUBLE END  
75-6387 8¾"

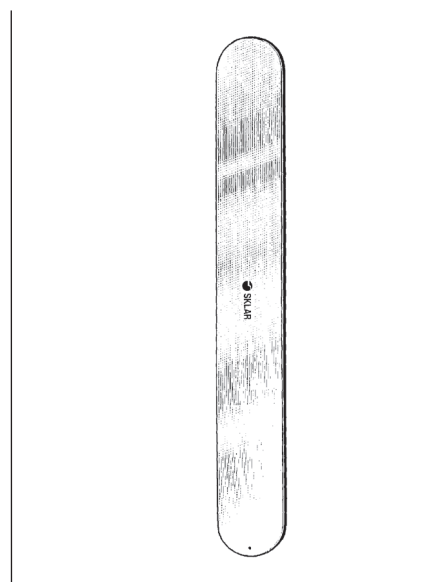

**ZALKIND (RIBBON) RETRACTORS**  
MALLEABLE

60-3594	¼" x 7¾"	60-3607	¾" x 13"
60-3596	½" x 7¾"	60-3610	1" x 13"
22-8067	⅝" x 7¾"	60-3612	1¼" x 13"
60-3598	¾" x 7¾"	60-3615	1½" x 13"
22-8075	1" x 7¾"	60-3617	1¾" x 13"
		60-3620	2" x 13"
		60-3625	2½" x 13"

## SKLAR DISINFECTANT™ SURFACE WIPES

READY-TO-USE, PRE-MOISTENED  
TOWELETTES

- 2 minute kill time.
- Ready to use, non-toxic formula.
- Specially formulated for the control of cross contamination.
- Effective against a broad range of pathogens including H1N1, HIV-1, HSV, VRE, Rotaviruses, Hep B & C as well as TB, MRSA and A. Baumannii.
- Safe for all areas of the facility.
- Satisfies OSHA's Bloodborne Pathogen Standards.
- Destroys odor-causing bacteria.
- 7" x 10" non-woven, tear resistant towelette.
- EPA registered.



Convenient  
Dispensing  
Canister

PRODUCT NUMBER	DESCRIPTION	QUANTITIES
10-1616	100 Towelettes/Canister	6/case
10-1617	100 Towelettes/Canister	12/case

For a complete listing of our ENT product line, visit [www.sklarcorp.com](http://www.sklarcorp.com).

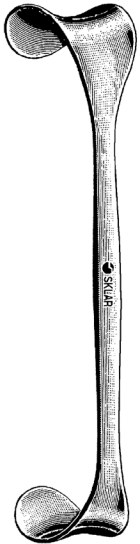

**GOELET RETRACTOR**  
DOUBLE END  
60-1075 7½" Long  
1¼" x 1½"

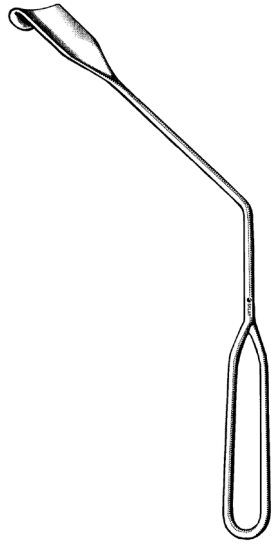

**LOTHROP UVULA  
RETRACTOR**  
75-2315 20mm wide

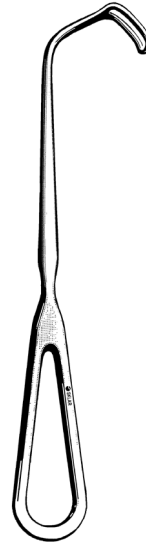

**CUSHING  
DECOMPRESSION  
RETRACTOR**  
50-1280 8"

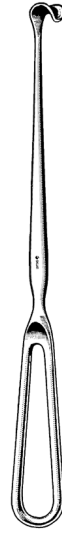

**CUSHING NERVE /  
VEIN RETRACTOR**  
50-1290 9"



**UNIVERSITY OF MINNESOTA  
CHEEK RETRACTOR**  
DOUBLE END  
75-1120 6"

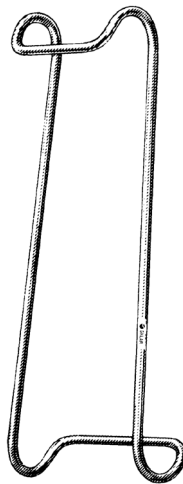

**COLUMBIA LIP RETRACTOR**  
DOUBLE END  
75-1122 5½"

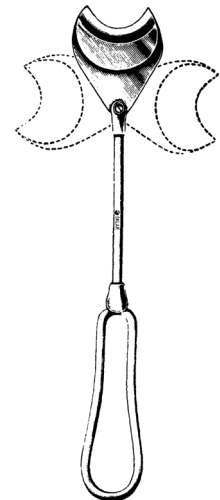

**CHEEK RETRACTOR  
WITH SWIVEL BLADE**  
75-1124 7¼"

**For a complete listing of our Plastic Surgery product line, visit [www.sklarcorp.com](http://www.sklarcorp.com).**

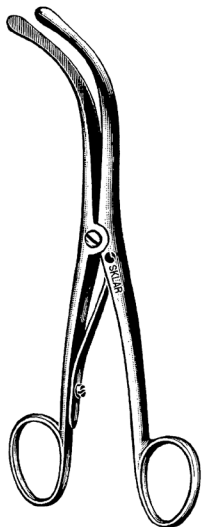

**TROUSSEAU TRACHEAL  
DILATOR**

78-3360 5½" Two Blades

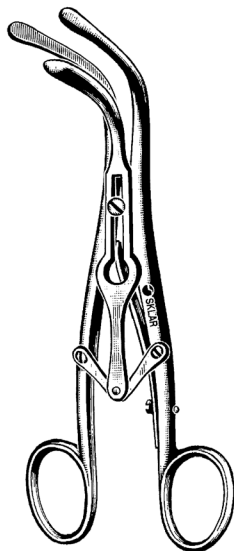

**LABORDE TRACHEAL DILATOR**

78-3460 5½" 3 Prong



**EVES TONSIL SNARES**

75-9070 Plain  
75-9075 With Ratchet

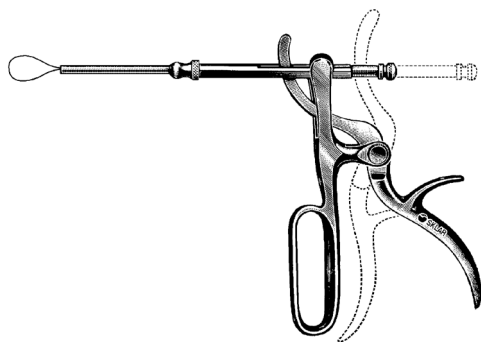

**TYDING TONSIL SNARES**

75-9250 One Straight Tip with 1doz. Cut & Bent Snare Wires

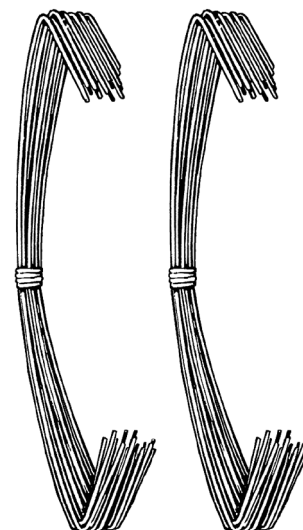

**SNARE WIRES CUT & BENT**

**1 PACKAGE OF 12 (12 WIRES)**

67-1753 #4 4" Long (Krause)	75-9507 #7 4" Long
75-9505 #5 4" Long	75-9508 #8 4" Long
75-9506 #6 4" Long	75-9509 #9 4" Long

**12 PACKAGE OF 12 (144 WIRES)**

67-1752 #4 4" Long (Krause)	75-9407 #7 4" Long
75-9405 #5 4" Long	75-9408 #8 4" Long
75-9406 #6 4" Long	75-9409 #9 4" Long

For a complete listing of our ENT product line, visit [www.sklarcorp.com](http://www.sklarcorp.com).



**ENT / PLASTIC SURGERY  
ADENOID INSTRUMENTS**



**LA FORCE ADENOTOMES**

- 70-9001 No. 1 Large Size
- 70-9002 No. 2 Medium
- 70-9003 No. 3 Small

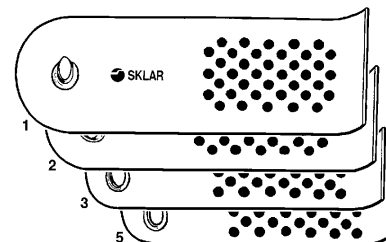

**LA FORCE ADENOTOMES**

**BLADES ONLY**

- 70-9101 No. 1 Large Size
- 70-9102 No. 2 Medium
- 70-9103 No. 3 Small



**BARNHILL ADENOID CURETTES**

- 70-9200 No. 0 8¼"
- 70-9201 No. 1 8¼"
- 70-9202 No. 2 8¼"
- 70-9203 No. 3 8¼"
- 70-9204 No. 4 8¼"

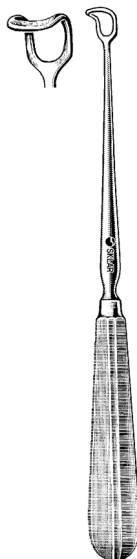

**VOGEL ADENOID CURETTE**

- 70-9210 Infant



**BECKMANN ADENOID CURETTES**

- 70-9220 #1 8½"
- 70-9221 #2 8½"
- 70-9222 #3 8½"
- 70-9223 #4 8½"
- 70-9224 #5 8½"

For a complete listing of our Plastic Surgery product line, visit [www.sklarcorp.com](http://www.sklarcorp.com).

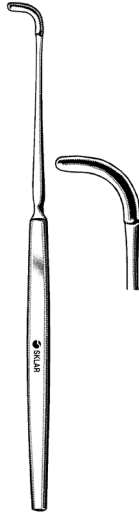

**TYDING TONSIL KNIFE**

75-7482 8½"

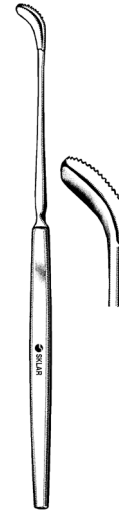

**FISHER TONSIL KNIFE**

75-7590 8½"

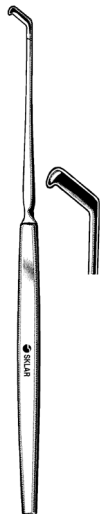

**DOUGLAS TONSIL KNIFE**

75-7282 8¼" Angled

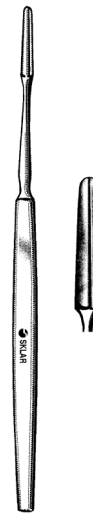

**DEAN TONSIL KNIFE**

**DOUBLE EDGE**  
75-7492 7¼" Straight

For a complete listing of our ENT product line, visit [www.sklarcorp.com](http://www.sklarcorp.com).

ENT / PLASTIC SURGERY

TONSIL INSTRUMENTS

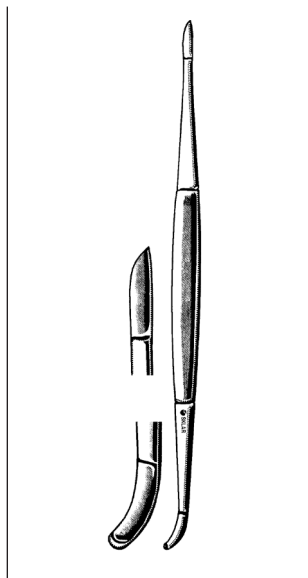

**LOTHROP TONSIL KNIFE**  
DOUBLE END  
75-7575 8"

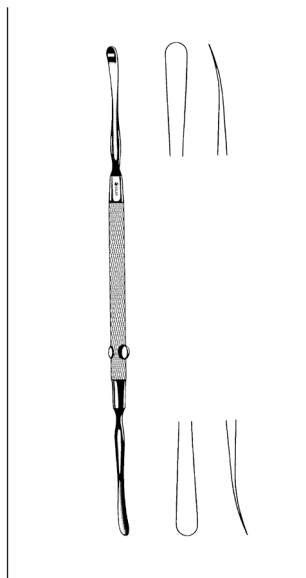

**FREER ELEVATORS**  
DOUBLE END  
47-2380 7¼" Sharp/Blunt  
47-2382 7¾" Sharp/Blunt

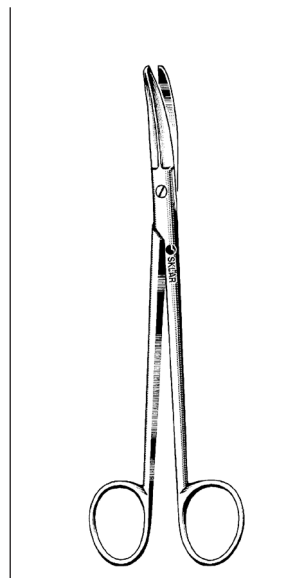

**BOETTCHER TONSIL SCISSOR**  
75-5070 7" Curved

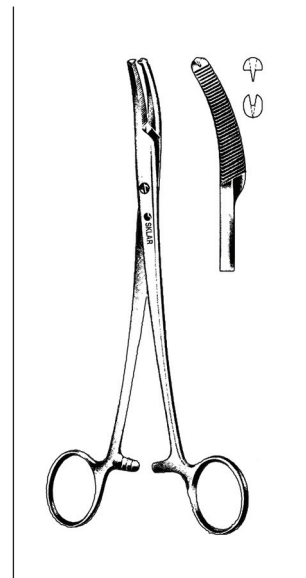

**MIKULICZ PERITONEAL FORCEPS**  
1X2 TEETH  
90-2584 8" Slight Curve

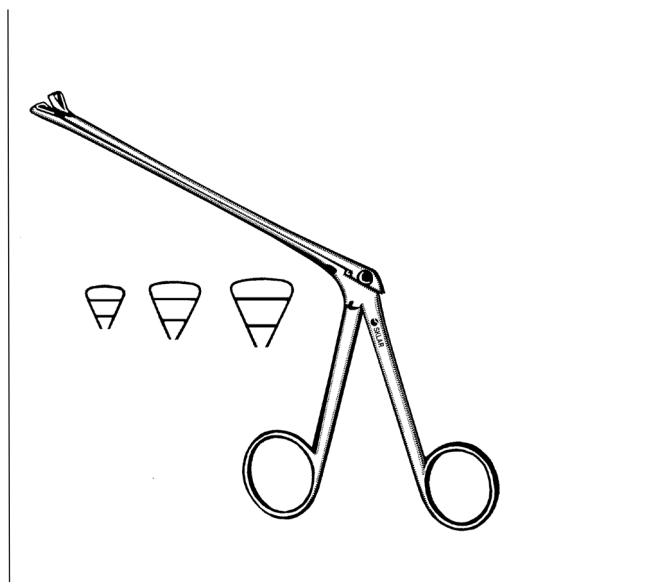

**SCHMEDEN TONSIL PUNCHES**  
5½" SHANK WITH TRIANGULAR BASKET TIP  
75-9601 Size 1  
75-9602 Size 2  
75-9603 Size 3

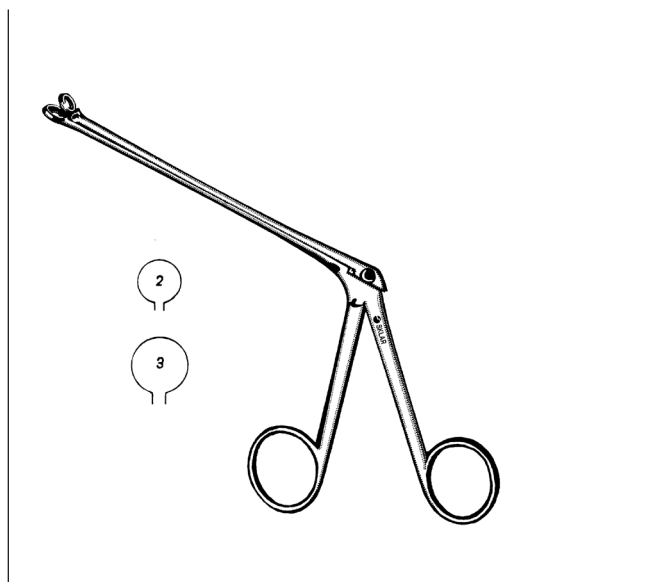

**HARTMANN (MOSHER) TONSIL PUNCHES**  
5½" SHANK WITH ROUND BASKET TIP  
75-9612 Size 2  
75-9613 Size 3

For a complete listing of our Plastic Surgery product line, visit [www.sklarcorp.com](http://www.sklarcorp.com).

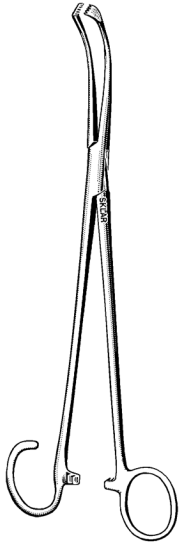

**WHITE TONSIL FORCEPS**

ONE OPEN RING

74-2575 7" Curved  
74-2590 9" Curved

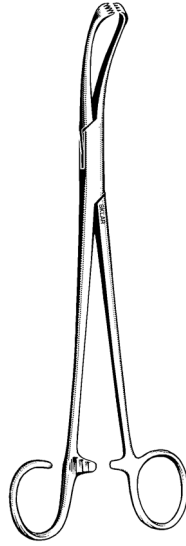

**COLVER-COAKLEY TONSIL  
FORCEPS**

74-2475 7½" Curved

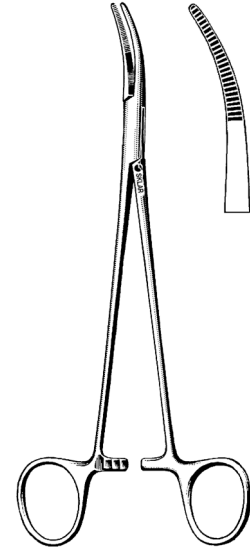

**SCHNIDT TONSIL FORCEPS**

74-3075 7½" Half Curved Jaw

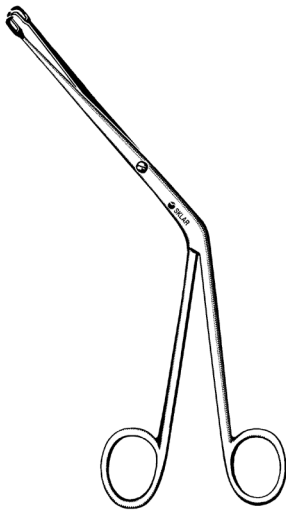

**TYDING TONSIL SEIZING  
FORCEPS**

74-1975 7½" 2x2 Angular With Catch

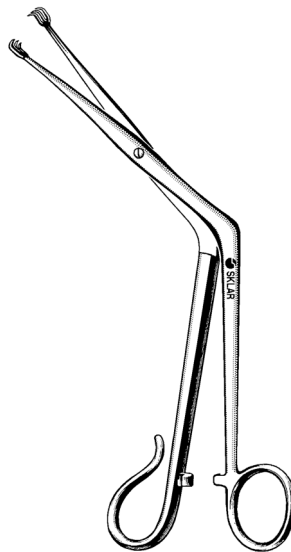

**TIVNEN TONSIL SEIZING  
FORCEPS**

74-2175 7½" 3x3 Angular With Catch

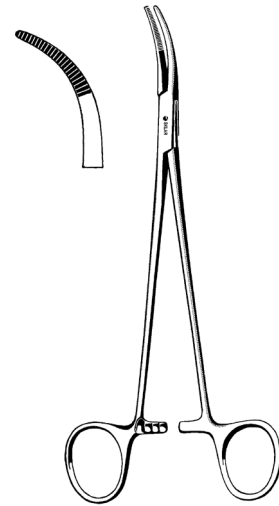

**SAWTELL TONSIL FORCEPS**

74-3175 7½" Full Curved

For a complete listing of our ENT product line, visit [www.sklarcorp.com](http://www.sklarcorp.com).

# ENT / PLASTIC SURGERY

## RETRACTORS

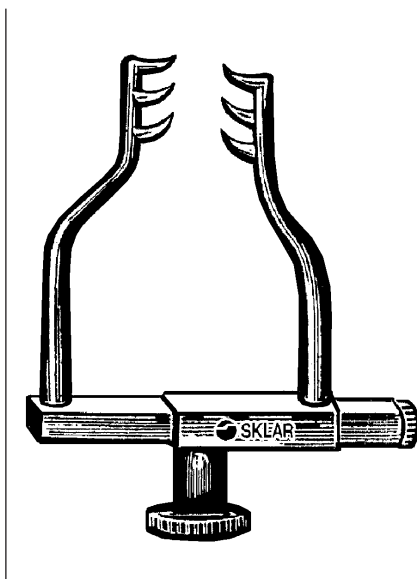

**GOLDSTEIN RETRACTOR**  
47-2913 1½" 3x3 Sharp Prongs

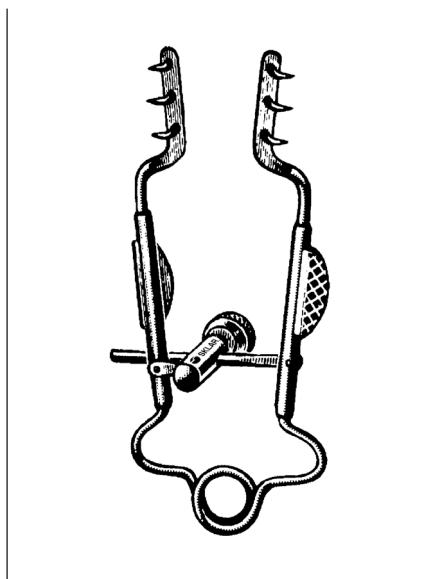

**MELLER LACRIMAL SAC  
RETRACTORS**  
**3X3 PRONGS**  
65-1815 1½" Sharp 4mm Deep Delicate  
65-1830 3" Blunt 3mm Deep

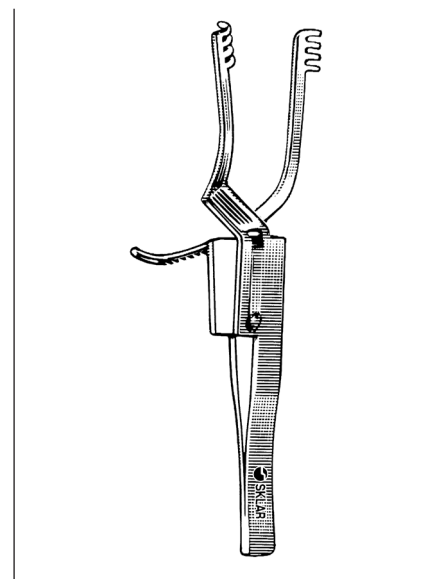

**HOLZHEIMER SELF-RETAINING  
RETRACTORS**  
**SHARP**  
22-8920 4" 4x4 Teeth  
**BLUNT**  
22-8940 4" 4x4 Teeth

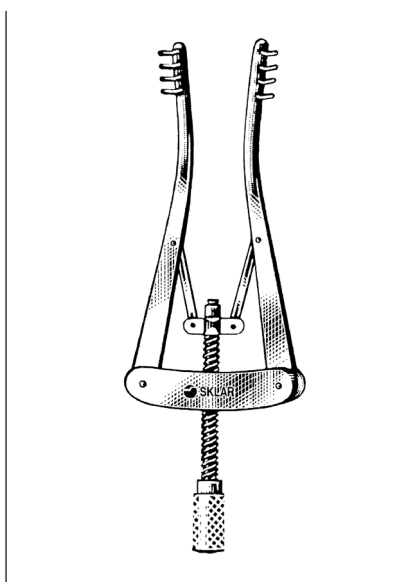

**ALM RETRACTORS**  
22-9027 2¾" 4x4 Teeth Blunt  
60-6340 4" 4x4 Teeth Blunt  
22-9029 2¾" 4x4 Teeth Sharp  
60-6342 4" 4x4 Teeth Sharp

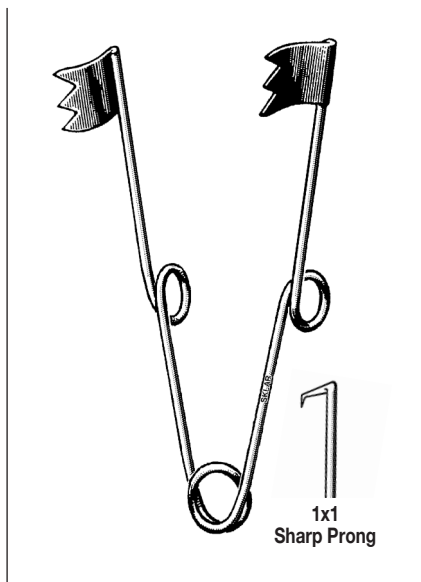

**WIRE RETAINING RETRACTORS**  
**SHARP**  
22-8832 3¼" 3x3 Prongs  
22-8834 3¼" 1x1 Prong

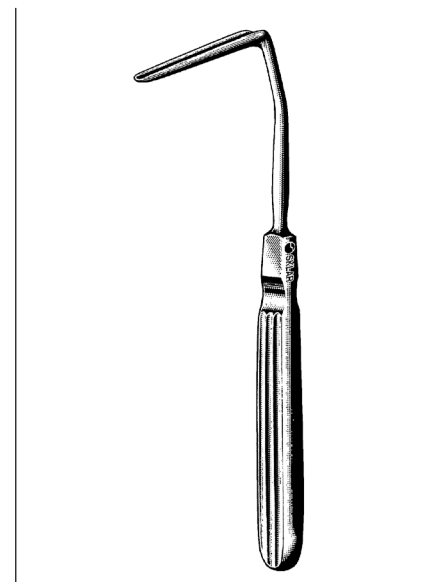

**AUFRICHT RETRACTOR**  
**SOLID BLADE**  
41-1410 6¼" x 1¼"

For a complete listing of our Plastic Surgery product line, visit [www.sklarcorp.com](http://www.sklarcorp.com).



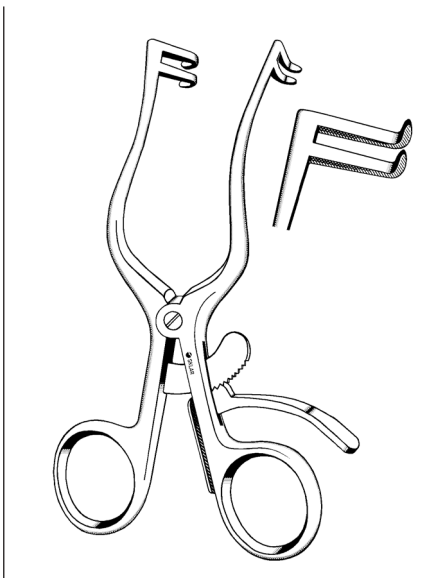

**PAPARELLA WEITLANER  
RETRACTOR**

1¼" INSIDE SPREAD

42-1820 5" 2x2 Semi Sharp Teeth

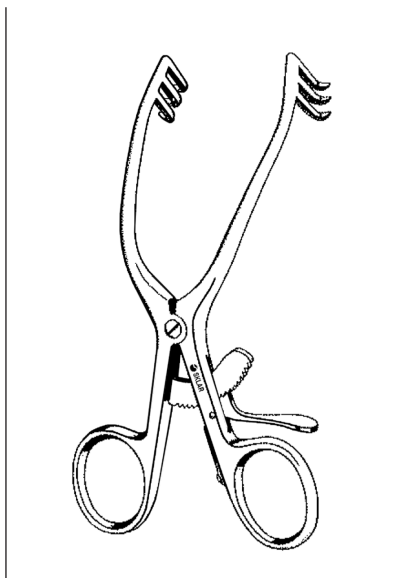

**SCHUKNECHT POSTAURICULAR  
RETRACTOR**

42-1822 5" 3x3 Teeth

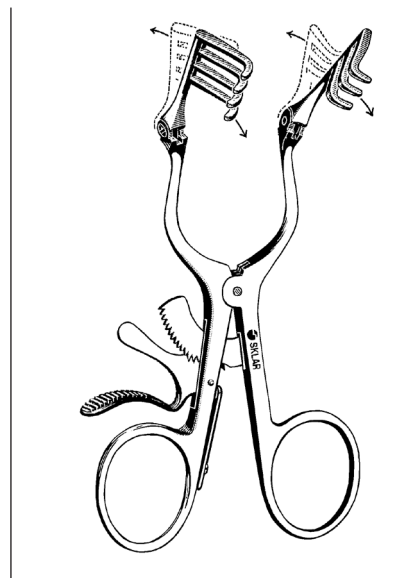

**WEITLANER-BECKMAN  
RETRACTORS**

HINGED BLADES WITH 3X4 PRONGS

BLUNT		SHARP	
42-1654	5½"	42-1764	5½"
42-1655	6½"	42-1765	6½"
42-1656	9"	42-1766	9"
42-1657	10¼"	42-1767	10¼"

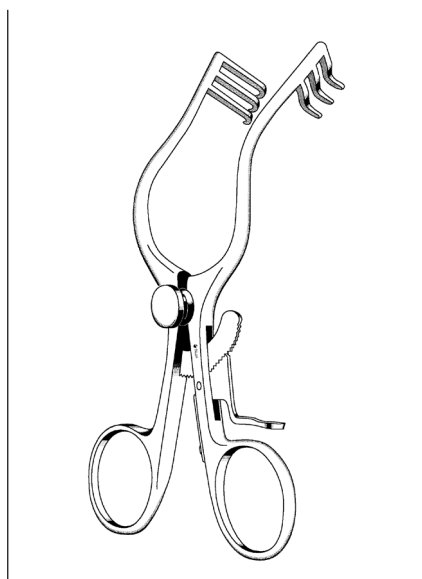

**WULLSTEIN ENDAURAL  
RETRACTOR**

42-1824 5" 3x3 Sharp Teeth

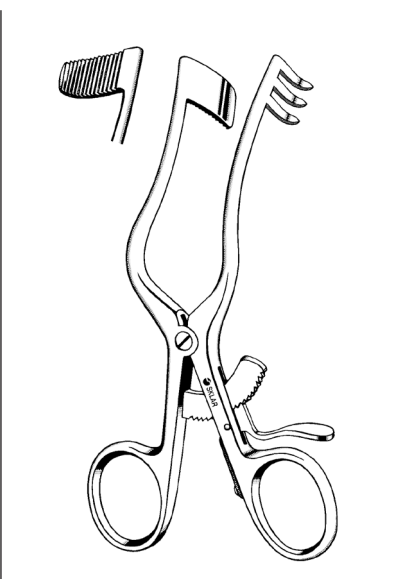

**PERKINS ENDAURAL  
RETRACTORS**

42-1826 5¼" Left Serrated Solid Blade  
42-1828 5¼" Right Serrated Solid Blade

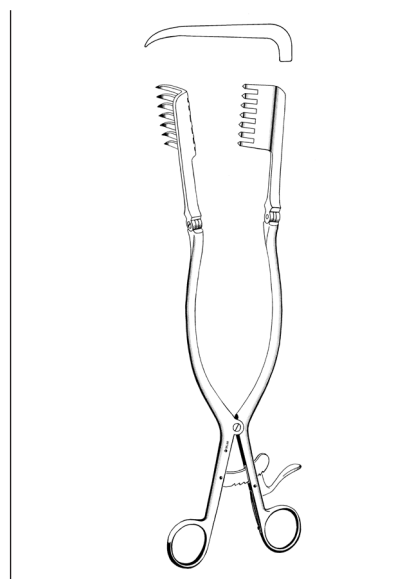

**BECKMAN-EATON RETRACTOR**

TRU-GRIP RATCHET

57-1325 13" 7x7 Sharp Prongs  
With Hinged Blades

For a complete listing of our ENT product line, visit [www.sklarcorp.com](http://www.sklarcorp.com).

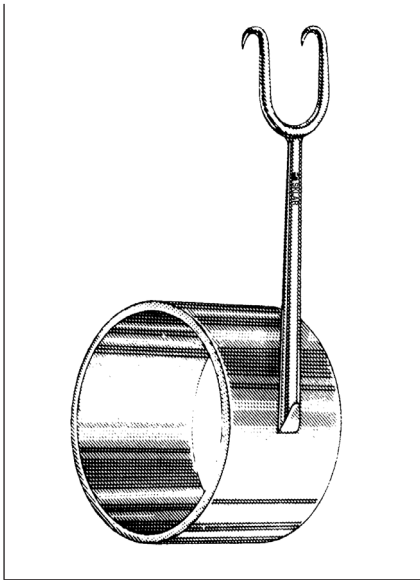

**COTTLE THUMB RETRACTOR**  
41-1380 1½" Sharp Double Hook

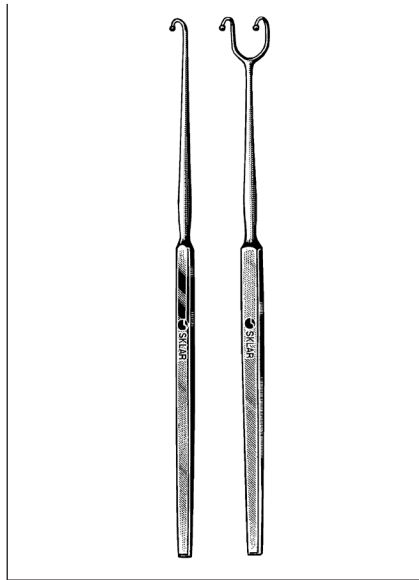

**FOMON RETRACTORS**  
**BALL END**  
41-1395 6¾" Single  
41-1396 6¼" Double

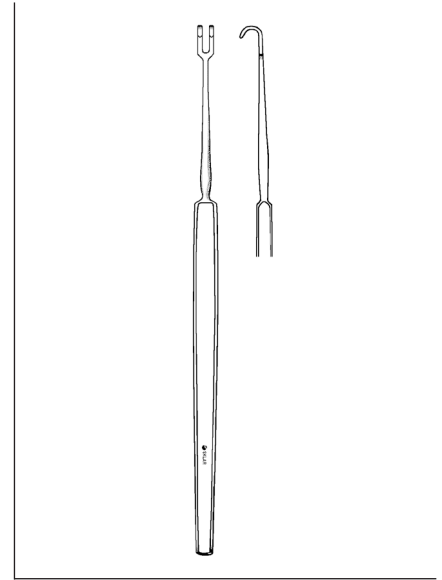

**DERMAL RETRACTORS**  
**2 PRONGS**  
47-2514 5¼" Sharp  
47-2516 5¼" Blunt

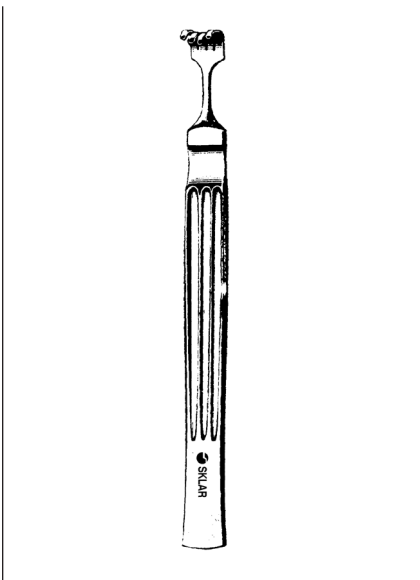

**COTTLE RETRACTOR**  
41-1385 5½" Two Center Prongs  
Recessed

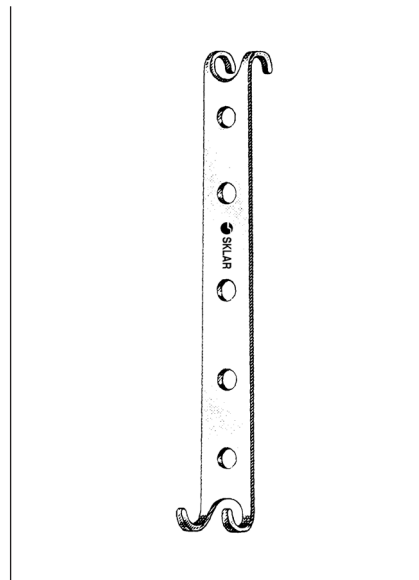

**CONVERSE ALAR RETRACTOR**  
41-1398 4½" Double End Blunt

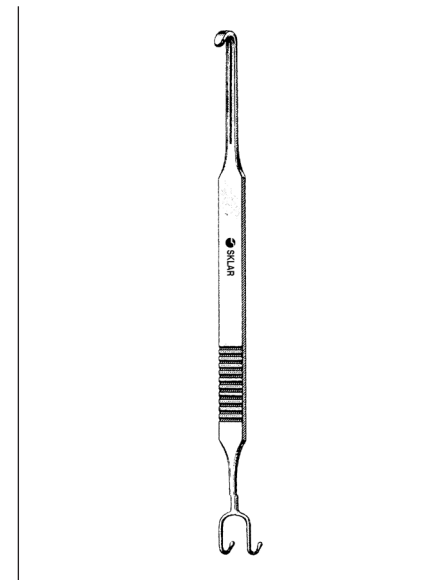

**COTTLE KNIFE GUARD AND  
RETRACTOR**  
**5MM WIDE SLOTTED HOOK**  
41-1382 8"

For a complete listing of our Plastic Surgery product line, visit [www.sklarcorp.com](http://www.sklarcorp.com).



**CONVERSE BLADE RETRACTORS**

- 41-1401 3¾" Size 1
- 41-1402 3¾" Size 2
- 41-1403 3¾" Size 3



**LOVE UVULA RETRACTORS**

- LIFTS SOFT PALATE AND ALLOWS FOR EASY REMOVAL OF ADENOID TISSUE
- 75-2318 18mm wide
  - 75-2320 20mm wide
  - 75-2322 22mm wide

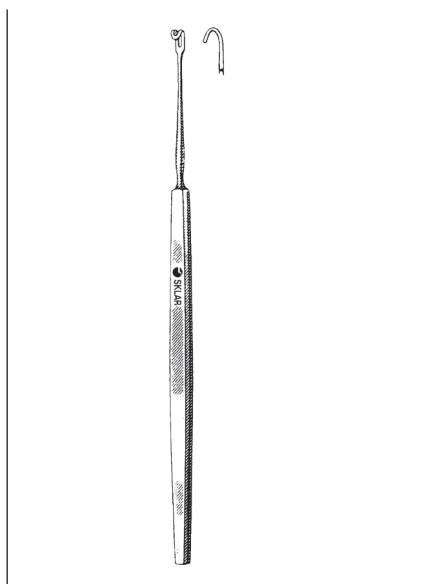

**MCGANNON IRIS RETRACTOR**

- 65-3258 5¼"

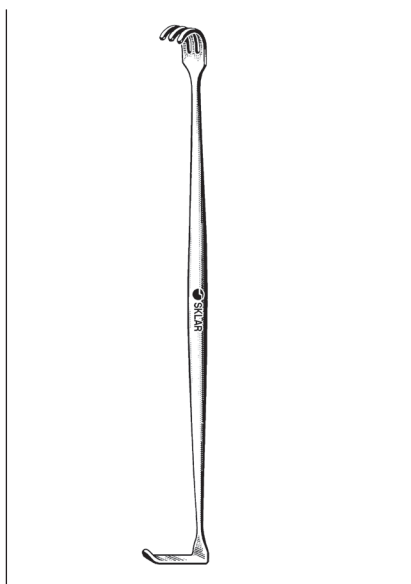

**MATHIEU RETRACTORS**

- DOUBLE END**
- 60-6062 6¼" Blunt
  - 60-6064 6¼" Sharp

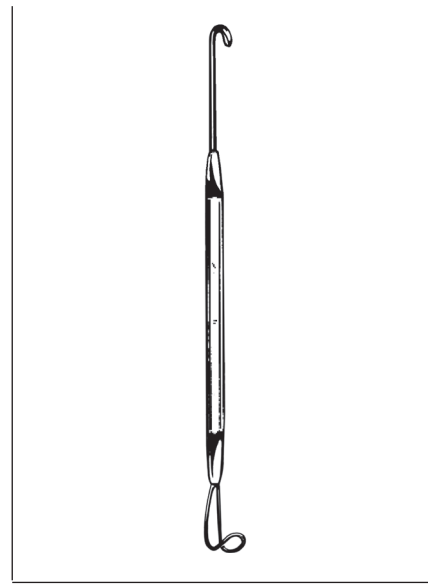

**NEIVERT KNIFE GUIDE AND  
RETRACTOR**

- DOUBLE END**
- 41-1383 6½"

For a complete listing of our ENT product line, visit [www.sklarcorp.com](http://www.sklarcorp.com).



**LOVE NERVE RETRACTORS**

**7MM BLADE**

50-1301	7½"	Straight
50-1302	7½"	Angled 45°
50-1303	7½"	Angled 90°

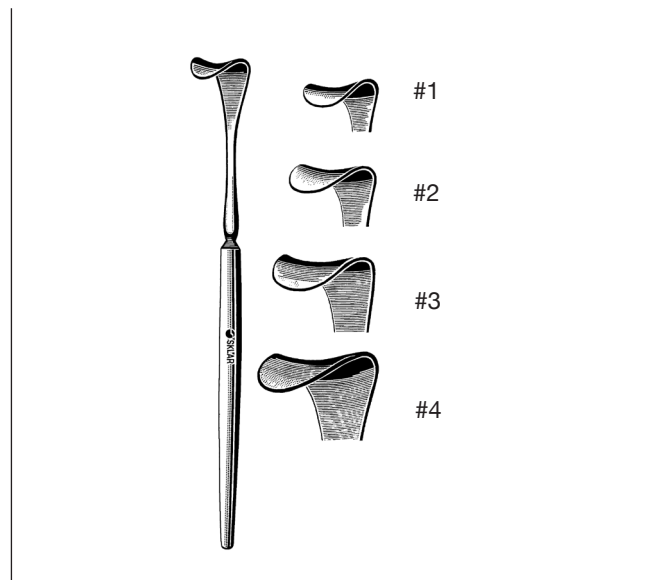

**DESMARRES LID RETRACTORS**

65-1841	#1	5½"	12mm Blade
65-1842	#2	5½"	14mm Blade
65-1843	#3	5½"	16mm Blade
65-1844	#4	5½"	18mm Blade

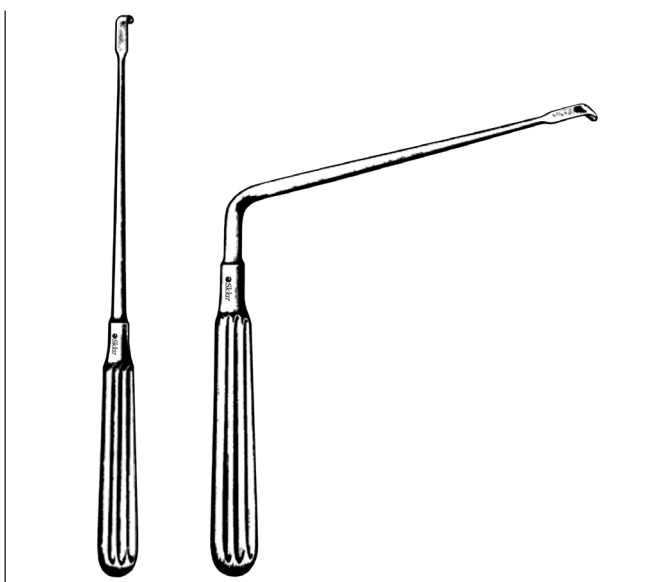

**SCOVILLE NERVE RETRACTORS**

**8MM BLADE**

50-1304	9"	Straight
50-1305	9"	Angular



**EAR SUCTION TUBE**

WITH TWO INTERCHANGEABLE TIPS - 20GA, 22GA

50-1950	7"
---------	----

For a complete listing of our Plastic Surgery product line, visit [www.sklarcorp.com](http://www.sklarcorp.com).

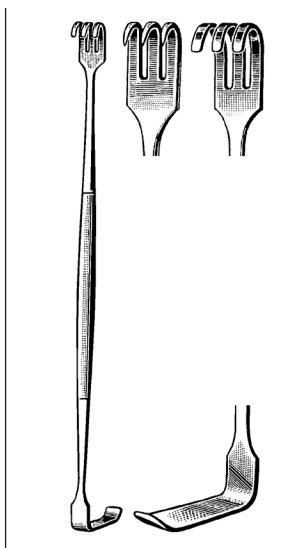

**SENN RETRACTORS**

**DOUBLE END**

- 60-6162 6¼" Sharp
- 60-6164 6¼" Blunt

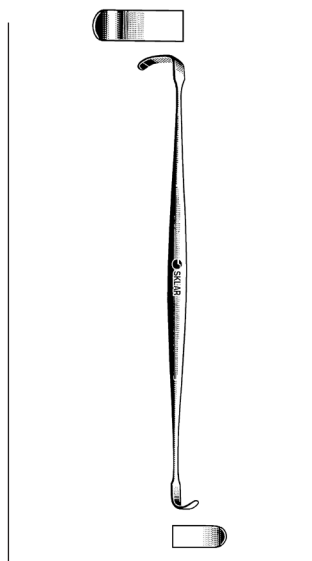

**RAGNELL RETRACTOR**

**DOUBLE END**

- 22-8560 6"

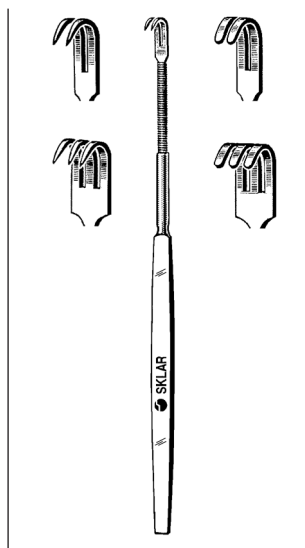

**PLASTIC SURGERY  
RETRACTORS**

**FLEXIBLE NECK**

**BLUNT**

- 22-9141 6" 1 Prongs
- 22-9142 6" 2 Prongs
- 22-9143 6" 3 Prongs

**SHARP**

- 22-9144 6" 1 Prongs
- 22-9132 6" 2 Prongs
- 22-9133 6" 3 Prongs

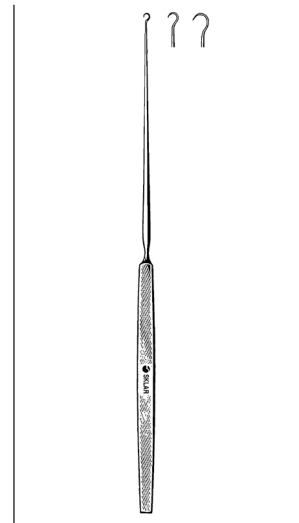

**GILLIES SKIN HOOKS**

- 47-2570 7" 3mm
- 47-2572 7" 4mm

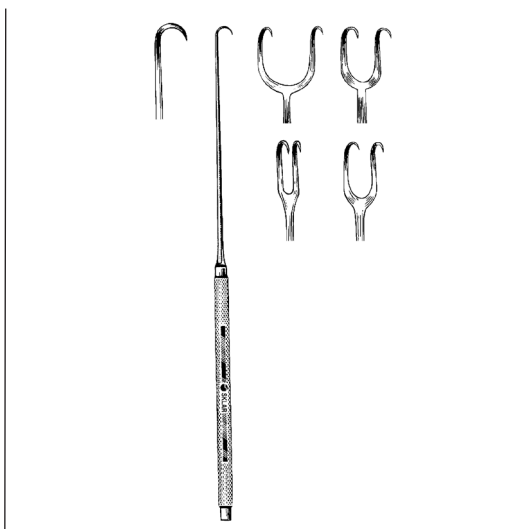

**JOSEPH SKIN HOOKS**

**SINGLE END**

- 47-2500 6¼" 1 Sharp Prong
- 47-2502 6¼" 2 Sharp Prongs 2mm
- 47-2505 6¼" 2 Sharp Prongs 5mm
- 47-2507 6¼" 2 Sharp Prongs 7mm
- 47-2510 6¼" 2 Sharp Prongs 10mm
- 47-2512 6¼" 2 Sharp Prongs 12mm

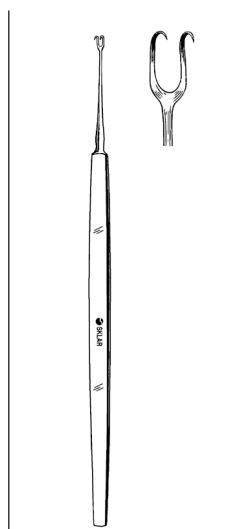

**GUTHRIE DOUBLE  
HOOKS**

**SHARP**

- 47-2651 5" Small 3mm
- 47-2650 5" Large 5mm

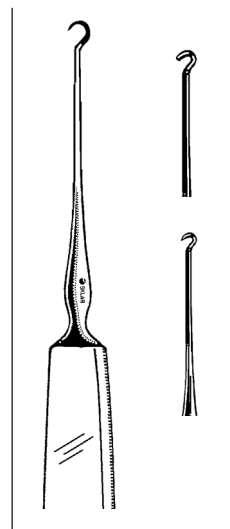

**TYRELL IRIS  
HOOKS**

- 65-3205 5" Blunt
- 65-3206 5" Sharp

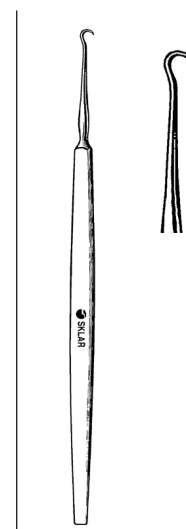

**FRAZIER MICRO  
HOOKS**

**EXTRA DELICATE**

- 47-2555 5" Sharp
- 47-2556 5" Blunt

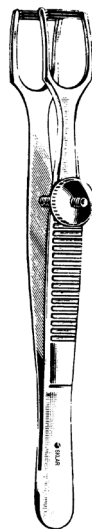

**COTTLE COLUMELLA FORCEPS**

66-1040 4½"

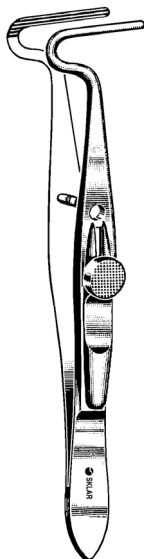

**BERKE PTOSIS FORCEPS**

66-6342 4¼"



**PRINCE MUSCLE FORCEPS**

66-5942 4" Left

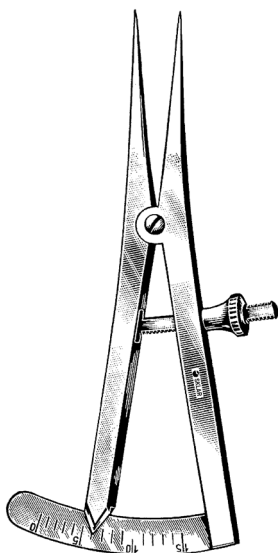

**CASTROVIEJO CALIPER**

¾" GRADUATED MEASURE

- 65-6730 0-15mm Straight
- 65-6732 0-20mm Straight
- 65-6734 0-20mm Curved

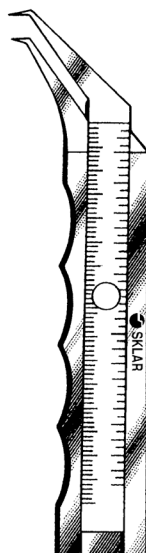

**THORPE CALIPER**

GRADUATED IN INCHES AND MM

65-6735 4½"



**STEEL RULERS**

GRADUATED IN INCHES AND MM

- 06-2860 6"
- 06-2862 8"
- 06-2861 12"
- 06-2863 20"

For a complete listing of our Plastic Surgery product line, visit [www.sklarcorp.com](http://www.sklarcorp.com).

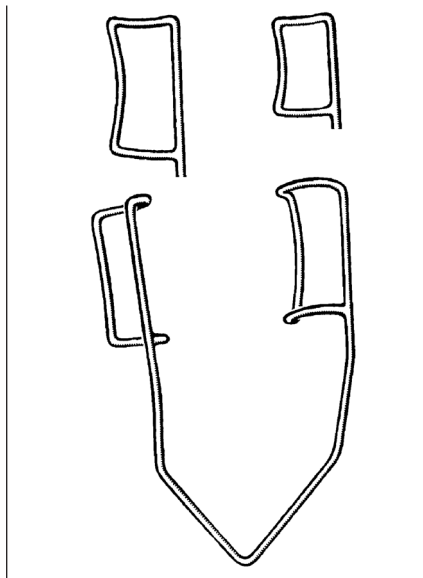

**BARRAQUER WIRE SPECULUM**

1½" LONG

65-1740	10mm loop	Child	
65-1742	15mm loop	Adult	
65-1744	15mm loop	Adult	heavy wire
65-1746	8mm loop	Infant	
65-1748	4mm loop	Infant	delicate

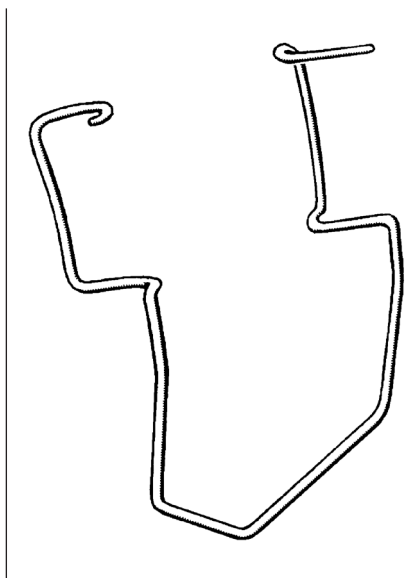

**KRATZ-BARRAQUER WIRE EYE SPECULUM**

BLADE WIDTH 14MM

65-1750	18mm blade spread	Adult
65-1752	15mm blade spread	Child
65-1754	10mm blade spread	Infant

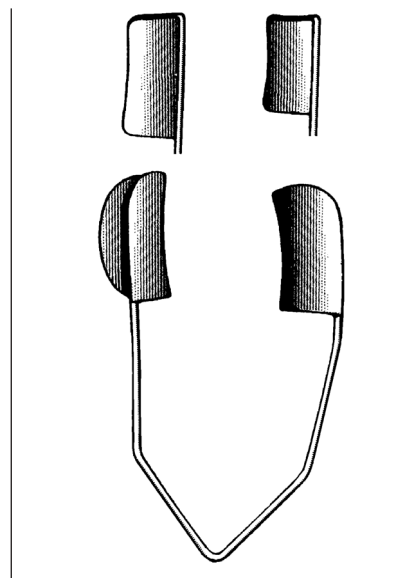

**BARRAQUER WIRE SPECULUM**

1½" LONG

65-1756	10mm solid blade	Child
65-1758	15mm solid blade	Adult

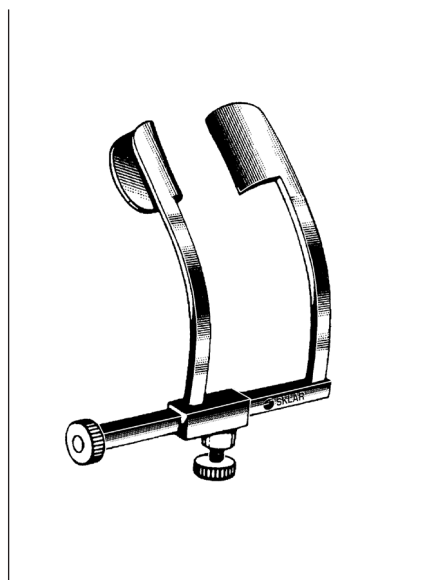

**COOK EYE SPECULUM**

2" LONG

65-1765	9x3mm solid blade spread	25mm, infant
65-1766	11x3mm solid blade spread	27mm, adult

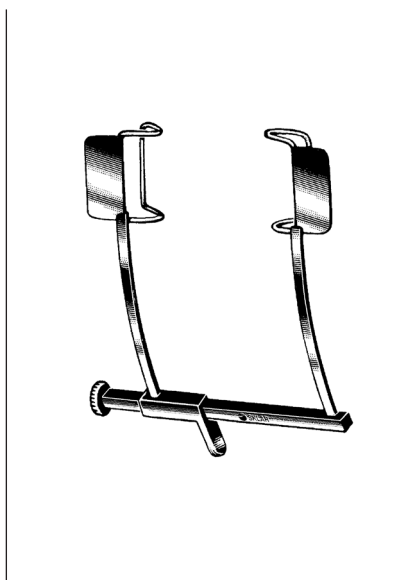

**WIENER EYE SPECULUM**

2¼"

65-1790	15mm blades with extensions to cover eye lashes, chrome
---------	---



**MURDOCK EYE SPECULUM**

2¼"

65-1540	15mm spread
---------	-------------

For a complete listing of our Ophthalmic product line, visit [www.sklarcorp.com](http://www.sklarcorp.com).



**OPHTHALMIC  
SPECULUM**

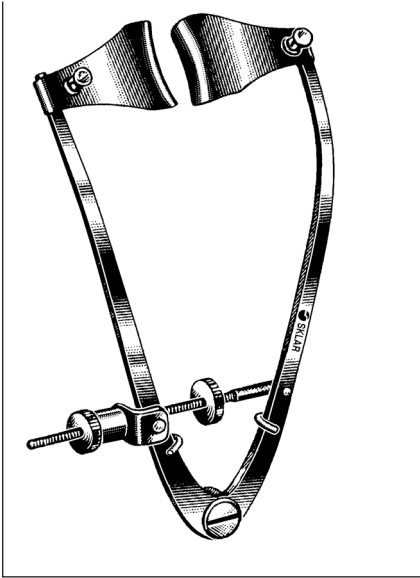

**MCPHERSON EYE SPECULUM**  
65-7360 3¼" Blades 13mm wide  
with suture posts

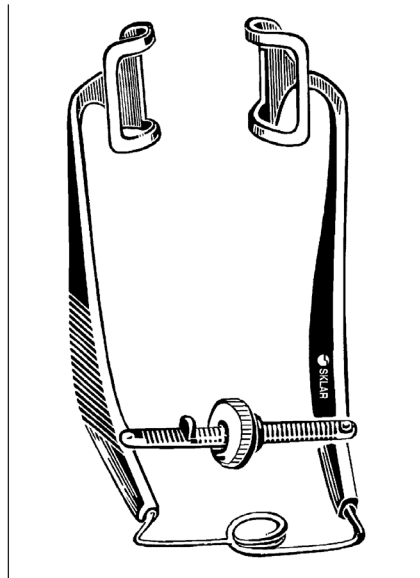

**ZIEGLER SPECULUM**  
65-1522 2¼"

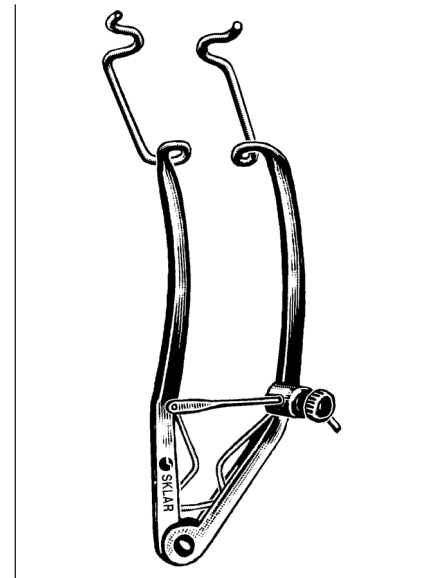

**KNAPP EYE SPECULUM**  
65-1545 Non-magnetic

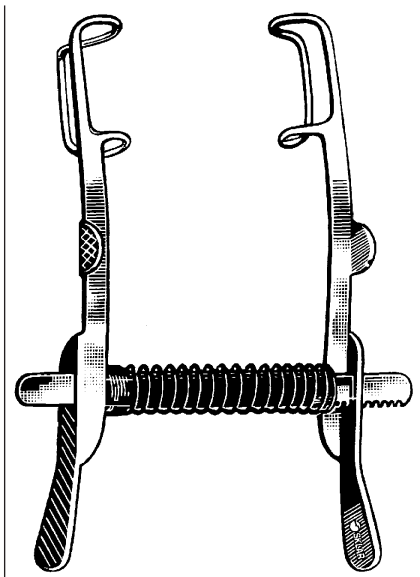

**MELLINGER SPECULUM**  
65-1426 2¾" Solid Blades  
65-1427 2¾" Fenestrated Blades

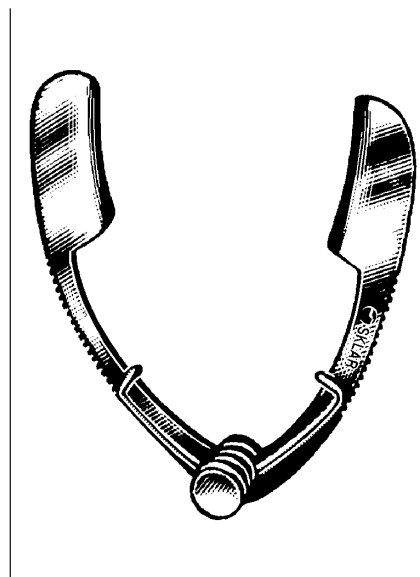

**SAUER EYE SPECULUM**  
INFANT  
65-1012 1¼" 10mm

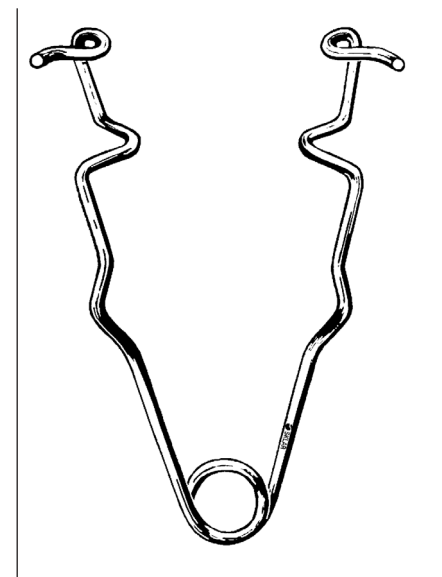

**PLAIN WIRE SPECULUM**  
65-1127 2¾" Adult

For a complete listing of our Ophthalmic product line, visit [www.sklarcorp.com](http://www.sklarcorp.com).



# OPHTHALMIC SPECULUM

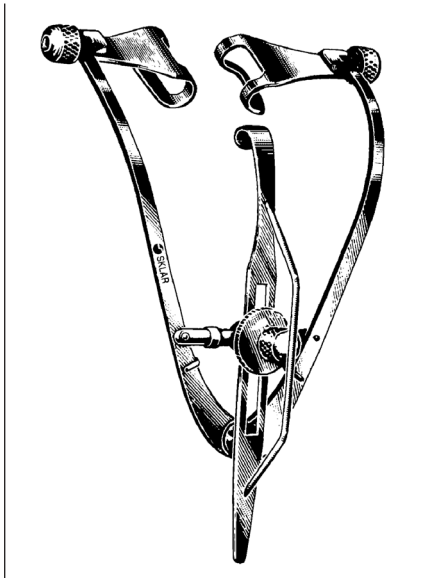

**PARK-MAUMENEE  
EYE SPECULUM**

65-1528 3¼" Non-magnetic guard over  
locking screw

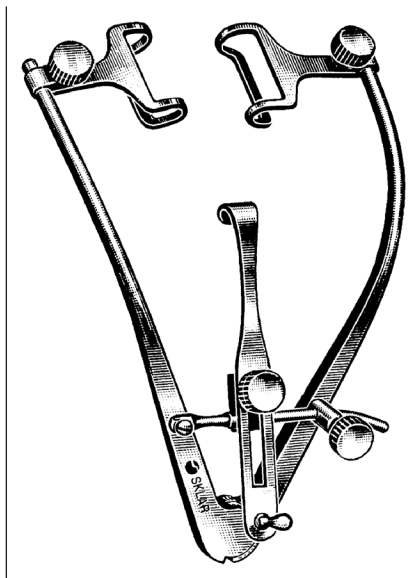

**PARK-GUYTON EYE SPECULUM**

65-1530 3" length

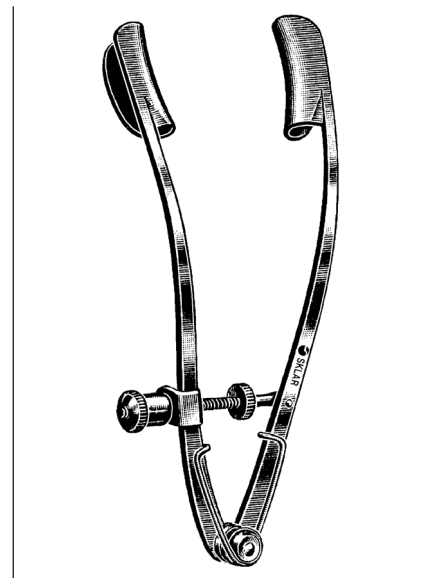

**LANCASTER EYE SPECULUM**

65-1532 3¼"

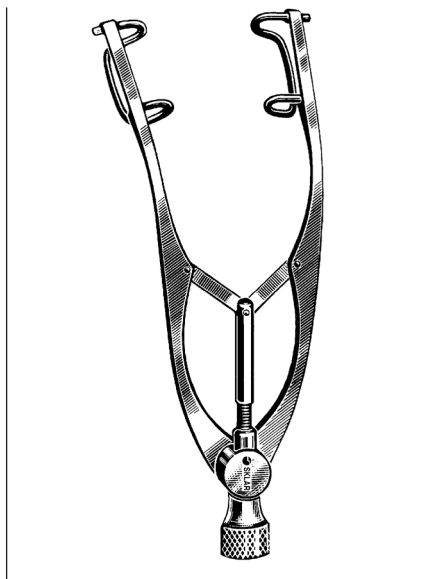

**CASTROVIEJO SPECULUM**

65-1535 3½" 15 x 5mm Blades  
65-1536 4" 15 x 5mm Blades

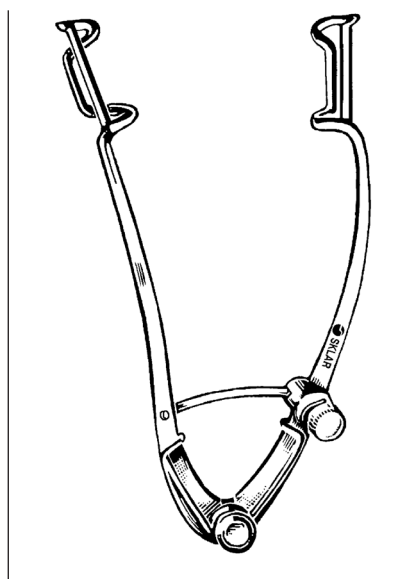

**WILLIAMS SPECULUM**

65-1227 2¾" Child  
65-1332 3¼" Adult

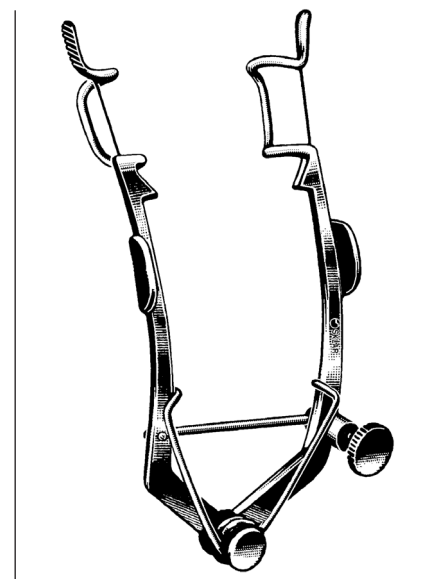

**WEEKS EYE SPECULUM**

65-1730 3¼" long 15 x 5mm loop

For a complete listing of our Ophthalmic product line, visit [www.sklarcorp.com](http://www.sklarcorp.com).



**OPHTHALMIC  
FIXATION RINGS**

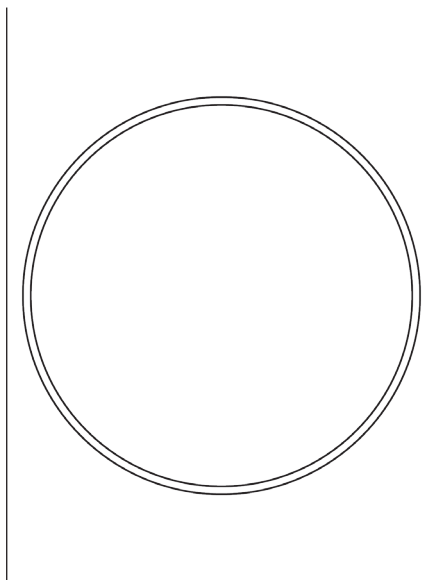

**FLIERINGA FIXATION RINGS**

- 66-7814 14mm Diameter
- 66-7816 16mm Diameter
- 66-7818 18mm Diameter
- 66-7820 20mm Diameter
- 66-7822 22mm Diameter
- 66-7824 24mm Diameter

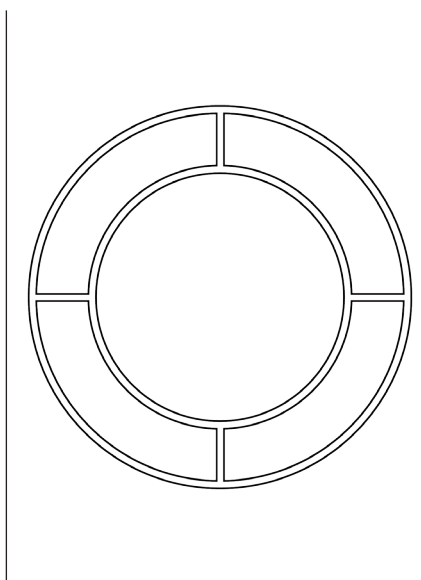

**FLIERINGA-LEGRAND FIXATION RING**

- 66-7830 14 x 23mm Diameter

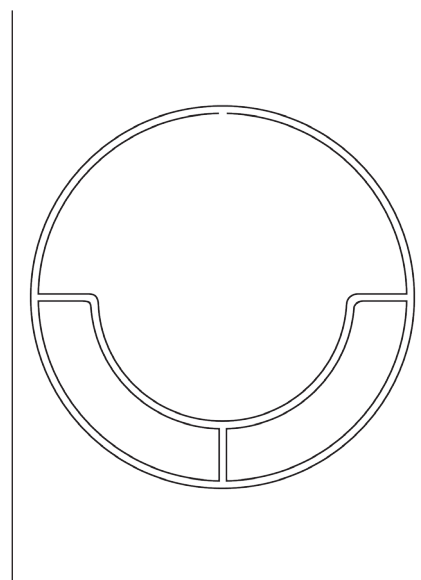

**CASANOVA FIXATION RINGS**

- 66-7840 15 x 24mm Diameter
- 66-7842 17 x 24mm Diameter

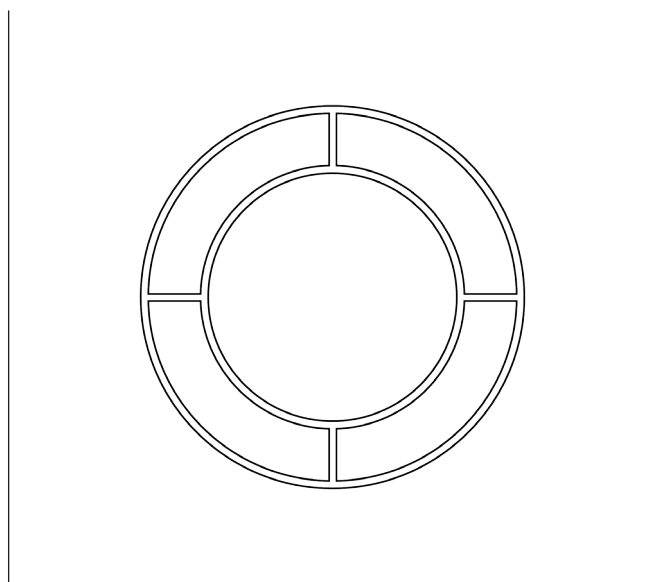

**FLIERINGA-LEGRAND FIXATION RING**

- 66-7850 17 x 24mm Diameter

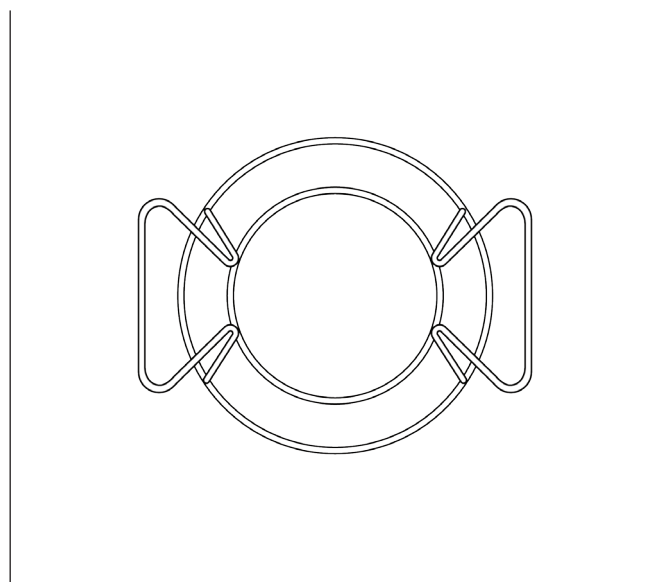

**MCNEIL-GOLDMAN FIXATION RING**

- 66-7852 17 x 24mm Diameter

For a complete listing of our Ophthalmic product line, visit [www.sklarcorp.com](http://www.sklarcorp.com).

**OPHTHALMIC  
RETRACTORS / EXPRESSORS**



**DESMARRES LID RETRACTORS**

65-1841	#1	5½"	12mm
65-1842	#2	5½"	14mm
65-1843	#3	5½"	16mm
65-1844	#4	5½"	18mm



**JAEGER LID PLATE**

65-1835 4¼" Stainless

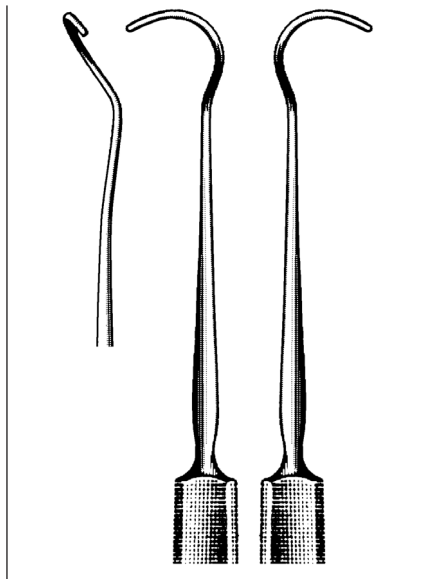

**ARRUGA LENS EXPRESSORS**

65-8350 Left  
65-8352 Right

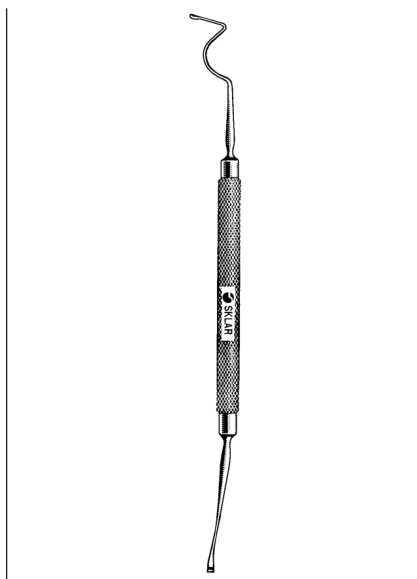

**RIZZUTI IRIS RETRACTOR & LENS  
EXPRESSOR**

5¾" (14.5CM)  
65-8354 2.5mm blade



**KIRBY MUSCLE HOOK & LENS  
EXPRESSOR**

5¾" (14.5CM)  
65-9085 Double ended  
10 x 2mm hooks

**For a complete listing of our Ophthalmic product line, visit [www.sklarcorp.com](http://www.sklarcorp.com).**



**OPHTHALMIC  
RETRACTORS**

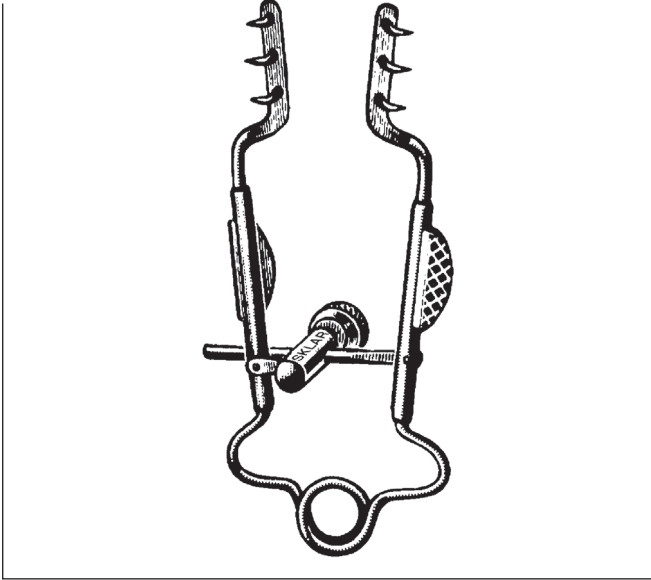

**MELLER RETRACTOR**  
65-1830 3" (7.6cm)

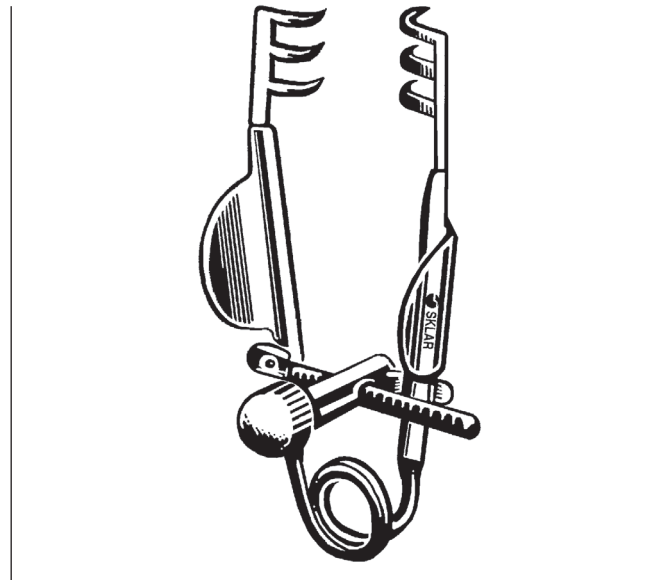

**MELLER RETRACTOR DELICATE**  
65-1815 1½"

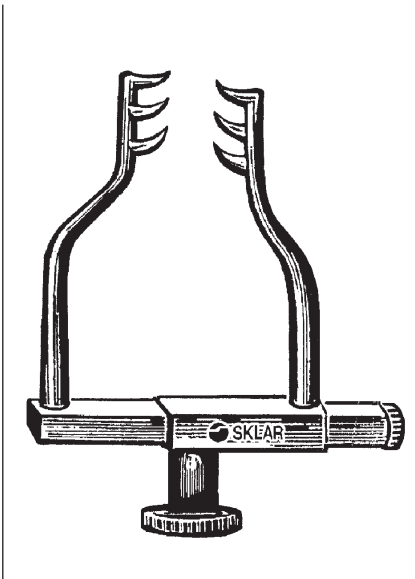

**GOLDSTEIN RETRACTOR**  
47-2913 1½"



**STEVENSON RETRACTOR**  
65-1831 3¼"

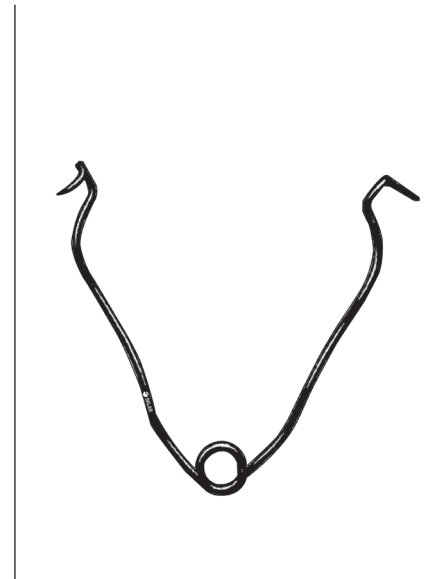

**FARR RETRACTORS**

**SHARP TIPS**

22-8835 1½" 22-8838 2½"

22-8836 2" 22-8839 3"

22-8837 2¼"

**FLAT TIPS**

22-8842 2¼"

For a complete listing of our Ophthalmic product line, visit [www.sklarcorp.com](http://www.sklarcorp.com).

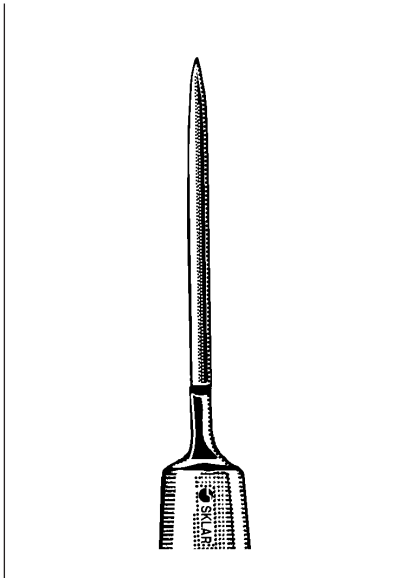

**GRAEFE CATARACT KNIFE**

65-3001 Small blade 1.7mm x 27mm

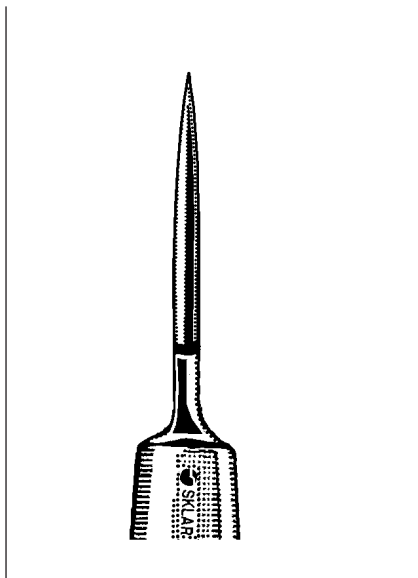

**WHEELER DISCISSION KNIFE**

65-3010 1mm

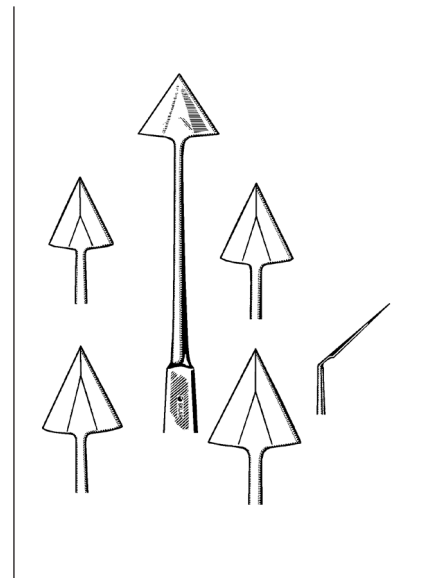

**GRIESHABER TYPE  
KERATOMES**

**ANGULAR BLADE WITH BEVELED BACK**

- |         |             |        |
|---------|-------------|--------|
| 65-3050 | Extra Small | Size 0 |
| 65-3051 | Small       | Size 1 |
| 65-3052 | Medium      | Size 2 |
| 65-3053 | Large       | Size 3 |

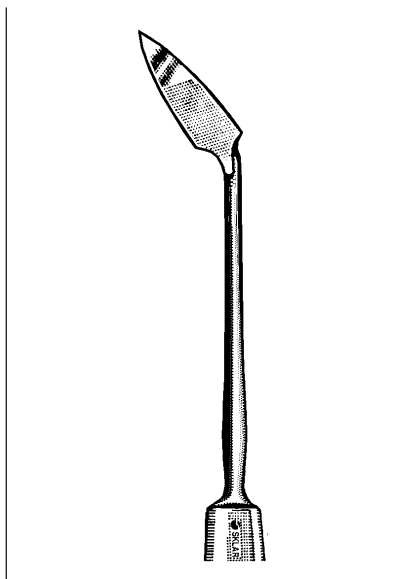

**CASTROVIEJO KERATOMES**

- 65-3030 Angled
- 65-3035 Straight

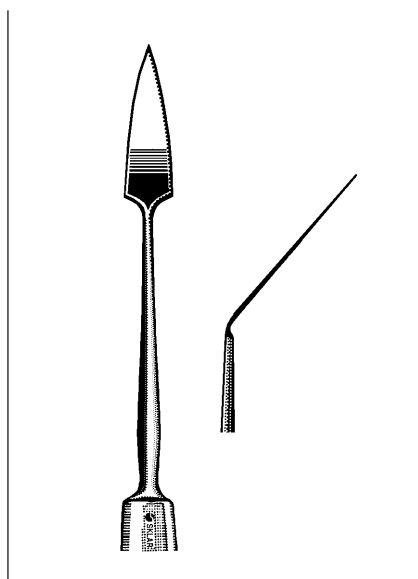

**BERENS KERATOME**

65-3060 19 x 3.25mm

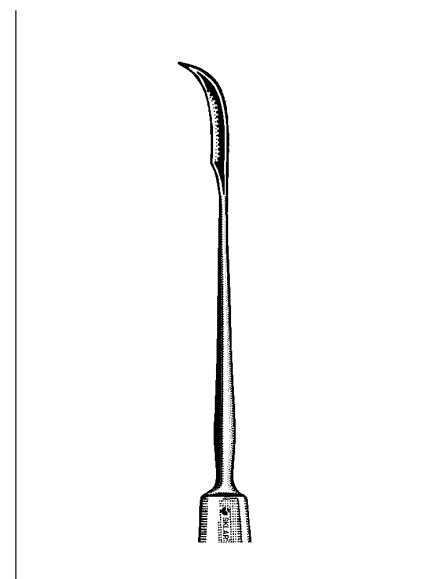

**VON GRAEFE KNIFE NEEDLE**

65-3062 Curved

For a complete listing of our Ophthalmic product line, visit [www.sklarcorp.com](http://www.sklarcorp.com).

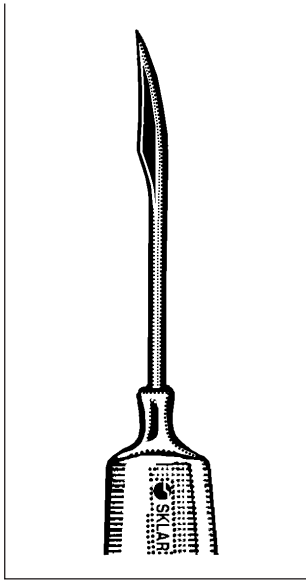

**ZIEGLER KNIFE-NEEDLE**  
ANGULAR BLADE, 4½"  
65-3094 Size 0 3mm blade

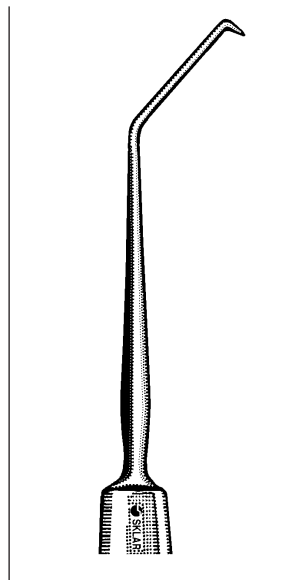

**VON GRAEFE  
CYSTOTOME**  
65-3017 Angled right, flexible

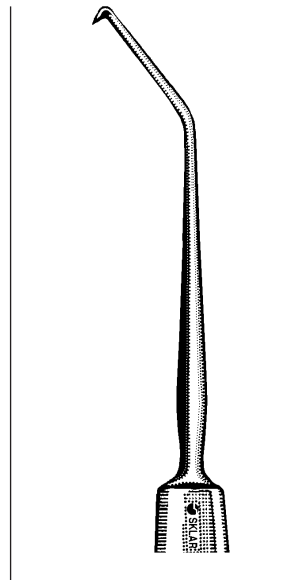

**VON GRAEFE  
CYSTOTOME**  
65-3018 Angled left, flexible

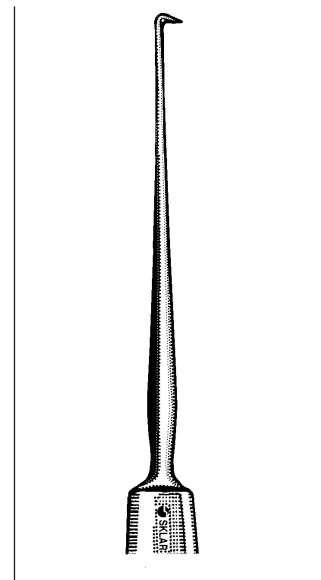

**VON GRAEFE  
CYSTOTOME**  
65-3016 Straight, flexible

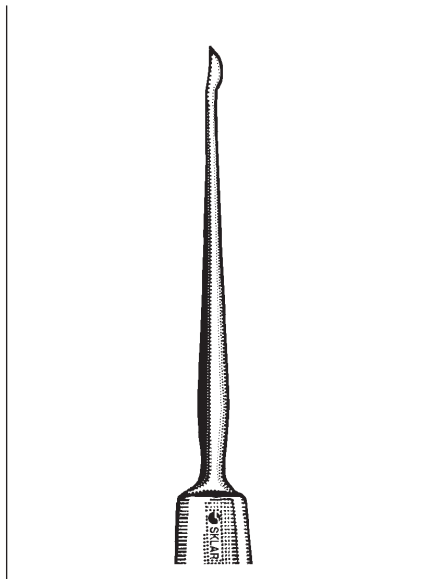

**BARKAN GONIOTOMY KNIFE**  
65-3022 4½"

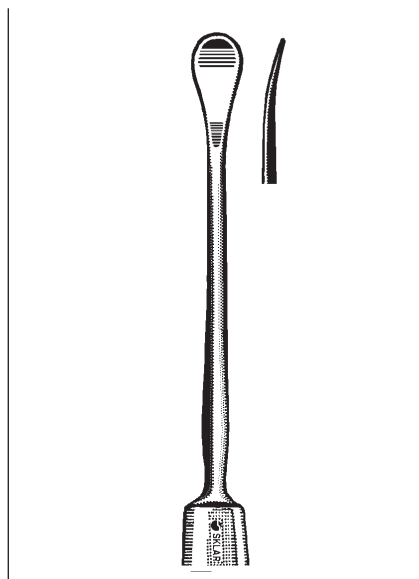

**GILL CORNEAL KNIFE**  
65-3025 4¾" Blade is slightly  
curved on flat

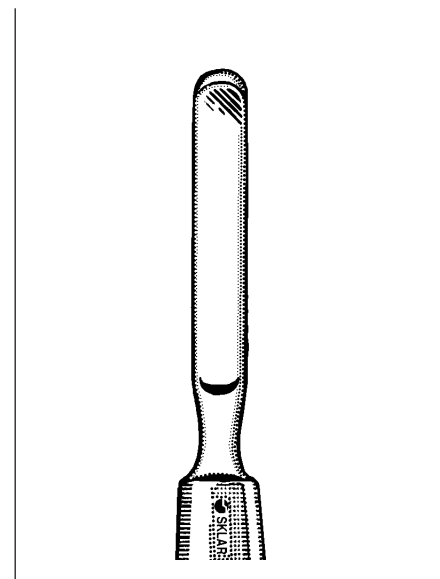

**TOOKE CORNEAL KNIFE**  
65-3028 4½"

For a complete listing of our Ophthalmic product line, visit [www.sklarcorp.com](http://www.sklarcorp.com).

**OPHTHALMIC  
FOREIGN BODY SPUDS**

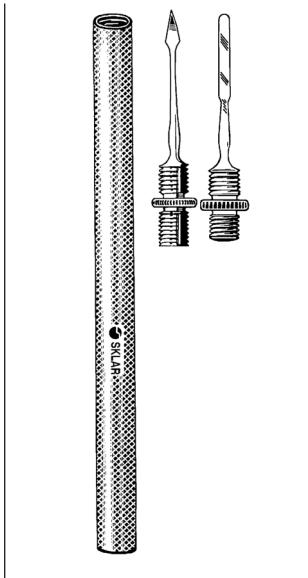

**DIX NEEDLE AND  
SPUD**

REVERSIBLE HANDLE

- 65-4030 Complete
- 65-4025 Needle, Blade Only
- 65-4026 Spud Only
- 65-4031 Single End Handle  
Only Chrome
- 65-4032 Double End Handle  
Only Chrome

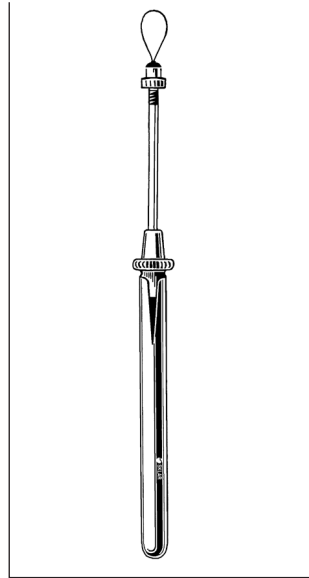

**BAILEY FOREIGN BODY  
REMOVER**

REVERSIBLE HANDLE

- 65-4080 Chrome Plated

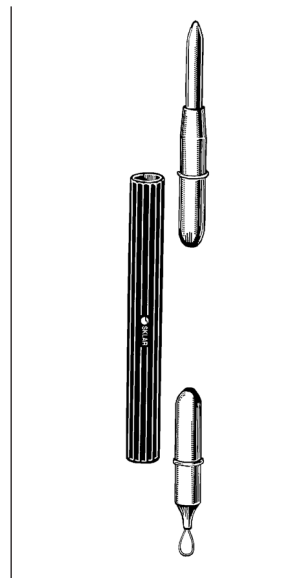

**JUNIOR MAGNETIC  
PROBE & FOREIGN  
BODY LOOP**

REVERSIBLE HANDLE

- 65-7422

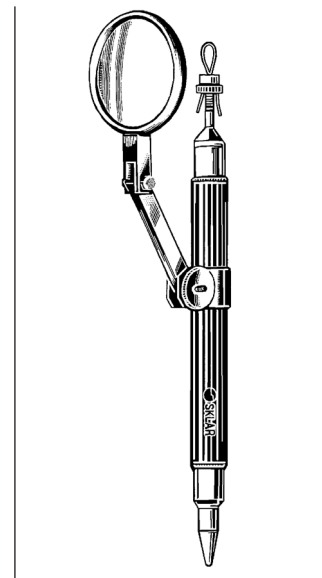

**JUNIOR MAGNETIC  
PROBE & FOREIGN  
BODY LOOP**

REVERSIBLE HANDLE

- 65-7425 With Magnifier  
Chrome  
Non-Autoclavable

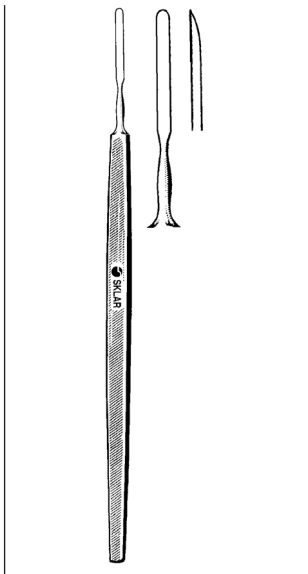

**DIX FOREIGN BODY  
SPUD**

- 65-7254 Blade beveled at tip

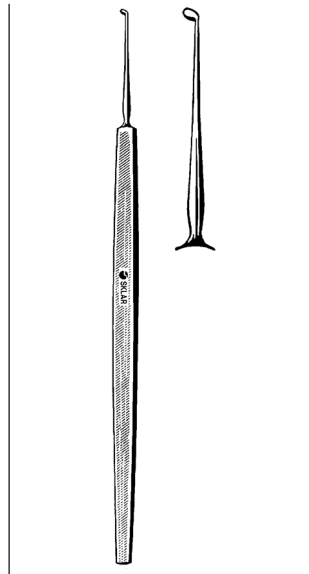

**LAFORCE FOREIGN  
BODY SPUD**

- 65-7255

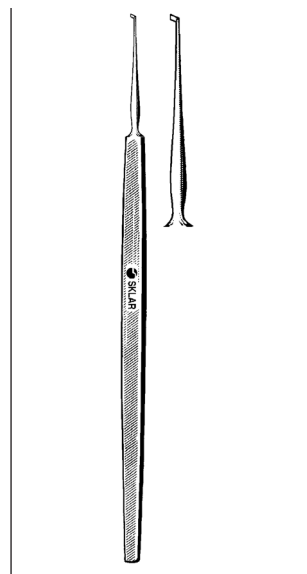

**FRANCIS FOREIGN  
BODY SPUD**

- 65-7257 Flag-shaped blade

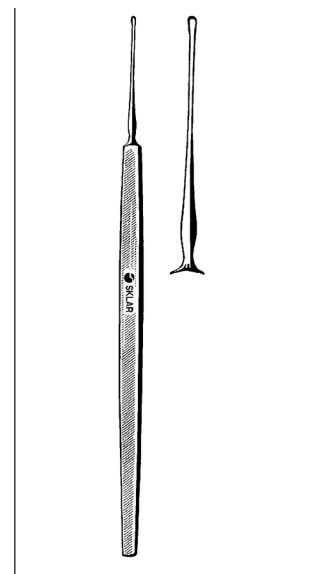

**DAVIS FOREIGN BODY  
SPUD**

- 65-7260 Chisel shape

**For a complete listing of our Ophthalmic product line, visit [www.sklarcorp.com](http://www.sklarcorp.com).**



**OPHTHALMIC  
FOREIGN BODY SPUDS / BLADE BREAKERS**

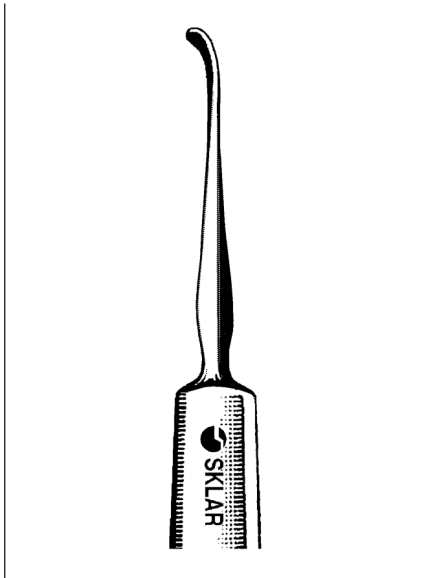

**ELLIS FOREIGN BODY SPUD  
CURVED**

65-7265 4½" 1.2mm Blade

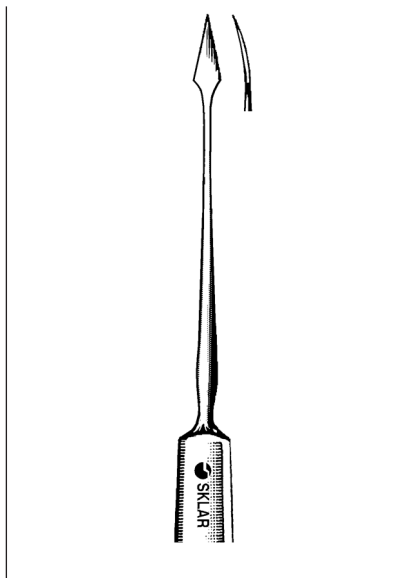

**FOREIGN BODY NEEDLES**

65-7270 Straight  
65-7272 Curved

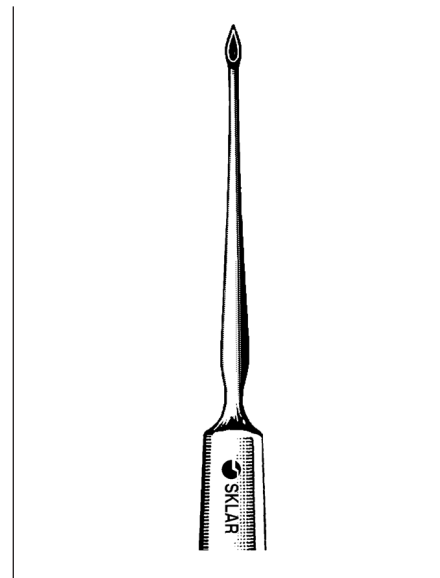

**ALVIS FOREIGN BODY SPUD  
WITH FINE POINT**

65-7275 4¾" 1mm x 3mm  
Oval curette

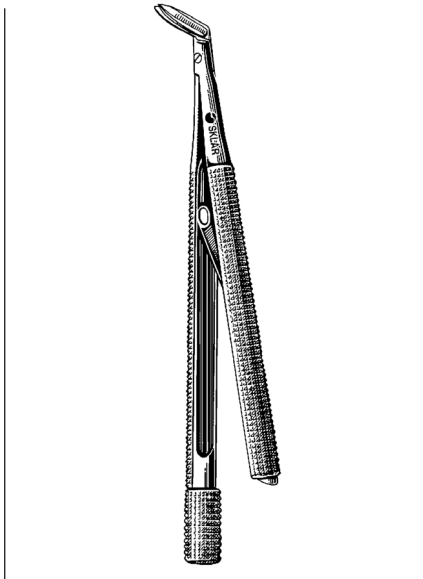

**TROUTMAN BLADE BREAKER**

65-2960 4" (10cm)  
65-2959 Breakable Razor Blades 10/pk



**CASTROVIEJO BLADE BREAKER**

65-2950 4" (10cm)

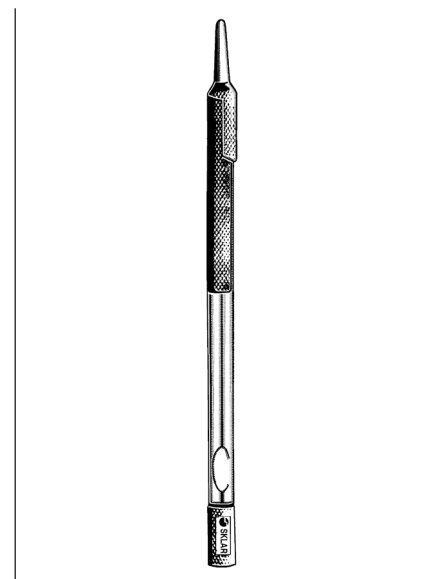

**SWISS MODEL BLADE  
BREAKER**

4¾" (12CM)  
65-2958 15 x 2.5mm jaws

For a complete listing of our Ophthalmic product line, visit [www.sklarcorp.com](http://www.sklarcorp.com).



OPHTHALMIC  
SPATULAS / SPOONS / HOOKS

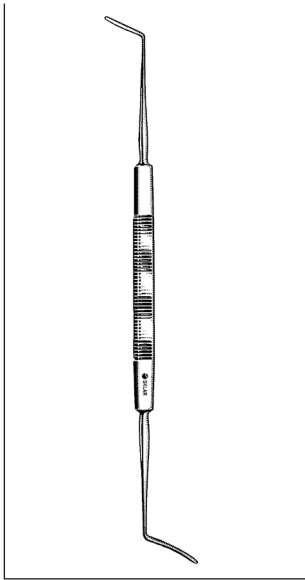

**CASTROVIEJO  
CYCLODIALYSIS  
SPATULAS**

10 AND 15MM LENGTHS  
DOUBLE ENDED

- 65-4062 0.5mm wide
- 65-4064 .75mm wide
- 65-4066 1mm wide

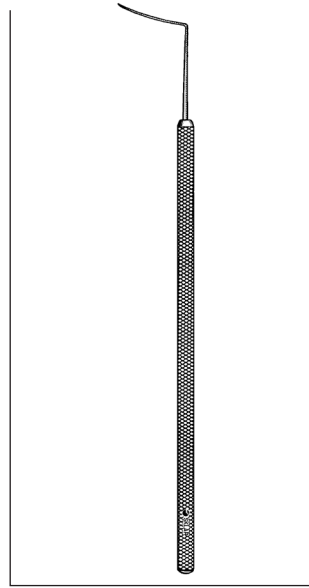

**BARRAQUER  
CYCLODIALYSIS  
SPATULA**

4¾" (12CM)

- 65-4068 .50mm diameter round  
15mm angled blade  
Smooth pointed tip

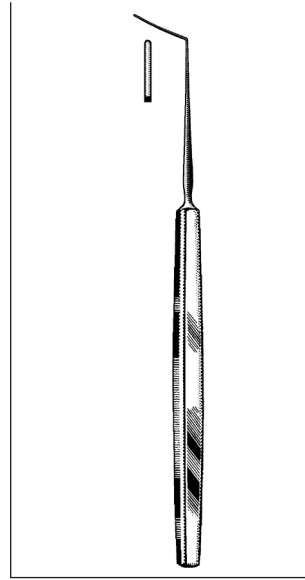

**ELSCHMIG  
CYCLODIALYSIS  
SPATULA**

65-4050 13cm 10mm x 1mm

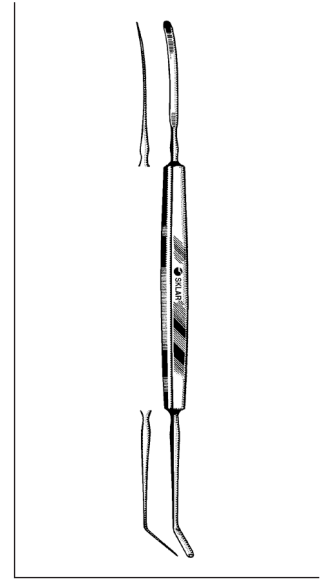

**CASTROVIEJO  
CYCLODIALYSIS  
SPATULAS**

- 65-4070 5¼" Blade 10 x 1mm
- 65-4072 5¼" Blade 15 x 1mm

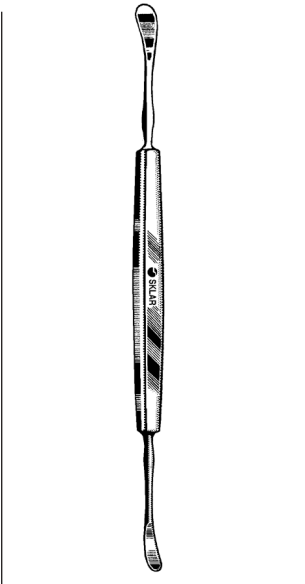

**GREEN SPATULA  
SLIGHTLY CURVED**

65-4074 6"

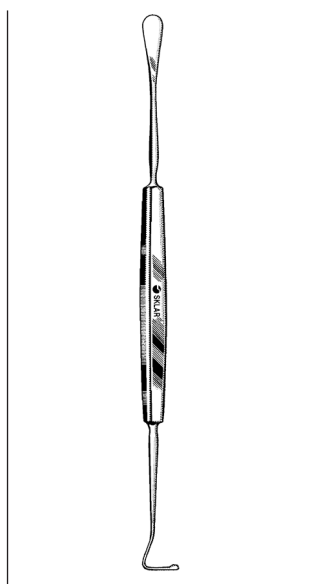

**MCREYNOLDS SPATULA  
AND HOOK**

DOUBLE ENDED  
65-4076 5¾"

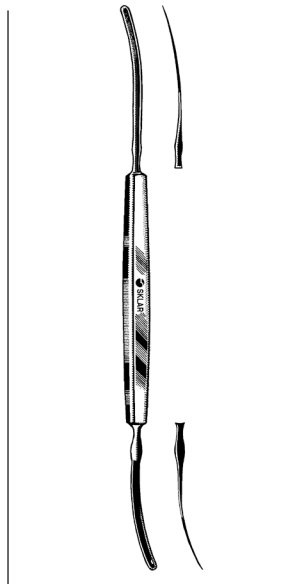

**SMITH-FISHER IRIS  
SPATULA**

ONE FLAT END, ONE SPOON END  
65-4078 5"

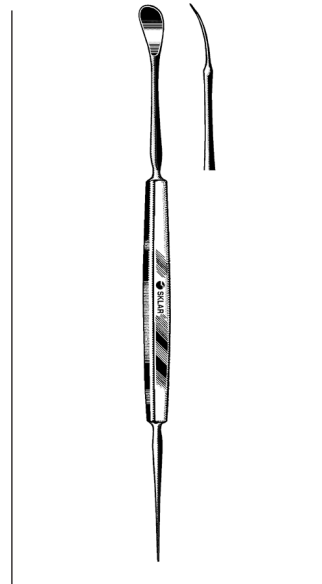

**FISHER SPOON AND  
NEEDLE**

65-4055 5½" Spoon end 7 x 1mm,  
Needle 33mm long

For a complete listing of our Ophthalmic product line, visit [www.sklarcorp.com](http://www.sklarcorp.com).

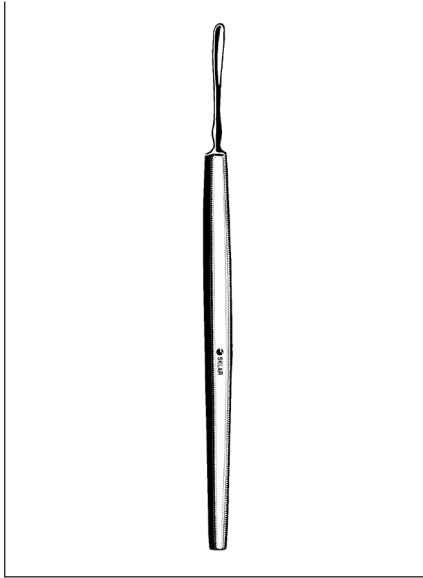

**DAVIEL CHALAZION CURETTE**  
5" (12.5CM)  
65-3140 3mm spoon

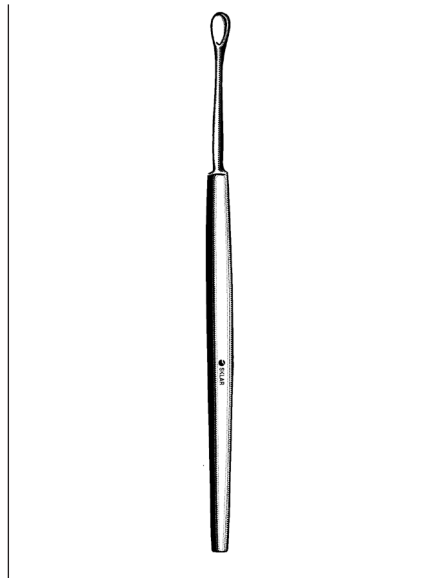

**KNAPP LENS SCOOP**  
5/4" (13.5CM)  
65-8195 5mm spoon

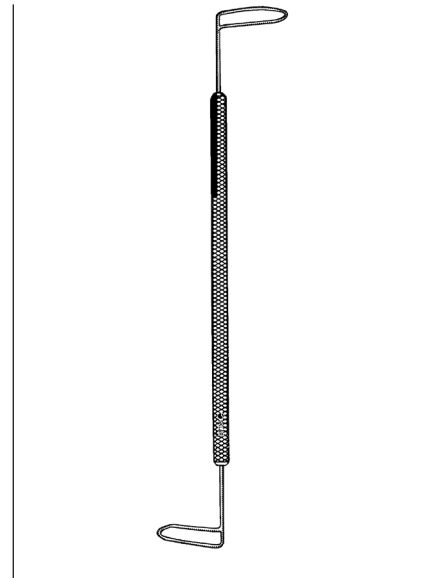

**SIMCOE NUCLEUS LOOP**  
5 2/5" (13.7CM)  
65-3295 Double ended, serrated loops,  
4mm x 20mm

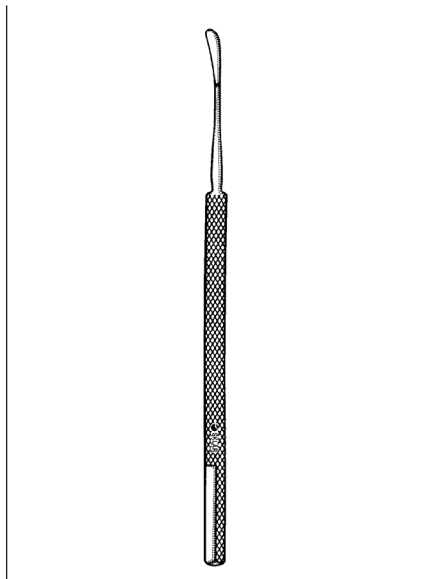

**WILDER LENS LOOP**  
5/4" (13.5CM)  
65-8215 Serrated  
65-8216 Smooth

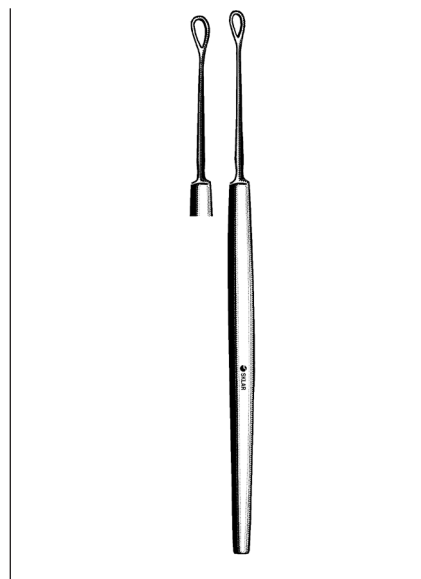

**LEWIS LENS LOOP**  
5/4" (13.5CM)  
65-8206 Smooth

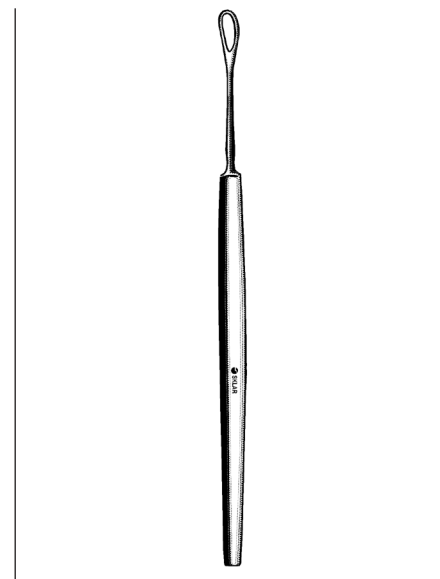

**NEW ORLEANS LENS LOOP**  
5/4" (13.5CM)  
65-8185 5mm loop

For a complete listing of our Ophthalmic product line, visit [www.sklarcorp.com](http://www.sklarcorp.com).

OPHTHALMIC  
HOOKS

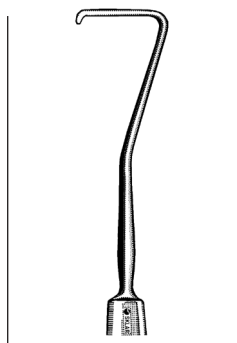

**GREEN STRABISMUS HOOK**  
65-3200

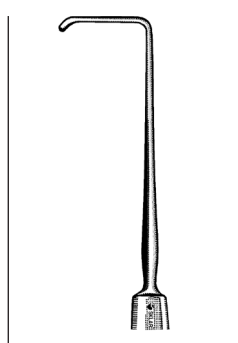

**O'CONNOR FLAT TENOTOMY HOOK**  
65-3192

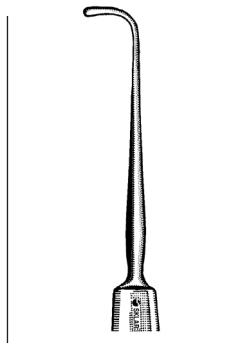

**CULLER RECTUS MUSCLE HOOK**  
65-3198

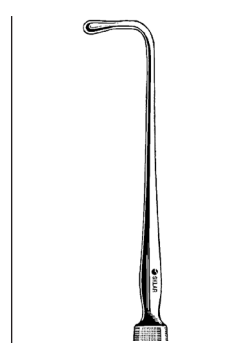

**GRAEFE STRABISMUS HOOKS**  
65-3215 Small  
65-3216 Medium  
65-3217 Large

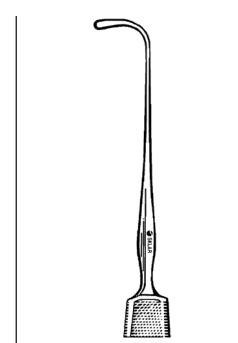

**STEVENS TENOTOMY HOOK**  
65-3191

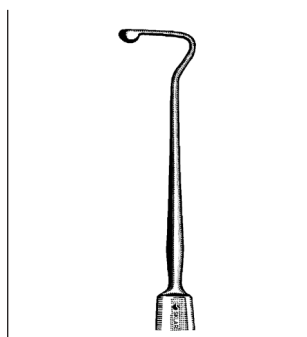

**JAMISON MUSCLE HOOK**  
65-3195 5" w/10mm hook

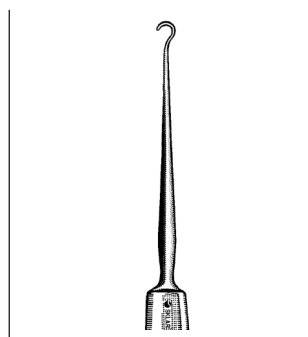

**TYRELL IRIS HOOKS**  
65-3205 Blunt  
65-3206 Sharp

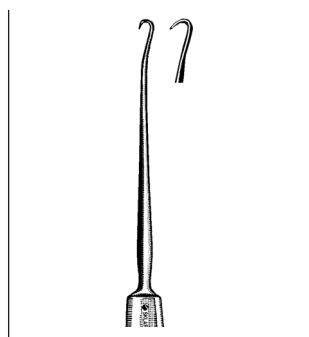

**BERENS SCLERAL HOOKS**  
65-3230 5" One sharp prong  
65-3232 5" Two sharp prongs

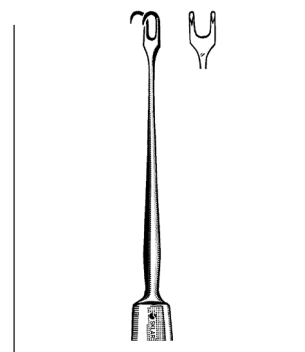

**GUTHRIE FIXATION HOOKS**  
47-2650 5" Two large prongs  
47-2651 5" Two small prongs

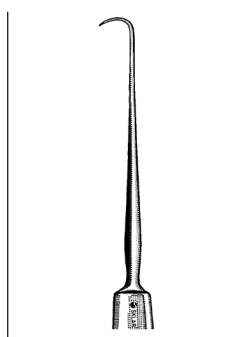

**WIENER CORNEAL HOOKS**  
65-3250 5" Sharp  
65-3248 5" Blunt

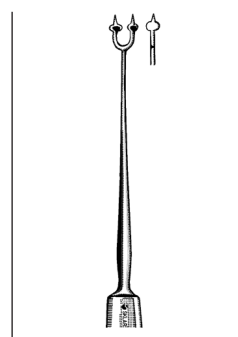

**BURCH FIXATION PICK**  
65-3255 5/4" Stainless  
Two prongs with stops to limit depth of penetration

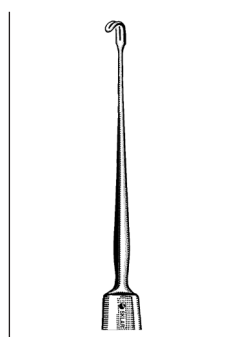

**MCGANNON IRIS RETRACTOR**  
65-3258 5/4"

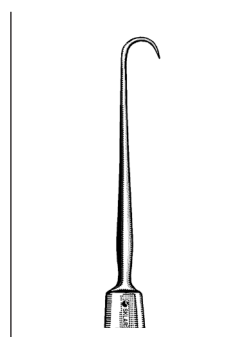

**O'CONNOR HOOK**  
65-3265 5" Sharp

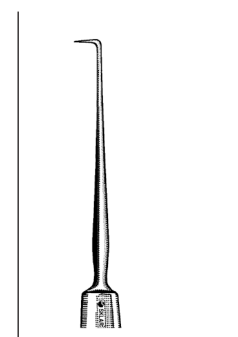

**NUGENT IRIS HOOK**  
65-3270 5" Right Angled Sharp

For a complete listing of our Ophthalmic product line, visit [www.sklarcorp.com](http://www.sklarcorp.com).



**OPHTHALMIC  
CURETTES / MANIPULATORS**

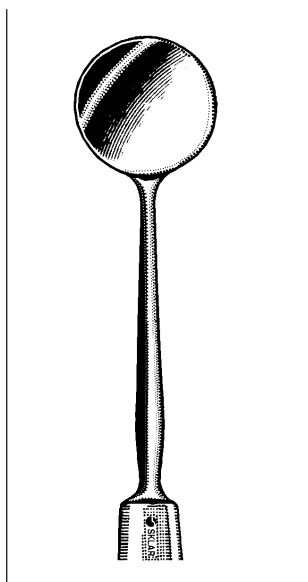

**BUNGE EVISCERATION  
SPOONS**

65-8151 Small  
65-8155 Large

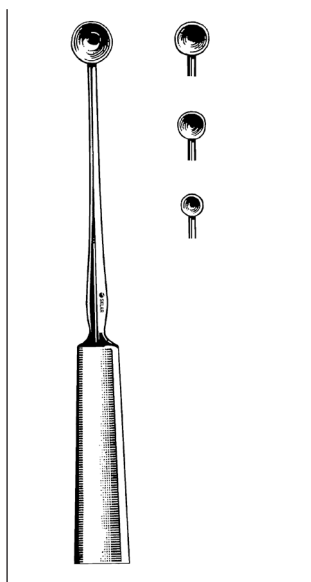

**MEYHOEFER  
CHALAZION CURETTES**

65-3169	#00	1.0mm
65-3170	#0	1.5mm
65-3171	#1	1.8mm
65-3172	#2	2.2mm
65-3173	#3	2.5mm
65-3174	#4	3.0mm

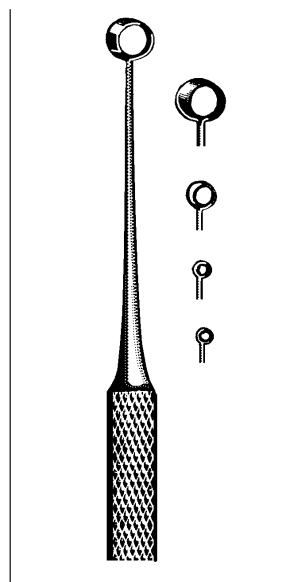

**HEATH CHALAZION  
CURETTES**

**ONE SHARP EDGE AND  
ONE DULL EDGE**

65-3180	#0	.5mm
65-3181	#1	1mm
65-3182	#2	2mm
65-3183	#3	3mm

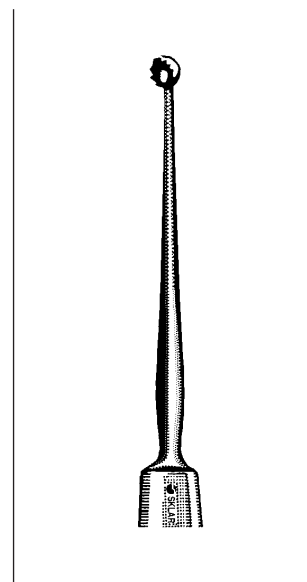

**SKEELE CHALAZION  
CURETTE**

65-3162 Serrated, 2mm  
Blade only, Stainless steel

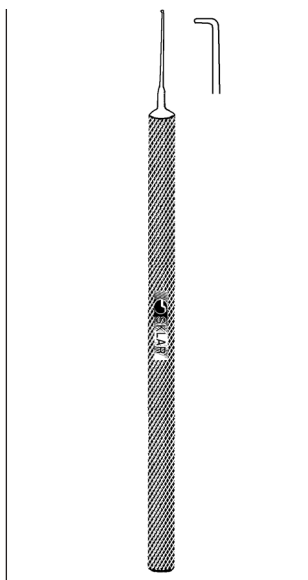

**AZAR LENS  
MANIPULATING HOOK**

66-7700 0.2mm hook  
Malleable shaft  
4 $\frac{2}{3}$ " (11.8 cm)

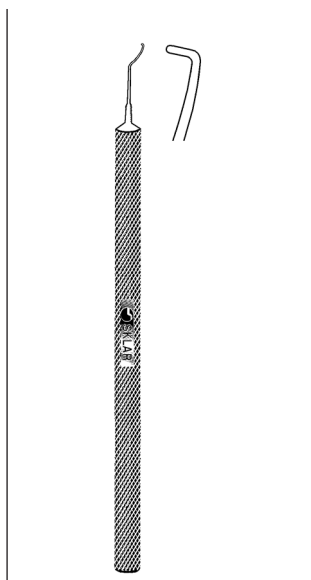

**LEWICKI HOOK**

66-7702 Curved 9mm  
90° angled tip  
4 $\frac{2}{3}$ " (11.8 cm)

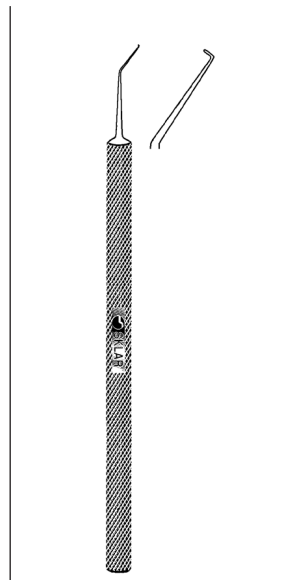

**CLAYMAN GUIDE**

66-7704 9mm with  
0.2mm hook  
Angled 45°  
4 $\frac{2}{3}$ " (11.8 cm)

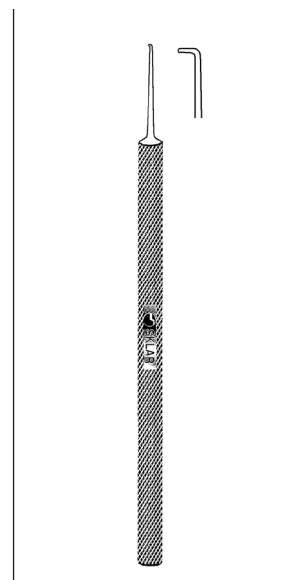

**SINSKEY MICRO IRIS  
HOOKS**

**BLUNT**  
66-7710 0.25mm dia.  
Straight  
66-7712 0.25mm dia.  
Angled 45°

For a complete listing of our Ophthalmic product line, visit [www.sklarcorp.com](http://www.sklarcorp.com).

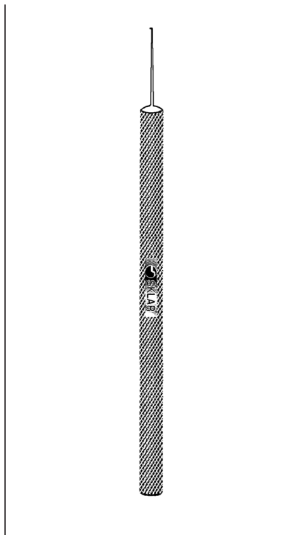

**JAFFE LENS  
MANIPULATING HOOK**  
BLUNT TIP  
66-7715 0.25mm diameter

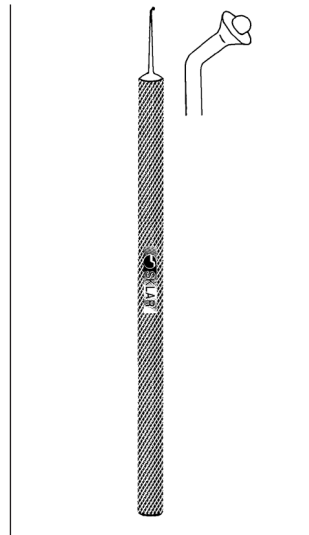

**TENNANT ANCHOR  
LENS INSERTION  
HOOK**  
4 1/3"  
66-7718 Angled .3mm tip

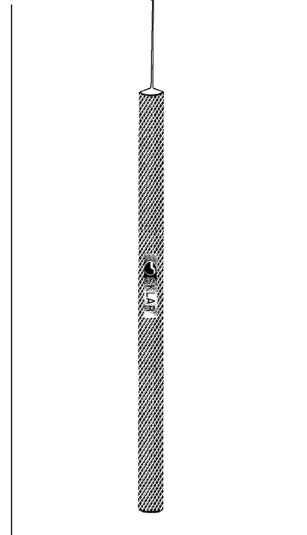

**SINSKEY II & III LENS  
MANIPULATING HOOKS**  
66-7720 0.2mm dia. Blunt  
tip Straight  
66-7721 0.2mm dia. Blunt  
tip Angled 45°  
66-7722 0.2mm dia. Blunt  
tip Curved  
shank, for no  
hole IOL's  
66-7723 0.2mm dia. Blunt  
tip Curved shank,  
angled for no hole IOL's

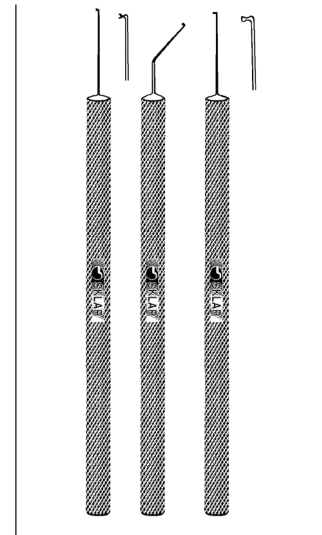

**KUGLEN IRIS HOOKS  
& LENS MANIPULATOR  
PUSH PULLS**  
66-7725 Straight  
66-7726 Angled  
66-7727 Cloverleaf

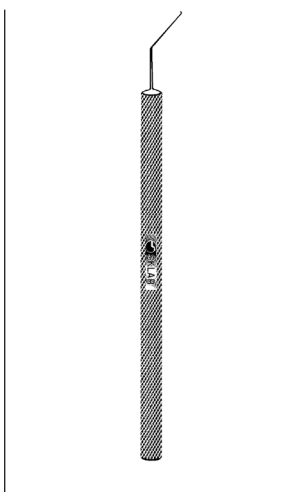

**HARRIS-SINSKEY  
LENS MANIPULATING  
HOOK**  
BLUNT, ANGLED  
66-7735

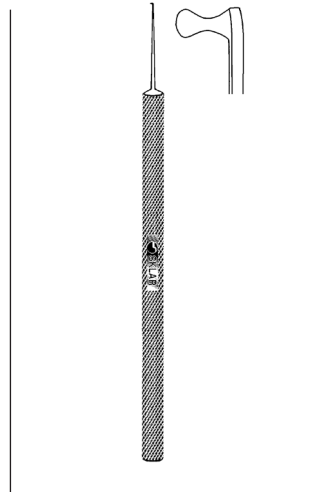

**LESTER LENS  
MANIPULATORS**  
4 1/2"  
66-7740 Straight  
66-7742 Angled 45°

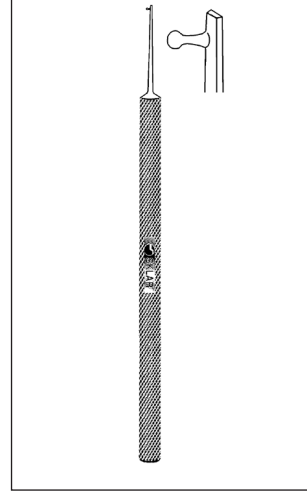

**LESTER II LENS  
MANIPULATORS**  
4 1/2"  
66-7750 Straight  
66-7752 Angled 45°

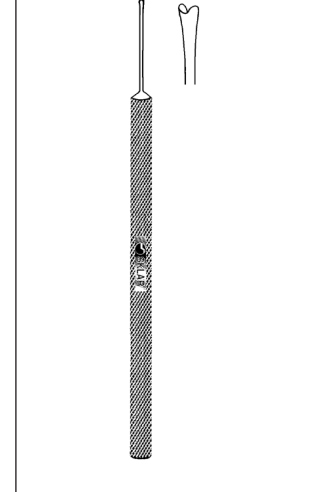

**AKER LENS PUSHERS**  
SMOOTH FISH-MOUTH SHAPED JAWS  
66-7760 Straight  
66-7762 Angled

For a complete listing of our Ophthalmic product line, visit [www.sklarcorp.com](http://www.sklarcorp.com).



**OPHTHALMIC  
MANIPULATORS**

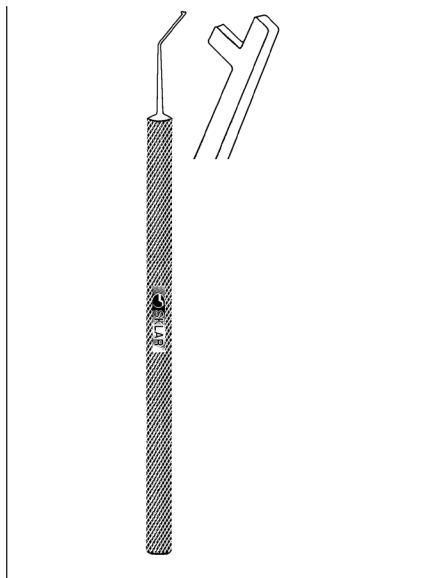

**FENZL INSERTION HOOK**  
4¾"  
66-7770 Angled 45° 10mm to tip  
0.2mm hook

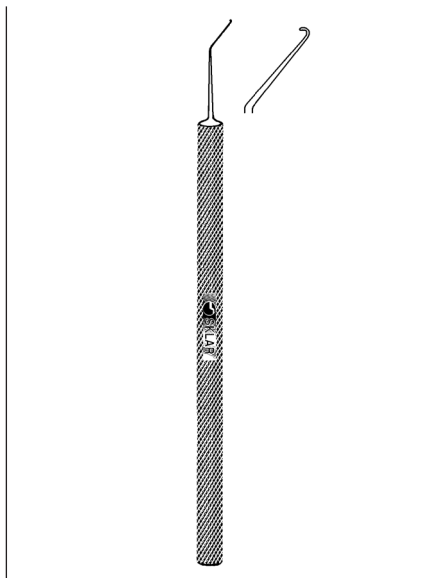

**CLAYMAN IRIS HOOK**  
4½"  
66-7772 Angled 45° 9mm to tip

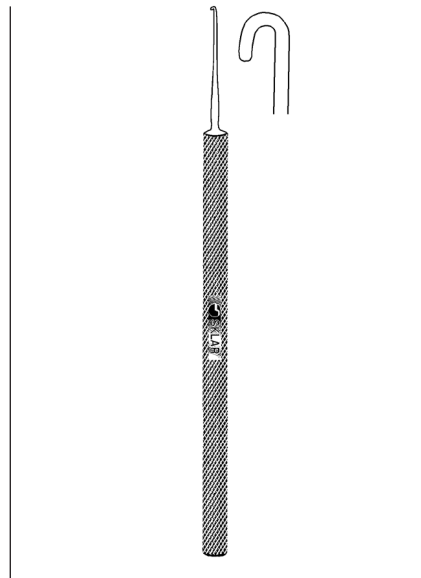

**IRIS HOOK**  
5"  
66-7775 Blunt

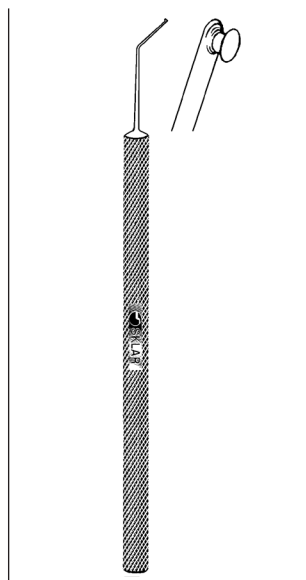

**GRAETHER COLLAR  
BUTTON**  
66-7780 On handle, angled  
45°, 10mm  
from bend to tip

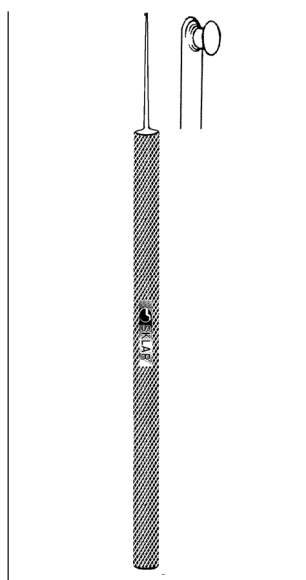

**GRAETHER COLLAR  
BUTTON**  
66-7782 On handle, straight

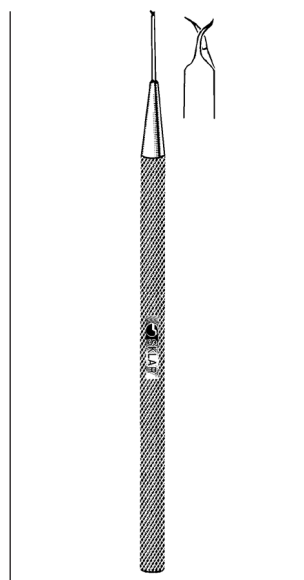

**SCLERAL TWIST  
FIXATION HOOKS**  
4¼" (11 CM)  
66-7790 Small 0.3mm Right  
66-7791 Small 0.3mm Left  
66-7792 Large 0.5mm Right  
66-7793 Large 0.5mm Left

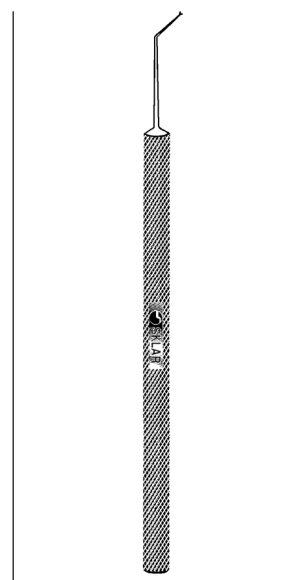

**BECHERT NUCLEUS  
ROTATOR**  
4¾" (12.4 CM)  
66-7795 Rotator on  
front of shaft

For a complete listing of our Ophthalmic product line, visit [www.sklarcorp.com](http://www.sklarcorp.com).

OPHTHALMIC  
DILATORS

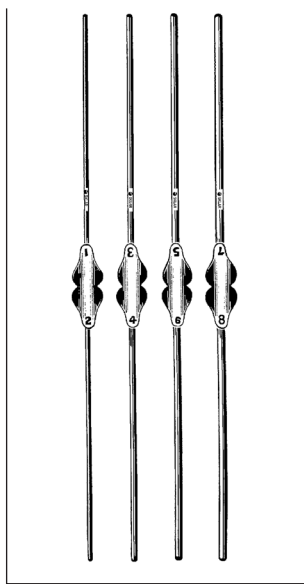

**BOWMAN LACHRYMAL  
DILATORS**

**DOUBLE END**

- 65-4098 #0000/000
- 65-4099 #00/0
- 65-4101 #1-2
- 65-4103 #3-4
- 65-4105 #5-6
- 65-4107 #7-8
- 65-4100 Set of 4 #1 thru #8

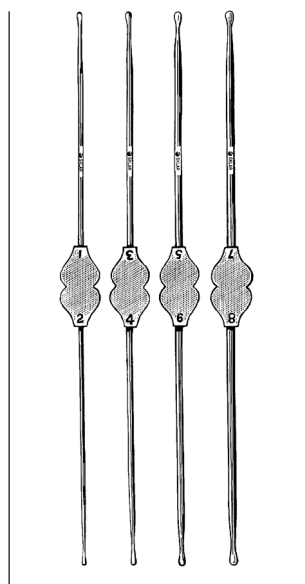

**WILLIAMS LACHRYMAL  
DILATORS**

**DOUBLE END STERLING SILVER**

- 65-4129 #0000-000
- 65-4128 #00-0
- 65-4121 #1-2
- 65-4123 #3-4
- 65-4125 #5-6
- 65-4127 #7-8
- 65-4120 Set of 4 #1 thru #8

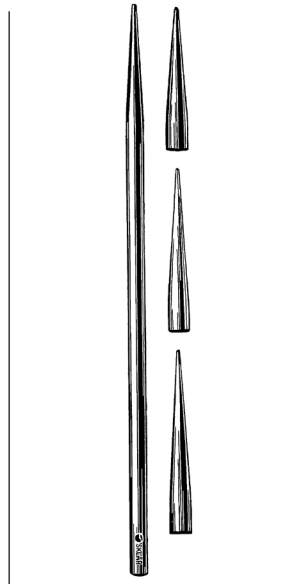

**WILDER LACHRYMAL  
DILATORS**

- 65-7001 Short Taper
- 65-7002 Medium Taper
- 65-7003 Long Taper

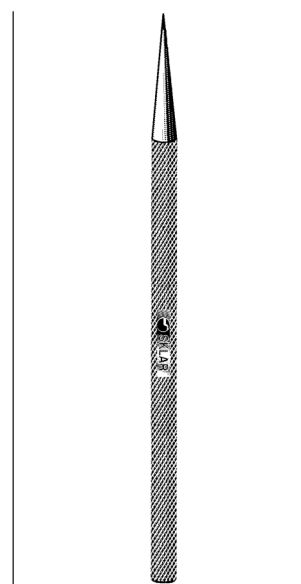

**INFANT LACHRYMAL  
DILATOR**

- EXTRA DELICATE 4 1/4"**
- 65-7000 0.5mm at tip

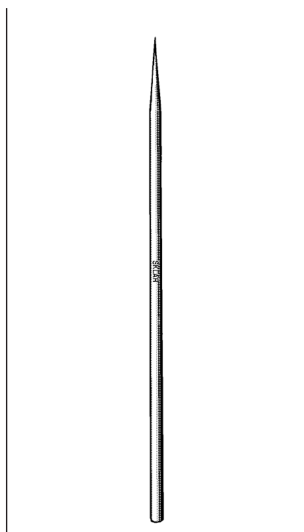

**RUEDEMANN  
LACHRYMAL  
DILATOR**

- 2 3/4"
- 65-6950 Short delicate  
needle tips

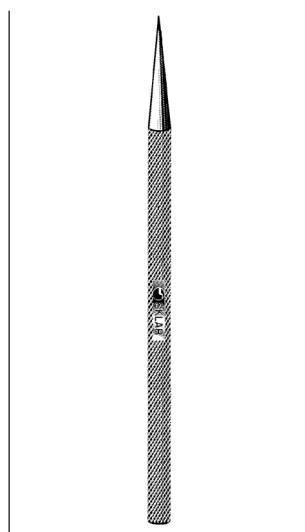

**MULDOON LACHRYMAL  
DILATOR**

- WITH STRAIGHT DISTAL END TO  
GUIDE DILATOR 4"**
- 65-6952

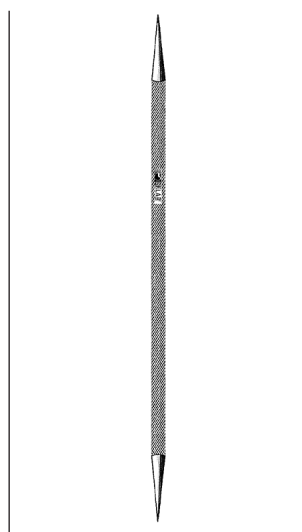

**CASTROVEIJO  
LACHRYMAL  
DILATOR**

- DOUBLE END TAPERS**
- 22MM X 18MM**
- 65-6960 5 1/2"

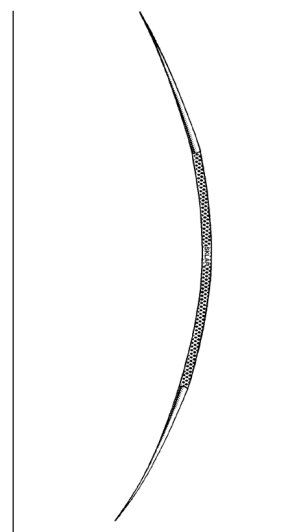

**ZIEGLER LACHRYMAL  
DILATOR**

- 14MM**
- 65-6965 Double ended  
Curved

For a complete listing of our Ophthalmic product line, visit [www.sklarcorp.com](http://www.sklarcorp.com).



**OPHTHALMIC  
TREPHINES**

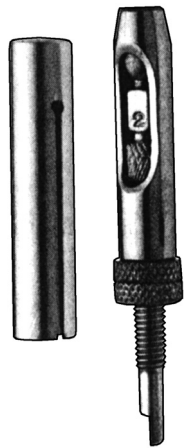

**CASTROVIEJO CORNEAL TREPHINES**

ADJUSTABLE WITH GUARD

66-7862	5.0mm diameter	66-7867	7.5mm diameter
66-7863	5.5mm diameter	66-7868	8.0mm diameter
66-7864	6.0mm diameter	66-7869	9.0mm diameter
66-7865	6.5mm diameter	66-7870	10.0mm diameter
66-7866	7.0mm diameter		

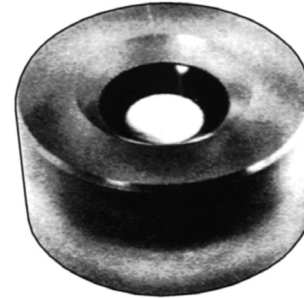

**CORNEAL CUTTING BLOCK**

66-7874

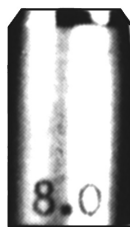

BLADE

PACKED STERILE

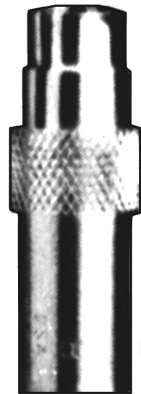

HANDLE

**CORNEAL TREPHINE BLADES AND HANDLES**

BLADES	DIAMETER	HANDLES	BLADES	DIAMETER	HANDLES
66-7875	6.0mm	66-7900	66-7885	8.5mm	66-7910
66-7876	6.2mm	66-7901	66-7886	8.7mm	66-7911
66-7877	6.5mm	66-7902	66-7887	9.0mm	66-7912
66-7878	6.7mm	66-7903	66-7888	9.2mm	66-7913
66-7879	7.0mm	66-7904	66-7889	9.5mm	66-7914
66-7880	7.2mm	66-7905	66-7890	9.7mm	66-7915
66-7881	7.5mm	66-7906	66-7891	10.0mm	66-7916
66-7882	7.7mm	66-7907	66-7892	10.5mm	66-7917
66-7883	8.0mm	66-7908	66-7893	11.0mm	66-7918
66-7884	8.2mm	66-7909			

**SHORT BLADE**



PACKED STERILE

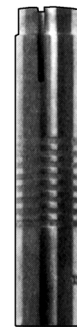

HANDLE

**CORNEAL TREPHINE BLADES AND HANDLES (SHORT)**

BLADES	DIAMETER	HANDLES	BLADES	DIAMETER	HANDLES
66-7925	6.0mm	66-7950	66-7935	8.5mm	66-7960
66-7926	6.2mm	66-7951	66-7936	8.7mm	66-7961
66-7927	6.5mm	66-7952	66-7937	9.0mm	66-7962
66-7928	6.7mm	66-7953	66-7938	9.2mm	66-7963
66-7929	7.0mm	66-7954	66-7939	9.5mm	66-7964
66-7930	7.2mm	66-7955	66-7940	9.7mm	66-7965
66-7931	7.5mm	66-7956	66-7941	10.0mm	66-7966
66-7932	7.7mm	66-7957	66-7943	11.0mm	66-7968
66-7933	8.0mm	66-7958			
66-7934	8.2mm	66-7959			

For a complete listing of our Ophthalmic product line, visit [www.sklarcorp.com](http://www.sklarcorp.com).



**OPHTHALMIC  
CORNEAL SCISSORS**

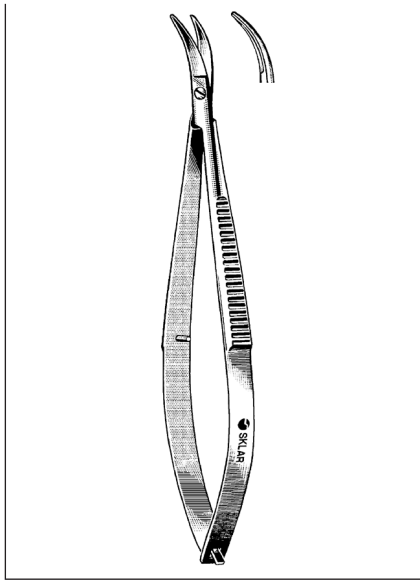

**CASTROVIEJO CORNEAL  
SCISSOR**

64-2442 4" Curved blunt blades  
Spring Handles

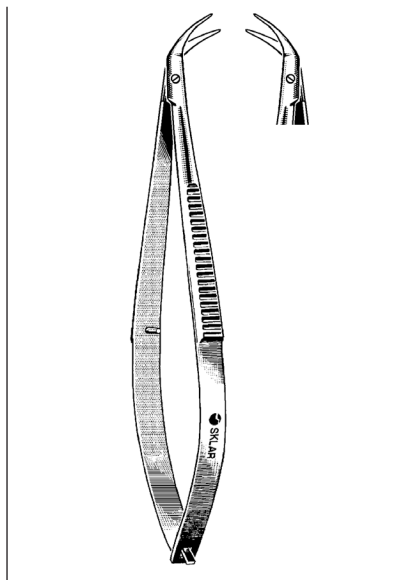

**CASTROVIEJO CORNEAL  
SCISSORS**

**MINIATURE WITH INNER BLADE 0.5MM LONGER  
THAN OUTER BLADE**

64-2242 4¼" Curved right  
64-2342 4¼" Curved left

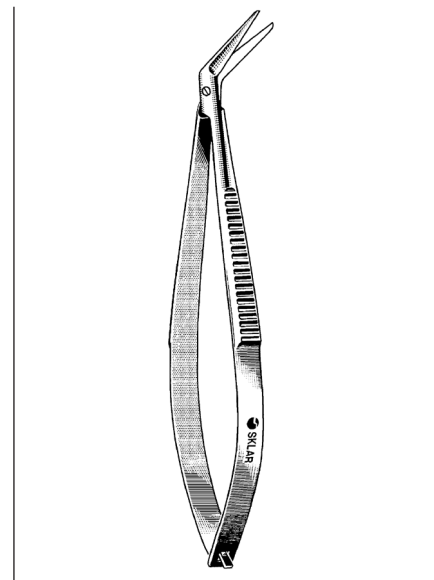

**CASTROVIEJO CORNEAL  
SCISSOR**

64-2535 4" 13mm blunt angled blades

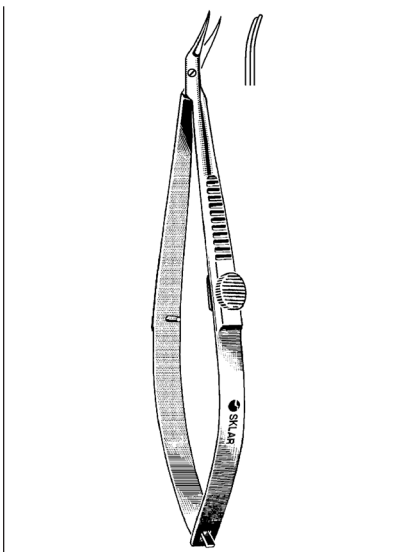

**CASTROVIEJO CORNEAL  
SCISSOR**

**INNER BLADE LONGER THAN OUTER BLADE**

64-3294 4" Right

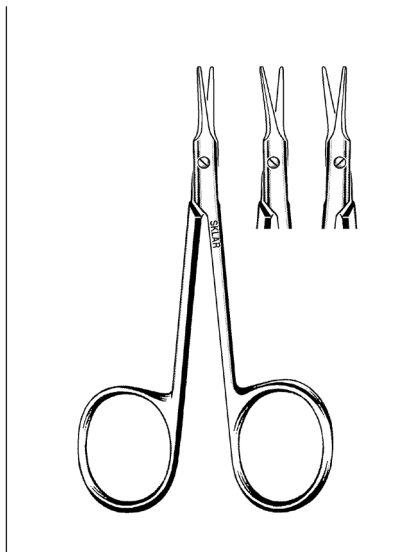

**AEBLI CORNEAL SCISSOR**

64-3270 4" Straight

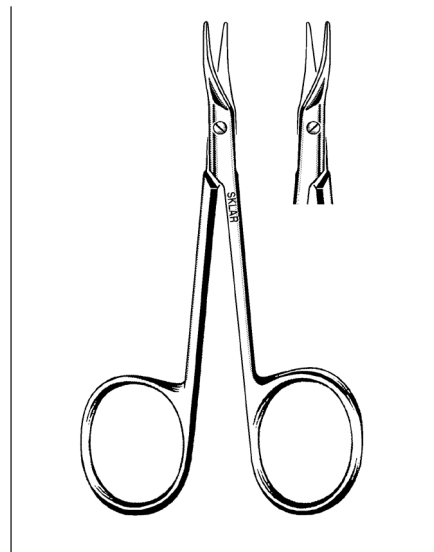

**MCGUIRE CORNEAL  
SCISSORS**

64-3297 4¼" 16mm delicate  
sharp blades Right

64-3298 4¼" 16mm delicate  
sharp blades Left

**For a complete listing of our Ophthalmic product line, visit [www.sklarcorp.com](http://www.sklarcorp.com).**



**OPHTHALMIC  
TENOTOMY SCISSORS**

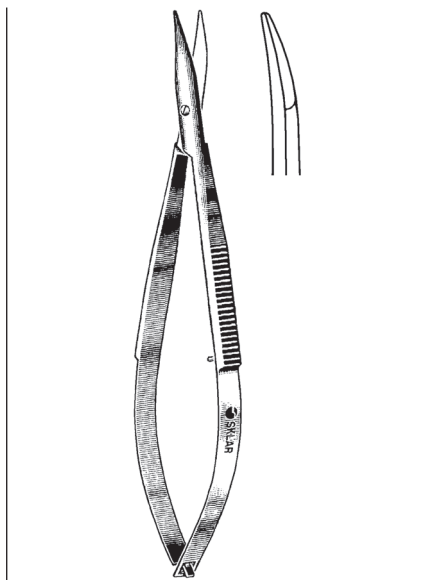

**WESTCOTT TENOTOMY  
SCISSOR**

64-3146 4 1/4" Blunt tips with  
spring handle



**WESTCOTT TENOTOMY  
SCISSORS**

**CURVED, SPRING HANDLE**  
64-3142 5" Right  
64-3144 5" Left

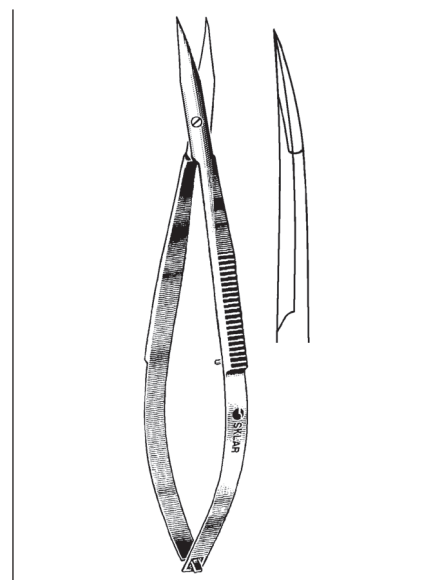

**WESTCOTT SCISSOR**

64-3145 4 1/4" Sharp tips with  
spring handle

**SKLAR SOAK™**

**SURGICAL INSTRUMENT SOAK**

Immersing soiled instruments in SKLAR SOAK™ for two minutes substantially reduces the risk of exposure to many infectious organisms.

- Effective Against: H1N1, HIV-1, HSV, VRE, Rotaviruses, Hep B & C as well as TB, MRSA, A. Baumannii.
- Non-Glutaraldehyde.
- PH Neutral Formula designed for safe use on all surgical instruments & stainless steelware.
- Non-Caustic Formula allows for use as a manual cleaner or in ultrasonic units.
- EPA Registered.
- Meets all OSHA standards on blood borne pathogen destruction.
- Ready to use.

PRODUCT NUMBER	FEATURES	QUANTITIES
10-1603	1 Gallon Bottles	4/case
10-1609	1 Gallon Bottle	1 bottle



For a complete listing of our Ophthalmic product line, visit [www.sklarcorp.com](http://www.sklarcorp.com).

**OPHTHALMIC  
TENOTOMY SCISSORS**



**STEVENS TENOTOMY SCISSORS**

STRAIGHT			CURVED		
64-1242	4½"	B/B	64-1342	4½"	B/B
64-1243	4½"	S/S	64-1343	4½"	S/S



**SKLARLITE™ STEVENS TENOTOMY SCISSORS**

STRAIGHT			CURVED		
23-1156	4½"	B/B	23-1157	4½"	B/B



**STEVENS TENOTOMY SCISSORS DELICATE**

STRAIGHT			CURVED		
22-1242	4½"	B/B	22-1342	4½"	B/B
22-1240	4½"	S/S	22-1241	4½"	S/S



**SKLARLITE XD™ STEVENS TENOTOMY SCISSORS**

STRAIGHT			CURVED		
23-1160	4½"	B/B	23-1161	4½"	B/B

For a complete listing of our Ophthalmic product line, visit [www.sklarcorp.com](http://www.sklarcorp.com).



**OPHTHALMIC  
IRIS SCISSORS**

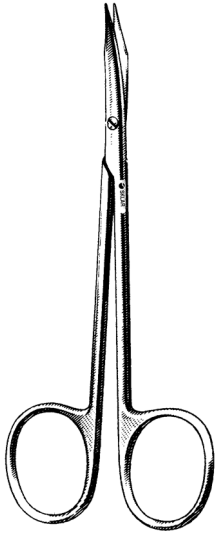

**KLEINERT-KUTZ TENOTOMY  
SCISSOR**

64-1250 5" Curved

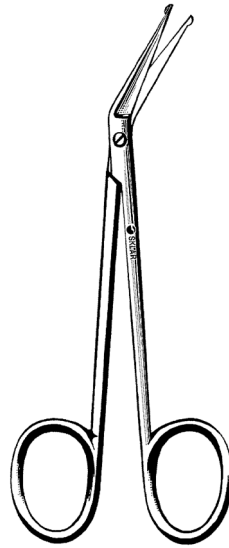

**IRIS SCISSOR PROBE POINT**

64-2042 4¼" Angled

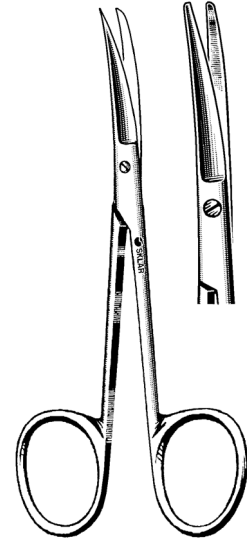

**KNAPP IRIS SCISSORS**

**CURVED**

64-3230 4" Sharp/Blunt  
64-3235 4" Blunt/Blunt

**STRAIGHT**

64-3430 4" Sharp/Blunt  
64-3435 4" Blunt/Blunt

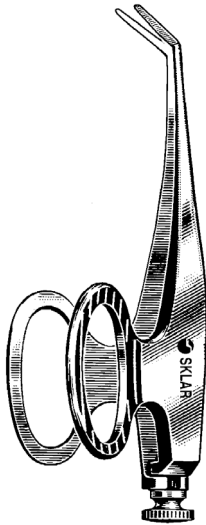

**BARRAQUER-DEWECKER IRIS SCISSORS**

64-3225 2¼" Fine 7mm blades  
64-3228 2¼" Delicate 10mm blades

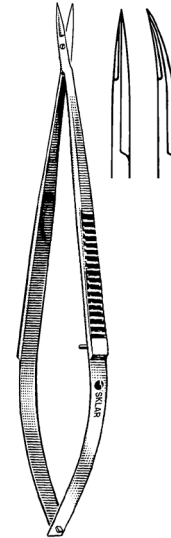

**IRIS MICRO-MINIATURE SCISSORS**

**EXTRA DELICATE, SHARP POINTS**

64-3050 4" Straight  
64-3052 4" Curved

For a complete listing of our Ophthalmic product line, visit [www.sklarcorp.com](http://www.sklarcorp.com).

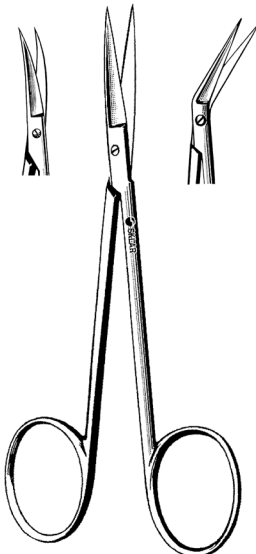

**IRIS SCISSORS**

**STRAIGHT**

47-1135	S/S	3½"
47-1140	B/B	3½"
47-1143	S/S	4"
47-1441	S/S	4", Heavy
47-1145	S/S	4½"
47-1144	B/B	4½"

**CURVED**

47-1235	S/S	3½"
47-1240	B/B	3½"
47-1243	S/S	4"
47-1442	S/S	4", Heavy
47-1245	S/S	4½"
47-1244	B/B	4½"

**ANGULAR**

64-2142	S/S	4½"
---------	-----	-----

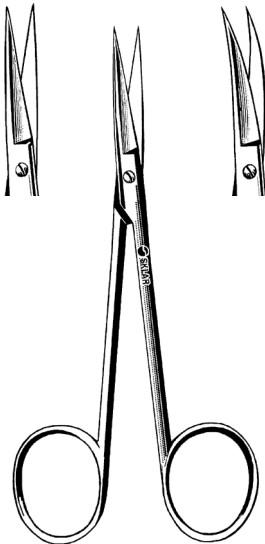

**SKLARLITE™  
IRIS SCISSORS**

**STRAIGHT**

23-1148	S/S	3½"
23-1149	S/S	4½"

**CURVED**

23-1150	S/S	3½"
23-1151	S/S	4½"

**SKLARLITE™  
THE LIGHT TOUCH**

**SKLARLITE™ AND  
SKLARLITE XD™ SCISSORS DELIVER  
THE ULTIMATE IN PRECISION**

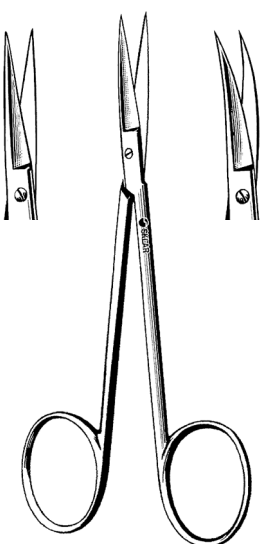

**IRIS SCISSORS  
DELICATE**

**STRAIGHT**

22-1135	S/S	3½"
47-1440	S/S	4"
47-1246	S/S	4½"

**CURVED**

22-1235	S/S	3½"
47-1248	S/S	4½"



**SKLARLITE XD™  
IRIS SCISSORS**

**STRAIGHT**

23-1152	S/S	3½"
23-1153	S/S	4½"

**CURVED**

23-1154	S/S	3½"
23-1155	S/S	4½"

**SKLARLITE XD™  
EXTRA DELICATE**

For a complete listing of our Ophthalmic product line, visit [www.sklarcorp.com](http://www.sklarcorp.com).



**OPHTHALMIC  
VANNAS / STITCH SCISSORS**

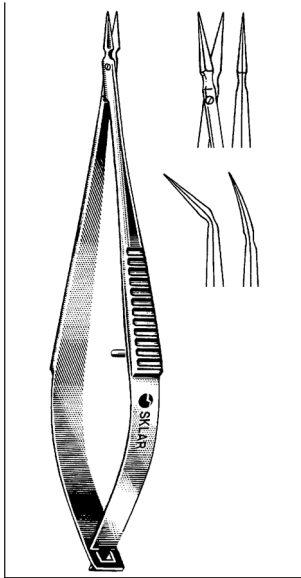

**VANNAS SPRING  
HANDLE SCISSORS**

**VERY DELICATE**

64-1950	3"	Straight
64-1951	3"	Curved
64-1952	3"	Angular

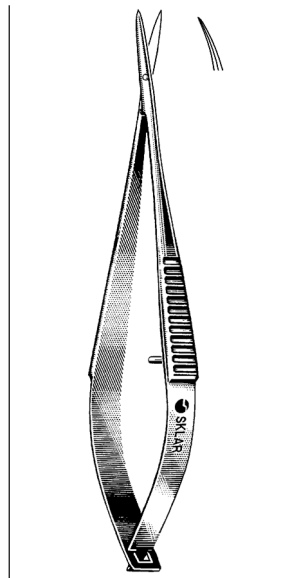

**MCPHERSON-VANNAS  
SCISSORS**

**VERY DELICATE**

64-1960	3"	Straight
64-1961	3"	Curved

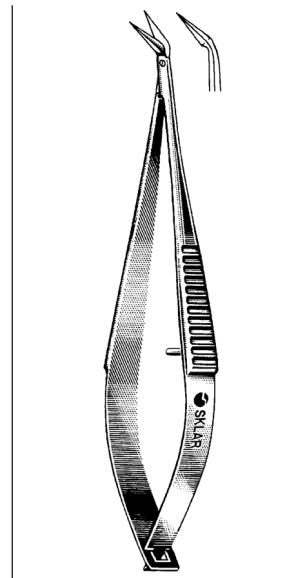

**VANNAS SCISSORS  
EXTREMELY DELICATE BLADES  
WITH SPRING HANDLE**

64-1955	3"	Angled on flat
64-1958	3"	Angled to side

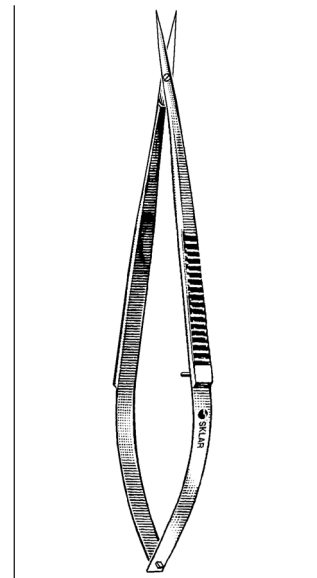

**FINE STITCH SCISSOR**

64-3260 4¼" Delicate  
Sharp blades

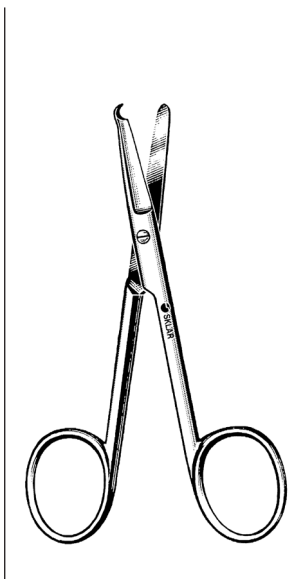

**SPENCER STITCH  
SCISSORS**

22-2835	3½"	
22-2845	4½"	
15-1355	5½"	Littauer

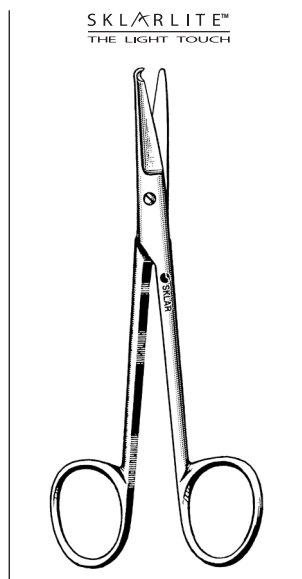

**SKLARLITE™ SPENCER  
STITCH SCISSORS**

23-1188	3½"	
23-1189	4½"	
23-1190	5½"	Littauer

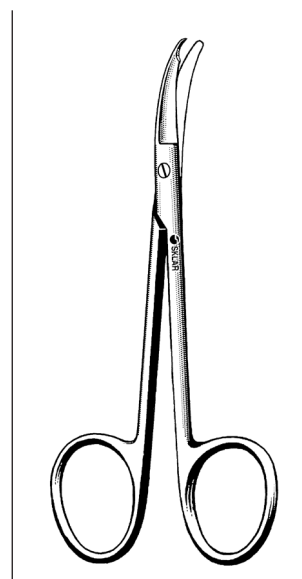

**SUTURE SCISSORS**

22-2935	3½"	Shortbent
22-2947	4¾"	Northbent

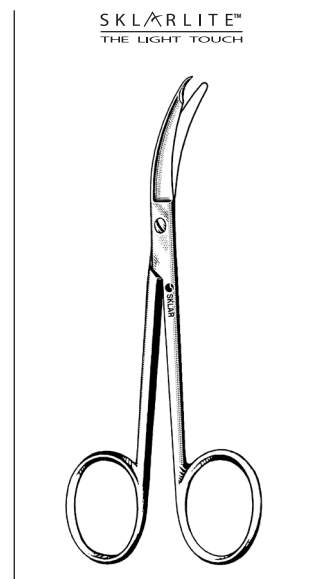

**SKLARLITE™  
SUTURE SCISSOR**

23-1191	3½"	Shortbent
---------	-----	-----------

For a complete listing of our Ophthalmic product line, visit [www.sklarcorp.com](http://www.sklarcorp.com).

**OPHTHALMIC  
IRIS / STITCH SCISSORS**

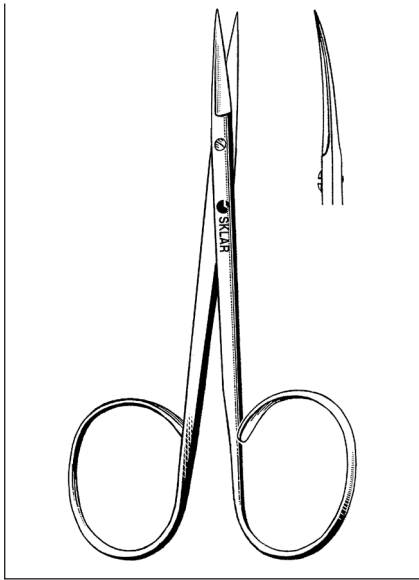

**RIBBON IRIS SCISSORS**  
STRAIGHT      CURVED  
47-1250 4"      47-1255 4"

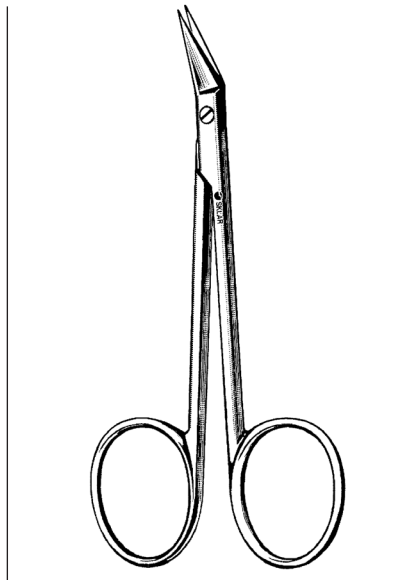

**WILMER SCISSOR**  
ANGLED ON FLAT  
64-1735 4"

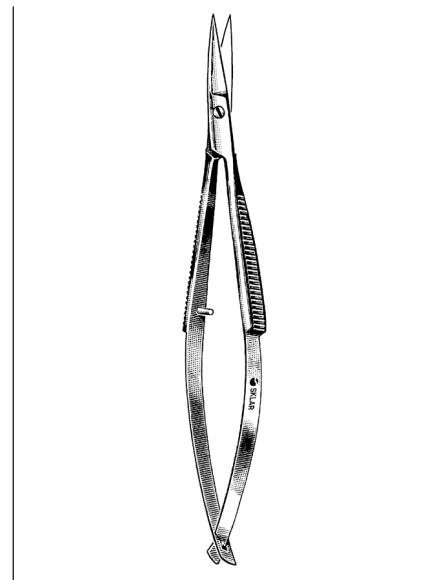

**MCCLURE SPRING HANDLE  
SCISSORS**  
64-1742 4 1/4" Angled  
64-1842 4 1/4" Straight  
64-1942 4 1/4" Curved

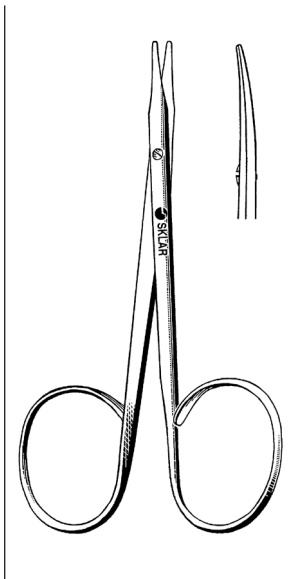

**RIBBON STEVENS  
TENOTOMY SCISSORS**  
STRAIGHT      CURVED  
64-1241 4"      64-1341 4"

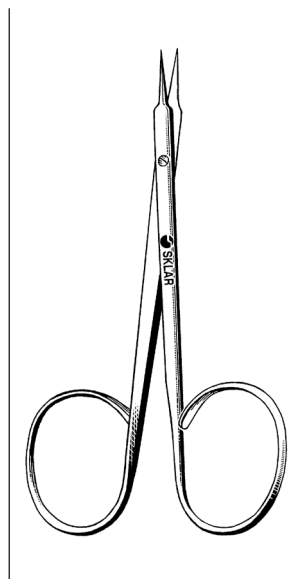

**RIBBON STITCH  
SCISSORS**  
STRAIGHT      CURVED  
64-1345 4"      64-1445 4"

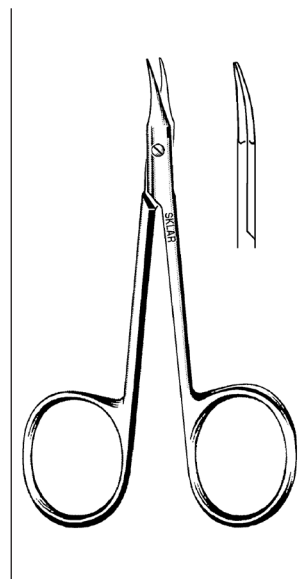

**GRADLE SCISSOR**  
SLIGHTLY CURVED  
SHARP  
64-3280 3 3/4"  
64-3284 4 3/4"

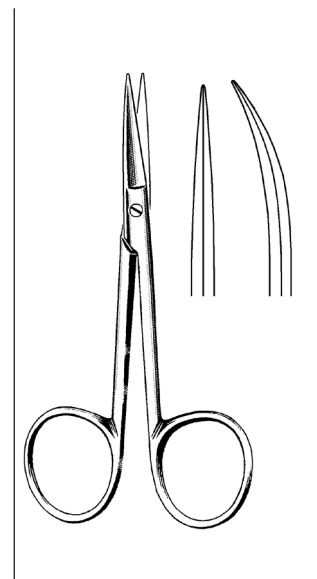

**SEALY DISSECTING  
SCISSORS**  
TWO BLUNT TIPS, MEDIUM WEIGHT  
DELICATE BLADES  
64-3285 4 1/4" Straight  
64-3288 4 1/4" Curved

For a complete listing of our Ophthalmic product line, visit [www.sklarcorp.com](http://www.sklarcorp.com).



**OPHTHALMIC  
STRABISMUS SCISSORS**



**STRABISMUS SCISSORS**

<b>STRAIGHT</b>	<b>CURVED</b>
64-1442 4½"	64-1542 4½"



SKLARLITE™  
THE LIGHT TOUCH

**SKLARLITE™ STRABISMUS SCISSORS**

<b>STRAIGHT</b>	<b>CURVED</b>
23-1158 4½"	23-1159 4½"



**STRABISMUS SCISSORS**

<b>DELICATE</b>	
<b>STRAIGHT</b>	<b>CURVED</b>
22-1442 4½"	22-1542 4½"



SKLARLITE XD™  
EXTRA DELICATE

**SKLARLITE XD™ STRABISMUS SCISSORS**

<b>STRAIGHT</b>	<b>CURVED</b>
23-1162 4½"	23-1163 4½"

For a complete listing of our Ophthalmic product line, visit [www.sklarcorp.com](http://www.sklarcorp.com).



# OPHTHALMIC

## IRIS FORCEPS

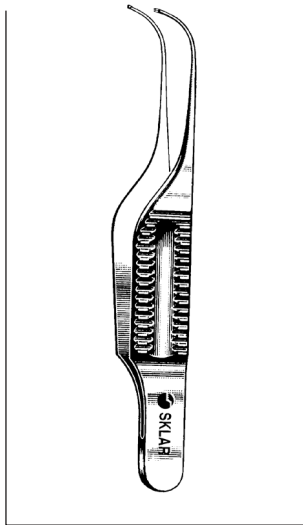

**GILL FORCEPS**  
66-7130 Iris, Curved,  
length 3" (7.6cm)

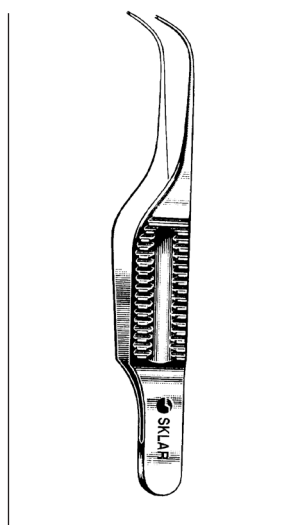

**GILL FORCEPS**  
66-7230 Curved,  
Extra Delicate,  
length 3" (7.6cm)

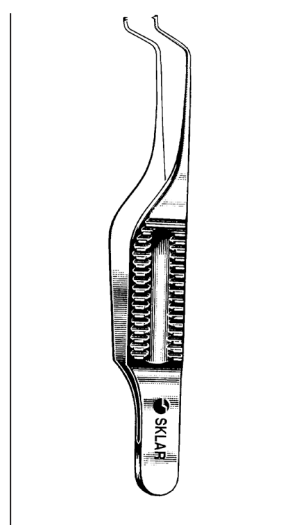

**GILL-HESS IRIS  
FORCEPS**  
66-7238 2¾" with 1x2 teeth  
forward 0.5mm  
66-7240 2¾" with 1x2 teeth  
down 0.5mm

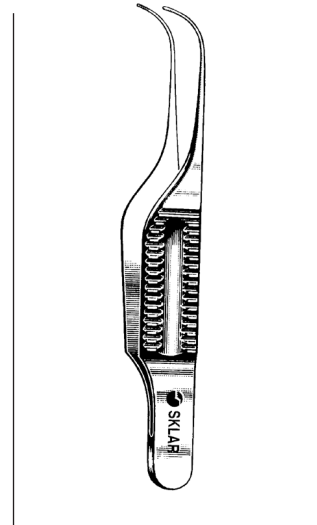

**GILL (CHANDLER) IRIS  
FORCEPS**  
66-7244 3" Fine cross  
serrated tips  
0.6mm wide  
66-7246 3" 1x2 Teeth,  
0.6mm wide

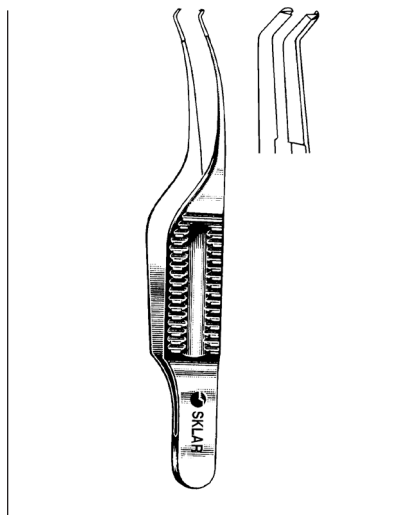

**TROUTMAN-  
BARRAQUER CORNEAL  
UTILITY FORCEPS  
COLIBRI TYPE**  
66-7250 1x2 0.5mm teeth, set at 45°  
with tying platform

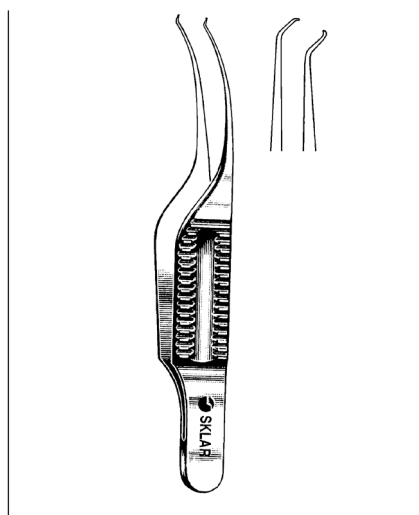

**COLIBRI CORNEAL UTILITY  
FORCEPS**  
3" (7.5 CM)  
66-7259 1x2 Teeth 0.12mm  
66-7261 1x2 Teeth 0.4mm

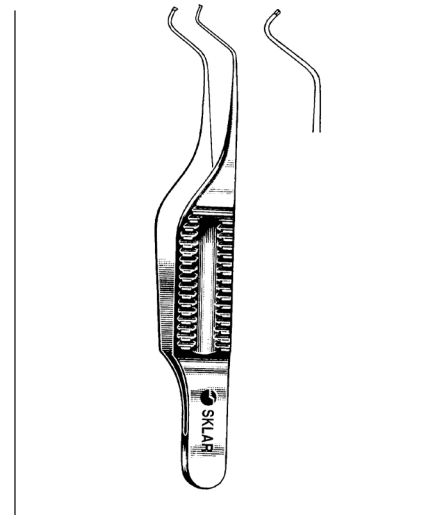

**BOTVIN IRIS FORCEPS**  
66-7258 2⅞" fine cross serrated tips,  
0.5mm wide

For a complete listing of our Ophthalmic product line, visit [www.sklarcorp.com](http://www.sklarcorp.com).



**OPHTHALMIC  
IRIS FORCEPS**

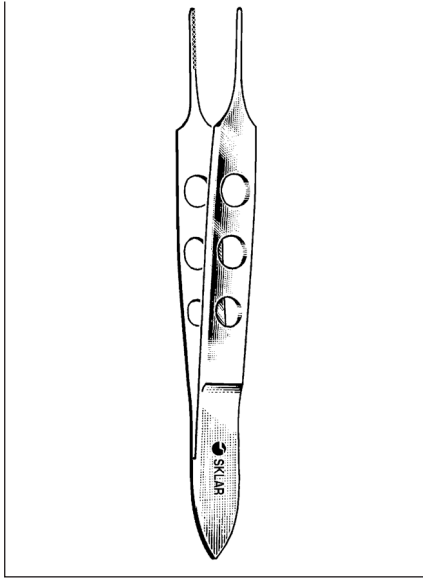

**BISHOP-HARMON IRIS FORCEPS**  
SERRATED, STRAIGHT TIPS  
66-4032 3½"

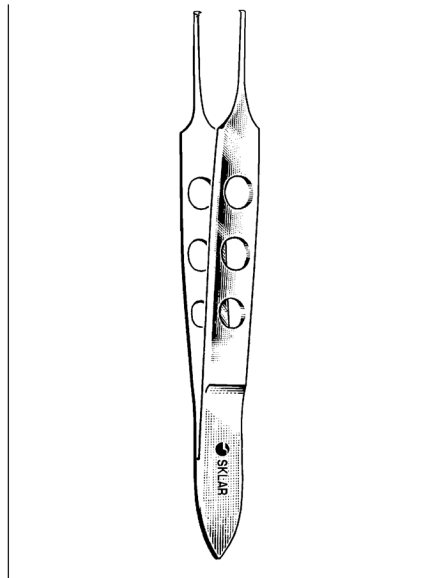

**BISHOP-HARMON IRIS FORCEPS**  
1X2 STRAIGHT TEETH, DELICATE TIP  
66-4232 3½"

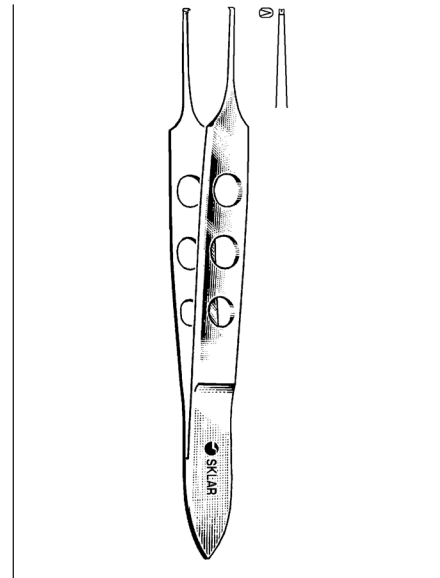

**BISHOP-HARMON IRIS FORCEPS**  
3½" STRAIGHT  
66-4132 1x2 teeth Standard pattern  
66-4133 Extra delicate for microsurgery

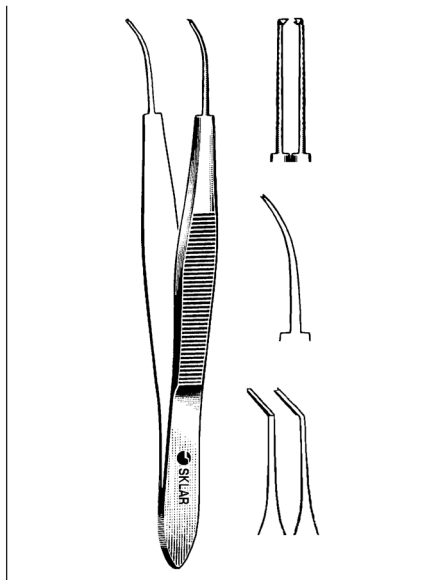

**STEVENS IRIS FORCEPS**  
WITHOUT CATCH

66-4947	Serrated	Straight
66-4948	Serrated	Curved
66-4949	Serrated	Angled
66-4950	1x2 Teeth	Straight
66-4951	1x2 Teeth	Curved
66-4955	1x2 Teeth	Angled

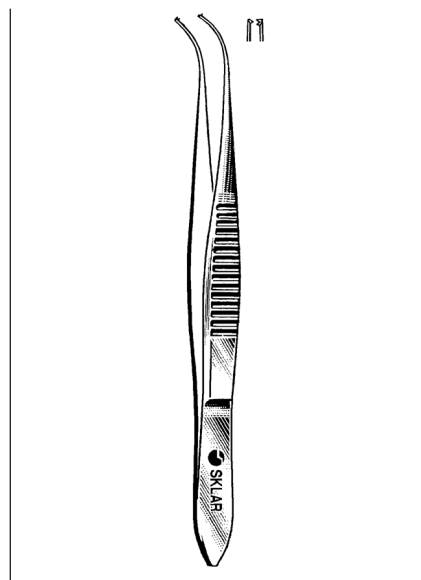

**FORESTER IRIS FORCEPS**  
3¾" CURVED TIPS, 1X2 TEETH ON  
OUTSIDE OF CURVE  
66-4530 Standard handle

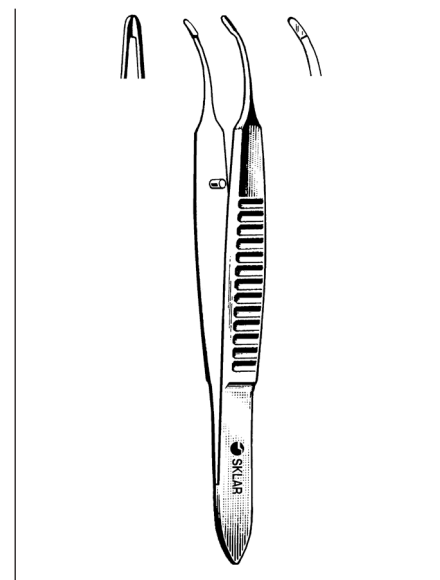

**CHANDLER IRIS FORCEPS**  
66-3927 2¾" Curved

For a complete listing of our Ophthalmic product line, visit [www.sklarcorp.com](http://www.sklarcorp.com).

**OPHTHALMIC  
IRIS / TISSUE FORCEPS**

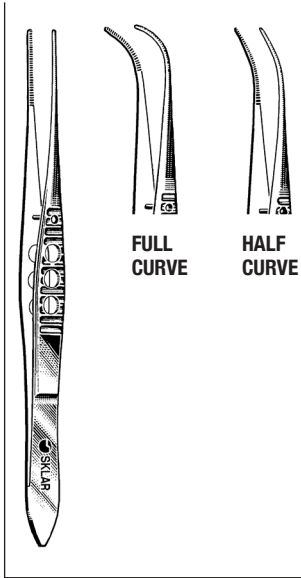

**FULL  
CURVE**      **HALF  
CURVE**

**SKLAR LITEGRIP™  
IRIS FORCEPS**

**SERRATED**

- 66-2742 4" Straight
- 66-2942 4" ½ Curved
- 66-3142 4" Full Curve

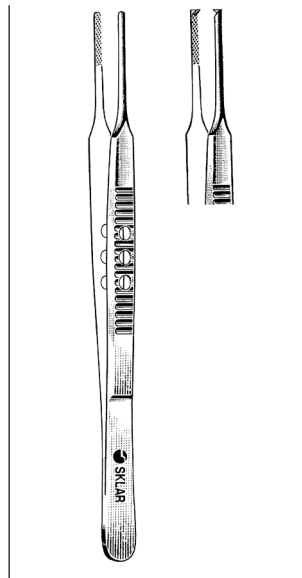

**SKLAR LITEGRIP™  
IRIS FORCEPS**

**1 X 2 TEETH**

- 66-3342 4" Straight
- 66-3542 4" ½ Curved
- 66-3742 4" Full Curve

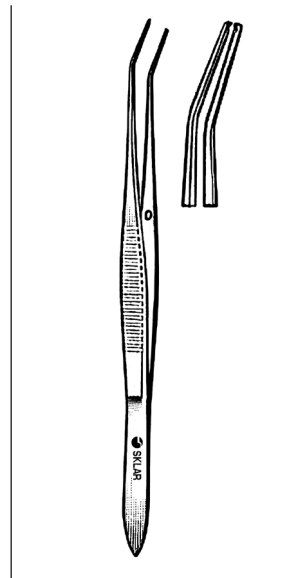

**O'CONNOR IRIS  
FORCEPS**

- 66-4956 3¾" Angular Jaws  
0.5 x 9mm  
with 1x2 Teeth

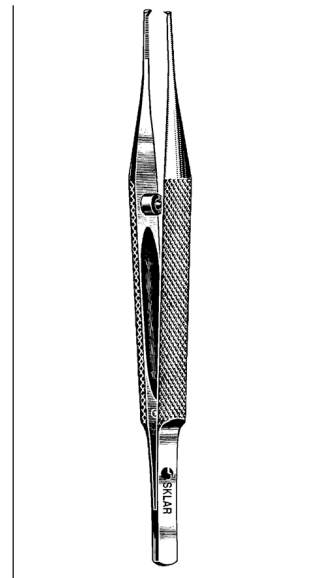

**KIRBY IRIS FORCEPS**

- 66-2750 4" Straight 1x2 teeth
- 66-2755 4" Curved 1x2 teeth
- 66-2760 4" Angled 1x2 teeth

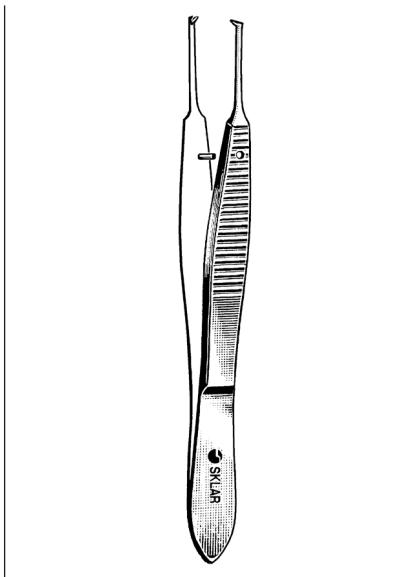

**GRAEFE FORCEPS**

- 66-4525 2¾" Straight 1x2 Teeth
- 66-4625 2¾" Curved 1x2 Teeth
- 66-4526 2¾" Straight Serrated
- 66-4626 2¾" Curved Serrated

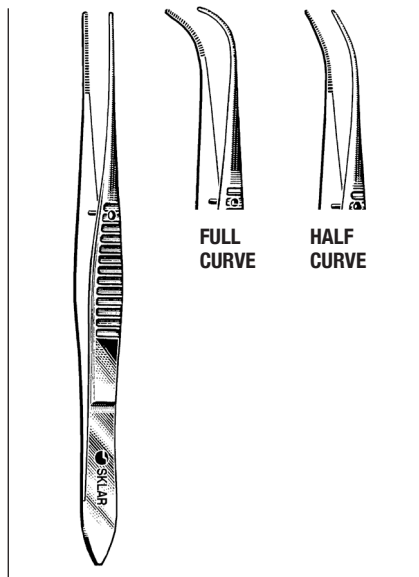

**FULL  
CURVE**      **HALF  
CURVE**

**EYE DRESSING FORCEPS**

**SERRATED**

- 66-2740 4" Straight
- 66-2940 4" ½ Curve
- 66-3140 4" Full Curve

**NON-MAGNETIC**

- 66-2840 4" Straight

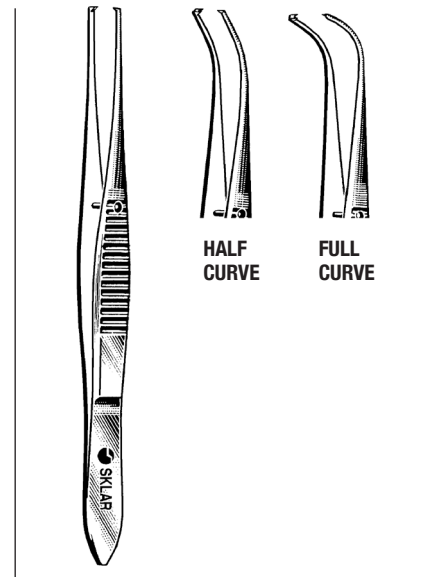

**HALF  
CURVE**      **FULL  
CURVE**

**EYE TISSUE FORCEPS**

**1 X 2 TEETH**

- 66-3340 4" Straight
- 66-3540 4" ½ Curve
- 66-3740 4" Full Curve

**NON-MAGNETIC**

- 66-3240 4" Straight

**For a complete listing of our Ophthalmic product line, visit [www.sklarcorp.com](http://www.sklarcorp.com).**



**OPHTHALMIC  
TISSUE / FIXATION FORCEPS**

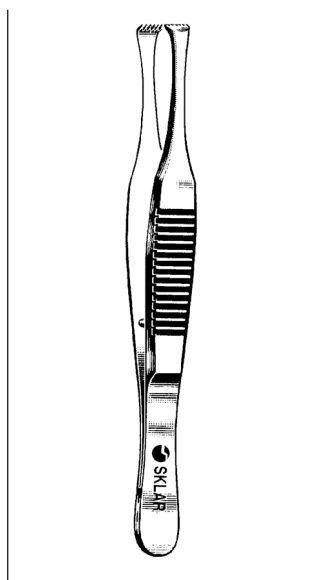

**HARMON FORCEP**  
66-1930 3" (7.6cm)

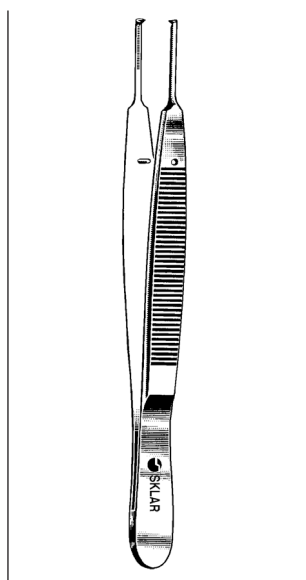

**LESTER FIXATION  
FORCEPS**  
**DELICATE**  
66-4237 3½" 1x2 Teeth  
66-4238 3½" 2x3 Teeth

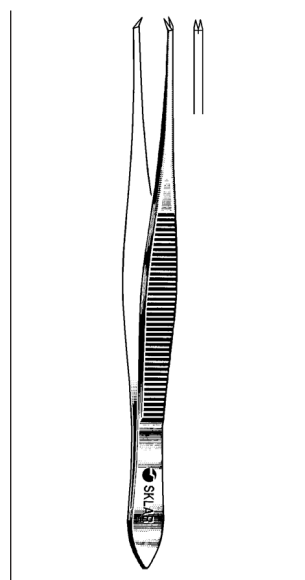

**ELSCHMIG FIXATION  
FORCEPS**  
**¼" ANGLED UPWARDS**  
66-2350 Strong 1x2 Teeth  
66-2351 Strong 2x3 Teeth  
66-2352 Strong 3x4 Teeth

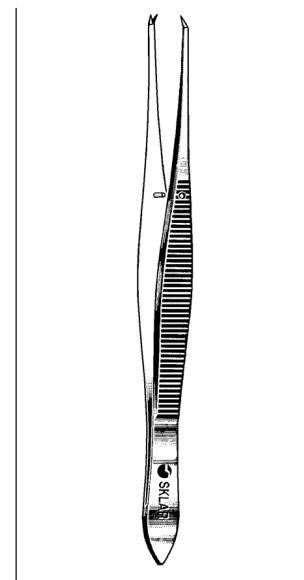

**KUHNT FIXATION  
FORCEPS**  
**1X2 CURVED TEETH**  
66-2355 ¼"

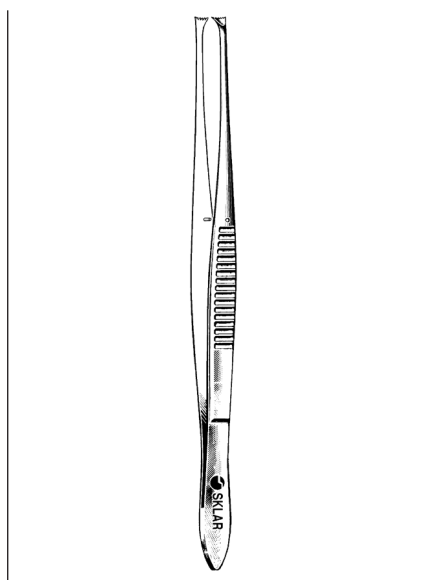

**WALDEAU FIXATION  
FORCEPS**  
**½" WITH FINE TEETH**  
66-2145 Concave Jaws  
5mm wide

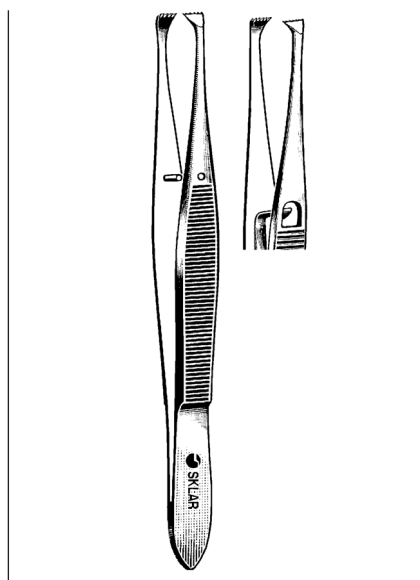

**GRAEFE FIXATION  
FORCEPS**  
66-1940 ¼" Without Lock  
66-2140 ¼" With Lock

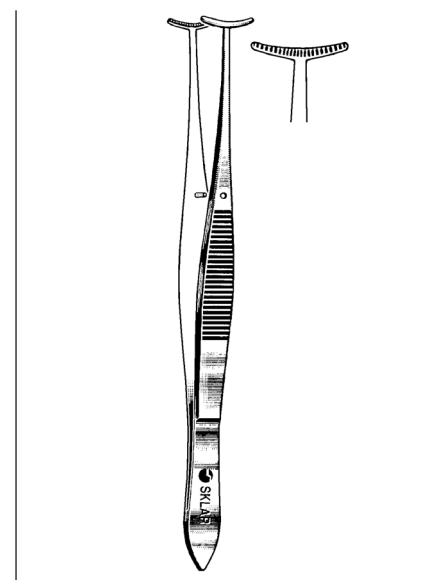

**GREEN FIXATION  
FORCEPS**  
**4"**  
66-2005 5mm Jaws  
66-2009 9mm Jaws  
66-2012 12.5mm Jaws

For a complete listing of our Ophthalmic product line, visit [www.skylarcorp.com](http://www.skylarcorp.com).

**OPHTHALMIC  
SUTURING / TYING FORCEPS**

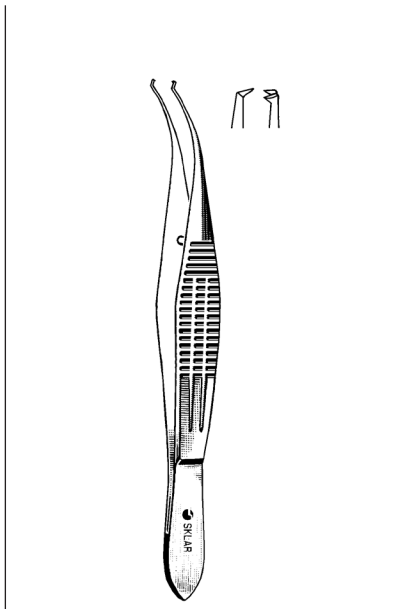

**CASTROVIEJO COLIBRI  
FORCEPS**

WIDE HANDLE 4" EXTRA DELICATE  
66-3450 1x2 0.12mm Teeth

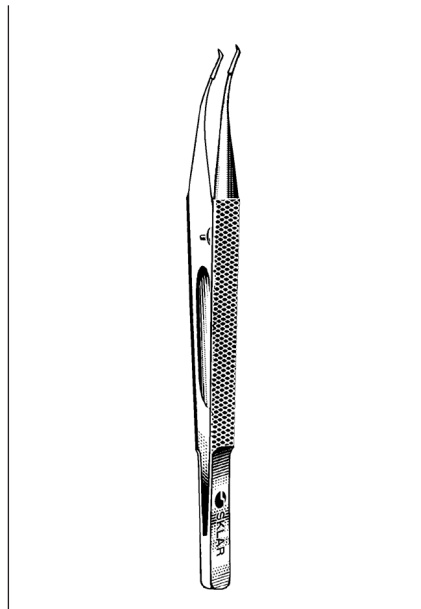

**GIRARD CORNEAL UTILITY  
FORCEPS**

4.0" WITH TYING PLATFORM, SMOOTH TIP,  
0.5MM WIDE  
66-6120

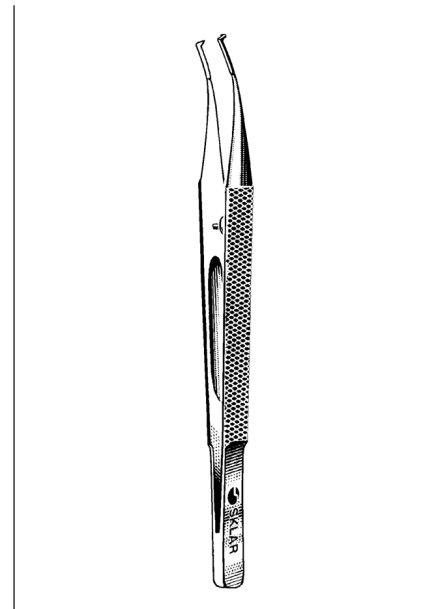

**GIRARD CORNEAL SCLERAL  
FORCEPS**

4.1" WITH TYING PLATFORM, 1X2  
66-6130 0.12mm Teeth Right  
66-6131 0.12mm Teeth Left  
66-6132 0.3mm Teeth Right  
66-6133 0.3mm Teeth Left

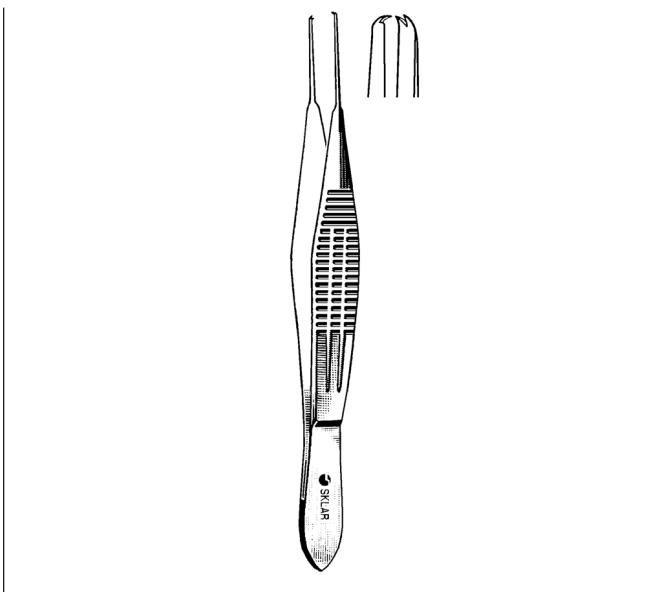

**CASTROVIEJO FIXATION FORCEPS**

4 1/4" (10.9CM), 1X2  
66-2640 0.3mm Teeth without tying platform  
66-2635 0.5mm Teeth without tying platform



**SIMCOE NUCLEUS FORCEPS**

4 1/4" (11CM)  
66-2638 Controlled nucleus delivery

For a complete listing of our Ophthalmic product line, visit [www.sklarcorp.com](http://www.sklarcorp.com).



**OPHTHALMIC  
SUTURING / TYING FORCEPS**

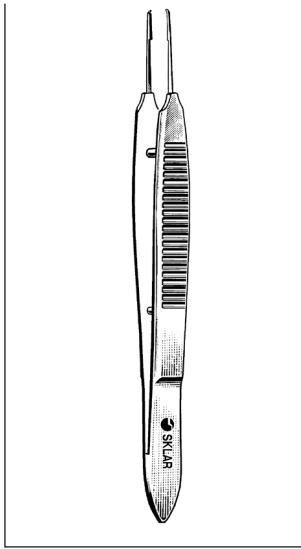

**CASTROVIEJO  
FORCEPS**

- 66-6119 4" .12mm Teeth
- 66-6103 4" .3mm Teeth
- 66-6105 4" .5mm Teeth
- 66-6109 4" .9mm Teeth

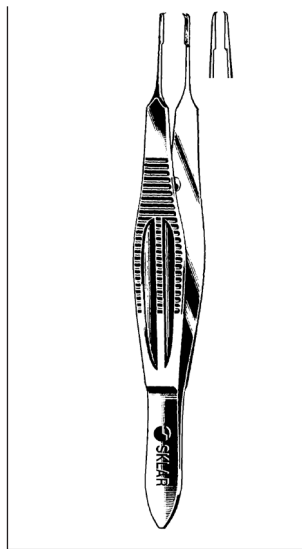

**CASTROVIEJO SUTURE  
FORCEPS**

- 4" 1X2 PLATFORM BEHIND  
TEETH LIMITS DEPTH OF  
PENETRATION WIDE HANDLE**
- 66-6116 0.12mm delicate teeth
  - 66-6117 0.3mm delicate teeth
  - 66-6115 0.5mm delicate teeth
  - 66-6118 1.5mm delicate teeth

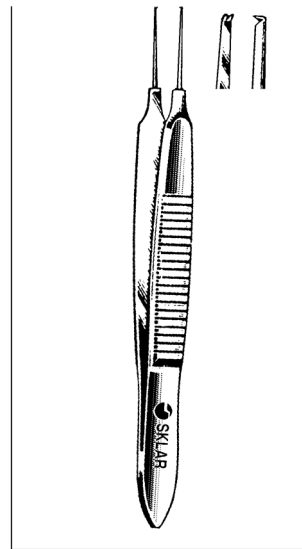

**BONN MICRO  
SUTURING FORCEPS**

- 66-6125 2¾" 1x2 Teeth  
0.12mm with  
tying platform
- 66-6126 3¾" 1x2 Teeth  
0.12mm with  
tying platform

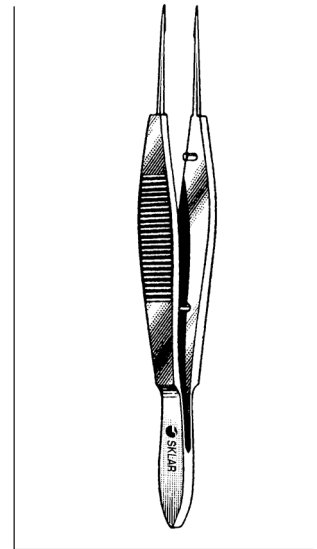

**BONN TYING FORCEPS  
WITH TYING PLATFORM  
0.3MM TIP WIDTH**

- 66-6160 Straight 4"

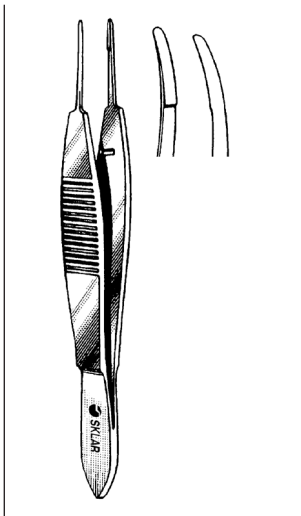

**HARMS TYING  
FORCEPS**

**WITH TYING PLATFORM 0.5MM TIP  
WIDTH 4.0"**

- 66-6140 Straight
- 66-6142 Curved

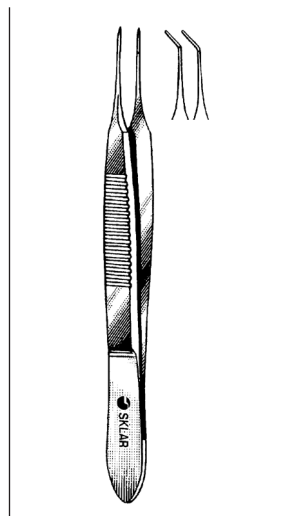

**MCPHERSON TYING  
FORCEPS**

**WITH TYING PLATFORM 4.0MM LONG  
0.3MM TIP WIDTH 3.38"**

- 66-6150 ¾" Straight
- 66-6152 4" Angled

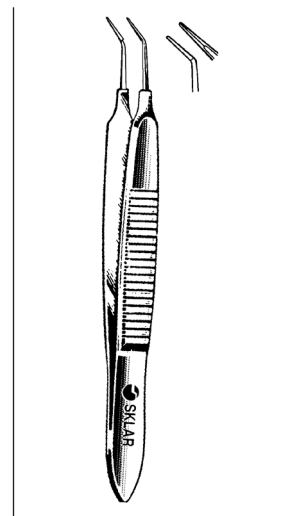

**MCPHERSON MICRO  
IRIS SUTURING  
FORCEPS**

**SMOOTH PLATFORM 0.3 X 5MM**

- 66-6164 ¾" Straight
- 66-6166 ¾" Angled

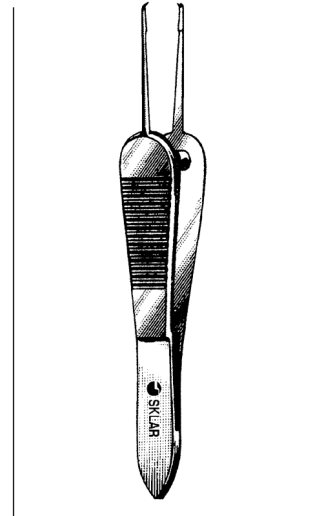

**MANHATTAN EYE & EAR  
SUTURING FORCEPS**

**¾" WITH SMOOTH PLATFORM  
1X2 CURVED TEETH OVERLAPPING  
EACH OTHER 0.7MM WIDE**

- 66-6168

For a complete listing of our Ophthalmic product line, visit [www.sklarcorp.com](http://www.sklarcorp.com).

OPHTHALMIC  
SUTURING / TYING FORCEPS

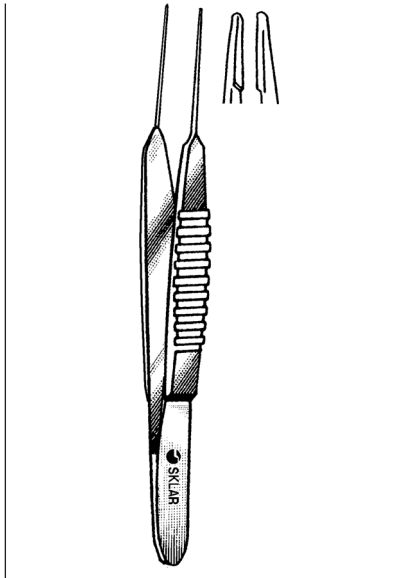

**KELMAN-MCPHERSON TYING  
FORCEPS**

STRAIGHT 86MM  
66-6175 Smooth

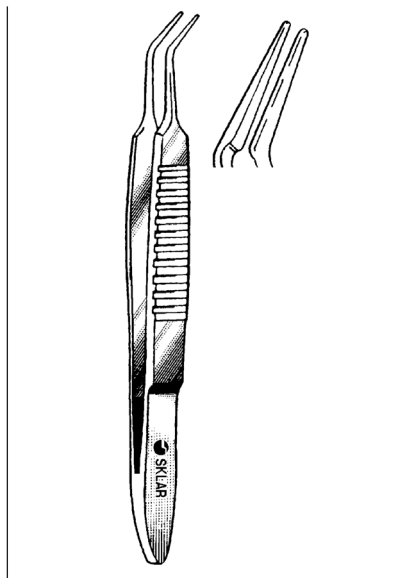

**BECHERT-MCPHERSON TYING  
FORCEPS**

10MM TYING PLATFORM, 83MM  
66-6178 Smooth jaws, angled

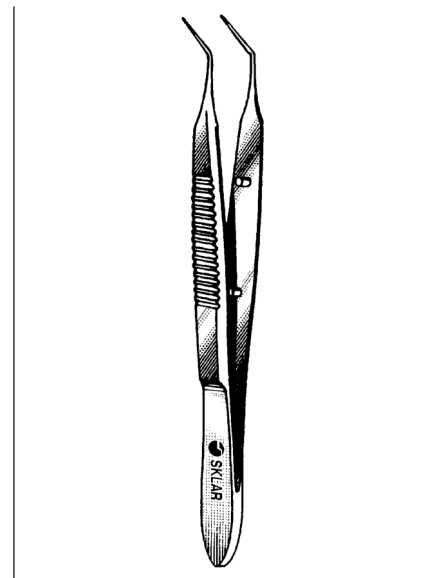

**KELMAN-MCPHERSON TYING  
FORCEPS**

WITH TYING PLATFORM 7.5MM LONG  
0.3MM TIP WIDTH ANGLED 3.3°  
66-6180

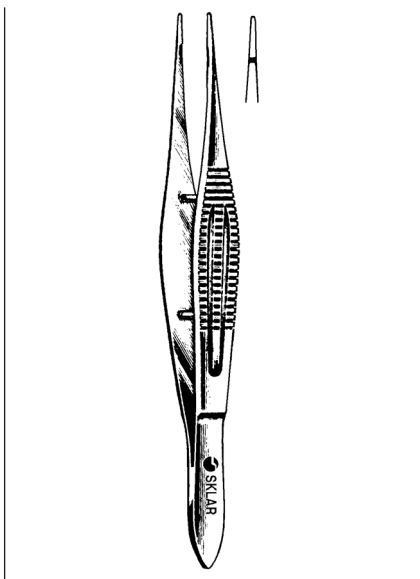

**WALTON SUTURE FORCEPS**  
WITH TYING PLATFORM

66-6182 4¼" with handle

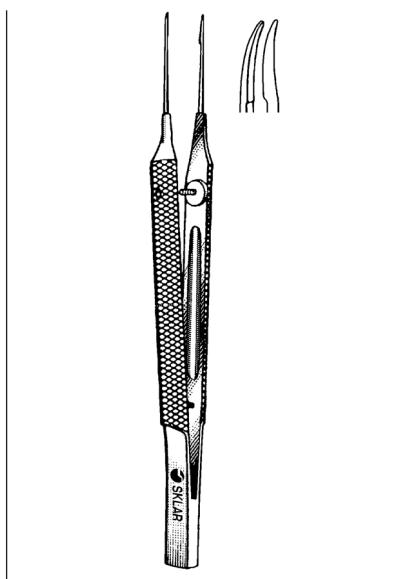

**GIRARD TYING FORCEPS**  
TYING PLATFORM  
SMOOTH TIPS

66-6190 9.9cm long Straight  
66-6192 9.9cm long Curved

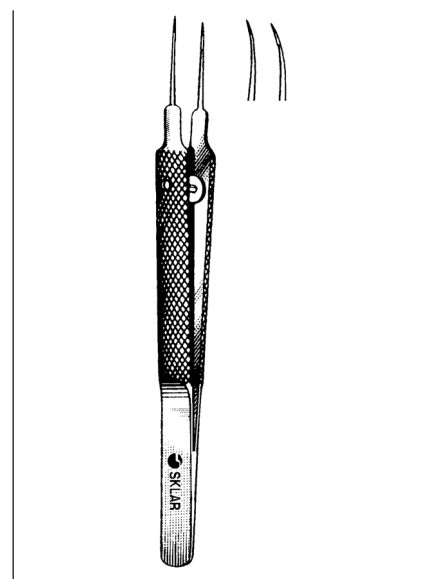

**TENNANT TYING FORCEPS**  
EXTRA DELICATE ROUND HANDLE TYING  
PLATFORM 6MM 0.3MM TIP WIDTH

66-6194 4" Straight  
66-6196 4" Curved

For a complete listing of our Ophthalmic product line, visit [www.sklarcorp.com](http://www.sklarcorp.com).



**OPHTHALMIC  
SUTURE / UTILITY FORCEPS**

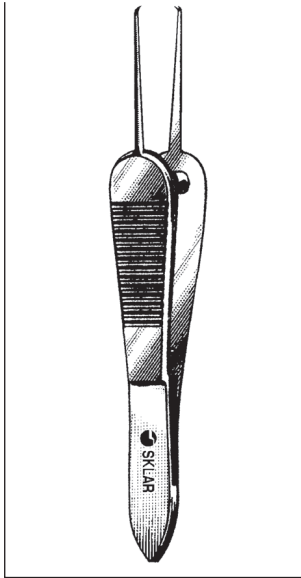

**SAUER SUTURING  
FORCEPS**  
1X2 CURVED TEETH OVERLAPPING  
EACH OTHER 0.6MM WIDE  
66-6330 3½"

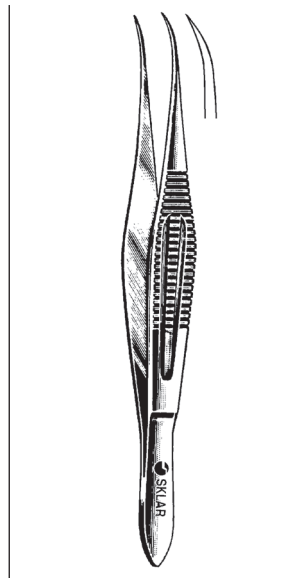

**MANHATTAN EYE AND  
EAR SUTURE FORCEPS**  
66-6250 4¼" with fine tips

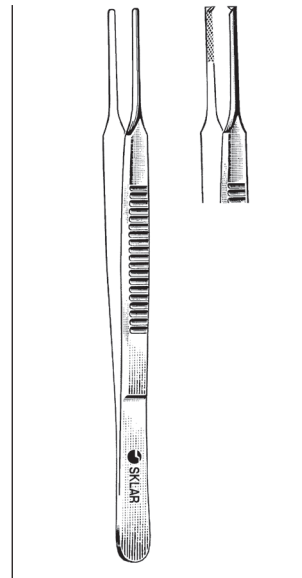

**MCCULLOUGH UTILITY  
FORCEPS**  
66-6110 4" Serrated  
66-6112 4" Smooth  
66-6114 4" 1x2 teeth with  
serrations

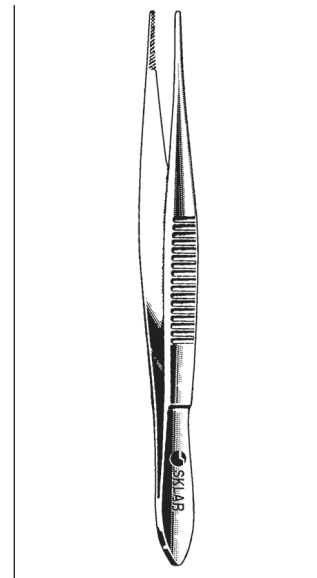

**WILLS HOSPITAL  
UTILITY FORCEPS**  
66-6268 4" Cross serrations on tips

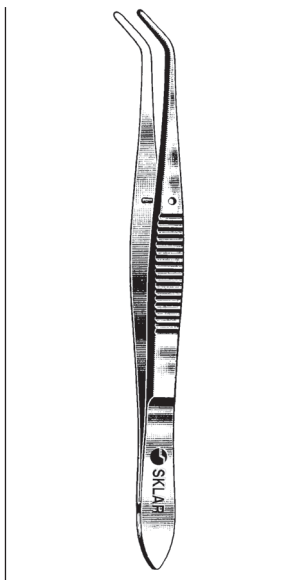

**NUGENT UTILITY  
FORCEPS**  
66-6240 4¼" Angular  
smooth tips  
66-6242 4¼" Angular  
serrated tips

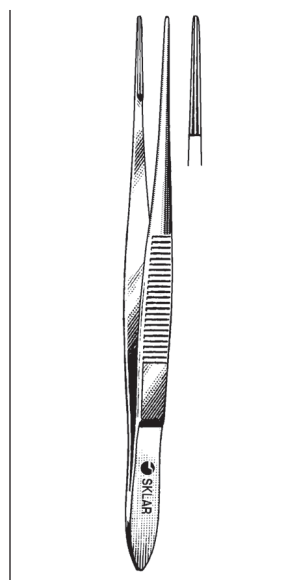

**BONACCOLTO UTILITY  
FORCEPS**  
CROSS SERRATED AT TIPS FOR  
BETTER PICK UP DELICATE PATTERN  
66-6340 1.2mm jaws  
66-6338 1.7mm jaws

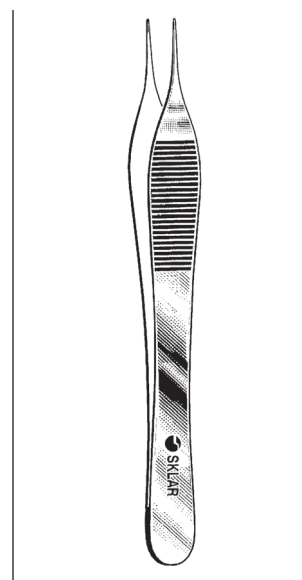

**THORPE  
CORNEOSCLERAL  
FORCEPS**  
66-7347 4¾" (12.1cm)

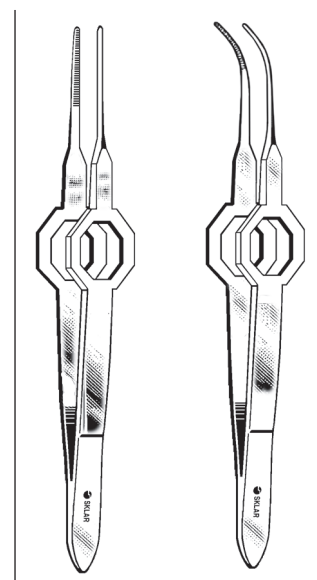

**FOERSTER EYE DRESSING  
FORCEPS**  
OCTAGONAL GRIP, 0.5MM  
66-6036 3¾" Straight, Serrated  
66-6038 3¾" Straight, 1x2 Teeth  
66-6037 3¾" Full Curve, Serrated  
66-6039 3¾" Full Curve, 1x2 Teeth

For a complete listing of our Ophthalmic product line, visit [www.sklarcorp.com](http://www.sklarcorp.com).



**OPHTHALMIC  
CAPSULE FORCEPS**

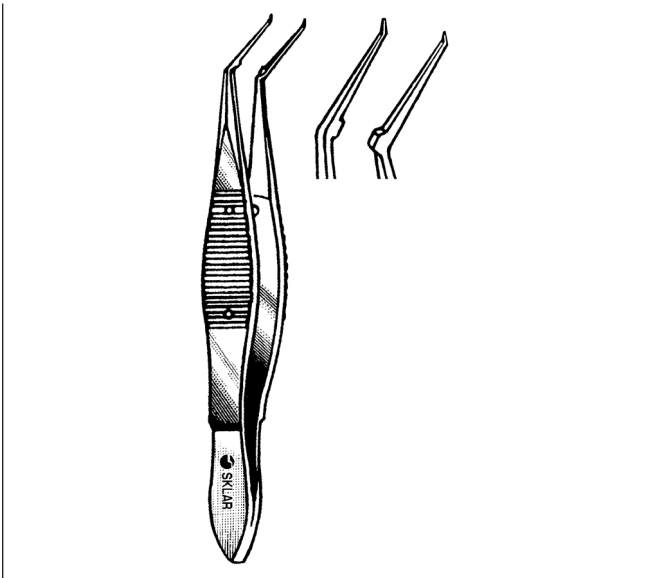

**KRAFF-UTRATA CAPSULORHEXIS FORCEPS**

WITH IRIS STOPS

12MM LONG SMOOTH JAWS

0.3MM TIP 4"

66-5351 Curved tips, flat handle

66-5352 Angled jaws, round handle

66-5353 Angled jaws, cystotome tips, round handle

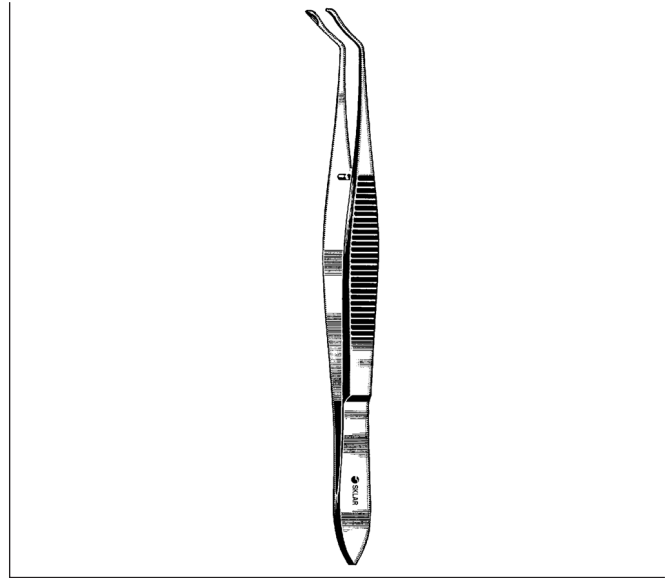

**KALT CAPSULE FORCEPS**

66-5240 4"

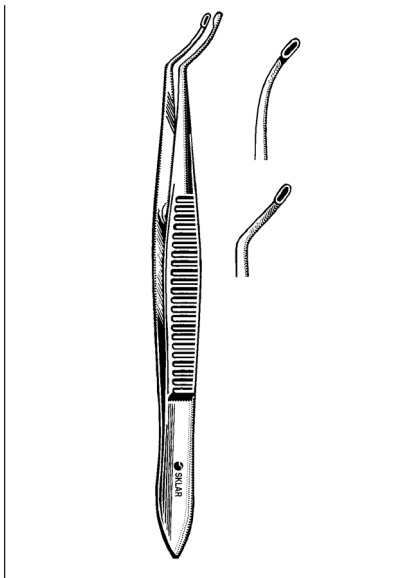

**ARRUGA CAPSULE FORCEPS**

66-5340 4" Standard curve

66-5342 4" New curve

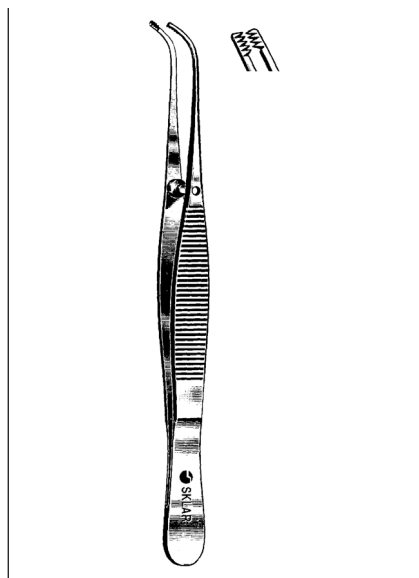

**SCHWEIGER EXTRA CAPSULAR  
FORCEPS**

66-5355 3¾" 4x5 Teeth

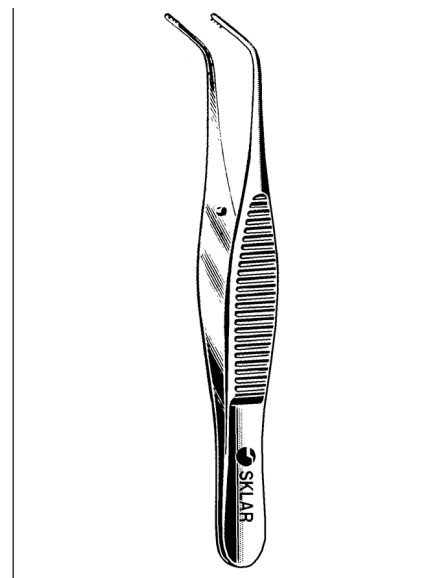

**FUCHS EXTRA CAPSULAR  
FORCEPS**

66-5530 2¾" 5x5 Teeth

**For a complete listing of our Ophthalmic product line, visit [www.sklarcorp.com](http://www.sklarcorp.com).**

**OPHTHALMIC  
CILIA FORCEPS**

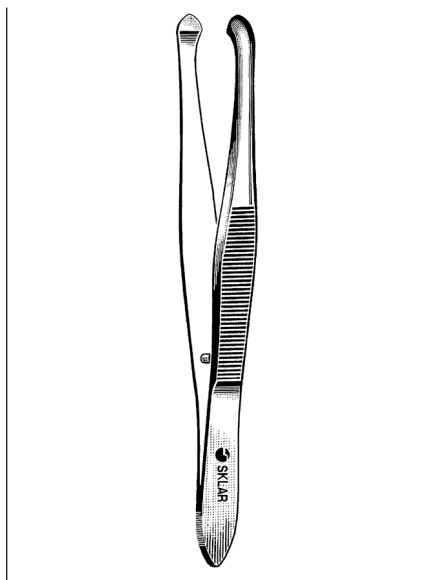

**ZIEGLER CILIA FORCEPS**

66-1535 3½"

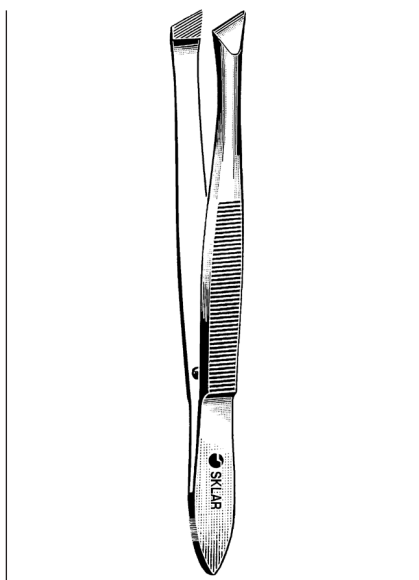

**BERGH CILIA FORCEPS**

66-1635 3½"

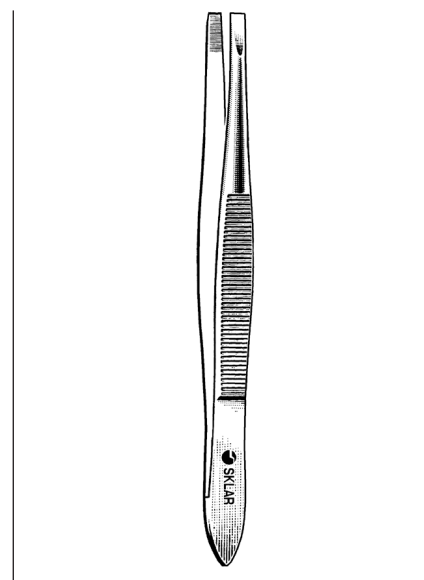

**DOUGLASS CILIA FORCEPS**

66-1830 3½"

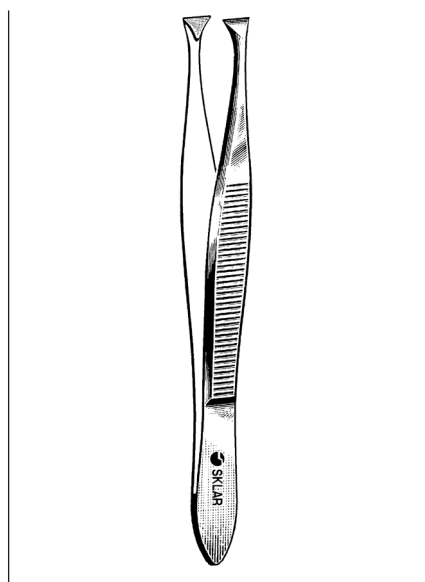

**LITTAUER CILIA FORCEPS**

66-1735 3½"

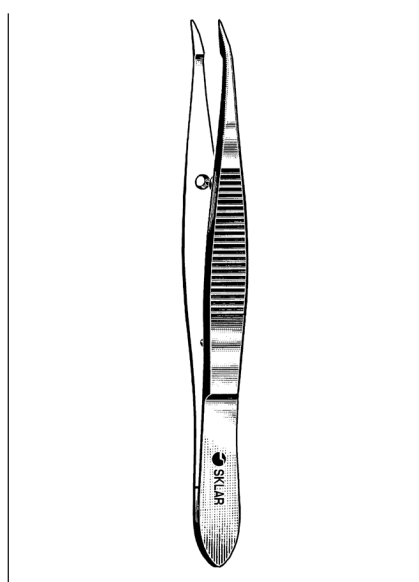

**BARRAQUER CILIA FORCEPS**

66-1742 4¼"

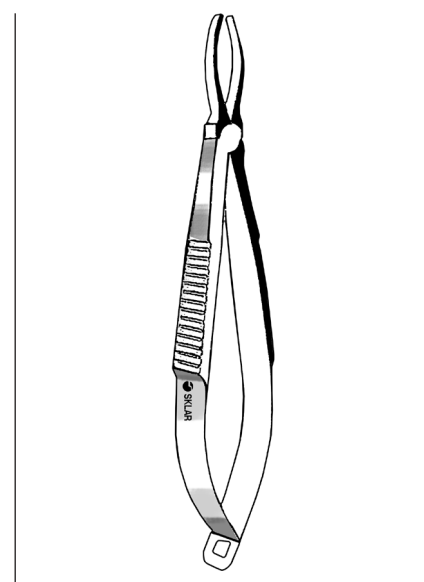

**GRADLE CILIA FORCEPS**

66-1745 4" Precision ground jaws  
1.4mm wide

For a complete listing of our Ophthalmic product line, visit [www.sklarcorp.com](http://www.sklarcorp.com).

OPHTHALMIC  
MUSCLE FORCEPS

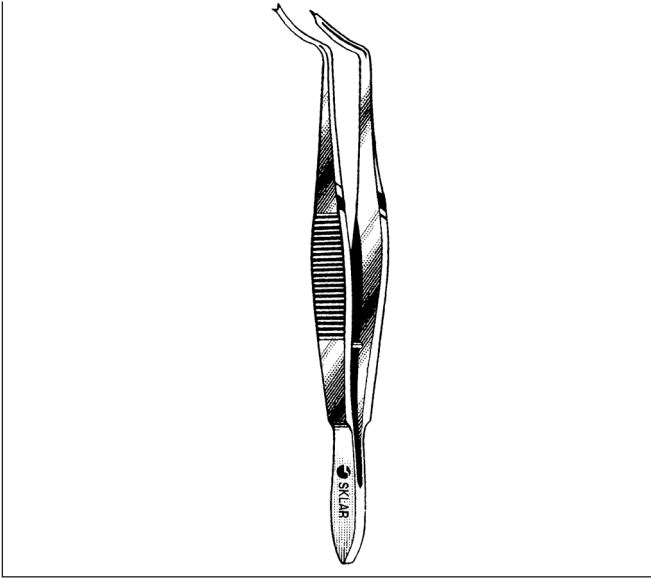

**TENNANT-TROUTMAN SUPERIOR RECTUS FORCEPS**

66-5950 4" Curved shanks 1x2 Teeth

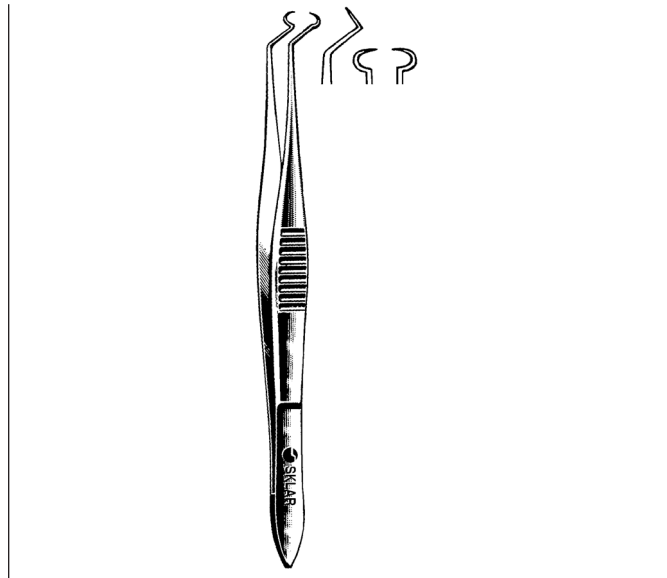

**NUGENT SUPERIOR RECTUS FORCEPS**

66-6955 3¾"



**JAMESON RECESSON FORCEPS**

66-5960 3¾" Left  
66-5962 3¾" Right

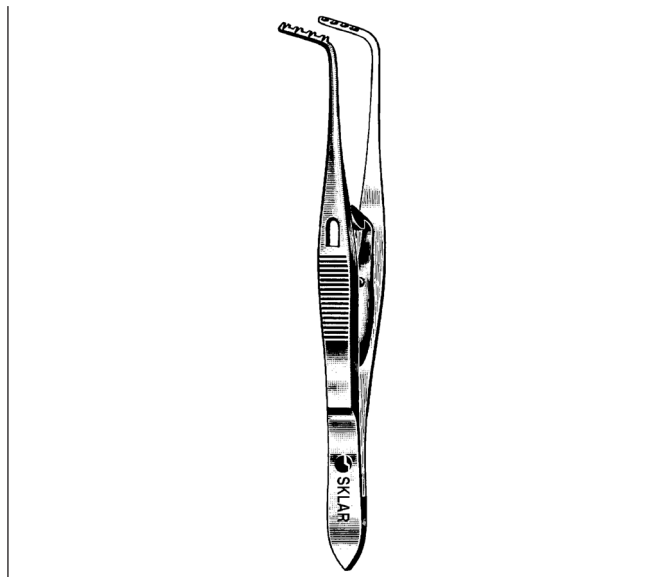

**PRINCE MUSCLE FORCEPS**

66-5942 4" Left

For a complete listing of our Ophthalmic product line, visit [www.sklarcorp.com](http://www.sklarcorp.com).



**OPHTHALMIC  
CHALAZION FORCEPS**

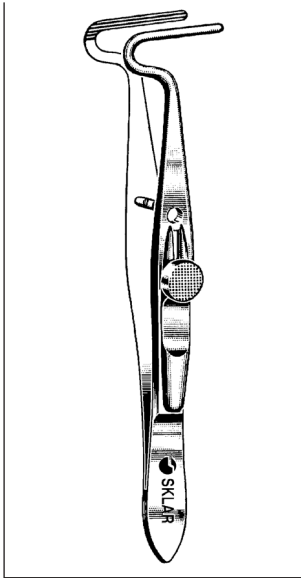

**BERKE PTOSIS  
FORCEPS**  
66-6342 4¼" (10.8cm)

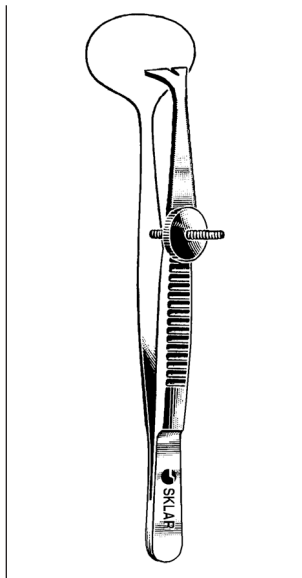

**ERHARDT LID FORCEPS**  
SERRATED AND FENESTRATED  
66-1030 3½" 15mm x 24mm  
plate

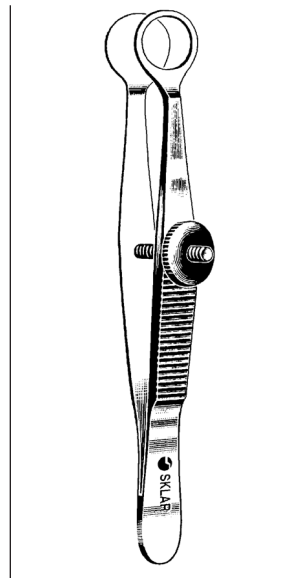

**LAMBERT CHALAZION  
FORCEPS**  
FENESTRATED SMOOTH JAWS  
66-1235 3½" 8.0mm  
66-1236 3½" 11.0mm

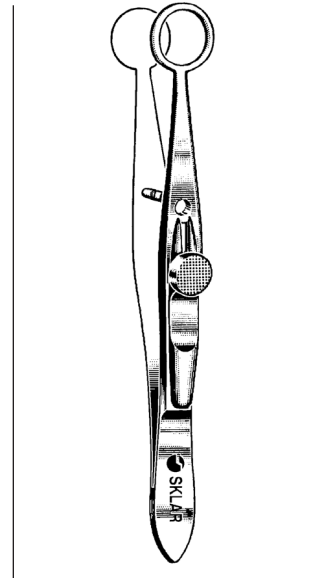

**SPENCER CHALAZION  
FORCEPS**  
WITH LOCK FENESTRATED  
SMOOTH JAWS  
66-1240 3⅝" 9.5mm Jaw

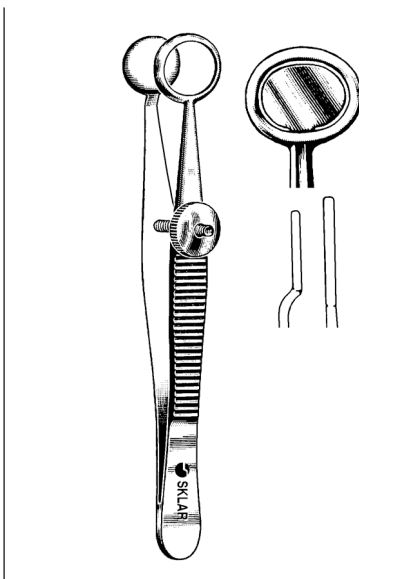

**BAIRD CHALAZION FORCEPS**  
3¾" LONG  
66-1250 8mm x 12mm upper plate

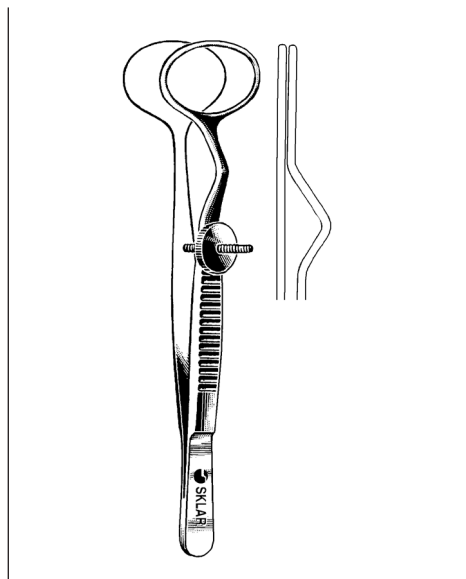

**FRANCIS CHALAZION FORCEPS**  
3¾" LONG  
66-1255 12mm x 14mm upper plate

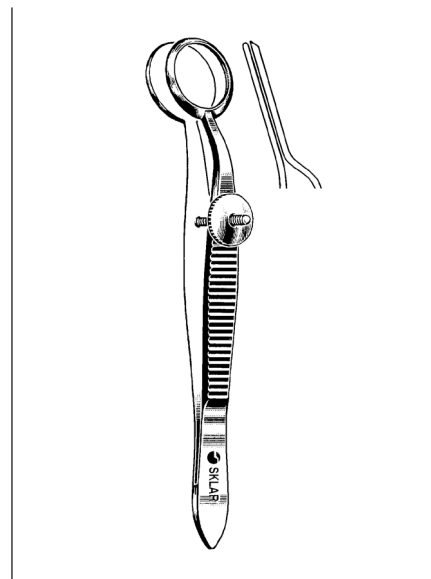

**HEATH CHALAZION FORCEPS**  
LOWER SHAFT CURVED  
UPPER SHAFT OFFSET TO PREVENT  
CRUSHING OF LID  
66-1037 3½" 11mm diameter  
66-1137 3½" 16mm diameter

For a complete listing of our Ophthalmic product line, visit [www.sklarcorp.com](http://www.sklarcorp.com).

**OPHTHALMIC  
CHALAZION FORCEPS**

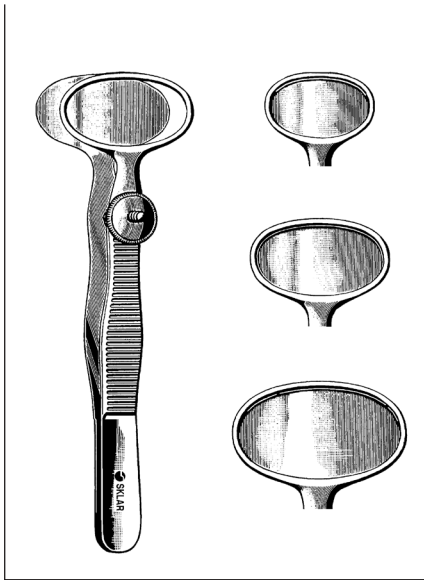

**DESMARRES CHALAZION  
FORCEPS**

- 66-1038 3½" Small
- 66-1036 3½" Medium
- 66-1035 3½" Large

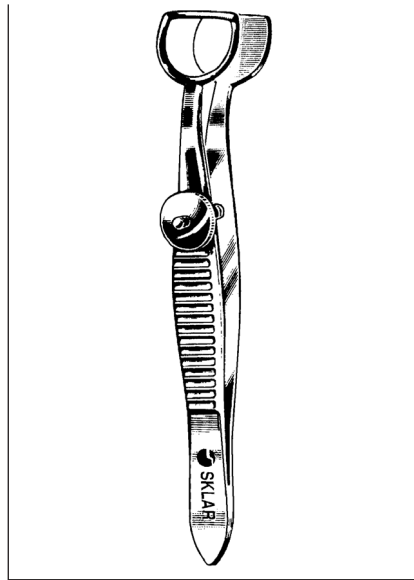

**WEIS CHALAZION  
FORCEPS**

- SERRATED AND FENESTRATED**  
66-1265 4" 9mm x 12mm jaw

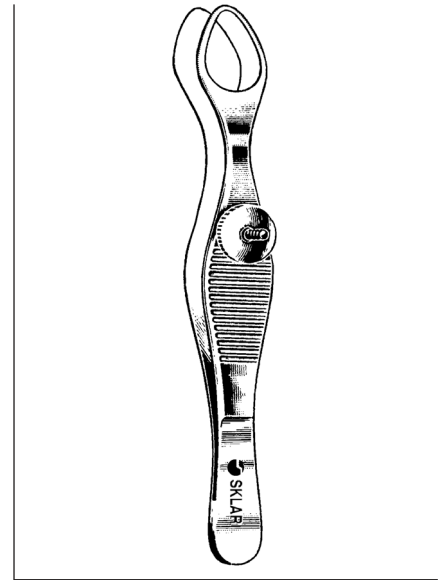

**LORDON CHALAZION  
FORCEPS**

- SERRATED AND FENESTRATED**  
66-1270 3½" 8mm x 13mm jaw

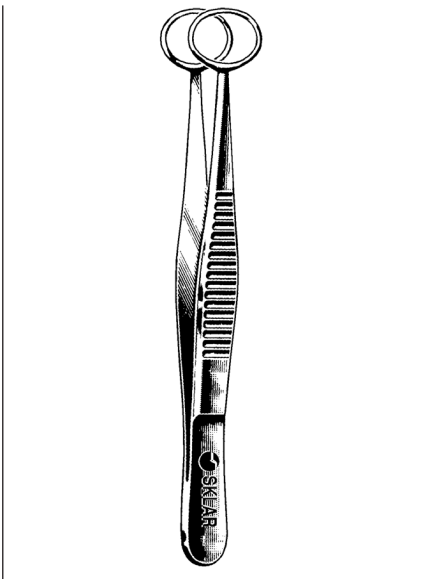

**PRINCE TRACHOMA  
FORCEPS**

- 66-1275 3½" Rings measure  
8mm x 10mm

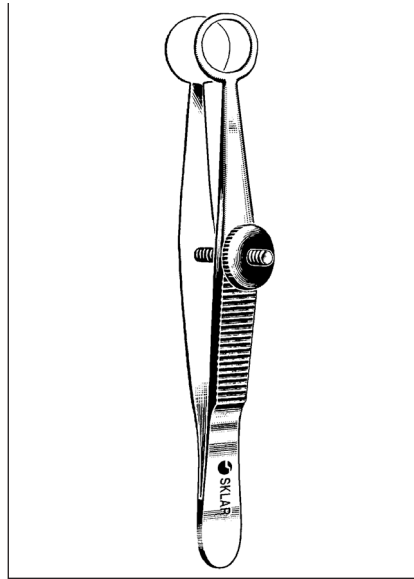

**AYER CHALAZION  
FORCEPS**

- 66-1435 3½" 9mm inside diameter

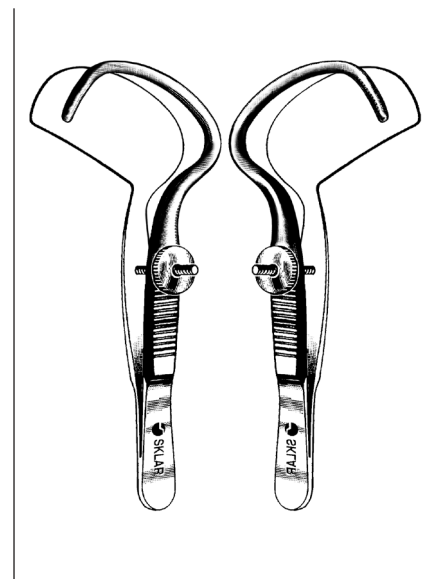

**SNELLEN ENTROPIUM  
FORCEPS**

- 3½" 35MM  
66-1280 Left  
66-1282 Right

**For a complete listing of our Ophthalmic product line, visit [www.sklarcorp.com](http://www.sklarcorp.com).**



**OPHTHALMIC  
INSERTING / JEWELERS FORCEPS**

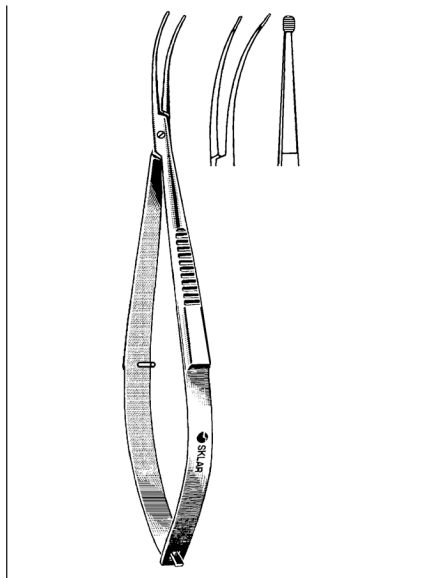

**SHEPARD I – IOL INSERTING  
FORCEPS**

**SERRATED PLATFORM (2MM X 8MM) 4.64"**

- 66-7660 Without lock-without irrigation
- 66-7662 With lock-without irrigation
- 66-7664 Without lock-with irrigation

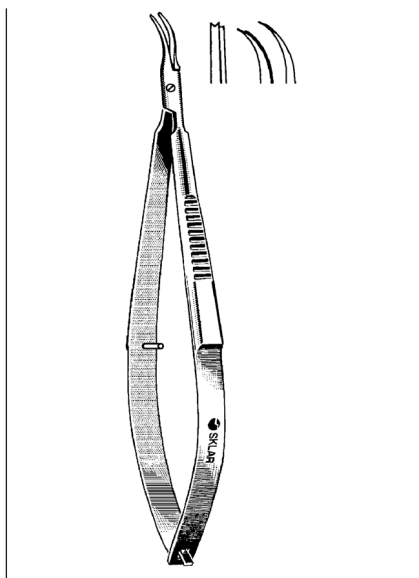

**SHEPARD II – IOL INSERTING  
FORCEPS**

**NOTCHED TIP (.5MM X .4MM) 4.4"**

- 66-7655 Without lock-with irrigation
- 66-7656 With lock-with irrigation

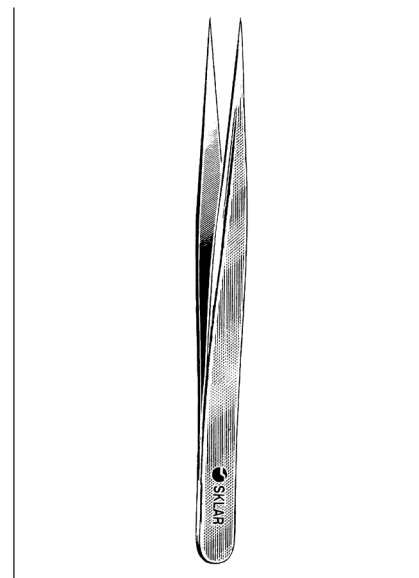

**JEWELERS STYLE FORCEPS**

66-7447 #3 Straight

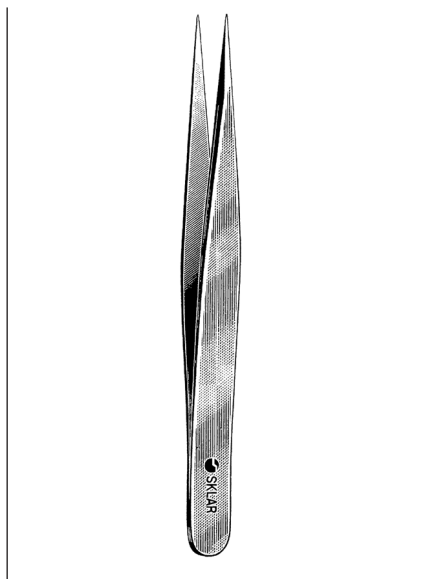

**JEWELERS STYLE FORCEPS**

66-7442 #3C Straight Delicate

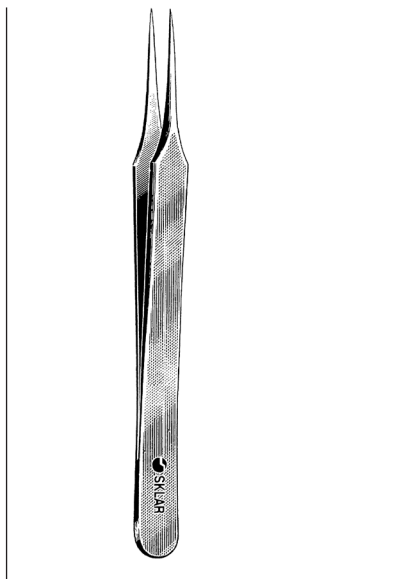

**JEWELERS STYLE FORCEPS**

66-7542 #4 Straight Delicate

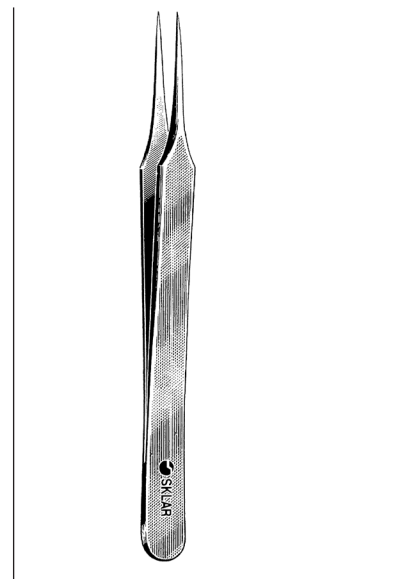

**JEWELERS STYLE FORCEPS**

66-7642 #5 Straight

**For a complete listing of our Ophthalmic product line, visit [www.sklarcorp.com](http://www.sklarcorp.com).**

**OPHTHALMIC  
NEEDLE HOLDERS**

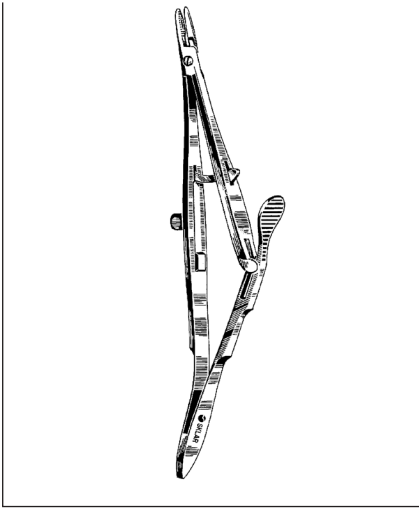

**CASTROVIEJO-KALT  
NEEDLE HOLDER  
WITH SUTURE CUTTER**  
65-6255 5½"

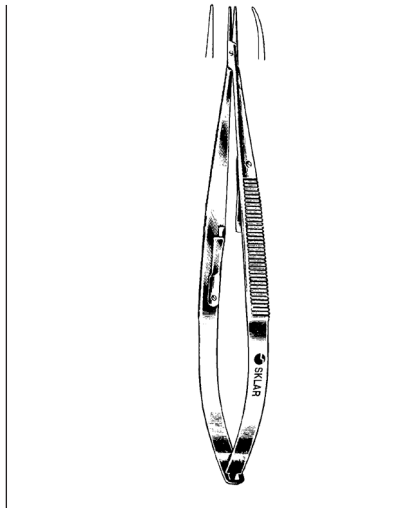

**CASTROVIEJO NEEDLE HOLDERS**  
STANDARD HANDLE, EXTRA DELICATE, SMOOTH  
JAWS TO HOLD 7-0 SUTURES (ESPECIALLY MILLED  
HANDLE TO IMPROVE TRACTION)

65-6350	5½"	Straight jaw without catch
65-6352	5½"	Straight jaw with catch
65-6354	5½"	Curved jaw with catch
65-6351	5½"	Curved jaw without catch

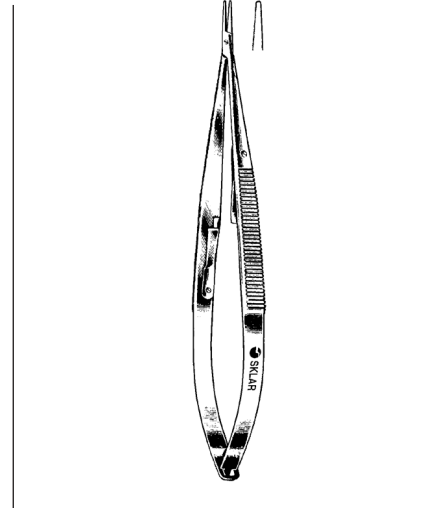

**CASTROVIEJO  
NEEDLE HOLDERS  
WITH CATCH**

65-6357	5½"	Straight
65-6358	5½"	Curved

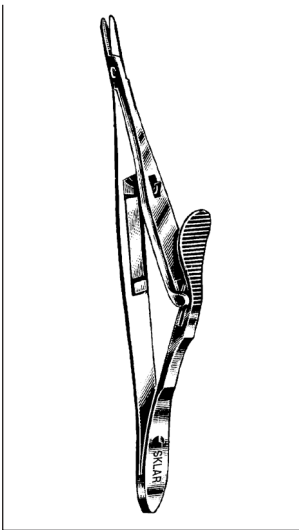

**CASTROVIEJO-KALT  
NEEDLE HOLDER**  
65-6055 6½" Straight

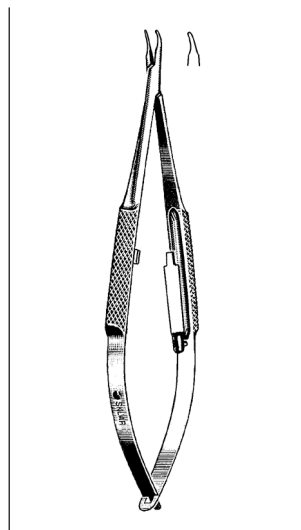

**BARRAQUER  
NEEDLE HOLDERS**  
ROUND GRIP SPRING HANDLE,  
WITH INSIDE CATCH  
CURVED JAW

65-6446	5½"	Delicate
65-6450	7½"	Delicate

**STRAIGHT JAW**

65-6445	5½"	Delicate
65-6449	7½"	Delicate

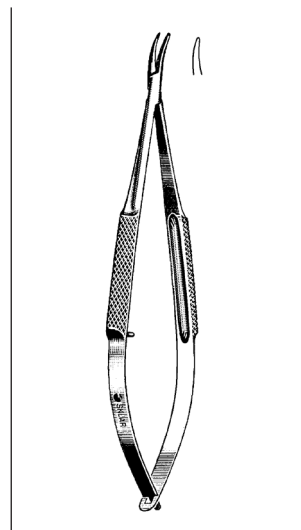

**BARRAQUER  
NEEDLE HOLDERS**  
DELICATE WITHOUT LOCK

65-6452	5¼"	Curved
65-6454	5½"	Straight
65-6455	5½"	Curved
65-6456	7½"	Straight
65-6457	7½"	Curved

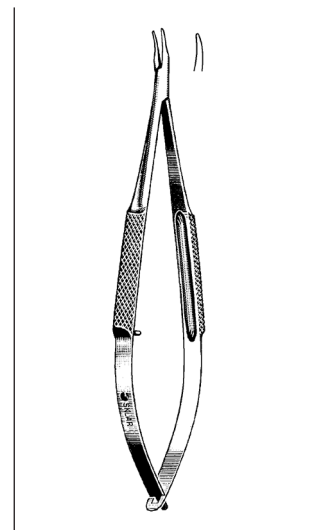

**TROUTMAN  
NEEDLE HOLDERS**  
EXTRA DELICATE, ROUND GRIP  
SPRING HANDLE

65-6461	4"	Straight, without inside catch
65-6460	4"	Curved, with inside catch
65-6462	4¾"	Curved, without inside catch

For a complete listing of our Ophthalmic product line, visit [www.sklarcorp.com](http://www.sklarcorp.com).



**OPHTHALMIC  
NEEDLE HOLDERS**



**COHAN NEEDLE HOLDERS**

**MINI-MICRO 7MM JAWS, 4" (100MM)**

65-6470 Curved without lock

65-6475 Curved with lock



**BOYNTON NEEDLE HOLDER**

20-3080 4¾"

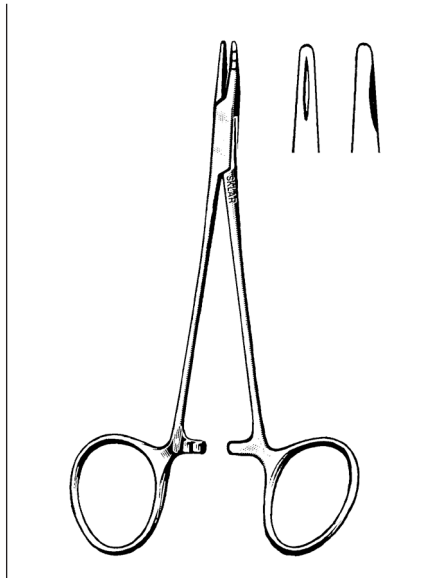

**NEIVERT NEEDLE HOLDER**

20-1760 5" One offset ring

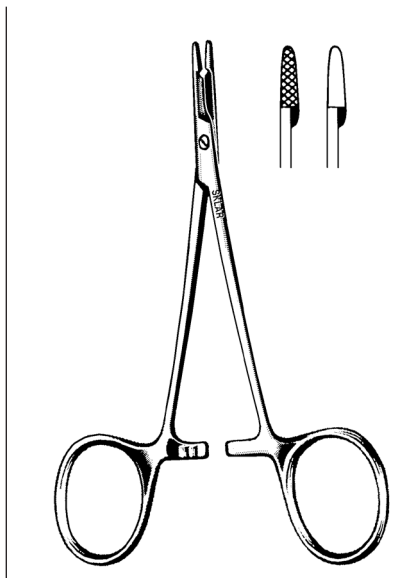

**OLSEN-HEGAR NEEDLE  
HOLDERS**

**SCISSOR COMBINATION**

20-2748	4¾"	Smooth	Delicate
20-2747	4¾"	Serrated	Delicate
20-2755	5½"	Serrated	
20-2765	6½"	Serrated	
20-2775	7"	Serrated	



**STEVENS NEEDLE HOLDER**

65-6265 6"

**For a complete listing of our Ophthalmic product line, visit [www.sklarcorp.com](http://www.sklarcorp.com).**



**OPHTHALMIC  
REUSABLE CANNULAS**

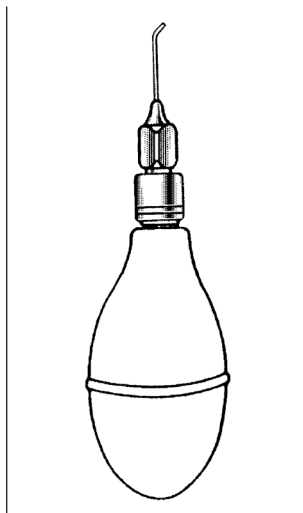

**BISHOP-HARMON  
ANTERIOR CHAMBER  
CANNULAS**

- 66-6810 Flattened 19 Gauge Angled 7mm tip complete with bulb and adapter
- 66-6811 Bishop-Harmon cannula only
- 66-6812 Adaptor for irrigator
- 66-6813 Silicone bulb only

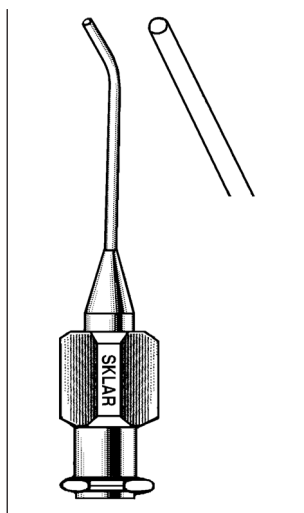

**AIR INJECTION  
CANNULA**  
66-6900 27 Gauge

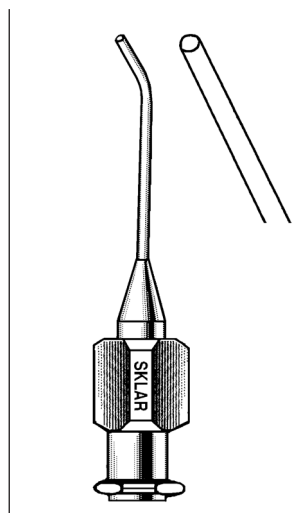

**AIR INJECTION  
CANNULA**  
66-6902 30 Gauge

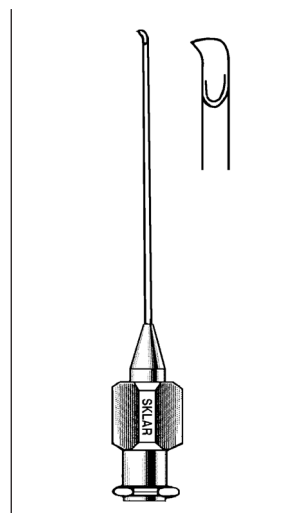

**KELMAN AIR  
CYSTOTOMES**

- 66-6910 22 Gauge Blunt
- 66-6912 22 Gauge Sharp
- 66-6914 22 Gauge Sharp (Sheets short model) 13mm long
- 66-6916 22 Gauge Sharp (Kelman) Double Blades

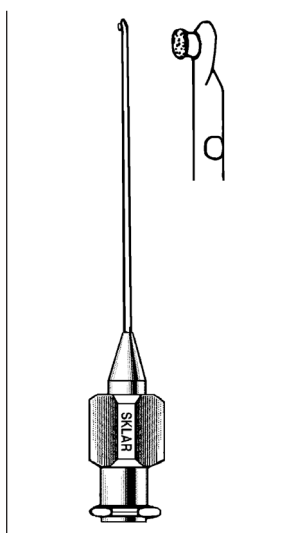

**GRAETHER COLLAR  
BUTTON MICRO-IRIS  
RETRACTORS**  
**ROUGHED POSTERIOR SURFACE, 25MM**

- 66-6920 23 Gauge Straight
- 66-6922 23 Gauge Angled 45°

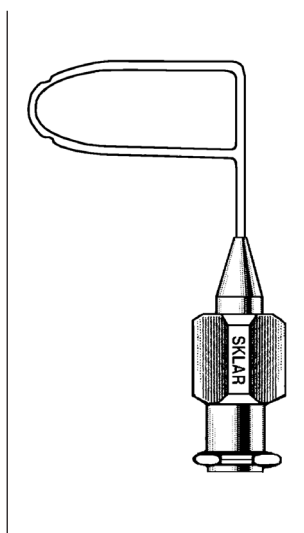

**SIMCOE NUCLEUS  
DELIVERY CANNULA**  
**THIN WALL**  
66-6925 25 Gauge Two ports Loop 13mm long 4mm Wide Serrations on lens loop, right

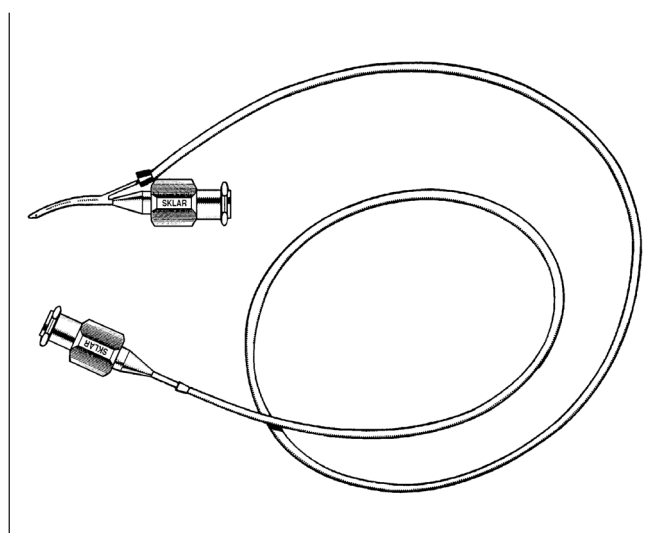

**SIMCOE IRRIGATING/ASPIRATING CANNULA**  
**REVERSE 15MM LONG**  
66-6930 23 Gauge T.W. x 23 gauge T.W. aspirating port facing into curve, aspiration on needle hub, irrigation in tubing hub

**SIMCOE CANNULA**  
**23 GAUGE THIN WALL**  
66-6932 Double barreled irrigating-aspirating

For a complete listing of our Ophthalmic product line, visit [www.sklarcorp.com](http://www.sklarcorp.com).



**OPHTHALMIC  
ACCESSORIES**

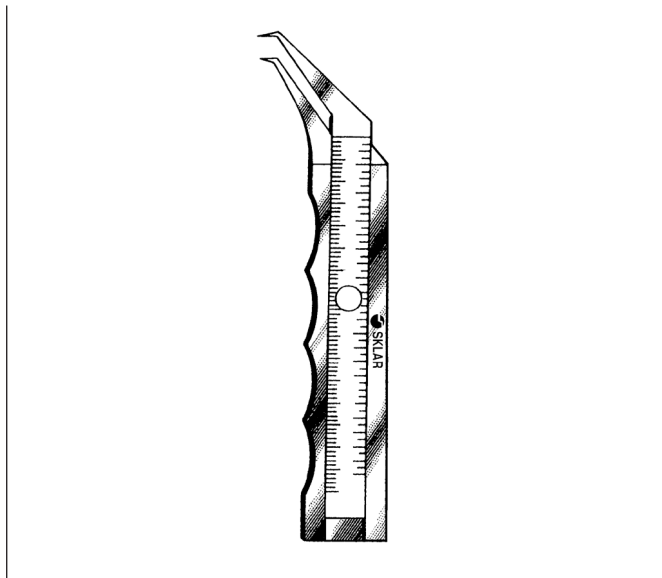

**THORPE CALIPER**  
GRADUATED IN INCHES AND MM  
65-6735 4½"

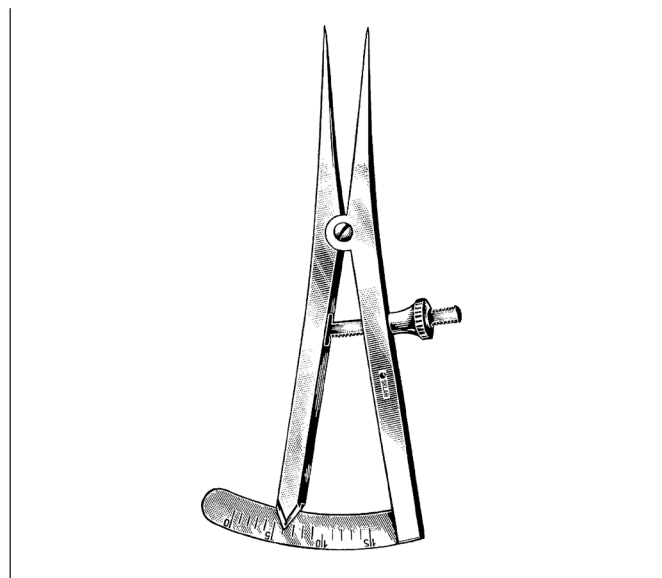

**CASTROVIEJO CALIPERS**  
GRADUATED AND MEASURE

65-6730	3¼"	0-15mm	Straight
65-6732	3¼"	0-20mm	Straight
65-6734	3¼"	0-20mm	Curved

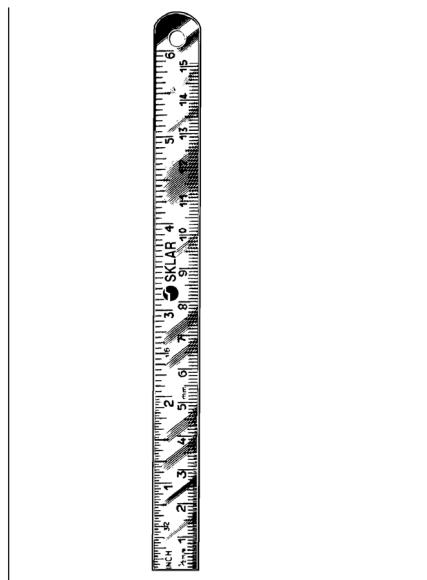

**STEEL RULERS**  
GRADUATED IN INCHES AND MM

06-2860	6"
06-2862	8"
06-2861	12"
06-2863	20"

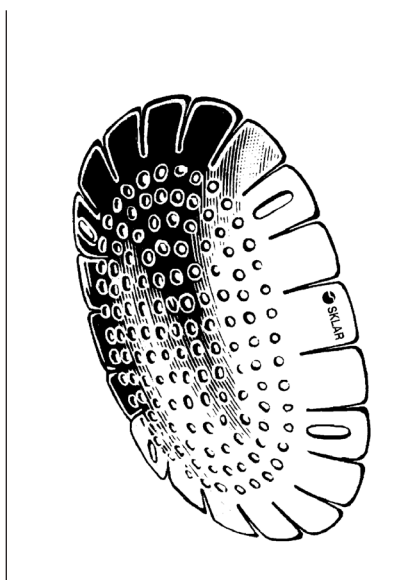

**FOX ALUMINUM EYE  
SHIELDS**

65-7634	Package of 12
65-7635	Package of 1

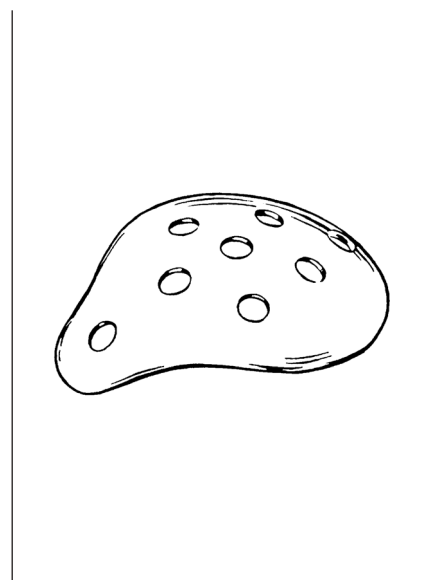

**DISPOSABLE EYE SHIELDS**

96-1070	Single Each
96-1071	Single Dozen

Lighter in weight, Sklar disposable eye shields offer an alternative to metal shields. Made of high impact plastic. Not Autoclavable.

For a complete listing of our Ophthalmic product line, visit [www.sklarcorp.com](http://www.sklarcorp.com).

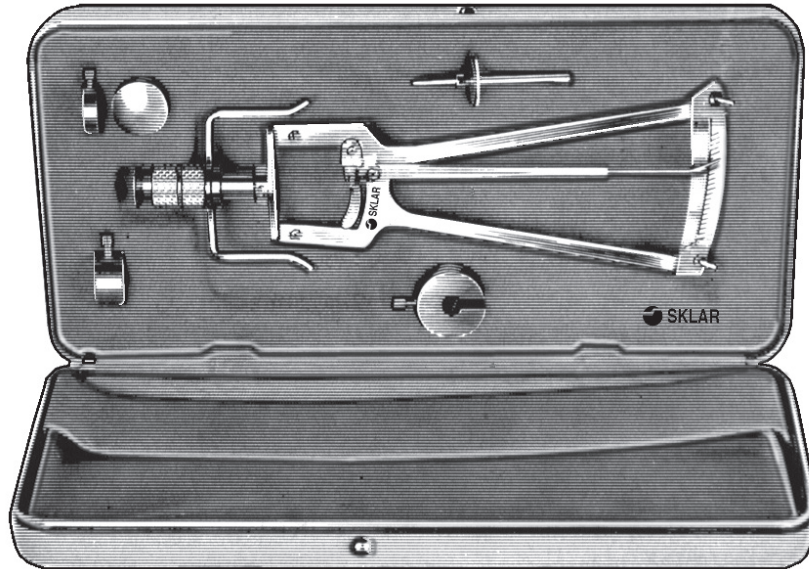

TEST BLOCK • FITTED TONOMETER CASE • CERTIFIED

**SCHIOTZ TONOMETER**

SKLAR ORIGINAL

65-7523 Screw-on 5.5GR Weight 2 Additional Weights 7.5 10GR

**SKLAR FACE MASKS**

The Sklar Disposable Face Mask features slip-on convenience and protects against infectious pathogens. Sklar masks are ≥98% BFE, non-woven, soft and breathable. Convenient ear loops and adjustable nose-bridge ensures a proper fit.

Latex Free.

**NON-STERILE**

PRODUCT NUMBER	FEATURES	QUANTITIES
96-5557	Mask Earloop, Blue	50/bx
96-5557A	Mask Earloop, Blue	500/cs
96-5557BNS	Mask Earloop, Blue, Bulk	2000/cs



For a complete listing of our Ophthalmic product line, visit [www.sklarcorp.com](http://www.sklarcorp.com).

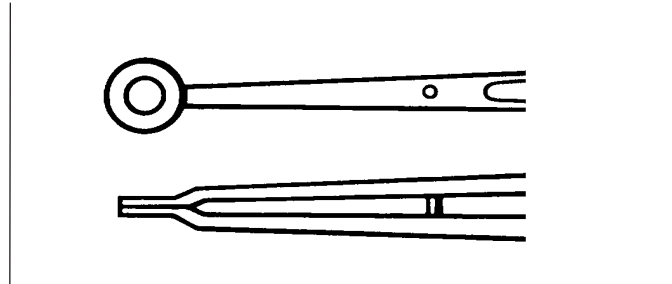
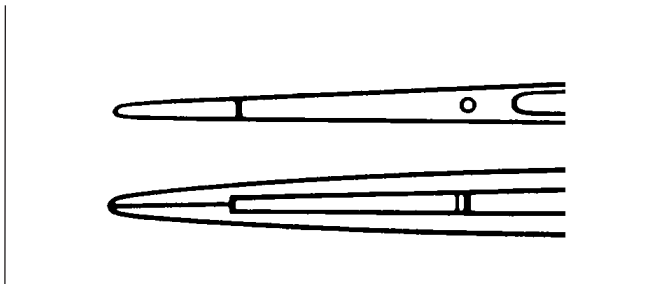
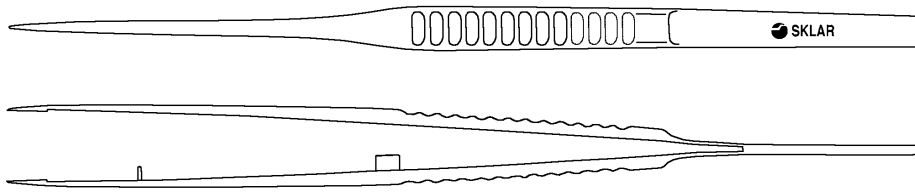

**MICRO FORCEPS**

**STRAIGHT FLAT HANDLE, POINTED TIP**

98-7710 240mm Long

**STRAIGHT FLAT HANDLE, BLUNT TIP**

98-7704 240mm Long

**TUMOR GRASPING FORCEPS**

**STRAIGHT FLAT TIP**

98-7720 240mm Long

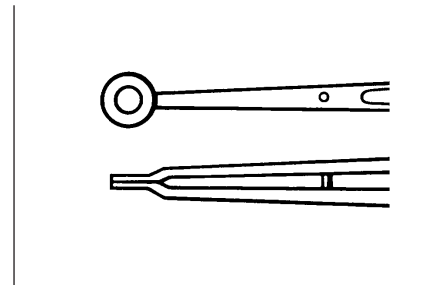
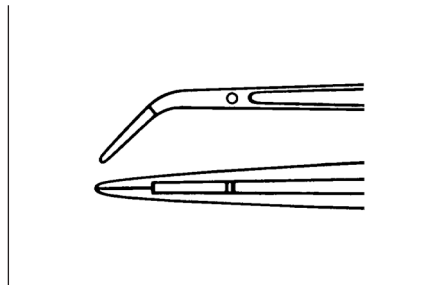
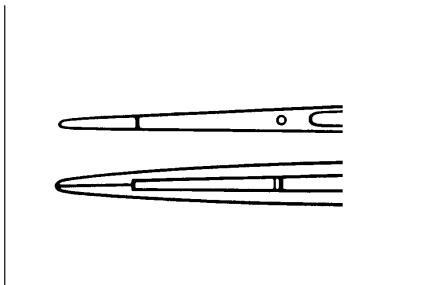
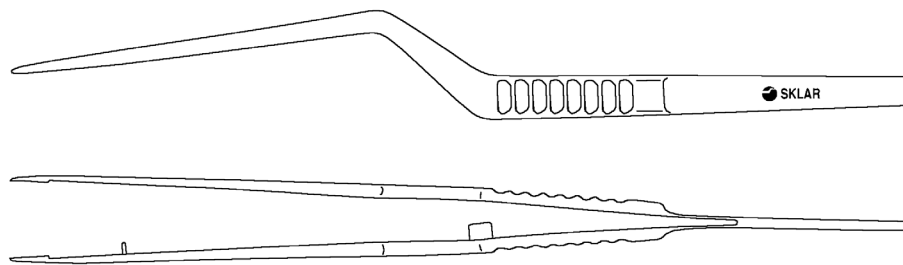

**MICRO FORCEPS**

**BAYONET FLAT HANDLE**

**STRAIGHT BLUNT TIP**

98-7740 160mm Long

98-7744 240mm Long

**MICRO FORCEPS**

**BAYONET FLAT HANDLE**

**ANGLED BLUNT TIP**

98-7754 200mm Long

**TUMOR GRASPING FORCEPS**

**BAYONET FLAT HANDLE**

98-7758 200mm Long

**MICROSURGERY  
NEEDLE HOLDERS**

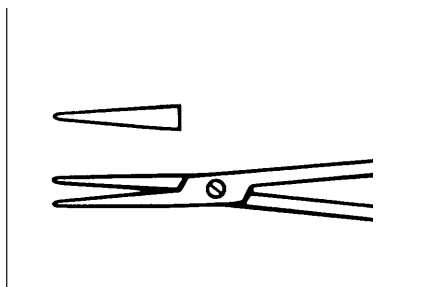
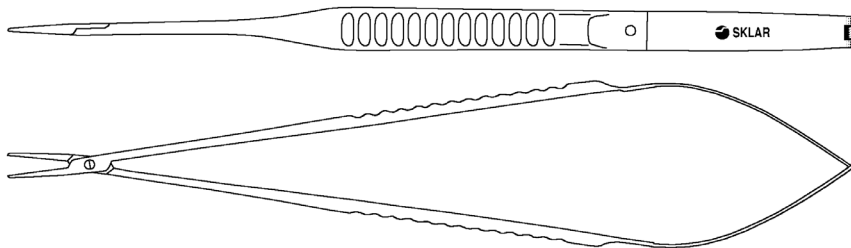

**NEEDLE HOLDERS**  
STRAIGHT FLAT HANDLE  
STRAIGHT TIP, WITHOUT LOCK  
98-7782 200mm Long  
98-7784 240mm Long

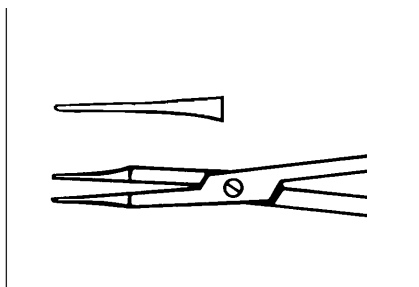

**MICRO NEEDLE HOLDERS**  
STRAIGHT FLAT HANDLE  
STRAIGHT TIP, WITHOUT LOCK  
98-7786 160mm Long  
98-7788 200mm Long

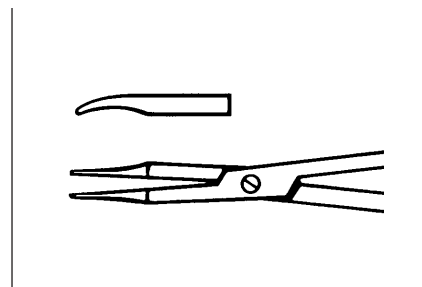

**MICRO NEEDLE HOLDERS**  
SLIGHTLY CURVED TIP, WITHOUT LOCK  
98-7794 200mm Long  
98-7796 240mm Long

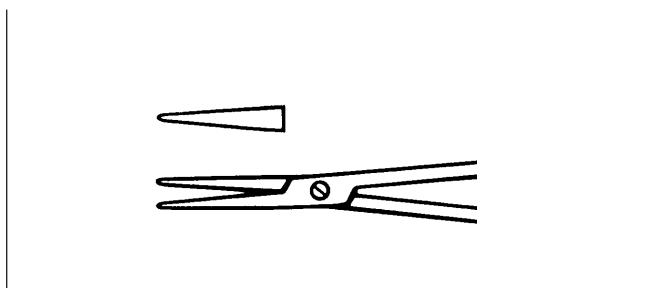
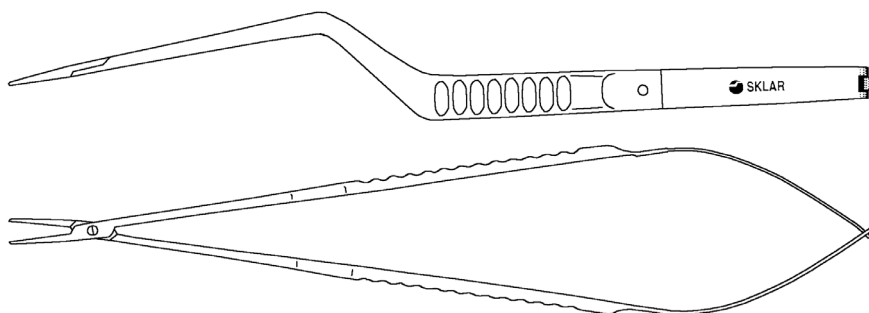

**NEEDLE HOLDER**  
BAYONET FLAT HANDLE (WITHOUT LOCK), STRAIGHT TIP  
98-7820 160mm Long

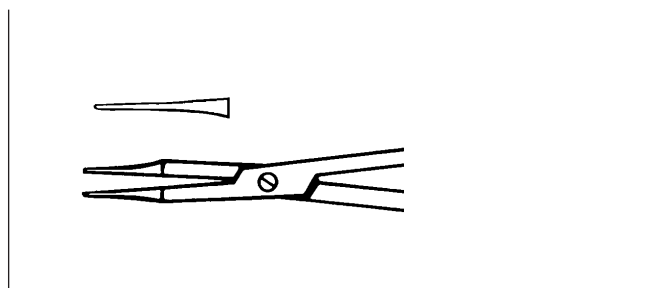

**MICRO NEEDLE HOLDER**  
BAYONET FLAT HANDLE (WITHOUT LOCK), STRAIGHT TIP  
98-7836 240mm Long

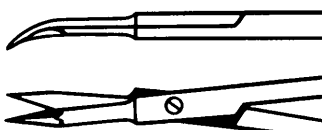
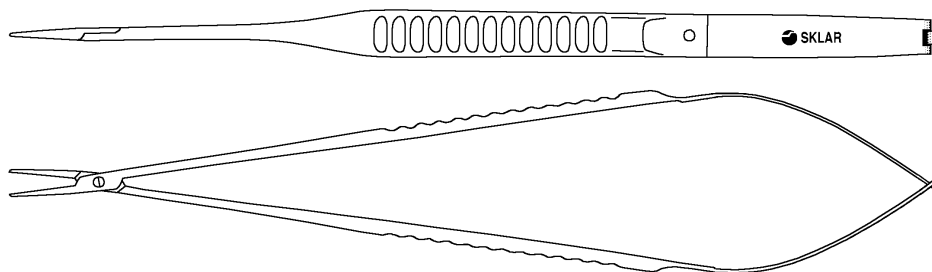

**MICRO SCISSORS**

STRAIGHT FLAT HANDLE, VANNAS BLADES

STRAIGHT TIP

98-7277 160mm Long

98-7278 200mm Long

98-7279 240mm Long

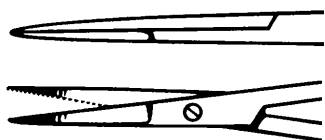
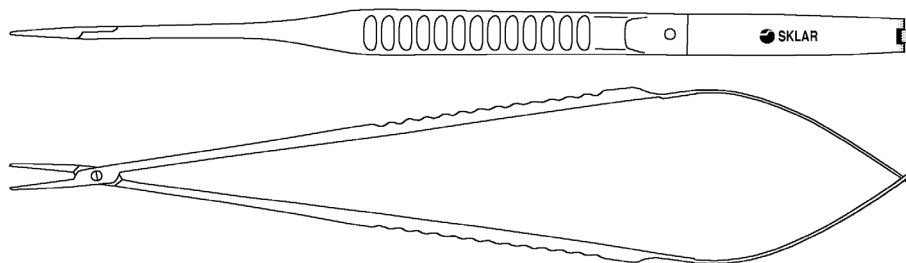

**SCISSORS**

STRAIGHT FLAT HANDLE

STRAIGHT TIP TOOTHED BLADES

98-7892 200mm Long

98-7894 240mm Long

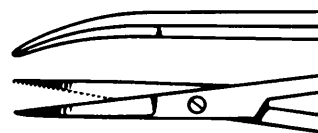

**SCISSOR**

STRAIGHT FLAT HANDLE

CURVED TIP TOOTHED BLADES

98-7898 200mm Long

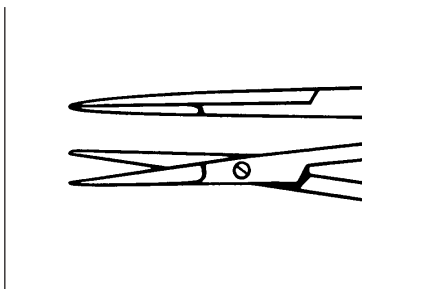
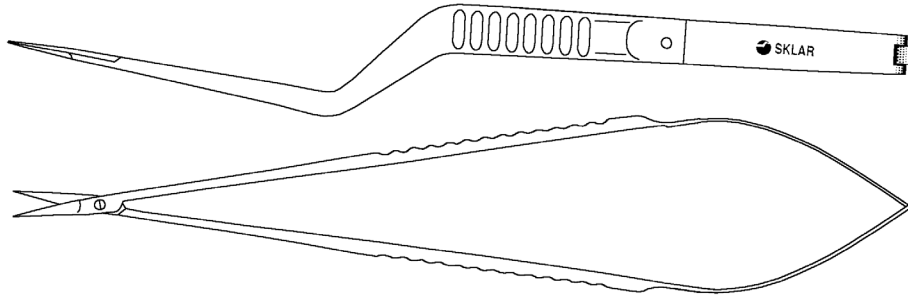

**MICRO SCISSORS**  
BAYONET FLAT HANDLE  
STRAIGHT TIP  
98-7920 160mm Long  
98-7924 240mm Long

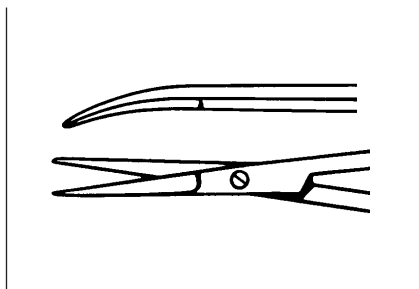

**MICRO SCISSOR**  
BAYONET FLAT HANDLE  
CURVED TIP  
98-7930 240mm Long

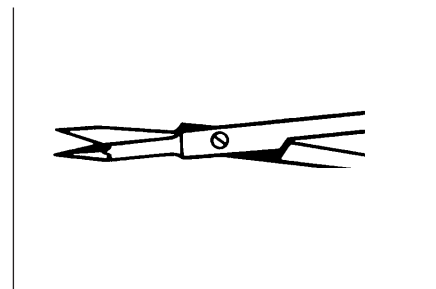

**MICRO SCISSOR**  
BAYONET FLAT HANDLE  
STRAIGHT TIP VANNAS BLADES  
98-7936 240mm Long

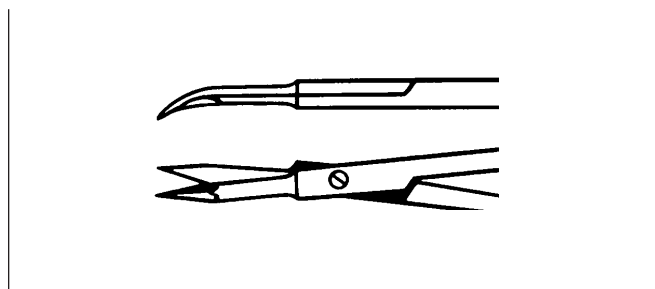

**MICRO SCISSORS**  
BAYONET FLAT HANDLE  
CURVED TIP VANNAS BLADES  
98-7950 160mm Long  
98-7952 200mm Long  
98-7954 240mm Long

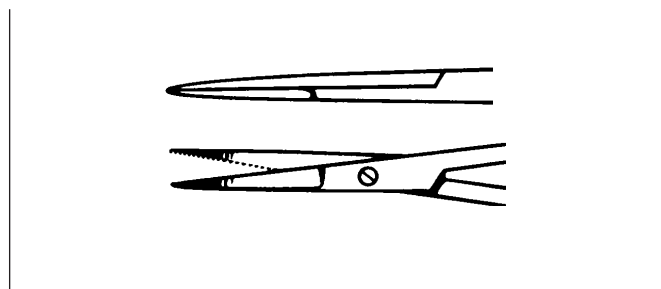

**SCISSOR**  
BAYONET FLAT HANDLE  
STRAIGHT TIP TOOTHED BLADES  
98-7960 240mm Long

MICROSURGERY

SCISSORS

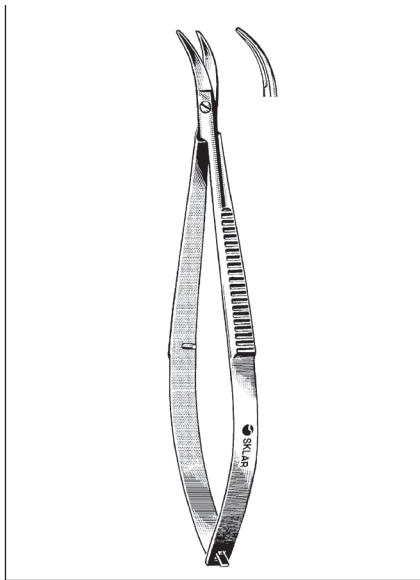

**CASTROVIEJO CORNEAL  
SCISSOR**

64-2442 4" Curved Blunt Blades

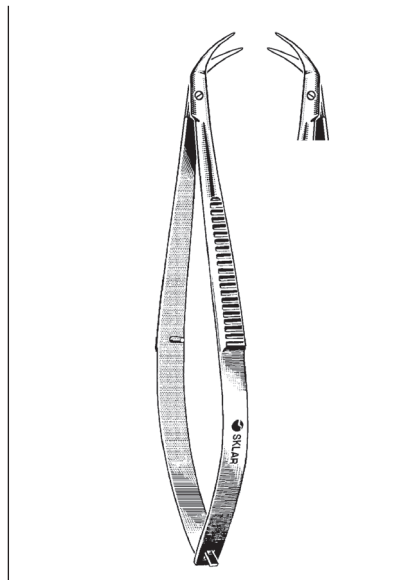

**CASTROVIEJO CORNEAL  
SCISSORS**

**MINIATURE WITH INNER BLADE,  
0.5 MM LONGER THAN OUTER  
BLADE**

64-2242 4¼" Curved Right

64-2342 4¼" Curved Left



**CASTROVIEJO CORNEAL  
SCISSOR**

64-2535 4" 13mm Blunt  
Angled Blades

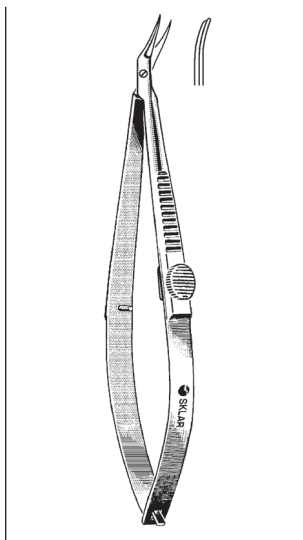

**CASTROVIEJO  
CORNEAL SCISSOR**  
INNER BLADE LONGER THAN OUTER  
BLADE

64-3294 4" Right

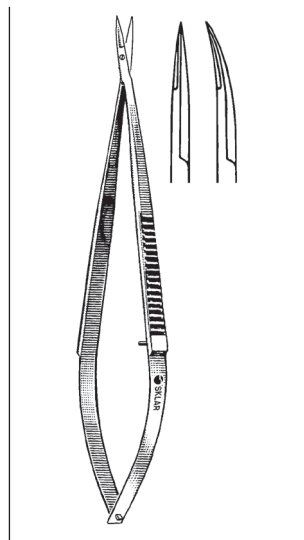

**IRIS  
MICRO-MINIATURE  
SCISSORS**

**EXTRA DELICATE, SHARP POINTS**

64-3050 4" Straight

64-3052 4" Curved

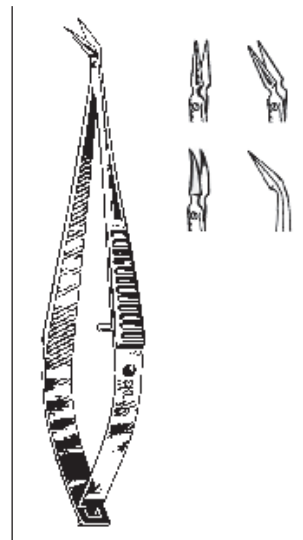

**VANNAS SPRING  
HANDLE SCISSORS**

**VERY DELICATE**

64-1950 3" Straight

64-1951 3" Curved

64-1952 3" Angular

64-1955 3" Angled on flat

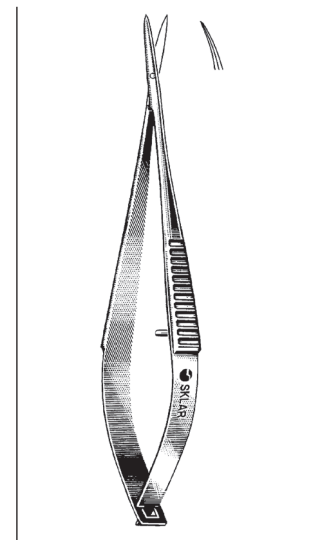

**MCPHERSON-VANNAS  
SCISSORS**

**VERY DELICATE**

64-1960 3" Straight

64-1961 3" Curved



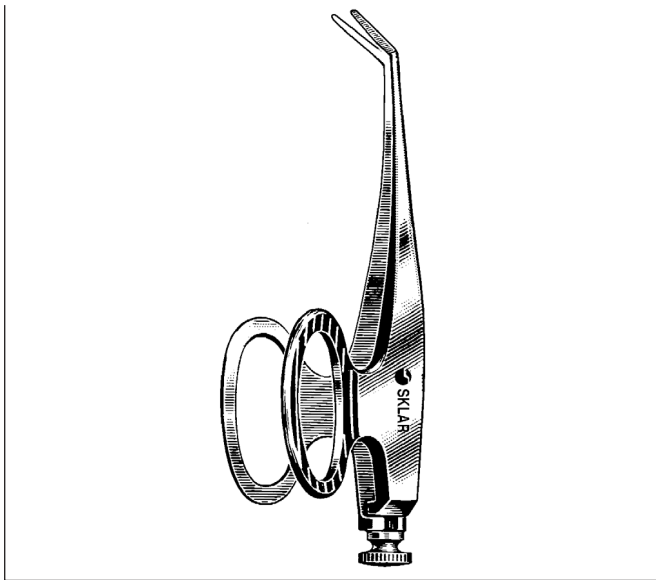

**BARRAQUER-DEWECKER IRIS SCISSORS**

64-3225 2¼" Fine 7mm Blades  
64-3228 2¼" Delicate 10mm Blades



**WILMER SCISSOR**

64-1735 4" Angled on Flat

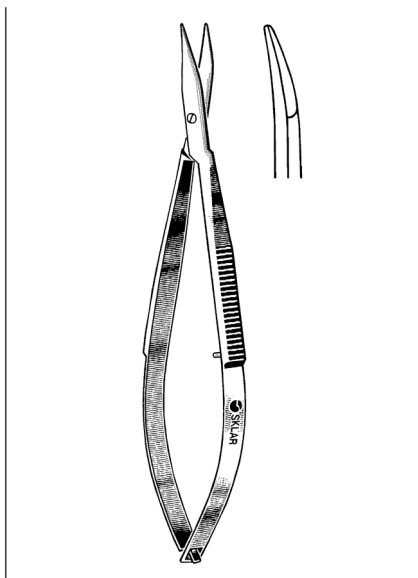

**WESTCOTT TENOTOMY  
SCISSOR**

64-3146 4¼" Blunt Tips with  
Spring Handle



**WESTCOTT TENOTOMY  
SCISSORS**

64-3142 5" Right  
64-3144 5" Left

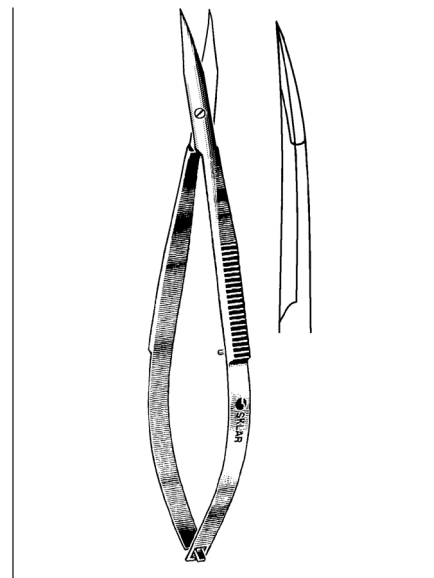

**WESTCOTT SCISSOR**

64-3145 4¼" Sharp Tips with  
Spring Handle

MICROSURGERY

FORCEPS

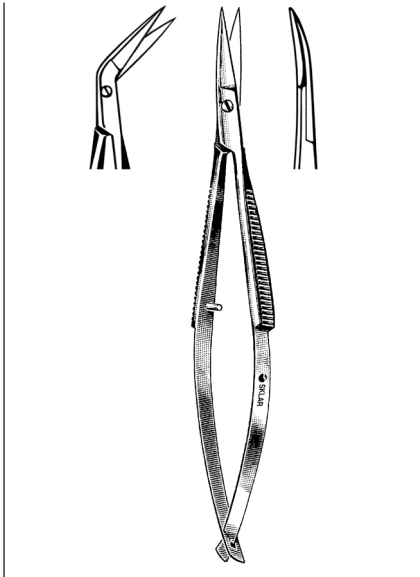

**McCLURE IRIS SCISSORS**

**7 MM STRAIGHT**

- 64-1742 4¼" Angled
- 64-1842 4¼" Straight
- 64-1942 4¼" Curved

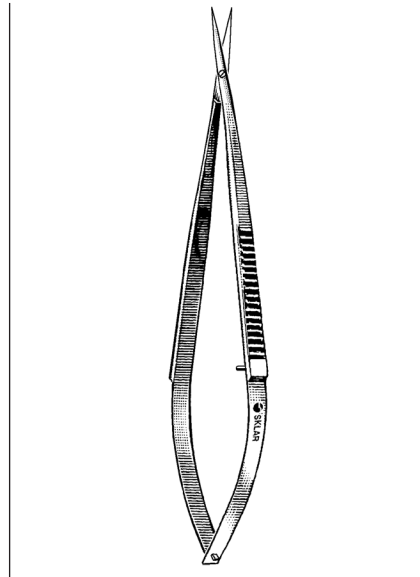

**FINE STITCH SCISSOR**

- 64-3260 4¼" Delicate Sharp Blades

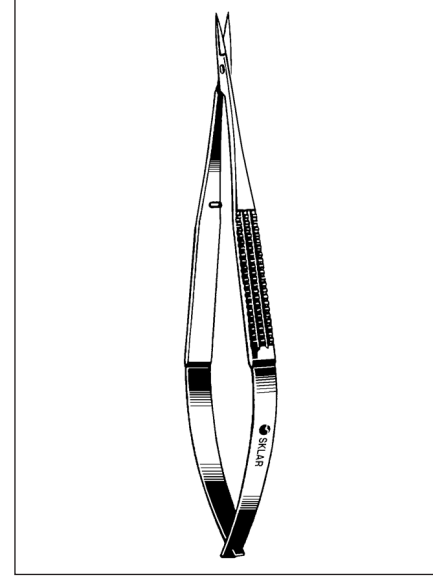

**MICRO SURGERY SCISSORS**

**6" SHARP POINTS FLAT HANDLE**

- 98-7810 Straight
- 98-7812 Curved

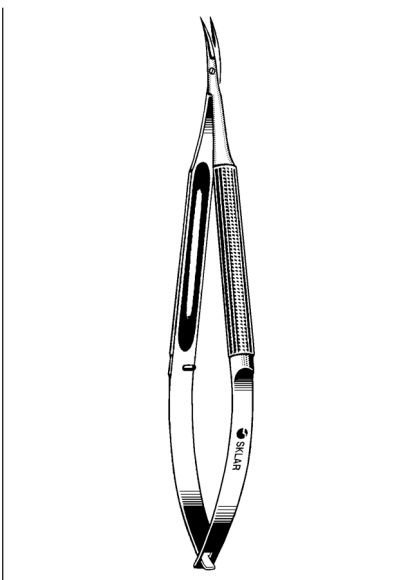

**MICRO SURGERY SCISSOR**

**6" SHARP POINTS ROUND HANDLE**

- 98-7815 Curved

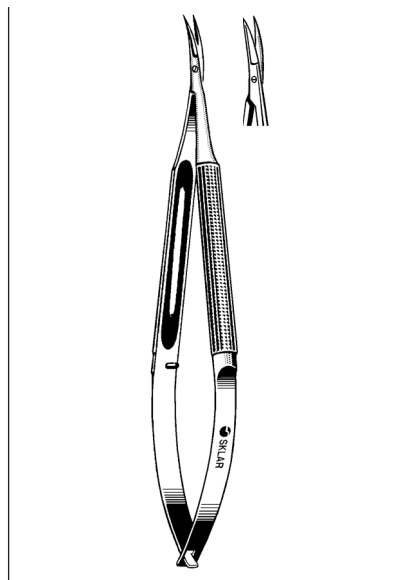

**MICRO SURGERY SCISSORS**

**7½" ROUND HANDLE**

- 98-7816 Straight
- 98-7817 Curved

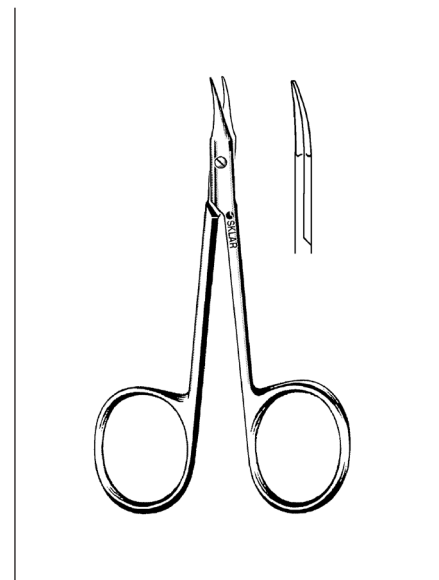

**GRADLE-SCISSOR**

**SLIGHTLY CURVED, SHARP**

- 64-3280 3¾"

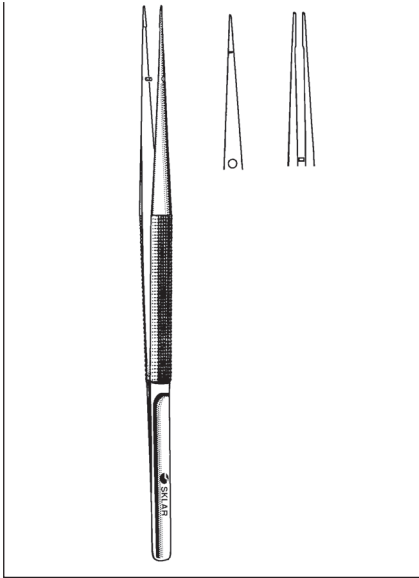

**RHOTON MICRO  
SUTURE FORCEPS**  
7" 0.6 MM TYING PLATFORM  
98-3055 Straight

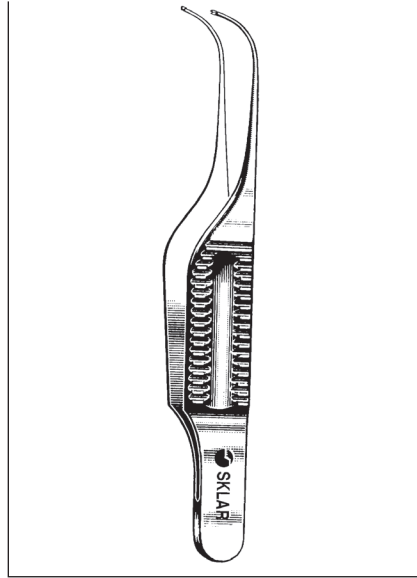

**GILL FORCEPS**  
66-7130 Iris Curved,  
Length 3"  
66-7230 Curved, Extra  
Delicate, Length 3"

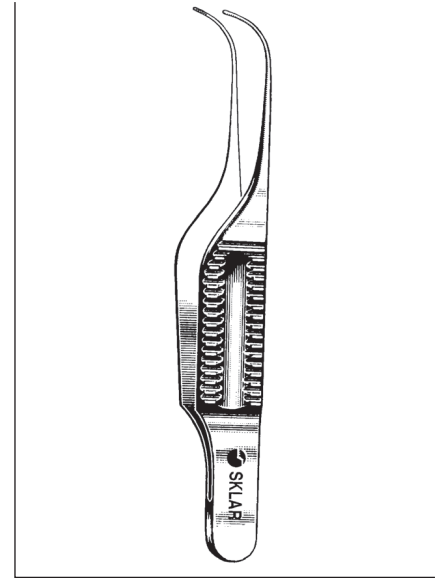

**GILL (CHANDLER) IRIS  
FORCEPS**  
0.6MM  
66-7244 3" Fine cross  
Serrated Tips  
66-7246 3" 1x2 Teeth

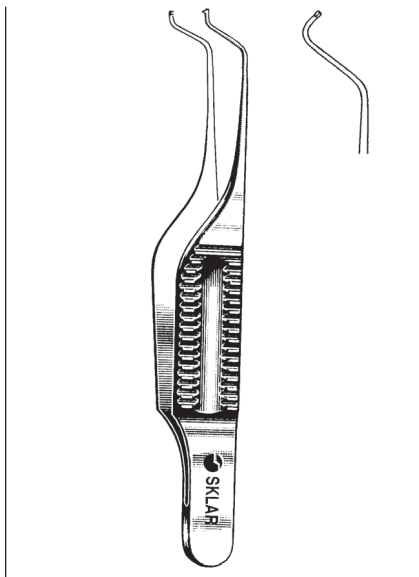

**GILL-HESS IRIS FORCEPS**  
66-7238 2¾" with 1x2 Teeth  
forward 0.5mm  
66-7240 2¾" with 1x2 Teeth  
down 0.5mm

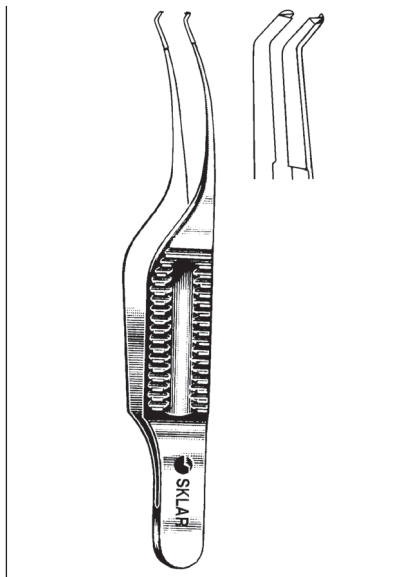

**TROUTMAN-BARRAQUER  
CORNEAL UTILITY FORCEPS**  
COLIBRI TYPE  
66-7250 1x2 0.5mm Teeth,  
set at 45° with  
tying platform

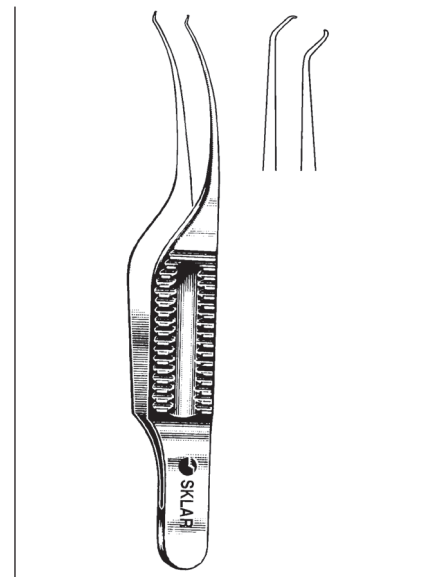

**COLIBRI CORNEAL UTILITY  
FORCEPS**  
3"  
66-7259 1x2 Teeth 0.12mm  
66-7261 1x2 Teeth 0.4mm

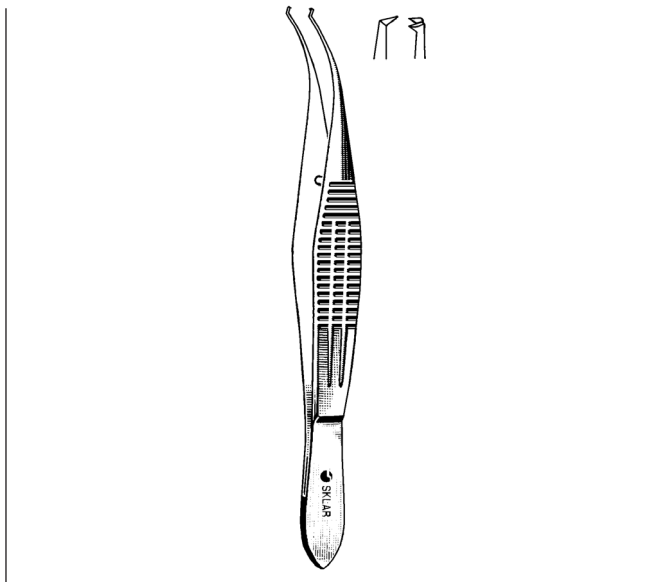

**CASTROVIEJO COLIBRI FORCEPS**

WIDE HANDLE 4" EXTRA DELICATE

66-3450 1x2 Teeth 0.12mm



**FORESTER IRIS FORCEPS**

3¾" CURVED TIPS, 1X2 TEETH ON OUTSIDE OF CURVE

66-4530 Standard handle



**BISHOP HARMON FORCEPS**

1X2 STRAIGHT TEETH, DELICATE TIP

66-4232 3½"

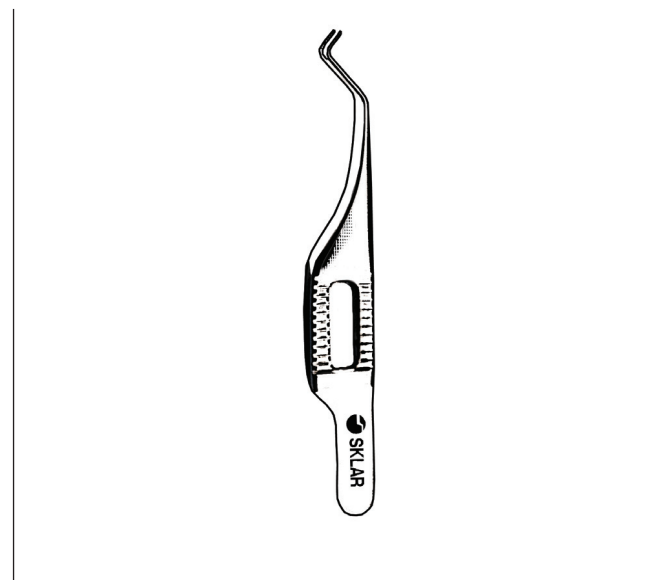

**BOTVIN IRIS FORCEPS**

66-7258 2⅞" Fine cross serrated tips 0.5mm wide

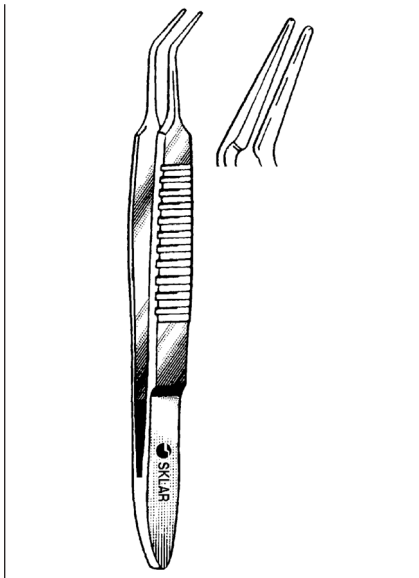

**BECHERT-MCPHERSON TYING FORCEPS**

10MM TYING PLATFORM, 83MM  
66-6178 Smooth jaws, angled

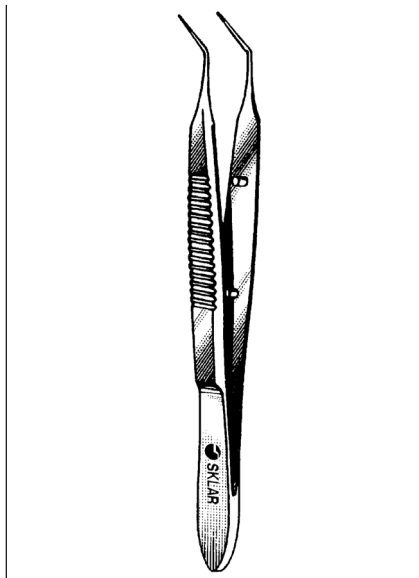

**KELMAN-McPHERSON TYING FORCEPS**

WITH TYING PLATFORM 7.5MM LONG, 0.3MM TIP WIDTH, ANGLED 3.31"  
66-6180

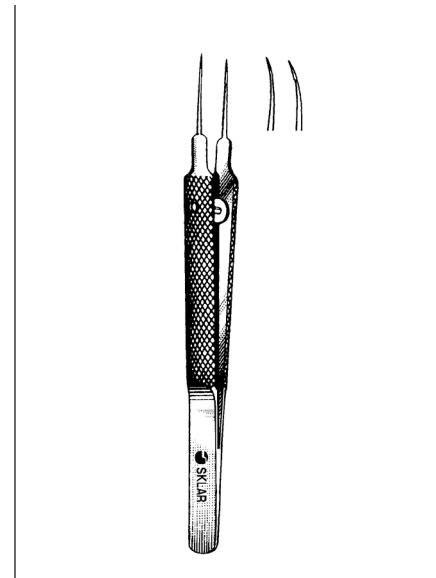

**TENNANT TYING FORCEPS**

EXTRA DELICATE, ROUND HANDLE TYING PLATFORM, 6MM, 0.3MM TIP WIDTH  
66-6194 4" Straight  
66-6196 4" Curved

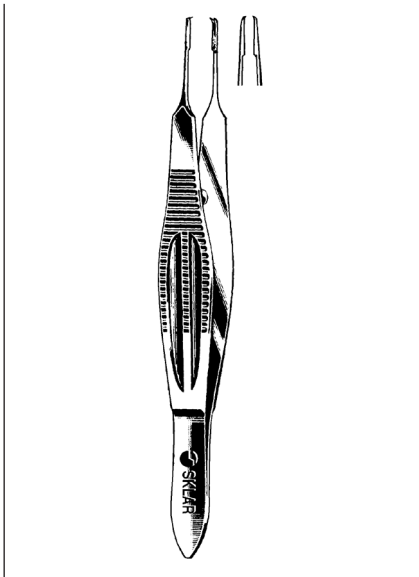

**CASTROVIEJO SUTURE FORCEPS**

4¼" 1X2 PLATFORM BEHIND TEETH LIMITS DEPTH OF PENETRATION, WIDE HANDLE  
66-6116 0.12mm delicate teeth  
66-6117 0.3mm delicate teeth  
66-6115 0.5mm delicate teeth  
66-6118 1.5mm delicate teeth

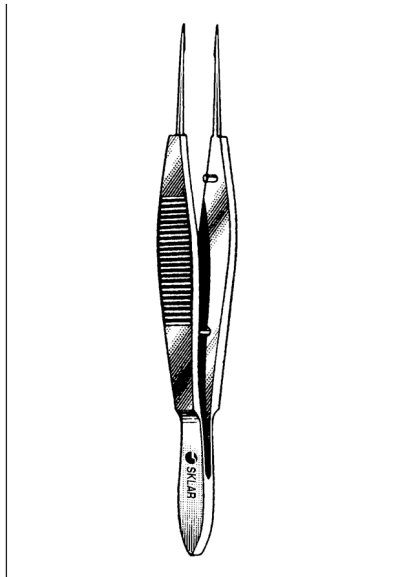

**BONN TYING FORCEPS**  
WITH TYING PLATFORM 0.3 MM TIP WIDTH  
66-6160 4" Straight

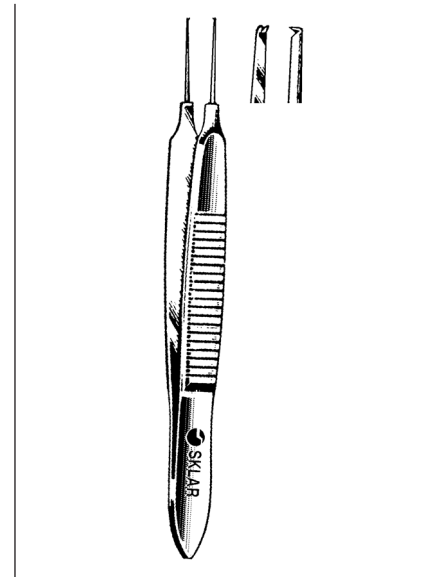

**BONN MICRO SUTURING FORCEPS**  
0.12 MM WITH TYING PLATFORM  
66-6125 2¾" 1x2 Teeth  
66-6126 3¾" 1x2 Teeth

**MICROSURGERY**

**JEWELERS FORCEPS**

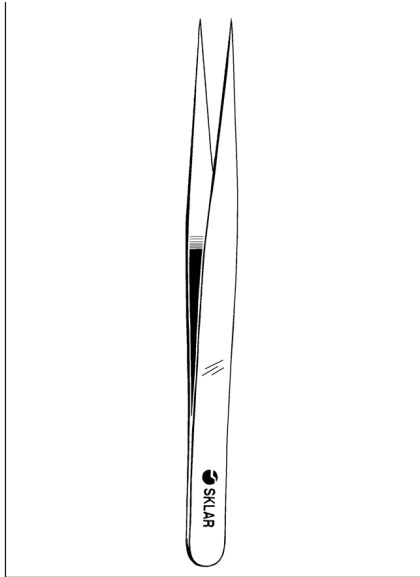

**JEWELERS STYLE FORCEPS**

66-7447 #3 Straight  
66-7443 #3 Straight, Micro-Fine

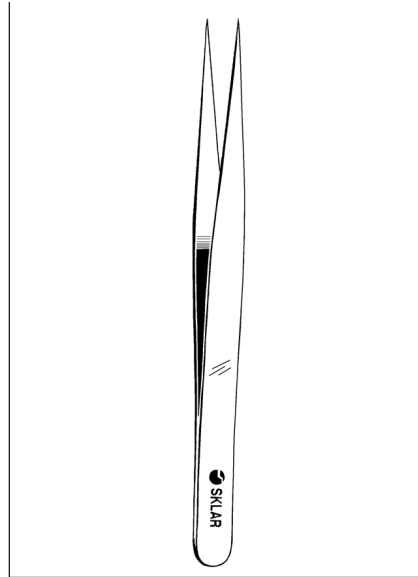

**JEWELERS STYLE FORCEPS**

66-7442 #3C Straight, Delicate

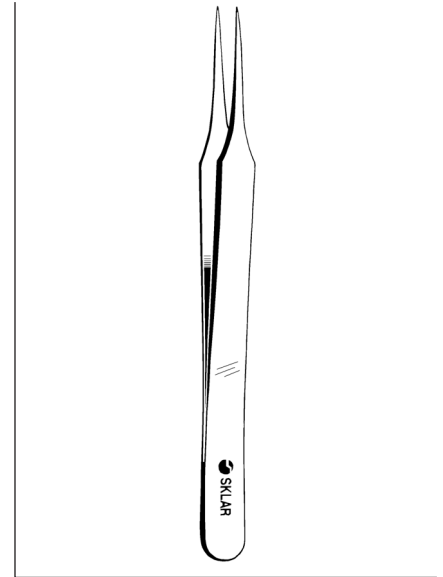

**JEWELERS STYLE FORCEPS**

66-7542 #4 Straight, Delicate

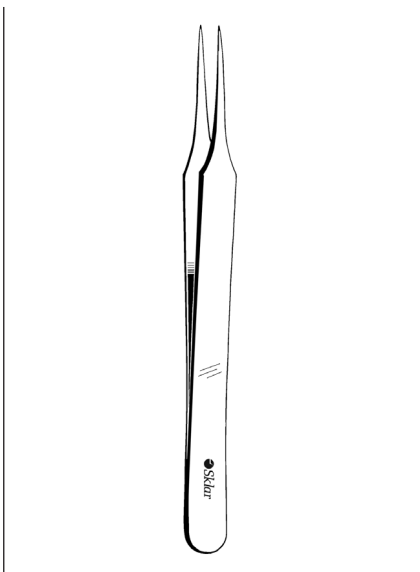

**JEWELERS STYLE FORCEPS**

66-7642 #5 Straight  
66-7643 #5 Straight, Micro-Fine

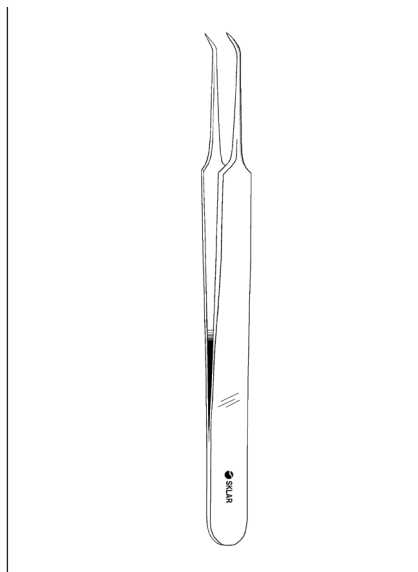

**JEWELERS STYLE FORCEPS**

66-7645 #5 Angled

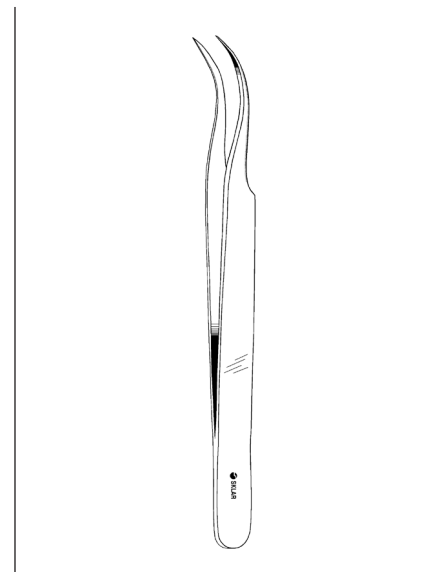

**JEWELERS STYLE FORCEPS**

66-7644 #7 Curved  
66-7446 #7 Curved, Micro-Fine

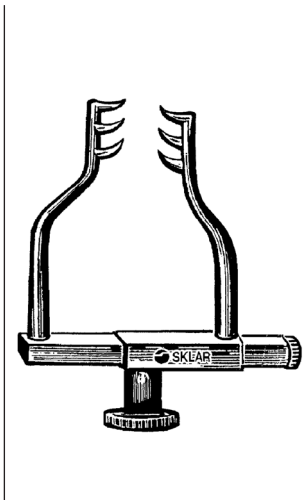

**GOLDSTEIN  
RETRACTOR**

47-2913 1½"

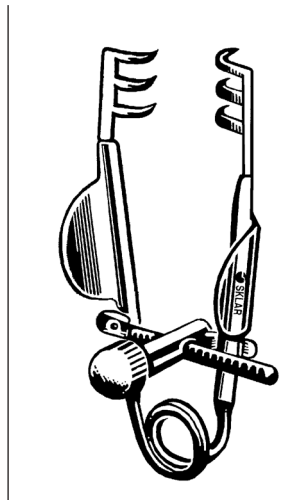

**MELLER DELICATE  
RETRACTOR**

65-1815 1½"

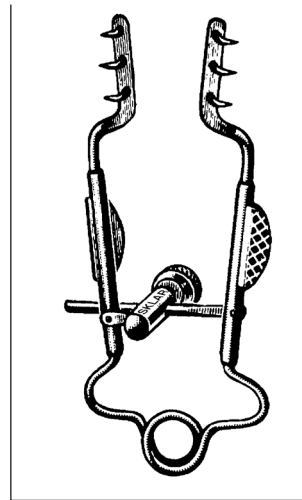

**MELLER LACRIMAL  
SAC RETRACTOR**

3 PRONG, 3 MM DEEP  
65-1830 3"

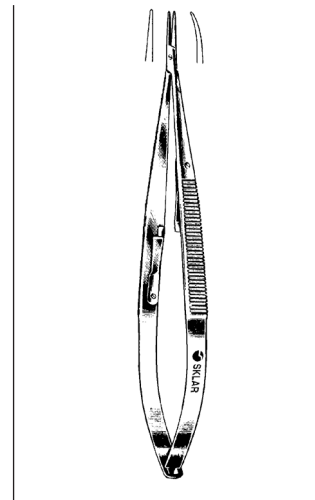

**CASTROVIEJO  
NEEDLE HOLDERS**

STANDARD HANDLE, DELICATE,  
SMOOTH JAWS TO HOLD 7-0  
SUTURES

**WITHOUT CATCH**

65-6350 5½" Straight Jaw  
65-6351 5½" Curved Jaw

**WITH CATCH**

65-6352 5½" Straight Jaw  
65-6354 5½" Curved Jaw

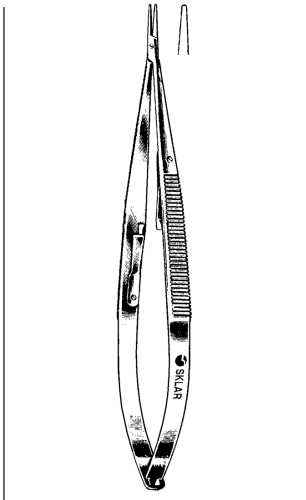

**CASTROVIEJO  
NEEDLE HOLDERS**

**WITH CATCH**

65-6357 5½" Straight  
65-6358 5½" Curved

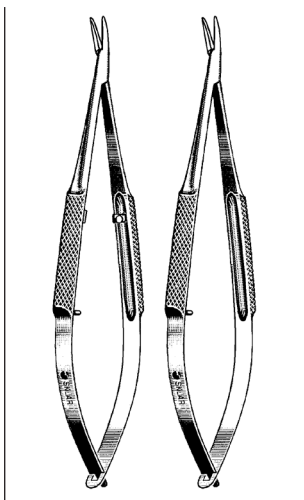

**COHAN NEEDLE  
HOLDERS**

MINI-MICRO, 7 MM JAWS, 4"

65-6470 Curved without lock  
65-6475 Curved with lock

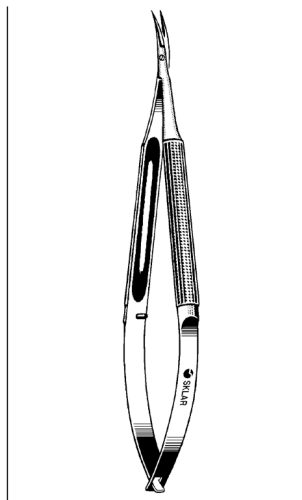

**MICRO SURGERY  
NEEDLE HOLDER**

5¼", WITH ROUND HANDLE

98-3180 Curved Jaws

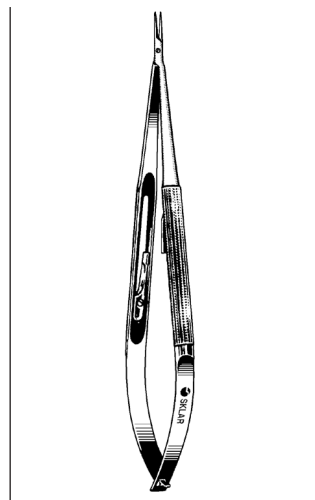

**MICRO SURGERY  
NEEDLE HOLDERS**

ROUND HANDLE, 0.6 MM TIP

**WITHOUT LOCK**

98-3182 6" Straight  
98-3183 6" Curved

**WITH LOCK**

98-3184 6" Straight  
98-3185 6" Curved

MICROSURGERY

NEEDLE HOLDERS

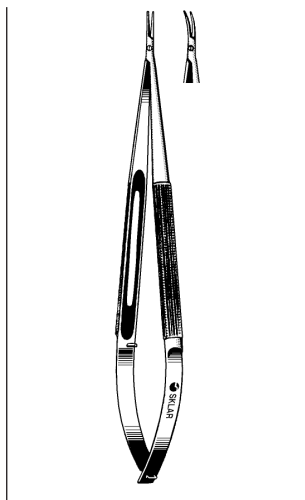

**MICRO SURGERY  
NEEDLE HOLDERS**

**7 1/8" WITH ROUND HANDLE**

- 98-3186 Straight Jaws  
0.6mm tips
- 98-3188 Curved Jaws  
0.6mm tips

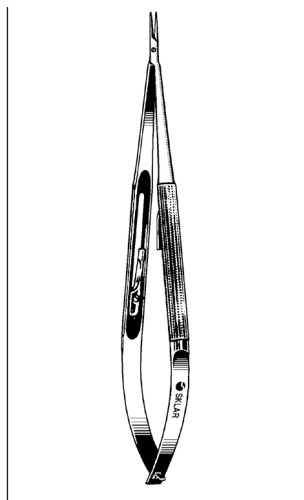

**MICRO SURGERY  
NEEDLE HOLDERS**

**7 1/8" WITH ROUND HANDLE**

- 98-3190 Straight Jaws with  
Lock, 0.6mm tips
- 98-3192 Curved Jaws with  
Lock, 0.6mm tips

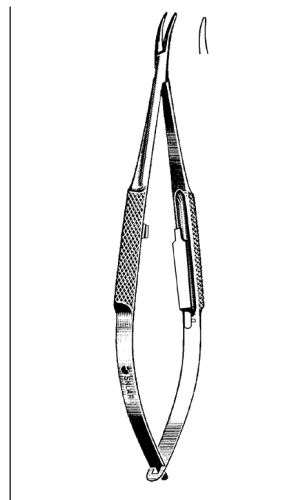

**BARRAQUER  
NEEDLE HOLDERS**

**ROUND GRIP SPRING HANDLE, WITH  
INSIDE CATCH, DELICATE**

- 65-6445 5 1/2" Straight
- 65-6446 5 1/2" Curved
- 65-6449 7 1/2" Straight
- 65-6450 7 1/2" Curved

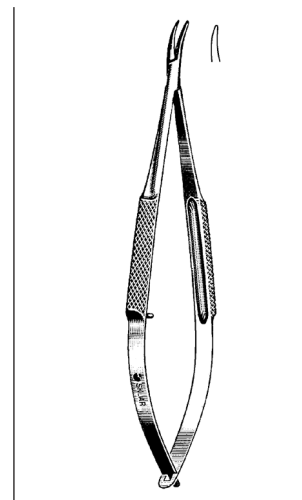

**BARRAQUER  
NEEDLE HOLDERS**

**ROUND GRIP, SPRING HANDLE**

- 65-6452 5 1/4" Curved
- 65-6454 5 1/2" Straight
- 65-6455 5 1/2" Curved
- 65-6456 7 1/2" Straight
- 65-6457 7 1/2" Curved

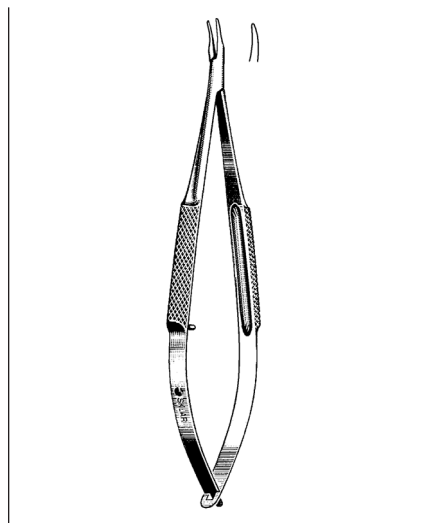

**TROUTMAN NEEDLE HOLDERS**

**EXTRA DELICATE CURVED JAW,  
ROUND GRIP, SPRING HANDLE**

- 65-6460 4" With inside catch
- 65-6462 4 3/4" Without inside catch



**STEVENS NEEDLE HOLDER**

- 65-6265 6 1/2"



**NEIVERT NEEDLE HOLDER**

- 20-1760 5" One offset Ring



**ORTHOPEDIC  
BONE CUTTING FORCEPS**

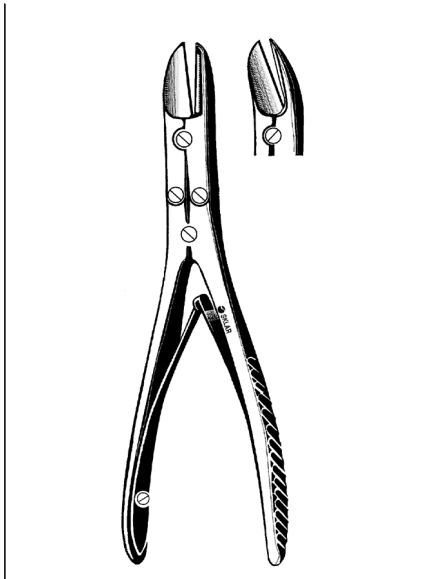

**RUSKIN-LISTON BONE CUTTING FORCEPS**

40-4572 7¼" Straight  
40-4575 7¼" Up-Angled

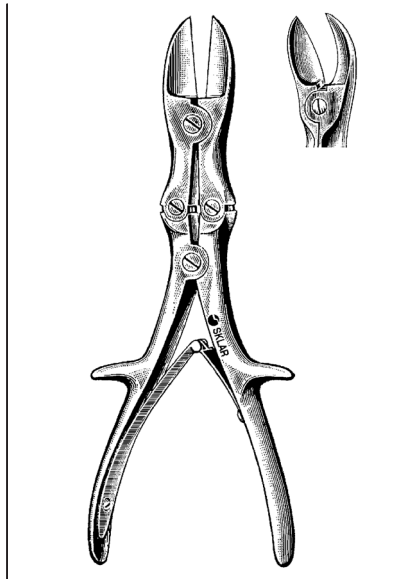

**STILLE-LISTON BONE CUTTING FORCEPS**

**DOUBLE ACTION**  
40-3710 10½" Straight  
40-3810 10½" Curved

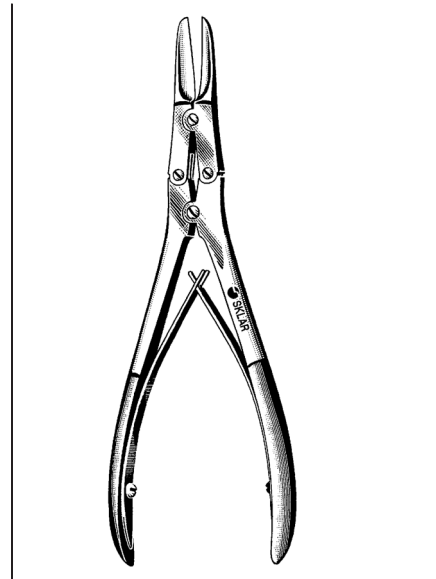

**KLEINERT-KUTZ BONE CUTTING FORCEPS**

**DOUBLE ACTION**  
40-4560 6" Straight  
40-4562 6" Delicate

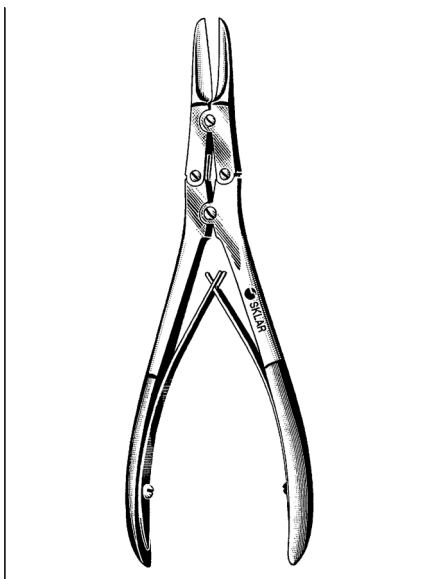

**ROWLAND BONE FORCEPS**

**DOUBLE ACTION**  
41-1175 7" Narrow Jaws

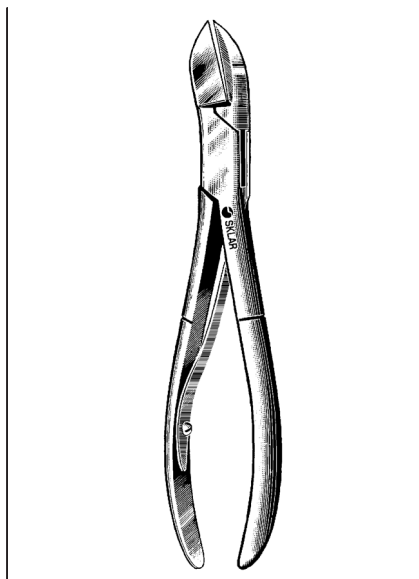

**LISTON BONE FORCEPS**

40-3155 5½" Angular  
40-3167 6¾" Angular  
40-3177 7¾" Angular  
40-3187 8¾" Angular

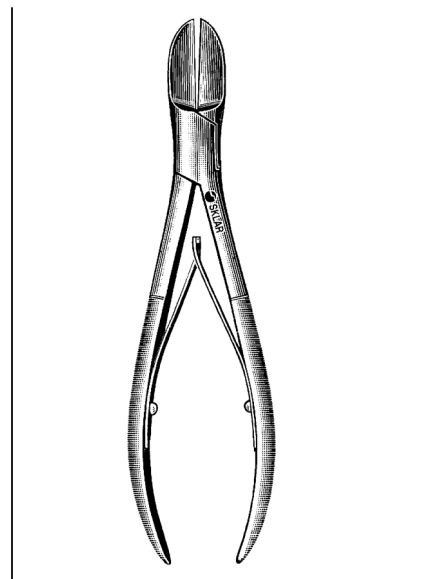

**LISTON BONE FORCEPS**

40-3055 5½" Straight  
40-3077 7¾" Straight  
40-3087 8¾" Straight

**For a complete listing of our Orthopedic product line, visit [www.sklarcorp.com](http://www.sklarcorp.com).**

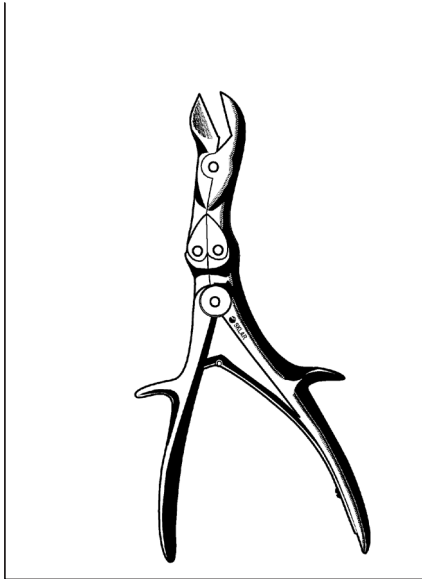

**STILLE-HORSLEY BONE CUTTING FORCEPS**

**BAYONET, DOUBLE ACTION**

40-3910 10½"

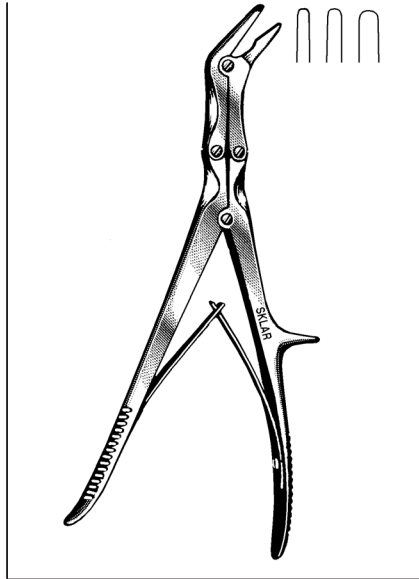

**ECHLIN RONGEURS**

**ANGULAR (DUCKBILL)**

40-4100 9" 2 x 15mm Bite  
40-4102 9" 3 x 15mm Bite  
40-4104 9" 4 x 15mm Bite

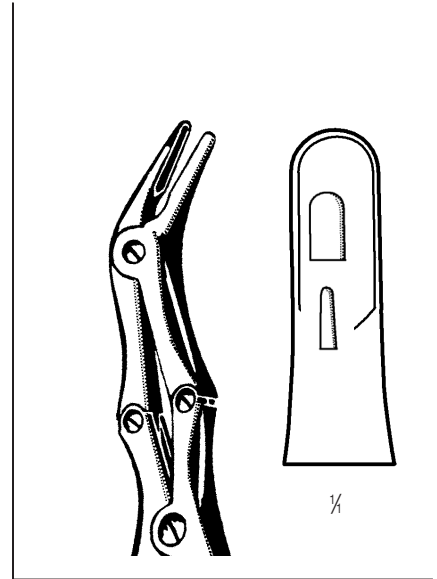

**LEKSELL RONGEURS**

**DOUBLE ACTION**

40-4092 9" Slightly Curved 8mm  
40-4095 9" Slightly Curved 3mm

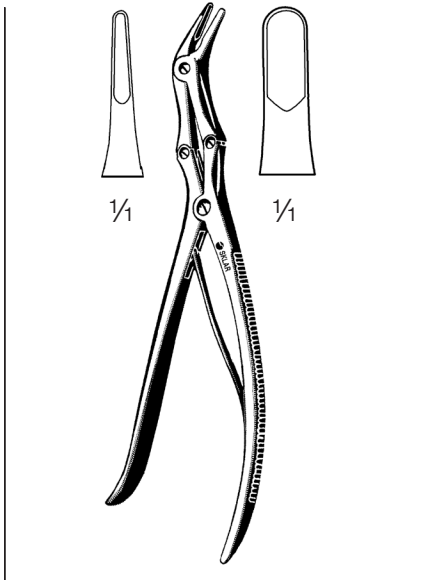

**LEKSELL ANGULAR BITE RONGEURS**

40-4097 9" 3mm Angled  
40-4098 9" 8mm Angled

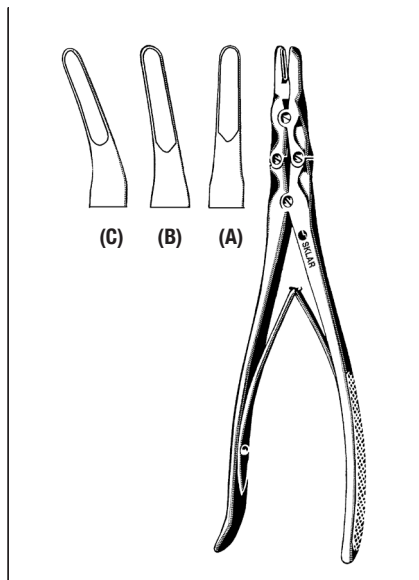

**SMITH-PETERSEN LAMINECTOMY RONGEURS**

40-4110 9½" 3mm Bite Straight (A)  
40-4112 9½" 3mm Bite Half Curved (B)  
40-4114 9½" 3mm Bite Full Curve (C)

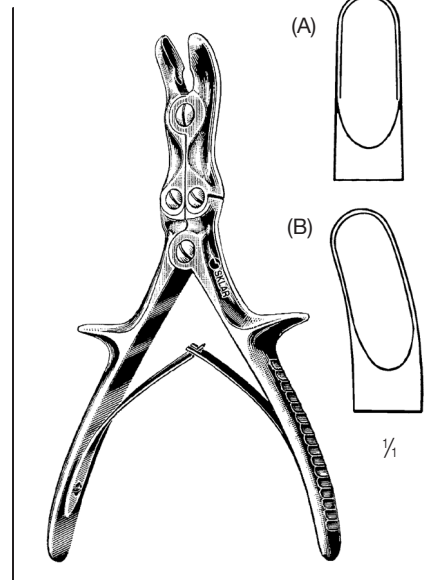

**STILLE-LUER RONGEURS**

**DOUBLE ACTION**

40-3985 8½" Straight (A)  
40-4085 8½" Curved (B)  
40-4090 8½" Angular

For a complete listing of our Orthopedic product line, visit [www.sklarcorp.com](http://www.sklarcorp.com).

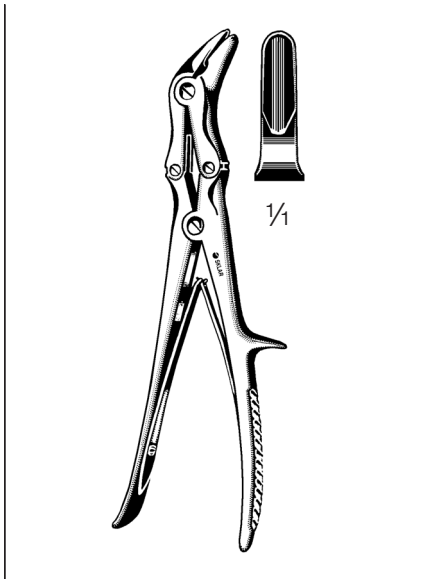

**STILLE-LUER ECHLIN RONGEUR**  
40-4125 9" 6 x 12mm Jaws  
Angled to Side

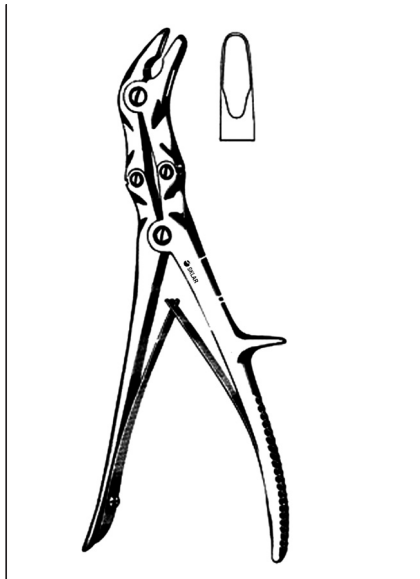

**STILLE RONGEUR**  
**DOUBLE ACTION**  
40-4086 9" 45° Angled  
6mm x 15mm Jaw

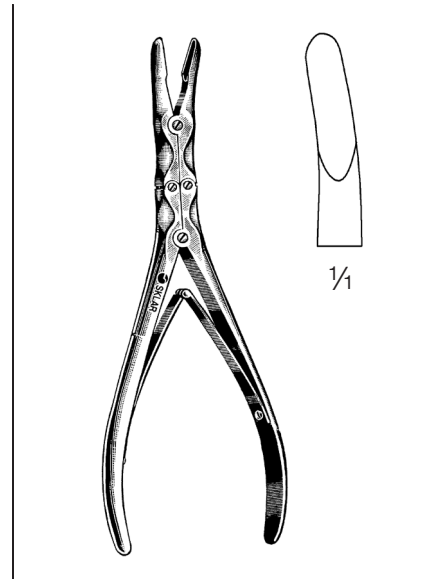

**ZAUFEL-JANSEN RONGEUR**  
40-4265 9" 5 x 15mm Curved Bite

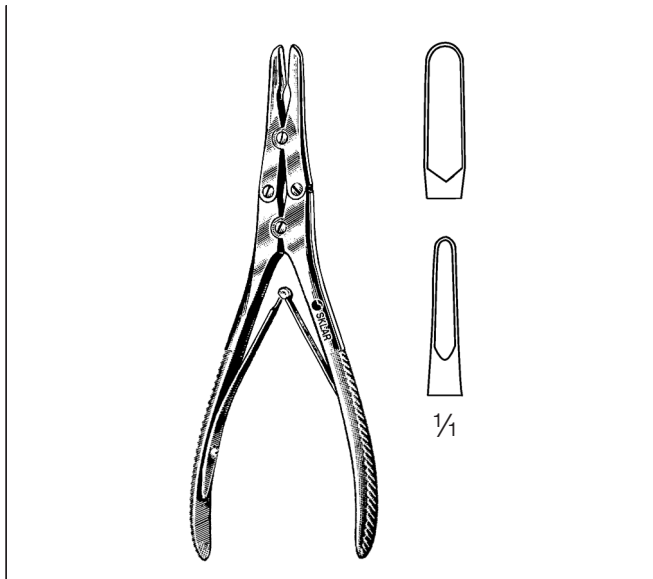

**RUSKIN RONGEURS**  
40-4360 6" Straight 2mm Bite  
40-4365 6" Curved 2mm Bite  
40-4272 7¼" Straight 5mm Bite  
40-4372 7¼" Curved 5mm Bite  
40-4472 7¼" Angled to Side 5mm Bite  
40-4512 9½" Curved 5mm Bite

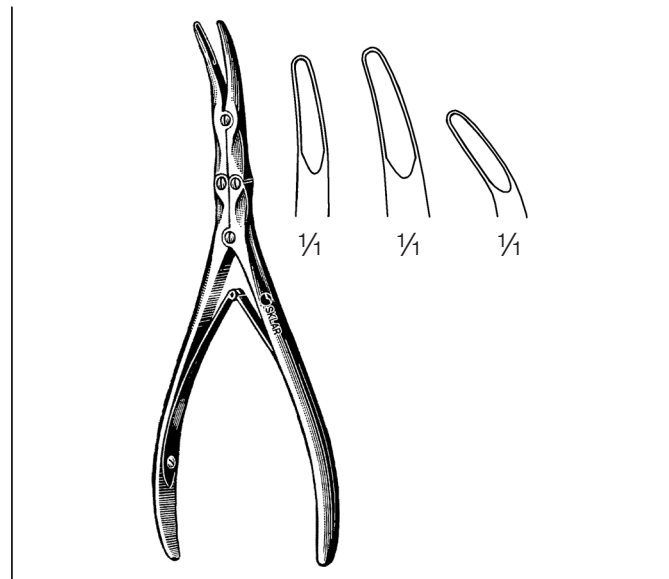

**KLEINERT-KUTZ RONGEURS**  
**DOUBLE ACTION**  
40-4190 6" Slight Curve 2 x 13mm Bite  
40-4192 6" Curved 3 x 16mm Bite  
40-4194 6" Full Curve 3 x 8mm Bite

For a complete listing of our Orthopedic product line, visit [www.sklarcorp.com](http://www.sklarcorp.com).

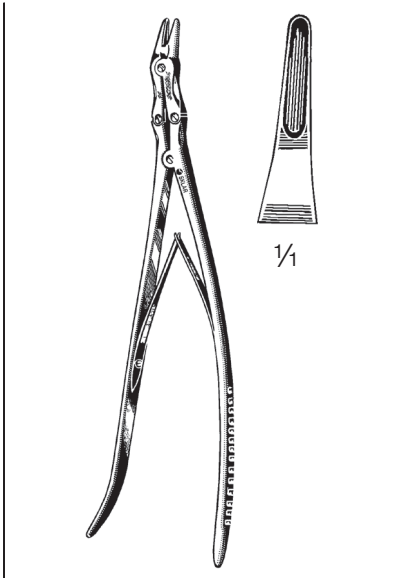
**DALE FIRST RIB RONGEUR**

55-1530 14" 3mm Bite

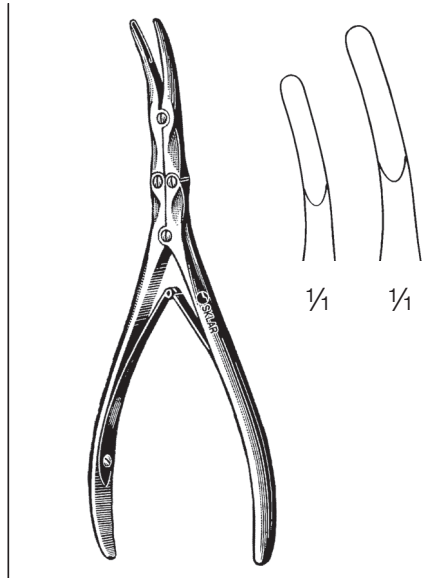

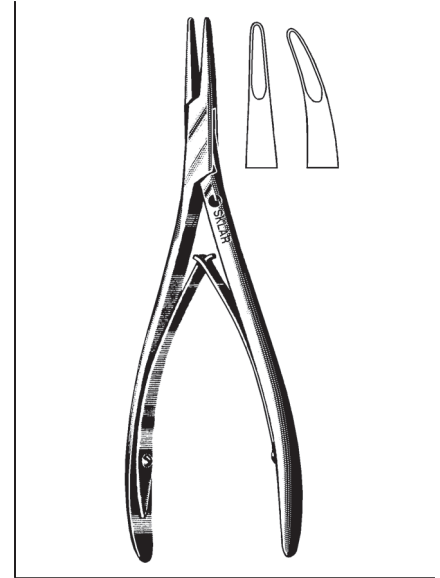
**BEYER BONE RONGEURS**
**DOUBLE ACTION**

 40-4268 7" Curved 3 x 14mm Jaw  
 40-4270 7" Curved 4 x 15mm Jaw

**LEMPERT RONGEURS**

 47-2467 6 1/4" Straight  
 47-2468 6 1/4" Curved  
 47-2465 7 1/2" Straight  
 47-2466 7 1/2" Curved

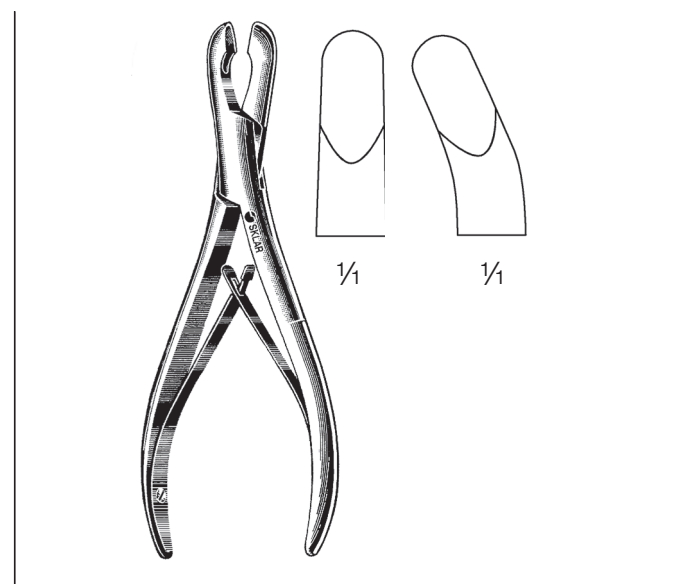
**DEAN BONE RONGEUR**
**SINGLE ACTION**

47-2455 5 1/2" Curved

**LUER BONE RONGEURS**

 40-3570 7" Straight 8 x 10mm  
 40-3670 7" Curved 8 x 10mm

 For a complete listing of our Orthopedic product line, visit [www.sklarcorp.com](http://www.sklarcorp.com).

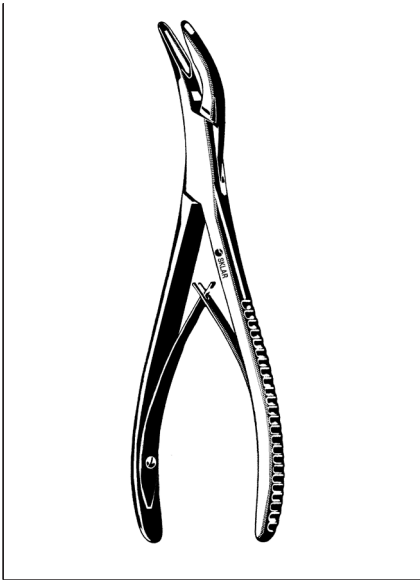

**OLIVECRONA RONGEUR**

47-2480 7½"

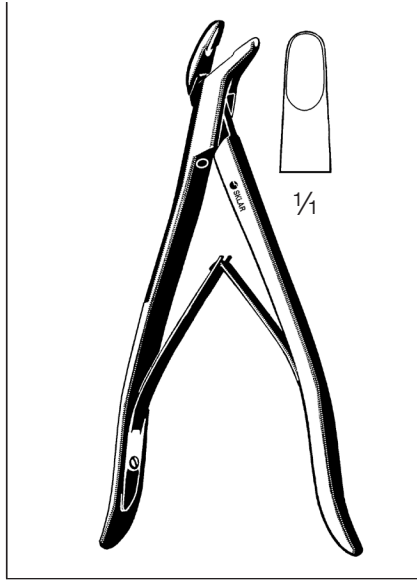

**BACON RONGEUR**

40-3480 8" Curved on Side  
5 x 15mm Bite

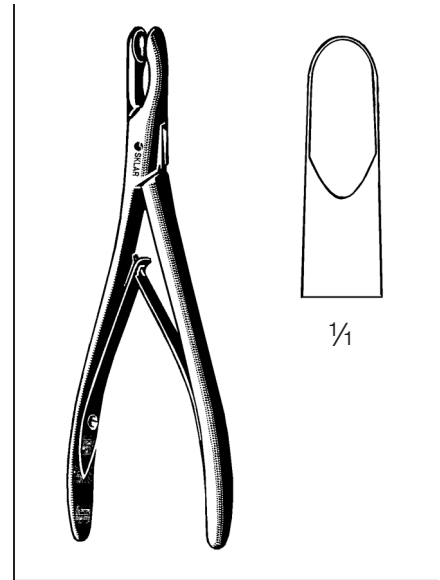

**ADSON RONGEUR**

50-1080 8"

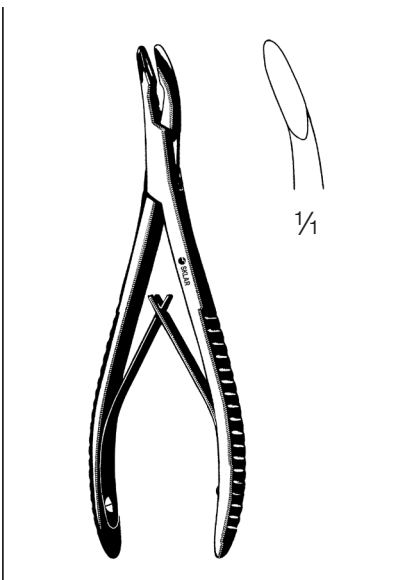

**BANE RONGEUR**

67-5175 7" Curved 3 x 16mm Bite

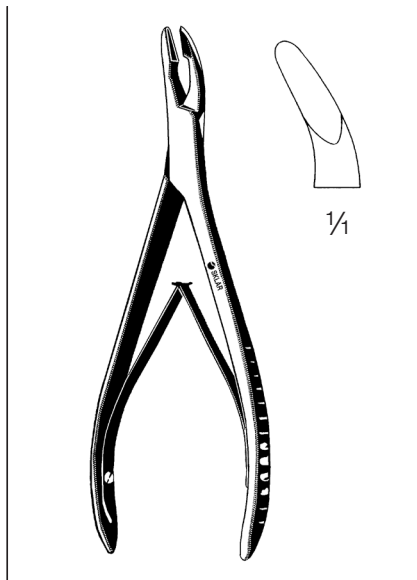

**HARTMANN RONGEUR**

67-5458 5¾" Full Curve 4 x 16mm Bite

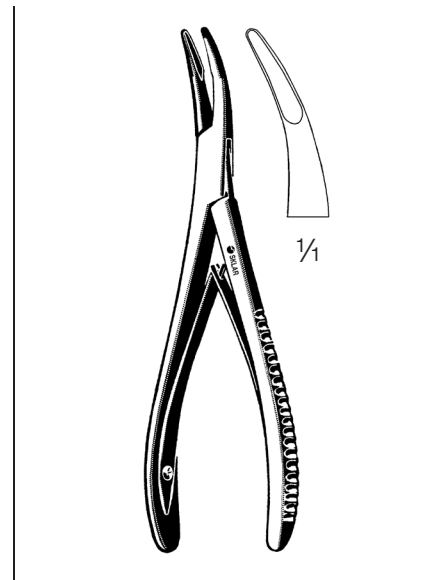

**BEYER RONGEUR**

40-3188 7"

For a complete listing of our Orthopedic product line, visit [www.sklarcorp.com](http://www.sklarcorp.com).

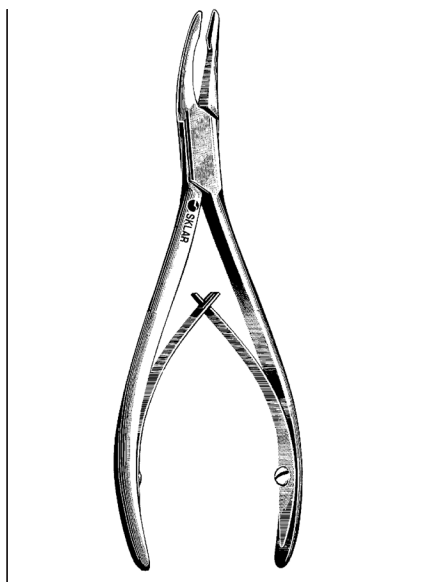

**FRIEDMAN BONE RONGEURS**

**DELICATE**

40-3190	5½"	Curved
40-3192	6½"	Curved

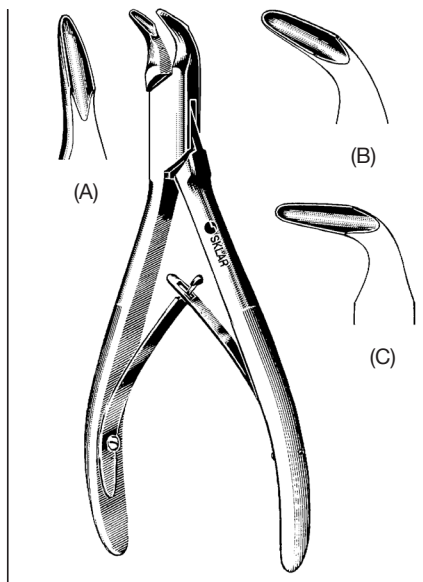

**BLUMENTHAL RONGEURS**

67-5990	6"	30° Angle (A)
67-5992	6"	45° Angle (B)
67-5994	6"	90° Angle (C)

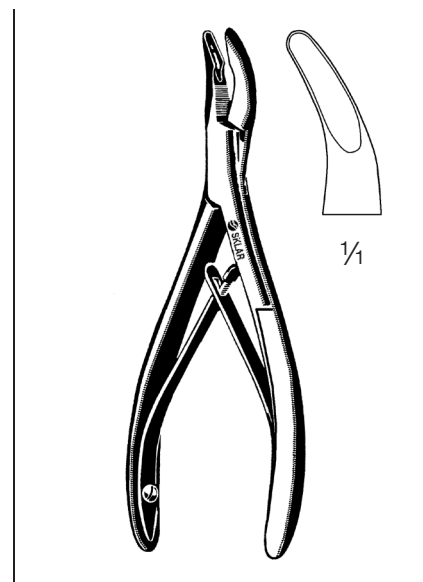

**MEAD RONGEURS**

40-3208	6½"	Curved	4 x 13mm Bite
40-3206	6½"	Slight Curve	4 x 13mm Bite

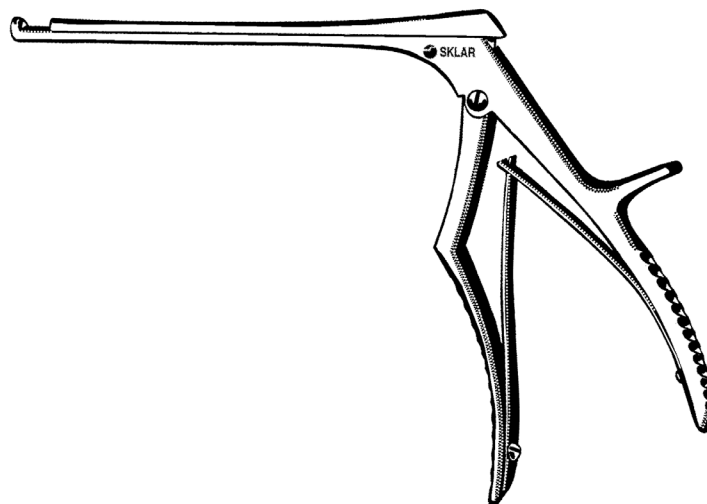
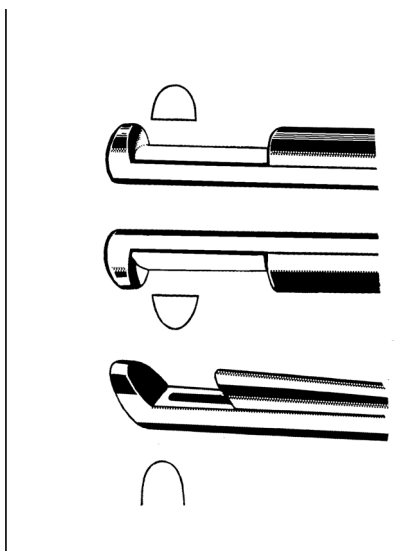

**LOVE-KERRISON-SCHLESINGER-COLCLOUGH LAMINECTOMY RONGEURS**

**UP-BITE**

42-3416	6" Shaft	3mm Bite
42-3417	6" Shaft	4mm Bite
42-3418	6" Shaft	5mm Bite
42-3453	8" Shaft	3mm Bite
42-3454	8" Shaft	4mm Bite
42-3455	8" Shaft	5mm Bite

**DOWN-BITE**

42-3425	6" Shaft	3mm Bite
42-3427	6" Shaft	4mm Bite
42-3429	6" Shaft	5mm Bite
42-3463	8" Shaft	3mm Bite
42-3464	8" Shaft	4mm Bite
42-3465	8" Shaft	5mm Bite

**40° FORWARD ANGLED TIP**



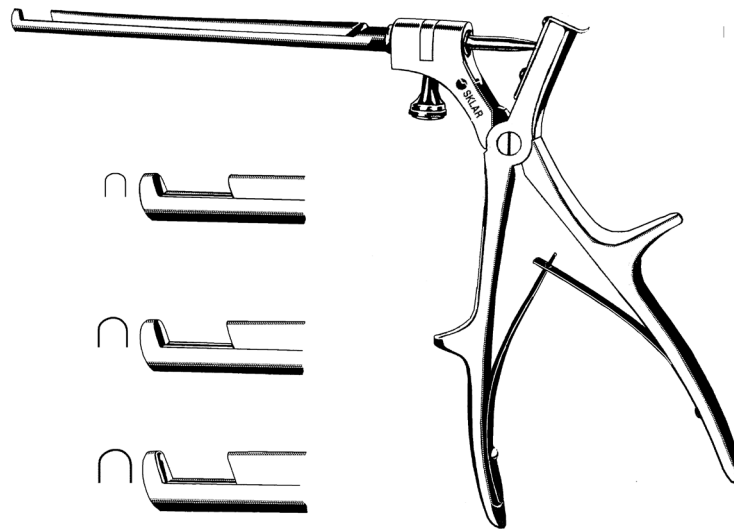

42-3441	6" Shaft	1mm Bite
42-3442	6" Shaft	2mm Bite
42-3430	6" Shaft	3mm Bite
42-3431	6" Shaft	4mm Bite
42-3432	6" Shaft	5mm Bite
42-3573	8" Shaft	3mm Bite
42-3574	8" Shaft	4mm Bite
42-3575	8" Shaft	5mm Bite

For a complete listing of our Orthopedic product line, visit [www.sklarcorp.com](http://www.sklarcorp.com).



**COLCLOUGH RONGEURS**

- 42-2255 5½" Beveled Blades
- 42-2355 5½" Thin Blades
- 42-2680 8" Backwood Cutting

-  3mm Up Bite ¼
-  3mm Down Bite ¼
-  5mm Up Bite ¼
-  5mm Down Bite ¼

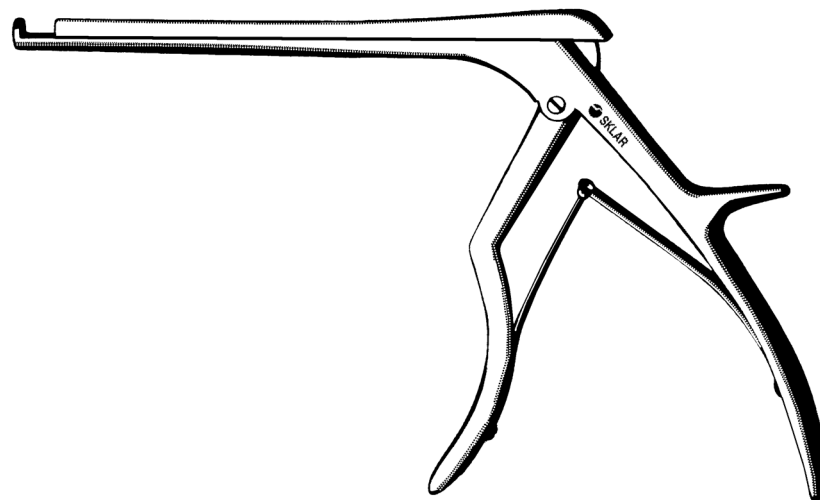

**SCHLESINGER CERVICAL LAMINECTOMY RONGEURS**

- 42-3435 6" 3mm Up Bite
- 42-3436 6" 3mm Down Bite
- 42-3437 6" 5mm Up Bite
- 42-3438 6" 5mm Down Bite

**For a complete listing of our Orthopedic product line, visit [www.sklarcorp.com](http://www.sklarcorp.com).**

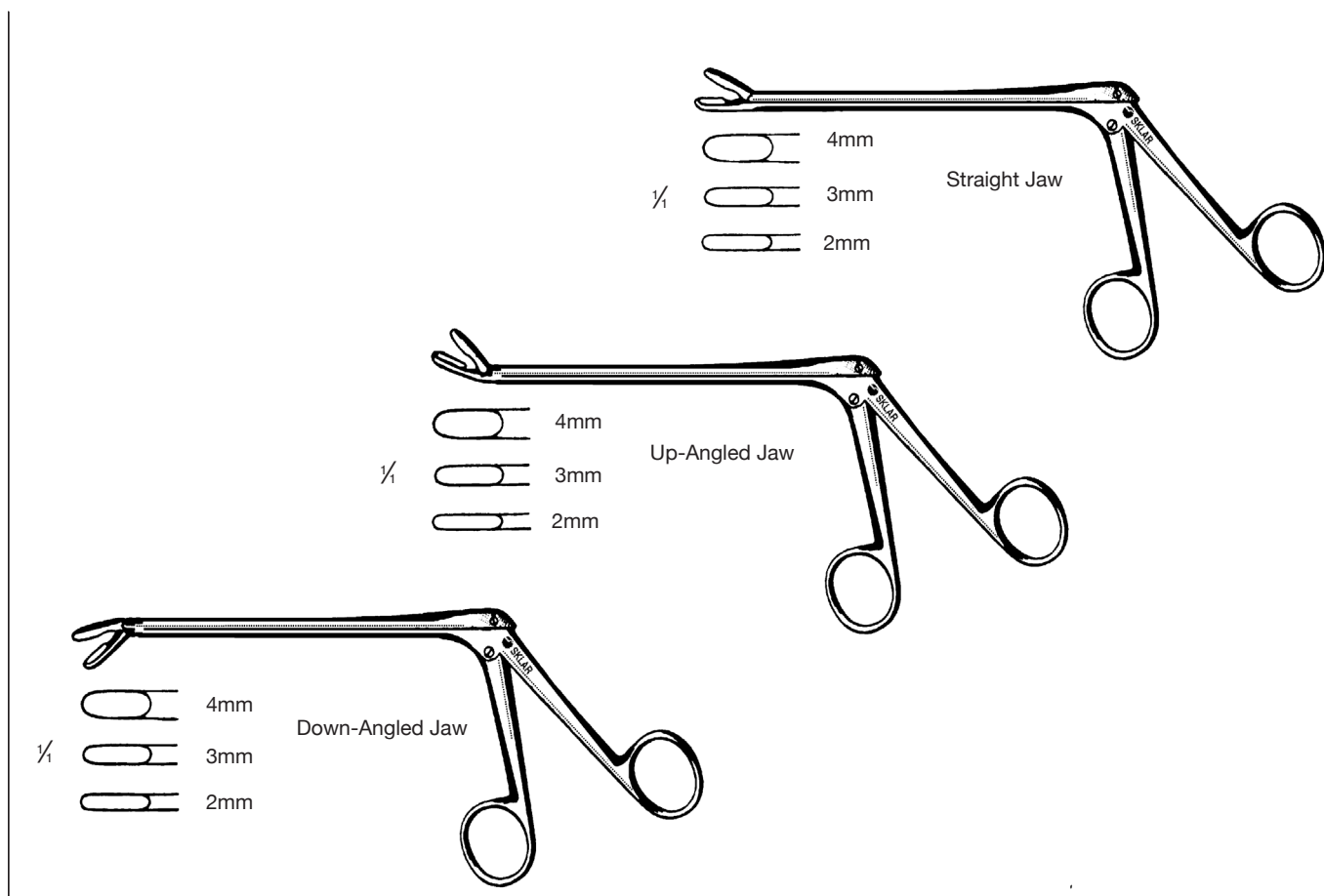

**INTERVERTEBRAL DISC RONGEURS (PITUITARY)**

**CUSHING**

42-3920	5" (12.7 cm) Shaft	2 x 10mm Cup	Straight
42-3921	5" (12.7 cm) Shaft	2 x 10mm Cup	Up-Angle
42-3922	5" (12.7 cm) Shaft	2 x 10mm Cup	Down-Angle

**CUSHING**

42-3925	7" (17.8 cm) Shaft	2 x 10mm Cup	Straight
42-3926	7" (17.8 cm) Shaft	2 x 10mm Cup	Up-Angle
42-3927	7" (17.8 cm) Shaft	2 x 10mm Cup	Down-Angle

**SPURLING**

42-2850	5" (12.7 cm) Shaft	4 x 10mm Cup	Straight
42-2851	5" (12.7 cm) Shaft	4 x 10mm Cup	Up-Angle
42-2852	5" (12.7 cm) Shaft	4 x 10mm Cup	Down-Angle

**SPURLING**

42-2855	7" (17.8 cm) Shaft	4 x 10mm Cup	Straight
42-2856	7" (17.8 cm) Shaft	4 x 10mm Cup	Up-Angle
42-2857	7" (17.8 cm) Shaft	4 x 10mm Cup	Down-Angle

**LOVE-GRUENWALD**

42-3150	5" (12.7 cm) Shaft	3 x 10mm Cup	Straight
42-3152	5" (12.7 cm) Shaft	3 x 10mm Cup	Up-Angle
42-3154	5" (12.7 cm) Shaft	3 x 10mm Cup	Down-Angle

**LOVE-GRUENWALD**

42-3156	7" (17.8 cm) Shaft	3 x 10mm Cup	Straight
42-3158	7" (17.8 cm) Shaft	3 x 10mm Cup	Up-Angle
42-3160	7" (17.8 cm) Shaft	3 x 10mm Cup	Down-Angle

For a complete listing of our Orthopedic product line, visit [www.sklarcorp.com](http://www.sklarcorp.com).



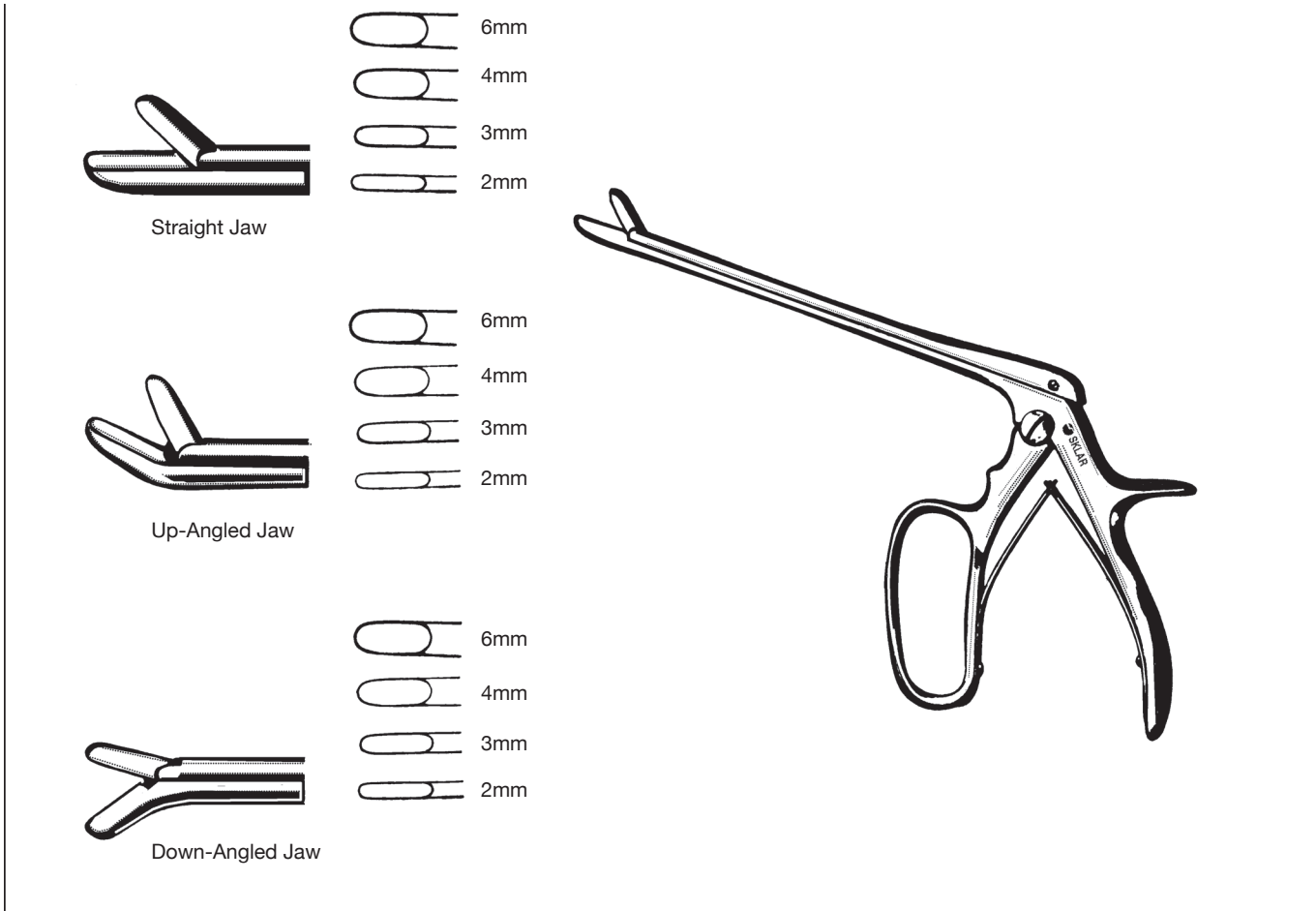

**FERRIS SMITH INTERVERTEBRAL DISC RONGEURS (PITUITARY)**

42-4000	7" (17.8 cm) Shaft	2 x 10mm Cup	Straight
42-4001	7" (17.8 cm) Shaft	2 x 10mm Cup	Up-Angle
42-4002	7" (17.8 cm) Shaft	2 x 10mm Cup	Down-Angle
42-4005	7" (17.8 cm) Shaft	3 x 10mm Cup	Straight
42-4006	7" (17.8 cm) Shaft	3 x 10mm Cup	Up-Angle
42-4007	7" (17.8 cm) Shaft	3 x 10mm Cup	Down-Angle
42-4010	7" (17.8 cm) Shaft	4 x 10mm Cup	Straight
42-4011	7" (17.8 cm) Shaft	4 x 10mm Cup	Up-Angle
42-4012	7" (17.8 cm) Shaft	4 x 10mm Cup	Down-Angle
42-4015	7" (17.8 cm) Shaft	6 x 12mm Cup	Straight
42-4016	7" (17.8 cm) Shaft	6 x 12mm Cup	Up-Angle
42-4017	7" (17.8 cm) Shaft	6 x 12mm Cup	Down-Angle

For a complete listing of our Orthopedic product line, visit [www.sklarcorp.com](http://www.sklarcorp.com).

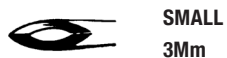

**SMALL**  
3Mm



**MEDIUM**  
4Mm



**LARGE**  
5Mm

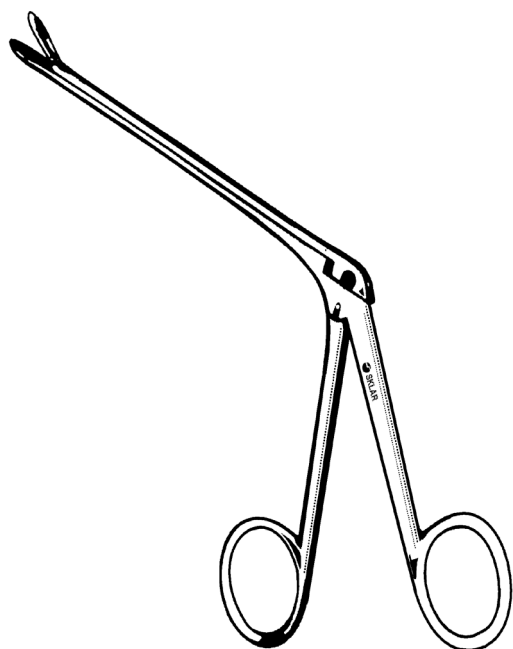

**WILDE INTERVERTEBRAL DISC RONGEURS**

**FENESTRATED JAWS**

70-5420	5" Shaft	Small, 3mm Bite
70-5421	5" Shaft	Medium, 4mm Bite
70-5422	5" Shaft	Large, 5mm Bite

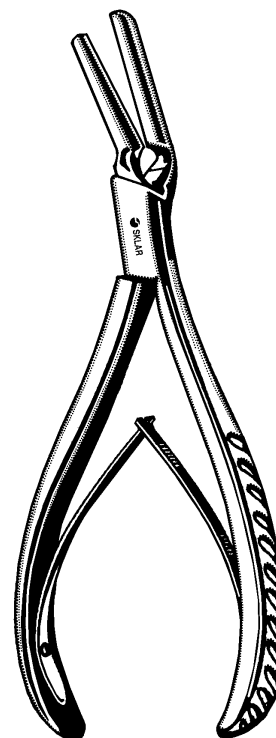

**ZIELKE INTERVERTEBRAL RONGEURS**

**CUTTING EDGES EXTRA LONG, ANGLED UP FOR REMOVAL OF THE INTERVERTEBRAL DISCS**

42-4020	Straight	5mm Jaw
42-4022	Curved to Right	3.5mm Jaw
42-4024	Curved to Left	3.5mm Jaw

For a complete listing of our Orthopedic product line, visit [www.sklarcorp.com](http://www.sklarcorp.com).

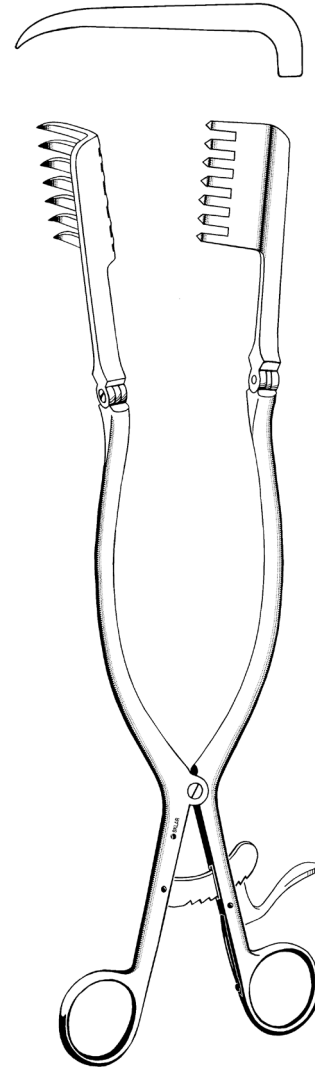
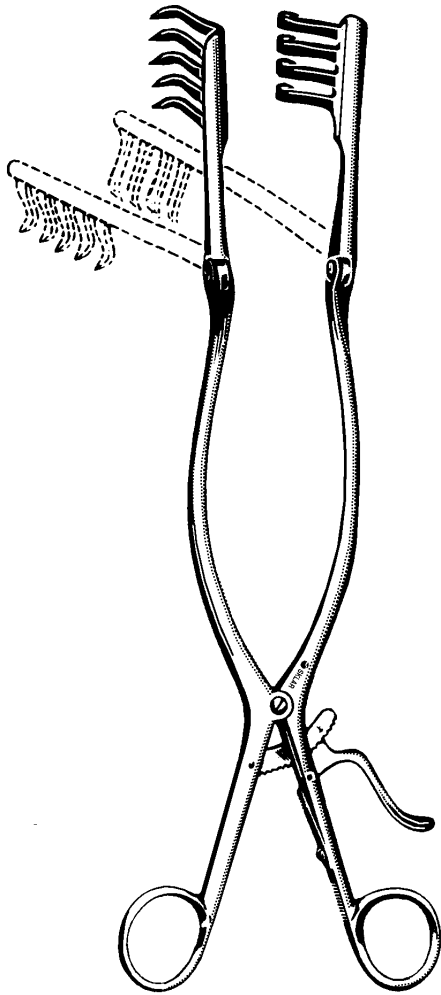

**BECKMAN-ADSON RETRACTORS**

**1" DEEP BLADES**

57-1322 12½" with Hinged Blades 4x4 Teeth, Sharp

**WEITLANER-BECKMAN RETRACTOR**

**½" DEEP BLADES (NOT PICTURED)**

42-1655 6½" with Hinged Blades 3x4 Teeth, Blunt

**BECKMAN-EATON RETRACTOR**

**1" DEEP BLADES**

57-1325 13" with Hinged Blades 7x7 Teeth, Sharp

**For a complete listing of our Orthopedic product line, visit [www.sklarcorp.com](http://www.sklarcorp.com).**



**ORTHOPEDIC  
RETRACTORS**

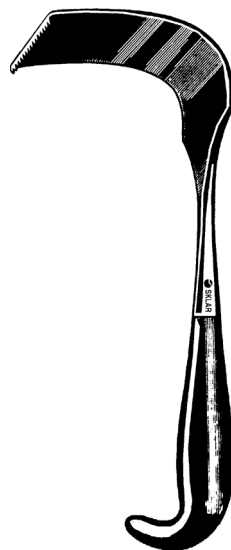

**MEYERDING RETRACTORS**

42-2085	7¾"	Small	2" x 5/8"
42-2092	8¾"	Medium	3" x 1"
42-2095	9½"	Large	3½" x 2"

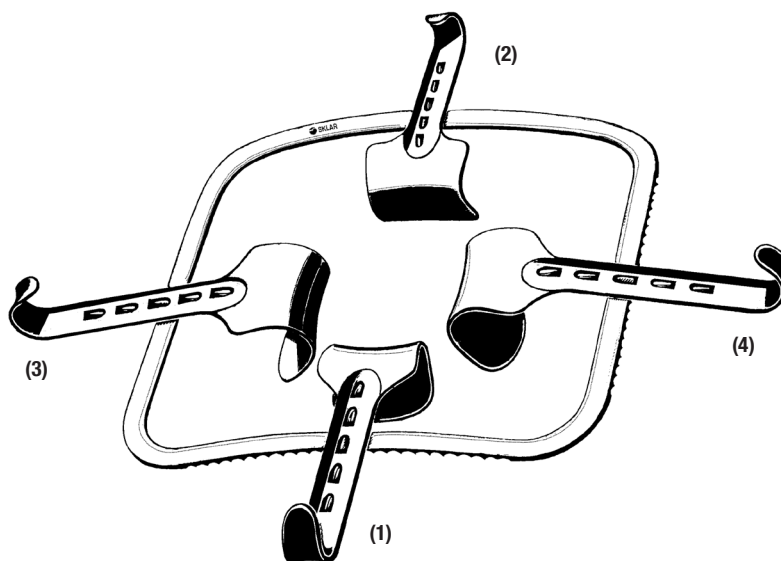

**KIRSCHNER RETRACTOR**

60-7200	Fixed Frame with 4 Blades
	Blades 1 and 2 40 x 55mm
	Blades 3 and 4 50 x 65mm

**For a complete listing of our Orthopedic product line, visit [www.sklarcorp.com](http://www.sklarcorp.com).**

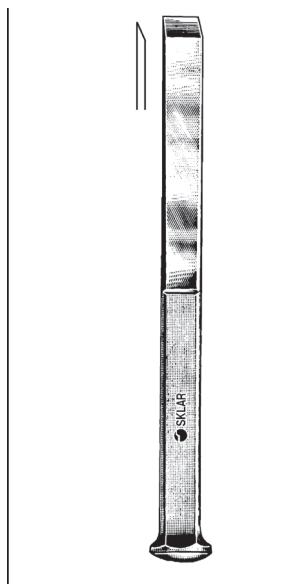

**ARMY CHISELS**

40-6106	6½"	6mm
40-6112	6½"	12mm
40-6118	6½"	18mm

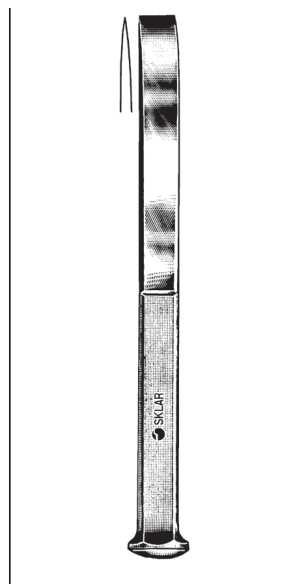

**ARMY OSTEOTOMES**

40-6206	6½"	6mm
40-6212	6½"	12mm
40-6218	6½"	18mm

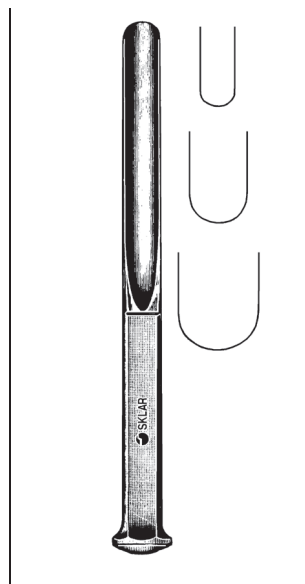

**ARMY GOUGES**

40-6306	6½"	6mm
40-6312	6½"	10mm
40-6318	6½"	14mm



**MURPHY BONE  
GOUGES**

40-6011	¾"
40-6012	1"
40-6013	1¼"
40-6014	1½"



**SMITH PETERSON OSTEOTOMES**

**8" (20.3 CM) STRAIGHT**

40-6771	¼"	6mm
40-6772	⅜"	10mm
40-6773	½"	13mm
40-6774	⅝"	16mm
40-6775	¾"	19mm
40-6776	1"	25mm
40-6777	1¼"	31mm

**8" (20.3 CM) CURVED**

40-6781	¼"	6mm
40-6782	⅜"	10mm
40-6783	½"	13mm
40-6784	⅝"	16mm
40-6785	¾"	19mm
40-6786	1"	25mm
40-6787	1¼"	31mm

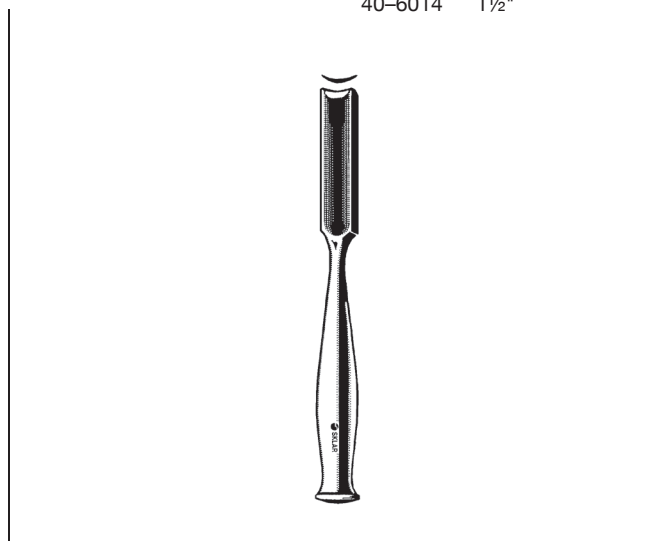

**SMITH PETERSON GOUGES**

**8" (20.3 CM) STRAIGHT**

40-6791	¼"	6mm
40-6792	⅜"	10mm
40-6793	½"	13mm
40-6794	⅝"	16mm
40-6795	¾"	19mm
40-6796	1"	25mm
40-6797	1¼"	31mm

**8" (20.3 CM) CURVED**

40-6799	¼"	6mm
40-6800	⅜"	10mm
40-6801	½"	13mm
40-6802	⅝"	16mm
40-6803	¾"	19mm
40-6804	1"	25mm
40-6805	1¼"	31mm

For a complete listing of our Orthopedic product line, visit [www.sklarcorp.com](http://www.sklarcorp.com).

ORTHOPEDIC



GOUGES / CHISEL / OSTEOTOMES

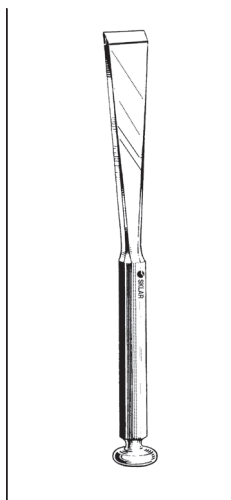

**STILLÉ CHISELS**

- 40-6338 8" 10mm
- 40-6339 8" 14mm
- 40-6340 8" 18mm
- 40-6341 8" 22mm

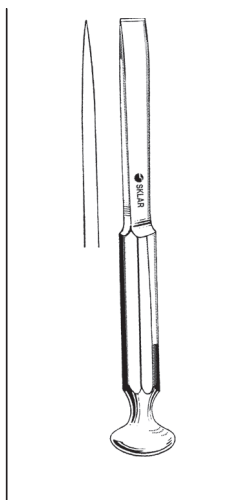

**STILLÉ OSTEOTOMES**

- 40-6330 8" 10mm
- 40-6331 8" 14mm
- 40-6332 8" 18mm
- 40-6333 8" 22mm

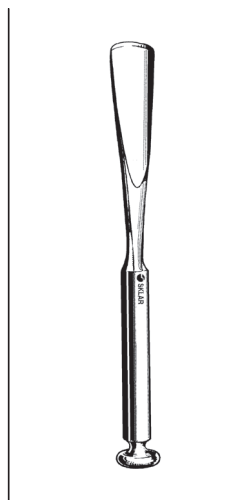

**STILLÉ GOUGES**

- 40-6334 8" 10mm
- 40-6335 8" 14mm
- 40-6336 8" 18mm
- 40-6337 8" 22mm

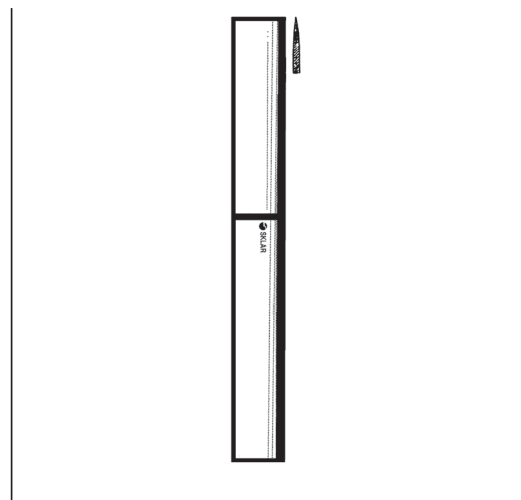

**LAMBOTTE OSTEOTOMES**

- | STRAIGHT 9"      | CURVED 9"        |
|------------------|------------------|
| 40-6560 6mm ¼"   | 40-6570 6mm ¼"   |
| 40-6561 13mm ½"  | 40-6571 13mm ½"  |
| 40-6562 19mm ¾"  | 40-6572 19mm ¾"  |
| 40-6563 25mm 1"  | 40-6573 25mm 1"  |
| 40-6564 31mm 1¼" | 40-6574 31mm 1¼" |
| 40-6565 38mm 1½" | 40-6575 38mm 1½" |
| 40-6567 Set of 6 | 40-6577 Set of 6 |

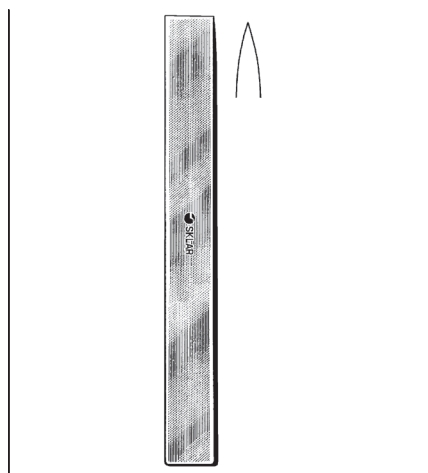

**LAMBOTTE OSTEOTOMES**

- CURVED 5"**
- 40-6514 4mm
  - 40-6516 6mm
  - 40-6518 8mm
  - 40-6520 10mm
  - 40-6522 12mm
  - 40-6530 Set of 9 includes 4, 6, 8, 10, 12, 14, 15, 18, and 19mm
  - 40-6524 14mm
  - 40-6525 15mm
  - 40-6528 18mm
  - 40-6529 19mm

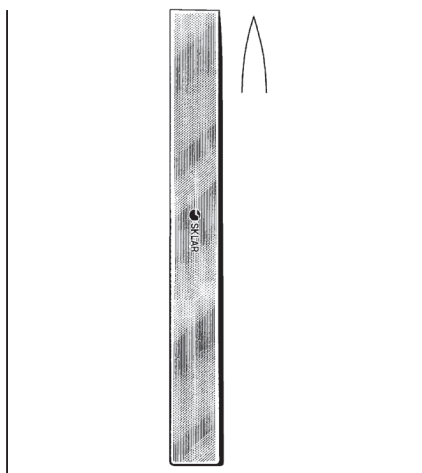

**LAMBOTTE OSTEOTOMES**

- STRAIGHT DELICATE 5"**
- 40-6532 2mm 5/64"
  - 40-6533 3mm 1/8"
  - 40-6534 4mm 5/32"
  - 40-6535 5mm 3/64"
  - 40-6536 6mm ¼"
  - 40-6537 7mm 3/11"
  - 40-6538 8mm 5/16"
  - 40-6540 10mm 3/8"
  - 40-6542 12mm 15/32"
  - 40-6544 14mm 9/16"
  - 40-6545 15mm 3/5"
  - 40-6548 18mm 23/32"
  - 40-6549 19mm ¾"
  - 40-6550 20mm 51/64"
  - 40-6552 Set of 9
  - Includes 2, 4, 6, 8, 10, 12, 14, 18 and 20mm

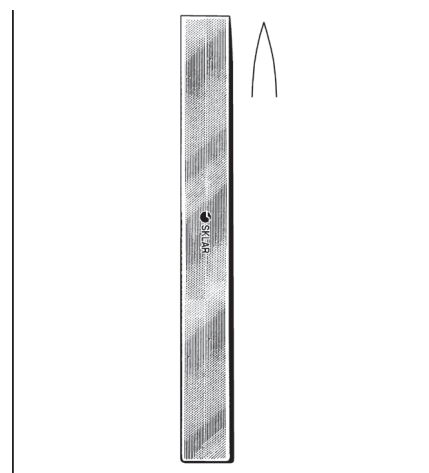

**JR. LAMBOTTE OSTEOTOMES**

- STRAIGHT 7"**
- 40-6624 4mm 5/32"
  - 40-6625 5mm 13/64"
  - 40-6626 6mm ¼"
  - 40-6628 8mm 5/16"
  - 40-6630 10mm 3/8"
  - 40-6632 12mm 15/32"
  - 40-6636 16mm 5/8"
  - 40-6639 19mm ¾"
  - 40-6642 22mm 7/8"
  - 40-6645 25mm 1"

For a complete listing of our Orthopedic product line, visit [www.sklarcorp.com](http://www.sklarcorp.com).

**ORTHOPEDIC  
GOUGES / CHISEL / OSTEOTOMES**



**HIBBS CHISELS**

**STRAIGHT 9½"**

40-6701	6mm	40-6723	22mm	40-6731	6mm	40-6736	22mm
40-6711	10mm	40-6724	25mm	40-6732	10mm	40-6737	25mm
40-6715	13mm	40-6725	28mm	40-6733	13mm	40-6738	28mm
40-6716	16mm	40-6726	31mm	40-6734	16mm	40-6739	31mm
40-6717	19mm	40-6728	38mm	40-6735	19mm	40-6740	38mm

**CURVED 9½"**

**HIBBS OSTEOTOMES**

**STRAIGHT 9½"**

40-6666	6mm	40-6671	22mm	40-6680	6mm	40-6685	22mm
40-6667	10mm	40-6672	25mm	40-6681	10mm	40-6686	25mm
40-6668	13mm	40-6673	28mm	40-6682	13mm	40-6687	28mm
40-6669	16mm	40-6674	32mm	40-6683	16mm	40-6688	31mm
40-6670	19mm	40-6675	38mm	40-6684	19mm	40-6689	38mm

**CURVED 9½"**

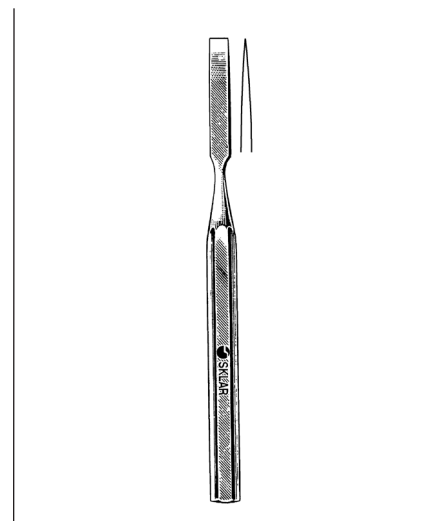
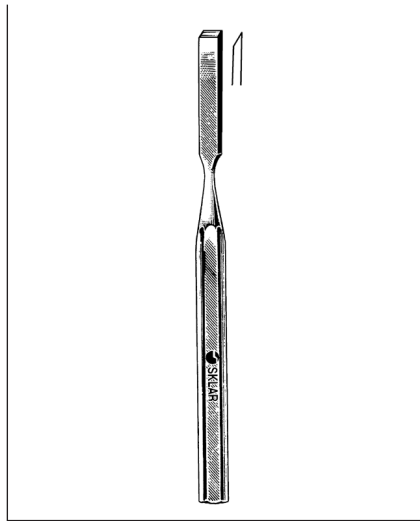
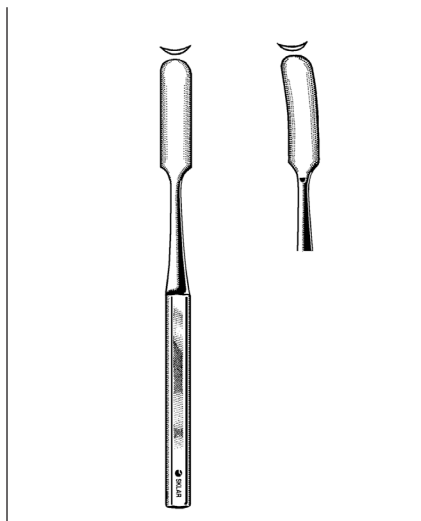

**HIBBS GOUGES**

**STRAIGHT, 9½"**

40-6828	6mm	40-6850	6mm
40-6829	9mm	40-6851	9mm
40-6830	10mm	40-6852	10mm
40-6831	13mm	40-6853	13mm
40-6833	16mm	40-6843	16mm
40-6832	19mm	40-6844	19mm
40-6835	22mm	40-6845	22mm
40-6836	25mm	40-6846	25mm
40-6837	29mm	40-6847	29mm
40-6838	32mm	40-6848	32mm
40-6839	38mm	40-6849	38mm

**CURVED, 9½"**

**HOKE CHISELS**

**STRAIGHT 5½"**

40-6984	4mm
40-6986	6mm
40-6990	10mm
40-6993	13mm
40-6996	16mm
40-6999	19mm

**HOKE OSTEOTOMES**

**STRAIGHT 5½"**

40-6953	3mm
40-6954	4mm
40-6956	6mm
40-6958	8mm
40-6970	10mm
40-6973	13mm
40-6976	16mm
40-6979	19mm

**For a complete listing of our Orthopedic product line, visit [www.sklarcorp.com](http://www.sklarcorp.com).**



ORTHOPEDIC

GOUGES / CHISEL / OSTEOTOMES

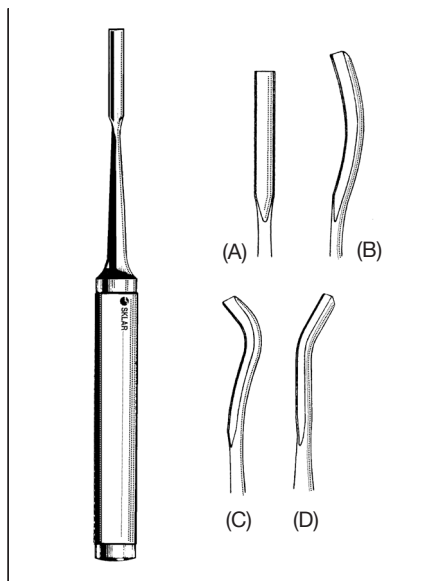

**COBB TYPE SPINAL GOUGES**

11" WITH 5/32" BLADE WIDTH

- 40-6920 Straight (A)
- 40-6921 Medium (B)
- 40-6922 Strong Curve (C)
- 40-6923 Reverse Curve (D)

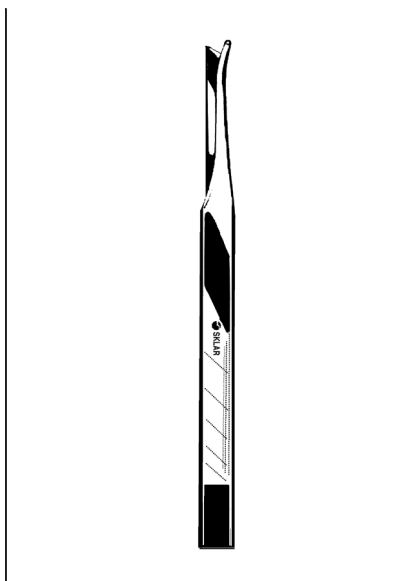

**SILVER OSTEOTOMES**

7" WITH SINGLE GUARD

- 41-1350 Straight
- 41-1355 Right
- 41-1360 Left

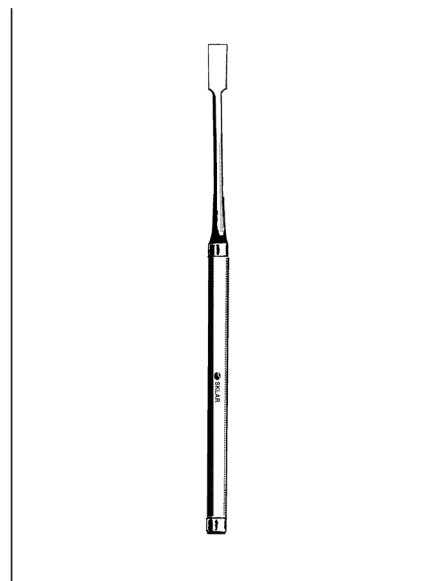

**SKLAR OSTEOTOME**

70-7170 6" 5mm

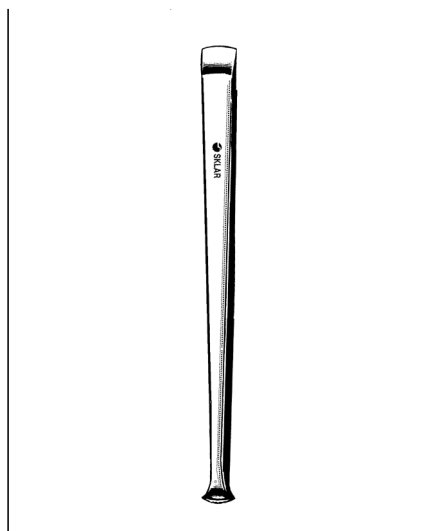

**ALEXANDER MASTOID CHISELS**

7"

- 67-4604 4mm
- 67-4606 6mm
- 67-4608 8mm
- 67-4610 10mm
- 67-4612 12mm
- 67-4614 14mm

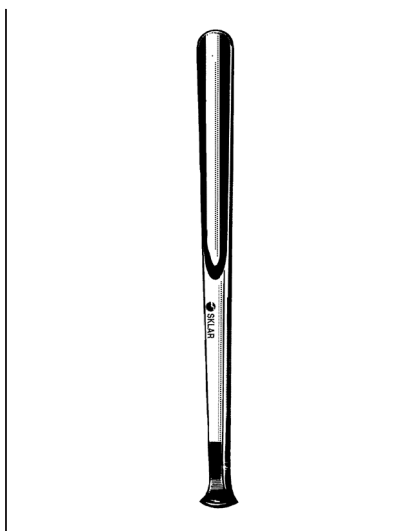

**ALEXANDER MASTOID GOUGES**

7"

- 67-4504 4mm
- 67-4506 6mm
- 67-4508 8mm
- 67-4510 10mm
- 67-4512 12mm
- 67-4514 14mm

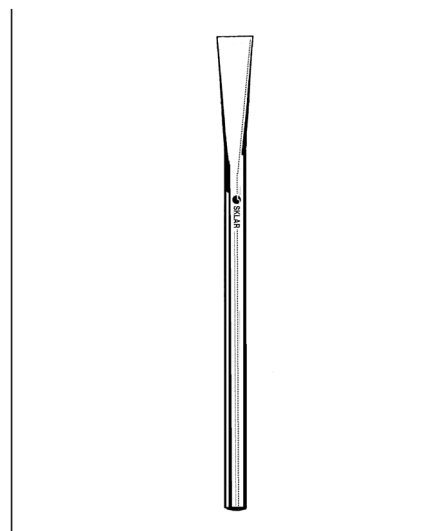

**SHEEHAN OSTEOTOMES**

STRAIGHT 6 1/4"

- 67-4620 2mm
- 67-4622 4mm
- 67-4624 6mm
- 67-4626 8mm
- 67-4628 10mm
- 67-4630 12mm
- 67-4632 15mm

For a complete listing of our Orthopedic product line, visit [www.sklarcorp.com](http://www.sklarcorp.com).





**LEXER MINI GOUGE**  
WITH SKLAR-DURA™ HANDLE  
40-6072 7" 6mm



**LEXER MINI CHISELS**  
WITH SKLAR-DURA™ HANDLE  
40-6020 7" 4mm  
40-6022 7" 6mm  
40-6024 7" 8mm  
40-6026 7" 10mm  
40-6028 7" 12mm



**CAPENER LAMINA GOUGES**  
WITH SKLAR-DURA™ HANDLE, 9¼"  
40-6074 ¼" Wide 6mm  
40-6076 ⅝" Wide 8mm  
40-6078 ⅞" Wide 11mm  
40-6079 1" Wide 16mm



**CAPENER OSTEOTOMES**  
WITH SKLAR-DURA™ HANDLE 10"  
40-6080 ⅜" Straight 10mm  
40-6082 ½" Straight 12mm  
40-6084 ⅝" Straight 15mm  
40-6085 ¾" Straight 20mm  
40-6086 1" Straight 25mm  
40-6088 1¼" Straight 30mm



**CAPENER OSTEOTOMES**  
WITH SKLAR-DURA™ HANDLE, 10"  
40-6093 ½" Curved 12mm  
40-6092 1¼" Curved 30mm



**LEXER GOUGES**  
40-6060 8½" 10mm  
40-6056 8½" 20mm

For a complete listing of our Orthopedic product line, visit [www.sklarcorp.com](http://www.sklarcorp.com).

ORTHOPEDIC

TAMPERS

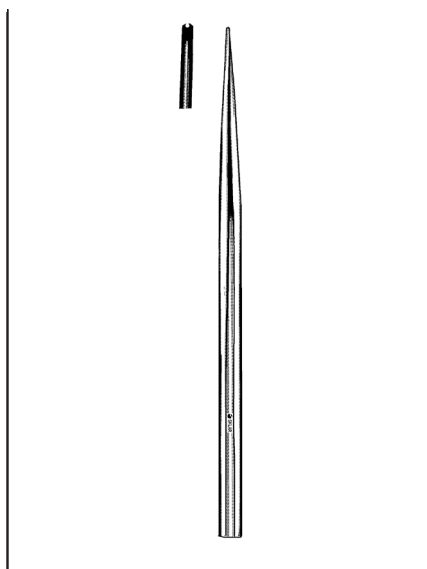

**BONE TAMPER  
WITH CONCAVE TIP**

40-7349 6" 2mm diameter

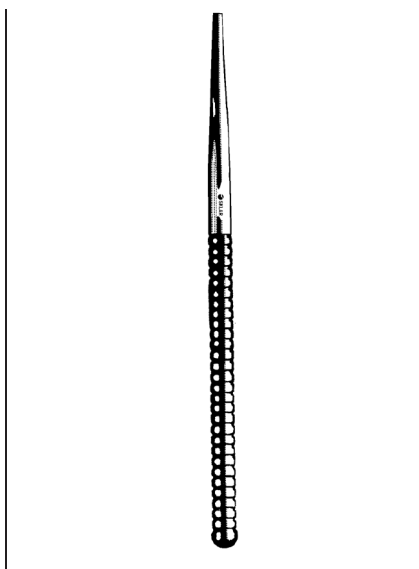

**BONE TAMPERS  
6" WITH CROSS SERRATED TIP**

- 40-7360 2mm diameter
- 40-7362 3mm diameter
- 40-7364 4mm diameter
- 40-7366 5mm diameter
- 40-7368 6mm diameter
- 40-7370 8mm diameter
- 40-7372 10mm diameter

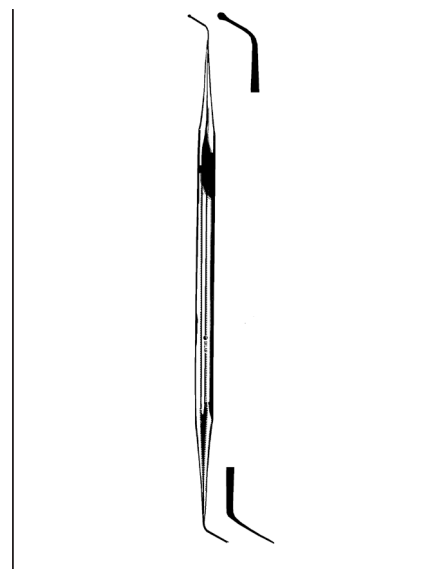

**BONE PACKER DISSECTOR  
6 3/4"**

40-7376 1.4mm Ball End  
2.5mm Blade End

**SKLAR DISINFECTANT**

READY-TO-USE SPRAY SURFACE DISINFECTANT

**2 MINUTE KILL TIME!**

- Ready to use, non-toxic formula.
- Specially formulated for the control of cross contamination.
- Effective against a broad range of pathogens including H1N1, HIV-1, HSV, VRE, Rotaviruses, Hep B & C as well as TB, MRSA and A. Baumannii.
- Safe for all areas of the facility including the NICU, operating rooms, isolation rooms, patient care areas and laboratories.
- Satisfies OSHA's Bloodborne Pathogen Standards.
- Non-irritating formula.
- EPA registered.

PRODUCT NUMBER	FEATURES	QUANTITIES
10-1643	24 oz. Spray Bottles	6/case
10-1642	24 oz. Spray Bottle	1 bottle
10-1653	1 Gallon Bottles	4/case
10-1654	1 Gallon Bottle	1 bottle
10-1644	2.5 Gallon Bottles	2/case



For a complete listing of our Orthopedic product line, visit [www.sklarcorp.com](http://www.sklarcorp.com).

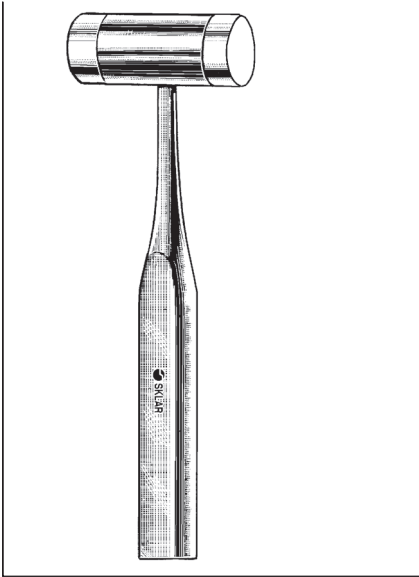

**MALLET**  
WITH TWO PLASTIC ENDS, REPLACEABLE  
40-5925 Flat Surfaces  
40-5926 Replaceable Ends

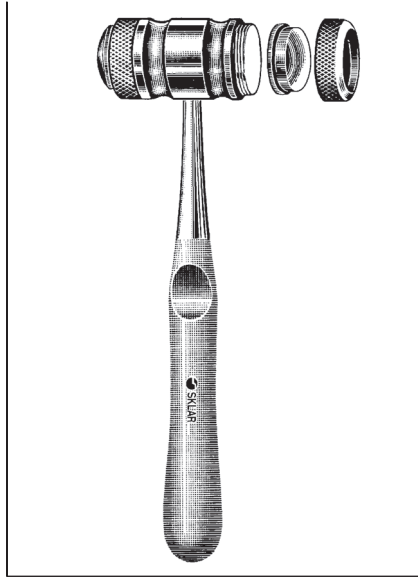

**SKLAR MALLET**  
WITH REPLACEABLE PLASTIC DISCS  
40-5870 Rounded Surfaces  
40-5871 Replaceable Discs

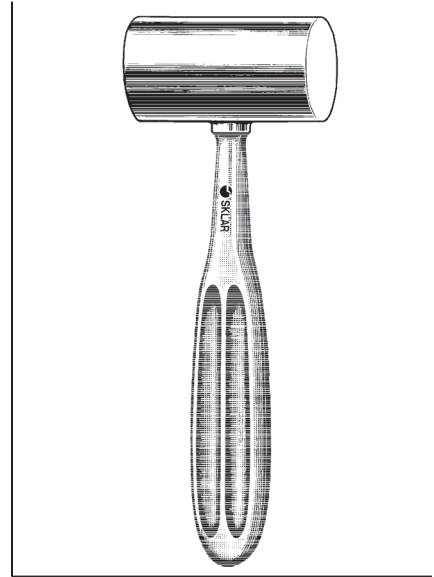

**KIRK BONE MALLET**  
SOLID BRONZE HEAD-26 OZ.  
40-5672 8" 1½" Diameter

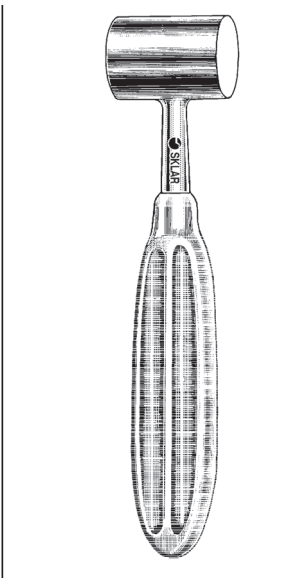

**GERZOG BONE MALLET**  
LEAD FILLED-14 OZ.  
40-5765 7½" 1" Diameter

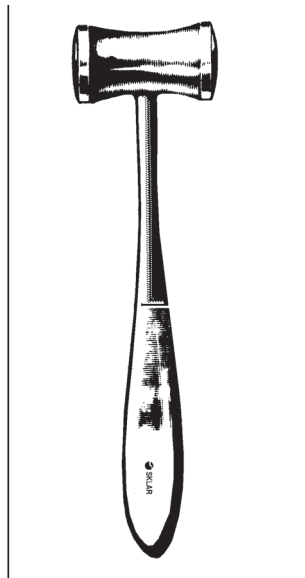

**LUCAE MALLET**  
BRONZE HEAD SMALL-8 OZ.  
40-5875 7½" 1" Diameter  
Chrome Plated

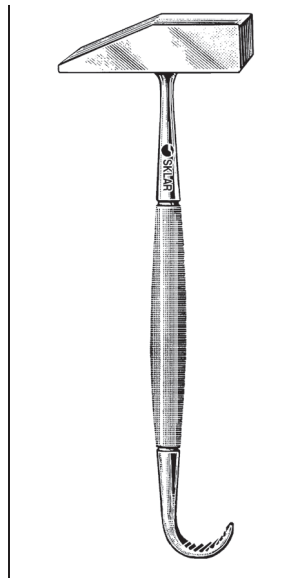

**STEEL BONE MALLET**  
HOOK HANDLE  
40-5910 10" 20 oz.



**MEYERDING BONE MALLET**  
40-5885

For a complete listing of our Orthopedic product line, visit [www.sklarcorp.com](http://www.sklarcorp.com).

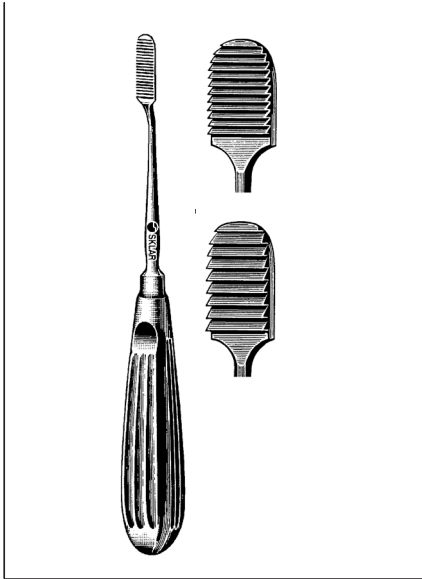

**LEWIS RASPS**

70-2292 7" Fine  
70-2293 7" Coarse

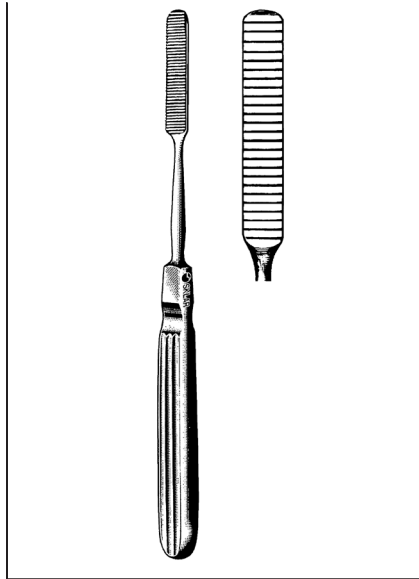

**COTTLE RASP**

40-9820 8" Backward Cutting

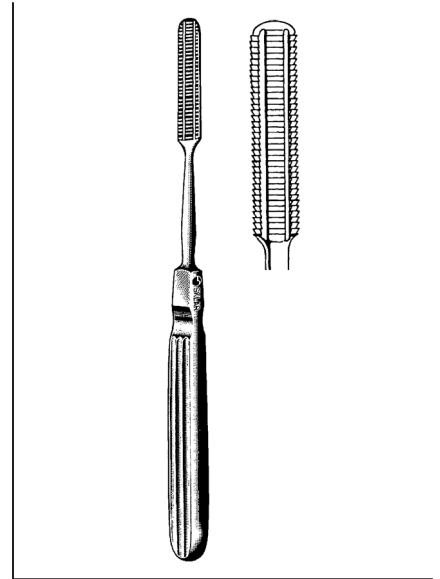

**MALTZ RASP**

40-9815 7" Backward Cutting

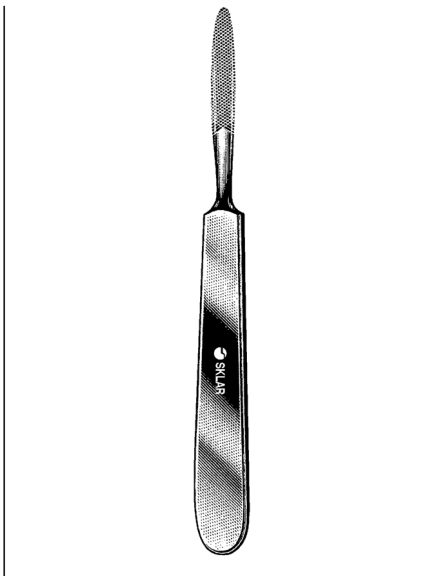

**JOSEPH RASP  
STRAIGHT HANDLE**

40-9825 6 1/4" Fine Cross Serrations

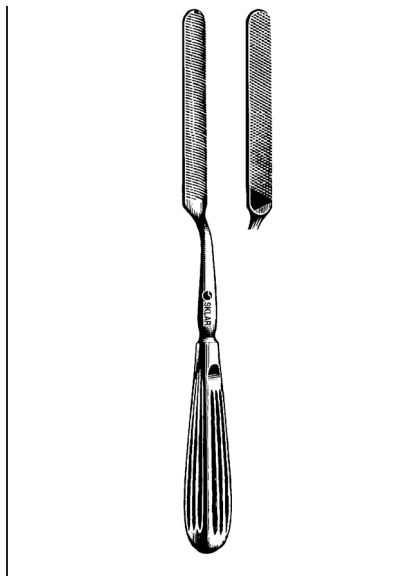

**BONE FILE  
BAYONET HANDLE**

40-9685 9"

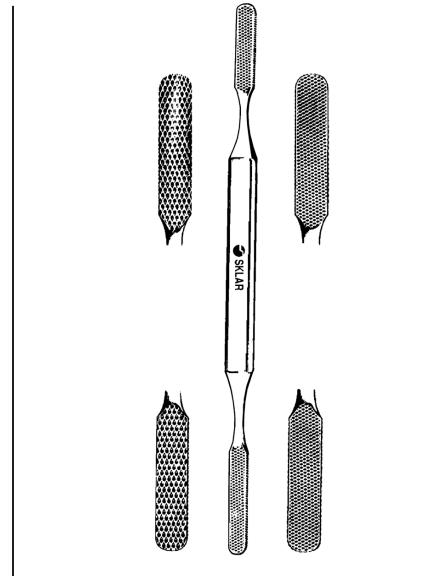

**FOMON RASPS  
DOUBLE ENDED, FLAT & CONVEX**

40-9686 8 1/4" 2 Sided, Coarse  
40-9688 8 1/2" 4 Sided, Coarse & Fine

**For a complete listing of our Orthopedic product line, visit [www.sklarcorp.com](http://www.sklarcorp.com).**

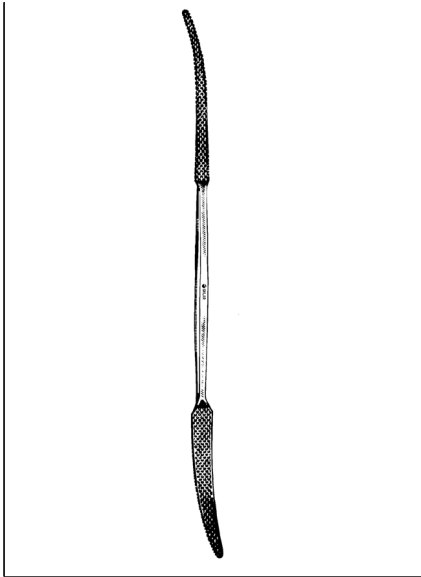

**PUTTI BONE RASP**

**CURVED ENDS**

40-9712 12" Round and half round tapered

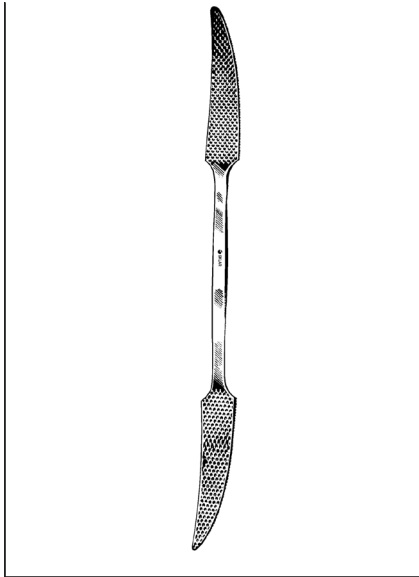

**PUTTI BONE RASP**

**STRAIGHT & CURVED**

40-9812 10¾"

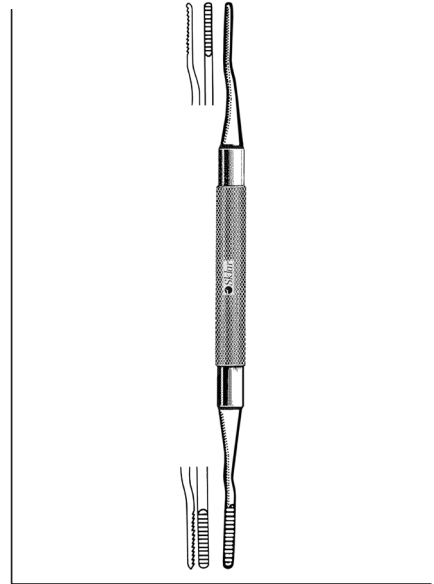

**NAIL AND BONE RASPS**

**DOUBLE END**

97-1640 7" 3-4mm  
97-1635 8½" 5-6mm

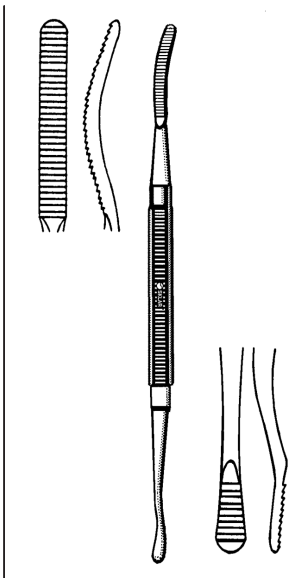

**BONE RASP #10**

**CURVED AND FLAT ENDS**

97-1615 7½" Plain Serrations

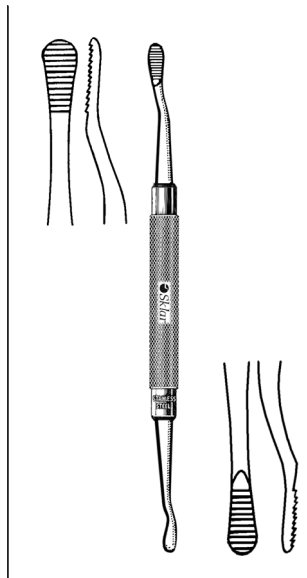

**BONE FILE #12**

**DOUBLE END**

97-1620 7" Plain Serrations

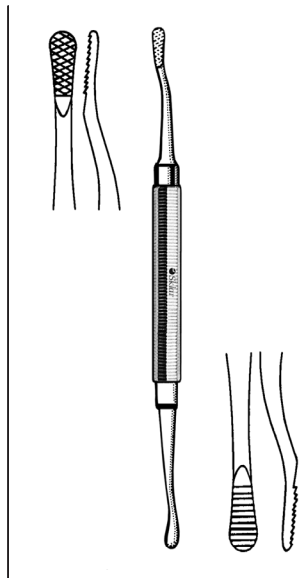

**BONE FILE #12A**

**DOUBLE END**

97-1625 7" Plain and Cross Serrations

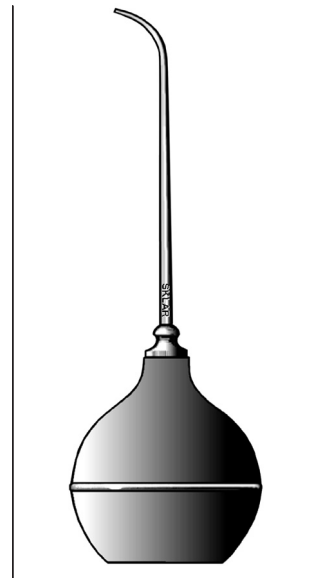

**CHIP BLOWER**

97-1650 Chip Blower Complete  
97-1652 Tip Only  
97-1654 Bulb Only

For a complete listing of our Orthopedic product line, visit [www.sklarcorp.com](http://www.sklarcorp.com).



ORTHOPEDIC

CURETTES

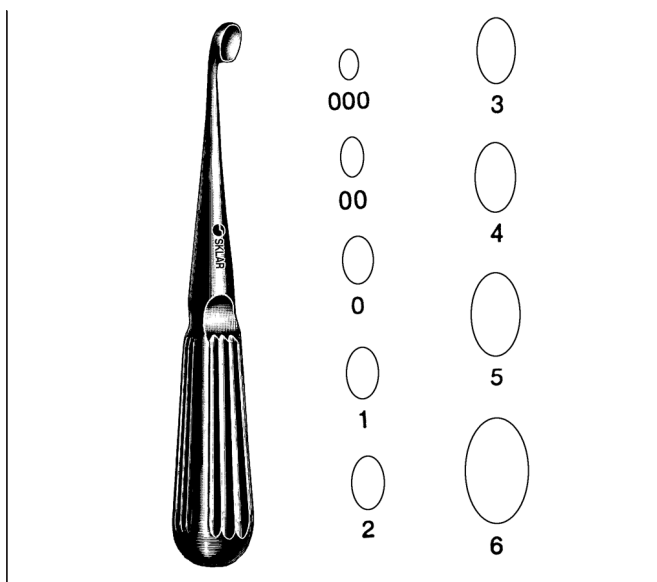

**BRUNS CURETTES**

**STRAIGHT, OVAL**

6¾"

40-7118 #5-0	40-7112 #2	40-7199 #6-0	40-7205 #1
40-7120 #4-0	40-7113 #3	40-7200 #5-0	40-7206 #2
40-7000 #3-0	40-7114 #4	40-7201 #4-0	40-7207 #3
40-7100 #2-0	40-7115 #5	40-7202 #3-0	40-7208 #4
40-7110 #1-0	40-7116 #6	40-7203 #2-0	40-7209 #5
40-7111 #1		40-7204 #0	40-7210 #6

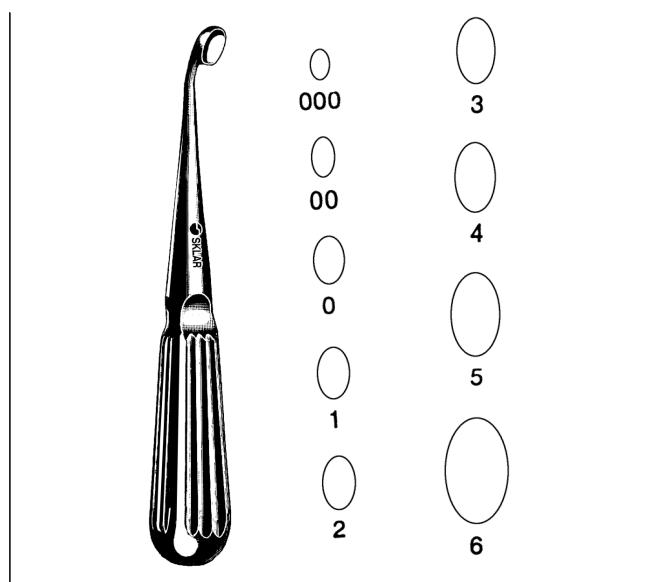

**BRUNS CURETTES**

**ANGLED, OVAL**

6½"

41-1710 #5-0	41-1716 #2	40-7219 #6-0	40-7225 #1
41-1711 #4-0	41-1717 #3	40-7220 #5-0	40-7226 #2
41-1712 #3-0	41-1718 #4	40-7221 #4-0	40-7227 #3
41-1713 #00	41-1719 #5	40-7222 #3-0	40-7228 #4
41-1714 #0	41-1720 #6	40-7223 #2-0	40-7229 #5
41-1715 #1		40-7224 #0	40-7230 #6



**BRUNS CURETTES**

**OVAL, HEXAGONAL HANDLE, 9"**

**STRAIGHT**

40-7330 #3-0	40-7335 #3
40-7331 #2-0	40-7336 #4
40-7332 #0	40-7337 #5
40-7333 #1	40-7338 #6
40-7334 #2	

**ANGLED**

40-7350 #3-0	40-7355 #3
40-7351 #2-0	40-7356 #4
40-7352 #0	40-7357 #5
40-7353 #1	40-7358 #6
40-7354 #2	

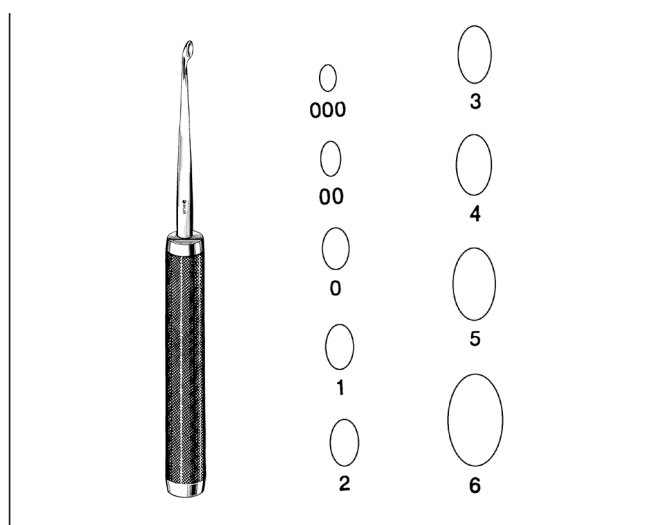

**COBB STYLE BONE CURETTES**

**11" HOLLOWED KNURLED HANDLE, OVAL CUP**

**STRAIGHT**

40-8100 #3-0	40-8105 #3
40-8101 #2-0	40-8106 #4
40-8102 #0	40-8107 #5
40-8103 #1	40-8108 #6
40-8104 #2	

**ANGLED**

40-8110 #3-0	40-8115 #3
40-8111 #2-0	40-8116 #4
40-8112 #0	40-8117 #5
40-8113 #1	40-8118 #6
40-8114 #2	

For a complete listing of our Orthopedic product line, visit [www.sklarcorp.com](http://www.sklarcorp.com).

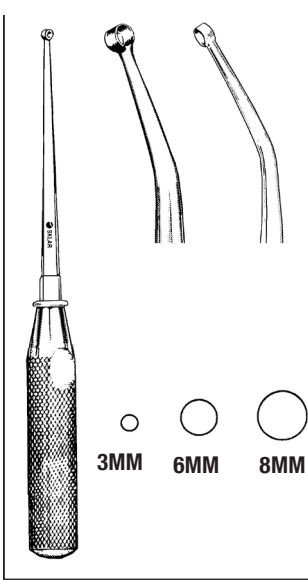

**CONE RING CURETTES**  
**9", STRAIGHT**

- 40-8130 3mm
- 40-8131 6mm
- 40-8132 8mm

**9" ANGLED 35°**

- 40-8138 3mm
- 40-8137 6mm
- 40-8136 8mm

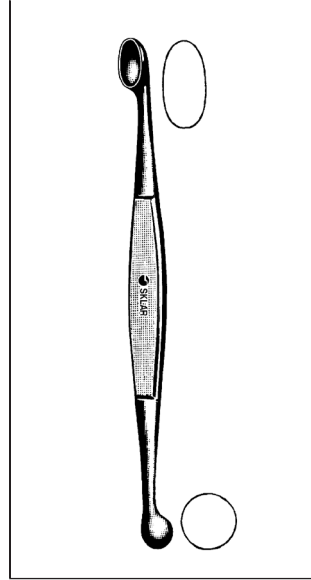

**VOLKMAN CURETTES**  
**DOUBLE END**

- 40-7250 5" Oval/Round
- 40-7165 6½" Oval/Oval
- 40-7265 6½" Oval/Round
- 40-7280 8" Oval/Round

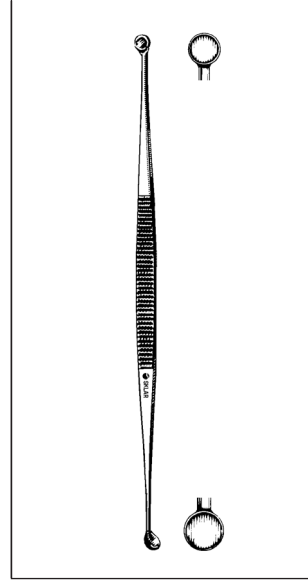

**MARTINI BONE CURETTE**  
**DOUBLE END, ROUND CUPS, 5½"**

- 40-7282 2.5mm x 3.5mm
- 40-7283 3.5mm x 4.5mm
- 40-7284 4mm x 5mm

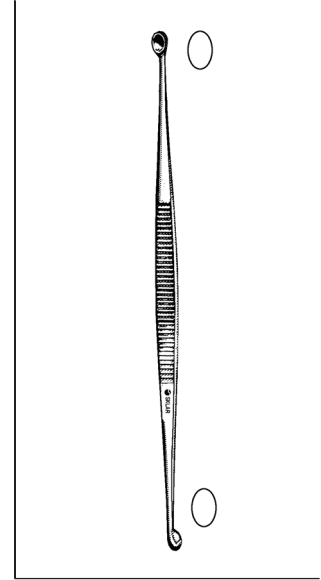

**WILLIGER OVAL CURETTE**  
**DOUBLE END, OVAL CUPS, 5½"**

- 40-7285 #00/0, 2mm x 2.5mm
- 40-7287 #0/1, 3mm x 4mm
- 40-7286 #1/2, 3mm x 4mm

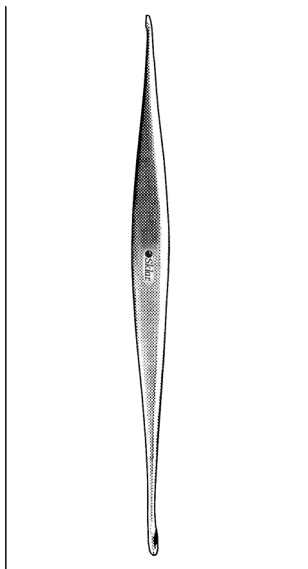

**BARTH CURETTE**  
**DOUBLE END**

- 40-7288 7"

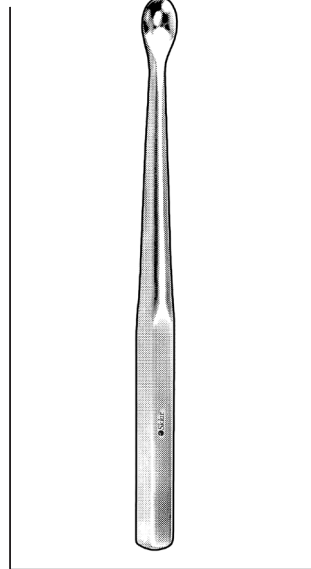

**HATT CURETTES**  
**OVAL CUP, HEX HANDLE**

- 41-1973 4"
- 41-1974 6"
- 41-1975 7¾"

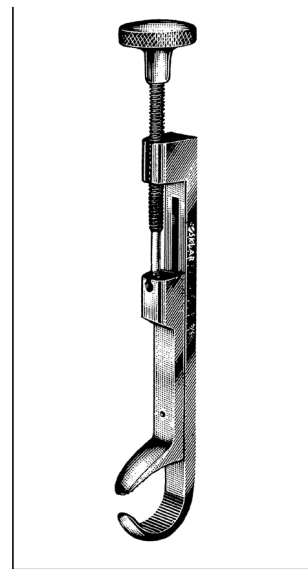

**LOWMAN CLAMPS**  
**1X1 PRONGS**

- 40-2925 4¾" x ¾" Jaw
- 40-2927 7¼" x 1½" Jaw
- 40-2928 8" x 1½" Jaw

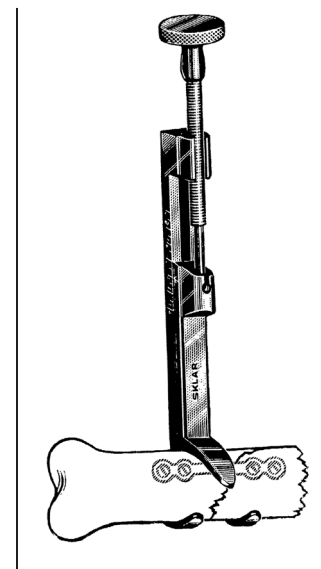

**LOWMAN CLAMPS**  
**1X2 PRONGS**

- 40-2921 4¾" x ¾" Jaw
- 40-2922 7¼" x 1½" Jaw
- 40-2923 8" x 1½" Jaw

For a complete listing of our Orthopedic product line, visit [www.sklarcorp.com](http://www.sklarcorp.com).



ORTHOPEDIC

BONE HOLDING FORCEPS



**LAMBOTTE BONE HOLDING FORCEPS**

DOUBLE ARTICULATION

- 40-2820 8½"
- 40-2830 10½"
- 40-2835 12½"



**FARABEU-F-LAMBOTTE BONE HOLDING FORCEPS**

40-2810 10"

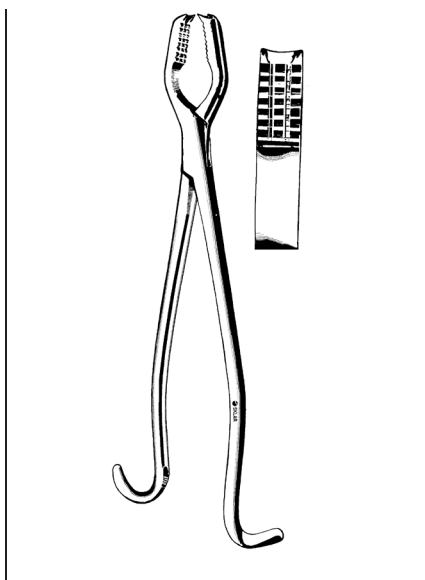

**LANE BONE HOLDING FORCEPS**

WITHOUT RATCHET

- 40-2313 13"
- 40-2417 17"

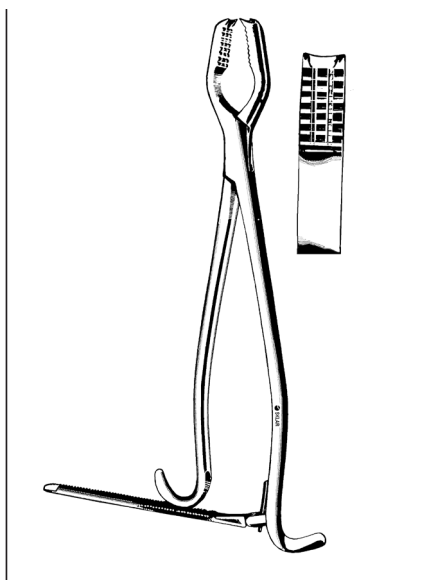

**LANE BONE HOLDING FORCEPS**

WITH RATCHET

- 40-2413 13"
- 40-2418 17"

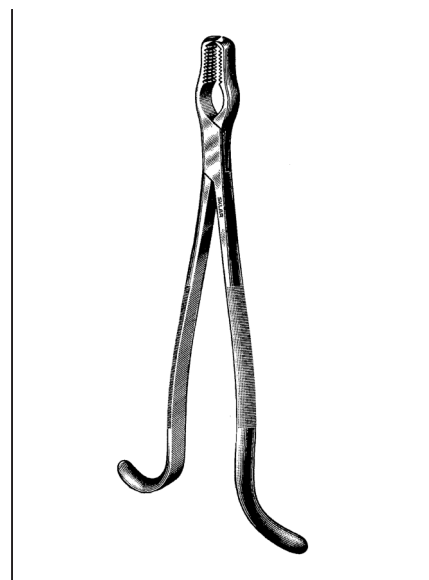

**KERN BONE HOLDING FORCEPS**

WITHOUT RATCHET

- 40-2480 5¾" Extra Small
- 40-2485 8½"

For a complete listing of our Orthopedic product line, visit [www.sklarcorp.com](http://www.sklarcorp.com).



**ORTHOPEDIC  
BONE HOLDING FORCEPS**

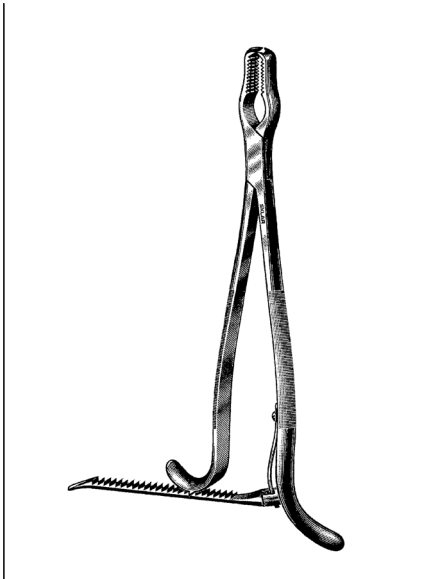

**KERN BONE HOLDING  
FORCEPS**

**WITH RATCHET**

40-2580 5¾" Extra Small  
40-2585 8½"

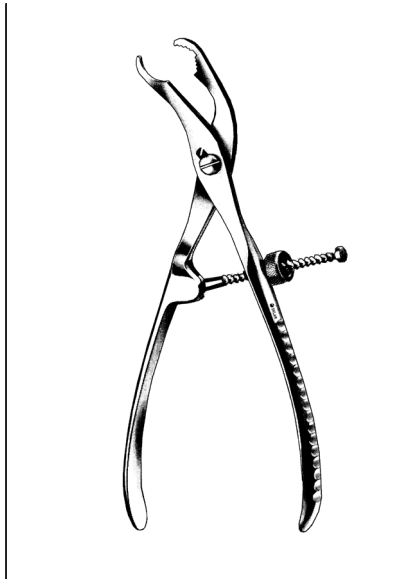

**SELF-RETAINING BONE  
HOLDING FORCEPS**

**ANGULAR WITH SIDE LOCK**

40-2590 6"

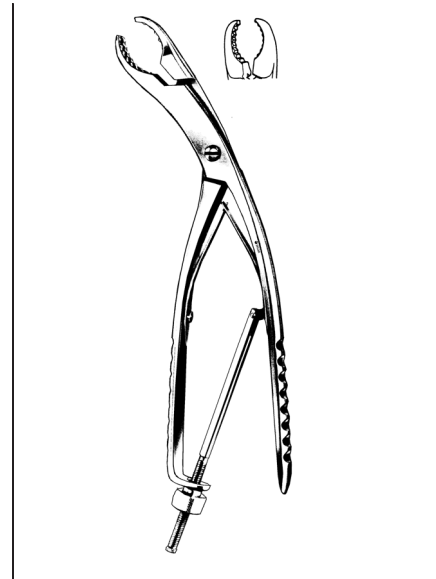

**SELF-RETAINING BONE  
HOLDING FORCEPS**

**ANGULAR WITH BOTTOM LOCK**

40-2595 5½"

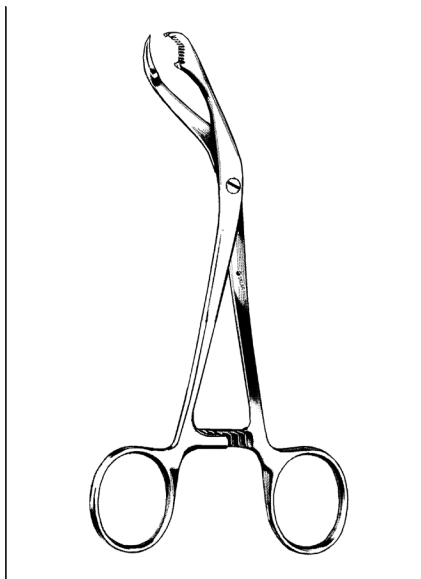

**VERBRUGGE BONE HOLDING  
FORCEPS**

40-2598 7" 5mm  
40-2599 10¼" 10.5mm  
40-2600 11" 12mm

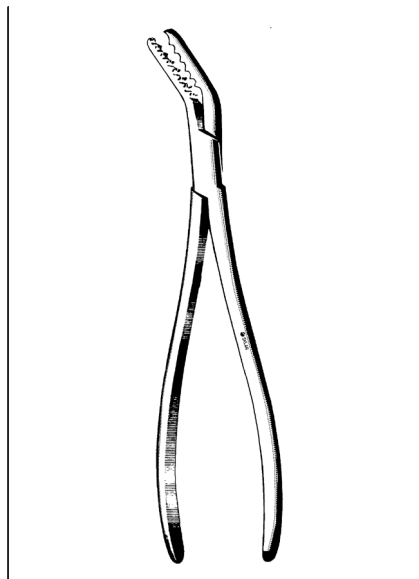

**SEMB BONE HOLDING FORCEPS**

40-2708 7½"

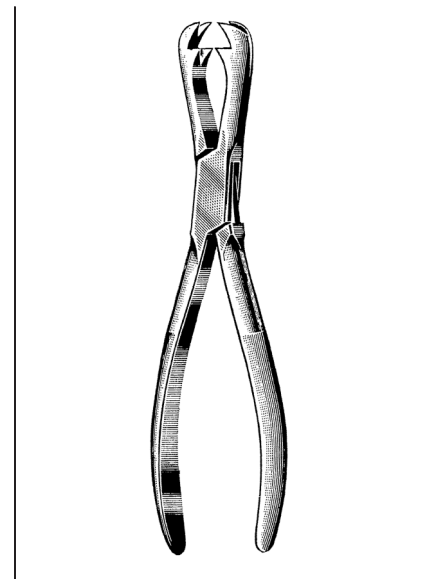

**FERGUSON BONE HOLDING  
FORCEPS**

40-2285 8½"

**For a complete listing of our Orthopedic product line, visit [www.sklarcorp.com](http://www.sklarcorp.com).**



ORTHOPEDIC

BONE HOLDING FORCEPS

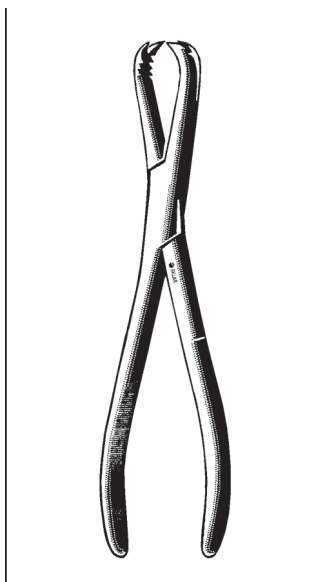

**LANGENBECK BONE  
HOLDING FORCEPS**

40-2705 8"

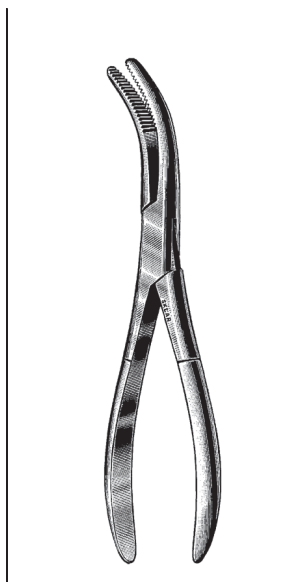

**VAN BUREN  
SEQUESTRUM  
FORCEPS**

40-2085 8½" Curved

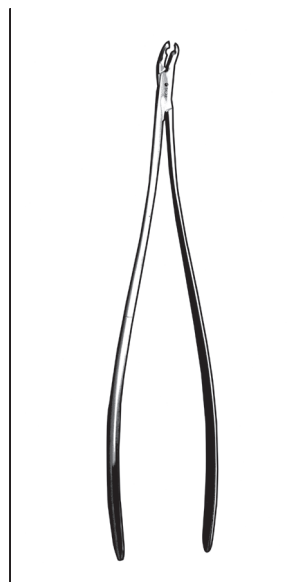

**LANE BONE SCREW  
HOLDING FORCEPS**

40-1790 9"

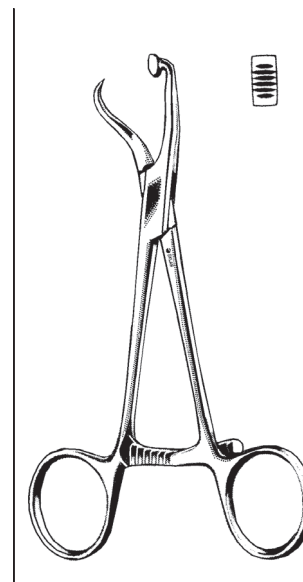

**PLATE AND BONE  
HOLDING FORCEPS**

ONE POINTED TIP AND FOOT PLATE  
40-2672 4¾"

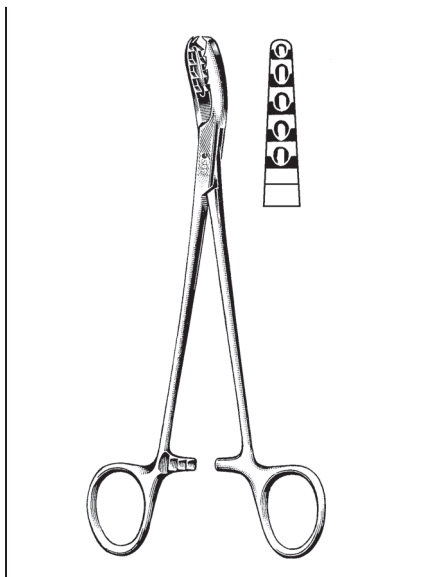

**BONE AND CARTILAGE CLAMP**

40-2275 8" Curved

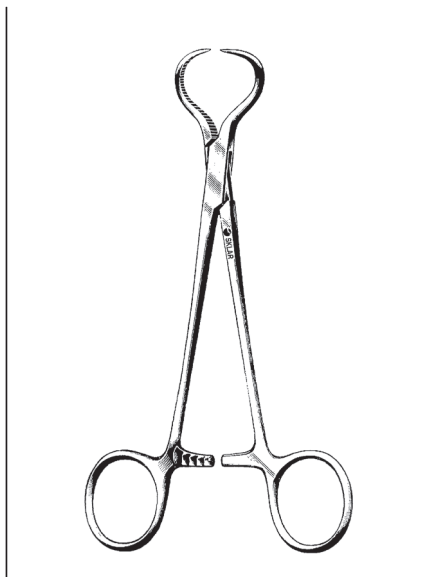

**LEWIN BONE FORCEPS**

40-2670 7" Serrated

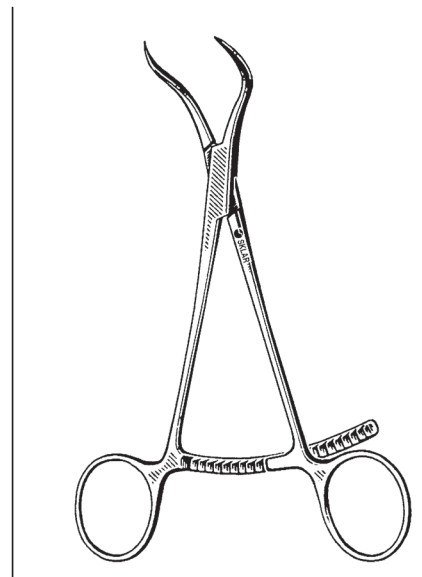

**BONE COMPRESSION FORCEPS**

40-2675 5½" Pointed Tip

For a complete listing of our Orthopedic product line, visit [www.sklarcorp.com](http://www.sklarcorp.com).



**TUCKER HALLUX FORCEPS**

40-2678 4½" Ball guarded points



**INGE RETRACTORS**

**WITH TEETH**

42-1420 6½"  
42-1425 10½"

**WITHOUT TEETH**

42-1421 6½"  
42-1422 10½"

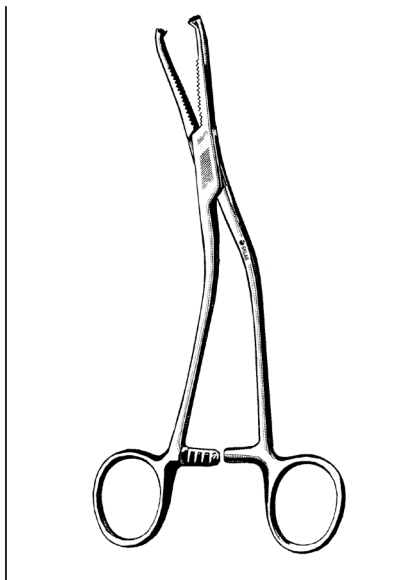

**DINGMAN SMALL BONE AND  
CARTILAGE CLAMP**

**SERRATED JAWS**

40-2660 7½" 4mm (2x2 teeth)

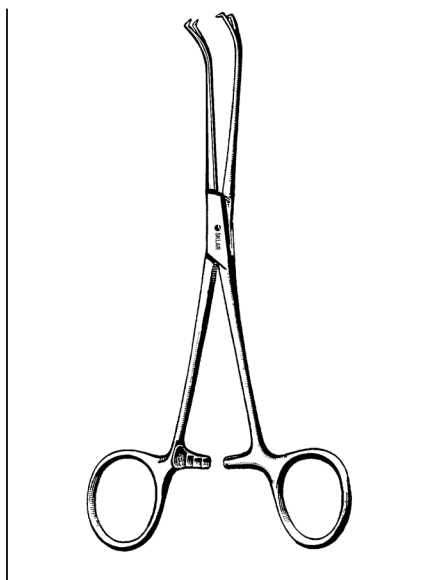

**SESAMOID CLAMP**

40-2655 6½"

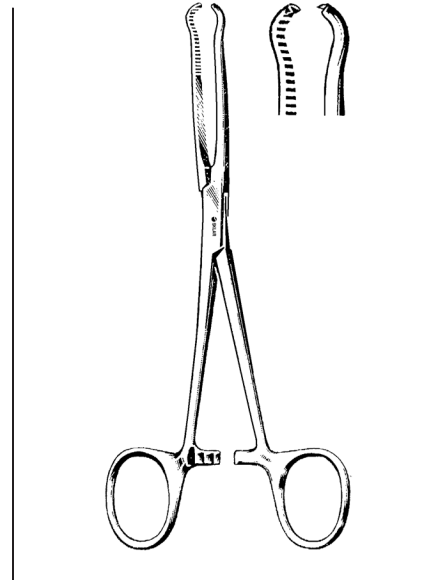

**LOCKE PHALANGEAL FORCEPS**

40-2650 6"

For a complete listing of our Orthopedic product line, visit [www.sklarcorp.com](http://www.sklarcorp.com).

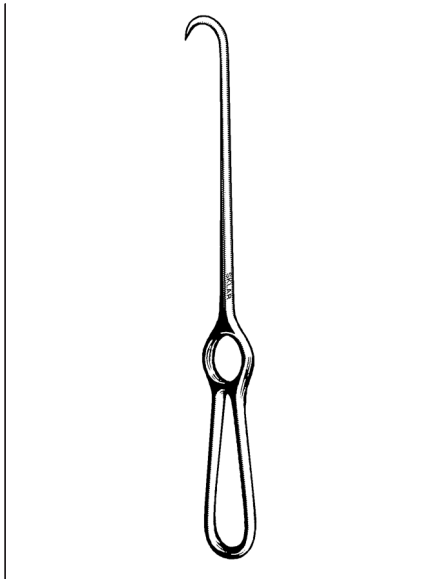

**VOLKMAN BONE HOOKS**

60-5820 8" Sharp  
60-5821 9" Blunt

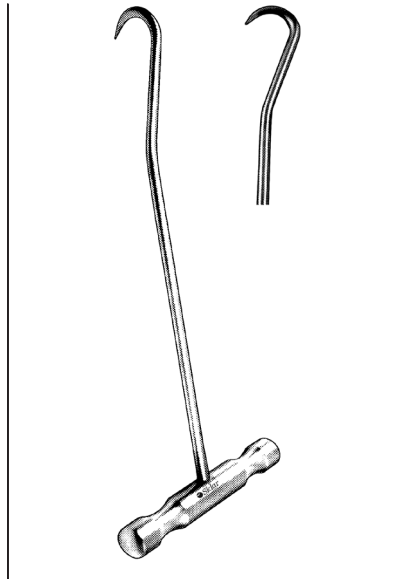

**BONE HOOK  
LARGE "T" HANDLE**

40-6855

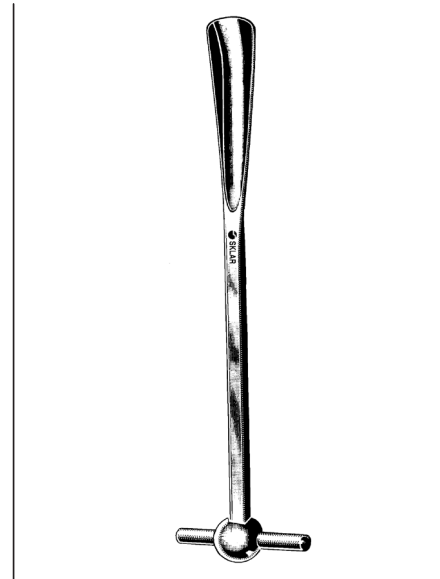

**MEYERDING SKID**

40-6914 13 1/4"

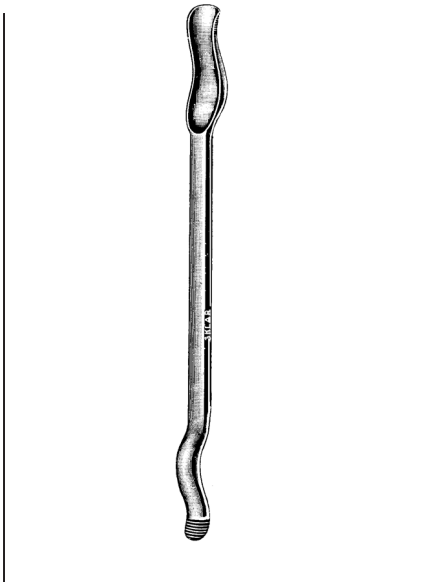

**MURPHY-LANE BONE SKID**

40-9613 12"

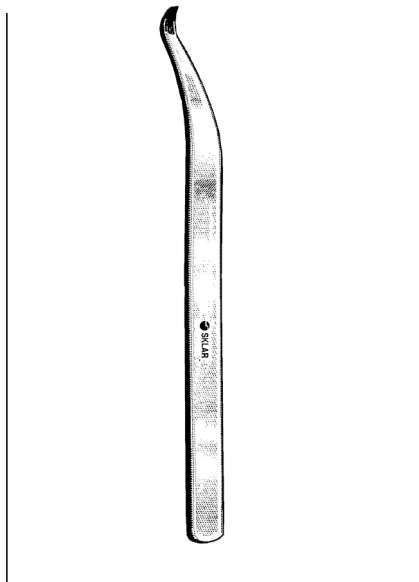

**HAYS HAND AND FINGER  
RETRACTOR**

3/8" WIDE TAPERING TO 1/8"  
40-8265 1 1/2" Long 6"

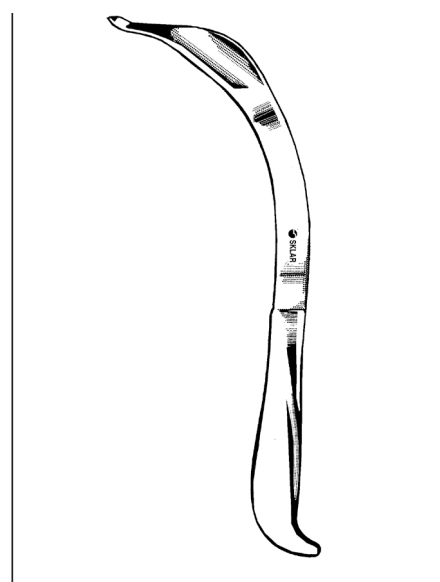

**AUFRANC COBRA RETRACTORS**

40-8280 Pointed Tip, Serrated  
40-8282 Blunt Tip, Serrated  
40-8284 Blunt Tip, Smooth

**For a complete listing of our Orthopedic product line, visit [www.sklarcorp.com](http://www.sklarcorp.com).**

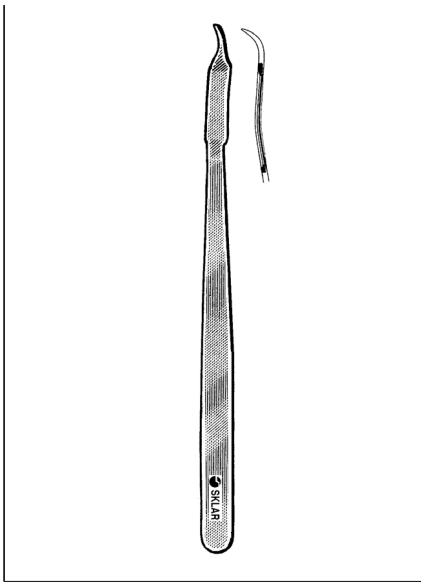

**MINI HOHMANN BONE ELEVATORS**

- 40-7450 6½" x 6mm
- 40-7451 6½" x 8mm

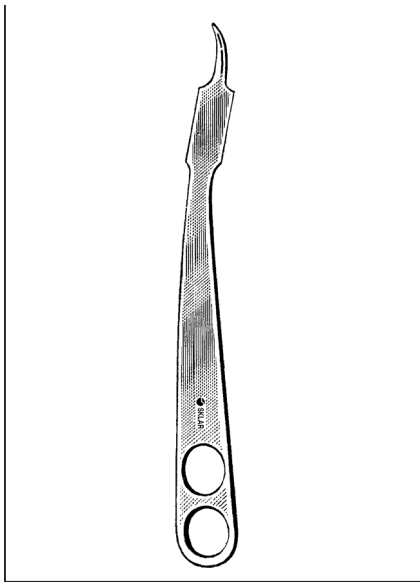

**HOHMANN BONE ELEVATORS**

- 40-7447 8½" 8mm
- 40-7448 9" 10mm
- 40-7452 9½" 18mm
- 40-7453 9½" 43mm
- 40-7454 10" 24mm
- 40-7455 10" 20mm
- 40-7456 10" 22mm
- 40-7458 10½" 65mm

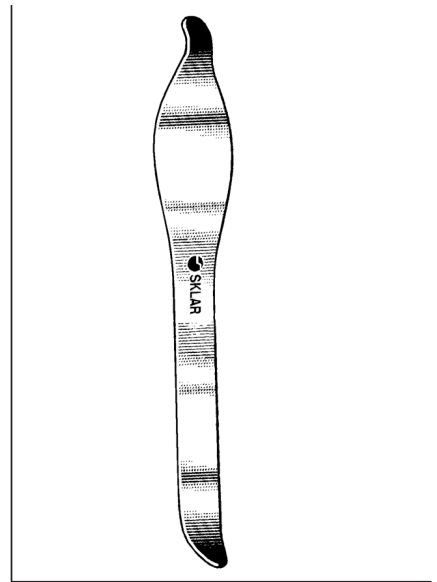

**BLOUNT SINGLE PRONG RETRACTOR**

- 40-8252 10½" 37mm blade width

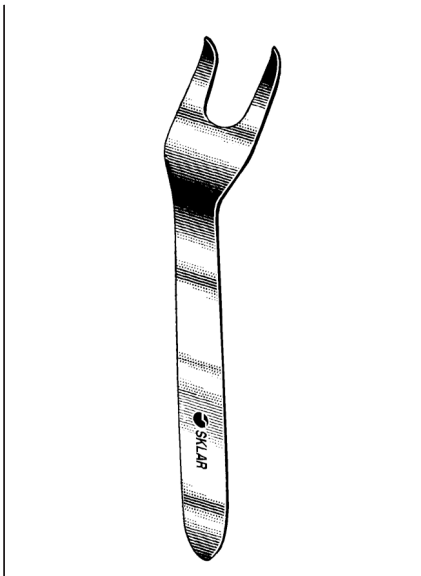

**BLOUNT DOUBLE PRONG RETRACTOR**

- 40-8255 10½" 44mm width

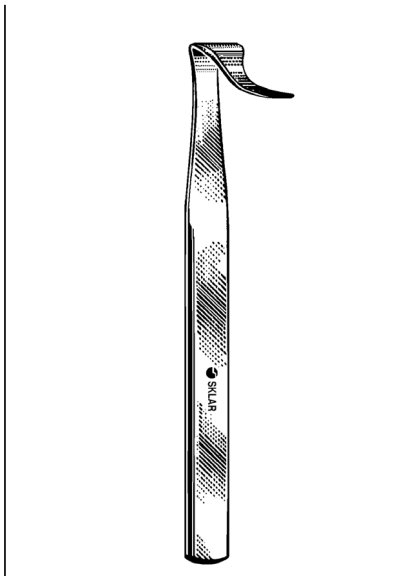

**BLOUNT KNEE RETRACTOR**

- 40-8250 7" Blade 1¼" deep,  
⅝" wide tapering  
to ⅜"

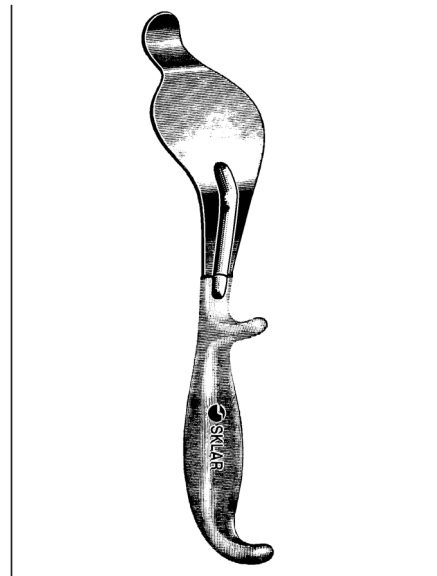

**BENNETT TIBIA RETRACTORS**

- 9½"
- 40-8175 1¼" (4.4cm) Small
- 40-8238 2¾" (6.4cm) Large

For a complete listing of our Orthopedic product line, visit [www.sklarcorp.com](http://www.sklarcorp.com).

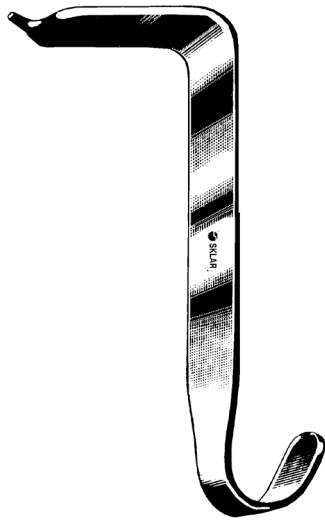

**TAYLOR SPINAL RETRACTORS**

42-2130 3" (7.6cm) Small Blade  
42-2140 4" (10.2cm) Large Blade

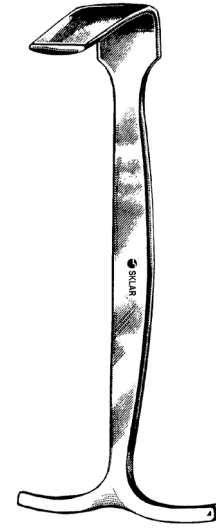

**SMILLE MENISCUS HOOK RETRACTOR**

40-2290 5¾" Long Blade ¾" x 1⅜"



**MATHIEU RASPATORIES**

6¼"  
40-8962 Straight with Convex Edge

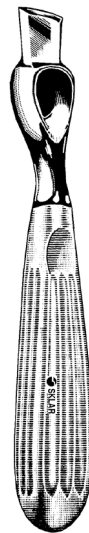

**KIRMISSION PERIOSTEAL RASPATORY**

40-9070 6¾" Sharp



**SEDILLOT ELEVATOR**

40-9370 7"

For a complete listing of our Orthopedic product line, visit [www.sklarcorp.com](http://www.sklarcorp.com).



**FARABEU F RASPATORY**

**STRAIGHT**

40-9160 6" (15.5cm)

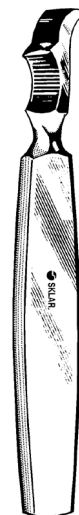

**FARABEU F RASPATORY**

**CURVED**

40-9260 6" (15.5cm)



**FARABEU F RASPATORY**

**DOUBLE ENDED**

40-9075 7½" (19cm)



**ALEXANDER RASPATORY**

55-5980 8" (20.3cm)

For a complete listing of our Orthopedic product line, visit [www.sklarcorp.com](http://www.sklarcorp.com).

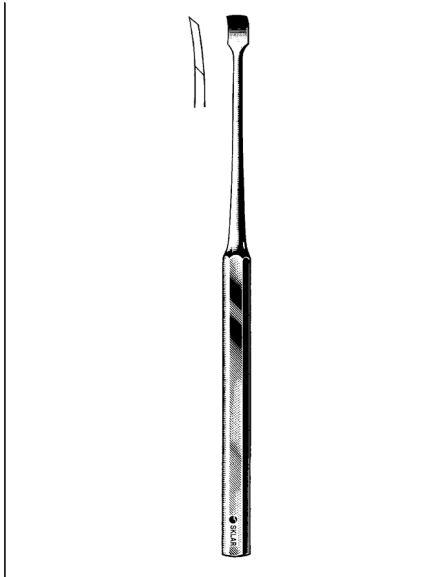

**KEY ELEVATORS**

- 40-7400 7" x 1/4"
- 40-7401 7 1/2" x 3/8"
- 40-7402 7 1/2" x 1/2"
- 40-7404 7 1/2" x 3/4"
- 40-7406 7 1/2" x 1"

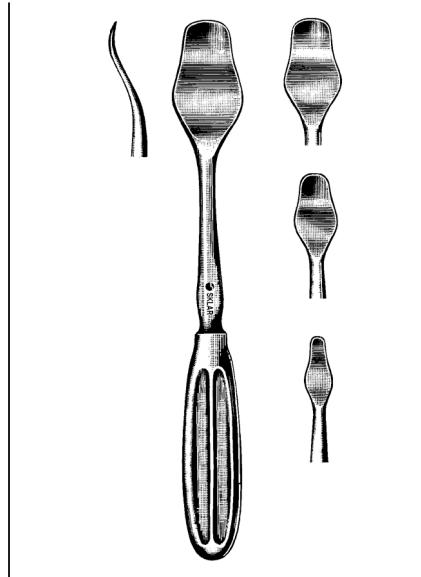

**CHANDLER ELEVATORS**

- 40-7430 7" 1/2" Width
- 40-7435 8" 3/4" Width
- 40-7440 9" 1" Width
- 40-7445 10" 1 1/4" Width

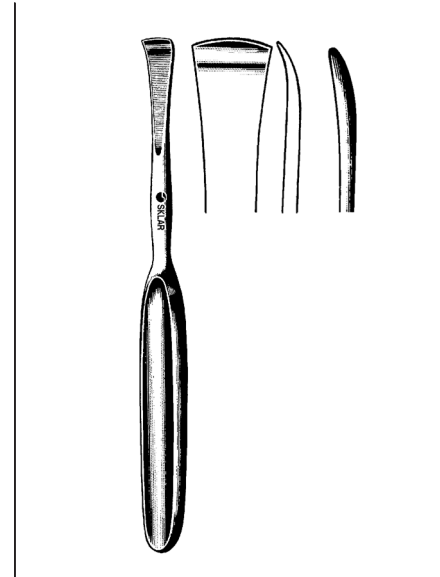

**LANGENBECK ELEVATORS**

- SINGLE END**
- 40-8675 7 1/2" Narrow
  - 40-8775 7 1/2" Broad

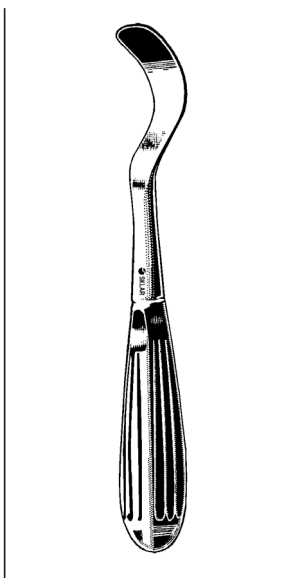

**CREGO ELEVATOR**

- FULL CURVE**
- 40-7410 7 3/4" Long x 14mm Wide

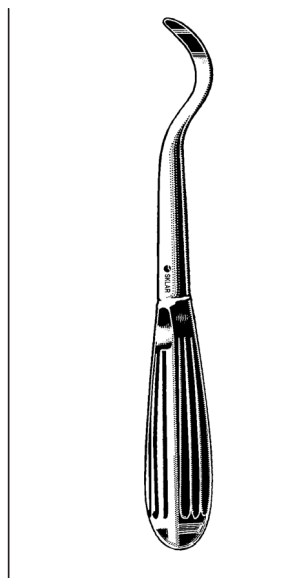

**CREGO ELEVATOR**

- FULL CURVE**
- 40-7415 8" Long x 6mm Wide

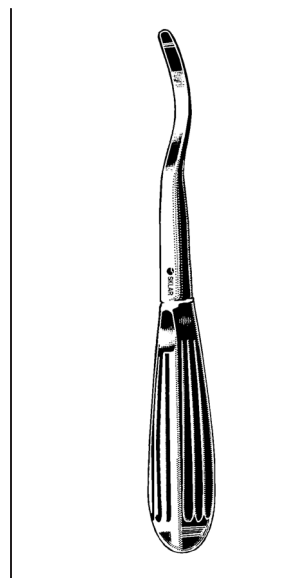

**CREGO ELEVATOR**

- SLIGHT CURVE**
- 40-7420 8" Long x 6mm Wide

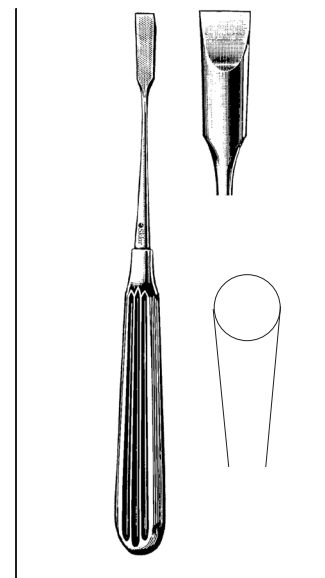

**ADSON ELEVATORS**

- 40-8270 6 3/4" Square End
- 40-8272 6 3/4" Round End

For a complete listing of our Orthopedic product line, visit [www.sklarcorp.com](http://www.sklarcorp.com).



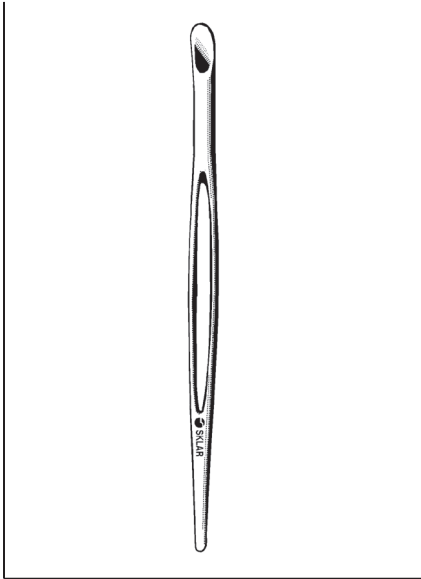

**SAYRE ELEVATORS**

**DOUBLE END**

40-9265 6½" (16cm) Sharp  
40-9365 6½" (16cm) Blunt

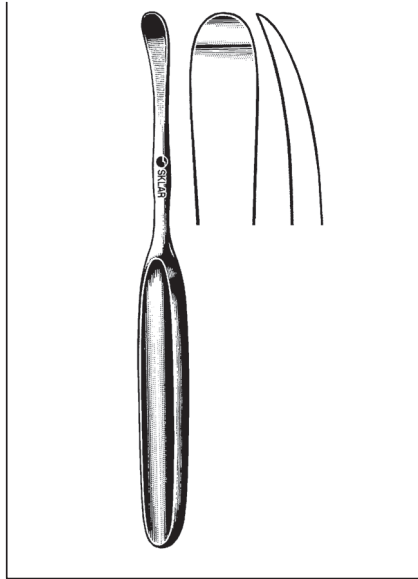

**LANE ELEVATORS**

**SINGLE END**

40-8375 7½" Narrow  
40-8275 7½" Wide



**SELDIN ELEVATOR**

97-0527 8" Double End

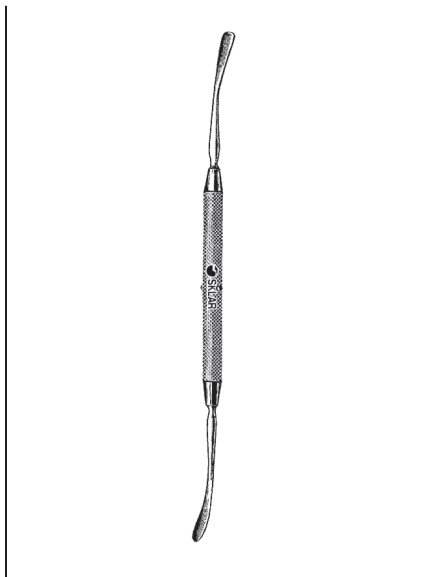

**FREER ELEVATOR**

**DOUBLE END**

47-2380 7¼" Sharp/Blunt

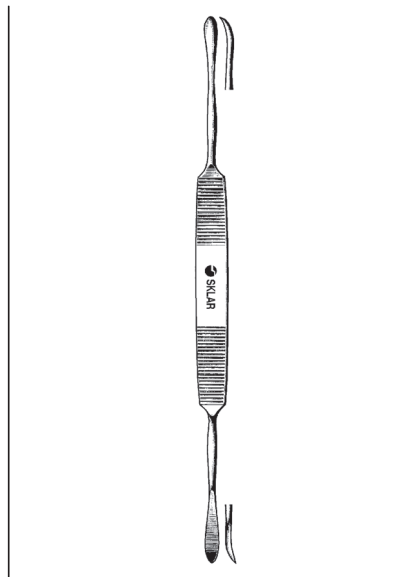

**OHL ELEVATOR**

**DOUBLE END**

97-0050 9"

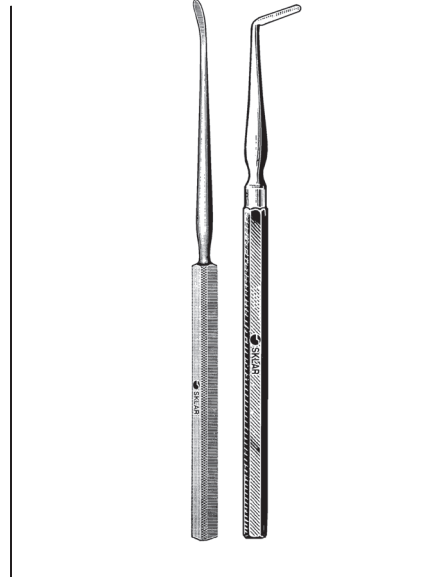

**FRAZIER BLUNT DISSECTOR**

47-2360 6" Angular

**WEST BLUNT DISSECTOR**

47-2262 6¼" Curved

For a complete listing of our Orthopedic product line, visit [www.sklarcorp.com](http://www.sklarcorp.com).



**ORTHOPEDIC  
TENDON INSTRUMENTS**

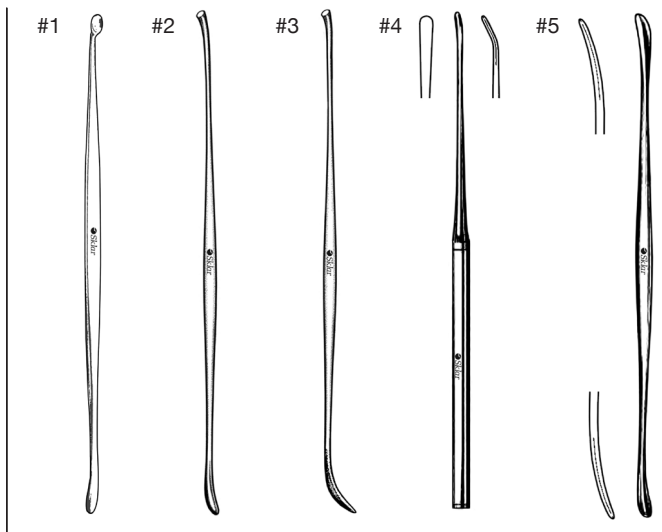

**PENFIELD DISSECTORS**

**DOUBLE END**

- 47-2255 #1 6mm Blunt Dissector with Slight Curve / 6mm Sharp Cup
- 47-2256 #2 6mm Blunt Dissector with Slight Curve / Tamper
- 47-2257 #3 6mm Blunt Dissector with Full Curve / Tamper
- 47-2259 #5 7mm / 8mm Blunt Dissector with Slight Curve

**SINGLE END**

- 47-2258 #4 3mm Blunt Dissector with Slight Curve



**BUNNELL TENDON STRIPPERS**

**6" (15 CM)**

- |         |     |         |     |
|---------|-----|---------|-----|
| 47-3403 | 3mm | 47-3406 | 6mm |
| 47-3404 | 4mm | 47-3407 | 7mm |
| 47-3405 | 5mm |         |     |

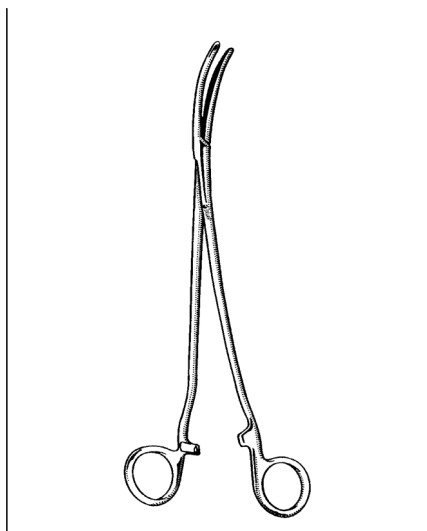

**PLATT TENDON  
TRANSPLANTATION FORCEPS**

- 47-3510 11" 279mm  
Stainless Steel

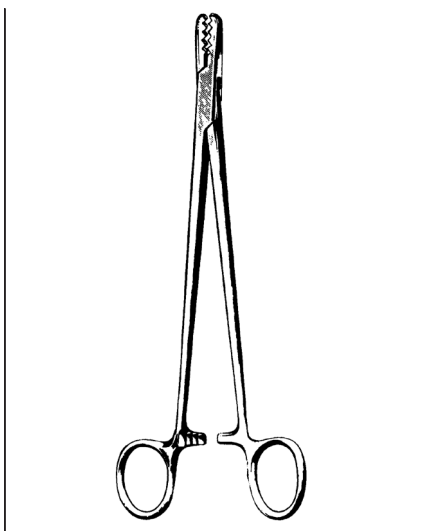

**SKLAR TENDON CLAMP  
IMPROVED PATTERN**

- 41-1140 8"

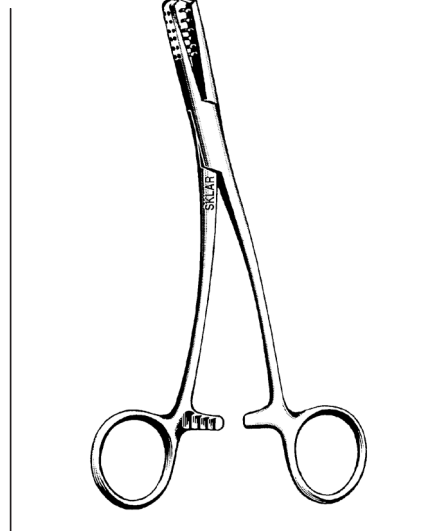

**SKLAR MENISCUS CLAMP  
WITH PINS**

- 40-2276 7½" (19.1cm)  
Shanks curved sideways

For a complete listing of our Orthopedic product line, visit [www.sklarcorp.com](http://www.sklarcorp.com).

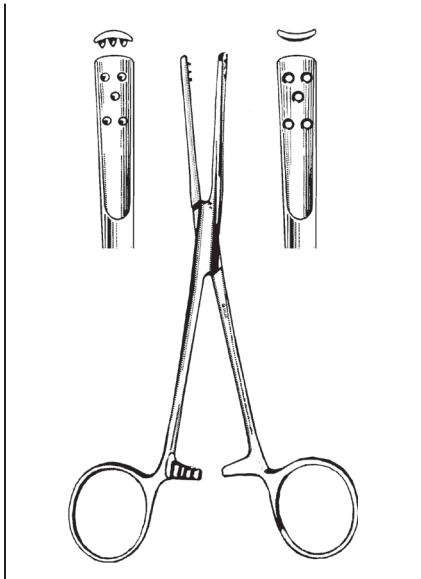

**PENNER FORCEPS**  
DOUBLE END  
97-1325 5¾"

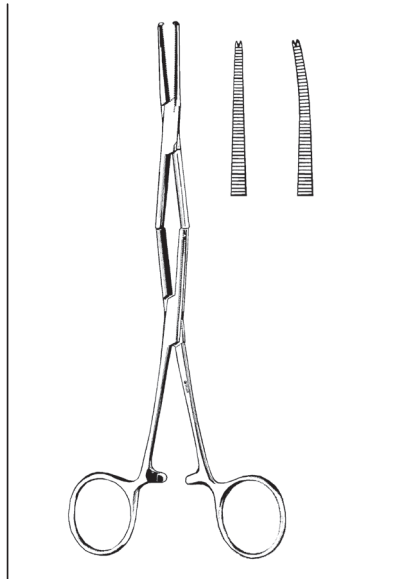

**BUCK-GRAMCKO TENDON  
RETRIEVERS**  
DOUBLE ACTION, SERRATED JAWS  
2X3 TEETH  
40-2640 8" Straight  
40-2642 8" Curved

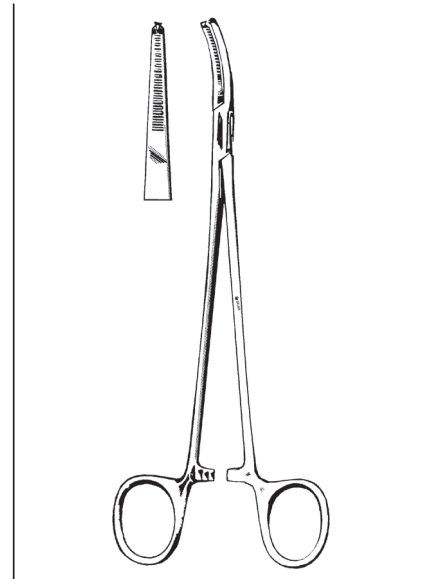

**PRESTON LIGAMENTUM  
FLAVUM FORCEPS**  
40-2665 7"

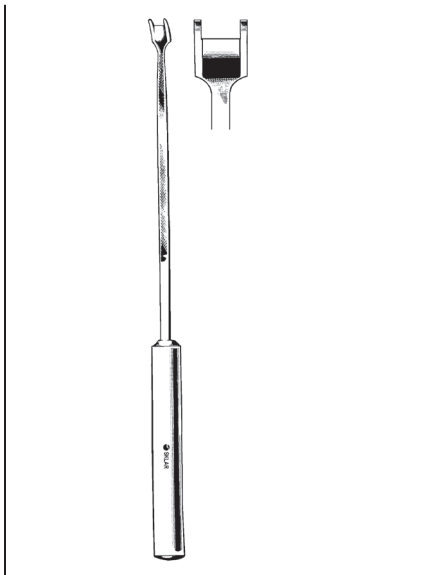

**LOWE-BRECK CARTILAGE  
KNIFE**  
STRAIGHT EDGE WITH GUARDS  
47-3418 10½"

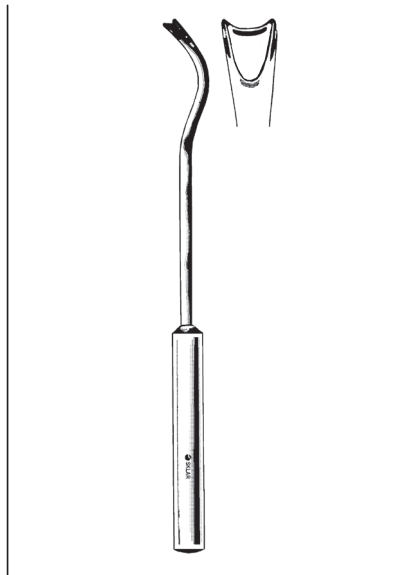

**DOWNING CARTILAGE KNIFE**  
CONCAVE EDGE WITH GUARDS  
47-3415 10"

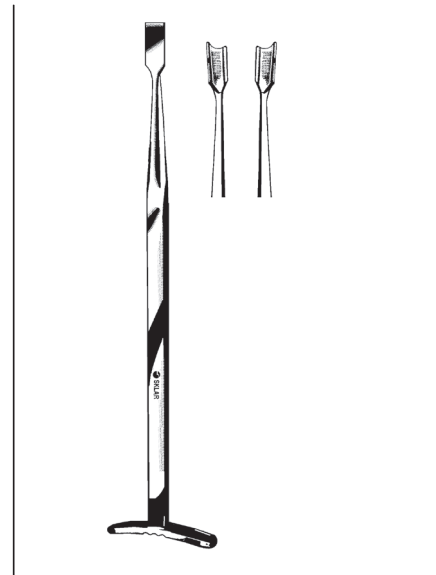

**SMILLIE MENISCUS KNIVES**  
47-3420 6¾" Straight Chisel Blade  
47-3422 6¾" Guarded Left  
47-3424 6¼" Guarded Right

For a complete listing of our Orthopedic product line, visit [www.sklarcorp.com](http://www.sklarcorp.com).

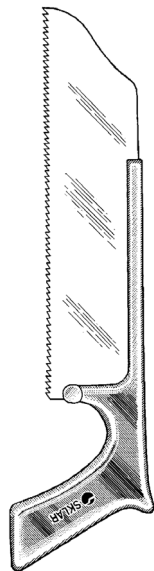

**SATTERLEE BONE SAW**

40-5311 12"



**CHARRIERE METACARPAL BONE SAW**

40-5210 12" 8" Blade, Chrome plated



**JOSEPH BONE SAWS**

70-7801	7½"	Right	Bayonet
70-7802	7½"	Left	Bayonet
70-7805	7½"	Straight	

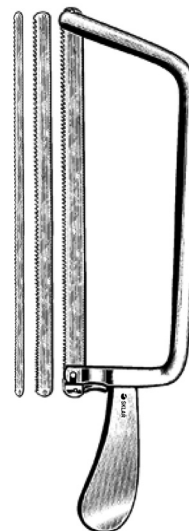

**CHARRIERE BONE SAW**

**WITH BOW HANDLE**

40-5213	13½"	With Three 8" Blades (12mm, 15mm, 18mm)
40-5212	12mm	Replacement Blade
40-5215	15mm	Replacement Blade
40-5218	18mm	Replacement Blade

For a complete listing of our Orthopedic product line, visit [www.sklarcorp.com](http://www.sklarcorp.com).

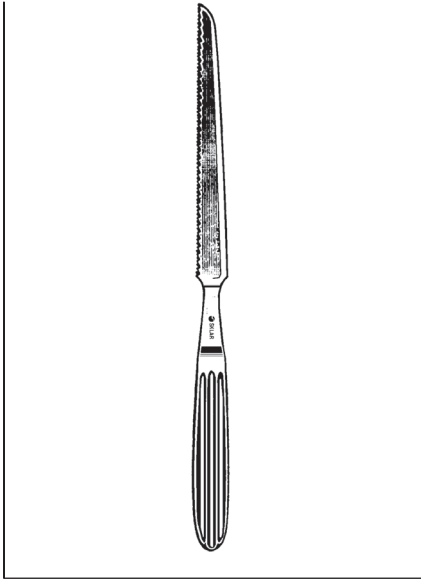

**LANGENBECK METACARPAL  
SAW**

40-5395 4½" (11.4cm) blade  
Total length 9" (22.86cm)



**LISTON AMPUTATING KNIVES**

12-1065 7" Blade, 12" Total  
12-1080 8" Blade, 13" Total

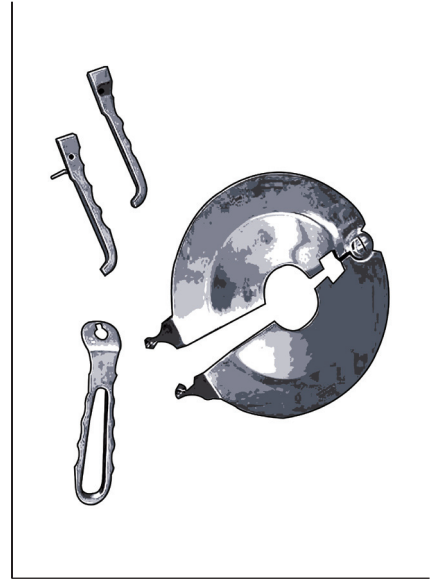

**PERCY AMPUTATION  
RETRACTOR**

40-5551 4 Piece



**GIGLI SAW HANDLES**

40-5520 Solid Style  
40-5535 Wire Loop Style (Not Shown)

**GIGLI SAW WIRES**

40-5540 9"      40-5544 20"  
40-5542 12"    40-5546 30"  
40-5543 16"

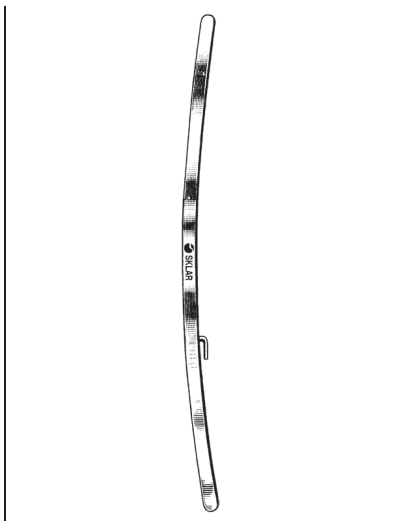

**BAILEY GIGLI SAW GUIDE**

50-2412

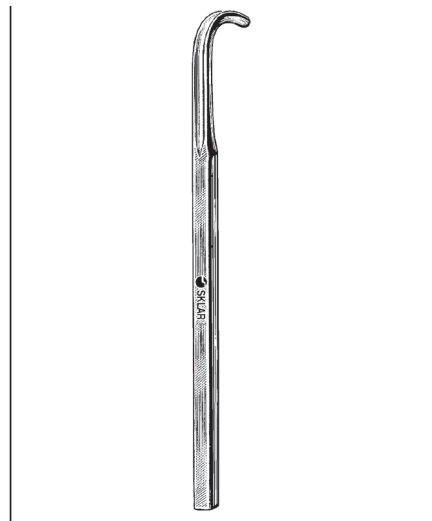

**JOSEPH SAW GUIDE**

41-1320 4mm Curved

For a complete listing of our Orthopedic product line, visit [www.sklarcorp.com](http://www.sklarcorp.com).

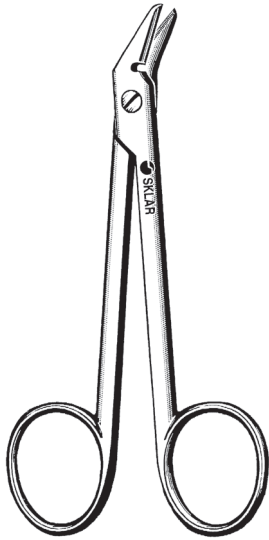

**SUTURE WIRE CUTTING  
SCISSORS**  
ANGULAR SERRATED  
24-2342 4¾"  
16-2800 4¾" TC

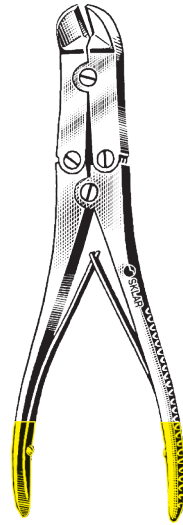

**TC PIN CUTTERS SIDE CUT**  
DOUBLE ACTION  
40-1023 7" Straight  
40-1024 8½" Angular

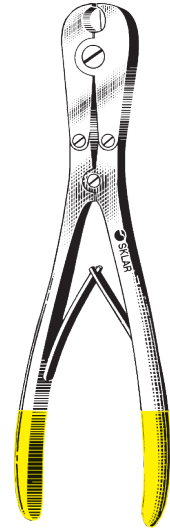

**TC PIN CUTTER**  
DOUBLE ACTION  
Cuts to .062" Wire 1.6mm  
40-1045 7" End Cut-Side Cut



**DOUBLE ACTION PIN  
CUTTER**  
STAINLESS  
40-1715 15" Cuts up to ½"

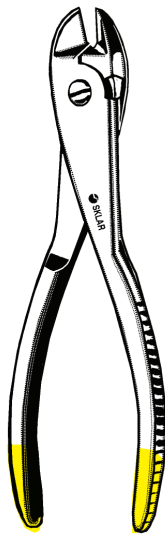

**TC WIRE AND PIN  
CUTTER**  
40-1018 8"

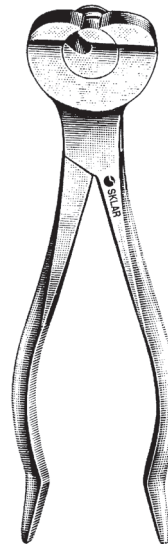

**DIAMOND PIN CUTTER**  
CHROME  
40-1762 6¼"

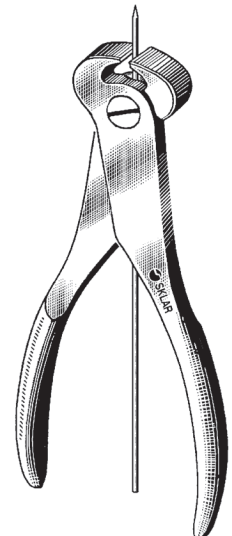

**SKLAR PIN CUTTER**  
END CUTTING  
40-1048 7"

For a complete listing of our Orthopedic product line, visit [www.sklarcorp.com](http://www.sklarcorp.com).

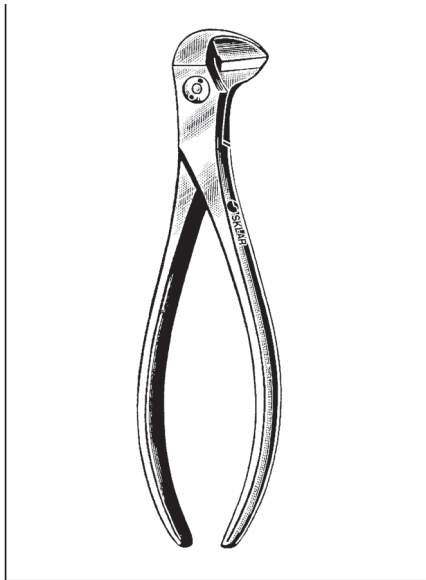

**IMPROVED SKLAR FORCEPS  
FOR CUTTING AND SHAPING WIRE**  
75-9550

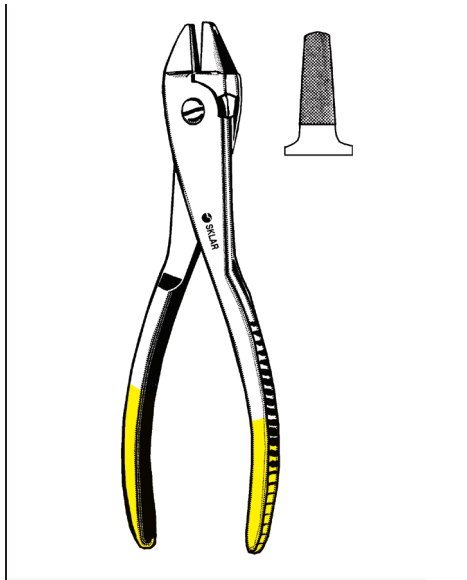

**TC WIRE PULLER**  
40-1730 8"

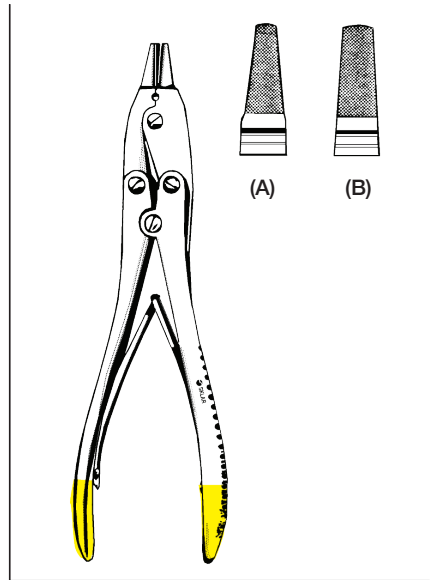

**TC WIRE PULLER  
DOUBLE ACTION**  
40-1735 7" 4mm (A)  
40-1738 7" 6mm (B)

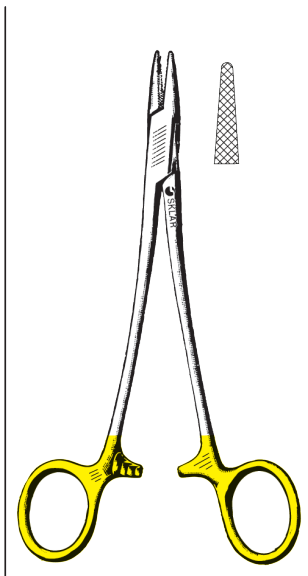

**TC RING HANDLE WIRE  
EXTRACTOR**  
40-1720 7"

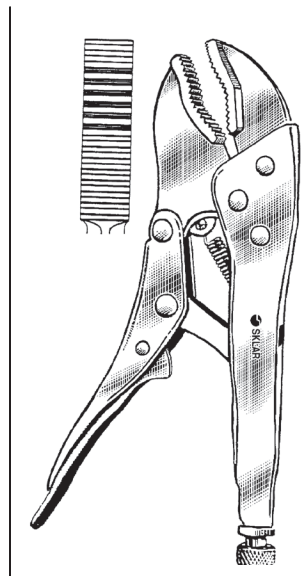

**SNAP LOCK PIN/WIRE  
EXTRACTOR**  
40-1725

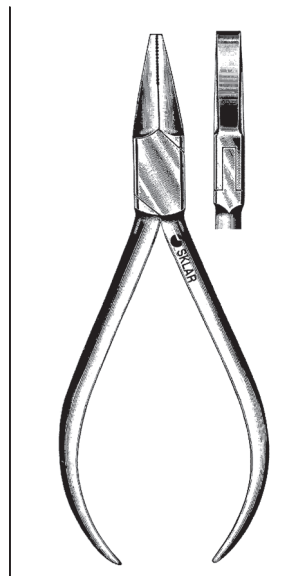

**FLAT NOSE PLIER**  
40-1778 5½"

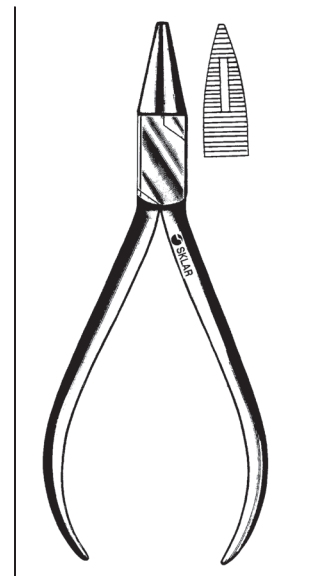

**NEEDLE NOSE PLIER**  
40-1775 5½"

For a complete listing of our Orthopedic product line, visit [www.sklarcorp.com](http://www.sklarcorp.com).

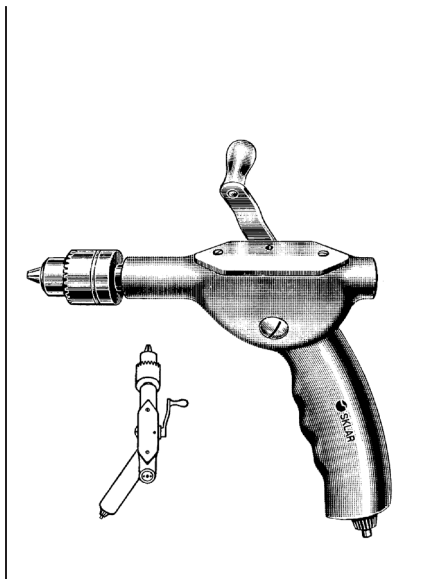

**SKLAR BONE DRILL-OFFSET HANDLE WITH JACOBS CHUCK**

40-1465 For Twist Drills and Kirschner Wires  
40-1478 Chuck Key Only

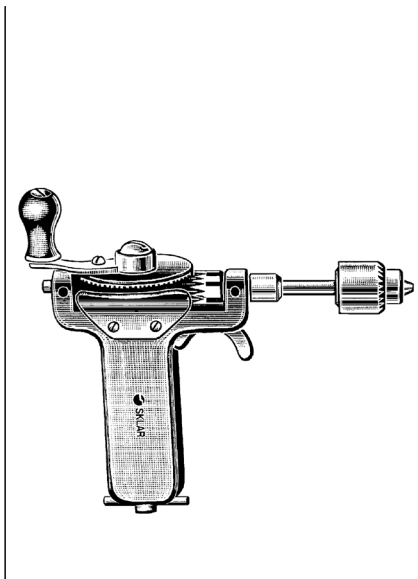

**BUNNELL DRILL-CANNULATED WITH JACOBS CHUCK**

40-1475 For Twist Drills and Kirschner Wires  
40-1478 Chuck Key Only

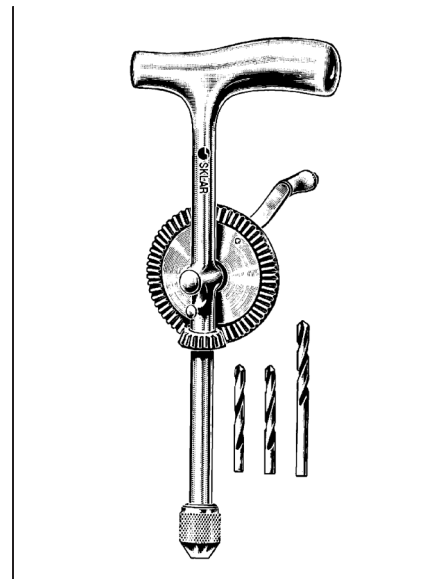

**MOORE DRILL WITH 3 DRILL POINTS**

40-1010 Complete



**KIRSCHNER BONE DRILL**

40-1520 Without Drills

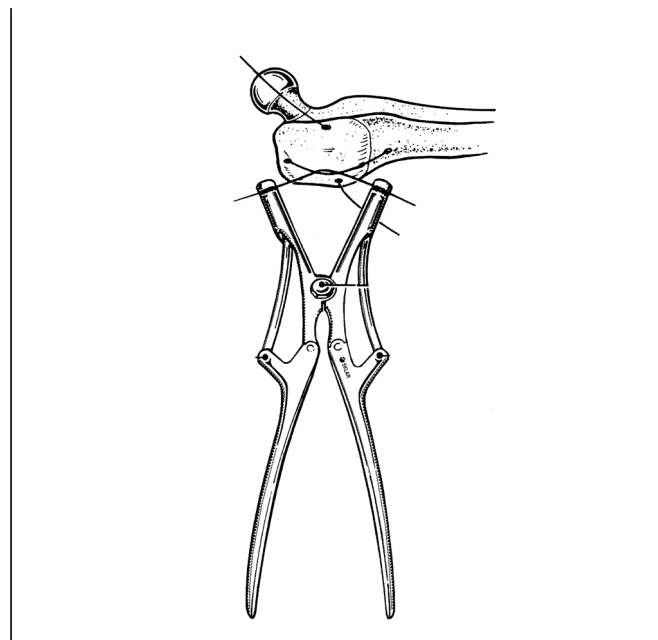

**HARRIS WIRE KNOT TIGHTENER**

40-1530 10" (254mm) Suitable for 18 and 20 gauge wire

For a complete listing of our Orthopedic product line, visit [www.sklarcorp.com](http://www.sklarcorp.com).



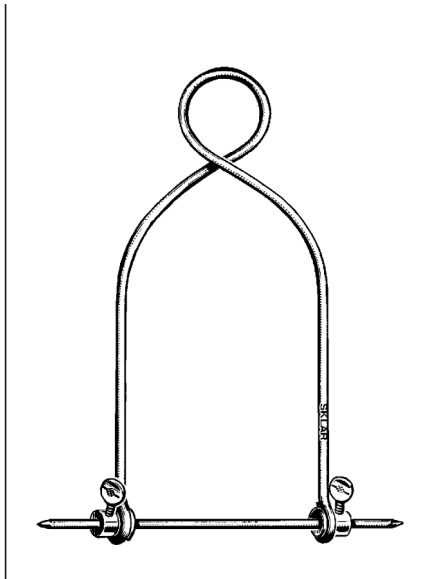

**BOHLER TRACTION BOWS**

**FOR STEINMANN PINS**

- 40-1765 3" x 5" Small
- 40-1766 4" x 8½" Large

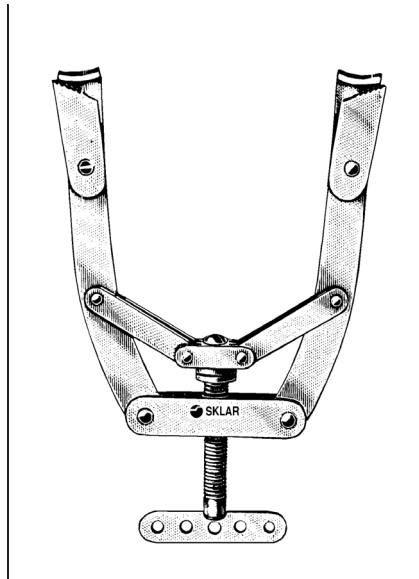

**KIRSCHNER BOWS**

- 40-1750 5¾" Medium  
Maximum Jaw Opening 5"
- 40-1752 7½" Large  
Maximum Jaw Opening 8½"
- 40-1754 9½" Extra Long  
Maximum Jaw Opening 8¾"

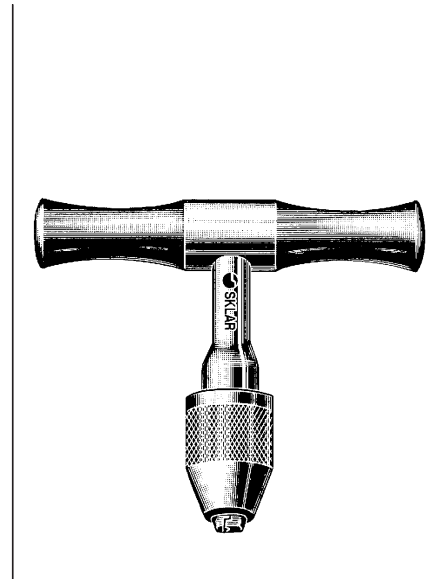

**STEINMANN PIN CHUCK**

- 40-1645 4½" Chrome

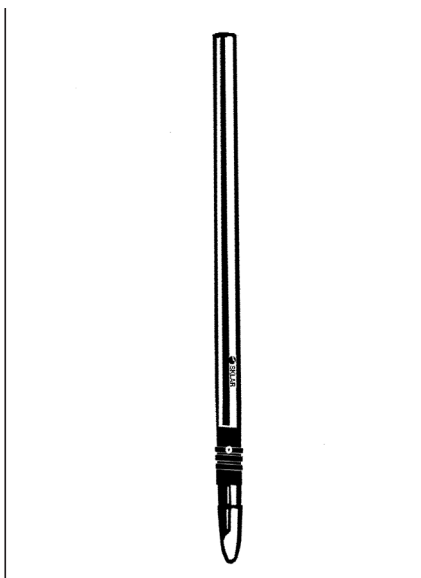

**SCREW DRIVER**

- 40-1640 9¾" Cross-Slit

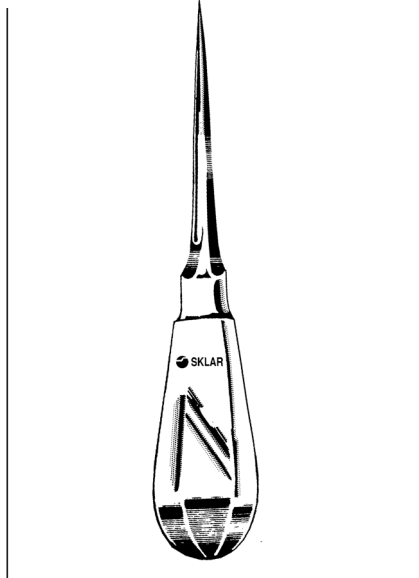

**BONE AWL**

- 40-1642 5½" Square taper

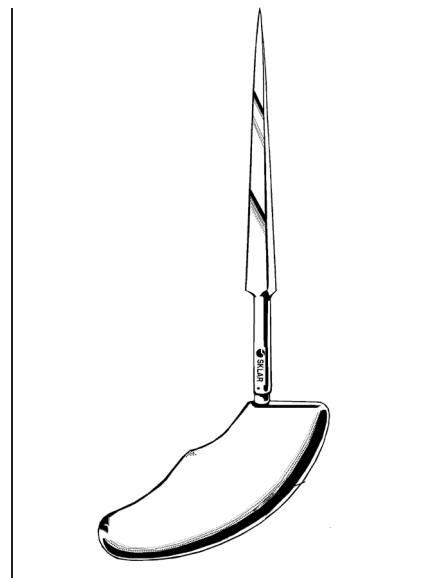

**PERTHES BONE AWL**

- 40-1644 8¼"

For a complete listing of our Orthopedic product line, visit [www.sklarcorp.com](http://www.sklarcorp.com).



**KIRSCHNER WIRES**

**TWO TROCAR ENDS**

40-1565	4" x .028	40-1580	9" x .035
40-1566	4" x .035	40-1582	9" x .045
40-1567	4" x .045	40-1584	9" x .062
40-1568	4" x .054	40-1535	12" x .035
40-1569	4" x .062	40-1545	12" x .045
40-1571	7½" x .045	40-1562	12" x .062
40-1572	7½" x .062		

**STEINMANN PINS**

**TROCAR POINT**

40-1590	9" x 2mm	40-1594	9" x 3.5mm
40-1591	9" x 2.4mm	40-1595	9" x 4.0mm
40-1592	9" x 2.8mm	40-1596	9" x 4.5mm
40-1593	9" x 3.2mm		

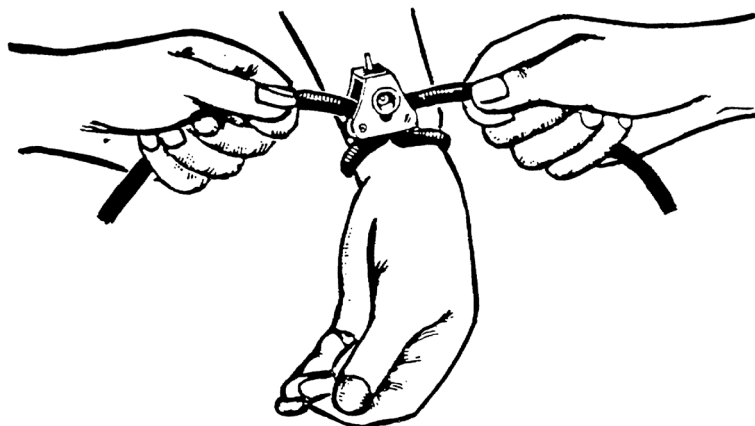

**N-I AUTOMATIC TOURNIQUET**

**BLACK TUBING**

- 40-1915 Complete
- 40-1916 Black Tubing Only
- 40-1917 Clip (for 40-1915)

**WHITE TUBING**

- 40-1918 Complete
- 40-1919 White Tubing Only

For a complete listing of our Orthopedic product line, visit [www.sklarcorp.com](http://www.sklarcorp.com).

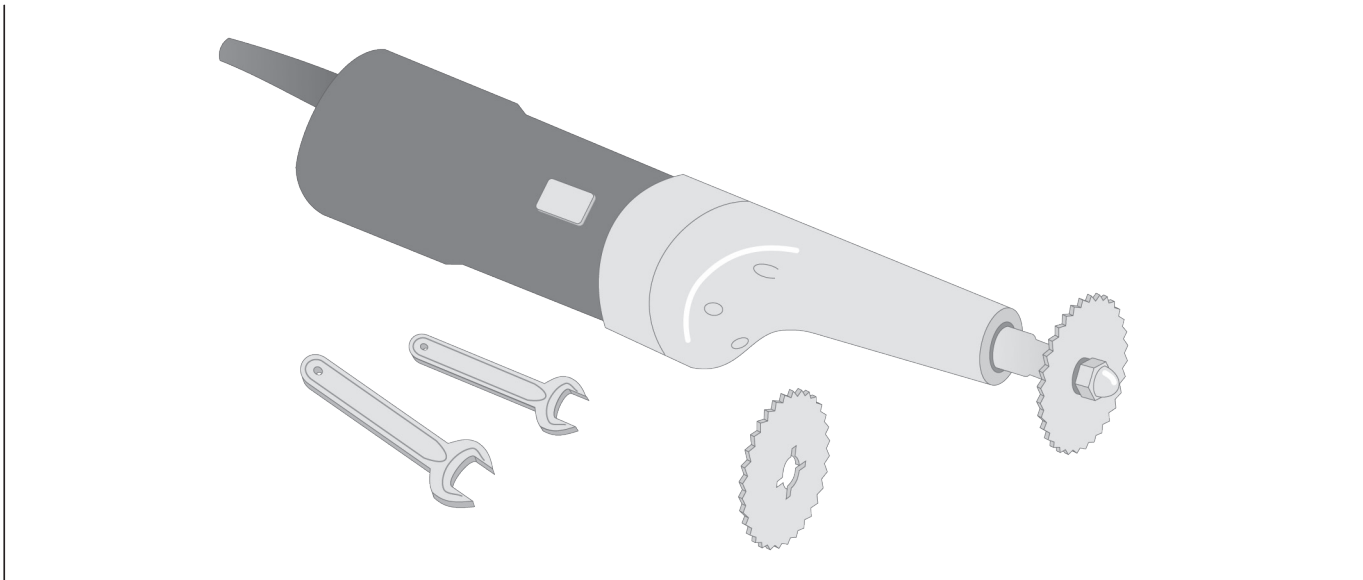

**OSCILLATING PLASTER SAWS**

11-2100	110V Complete	
11-2101	220V Complete	
11-2105	Blade Only	50mm
11-2110	Blade Only	65mm
11-2112	Blade Only	65mm, For use on Synthetic Plaster
11-2115	Wrenches only	Set of 2



**ENGEL PLASTER SAW**

11-1525 Chrome Plated



**MURPHY PLASTER KNIFE**

WOOD HANDLE

11-1540

For a complete listing of our Orthopedic product line, visit [www.sklarcorp.com](http://www.sklarcorp.com).



**SEUTIN PLASTER SHEARS**

**HEAVY PLIER HANDLE**

11-1490 9" Serrated



**BRUNS PLASTER SHEARS**

**SERRATED**

11-1295 9¼"  
16-2820 9½" TC

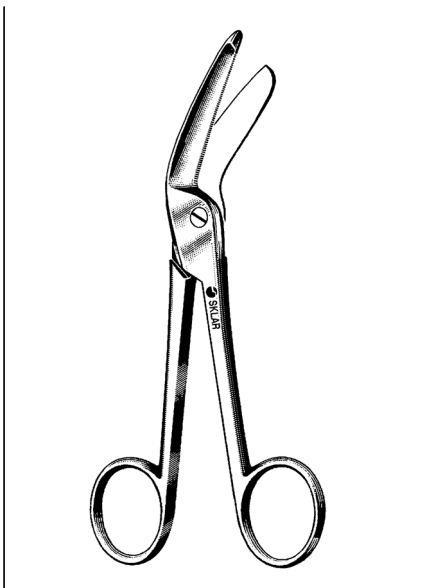

**HERCULES UTILITY SCISSOR**

11-1297 7½" Serrated

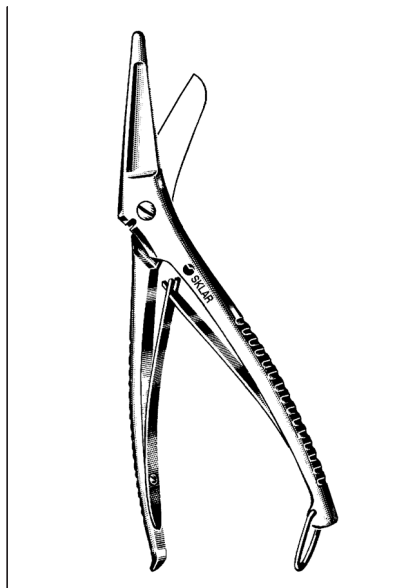

**COMMANDER UTILITY SHEARS**

**HEAVY DUTY WITH WIRE CUTTING NOTCH**

11-1298 8½"

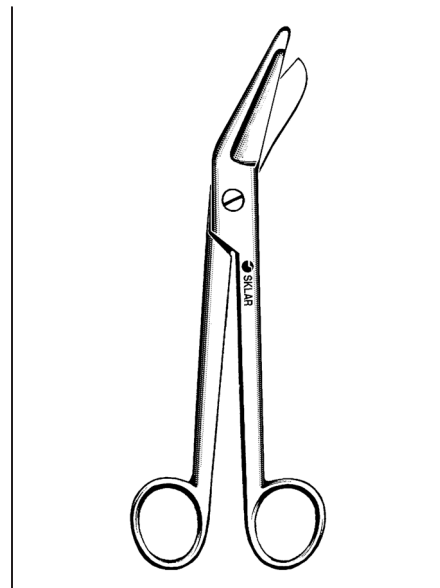

**BRUNS PLASTER SHEARS**

**HEAVY PATTERN**

11-1380 8"  
11-1390 9"

**For a complete listing of our Orthopedic product line, visit [www.sklarcorp.com](http://www.sklarcorp.com).**

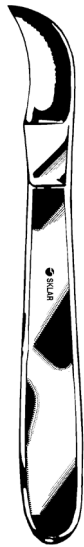

**REINER PLASTER KNIFE**

METAL HANDLE

11-1550 7" 1½" Blade



**PEDIATRIC CAST BREAKER**

11-2098 7" (18 cm) Mason

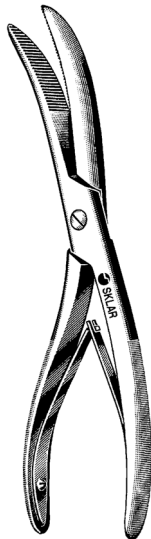

**WOLFE-BOEHLER PLASTER CAST BREAKER**

11-2095 10"



**STILLE PLASTER SHEARS**

11-1610 10"

11-1615 15"

For a complete listing of our Orthopedic product line, visit [www.sklarcorp.com](http://www.sklarcorp.com).

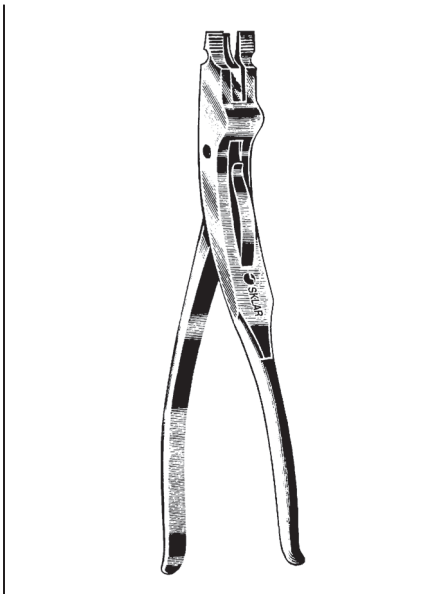

**WALTON PLASTER SPREADER**  
3 BLADES  
11-1990 9"

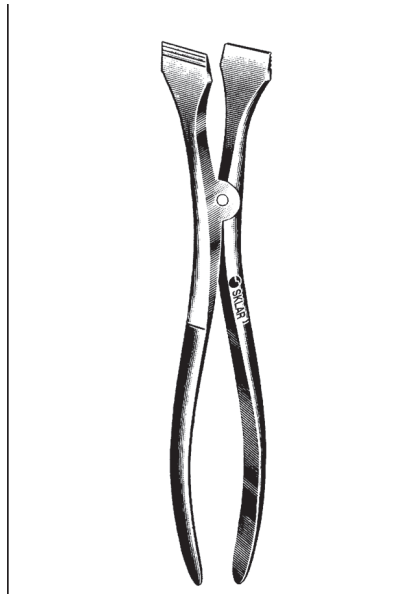

**HENNIG PLASTER SPREADER**  
2 BLADES  
11-1910 11"



**BEESON PLASTER SPREADER**  
2 BLADES  
11-1812 12"



**MULTI-CUT UTILITY SCISSORS**  
SERRATED

11-1278	6"	Blue
11-1280	7½"	Blue
11-1281	7½"	Black
11-1282	7½"	Green
11-1283	7½"	Red
11-1284	7½"	White
11-1285	7½"	Purple
11-1286	7½"	Orange
11-1287	7½"	Yellow

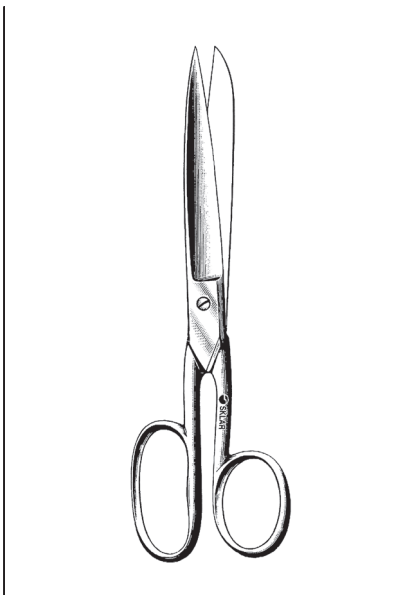

**USA PATTERN GAUZE SCISSOR**  
11-1180 8"

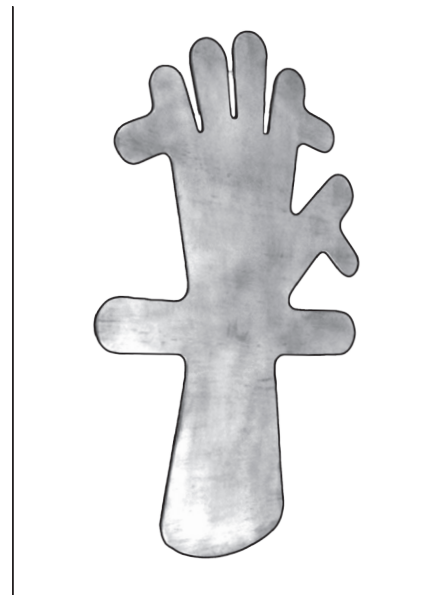

**LEAD HANDS**  
40-3052 Child  
40-3050 Adult

For a complete listing of our Orthopedic product line, visit [www.sklarcorp.com](http://www.sklarcorp.com).

# SKLAR ARTHROSCOPY INSTRUMENTS

Sklar is proud to present its line of arthroscopy instruments, featuring dual safety pins and an innovative spring system that prevents tip breakage even during the most intricate procedures.

The knurled screw at the junction of the instrument's shaft and handle, contains the innovative spring system. Pressure applied to the handle advances a wire within the instrument shaft, pushing the top jaw down. As the jaws bite into meniscus, they meet resistance from the wire. When this pressure becomes too great, the spring mechanism allows the handle to close, but not the jaws. When the pressure decreases, function returns to normal.

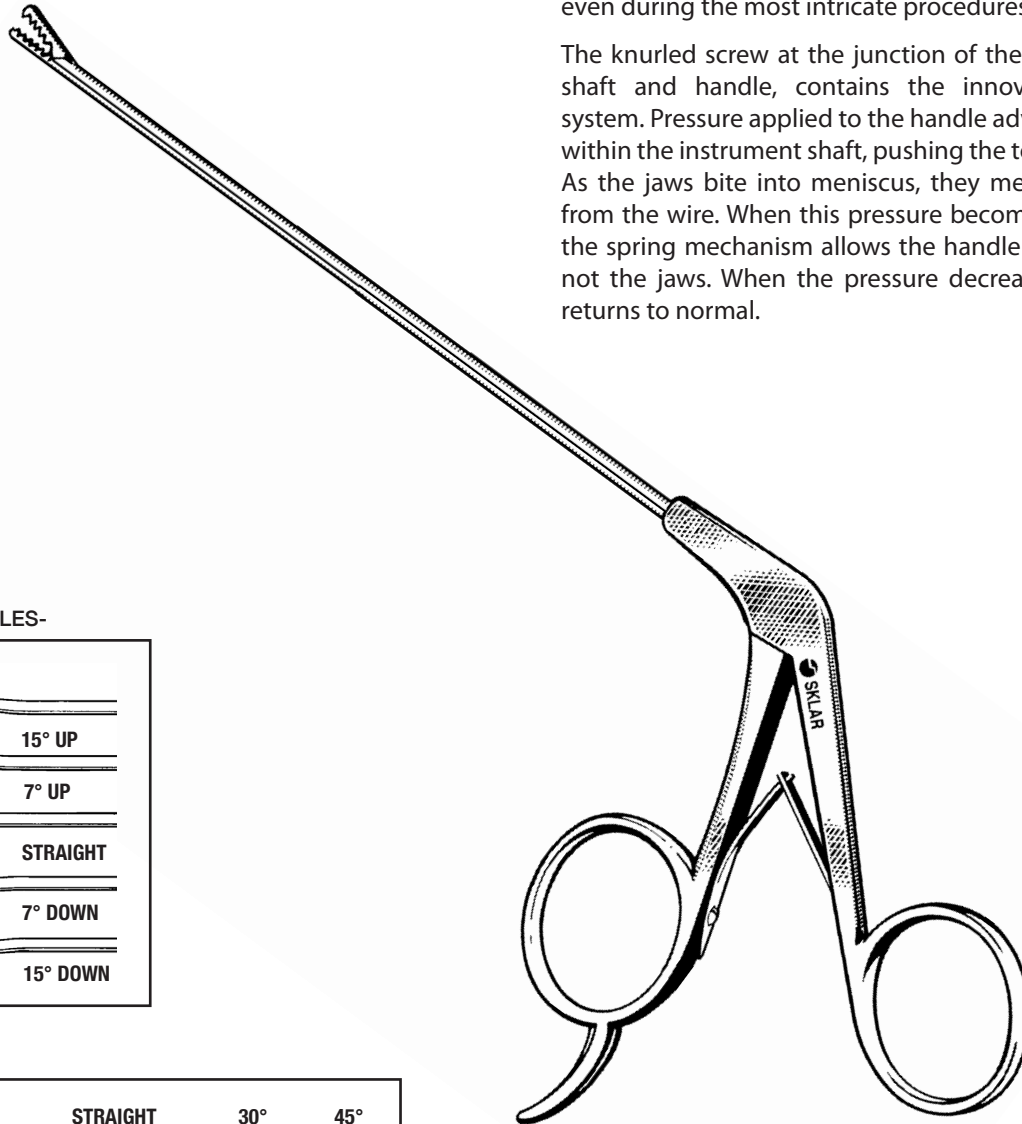

AVAILABLE ANGLES-

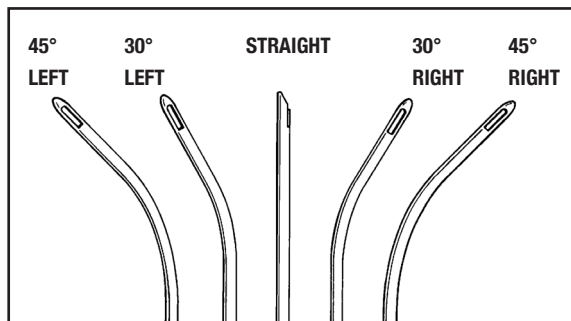
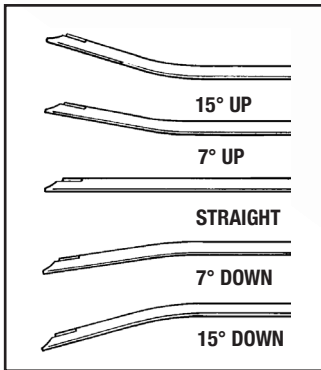

ARTHROSCOPY  
GENERAL

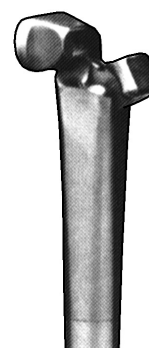
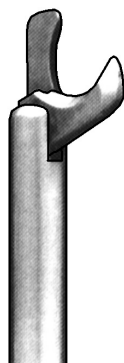
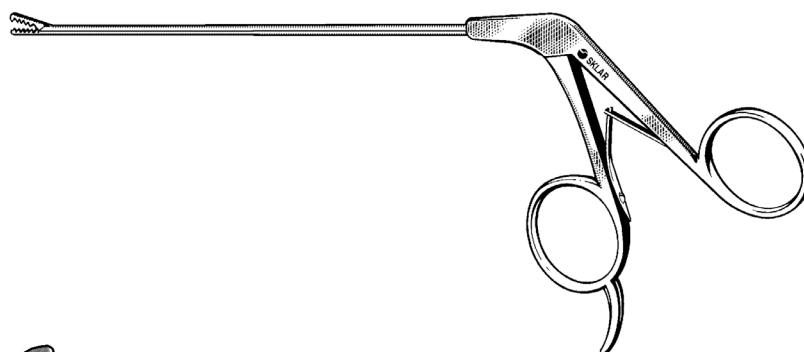

**SCISSORS**

45-6080	2.75mm	Straight Hook
45-6082	2.75mm	30° Right Hook
45-6084	2.75mm	30° Left Hook
45-6086	3.4mm	Straight Hook
45-6088	3.4mm	30° Right Hook
45-6089	3.4mm	30° Left Hook

**BASKET FORCEPS SIDE BITER**

45-6090	3.4mm	90° Right Scoop
45-6092	3.4mm	90° Left Scoop
45-6094	3.4mm	45° Right Scoop
45-6096	3.4mm	45° Left Scoop
45-6098	3.4mm	90° Right Blunt
45-6100	3.4mm	90° Left Blunt
45-6102	3.4mm	45° Right Blunt
45-6104	3.4mm	45° Left Blunt

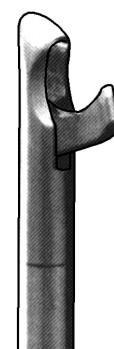
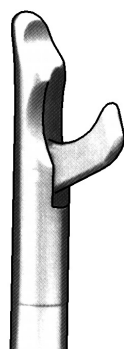

**BASKET FORCEPS SCOOP NOSE**

45-6112	2.75mm	Straight	45-6140	3.4mm	Straight
45-6114	2.75mm	45° Right	45-6142	3.4mm	45° Right
45-6116	2.75mm	45° Left	45-6144	3.4mm	45° Left
45-6118	2.75mm	30° Right	45-6146	3.4mm	30° Right
45-6120	2.75mm	30° Left	45-6148	3.4mm	30° Left
45-6122	2.75mm	7° Upward	45-6150	3.4mm	7° Upward
45-6124	2.75mm	7° Downward	45-6152	3.4mm	7° Downward
45-6126	2.75mm	15° Upward	45-6154	3.4mm	5° Upward
45-6128	2.75mm	15° Downward	45-6156	3.4mm	15° Downward

**BASKET FORCEPS BLUNT NOSE**

45-6210	2.75mm	Straight	45-6240	3.4mm	Straight
45-6212	2.75mm	45° Right	45-6242	3.4mm	45° Right
45-6214	2.75mm	45° Left	45-6244	3.4mm	45° Left
45-6216	2.75mm	30° Right	45-6246	3.4mm	30° Right
45-6218	2.75mm	30° Left	45-6248	3.4mm	30° Left
45-6220	2.75mm	7° Upward	45-6250	3.4mm	7° Upward
45-6222	2.75mm	7° Downward	45-6252	3.4mm	7° Downward
45-6224	2.75mm	15° Upward	45-6254	3.4mm	15° Upward
45-6226	2.75mm	15° Downward	45-6256	3.4mm	15° Downward



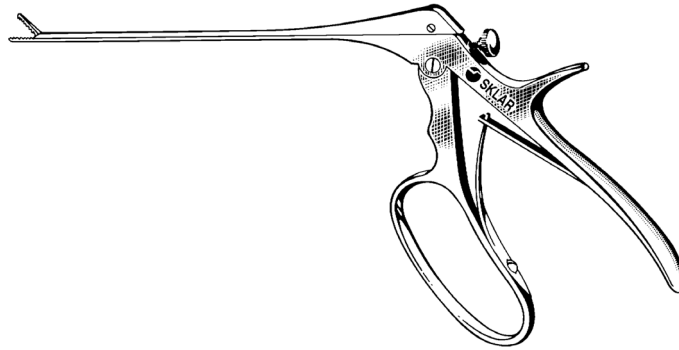

**MAXI GRASPER WITH LOCKING SCREW**

45-6260

3.4mm

Large Closed Handle

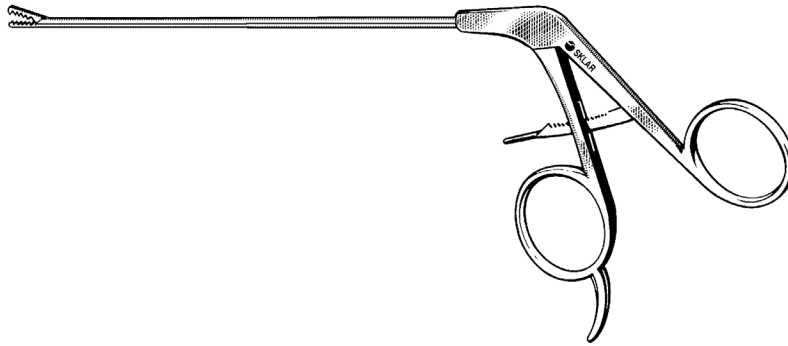

**ATLANTIC GRASPER WITH RATCHET**

45-6266

2.75mm

45-6268

3.4mm 1x2 Teeth

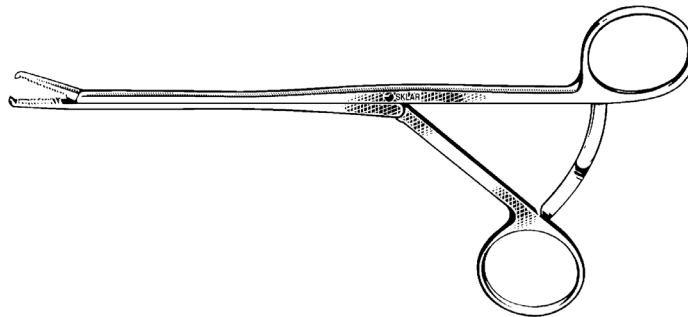
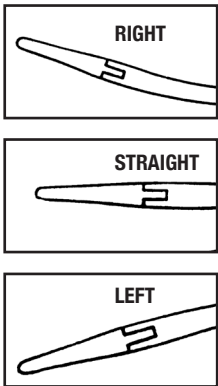

**PACIFIC GRASPER**

45-6272

Straight

45-6274

Curved Right

45-6276

Curved Left

ARTHROSCOPY

GENERAL

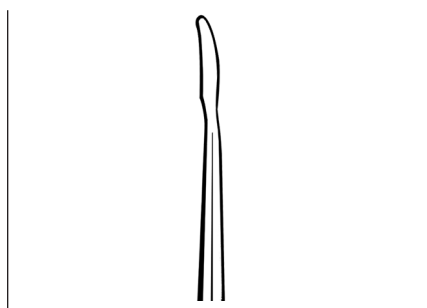

**DOUBLE EDGE BANANA KNIFE**

45-6050 With Knurled Handle



**BANANA KNIFE SERRATED**

45-6052 With Knurled Handle



**HOOK KNIFE 90°**

45-6054 With Knurled Handle

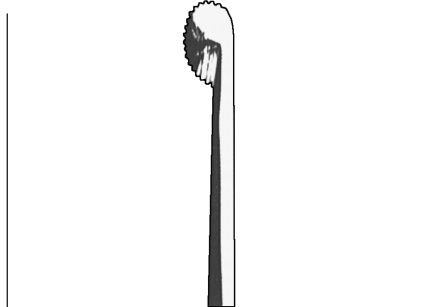

**ROSETTE KNIFE STRAIGHT  
SERRATED**

45-6056 With Knurled Handle



**MENISCUTOME**

45-6058 With Knurled Handle

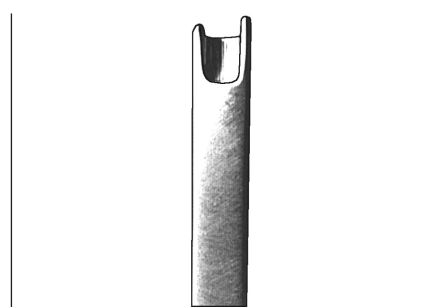

**SMILIE KNIFE**

45-6060 With Knurled Handle 5mm

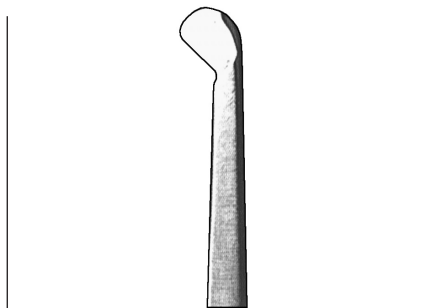

**RETROGRADE KNIFE 45°**

45-6062 With Knurled Handle

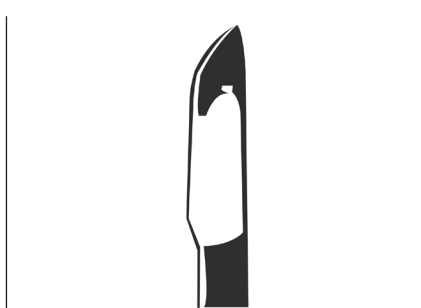

**TRADITIONAL KNIFE**

45-6064 With Knurled Handle

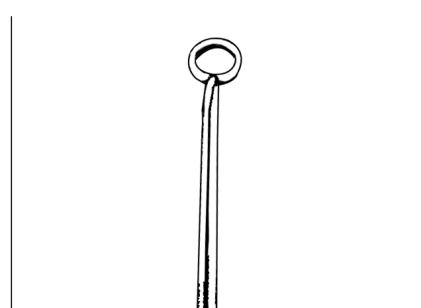

**RING CURETTE**

45-6066 With Knurled Handle 3mm



**SPOON 30° CURVED**

45-6068 With Knurled Handle 3mm

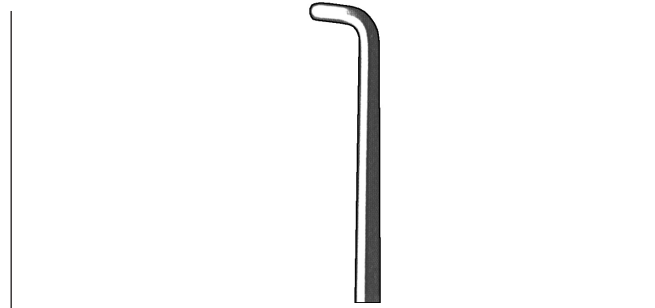

**HOOK GRADUATED PROBE**

45-6070 With Knurled Handle 90°

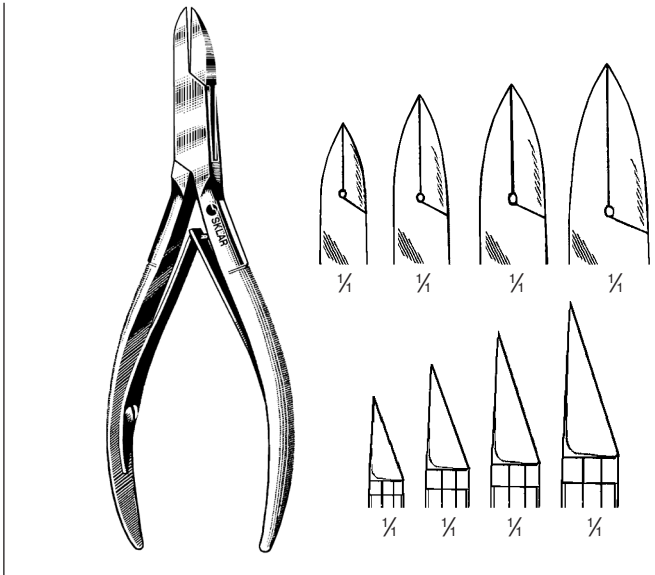

**LITTAUER CUTTING FORCEPS**

**STRAIGHT BACK-STAINLESS**

- 97-1251 4"
- 97-1255 4½"
- 97-1259 5"
- 97-1262 6"
- 97-1261 6¼"

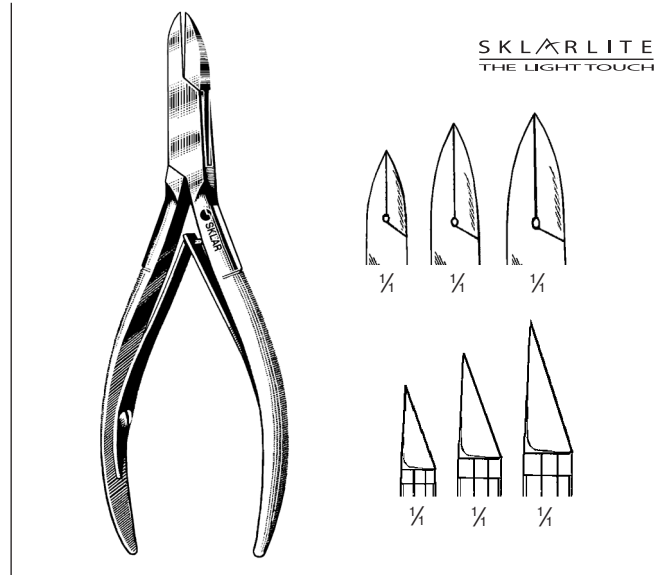

**SKLARLITE™ LITTAUER CUTTING FORCEPS**

**STRAIGHT BACK-STAINLESS**

- 23-9251 4"
- 23-9255 4½"
- 23-9259 5"

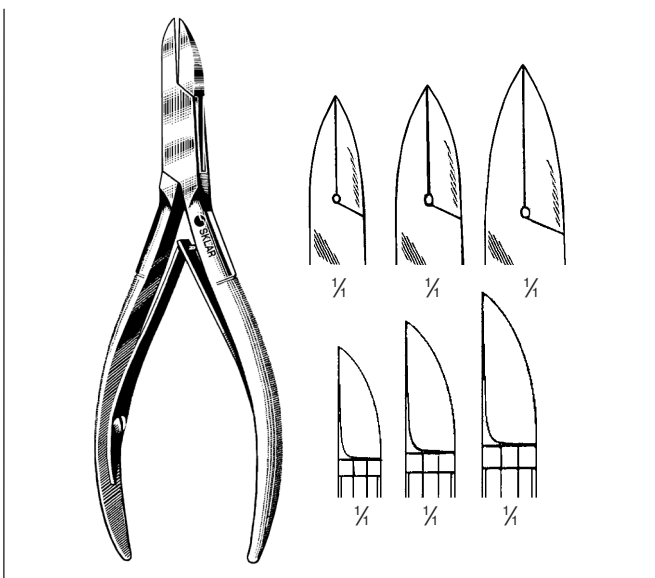

**LITTAUER CUTTING FORCEPS**

**CURVED BACK-STAINLESS**

- 97-1280 4½"
- 97-1285 5"
- 97-1286 6"

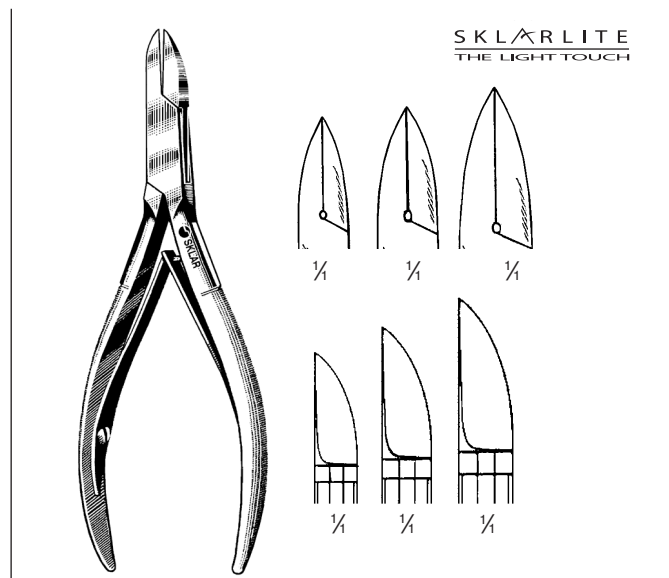

**SKLARLITE™ LITTAUER CUTTING FORCEPS**

**CURVED BACK-STAINLESS**

- 23-9273 4½"
- 23-9275 5"
- 23-9276 6"

For a complete listing of our Podiatry product line, visit [www.sklarcorp.com](http://www.sklarcorp.com).

PODIATRY

CUTTERS

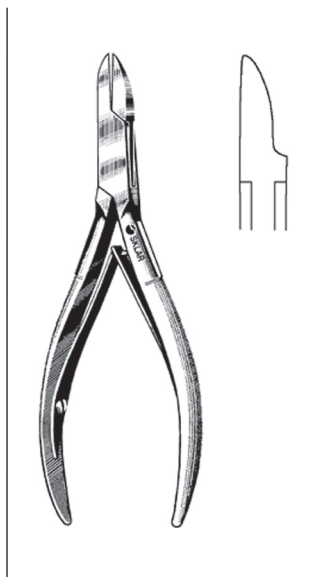

**SKLAR-TAPER™  
LITTAUER CUTTING  
FORCEPS**

STAINLESS  
97-1174 5"

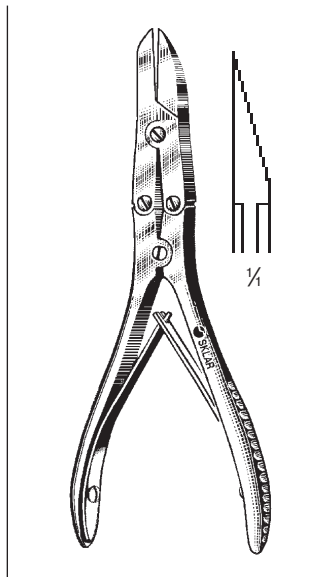

**SKLAR LITTAUER  
CUTTING FORCEPS**  
DOUBLE-ACTION

97-1185 6" Straight

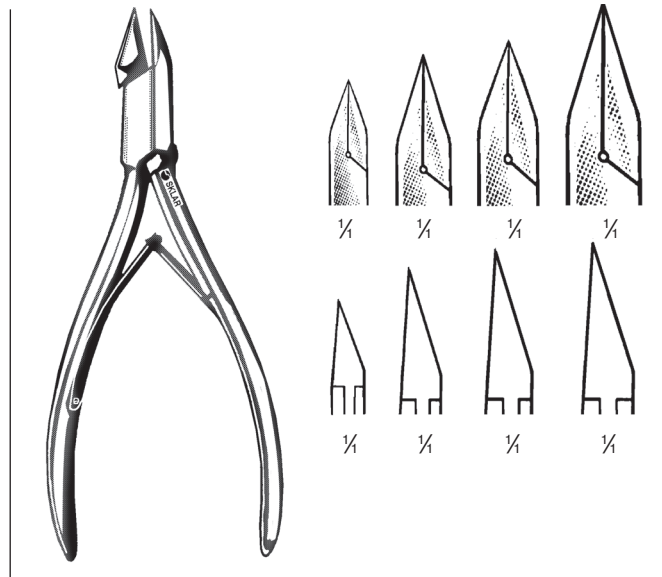

**NAIL SPLITTERS**

TAPERED JAW, STRAIGHT BACK-STAINLESS

97-1660 4"  
97-1661 4½"  
97-1662 5"  
97-1663 6"

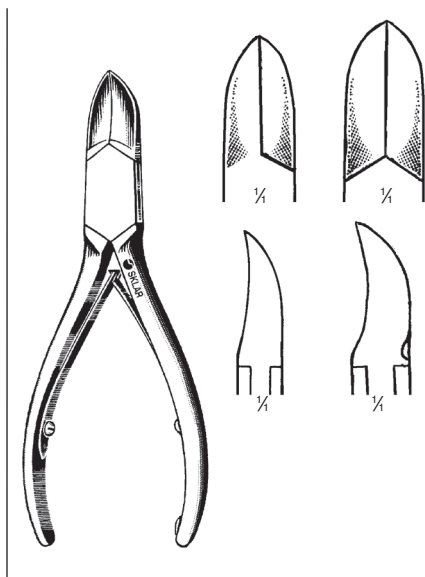

**NAIL NIPPERS**  
CONCAVE BLADES

97-1308 6" Stainless Narrow  
97-1309 5½" Stainless Heavy

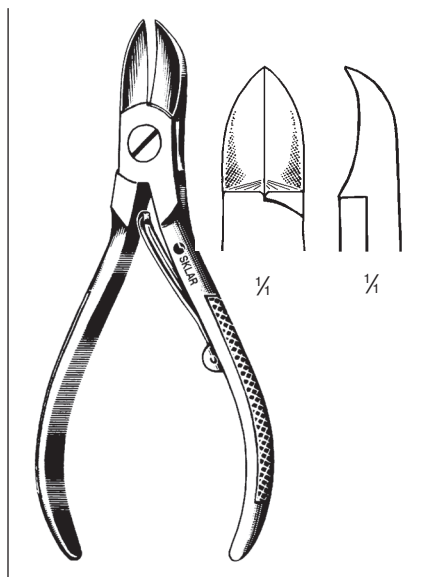

**NAIL NIPPERS**  
CONCAVE BLADES- STAINLESS

97-1145 4½" Folding Spring  
97-1148 4½" Double Spring

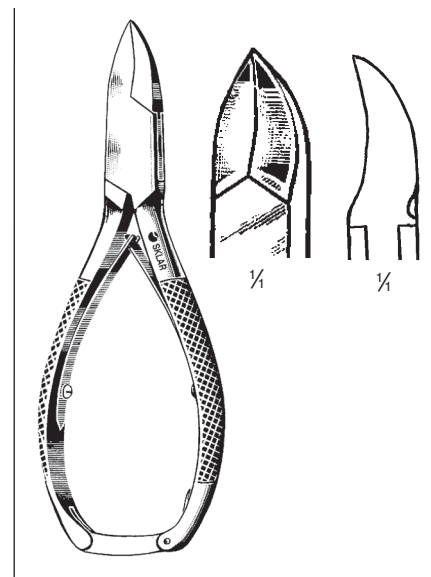

**NAIL NIPPER**  
CONCAVE BLADES

97-1055 5½" Stainless

For a complete listing of our Podiatry product line, visit [www.sklarcorp.com](http://www.sklarcorp.com).

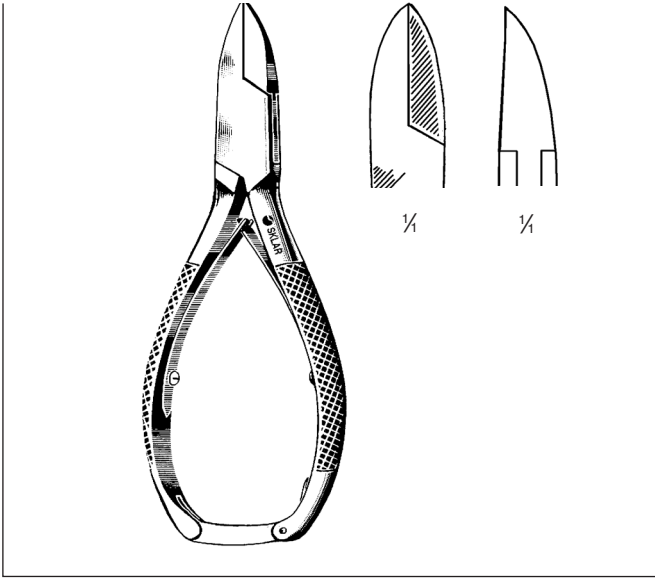

**NAIL NIPPER**  
97-1056 5½" Straight Back

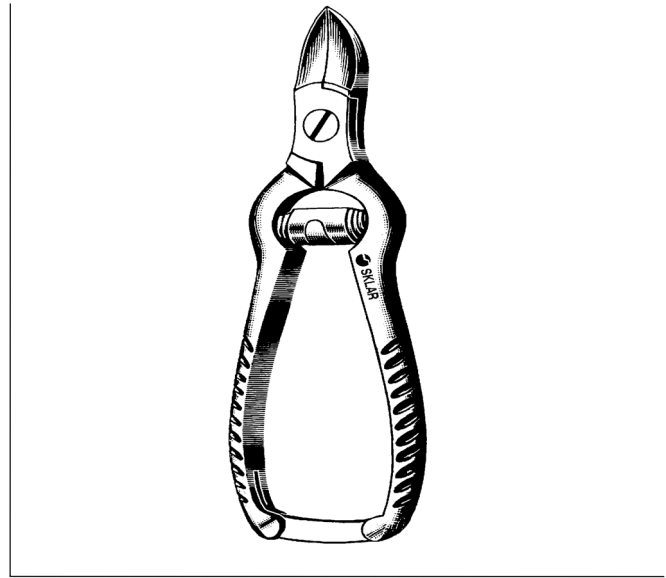

**NAIL NIPPERS**  
**CONCAVE BLADES—BARREL SPRING**  
97-1045 4½"  
97-1046 5½"

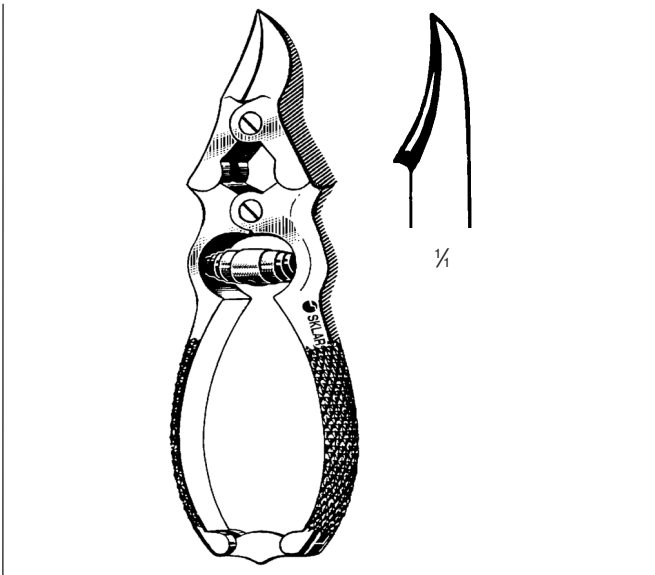

**MYCOTIC NAIL NIPPER**  
**DOUBLE ACTION**  
97-1057 5¾" Stainless

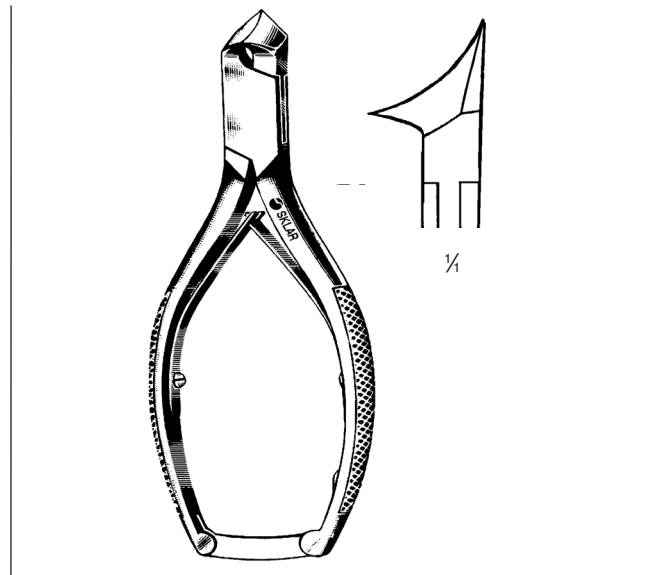

**NAIL NIPPER**  
**ANGLED CONCAVE BLADES**  
97-1156 5½" Stainless

For a complete listing of our Podiatry product line, visit [www.sklarcorp.com](http://www.sklarcorp.com).



**PODIATRY  
CUTTERS**

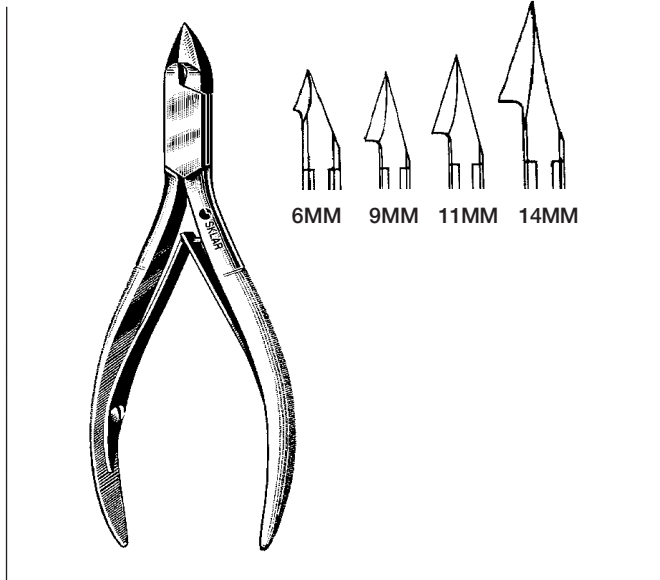

**TISSUE NIPPERS**  
CONVEX BLADES – STAINLESS

97-1241	4"	6mm	
97-0335	4"	9mm	
97-1300	4"	9mm	Chrome
97-1242	4½"	11mm	
97-1243	5"	14mm	



SKLARLITE  
THE LIGHT TOUCH

**SKLARLITE™ TISSUE NIPPER**  
CONVEX BLADES–STAINLESS

23-9292	4½"	Double Spring	11mm
---------	-----	---------------	------

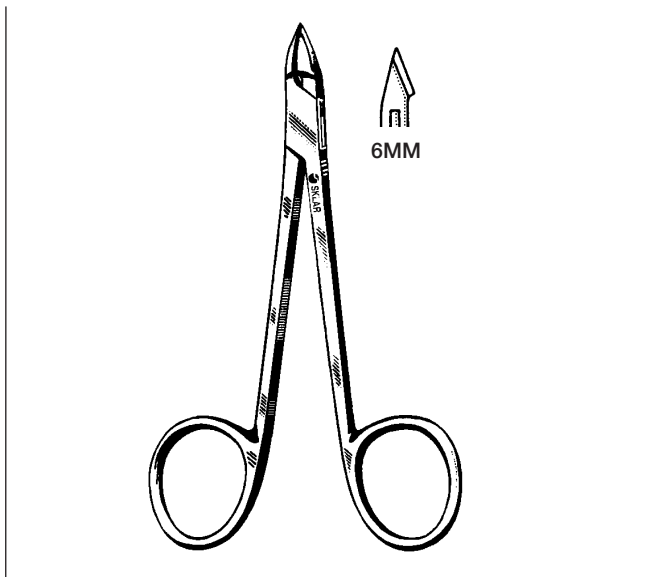

**TISSUE FORCEPS**  
SCISSORS HANDLE–STRAIGHT JAWS

97-1238	Stainless	4"
---------	-----------	----



**CUTICLE AND NAIL NIPPERS**  
RING HANDLE

97-1235	3½"	Finger Nail	Straight
97-1245	4¼"	Toe Nail	Curved

For a complete listing of our Podiatry product line, visit [www.sklarcorp.com](http://www.sklarcorp.com).

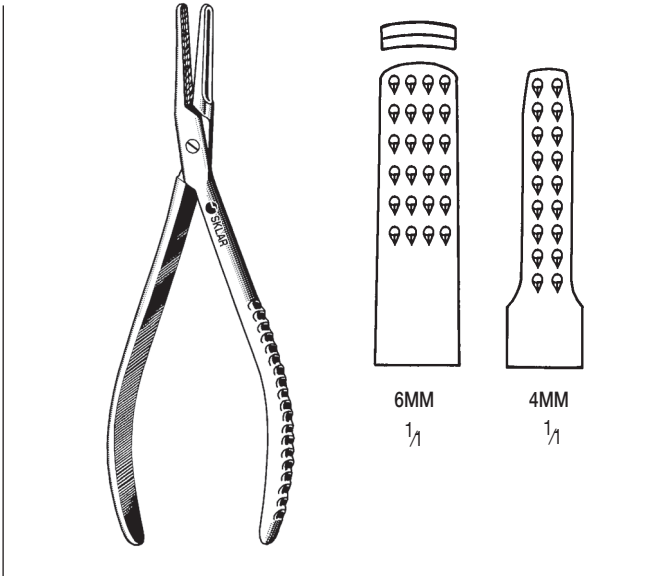

**PLATYPUS NAIL FORCEPS**

**PLIER HANDLE**

97-1318 5½" 6mm wide  
97-1315 5½" 4mm wide



**INGROWN NAIL SPLITTING SCISSOR**

**ONE POINTED BLADE**

97-0555 6" One Blade Serrated



**INGROWN TOE NAIL FORCEPS**

**ENGLISH (ANVIL) PATTERN**

97-1150 5" Stainless



**SKLARLITE™ INGROWN TOE NAIL FORCEPS**

**ENGLISH (ANVIL) PATTERN**

23-9250 5" Stainless

For a complete listing of our Podiatry product line, visit [www.sklarcorp.com](http://www.sklarcorp.com).

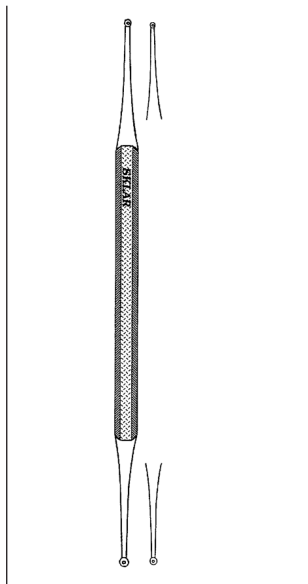

**CURETTE-EXCAVATORS**

DOUBLE END WITH HOLE 5½"

97-0532 #58-1-2 1.5-2.0mm  
97-0536 #58-1-3 1.5-2.5mm

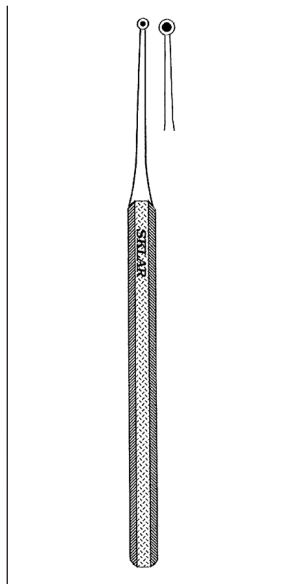

**CURETTE-EXCAVATORS**

SINGLE END WITH HOLE 5"

97-0512 #58-0 1.0mm  
97-0522 #58-1 1.5mm  
97-0524 #58-2 2.0mm  
97-0528 #58-3 2.5mm

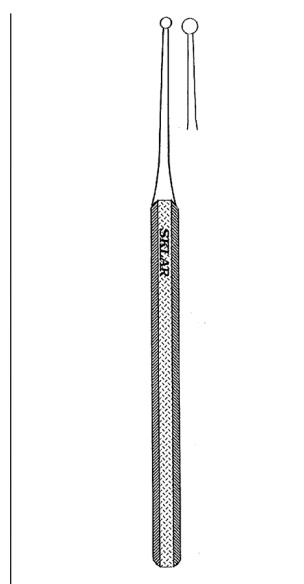

**CURETTE-EXCAVATORS**

SINGLE END WITHOUT HOLE 5"

97-0503 #57-0 1.0mm  
97-0505 #57-1 1.5mm  
97-0507 #57-2 2.0mm  
97-0509 #57-3 2.5mm

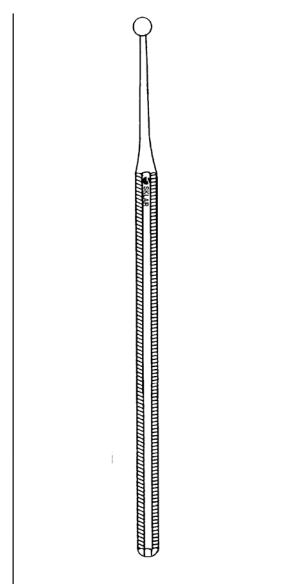

**VERUCCA CURETTE**  
WITHOUT HOLE

97-0564 5" 4mm Cup

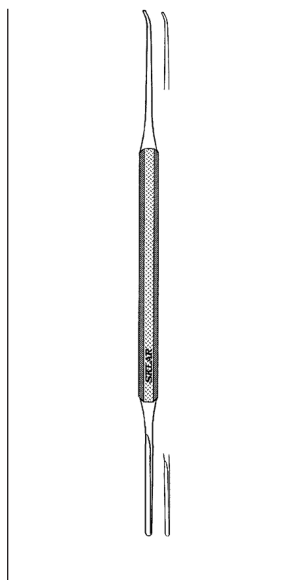

**PROBE AND PACKER**

DOUBLE END

97-0539 6" Blunt

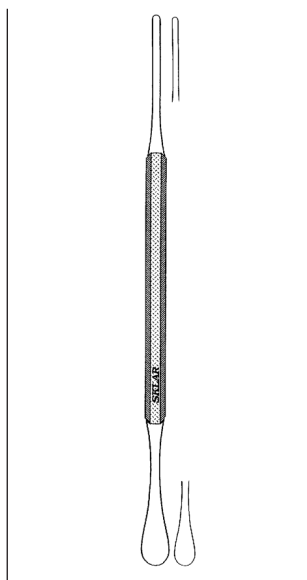

**SPATULA AND PACKER**

DOUBLE END

97-0542 5¾"

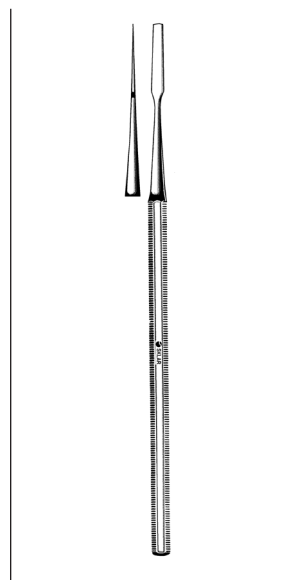

**SPATULA**

SQUARE END

97-0580 11-S 6mm

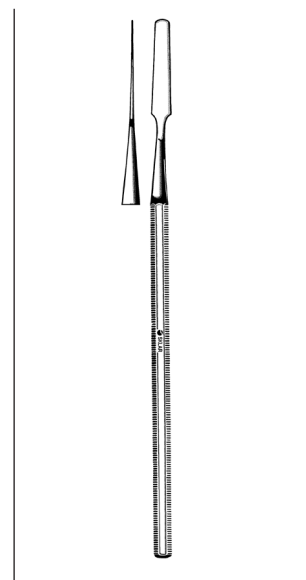

**SPATULA**

ROUNDED END

97-0581 4mm

For a complete listing of our Podiatry product line, visit [www.sklarcorp.com](http://www.sklarcorp.com).



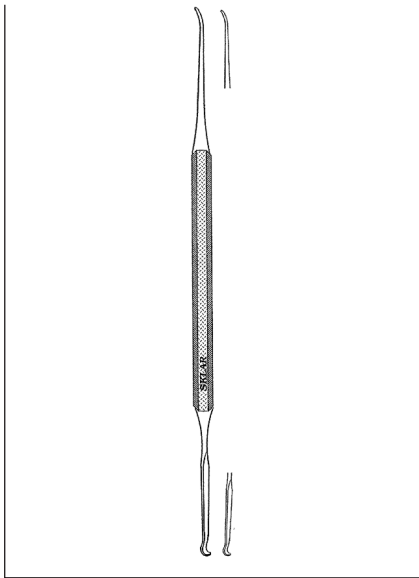

**EXCAVATOR & PACKER  
DOUBLE END**  
97-0562 6"

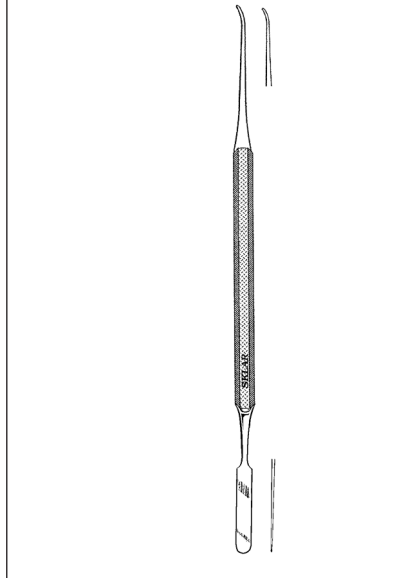

**PROBE & SPATULA  
DOUBLE END**  
97-0548 6"

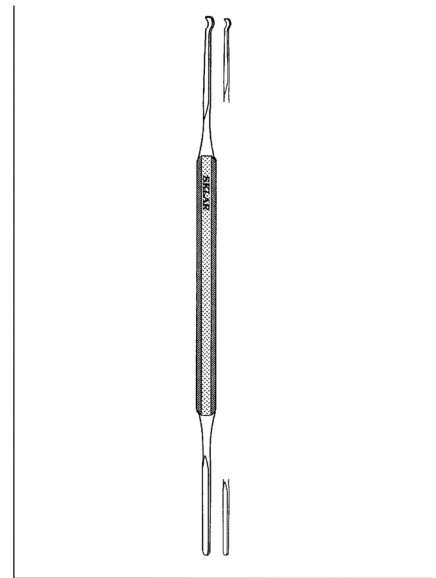

**EXCAVATOR & PACKER  
DOUBLE END**  
97-0546 5 3/4"

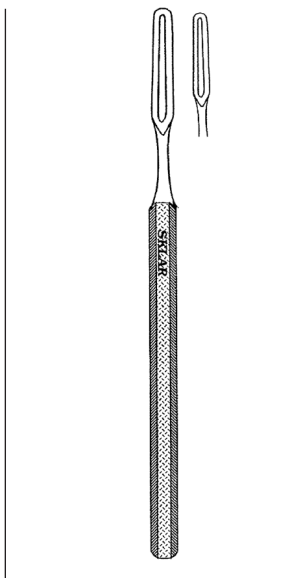

**INGROWN NAIL  
SHAVER  
FENESTRATED**  
97-0554

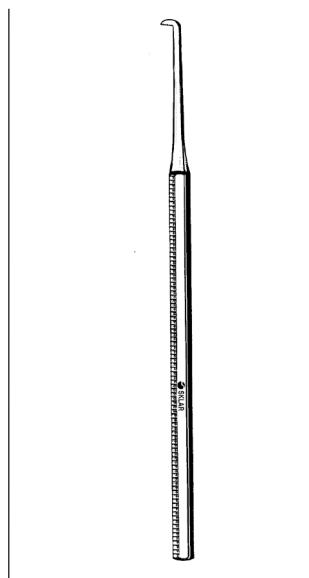

**BAKER INGROWN  
NAIL CUTTER**  
97-0552 5"

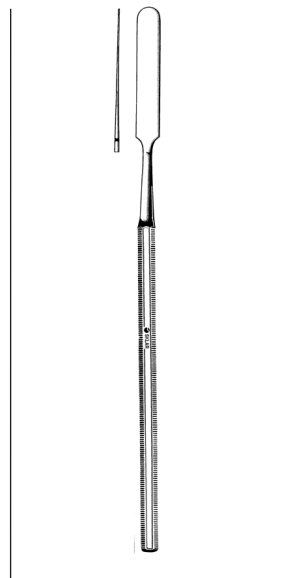

**SPATULA  
ROUNDED END**  
97-0582 6mm #24A

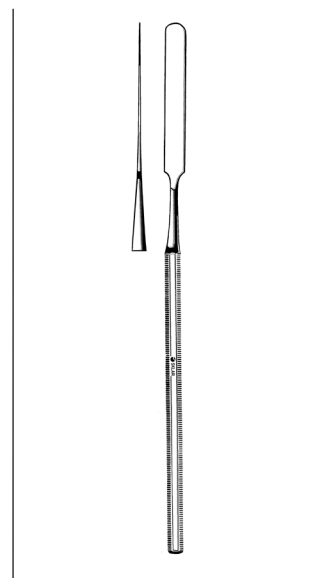

**SPATULA  
ROUNDED END**  
97-0583 7mm #24

For a complete listing of our Podiatry product line, visit [www.sklarcorp.com](http://www.sklarcorp.com).

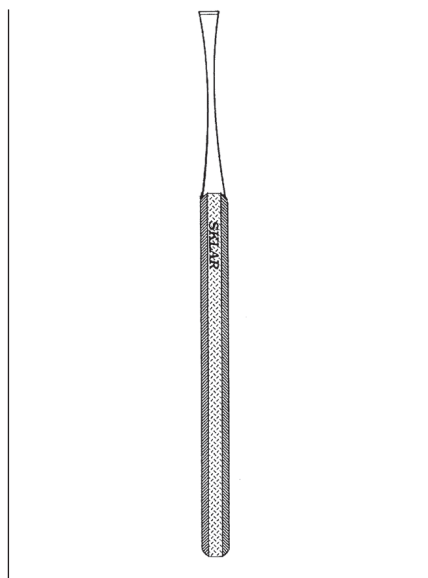

**NAIL SPLITTERS**

**STRAIGHT**

- 97-0601 Narrow 2mm
- 97-0604 Wide 3.5mm

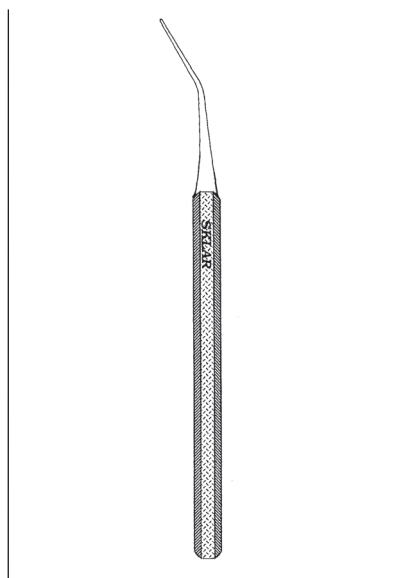

**NAIL SPLITTER**

- 97-0606 Angular-Narrow 2mm

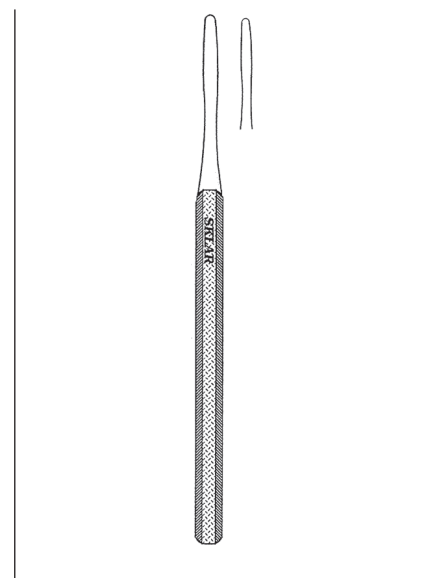

**NUCLEUS KNIFE**

**SINGLE END**

- 97-0568 Narrow 2mm

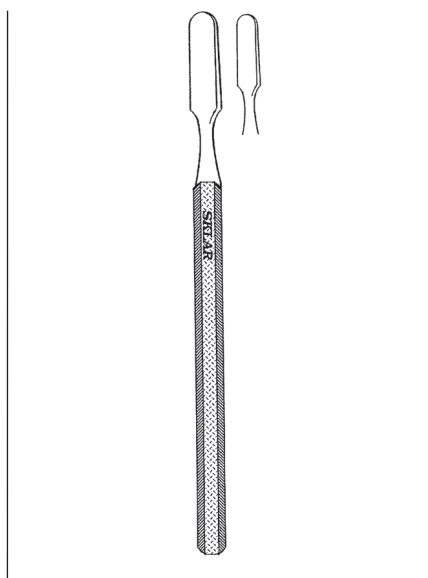

**LOCKE ELEVATORS**

- 97-0623 Narrow 3 x 15mm
- 97-0634 Wide 5 x 20mm

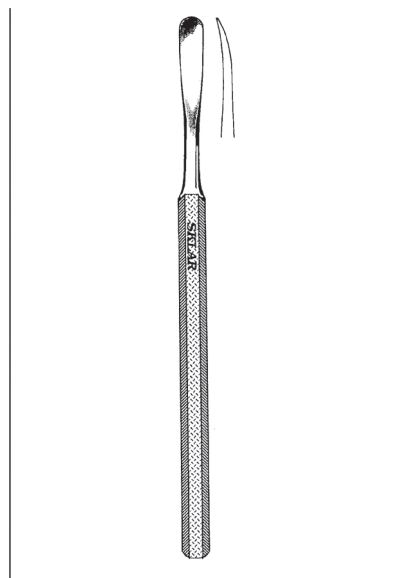

**ELEVATOR CURVED EDGE**

- SEMI-SHARP**
- 97-0048 5½"

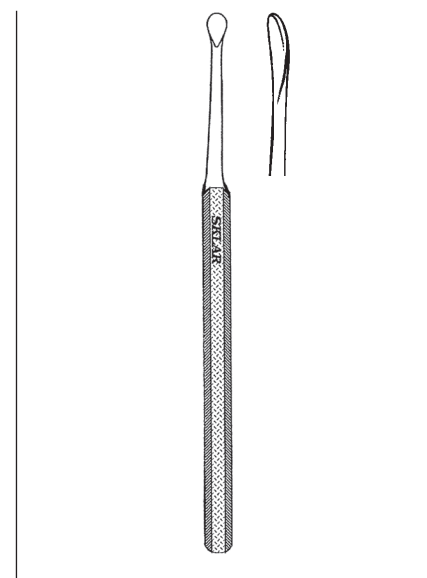

**SOFT CORN KNIVES**

**ROUND BLADE**

- 97-0035 Straight
- 97-0036 Curved Blade

For a complete listing of our Podiatry product line, visit [www.sklarcorp.com](http://www.sklarcorp.com).

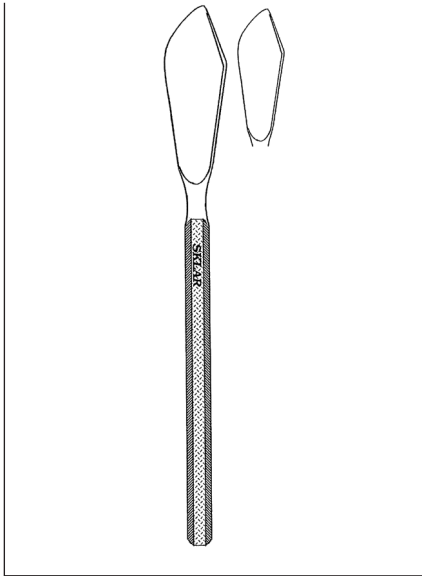

**CORN KNIVES**

**EXTRA HEAVY**

**CURVED EDGE**

- 97-0021 Small
- 97-0020 Medium
- 97-0019 Large

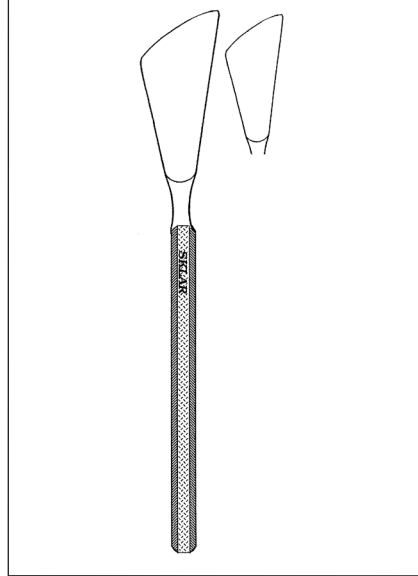

**KNIVES**

**STRAIGHT BACK**

- 97-0015 Small 15mm
- 97-0017 Large 18mm

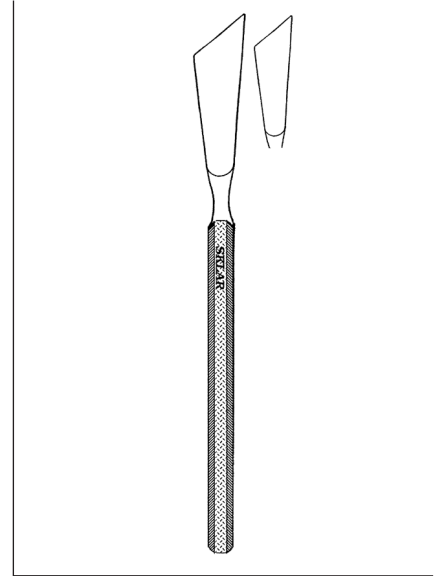

**CHISEL KNIVES**

**STRAIGHT EDGE**

- 97-0010 Small 8mm
- 97-0011 Medium 15mm

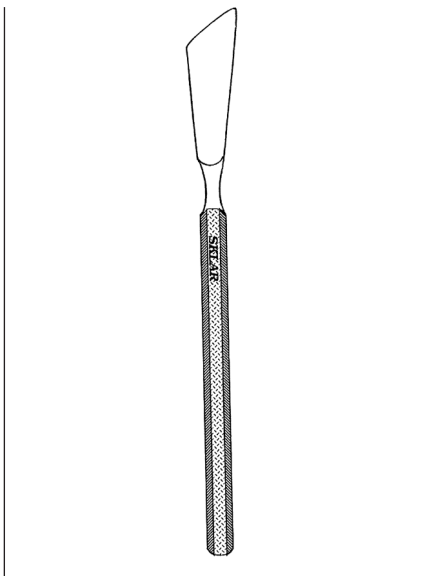

**CHISEL KNIFE**

**CURVED EDGE**

- 97-0006 Medium 18mm

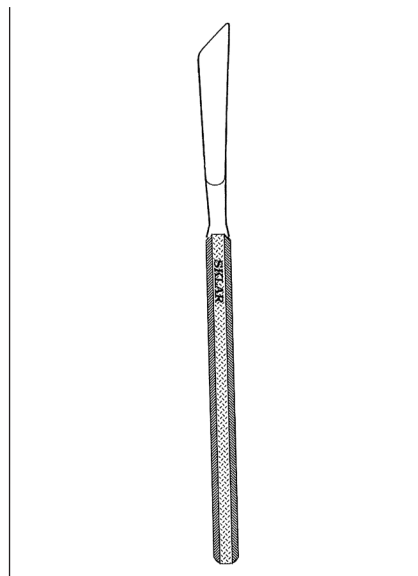

**CORN CHISEL**

**ANGLED EDGE**

- 97-0040 Sharp Point

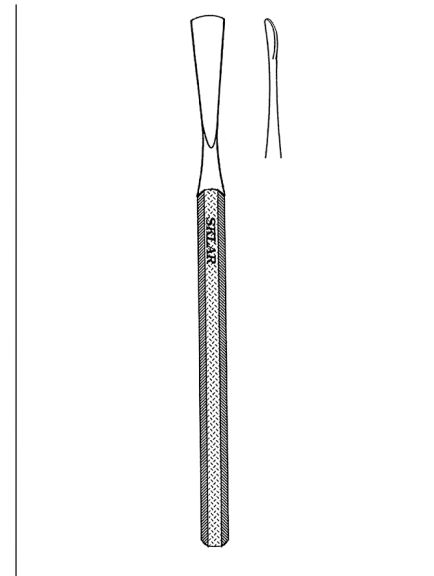

**CORN CHISEL**

**CURVED EDGE**

- 97-0545 5/4" Spoon Shape

For a complete listing of our Podiatry product line, visit [www.sklarcorp.com](http://www.sklarcorp.com).

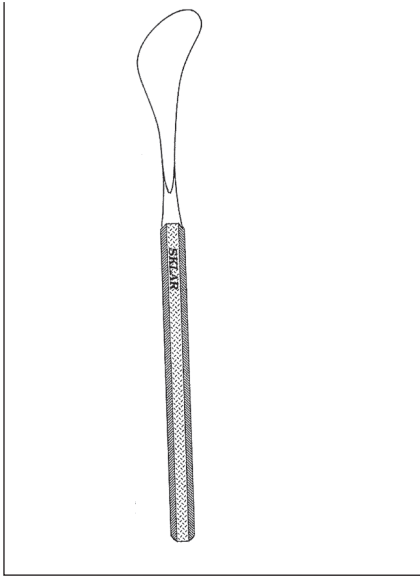

**GOLF STICK KNIVES**

- 97-0025 Small
- 97-0026 Medium
- 97-0027 Large

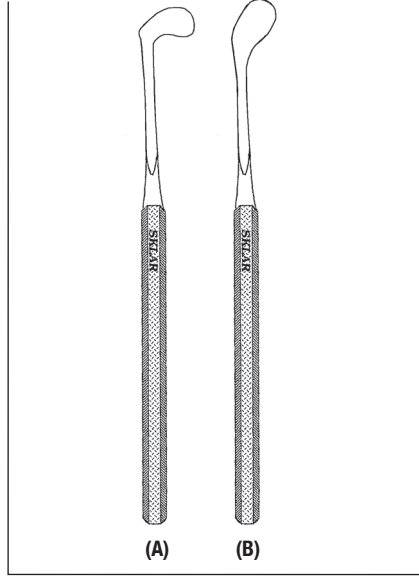

**GOLF STICK KNIVES**

- 97-0028 Style A
- 97-0030 Style B

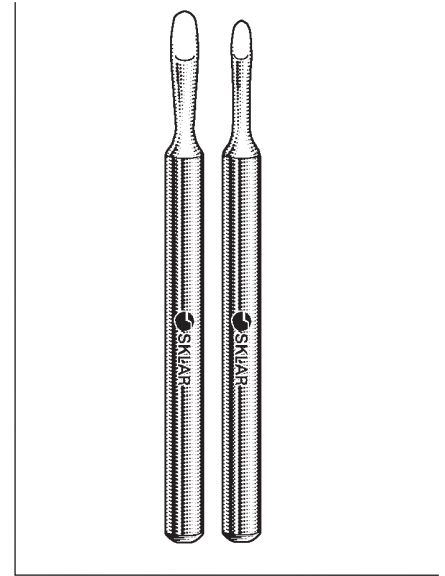

**FROST ELEVATORS**

- 97-0640 Narrow
- 97-0641 Wide

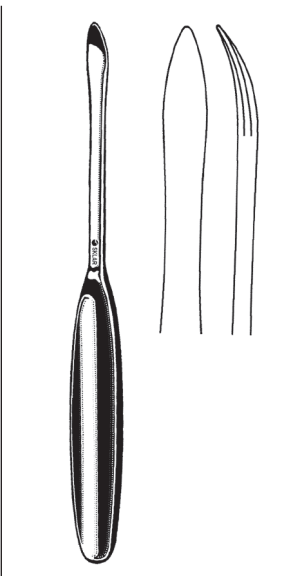

**LANE ELEVATORS**

- SINGLE END**
- 40-8375 7½" Narrow
- 40-8275 7½" Wide

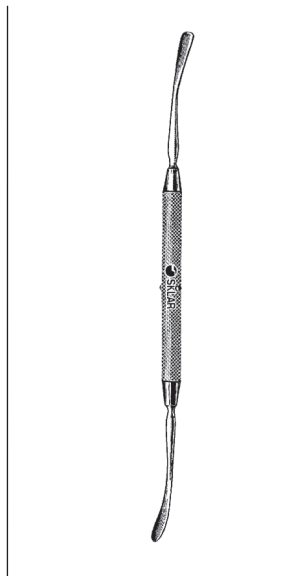

**FREER ELEVATOR**

- DOUBLE END**
- 47-2380 7¼" Sharp/Blunt

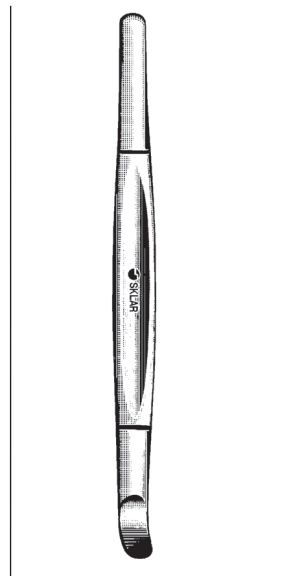

**SAYRE ELEVATORS**

- DOUBLE END**
- 40-9265 6½" Sharp
- 40-9365 6½" Blunt

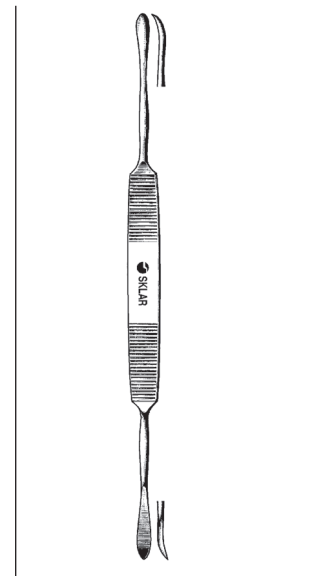

**OHL ELEVATOR**

- 97-0050 9"

For a complete listing of our Podiatry product line, visit [www.sklarcorp.com](http://www.sklarcorp.com).

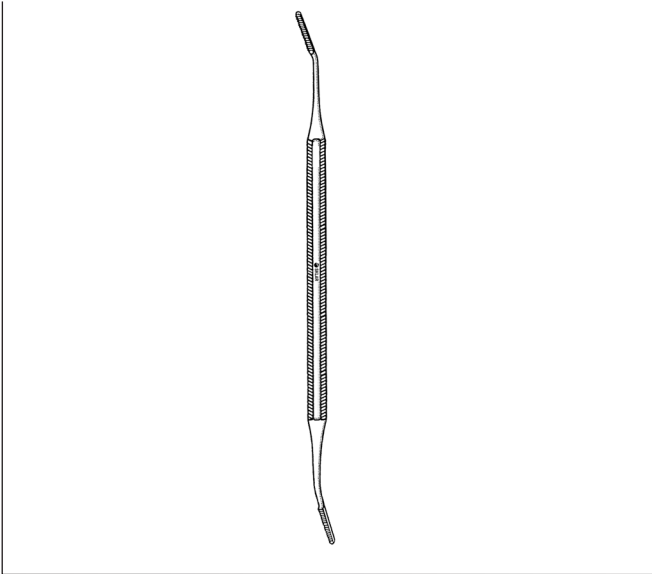

**NAIL AND BONE RASPS**

**DOUBLE END**

97-1610 Inside/Outside Cut #92

**SINGLE END**

97-1600 Inside Cut #92A

97-1605 Outside Cut #92B

**PODI-BONE RASP**

**SINGLE END**

97-1649 4 1/4" 3/8" Tip

**SKLAR DISINFECTANT**

READY-TO-USE SPRAY SURFACE DISINFECTANT  
2 MINUTE KILL TIME!

- Ready to use, non-toxic formula.
- Specially formulated for the control of cross contamination.
- Effective against a broad range of pathogens including H1N1, HIV-1, HSV, VRE, Rotaviruses, Hep B & C as well as TB, MRSA and A. Baumannii.
- Safe for all areas of the facility including the NICU, operating rooms, isolation rooms, patient care areas and laboratories.
- Satisfies OSHA's Bloodborne Pathogen Standards.
- Non-irritating formula.
- EPA registered.

PRODUCT NUMBER	FEATURES	QUANTITIES
10-1643	24 oz. Spray Bottles	6/case
10-1642	24 oz. Spray Bottle	1 bottle
10-1653	1 Gallon Bottles	4/case
10-1654	1 Gallon Bottle	1 bottle
10-1644	2.5 Gallon Bottles	2/case



For a complete listing of our Podiatry product line, visit [www.sklarcorp.com](http://www.sklarcorp.com).

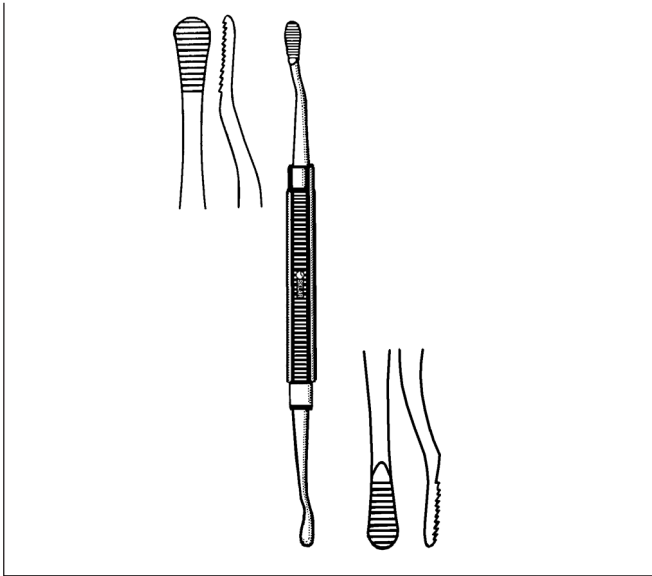

**BONE FILE #12**  
**DOUBLE END**  
 97-1620 7" Plain Serrations

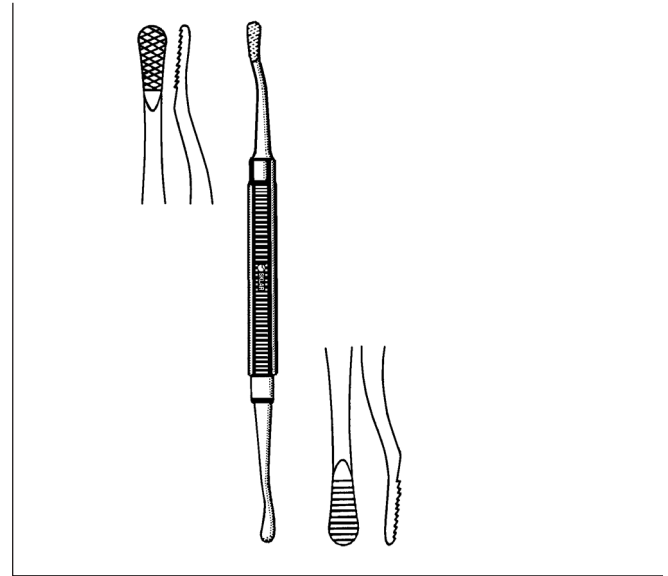

**BONE FILE #12A**  
**DOUBLE END**  
 97-1625 7" Plain Serrations & Cross Serrations

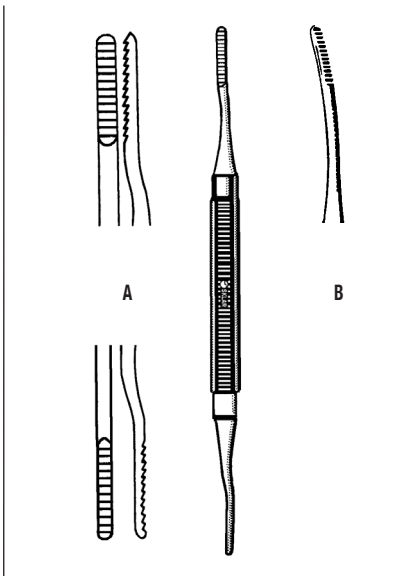

**NAIL AND BONE RASPS**  
 97-1640 7" Plain Serrations (A)  
 Double End, 3 mm & 4 mm  
 97-1642 6½" Polokoff Medium Serrations (B)  
 Single End

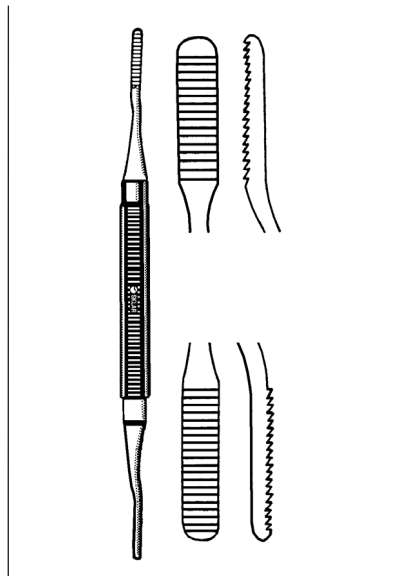

**NAIL AND BONE RASP**  
**DOUBLE END**  
 97-1645 7½" Plain Serrations

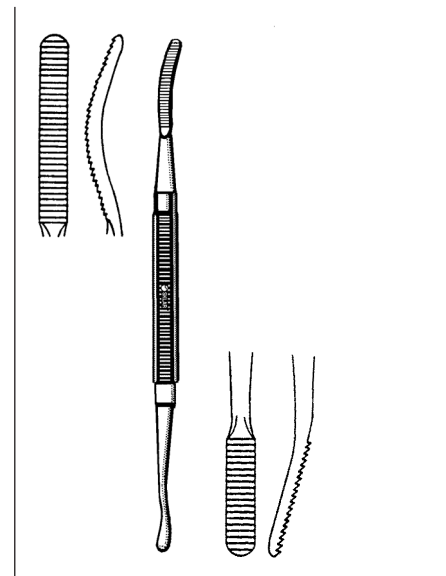

**BONE RASP #10**  
**DOUBLE END—CURVED & FLAT ENDS**  
 97-1615 7½"

**For a complete listing of our Podiatry product line, visit [www.sklarcorp.com](http://www.sklarcorp.com).**

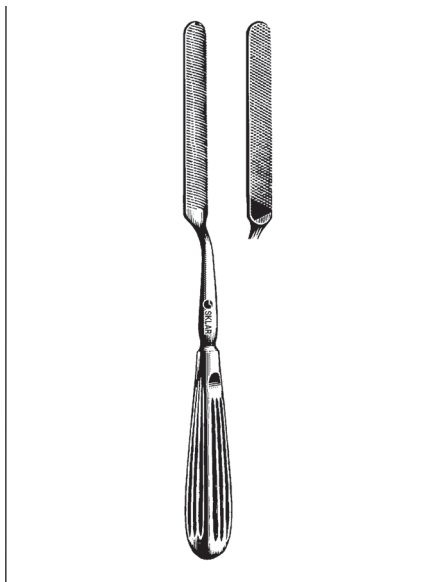

**BONE FILE**  
BAYONET HANDLE  
40-9685 9"

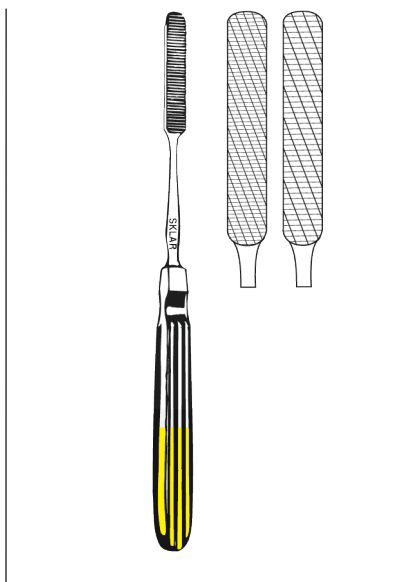

**TC MALTZ RASPS**  
SINGLE END  
97-1505 Fine  
97-1506 Medium

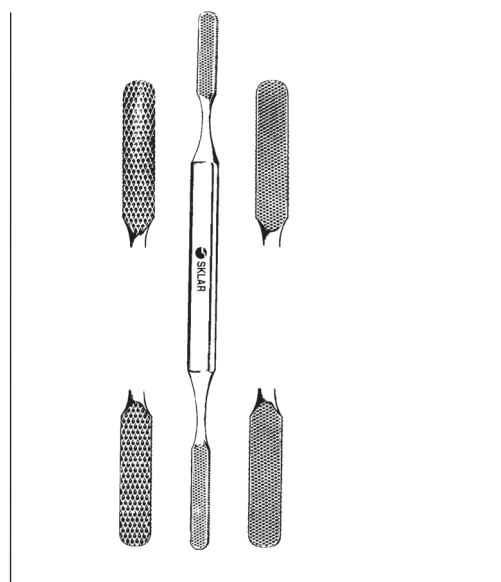

**FOMON RASPS**  
DOUBLE ENDED, FLAT & CONVEX  
40-9686 8¼" 2 Sided, Coarse  
40-9688 8½" 4 Sided, Coarse & Fine

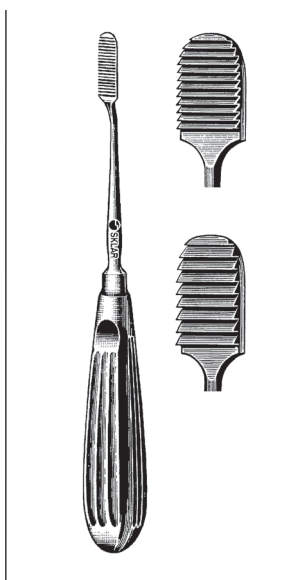

**LEWIS RASPS**  
70-2292 7" Fine  
70-2293 7" Coarse

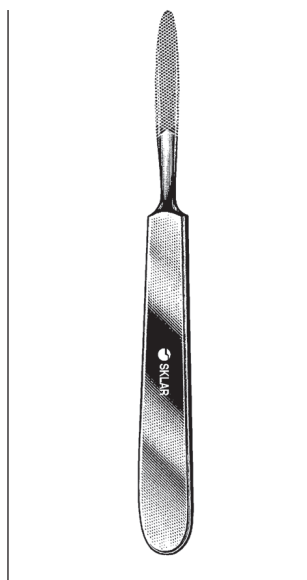

**JOSEPH RASP**  
STRAIGHT HANDLE  
40-9825 6¼"

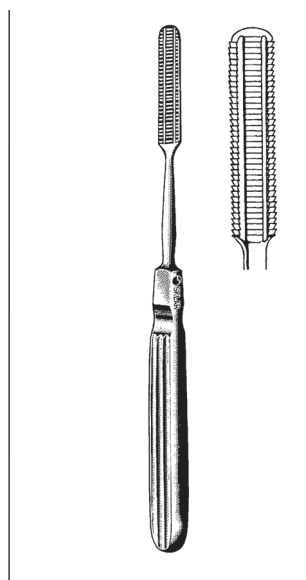

**MALTZ RASP**  
40-9815 7"

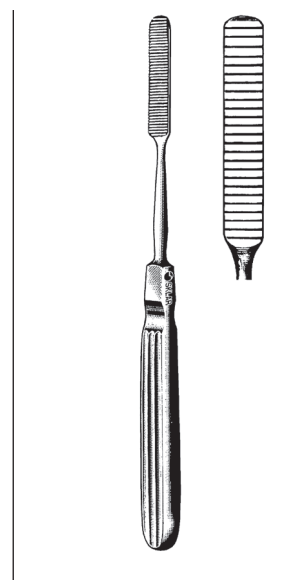

**COTTLE RASP**  
40-9820 8"

For a complete listing of our Podiatry product line, visit [www.sklarcorp.com](http://www.sklarcorp.com).

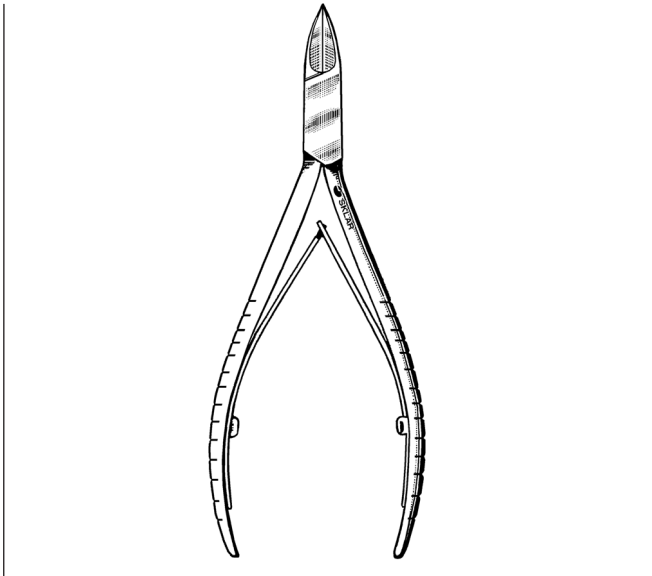

**PNA FORCEPS**  
97-1340 4½"

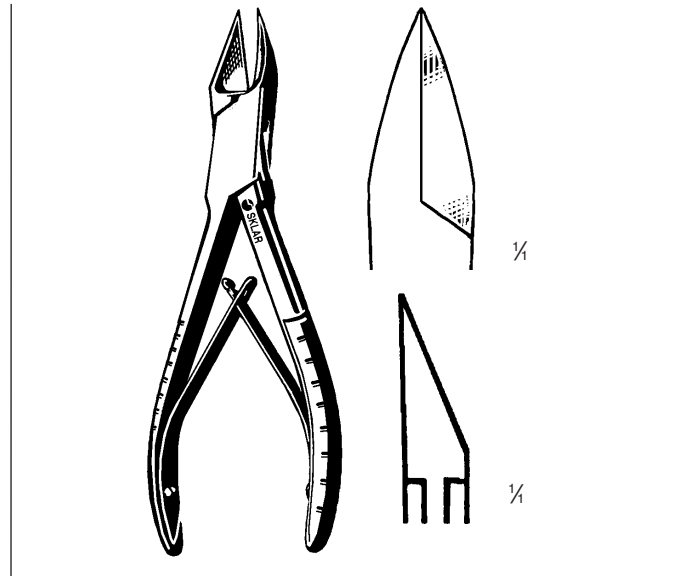

**LISTON BONE FORCEPS**  
SHARP POINTS  
40-3040 5½" Straight



**ROWLAND BONE FORCEPS**  
DOUBLE ACTION  
41-1175 7" Narrow Jaws



**MCINDOE BONE CUTTING FORCEPS**  
DOUBLE ACTION  
41-1170 7½" Slight Angle

for a complete listing of our Podiatry product line, visit [www.sklarcorp.com](http://www.sklarcorp.com).



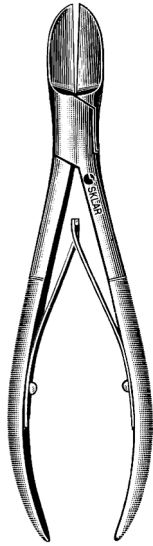

**LISTON BONE FORCEPS**

**STRAIGHT**

- 40-3055 5½"
- 40-3077 7¾"
- 40-3087 8¾"

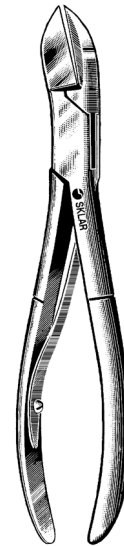

**LISTON BONE FORCEPS**

**ANGULAR**

- 40-3155 5½"
- 40-3167 6¾"
- 40-3177 7¾"
- 40-3187 8¾"

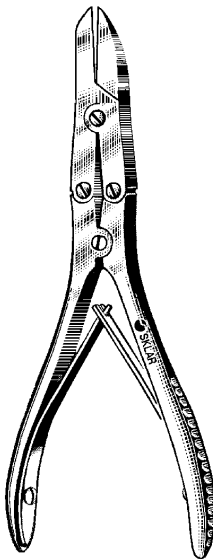

**KLEINERT-KUTZ BONE CUTTING FORCEPS**

**DOUBLE ACTION**

- 40-4560 6" Straight
- 40-4562 6" Delicate

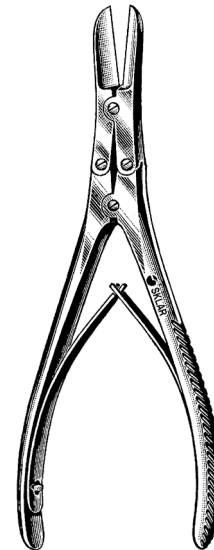

**RUSKIN-LISTON BONE CUTTING FORCEPS**

**DOUBLE ACTION**

- 40-4572 7¼" Straight
- 40-4575 7¼" Up-Angled

For a complete listing of our Podiatry product line, visit [www.sklarcorp.com](http://www.sklarcorp.com).



**RONGEUR NO. 5S**  
40-3196 5 3/4" Side Cut



**RONGEUR NO. 5**  
40-3198 6 1/2" Side Cut

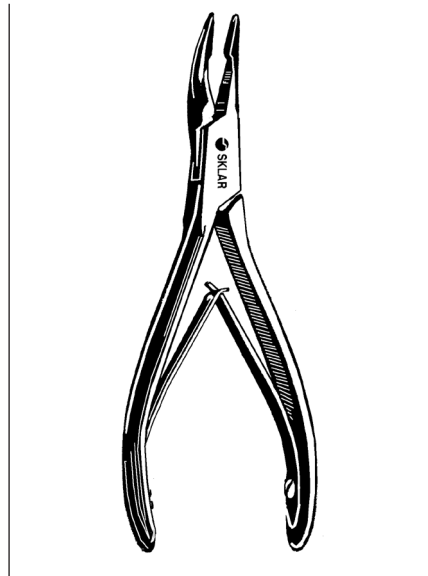

**MINI BLUMENTHAL RONGEURS**  
**DELICATE**  
67-5987 4 3/4" 30° Angle  
67-5988 4 3/4" 45° Angle

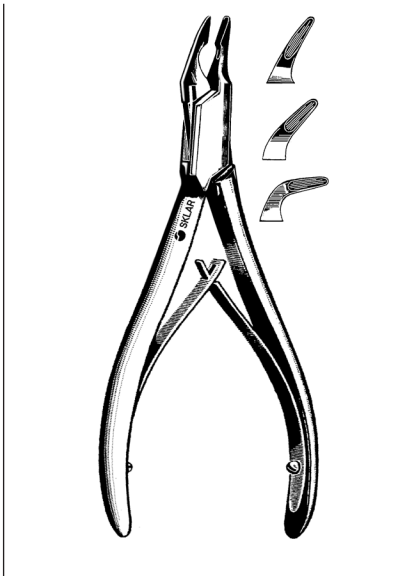

**BLUMENTHAL RONGEURS**  
67-5990 6" 30° Angle  
67-5991 7" 30° Angle  
67-5992 6" 45° Angle  
67-5994 6" 90° Angle

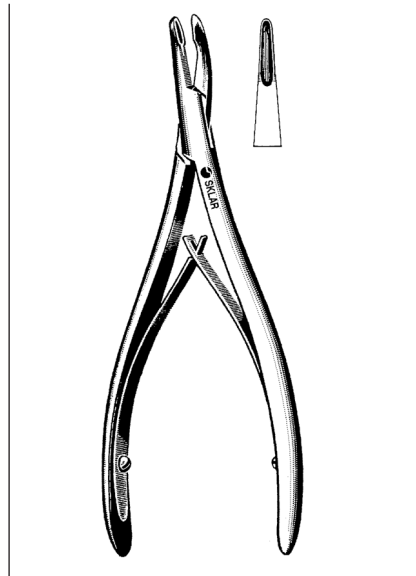

**LEMPERT RONGEURS**  
47-2467 6 1/4" Straight  
47-2468 6 1/4" Curved  
47-2465 7 1/2" Straight  
47-2466 7 1/2" Curved

**For a complete listing of our Podiatry product line, visit [www.sklarcorp.com](http://www.sklarcorp.com).**



**FRIEDMAN BONE RONGEURS**

**DELICATE**

- 40-3190 5½" Curved
- 40-3192 6½" Curved



**CLEVELAND RONGEURS**

**CURVED**

- 40-3200 5½" #4
- 40-3202 6½" #4A

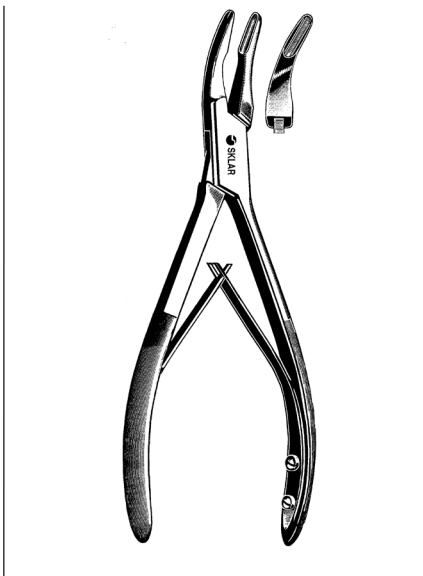

**MEAD RONGEURS**

- 40-3206 6½" Slight Curve
- 40-3208 6½" Curved

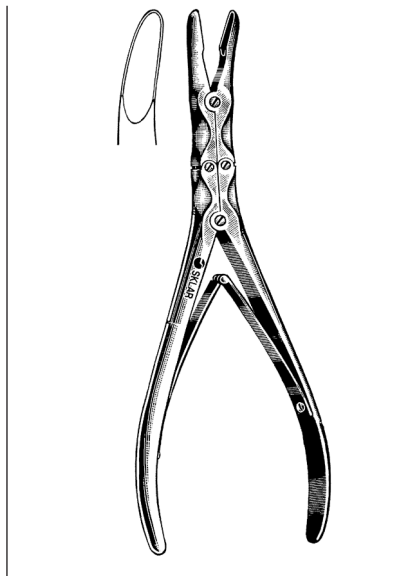

**ZAUFEL-JANSEN RONGEUR**

**DOUBLE ACTION**

- 40-4265 7" 5 x 15mm Curved Bite

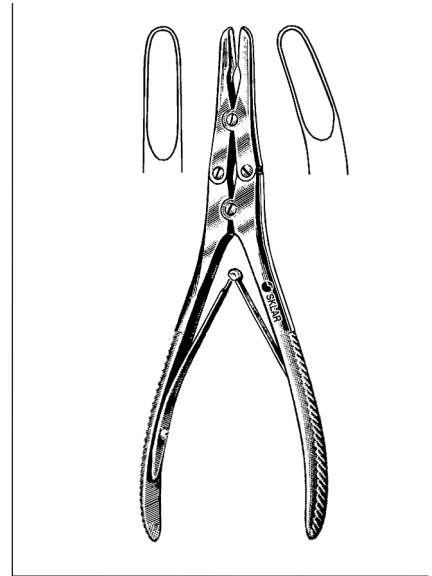

**RUSKIN RONGEURS**

- 40-4360 6" Straight 2mm Bite
- 40-4365 6" Curved 2mm Bite
- 40-4272 7¼" Straight 5mm Bite
- 40-4372 7¼" Curved 5mm Bite
- 40-4472 7¼" Angled to Side 5mm Bite
- 40-4512 9½" Curved 5mm Bite

For a complete listing of our Podiatry product line, visit [www.sklarcorp.com](http://www.sklarcorp.com).

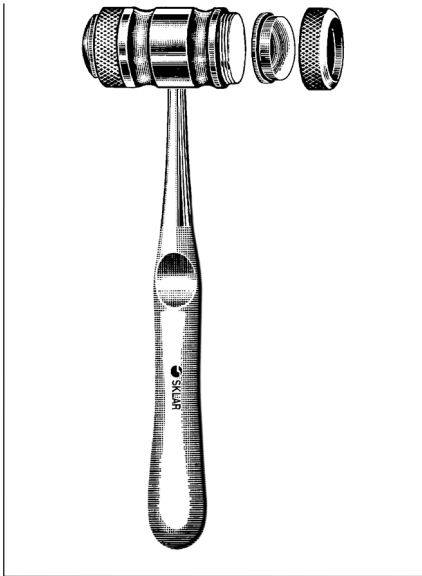

**SKLAR MALLET**  
**WITH REPLACEABLE PLASTIC DISCS**  
 40-5870 Rounded Surfaces  
 40-5871 Replaceable Discs

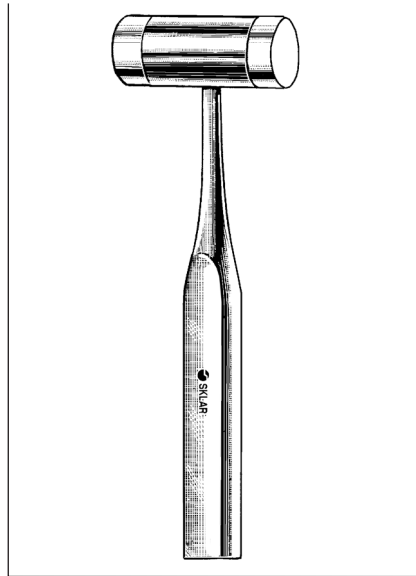

**MALLET WITH TWO  
PLASTIC ENDS**  
**REPLACEABLE**  
 40-5925 Flat Surfaces  
 40-5926 Replaceable Ends

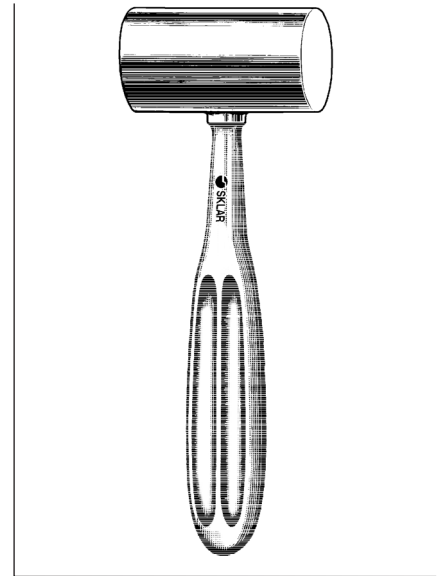

**KIRK BONE MALLET**  
**SOLID BRONZE HEAD-260Z.**  
 40-5672 8" 1½" Diameter

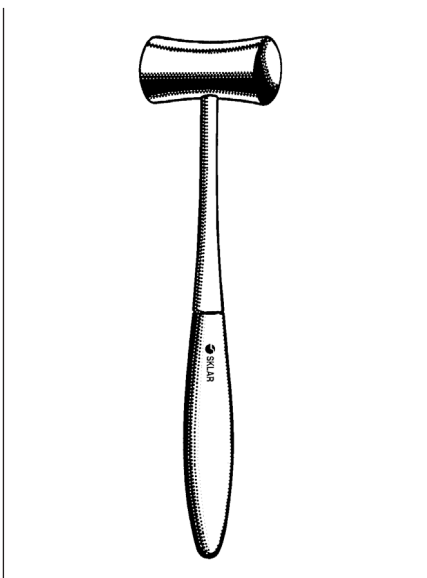

**LUCAE MALLET**  
**BRONZE HEAD, SMALL 80Z.**  
 40-5875 7½" 1" Diameter, Chrome Plated

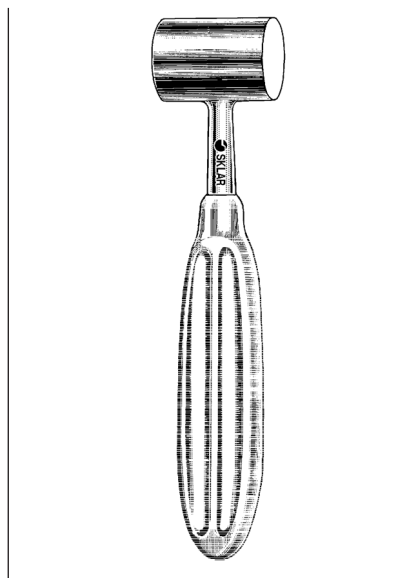

**GERZOG BONE MALLET**  
**LEAD FILLED-140Z.**  
 40-5765 7½" 1" Diameter

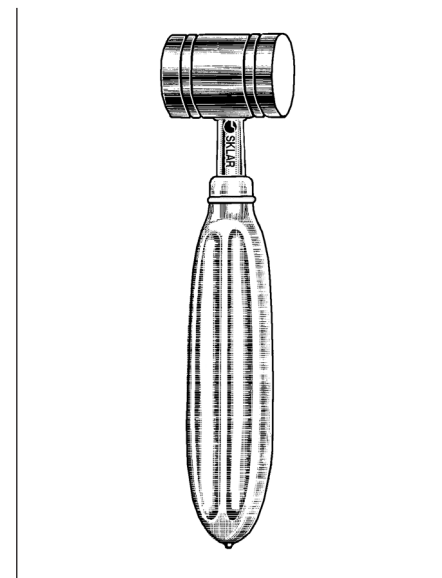

**RUSH MALLET (CRANE)**  
 40-5665 1½" Diameter

**For a complete listing of our Podiatry product line, visit [www.sklarcorp.com](http://www.sklarcorp.com).**

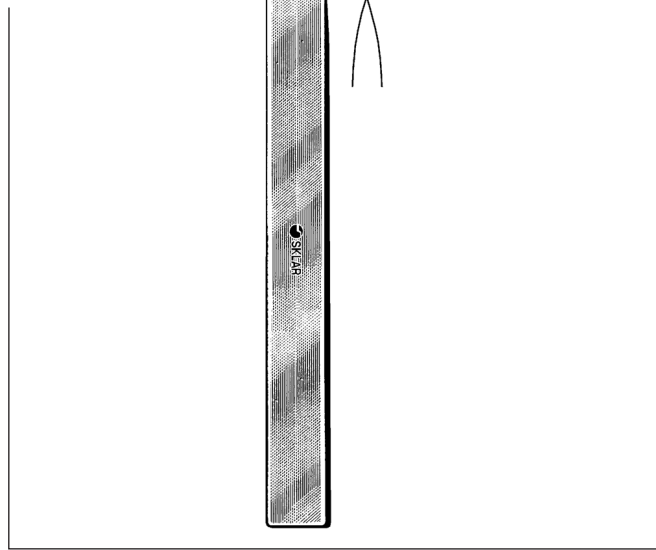
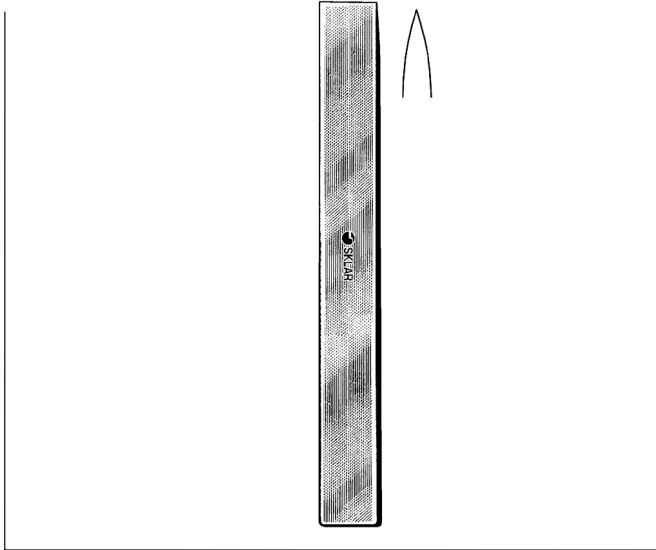

**LAMBOTTE OSTEOTOMES**

**STRAIGHT DELICATE 5"**

40-6532	2mm- $\frac{5}{64}$ "	40-6540	10mm- $\frac{2}{5}$ "
40-6533	3mm- $\frac{1}{8}$ "	40-6542	12mm- $\frac{15}{32}$ "
40-6534	4mm- $\frac{5}{32}$ "	40-6544	14mm- $\frac{9}{16}$ "
40-6535	5mm- $\frac{1}{5}$ "	40-6545	15mm- $\frac{11}{16}$ "
40-6536	6mm- $\frac{1}{4}$ "	40-6548	18mm- $\frac{23}{32}$ "
40-6537	7mm- $\frac{3}{11}$ "	40-6549	19mm- $\frac{3}{4}$ "
40-6538	8mm- $\frac{5}{16}$ "	40-6550	20mm- $\frac{51}{64}$ "
		40-6552	Set includes 2, 4, 6, 8 10, 12, 14, 18 and 20 mm

**JR. LAMBOTTE OSTEOTOMES**

**STRAIGHT 7"**

40-6624	4mm- $\frac{5}{32}$ "	40-6632	12mm- $\frac{15}{32}$ "
40-6625	5mm- $\frac{13}{64}$ "	40-6636	16mm- $\frac{5}{8}$ "
40-6626	6mm- $\frac{1}{4}$ "	40-6639	19mm- $\frac{3}{4}$ "
40-6628	8mm- $\frac{5}{16}$ "	40-6642	22mm- $\frac{7}{8}$ "
40-6630	10mm- $\frac{2}{5}$ "	40-6645	25mm-1"



**HOKE CHISELS**

**STRAIGHT 5 1/2"**

40-6984	4mm- $\frac{5}{32}$ "	40-6993	13mm- $\frac{1}{2}$ "
40-6986	6mm- $\frac{1}{4}$ "	40-6996	16mm- $\frac{5}{8}$ "
40-6990	10mm- $\frac{2}{5}$ "	40-6999	19mm- $\frac{3}{4}$ "

**HOKE OSTEOTOMES**

**STRAIGHT 5 1/2"**

40-6953	3mm- $\frac{1}{8}$ "	40-6970	10mm- $\frac{2}{5}$ "
40-6954	4mm- $\frac{5}{32}$ "	40-6973	13mm- $\frac{1}{2}$ "
40-6956	6mm- $\frac{1}{4}$ "	40-6976	16mm- $\frac{5}{8}$ "
40-6958	8mm- $\frac{5}{16}$ "	40-6979	19mm- $\frac{3}{4}$ "

For a complete listing of our Podiatry product line, visit [www.sklarcorp.com](http://www.sklarcorp.com).

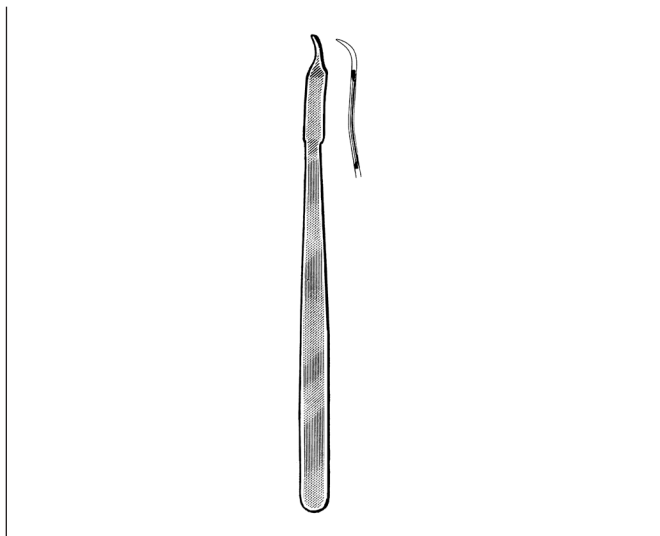

**MINI HOHMANN BONE ELEVATORS**

- 40-7450 6½" x 6mm
- 40-7451 6½" x 8mm



**HOHMANN BONE ELEVATORS**

- 40-7447 8½" 8mm
- 40-7448 9" 10mm
- 40-7452 9½" 18mm
- 40-7453 9½" 43mm
- 40-7454 10" 24mm
- 40-7455 10" 20mm
- 40-7456 10" 22mm
- 40-7458 10½" 65mm



**CREGO ELEVATORS**

- 40-7410 7¾" Full Curve 14mm
- 40-7415 8" Full Curve 6mm
- 40-7420 8" Slight Curve 6mm



**VOLKMAN CURETTES**

- DOUBLE END**
- 40-7250 5" Oval/Round
  - 40-7165 6½" Oval/Oval
  - 40-7265 6½" Oval/Round
  - 40-7280 8" Oval/Round

**For a complete listing of our Podiatry product line, visit [www.sklarcorp.com](http://www.sklarcorp.com).**

**PODIATRY  
CURETTES**

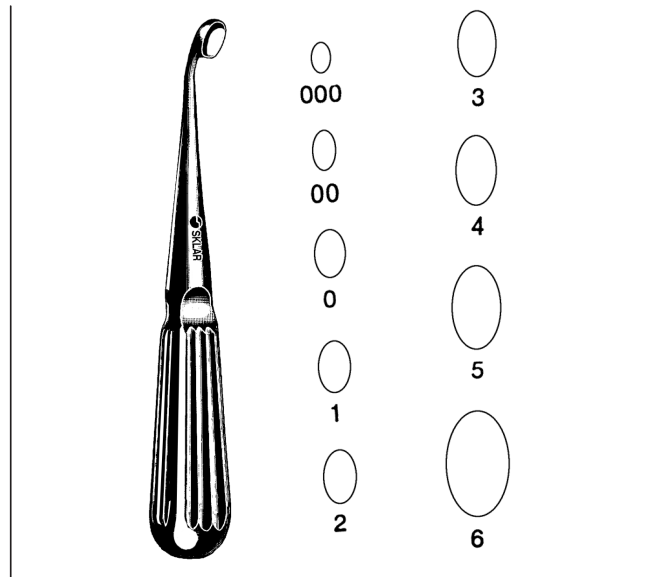
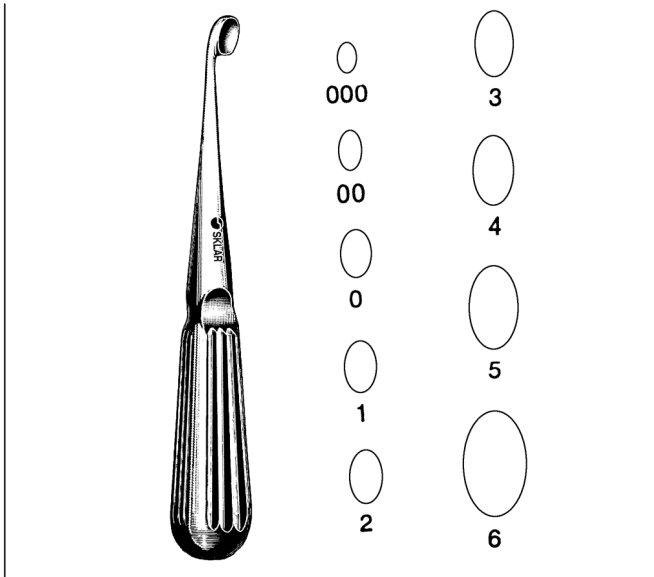

**BRUNS CURETTES**

**STRAIGHT, OVAL**

6 3/4"

40-7118	#5-0	40-7112	#2
40-7120	#4-0	40-7113	#3
40-7000	#3-0	40-7114	#4
40-7100	#2-0	40-7115	#5
40-7110	#1-0	40-7116	#6
40-7111	#1		

9"

40-7199	#6-0	40-7205	#1
40-7200	#5-0	40-7206	#2
40-7201	#4-0	40-7207	#3
40-7202	#3-0	40-7208	#4
40-7203	#2-0	40-7209	#5
40-7204	#0	40-7210	#6

**BRUNS CURETTES**

**ANGLED, OVAL**

6 1/2"

41-1710	#5-0	41-1716	#2
41-1711	#4-0	41-1717	#3
41-1712	#3-0	41-1718	#4
41-1713	#00	41-1719	#5
41-1714	#0	41-1720	#6
41-1715	#1		

9"

40-7219	#6-0	40-7225	#1
40-7220	#5-0	40-7226	#2
40-7221	#4-0	40-7227	#3
40-7222	#3-0	40-7228	#4
40-7223	#2-0	40-7229	#5
40-7224	#0	40-7230	#6

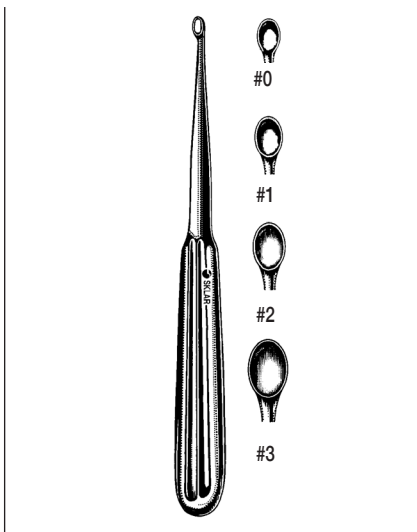

**SKLAR DERMAL CURETTES**

**OVAL 6 1/4"**

06-4112	#0
06-4113	#1
06-4114	#2
06-4115	#3

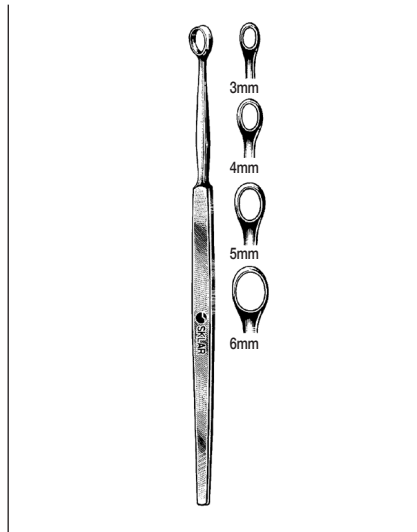

**FOX DERMAL CURETTES**

**OVAL 5 1/2"**

06-4133	3mm
06-4134	4mm
06-4135	5mm
06-4136	6mm

**ROUND 5 1/2"**

06-4138	3mm
06-4139	4mm
06-4140	5mm
06-4141	6mm

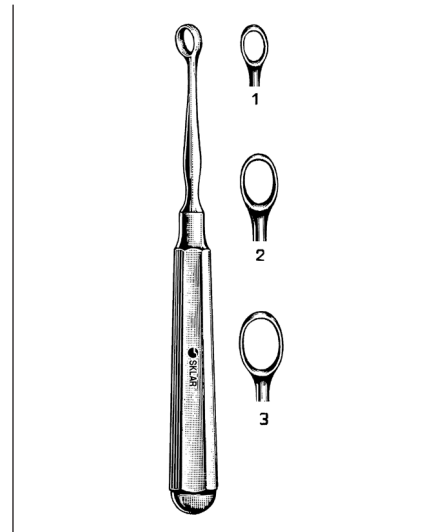

**PIFFARD CURETTES**

**OVAL 6"**

06-4130	#1
06-4131	#2
06-4132	#3

For a complete listing of our Podiatry product line, visit [www.sklarcorp.com](http://www.sklarcorp.com).

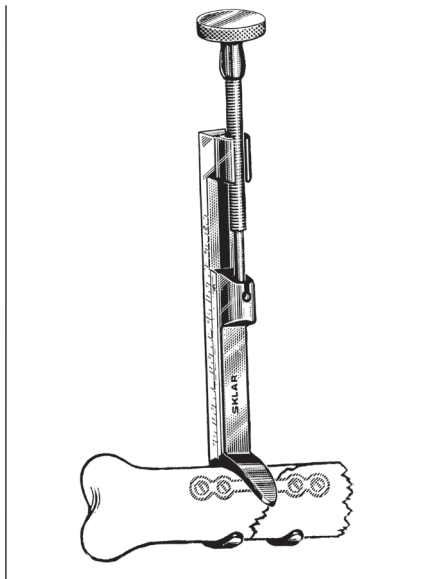

**LOWMAN CLAMPS**

**1X2 PRONGS**

- 40-2921 4¾" x ¾" Jaw
- 40-2922 7¼" x 1½" Jaw
- 40-2923 8" x 1½" Jaw

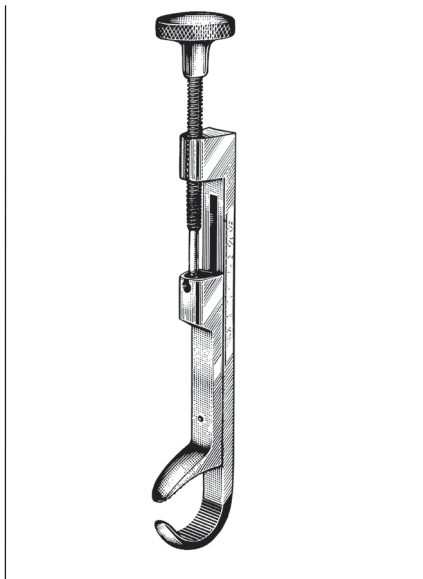

**LOWMAN CLAMPS**

**1X1 PRONGS**

- 40-2925 4¾" x ¾" Jaw
- 40-2927 7¼" x 1½" Jaw
- 40-2928 8" x 1½" Jaw

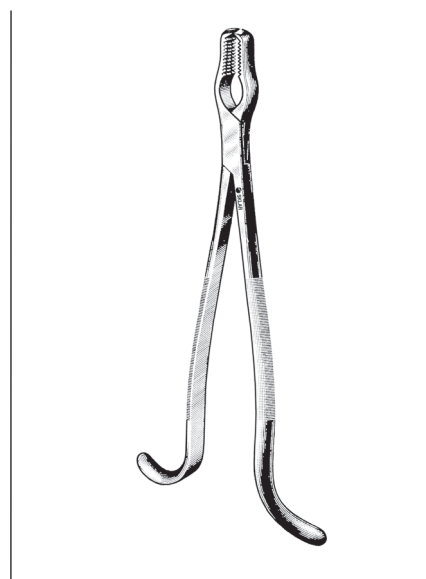

**KERN BONE HOLDING FORCEPS**

**WITHOUT RATCHET**

- 40-2480 5¾" Extra Small
- 40-2485 8½"

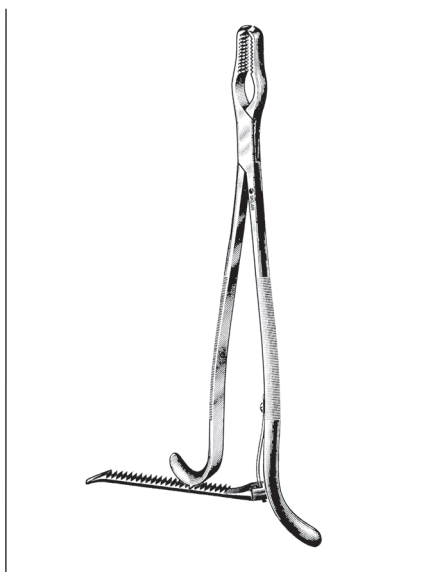

**KERN BONE HOLDING FORCEPS**

**With Ratchet**

- 40-2580 5¾" Extra Small
- 40-2585 8½"

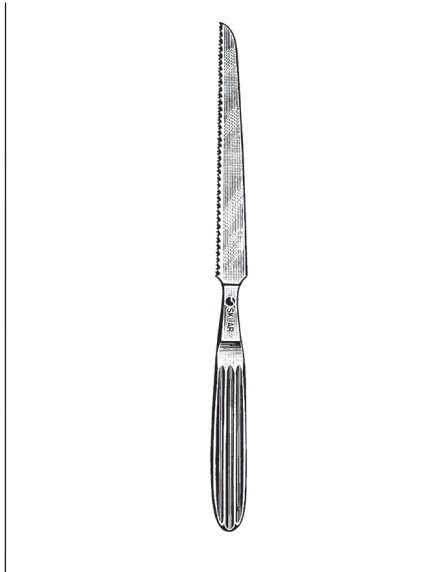

**LANGENBECK METACARPEL  
SAW**

- 40-5395 9" 4½" Blade

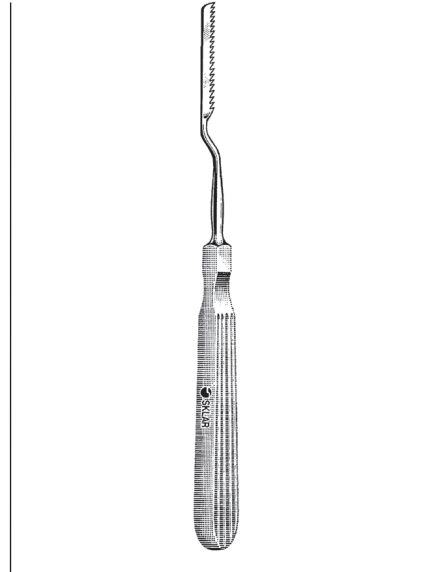

**JOSEPH BONE SAWS**

- 70-7801 7½" Right Bayonet
- 70-7802 7½" Left Bayonet
- 70-7805 7½" Straight

For a complete listing of our Podiatry product line, visit [www.sklarcorp.com](http://www.sklarcorp.com).



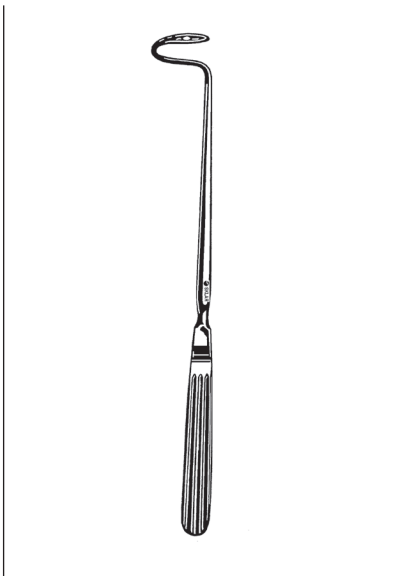

**DESCHAMP NEEDLES**

**BLUNT**  
26-1280 8" Curved Right  
26-1380 8" Curved Left

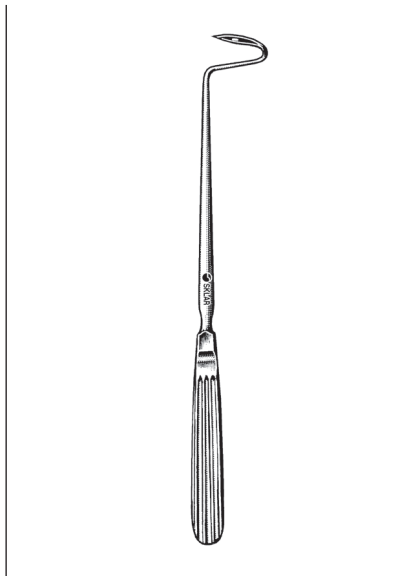

**DESCHAMP NEEDLES**

**SHARP**  
26-1480 8" Curved Right  
26-1580 8" Curved Left

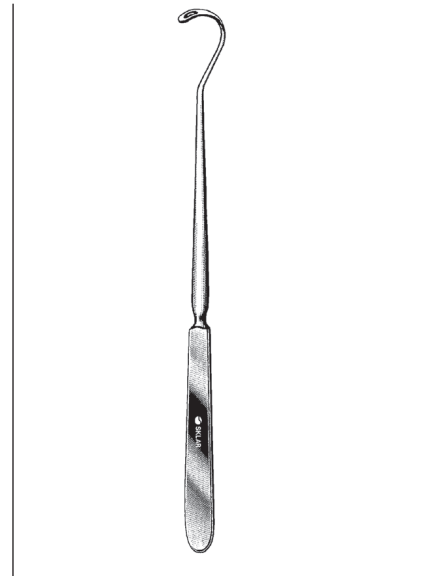

**NELSON LIGATURE NEEDLE**

55-6492 9 1/4"

# SKLAR SOAK™

## SURGICAL INSTRUMENT SOAK

Immersing soiled instruments in SKLAR SOAK™ for two minutes substantially reduces the risk of exposure to many infectious organisms.

- Effective Against: H1N1, HIV-1, HSV, VRE, Rotaviruses, Hep B & C as well as TB, MRSA, A. Baumannii.
- Non-Glutaraldehyde.
- PH Neutral Formula designed for safe use on all surgical instruments & stainless steelware.
- Non-Caustic Formula allows for use as a manual cleaner or in ultrasonic units.
- EPA Registered.
- Meets all OSHA standards on blood borne pathogen destruction.
- Ready to use.



PRODUCT NUMBER	FEATURES	QUANTITIES
10-1603	1 Gallon Bottles	4/case
10-1609	1 Gallon Bottle	1 bottle

For a complete listing of our Podiatry product line, visit [www.sklarcorp.com](http://www.sklarcorp.com).



**ALLIS TISSUE FORCEPS**

36-2060	6"	3x4
36-2160	6"	4x5
36-2260	6"	5x6
36-2275	7½"	5x6



**SKLARLITE™ ALLIS TISSUE FORCEPS**

23-2851	6"	4x5
23-2852	6"	5x6

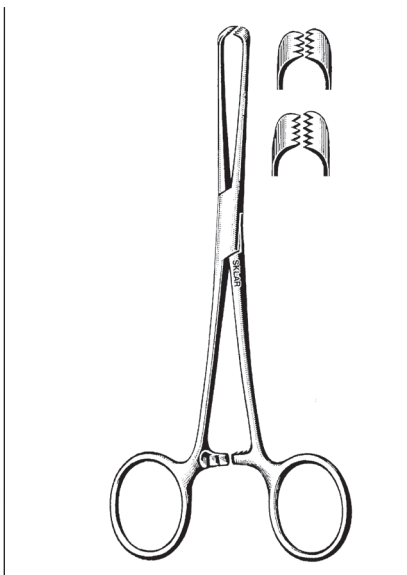

**ALLIS TISSUE FORCEPS**

**DELICATE**

18-2140	4"	4x5
18-2155	5"	4x5
22-6157	5½"	4x5
18-2162	6"	4x5
18-2164	6"	5x6
36-2295	9½"	5x6

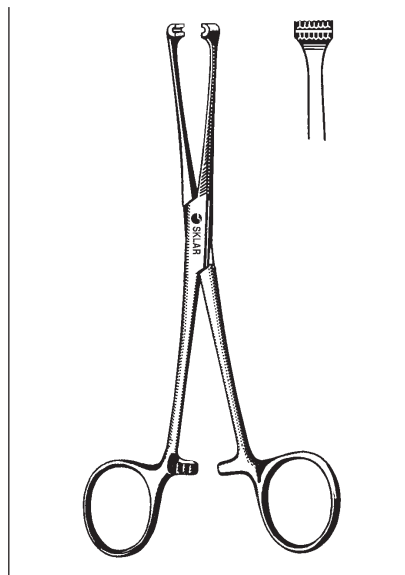

**ATRAUMATIC ALLIS FORCEPS**

**DOUBLE ROW NON-TRAUMATIC TEETH**

36-2298	6"
36-2280	8"
36-2385	10"

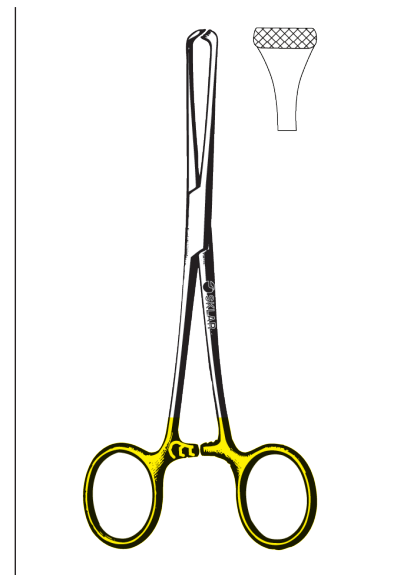

**TC ALLIS FORCEPS**

**ATRAUMATIC**

97-1555	6"
97-1560	7½"

**For a complete listing of our Podiatry product line, visit [www.sklarcorp.com](http://www.sklarcorp.com).**

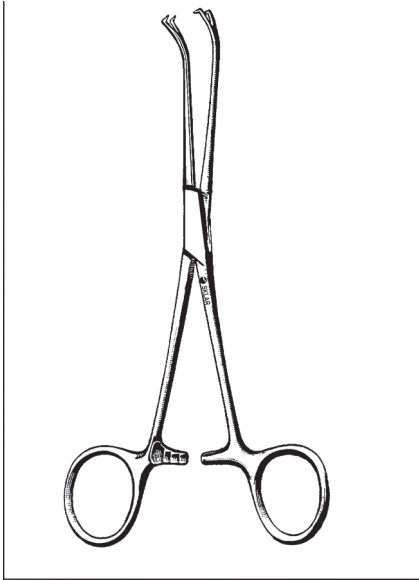

**SESAMOID CLAMP**

40-2655 6½"

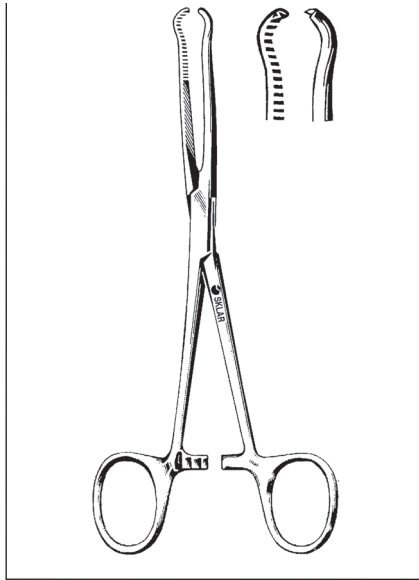

**LOCKE PHALANGEAL FORCEPS**

40-2650 6"

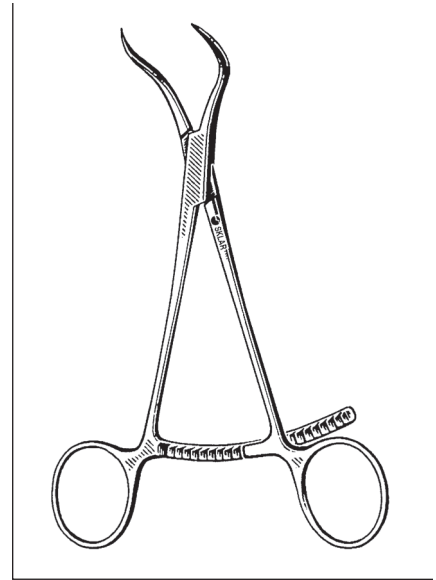

**BONE COMPRESSION FORCEPS**

40-2675 5½" Pointed Tips

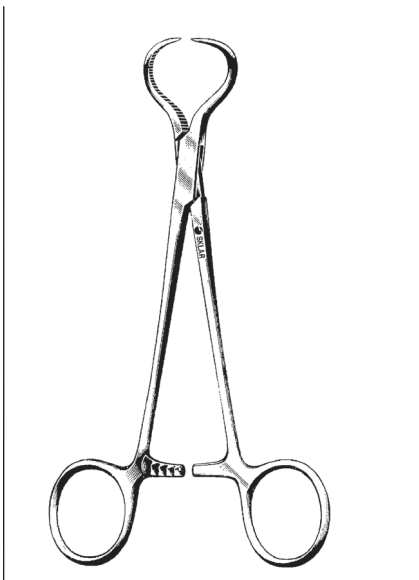

**LEWIN BONE FORCEPS**

40-2670 7" Serrated



**BONE AND CARTILAGE CLAMP**

40-2275 8" Curved

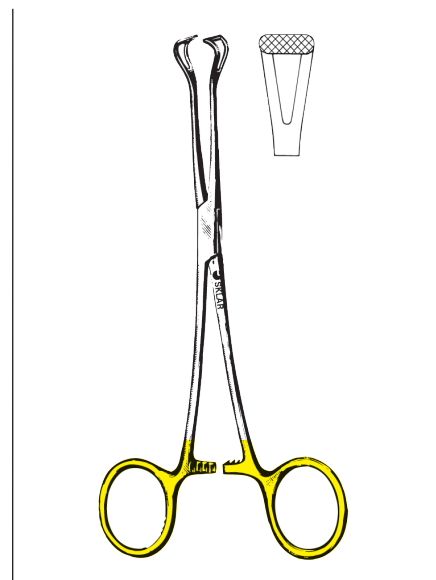

**TC BABCOCK FORCEPS**

97-1565 6¼"  
97-1570 8"

For a complete listing of our Podiatry product line, visit [www.sklarcorp.com](http://www.sklarcorp.com).

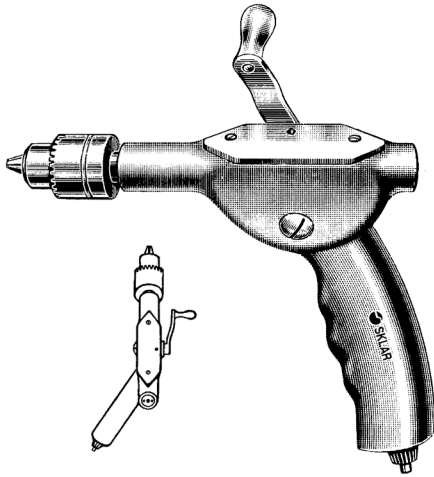

**SKLAR BONE DRILL-OFFSET HANDLE**

**WITH JACOBS CHUCK**

40-1465 For Twist Drills and Kirschner Wires

40-1478 Chuck Key Only

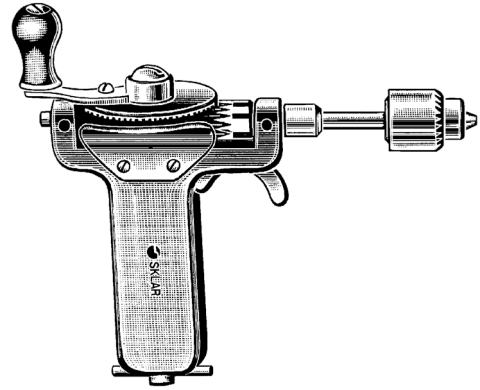

**BUNNELL DRILL-CANNULATED**

**WITH JACOBS CHUCK**

40-1475 For Twist Drills and Kirschner Wires

40-1478 Chuck Key Only



**KIRSCHNER WIRES**

**TWO TROCAR ENDS**

40-1565 4" x .028

40-1566 4" x .035

40-1567 4" x .045

40-1568 4" x .054

40-1569 4" x .062

40-1580 9" x .035

40-1582 9" x .045

40-1584 9" x .062

40-1535 12" x .035

40-1545 12" x .045

40-1562 12" x .062



**STEINMANN PINS**

**TROCAR POINT**

40-1590 9" x 2.0mm 40-1594 9" x 3.5mm

40-1591 9" x 2.4mm 40-1595 9" x 4.0mm

40-1592 9" x 2.8mm 40-1596 9" x 4.5mm

40-1593 9" x 3.2mm

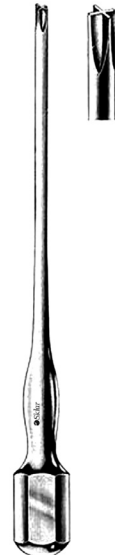

**LANE SCREW DRIVER**

40-1650 10" Cross-Slot

**For a complete listing of our Podiatry product line, visit [www.sklarcorp.com](http://www.sklarcorp.com).**

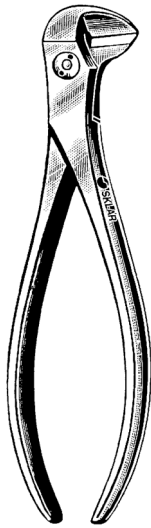

**IMPROVED SKLAR FORCEPS  
FOR CUTTING AND SHAPING WIRE**  
75-9550



**CONE WIRE TWISTER**  
50-3970 7"



**DOUBLE ACTION PIN CUTTER**  
STAINLESS  
40-1715 15" Cuts up to 5/32"

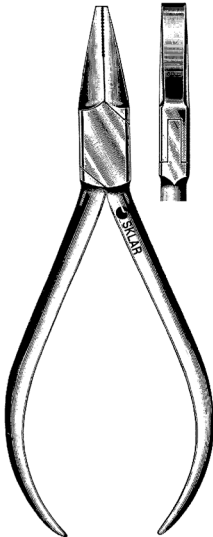

**FLAT NOSE PLIERS**  
40-1778 5 1/2"

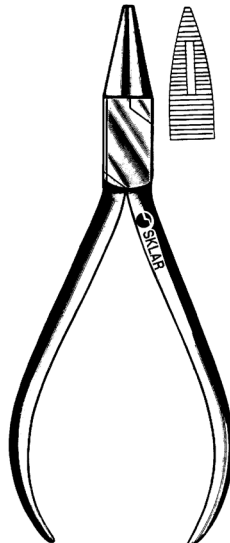

**NEEDLE NOSE PLIERS**  
40-1775 5 1/2"

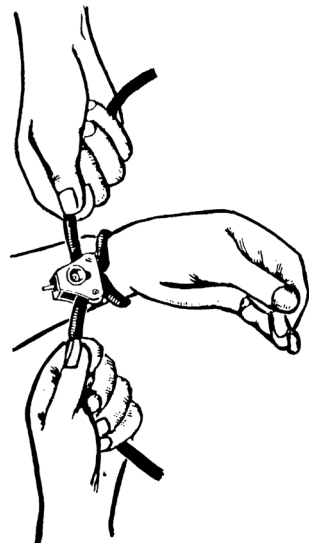

**N-I AUTOMATIC TOURNIQUETS**  
**BLACK TUBING**  
40-1915 Complete  
40-1916 Black Tubing Only  
40-1917 Clip for 40-1915 Only  
**WHITE TUBING**  
40-1918 Complete  
40-1919 White Tubing Only

For a complete listing of our Podiatry product line, visit [www.sklarcorp.com](http://www.sklarcorp.com).



**TC DOUBLE ACTION WIRE EXTRACTION PLIERS**  
40-1744 7" Narrow  
40-1745 7" Wide



**TC RING HANDLE PIN AND WIRE EXTRACTOR**  
40-1720 7"



**INGE RETRACTORS**

**WITH TEETH**

42-1420 6½"  
42-1425 10½"

**WITHOUT TEETH**

42-1421 6½"  
42-1422 10½"

**SKLAR DISINFECTANT™  
SURFACE WIPES**

CONVENIENT DISPENSING CANISTER  
READY-TO-USE

2 MINUTE KILL TIME

PRODUCT NUMBER	DESCRIPTION	QUANTITIES
10-1616	100 Towelettes/Canister	6/CS
10-1617	100 Towelettes/Canister	12/CS

For a complete listing of our Podiatry product line, visit [www.sklarcorp.com](http://www.sklarcorp.com).



**TC PIN CUTTERS**

**SIDE CUT, DOUBLE ACTION**

40-1023 7" Straight  
40-1024 8½" Angular



**TC PIN CUTTER**

**DOUBLE ACTION, CUTS TO .062" WIRE (1.6MM)**

40-1045 7" End Cut-Side Cut

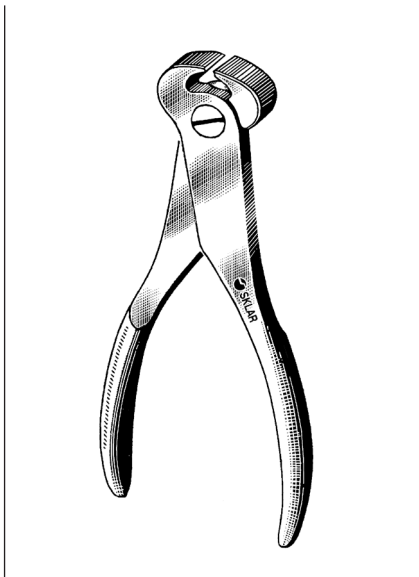

**SKLAR PIN CUTTER**

**END CUTTING**

40-1048 7"

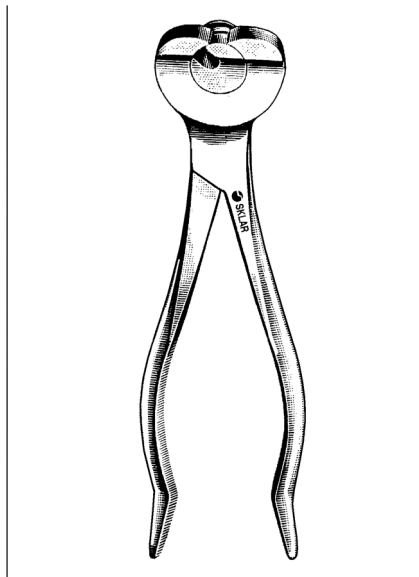

**DIAMOND PIN CUTTER**

**CHROME**

40-1762 6¼"

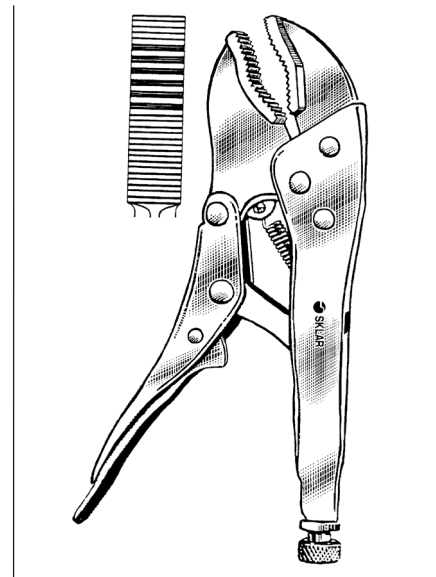

**SNAP LOCK PIN/WIRE  
EXTRACTOR**

40-1725

For a complete listing of our Podiatry product line, visit [www.sklarcorp.com](http://www.sklarcorp.com).

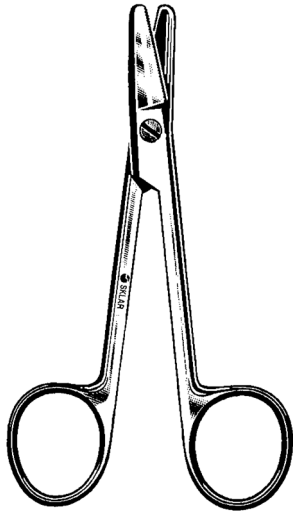

**SUTURE WIRE CUTTING SCISSOR**

**SERRATED EDGES**

24-2347 4¾" Straight

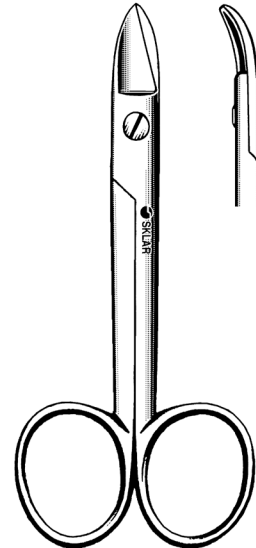

**CROWN & COLLAR CUTTING SCISSORS**

**STRAIGHT**

24-2345 4" Smooth  
24-2340 4" Serrated

**CURVED**

24-2346 4" Smooth  
24-2341 4" Serrated

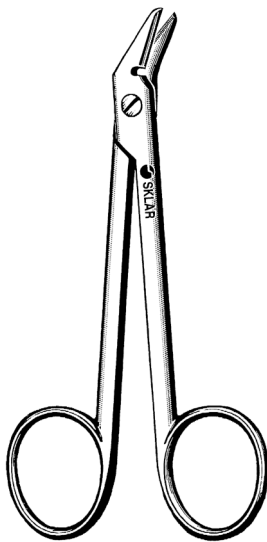

**SUTURE WIRE CUTTING SCISSORS**

**ANGULAR SERRATED**

24-2342 4¾"  
16-2800 4¾" TC

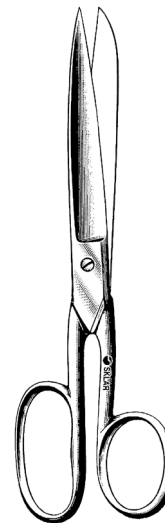

**USA PATTERN GAUZE SCISSOR**

11-1180 8"

**For a complete listing of our Podiatry product line, visit [www.sklarcorp.com](http://www.sklarcorp.com).**



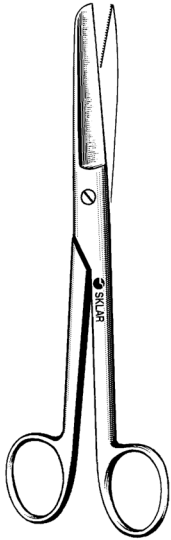

**MOLESKIN SCISSORS**  
ONE BLADE SERRATED, SHARP/BLUNT  
97-1350 7½" Straight  
97-1351 7½" Curved

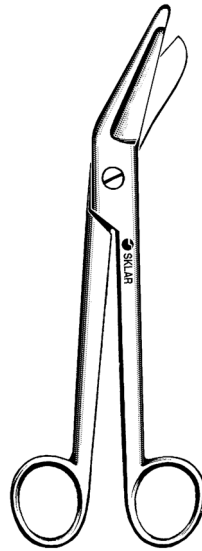

**ESMARCH SHEARS**  
HEAVY PATTERN  
11-1380 8"  
11-1390 9"

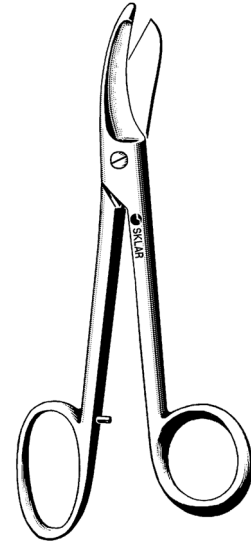

**BRUNS SHEARS**  
SERRATED  
11-1295 9¼"  
16-2820 9½" TC

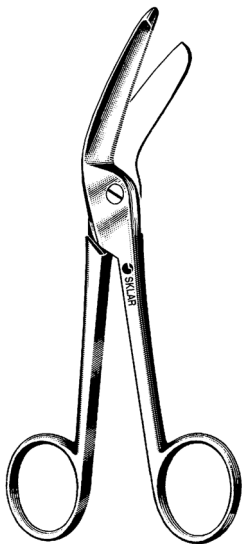

**HERCULES UTILITY SCISSOR**  
11-1297 7½" Serrated

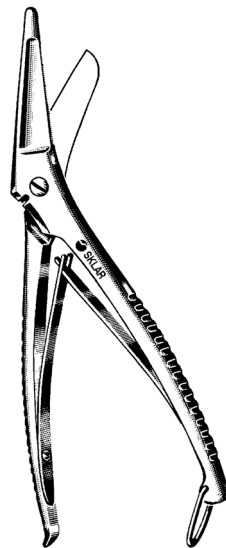

**COMMANDER UTILITY SHEAR**  
HEAVY DUTY WITH WIRE CUTTING NOTCH  
11-1298 8½"



**SEUTIN PLASTER SHEAR**  
HEAVY PLIER HANDLE  
11-1490 9" Serrated

For a complete listing of our Podiatry product line, visit [www.sklarcorp.com](http://www.sklarcorp.com).

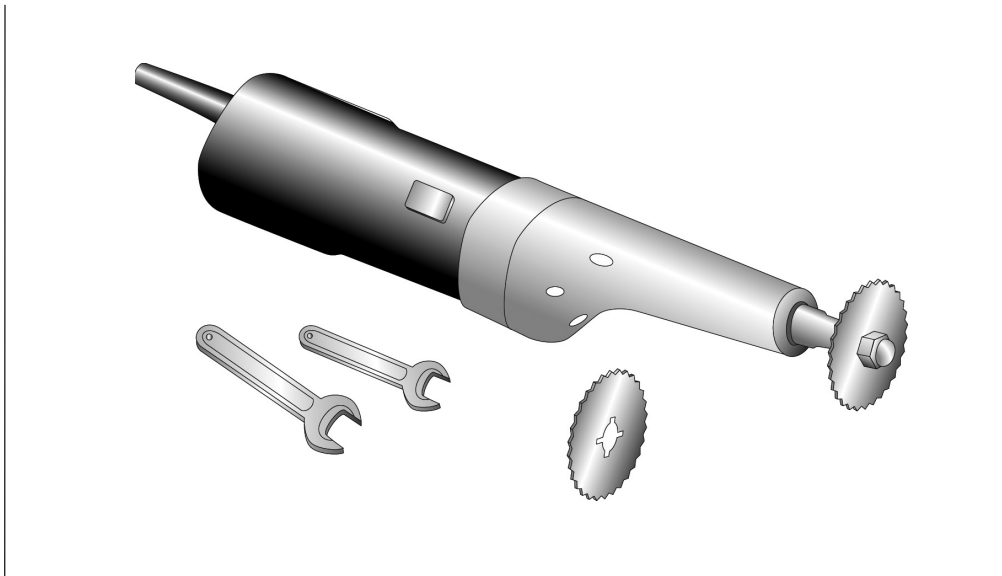

**OSCILLATING PLASTER SAWS**

- 11-2100 110V Complete
- 11-2101 220V Complete
- 11-2105 Blade Only 50mm
- 11-2110 Blade Only 65mm
- 11-2112 Blade Only 65mm, For use on Synthetic Plaster
- 11-2115 Wrenches only Set of 2

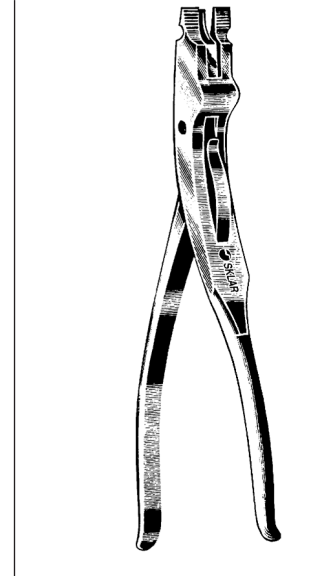

**WALTON PLASTER SPREADER**

- 3 BLADES**
- 11-1990 9"



**HENNIG PLASTER SPREADER**

- 2 BLADES**
- 11-1910 11"

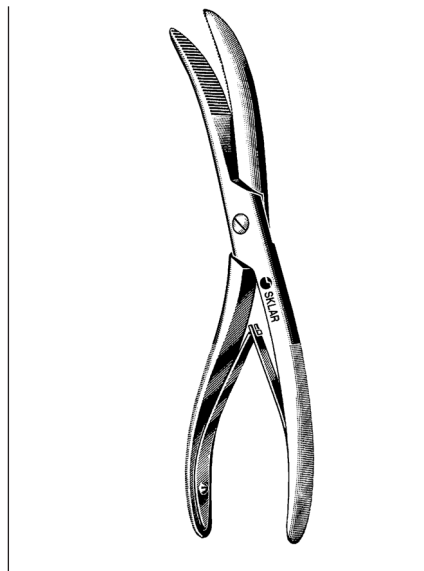

**WOLFE-BOEHLER PLASTER CAST BREAKER**

- 11-2095 10"

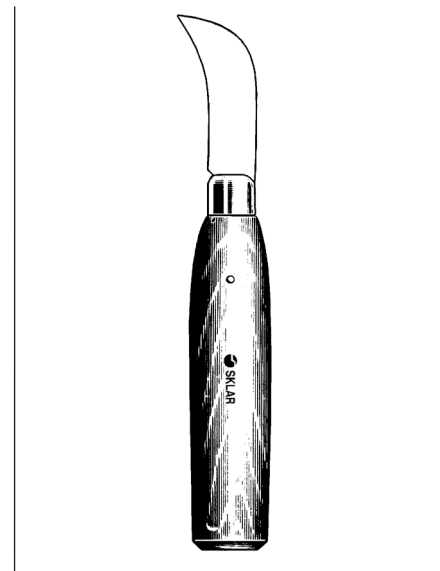

**MURPHY PLASTER KNIFE**

- WOOD HANDLE**
- 11-1540

**For a complete listing of our Podiatry product line, visit [www.sklarcorp.com](http://www.sklarcorp.com).**



**GRAVES VAGINAL SPECULUMS**

90-3700	3" x ¾"	Small
90-3701	4" x 1¼"	Medium
90-3702	4½" x 1⅜"	Large



**GRAVES VAGINAL SPECULUMS**

90-3800	3" x ½"	Extra Small
90-3802	4¾" x 1½"	Extra Large
90-3803	6" x 1½"	Extra Long

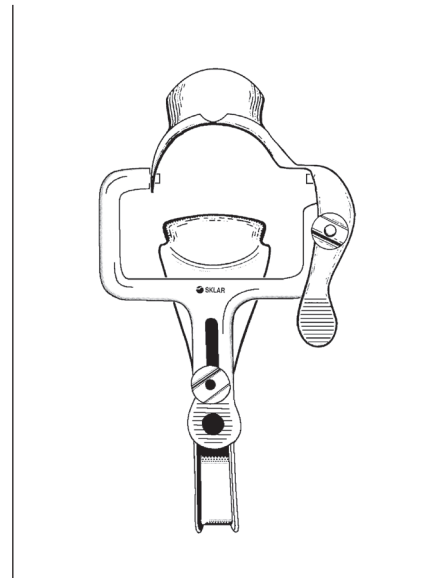

**GRAVES OB-VIEW VAGINAL SPECULUMS**

90-3740	4" x 1¼"	Medium
90-3741	4¾" x 1½"	Large

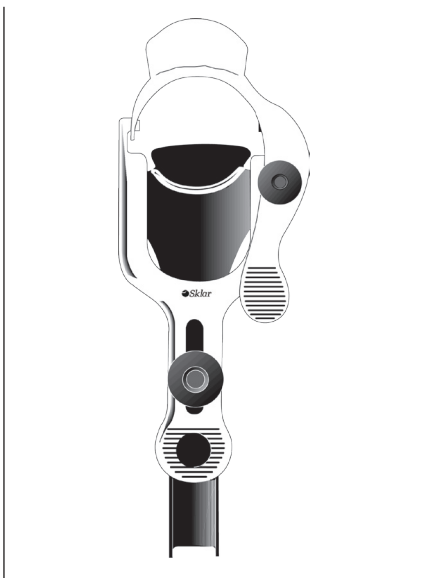

**GRAVES VAGINAL SPECULUM  
WIDE VIEW PATTERN**

WIDE PROXIMAL OPENING FOR INSTRUMENTATION

90-3705	4" x 1¼"	Medium
---------	----------	--------

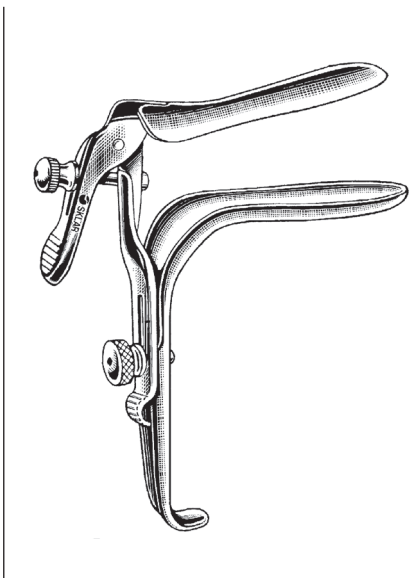

**FREEWAY GRAVES VAGINAL  
SPECULUM**

OPEN SIDE

90-3750	4" x 1¼"	90° Angle
---------	----------	-----------

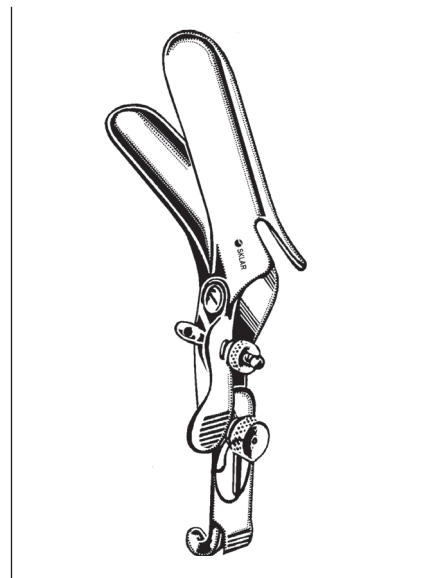

**FREEWAY GRAVES VAGINAL  
SPECULUM**

OPEN SIDE

90-3752	4" x 1¼"	45° Angle
---------	----------	-----------

For a complete listing of our OB/GYN product line, visit [www.sklarcorp.com](http://www.sklarcorp.com).

OB/GYN INSTRUMENTS

SPECULUMS



**GRAVES VAGINAL SPECULUMS**

**GOLD SCREWS**

90-3720	3/4" x 3"	Small
90-3721	1 1/4" x 4"	Medium
90-3722	1 3/8" x 4 1/4"	Large



**PEDERSON VAGINAL SPECULUMS**

**GOLD SCREWS**

90-3730	1/2" x 3"	Small
90-3731	7/8" x 4"	Medium
90-3732	1" x 4 3/4"	Large



**PEDERSON VAGINAL SPECULUMS**

**NARROW BLADES**

90-3710	3" x 1/2"	Small
90-3712	4" x 5/8"	Slender
90-3713	4" x 7/8"	Medium
90-3711	4 3/4" x 1"	Large



**PEDERSON VAGINAL SPECULUMS**

90-3849	2 3/4" x 1/2"	Extra Small
90-3851	4 3/4" x 1 5/8"	Extra Large

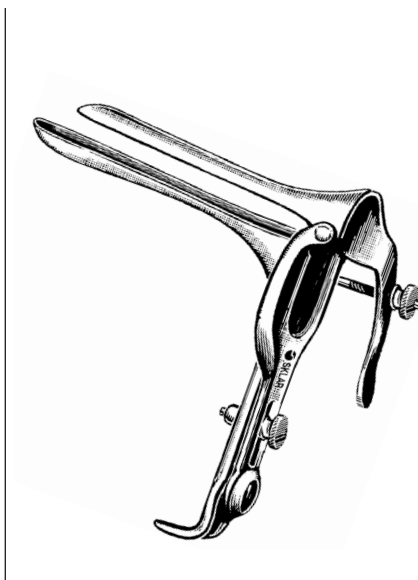

**PEDERSON OPEN-SIDED VAGINAL SPECULUM**

90-3751	4" x 1"	Open on Right Side
---------	---------	--------------------

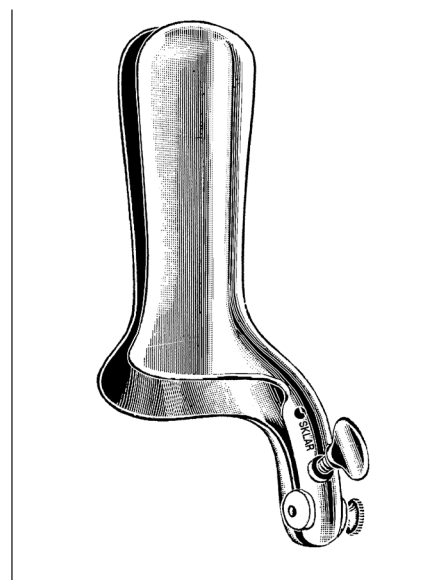

**COLLIN VAGINAL SPECULUMS**

90-3943	3 1/2" x 1 1/4"	Small
90-3945	4 1/4" x 1 1/4"	Medium
90-3944	4 1/2" x 1 1/2"	Large

For a complete listing of our OB/GYN product line, visit [www.skларcorp.com](http://www.skларcorp.com).



SIDE  
SCREW

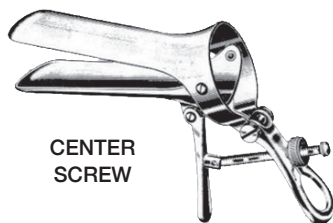

CENTER  
SCREW

**CUSCO VAGINAL SPECULUMS**

**WITH SIDE SCREW**

90-3957	3" x 1¼"	Small
90-3959	3¼" x 1½"	Medium
90-3960	3¾" x 1¾"	Large

**WITH CENTER SCREW**

90-3951	3" x ¾"	X-Small
90-3952	3" x 1¼"	Small
90-3953	3¼" x 1¼"	Medium
90-3954	3¾" x 1½"	Large
90-3955	4¼" x 1½"	X-Large

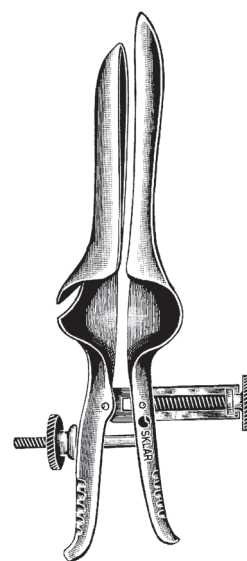

**DE VILBISS VAGINAL SPECULUM**

**(MILLER)**

90-3865	4 x 1¼" Blades	Parallel Opening, Chrome Plated
---------	----------------	---------------------------------



**SKLAR LATERAL VAGINAL RETRACTOR**

**RATCHET HANDLE**

90-3980	Fits inside Vaginal Speculum
---------	------------------------------

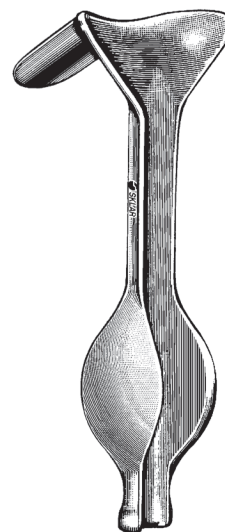

**AUWARD WEIGHTED VAGINAL SPECULUMS**

**BLADES 2¾" X 1½"**

90-3525	Light	2 lbs.
90-3526	Medium	2½ lbs.
90-3527	Heavy	3 lbs.

**EXTRA LONG BLADES 4" X 1¾"**

90-3530	Medium	2½ lbs.
---------	--------	---------

For a complete listing of our OB/GYN product line, visit [www.sklarcorp.com](http://www.sklarcorp.com).

OB/GYN INSTRUMENTS

SPECULUMS



**GARRIGUE WEIGHTED VAGINAL SPECULUMS**

**BLADES 3" X 1½"**

- |         |        |         |
|---------|--------|---------|
| 90-3535 | Light  | 2 lbs.  |
| 90-3536 | Medium | 2½ lbs. |
| 90-3537 | Heavy  | 3 lbs.  |



**STEINER-AUVARD WEIGHTED VAGINAL SPECULUM**

**BLADES 5½" X 1¼"**

- |         |          |
|---------|----------|
| 90-3559 | 2½" lbs. |
|---------|----------|



**HENROTIN WEIGHTED VAGINAL SPECULUM**

- |         |                       |        |
|---------|-----------------------|--------|
| 90-3555 | 3¼" x 1¼"             | 3 lbs. |
|         | 30° Blade Angled Down |        |



**BERLIND-AUVARD WEIGHTED VAGINAL SPECULUM**

- |         |           |         |
|---------|-----------|---------|
| 90-3558 | 4¼" x 1⅝" | 2½ lbs. |
|---------|-----------|---------|

For a complete listing of our OB/GYN product line, visit [www.sklarcorp.com](http://www.sklarcorp.com).

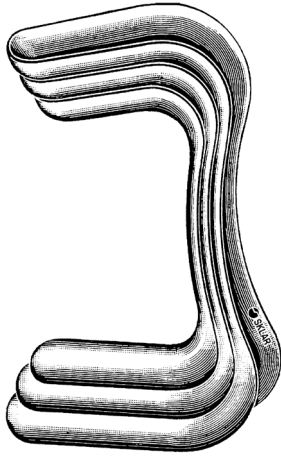

**SIMS VAGINAL RETRACTORS**

**DOUBLE END**

90-3150	7/8" x 2 1/2" and 1" x 3"	#1
90-3151	1" x 2 1/2" and 1 1/8" x 3"	#2
90-3152	1" x 3" and 1 1/4" x 3 1/4"	#3
90-3153	1 1/4" x 3" and 1 1/2" x 3 1/4"	#4
90-3154	1 1/4" x 3 1/4" and 1 1/2" x 4"	#5
90-3155	1 1/4" x 3 1/4" and 1 3/4" x 4"	#6

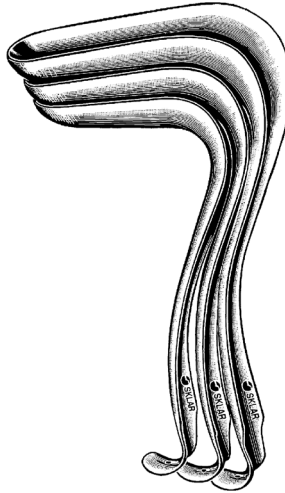

**SIMS VAGINAL RETRACTORS**

**SINGLE END**

90-3225	2 1/2" x 1"	Small
90-3230	3" x 1 1/4"	Medium
90-3235	3 1/2" x 1 1/2"	Large

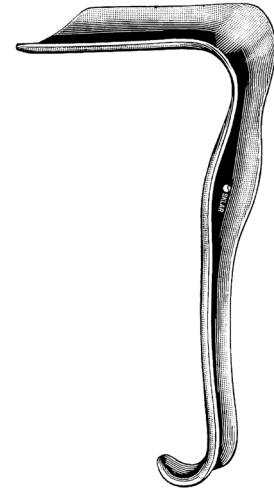

**JACKSON VAGINAL RETRACTORS**

**SINGLE END**

90-3130	3" x 1 1/2"	Small
90-3135	3 1/2" x 1 1/2"	Medium
90-3140	4" x 1 1/2"	Large

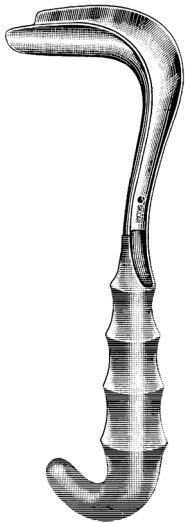

**SIMS-KELLY VAGINAL RETRACTORS**

**SKLAR-GRIP HANDLE**

90-3422	2 1/4" x 1"	Small
90-3427	2 3/4" x 1 1/4"	Medium
90-3430	3" x 1 1/2"	Large

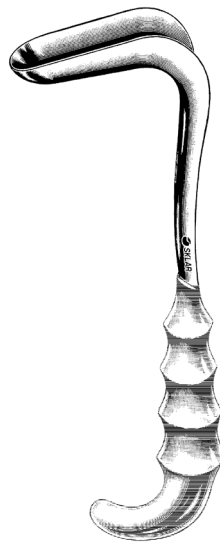

**SIMS VAGINAL RETRACTORS**

**SKLAR-GRIP HANDLE**

90-3327	2 3/4" x 1"	Small
90-3330	3" x 1 1/4"	Medium
90-3335	3 1/2" x 1 1/2"	Large

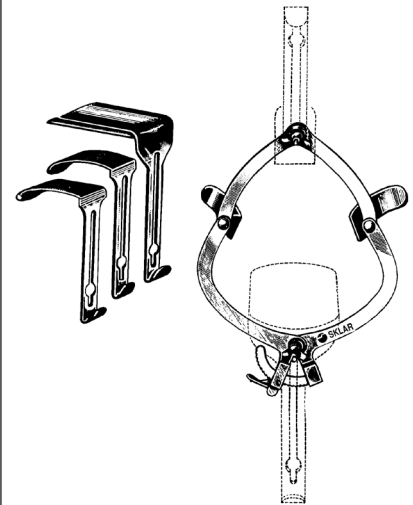

**O'SULLIVAN O'CONNER RETRACTORS**

**WITH 3 INTERCHANGEABLE BLADES**

90-3045	1 1/2" x 3/4"	Small
	3" x 1 1/2"	Medium
	3 1/2" x 1 3/4"	Large

For a complete listing of our OB/GYN product line, visit [www.sklarcorp.com](http://www.sklarcorp.com).

OB/GYN INSTRUMENTS



RETRACTORS

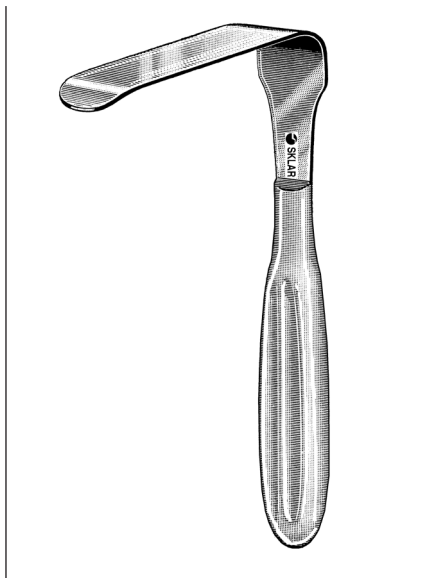

**BRANTLEY-TURNER VAGINAL RETRACTOR**

90-3470 4" x 1¼" Blade 7"

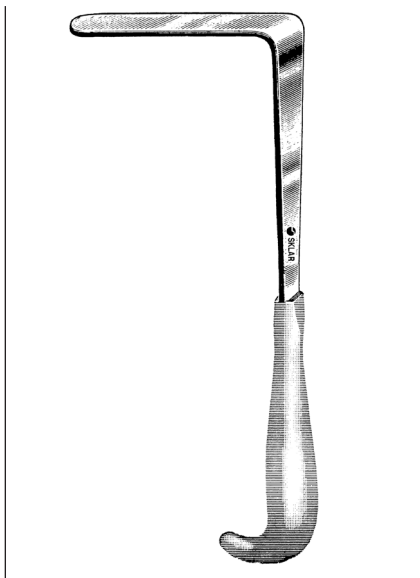

**PRYOR-PEAN VAGINAL RETRACTOR**

90-3510 4¼" x 1" Blade 10¾"

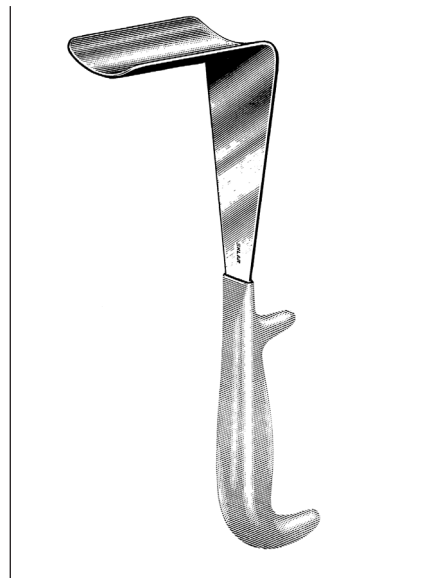

**DOYEN RETRACTORS**

60-2185	1¾" x 2⅛"	9"
60-2190	1¾" x 3¼"	9"
60-2195	2¼" x 3¼"	9"

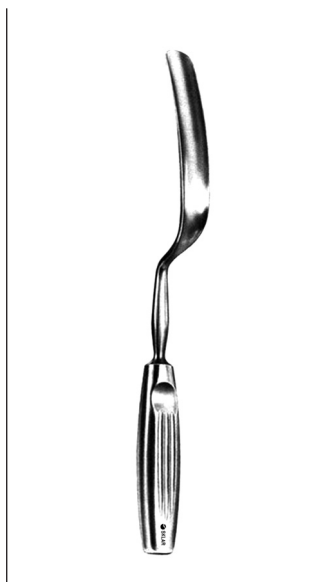

**BREISKY RETRACTORS**

90-3520	100mm x 20mm
90-3521	100mm x 25mm
90-3522	100mm x 30mm
90-3541	130mm x 25mm
90-3528	130mm x 40mm
90-3529	156mm x 40mm



**SEGOND VAGINAL SPATULA**

90-3610 4¾" x 1⅜" 10½"

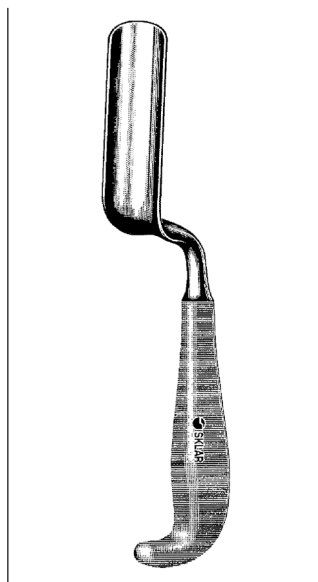

**TAUBER VAGINAL SPATULA**

90-3692 3½" x 1⅜" 10"

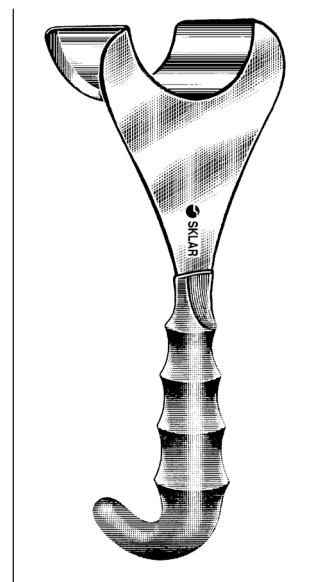

**DELEE RETRACTOR UNIVERSAL**

90-3452 2¾" x 2" 9½"

For a complete listing of our OB/GYN product line, visit [www.sklarcorp.com](http://www.sklarcorp.com).



# OB/GYN INSTRUMENTS

## ENDOCERVICAL SPECULUMS

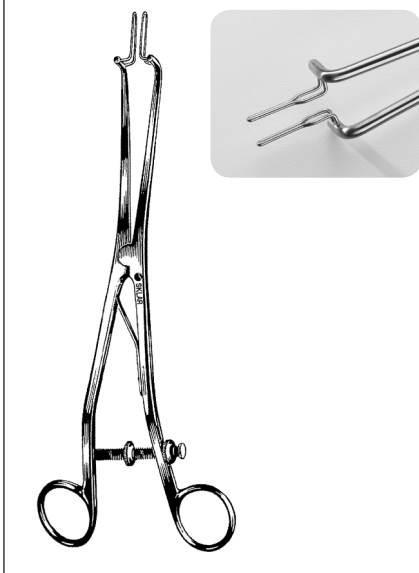

**KOGEN ENDOCERVICAL  
SPECULUM**  
WITH GAUGE AND SCREWS  
90-3990 Narrow Wire Blades

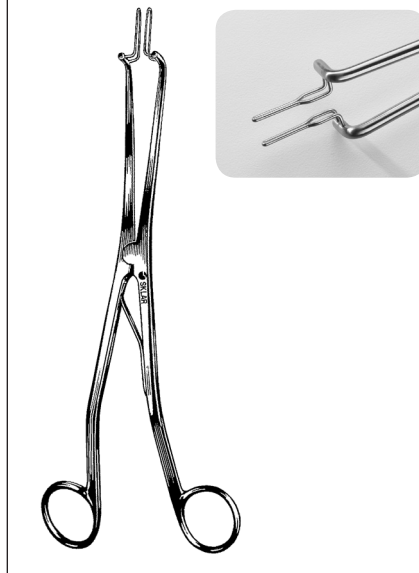

**KOGEN ENDOCERVICAL  
SPECULUM**  
WITH SPRING  
90-3996 Narrow Wire Blades



**KOGEN ENDOCERVICAL  
SPECULUM**  
WITH RATCHET  
90-3997 Narrow Wire Blades

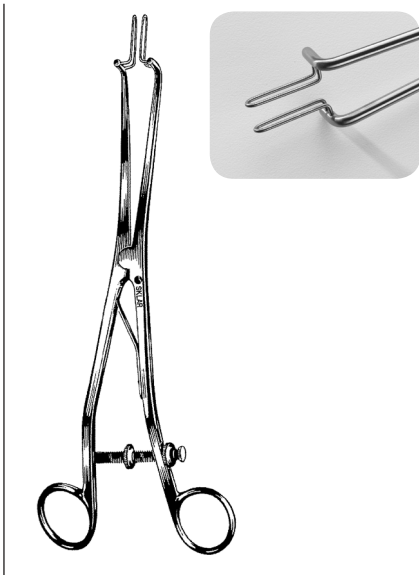

**KOGEN ENDOCERVICAL  
SPECULUM**  
WITH GAUGE AND SCREWS  
90-3995 Wide Wire Blades



**KOGEN ENDOCERVICAL  
SPECULUM**  
WITH SPRING  
90-3994 Wide Wire Blades



**KOGEN ENDOCERVICAL  
SPECULUM**  
WITH RATCHET  
90-3998 Wide Wire Blades

For a complete listing of our OB/GYN product line, visit [www.sklarcorp.com](http://www.sklarcorp.com).

OB/GYN INSTRUMENTS



HOOKS

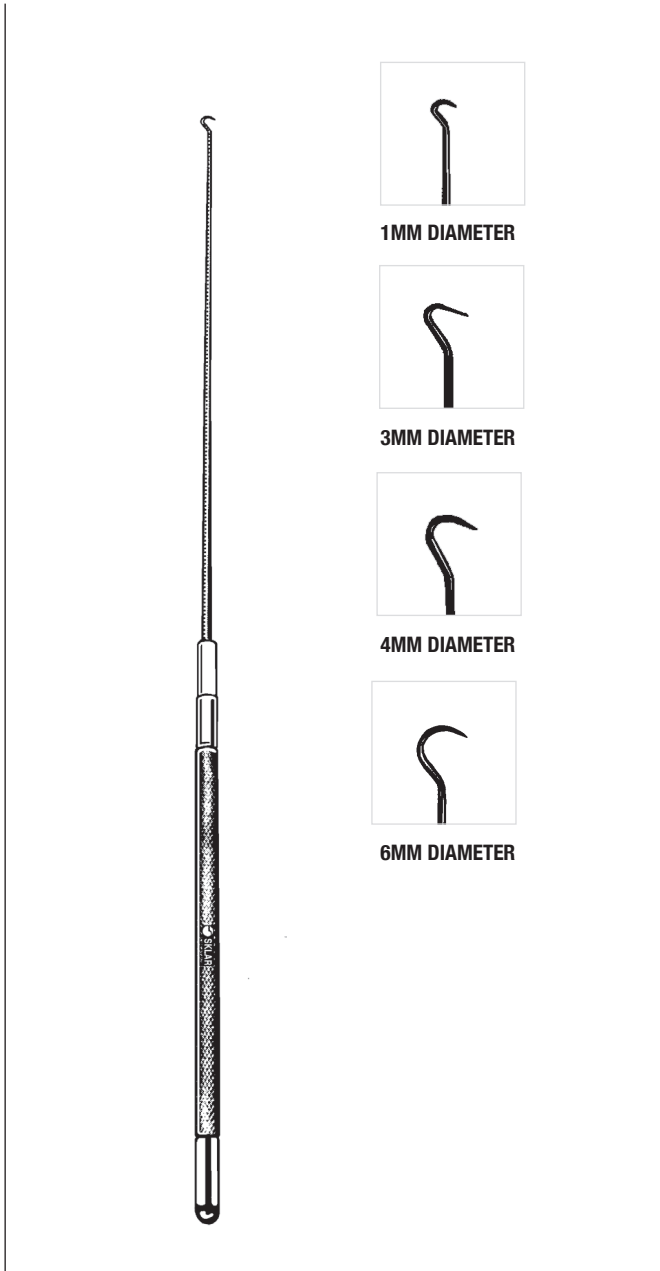

1MM DIAMETER



3MM DIAMETER



4MM DIAMETER



6MM DIAMETER

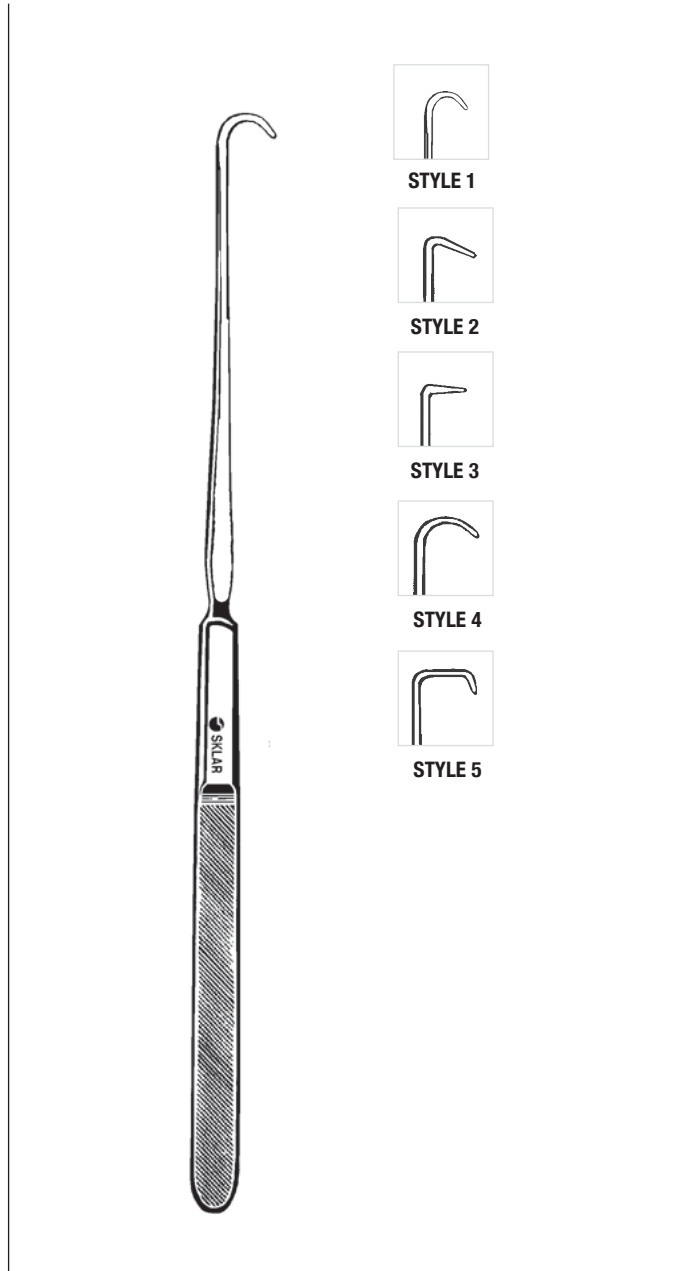

STYLE 1



STYLE 2



STYLE 3



STYLE 4



STYLE 5

**IRIS HOOKS**

**QUICK RELEASE**

90-8336	9"	1mm	90-8348	12"	1mm
90-8335	9"	3mm	90-8346	12"	3mm
90-8334	9"	4mm	90-8344	12"	4mm
90-8333	9"	6mm	90-8342	12"	6mm
90-8332	9"	Set of 4	90-8341	12"	Set of 4

**EMMETT HOOKS**

90-8301	9"	Style 1
90-8302	9"	Style 2
90-8303	9"	Style 3
90-8304	9"	Style 4
90-8305	9"	Style 5
90-8306	9"	Set of 5

For a complete listing of our OB/GYN product line, visit [www.sklarcorp.com](http://www.sklarcorp.com).



**WALTHER DILATOR-CATHETERS**

5¼"

85-2010	Set of 14	85-2026	26 French
85-2012	12 French	85-2028	28 French
85-2014	14 French	85-2030	30 French
85-2016	16 French	85-2032	32 French
85-2018	18 French	85-2034	34 French
85-2020	20 French	85-2036	36 French
85-2022	22 French	85-2038	38 French
85-2024	24 French		

**FEMALE CATHETERS**

**CHROME**

85-2210	10 French
85-2212	12 French
85-2214	14 French
85-2216	16 French
85-2218	18 French
85-2220	20 French

For a complete listing of our OB/GYN product line, visit [www.sklarcorp.com](http://www.sklarcorp.com).



# OB/GYN INSTRUMENTS

## SOUNDS / PUNCHES / DILATORS

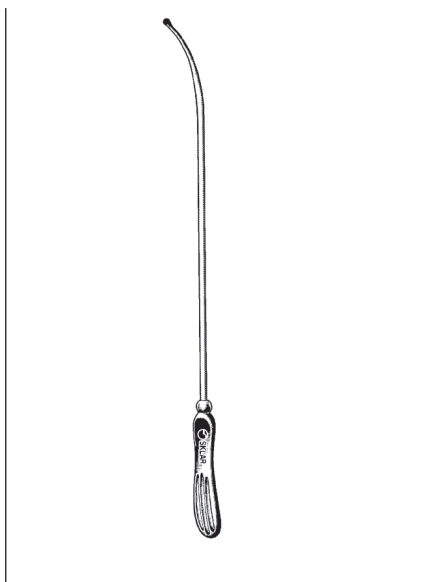

### SIMS UTERINE SOUNDS

MALLEABLE - SILVER PLATED

- 90-5312 12½" Non-Graduated
- 90-5314 12½" Graduated

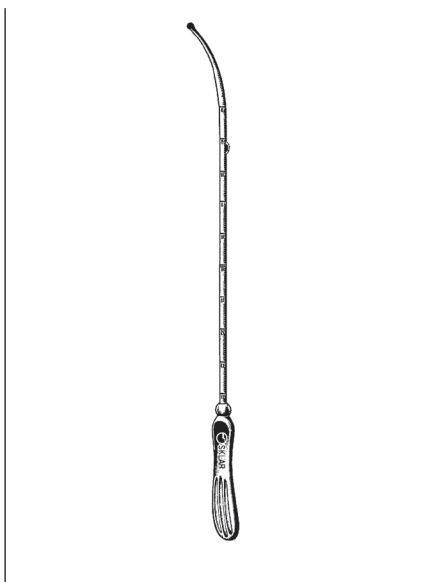

### SIMPSON UTERINE SOUNDS

GRADUATED - SILVER PLATED-MALLEABLE

- 90-5412 12½" Inch Markings
- 90-5413 12½" Centimeter Markings



### SKLAR MINI-DILATOR/ OS FINDER SET

SMALL SIZE DILATOR UTERINE

- 90-6280 From 1mm to 3mm in .5mm increments. All five dilators interchange on a universal handle.
- 90-6281 Handle Only

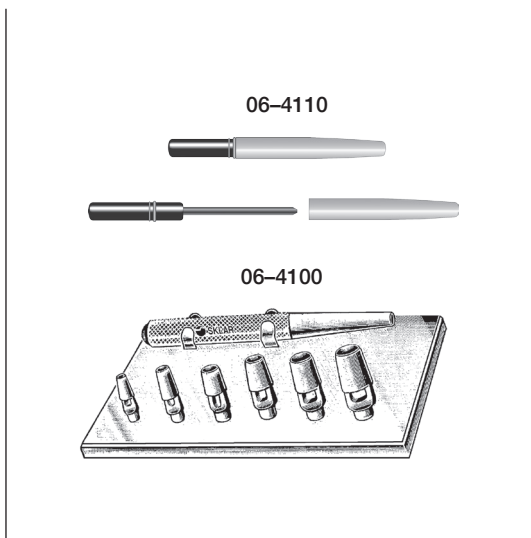

### KEYES VULVAR/DERMAL PUNCHES

- 06-4100 6 Punches interchangeable on Universal Handle 2mm thru 7mm with sterilizable base.
- 06-4110 Keyes Punch Sharpener to maintain a keen edge on all Keyes Punches.



### KEYES BIOPSY PUNCHES

- 06-4142 2mm
- 06-4143 3mm
- 06-4144 4mm
- 06-4145 5mm
- 06-4146 6mm
- 06-4147 7mm
- 06-4148 8mm
- 06-4110 Keyes Punch Sharpener

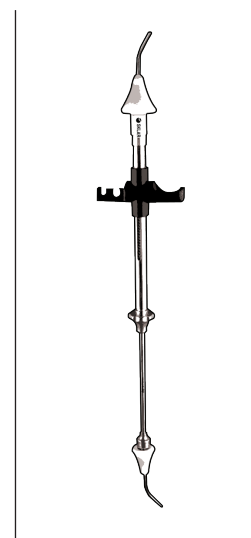

### COHEN UTERINE MANIPULATOR

- 91-1293 14½"

For a complete listing of our OB/GYN product line, visit [www.sklarcorp.com](http://www.sklarcorp.com).

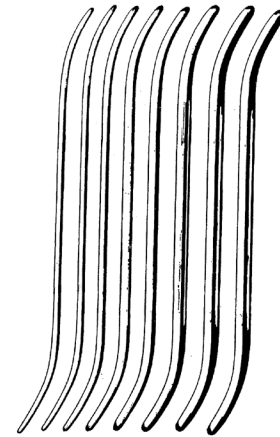
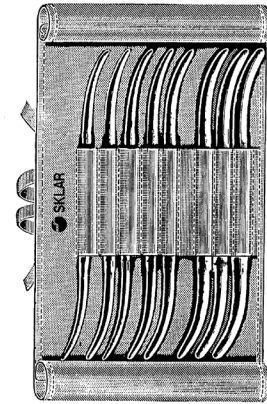
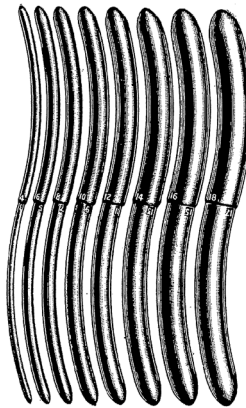
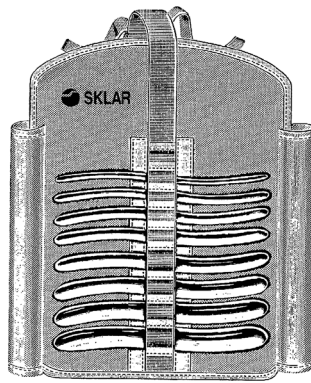
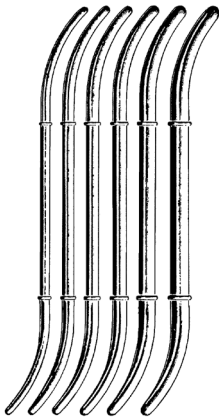
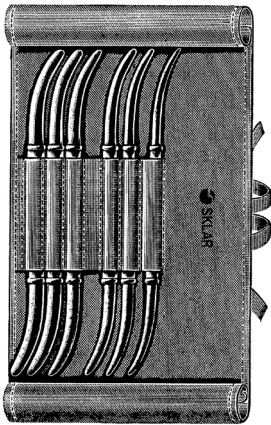

**HANK UTERINE DILATORS**

**AMERICAN SCALE**

90-4908	7/8
90-4910	9/10
90-4912	11/12
90-4914	13/14
90-4916	15/16
90-4918	17/18
90-4920	19/20
90-4928	27/28
90-4925	Set of 6, 9/10-19/20 without Khaki Roll
90-4926	Set of 6, 9/10-19/20 with Khaki Roll
90-4927	Khaki Roll Only

**HEGAR UTERINE DILATORS**

**DOUBLE END, 7"**

90-4802	1/2mm
90-4804	3/4mm
90-4806	5/6mm
90-4808	7/8mm
90-4810	9/10mm
90-4812	11/12mm
90-4814	13/14mm
90-4816	15/16mm
90-4818	17/18mm
90-4828	27/28mm
90-4832	31/32mm

**SINGLE END, 7"**

90-4784	1.0mm
90-4785	1.5mm
90-4786	2.0mm
90-4787	2.5mm
90-4788	3.0mm
90-4789	3.5mm
90-4790	4.0mm
90-4791	4.5mm
90-4792	5.0mm
90-4793	5.5mm
90-4794	6.0mm
90-4795	6.5mm
90-4796	7.0mm
90-4797	7.5mm
90-4798	8.0mm
90-4799	9.0mm

90-4825 Set of 8 without Khaki Roll,  
Sizes 3/4 thru 17/18

90-4826 Set of 8 with Khaki Roll,  
Sizes 3/4 thru 17/18

**PRATT UTERINE DILATORS**

90-5215	13/15 French
90-5219	17/19 French
90-5223	21/23 French
90-5227	25/27 French
90-5231	29/31 French
90-5235	33/35 French
90-5239	37/39 French
90-5243	41/43 French
90-5245	45/47 French
90-5249	49/51 French
90-5253	53/55 French
90-5250	Set of 8 Sizes 13/15 thru 41/43 with Khaki Roll

For a complete listing of our OB/GYN product line, visit [www.sklarcorp.com](http://www.sklarcorp.com).

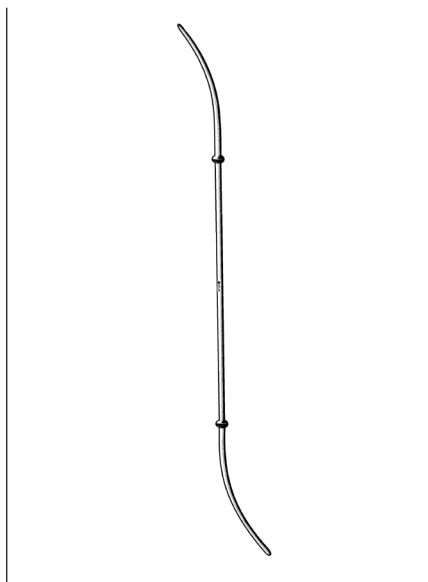

### KLEEGMAN DILATOR

NARROW

90-4902 10½"

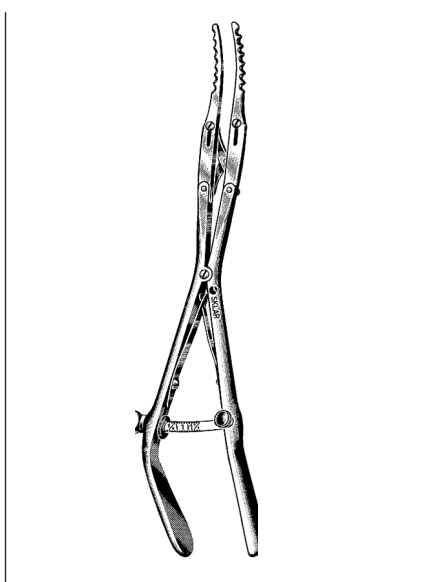

### GOODELL UTERINE DILATOR

90-4713 13"

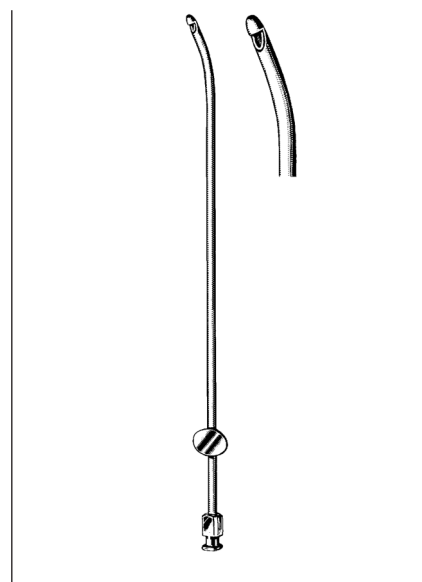

### NOVAK ENDOMETRIAL CURETTES

90-6289	9½"	1mm
90-6290	9½"	2mm
90-6291	9½"	3mm
90-6292	9½"	4mm

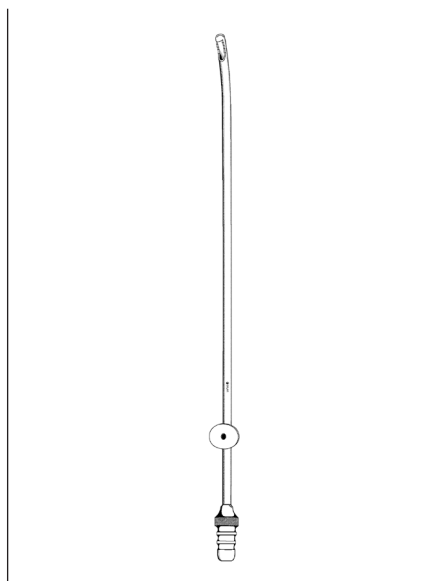

### LAUFE-NOVAK DIAGNOSTIC CURETTE

WITH SUCTION FINGER CONTROL

90-5834 Small

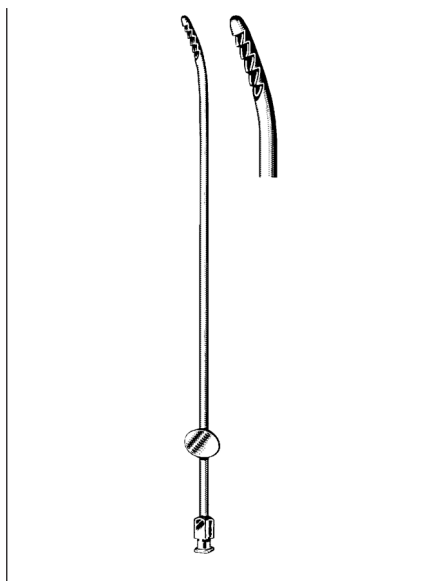

### RANDALL ENDOMETRIAL CURETTE

90-6295 9½" 4mm

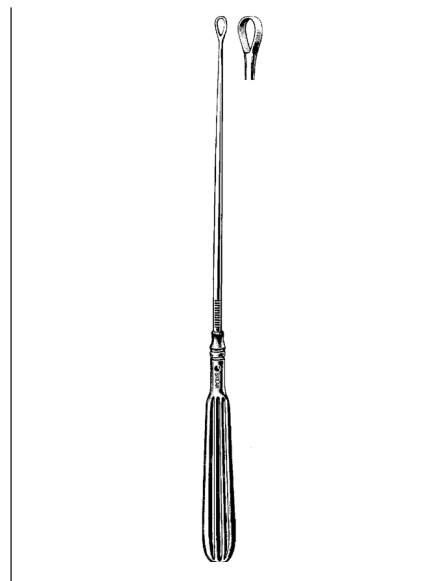

### HOLDEN UTERINE CURETTE SEMI-SHARP

90-5710 10¾" Extra Small

For a complete listing of our OB/GYN product line, visit [www.sklarcorp.com](http://www.sklarcorp.com).



**SKLAR MINI ENDOCERVICAL CURETTE**

90-6285 Small rounded tip for easier entry into stenosed cervix

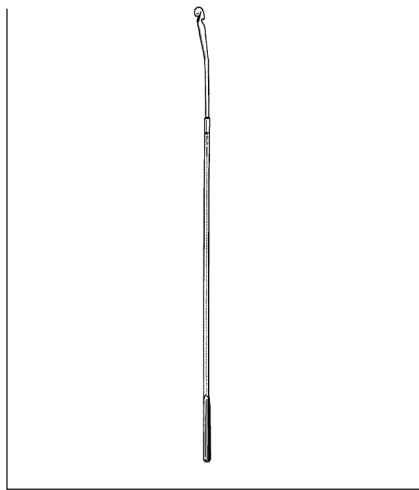

**IUD EXTRACTOR**

90-8210 10½"



**RECAMIER UTERINE CURETTES**

**SHARP 12½" WITH MALLEABLE SHAFT**

- 90-5610 #00
- 90-5611 #0
- 90-5612 #1
- 90-5613 #2
- 90-5614 #3
- 90-5615 #4
- 90-5616 #5
- 90-5617 #6
- 90-5618 #7
- 90-5619 #8
- 90-5620 #9
- 90-5621 #10

**BLUNT 12½" WITH MALLEABLE SHAFT**

- 90-5622 #00
- 90-5623 #0
- 90-5624 #1
- 90-5625 #2
- 90-5626 #3
- 90-5627 #4
- 90-5628 #5
- 90-5629 #6
- 90-5630 #7
- 90-5631 #8
- 90-5632 #9
- 90-5633 #10

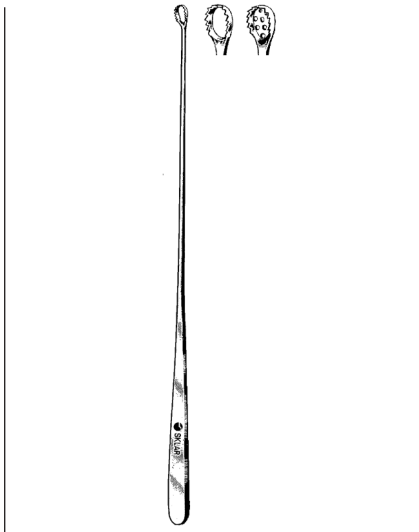

**HEANEY UTERINE CURETTES**

**SERRATED**

- 90-6095 9½" Open Curette
- 90-6195 9½" With Basket

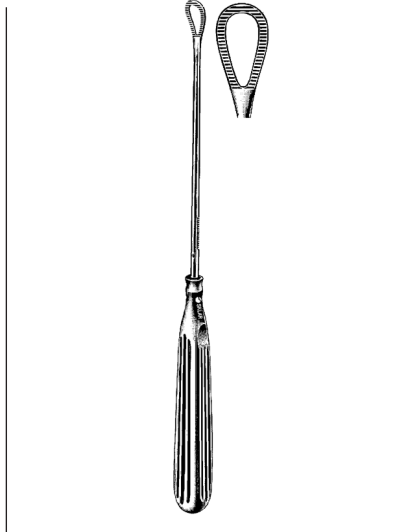

**GREENE UTERINE CURETTE**

90-5566 11¾" Serrated

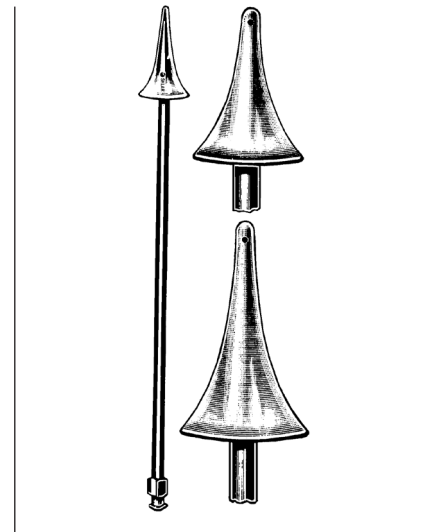

**HOLMAN-MATHIEU CANNULAS**

**FOR HISTEROSALPHINGOGRAPHY**

- 90-6582 8¼" (21cm) with Luer-Lok Hub Chrome Plated Small Size
- 90-6590 9" (22.9cm) Large Size

For a complete listing of our OB/GYN product line, visit [www.sklarcorp.com](http://www.sklarcorp.com).

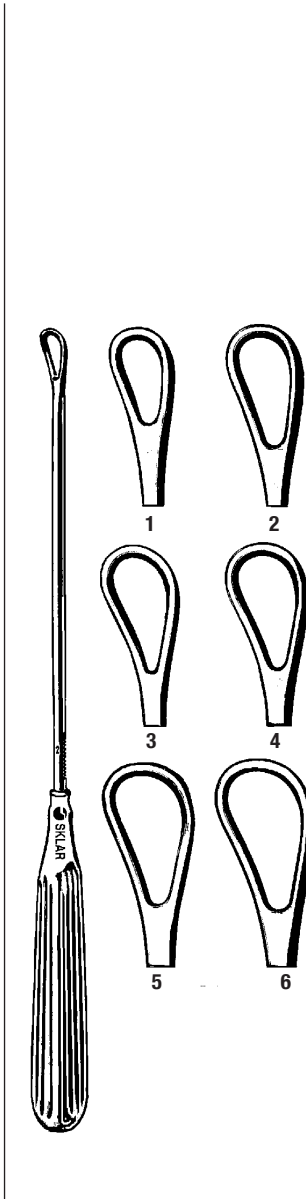

**THOMAS UTERINE CURETTES**

**BLUNT, 11"**

- 90-5431 No. 1
- 90-5432 No. 2
- 90-5433 No. 3
- 90-5434 No. 4
- 90-5435 No. 5
- 90-5436 No. 6
- 90-5438 Set of 6

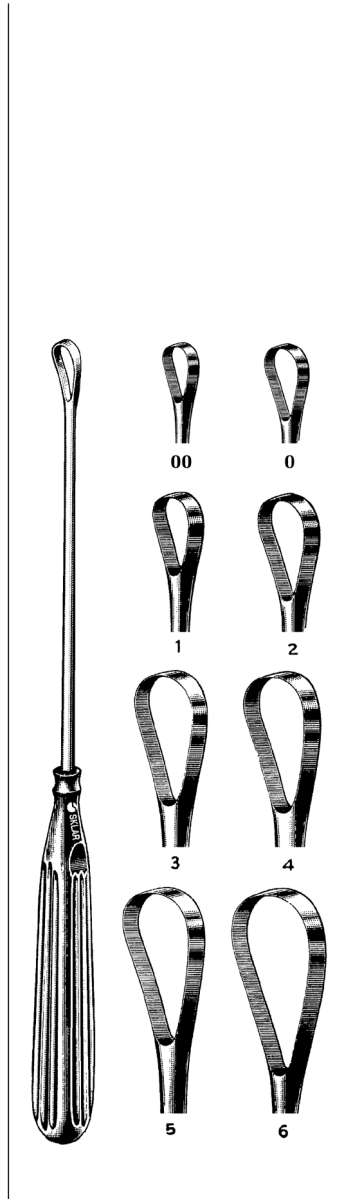

**SIMS UTERINE CURETTES**

**SHARP, 11"**

- 90-5499 No. 00
- 90-5500 No. 0
- 90-5421 No. 1
- 90-5422 No. 2
- 90-5423 No. 3
- 90-5424 No. 4
- 90-5425 No. 5
- 90-5426 No. 6
- 90-5428 Set of 6

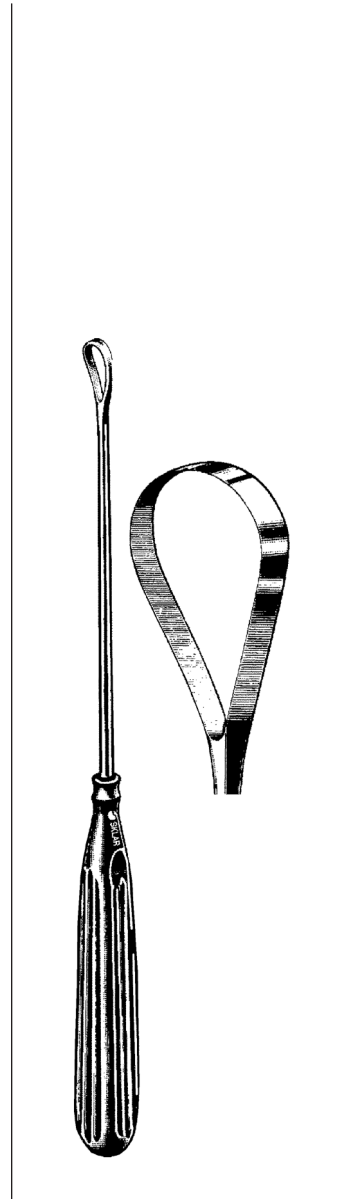

**LOUNSBURY PLACENTA CURETTE**

90-5713 13" 3/4" Wide

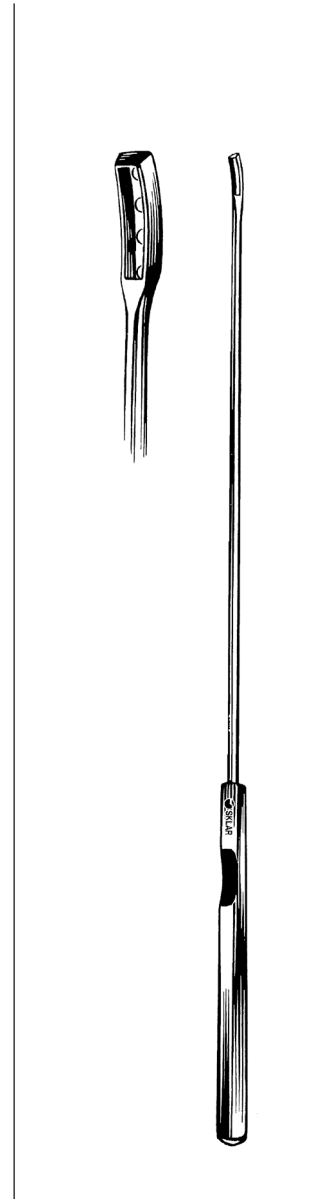

**KEVORKIAN-YOUNGE ENDOCERVICAL CURETTES**

**NARROW TIP**

- 90-6611 12" Without Basket
- 90-6612 12" With Basket

For a complete listing of our OB/GYN product line, visit [www.skларcorp.com](http://www.skларcorp.com).



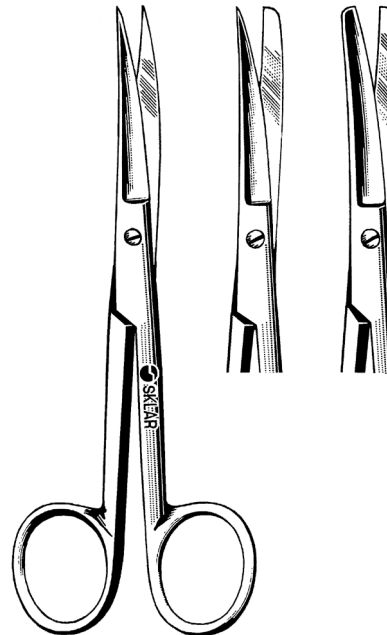
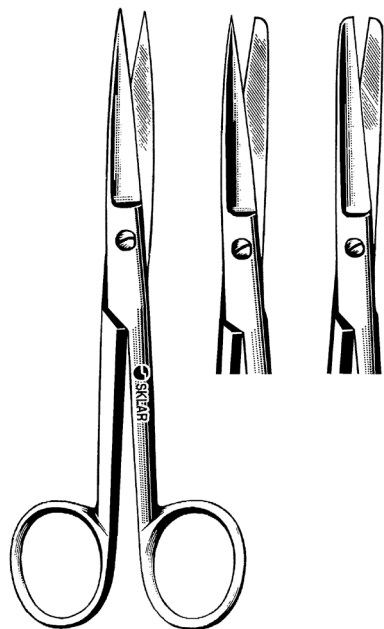

**OPERATING SCISSORS**

**STRAIGHT**

13-1045	4½"	Sharp/Sharp
14-1045	4½"	Sharp/Blunt
15-1045	4½"	Blunt/Blunt
13-1050	5"	Sharp/Sharp
14-1050	5"	Sharp/Blunt
15-1050	5"	Blunt/Blunt
13-1055	5½"	Sharp/Sharp
14-1055	5½"	Sharp/Blunt
15-1055	5½"	Blunt/Blunt
13-1060	6"	Sharp/Sharp
14-1060	6"	Sharp/Blunt
15-1060	6"	Blunt/Blunt
13-1065	6½"	Sharp/Sharp
14-1065	6½"	Sharp/Blunt
15-1065	6½"	Blunt/Blunt
13-1072	7¼"	Sharp/Sharp
14-1072	7¼"	Sharp/Blunt

**DELICATE**

22-1145	4½"	Sharp/Sharp
22-1245	4½"	Sharp/Blunt
22-1345	4½"	Blunt/Blunt
22-1150	5"	Sharp/Sharp
22-1250	5"	Sharp/Blunt
22-1350	5"	Blunt/Blunt
22-1155	5½"	Sharp/Sharp
22-1255	5½"	Sharp/Blunt
22-1355	5½"	Blunt/Blunt

**OPERATING SCISSORS**

**CURVED**

13-2045	4½"	Sharp/Sharp
14-2045	4½"	Sharp/Blunt
15-2045	4½"	Blunt/Blunt
13-2050	5"	Sharp/Sharp
14-2050	5"	Sharp/Blunt
15-2050	5"	Blunt/Blunt
13-2055	5½"	Sharp/Sharp
14-2055	5½"	Sharp/Blunt
15-2055	5½"	Blunt/Blunt
13-2060	6"	Sharp/Sharp
14-2060	6"	Sharp/Blunt
15-2060	6"	Blunt/Blunt
13-2065	6½"	Sharp/Sharp
14-2065	6½"	Sharp/Blunt
15-2065	6½"	Blunt/Blunt
13-2072	7¼"	Sharp/Sharp
14-2072	7¼"	Sharp/Blunt

**DELICATE**

22-1445	4½"	Sharp/Sharp
22-1545	4½"	Sharp/Blunt
22-1645	4½"	Blunt/Blunt
22-1450	5"	Sharp/Sharp
22-1550	5"	Sharp/Blunt
22-1650	5"	Blunt/Blunt
22-1455	5½"	Sharp/Sharp
22-1555	5½"	Sharp/Blunt
22-1655	5½"	Blunt/Blunt

For a complete listing of our OB/GYN product line, visit [www.sklarcorp.com](http://www.sklarcorp.com).

# OB/GYN INSTRUMENTS



## SCISSORS

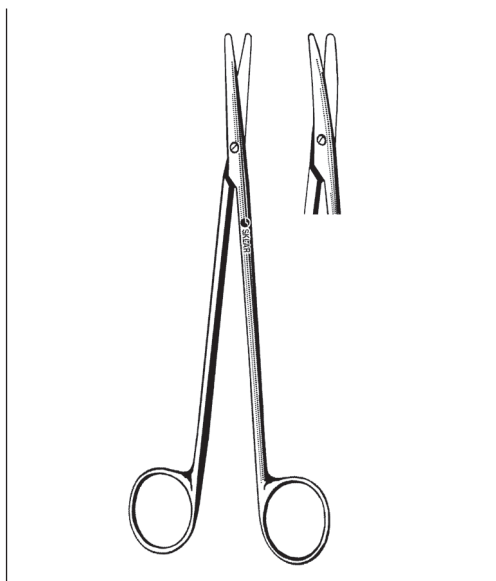

### METZENBAUM DISSECTING SCISSORS

**STRAIGHT**

- 75-5570 7"
- 55-9180 8" (Nelson)
- 55-9190 9" (Nelson)
- 55-9310 10" (Nelson)
- 55-9311 11" (Nelson)

**CURVED**

- 75-5670 7"
- 55-9080 8" (Nelson)
- 55-9090 9" (Nelson)
- 55-9210 10" (Nelson)
- 55-9411 11" (Nelson)
- 55-9612 12" (Nelson)
- 55-9614 14" (Nelson)

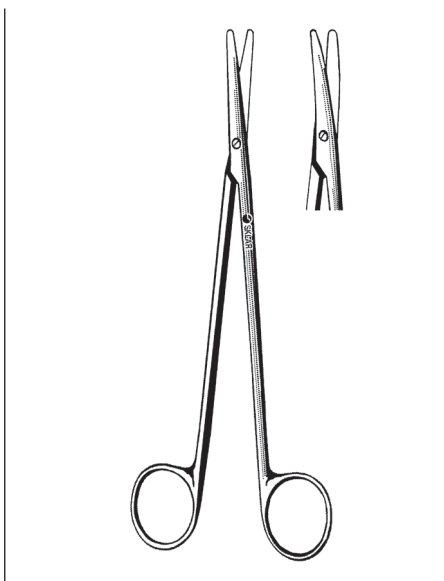

### METZENBAUM DISSECTING SCISSORS

**DELICATE**

**STRAIGHT**

- 22-1071 7"
- 55-9184 8" (Nelson)
- 55-9194 9" (Nelson)

**CURVED**

- 22-1070 7"
- 55-9084 8" (Nelson)
- 55-9094 9" (Nelson)

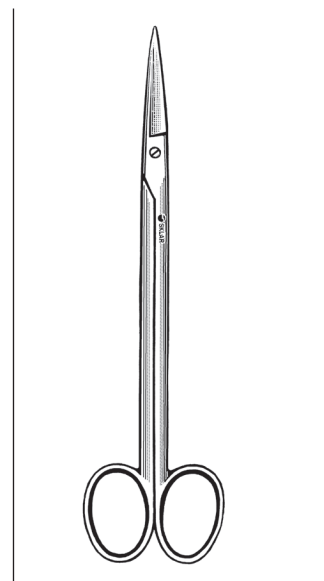

### KELLY-ADSON SCISSORS

- 50-4562 6¼" Smooth/Straight
- 50-4563 6¼" Serrated/Straight
- 50-4662 6¼" Smooth/Curved

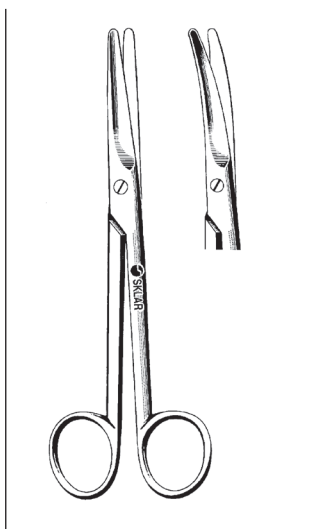

### MAYO DISSECTING SCISSORS

**STRAIGHT**

- 15-1555 5½"
- 15-1567 6¾"
- 90-1590 9"
- 55-8711 11"  
Harrington

**CURVED**

- 15-2555 5½"
- 15-2567 6¾"
- 90-1690 9"
- 55-8611 11"  
Harrington

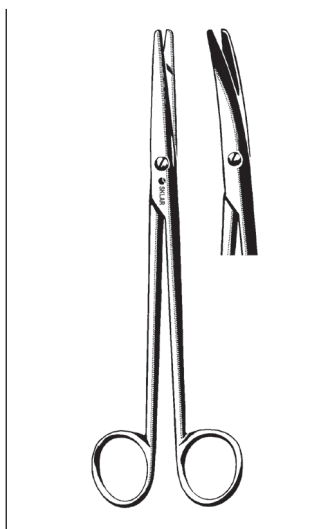

### MAYO-STILLE DISSECTING SCISSORS

**ROUNDED BLADES**

**STRAIGHT**

- 15-1655 5½"
- 15-1667 6¾"

**CURVED**

- 15-2655 5½"
- 15-2667 6¾"

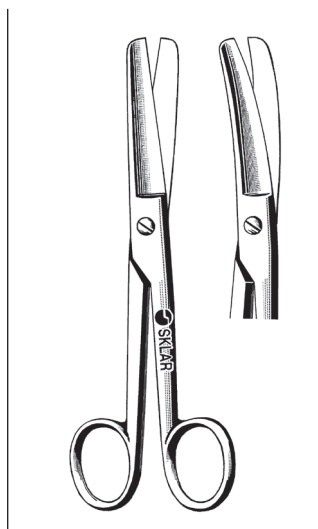

### DOYEN SCISSORS

**STRAIGHT**

- 15-1307 7" Smooth
- 15-1308 7" Serrated

**CURVED**

- 15-2307 7" Smooth
- 15-2308 7" Serrated

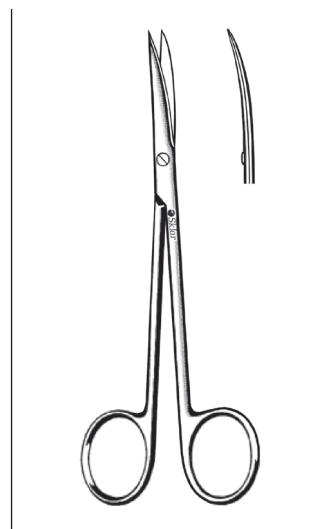

### BROPHY SULLIVAN SCISSORS

- 22-2755 5¾" Serrated Curved
- 22-2855 5¾" Serrated Straight

For a complete listing of our OB/GYN product line, visit [www.sklarcorp.com](http://www.sklarcorp.com).

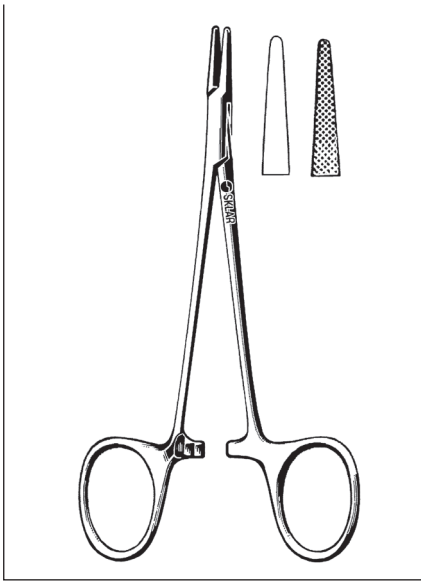

**WEBSTER NEEDLE HOLDERS**

- 20-1352 5¼" Serrated Jaw
- 20-1350 5¼" Smooth Jaw
- 20-3090 5¼" Smooth Jaw Heavy

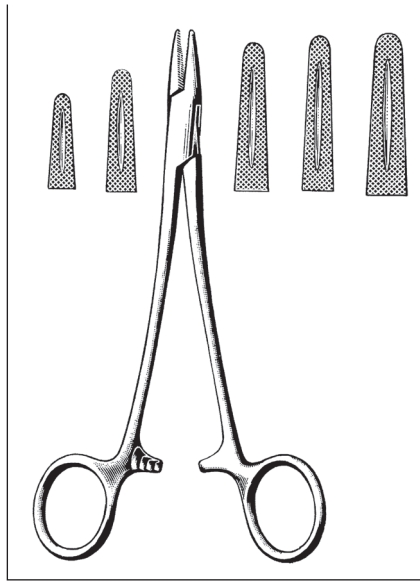

**MAYO-HEGAR NEEDLE HOLDERS**

- SERRATED**
- 20-2052 5¼"
  - 20-2060 6"
  - 20-2070 7"
  - 20-2270 7" Broad Jaw
  - 20-2480 8"
  - 20-2490 9½"
  - 20-2910 10½" Masson
  - 20-2911 11½" Masson

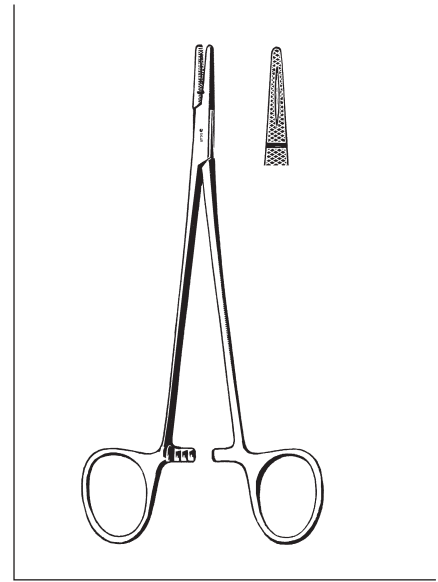

**CRILE-WOOD NEEDLE HOLDERS**

- SERRATED**
- 20-1265 6" Narrow Jaw
  - 20-1270 7" DeBakey Type
  - 20-1280 8" DeBakey Type
  - 20-1290 9" DeBakey Type
  - 20-1295 10½" DeBakey Type

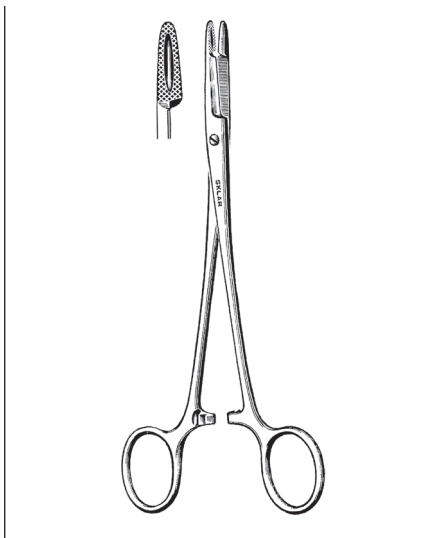

**OLSEN-HEGAR NEEDLE HOLDERS**

- SCISSORS COMBINATION**
- 20-2747 4¾" Serrated Delicate
  - 20-2748 4¾" Smooth Delicate
  - 20-2755 5½" Serrated
  - 20-2765 6½" Serrated
  - 20-2775 7" Serrated



**FINOCHIETTO NEEDLE HOLDER**

- 20-4510 10¼"

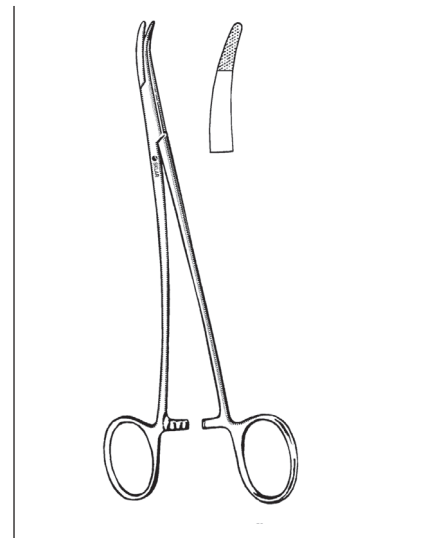

**STRATTE NEEDLE HOLDERS**

- 20-4795 9" Standard
- 21-8065 9" Tungsten Carbide

For a complete listing of our OB/GYN product line, visit [www.sklarcorp.com](http://www.sklarcorp.com).

OB/GYN INSTRUMENTS

NEEDLE HOLDERS

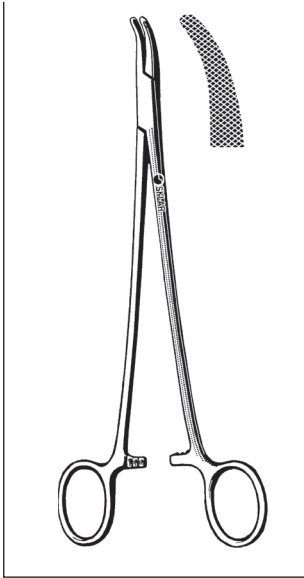

**HEANEY  
NEEDLE HOLDER**

20-4682 8¼"

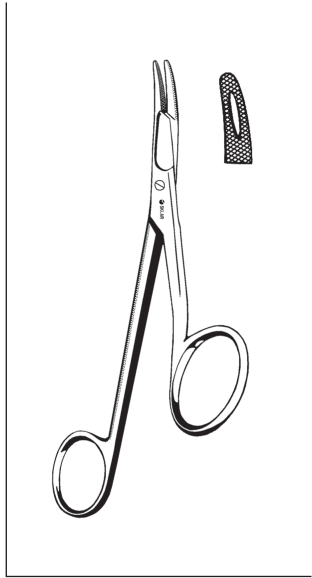

**GILLIES  
NEEDLE HOLDER**

20-2662 6" Serrated

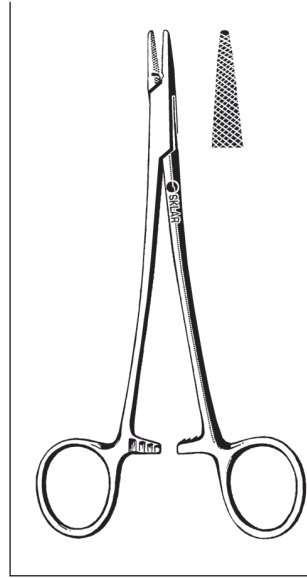

**CRILE  
NEEDLE HOLDER**

20-1160 6"

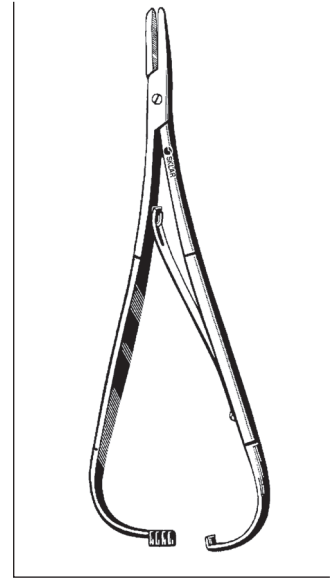

**MATHIEU  
NEEDLE HOLDERS**

20-3055 5½"  
20-3075 7½"

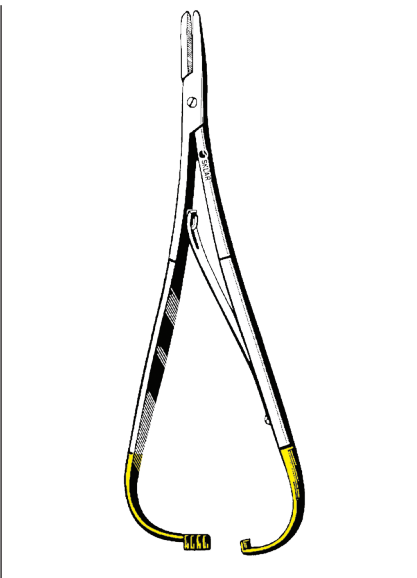

**TC MATHIEU  
NEEDLE HOLDERS**

21-8070 5½"  
21-8071 6¾"

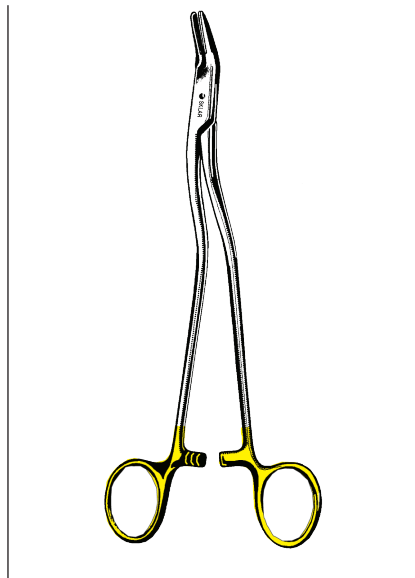

**TC BOZEMAN-HEANEY  
NEEDLE HOLDER**

21-8062 10½" (26.5cm)  
Tungsten Carbide

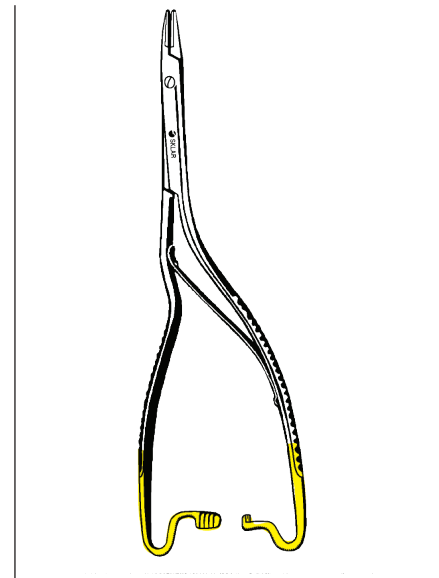

**TC LUETHY-BECK  
NEEDLE HOLDER**

21-8064 8" (20cm)  
Tungsten Carbide

For a complete listing of our OB/GYN product line, visit [www.sklarcorp.com](http://www.sklarcorp.com).

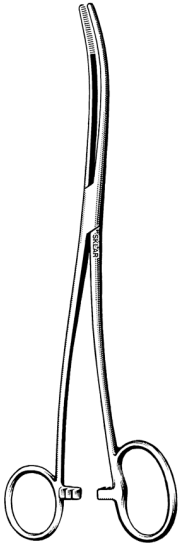

**BOZEMAN FORCEPS**

**ONE LARGE RING**

90-7710 10¼" S-Curve



**BOZEMAN FORCEPS**

90-7610 10½" Straight  
80-1410 10¼" S-Curve

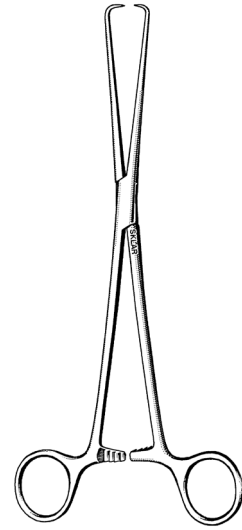

**SCHROEDER TENACULUM FORCEPS**

91-1290 10" Braun (Flat Tips)  
91-1298 10" Pozzi (Round Tips)

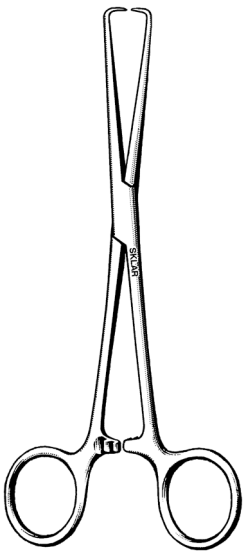

**BARRRETT TENACULUM FORCEPS**

18-2257 6½" Delicate  
91-1070 7"

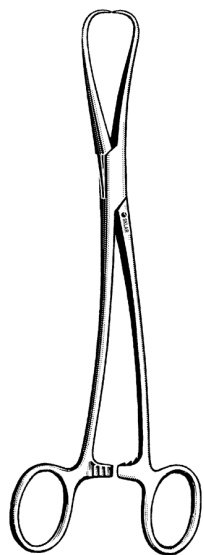

**JARCHO TENACULUM FORCEPS**

91-1275 7½" Double Curve



**DUPLAY TENACULUM FORCEPS**

91-1111 11" S-Curve

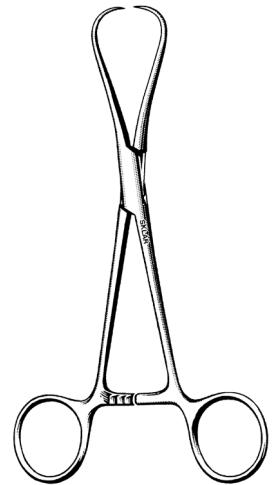

**STAUDE-MOORE TENACULUM FORCEPS**

91-1455 5½"  
91-1465 6½"

For a complete listing of our OB/GYN product line, visit [www.sklarcorp.com](http://www.sklarcorp.com).

OB/GYN INSTRUMENTS

FORCEPS



**ALLIS TISSUE FORCEPS**

**DELICATE**

18-2140	4"	4x5
18-2155	5"	4x5
18-2162	6"	4x5
18-2164	6"	5x6
36-2295	9½"	5x6

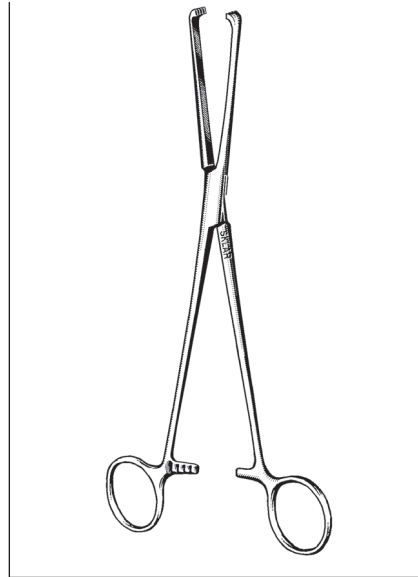

**ALLIS FORCEPS  
WITH ATRAUMATIC JAWS**

36-2298	6"	Straight
36-2280	8"	Straight
36-2385	10"	Straight

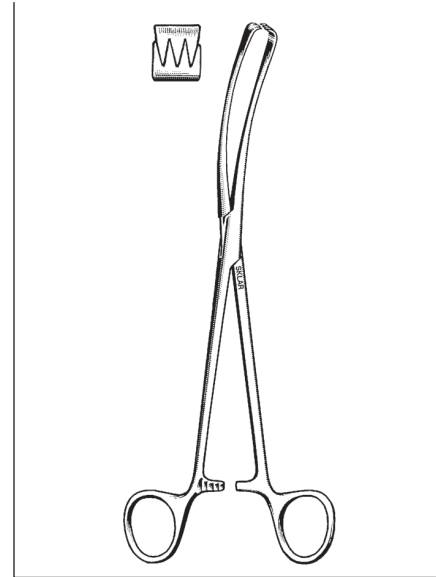

**TEALE VULSELLUM FORCEPS  
CURVED SIDEWAYS**

91-2695	9"	3x4 Teeth
---------	----	-----------

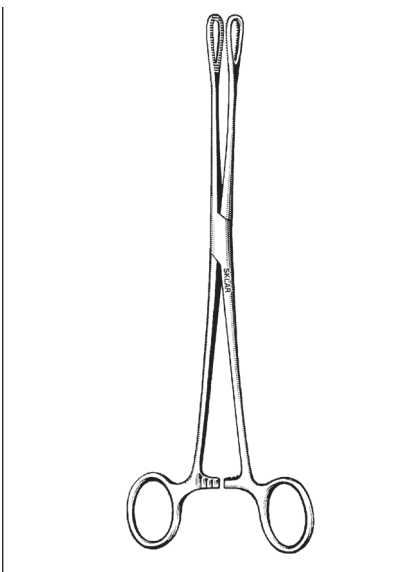

**SCHWEIZER UTERINE  
FORCEPS**

90-7995	9½"	Straight
---------	-----	----------

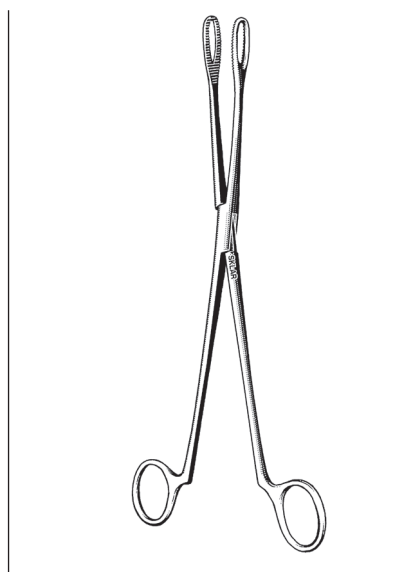

**CLEMENTSON UTERINE  
FORCEPS**

90-7895	9½"	Straight, No Ratchet
---------	-----	----------------------

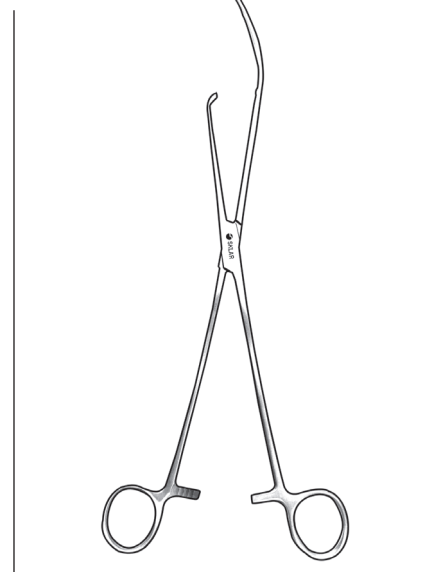

**HULKA TENACULUM  
FORCEPS**

91-1280	11½"	
---------	------	--

For a complete listing of our OB/GYN product line, visit [www.sklarcorp.com](http://www.sklarcorp.com).



**LAUFE UTERINE POLYP FORCEPS**  
90-7977 7¾" Curved



**DELEE UTERINE FORCEPS**  
90-8111 11" Heavy

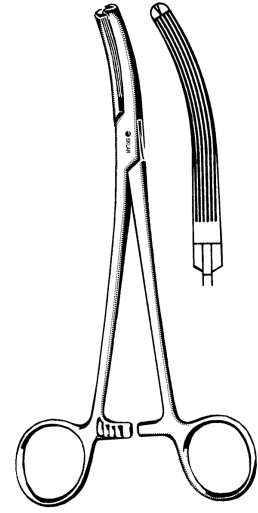

**LONG FORCEPS**  
90-2690 7½"



**HEANEY FORCEPS**  
90-1977 7¾" Light  
90-2177 8¾" Heavy

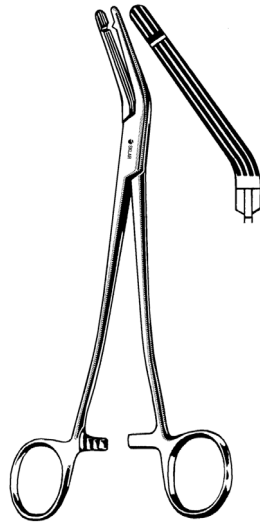

**LAWTON FORCEPS**  
90-2180 8¼"

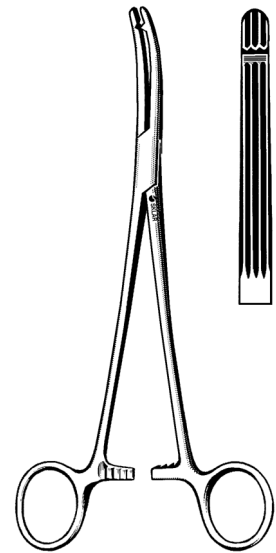

**HEANEY-BALLENTINE FORCEPS**  
**LONGITUDINAL SERRATIONS**  
90-2480 8" Straight  
90-2580 8" Curved

For a complete listing of our OB/GYN product line, visit [www.sklarcorp.com](http://www.sklarcorp.com).

OB/GYN INSTRUMENTS



FORCEPS

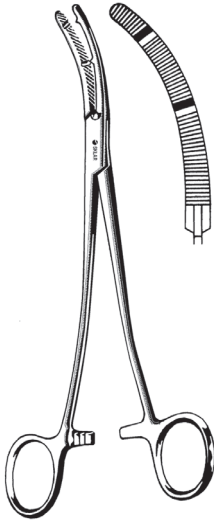

**HEANEY-KANTER FORCEPS**  
90-2379 8"



**CAMPION FORCEPS**  
90-7898 9¼" Curved



**BABCOCK FORCEPS**  
22-6155 5½"  
36-1662 6¼"  
36-1677 8"  
36-1692 9½"

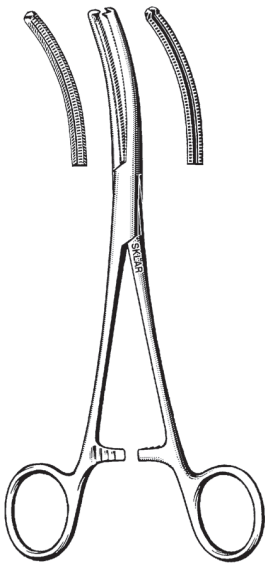

**GELPI-LOWRIE FORCEPS**  
90-1885 8½"

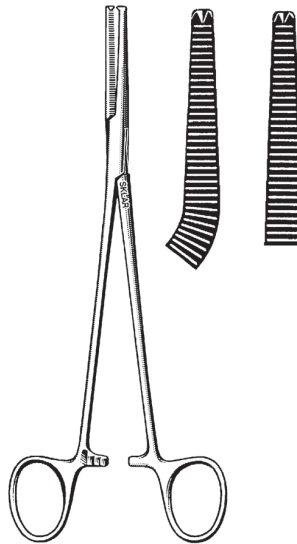

**PHANEUF FORCEPS**  
90-2680 8¼" Curved  
90-2682 8¼" Straight



**SOMER UTERINE ELEVATING  
FORCEPS**  
90-5297 9"

For a complete listing of our OB/GYN product line, visit [www.skylarcorp.com](http://www.skylarcorp.com).



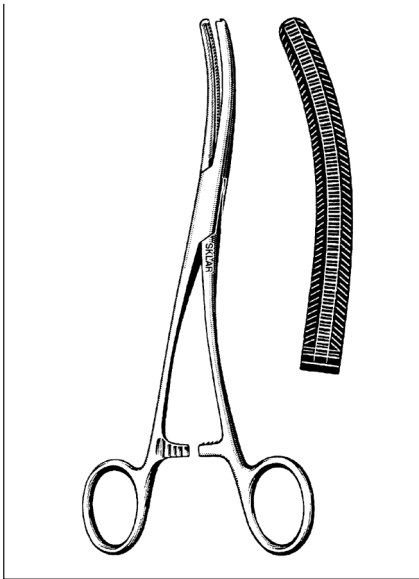

**DE ALVAREZ CLAMP**  
90-2782 7¾" Double Curve

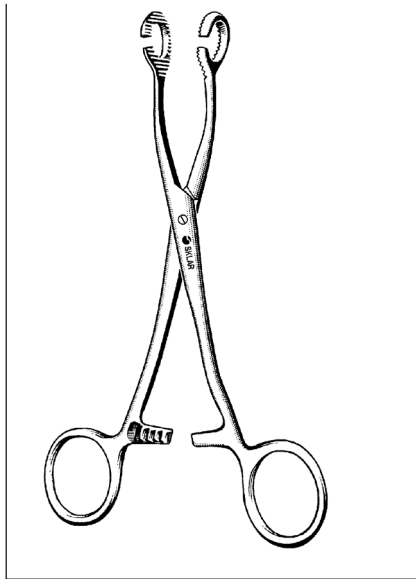

**HILDEBRANDT UTERINE  
FORCEPS**  
90-8065 6½"

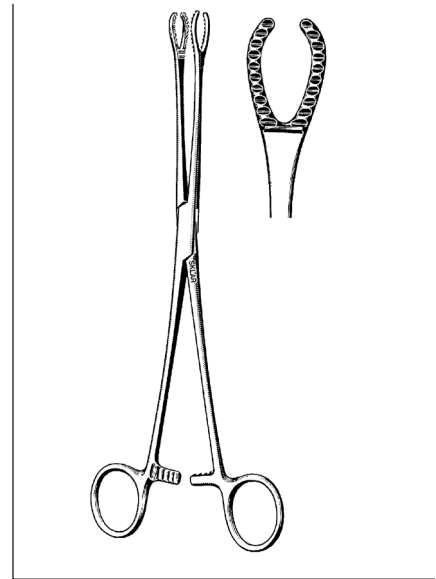

**GUTGLASS CERVIX FORCEPS**  
90-8090 9½"

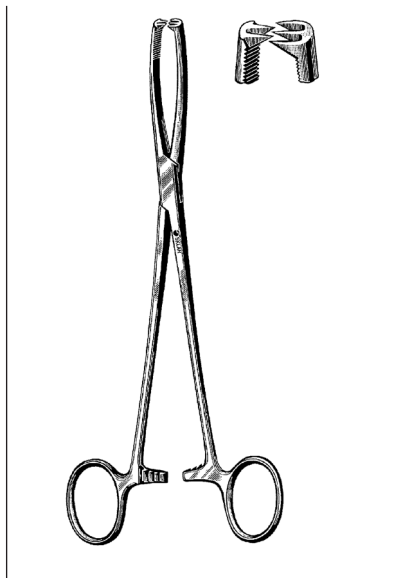

**HENROTIN VULSELLUM  
FORCEPS**  
91-2585 8½" 2x3 Teeth

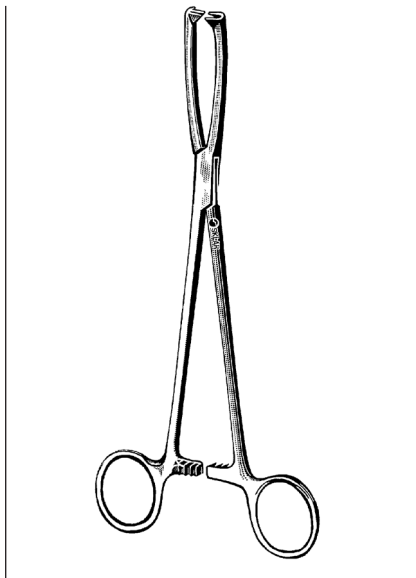

**DOYEN VULSELLUM FORCEPS**  
91-2482 8¼" 2x2 Teeth

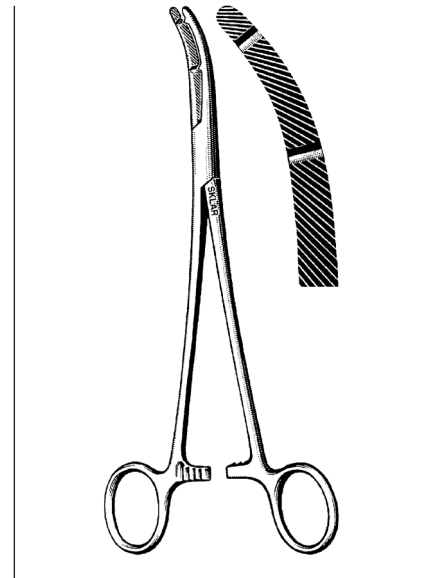

**HEANEY FORCEPS  
HEAVY DOUBLE TOOTH**  
90-2280 8"  
90-2387 8¾"

For a complete listing of our OB/GYN product line, visit [www.sklarcorp.com](http://www.sklarcorp.com).

# OB/GYN INSTRUMENTS

## Z-TYPE SCISSORS & FORCEPS



Sklar's Z-Type Hysterectomy/Parametrium Scissors and Forceps are specifically designed to ideally meet the surgeon's needs during vaginal and abdominal hysterectomy procedures. Manufactured from German grade stainless steel and under the highest quality standards, these specialized instruments provide uncompromised balance, feel and performance.

### Z-TYPE SCISSORS

With solid Tungsten Carbide inserts, Z-Type Scissors have extremely sharp, strong and precise cutting edges with lasting durability, and are specifically formed to cut tissue laterally. They are designed to complement the curvature of Z-Type Forceps for optimal access, visibility and control.

PRODUCT NUMBER		DESCRIPTION
16-4000	9"	Z-Type Parametrium Scissors, Slight Curve
16-4001	9"	Z-Type Parametrium Scissors, Curved
16-4002	9"	Z-Type Parametrium Scissors, Full Curve
16-4004	10½"	Z-Type Parametrium Scissors, Slight Curve
16-4005	10½"	Z-Type Parametrium Scissors, Curved
16-4006	10½"	Z-Type Parametrium Scissors, Full Curve
16-4008	12"	Z-Type Parametrium Scissors, Slight Curve
16-4009	12"	Z-Type Parametrium Scissors, Curved
16-4010	12"	Z-Type Parametrium Scissors, Full Curve
16-4012	14"	Z-Type Parametrium Scissors, Slight Curve
16-4013	14"	Z-Type Parametrium Scissors, Curved
16-4014	14"	Z-Type Parametrium Scissors, Full Curve



### Z-TYPE FORCEPS

Longitudinal grooves with tip serrations on Z-Type Forceps ensure an atraumatic yet firm grip on tissue, minimizing slippage and tissue trauma. Longer instrument design and off-set handles ensure superior manipulation and exposure especially for deep pelvic surgery or obese patients.

PRODUCT NUMBER		DESCRIPTION
90-2785	8¼"	Z-Type Hysterectomy Forceps, Straight
90-2786	8¼"	Z-Type Hysterectomy Forceps, Slight Curve
90-2787	8¼"	Z-Type Hysterectomy Forceps, Full Curve
90-2788	8¼"	Z-Type Hysterectomy Forceps, Angled
90-2790	9½"	Z-Type Hysterectomy Forceps, Straight
90-2792	9½"	Z-Type Hysterectomy Forceps, Slight Curve
90-2793	9½"	Z-Type Hysterectomy Forceps, Full Curve
90-2794	9½"	Z-Type Hysterectomy Forceps, Angled
90-2796	12"	Z-Type Hysterectomy Forceps, Straight
90-2797	12"	Z-Type Hysterectomy Forceps, Slight Curve
90-2798	12"	Z-Type Hysterectomy Forceps, Full Curve
90-2799	12"	Z-Type Hysterectomy Forceps, Angled
90-2801	14"	Z-Type Hysterectomy Forceps, Straight
90-2802	14"	Z-Type Hysterectomy Forceps, Slight Curve
90-2803	14"	Z-Type Hysterectomy Forceps, Full Curve
90-2804	14"	Z-Type Hysterectomy Forceps, Angled



**For a complete listing of our OB/GYN product line, visit [www.sklarcorp.com](http://www.sklarcorp.com).**



**SCHROEDER VULSELLUM FORCEPS**

91-1590 9½"



**SCHROEDER VULSELLUM FORCEPS**

91-1690 9" Curved on Flat  
91-1890 9½" Slight Curve Sideways

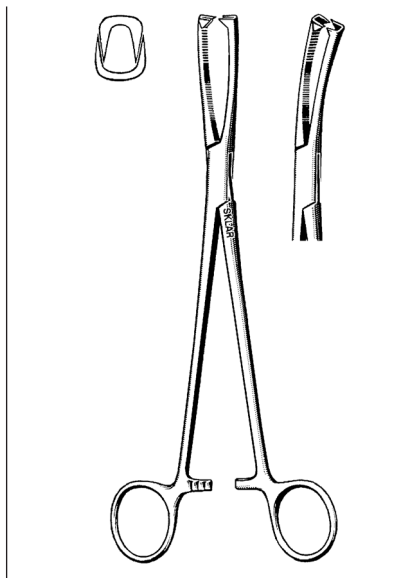

**JACOBS VULSELLUM FORCEPS**

**SERRATED JAWS**  
91-2282 8¼" Straight  
91-2382 8¼" Angular

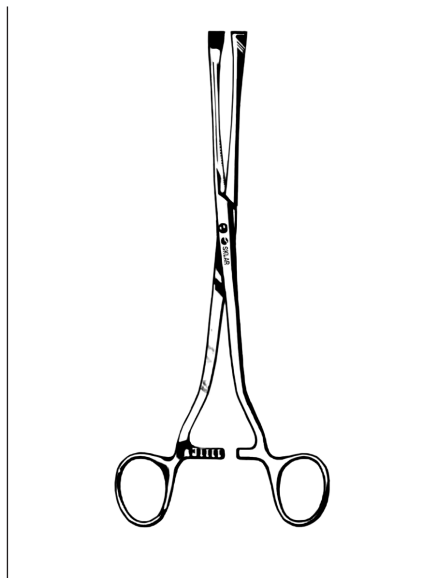

**GREEN ARMYTAGE FORCEPS**

90-5420 8¼" Straight  
90-5419 8¼" Curved

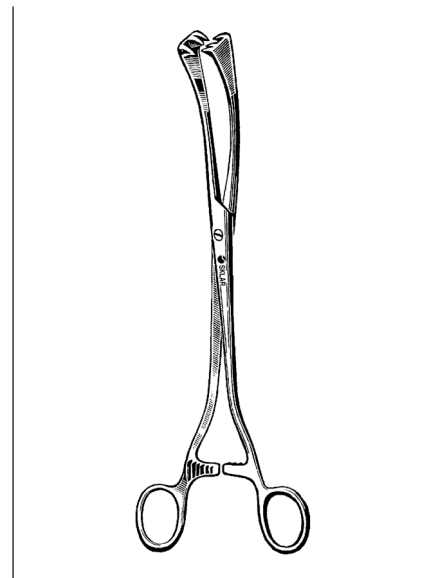

**SECOND (COLLIN) FORCEPS**

**3X3 TEETH**  
91-3095 9½" Straight  
91-3195 9½" Curved sideways

For a complete listing of our OB/GYN product line, visit [www.sklarcorp.com](http://www.sklarcorp.com).

OB/GYN INSTRUMENTS



FORCEPS

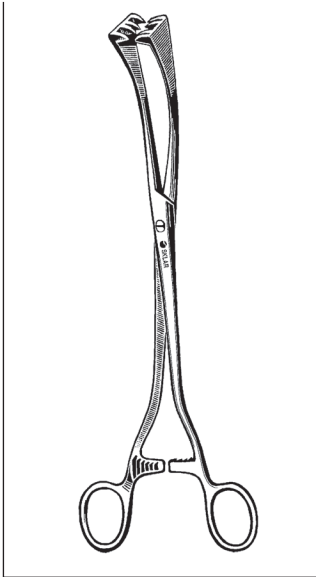

**SECOND (COLLIN)  
FORCEPS**

4 X 4 TEETH

91-3795 9½" Curved on flat

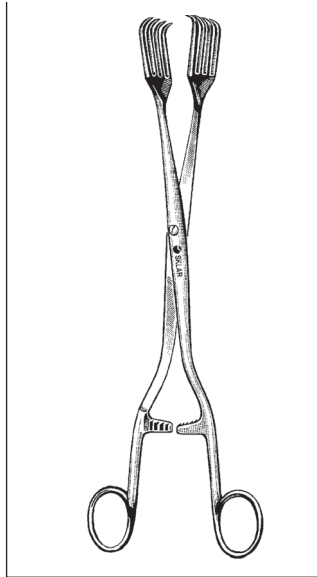

**BILLROTH FORCEPS**

91-3810 10¾" 4 x 4 teeth

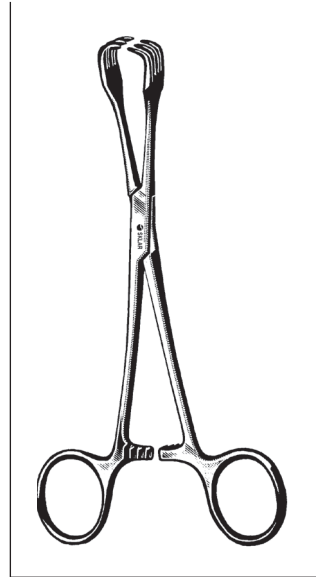

**LAHEY TRACTION  
FORCEPS**

17-3562 6¼" Light Pattern

91-2080 8" Regular Pattern (MGH)

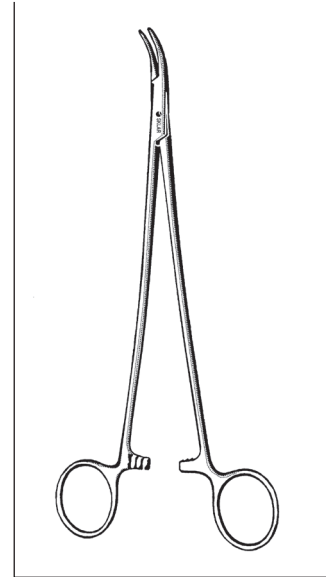

**CLARK ARTERY  
FORCEPS**

90-2354 8¼"

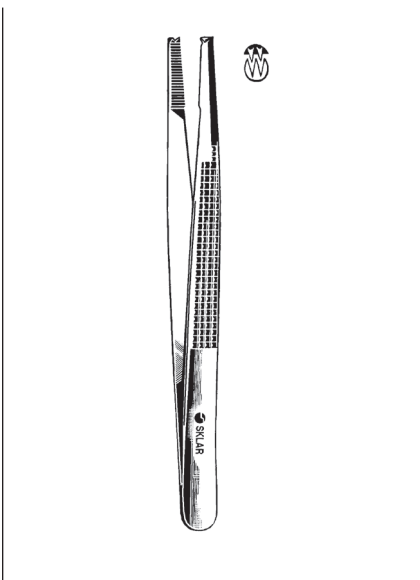

**BONNEY TISSUE FORCEPS**

1X2 TEETH

19-2170 7"

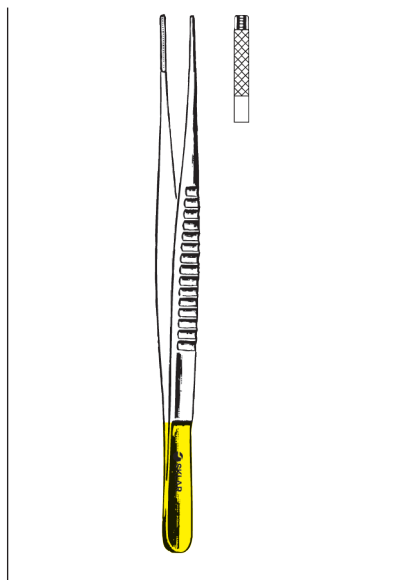

**TC DEBAKEY FORCEPS**

97-1530 6" 2.0mm Tips

97-1531 6" 2.7mm Tips

97-1540 8" 2.0mm Tips

97-1541 8" 2.7mm Tips

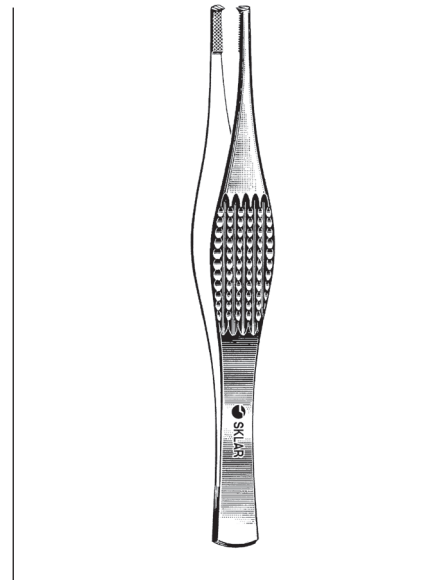

**FERRIS-SMITH TISSUE FORCEPS**

47-1470 7" 1x2 Teeth

52-3970 7" 2x3 Teeth

For a complete listing of our OB/GYN product line, visit [www.sklarcorp.com](http://www.sklarcorp.com).



**ELLIOTT OBSTETRICAL  
FORCEPS**

92-1712 12½"  
92-1715 15" Long

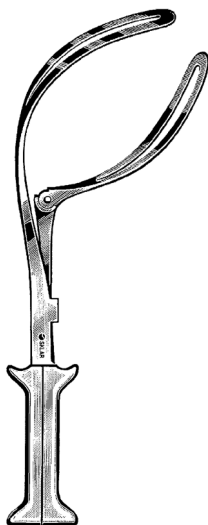

**BARTON OBSTETRICAL  
FORCEPS**

92-1814 14"



**PIPER OBSTETRICAL  
FORCEPS**

**FOR BREECH PRESENTATION**  
92-2717 17½"

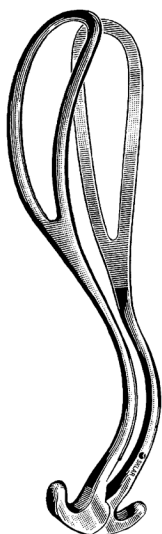

**LAUFE-PIPER OBSTETRICAL  
FORCEPS**

**FOR BREECH PRESENTATION**  
92-2812 12"

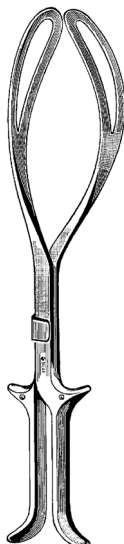

**KIELAND OBSTETRICAL  
FORCEPS**

92-1915 15¾"

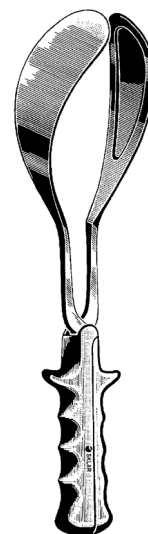

**LUIKART OBSTETRICAL  
FORCEPS**

92-2015 15¾"

For a complete listing of our OB/GYN product line, visit [www.sklarcorp.com](http://www.sklarcorp.com).

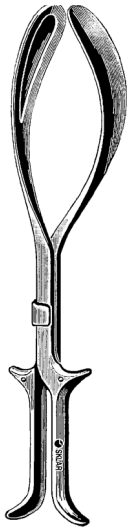

**KIELAND-LUIKART  
OBSTETRICAL FORCEPS**

92-2115 15¾"

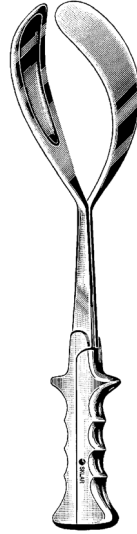

**McLANE-TUCKER-LUIKART  
OBSTETRICAL FORCEPS**

92-2215 15½"

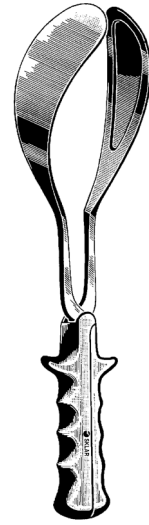

**SIMPSON-LUIKART  
OBSTETRICAL FORCEPS**

**LONG PATTERN**  
92-2314 14"

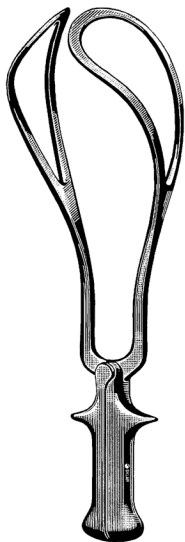

**DE LEE OBSTETRICAL  
FORCEPS**

92-1012 Short, for cesarean section,  
length 12"  
92-1014 Standard, length 14"

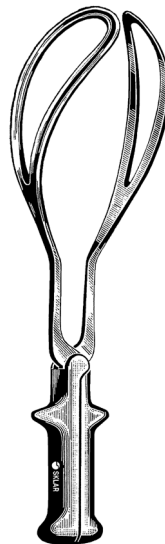

**SIMPSON OBSTETRICAL  
FORCEPS**

92-1112 12" Short  
92-1114 14¼" Long

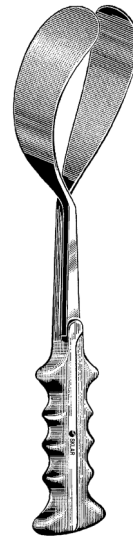

**McLANE-TUCKER  
OBSTETRICAL FORCEPS**

**SOLID BLADES**  
92-1415 15¼"

**For a complete listing of our OB/GYN product line, visit [www.sklarcorp.com](http://www.sklarcorp.com).**

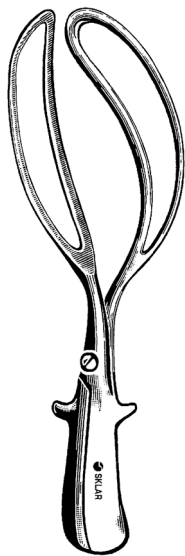

**HALE OBSTETRICAL FORCEPS**

92-1610 10¼"

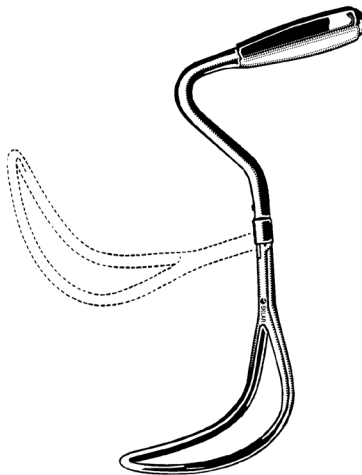

**MURLESS HEAD EXTRACTOR  
FOR CAESAREAN**

92-2915 10½"



**DEWEY OBSTETRICAL FORCEPS**

92-3215 15" Axis Traction

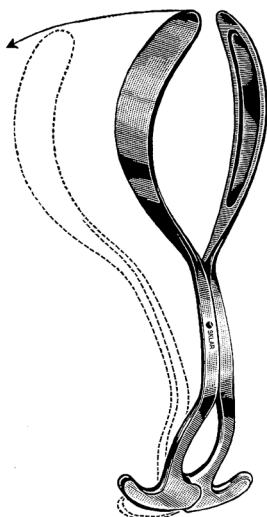

**LAUFE DIVERGENT OUTLET  
OBSTETRICAL FORCEPS**

92-2912 12½"

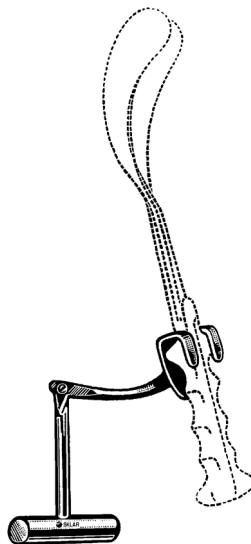

**BILL TRACTION HANDLE  
FOR USE ON STANDARD FORCEPS**

92-3350

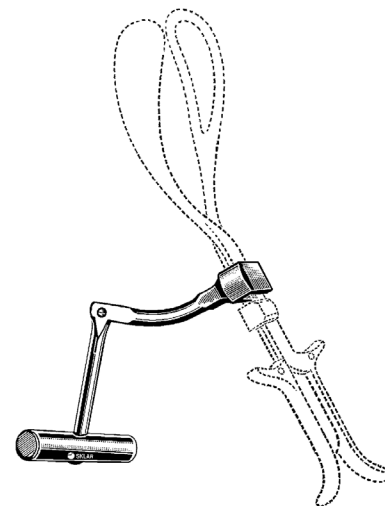

**LUIKART-BILL TRACTION  
HANDLE**

FOR USE WITH LUIKART HANDLES  
92-3360

For a complete listing of our OB/GYN product line, visit [www.sklarcorp.com](http://www.sklarcorp.com).

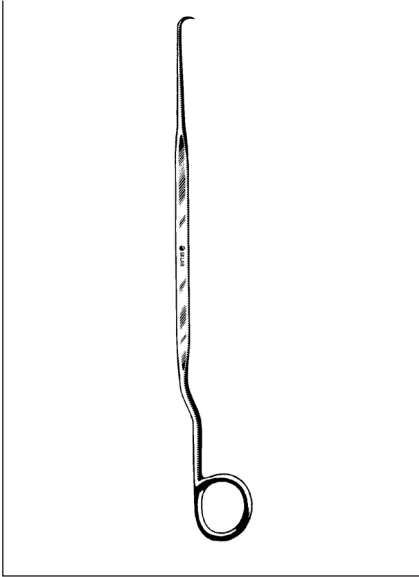

**BEACHAM AMNIOTOME**

91-4210 10¼" (26 cm)

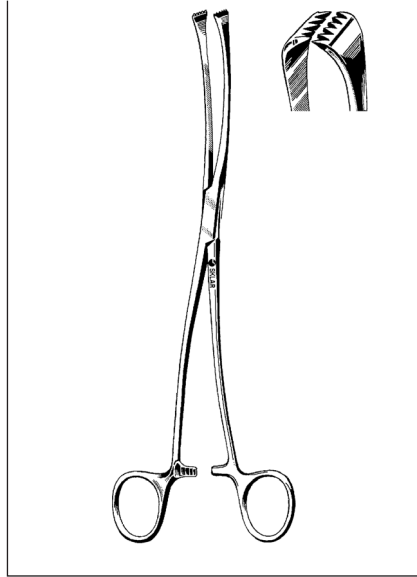

**IOWA MEMBRANE FORCEPS**

91-4310 10"

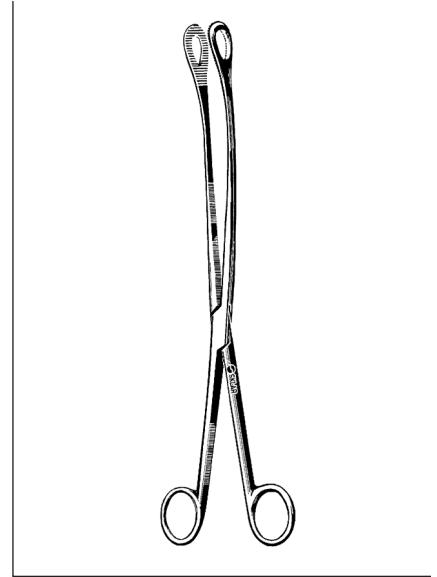

**KELLY PLACENTA FORCEPS**

**CURVED**  
92-5012 12"

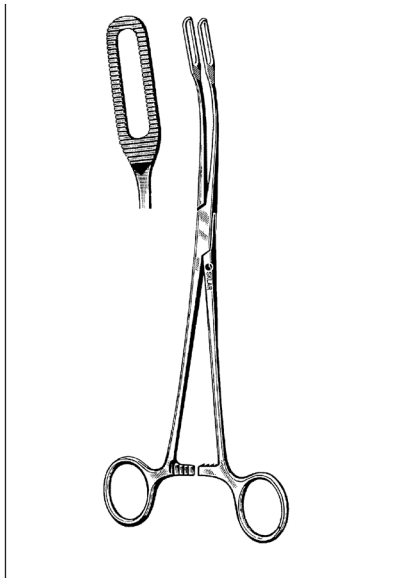

**JAVERTS PLACENTA FORCEPS  
(LONG ISLAND COLLEGE)**

92-5095 9½" Serrated  
92-5195 9½" Smooth

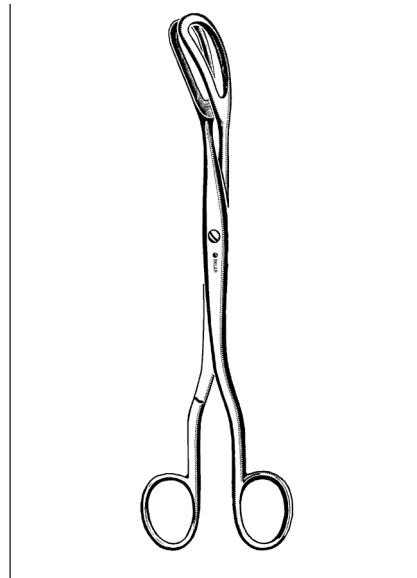

**COREY OVUM FORCEPS**

92-5295 9½"

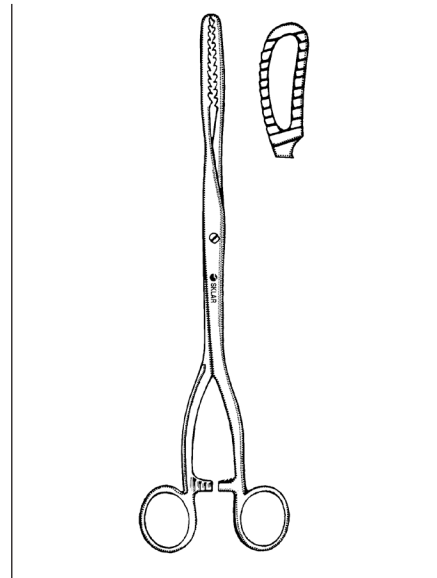

**BIERER OVUM FORCEPS  
WITH RATCHET**

92-5298 11" Serrated  
**WITHOUT RATCHET**  
91-3822 11" Serrated  
91-3823 12½" Serrated

**For a complete listing of our OB/GYN product line, visit [www.sklarcorp.com](http://www.sklarcorp.com).**



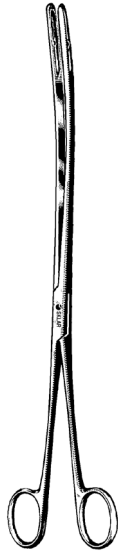

**BOND PLACENTA FORCEPS**

92-5412 12"

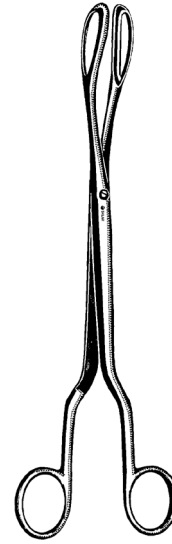

**BARRETT PLACENTA FORCEPS**

92-5310 10"

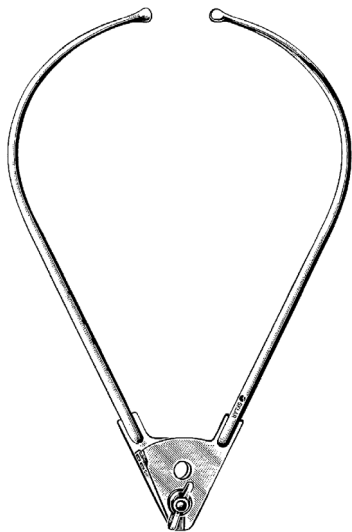

**COLLYER PELVIMETER**

92-4100

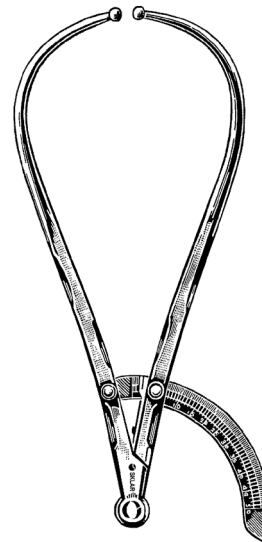

**MARTIN PELVIMETER**

92-4130

For a complete listing of our OB/GYN product line, visit [www.sklarcorp.com](http://www.sklarcorp.com).



# OB/GYN INSTRUMENTS PREMIUM | BIOPSY FORCEPS

**PRECISION ENGINEERED** and hand-crafted of the finest materials, Sklar Biopsy Punches have a reputation for being the best in the industry. A complete selection of forcep tips combined with three specific handle configurations provide the flexibility, comfort and control required by the most selective physicians.

### MICRO-CUT

Micro-Cut Premium Grade Biopsy Punches feature a knife honed edge on the upper jaw for a cleaner, more precise cut. Precisely balanced and superior workmanship delivers the finest value in quality gynecological instruments. Micro-Cut Forceps are easily identified by their dual gold handles.

#### MICRO-CUT TISCHLER KEVORKIAN BIOPSY PUNCH

PRODUCT NUMBER	DESCRIPTION
90-8920	3mm x 9.5mm Bite

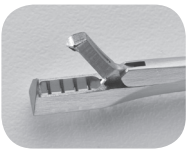

#### MICRO-CUT MINI-TISCHLER PUNCH

PRODUCT NUMBER	DESCRIPTION
90-8945	2.3mm x 4.2mm Bite



#### MICRO-CUT TISCHLER OVAL BIOPSY PUNCH

PRODUCT NUMBER	DESCRIPTION
90-8940	3mm x 7mm Bite



#### MICRO-CUT KEVORKIAN BIOPSY PUNCH

PRODUCT NUMBER	DESCRIPTION
90-8952	3mm x 8mm Bite

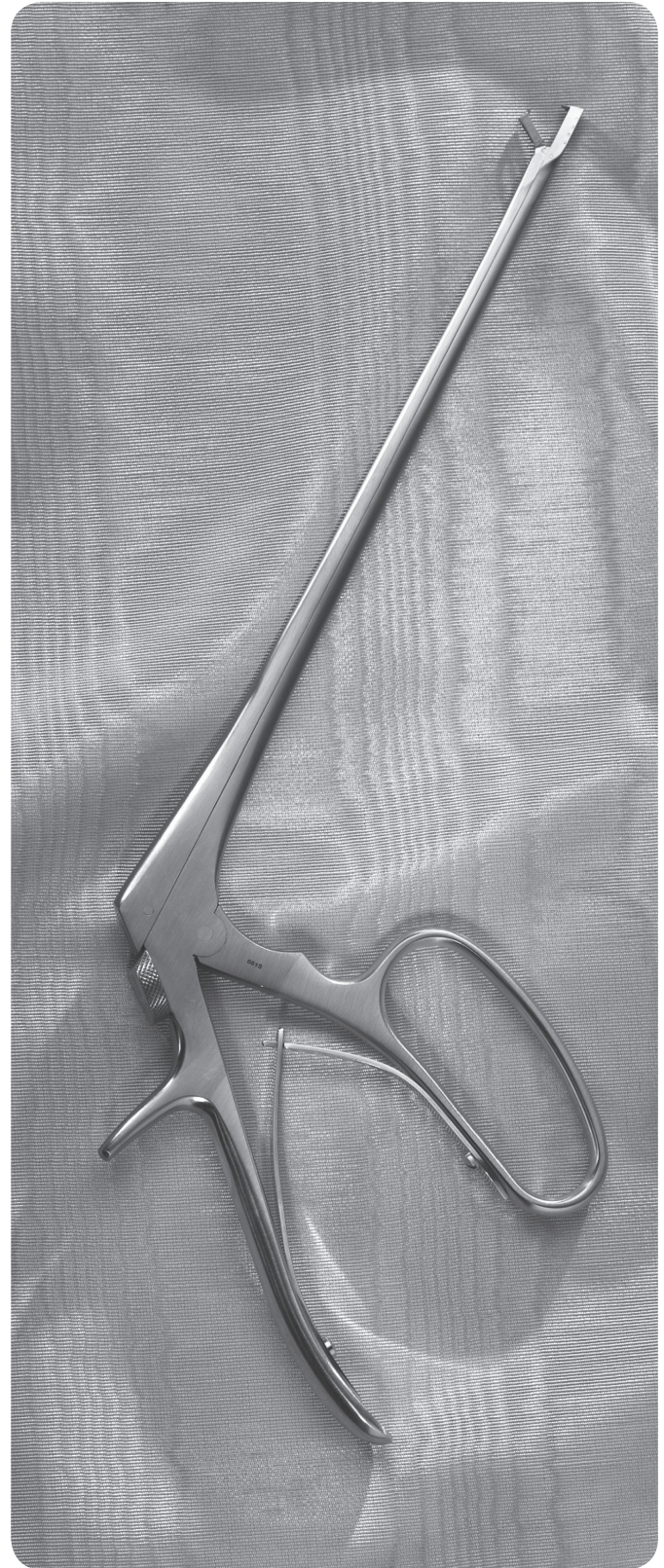
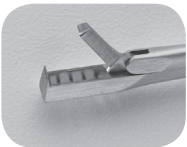

For a complete listing of our OB/GYN product line, visit [www.sklarcorp.com](http://www.sklarcorp.com).

**MICRO-CUT OVAL BIOPSY PUNCH**

PRODUCT NUMBER	DESCRIPTION
90-8948	3mm x 5mm Bite



**MICRO-CUT KEVORKIAN-YOUNGE BIOPSY PUNCH**

PRODUCT NUMBER	DESCRIPTION
90-8905	3mm x 9.7mm Bite



**MICRO-CUT EPPENDORFER BIOPSY PUNCH**

PRODUCT NUMBER	DESCRIPTION
90-8010	4mm x 8mm Bite



**MICRO-CUT WITTNER UTERINE BIOPSY PUNCH**

PRODUCT NUMBER	DESCRIPTION
90-8900	4mm x 8mm Bite, Straight

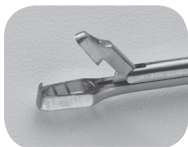

For a complete listing of our OB/GYN product line, visit [www.sklarcorp.com](http://www.sklarcorp.com).



# OB/GYN INSTRUMENTS

## PREMIUM | BIOPSY FORCEPS

### SKLAR FULLY ROTATIONAL BIOPSY FORCEPS

**MICRO-CUT** Premium Grade Biopsy Forceps rotate a full 360° and are designed to obtain a perfect sample without obstruction of the biopsy site. Combining fine craftsmanship with the added benefit of a knife honed edge on the upper jaw, Micro-Cut Forceps allow for a cleaner, more precise cut. A full assortment of tip-shaft combinations provide flexible configurations to compliment the most difficult gynecological procedure. Micro-Cut Forceps are easily identifiable by their dual gold handles.

#### COMPLETE INSTRUMENT

##### MICRO-CUT TISCHLER OVAL BIOPSY PUNCH

PRODUCT NUMBER	DESCRIPTION
90-8960	3mm x 7mm Bite 7" Shaft Length
90-8981	3mm x 7mm Bite 12" Shaft Length



##### MICRO-CUT OVAL BIOPSY PUNCH

PRODUCT NUMBER	DESCRIPTION
90-8962	3mm x 5mm Bite 7" Shaft Length
90-8982	3mm x 5mm Bite 12" Shaft Length



##### MICRO-CUT MINI TISCHLER BIOPSY PUNCH

PRODUCT NUMBER	DESCRIPTION
90-8964	2.3mm x 4.2mm Bite 7" Shaft Length
90-8983	2.3mm x 4.2mm Bite 12" Shaft Length



##### MICRO-CUT KEVORKIAN BIOPSY PUNCH

PRODUCT NUMBER	DESCRIPTION
90-8966	3mm x 8mm Bite 7" Shaft Length
90-8984	3mm x 8mm Bite 12" Shaft Length

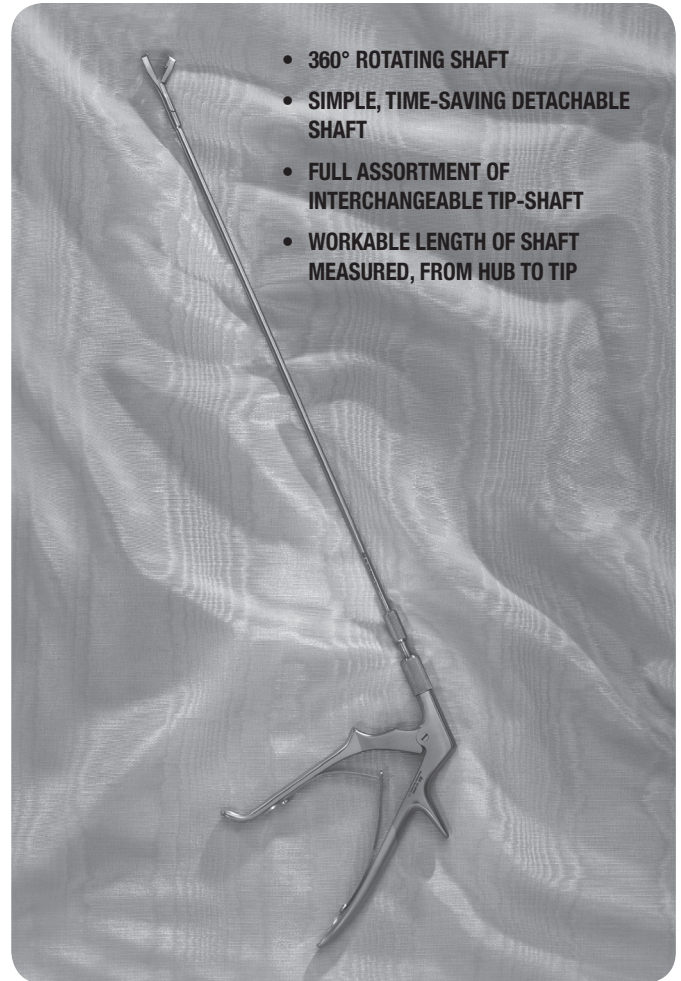

- 360° ROTATING SHAFT
- SIMPLE, TIME-SAVING DETACHABLE SHAFT
- FULL ASSORTMENT OF INTERCHANGEABLE TIP-SHAFT
- WORKABLE LENGTH OF SHAFT MEASURED, FROM HUB TO TIP

#### CANNULA WITH TIP ONLY

PRODUCT NUMBER	DESCRIPTION
90-8970	7" Tischler Oval
90-8972	7" Oval
90-8974	7" Mini Tischler
90-8976	7" Kevorkian
90-8986	12" Tischler Oval
90-8987	12" Oval
90-8988	12" Mini Tischler
90-8989	12" Kevorkian

#### HANDLE ONLY

PRODUCT NUMBER	DESCRIPTION
90-8980	Handle for use with 7" Cannula
90-8985	Handle for use with 12" Cannula

For a complete listing of our OB/GYN product line, visit [www.sklarcorp.com](http://www.sklarcorp.com).

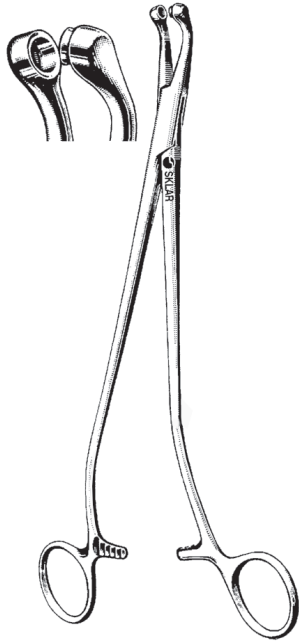

**MICRO-CUT GAYLOR BIOPSY PUNCH**  
90-8925 9½"

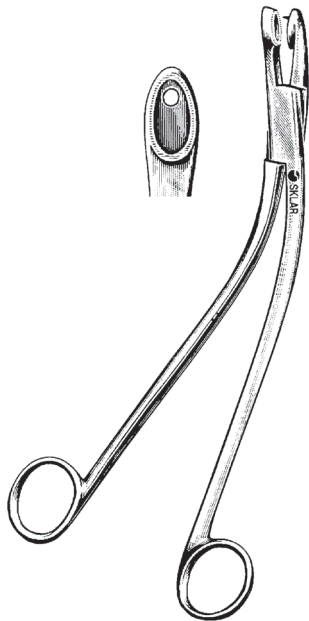

**MICRO-CUT GELLHORN BIOPSY PUNCH**  
90-8930 9½"

# SKLAR DISINFECTANT™

SPRAY SURFACE DISINFECTANT

2 MINUTE KILL TIME

- Ready to use, non-toxic formula.
- Specially formulated for the control of cross contamination.
- Effective against a broad range of pathogens including H1N1, HIV-1, HSV, VRE, Rotaviruses, Hep B & C as well as TB, MRSA and A. Baumannii.
- Safe for all areas of the facility including the NICU, operating rooms, isolation rooms, patient care areas and laboratories.
- Satisfies OSHA's Bloodborne Pathogen Standards.
- Non-irritating formula.
- EPA registered.



PRODUCT NUMBER	DESCRIPTION	Quantities
10-1643	24 oz. Spray Bottles	6/cs
10-1653	1 Gallon Bottles	4/cs

For a complete listing of our OB/GYN product line, visit [www.sklarcorp.com](http://www.sklarcorp.com).

# OB/GYN INSTRUMENTS



## GENERAL SURGERY | BIOPSY FORCEPS

**PRECISION**, balance and control are the key features of Sklar's line of OR Grade Biopsy Punches and reflect the highest level of hand-crafted workmanship. A variety of tip-handle combinations provide the flexibility, comfort and control required by the most selective physicians. Select forcep tips are available with a 60° Wide Bite mouth for easy removal of biopsy and safer cleaning and are easily identified by their Dual Gold handles. Guaranteed for a lifetime against manufacturing defects.

### TISCHLER KEVORKIAN BIOPSY PUNCH

PRODUCT NUMBER	DESCRIPTION
90-6887	3mm x 9.5mm Bite
90-9570	3mm x 9.5mm Bite, 60° Opening



### MINI TISCHLER BIOPSY PUNCH

PRODUCT NUMBER	DESCRIPTION
90-7530	2.3mm x 4.2mm Bite
90-9555	2.3mm x 4.2mm, 60° Opening

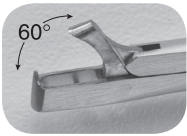

### TISCHLER OVAL BIOPSY PUNCH

PRODUCT NUMBER	DESCRIPTION
90-7520	3mm x 7mm Bite
90-9560	3mm x 7mm Bite, 60° Opening



### KEVORKIAN BIOPSY PUNCH

PRODUCT NUMBER	DESCRIPTION
90-7540	3mm x 8mm Bite
90-9575	3mm x 8mm Bite, 60° Opening

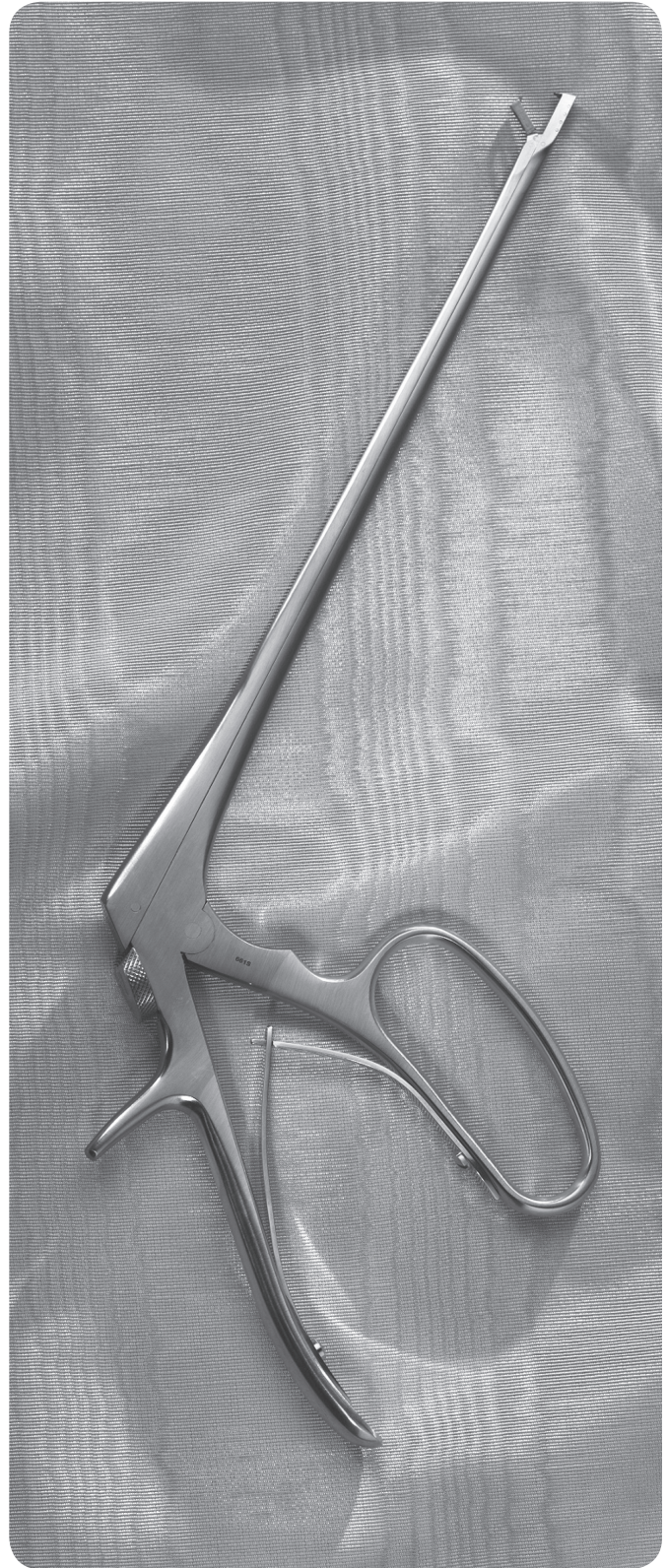
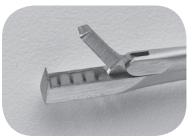

For a complete listing of our OB/GYN product line, visit [www.sklarcorp.com](http://www.sklarcorp.com).

**OVAL BIOPSY PUNCH**

PRODUCT NUMBER	DESCRIPTION
90-7525	3mm x 5mm Bite
90-9565	3mm x 5mm Bite, 60° Opening



**KEVORKIAN-YOUNGE BIOPSY PUNCH**

PRODUCT NUMBER	DESCRIPTION
90-6610	3mm x 9.7mm Bite



**EPPENDORFER BIOPSY PUNCH**

PRODUCT NUMBER	DESCRIPTION
90-6820	4mm x 8mm Bite



**WITTNER UTERINE BIOPSY PUNCH**

PRODUCT NUMBER	DESCRIPTION
90-6600	4mm x 8mm Bite, Straight
90-6602	4mm x 8mm Bite, Angular

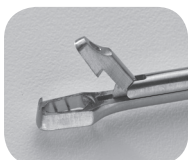

For a complete listing of our OB/GYN product line, visit [www.sklarcorp.com](http://www.sklarcorp.com).



## SKLAR FULLY ROTATIONAL BIOPSY FORCEPS

**FULLY ROTATIONAL**, Sklar's line of 360° OR Grade Rotating Biopsy Forceps are designed to obtain a perfect sample without obstructing the biopsy site. The shaft is detachable from the handle allowing for a full assortment of tip-shaft combinations to compliment the most difficult gynecological procedure. Flexible configurations, high-quality and precision craftsmanship are backed by a lifetime guarantee against manufacturing defects.

### COMPLETE INSTRUMENT

#### TISCHLER OVAL BIOPSY PUNCH

PRODUCT NUMBER	DESCRIPTION
90-7551	3mm x 7mm Bite 7" Shaft Length
90-7571	3mm x 7mm Bite 12" Shaft Length

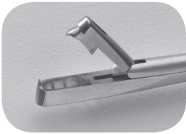

#### MINI TISCHLER BIOPSY PUNCH

PRODUCT NUMBER	DESCRIPTION
90-7553	2.3mm x 4.2mm Bite 7" Shaft Length
90-7573	2.3mm x 4.2mm Bite 12" Shaft Length



#### OVAL BIOPSY PUNCH

PRODUCT NUMBER	DESCRIPTION
90-7552	3mm x 5mm Bite 7" Shaft Length
90-7572	3mm x 5mm Bite 12" Shaft Length



#### KEVORKIAN BIOPSY PUNCH

PRODUCT NUMBER	DESCRIPTION
90-7554	3mm x 8mm Bite 7" Shaft Length
90-7574	3mm x 8mm Bite 12" Shaft Length

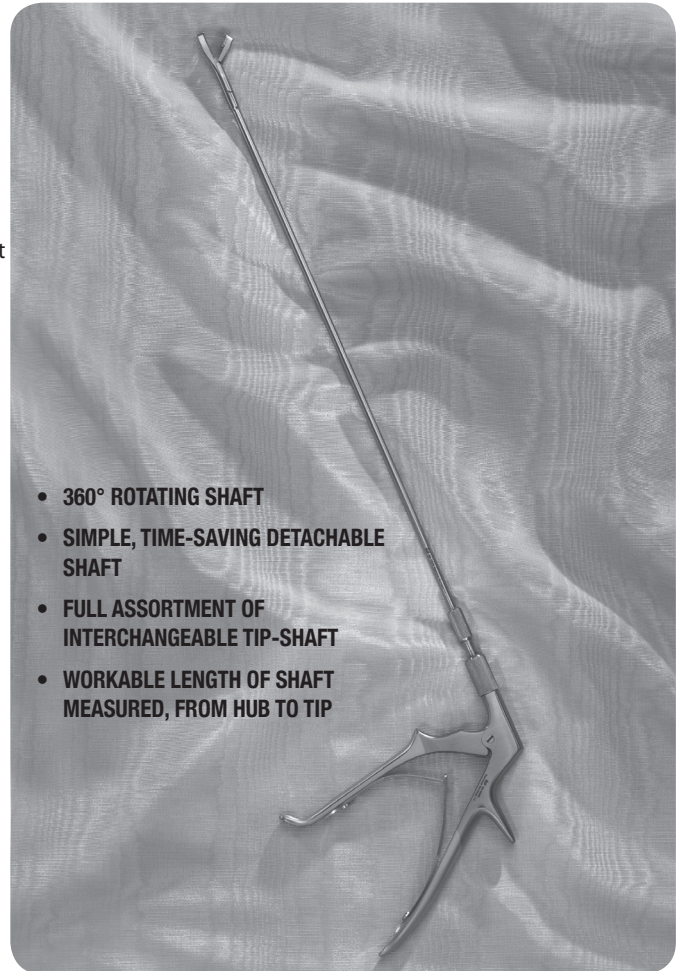
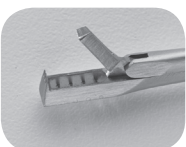

- 360° ROTATING SHAFT
- SIMPLE, TIME-SAVING DETACHABLE SHAFT
- FULL ASSORTMENT OF INTERCHANGEABLE TIP-SHAFT
- WORKABLE LENGTH OF SHAFT MEASURED, FROM HUB TO TIP

### CANNULA WITH TIP ONLY

PRODUCT NUMBER	DESCRIPTION
90-7555	7" Tischler Oval
90-7556	7" Oval
90-7557	7" Mini Tischler
90-7558	7" Kevorkian
90-7576	12" Tischler Oval
90-7577	12" Oval
90-7578	12" Mini Tischler
90-7579	12" Kevorkian

### HANDLE ONLY

PRODUCT NUMBER	DESCRIPTION
90-7560	Handle for use with 7" Cannula
90-7575	Handle for use with 12" Cannula

For a complete listing of our OB/GYN product line, visit [www.sklarcorp.com](http://www.sklarcorp.com).



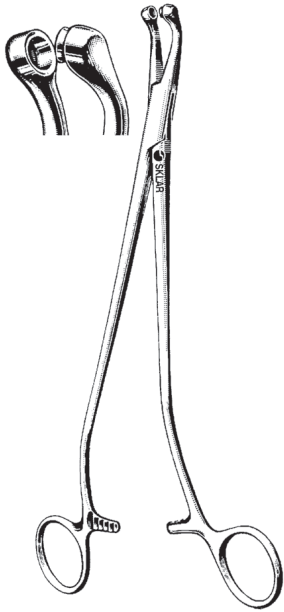

**GAYLOR BIOPSY PUNCH**

IMPROVED JAWS

90-7385 9½"

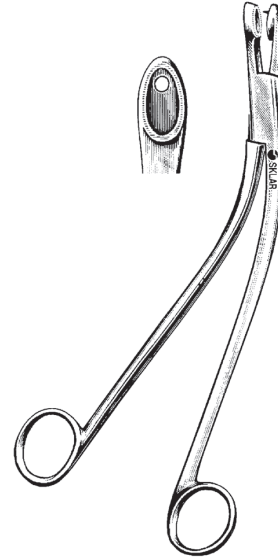

**GELLHORN BIOPSY PUNCH**

90-7492 9½"



**SCHUBERT-VAN DOREN BIOPSY PUNCH**

90-7511 10" Angular Tip and Shanks

**SKLAR DISINFECTANT™  
SURFACE WIPES**

CONVENIENT DISPENSING CANISTER  
READY-TO-USE

2 MINUTE KILL TIME



PRODUCT NUMBER	DESCRIPTION	QUANTITIES
10-1616	100 Towelettes/Canister	6/CS
10-1617	100 Towelettes/Canister	12/CS

For a complete listing of our OB/GYN product line, visit [www.sklarcorp.com](http://www.sklarcorp.com).



# Sklar Black™ Laser Instrumentation

## SANDBLASTED VS COATED INSTRUMENTS

Sklar understands the increased importance of patient/surgeon safety during laser procedures. So we utilize an improved black polymer coating on the Sklar Black™ Laser instruments. Applied on a sandblasted surface, Sklar Black™ Laser instruments effectively reduce reflective energy during laser procedures and improve safety. This durable application process delivers a reliable instrument you can use with confidence for years of service.

All Sklar laser coatings are guaranteed for one year against manufacturing defects.

**Sklar Exclusive!**



### GRAVES VAGINAL SPECULUMS WITH LOOPS FOR SMOKE EVACUATION TUBING

90-9005	3" x ¾"	Extra Small
90-9000	3" x ¾"	Small
90-9002	4" x 1¼"	Medium
90-9004	4½" x 1⅜"	Large
90-9006	4¾" x 1½"	Extra Large



### GRAVES VAGINAL SPECULUMS WITH PERMANENT SMOKE EVACUATION TUBING

90-9015	3" x ¾"	Small
90-9016	4" x 1¼"	Medium
90-9018	4½" x 1⅜"	Large
90-9020	4¾" x 1½"	Extra Large

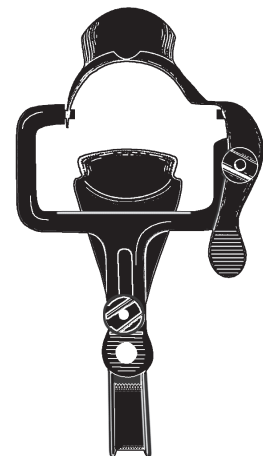

### GRAVES OB-VIEW VAGINAL SPECULUMS

WITH SMOKE EVACUATION TUBING		
90-9057	4" x 1¼"	Medium
90-9058	4¾" x 1½"	Large

For a complete listing of our OB/GYN product line, visit [www.sklarcorp.com](http://www.sklarcorp.com).



# *Sklar Black™ Laser Instrumentation*

## SANDBLASTED VS COATED INSTRUMENTS

Sklar Black™ Laser instruments use an improved black polymer coating over a sandblasted surface to reduce reflective energy during surgical laser procedures. The durable coating improves patient safety and provides a reliable instrument you can use with confidence.

All Sklar laser coatings are guaranteed for one year against manufacturing defects.

***Sklar Exclusive!***



### PEDERSON VAGINAL SPECULUMS

#### WITH LOOPS FOR SMOKE EVACUATION TUBING

90-9030	3" x ½"	Small
90-9038	4" x 5/8"	Slender
90-9032	4" x 7/8"	Medium
90-9034	4¾" x 1"	Large
90-9035	2¾" x ½"	Extra Small

### PEDERSON VAGINAL SPECULUMS

#### WITH PERMANENT SMOKE EVACUATION TUBING

90-9040	3" x ½"	Small
90-9050	4" x 5/8"	Slender
90-9042	4" x 7/8"	Medium
90-9044	4¾" x 1"	Large
90-9048	4¾" x 1 5/8"	Extra Large



Autoclavable

For a complete listing of our OB/GYN product line, visit [www.sklarcorp.com](http://www.sklarcorp.com).

[www.sklarcorp.com](http://www.sklarcorp.com) 800.221.2166

OB/GYN INSTRUMENTS

SKLAR BLACK™ LASER



**GRAVES VAGINAL SPECULUMS**

- |         |                 |             |
|---------|-----------------|-------------|
| 90-3812 | 3" x 1/2"       | Extra Small |
| 90-3804 | 3" x 3/4"       | Small       |
| 90-3806 | 4" x 1 1/4"     | Medium      |
| 90-3808 | 4 1/2" x 1 3/8" | Large       |
| 90-3810 | 4 3/4" x 1 1/2" | Extra Large |



**PEDERSON VAGINAL SPECULUMS**

- |         |               |             |
|---------|---------------|-------------|
| 90-3841 | 2 3/4" x 1/2" | Extra Small |
| 90-3833 | 3" x 1/2"     | Small       |
| 90-3837 | 4" x 5/8"     | Slender     |
| 90-3839 | 4" x 7/8"     | Medium      |
| 90-3835 | 4 3/4" x 1"   | Large       |

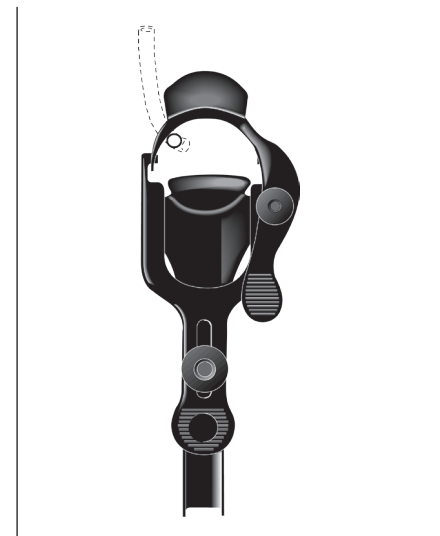

**GRAVES WIDE VIEW VAGINAL SPECULUMS**

- 4" X 1 1/4" MEDIUM**  
**WIDE PROXIMAL OPENING FOR INSTRUMENTATION**
- |         |  |
|---------|--|
| 90-9055 | With loop to hold and direct disposable smoke evacuation tubing. |
| 90-9054 | With permanent Smoke Evacuation Tube.                            |



**FREEWAY GRAVES VAGINAL SPECULUMS**

- 4" X 1 1/4" OPEN SIDE 90° ANGLE**
- |         |  |
|---------|--|
| 90-3755 | With loop to hold and direct disposable smoke evacuation tubing. |
| 90-3754 | With permanent Smoke Evacuation Tube.                            |



**FREEWAY GRAVES VAGINAL SPECULUMS**

- 4" X 1 1/4" 45° ANGLE MEDIUM**
- |         |  |
|---------|--|
| 90-3815 | With loop to hold and direct disposable smoke evacuation tubing. |
| 90-3814 | With permanent Smoke Evacuation Tube.                            |

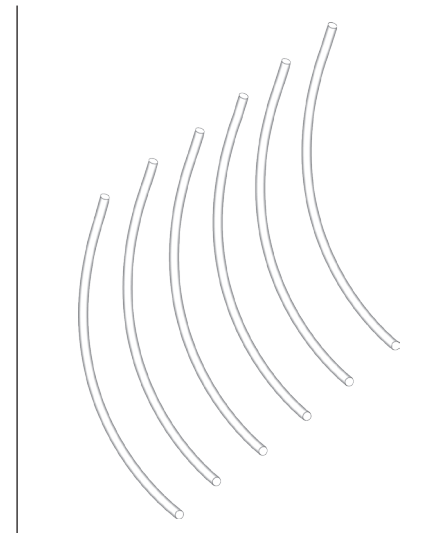

**DISPOSABLE SMOKE EVACUATION TUBING**

- |         |  |
|---------|--|
| 93-2160 | Case of 50 in 10" precut 3/16" Inside Diameter 1/4" Outside Diameter |
|---------|--|

For a complete listing of our OB/GYN product line, visit [www.sklarcorp.com](http://www.sklarcorp.com).



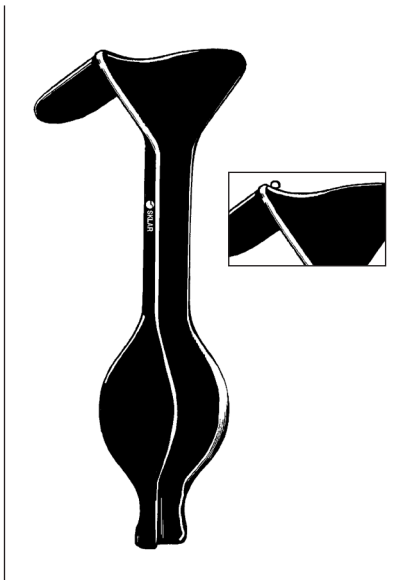

**AUWARD VAGINAL SPECULUMS**  
BLADES 2¾" X 1½", MEDIUM 2½ LBS.

- 90-9100 Without loop
- 90-9102 With loop to hold and direct disposable evacuation tubing.
- 90-9103 With permanent Smoke Evacuation Tube.

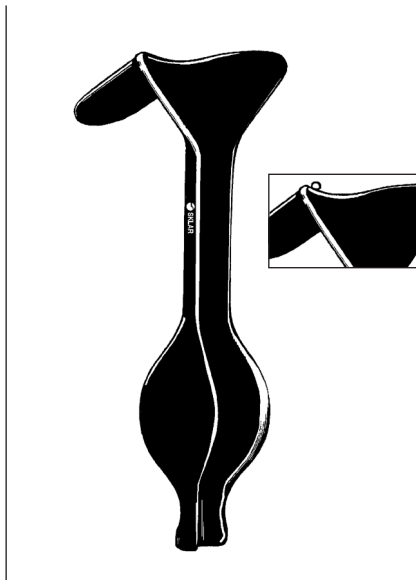

**AUWARD VAGINAL SPECULUMS**  
LONG BLADES 4" X 1¾", MEDIUM 2½ LBS.

- 90-9106 Without loop
- 90-9108 With loop to hold and direct disposable evacuation tubing.
- 90-9109 With permanent Smoke Evacuation Tube.

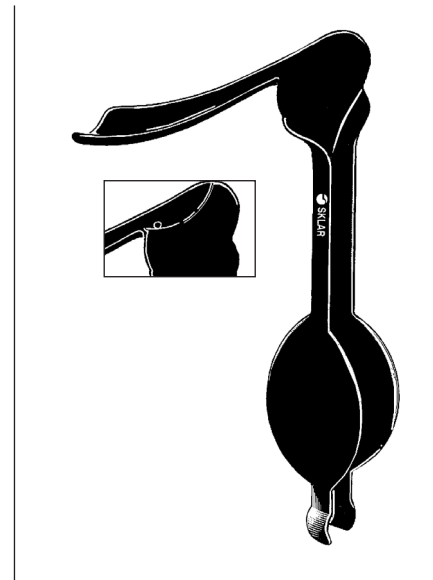

**STEINER-AUWARD VAGINAL SPECULUMS**  
EXTRA LONG BLADES 5½" X 1¼"

- 90-3560 2½ lbs. Without loop
- 90-3561 2½ lbs. With loop to hold and direct disposable evacuation tubing.
- 90-3562 2½ lbs. with permanent Smoke Evacuation Tube.

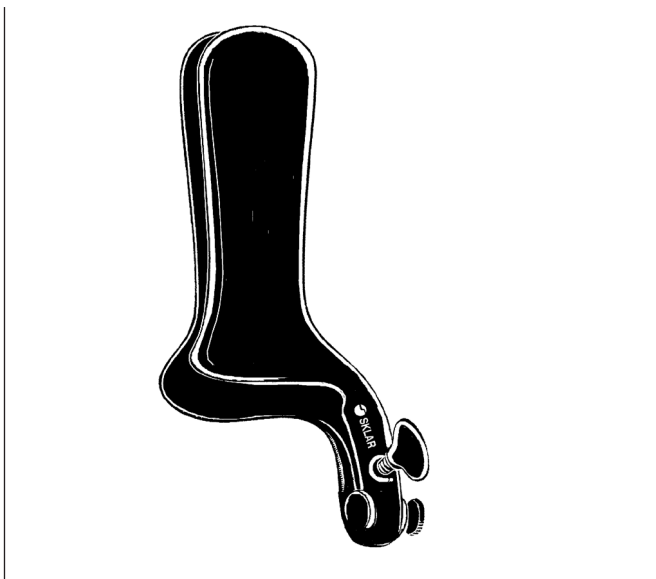

**COLLIN VAGINAL SPECULUM**

- 4¼" X 1¼"  
90-3946 Medium with permanent Smoke Evacuation Tube.



**LATERAL VAGINAL SPECULUM**

- 90-8845 Ratchet Handle



Autoclavable

For a complete listing of our OB/GYN product line, visit [www.sklarcorp.com](http://www.sklarcorp.com).



OB/GYN INSTRUMENTS

SKLAR BLACK™ LASER

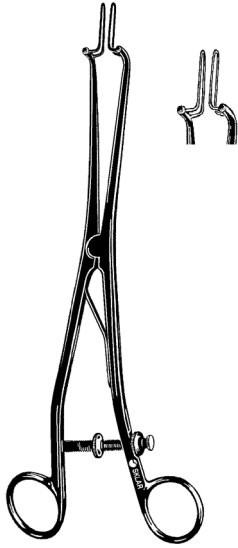

**KOGAN ENDOCERVICAL SPECULUM**  
WITH GAUGE AND SCREWS  
90-8855 Narrow Wire Blades

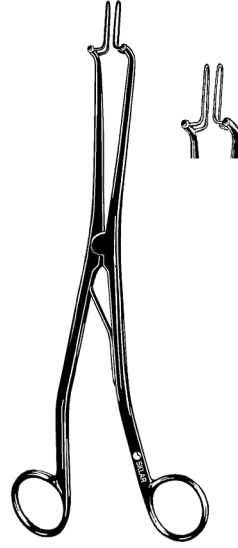

**KOGAN ENDOCERVICAL SPECULUM**  
WITH SPRING  
90-8865 Narrow Wire Blades

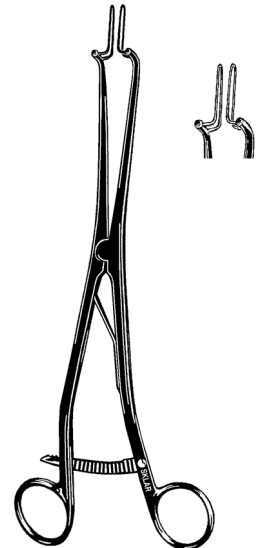

**KOGAN ENDOCERVICAL SPECULUM**  
WITH RATCHET  
90-8862 Narrow Wire Blades

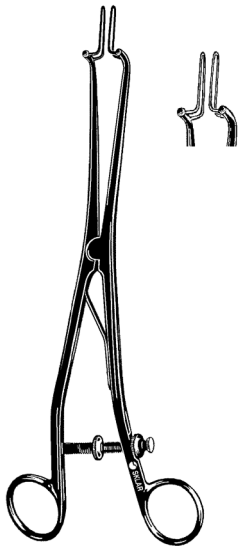

**KOGAN ENDOCERVICAL SPECULUM**  
WITH GAUGE AND SCREWS  
90-8858 Wide Wire Blades

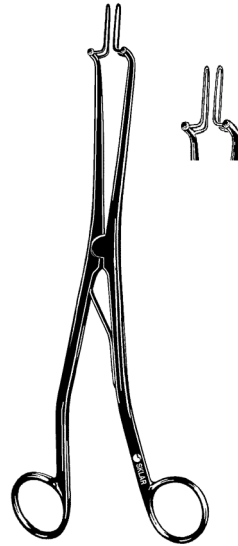

**KOGAN ENDOCERVICAL SPECULUM**  
WITH SPRING  
90-8850 Wide Wire Blades

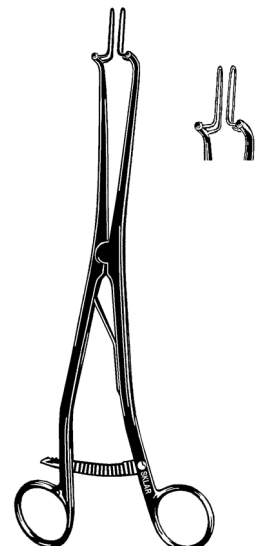

**KOGAN ENDOCERVICAL SPECULUM**  
WITH RATCHET  
90-8860 Wide Wire Blades

For a complete listing of our OB/GYN product line, visit [www.sklarcorp.com](http://www.sklarcorp.com).



# OB/GYN INSTRUMENTS

## SKLAR BLACK™ LASER



1MM DIAMETER



4MM DIAMETER



3MM DIAMETER



6MM DIAMETER



STYLE 1



STYLE 4



STYLE 2



STYLE 5



STYLE 3

### IRIS HOOKS

#### QUICK RELEASE

90-2126	9"	1mm	90-2128	12"	1mm
90-2122	9"	3mm	90-2124	12"	3mm
90-2118	9"	4mm	90-2120	12"	4mm
90-2114	9"	6mm	90-2116	12"	6mm
90-2160	9"	Set of 4	90-2131	12"	Set of 4

### EMMETT TENACULUM HOOKS

90-2171	9"	Style 1
90-2172	9"	Style 2
90-2173	9"	Style 3
90-2174	9"	Style 4
90-2175	9"	Style 5
90-2170	9"	Set of 5

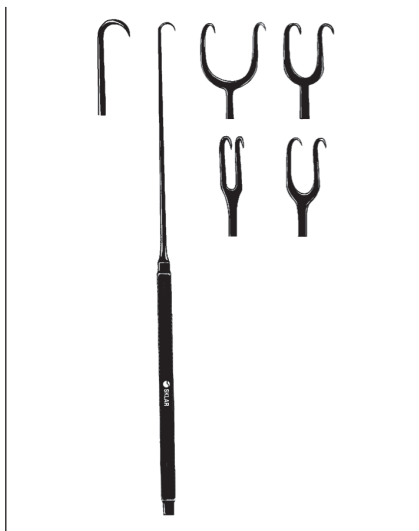

### JOSEPH SKIN HOOKS

#### SHARP, 6¼"

90-1050		1 Sharp Prong
90-1051	2mm	2 Prongs
90-1052	5mm	2 Prongs
90-1053	7mm	2 Prongs
90-1054	10mm	2 Prongs
90-1055	12mm	2 Prongs

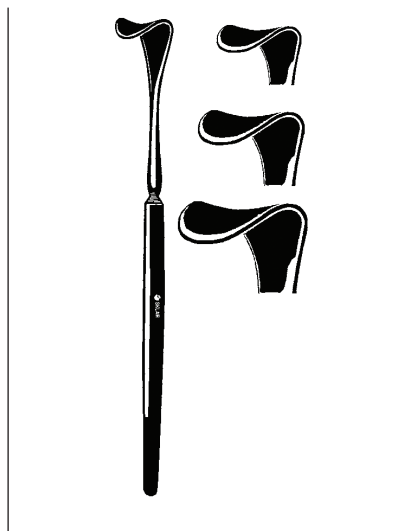

### DEMARRES LID RETRACTORS

90-1038	12mm
90-1036	16mm
90-1035	18mm

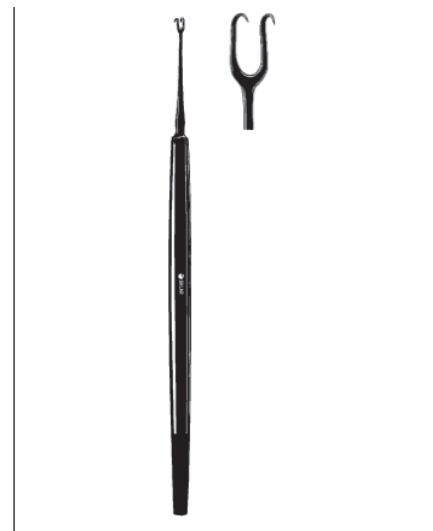

### GUTHRIE DOUBLE HOOKS

#### SHARP, 5"

90-1046	3mm	2 Small Prongs
90-1044	5mm	2 Large Prongs



Autoclavable

For a complete listing of our OB/GYN product line, visit [www.sklarcorp.com](http://www.sklarcorp.com).



OB/GYN INSTRUMENTS

SKLAR BLACK™ LASER

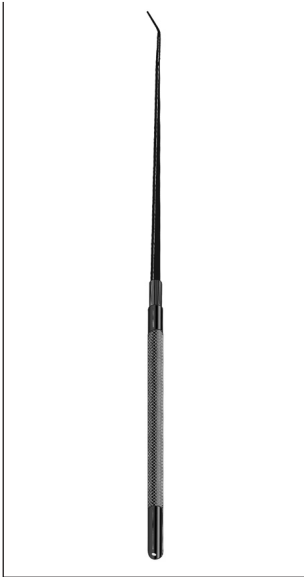

**NEWPORT PROBE**  
45° ANGLE  
90-9132 12"

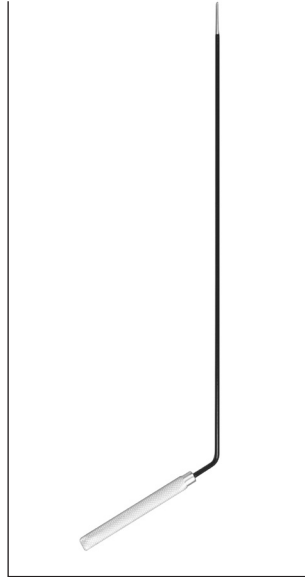

**DEPTH AND WIDTH RULER**  
12" OVERALL LENGTH  
90-2242 Depth in Millimeters

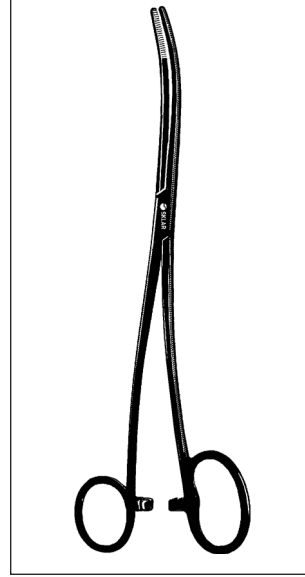

**BOZEMAN FORCEPS**  
ONE LARGE RING  
90-2342 10 1/4" S-Curve



**BOZEMAN FORCEPS**  
90-2340 10 1/4" S-Curve

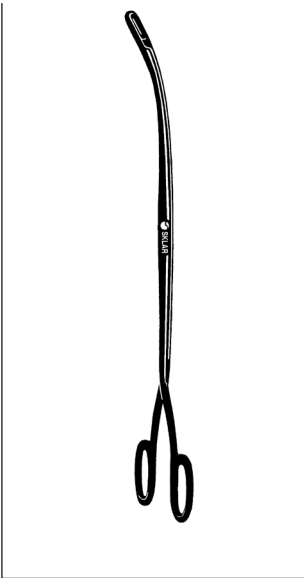

**CAMPION GRASPING FORCEPS**  
90-2298 9 1/4" Curved



**SCHROEDER TENACULUM FORCEPS**  
90-2325 10" (Braun)  
90-2326 10" (Pozzi)

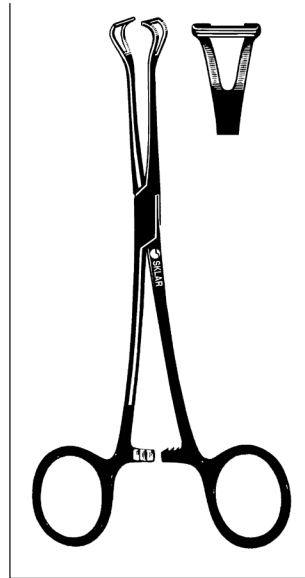

**BABCOCK FORCEPS**  
90-2278 8"  
90-2295 9 1/2"

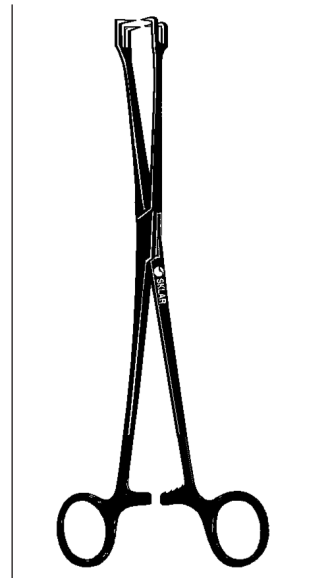

**SCHROEDER VULSELLUM FORCEPS**  
90-1790 9 1/2" Straight  
90-1890 9 1/2" Curved Sideways

For a complete listing of our OB/GYN product line, visit [www.sklarcorp.com](http://www.sklarcorp.com).







**ALLIS TISSUE FORCEPS**

90-2276 7½" 5x6  
90-2279 9½" 5x6

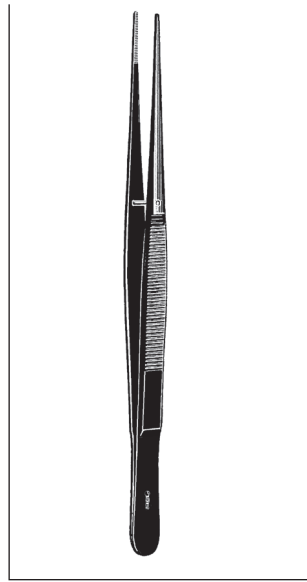

**POTTS-SMITH FORCEPS**

90-2304 7" Serrated  
90-2306 10" Serrated

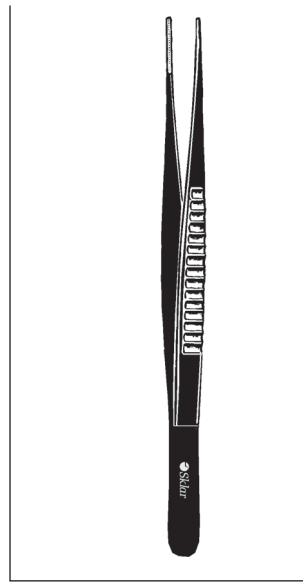

**DEBAKEY ATRAUMATIC TISSUE FORCEPS**

**2.0MM JAWS**  
90-2310 7¾"  
90-2312 9½"

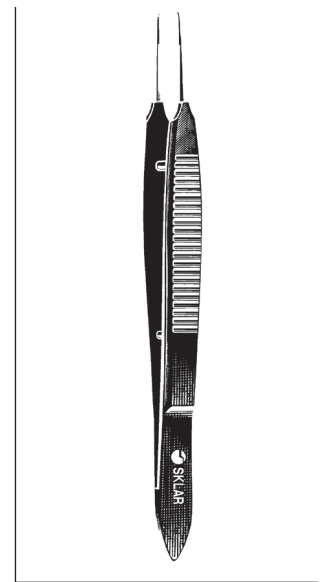

**CASTROVIEJO FORCEPS**

90-2313 4¼" .5mm Teeth



**TUTTLE/SINGLEY FORCEPS**

90-2270 7" Tuttle  
90-2272 9" Singley

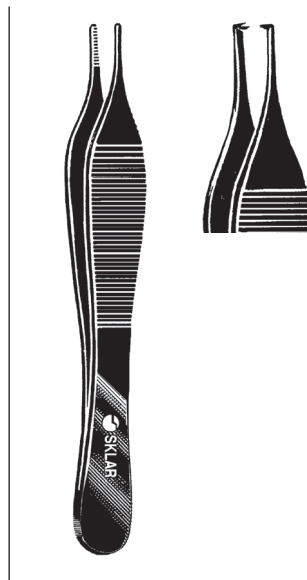

**ADSON FORCEPS**

90-2261 4¾" Serrated  
90-1060 4¾" 1x2 Teeth  
90-1061 4¾" 2x3 Teeth



**ROCHESTER-PEAN FORCEPS**

90-2292 7¼" Curved



**SCHWEIZER FORCEPS**

90-2350 9½" Straight



Autoclavable

For a complete listing of our OB/GYN product line, visit [www.sklarcorp.com](http://www.sklarcorp.com).



OB/GYN INSTRUMENTS

SKLAR BLACK™ LASER



**CLEMETSON FORCEPS**

90-2348 9½" No-Ratchet



**LAUFE UTERINE POLYP FORCEPS**

90-2345 7¾" Curved

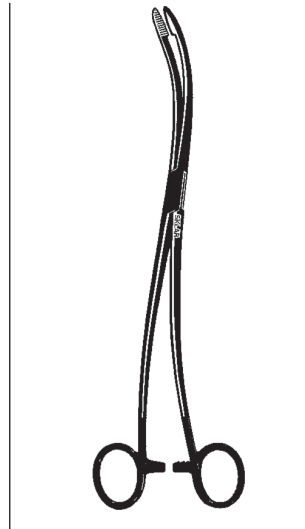

**DELEE UTERINE FORCEPS**

90-7111 11" Heavy S-Curved

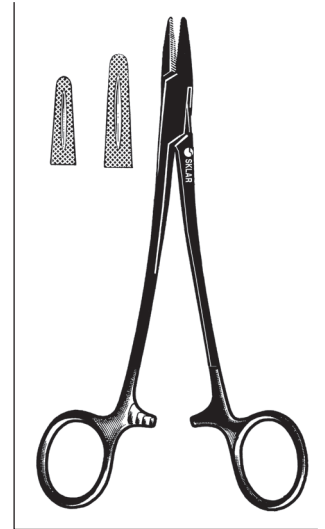

**HEANEY NEEDLE HOLDER**

90-2330 8¼"



**MAYO-HEGAR NEEDLE HOLDERS**

90-2287 7"  
90-2288 8"



**JACKSON RETRACTORS**

**SINGLE END**

- 90-9064 3" x 1½" Small with Permanent Smoke Evacuation Tube
- 90-9065 3½" x 1½" Medium without Tube or Loops
- 90-9066 3½" x 1½" Medium with Loop to hold and direct disposable Smoke Evacuation Tubing
- 90-9069 3½" x 1½" Medium with Permanent Smoke Evacuation Tube
- 90-9067 4" x 1½" Large without Tube or Loops
- 90-9068 4" x 1½" Large with Loop to hold and direct disposable Smoke Evacuation Tubing
- 90-9070 4" x 1½" Large with Permanent Smoke Evacuation Tube

For a complete listing of our OB/GYN product line, visit [www.sklarcorp.com](http://www.sklarcorp.com).



Autoclavable

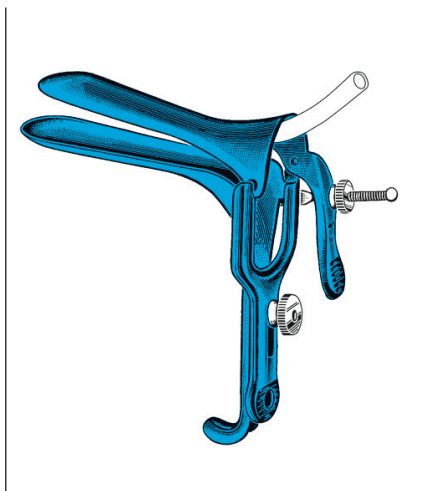

**GRAVES VAGINAL SPECULUMS  
WITH LOOP FOR DISPOSABLE SMOKE EVACUATION  
TUBING**

91-5015	3" x 1/2"	Extra Small
91-5010	3" x 3/4"	Small
91-5012	4" x 1 1/4"	Medium
91-5014	4 1/2" x 1 3/8"	Large
91-5018	4 3/4" x 1 1/2"	Extra Large

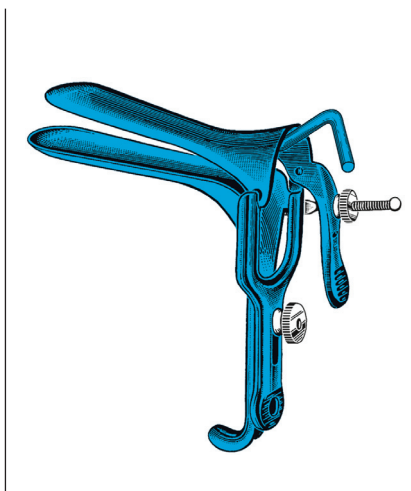

**GRAVES VAGINAL SPECULUMS  
WITH PERMANENT SMOKE EVACUATION TUBE**

91-5020	3" x 3/4"	Small
91-5022	4" x 1 1/4"	Medium
91-5024	4 1/2" x 1 3/8"	Large
91-5028	4 3/4" x 1 1/2"	Extra Large

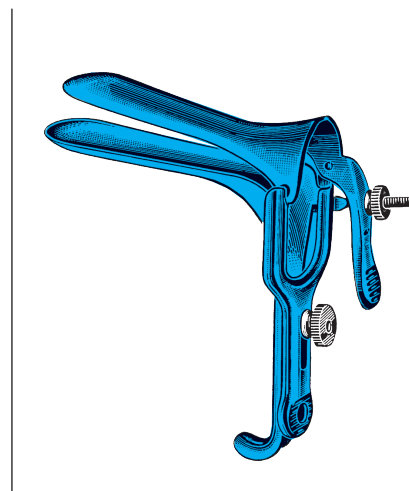

**GRAVES VAGINAL SPECULUMS  
WITHOUT TUBE OR LOOP**

91-5066	3" x 1/2"	Extra Small
91-5060	3" x 3/4"	Small
91-5062	4" x 1 1/4"	Medium
91-5064	4 1/2" x 1 3/8"	Large
91-5068	4 3/4" x 1 1/2"	Extra Large

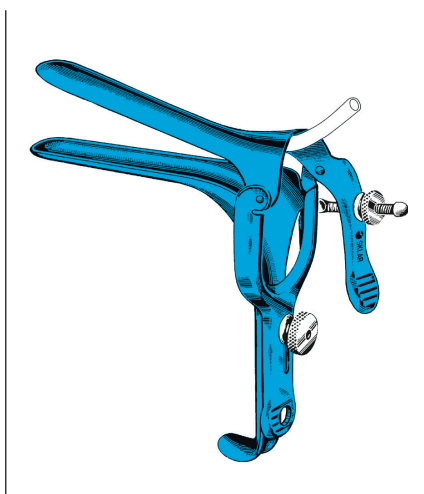

**PEDERSON VAGINAL SPECULUMS  
WITH LOOP FOR DISPOSABLE SMOKE EVACUATION  
TUBING**

91-5038	2 3/4" x 1/2"	Extra Small
91-5032	3" x 1/2"	Small
91-5040	4" x 5/8"	Slender
91-5034	4" x 7/8"	Medium
91-5036	4 3/4" x 1"	Large

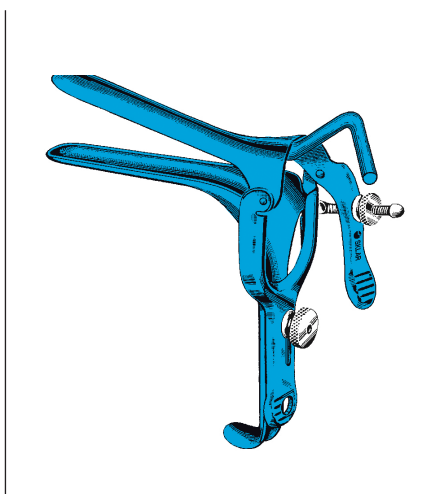

**PEDERSON VAGINAL SPECULUMS  
WITH PERMANENT SMOKE EVACUATION TUBE**

91-5042	3" x 1/2"	Small
91-5050	4" x 5/8"	Slender
91-5044	4" x 7/8"	Medium
91-5046	4 3/4" x 1"	Large
91-5047	4 3/4" x 1 5/8"	Extra Large

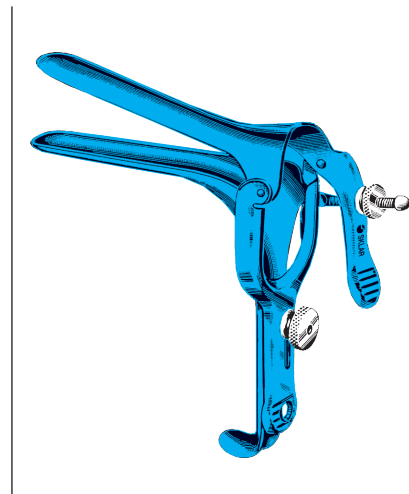

**PEDERSON VAGINAL SPECULUMS  
WITHOUT TUBE OR LOOP**

91-5088	2 3/4" x 1/2"	Extra Small
91-5082	3" x 1/2"	Small
91-5092	4" x 5/8"	Slender
91-5084	4" x 7/8"	Medium
91-5086	4 3/4" x 1"	Large



Autoclavable

For a complete listing of our OB/GYN product line, visit [www.sklarcorp.com](http://www.sklarcorp.com).



**OB/GYN INSTRUMENTS**  
**SKLAR BLUE™ ELECTRO SURGERY**

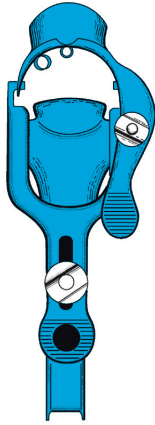

**GRAVES VAGINAL SPECULUM  
WIDE VIEW PATTERN**

**WITH LARGE PROXIMAL OPENING FOR  
INSTRUMENTATION**

91-5080 4" x 1¼" Medium, with loop  
to hold and direct  
disposable Smoke  
Evacuation Tubing

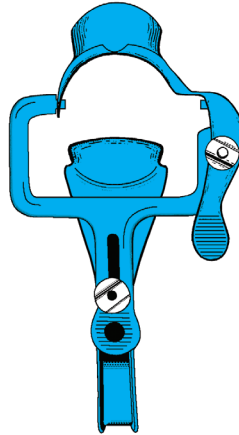

**GRAVES OB-VIEW VAGINAL  
SPECULUMS**

**WITH PERMANENT SMOKE EVACUATION TUBE  
(NOT ILLUSTRATED)**

91-3740 4" x 1½" Medium  
91-3741 4¾" x 1½" Large

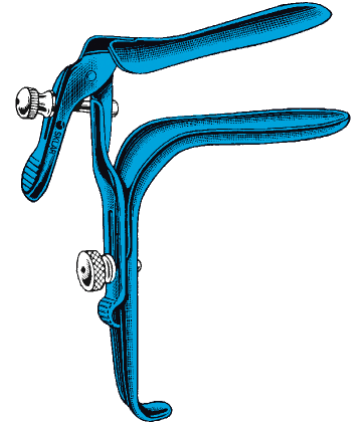

**FREEWAY GRAVES VAGINAL  
SPECULUMS**

**OPEN SIDE, 90° ANGLE**

91-5160 4" x 1¼" Medium, with permanent  
Smoke Evacuation Tube  
(not illustrated)  
91-5161 4" x 1¼" Medium, without  
permanent Smoke  
Evacuation Tube

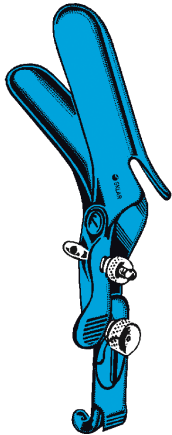

**FREEWAY GRAVES VAGINAL  
SPECULUM**

**OPEN SIDE, 45° ANGLE**

91-5162 4" x 1¼" Medium, with  
permanent Smoke  
Evacuation Tube  
(not illustrated)



**CUSCO VAGINAL SPECULUMS**

**WITH PERMANENT SMOKE EVACUATION TUBE**

91-5150 3" x 1¼" Small  
91-5152 3⅞" x 1⅓" Medium  
91-5154 3¾" x 1⅞" Large

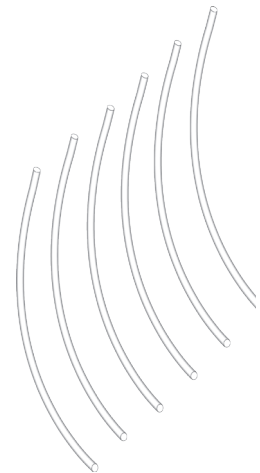

**DISPOSABLE SMOKE  
EVACUATION TUBING**

93-2160 10" Precut  
⅜" Inside Diameter  
¼" Outside Diameter 50/cs

For a complete listing of our OB/GYN product line, visit [www.sklarcorp.com](http://www.sklarcorp.com).



# OB/GYN INSTRUMENTS

## SKLAR BLUE™ ELECTRO SURGERY

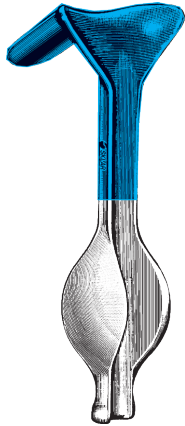

### AUWARD VAGINAL SPECULUMS

#### MEDIUM

- 91-5120 2¾" x 1½" 2½ lbs. with permanent Smoke Evacuation Tube (not illustrated)
- 91-5122 2¾" x 1½" 2½ lbs. with loop to hold and direct disposable Smoke Evacuation Tubing



### AUWARD VAGINAL SPECULUMS

#### MEDIUM LONG BLADE

- 91-5130 4" x 1¾" 2½ lbs. without loop
- 91-5132 4" x 1¾" 2½ lbs. with loop to hold and direct disposable Smoke Evacuation Tubing



### STEINER-AUWARD VAGINAL SPECULUMS

#### MEDIUM EXTRA LONG BLADE

- 91-5140 5½" x 1¼" 2½ lbs. without loop
- 91-5142 5½" x 1¼" 2½ lbs. with loop to hold and direct disposable Smoke Evacuation Tubing



### COLLIN VAGINAL SPECULUMS

- 91-5180 4¼" x 1¼" Medium, with permanent Smoke Evacuation Tube (not illustrated)
- 91-5185 4¼" x 1¼" Medium, with loop to hold and direct disposable Smoke Evacuation Tubing

# MONSEL'S & LUGOL'S

IN-OFFICE  
GYNECOLOGICAL  
ELECTROSURGERY



MONSEL'S PASTE Item #96-1200  
LUGOL'S SOLUTION Item #96-1210  
8ml Ready to use bottles



Autoclavable

For a complete listing of our OB/GYN product line, visit [www.sklarcorp.com](http://www.sklarcorp.com).

[www.sklarcorp.com](http://www.sklarcorp.com) 800.221.2166



**OB/GYN INSTRUMENTS**  
**SKLAR BLUE™ ELECTRO SURGERY**

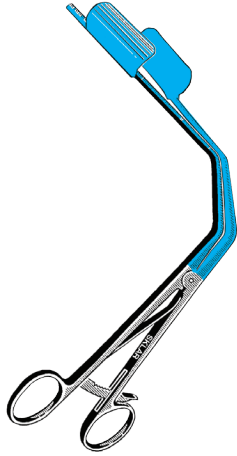

**LATERAL VAGINAL RETRACTOR  
WITH RATCHET**

91-5190 Fits Inside Speculum

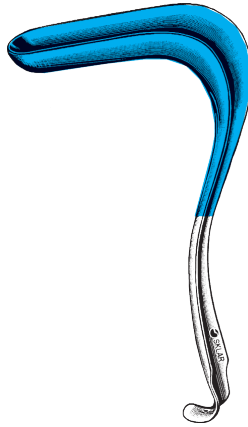

**SIMS VAGINAL RETRACTORS**

**SINGLE END**

- 91-5200 Medium
- 91-5202 Medium with loop to hold and direct disposable Smoke Evacuation Tubing (not illustrated)

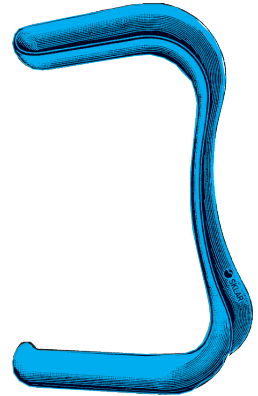

**SIMS VAGINAL RETRACTORS**

**DOUBLE END**

- 91-5210 Medium
- 91-5212 Medium with loop to hold and direct disposable Smoke Evacuation Tubing (not illustrated)

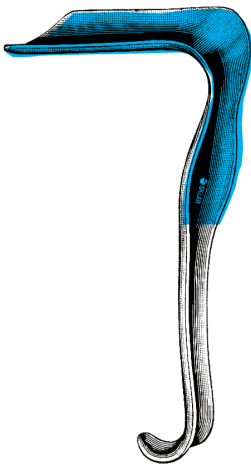

**JACKSON VAGINAL RETRACTORS**

**SINGLE END**

- 91-5215 3" x 1½" Small
- 91-5218 3½" x 1½" Medium
- 91-5220 4" x 1½" Large



**TAUBER VAGINAL SPATULA**

91-5176 3½"

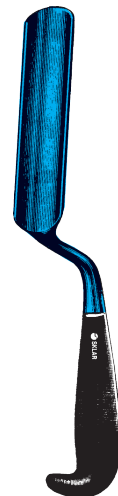

**SEGOND VAGINAL SPATULA**

91-5178 4¾"

For a complete listing of our OB/GYN product line, visit [www.sklarcorp.com](http://www.sklarcorp.com).



# OB/GYN INSTRUMENTS

## SKLAR BLUE™ ELECTRO SURGERY

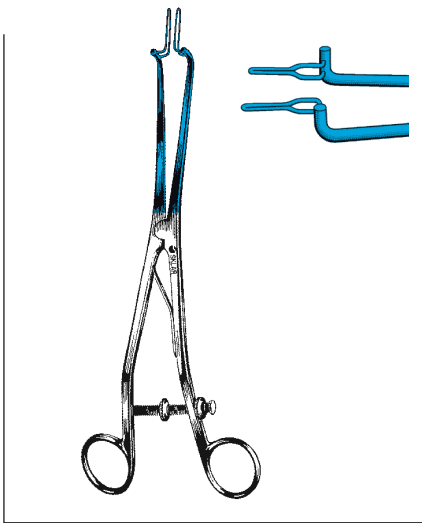

**KOGAN ENDOCERVICAL SPECULUM**

WITH GAUGE AND SCREW

91-5230 Narrow Wire Blades

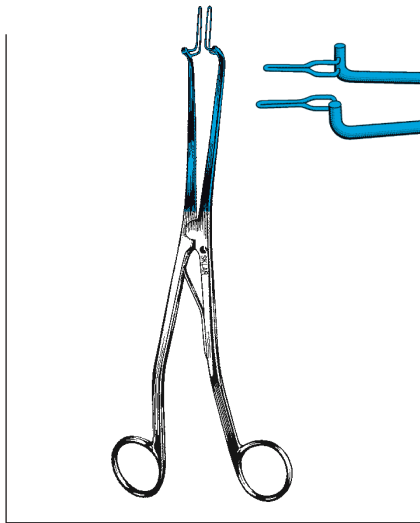

**KOGAN ENDOCERVICAL SPECULUM**

WITH SPRING HANDLE

91-5228 Narrow Wire Blades

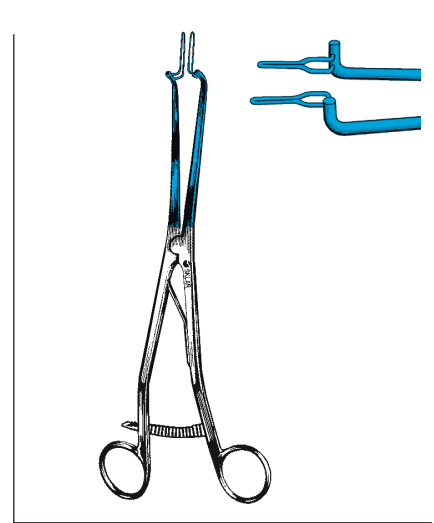

**KOGAN ENDOCERVICAL SPECULUM**

WITH RATCHET HANDLE

91-5235 Narrow Wire Blades



**KOGAN ENDOCERVICAL SPECULUM**

WITH GAUGE AND SCREW

91-5232 Wide Wire Blades

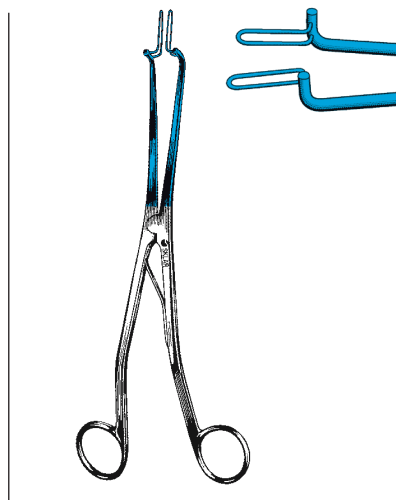

**KOGAN ENDOCERVICAL SPECULUM**

WITH SPRING HANDLE

91-5226 Wide Wire Blades

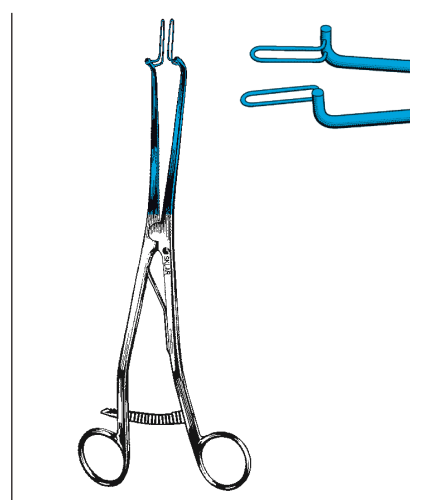

**KOGAN ENDOCERVICAL SPECULUM**

WITH RATCHET HANDLE

91-5234 Wide Wire Blades



Autoclavable

For a complete listing of our OB/GYN product line, visit [www.sklarcorp.com](http://www.sklarcorp.com).



**OB/GYN INSTRUMENTS**  
**SKLAR BLUE™ ELECTRO SURGERY**



**SCHWEIZER FORCEPS**

91-5404 9½" Straight



**CLEMETSON FORCEPS**

**WITHOUT RATCHET**

91-5400 9½" Straight

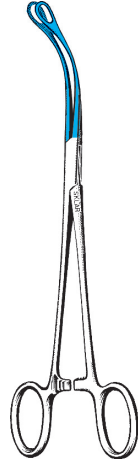

**LAUFE UTERINE POLYP FORCEPS**

91-5408 7¾"

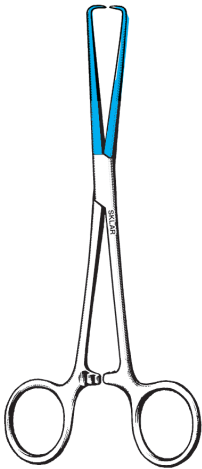

**SCHROEDER TENACULUM  
FORCEPS**

91-5450 10" Braun Flat Tips  
91-5452 10" Pozzi Round Tips



**BABCOCK FORCEPS**

91-5268 8"  
91-5270 9½"

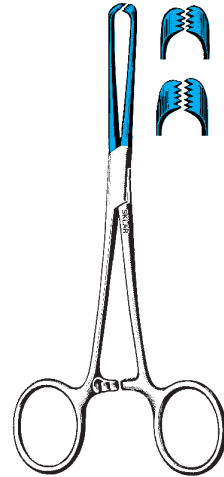

**ALLIS TISSUE FORCEPS**

91-5278 7½" 5x6 Teeth  
91-5440 9½" 5x6 Teeth

For a complete listing of our OB/GYN product line, visit [www.sklarcorp.com](http://www.sklarcorp.com).



Autoclavable



# OB/GYN INSTRUMENTS

## SKLAR BLUE™ ELECTRO SURGERY



### BOZEMAN FORCEPS

91-5310 10 1/4" S-Curve, One Large Ring

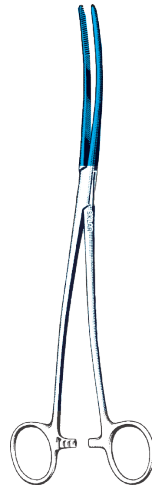

### BOZEMAN FORCEPS

91-5307 10 1/2" Straight  
91-5308 10 1/4" S-Curve



### ADSON FORCEPS

91-5428 4 3/4" Serrated



### DRESSING FORCEPS

91-5420 8" Serrated  
91-5422 10" Serrated  
91-5424 12" Serrated

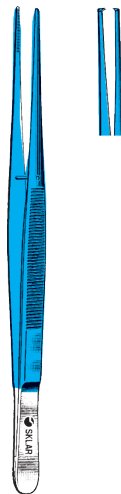

### POTTS-SMITH FORCEPS

91-5411 7" Serrated  
91-5412 10" Serrated  
91-5413 8 1/4" 1x2 Teeth  
91-5414 10" 1x2 Teeth

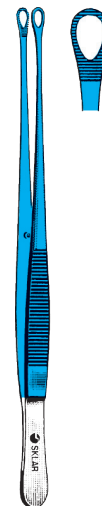

### TUTTLE/ SINGLEY FORCEPS

91-5300 7" Tuttle  
91-5302 9" Singley



Autoclavable

For a complete listing of our OB/GYN product line, visit [www.sklarcorp.com](http://www.sklarcorp.com).

[www.sklarcorp.com](http://www.sklarcorp.com)  800.221.2166



OB/GYN INSTRUMENTS  
SKLAR BLUE™ ELECTRO SURGERY



1 MM DIAMETER



3 MM DIAMETER



4 MM DIAMETER



6 MM DIAMETER

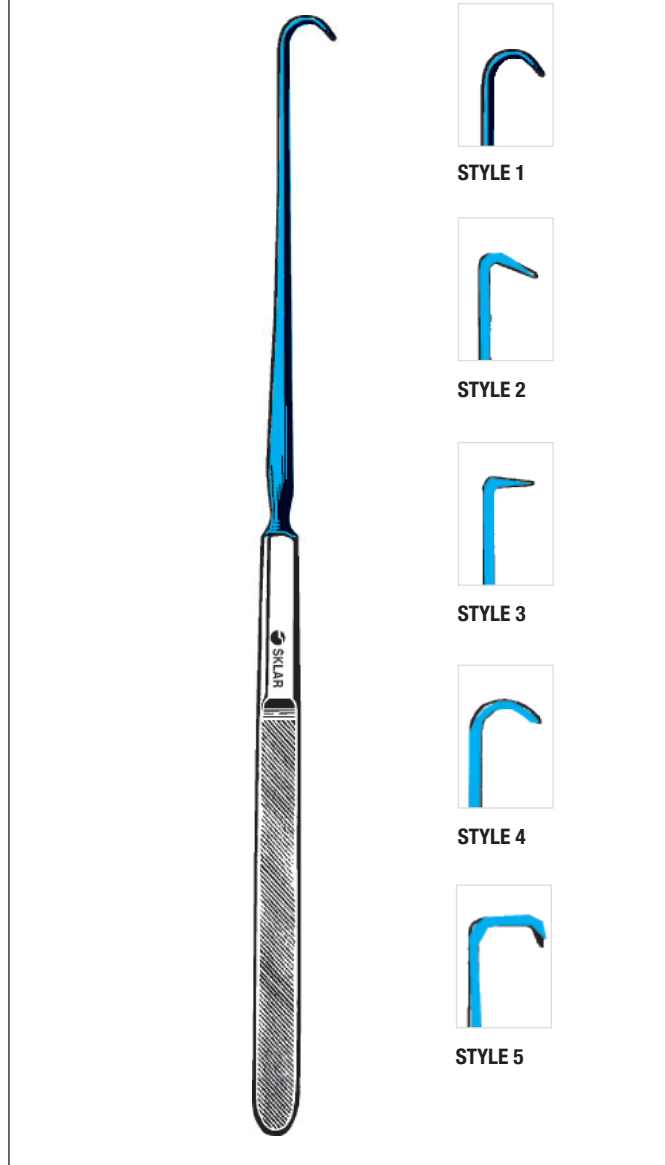

STYLE 1



STYLE 2



STYLE 3



STYLE 4



STYLE 5

**IRIS HOOKS**

**QUICK RELEASE**

91-5244	9"	1mm	91-5248	12"	1mm
91-5243	9"	3mm	91-5247	12"	3mm
91-5242	9"	4mm	91-5246	12"	4mm
91-5241	9"	6mm	91-5245	12"	6mm
91-5236	9"	Set of 4	91-5238	12"	Set of 4

**EMMETT HOOKS**

91-5251	9"	Style 1
91-5252	9"	Style 2
91-5253	9"	Style 3
91-5254	9"	Style 4
91-5255	9"	Style 5
91-5250	9"	Set of 5

For a complete listing of our OB/GYN product line, visit [www.sklarcorp.com](http://www.sklarcorp.com).



Autoclavable

# ELECTRO SURGERY

## ELECTROSURGICAL PENCILS



### Single Use / Sterile

Sklar Premium Electrosurgical Pencils are available in a push button, foot switch or rocker switch configuration. Sklar pencils are ergonomically designed to provide maximum balance and comfort for the surgeon. Each pencil features a removable 2.75" stainless steel blade electrode, with hex locking feature to provide stability during difficult surgical procedures.

Unsurpassed performance and design features, like sealed switching components, make the Sklar Premium Electrosurgical Pencil the right choice. Pencil tips are interchangeable with any of Sklar's electrodes and most other manufacturer's electrodes. Sklar Pencils come standard with a pre-attached 3 meter cord with a standard three prong plug. All Electrosurgical Pencils are provided in a single use, sterile pouch.

### PUSH BUTTON SWITCH

PRODUCT NUMBER	FEATURES	ACCESSORIES	QUANTITIES
96-9601	2.75" Blade Electrode	-	50/Box
96-9602	2.75" Blade Electrode	-	50/bx, 2bx/cs, 100/cs
96-9603	2.75" Blade Electrode	Holster	50/Box
96-9604	2.75" Blade Electrode	Holster	50/bx, 2bx/cs, 100/cs
96-9605	2.75" Blade Electrode	Holster, Tip Cleaner	50/Box
96-9606	2.75" Blade Electrode	Holster, Tip Cleaner	50/bx, 2bx/cs, 100/cs
96-9607	2.75" Coated Blade Electrode	-	50/Box
96-9608	2.75" Coated Blade Electrode	-	50/bx, 2bx/cs, 100/cs
96-9609	2.75" Coated Blade Electrode	Holster	50/Box
96-9610	2.75" Coated Blade Electrode	Holster	50/bx, 2bx/cs, 100/cs



### ROCKER SWITCH

PRODUCT NUMBER	FEATURES	ACCESSORIES	QUANTITIES
96-9611	2.75" Blade Electrode	-	50/Box
96-9612	2.75" Blade Electrode	-	50/bx, 2bx/cs, 100/cs
96-9613	2.75" Blade Electrode	Holster	50/Box
96-9614	2.75" Blade Electrode	Holster	50/bx, 2bx/cs, 100/cs
96-9615	2.75" Blade Electrode	Holster, Tip Cleaner	50/Box
96-9616	2.75" Blade Electrode	Holster, Tip Cleaner	50/bx, 2bx/cs, 100/cs
96-9617	2.75" Coated Blade Electrode	-	50/Box
96-9618	2.75" Coated Blade Electrode	-	50/bx, 2bx/cs, 100/cs
96-9619	2.75" Coated Blade Electrode	Holster	50/Box
96-9620	2.75" Coated Blade Electrode	Holster	50/bx, 2bx/cs, 100/cs



### FOOT SWITCH

PRODUCT NUMBER	FEATURES	ACCESSORIES	QUANTITIES
96-9621	2.75" Blade Electrode	-	50/Box
96-9622	2.75" Blade Electrode	-	50/bx, 2bx/cs, 100/cs
96-9623	2.75" Blade Electrode	Holster	50/Box
96-9624	2.75" Blade Electrode	Holster	50/bx, 2bx/cs, 100/cs
96-9625	2.75" Blade Electrode	Holster, Tip Cleaner	50/Box
96-9626	2.75" Blade Electrode	Holster, Tip Cleaner	50/bx, 2bx/cs, 100/cs
96-9627	2.75" Coated Blade Electrode	-	50/Box
96-9628	2.75" Coated Blade Electrode	-	50/bx, 2bx/cs, 100/cs
96-9629	2.75" Coated Blade Electrode	Holster	50/Box
96-9630	2.75" Coated Blade Electrode	Holster	50/bx, 2bx/cs, 100/cs

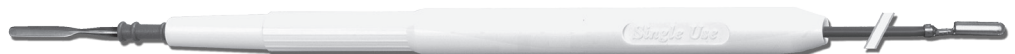



# ELECTROSURGERY ELECTRODES

## Single Use / Sterile

Sklar Premium Blade Electrodes feature a ribbed molded insulator, which allows the surgeon or technician easy removal of the electrode during procedures. They are available with a hex lock feature that assures stability and prohibits rotation of the blade during difficult procedures. They are also available coated with an anti-stick material that allows easy clean up of accumulated debris.

### BLADE ELECTRODES

PRODUCT NUMBER	FEATURES	QUANTITIES
96-9632	Flex Tip Blade, 2.4"	10/Box
96-9633	Flex Tip Blade, 2.4"	10/bx, 10bx/cs, 100/cs
96-9634	Flex Tip Blade, Hex Lock Hub, 2.4"	10/Box
96-9635	Flex Tip Blade, Hex Lock Hub, 2.4"	10/bx, 10bx/cs, 100/cs
96-9636	Solid Steel Blade, 2.75"	10/Box
96-9637	Solid Steel Blade, 2.75"	10/bx, 10bx/cs, 100/cs
96-9638	Solid Steel Coated Blade, 2.75"	10/Box
96-9639	Solid Steel Coated Blade 2.75"	10/bx, 10bx/cs, 100/cs
96-9640	Solid Steel Blade, Hex Lock Hub, 2.75"	10/Box
96-9641	Solid Steel Blade, Hex Lock Hub, 2.75"	10/bx, 10bx/cs, 100/cs
96-9642	Solid Steel Coated Blade, Hex Lock Hub, 2.75"	10/Box
96-9643	Solid Steel Coated Blade, Hex Lock Hub, 2.75"	10/bx, 10bx/cs, 100/cs



PRODUCT NUMBER	FEATURES	QUANTITIES
96-9644	Solid Steel Blade, 6"	10/Box
96-9645	Solid Steel Blade, 6"	10/bx, 10bx/cs, 100/cs



PRODUCT NUMBER	FEATURES	QUANTITIES
96-9646	Solid Steel Coated Blade, 6"	10/Box
96-9647	Solid Steel Coated Blade, 6"	10/bx, 10bx/cs, 100/cs



PRODUCT NUMBER	FEATURES	QUANTITIES
96-9648	Solid Steel Blade, 10"	10/Box
96-9649	Solid Steel Blade, 10"	10/bx, 10bx/cs, 100/cs



PRODUCT NUMBER	FEATURES	QUANTITIES
96-9650	Solid Steel Coated Blade, 10"	10/Box
96-9651	Solid Steel Coated Blade, 10"	10/bx, 10bx/cs, 100/cs



**Single Use / Sterile**

Sklar Premium Loop Electrodes feature a strong and durable tungsten steel loop incorporated into a reinforced T-molded head for added stability during difficult and delicate surgical procedures. All electrodes are a standard five inches in length and feature an extended insulation covering to protect the surgeon and patient.

**LOOP ELECTRODES**

PRODUCT NUMBER	FEATURES	QUANTITIES
----------------	----------	------------

96-9652	Tungsten Loop, 10mm x 5mm, 5"	5/Box
---------	-------------------------------	-------

96-9653	Tungsten Loop, 10mm x 5mm, 5"	5/bx, 10bx/cs, 50/cs
---------	-------------------------------	----------------------



96-9654	Tungsten Loop, 10mm x 10mm, 5"	5/Box
---------	--------------------------------	-------

96-9655	Tungsten Loop, 10mm x 10mm, 5"	5/bx, 10bx/cs, 50/cs
---------	--------------------------------	----------------------



96-9656	Tungsten Loop, 15mm x 10mm, 5"	5/Box
---------	--------------------------------	-------

96-9657	Tungsten Loop, 15mm x 10mm, 5"	5/bx, 10bx/cs, 50/cs
---------	--------------------------------	----------------------



96-9658	Tungsten Loop, 15mm x 15mm, 5"	5/Box
---------	--------------------------------	-------

96-9659	Tungsten Loop, 15mm x 15mm, 5"	5/bx, 10bx/cs, 50/cs
---------	--------------------------------	----------------------



96-9660	Tungsten Loop, 20mm x 10mm, 5"	5/Box
---------	--------------------------------	-------

96-9661	Tungsten Loop, 20mm x 10mm, 5"	5/bx, 10bx/cs, 50/cs
---------	--------------------------------	----------------------



96-9662	Tungsten Loop, 20mm x 15mm, 5"	5/Box
---------	--------------------------------	-------

96-9663	Tungsten Loop, 20mm x 15mm, 5"	5/bx, 10bx/cs, 50/cs
---------	--------------------------------	----------------------

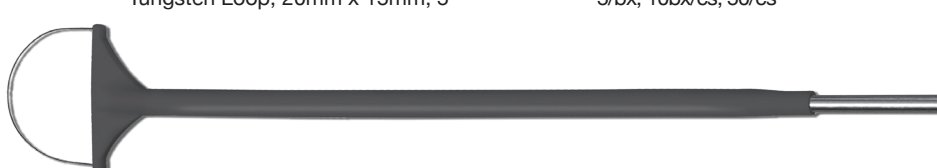



# ELECTROSURGERY ELECTRODES

Single Use / Sterile

### LLETZ BALL ELECTRODES

PRODUCT NUMBER	FEATURES	QUANTITIES
96-1040	3mm / 0.3cm	5/Box



### LLETZ SQUARE ELECTRODES

PRODUCT NUMBER	FEATURES	QUANTITIES
96-1099	10 x 8mm / 1.0 x 0.8cm	5/Box



### LLETZ LOOP ELECTRODES

PRODUCT NUMBER	FEATURES	QUANTITIES
96-1060	15 x 8mm / 1.5 x 0.8cm	5/Box
96-1075	20 x 8mm / 2.0 x 0.8cm	5/Box
96-1085	20 x 20mm / 2.0 x 2.0cm	5/Box



**Single Use / Sterile**

Sklar Premium Needle Electrodes feature a durable and ultra fine needle point for precise locations during the surgical procedure. All electrodes feature a ribbed molded insulation for easy removal and extended insulation to protect the surgeon and patient.

**STRAIGHT NEEDLE ELECTRODES**

PRODUCT NUMBER	FEATURES	QUANTITIES
96-9664	Solid Stainless Steel Needle, 2.8"	10/Box
96-9665	Solid Stainless Steel Needle, 2.8"	10/bx, 10bx/cs, 100/cs
96-9666	Solid Stainless Steel Coated Needle, 2.8"	10/Box
96-9667	Solid Stainless Steel Coated Needle, 2.8"	10/bx, 10bx/cs, 100/cs

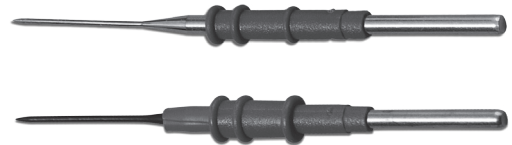

96-9668	Solid Stainless Steel Needle, 6"	10/Box
96-9669	Solid Stainless Steel Needle, 6"	10/bx, 10bx/cs, 100/cs



96-9670	Solid Stainless Steel Coated Needle, 6"	10/Box
96-9671	Solid Stainless Steel Coated Needle, 6"	10/bx, 10bx/cs, 100/cs



96-9672	Solid Stainless Steel Needle, 10"	10/Box
96-9673	Solid Stainless Steel Needle, 10"	10/bx, 10bx/cs, 100/cs



96-9674	Solid Stainless Steel Coated Needle, 10"	10/Box
96-9675	Solid Stainless Steel Coated Needle, 10"	10/bx, 10bx/cs, 100/cs





# ELECTROSURGERY ELECTRODES

## Single Use / Sterile

Sklar Premium Straight Ball Electrodes feature our Hex Locking system to assure stability during difficult procedures. They also have our Ribbed Molded insulation for easy removal and extended insulation for protection of the surgeon and patient.

### STRAIGHT BALL ELECTRODES

PRODUCT NUMBER	FEATURES	QUANTITIES
96-9676	Stainless Steel 4mm Ball, 2"	10/Box
96-9677	Stainless Steel 4mm Ball, 2"	10/bx, 10bx/cs, 100/cs
96-9678	Stainless Steel 4mm Coated Ball, 2"	10/Box
96-9679	Stainless Steel 4mm Coated Ball, 2"	10/bx, 10bx/cs, 100/cs
96-9680	Stainless Steel 5mm Ball, 2"	10/Box
96-9681	Stainless Steel 5mm Ball, 2"	10/bx, 10bx/cs, 100/cs
96-9682	Stainless Steel 5mm Coated Ball, 2"	10/Box
96-9683	Stainless Steel 5mm Coated Ball, 2"	10/bx, 10bx/cs, 100/cs

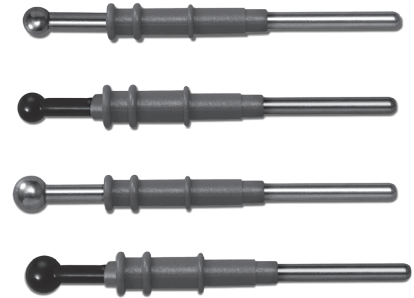

96-9684	Stainless Steel 5mm Ball, 5.3"	10/Box
96-9685	Stainless Steel 5mm Ball, 5.3"	10/bx, 10bx/cs, 100/cs



96-9686	Stainless Steel 5mm Coated Ball, 5.3"	10/Box
96-9687	Stainless Steel 5mm Coated Ball, 5.3"	10/bx, 10bx/cs, 100/cs





**Single Use / Non-Sterile**

Sklar Premium Patient Return Pads are manufactured using an advanced design hydro-gel adhesive that, incorporated with a gel overlay system, provide a much safer return pad for both the patient and surgeon. Sklar offers Patient Return Pads in five different configurations.

**RETURN ELECTRODES / GROUNDING PADS**

PRODUCT NUMBER	FEATURES	QUANTITIES
96-9688	Dual Element, 9' Cord Attached, Standard	50/cs
96-9690	Dual Element, Non-Corded, Standard	5/pk, 40pk/cs, 200/cs

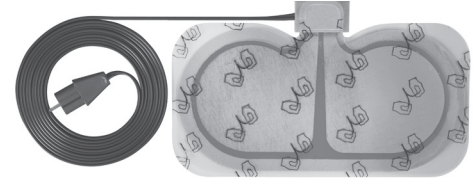

96-9688 and 96-9690 are dual element return pads designed to be used with electrosurgical units that are equipped with REM or Neutral Electrode safety systems that continually monitor impedance levels. The 96-9688 comes with a pre-attached 9 foot cord with standard plug. The 96-9690 requires the use of a reusable cable, 96-9698, and come in a resealable foil pouch.

PRODUCT NUMBER	FEATURES	QUANTITIES
96-9692	Single Element, 9' Cord Attached, Standard	50/cs
96-9694	Single Element, Non-Corded, Standard	5/pk, 40pk/cs, 200/cs

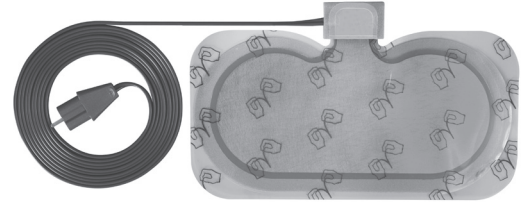

96-9692 and 96-9694 are traditional single element return pads manufactured using the same hydro-gel technology. Both are designed for use with all electrosurgical generators. The 96-9692 comes with a pre-attached 9 foot cord, with standard connector. The 96-9694 requires the use of a reusable cable, 96-9698, and come in a resealable foil pouch.

PRODUCT NUMBER	FEATURES	QUANTITIES
96-9696	Dual Element, 9' Cord Attached, Pediatric / Infant	50/cs

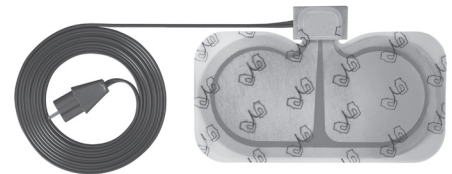



# ELECTROSURGERY ACCESSORIES

## CORDS AND CABLES

PRODUCT NUMBER	FEATURES	QUANTITIES
96-9698	Reusable Return Pad Cable For Use With Non-Corded Pads, 15' Non-Sterile	10/Box

PRODUCT NUMBER	FEATURES	QUANTITIES
96-9700	Single Use, Sterile, Bipolar Forceps Cord, Flying Lead, 12'	10/Box
96-9701	Single Use, Sterile, Bipolar Forceps Cord, Flying Lead, 12'	10/bx, 5bx/cs 50/cs

PRODUCT NUMBER	FEATURES	QUANTITIES
96-9702	Single Use, Sterile, Bipolar Forceps Cord, Solid Connector, 12'	10/Box
96-9703	Single Use, Sterile, Bipolar Forceps Cord, Solid Connector, 12'	10/bx, 5bx/cs 50/cs



## TIP CLEANERS-DISPOSABLE

PRODUCT NUMBER	FEATURES	QUANTITIES
96-9704	Sterile	50/Box
96-9706	Non-Sterile	500/Box

42.5MM X 42.5MM  
(1.7" X 1.7")



## HOLSTERS-DISPOSABLE

PRODUCT NUMBER	FEATURES	QUANTITIES
96-9708	Sterile	100/Box
96-9710	Non-Sterile	500/Box



**ADSON FORCEPS**

PRODUCT NUMBER	FEATURES
91-6100	1mm, 4 3/4"



**COAPTATION FORCEPS**

PRODUCT NUMBER	FEATURES
91-6101	.5mm, 4"

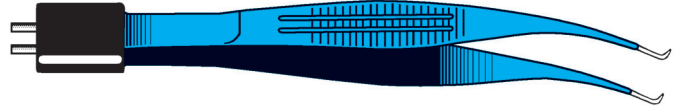

**CUSHING FORCEPS**

PRODUCT NUMBER	FEATURES
91-6102	1mm, 6"



**GERALD BAYONET FORCEPS**

PRODUCT NUMBER	FEATURES
91-6103	1mm, 7"



**GERALD FORCEPS**

PRODUCT NUMBER	FEATURES
91-6104	1mm, 7"



**HARDY BAYONET FORCEPS**

PRODUCT NUMBER	FEATURES
91-6105	1mm, 8 1/2"



**REUSABLE SILICONE BIPOLAR CABLE**

PRODUCT NUMBER	FEATURES
91-6113	10'

2-Pin US Instrument Plug with 4mm Generator Plug.  
Compatible with most US Generators

**WARNING: STERILIZATION GUIDELINES**

Follow manufacturer's recommendations and AAMI standards for sterilization.

STEAM: steam autoclave at 250°F / 121°C for 20 minutes.

FLASH: steam autoclave at 275°F / 134°C for 10 minutes.

GAS (ETO): follow manufacturer's guide for the unit which you are using.

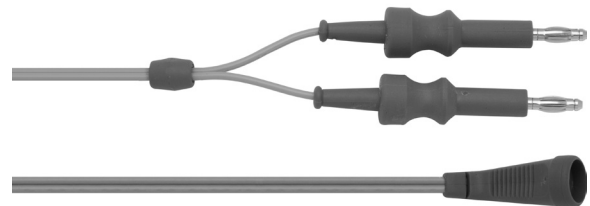



# ELECTROSURGERY BIPOLAR FORCEPS

## JANSEN BAYONET FORCEPS

PRODUCT NUMBER	FEATURES
91-6106	1mm, 6"



## JEWELER #5 FORCEPS

PRODUCT NUMBER	FEATURES
91-6107	.5mm 4½"



## MALIS FORCEPS

PRODUCT NUMBER	FEATURES
91-6108	1mm, 7"



## MCPHERSON FORCEPS

PRODUCT NUMBER	FEATURES
91-6109	.5mm, 3½" Curved



## MCPHERSON FORCEPS

PRODUCT NUMBER	FEATURES
91-6110	.5mm, 3½" Straight



## SEMKIN FORCEPS

PRODUCT NUMBER	FEATURES
91-6111	.5mm, 5½"



## TENZEL FORCEPS

PRODUCT NUMBER	FEATURES
91-6112	.5mm, 4"



# SINGLE PORT LAPAROSCOPY

## Discover the New Evolution in minimally invasive Laparoscopic Surgery

Single Port Laparoscopic surgery is an innovative procedure in which the skilled surgeon operates almost exclusively through a single entry point, typically the patients navel. Unlike the traditional multi-port laparoscopic approach, SPL leaves only a single small scar and most patients report less discomfort and faster recovery.

- Decreased trauma and risk for herniation
- Enhanced cosmetic benefits with minimal visible scarring
- Reduced post-operative pain
- Accelerated recovery time



Item Number 31-9415  
20mm Diameter

Trocar that supports (2) 5mm and (1) 10mm Trocar/Obturator

### SINGLE PORT TROCARS

INSTRUMENT	DIAMETER	FEATURES
31-9415	20mm	Trocar that supports (2) 5mm and (1) 10mm Trocar/Obturator
31-9416	5mm	Trocar/Obturator Support
31-9417	10mm	Trocar/Obturator Support
31-9418	12.5mm	Trocar/Obturator Support



### SUCTION IRRIGATION

INSTRUMENT	DIAMETER	LENGTH	FEATURES
31-9411	5mm	35cm	Non-Ratcheted Handle



### ETH NEEDLE HOLDERS

INSTRUMENT	DIAMETER	LENGTH	FEATURES
31-9404	5mm	35cm	Single Curve, Non-Ratcheted Handle
31-9412	5mm	35cm	Double Curve, Non-Ratcheted Handle

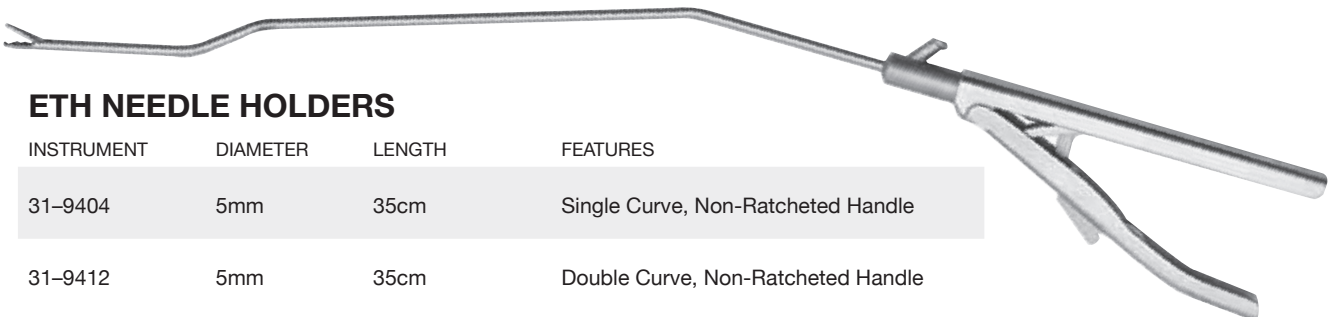



# LAPAROSCOPIC SKLARTECH 5000 | SINGLE PORT

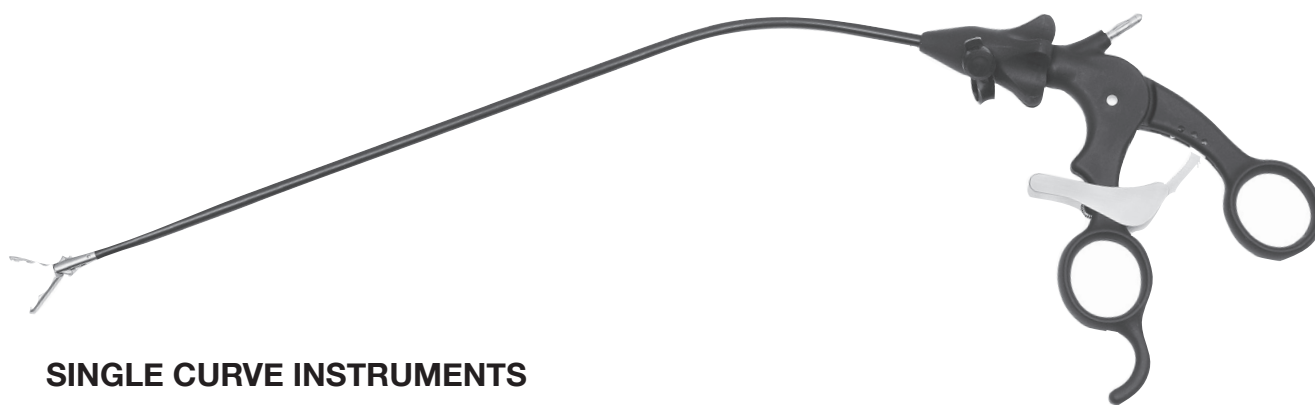

## SINGLE CURVE INSTRUMENTS

INSTRUMENT	DIAMETER	LENGTH	FEATURES
31-9400	5mm	35cm	Metzenbaum Scissor, Non-Ratcheted Handle
31-9401	5mm	35cm	Maryland Dissector, Non-Ratcheted Handle
31-9402	5mm	35cm	Endo Clinch Grasping Forceps, Ratchet Handle
31-9403	5mm	35cm	Maxi Grasping Forceps, Ratchet Handle

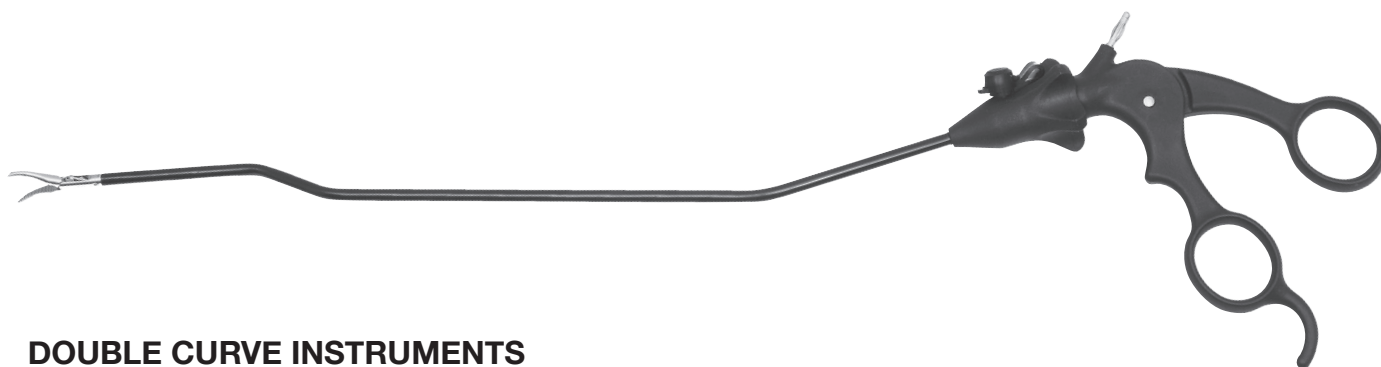

## DOUBLE CURVE INSTRUMENTS

INSTRUMENT	DIAMETER	LENGTH	FEATURES
31-9405	5mm	35cm	Metzenbaum Scissor, Non-Ratcheted Handle
31-9406	5mm	35cm	Maryland Dissector, Non-Ratcheted Handle
31-9407	5mm	35cm	Endo Clinch Grasping Forceps, Ratcheted Handle
31-9408	5mm	35cm	Maxi Grasping Forceps, Ratcheted Handle
31-9409	5mm	35cm	L-Hook Electrode, Non-Ratcheted Handle
31-9410	5mm	35cm	Button Electrode, Non-Ratcheted Handle



# LAPAROSCOPIC

## SKLARTECH 5000 | SCISSORS



Offering a full range of the most popular patterns and sizes, SklarTech 5000 Laparoscopic complete instruments come standard with insert and tip, insulated cannula and handle with locking collar. Sklar also carries a full line of interchangeable replacement parts, accessories and miniature instruments for your surgical preference.

### PERITONEAL SCISSORS

COMPLETE INSTRUMENT	REPLACEMENT INSERT	DIAMETER	LENGTH	FEATURES
31-9026XC	31-9026	5mm	33cm	Straight, Blunt Tips, XC Handle



### OPERATING SCISSORS

COMPLETE INSTRUMENT	REPLACEMENT INSERT	DIAMETER	LENGTH	FEATURES
31-9027XC	31-9027	10mm	33cm	Straight, XC Handle

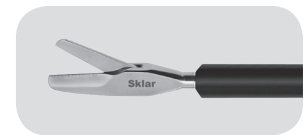

### METZENBAUM SCISSORS

COMPLETE INSTRUMENT	REPLACEMENT INSERT	DIAMETER	LENGTH	FEATURES
31-9005XC	31-9005	5mm	33cm	Straight, XC Handle
31-9005YC	31-9005	5mm	33cm	Straight, YC Handle



COMPLETE INSTRUMENT	REPLACEMENT INSERT	DIAMETER	LENGTH	FEATURES
31-9010XC	31-9010	5mm	33cm	Curved, XC Handle
31-9010XC-45	31-9010-45	5mm	45cm	Curved, XC Handle



COMPLETE INSTRUMENT	REPLACEMENT INSERT	DIAMETER	LENGTH	FEATURES
31-9012XC	31-9012	5mm	33cm	Curved, Serrated, XC Handle
31-9012XC-45	31-9012-45	5mm	45cm	Curved, Serrated, XC Handle





# LAPAROSCOPIC SKLARTECH 5000 | SCISSORS

## HOOK SCISSORS

COMPLETE INSTRUMENT	REPLACEMENT INSERT	DIAMETER	LENGTH	FEATURES
31-9016XC	31-9016	5mm	33cm	Standard, Flush Tips, XC Handle



COMPLETE INSTRUMENT	REPLACEMENT INSERT	DIAMETER	LENGTH	FEATURES
31-9015XC	31-9015	5mm	33cm	Sharp Cutting Edge, Overlapping Tips, XC Handle
31-9015XC-45	31-9015-45	5mm	45cm	Sharp Cutting Edge, Overlapping Tips, XC Handle



## MICRO SCISSORS

COMPLETE INSTRUMENT	REPLACEMENT INSERT	DIAMETER	LENGTH	FEATURES
31-9020XC	31-9020	5mm	33cm	Straight, Extremely Delicate, XC Handle

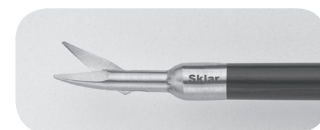

COMPLETE INSTRUMENT	REPLACEMENT INSERT	DIAMETER	LENGTH	FEATURES
31-9025XC	31-9025	5mm	33cm	Curved, Extremely Delicate, XC Handle





**MARYLAND DISSECTORS**

COMPLETE INSTRUMENT	REPLACEMENT INSERT	DIAMETER	LENGTH	FEATURES
31-9030XC	31-9030	5mm	33cm	Cross Serration, XC Handle
31-9030XC-45	31-9030-45	5mm	45cm	Cross Serration, XC Handle



COMPLETE INSTRUMENT	REPLACEMENT INSERT	DIAMETER	LENGTH	FEATURES
31-9031XC	31-9031	5mm	33cm	Diamond Serration, XC Handle
31-9120XC	31-9120	10mm	33cm	Diamond Serration, XC Handle



**MIXTER FORCEPS**

COMPLETE INSTRUMENT	REPLACEMENT INSERT	DIAMETER	LENGTH	FEATURES
31-9033XC	31-9033	5mm	33cm	90° Angle, Cross Serration, XC Handle



COMPLETE INSTRUMENT	REPLACEMENT INSERT	DIAMETER	LENGTH	FEATURES
31-9035XC	31-9035	5mm	33cm	90° Angle, Diamond Serration XC Handle
31-9125XC	31-9125	10mm	33cm	90° Angle, Diamond Serration XC Handle
31-9125XC-45	31-9125-45	10mm	45cm	90° Angle, Diamond Serration XC Handle

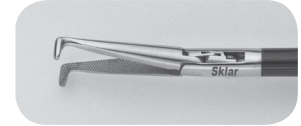

**DISSECTING FORCEPS**

COMPLETE INSTRUMENT	REPLACEMENT INSERT	DIAMETER	LENGTH	FEATURES
31-9036XC	31-9036	5mm	33cm	Curved, Serrated, XC Handle

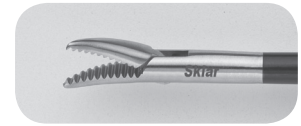

**DOLPHIN FORCEPS**

COMPLETE INSTRUMENT	REPLACEMENT INSERT	DIAMETER	LENGTH	FEATURES
31-9040XC	31-9040	5mm	33cm	Short, XC Handle

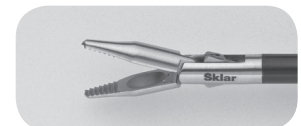



# LAPAROSCOPIC SKLARTECH 5000 | FORCEPS

## KELLY FORCEPS

COMPLETE INSTRUMENT	REPLACEMENT INSERT	DIAMETER	LENGTH	FEATURES
31-9043XC	31-9043	5mm	33cm	Double Action, XC Handle



## GLASSMANN FORCEPS

COMPLETE INSTRUMENT	REPLACEMENT INSERT	DIAMETER	LENGTH	FEATURES
31-9096YC	31-9096	5mm	33cm	Atraumatic Clamp, YC Handle



## TENACULUM FORCEPS

COMPLETE INSTRUMENT	REPLACEMENT INSERT	DIAMETER	LENGTH	FEATURES
31-9111YC	31-9111	5mm	33cm	1x1 Sharp Teeth, YC Handle
31-9113YC	31-9113	10mm	33cm	1x1 Sharp Teeth, YC Handle



## KOCHER FORCEPS

COMPLETE INSTRUMENT	REPLACEMENT INSERT	DIAMETER	LENGTH	FEATURES
31-9128XC	31-9128	10mm	33cm	60mm Jaws, Axial Serration, XC Handle



## SPOON FORCEPS

COMPLETE INSTRUMENT	REPLACEMENT INSERT	DIAMETER	LENGTH	FEATURES
31-9135XC	31-9135	10mm	33cm	XC Handle



## CLAW FORCEPS

COMPLETE INSTRUMENT	REPLACEMENT INSERT	DIAMETER	LENGTH	FEATURES
31-9045XC	31-9045	5mm	33cm	Traumatic Jaws, XC Handle
31-9045YC	31-9045	5mm	33cm	Traumatic Jaws, YC Handle
COMPLETE INSTRUMENT	REPLACEMENT INSERT	DIAMETER	LENGTH	FEATURES
31-9130XC	31-9130	10mm	33cm	Traumatic Jaws, XC Handle



**BABCOCK FORCEPS**

COMPLETE INSTRUMENT	REPLACEMENT INSERT	DIAMETER	LENGTH	FEATURES
31-9105YC	31-9105	5mm	33cm	YC Handle



COMPLETE INSTRUMENT	REPLACEMENT INSERT	DIAMETER	LENGTH	FEATURES
31-9140XC	31-9140	10mm	33cm	XC Handle
31-9140YC	31-9140	10mm	33cm	YC Handle
31-9140YC-45	31-9140-45	10mm	45cm	YC Handle

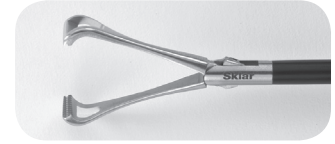

**ALLIS FORCEPS**

COMPLETE INSTRUMENT	REPLACEMENT INSERT	DIAMETER	LENGTH	FEATURES
31-9067YC	31-9067	5mm	33cm	TC Inserted Jaws, Atraumatic Clamp, YC Handle

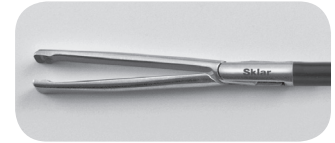

COMPLETE INSTRUMENT	REPLACEMENT INSERT	DIAMETER	LENGTH	FEATURES
31-9144YC	31-9144	10mm	33cm	TC Inserted Jaws, Diamond Serrations, YC Handle



**STRONG ATRAUMATIC CLAMP**

COMPLETE INSTRUMENT	REPLACEMENT INSERT	DIAMETER	LENGTH	FEATURES
31-9145YC	31-9145	10mm	33cm	40mm Jaws, Straight, YC Handle

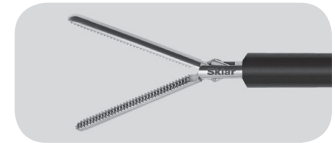

**NEEDLE HOLDER**

COMPLETE INSTRUMENT	REPLACEMENT INSERT	DIAMETER	LENGTH	FEATURES
31-9112YC	31-9112	5mm	33cm	10mm Jaws, Pointed, YC Handle





# LAPAROSCOPIC

## SKLARTECH 5000 | FORCEPS

### GRASPING FORCEPS

COMPLETE INSTRUMENT	REPLACEMENT INSERT	DIAMETER	LENGTH	FEATURES
31-9050XC	31-9050	5mm	33cm	Standard, Cross Serrations, XC Handle
31-9050YC	31-9050	5mm	33cm	Standard, Cross Serrations, YC Handle
31-9050YC-45	31-9050-45	5mm	45cm	Standard, Cross Serrations, YC Handle



COMPLETE INSTRUMENT	REPLACEMENT INSERT	DIAMETER	LENGTH	FEATURES
31-9051YC	31-9051	5mm	33cm	Tapered, Rounded Jaws, YC Handle
31-9051YC-45	31-9051-45	5mm	45cm	Tapered, Rounded Jaws, YC Handle

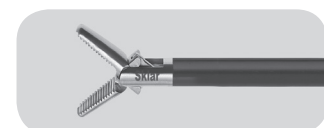

COMPLETE INSTRUMENT	REPLACEMENT INSERT	DIAMETER	LENGTH	FEATURES
31-9055YC	31-9055	5mm	33cm	Endo Clinch, Extremely Atraumatic Serrations, YC Handle



COMPLETE INSTRUMENT	REPLACEMENT INSERT	DIAMETER	LENGTH	FEATURES
31-9080YC	31-9080	5mm	33cm	With Spoon, YC Handle
31-9080XC	31-9080	5mm	33cm	With Spoon, XC Handle



COMPLETE INSTRUMENT	REPLACEMENT INSERT	DIAMETER	LENGTH	FEATURES
31-9085YC	31-9085	5mm	33cm	Pointed with Spoon, YC Handle

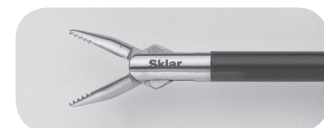

COMPLETE INSTRUMENT	REPLACEMENT INSERT	DIAMETER	LENGTH	FEATURES
31-9100YC	31-9100	5mm	33cm	Maxi (Fundus), YC Handle



**WAVE FORCEPS**

COMPLETE INSTRUMENT	REPLACEMENT INSERT	DIAMETER	LENGTH	FEATURES
31-9060YC	31-9060	5mm	33cm	Atraumatic Wavelike Serrations, Single Action, YC Handle
31-9060YC-45	31-9060-45	5mm	45cm	Atraumatic Wavelike Serrations, Single Action, YC Handle
31-9061YC	31-9061	5mm	33cm	Atraumatic Wavelike Serrations, Double Action, YC Handle



**DEBAKEY FORCEPS**

COMPLETE INSTRUMENT	REPLACEMENT INSERT	DIAMETER	LENGTH	FEATURES
31-9065YC	31-9065	5mm	33cm	40mm Jaws, YC Handle
31-9065XC	31-9065	5mm	33cm	40mm Jaws, XC Handle
31-9065YC-45	31-9065-45	5mm	45cm	40mm Jaws, YC Handle
31-9065XC-45	31-9065-45	5mm	45cm	40mm Jaws, XC Handle

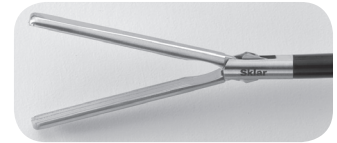

**BABCOCK/DEBAKEY FORCEPS**

COMPLETE INSTRUMENT	REPLACEMENT INSERT	DIAMETER	LENGTH	FEATURES
31-9142XC	31-9142	10mm	33cm	Atraumatic Serrations, XC Handle



**COBRA FORCEPS**

COMPLETE INSTRUMENT	REPLACEMENT INSERT	DIAMETER	LENGTH	FEATURES
31-9075YC	31-9075	5mm	33cm	2x3 Teeth, Double Action, YC Handle



**ALLIGATOR FORCEPS**

COMPLETE INSTRUMENT	REPLACEMENT INSERT	DIAMETER	LENGTH	FEATURES
31-9070YC	31-9070	5mm	33cm	Double Action, YC Handle





# LAPAROSCOPIC SKLARTECH 5000 | FORCEPS

## ATRAUMATIC GRASPERS

COMPLETE INSTRUMENT	REPLACEMENT INSERT	DIAMETER	LENGTH	FEATURES
31-9098YC	31-9098	5mm	33cm	Single Action, YC Handle



COMPLETE INSTRUMENT	REPLACEMENT INSERT	DIAMETER	LENGTH	FEATURES
31-9097XC	31-9097	5mm	33cm	Diamond Serrations, XC Handle
31-9097YC	31-9097	5mm	33cm	Diamond Serrations, YC Handle



## FENESTRATED GRASPING DISSECTOR

COMPLETE INSTRUMENT	REPLACEMENT INSERT	DIAMETER	LENGTH	FEATURES
31-9042XC	31-9042	5mm	33cm	16mm Double Action Jaw, XC Handle



## FENESTRATED GRASPING FORCEPS

COMPLETE INSTRUMENT	REPLACEMENT INSERT	DIAMETER	LENGTH	FEATURES
31-9090YC	31-9090	5mm	33cm	22mm Double Action Jaw, YC Handle
31-9090XC-45	31-9090-45	5mm	45cm	22mm Double Action Jaw, XC Handle

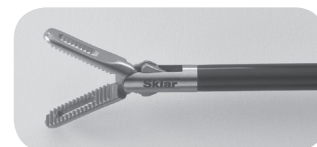

COMPLETE INSTRUMENT	REPLACEMENT INSERT	DIAMETER	LENGTH	FEATURES
31-9095XC	31-9095	5mm	33cm	40mm Double Action Jaw, XC Handle
31-9095YC	31-9095	5mm	33cm	40mm Double Action Jaw, YC Handle
31-9095XC-45	31-9095-45	5mm	45cm	40mm Double Action Jaw, XC Handle
31-9095YC-45	31-9095-45	5mm	45cm	40mm Double Action Jaw, YC Handle

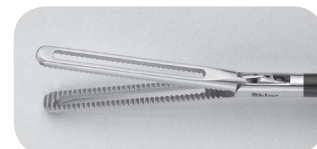

**PUNCH**

COMPLETE INSTRUMENT	REPLACEMENT INSERT	DIAMETER	LENGTH	FEATURES
31-9046XC	31-9046	5mm	33cm	Probe Excision



**BIOPSY PUNCH**

COMPLETE INSTRUMENT	REPLACEMENT INSERT	DIAMETER	LENGTH	FEATURES
31-9047XC	31-9047	5mm	33cm	No Tooth, XC Handle



COMPLETE INSTRUMENT	REPLACEMENT INSERT	DIAMETER	LENGTH	FEATURES
31-9110YC	31-9110	5mm	33cm	With Tooth, YC Handle
31-9110YC-45	31-9110-45	5mm	45cm	With Tooth, YC Handle



COMPLETE INSTRUMENT	REPLACEMENT INSERT	DIAMETER	LENGTH	FEATURES
31-9115XC	31-9115	5mm	33cm	Spoon with Teeth, XC Handle
31-9115YC	31-9115	5mm	33cm	Spoon with Teeth, YC Handle
31-9115YC-45	31-9115-45	5mm	45cm	Spoon with Teeth, YC Handle



**SKLAR  
STERILE TRAYS**

Sklar Sterile provides high quality products competitively priced to ensure unsurpassed value. Our procedure trays feature high quality Econo Floor Grade instruments from Sklar.

96-1715  
MINOR LACERATION TRAY 12/CASE

96-1725  
SUTURE TRAY 10/CASE

96-0095  
CT BIOPSY TRAY 10/CASE





# LAPAROSCOPIC SKLARTECH 5000 | HANDLES & CANNULAS

## SKLAR "XC" CARBON HANDLE

INSTRUMENT	FEATURES
31-9001XC	Standard, non-ratchet, lightweight, carbon fiber reinforced non-conductive safety handle with locking collar. Fully rotating with a proximally positioned high-frequency connector.

## SKLAR "YC" CARBON HANDLE

INSTRUMENT	FEATURES
31-9002YC	Standard, ratchet, lightweight, carbon fiber reinforced non-conductive safety handle with locking collar. Fully rotating with a proximally positioned high-frequency connector.

## SKLAR "XYC" COMBO HANDLE

INSTRUMENT	FEATURES
31-9003XYC	Lightweight, carbon fiber reinforced non-conductible safety handle with locking collar. Standard non-ratchet design but features an engageable ratchet to use as desired without changing handles. Fully rotating with a proximally positioned high-frequency connector.



## CANNULAS



INSTRUMENT	DIAMETER	LENGTH	FEATURES
31-9155	5mm	33cm	Insulated
31-9155-45	5mm	45cm	Insulated



INSTRUMENT	DIAMETER	LENGTH	FEATURES
31-9150	10mm	33cm	Insulated With Permanent Locking Collar Attached
31-9150-45	10mm	45cm	Insulated With Permanent Locking Collar Attached

Instruments may be ordered as complete sets or assembled from components ordered separately. Optional handles for customizing instruments – interchangeable for 3mm, 5mm or 10mm – are available for special order. Contact your Sklar Sales Representative for details.



## REPLACEMENT LOCKING COLLAR

INSTRUMENT	FEATURES
31-9160	For Sklar Standard Handles



### HASSON TROCAR WITH TRAP DOOR

COMPLETE INSTRUMENT	REPLACEMENT OBTURATOR	LENGTH	FEATURES
31-1001	31-0004	11mm	Hasson Trumpet Valve Cannula with 11mm Blunt Tip Obturator



### STANDARD TROCAR WITH TRUMPET VALVE

COMPLETE INSTRUMENT	REPLACEMENT OBTURATOR	LENGTH	FEATURES
31-1007	31-1010	5.5mm	Trumpet Valve Cannula With 5.5mm Sharp Obturator



### STANDARD TROCAR WITH TRAP DOOR

COMPLETE INSTRUMENT	REPLACEMENT OBTURATOR	LENGTH	FEATURES
31-1004	31-1011	11mm	Trap Door Cannula With 11mm Sharp Obturator



### STANDARD TROCAR WITH AUTOMATIC VALVE

COMPLETE INSTRUMENT	REPLACEMENT OBTURATOR	LENGTH	FEATURES
31-1015	31-1010	5.5mm	Automatic Valve Cannula with 5.5mm Sharp Obturator, Dismountable
31-1016	31-1011	11mm	Automatic Valve Cannula with 11mm Sharp Obturator, Dismountable

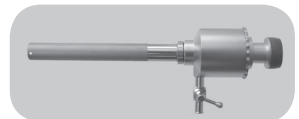

### STANDARD TROCAR WITH SILICON VALVE

COMPLETE INSTRUMENT	REPLACEMENT OBTURATOR	LENGTH	FEATURES
31-1017	31-1010	5.5mm	Silicon Valve Cannula with LL Stopcock & 5.5mm Sharp Obturator, Dismountable
31-1018	31-1011	11mm	Silicon Valve Cannula with LL Stopcock & 11mm Sharp Obturator, Dismountable

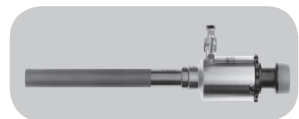

## OBTURATORS

INSTRUMENT	LENGTH	FEATURES
31-0004	11mm	Blunt Tip Obturator for 11mm Hasson Cannula
31-1011	11mm	Extremely Sharp Pyramidal Tip Obturator for Standard Trocar
31-1010	5.5mm	Extremely Sharp Pyramidal Tip Obturator for Standard Trocar

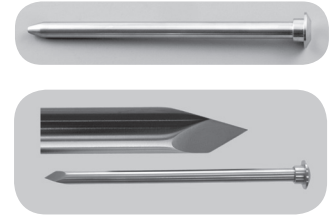

## THREADED CANNULA SLEEVE

INSTRUMENT	LENGTH	FEATURES
31-1020	5.5mm	Interchangeable with Standard Smooth Cannulas



## SNAP ON FLIP REDUCER

INSTRUMENT	LENGTH	FEATURES
31-1042	-	Reduces from 11mm to 5.5mm

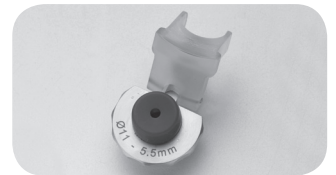

## S-RETRACTOR

INSTRUMENT	LENGTH	FEATURES
60-6130	6¼"	Set of 2

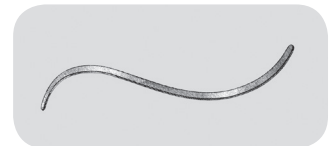

## TROCAR CANNULA PARTS

FOR USE WITH STANDARD & HASSON VALVE CANNULAS				
EXTERNAL SEALS	5.5mm	11mm	11mm (Hasson)	11mm (Hasson)
	RED	BLUE	BLUE	GRAY
	31-0003	31-0001	31-0001	31-0002
FOR USE WITH TRAP DOOR CANNULAS				
INTERNAL SEAL	5.5mm		11mm	
	GRAY		YELLOW	
	31-4323		31-4324	
FOR USE WITH SILICON VALVE CANNULAS				
SILICON VALVE	5.5mm		11mm	
	31-4328		31-4329	

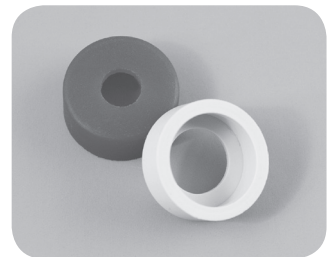

Each coagulating Electrode is able to connect to the suction control valve of your choice (Listed below).  
Insulated Electrodes and Control Valves sold separately.

**INSULATED ELECTRODES, WITH SUCTION**

INSTRUMENT	DIAMETER	FEATURES
31-2235 (A)	5mm	Spatula
31-2237 (B)	5mm	L-Hook
31-2241 (C)	5mm	Knife
31-2243 (D)	5mm	J-Hook
31-2244 (E)	5mm	Blunt

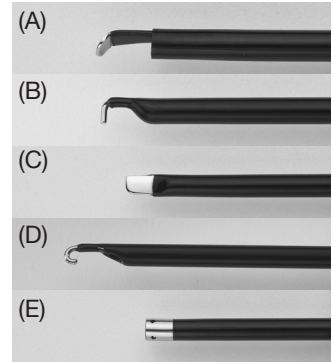

**HIGH FREQUENCY SUCTION CONTROL VALVES**

INSTRUMENT	DIAMETER	FEATURES
31-2227 (A)	5mm	Insulated Suction Control with Single Trumpet Valve
31-2233 (B)	5mm	Insulated Suction Control with Double Trumpet Valve
31-2229 (C)	5mm	Insulated Suction Control with Double Trumpet Valve and Handle

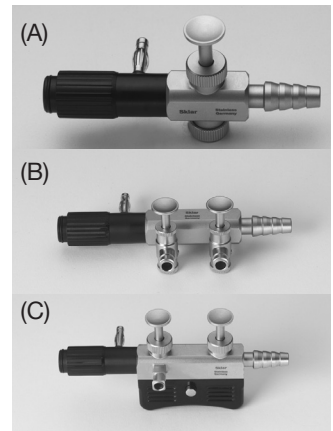

**INSULATED ELECTRODES, WITHOUT SUCTION**

Each Electrode has a permanently fitted adapter for connecting to the Electrosurgical Cable. Insulated Electrodes and Cables sold separately.

INSTRUMENT	DIAMETER	LENGTH	FEATURES
31-2435 (A)	5mm	33cm	Spatula
31-2437 (B)	5mm	33cm	L-Hook
31-2437-45	5mm	45cm	L-Hook
31-2443 (C)	5mm	33cm	J-Hook
31-2445 (D)	5mm	33cm	Button
31-2447 (E)	5mm	33cm	Cone

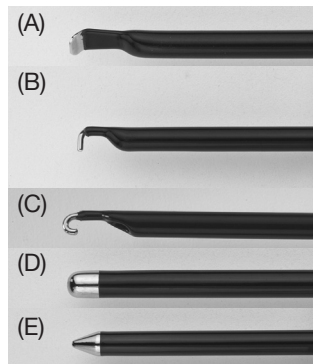

**ELECTROSURGICAL CABLE**

INSTRUMENT	FEATURES
31-2242	9' 4mm Tip, Monopolar: Compatible with Martin, Berchtold, Erbe T-Series
31-2253	10' 8mm Tip, Monopolar: Compatible with ValleyLab, Bovie, Conmed





# LAPAROSCOPIC SKLARTECH 5000 | MINIATURE

## METZENBAUM SCISSORS

COMPLETE INSTRUMENT	REPLACEMENT INSERT	DIAMETER	LENGTH	FEATURES
31-4306XC	31-4306	3mm	33cm	Mini, Straight, XC Handle
31-4303XC	31-4303	3mm	33cm	Mini, Curved, XC Handle
31-4307XC	31-4307	3mm	33cm	Mini, Curved, Serrated, XC Handle

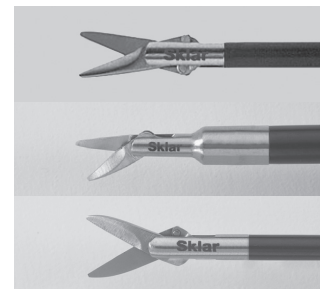

## HOOK SCISSORS

COMPLETE INSTRUMENT	REPLACEMENT INSERT	DIAMETER	LENGTH	FEATURES
31-4304XC	31-4304	3mm	33cm	Mini, Delicate, Straight, XC Handle



## MARYLAND DISSECTOR

COMPLETE INSTRUMENT	REPLACEMENT INSERT	DIAMETER	LENGTH	FEATURES
31-4310XC	31-4310	3mm	33cm	Mini, Cross Serrations, Curved XC Handle



## FORCEPS

COMPLETE INSTRUMENT	REPLACEMENT INSERT	DIAMETER	LENGTH	FEATURES
31-4314YC	31-4314	3mm	33cm	Mini Duck Nose, Cross Serrations, Straight, YC Handle
31-4309XC	31-4309	3mm	33cm	Mini Kelly, Double Action Delicate Jaws, XC Handle
31-4315XC	31-4315	3mm	33cm	Mini Spoon, XC Handle
31-4316XC	31-4316	3mm	33cm	Mini Spoon, Serrated, XC Handle



**GRASPING FORCEPS**

COMPLETE INSTRUMENT	REPLACEMENT INSERT	DIAMETER	LENGTH	FEATURES
31-4308YC	31-4308	3mm	33cm	Mini Grasping Forceps, YC Handle
31-4311XC	31-4311	3mm	33cm	Mini Atraumatic, Dissector, Straight XC Handle
31-4312YC	31-4312	3mm	33cm	Mini Grasping Forceps, Heavy Serrations, YC Handle
31-4313YC	31-4313	3mm	33cm	Mini Cobra, Heavy Serrations YC Handle
31-4317YC	31-4317	3mm	33cm	Mini Fenestrated, 8mm Double Action Jaws, YC Handle

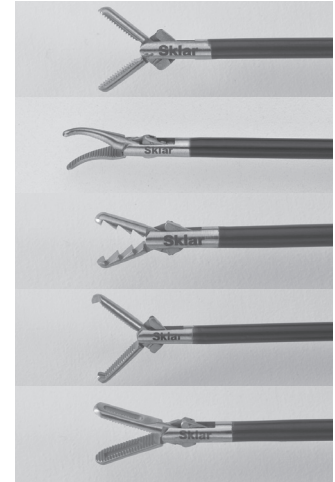

**PUNCH**

COMPLETE INSTRUMENT	REPLACEMENT INSERT	DIAMETER	LENGTH	FEATURES
31-4305XC	31-4305	3mm	33cm	Mini Punch, Delicate



**NEEDLE HOLDER**

**NON-INSULATED WITH TUNGSTEN CARBIDE JAW INSERTS AND AXIAL HANDLE**

COMPLETE INSTRUMENT	DIAMETER	LENGTH	FEATURES
31-9360AX	3mm	33cm	Mini, Straight, Axial Ring Handle
31-9362AX	3mm	33cm	Mini, Curved Right, Axial Ring Handle
31-9364AX	3mm	33cm	Mini, Curved Left, Axial Ring Handle

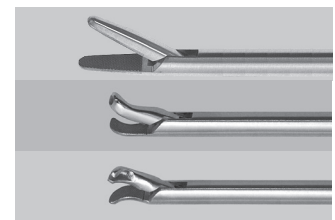

**COMPLETE INSTRUMENT**

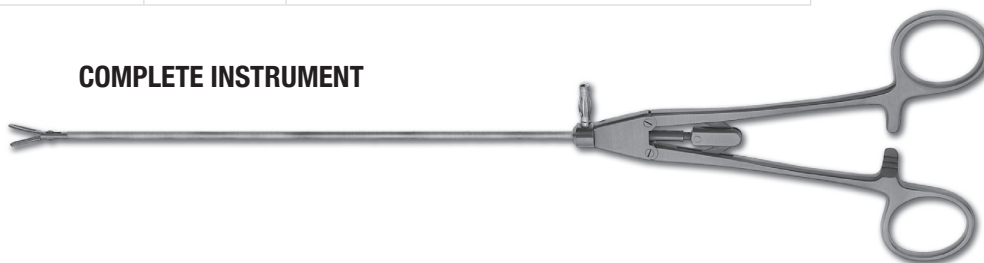



# LAPAROSCOPIC SKLARTECH 5000 | MINIATURE

## MINIATURE ENDOSCOPE

COMPLETE INSTRUMENT	DIAMETER	LENGTH	FEATURES
31-4301	2.7mm	30cm	Miniature, Autoclavable



## MINIATURE TROCAR

COMPLETE INSTRUMENT	REPLACEMENT OBTURATOR	DIAMETER	FEATURES
31-4302	31-4318	3mm	Mini, with Trap Door Cannula, Reusable, Includes 3mm Obturator
31-4320	-	3mm	External Seal, Red For use with Standard and Hasson Cannulas
31-4321	-	3mm	Internal Seal, Gray For use with Trap Door Cannulas only

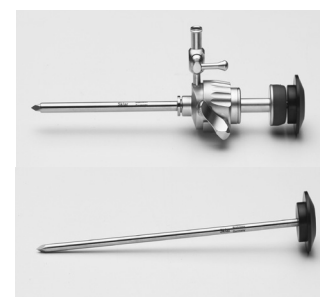

## ELECTROSURGERY

### INSULATED ELECTRODES WITHOUT SUCTION

Each Electrode has a permanently fitted adapter for connecting to the Electrosurgical Cable. Insulated Electrodes and Cables sold separately.

INSTRUMENT	DIAMETER	FEATURES
31-4325 (A)	3mm	Mini, Spatula
31-4326 (B)	3mm	Mini, L-Hook
31-4327 (C)	3mm	Mini, J-Hook

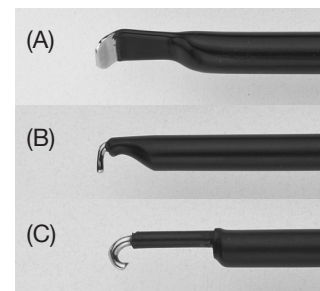

## ELECTROSURGICAL CABLE

INSTRUMENT	LENGTH	FEATURES
31-2242	9'	4mm Tip, Monopolar: Compatible with Martin, Berchtold, Erb T-Series
31-2253	10'	8mm Tip, Monopolar: Compatible with ValleyLab, Bovie, Conmed





**VERRES NEEDLE WITH STOPCOCK**

INSTRUMENT	DIAMETER	LENGTH	FEATURES
31-2327	2.3mm	100mm	Stopcock
31-2350	2.3mm	120mm	Stopcock
31-2352	2.3mm	150mm	Stopcock



**NEEDLE FOR INJECTION AND IRRIGATION**

INSTRUMENT	DIAMETER	LENGTH	FEATURES
31-2355	5mm	33cm	Luer Lock, 2mm Hollow Needle
31-2355-45	5mm	45cm	Luer Lock, 2mm Hollow Needle



**GRADUATED PROBE**

INSTRUMENT	DIAMETER	LENGTH	FEATURES
31-2365	5.5mm	33cm	Graduated



**LAPAROSCOPIC  
SKLARTECH 5000 | ACCESSORIES**



**ESOPHAGUS RETRACTOR**

INSTRUMENT	DIAMETER	LENGTH	FEATURES
31-4565	5mm	33cm	For Gastric Band Application



**FAN RETRACTOR**

INSTRUMENT	DIAMETER	LENGTH	FEATURES
31-4562	5mm	33cm	3 Finger Articulating Fan, Slightly Bent



**FAN RETRACTOR**

INSTRUMENT	DIAMETER	LENGTH	FEATURES
31-4563	10mm	33cm	5 Finger Articulating Fan, Slightly Bent



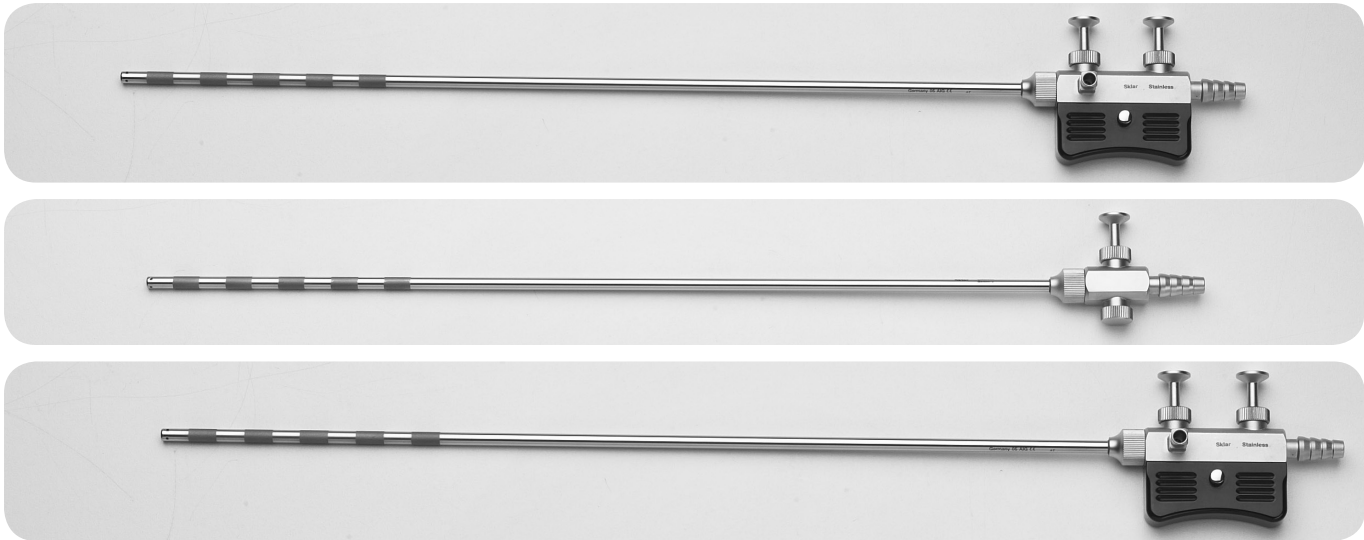

**SUCTION IRRIGATION SYSTEM**

COMPLETE INSTRUMENT	DIAMETER	LENGTH	FEATURES
31-2238	5mm	33cm	Dual Trumpet Valve (also fits 10mm Sheath)
31-2238-45	5mm	45cm	Dual Trumpet Valve (also fits 10mm Sheath)
31-2258	5mm	33cm	Single Trumpet Valve (also fits 10mm Sheath)
31-4003	5mm	33cm	Sheath Only
31-4004	10mm	33cm	Sheath Only
31-2205	5mm	33cm	Tube Channel, for Laser-Fiber
31-2238OR	-	-	O-Ring, Replacement Pk/10



**HIGH-VOLUME SUCTION IRRIGATION SYSTEM**

COMPLETE INSTRUMENT	DIAMETER	LENGTH	FEATURES
31-2239	5mm 10mm	33cm	Dual Trumpet Valve (includes both 5mm and 10mm Sheaths)
31-2347	5mm	33cm	Sheath Only
31-2349	10mm	33cm	Sheath Only



**LAPAROSCOPIC**  
**SKLARTECH 5000 | NEEDLE HOLDERS**

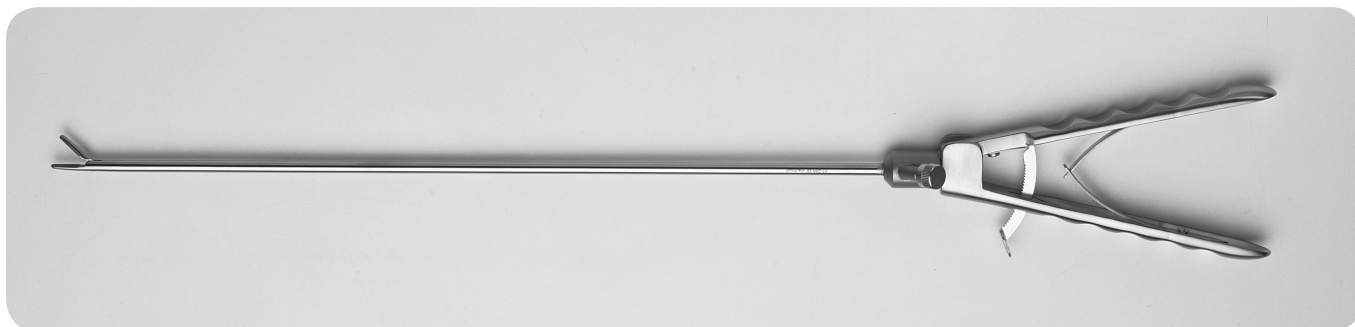

**TC NEEDLEHOLDER**  
**NON-INSULATED WITH TUNGSTEN CARBIDE JAW INSERTS AND AXIAL HANDLE**

COMPLETE INSTRUMENT	DIAMETER	LENGTH	FEATURES
31-2550	5mm	33cm	Standard, Straight, Flushable Shaft, 10mm Jaw, Axial Handle
31-2550-45	5mm	45cm	Standard, Straight, Flushable Shaft, 10mm Jaw, Axial Handle
31-2551	5mm	33cm	Standard, Curved Right, Flushable Shaft, 10mm Jaw, Axial Handle
31-2552	5mm	33cm	Standard, Curved Left, Flushable Shaft, 10mm Jaw, Axial Handle
31-2552-45	5mm	45cm	Standard, Curved Left, Flushable Shaft, 10mm Jaw, Axial Handle
31-2553	5mm	33cm	Standard, Straight, Solid Shaft, 8mm Jaw, Axial Handle

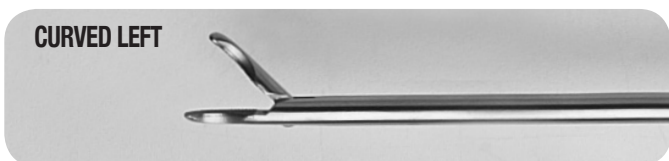
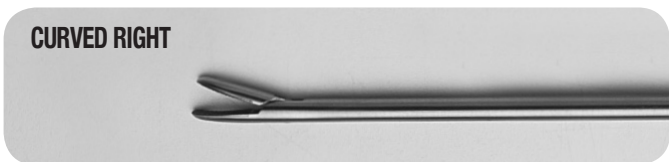
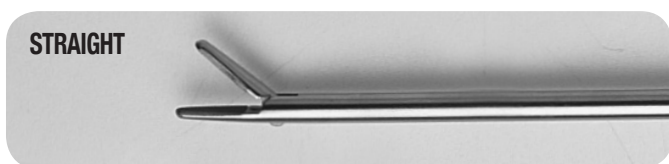

**98-1354 - BAND SET**

PRODUCT NUMBER	DESCRIPTION	QUANTITY
31-2238-45	Suction/Irrigation System with 45mm Cannula Dual Trumpet Valve	1
31-9012XC-45	Metzenaum Scissors, Curved - 5mm, 45cm	1
31-9030XC-45	Maryland Dissector - 5mm, 45cm	1
31-9090XC-45	Fenestrated Grasper, 22mm Jaw - 5mm, 45cm	1
31-9095XC-45	Fenestrated Grasper, 40mm Jaw - 5mm, 45cm	1
31-4565	Esophagus Retractor - 5mm	1

**98-1355 - CHOLECYSTECTOMY SET**

PRODUCT NUMBER	DESCRIPTION	QUANTITY
31-2227	Suction Control Handle for Spatula Electrode	2
31-2235	Spatula Electrode with Suction - 5mm	1
31-2237	L Hook Electrode with Suction - 5mm	1
31-2239	High Volume Suction Irrigation System	1
31-2355	Needle for Injection and Irrigation - 5mm	1
31-9005XC	Metzenbaum Scissors, Straight - 5mm, 33cm	1
31-9010XC	Metzenbaum Scissors, Curved - 5mm, 33cm	1
31-9015XC	Hook Scissors - 5mm, 33cm	1
31-9025XC	Micro Scissors, Curved - 5mm, 33cm	1
31-9030XC	Maryland Dissector - 5mm, 33cm	1
31-9035XC	Mixer Forceps, Diamond Serrations - 5mm, 33cm	1
31-9040XC	Dolphin Forceps with Spoon - 5mm, 33cm	1
31-9050YC	Standard Grasping Forceps - 5cm, 33cm	1
31-9060YC	Wave Grasper - 5mm, 33cm	1
31-9100YC	Maxi (Fundus) Grasper - 5mm, 33cm	1
31-9125XC	Mixer Forceps - 10mm, 33cm	1
31-9130XC	Claw Forceps - 10mm, 33cm	1
31-9135XC	Spoon Forceps - 10mm, 33cm	1

**98-1356 - APPENDECTOMY SET**

PRODUCT NUMBER	DESCRIPTION	QUANTITY
31-2239	High Volume Suction Irrigation System	1
31-2552	TC Needle Holder, Curved Left - 5mm, 33cm	1
31-9010XC	Metzenbaum Scissors, Curved - 5mm, 33cm	1
31-9025XC	Micro Scissors, Curved - 5mm, 33cm	1
31-9050YC	Standard Grasping Forceps - 5mm, 33cm	1
31-9085YC	Pointed Grasping Forceps with Spoon - 5mm, 33cm	1
31-9125XC	Mixer Forceps - 10mm, 33cm	1
31-9130XC	Claw Forceps - 10mm, 33mm	1

**98-1357 - BOWEL RESECTION SET**

PRODUCT NUMBER	DESCRIPTION	QUANTITY
31-2552	TC Needle Holder, Curved Left - 5mm, 33cm	1
31-2235	Spatula Electrode with Suction - 5mm	1
31-2227	Suction Control Valve for Spatula Electrode	1
31-9067YC	Allis Forceps TC - 5mm, 33cm	1
31-9080YC	Grasping Forceps with Spoon - 5mm, 33cm	1
31-9051YC	Tapering Grasping Forceps - 5mm, 33cm	1
31-9040XC	Dolphin Forceps with Spoon - 5mm, 33cm	1
31-9140YC	Babcock Forceps - 10mm, 33cm	1
31-9095YC	Fenestrated Grasper, 40mm Jaws - 5mm, 33cm	1
31-9010XC	Metzenbaum Scissors, Curved - 5mm 33cm	1
31-9025XC	Micro Scissors, Curved - 5mm, 33cm	1



# LAPAROSCOPIC SKLARTECH 5000 | LIGATURES

## LIGATION CLIPS

Sklar is pleased to offer the most atraumatic shaped clip on the market. Sklar Ligation Clips' unique "U-Shape" design provides a stronger, more permanent hold. The unique and highly-advanced cross-serrations on each clip make it extremely secure, eliminating slippage from the vessel after closure. And the solid titanium gives a scatter-free CT image and is MRI compatible.

Sklar Ligation Clips are conveniently packaged in sterile cartridges holding six single clips, eliminating waste. Cartridges feature an adhesive backing to easily affix to any surface.

Perfect compatibility between special applicators and clips allow for an effortless loading system while the chevron shape facilitates a surgeon's choice "tip-first" closing action. Vessels are contained within the clip so full control is available before ligation.



### STERILE

INSTRUMENT	SIZE	FEATURES	QUANTITIES
31-7300	Small	Yellow	6/pk, 20pk/cs, 120/cs
31-7301	Medium	Blue	6/pk, 20pk/cs, 120/cs
31-7302	Medium/Large	Green	6/pk, 20pk/cs, 120/cs
31-7303	Large	Orange	6/pk, 20pk/cs, 120/cs

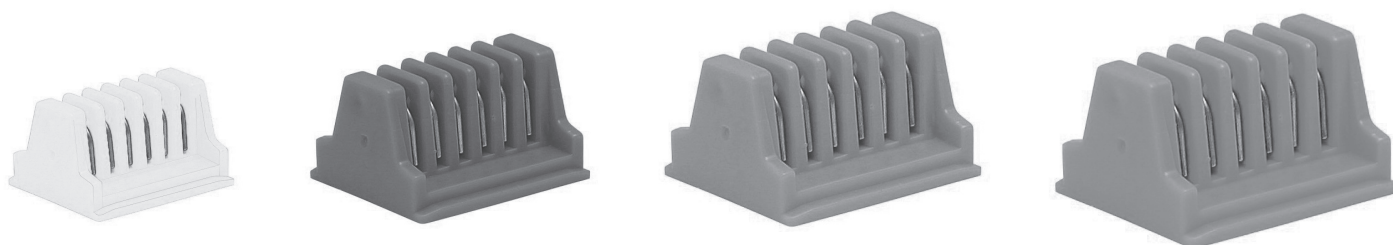

**OPEN SURGERY APPLIERS**

- Easy and Convenient Loading System
- Spring Action controls jaw compression
- Firm Grasp of clips
- Safe and precise closing action
- Color Coded for easy identification
- Full Range of Sizes to fit any application

**SMALL**

INSTRUMENT	LENGTH	FEATURES
31-7305	6" 150mm	Straight, Yellow
31-7306	7½" 190mm	Straight, Yellow
31-7307	7½" 190mm	Right Angle, Yellow

**MEDIUM**

INSTRUMENT	LENGTH	FEATURES
31-7308	6" 150mm	Straight, Blue
31-7309	7½" 190mm	Straight, Blue
31-7310	7½" 190mm	Right Angle, Blue
31-7311	11" 280mm	Straight, Blue
31-7312	11" 280mm	Right Angle, Blue

**MEDIUM/LARGE**

INSTRUMENT	LENGTH	FEATURES
31-7313	7½" 190mm	Straight, Green
31-7314	7½" 190mm	Right Angle, Green
31-7315	11" 280mm	Straight, Green
31-7316	11" 280mm	Right Angle, Green

**LARGE**

INSTRUMENT	LENGTH	FEATURES
31-7317	7½" 190mm	Straight, Orange
31-7318	7½" 190mm	Right Angle, Orange
31-7319	11" 280mm	Straight, Orange
31-7320	11" 280mm	Right Angle, Orange

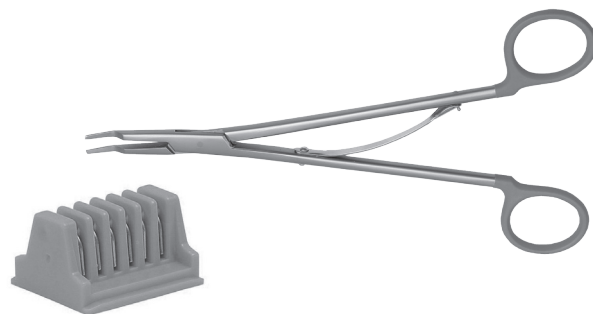

Clips and Appliers sold separately.



# LAPAROSCOPIC SKLARTECH 5000 | LIGATURES

## ROTATABLE APPLIERS

- Easy and Convenient Loading System
- Full 360° Rotation of applicator shape
- Sized to match popular clip sizes



INSTRUMENT	DIAMETER	LENGTH	FEATURES
31-7321	5mm	35cm	Clip Applicator for Small Ligation Clips



INSTRUMENT	DIAMETER	LENGTH	FEATURES
31-7322	8mm	35cm	Clip Applicator for Medium Ligation Clips

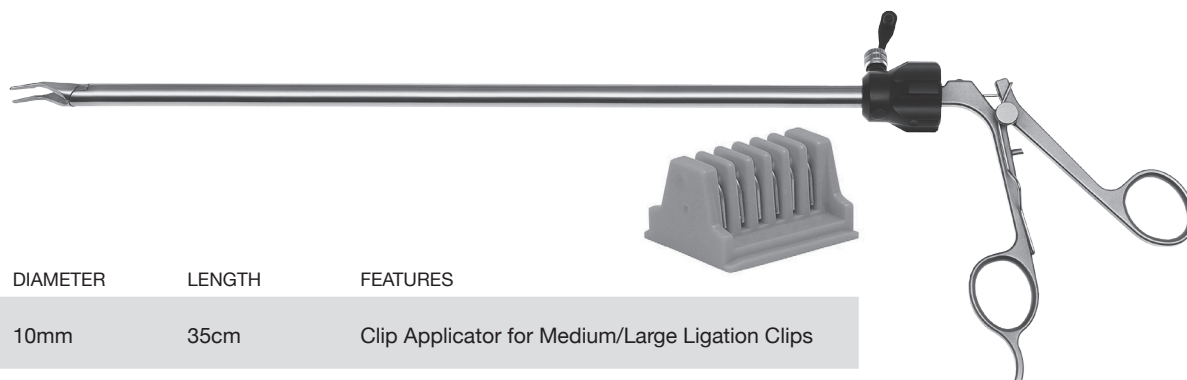

INSTRUMENT	DIAMETER	LENGTH	FEATURES
31-7323	10mm	35cm	Clip Applicator for Medium/Large Ligation Clips



INSTRUMENT	DIAMETER	LENGTH	FEATURES
31-7324	12.5mm	35cm	Clip Applicator for Large Ligation Clips

Clips and Appliers sold separately.

## HX-LINE Disposable Sheath/Insert with Reusable Handles

Sklar is proud to introduce the SKLARTECH 5000HX-Line of Disposable Laparoscopic Instruments featuring a disposable sheath/insert combination and reusable carbon fiber handle. With a disposable sheath/insert combination, all parts of the instrument that had direct contact during surgery can be disposed of immediately after procedures. The carbon fiber handles, available with or without ratchet, can quickly and easily be cleaned and sterilized for continued use.

- Choose from a full line of the most popular patterns.
- Benefit from factory-honed instrument edge with every use.
- Improved operating room efficiency.
- Eliminate difficult reprocessing procedures.
- Enhanced efficiency and cost savings.

**NEW!**

*Sklartech 5000HX*



### REUSABLE HANDLES

INSTRUMENT	DESCRIPTION	QUANTITIES
31-7001XC	Carbon Fiber without Ratchet	Each
31-7002YC	Carbon Fiber with Ratchet	Each

## DISPOSABLE SHEATH/INSERT

INSTRUMENT	DIAMETER	LENGTH	FEATURES	QUANTITIES
31-7070	5mm	33cm	Fenestrated Grasping Forceps, Serrated	10/pk
31-7070-45	5mm	45cm	Fenestrated Grasping Forceps, Serrated	10/pk
31-7030	5mm	33cm	Maryland Dissector, Curved, Cross Serrations	10/pk
31-7030-45	5mm	45cm	Maryland Dissector, Curved, Cross Serrations	10/pk
31-7055	5mm	33cm	Endo Clinch Forceps, Extremely Atraumatic, Serrated	10/pk
31-7055-45	5mm	45cm	Endo Clinch Forceps, Extremely Atraumatic, Serrated	10/pk
31-7061	5mm	33cm	Wave Grasper Forceps, Wavelike Serrations	10/pk
31-7061-45	5mm	45cm	Wave Grasper Forceps, Wavelike Serrations	10/pk
31-7035	5mm	33cm	Mixer Clamp Forceps, 90° Angle	10/pk
31-7035-45	5mm	45cm	Mixer Clamp Forceps, 90° Angle	10/pk
31-7040	5mm	33cm	Dolphin Nose Forceps, Serrated	10/pk
31-7040-45	5mm	45cm	Dolphin Nose Forceps, Serrated	10/pk
31-7073	5mm	33cm	Allis Forceps, 3x4 Teeth	10/pk
31-7073-45	5mm	45cm	Allis Forceps, 3x4 teeth	10/pk
31-7016	5mm	33cm	Hook Scissors, Single Action	10/pk
31-7016-45	5mm	45cm	Hook Scissors, Single Action	10/pk
31-7012	5mm	33cm	Metzenbaum Scissors, Curved, Serrated	10/pk
31-7012-45	5mm	45cm	Metzenbaum Scissors, Curved, Serrated	10/pk
31-7007	5mm	33cm	Metzenbaum Scissors, Straight, Serrated	10/pk
31-7007-45	5mm	45cm	Metzenbaum Scissors, Straight, Serrated	10/pk
31-7107	5mm	33cm	Babcock-Debaquey Forceps, Atraumatic Serrations	10/pk
31-7107-45	5mm	45cm	Babcock-Debaquey Forceps, Atraumatic Serrations	10/pk



Item Number 31-7030  
Maryland Forcep, Curved, Cross Serrations



# SKLARTECH 5000X

Sklar is pleased to introduce a new line of sterile, 100% Disposable Laparoscopic instruments. Complete with HF Port, the X-Line delivers quality and performance at an economical price. Improve safety and reduce the risk of cross contamination to patient and staff by disposing of the entire instrument immediately following procedures.

- Advantage of factory-honed instruments with every use.
- Simplify cost-accounting per operation.
- Eliminate reprocessing time and expense.
- Eliminate Maintenance.
- Reduce inventory.

**NEW!**

Sklartech 5000X

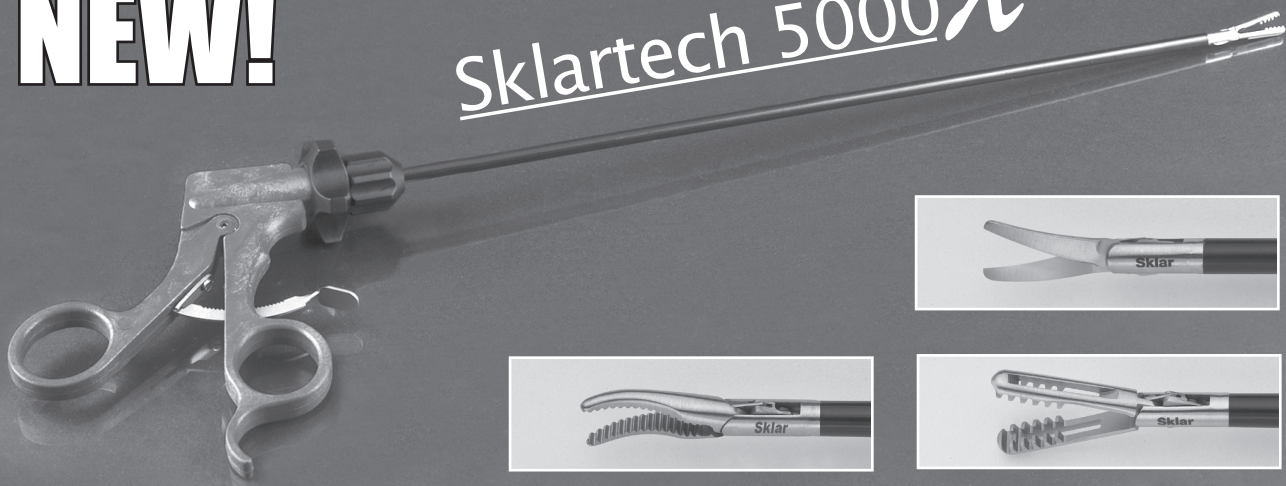

## X-LINE DISPOSABLE INSTRUMENTS, COMPLETE UNIT

COMPLETE INSTRUMENT	DIAMETER	LENGTH	FEATURES	QUANTITIES
31-7012XC	5mm	33cm	Metzenbaum Scissors, Curved with Non-Ratcheted Handle, Red	6/pk
31-7030XC	5mm	33cm	Maryland Dissector, Cross Serrations with Non-Ratcheted Handle, Yellow	6/pk
31-7055XC	5mm	33cm	Endo Clinch Forceps, Cross Serrations with Non-Ratcheted Handle, Blue	6/pk
31-7055YC	5mm	33cm	Endo Clinch Forceps, Cross Serrations with Ratchet Handle, Blue	6/pk



# LAPAROSCOPIC SKLARTECH 5000 | DISPOSABLE TROCARS

## DISPOSABLE TROCARS

INSTRUMENT	DIAMETER	LENGTH	FEATURES	QUANTITIES
31-7200	10mm	10cm	Hasson, Blunt	10/pk
31-7205	12.5mm	10cm	Hasson, Blunt	10/pk
31-7210	5mm	10cm	Safety Shield	10/pk
31-7215	10mm	10cm	Safety Shield	10/pk
31-7220	12.5mm	10cm	Safety Shield	10/pk
31-7225	5mm	10cm	Conical Tip, Pyramidal Obturator	10/pk
31-7230	10mm	10cm	Conical Tip, Conical Obturator	10/pk
31-7235	5mm	10cm	Dilating Tip Obturator	10/pk
31-7240	10mm	10cm	Dilating Tip Obturator	10/pk
31-7245	12.5mm	10cm	Dilating Tip Obturator	10/pk
31-7250	5mm	10cm	Sheath Only	10/pk
31-7255	10mm	10cm	Sheath Only	10/pk
31-7260	12.5mm	10cm	Sheath Only	10/pk

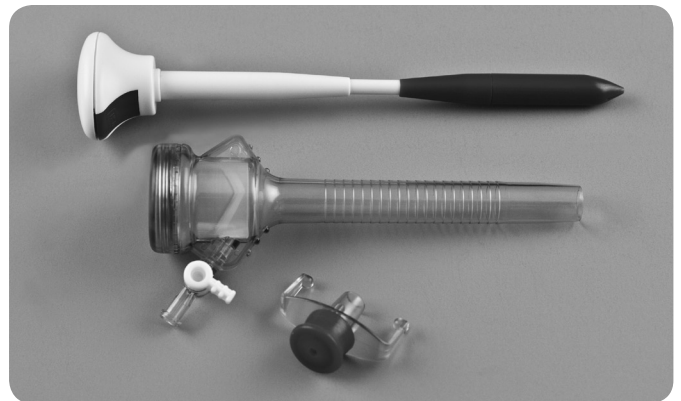
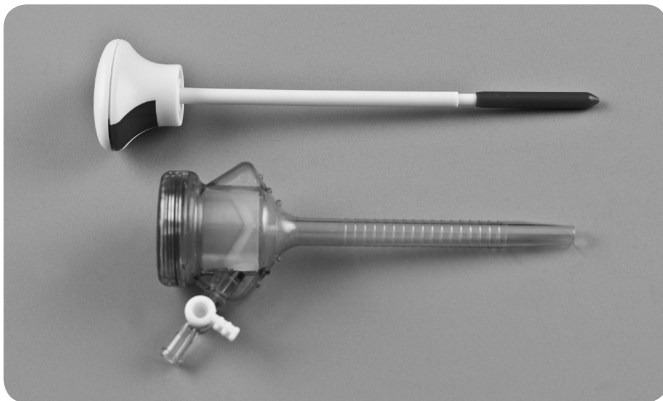



## SKLARSPEC™ DISPOSABLE GRAVES VAGINAL SPECULUMS

SKLARSPEC plastic specula are clear, disposable, and comfortable. Plastic material allows 360 degree visibility and reduces thermal shock. Provides protection of the doctor, the nurse and the patient from cross contamination. Clean up is eliminated by single-use only. Plastic material avoids unpleasant temperature shock associated with metal. One hand operation with wide range adjustment.

### PLASTIC VAGINAL SPECULUMS, GRAVES STYLE

#### STERILE

PRODUCT NUMBER	DESCRIPTION	QUANTITIES
96-2602	Small	50/cs
96-2604	Medium	50/cs
96-2606	Large	50/cs
96-1857	Small	100/cs
96-1867	Medium	100/cs
96-1877	Large	100/cs

#### NON-STERILE

PRODUCT NUMBER	DESCRIPTION	QUANTITIES
96-0857	Small	100/cs
96-0867	Medium	100/cs
96-0877	Large	100/cs



## DISPOSABLES SPECULUMS



### SKLARSPEC™ PLASTIC GRAVES VAGINAL SPECULUMS, LIGHT SOURCE STYLE

FOR USE WITH INDEPENDANT LIGHT SOURCE, NON-STERILE

PRODUCT NUMBER	DESCRIPTION	QUANTITIES
96-0827	Small, Blue	100/cs
96-0837	Medium, Green	100/cs
96-0847	Large, White	100/cs



### SKLARSPEC™ PLASTIC VAGINAL SPECULUMS LIGHT SOURCE STYLE

WITH BUILT IN LED LIGHT, NON-STERILE

PRODUCT NUMBER	DESCRIPTION	QUANTITIES
96-0920	Small	100/cs
96-0921	Medium	100/cs
96-0922	Large	100/cs



**SKLAR MONSEL'S FERRIC SUBSULFATE PASTE**

A ONE-TIME USE pre-mixed paste packaged in convenient ready-to-use bottles. Also includes 12 rayon tip applicators.

Sklar has converted Monsel's solution (ferric subsulfate) into an efficacious and conveniently packaged paste. As a hemostatic agent it is ideal to apply to cervical tissue following colposcopic biopsy, electrosurgical excision (LLETZ or LEEP) and ablative (LASER) surgery. Sklar Monsel's is fabricated to relieve office personnel from the inexact and messy task of mixing their own compound for post-surgical treatment of their female patients.

PRODUCT NUMBER	DESCRIPTION	QUANTITIES
96-1200	8ml Bottle & Swab	12 Each

**SKLAR LUGOL'S STRONG IODINE SOLUTION USP**

A ONE-TIME USE pre-mixed iodine solution packaged in convenient ready-to-use bottles. Also includes 12 rayon tip applicators.

This iodine contrast medium is also sealed in airtight bottles which assist in mitigating waste associated with the use of this product. The Lugol's works quickly to assist the Colposcopist to identify potentially diseased cervical tissue (CIN) by changing suspect tissue in the cervical transformation zone into a white "target" for excision or biopsy. Healthy tissue will remain unchanged by the application of Lugol's.

PRODUCT NUMBER	DESCRIPTION	QUANTITIES
96-1210	8ml Bottle & Swab	12 Each



## DISPOSABLES DILATORS

### SKLAR SILICONE VAGINAL DILATORS

Sklar Silicone Vaginal Dilators are used to enlarge the vagina for the purposes of examination, a surgical procedure or for the relief of vaginismus. This is accomplished by supporting or distending the vaginal canal. They are contraindicated in acute genital tract or pelvic infections or with non-compliant patients.

### VAGINAL DILATOR SETS

#### NON-STERILE

PRODUCT NUMBER	DESCRIPTION	Length	Small OD	Large OD	QUANTITIES
90-5260	Small Family				Set of 4
	XL	75.0mm	13.5mm	18.0mm	
	L	65.0mm	12.0mm	16.0mm	
	M	60.0mm	10.5mm	14.0mm	
	S	50.0mm	9.5mm	13.0mm	
90-5262	Medium Family				Set of 4
	XL	95.0mm	26.0mm	33.0mm	
	L	86.0mm	22.5mm	28.0mm	
	M	78.0mm	19.5mm	23.0mm	
	S	75.0mm	12.5mm	17.0mm	
90-5264	Large Family				Set of 4
	XL	150.0 mm	30.0mm	38.0mm	
	L	138.0 mm	25.5mm	32.0mm	
	M	128.0 mm	22.5mm	28.0mm	
	S	120.0 mm	19.5mm	24.0mm	



#### Normal Anatomy

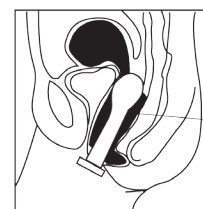
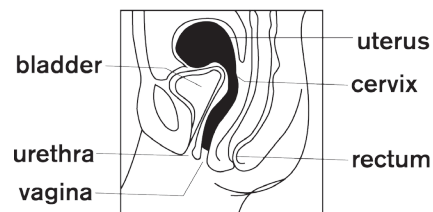

Dilator in Position



**SKLAR STERILE DISPOSABLE ENDOCERVICAL CURETTE**

**SINGLE PEEL POUCHES, SINGLE USE ONLY**

PRODUCT NUMBER	QUANTITIES
96-4143	25/bx

Federal law restricts the sale of this device by or on the order of a physician. Contents sterile unless package has been opened or damaged.



**SKLAR OS DILATORS, DISPOSABLE**

**STERILE**

PRODUCT NUMBER	QUANTITIES
96-4155	50/bx

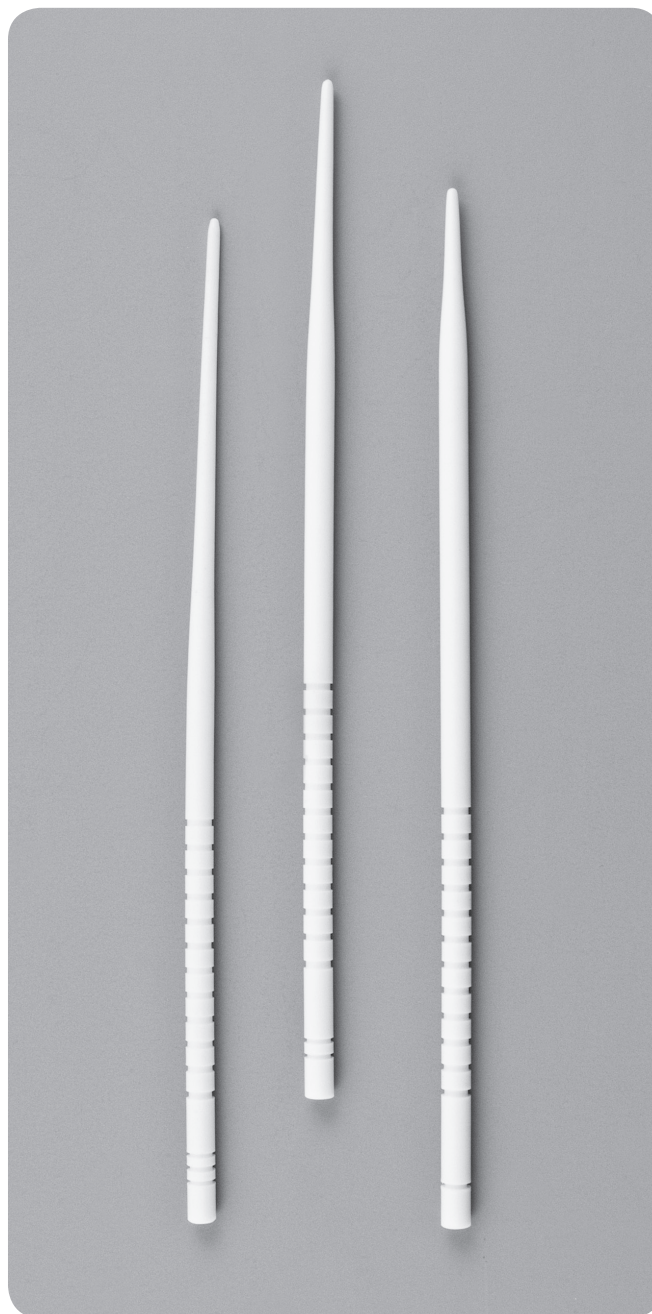

**SKLAR OS FINDER CERVICAL DILATOR SET**

**NON-STERILE**

PRODUCT NUMBER	DESCRIPTION	QUANTITIES
96-4150	Teflon Reusable Set Includes Os Locator, Canal Finder, Fundus Dilator	Set of 3



## DISPOSABLES

## PESSARIES

## PESSARIES

Sklar offers a full line of soft, silicone Pessaries for effective vaginal support and relief of incontinence. Pessaries are uniquely designed for ease of insertion and removal. Properly fitted, Pessaries can be successfully used to treat a variety of gynecologic conditions and abnormalities. Choose from the most popular patterns, available in a variety of shapes and sizes. Latex Free.

**RING WITH SUPPORT**

For Mild Uterine Prolapse or a Cystocele

PRODUCT NUMBER	DESCRIPTION	QUANTITIES
90-5291	#1 2"	1 Each
90-5392	#2 2¼"	1 Each
90-5393	#3 2½"	1 Each
90-5294	#4 2¾"	1 Each
90-5295	#5 3"	1 Each
90-5296	#6 3¼"	1 Each
90-5397	#7 3½"	1 Each

**GELLHORN PESSARY WITH DRAIN**

For a Mild Cystocele or Moderate Uterine Prolapse

PRODUCT NUMBER	DESCRIPTION	QUANTITIES
90-5282	#2 2"	1 Each
90-5283	#3 2¼"	1 Each
90-5284	#4 2½"	1 Each
90-5285	#5 2¾"	1 Each
90-5286	#6 3"	1 Each

**DONUT**

For Moderate Uterine Prolapse or a Mild Cystocele or Rectocele

PRODUCT NUMBER	DESCRIPTION	QUANTITIES
90-5271	#1 2¼"	1 Each
90-5272	#2 2½"	1 Each
90-5273	#3 2¾"	1 Each
90-5274	#4 3"	1 Each
90-5275	#5 3¼"	1 Each
90-5276	#6 3½"	1 Each

**CUBE WITH DRAIN**

For Moderate to Severe Uterine Prolapse or a Mild Cystocele or Rectocele

PRODUCT NUMBER	DESCRIPTION	QUANTITIES
90-5301	#1 29mm	1 Each
90-5302	#2 33mm	1 Each
90-5303	#3 37mm	1 Each
90-5304	#4 41mm	1 Each
90-5305	#5 45mm	1 Each



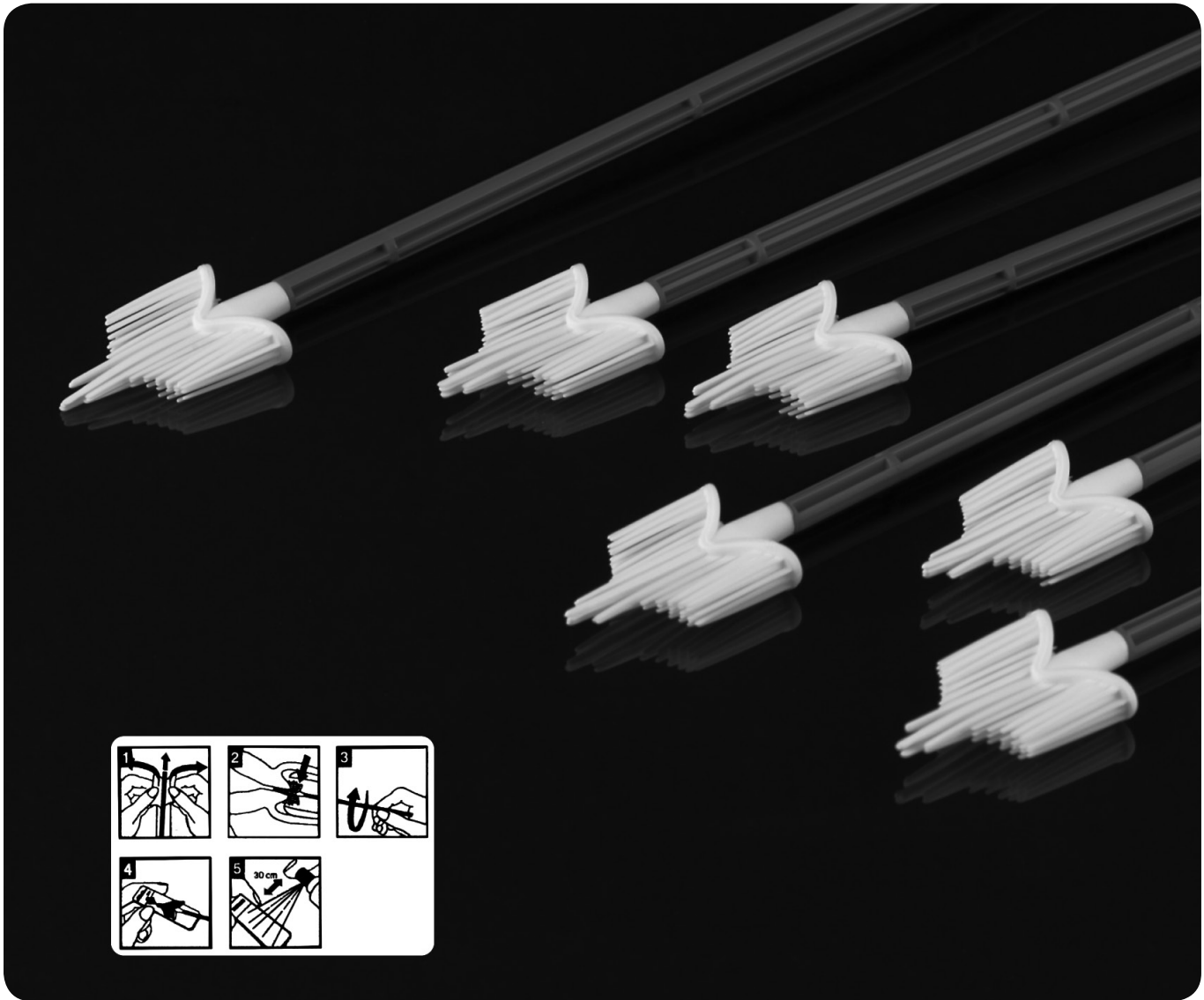

**SKLAR CERVIX BRUSH  
CERVICAL CELL SAMPLER**

Sklar's Cervix Brush is made of polyethylene and has a total length of 20 centimeters. The top portion uses a soft flexible brush to obtain cell samples. The brush consists of 57 semi-circular plastic bristles of various lengths. The shape is such that the top edges of the brush follow the contours of the cervix. The longer middle bristles reach deep into the endocervical canal. The shorter bristles touch both the ectocervical area and transformation zone at the same time.

**SKLAR CERVIX BRUSH**

**STERILE**

PRODUCT NUMBER	QUANTITIES
96-4140	100/bx

**NON-STERILE**

PRODUCT NUMBER	QUANTITIES
96-4140NS	100/bx



## DISPOSABLES CANNULAS / EXTENDERS

### ENDOMETRIAL BIOPSY CANNULA

STERILE

PRODUCT NUMBER	DESCRIPTION	QUANTITIES
96-4100	For Aspiration Biopsy 3mm OD, 23.5cm Length	25/cs



### ENDOMETRIAL SAMPLING SET

STERILE

PRODUCT NUMBER	DESCRIPTION	QUANTITIES
96-4160	3mm, 10ml Syringe	10/bx



### NEEDLE EXTENDERS, DISPOSABLE

PLASTIC LUER LOCK ADAPTER

STERILE

PRODUCT NUMBER	DESCRIPTION	QUANTITIES
96-5190	3"	10/bx
96-5192	4"	10/bx
96-5194	5"	10/bx
96-5196	6"	10/bx



### NEEDLE EXTENDERS, REUSABLE

PRODUCT NUMBER	DESCRIPTION	QUANTITIES
96-4190	3"	1
96-4192	4"	1
96-4194	5"	1
96-4196	6"	1

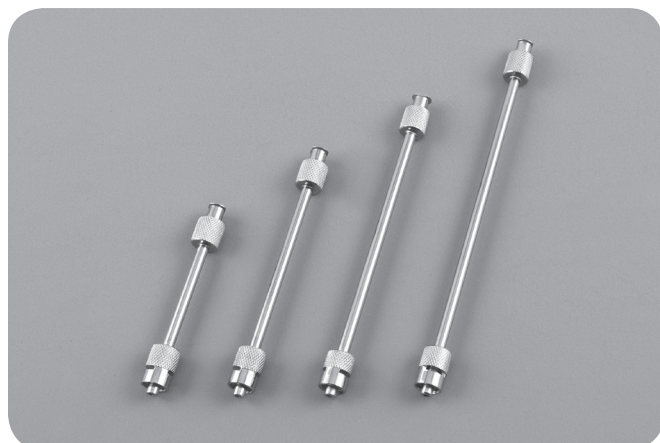



### SKLAR TRU-PUNCH™ DISPOSABLE VULVAR BIOPSY PUNCH

The SKLAR Tru-punch has a seamless steel tip carefully honed for a razor sharp incision and perfect sample. The ribbed and hollow handle permits tissue to be easily dislodged.

#### STERILE DISPOSABLE BIOPSY PUNCH

PRODUCT NUMBER	DESCRIPTION	QUANTITIES	PRODUCT NUMBER	DESCRIPTION	QUANTITIES
96-0192	1mm	25/bx	96-1092	1mm	50/bx
96-1097	1.5mm	25/bx	96-1098	1.5mm	50/bx
96-1140	2mm	25/bx	96-1100	2mm	50/bx
96-0102	2.5mm	25/bx	96-1102	2.5mm	50/bx
96-1142	3mm	25/bx	96-1105	3mm	50/bx
96-1144	3.5mm	25/bx	96-1110	3.5mm	50/bx
96-1146	4mm	25/bx	96-1115	4mm	50/bx
96-1148	5mm	25/bx	96-1120	5mm	50/bx
96-1150	6mm	25/bx	96-1125	6mm	50/bx
96-1152	8mm	25/bx	96-1130	8mm	50/bx
96-1160	Assorted - 5 of each: 2, 3, 3.5, 4 & 5mm	25/bx	96-0160	Assorted - 5 of each: 2, 3, 3.5, 4 & 5mm	50/bx



**BARIATRIC  
SCISSORS**

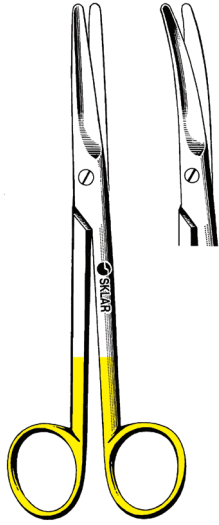

**TC MAYO SCISSORS**

TUNGSTEN CARBIDE

**STRAIGHT**

16-1520	12"
16-1525	14"
61-0009	16"
61-1009	18"
61-2009	20"

**CURVED**

16-1620	12"
16-1625	14"
61-0010	16"
61-1010	18"
61-2010	20"

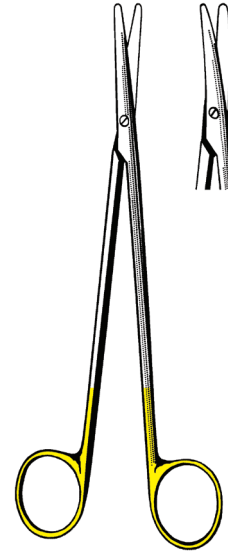

**TC METZENBAUM-NELSON SCISSORS**

TUNGSTEN CARBIDE

**STRAIGHT**

61-0001	12"
61-0002	14"
61-0006	16"
61-1006	18"
61-2006	20"

**CURVED**

61-0005	12"
61-0007	14"
61-0008	16"
61-1008	18"
61-2008	20"

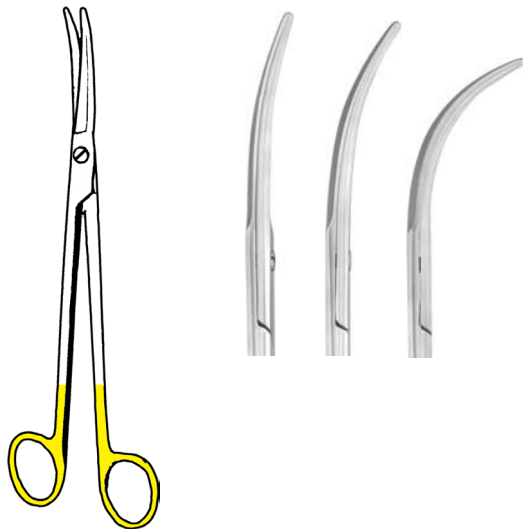

**Z-TYPE PARAMETRIUM SCISSORS**

TUNGSTEN CARBIDE

**SLIGHT CURVE**

16-4008	12"
16-4012	14"
61-0012	16"
61-1012	18"
61-2012	20"

**CURVED**

16-4009	12"
16-4013	14"
61-0013	16"
61-1013	18"
61-2013	20"

**FULL CURVE**

16-4010	12"
16-4014	14"
61-0014	16"
61-1014	18"
61-2014	20"

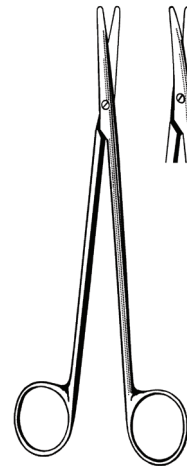

**METZENBAUM-NELSON SCISSORS**

**STRAIGHT**

55-9312	12"
55-9314	14"
61-0003	16"
61-1003	18"
61-2003	20"

**CURVED**

55-9612	12"
55-9614	14"
61-0004	16"
61-1004	18"
61-2004	20"

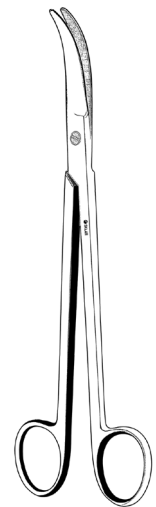

**JORGENSEN SCISSORS**

**STRONG CURVE**

52-2979	12"
52-2980	14"
61-0011	16"
61-1011	18"
61-2011	20"

# BARIATRIC FORCEPS



## DRESSING FORCEPS

### SERRATED

19-1112	12"
19-1114	14"
61-0115	16"
61-1115	18"
61-2115	20"

## TISSUE FORCEPS

### 1X2 TEETH

19-1312	12"
19-1314	14"
61-0116	16"
61-1116	18"
61-2116	20"

### 2X3 TEETH

19-1512	12"
19-1514	14"
61-0117	16"
61-1117	18"
61-2117	20"

### 3X4 TEETH

19-1712	12"
19-1714	14"
61-0118	16"
61-1118	18"
61-2118	20"

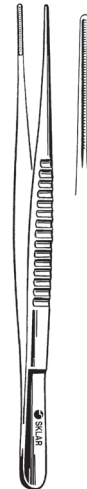
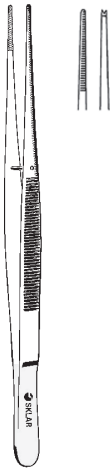

## POTTS-SMITH FORCEPS

### 1X2 TEETH

52-3412	12"
52-3414	14"
61-0126	16"
61-1126	18"
61-2126	20"

### SERRATED

52-3312	12"
52-3314	14"
61-0125	16"
61-1125	18"
61-2125	20"

## DEBAKEY ATRAUMATIC FORCEPS

### STRAIGHT

52-5098	12"	1.5mm
52-5099	14"	1.5mm
61-0122	16"	1.5mm
61-1122	18"	1.5mm
61-2122	20"	1.5mm
52-5198	12"	2mm
52-5199	14"	2mm
61-0121	16"	2mm
61-1121	18"	2mm
61-2121	20"	2mm
52-5182	12"	2.7mm
52-5184	14"	2.7mm
61-0113	16"	2.7mm
61-1113	18"	2.7mm
61-2113	20"	2.7mm

### ANGLED

52-5312	12"	2.5mm
52-5314	14"	2.5mm
61-0123	16"	2.5mm
61-1123	18"	2.5mm
61-2123	20"	2.5mm



**BARIATRIC  
FORCEPS**



**ALLIS TISSUE FORCEPS**

4X5 TEETH		5X6 TEETH	
36-2390	12"	36-2392	12"
36-2391	14"	36-2393	14"
61-0104	16"	61-0105	16"
61-1104	18"	61-1105	18"
61-2104	20"	61-2105	20"



**BABCOCK FORCEPS**

36-1695	12"
36-1697	14"
61-0111	16"
61-1111	18"
61-2111	20"

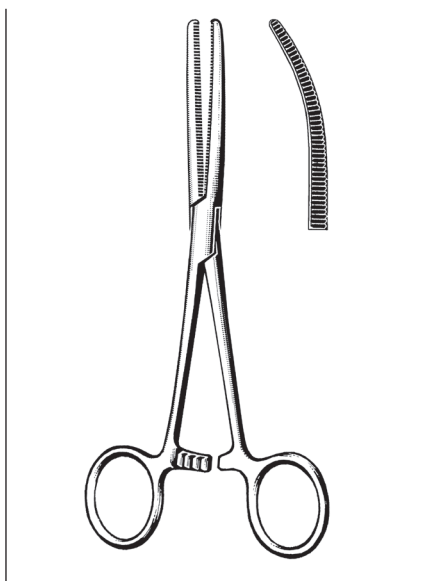

**ROCHESTER-PEAN FORCEPS**

STRAIGHT		CURVED	
36-2712	12"	36-2812	12"
36-2714	14"	36-2814	14"
61-0100	16"	61-0101	16"
61-1100	18"	61-1101	18"
61-2100	20"	61-2101	20"

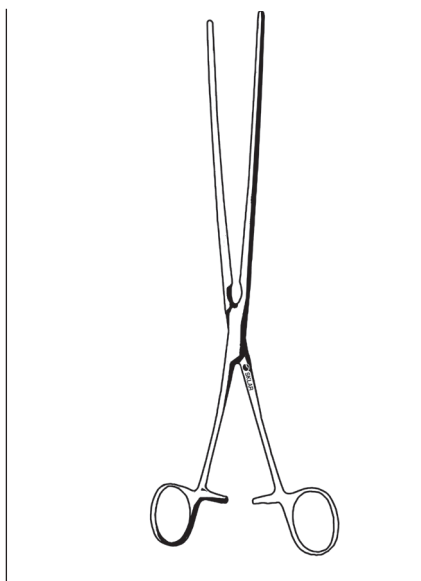

**KOCHER FORCEPS**

STRAIGHT		CURVED	
36-2660	12"	36-2661	12"
36-2662	14"	36-2663	14"
61-0102	16"	61-0103	16"
61-1102	18"	61-1103	18"
61-2102	20"	61-2103	20"

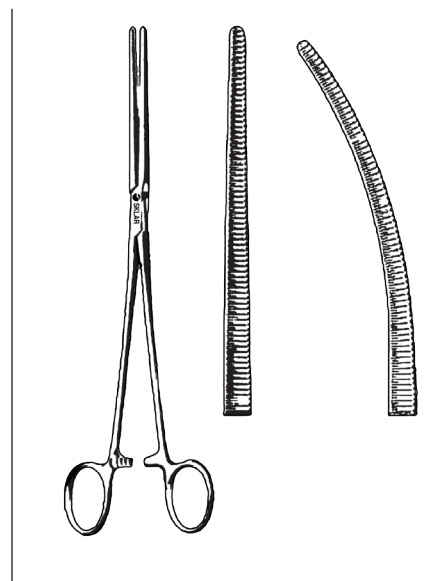

**SAROT FORCEPS**

STRAIGHT		CURVED	
32-2265	12"	32-2266	12"
32-2275	14"	32-2276	14"
61-0106	16"	61-0107	16"
61-1106	18"	61-1107	18"
61-2106	20"	61-2107	20"

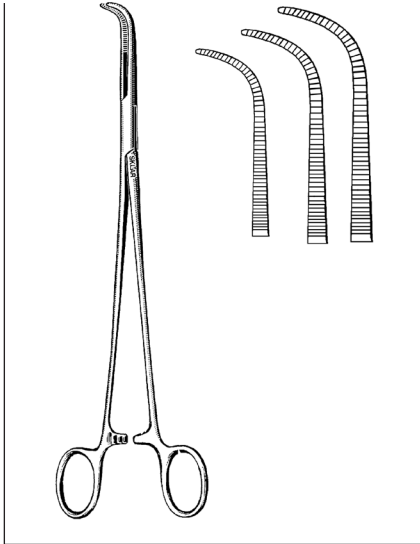

**GEMINI MIXTER FORCEPS**

**CURVED**

55-3162	12"
55-3164	14"
61-0119	16"
61-1119	18"
61-2119	20"

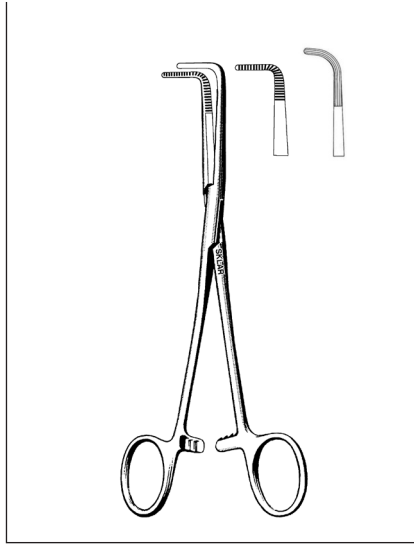

**MIXTER FORCEPS**

**RIGHT ANGLE**

55-3152	12"
55-3154	14"
61-0114	16"
61-1114	18"
61-2114	20"

**RIGHT ANGLE,  
LONGITUDINAL SERRATIONS**

55-2912	12"
55-2914	14"
61-0124	16"
61-1124	18"
61-2124	20"

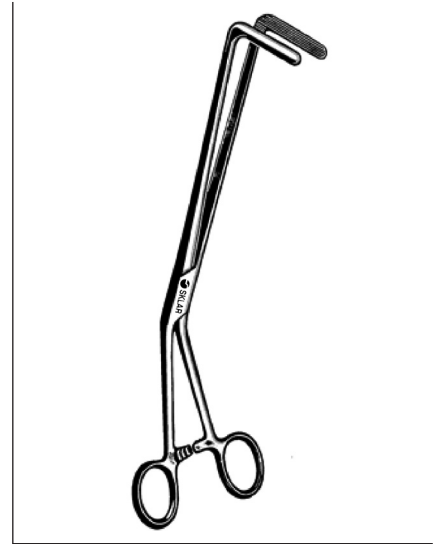

**HARRINGTON FORCEPS**

**RIGHT ANGLE**

55-2310	12"
55-2314	14"
61-0112	16"
61-1112	18"
61-2112	20"

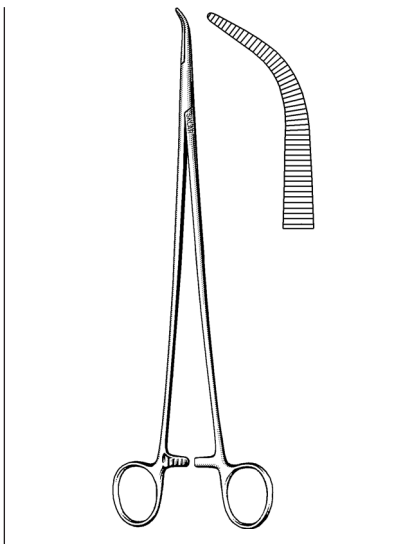

**LAWRENCE FORCEPS**

**STRAIGHT**

55-2820	12"
55-2822	14"
61-0120	16"
61-1120	18"
61-2120	20"

**CURVED**

55-2821	12"
55-2823	14"
61-0110	16"
61-1110	18"
61-2110	20"

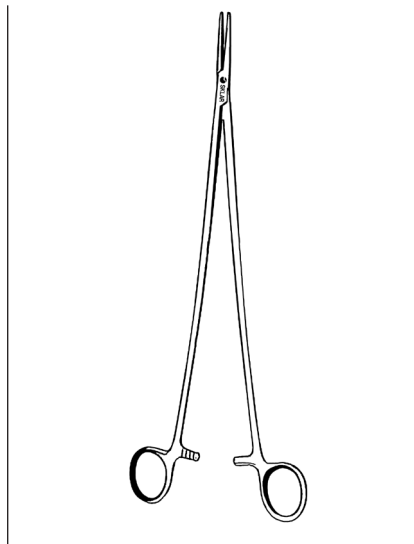

**BRIDGE FORCEPS**

**STRAIGHT**

90-2650	12"
90-2660	14"
61-0108	16"
61-1108	18"
61-2108	20"

**CURVED**

90-2651	12"
90-2661	14"
61-0109	16"
61-1109	18"
61-2109	20"

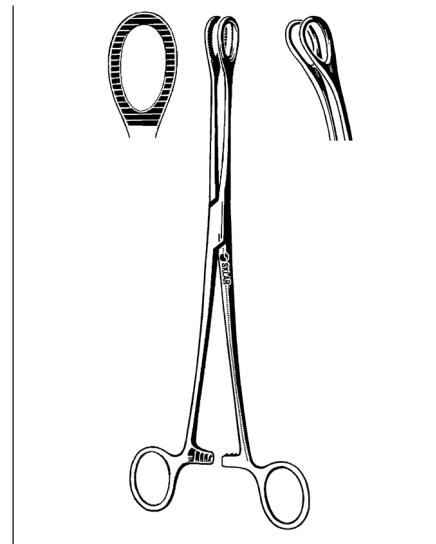

**FOERSTER SPONGE FORCEPS**

**STRAIGHT**

87-2490	12"
87-2492	14"
61-0127	16"
61-1127	18"
61-2127	20"

**CURVED**

87-2491	12"
87-2493	14"
61-0128	16"
61-1128	18"
61-2128	20"



**BARIATRIC  
NEEDLE HOLDERS**



**TC CRILE-WOOD NEEDLE HOLDERS**

TUNGSTEN CARBIDE, SERRATED

- 21-8011 12"
- 21-4914 14"
- 61-0201 16"
- 61-1201 18"
- 61-2201 20"



**TC MAYO HEGAR NEEDLE HOLDERS**

TUNGSTEN CARBIDE, SERRATED

- 21-8035 12"
- 21-2914 14"
- 61-0200 16"
- 61-1200 18"
- 61-2200 20"



**TC DEBAKEY NEEDLE HOLDERS**

TUNGSTEN CARBIDE, SERRATED

- 21-5112 12"
- 21-5114 14"
- 61-0202 16"
- 61-1202 18"
- 61-2202 20"



**STETHOSCOPES**

SKLAR OFFERS A COMPLETE LINE OF  
HIGH QUALITY STETHOSCOPES

For a complete listing of Sklar's extensive Stethoscope product line see pages 675-681. For more information contact your Sklar Account Manager or Distributor Sales Representative.



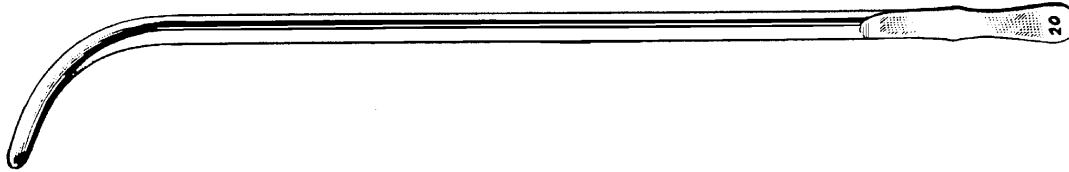

**VAN BUREN URETHRAL SOUNDS**

85-1008	8 Fr.	85-1018	18 Fr.	85-1028	28 Fr.	85-1038	38 Fr.
85-1010	10 Fr.	85-1020	20 Fr.	85-1030	30 Fr.	85-1040	40 Fr.
85-1012	12 Fr.	85-1022	22 Fr.	85-1032	32 Fr.		
85-1014	14 Fr.	85-1024	24 Fr.	85-1034	34 Fr.		
85-1016	16 Fr.	85-1026	26 Fr.	85-1036	36 Fr.		

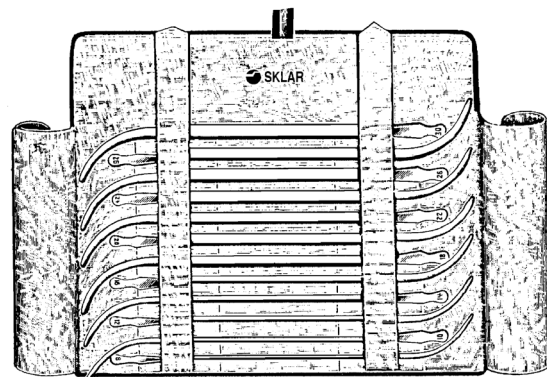
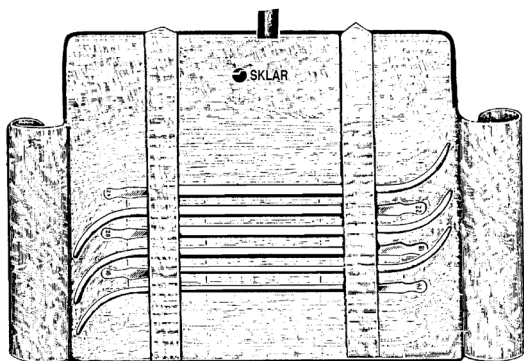

**VAN BUREN URETHRAL SOUNDS**

- 85-1065 Van Buren Sounds, Complete Set of 17
- 85-1070 Set of 6 in Khaki Case, Sizes 14-16-18-20-22-24 French Diameter
- 85-1075 Set of 12 in Khaki Case, Sizes 8-10-12-14-16-18-20-22-24-26-28-30 French Diameter
- 85-1076 Khaki Case Only, Holds up to 12 Sounds

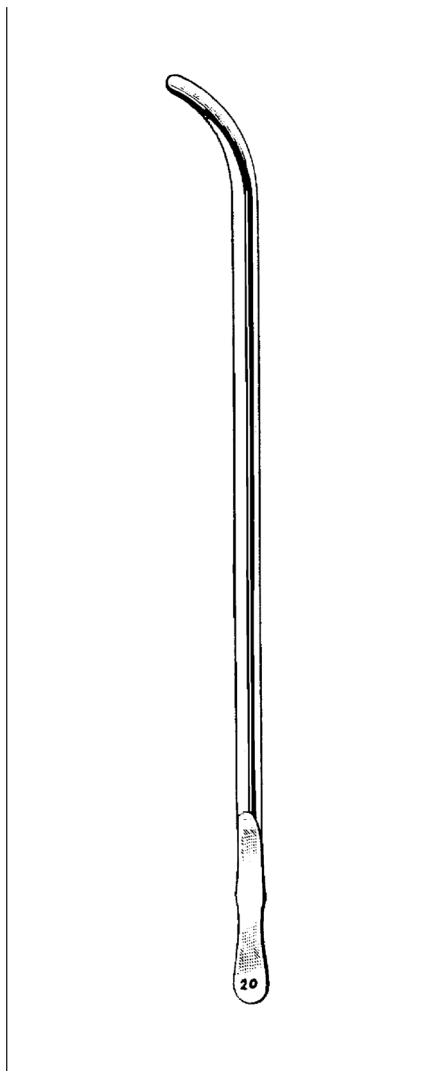

**OTIS/DITTEL URETHRAL SOUNDS**

**SHORT CURVE, 11½"**

85-1408	8 Fr.	85-1426	26 Fr.
85-1410	10 Fr.	85-1428	28 Fr.
85-1412	12 Fr.	85-1430	30 Fr.
85-1414	14 Fr.	85-1432	32 Fr.
85-1416	16 Fr.	85-1434	34 Fr.
85-1418	18 Fr.	85-1436	36 Fr.
85-1420	20 Fr.	85-1438	38 Fr.
85-1422	22 Fr.	85-1440	40 Fr.
85-1424	24 Fr.		

**SETS IN KHAKI ROLL**

85-1442	Set of 8 16-30 French
85-1446	Set of all 17 sizes

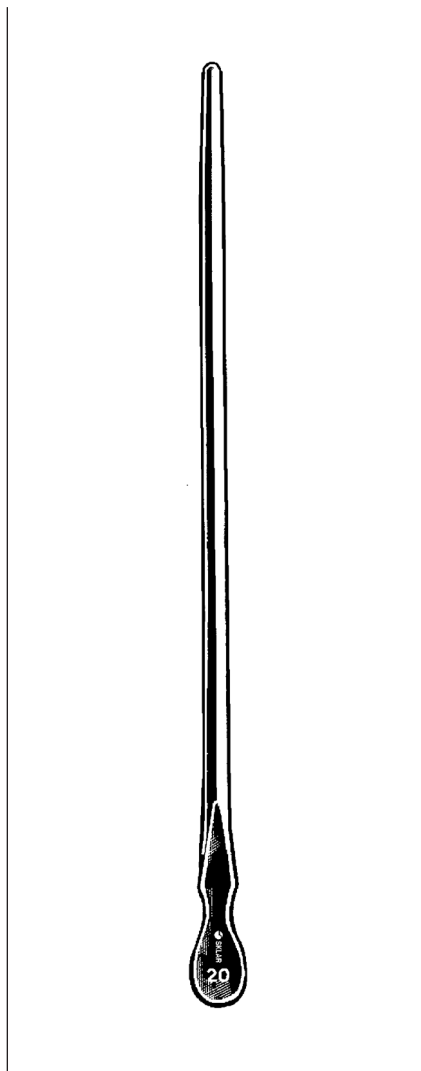

**DITTEL URETHRAL SOUNDS**

**STRAIGHT-FRENCH DIAMETER, 11½"**

85-1308	No. 8	85-1326	No. 26
85-1310	No. 10	85-1328	No. 28
85-1312	No. 12	85-1330	No. 30
85-1314	No. 14	85-1332	No. 32
85-1316	No. 16	85-1334	No. 34
85-1318	No. 18	85-1336	No. 36
85-1320	No. 20	85-1338	No. 38
85-1322	No. 22	85-1340	No. 40
85-1324	No. 24		

**SETS IN KHAKI ROLL**

85-1342	Set of 6 Sizes 8, 12, 16, 20, 24, 30
85-1346	Set of all 17 sizes

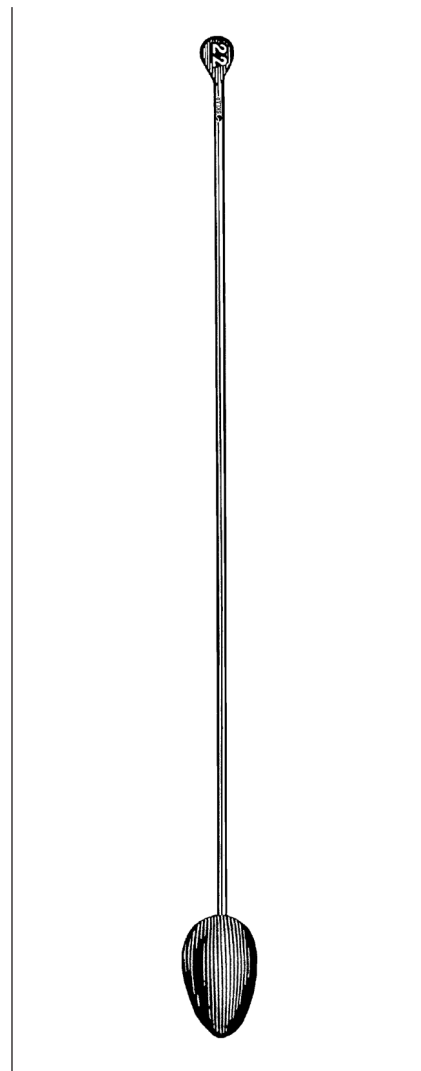

**OTIS BOUGIE A BOULE**

**STRAIGHT, 9¾"**

85-1608	8 Fr.	85-1622	22 Fr.
85-1610	10 Fr.	85-1624	24 Fr.
85-1612	12 Fr.	85-1626	26 Fr.
85-1614	14 Fr.	85-1628	28 Fr.
85-1616	16 Fr.	85-1630	30 Fr.
85-1618	18 Fr.	85-1632	32 Fr.
85-1620	20 Fr.	85-1637	36 Fr.

**SETS IN KHAKI ROLL**

85-1635	Set of 8 Sizes 16-30
85-1636	Set of 13 Sizes 8-32

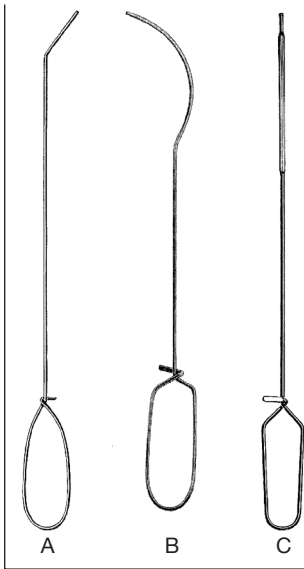

**CATHETER GUIDES**

**FLEXIBLE, 8FR**

- |         |                |                    |
|---------|----------------|--------------------|
| 85-2355 | BENIQUE        | Catheter Guide (A) |
| 85-2360 | GUYON          | Catheter Guide (B) |
| 85-2365 | Catheter Guide | Straight (C)       |

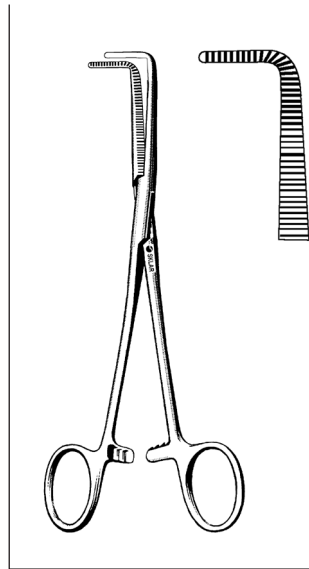

**MIXTER FORCEPS**

**RIGHT ANGLE**

- |         |      |
|---------|------|
| 18-1250 | 5½"  |
| 17-1762 | 6¼"  |
| 17-1772 | 7¼"  |
| 55-2892 | 9¼"  |
| 55-2894 | 10½" |
| 55-3012 | 12"  |
- Longitudinal Serrations  
Longitudinal Serrations

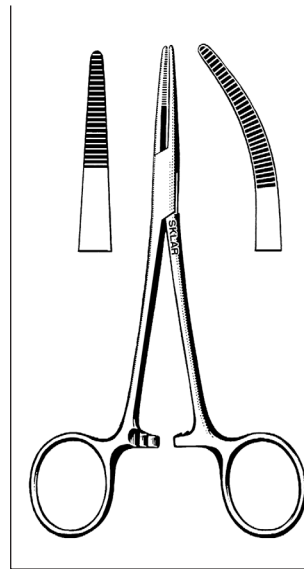

**KELLY HEMOSTATIC FORCEPS**

- |         |     |             |
|---------|-----|-------------|
| 17-2055 | 5½" | Straight    |
| 17-2155 | 5½" | Curved      |
| 74-3260 | 7"  | Straight    |
|         |     | Extra Heavy |
| 74-3270 | 7"  | Curved      |
|         |     | Extra Heavy |

**DELICATE**

- |         |     |          |
|---------|-----|----------|
| 18-1552 | 5½" | Straight |
| 18-1652 | 5½" | Curved   |

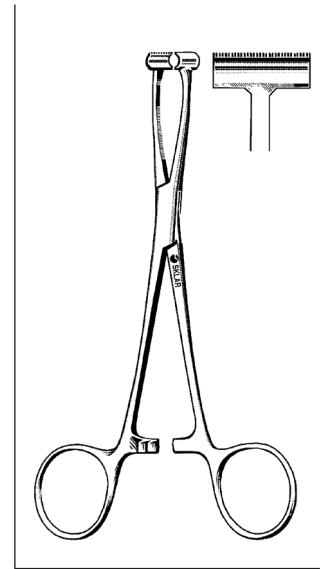

**PRATT T SHAPED CLAMP**

- |         |    |
|---------|----|
| 17-1055 | 6" |
|---------|----|

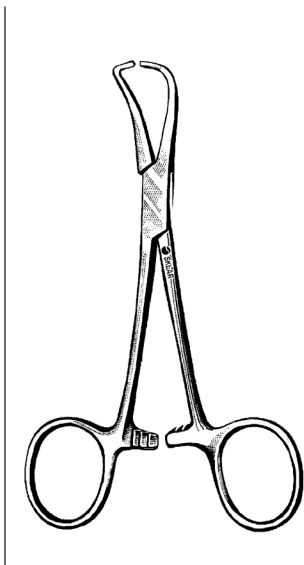

**TEXTOR VASECTOMY CLAMP**

- |         |     |
|---------|-----|
| 85-6555 | 5½" |
|---------|-----|

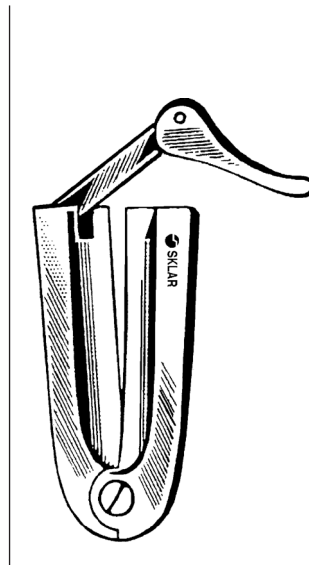

**MOGEN CIRCUMCISION CLAMP**

- |         |                |
|---------|----------------|
| 85-6550 | 2.5mm Aperture |
|---------|----------------|

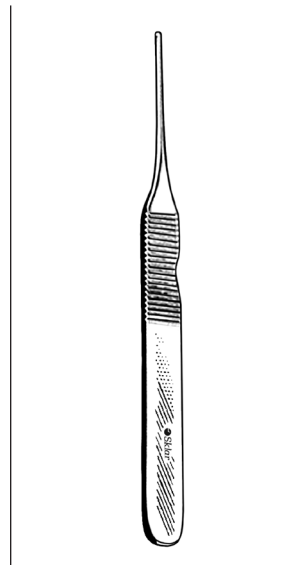

**CIRCUMCISION PROBE**

- |         |    |
|---------|----|
| 85-6551 | 5" |
|---------|----|

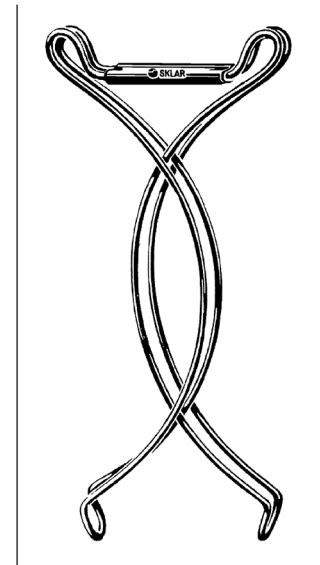

**STOCKMAN (ZIPSER) PENIS CLAMP**

- |         |
|---------|
| 85-6450 |
|---------|

GENITO-URINARY  
GENERAL

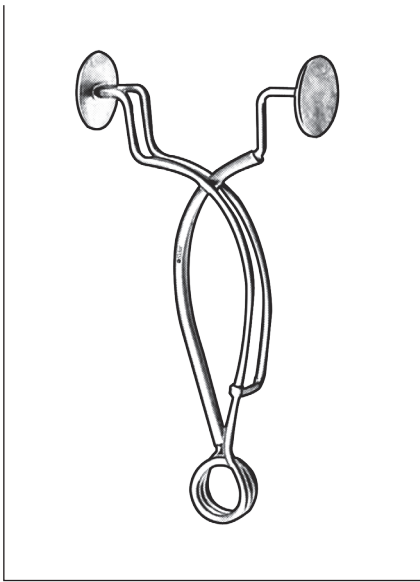

**STOCKMAN PENIS CLAMP**  
85-6453 4¼"

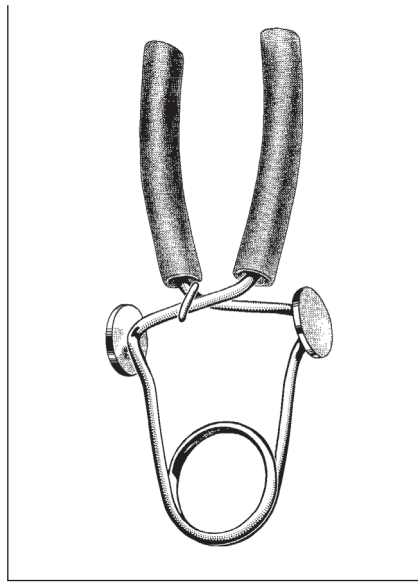

**STRAUS PENIS CLAMP**  
85-6460 4¾"

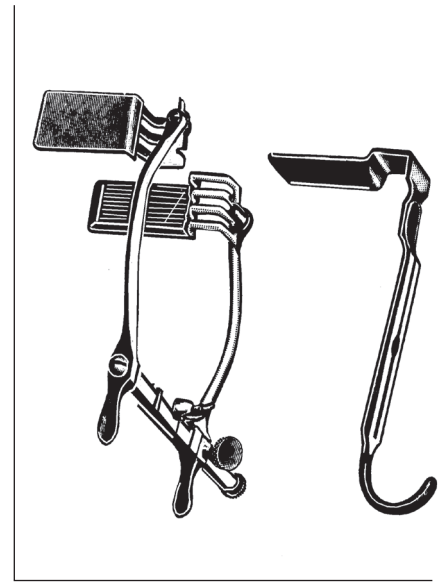

**JUDD-MASSON BLADDER AND SUPRAPUBIC RETRACTOR**  
85-5350 With 2 Blades

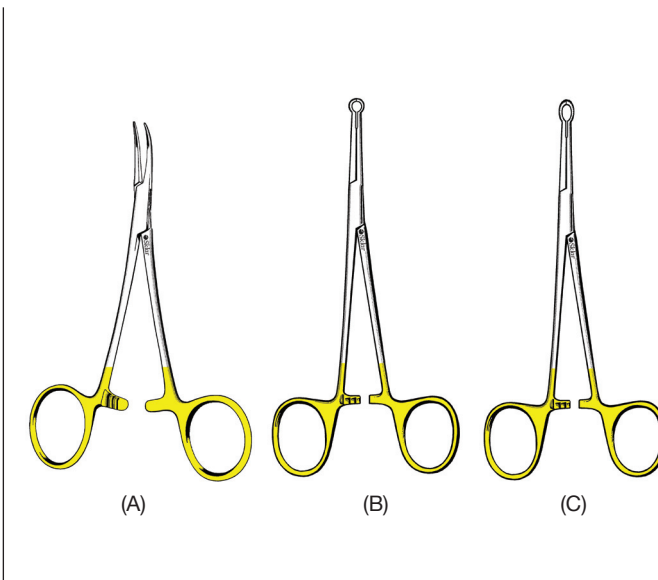

**VASECTOMY SET**  
**INCLUDES PIERCING FORCEP AND CLAMP**

85-6220	Set of 2	Ring Tip
85-6222	Set of 2	Oval Tip
85-6224	5½"	Piercing Forceps, Curved (A)
85-6221	5¾"	Fixation Clamp, Ring Tip (B)
85-6223	5¾"	Fixation Clamp, Oval Tip (C)

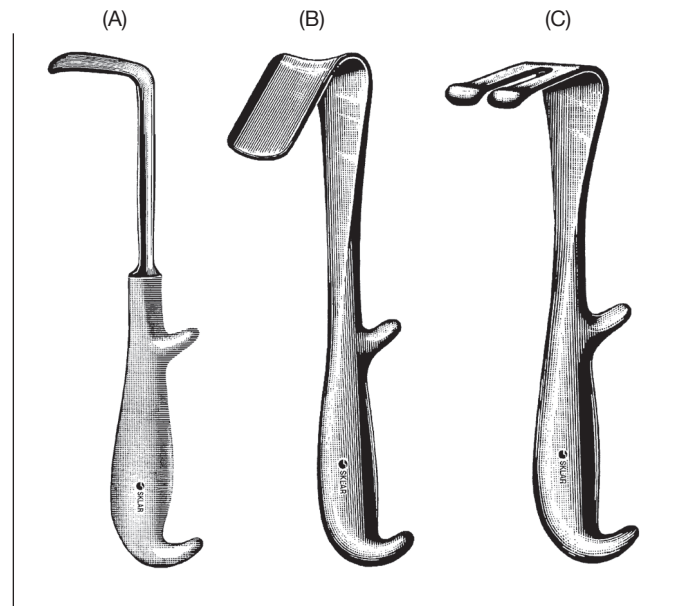

**YOUNG PROSTRATIC RETRACTOR**

85-4697	8½"	Lateral (A)
85-4780	8"	Anterior (B)
85-4970	8½"	Bifurcated (C)

**GENITO-URINARY  
SCISSORS**



**MAYO DISSECTING SCISSORS**

STRAIGHT		CURVED	
15-1555	5½"	15-2555	5½"
15-1567	6¾"	15-2567	6¾"
90-1590	9"	90-1690	9"
55-8711	11" Harrington	55-8611	11" Harrington



**SKLARLITE™ MAYO DISSECTING SCISSORS**

STRAIGHT		CURVED	
23-1164	5½"	23-1166	5½"
23-1165	6¾"	23-1167	6¾"

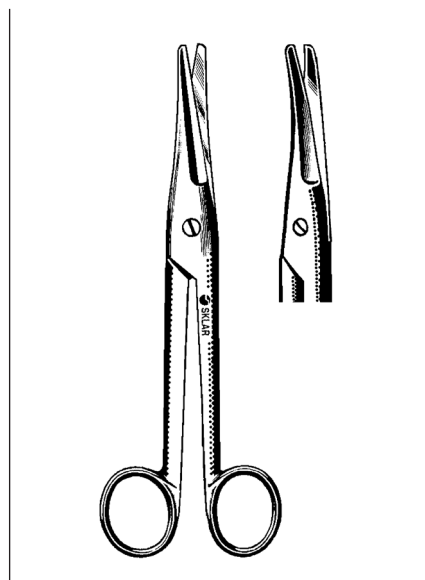

**MAYO-NOBLE DISSECTING SCISSORS**

STRAIGHT		CURVED	
15-1762	6½"	15-2762	6½"

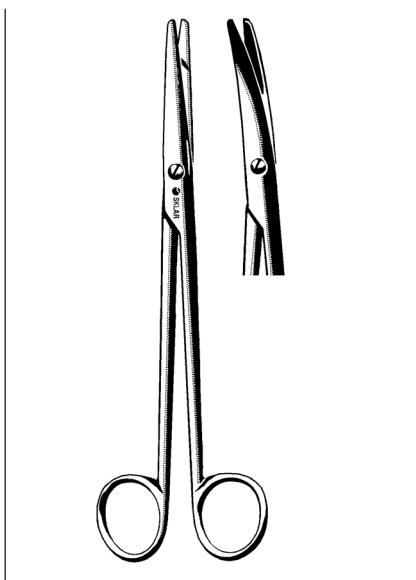

**MAYO-STILLE DISSECTING SCISSORS**

ROUNDED BLADES			
STRAIGHT		CURVED	
15-1655	5½"	15-2655	5½"
15-1667	6¾"	15-2667	6¾"

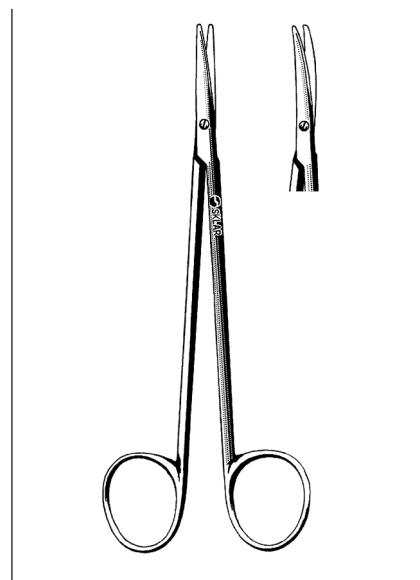

**METZENBAUM SCISSORS**

STRAIGHT		CURVED	
75-5570	7"	75-5670	7"
55-9180	8" (Nelson)	55-9080	8" (Nelson)
55-9190	9" (Nelson)	55-9090	9" (Nelson)
55-9310	10" (Nelson)	55-9210	10" (Nelson)
55-9311	11" (Nelson)	55-9411	11" (Nelson)
55-9312	12" (Nelson)	55-9612	12" (Nelson)
55-9314	14" (Nelson)	55-9614	14" (Nelson)

GENITO-URINARY  
SCISSORS



**KELLY-ADSON SCISSOR**

**CURVED**

50-4662 6¼" Smooth

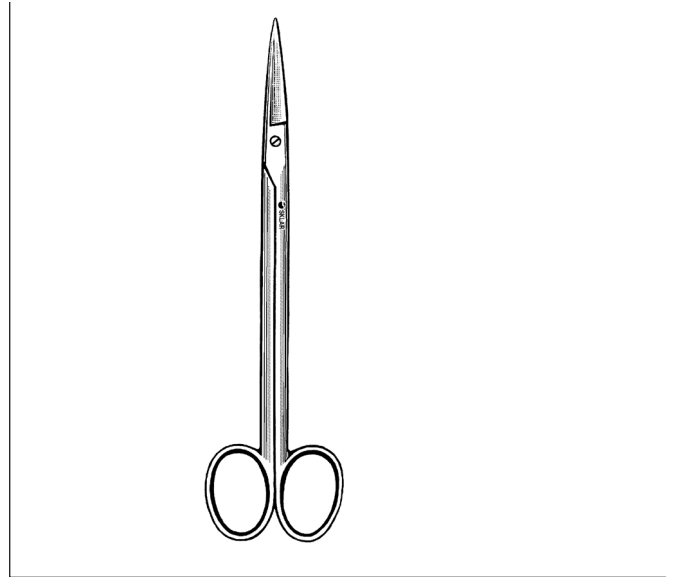

**KELLY-ADSON SCISSORS**

**STRAIGHT**

50-4562 6¼" Smooth  
50-4563 6¼" Serrated

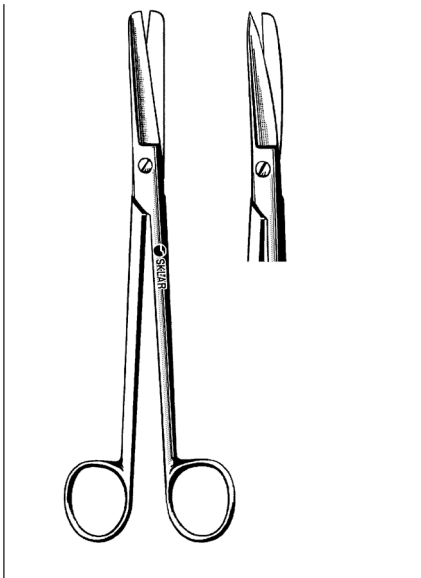

**SIMS SCISSORS**

**STRAIGHT**

**CURVED**

90-1280	8" S/S	90-1580	8" S/S
90-1180	8" S/B	90-1480	8" S/B
90-1080	8" B/B	90-1380	8" B/B

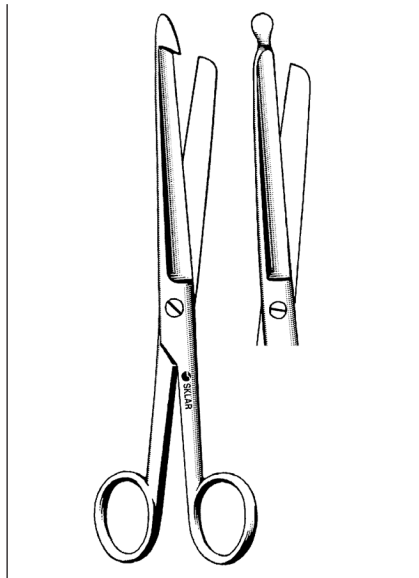

**ENTEROTOME SCISSORS**

15-1282	8¼" Hook Point
15-1285	8¼" Probe Point

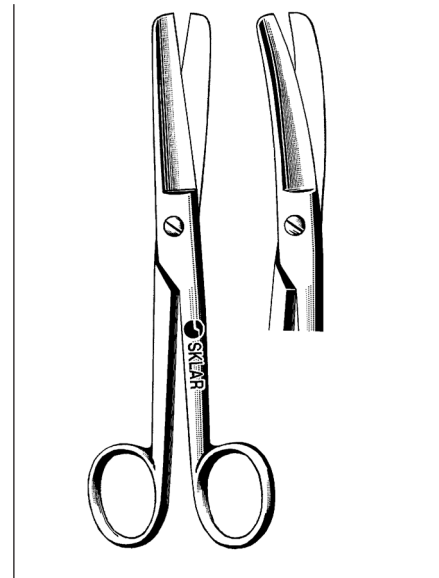

**DOYEN SCISSORS**

**STRAIGHT**

**CURVED**

15-1307	7"	15-2307	7"
15-1308	7" Serrated	15-2308	7" Serrated

**RUDD CLINIC LIGATOR SET**

80-1914 Set Includes: Ligator, Forceps, 100 "O" Rings and Speculum

The Ruud Clinic Hemorrhoidal Ligator is an improved instrument for elastic band ("O" Ring) ligation of hemorrhoids. It is simply designed with only one moving part for greater dependability and trouble-free performance. Separate loading cone facilitates loading "O" ring bands on cylinder. Instead of suddenly releasing the band around entire hemorrhoid, the Ruud Ligator releases the band from one side of the applicator for a more gradual encirclement of the hemorrhoid.

This instrument also features a shorter and wider cylinder to allow for use on larger hemorrhoids and mucosal prolapse. It provides better visibility before, during and after ligation, to assure proper placement of bands.

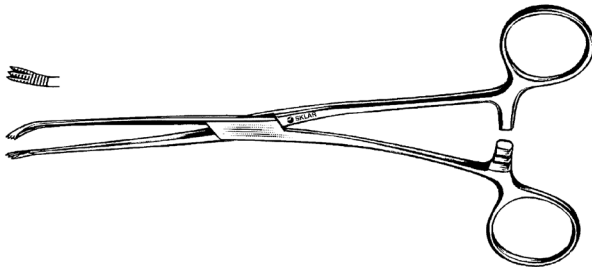
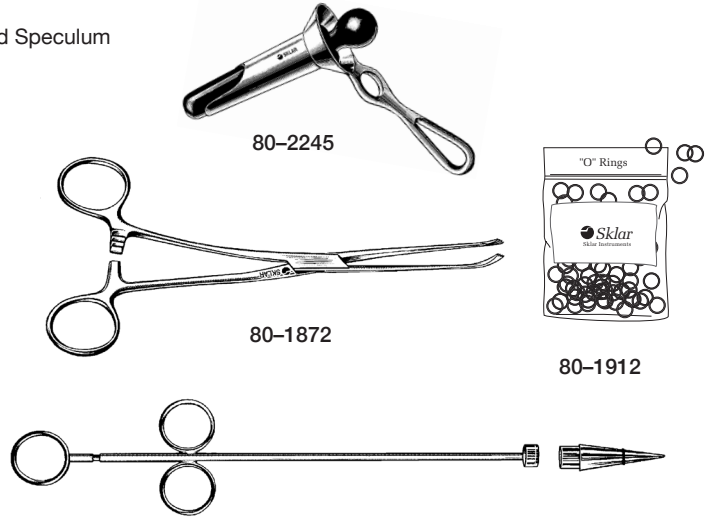

**SKLAR HEMORRHOIDAL FORCEPS**

80-1872 7¼"

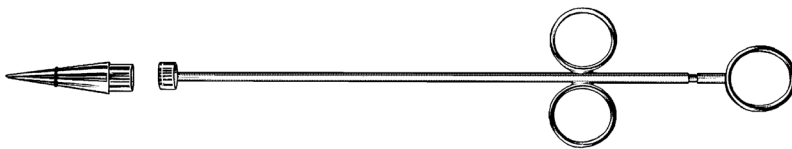

**RUDD CLINIC HEMORRHOIDAL LIGATOR**

WITH LOADING CONE AND 100 "O" RINGS

- 80-1910 Complete
- 80-1911 Loading Cone Only for Ruud
- 80-1912 Ligating "O" Rings (Package of 100)
- 80-1918 Improved Ruud Ligator



**IVES RECTAL SPECULUM  
(FANSLER)**

- 80-2245 3¼" Long
- 80-2244 Obturator Only

# RECTAL INSTRUMENTS

## HEMORRHOIDAL



### McGIVNEY HEMORRHOIDAL LIGATOR SET

80-1945 Set Includes: Ligator, Forceps, 100 "O" Rings and Speculum

The McGivney Hemorrhoidal Ligator Set provides the convenience of a plier handle elastic band applicator.

- It is supplied with a separate loading cone.
- A specially designed double bend forceps that provides better visualization.
- The Ives (Fansler) Rectal Speculum is the instrument of choice for Ligation procedures.

Included are 100 Elastic "O" Rings that can be reordered as 80-1912.

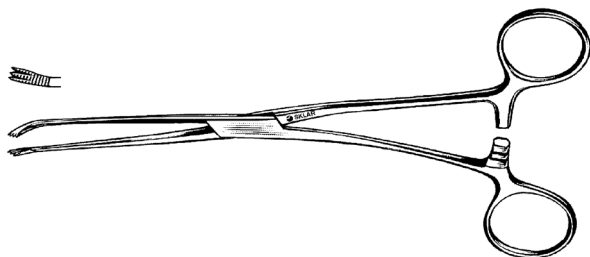
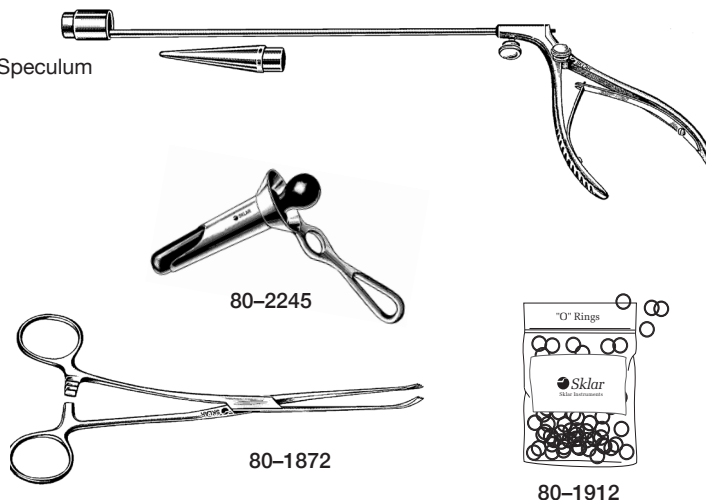

### SKLAR HEMORRHOIDAL FORCEPS

80-1872 7 1/4"

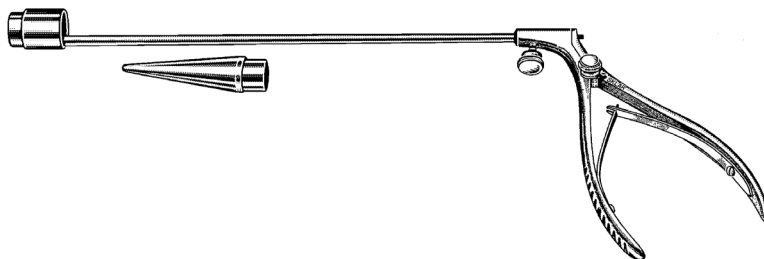

### McGIVNEY HEMORRHOIDAL LIGATOR

- 80-1950 7" Complete with Loading Cone and 100 "O" Rings
- 80-1952 Loading Cone Only for McGivney
- 80-1912 Ligating "O" Rings (Package of 100)

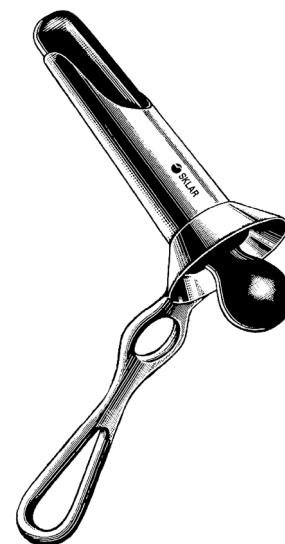

### IVES RECTAL SPECULUM (FANSLER)

- 80-2245 3 1/4" Long
- 80-2244 Obturator Only



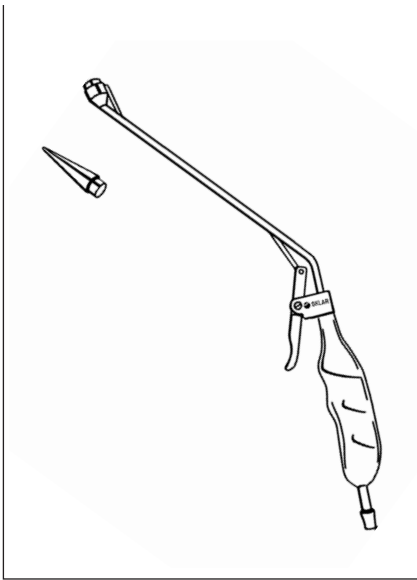

**HEMORRHOIDAL SUCTION  
LIGATOR**

30° UP WITH LOADING CONE

- 80-1970 Complete
- 80-1974 Loading Cone
- 80-1912 Ligating "O" Rings  
(Package of 100)

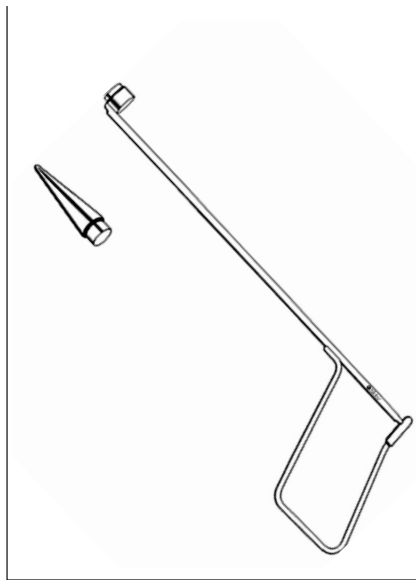

**SKLAR IMPROVED  
HEMORRHOIDAL LIGATOR**

WITH LOADING CONE

- 80-1930 Complete Pistol Grip
- 80-1931 Loading Cone

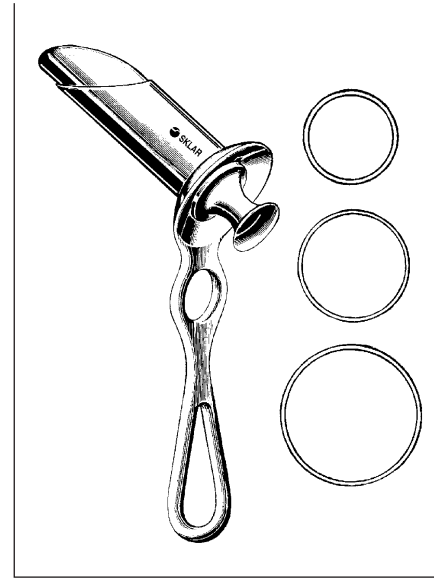

**HIRSCHMAN ANOSCOPES**

- |         |                  |        |        |
|---------|------------------|--------|--------|
| 80-2688 | 9/16" Diameter   | Small  | 2 3/4" |
| 80-2689 | 1 1/16" Diameter | Medium | 2 3/4" |
| 80-2690 | 7/8" Diameter    | Large  | 2 7/8" |

**HIRSCHMAN PROCTOSCOPE**

- 80-2595 5"



**BRINCKERHOFF SPECULUMS**

- 80-2142 Small
- 80-2143 Medium
- 80-2144 Large

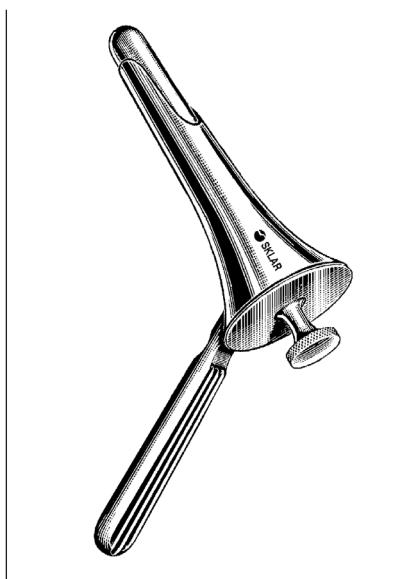

**HINKLE-JAMES SPECULUM**

- 80-2274 Medium Stainless



**CHELSEA EATON ANAL  
SPECULUMS**

- 80-2260 Small
- 80-2261 Large

RECTAL INSTRUMENTS



GENERAL

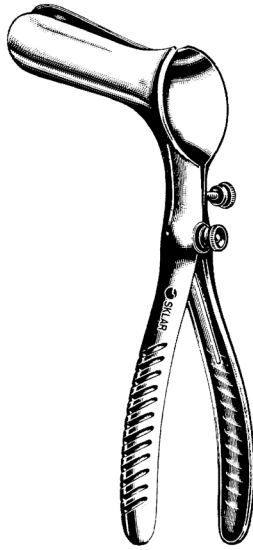

**PRATT RECTAL SPECULUM**  
WITH SET SCREW  
80-2132

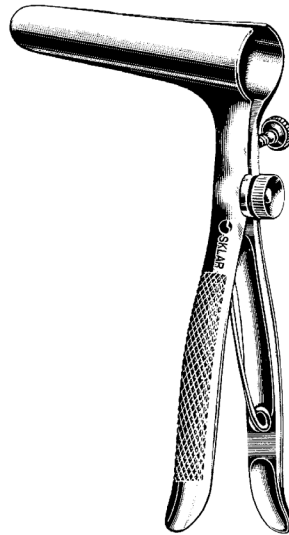

**BODENHAMMER RECTAL SPECULUM**  
WITH SET SCREW  
80-2120 3½" Blades

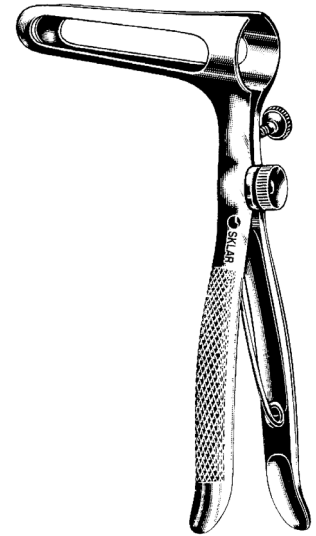

**SIMS RECTAL SPECULUM**  
WITH SET SCREW  
80-2125 Fenestrated Blades

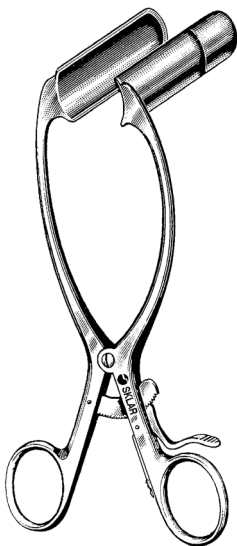

**BARR RECTAL RETRACTOR**  
TRU-GRIP RATCHET  
80-2100 2¾" Blades

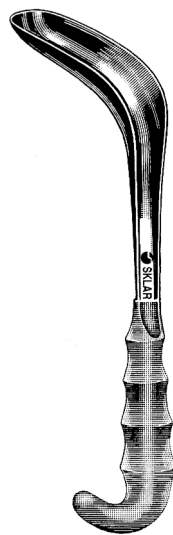

**SAWYER RECTAL RETRACTORS**  
WITH SKLAR GRIP HANDLE

80-3922	2¼" x ⅞"	Small
80-3927	2¾" x 1"	Medium
80-3935	3½" x 1½"	Large

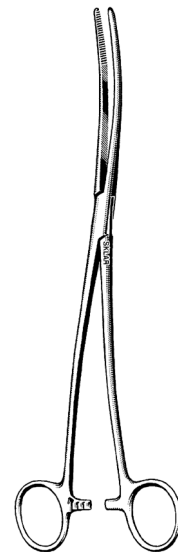

**BOZEMAN DRESSING FORCEPS**

80-1410	10¼"	S-Curve
90-7610	10½"	Straight
<b>ONE LARGE RING</b>		
90-7710	10¼"	S-Curve

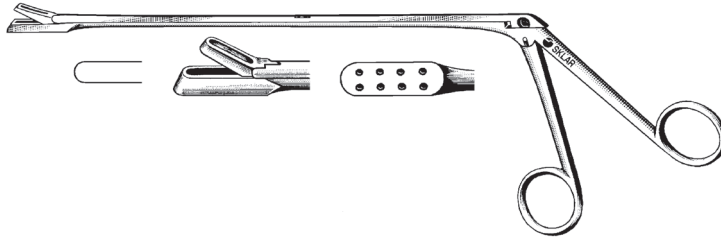

### YEOMAN RECTAL BIOPSY PUNCHES

#### WITH BASKET

80-1728	11"
80-1735	13¾"
80-1742	16½"

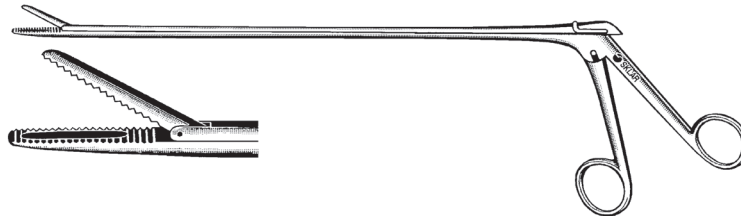

### MATHIEU FOREIGN BODY FORCEPS

#### SERRATED

79-3230	11"
---------	-----

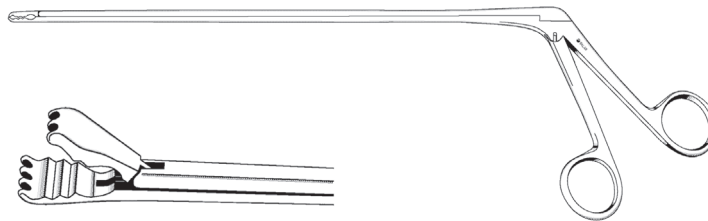

### BARON ALLIGATOR GRASPING FORCEPS

#### ATRAUMATIC

80-1940	10"
---------	-----



### BUIE SUCTION TUBE

80-2815	15 French without Valve
80-2715	15 French with Valve

RECTAL INSTRUMENTS



GENERAL

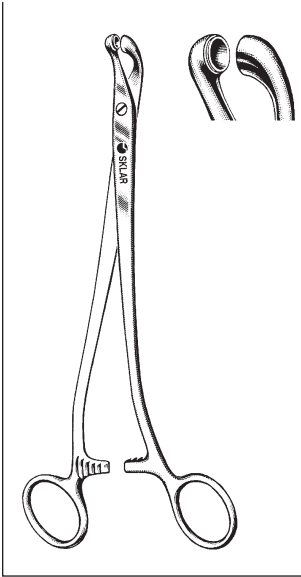

**THOMS-GAYLOR  
BIOPSY FORCEPS  
IMPROVED**  
80-1695 9½"

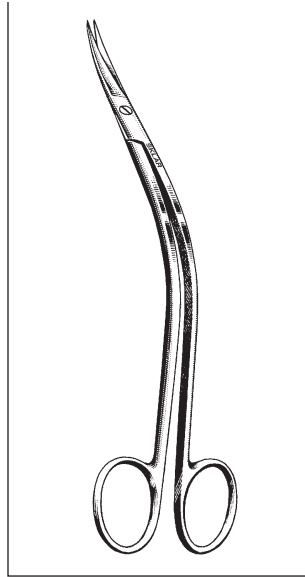

**MILLER RECTAL  
SCISSOR  
DOUBLE CURVE**  
80-1565 6½" Serrated

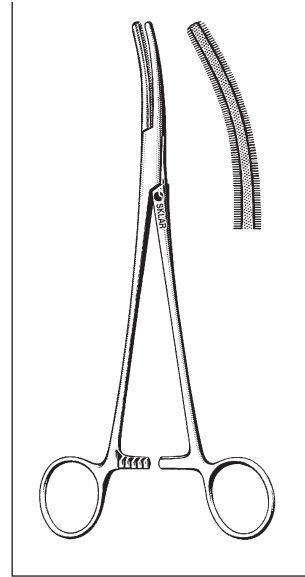

**BUIE PILE CLAMP**  
80-1082 8¼"

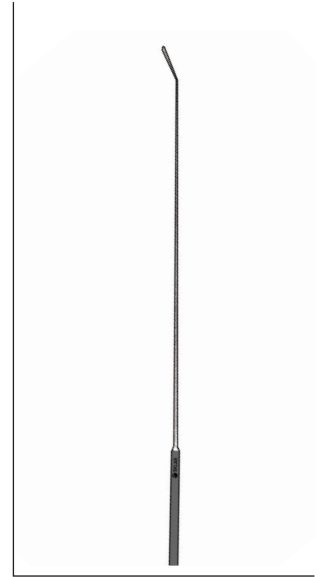

**PRATT RECTAL PROBE  
STERLING SILVER SHAFT**  
80-1260 11" With 8" Shaft

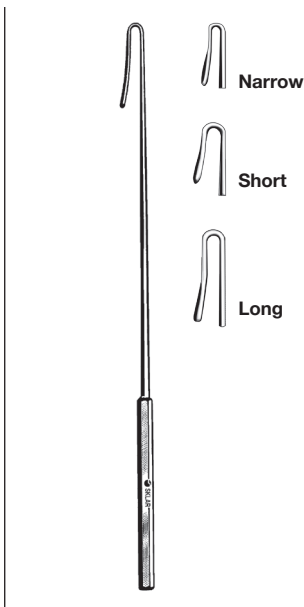

**PRATT CRYPT HOOKS**  
80-3285 8½" Narrow  
80-3185 8½" Short  
80-3085 8½" Long

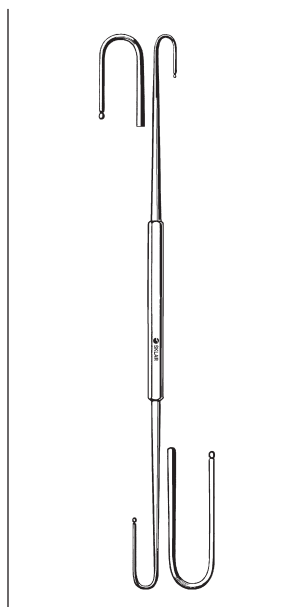

**BARR CRYPT HOOK  
DOUBLE END**  
80-3510 10"

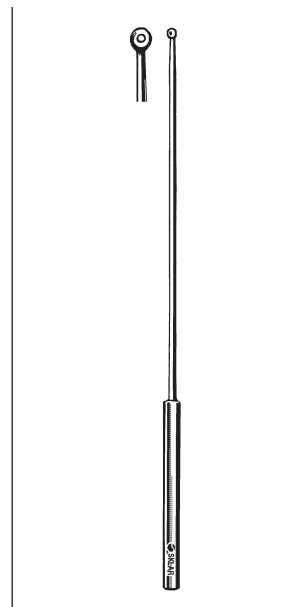

**BARR FISTULA PROBE  
WITH EYE, 11½"**  
80-2910 8" Sterling Shaft

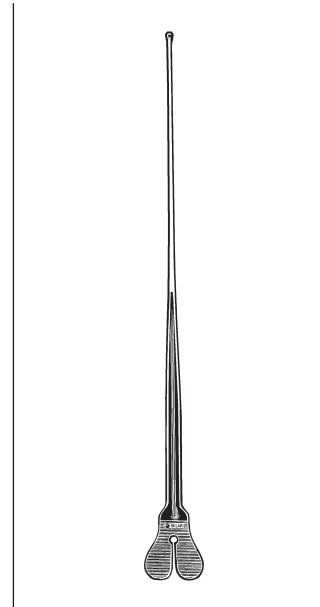

**LARRY RECTAL PROBE**  
80-2870 7"



**SKLAR BLACK™ LASER TUTTLE FORCEPS**  
90-2270 7"



**SKLAR BLACK™ LASER POTTS-SMITH FORCEPS**  
90-2306 10" Serrated



**SKLAR BLACK™ LASER BABCOCK FORCEPS**  
90-2278 8"



**SKLAR BLACK™ LASER ALLIS FORCEPS**  
90-2276 7½" 5x6 Teeth



**THORACIC  
FORCEPS**

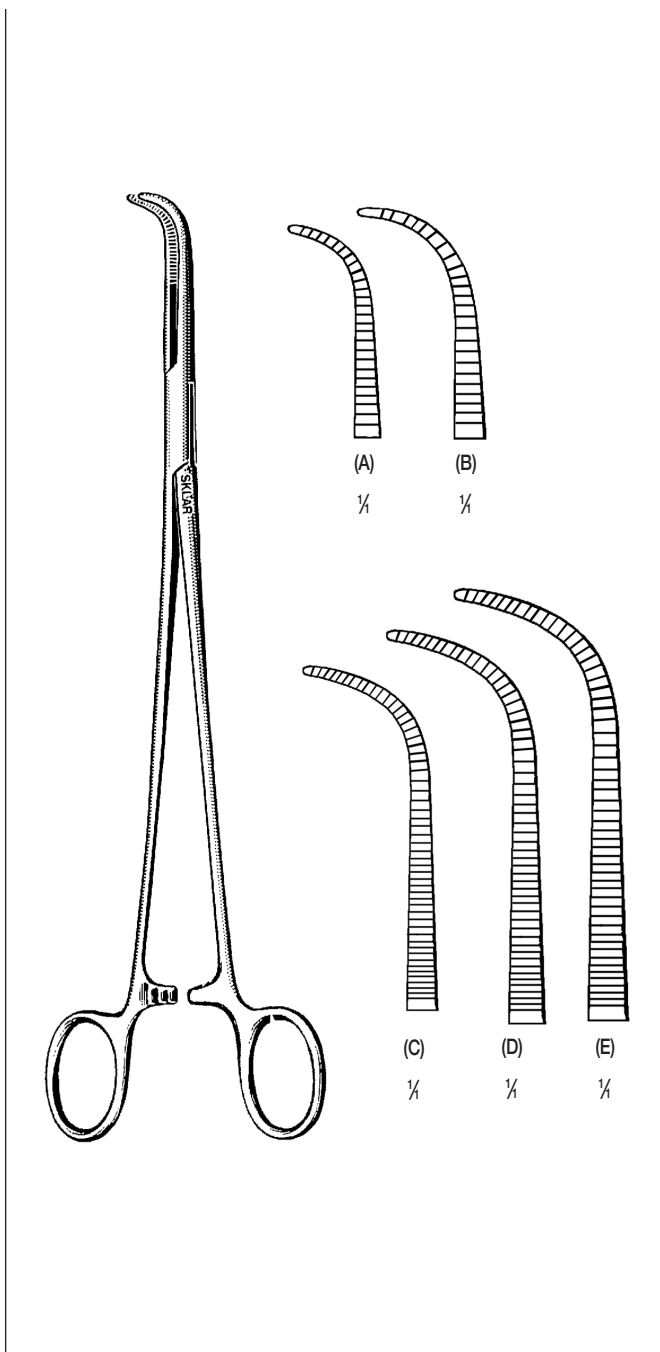

**GEMINI FORCEPS**

**DELICATE RIGHT ANGLE**

55-2855	5"	(A)
55-2870	6 1/4"	(B)
55-2880	8"	(C)
55-2890	9"	(D)
55-2898	11"	(E)

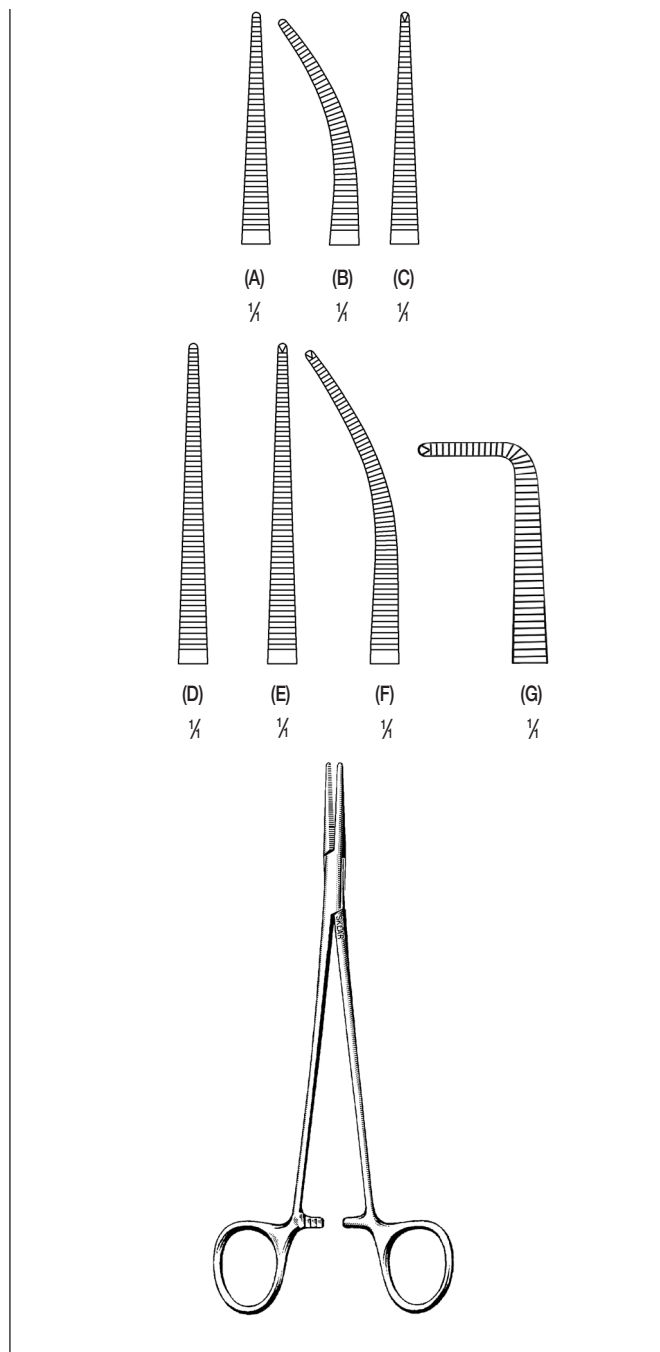

**DELICATE-LONG MOSQUITO FORCEPS**

55-2021	7"	Straight Serrated	(A)
55-2022	7"	Curved Serrated	(B)
55-2023	7"	Straight Serrated 1x2	(C)
55-2025	8 1/4"	Straight Serrated	(D)
55-2026	8 1/4"	Straight Serrated 1x2	(E)
55-2027	8 1/4"	Curved Serrated 1x2	(F)
55-2028	7 3/4"	Right Angle 1x2	(G)

For a complete listing of our Cardiovascular product line, visit [www.sklarcorp.com](http://www.sklarcorp.com).

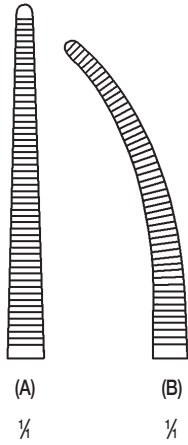

**LERICHE FORCEPS**

**SERRATED**

- 17-1272 6" Straight (A)
- 17-1274 6" Curved (B)

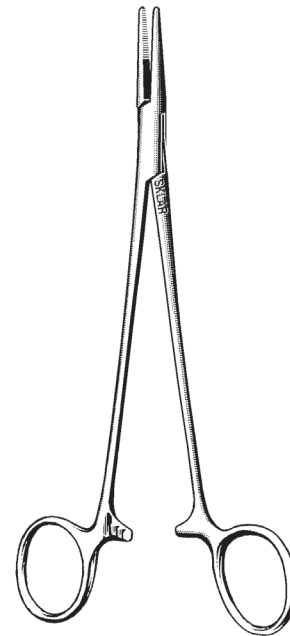
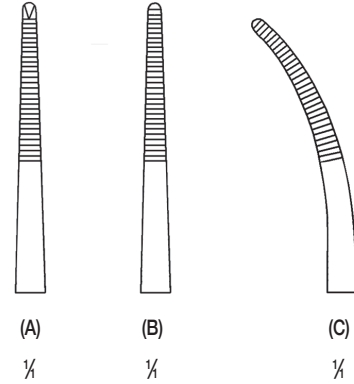

**ADSON FORCEPS**

- 50-1574 7" Straight 1x2 (A)
- 50-1372 7 1/4" Straight (B)
- 50-1472 7 1/4" Curved (C)

For a complete listing of our Cardiovascular product line, visit [www.sklarcorp.com](http://www.sklarcorp.com).

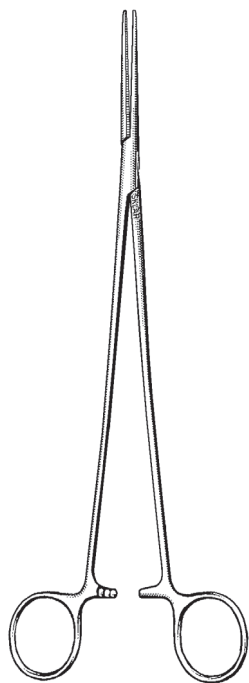
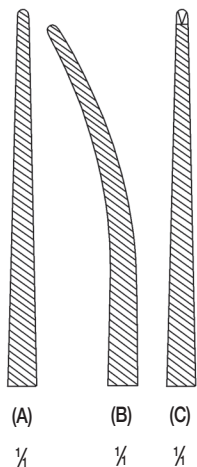

**BENGOLEA FORCEPS**

**DIAGONAL SERRATIONS**

55-2045	8 1/4"	Straight	(A)
55-2050	10 1/4"	Curved	(B)
55-2060	10 1/4"	Straight 1x2	(C)

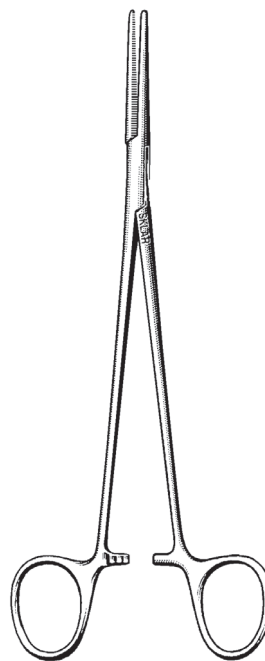
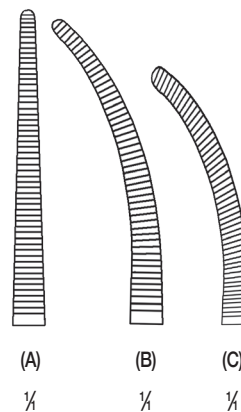

**HEISS FORCEPS**

**SERRATED**

55-2320	8"	Straight	(A)
55-2322	8"	Half-Curved	(B)
55-2324	8"	Full-Curved	(C)

For a complete listing of our Cardiovascular product line, visit [www.sklarcorp.com](http://www.sklarcorp.com).



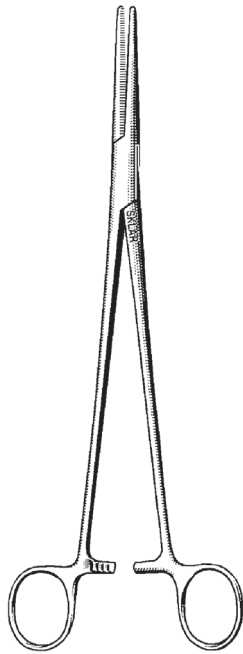
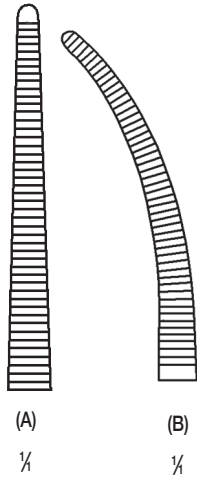

**ROBERTS FORCEPS**

**SERRATED**

55-2684 8 $\frac{3}{4}$ " Curved (B)  
55-2682 9" Straight (A)

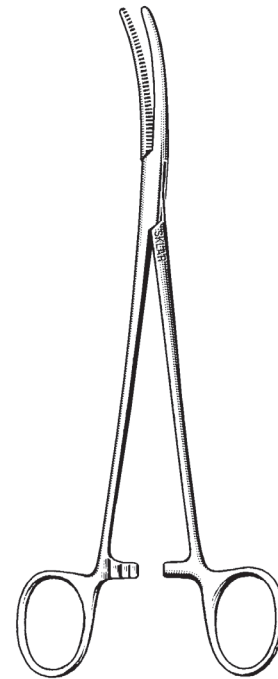

**VANDERBILT UNIVERSITY FORCEPS**

**SERRATED**

55-2688 8 $\frac{1}{2}$ " Curved

For a complete listing of our Cardiovascular product line, visit [www.sklarcorp.com](http://www.sklarcorp.com).

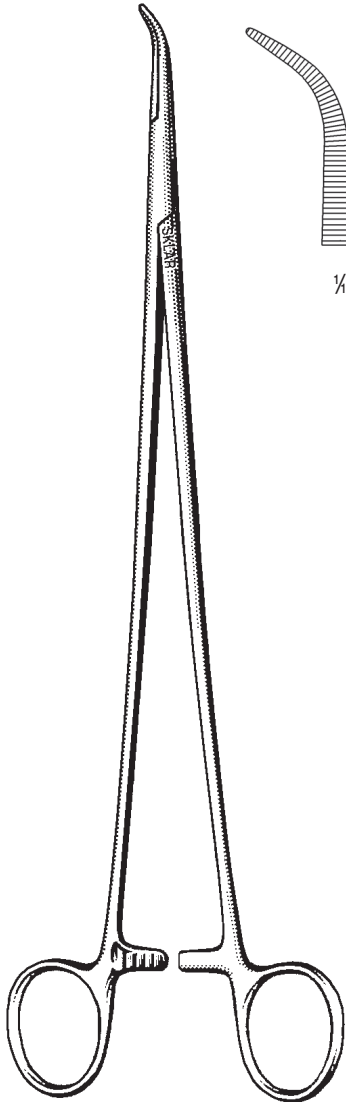

**LAWRENCE FORCEPS**

**SERRATED**

55-2685 10 3/4" Curved

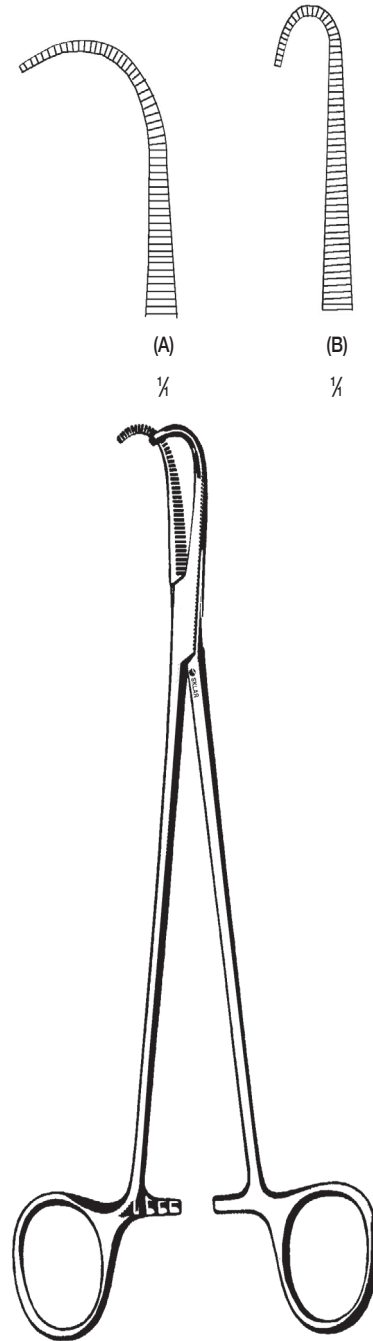

**NEGUS HEMOSTATIC FORCEPS**

55-2342 7 1/2" Full Curve (A)

55-2340 7 1/2" Small Hook Shaped Curve (B)

For a complete listing of our Cardiovascular product line, visit [www.sklarcorp.com](http://www.sklarcorp.com).

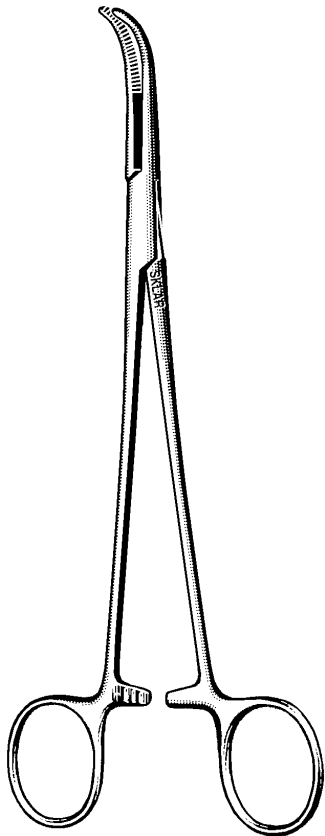
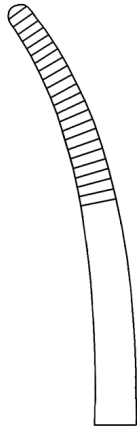

**SCHNIDT FORCEPS**

**SERRATED**

74-3075 7½" Half Curved

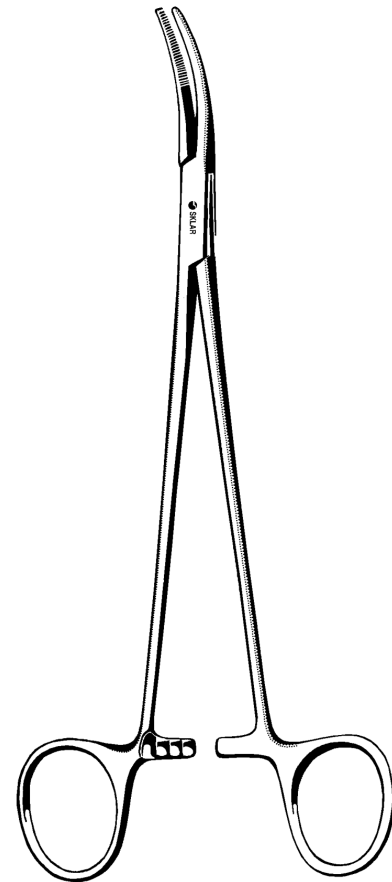
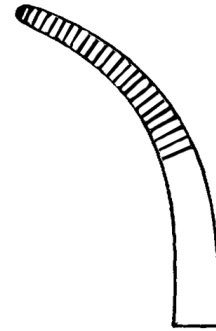

**SAWTELL FORCEPS**

**SERRATED**

74-3175 7½" Full Curve

**For a complete listing of our Cardiovascular product line, visit [www.sklarcorp.com](http://www.sklarcorp.com).**

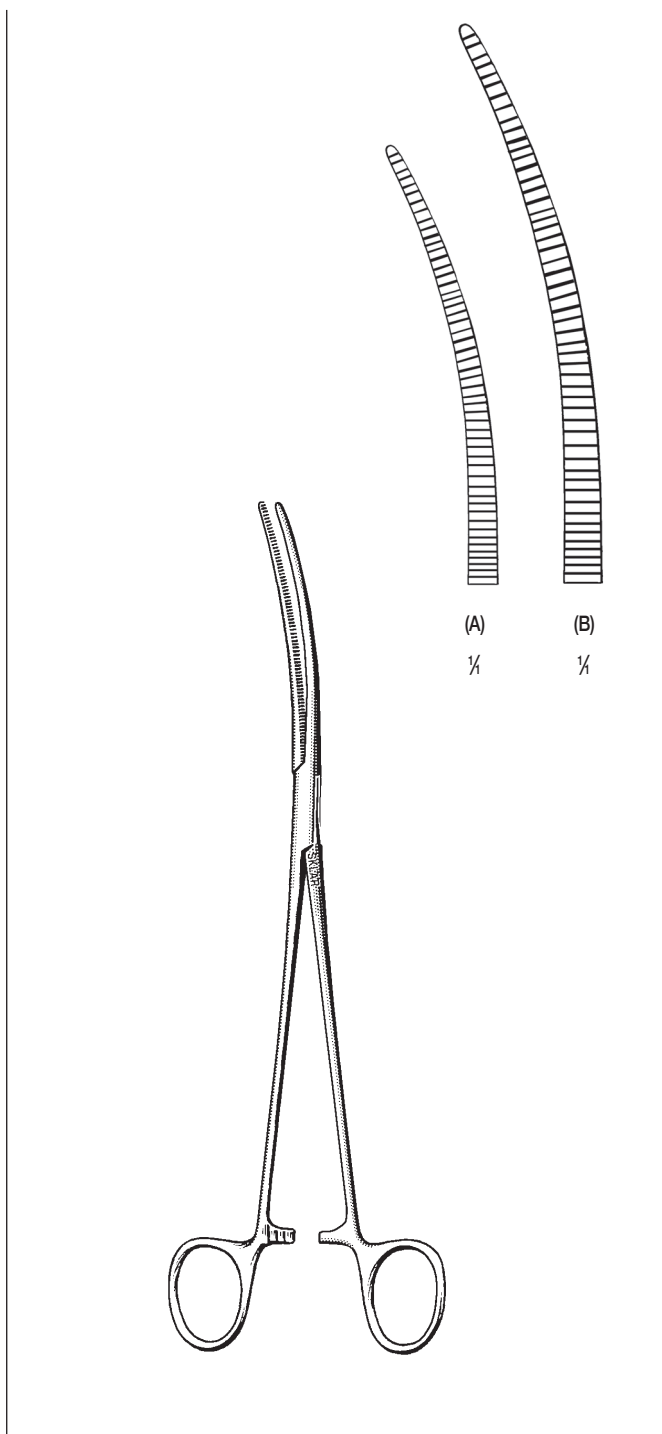

**CRAFOORD FORCEPS**

**SERRATED**

- 55-2330 7" Curved (A)
- 55-2334 9½" Curved (B)

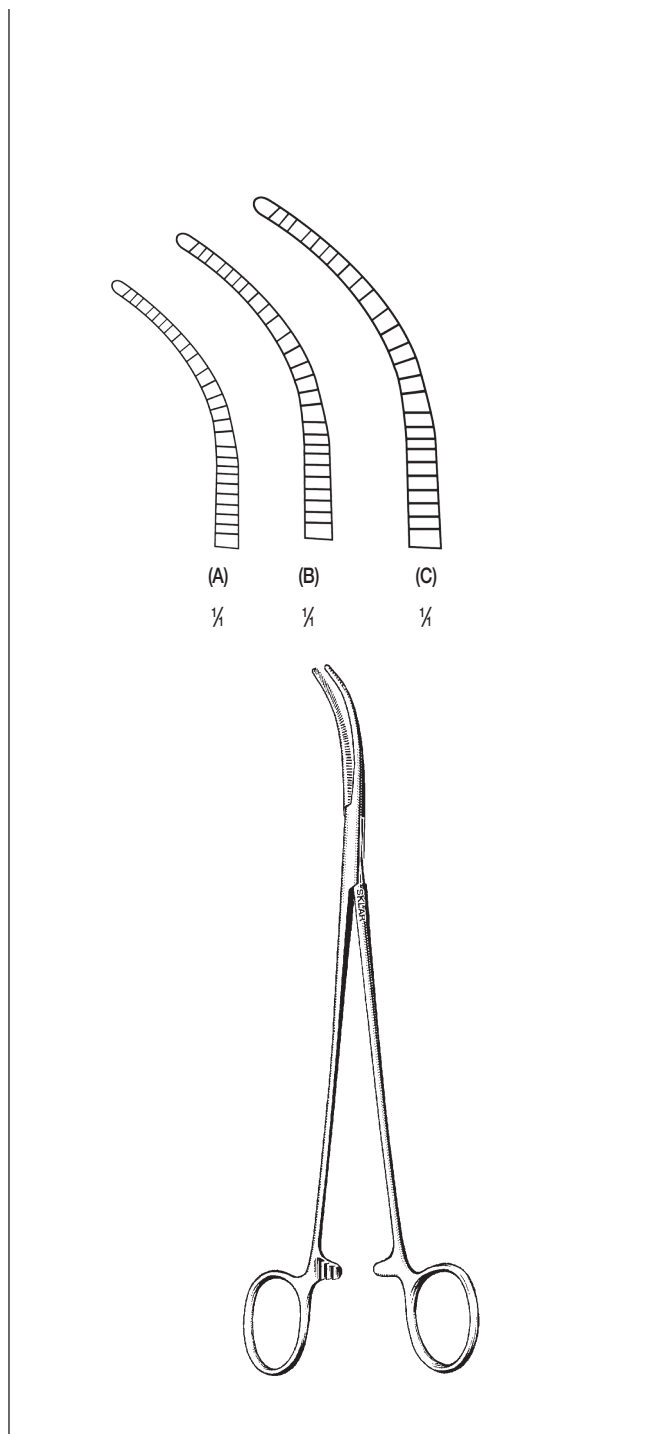

**OVERHOLT FORCEPS**

- 55-2187 8¼" Small Jaw (A)
- 55-2190 8¼" Medium Jaw (B)
- 55-2195 8¼" Long Jaw (C)

For a complete listing of our Cardiovascular product line, visit [www.sklarcorp.com](http://www.sklarcorp.com).

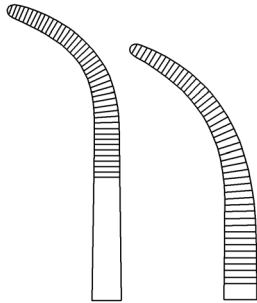

(A)  $\frac{1}{4}$  (B)  $\frac{1}{4}$

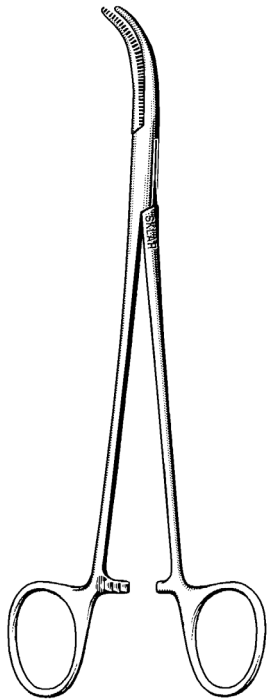

**OVERHOLT-GEISSENDOERFER FORCEPS**

- 55-2350 8¼" Curved Half-Serrated (A)
- 55-2352 8¼" Curved Full-Serrated (B)



$\frac{1}{4}$

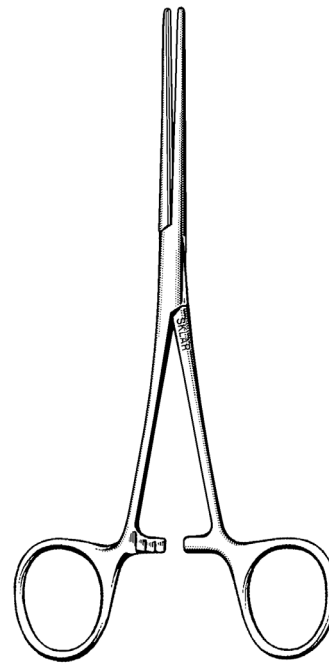

**BAINBRIDGE FORCEPS**

**LONGITUDINAL SERRATIONS**

- 17-3660 6" Straight
- 17-3760 6" Curved
- 17-3670 7" Straight

For a complete listing of our Cardiovascular product line, visit [www.skларcorp.com](http://www.skларcorp.com).

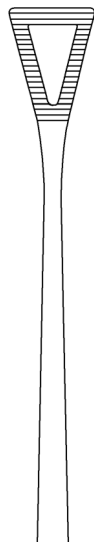

¼

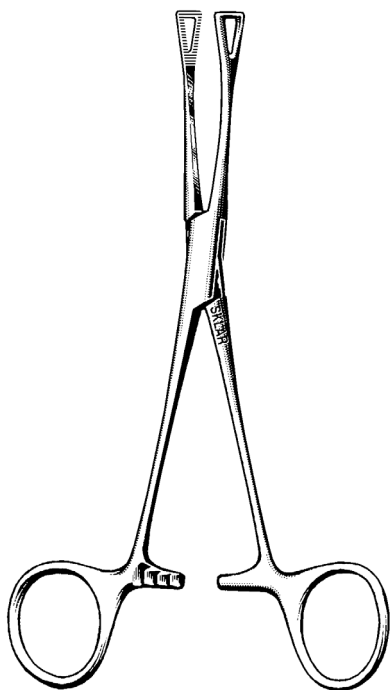

**PENNINGTON GRASPING FORCEPS**

17-2957 6¼" ½" Jaw  
17-2958 8" ½" Jaw



¼

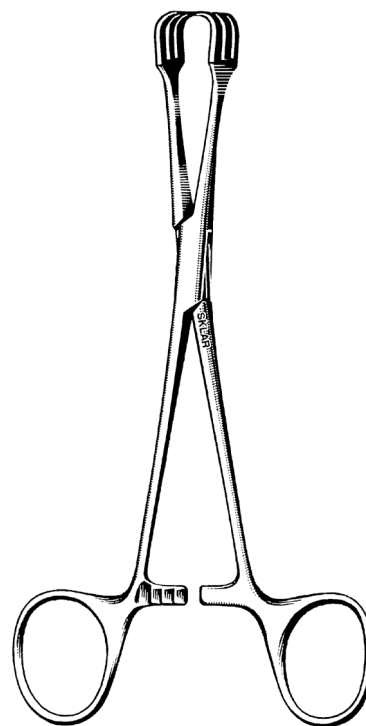

**LAHEY TRACTION FORCEPS**

17-3562 6¼" 3 Prongs with Teeth  
91-2080 8" 3 Prongs with Teeth

For a complete listing of our Cardiovascular product line, visit [www.sklarcorp.com](http://www.sklarcorp.com).

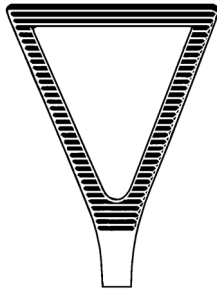

1/4

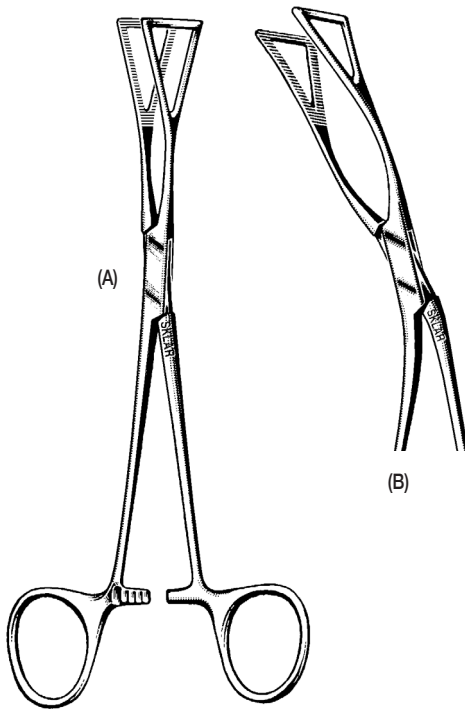

**LOVELACE GRASPING FORCEPS**

32-2470 7" Angled To Side (B)  
32-2477 8" Straight (A)

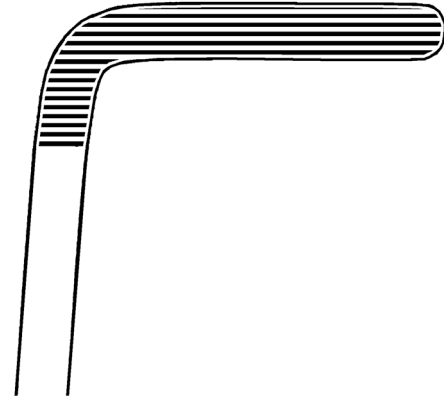

1/4

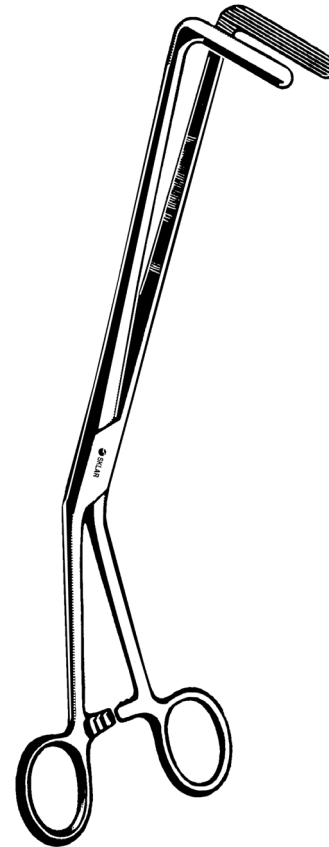

**HARRINGTON FORCEPS**

55-2311 11 3/4" Angled

For a complete listing of our Cardiovascular product line, visit [www.sklarcorp.com](http://www.sklarcorp.com).



**THORACIC  
SPREADERS**



**BURFORD-FINOCHIETTO RIB SPREADER**

**2 SETS OF BLADES**

55-7880 2½" x 2½" 8" spread  
1½" x 2½"

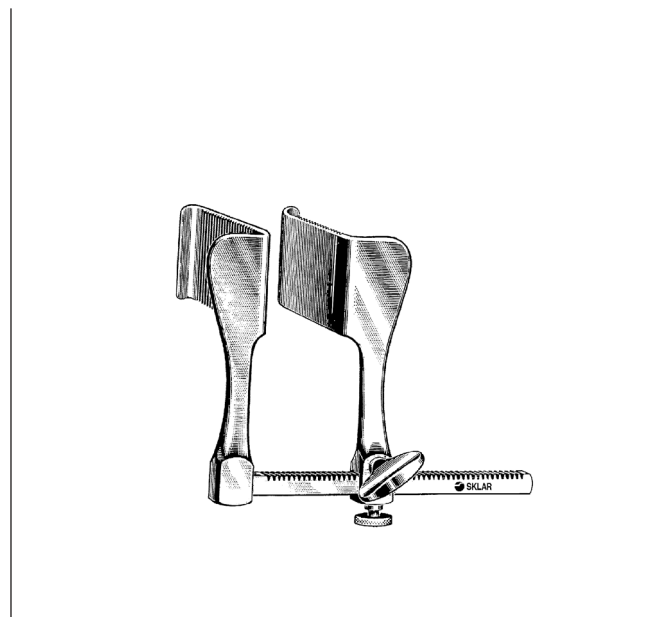

**TUFFIER RIB SPREADERS**

55-7445 2" x 2" 4½" Spread  
55-7465 2" x 2" 6½" Spread

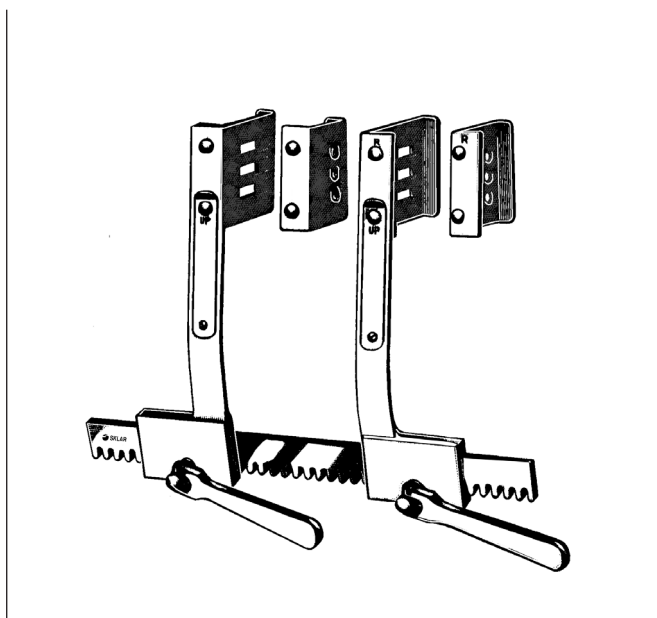

**BURFORD-FINOCHIETTO RIB SPREADER**

55-7980 With both arms movable and two sets of interchangeable blades, large, 2½" x 2½", small, 1½" x 2½", curved arms, total opening 8" (20.3 cm)

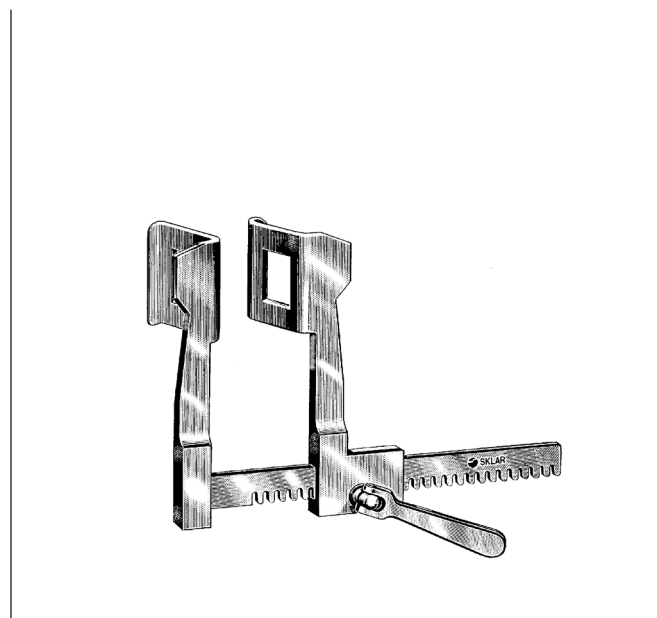

**FINOCHIETTO RIB SPREADERS**

55-7675 1¼" x 1¼" 6" Spread Small  
55-7685 1¾" x 2½" 8½" Spread Medium  
55-7680 2¾" x 2½" 10" Spread Large

For a complete listing of our Cardiovascular product line, visit [www.sklarcorp.com](http://www.sklarcorp.com).



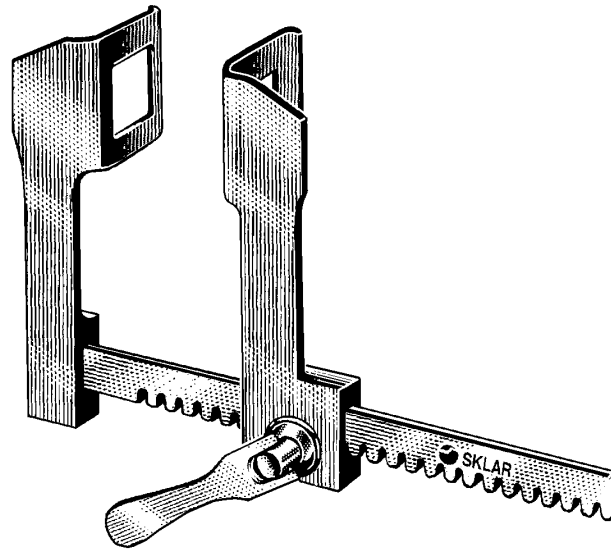

**HAIGHT-FINOCHIETTO RIB RETRACTOR**

22-7855 Total opening 3½"

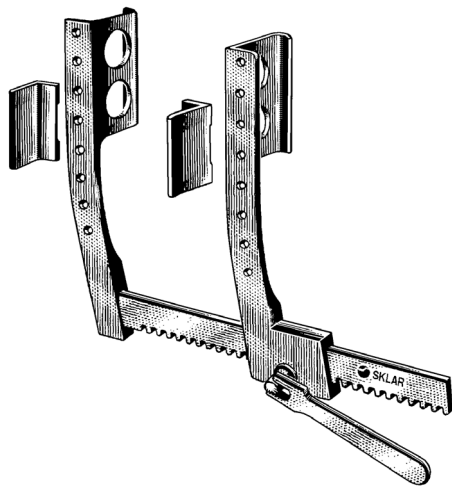

**HARKEN RIB SPREADER**

55-7785 1¼" Deep x 3" Wide, Solid scapula blades,  
1½" Deep x 2" Wide, Total opening 10"

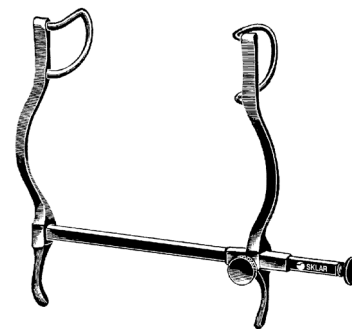

**NELSON RETRACTORS (GOSSET)**

**SELF-RETAINING**

55-7355	2½" x 1¼" Blades	5½" Spread
60-6240	1" x 1½" Blades	4" Spread

For a complete listing of our Cardiovascular product line, visit [www.sklarcorp.com](http://www.sklarcorp.com).

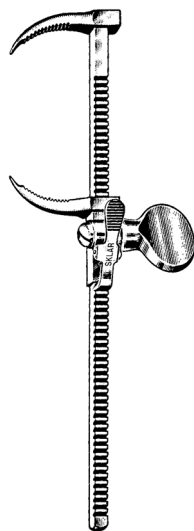

**LEMMON STERNAL APPROXIMATOR**

55-7360 Adult

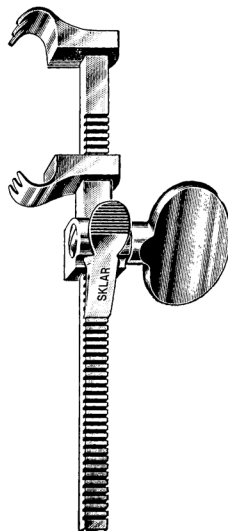

**BAILEY RIB CONTRACTOR**

55-7365 Pediatric

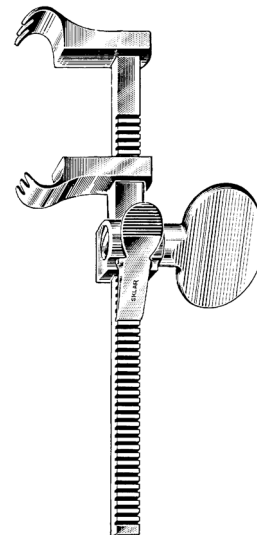

**BAILEY-GIBBON RIB CONTRACTOR**

55-7366 Adult

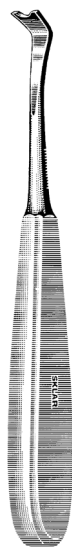

**SEMB RASPATORY**

NOTCHED END

55-4510 8" Angular

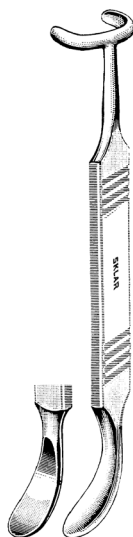

**MATSON RIB STRIPPER/ELEVATOR**

DOUBLE END

55-6887 8¾" Adult



**ALEXANDER RASPATORY**

DOUBLE END

22-7560 Pediatric 6"

55-5980 Adult 8"

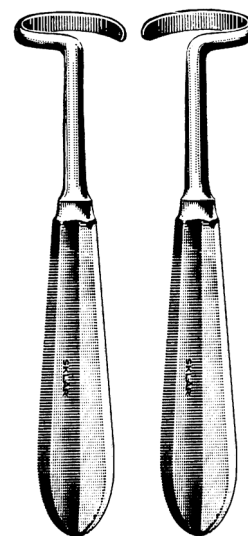

**DOYEN RIB RASPATORY**

55-6965 Right 6½"

55-7065 Left 6½"

55-7067 Set/2 6½"

22-7660 Right 7"

22-7760 Left 7"

For a complete listing of our Cardiovascular product line, visit [www.sklarcorp.com](http://www.sklarcorp.com).

THORACIC  
SHEARS



**STILLE RIB SHEAR**  
55-1685 8½"

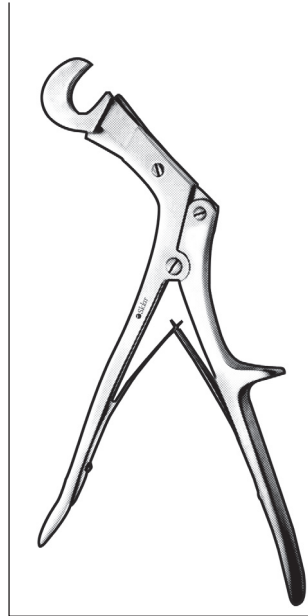

**GIERTZ-STILLE RIB CUTTER**  
55-2011 10½"

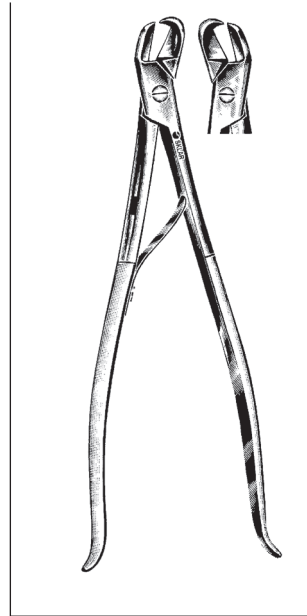

**CORYLLOS RIB SHEARS**  
55-1414 14" Right  
55-1514 14" Left

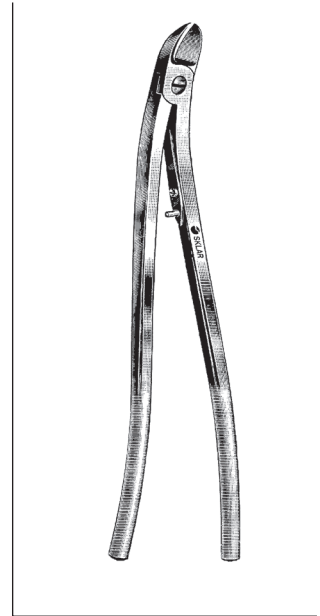

**BETHUNE RIB SHEAR**  
55-1614 14" (Nelson)

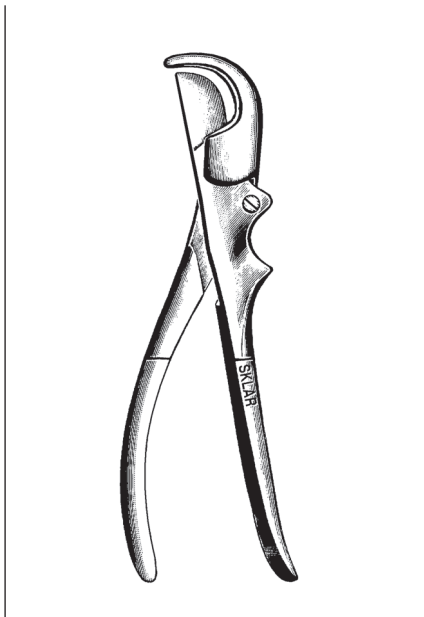

**GLUCK RIB SHEAR**  
55-1687 8¾"

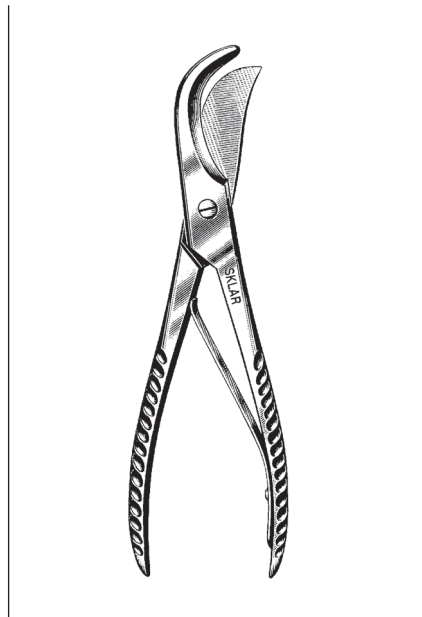

**COLLINS RIB SHEAR**  
55-1692 9¼"

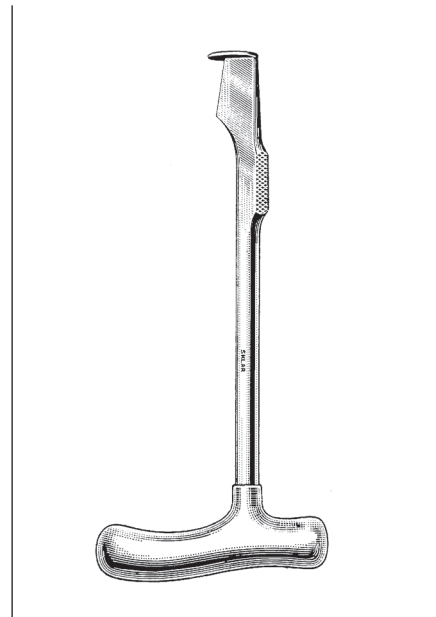

**LEBSCHKE STERNUM CHISEL**  
55-2010 10"

For a complete listing of our Cardiovascular product line, visit [www.sklarcorp.com](http://www.sklarcorp.com).

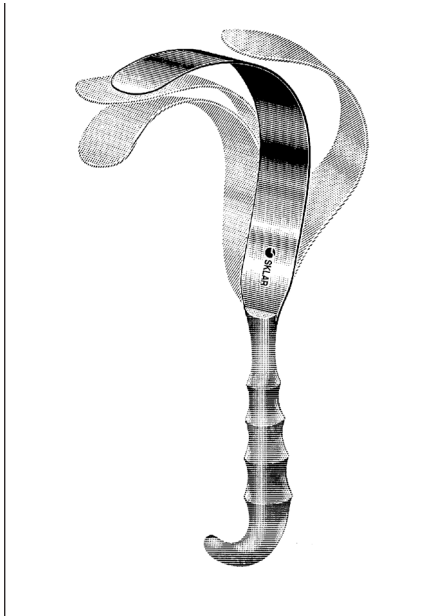

### ZALKIND LUNG RETRACTORS

**MALLEABLE**

55-7220 2" x 12"

55-7230 3" x 12"

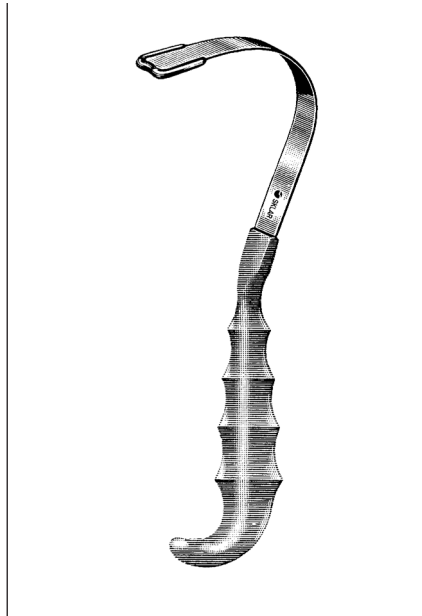

### HARRINGTON RETRACTOR

22-7795 1" x 10" Pediatric



### HARRINGTON SPLANCHNIC RETRACTORS

**12½" LONG**

55-7115 1½" x 5" Blade

55-7125 2½" x 5" Blade

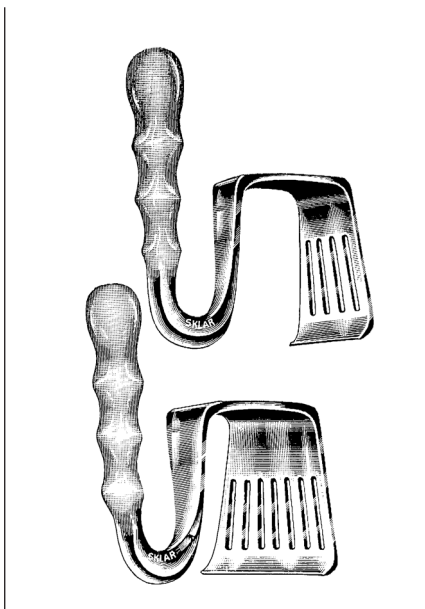

### DAVIDSON SCAPULA RETRACTORS

55-7195 Large 3" x 3½"

55-7196 Small 3" x 2"

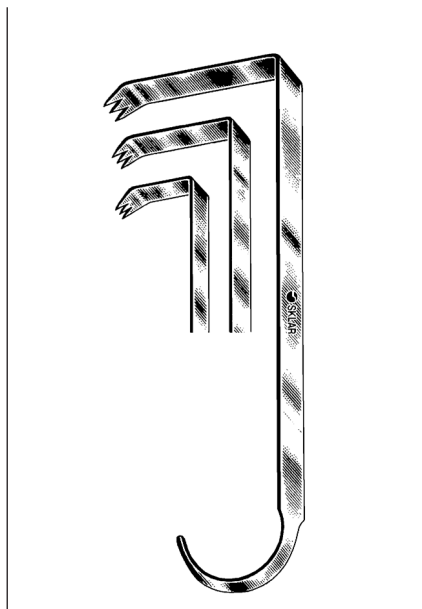

### HIBBS RETRACTORS

55-7167 ½" x 1¼" 6¾"

55-7175 ⅝" x 2" 9"

55-7192 1" x 3" 9½"

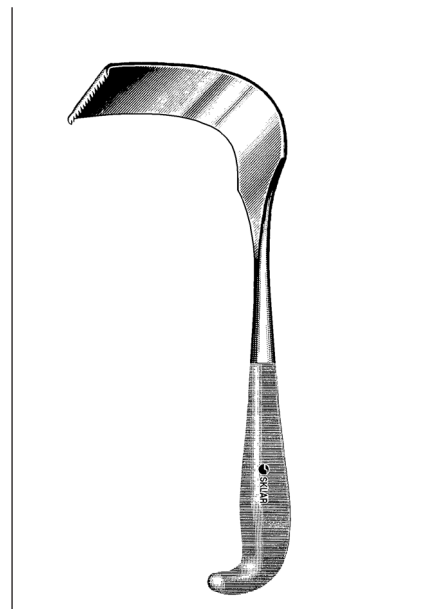

### MEYERDING RETRACTORS

42-2085 7¾" Small ⅝" x 2" Blade

42-2092 8¾" Medium 1" x 3" Blade

42-2095 9½" Large 2" x 3½" Blade

For a complete listing of our Cardiovascular product line, visit [www.sklarcorp.com](http://www.sklarcorp.com).

**THORACIC  
RETRACTORS / CLAMPS**

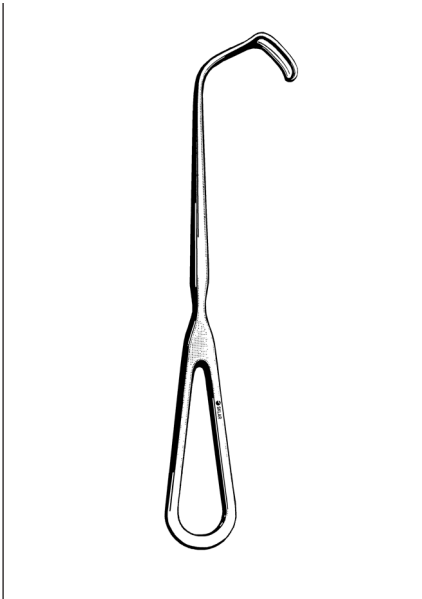

**CUSHING RETRACTOR**

50-1280 8"

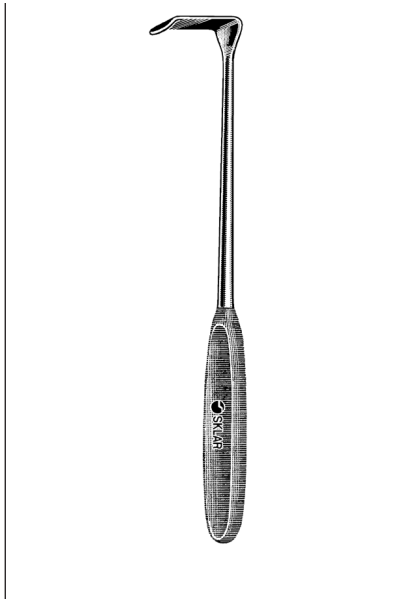

**LANGENBECK RETRACTORS**

- 60-1891 3/8" x 1 1/8" 9"
- 60-1892 1/2" x 1 1/4" 9"
- 60-1893 5/8" x 1 1/4" 9"
- 60-1894 3/8" x 1 1/2" 9"
- 60-1895 3/8" x 2" 9"

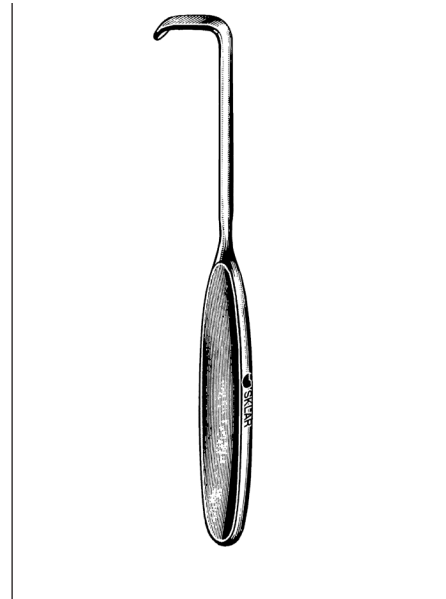

**LAHEY RETRACTOR**

52-1277 7"

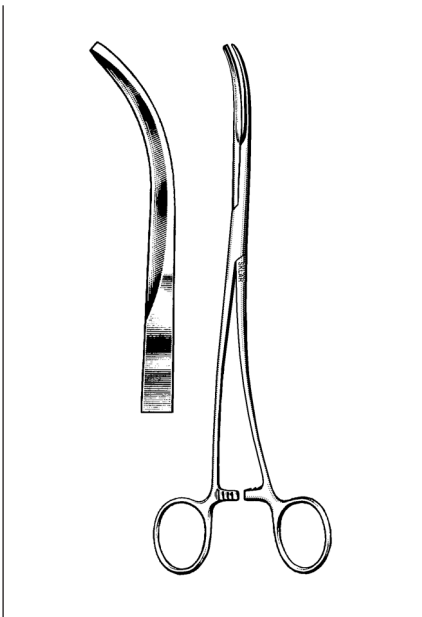

**SEMB DISSECTING FORCEPS**

55-2395 Shallow Curve 9 1/2"

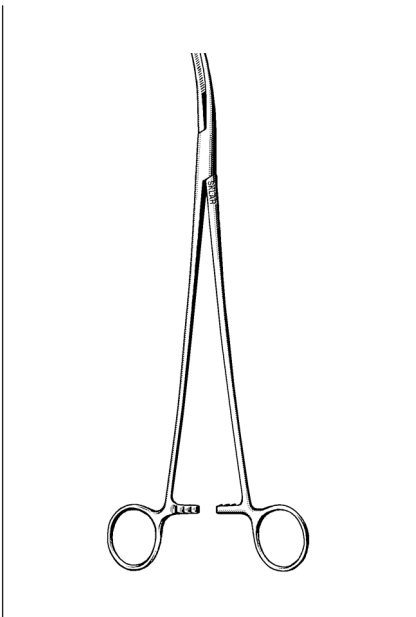

**SKLAR THORACIC CLAMPS**

- 55-3080 7" Curved
- 55-3110 10" Curved

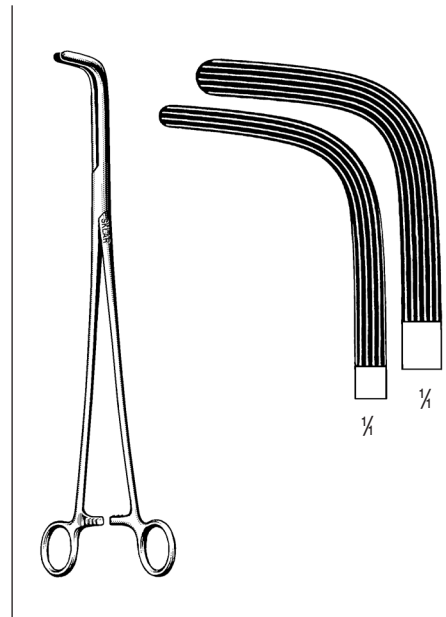

**HARRINGTON-MIXTER CLAMPS**

- 55-2912 12" Curved, Light Model
- 55-3012 12" Curved, Heavy Model

For a complete listing of our Cardiovascular product line, visit [www.sklarcorp.com](http://www.sklarcorp.com).

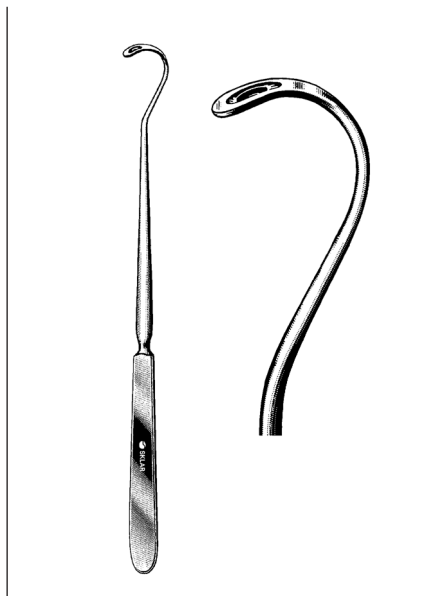

**NELSON LIGATURE NEEDLE**

55-6492 9¼"

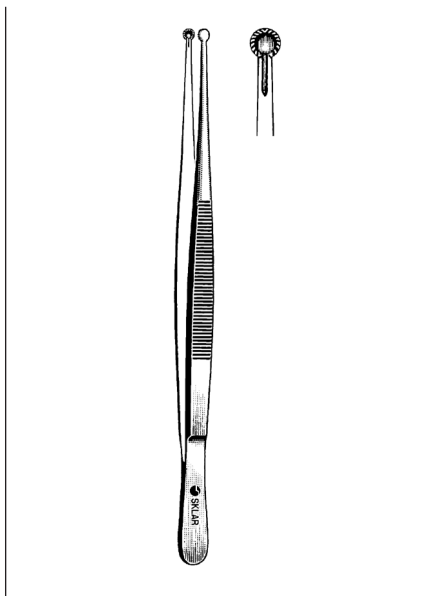

**SELMAN FORCEPS**

**NON-SLIP**

- 52-4260 6"
- 52-4280 8"
- 52-4310 10"

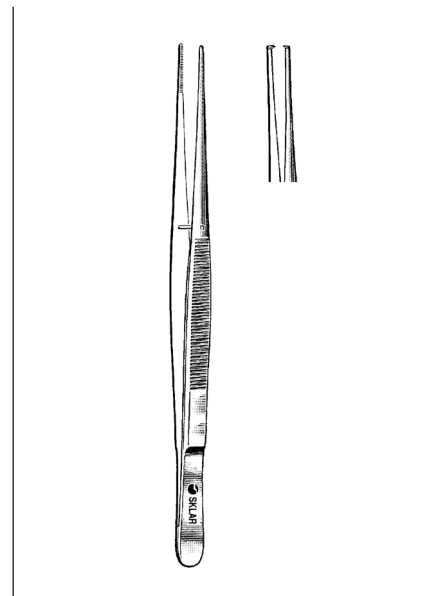

**POTTS-SMITH FORCEPS**

- 52-3270 7" Serrated
- 52-3282 8¼" Serrated
- 52-3370 7" 1x2
- 52-3382 8¼" 1x2
- 52-3310 10" Serrated
- 52-3410 10" 1x2
- 52-3312 12" Serrated
- 52-3412 12" 1x2



**KANTROWITZ TISSUE FORCEPS**

52-3597 9¾" Curved, 1x2



**HARRINGTON-MAYO BAYONET TISSUE FORCEPS**

55-4114 14"

For a complete listing of our Cardiovascular product line, visit [www.sklarcorp.com](http://www.sklarcorp.com).

**THORACIC  
SCISSORS**

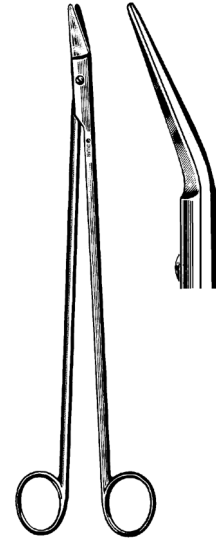
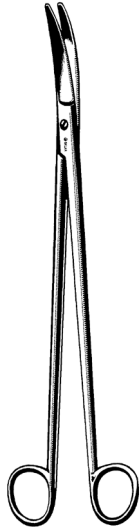

**MAYO DISSECTING SCISSORS**

**STRAIGHT**

- 15-1555 5½"
- 15-1567 6¾"
- 90-1590 9"
- 55-8711 11" Harrington

**CURVED**

- 15-2555 5½"
- 15-2567 6¾"
- 90-1690 9"
- 55-8611 11" Harrington

**FINOCHIETTO SCISSOR**

**THORACIC, ANGULAR**

- 55-8310 10¾"

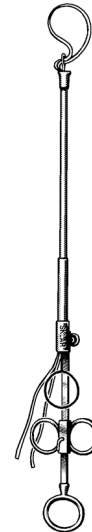
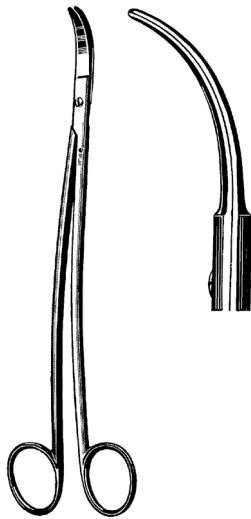

**SATINSKY SCISSOR**

**DOUBLE CURVE**

- 55-8495 9½"

**RUMEL TOURNIQUET**

**COMPLETE WITH THREADING STYLET**

- 52-4113 13"

**For a complete listing of our Cardiovascular product line, visit [www.sklarcorp.com](http://www.sklarcorp.com).**



**CARDIOVASCULAR**

**TISSUE FORCEPS**



**DEBAKEY ATRAUMATIC TISSUE FORCEPS**

**1.5MM JAWS**

- 52-5062 6¼"
- 52-5077 7¾"
- 52-5095 9½"
- 52-5098 12"



**DEBAKEY ATRAUMATIC TISSUE FORCEPS**

**2.0MM JAWS**

- 52-5162 6¼"
- 52-5177 7¾"
- 52-5195 9½"
- 52-5198 12"

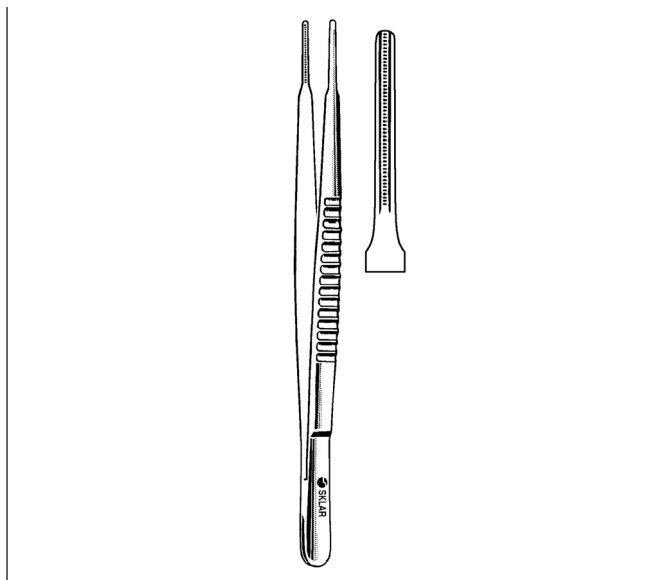

**DEBAKEY ATRAUMATIC TISSUE FORCEPS**

**3.5MM JAWS**

- 52-5262 6¼"
- 52-5277 7¾"
- 52-5295 9½"

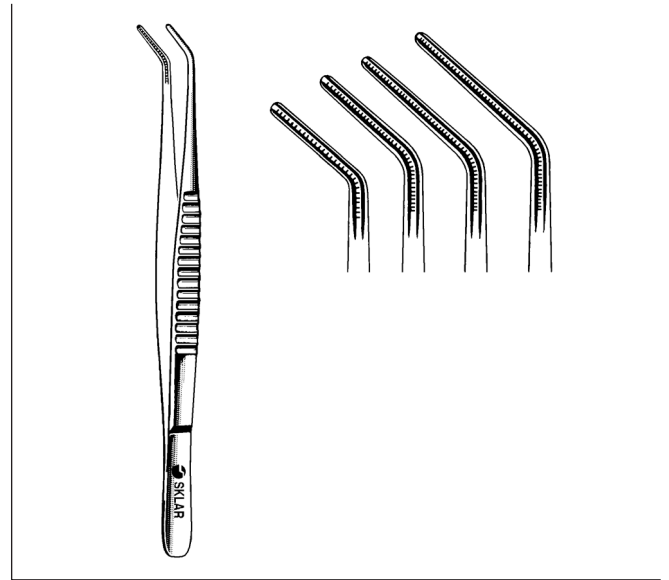

**DEBAKEY ATRAUMATIC TISSUE FORCEPS**

- 52-5202 6¼" 1.5mm
- 52-5307 7¾" 2mm
- 52-5309 9½" 2.7mm
- 52-5312 12" 2.5mm

For a complete listing of our Cardiovascular product line, visit [www.sklarcorp.com](http://www.sklarcorp.com).



**CARDIOVASCULAR  
TISSUE FORCEPS**

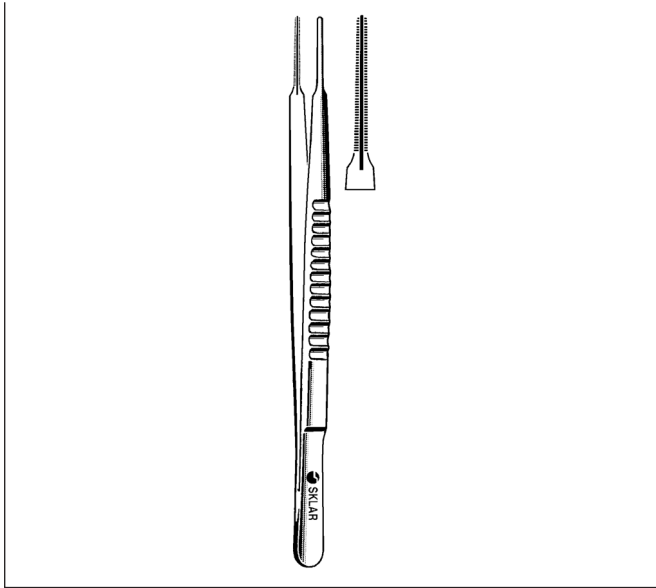

**COOLEY VASCULAR TISSUE FORCEPS**

- 52-6690 6"
- 52-6694 8"
- 52-6696 9½"



**POTTS-SMITH FORCEPS**

- |         |     |          |         |     |          |
|---------|-----|----------|---------|-----|----------|
| 52-3270 | 7"  | Serrated | 52-3310 | 10" | Serrated |
| 52-3370 | 7"  | 1x2      | 52-3410 | 10" | 1x2      |
| 52-3282 | 8¼" | Serrated | 52-3312 | 12" | Serrated |
| 52-3382 | 8¼" | 1x2      | 52-3412 | 12" | 1x2      |

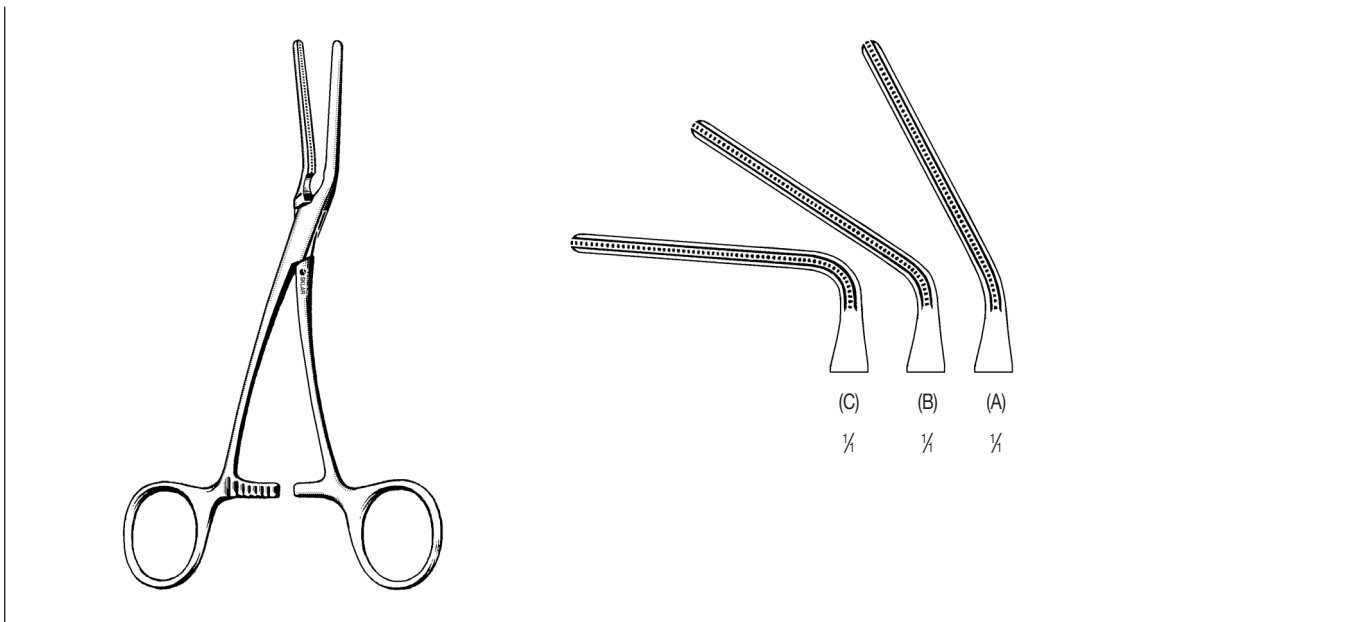

**DEBAKEY ATRAUMATIC TISSUE FORCEPS**

- |         |     |                       |     |
|---------|-----|-----------------------|-----|
| 52-6585 | 5½" | Pediatric Straight    |     |
| 52-6587 | 5½" | Pediatric Angular 30° | (A) |
| 52-6588 | 5½" | Pediatric Angular 60° | (B) |
| 52-6589 | 5½" | Pediatric Angular 90° | (C) |

For a complete listing of our Cardiovascular product line, visit [www.sklarcorp.com](http://www.sklarcorp.com).



**CARDIOVASCULAR  
NEEDLE HOLDERS / FORCEPS**

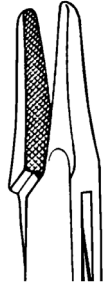

**LEMMON VASCULAR NEEDLE HOLDERS**

- 20-4175 6 3/4"
- 20-4178 7 3/4"

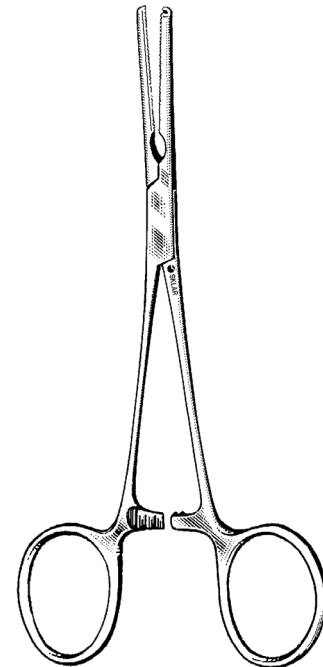
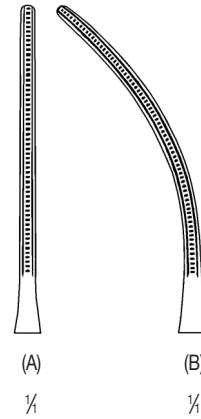

**DEBAKEY ATRAUMATIC VASCULAR TISSUE  
FORCEPS**

- |         |    |                     |          |     |
|---------|----|---------------------|----------|-----|
| 52-6575 | 5" | Ring Handle Bulldog | Straight | (A) |
| 52-6577 | 5" | Ring Handle Bulldog | Curved   | (B) |

**For a complete listing of our Cardiovascular product line, visit [www.sklarcorp.com](http://www.sklarcorp.com).**

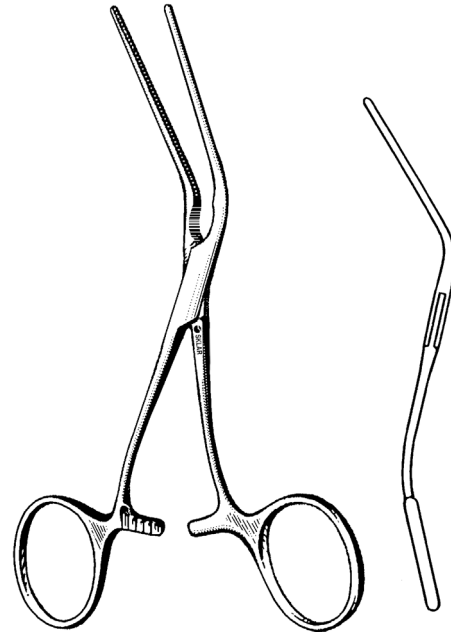
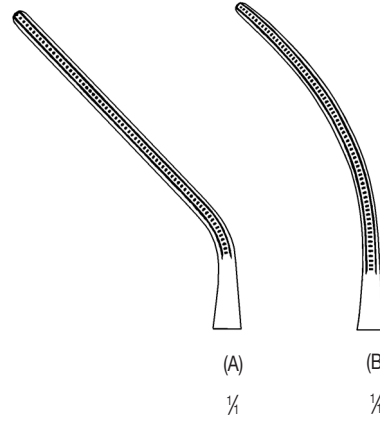
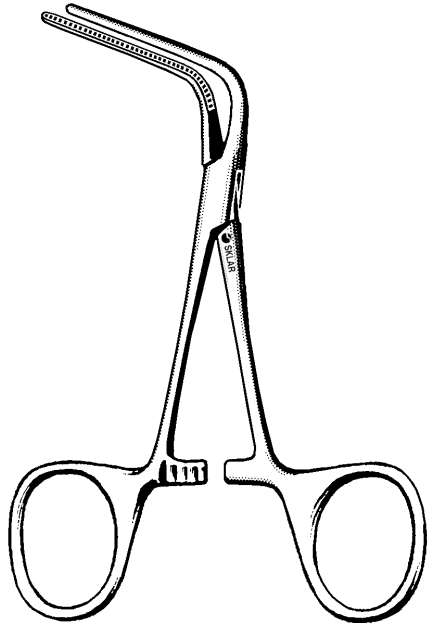
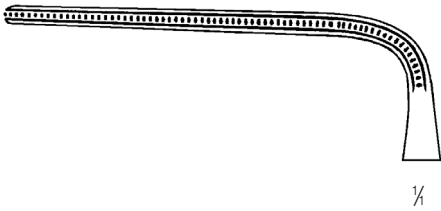

**DEBAKEY ATRAUMATIC VASCULAR FORCEPS**  
52-6579 4 3/4" Ring Handle Bulldog 90° Angle

**DEBAKEY ATRAUMATIC VASCULAR FORCEPS**  
52-6580 5" Ring Handle Bulldog 45° Angle (A)  
52-6582 5" Ring Handle Bulldog S-Curve (B)

For a complete listing of our Cardiovascular product line, visit [www.sklarcorp.com](http://www.sklarcorp.com).

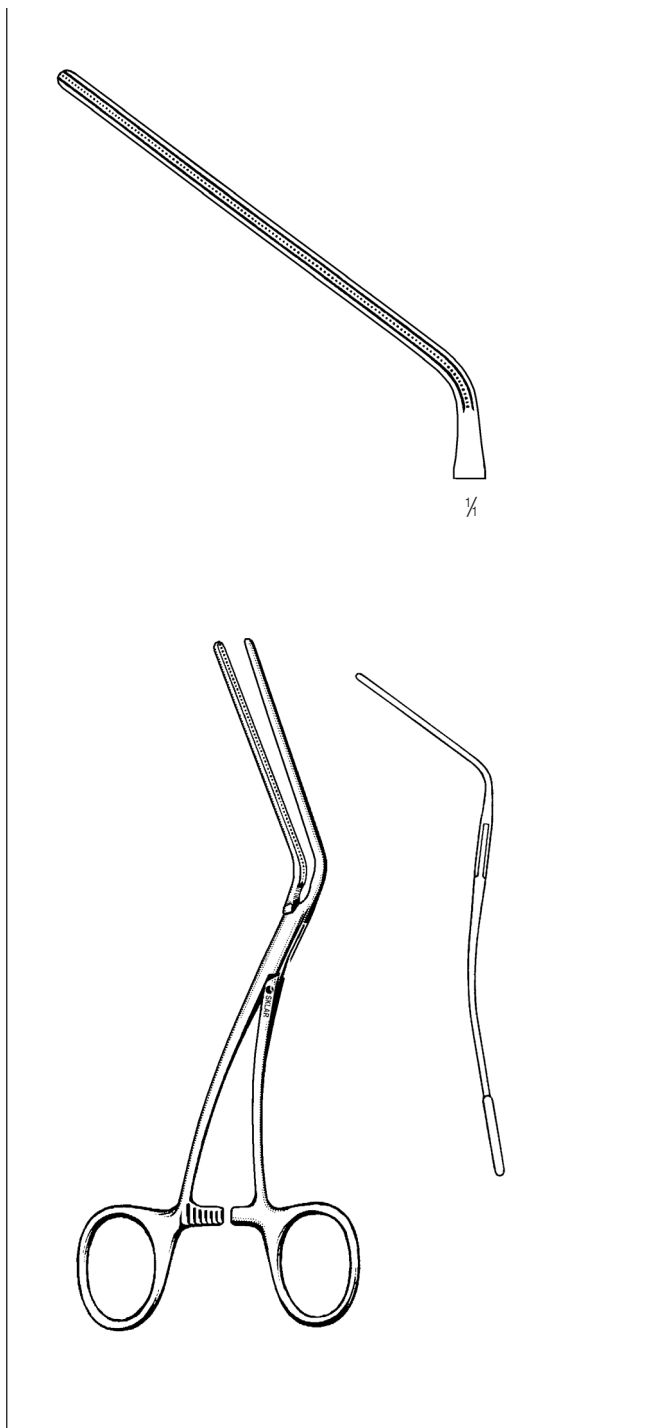

**DEBAKEY ATRAUMATIC PERIPHERAL  
VESSEL FORCEPS**

52-6600 7" Jaw Length 65mm

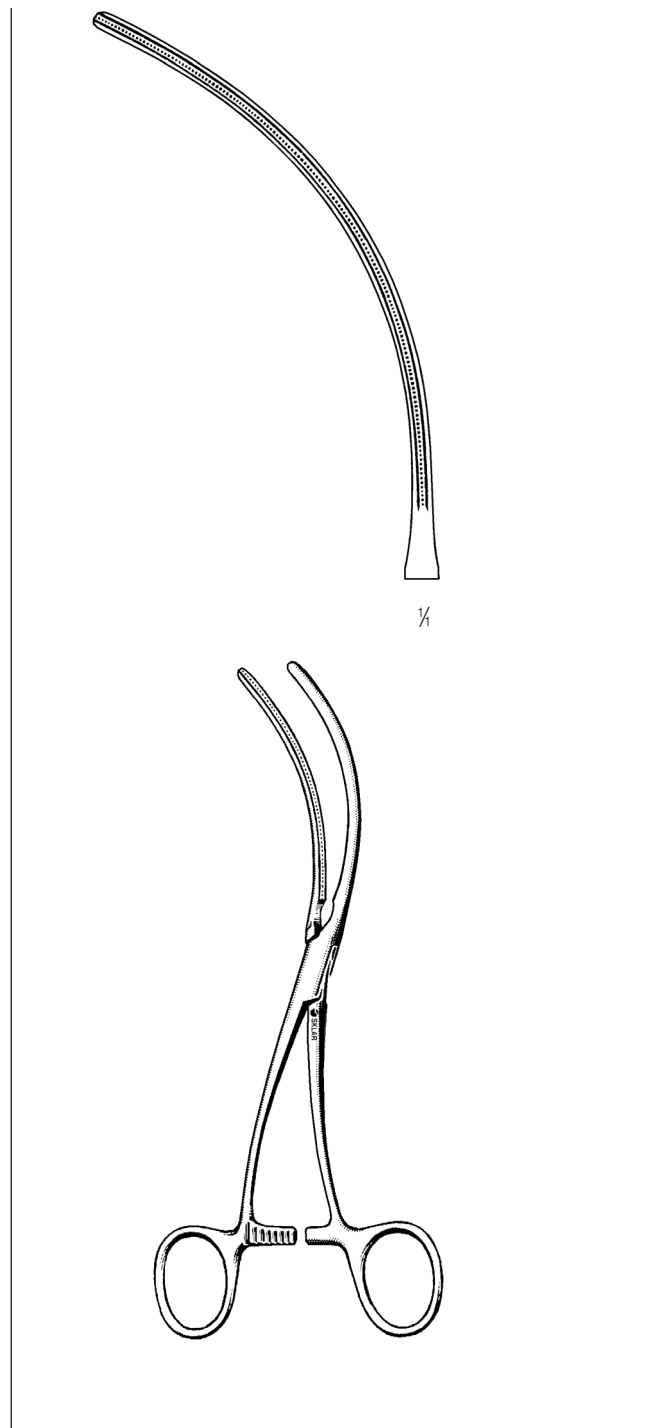

**DEBAKEY PERIPHERAL VASCULAR CLAMP**

52-6603 8" S-Curve

For a complete listing of our Cardiovascular product line, visit [www.sklarcorp.com](http://www.sklarcorp.com).

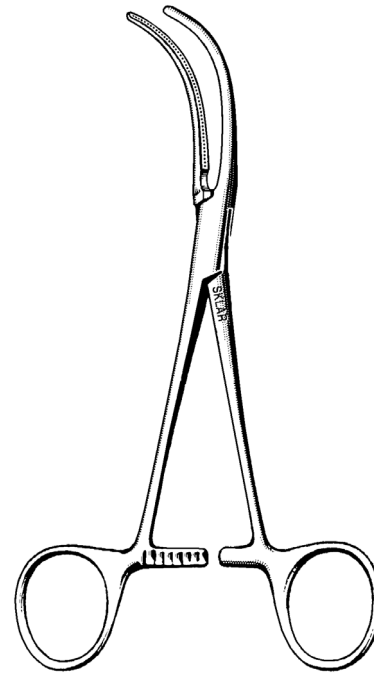
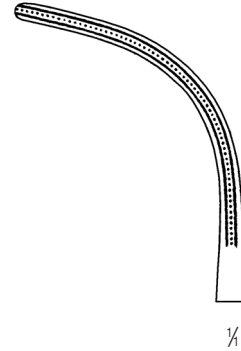
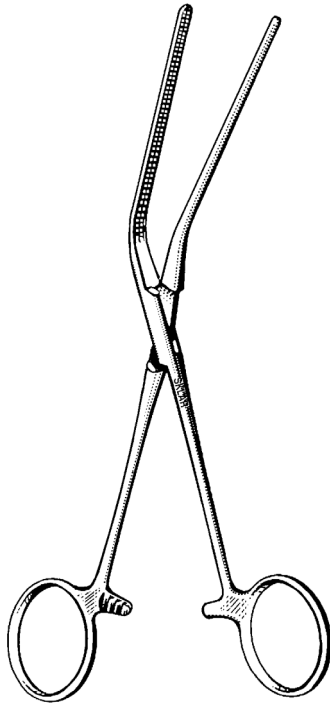
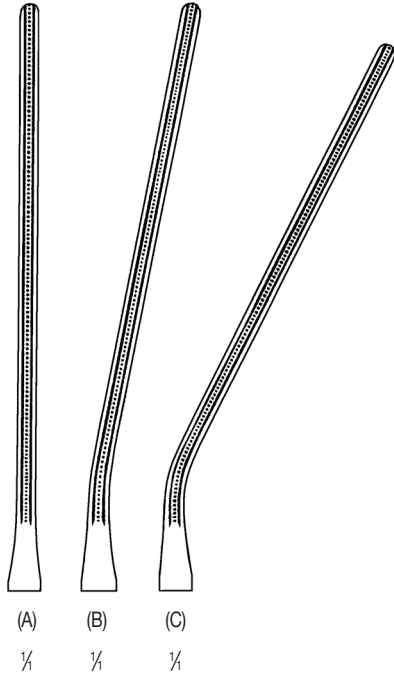

**DEBAKEY ATRAUMATIC FORCEPS**

**LELAND JONES PATTERN**

52-6655	7 1/2"	Straight	(A)
52-6657	7 1/2"	15° Angle	(B)
52-6659	7 1/2"	30° Angle	(C)

**DEBAKEY ATRAUMATIC FORCEPS**

52-6602 6" Full curve with straight handle

For a complete listing of our Cardiovascular product line, visit [www.sklarcorp.com](http://www.sklarcorp.com).

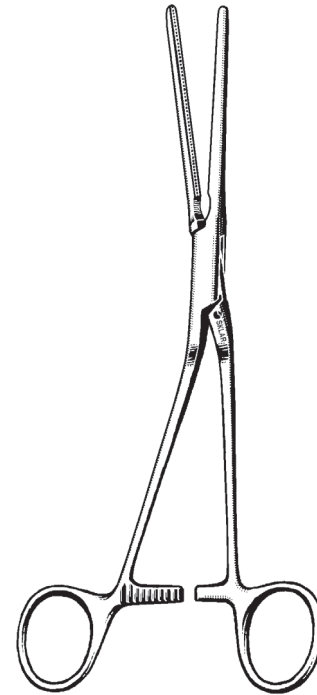
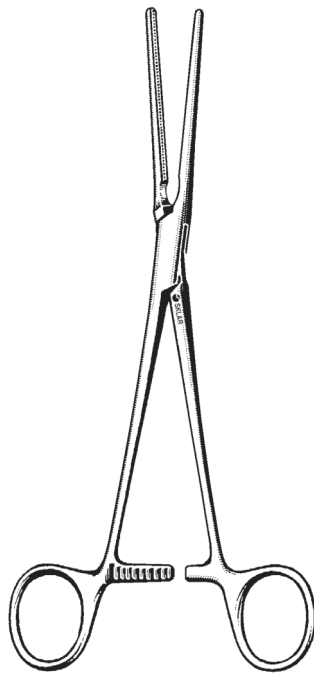
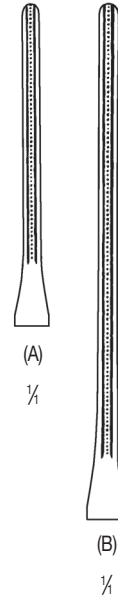
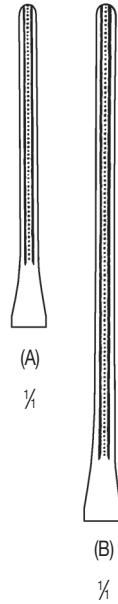

**ATRAUMATIC FORCEPS**

52-1980 8 1/4" Patent Ductus Straight (A)  
52-2082 8 3/4" Coarctation Straight (B)

**ATRAUMATIC FORCEPS**

52-1975 Patent Ductus Angular 8 1/4" (A)  
52-2080 Coarctation Angular 8 3/4" (B)

For a complete listing of our Cardiovascular product line, visit [www.sklarcorp.com](http://www.sklarcorp.com).

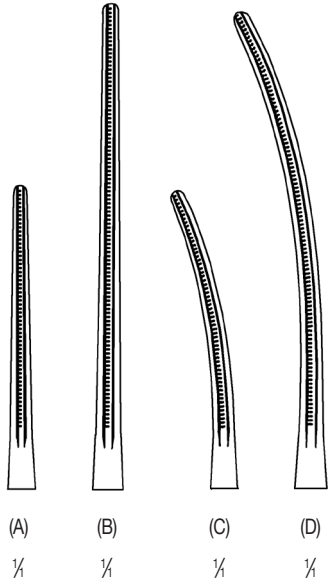

(A) 1/4  
(B) 1/4  
(C) 1/4  
(D) 1/4

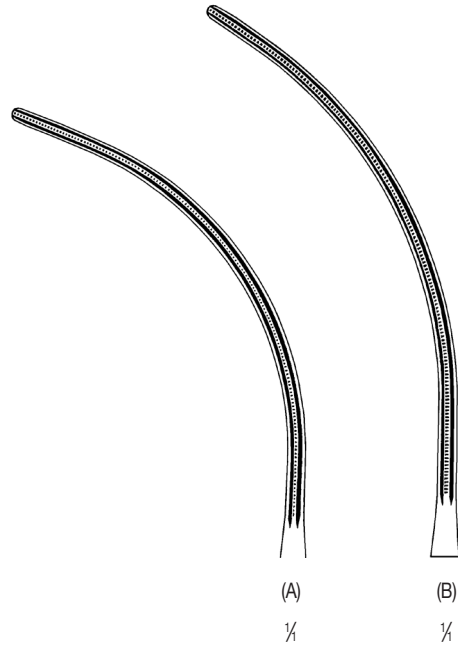
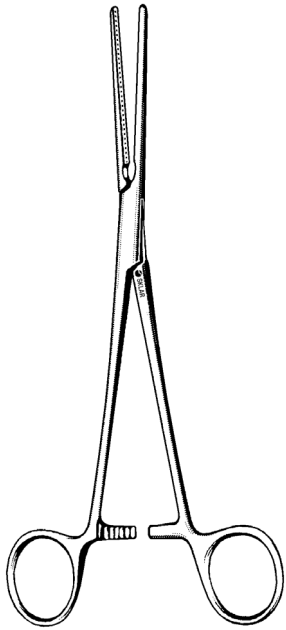

(A) 1/4  
(B) 1/4

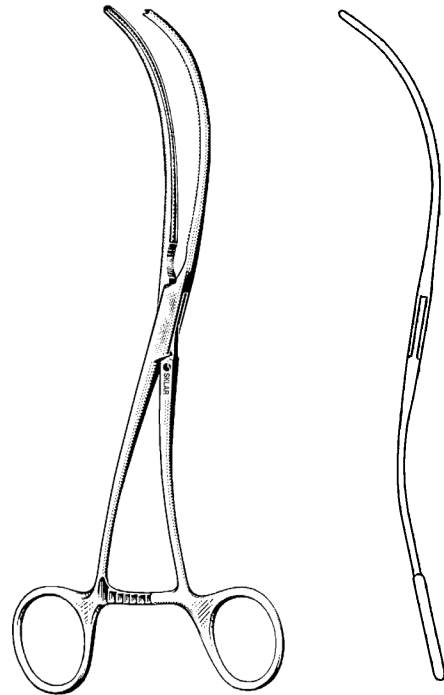

**BAINBRIDGE VASCULAR FORCEPS**

52-6700	6"	Straight	(A)
52-6702	7"	Straight	(B)
52-6704	6"	Curved	(C)
52-6706	7"	Curved	(D)

**DEBAKEY ATRAUMATIC PERIPHERAL  
VESSEL FORCEPS**

52-6604	7 1/4"	S-Curve	85mm Jaw (A)
52-6605	8"	S-Curve	85mm Jaw (B)

For a complete listing of our Cardiovascular product line, visit [www.sklarcorp.com](http://www.sklarcorp.com).

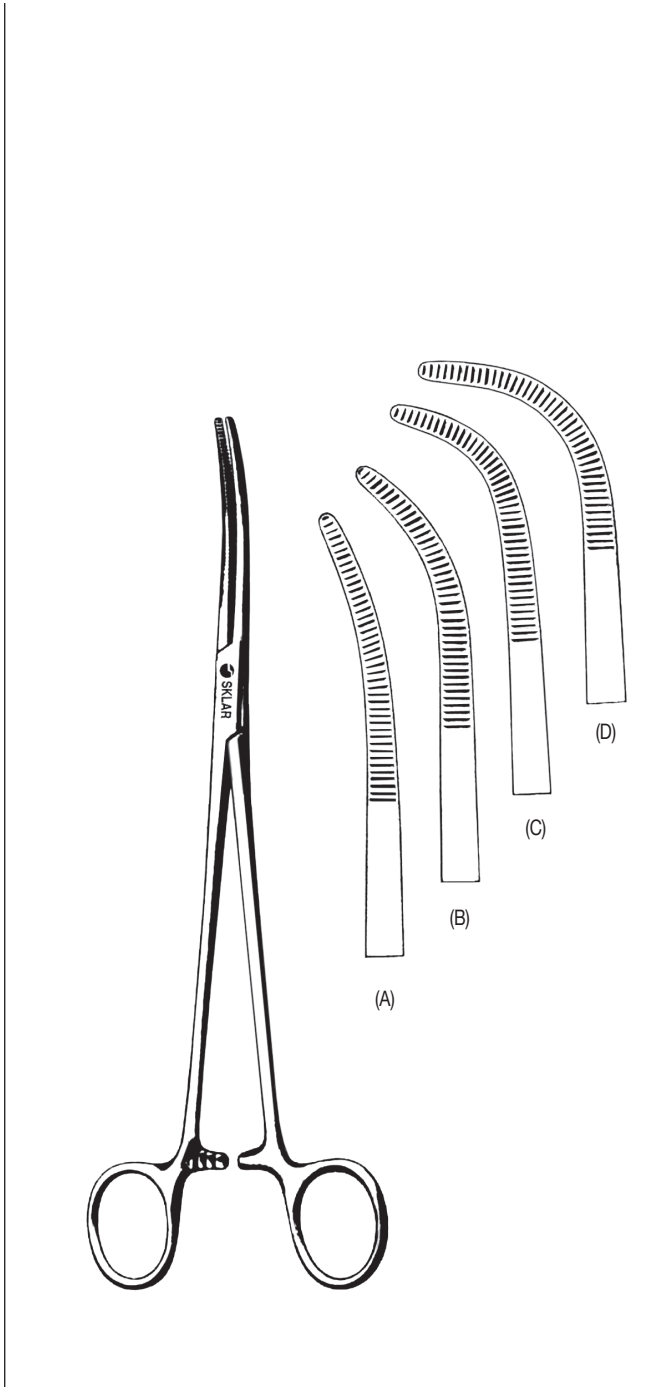

**RUMEL THORACIC FORCEPS**

2<sup>3</sup>/<sub>8</sub>" JAW, 9"

- 55-3123 (A) Slight Curve
- 55-3125 (B) Medium Curve
- 55-3127 (C) Full Curve
- 55-3129 (D) Angled

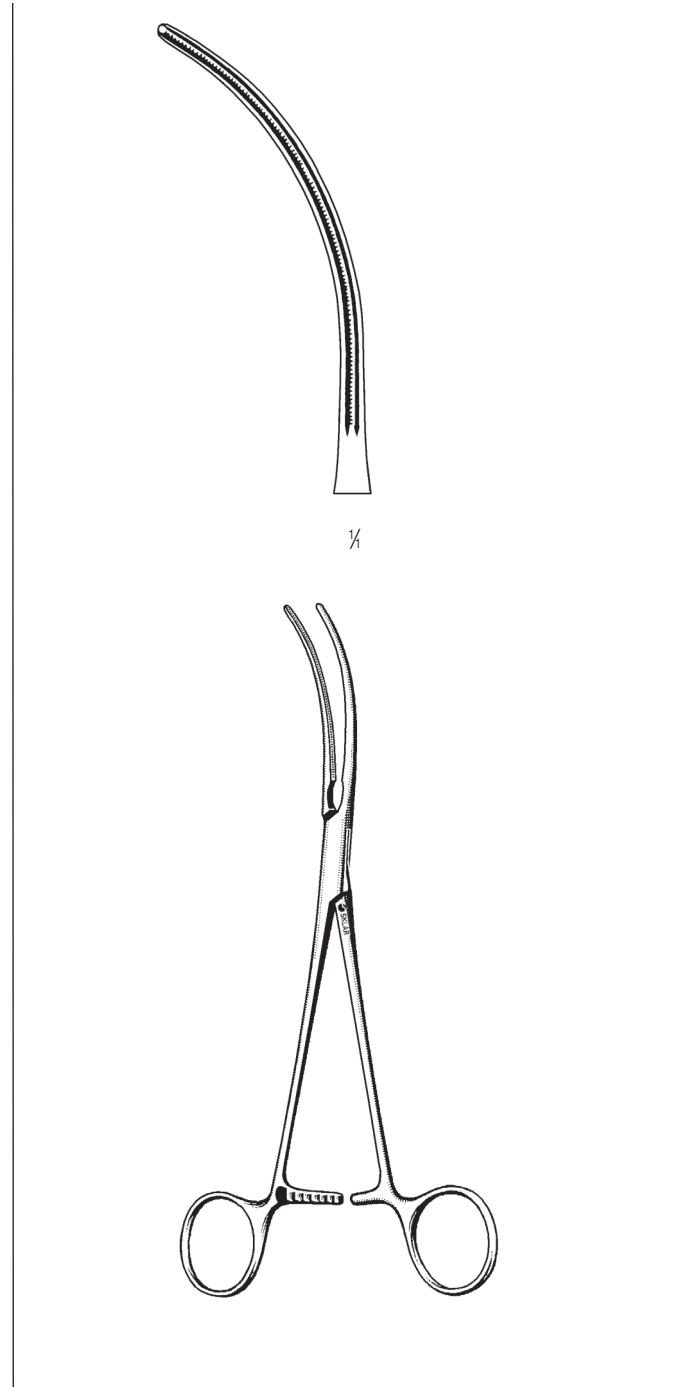

**GLOVER FORCEPS**

52-2178 8<sup>3</sup>/<sub>4</sub>" Curved

For a complete listing of our Cardiovascular product line, visit [www.sklarcorp.com](http://www.sklarcorp.com).



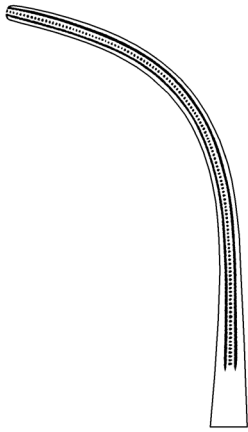

1/4

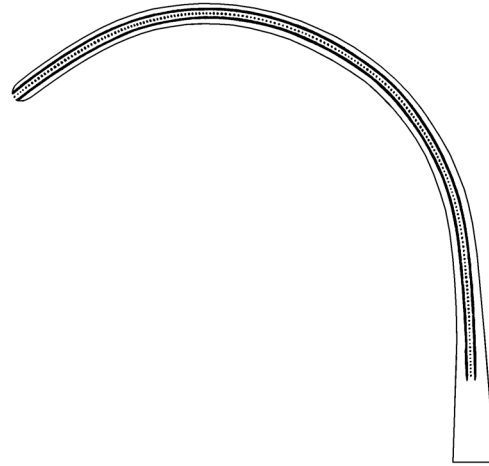
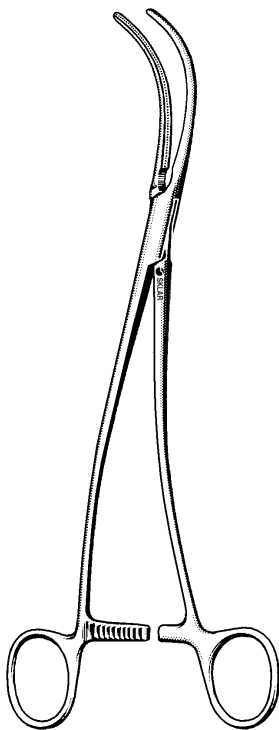

1/4

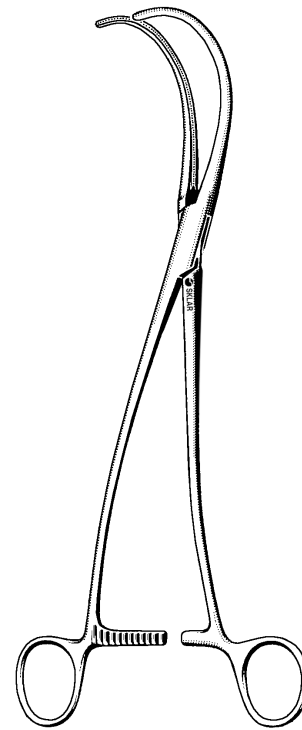

**DEBAKEY VASCULAR CLAMP**

52-6732 9½" Full Curve

**DEBAKEY VASCULAR CLAMP**

52-6730 10" Acutely Curved, Extra Large Jaw  
Length 9.5cm

For a complete listing of our Cardiovascular product line, visit [www.sklarcorp.com](http://www.sklarcorp.com).



**CARDIOVASCULAR  
CLAMPS**

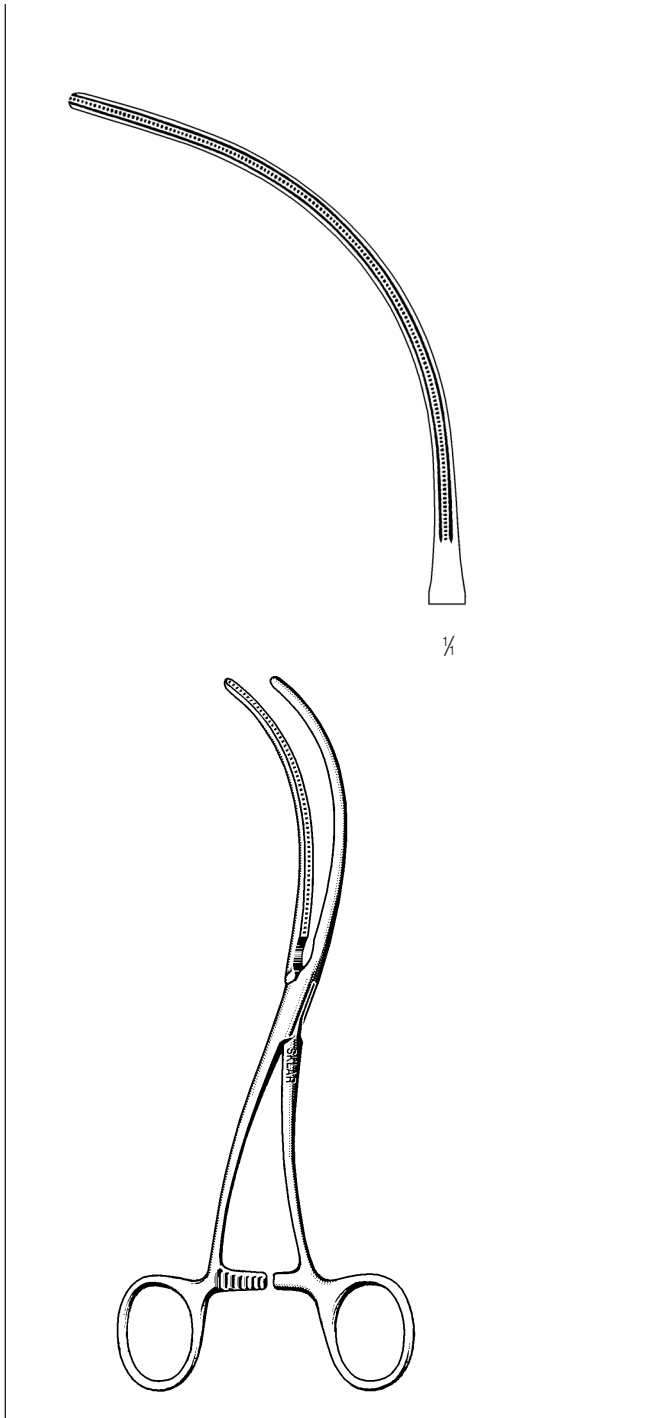

**DEBAKEY AORTIC EXCLUSION CLAMP**

52-6601 7 1/4" Acute S-Curve

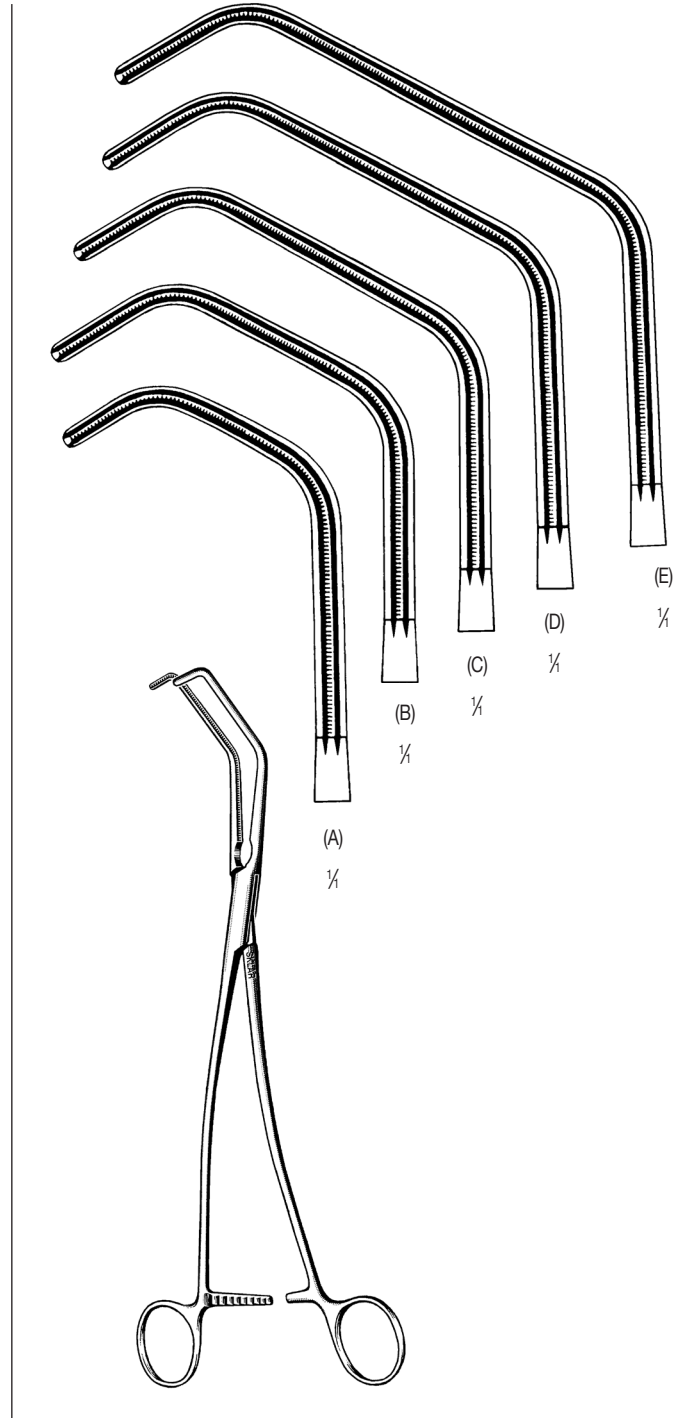

**DEBAKEY ATRAUMATIC TANGENTIAL CLAMPS**

- 52-6620 8" (A)
- 52-6622 9 3/4" (B)
- 52-6624 10" (C)
- 52-6626 10 1/2" (D)
- 52-6628 10 3/4" (E)

For a complete listing of our Cardiovascular product line, visit [www.sklarcorp.com](http://www.sklarcorp.com).

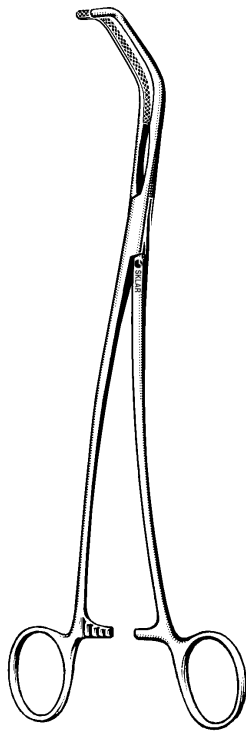
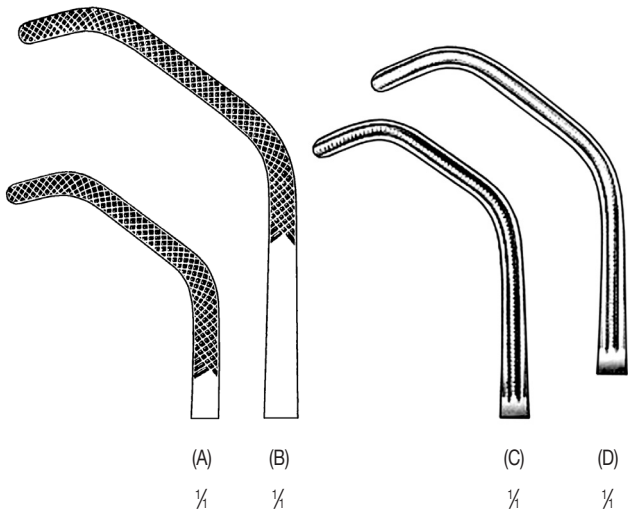

**VENA CAVA CLAMPS**

52-1595	9½"	Cross Serrations	(A)	Satinsky
52-1695	10¾"	Cross Serrations	(B)	Satinsky
52-6612	9"	Small	(C)	DeBakey
52-6614	9½"	Medium	(D)	DeBakey

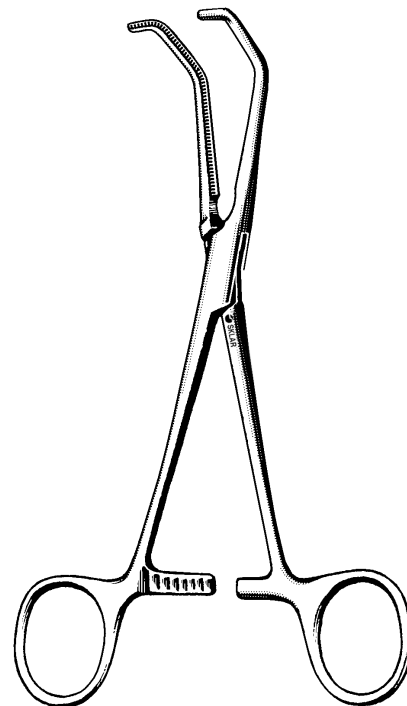
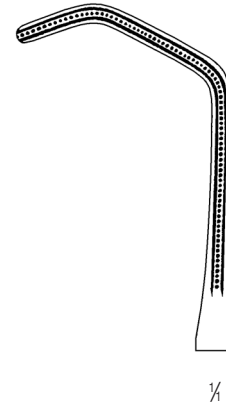

**DEBAKEY-BECK AORTIC CLAMP**

52-6745	6½"	Pediatric
---------	-----	-----------

For a complete listing of our Cardiovascular product line, visit [www.sklarcorp.com](http://www.sklarcorp.com).

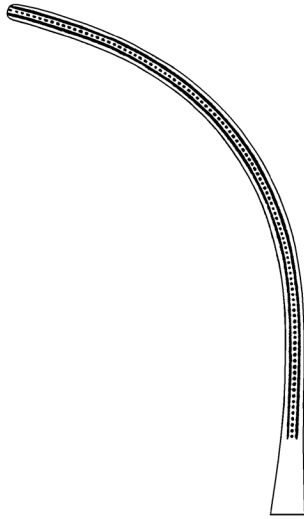

1/4

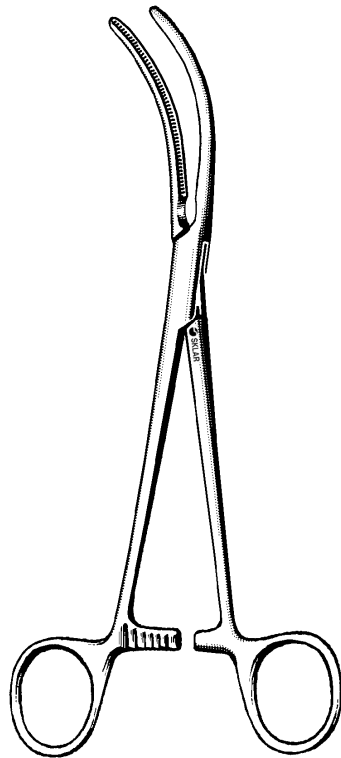

**GLOVER CURVED CLAMP**

52-6750 9 1/2"

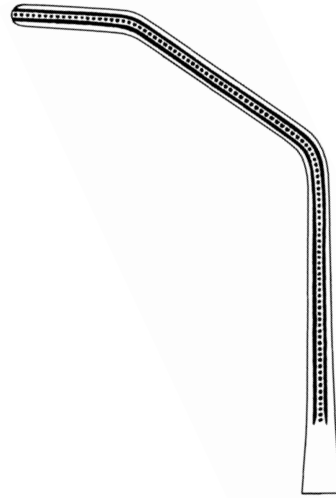

1/4

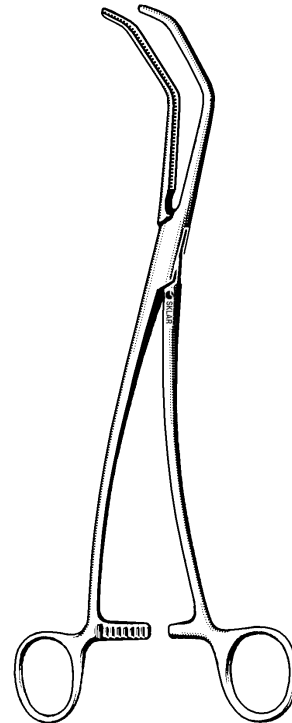

**GLOVER ANASTOMOSIS CLAMP**

52-6760 9 3/4"

For a complete listing of our Cardiovascular product line, visit [www.sklarcorp.com](http://www.sklarcorp.com).

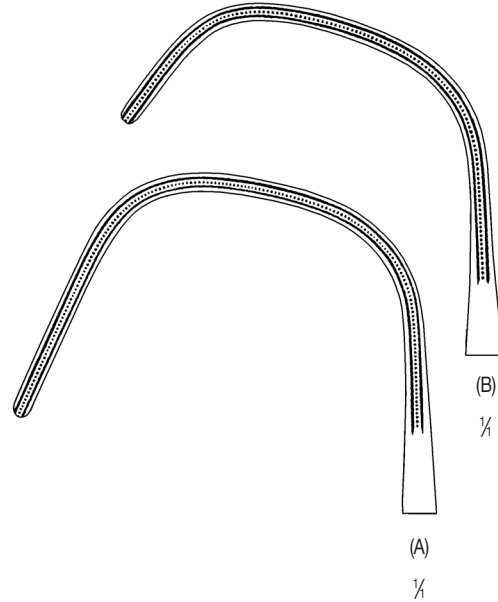
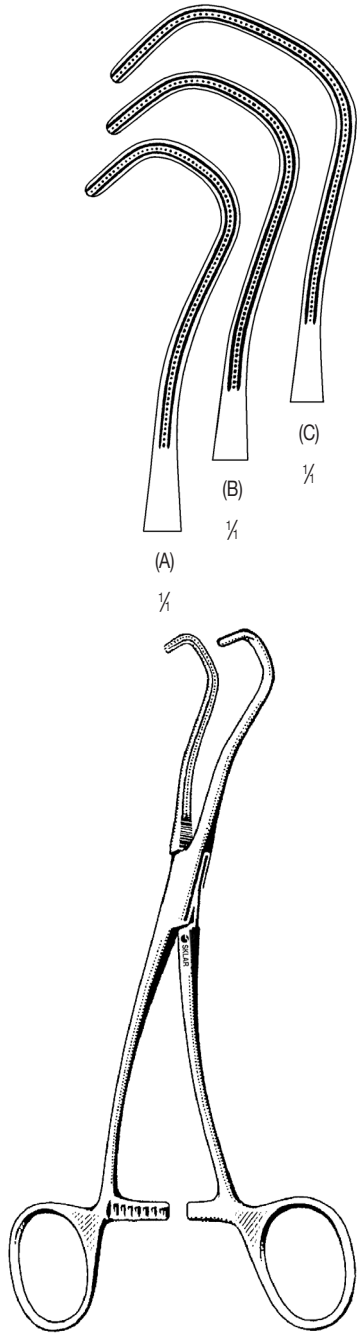

**DEBAKEY-DERRA ATRAUMATIC FORCEPS**

**ANASTAMOSIS**

- 52-6650 6 1/4" Small (A)
- 52-6652 6 3/4" Medium (B)
- 52-6654 7" Large (C)

**KAY AORTA CLAMP**

- 52-6775 8" Jaw Length 4.5cm Depth 3.2cm (A)

**LAMBERT-KAY AORTA CLAMP**

- 52-6778 8" Jaw Length 4.5cm Depth 1.9cm (B)

For a complete listing of our Cardiovascular product line, visit [www.sklarcorp.com](http://www.sklarcorp.com).

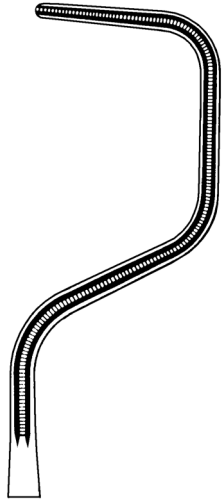

1/4

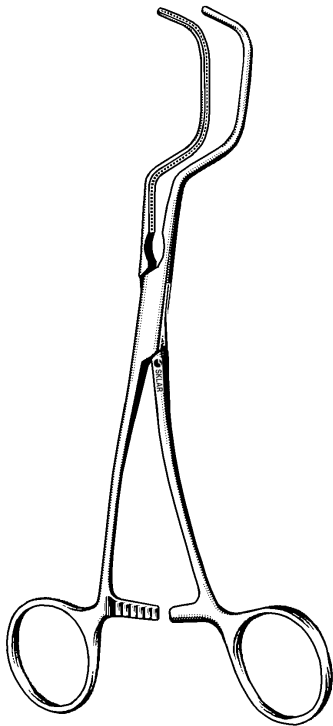

**DALE ATRAUMATIC CARDIOVASCULAR FORCEPS**

52-6785 7"

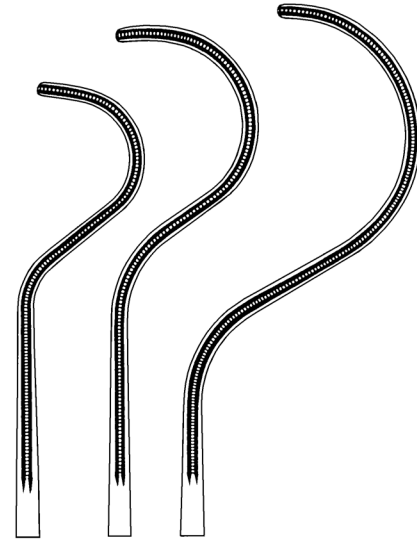

(A)

(B)

(C)

1/4

1/4

1/4

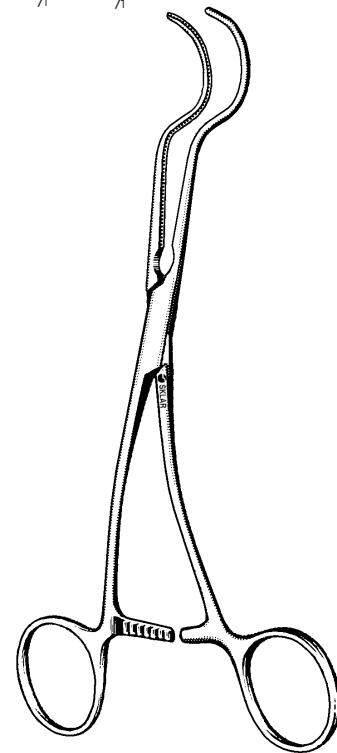

**DALE ATRAUMATIC CARDIOVASCULAR FORCEPS**

52-6790 6 1/2" (A)

52-6792 7" (B)

52-6794 7 1/4" (C)

For a complete listing of our Cardiovascular product line, visit [www.sklarcorp.com](http://www.sklarcorp.com).

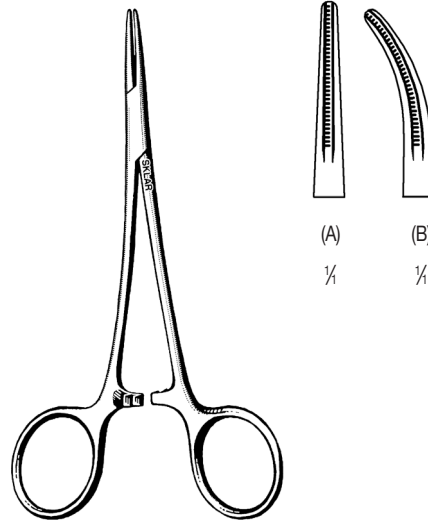
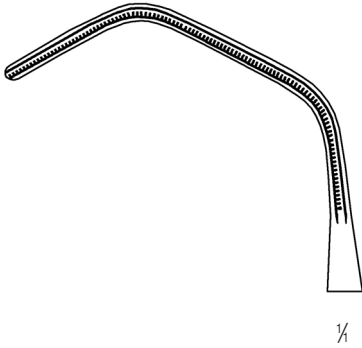

**DEBAKEY HALSTED MOSQUITO FORCEPS**

- 52-6830 5" Straight (A)
- 52-6832 5" Curved (B)

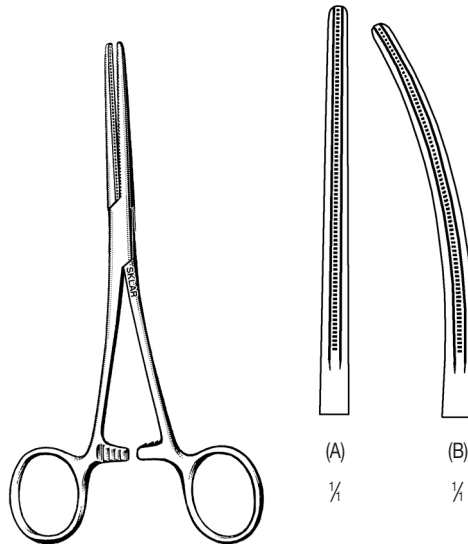
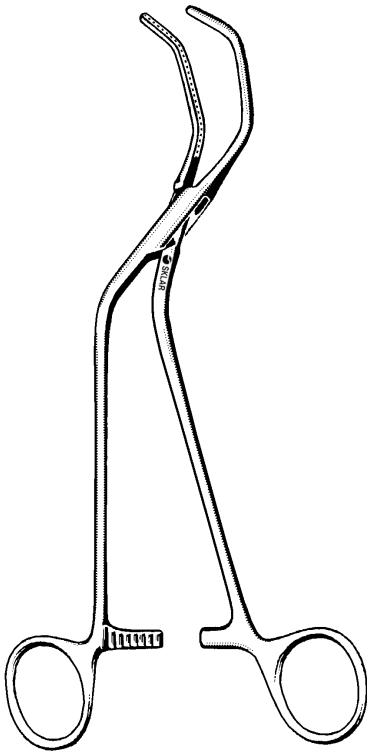

**DIETHRICH AORTA CLAMP**

52-6780 8 1/4" Jaw Length 4.7cm

**DEBAKEY PEAN FORCEPS**

- 52-6840 6" Straight (A)
- 52-6842 6" Curved (B)

For a complete listing of our Cardiovascular product line, visit [www.sklarcorp.com](http://www.sklarcorp.com).

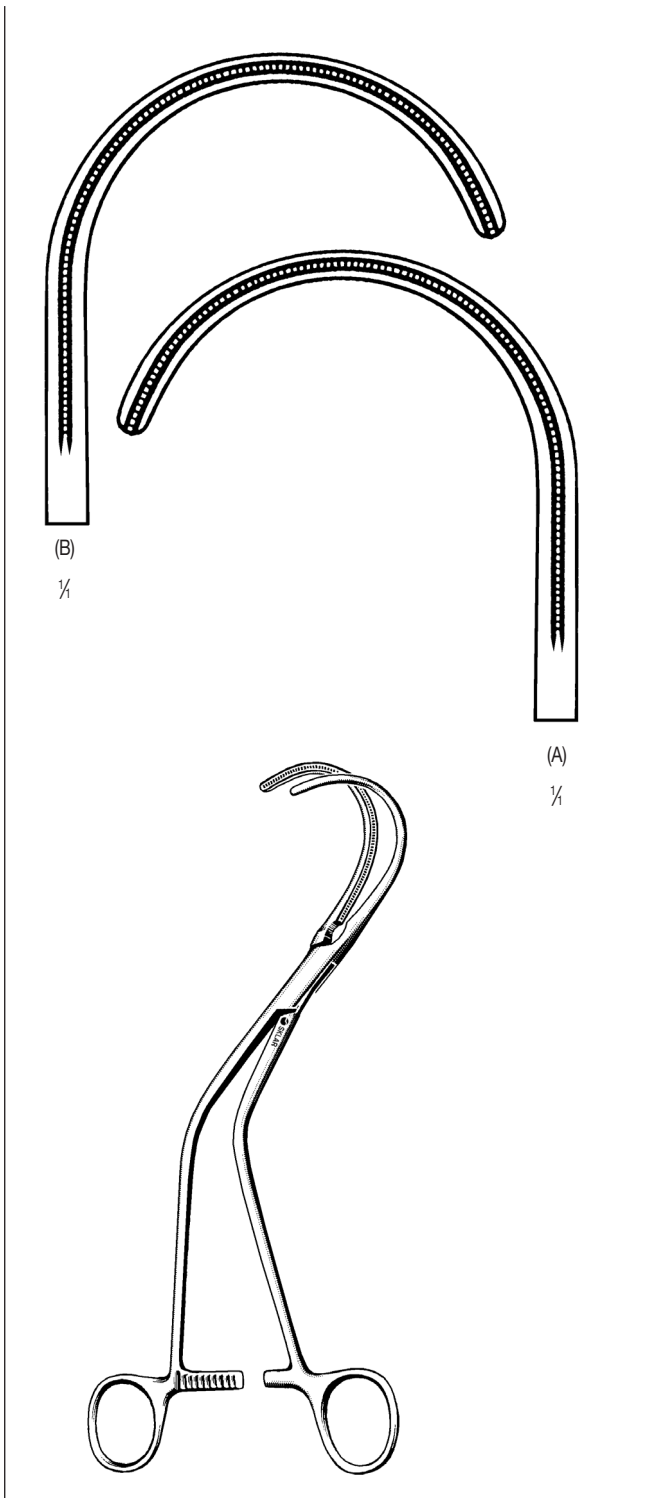

**WEBER AORTIC CLAMPS**

52-6680 10" Right (A)  
52-6681 10" Left (B)

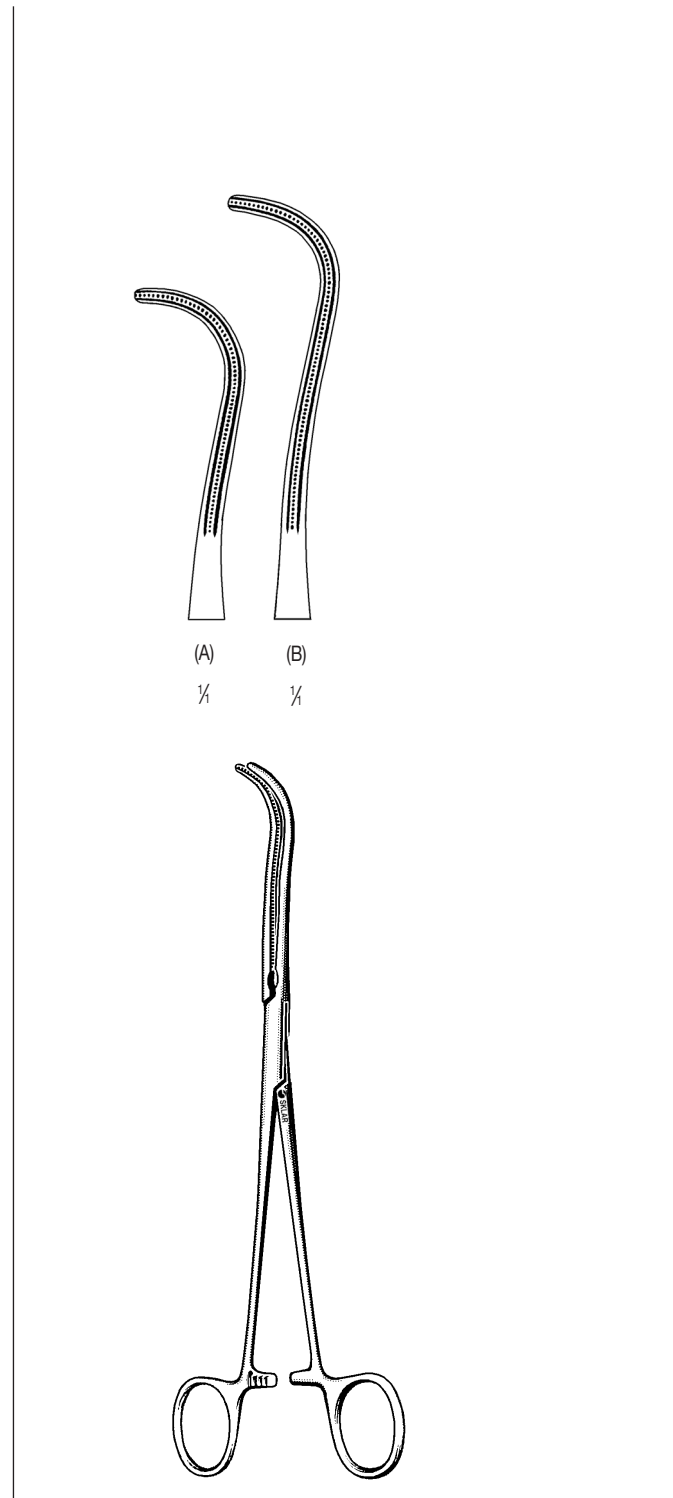

**DEBAKEY DISSECTING AND LIGATURE FORCEPS**

52-6820 8" (A)  
52-6822 9" (B)

For a complete listing of our Cardiovascular product line, visit [www.sklarcorp.com](http://www.sklarcorp.com).



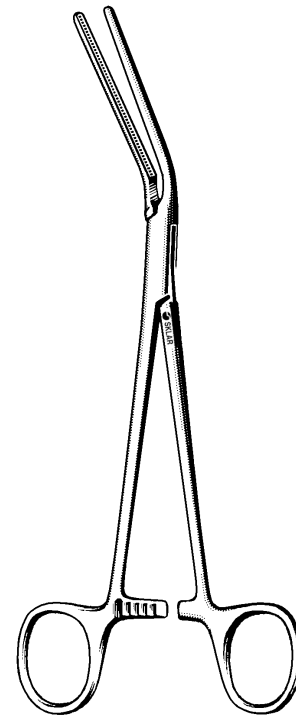
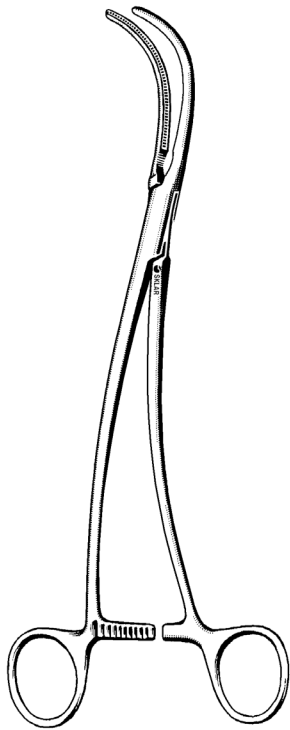
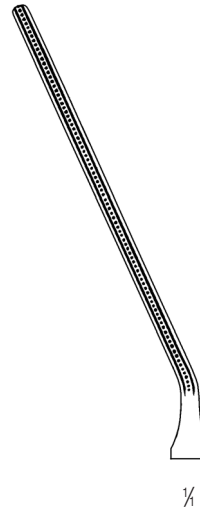
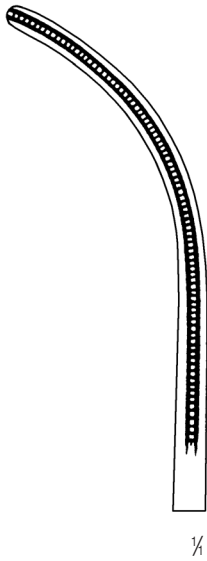

**DEBAKEY-BAHNSON ATRAUMATIC FORCEPS**

52-6796 10"

**DEBAKEY ANGULAR CLAMP**

52-6740 8½"

For a complete listing of our Cardiovascular product line, visit [www.sklarcorp.com](http://www.sklarcorp.com).

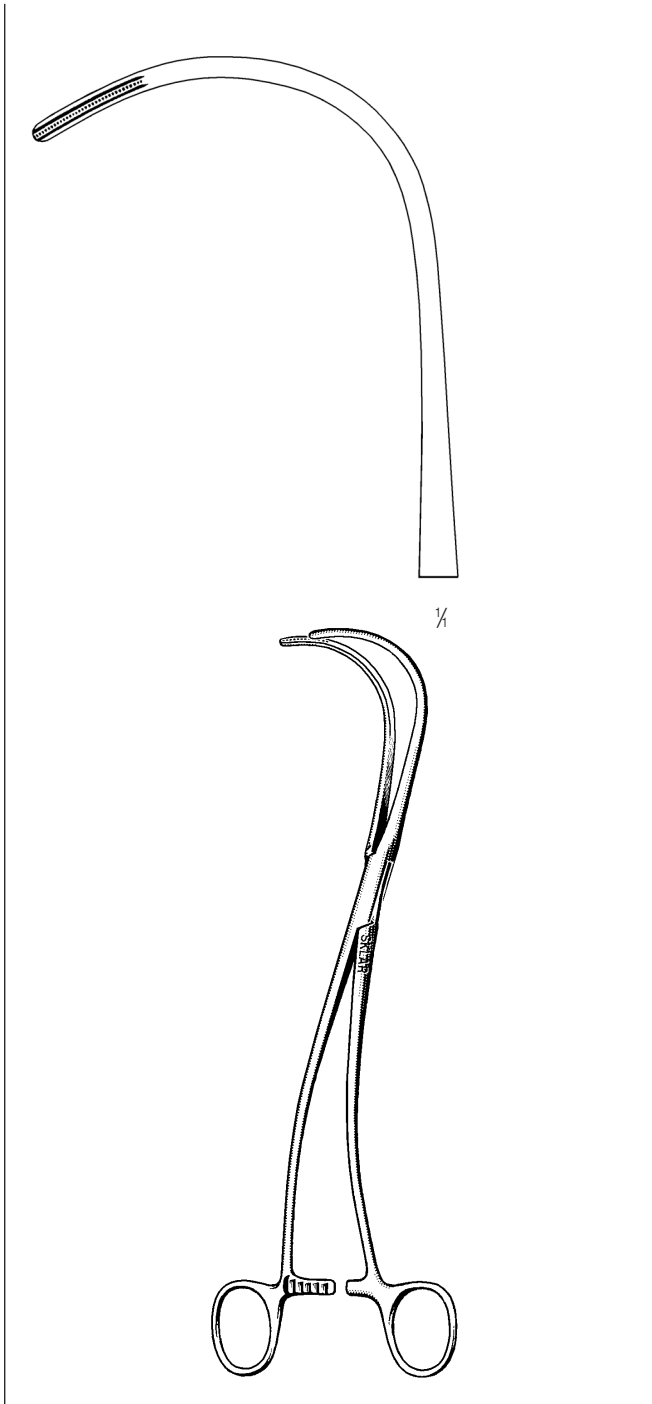

**DEBAKEY-SEMB LIGATURE CARRIER**

52-6850 10" Jaw Length 1.5cm

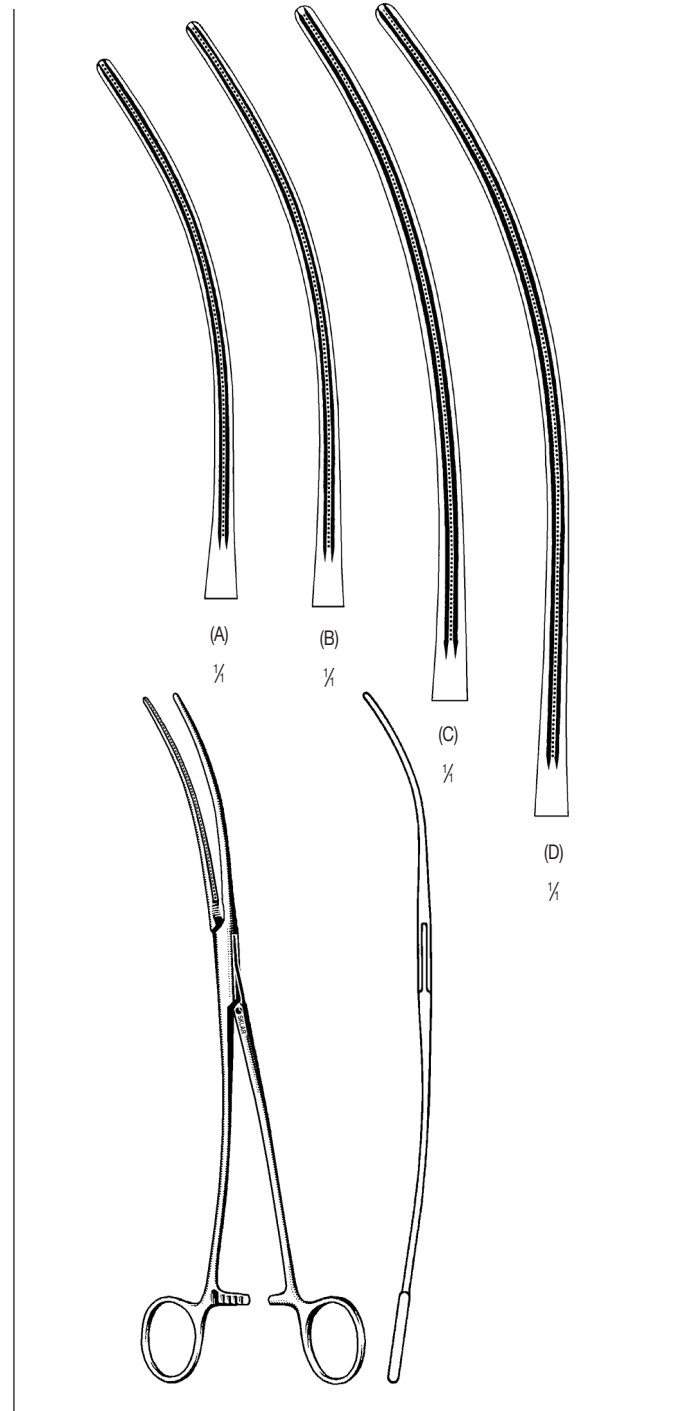

**DEBAKEY AORTIC ANEURYSM CLAMPS**

- 52-6648 9½" (A)
- 52-6661 10½" (B)
- 52-6662 12½" (C)
- 52-6663 13" (D)

For a complete listing of our Cardiovascular product line, visit [www.sklarcorp.com](http://www.sklarcorp.com).

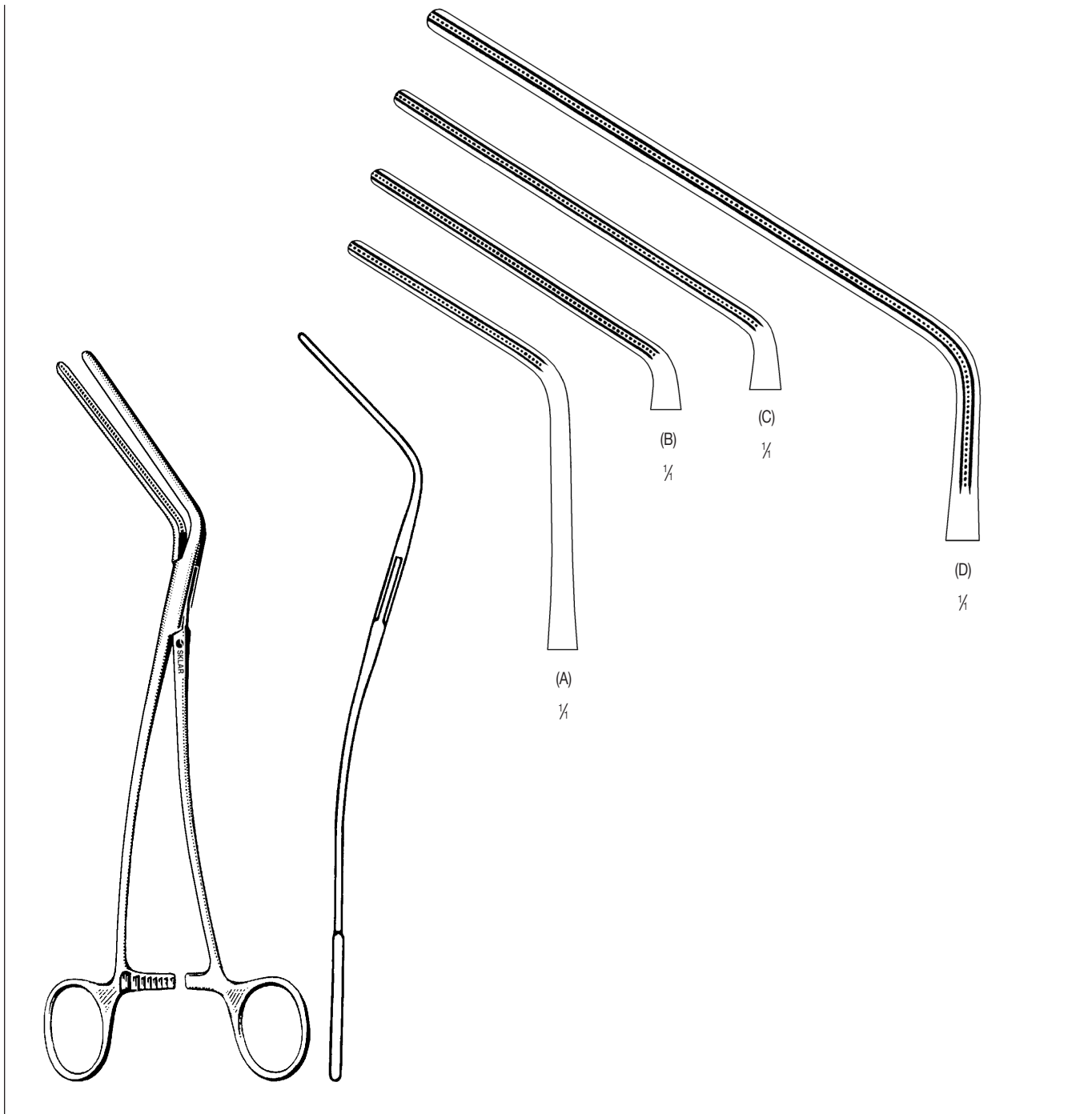

**DEBAKEY ATRAUMATIC FORCEPS**

**MULTI-PURPOSE 60° ANGLE**

- 52-6631 10" (A)
- 52-6630 8" (B)
- 52-6634 9½" (C)
- 52-6635 12" (D)

**For a complete listing of our Cardiovascular product line, visit [www.sklarcorp.com](http://www.sklarcorp.com).**

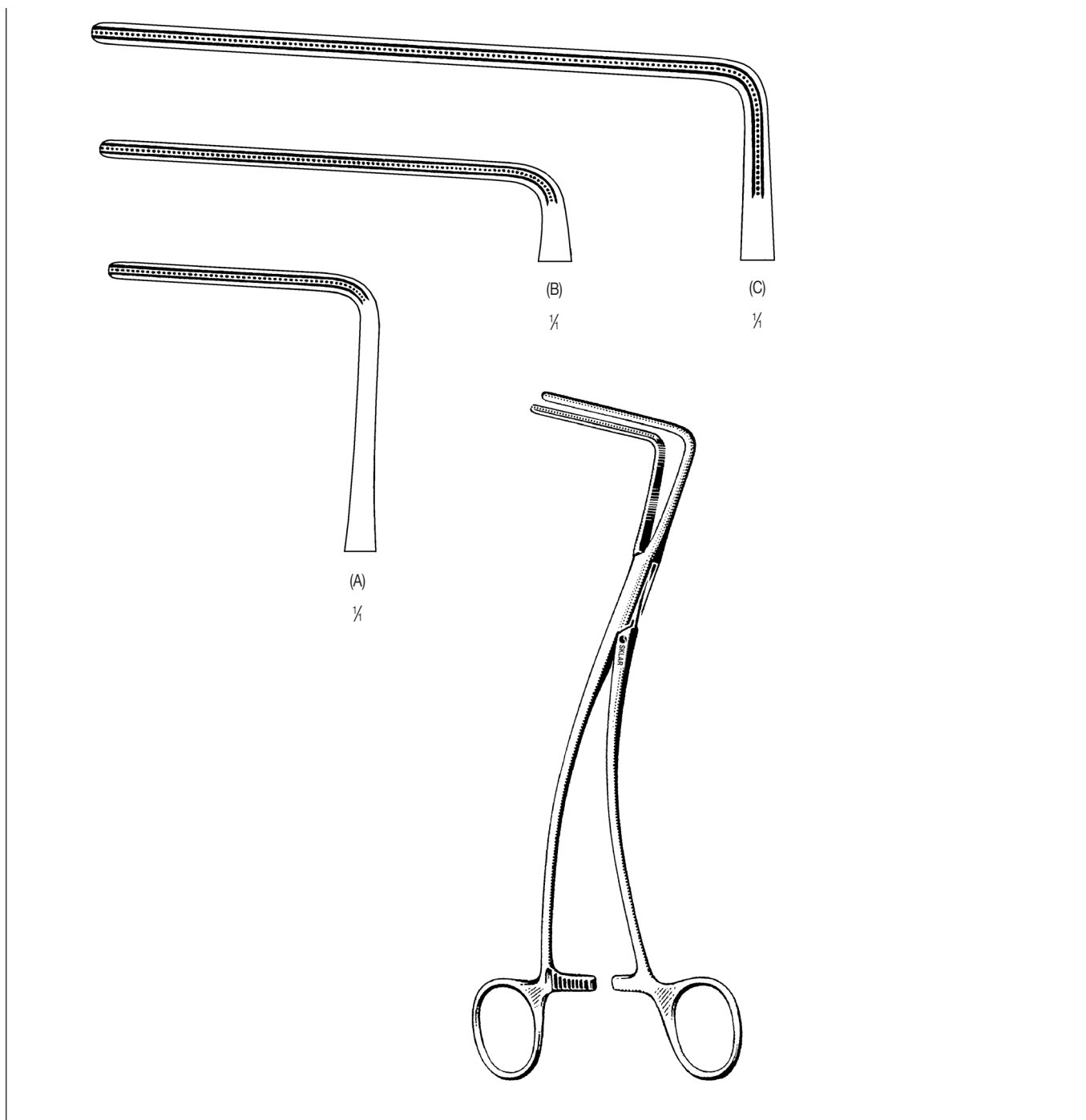

**DEBAKEY ATRAUMATIC FORCEPS**

**MULTI-PURPOSE 90° ANGLE**

52-6640	9"	(A)
52-6644	8½"	(B)
52-6645	11"	(C)

For a complete listing of our Cardiovascular product line, visit [www.sklarcorp.com](http://www.sklarcorp.com).

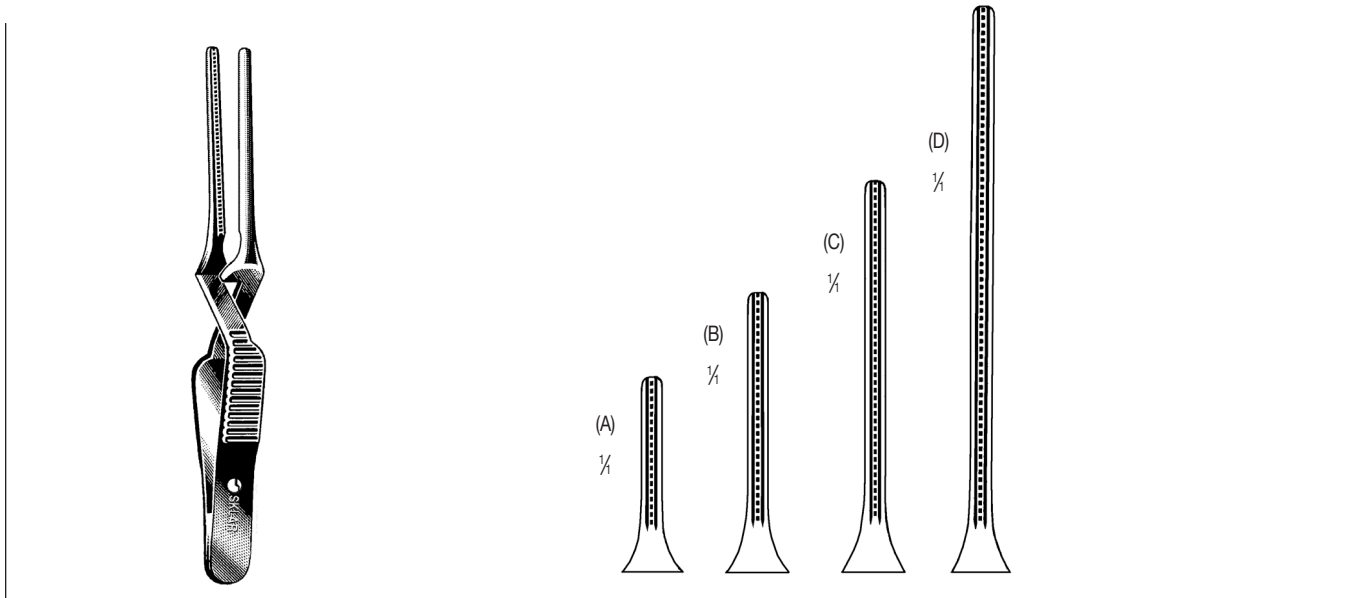

**DEBAKEY BULLDOG CLAMPS**

**STRAIGHT CROSS ACTION**

52-1530	3"	(7.6cm)	(A)
52-1531	3½"	(8.9cm)	(B)
52-1532	4¼"	(10.8cm)	(C)
52-1533	4¾"	(12.1cm)	(D)

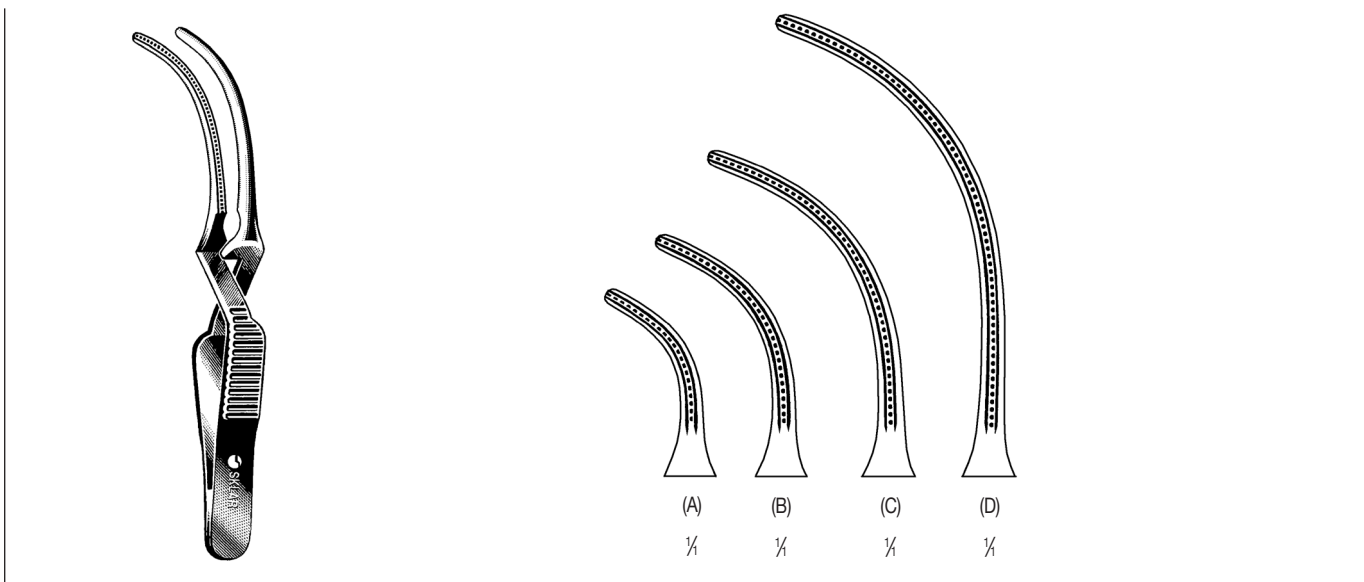

**DEBAKEY BULLDOG CLAMPS**

**CURVED CROSS ACTION**

52-1540	2¾"	(7cm)	(A)
52-1541	3¼"	(7.8cm)	(B)
52-1542	4"	(10.2cm)	(C)
52-1543	4¾"	(12.1cm)	(D)

For a complete listing of our Cardiovascular product line, visit [www.sklarcorp.com](http://www.sklarcorp.com).



# CARDIOVASCULAR

## BULLDOG CLAMPS

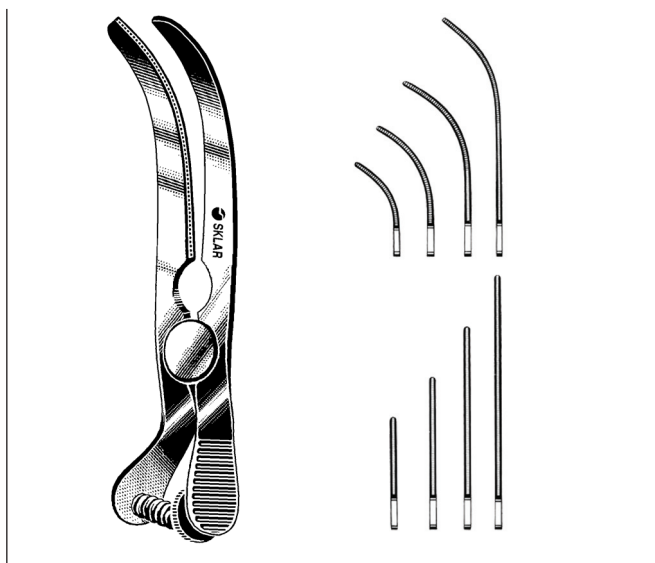

### GLOVER BULLDOG CLAMPS

**STRAIGHT**

52-1545	2½"	20mm Jaw
52-1546	2¾"	30mm Jaw
52-1547	3½"	43mm Jaw
52-1549	4"	56mm Jaw

**CURVED**

52-1550	2½"	20mm Jaw
52-1551	2¾"	30mm Jaw
52-1552	3½"	43mm Jaw
52-1553	4"	56mm Jaw

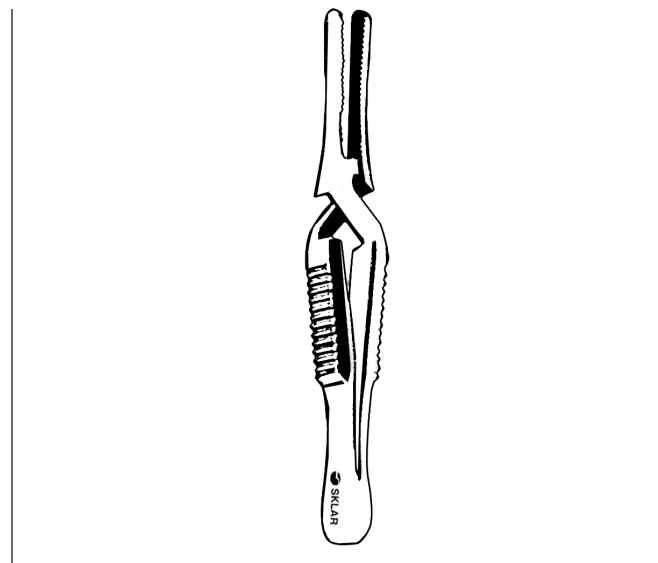

### DIEFFENBACH BULLDOG CLAMPS

**CROSS ACTION**

17-3815	1½"	Straight
17-3915	1½"	Curved
17-3817	2¼"	Straight
17-3917	2¼"	Curved



### JOHN HOPKINS BULLDOG CLAMPS

**CROSS ACTION**

**CURVED**

52-1415	1½"	(3.8cm)
52-1417	1¾"	(4.4cm)
52-1420	2"	(5.1cm)
52-1422	2¼"	(5.7cm)
52-1425	2½"	(6.4cm)
52-1427	2¾"	(7cm)
52-1430	3"	(7.6cm)
52-1435	3½"	(8.9cm)

**STRAIGHT**

52-1416	1½"	(3.8cm)
52-1421	2"	(5.1cm)
52-1423	2¼"	(5.7cm)
52-1426	2½"	(6.4cm)
52-1428	2¾"	(7cm)
52-1431	3"	(7.6cm)
52-1436	3½"	(8.9cm)



### SANTULLI BULLDOG CLAMP

**CROSS ACTION**

52-1548	2¾"
---------	-----

For a complete listing of our Cardiovascular product line, visit [www.sklarcorp.com](http://www.sklarcorp.com).

**CARDIOVASCULAR  
BULLDOG CLAMPS**

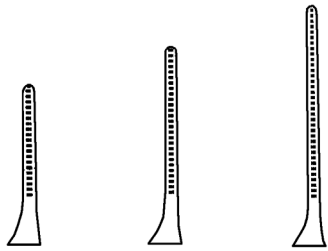

(A) 1/4 (B) 1/2 (C) 3/4

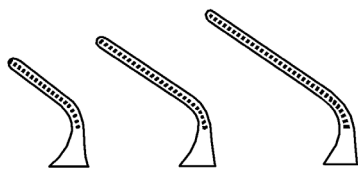

(D) 1/4 (E) 1/2 (F) 3/4

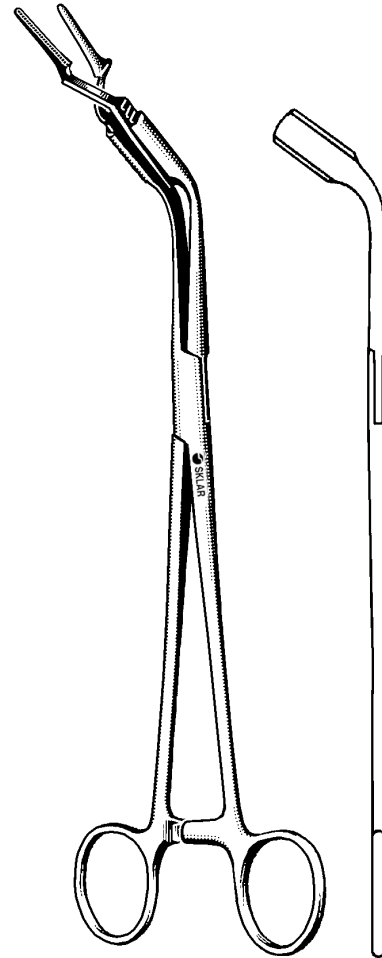

**DIETRICH MICROCORONARY BULLDOG CLAMPS**

**CROSS ACTION**

98-4008	8mm	Straight	(A)
98-4012	12mm	Straight	(B)
98-4020	20mm	Straight	(C)
98-4108	8mm	Angled	(D)
98-4112	12mm	Angled	(E)
98-4120	20mm	Angled	(F)

**BULLDOG CLAMP APPLYING FORCEPS**

**CROSS ACTION**

52-1390	9" Applying Clamp Only
---------	------------------------

For a complete listing of our Cardiovascular product line, visit [www.sklarcorp.com](http://www.sklarcorp.com).

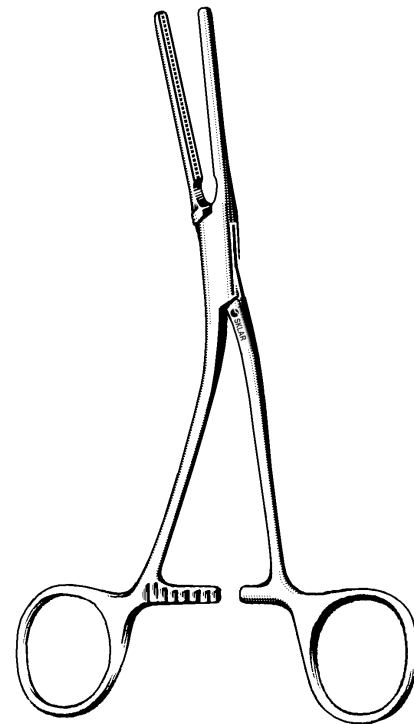
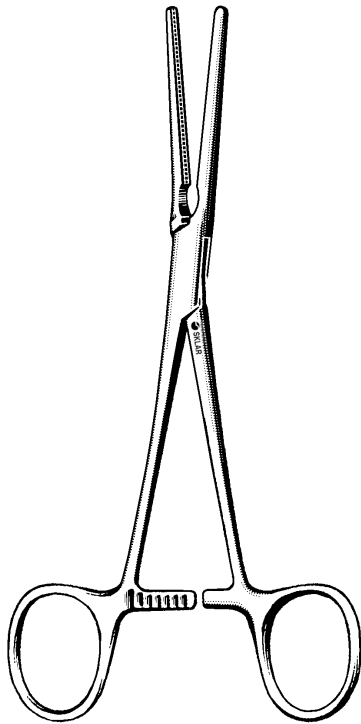
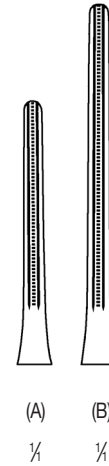
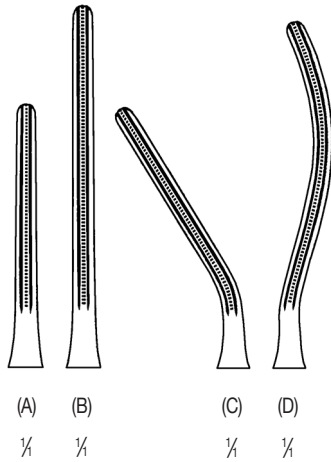

**DEBAKEY PEDIATRIC FORCEPS**

- 52-1900 6 1/4" (A) Patent Ductus
- 52-1902 6 1/2" (B) Coarctation
- 52-1904 6" (C) Angular
- 52-1906 6 1/2" (D) Spoon Shape (Cooley)

**DEBAKEY PEDIATRIC FORCEPS**

- ANGULAR SHAFT**
- 52-1910 6" (A) Patent Ductus
  - 52-1912 6 1/2" (B) Coarctation

For a complete listing of our Cardiovascular product line, visit [www.sklarcorp.com](http://www.sklarcorp.com).



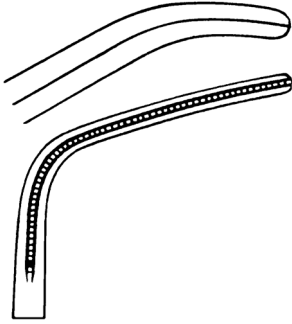

¼

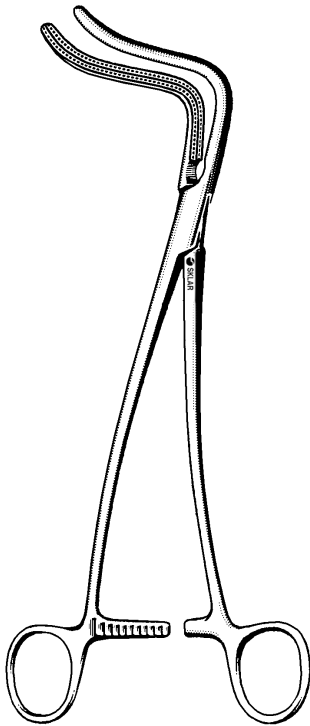

**SUBRAMANIAN MINIATURE AORTA CLAMP**

52-1920 5½"

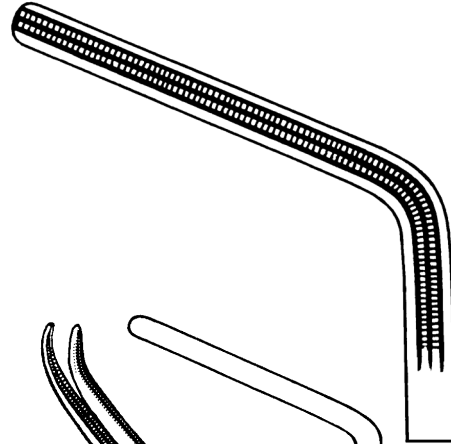

¼

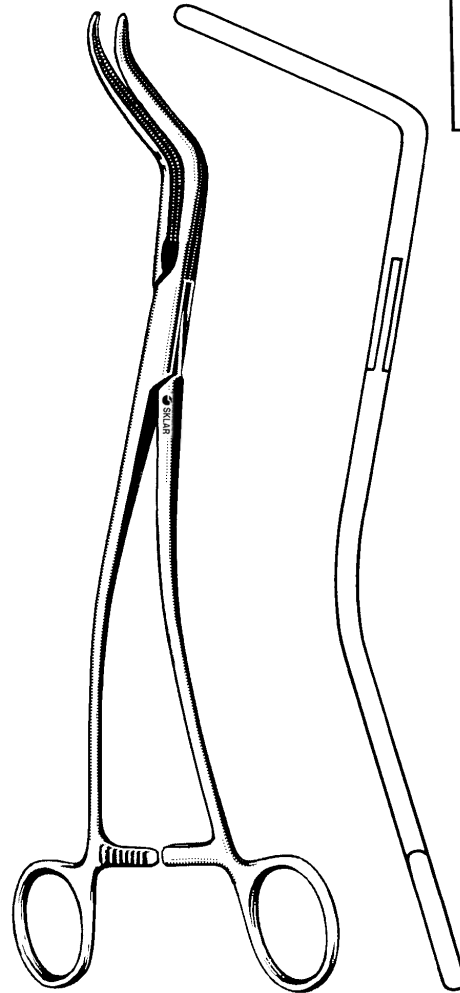

**DEBAKEY BRONCHUS FORCEPS**

52-2385 10½"

For a complete listing of our Cardiovascular product line, visit [www.sklarcorp.com](http://www.sklarcorp.com).



CARDIOVASCULAR

FORCEPS

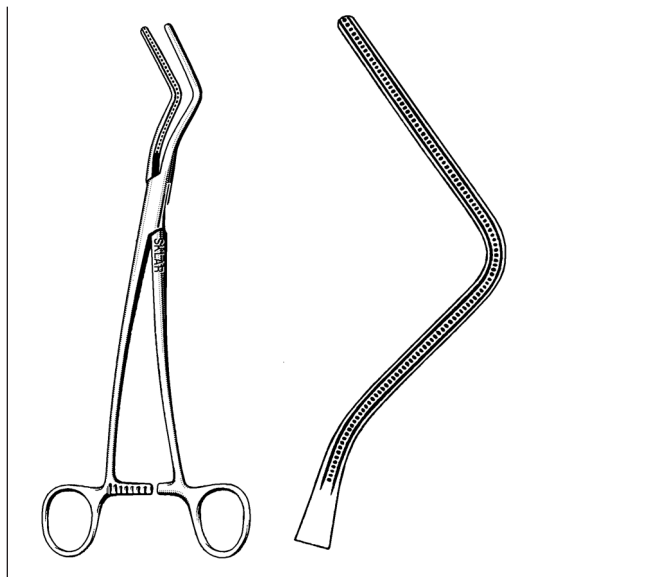

**LEES BRONCHUS CLAMP**

52-2382 9 3/4"



**LEES BRONCHUS CLAMP**

52-2380 9"



**DEBAKEY-MCQUIGG MIXTER THORACIC CLAMP**

52-6825 8"

For a complete listing of our Cardiovascular product line, visit [www.sklarcorp.com](http://www.sklarcorp.com).

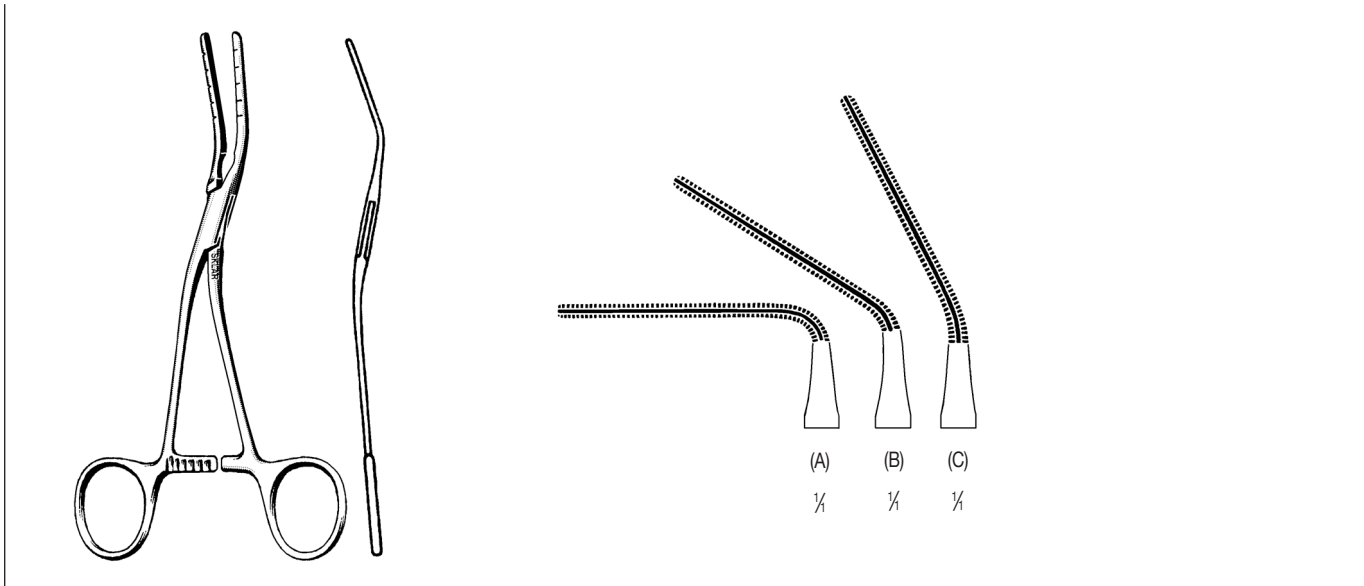

**COOLEY MULTI-PURPOSE CLAMPS**

- 52-6900 5½" 90° Angle (A)
- 52-6902 6½" 45° Angle (B)
- 52-6904 6½" 30° Angle (C)

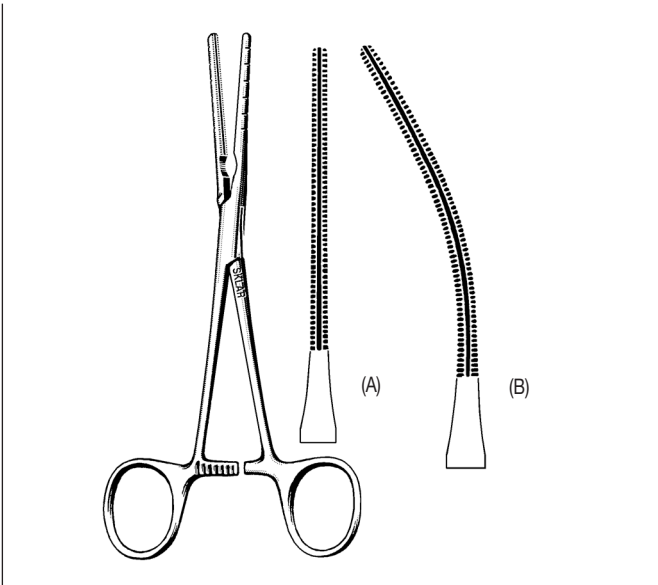

**COOLEY MULTI-PURPOSE CLAMPS**

- 52-6910 6½" Straight (A)
- 52-6912 6¾" Curved (B)



**COOLEY MULTI-PURPOSE CLAMP**

- 52-6920 6" Straight

For a complete listing of our Cardiovascular product line, visit [www.sklarcorp.com](http://www.sklarcorp.com).



**COOLEY PATENT DUCTUS FORCEPS**

52-6925 6"

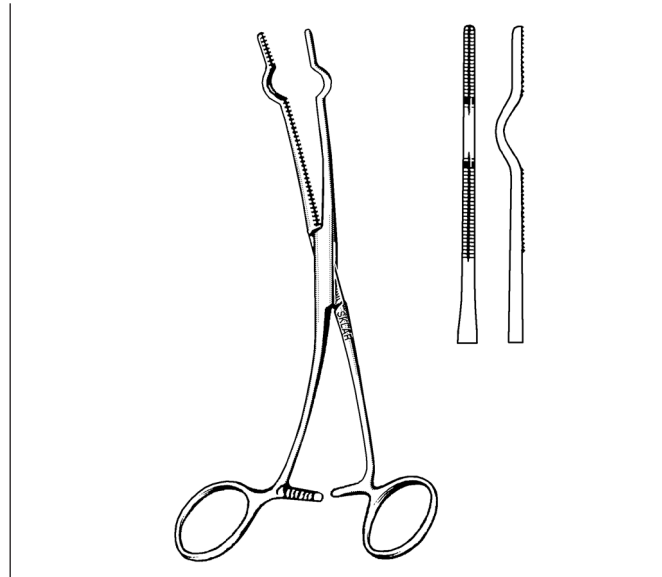

**COOLEY CAVA OCCLUSION CLAMPS**

52-7046 30 French Diameter  
52-7048 32 French Diameter  
52-7050 36 French Diameter



**COOLEY COARCTATION FORCEPS**

52-6930 6½"

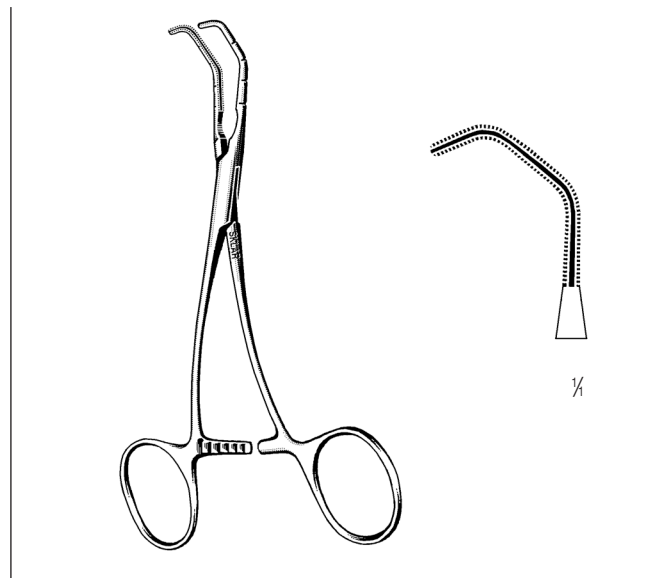

**COOLEY SATINSKY ANASTOMOSIS FORCEPS**

52-6950 5½"

For a complete listing of our Cardiovascular product line, visit [www.sklarcorp.com](http://www.sklarcorp.com).

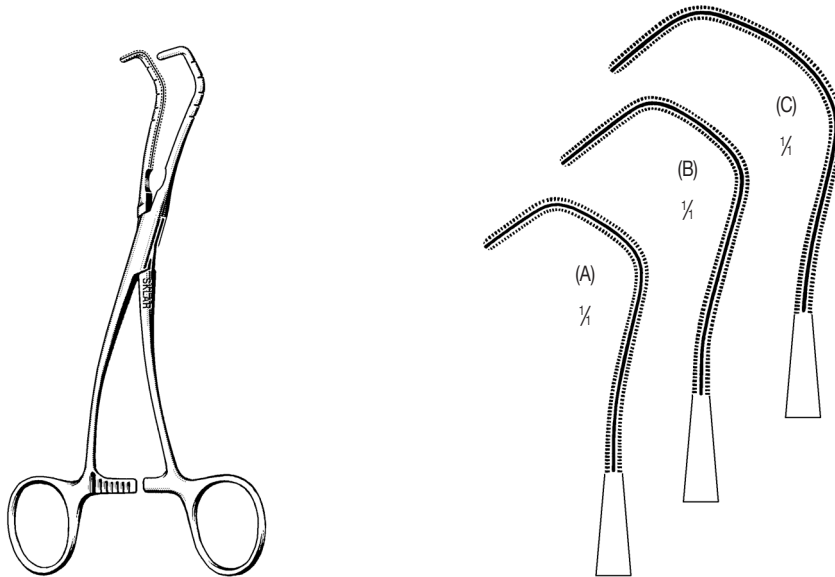

**COOLEY-DERRA ANASTOMOSIS CLAMPS**

52-6955	6½"	Small	(A)
52-6956	7"	Medium	(B)
52-6957	7¼"	Large	(C)

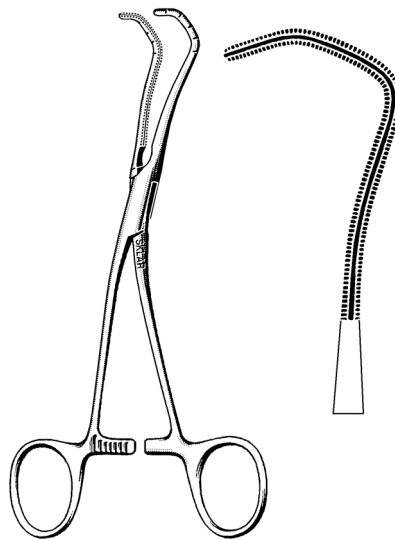

**COOLEY ANASTOMOSIS CLAMP**

52-6960	6½"	Standard
---------	-----	----------

For a complete listing of our Cardiovascular product line, visit [www.sklarcorp.com](http://www.sklarcorp.com).

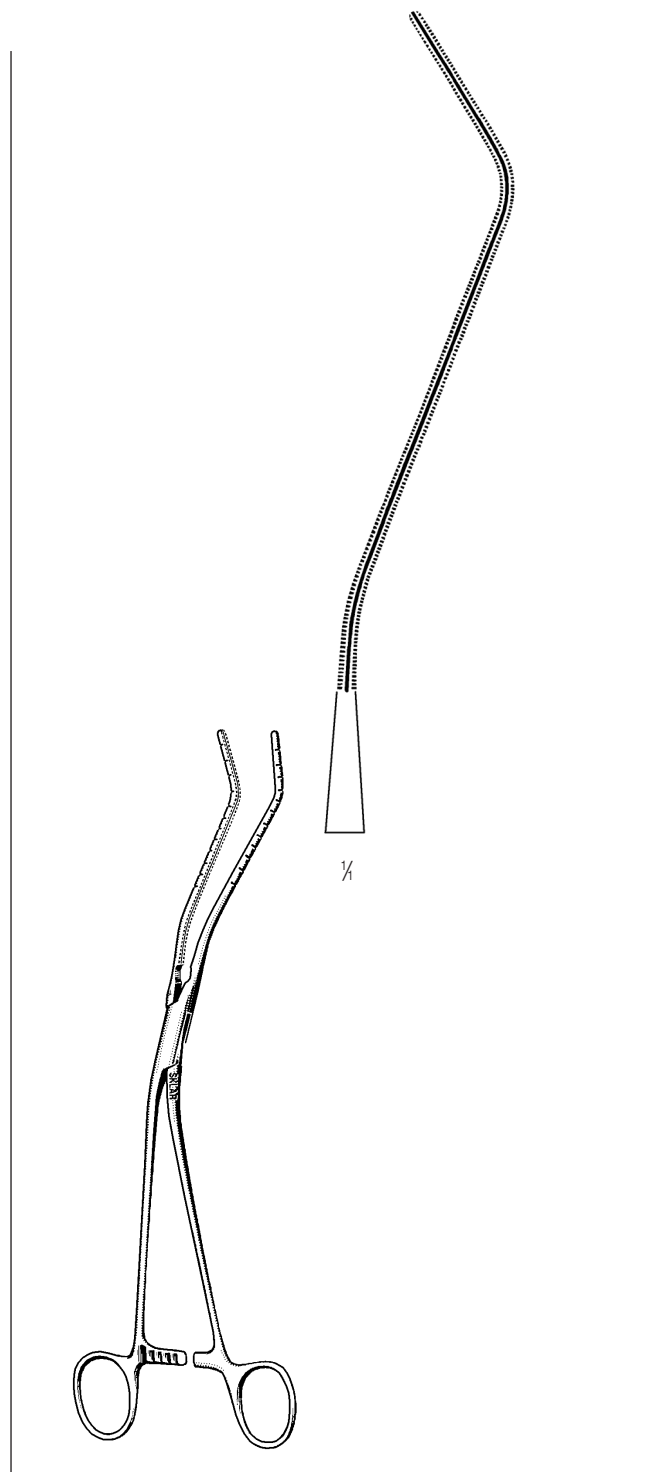
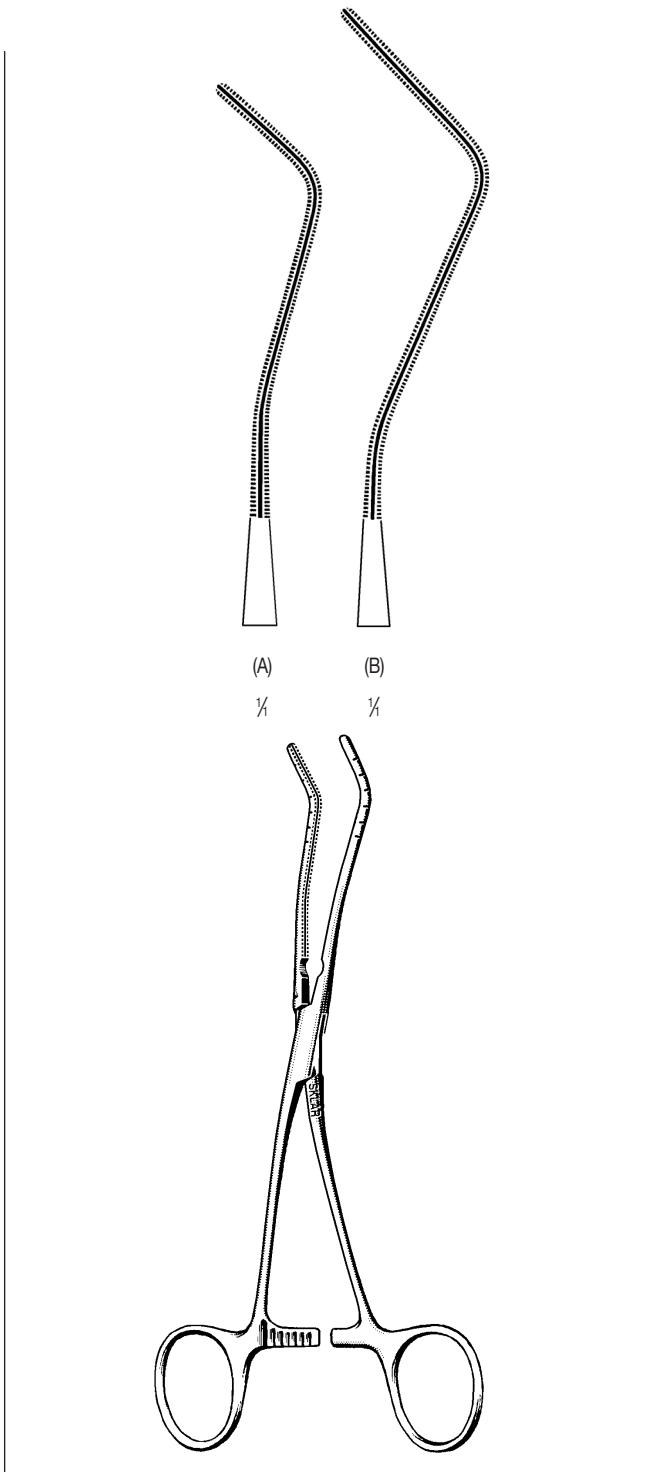

**RENAL ARTERY CLAMPS**

**COOLEY JAWS**

- 52-6965 7¼" (A)
- 52-6966 7½" (B)

**RENAL ARTERY CLAMP**

**COOLEY JAWS**

- 52-6968 10¾"

For a complete listing of our Cardiovascular product line, visit [www.sklarcorp.com](http://www.sklarcorp.com).

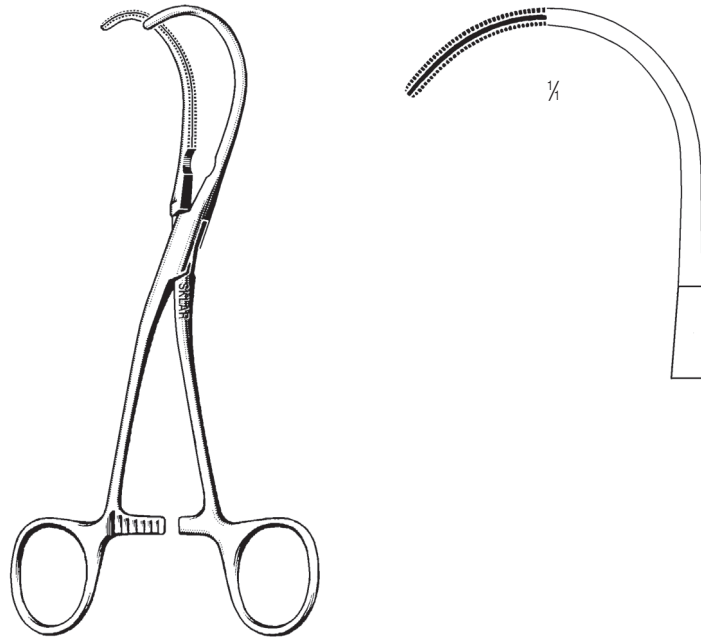

**COOLEY LIGATURE CARRIERS**

52-6975 6½" (A) Partial Serrations

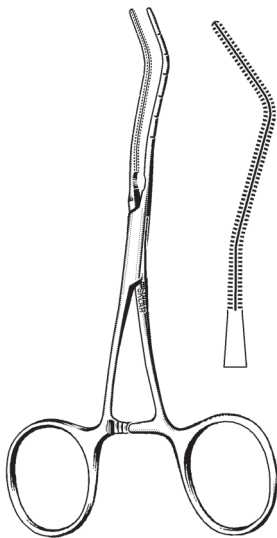

**COOLEY NEONATAL VASCULAR CLAMP**

52-6985 5"

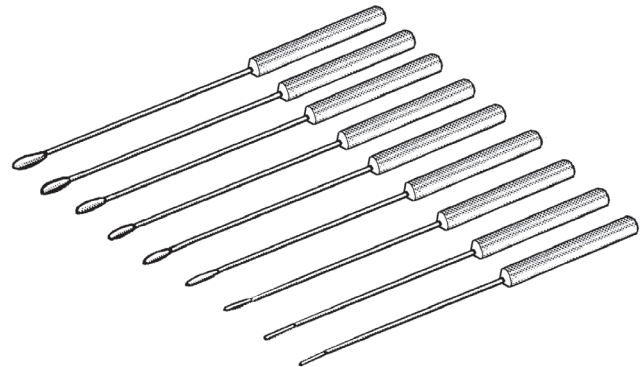

**VASCULAR DILATORS LONG**

52-7020 Set of 9 long dilators (1, 1.5, 2, 2.5, 3, 3.5, 4, 4.5 and 5mm). 8½" (22cm) long

**VASCULAR DILATORS SHORT**

52-7000 Set of 9 short dilators (1, 1.5, 2, 2.5, 3, 3.5, 4, 4.5 and 5mm). 5½" (14cm) long

For a complete listing of our Cardiovascular product line, visit [www.sklarcorp.com](http://www.sklarcorp.com).

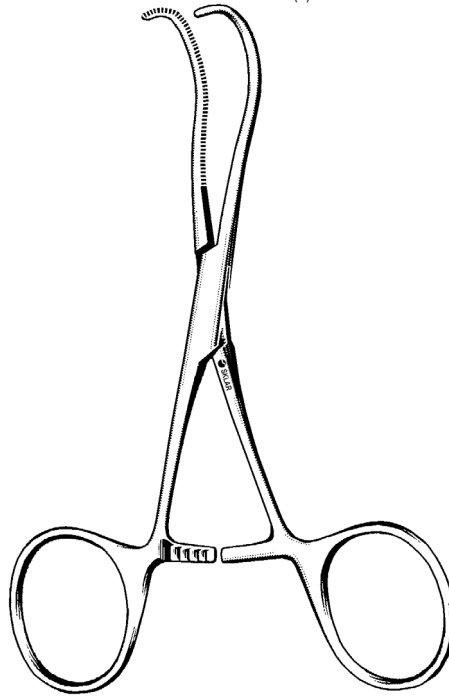
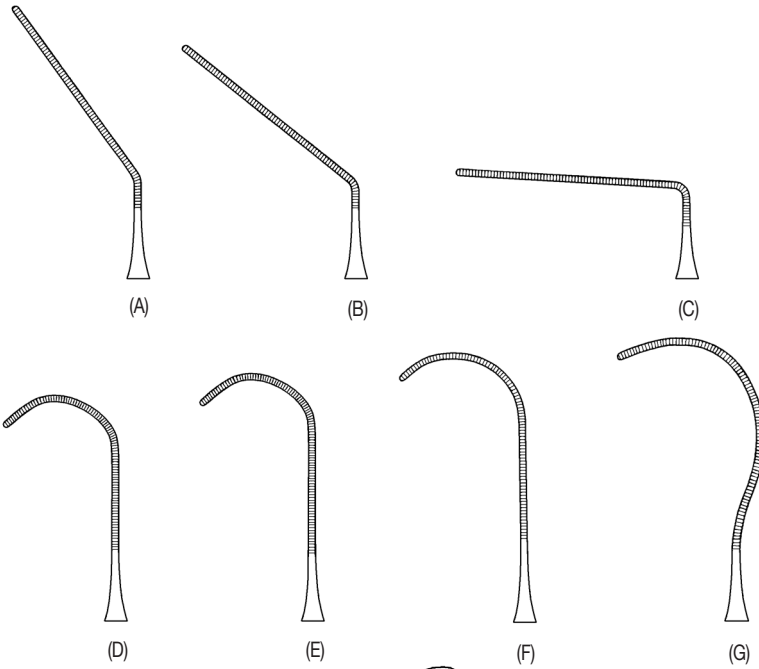

**CASTANEDA NEONATAL CLAMPS**

52-6990	5"	(A)
52-6991	5"	(B)
52-6992	5"	(C)
52-6993	6"	(D)
52-6994	6"	(E)
52-6995	6"	(F)
52-6996	6"	(G)

For a complete listing of our Cardiovascular product line, visit [www.sklarcorp.com](http://www.sklarcorp.com).



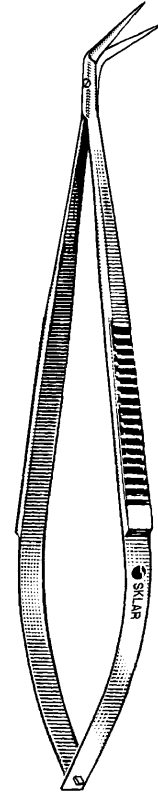
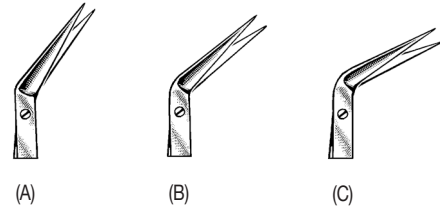
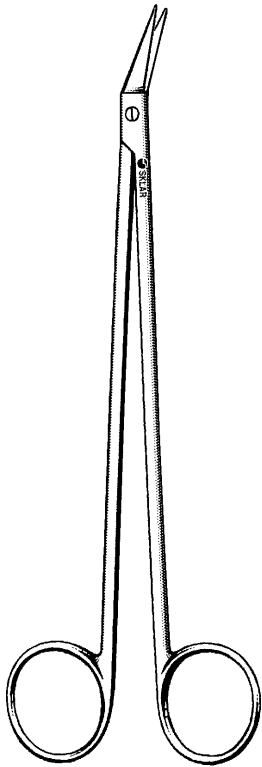
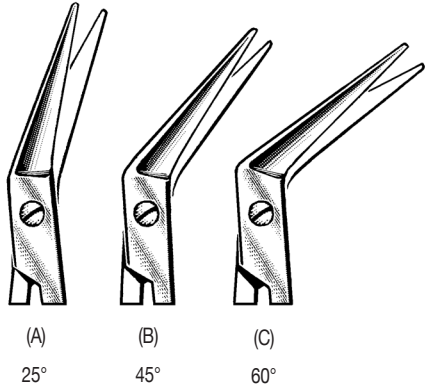

**POTTS-SMITH SCISSORS**

- 52-2825 7¼" 25° Angle (A)
- 52-2845 7¼" 45° Angle (B)
- 52-2860 7¼" 60° Angle (C)

**SPRING HANDLE VASCULAR SCISSORS**

- POTTS-SMITH TYPE**
- 98-1075 7" 25° Angle (A)
  - 98-1076 7" 45° Angle (B)
  - 98-1077 7" 60° Angle (C)

For a complete listing of our Cardiovascular product line, visit [www.sklarcorp.com](http://www.sklarcorp.com).

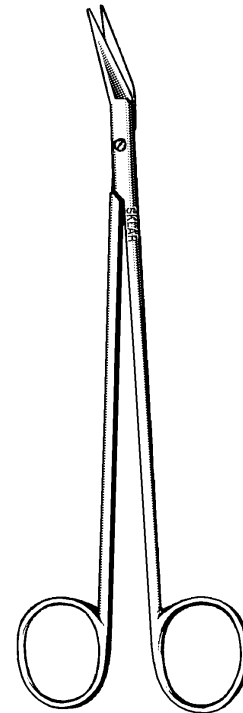
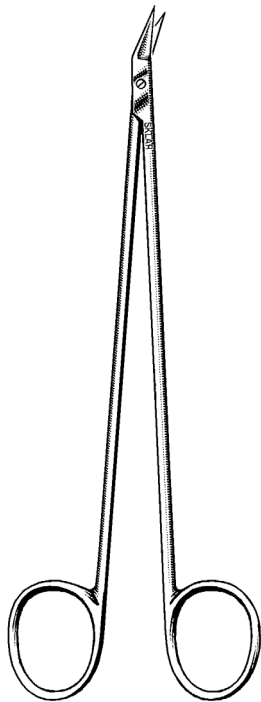
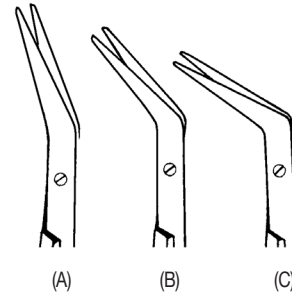
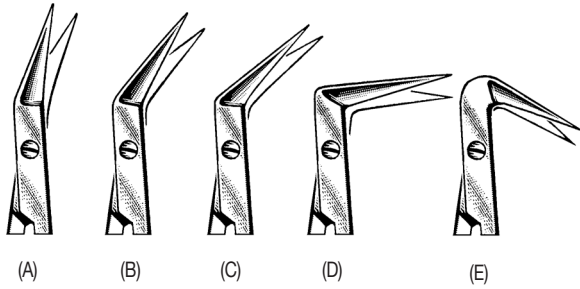

**DIETHRICH CORONARY ARTERY SCISSORS**

52-3225	7"	25° Angle	(A)
52-3245	7"	45° Angle	(B)
52-3260	7"	60° Angle	(C)
52-3290	7"	90° Angle	(D)
52-3295	7"	125° Angle	(E)

**DEBAKEY VASCULAR SCISSORS**

25° ANGLE (A)		45° ANGLE (B)		60° ANGLE (C)	
52-2800	7"	52-2802	7"	52-2804	7"
52-2810	9"	52-2812	9"	52-2814	9"
52-2820	11"	52-2822	11"	52-2824	11"

For a complete listing of our Cardiovascular product line, visit [www.sklarcorp.com](http://www.sklarcorp.com).

**CARDIOVASCULAR  
SCISSORS**



**METZENBAUM DISSECTING SCISSORS DELICATE**

**STRAIGHT**

- 22-1071 7"
- 55-9184 8" (Nelson)
- 55-9194 9" (Nelson)

**CURVED**

- 22-1070 7"
- 55-9084 8" (Nelson)
- 55-9094 9" (Nelson)
- 55-9414 11" (Nelson)

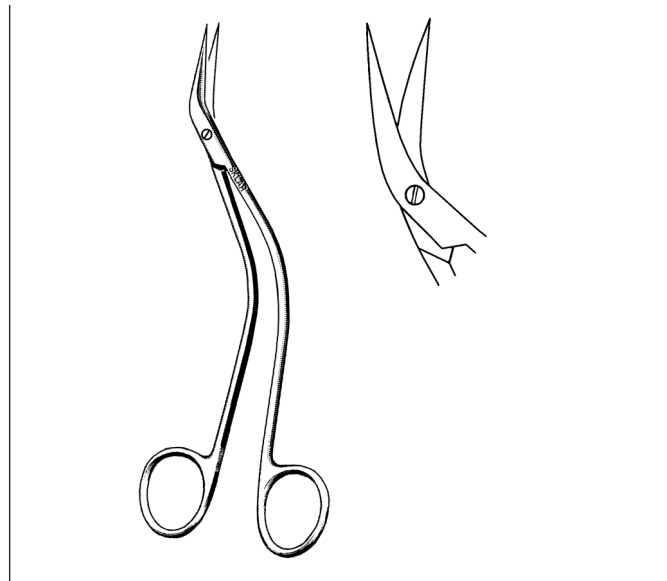

**DEBAKEY VASCULAR SCISSOR**

52-2885 6" Double Angled

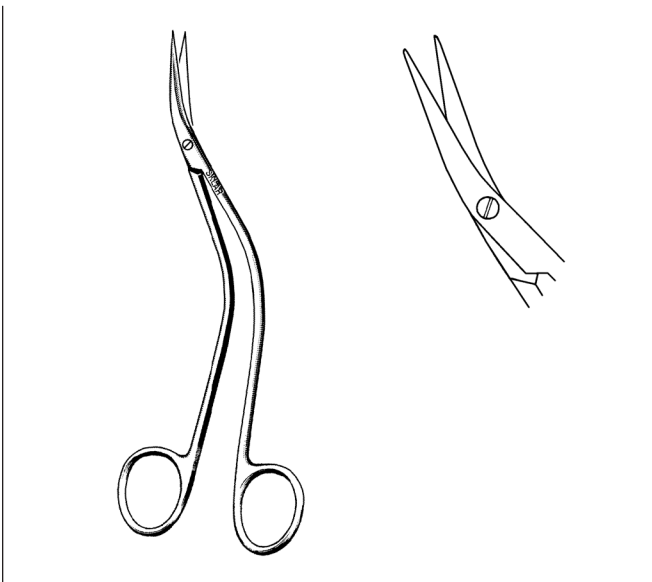

**DEBAKEY VASCULAR SCISSOR**

52-2888 6" Curved



PRODUCT NUMBER	FEATURES	QUANTITIES
10-2722	22 oz. Refillable Spray Bottles	12/case
10-2724	1 Gallon Bottles	4/case

For a complete listing of our Cardiovascular product line, visit [www.sklarcorp.com](http://www.sklarcorp.com).

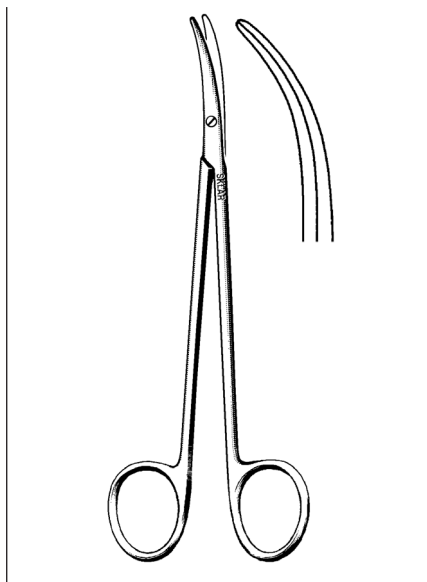

**DEBAKEY  
ENDARTERECTOMY SCISSOR**

55-8488 7" (17.5cm) Full Curve

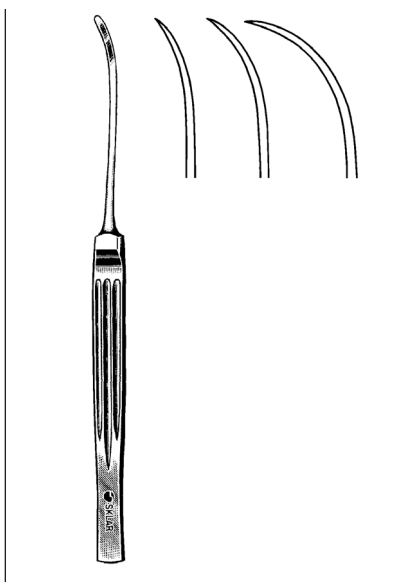

**LEMMON INTIMA DISSECTORS**

55-8390	6½"	Slight Curve
55-8391	6½"	Standard Curve
55-8392	6½"	Full Curve

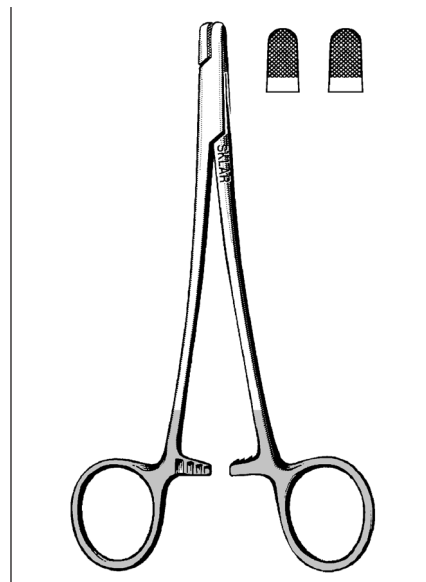

**TC SKLAR STERNAL WIRE  
TWISTERS**

21-9060	5"
21-9065	7"

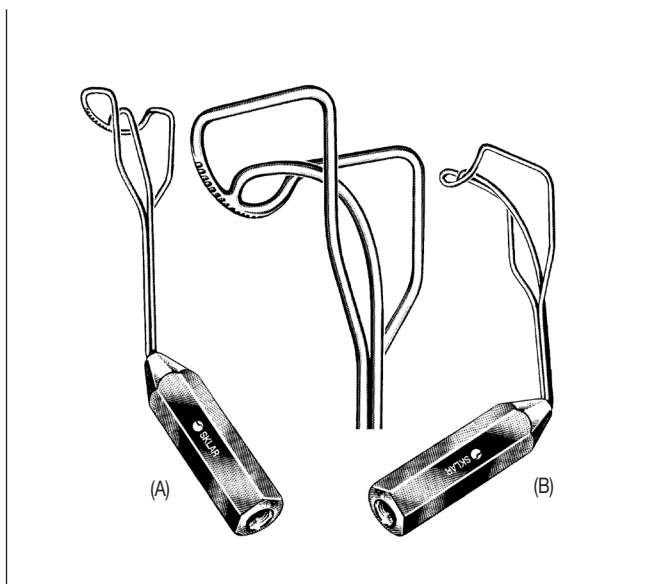

**COOLEY ATRIAL VALVE RETRACTORS**

55-8284	Right, 40mm wide, 30mm deep	(A)
55-8288	Left, 50mm wide, 10mm deep	(B)



**VESSEL AND NERVE RETRACTORS**

**MALLEABLE**

55-8300	11mm
55-8302	15mm
55-8304	17mm
55-8306	20mm

For a complete listing of our Cardiovascular product line, visit [www.sklarcorp.com](http://www.sklarcorp.com).

# DERMAL INSTRUMENTS

## SPLINTER FORCEPS

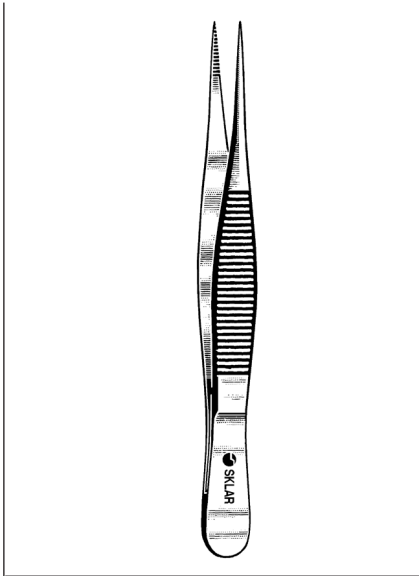

### FINE POINT SPLINTER FORCEPS

- 19-3035 3½"
- 19-3040 4"
- 19-3045 4½"



### CARMALT SPLINTER FORCEPS

- 19-3240 4¼" Straight
- 19-3340 4¼" Curved

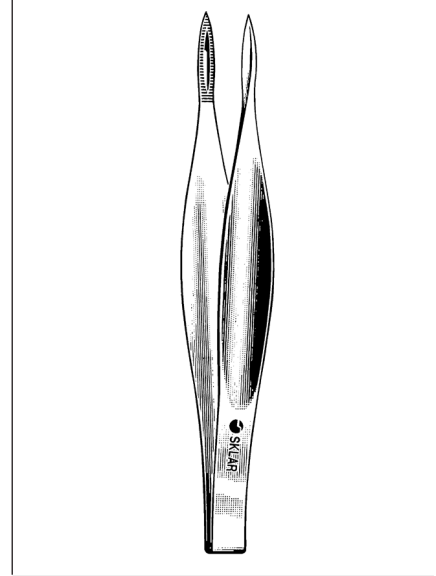

### FEILCHENFELD SPLINTER FORCEPS

- 19-2930 3"
- 19-2945 4½"



### PLAIN SPLINTER FORCEPS WITH MAGNIFIER

- 19-3030 3" Non-Autoclavable
- 94-7001 3" Floor Grade
- 21-708 3" Floor Grade, 12/Box

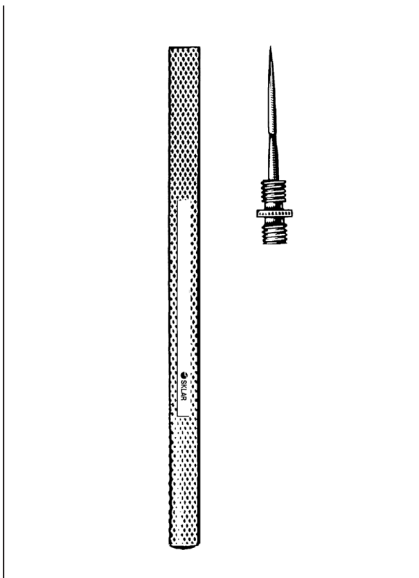

### VANGUARD SPLINTER LIBERATOR TROCAR POINT

- 19-3350 3¼" Handle, 4½" Overall

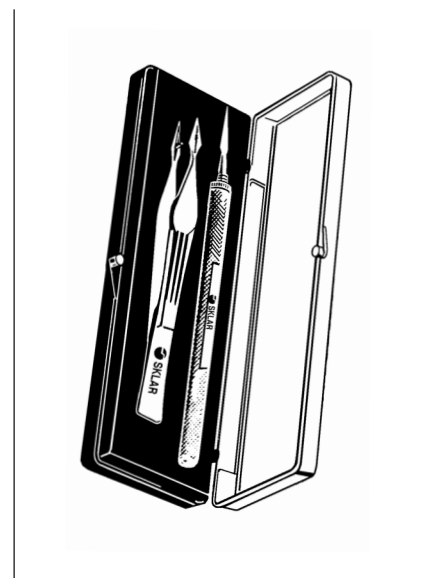

### SKLAR SPLINTER REMOVAL KIT

- 19-3360 Containing one 19-3240 and one 19-3350 in a convenient storage case.

For a complete listing of our Dermal product line, visit [www.sklarcorp.com](http://www.sklarcorp.com).

DERMAL INSTRUMENTS

SPLINTER FORCEPS

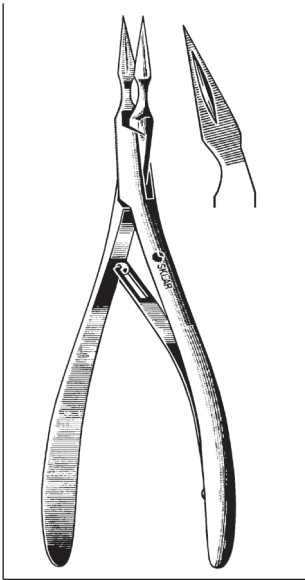

**VIRTUS SPLINTER  
FORCEPS**

**SERRATED**

19-3160 6" Straight  
19-3162 6" Angled



**ARCHER SPLINTER  
FORCEPS**

**SERRATED**

19-3155 5½" Straight

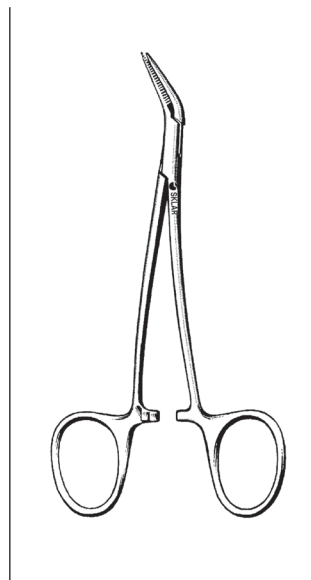

**PEET SPLINTER  
FORCEPS**

**DOUBLE EDGE**

19-3147 4¾" Angled

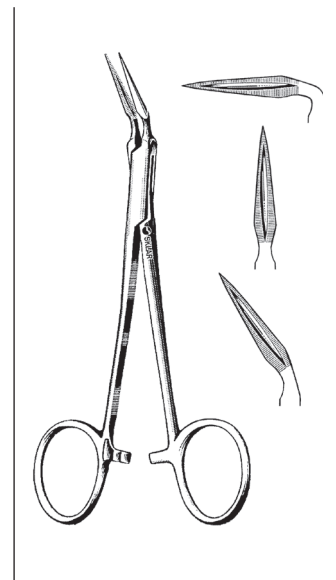

**WILLIAMS (STIEGLITZ)  
SPLINTER FORCEPS**

19-3056 4¾" Right Angle  
19-3055 5½" 45° Angle  
19-3161 5½" Straight

**SKLAR SOAK™**

**SURGICAL INSTRUMENT SOAK**

Immersing soiled instruments in SKLAR SOAK™ for two minutes substantially reduces the risk of exposure to many infectious organisms.

- Effective Against: H1N1, HIV-1, HSV, VRE, Rotaviruses, Hep B & C as well as TB, MRSA, A. Baumannii.
- Non-Glutaraldehyde.
- PH Neutral Formula designed for safe use on all surgical instruments & stainless steelware.
- Non-Caustic Formula allows for use as a manual cleaner or in ultrasonic units.
- EPA Registered.
- Meets all OSHA standards on blood borne pathogen destruction.
- Ready to use.



PRODUCT NUMBER	FEATURES	QUANTITIES
10-1603	1 Gallon Bottles	4/case
10-1609	1 Gallon Bottle	1 bottle

For a complete listing of our Dermal product line, visit [www.sklarcorp.com](http://www.sklarcorp.com).

# DERMAL INSTRUMENTS

## EXTRACTORS / PUNCHES

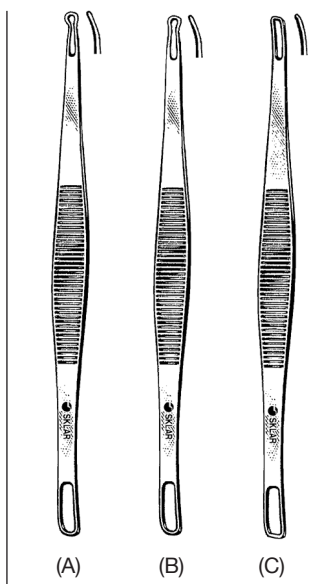

### SCHAMBERG COMEDONE EXTRACTORS

- 06-4120 Regular Size (A)
- 06-4121 One End Extra Fine (B)
- 06-4122 Square Ends (C)

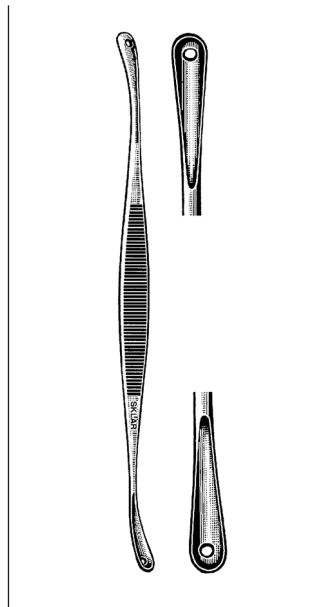

### UNNA COMEDONE EXTRACTORS

- DOUBLE END**
- 06-4125 5/4" Oval
  - 06-4191 5/4" Round

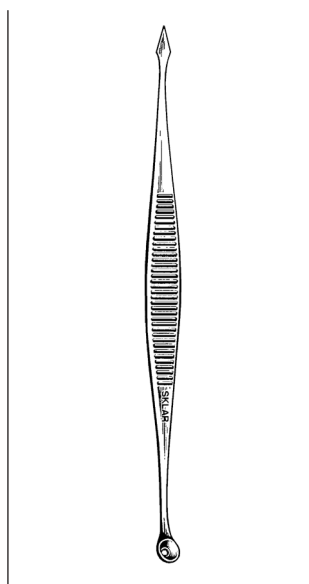

### COMEDONE EXTRACTOR

- SPEAR POINT**
- 06-4126 4"

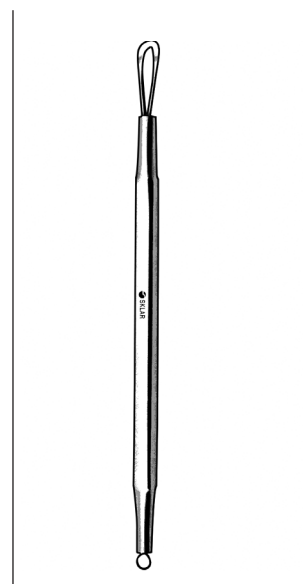

### COMEDONE EXTRACTOR

- DOUBLE END**
- 06-4123 4 1/2" Flat and Wire  
End Expressors

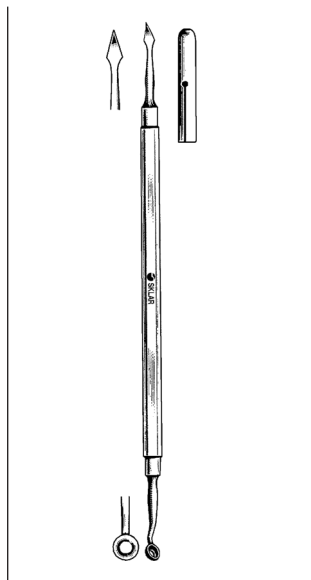

### COMEDONE EXTRACTOR

- SPEAR POINT WITH COVER**
- 06-4128 Double End

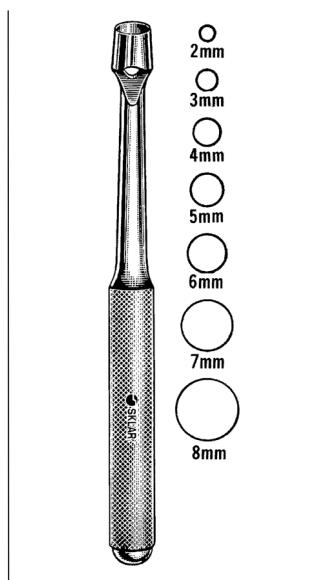

### KEYES CUTANEOUS PUNCHES

- 4"**
- 06-4142 2mm
  - 06-4143 3mm
  - 06-4144 4mm
  - 06-4145 5mm
  - 06-4146 6mm
  - 06-4147 7mm
  - 06-4148 8mm

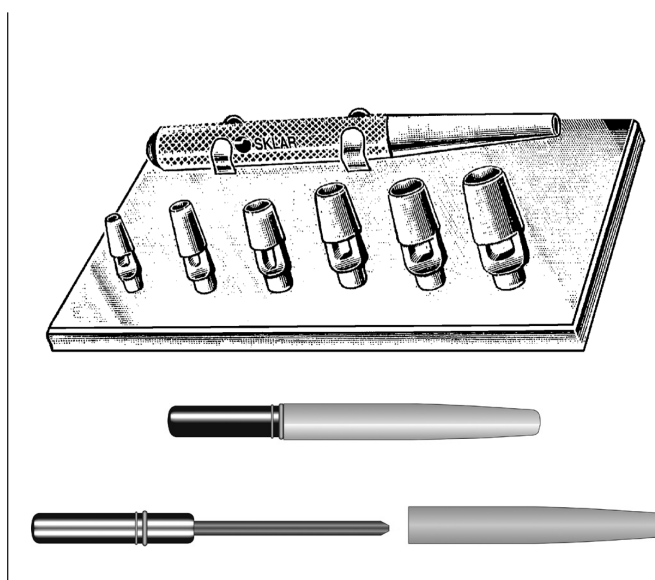

### KEYES DERMAL PUNCH

- 06-4100 Set of 6, 2mm thru 7mm with Universal Handle and Sterilizable Base
- 06-4110 KEYES Sharpening Stone

For a complete listing of our Dermal product line, visit [www.sklarcorp.com](http://www.sklarcorp.com).

# DERMAL INSTRUMENTS

## CURETTES / CUTTERS

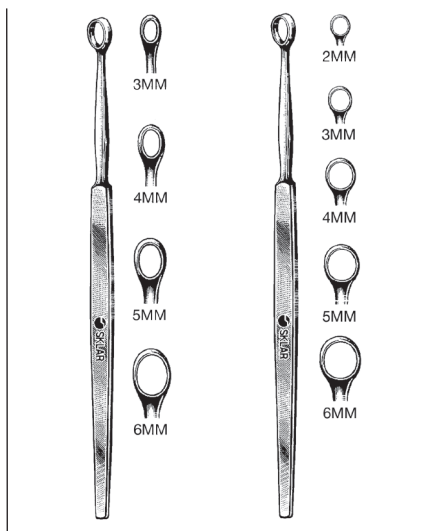

### FOX DERMAL CURETTES

#### OVAL 5½"

- 06-4133 3mm
- 06-4134 4mm
- 06-4135 5mm
- 06-4136 6mm

#### ROUND 5½"

- 06-4137 2mm
- 06-4138 3mm
- 06-4139 4mm
- 06-4140 5mm
- 06-4141 6mm

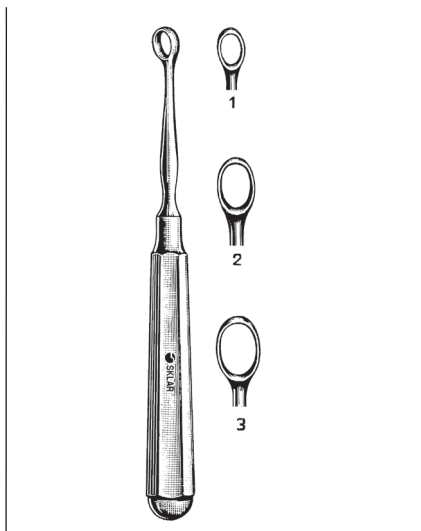

### PIFFARD DERMAL CURETTES

- 06-4130 #1
- 06-4131 #2
- 06-4132 #3

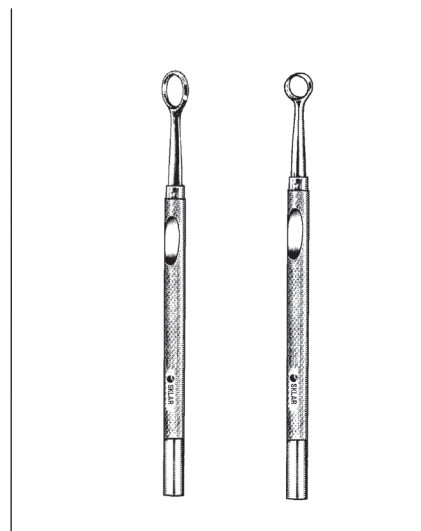

### REIN CURETTES

#### OVAL

- 06-4053 #1
- 06-4058 #6

#### ROUND

- 06-4059 2mm
- 06-4060 3mm
- 06-4061 4mm

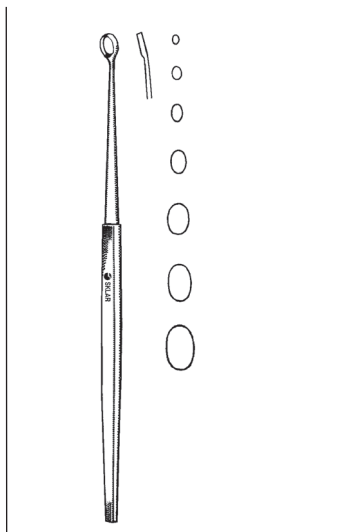

### CANNON CURETTES

- 06-4001 #00
- 06-4002 #0
- 06-4003 #1
- 06-4004 #2
- 06-4005 #3
- 06-4006 #4
- 06-4007 #5

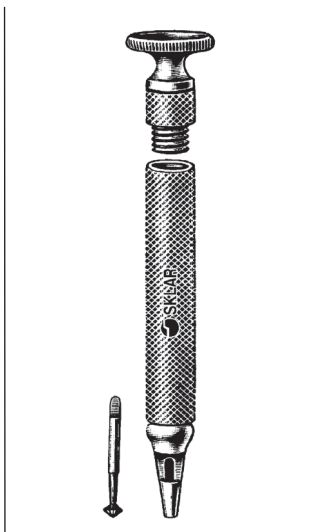

### SKLAR NAIL DRILL

#### THREE DRILLS IN HANDLE

- 06-4160 Complete
- 06-4161 Set of Drill Points Only

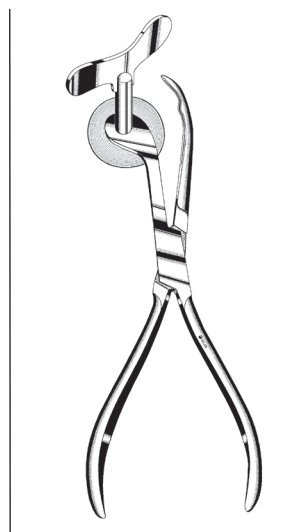

### KEYES FINGER RING CUTTER

#### STAINLESS STEEL

- 06-4150 Ring Cutter Complete
- 06-4151 Blades w/Brass Bushings Attached for above Ring Cutter

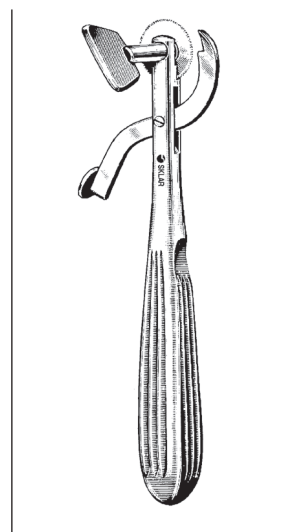

### SKLAR FINGER RING CUTTER

#### STAINLESS STEEL

- 06-4152 6"
- 06-4153 Blade Only

For a complete listing of our Dermal product line, visit [www.sklarcorp.com](http://www.sklarcorp.com).



# SURGICAL INSTRUMENT SETS

## GENERAL SURGERY SETS



### 98-1000 MAJOR BASIC SURGERY SET

PRODUCT NUMBER	DESCRIPTION	FEATURES	QUANTITIES
06-2860	Ruler	Steel, 6"	1
06-2903	Scalpel Handles	#3	2
06-2904	Scalpel Handles	#4	2
07-1805	Yankauer Suction Tubes	Stainless Steel	2
10-1805	Weinstein Sterilizing Racks	11¼" x 3¼"	3
15-1555	Mayo Dissecting Scissor	Straight, 5½"	1
15-2567	Mayo Dissecting Scissor	Curved, 6¾"	1
17-1235	Hartmann Mosquito Forceps	Straight, Serrated, 3½"	3
17-1335	Hartmann Mosquito Forceps	Curved, Serrated, 3½"	3
17-1450	Halsted Mosquito Forceps	Straight, 5"	6
17-1550	Halsted Mosquito Forceps	Curved, 5"	6
17-2262	Rochester-Pean Forceps	Curved, 6¼"	6
17-2280	Rochester-Pean Forceps	Curved, 8"	3
17-2462	Rochester-Pean Forceps	Straight, 6¼"	6
17-2480	Rochester-Pean Forceps	Straight, 8"	3
17-2662	Rochester-Ochsner Forceps	Curved, 1x2 Teeth, 6¼"	2
17-2862	Rochester-Ochsner Forceps	Straight, 1x2 Teeth, 6¼"	2
17-2880	Rochester-Ochsner Forceps	Straight, 1x2 Teeth, 8"	2
17-3055	Crile Forceps	Straight, 5½"	12
17-3155	Crile Forceps	Curved, 5½"	12
19-1055	Dressing Forceps	Serrated, 5½"	2
19-1080	Dressing Forceps	Serrated, 8"	2
19-1255	Tissue Forceps	1x2 Teeth, 5½"	3
19-1280	Tissue Forceps	1x2 Teeth, 8"	1
19-2280	Russian Tissue Forceps	8"	2
21-8031	TC Mayo-Hegar Needle Holders	Serrated, 6"	2
21-8032	TC Mayo-Hegar Needle Holders	Serrated, 7"	2
23-1106	Sklarlite™ Operating Scissors	Straight, Sharp/Blunt, 5½"	2
23-1130	Sklarlite™ Operating Scissors	Curved, Sharp/Blunt, 5½"	2
23-1157	Sklarlite™ Stevens Tenotomy Scissor	Curved, Blunt/Blunt, 4½"	1
30-1560	Probes	Double End, 6"	2
30-1960	Probes	With Eye, 6"	2
36-1662	Babcock Intestinal Forceps	6¼"	2
36-1677	Babcock Intestinal Forceps	8"	2
36-2160	Allis Tissue Forceps	4x5 Teeth, 6"	3
36-2275	Allis Tissue Forceps	5x6 Teeth, 7½"	6
47-1447	Adson Brown Forceps	9x9 Teeth, Side Grasping, 4¾"	2
47-2147	Adson Forceps	Delicate, Serrated, 4¾"	1
47-2955	Backhaus Towel Clamps	5¼"	12
55-9090	Metzenbaum-Nelson Scissor	Curved, 9"	1
60-1085	US Army Retractors	Set of 2, Double End, 8¼"	2
60-1681	Richardson Retractor	SklarGrip Handle, Medium, 9½", 1" x 1¼"	1
60-1691	Richardson Retractor	Sklar-Grip Handle, X-Large, 9½", ¾" x 2"	1
60-1695	Richardson-Eastman Retractor	Set of 2	1
60-2713	Deaver Retractors	Sklar-Grip Handle, #2, 1" x 13"	2
60-3090	Deaver Retractors	#0, 1" x 9"	2
60-3212	Deaver Retractors	#3, 1½" x 12"	2
60-3312	Deaver Retractor	#4, 2" x 12"	1
60-3598	Zalkind Ribbon Retractors	Malleable, ¾" x 7¾"	2

**SURGICAL INSTRUMENT SETS**  
**GENERAL SURGERY SETS**



**98-1000 MAJOR BASIC SURGERY SET (CONTINUED)**

PRODUCT NUMBER	DESCRIPTION	FEATURES	QUANTITIES
60-3610	Zalkind Ribbon Retractors	Malleable, 1" x 13"	2
60-3615	Zalkind Ribbon Retractors	Malleable, 1½" x 13"	2
60-6162	Senn Retractors	Double End, Sharp, 3 Prongs, 6¼"	2
60-6164	Senn Retractors	Double End, Blunt, 3 Prongs, 6¼"	2
60-6670	Balfour Abdominal Retractor	7" Spread, 2" Deep Blade	1
74-3075	Schmidt Tonsil Forceps	Half Curved Jaws, 7½"	2
75-5670	Metzenbaum Scissors	Curved, 7"	2
87-2195	Foerster Sponge Forceps	Straight, Serrated, 9½"	2
87-2395	Foerster Sponge Forceps	Curved, Serrated, 9½"	2

**98-1002 MINOR BASIC SURGERY SET**

PRODUCT NUMBER	DESCRIPTION	FEATURES	QUANTITIES
06-2903	Scalpel Handles	#3	2
06-2904	Scalpel Handles	#4	2
07-1805	Yankauer Suction Tubes	Stainless Steel	2
15-2555	Mayo Dissecting Scissor	Curved, 5½"	1
15-2567	Mayo Dissecting Scissor	Curved, 6¾"	1
17-1450	Halsted Mosquito Forceps	Straight, 5"	6
17-1550	Halsted Mosquito Forceps	Curved, 5"	6
17-3055	Crile Forceps	Straight, 5½"	12
17-3155	Crile Forceps	Curved, 5½"	12
19-1055	Dressing Forceps	Serrated, 5½"	2
19-1080	Dressing Forceps	Serrated, 8"	1
19-1255	Tissue Forceps	1x2 Teeth, 5½"	3
21-8031	TC Mayo-Hegar Needle Holders	Serrated, 6"	2
23-1102	Sklarlite™ Operating Scissors	Straight, Sharp/Sharp, 5½"	2
23-1166	Sklarlite™ Mayo Dissecting Scissor	Curved, 5½"	1
23-1167	Sklarlite™ Mayo Dissecting Scissor	Curved, 6¾"	1
30-1560	Probes	Double End, 6"	2
36-2160	Allis Tissue Forceps	4x5 Teeth, 6"	3
47-1447	Adson Brown Forceps	9x9 Teeth, Side Grasping, 4¾"	2
47-2955	Backhaus Towel Clamps	5¼"	12
50-2008	Frazier Suction Tube	8 French	1
60-1075	Goelet Retractors	Double End, 1¼" x 1½"	2
60-1085	US Army Retractors	Set of 2, Double End, 8¼"	2
60-3598	Zalkind Ribbon Retractors	Malleable, ¾" x 7¾"	2
60-6162	Senn Retractors	Double End, Sharp, 3 Prongs, 6¼"	2
60-6164	Senn Retractors	Double End, Blunt, 3 Prongs, 6¼"	2
75-5670	Metzenbaum Scissors	Curved, 7"	2
87-2195	Foerster Sponge Forceps	Straight, Serrated, 9½"	2
87-2395	Foerster Sponge Forceps	Curved, Serrated, 9½"	2

# SURGICAL INSTRUMENT SETS

## GENERAL SURGERY SETS



### 98-1005 MINI MINOR SET

PRODUCT NUMBER	DESCRIPTION	FEATURES	QUANTITIES
06-2903	Scalpel Handle	#3	1
10-1670	Iodine Cups	6oz., 3 7/16" x 2"	2
10-1675	Medicine Cup	2oz., Graduated Measure	1
16-1510	Sklar Edge™ Mayo Dissecting Scissor	TC, Straight, 6 3/4"	1
16-1905	Sklar Edge™ Metzenbaum Lahey Scissor	TC, Delicate, Curved, 5 3/4"	1
17-1450	Halsted Mosquito Forceps	Straight, 5"	4
17-1550	Halsted-Mosquito Forceps	Curved, 5"	6
17-3055	Crile Forceps	Straight, 5 1/2"	2
17-3155	Crile Forceps	Curved, 5 1/2"	2
19-1060	Dressing Forceps	Serrated, 6"	1
19-1260	Tissue Forceps	1x2 Teeth, 6"	1
21-8002	TC Webster Needle Holder	Smooth, 5"	1
22-8920	Holzheimer Retractor	4x4 Sharp Prongs, 4"	1
36-2260	Allis Tissue Forceps	5x6 Teeth, 6"	2
47-2500	Joseph Hooks	1 Sharp Prong, 6 1/4"	2
47-2655	Blair-Rollet Retractors	4 Prong, Sharp, Delicate, 5 1/2"	2
50-3047	Adson Tissue Forceps	1x2 Teeth, 4 3/4"	1
50-3147	Adson Dressing Forceps	Serrated, 4 3/4"	1
60-6162	Senn Retractors	Double-End, Sharp, 3 Prongs, 6 1/4"	2
64-1342	Stevens Tenotomy Scissor	Curved, Blunt/Blunt, 4 1/2"	1
74-1470	Ballenger Sponge Forceps	Straight, Serrated, 7"	1

### 98-1058 BASIC DERMAL INSTRUMENT SET

PRODUCT NUMBER	DESCRIPTION	FEATURES	QUANTITIES
06-4120	Shamberg Comedone Extractor	Pinched End	1
06-4125	Unna Comedone Extractor	5 3/4"	1
11-1045	Lister Bandage Scissor	4 1/2"	1
11-1055	Lister Bandage Scissor	5 1/2"	1
15-1555	Mayo Dissecting Scissor	Straight, 5 1/2"	1
15-2555	Mayo Dissecting Scissor	Curved, 5 1/2"	1
17-1235	Hartmann Mosquito Forceps	Straight, Serrated, 3 1/2"	1
17-1335	Hartmann Mosquito Forceps	Curved, Serrated, 3 1/2"	1
17-1450	Halsted Mosquito Forceps	Straight, 5"	1
17-1550	Halsted Mosquito Forceps	Curved, 5"	1
19-1055	Dressing Forceps	Serrated, 5 1/2"	1
19-1255	Tissue Forceps	1x2 Teeth, 5 1/2"	1
19-3035	Fine Point Splinter Forceps	3 1/2"	1
19-3045	Fine Point Splinter Forceps	4 1/2"	1
20-1350	Webster Needle Holder	Smooth, 5 1/4"	1
20-1352	Webster Needle Holder	Serrated, 5 1/4"	1
20-1547	Derf Needle Holder	Serrated, 4 3/4"	1
20-1750	Halsey Needle Holder	Smooth, 5"	1
20-1751	Halsey Needle Holder	Serrated, 5"	1
20-2747	Olsen-Hegar Needle Holder	4 3/4"	1
20-2755	Olsen-Hegar Needle Holder	5 1/2"	1
30-1945	Probe	With Eye, 4 1/2"	1
30-1955	Probe	With Eye, 5 1/2"	1

**SURGICAL INSTRUMENT SETS**  
**GENERAL SURGERY SETS**



**98-1058 BASIC DERMAL INSTRUMENT SET (CONTINUED)**

PRODUCT NUMBER	DESCRIPTION	FEATURES	QUANTITIES
36-2060	Allis Tissue Forceps	3x4 Teeth, 6"	1
36-2275	Allis Tissue Forceps	5x6 Teeth, 7½"	1
47-1145	Iris Scissor	Straight, Sharp/Sharp, 4½"	1
47-1245	Iris Scissor	Curved, Sharp/Sharp, 4½"	1
47-1246	Iris Scissor	Straight, Sharp/Sharp, Delicate, 4½"	1
47-1248	Iris Scissor	Curved, Sharp/Sharp, Delicate, 4½"	1
47-1360	Metzenbaum Scissor	Curved, 5¾"	1
47-2047	Adson Tissue Forceps	1x2 Teeth, Delicate, 4¾"	1
47-2147	Adson Forceps	Serrated, Delicate, 4¾"	1
47-2935	Backhaus Towel Clamp	3½"	1
47-2955	Backhaus Towel Clamp	5¼"	1
50-3047	Adson Tissue Forceps	1x2 Teeth, 4¾"	1
50-3147	Adson Dressing Forceps	Serrated, 4¾"	1
64-1242	Stevens Tenotomy Scissor	Straight, Blunt/Blunt, 4½"	1
64-1342	Stevens Tenotomy Scissor	Curved, Blunt/Blunt, 4½"	1
67-2502	Buck Ear Curette	#2, Angled, Sharp	1
67-2517	Buck Ear Curette	#2, Straight, Sharp	1
74-1370	Ballenger Sponge Forceps	Straight, Smooth, 7"	1
74-1670	Ballenger Sponge Forceps	Curved, Serrated, 7"	1
75-5460	Metzenbaum Scissor	Straight, 5¾"	1

**98-1015 BASIC DERMAL EXCISION SET**

PRODUCT NUMBER	DESCRIPTION	FEATURES	QUANTITIES
06-2903	Scalpel Handle	#3	1
06-3011	Surgical Blades	#11, Box of 100, Carbon Steel	1
06-3015	Surgical Blades	#15, Box of 100, Carbon Steel	1
20-1750	Halsey Needle Holder	Smooth, 5"	1
22-2545	Metzenbaum Scissor	Curved, 4¾"	1
47-1145	Iris Scissor	Straight, Sharp/Sharp, 4½"	1
47-1245	Iris Scissor	Curved, Sharp/Sharp, 4½"	1
47-2047	Adson Tissue Forceps	1x2 Teeth, Delicate, 4¾"	1
47-2147	Adson Forceps	Serrated, Delicate, 4¾"	1

**98-1009 BASIC NAIL SET**

PRODUCT NUMBER	DESCRIPTION	FEATURES	QUANTITIES
97-1046	Nail Nipper	Barrel Spring, Concave, 5½"	1
97-1242	Tissue Nipper	Convex Jaw 11mm, 4½"	1
97-1255	Littauer Cutting Forceps	4½"	1
97-1262	Littauer Cutting Forceps	6"	1
97-1662	Nail Splitter	Tapered Jaw, 5"	1

# SURGICAL INSTRUMENT SETS

## GENERAL SURGERY SETS



### 98-1010 BASIC PODIATRY SET

PRODUCT NUMBER	DESCRIPTION	FEATURES	QUANTITIES
06-2903	Scalpel Handle	#3	1
06-3011	Surgical Blades	#11, Box of 100, Carbon Steel	1
06-3015	Surgical Blades	#15, Box of 100, Carbon Steel	1
11-1055	Lister Bandage Scissor	5½"	1
11-1255	Knowles Bandage Scissor	5½"	1
13-1055	Operating Scissor	Straight, Sharp/Sharp, 5½"	1
15-1355	Littauer Stitch Scissor	5½"	1
16-2800	TC Wire Cutting Scissor	Angled, 4¾"	1
17-1450	Halsted Mosquito Forceps	Straight, 5"	3
17-1550	Halsted Mosquito Forceps	Curved, 5"	3
19-1055	Dressing Forceps	Serrated, 5½"	2
19-1255	Tissue Forceps	1x2 Teeth, 5½"	1
19-3045	Fine Point Splinter Forceps	4½"	1
21-8002	TC Webster Needle Holder	Smooth, 5¼"	1
21-8027	TC Olsen-Hegar Needle Holder	Serrated, 5½"	1
23-1102	Sklarlite Operating Scissor	Straight, Sharp/Sharp, 5½"	1
23-1106	Sklarlite™ Operating Scissor	Straight, Sharp/Blunt, 5½"	1
23-1189	Sklarlite™ Spencer Stitch Scissor	4½"	1
23-2110	Sklarlite™ Crile Forceps	Straight, 5½"	3
23-2113	Sklarlite™ Crile Forceps	Curved, 5½"	3
23-2602	Sklarlite™ Adson Tissue Forceps	1x2 Teeth, 4¾"	2
40-9825	Joseph Rasp	Straight, Fine Cross Serrations, 6½"	1
47-2380	Freer Elevator	Double End, Sharp/Blunt, 7¼"	1
47-2935	Backhaus Towel Clamps	3½"	6
50-1355	Dandy Scalp Hemostatic Forceps	5½"	1
50-2006	Frazier Suction Tubes	6 French	2
50-3147	Adson Dressing Forceps	Serrated, 4¾"	2
97-0335	Tissue Nipper	Convex Jaw, 9mm, 4"	1
97-0532	Curette/Excavator	#58 1-2, Double End	1
97-0536	Curette/Excavator	#58 1-3, Double End	1
97-0542	Spatula and Packer	#91, Double End	1
97-0545	Corn Chisel	Curved Edge, Spoon	1
97-0554	Ingrown Nail Shaver	Fenestrated	1
97-1150	Ingrown Nail Splitting Forceps	English Anvil, 5"	1
97-1318	Platypus Nail Forceps	6mm, 5½"	1

# SURGICAL INSTRUMENT SETS

## GENERAL SURGERY SETS



### 98-1022 INFANT LAPAROTOMY SET

PRODUCT NUMBER	DESCRIPTION	FEATURES	QUANTITIES
06-2903	Scalpel Handles	#3	2
14-1055	Operating Scissors	Straight, Sharp/Blunt, 5½"	1
17-1450	Halsted Mosquito Forceps	Straight, 5"	6
17-1550	Halsted Mosquito Forceps	Curved, 5"	6
17-3055	Crile Forceps	Straight, 5½"	4
17-3155	Crile Forceps	Curved, 5½"	4
18-1752	Rochester-Ochsner Forceps	Straight, 5½"	3
18-1852	Rochester-Ochsner Forceps	Curved, 5½"	3
22-1057	Metzenbaum Scissor	Curved, 5¾"	1
22-1070	Metzenbaum Scissor	Curved, Delicate, 7"	1
22-3555	Rochester-Pean Forceps	Straight, 5½"	3
22-3655	Rochester-Pean Forceps	Curved, 5½"	3
22-4150	Semkin Dressing Forceps	Serrated, Narrow, 5"	1
22-4350	Semkin Tissue Forceps	1x2 Teeth, Narrow, 5"	1
22-6155	Babcock Forceps	5½"	3
22-6157	Allis Tissue Forceps	4x5 Teeth, 5½"	3
22-6585	Yankauer Suction Tube	Pediatric	1
22-8360	Miller-Senn Retractor	Double End, Sharp, 6"	1
22-8460	Miller-Senn Retractor	Double End, Blunt, 6"	1
22-9030	Baby Balfour Retractor	Pediatric, 1¼" Deep, 4" Spread	1
47-2047	Adson Tissue Forceps	1x2 Teeth, Delicate, 4¾"	1
47-2147	Adson Dressing Forceps	Serrated, Delicate, 4¾"	1
60-1350	Parker Retractor	Set of 2, Double End, 8¼"	1
60-3596	Zalkind Ribbon Retractor	Malleable, ½" x 7¾"	1
60-3598	Zalkind Ribbon Retractor	Malleable, ¾" x 7¾"	1
74-1470	Ballenger Sponge Forceps	Straight, Serrated, 7"	2

### 98-1007 MASTECTOMY SET

PRODUCT NUMBER	DESCRIPTION	FEATURES	QUANTITIES
06-2903	Scalpel Handles	#3	2
06-2907	Scalpel Handle	#7	1
16-1510	Sklar Edge™ Mayo Dissecting Scissor	TC, Straight, 6¾"	1
16-1610	Sklar Edge™ Mayo Dissecting Scissor	TC, Curved, 6¾"	1
16-1905	Sklar Edge™ Metzenbaum Lahey Scissor	TC, Delicate, Curved, 5¾"	1
16-2110	Sklar Edge™ Metzenbaum Scissor	TC, Curved, 7"	1
16-2310	Sklar Edge™ Metzenbaum Scissor	TC, Curved, 9"	1
17-1550	Halsted-Mosquito Forceps	Curved, 5"	10
17-2262	Rochester-Pean Forceps	Curved, 6¼"	10
17-2280	Rochester-Pean Forceps	Curved, 8"	4
17-2862	Rochester-Ochsner Forceps	Straight, 1x2 Teeth, 6¼"	8
17-2880	Rochester-Ochsner Forceps	Straight, 1x2 Teeth, 8"	4
17-3055	Crile Forceps	Straight, 5½"	4
17-3155	Crile Forceps	Curved, 5½"	24
17-3562	Lahey Traction Forceps	6¼"	6
19-1060	Dressing Forceps	Serrated, 6"	2
19-1080	Dressing Forceps	Serrated, 8"	2
19-1260	Tissue Forceps	1x2 Teeth, 6"	2

## SURGICAL INSTRUMENT SETS

### GENERAL SURGERY SETS



#### 98-1007 MASTECTOMY SET (CONTINUED)

PRODUCT NUMBER	DESCRIPTION	FEATURES	QUANTITIES
19-1280	Tissue Forceps	1x2 Teeth, 8"	2
21-8001	TC Halsey Needle Holder	Serrated, 5¼"	1
21-8032	TC Mayo-Hegar Needle Holders	Serrated, 7"	2
21-8033	TC Mayo-Hegar Needle Holders	Serrated, 8"	2
30-1970	Probe	With Eye, 7"	1
36-1662	Babcock Intestinal Forceps	6¼"	2
36-1677	Babcock Intestinal Forceps	8"	2
36-2160	Allis Tissue Forceps	4x5 Teeth, 6"	8
47-2500	Joseph Hooks	1 Sharp Prong, 6¼"	2
47-2955	Backhaus Towel Clamps	5¼"	4
50-1290	Cushing Vein Retractors	9"	2
50-3047	Adson Tissue Forceps	1x2 Teeth, 4¾"	2
52-5177	DeBakey Atraumatic Tissue Forceps	2mm, 7¾"	2
55-2880	Gemini Clamps	Angled, 8", Delicate	4
60-1085	US Army Retractor	Set of 2, Double End, 8¼"	1
60-1676	Richardson Retractors	SklarGrip Handle, Small, 9½", ¾" x 1"	2
60-1681	Richardson Retractors	SklarGrip Handle, Medium, 9½", 1" x 1¼"	2
60-1686	Richardson Retractors	Sklar-Grip Handle, X-Large, 9½", ¾" x 2"	2
60-5814	Volkman Retractors	Ring Handle, 4 Prongs, Blunt, 8½"	2
60-5816	Volkman Retractors	Ring Handle, 6 Prongs, Blunt, 8½"	2
60-6162	Senn Retractors	Double End, Sharp, 3 Prongs, 6¼"	2
74-3075	Schmidt Tonsil Forceps	Half Curved Jaws, 7½"	4
87-2195	Foerster Sponge Forceps	Straight, Serrated, 9½"	3
91-1070	Barrett Tenaculum Forceps	Straight, 7"	20

#### 80-1914 R-C HEMORRHOIDAL LIGATION SET

PRODUCT NUMBER	DESCRIPTION	FEATURES	QUANTITIES
80-1872	Hemorrhoidal Grasping Forceps	7¼"	1
80-1910	Rudd Clinic Hemorrhoidal Ligator	With Loading Cone	1
80-1912	Kraton O'Rings	Latex-Free, Bag of 100	1
80-2245	Ives Rectal Speculum	18mm Tip, 3¼"	1

#### 80-1945 MCGIVNEY HEMORRHOID LIGATOR SET

PRODUCT NUMBER	DESCRIPTION	FEATURES	QUANTITIES
80-1872	Hemorrhoidal Grasping Forceps	7¼"	1
80-1950	McGivney Hemorrhoidal Ligator	With Loading Cone	1
80-1912	Kraton O'Rings	Latex-Free, Bag of 100	1
80-2245	Ives Rectal Speculum	18mm Tip, 3¼"	1

**SURGICAL INSTRUMENT SETS**  
**GENERAL SURGERY SETS**



**98-1012 RECTAL SURGERY SET**

PRODUCT NUMBER	DESCRIPTION	FEATURES	QUANTITIES
06-2903	Scalpel Handle	#3	1
06-2904	Scalpel Handle	#4	1
13-1055	Operating Scissor	Straight, Sharp/Sharp, 5½"	1
14-1055	Operating Scissor	Straight, Sharp/Blunt, 5½"	1
15-1555	Mayo Dissecting Scissor	Straight, 5½"	1
15-2567	Mayo Dissecting Scissor	Curved, 6¾"	1
17-1055	Pratt T-Shaped Clamps	Straight, 6"	2
17-2055	Kelly Forceps	Straight, 5½"	6
17-2155	Kelly Forceps	Curved, 5½"	6
17-2272	Rochester-Pean Forceps	Curved, 7¼"	3
17-2472	Rochester-Pean Forceps	Straight, 7¼"	3
17-2880	Rochester-Ochsner Forceps	Straight, 1x2 Teeth, 8"	2
17-2957	Pennington Clamps	Straight, 6¼"	2
19-1060	Dressing Forceps	Serrated, 6"	1
19-1260	Tissue Forceps	1x2 Teeth, 6"	1
21-1260	TC Crile-Murray Needle Holders	Serrated, 6"	2
21-8032	TC Mayo-Hegar Needle Holder	Serrated, 7"	1
36-2160	Allis Tissue Forceps	4x5 Teeth, 6"	2
36-2275	Allis Tissue Forceps	5x6 Teeth, 7½"	2
47-2955	Backhaus Towel Clamps	5¼"	6
50-2010	Frazier Suction Tube	10 French	1
50-2012	Frazier Suction Tube	12 French	1
75-5670	Metzenbaum Scissor	Curved, 7"	1
80-1735	Yeoman Rectal Punch	With Basket, 13¾"	1
80-2132	Pratt Rectal Speculum	With Set Screw	1
80-2688	Hirschman Anoscope	Small, 65mm x 16mm	1
80-2689	Hirschman Anoscope	Medium, 65mm x 19mm	1
80-2690	Hirschman Anoscope	Large, 65mm x 22mm	1
80-2715	Buie Suction Tube	With Valve, 15 French	1
80-2870	Larry Rectal Probe	7"	1
80-3185	Pratt Crypt Hook	Short, 8½"	1
80-3510	Barr Crypt Hook	Double End, 10"	1
80-3927	Sawyer Retractor	Sklar-Grip Handle, Medium	1
80-3935	Sawyer Retractor	Sklar-Grip Handle, Large	1
87-2395	Foerster Sponge Forceps	Curved, Serrated, 9½"	2

**98-1046 SUTURE REMOVAL SET**

PRODUCT NUMBER	DESCRIPTION	FEATURES	QUANTITIES
19-1050	Dressing Forceps	Serrated, 5¾"	1
22-2835	Spencer Stitch Scissor	5½"	1

**85-6222 WILSON VASECTOMY SET**

PRODUCT NUMBER	DESCRIPTION	FEATURES	QUANTITIES
85-6223	Vas Fixation Forceps	Oval Tip, 5¾"	1
85-6224	Vas Piercing Forceps	5½"	1



# SURGICAL INSTRUMENT SETS

## GENERAL SURGERY SETS



### 98-1064 BASIC TISSUE DISSECTION SET

PRODUCT NUMBER	DESCRIPTION	FEATURES	QUANTITIES
06-2903	Scalpel Handle	#3	1
06-3011	Surgical Blades	#11, Box of 100, Carbon Steel	1
06-3015	Surgical Blades	#15, Box of 100, Carbon Steel	1
17-1650	Halsted Mosquito Forceps	Straight, 1x2 Teeth, 5"	1
18-1050	Halsted Mosquito Forceps	Straight, 5"	3
18-1150	Halsted Mosquito Forceps	Curved, 5"	3
20-1750	Halsey Needle Holder	Smooth, 5"	1
22-1163	Dressing Forceps	Straight, Serrated, Delicate, 5½"	1
22-2545	Metzenbaum Scissor	Curved, 4¾"	1
22-2652	Ragnell Dissecting Scissor	Curved, 5"	1
22-2947	Northbent Suture Scissor	4¾"	1
24-2155	Healy Suture Removing Forceps	5½"	1
47-1145	Iris Scissor	Straight, Sharp/Sharp, 4½"	1
47-1235	Iris Scissor	Curved, Sharp/Sharp, 3½"	1
47-2047	Adson Tissue Forceps	1x2 Teeth, Delicate, 4¾"	1
47-2147	Adson Forceps	Serrated, Delicate, 4¾"	1
47-2502	Joseph Hook	2 Sharp Prongs, 2mm, 6¼"	1
47-2505	Joseph Hook	2 Sharp Prongs, 5mm, 6¼"	1
47-2570	Gilles Skin Hook	3mm, 7"	1
47-2572	Gilles Skin Hook	4mm, 7"	1
64-3280	Gradle Dissecting Scissor	Curved, Sharp, 3¾"	1
65-1841	Desmarres Lid Retractor	12mm	1
66-3540	Eye Tissue Forceps	Half-Curve, 1x2 Teeth, 4"	1

### 98-1468 TRACHEOTOMY SET

PRODUCT NUMBER	DESCRIPTION	FEATURES	QUANTITIES
06-2903	Scalpel Handle	#3	1
07-1820	Oral Surgery Suction System	Complete With Handle, Adapter, 4 Tubes, 1 Tip	1
15-1555	Mayo Dissecting Scissor	Straight 5½"	1
17-1450	Halsted Mosquito Forceps	Straight, 5"	3
17-1550	Halsted Mosquito Forceps	Curved, 5"	3
17-2255	Rochester-Pean Forceps	Curved, 5½"	2
17-3155	Crile Forceps	Curved, 5½"	4
21-9030	TC Crile-Wood Needle Holder	Left Hand, 6"	1
22-2845	Spencer Stitch Scissor	3½"	1
22-8255	Weitlaner Retractor	2x3 Teeth, Sharp, 4½"	1
36-2260	Allis Tissue Forceps	5x6 Teeth, 6"	2
47-1360	Metzenbaum Scissor	Curved, 5¾"	1
47-2935	Backhaus Towel Clamps	3½"	4
50-1307	Cushing Nerve Hooks	#1, 7½"	2
50-3047	Adson Tissue Forceps	1x2 Teeth, 4¾"	1
50-3147	Adson Dressing Forceps	Serrated, 4¾"	1
74-1670	Ballenger Sponge Forceps	Curved, Serrated, 7"	1
78-3545	News Tracheal Hook	6"	1
78-3580	Lukens Retractor	6¾"	1

**SURGICAL INSTRUMENT SETS**

**OPHTHALMIC**



**98-1034 BASIC EYE SURGERY SET**

PRODUCT NUMBER	DESCRIPTION	FEATURES	QUANTITIES
06-2903	Scalpel Handle	#3	1
06-2907	Scalpel Handle	#7	1
18-1050	Halsted Mosquito Forceps	Straight, 5"	2
18-1150	Halsted Mosquito Forceps	Curved, 5"	4
20-2070	Mayo-Hegar Needle Holder	7"	1
21-1260	TC Crile-Murray Needle Holder	Serrated, 6"	1
21-8013	TC Ryder Micro Needle Holder	Serrated, 6"	1
22-2652	Ragnell Dissecting Scissor	Curved, Flat Tip, 5"	1
22-2760	Reynolds Scissor	Curved, Narrow Tip, 6"	1
22-4150	Semken Dressing Forceps	Serrated, Narrow, 5"	2
22-4350	Semken Tissue Forceps	1x2 Teeth, Narrow, 5"	2
22-8360	Miller-Senn Retractor	Double End, Sharp, 6"	1
22-8460	Miller-Senn Retractor	Double End, Blunt, 6"	1
22-9027	Alm Retractor	4x4 Teeth, Blunt, 2¾"	1
23-1106	Sklarlite™ Operating Scissors	Straight, Sharp/Blunt, 5½"	2
23-1158	Sklarlite™ Strabismus Scissor	Straight, 4½"	1
23-1164	Sklarlite™ Mayo Dissecting Scissor	Straight, 5½"	1
23-1167	Sklarlite™ Mayo Dissecting Scissor	Curved, 6¾"	1
23-1280	Sklarlite™ Sklarcut Scissor	Curved, Blunt, 5¾"	1
23-2510	Sklarlite XD™ Crile Forceps	Straight, 5½"	12
23-2513	Sklarlite XD™ Crile Forceps	Curved, 5½"	12
47-1047	Wagner Scissors	Straight, Sharp/Sharp, 4¾"	2
47-1068	Wagner Scissor	Curved, Sharp/Blunt, 4¾"	1
47-1145	Iris Scissor	Straight, Sharp/Sharp, 4½"	1
47-1235	Iris Scissor	Curved, Sharp/Sharp, 3½"	1
47-1245	Iris Scissor	Curved, Sharp/Sharp, 4½"	1
47-1447	Adson Brown Forceps	9x9 Teeth, Side Grasping, 4¾"	2
47-2834	Jansen Retractor	3x3 Teeth, Sharp, 4"	1
47-2955	Backhaus Towel Clamp	5¼"	1
50-1372	Adson Forceps	Straight, 7¼"	3
50-1472	Adson Forceps	Curved, 7¼"	3
50-2012	Frazier Suction Tubes	12 French	2
50-3047	Adson Tissue Forceps	1x2 Teeth, 4¾"	1
50-3147	Adson Dressing Forceps	Serrated, 4¾"	1
55-2855	Gemini Clamps	Angled, Delicate, 5½"	2
57-1445	Crile Retractors	Double End, Small, 4½"	2
60-3598	Zalkind Ribbon Retractors	Malleable, ¾" x 7¾"	2
64-1242	Stevens Tenotomy Scissor	Straight, Blunt/Blunt, 4½"	1
64-1342	Stevens Tenotomy Scissor	Curved, Blunt/Blunt, 4½"	1
64-2242	Castroviejo Corneal Scissor	Curved Right, 4¼"	1
64-2342	Castroviejo Corneal Scissor	Curved Left, 4¼"	1
65-1532	Lancaster Eye Speculum	3¼"	1
65-1535	Castroviejo Speculum	3½"	1
65-1842	Desmarres Lid Retractor	14mm	1
65-6357	Castroviejo Needle Holder	Straight, Smooth, with Lock, 5½"	1
66-2740	Iris Forceps	Straight, Serrated, 4"	1
66-2940	Eye Dressing Forceps	Half Curve, Serrated, 4"	1
66-3340	Eye Tissue Forceps	Straight, 1x2 Teeth, 4"	1

# SURGICAL INSTRUMENT SETS

## OPHTHALMIC SETS



### 98-1034 BASIC EYE SURGERY SET (CONTINUED)

PRODUCT NUMBER	DESCRIPTION	FEATURES	QUANTITIES
66-3540	Eye Tissue Forceps	Half-Curve, 1x2 Teeth, 4"	1
66-5340	Arruga Capsule Forceps	Standard Curve, 4"	1

### 98-1094 CATARACT SURGERY SET

PRODUCT NUMBER	DESCRIPTION	FEATURES	QUANTITIES
06-2907	Scalpel Handle	#7	1
06-2910	Scalpel Handle	#3 With Metric Scale	1
21-8040	TC Castroviejo Needle Holder	Straight, Smooth, with Lock, 5½"	1
21-8043	TC Castroviejo Needle Holder	Curved with Lock, Delicate, 5½"	1
22-1241	Stevens Tenotomy Scissor	Curved, Delicate, Sharp/Sharp, 4½"	1
23-2505	Skarlite XD™ Halsted Mosquito Forceps	Straight, 5"	4
23-2506	Skarlite XD™ Halsted Mosquito Forceps	Curved, 5"	6
47-1135	Iris Scissor	Straight, Sharp/Sharp, 3½"	1
47-1235	Iris Scissor	Curved, Sharp/Sharp, 3½"	1
47-2935	Backhaus Towel Clamps	3½"	4
64-1735	Wilmer Scissor	Angled on Flat, 4"	1
64-1950	Vannas Scissor	Straight, Delicate, 3"	1
64-2242	Castroviejo Corneal Scissor	Curved Right, 4¼"	1
64-2342	Castroviejo Corneal Scissor	Curved Left, 4¼"	1
64-3050	Iris Micro-Miniature Scissor	Straight, Extra-Delicate, 4"	1
64-3142	Westcott Tenotomy Scissor	Right, Blunt, 5"	1
64-3280	Gradle Dissecting Scissor	Curved, Sharp, 3¾"	1
65-1528	Park-Maumenee Eye Speculum		1
65-1532	Lancaster Eye Speculum	3¼"	1
65-1535	Castroviejo Speculum	3½"	1
65-1842	Desmarres Lid Retractor	14mm	1
65-2960	Troutman Blade Breaker		1
65-3216	Graefe Strabismus Hooks	Medium	2
65-4062	Castroviejo Cyclodialysis Spatula	Double End, .5mm	1
65-6732	Castroviejo Caliper	3¼"	1
65-7635	Fox Aluminum Eye Shields		2
65-8216	Wilder Lens Scoop	Smooth	1
65-9085	Kirby Hook & Expressor	Double End, 10mm x 2mm Hooks, 5¾"	1
66-1036	Desmarres Chalazion Forceps	Medium, 3½"	1
66-1940	Graefe Fixation Forceps	Without Catch, 4mm, 4⅞"	1
66-2350	Elsching Fixation Forceps	Angled Up, 4¼"	1
66-2640	Castroviejo Fixation Forceps	1x2 Teeth, .3mm, 4"	1
66-2740	Iris Forceps	Straight, Serrated, 4"	1
66-2940	Eye Dressing Forceps	Half Curve, Serrated, 4"	1
66-3240	Eye Tissue Forceps	Straight, 1x2 Teeth, 4", Non-Magnetic	1
66-3340	Eye Tissue Forceps	Straight, 1x2 Teeth, 4"	1
66-5340	Arruga Capsule Forceps	Standard Curve, 4"	1
66-6105	Castroviejo Suture Forceps	Straight, .5mm, 4"	1
66-7261	Colibri Corneal Utility Forceps	1x2 Teeth, .4mm, 3"	1
97-1450	Scalpel Handle	#3K For Miniature Edge Blades	1

## SURGICAL INSTRUMENT SETS



## OPHTHALMIC

### 98-1031 CHALAZION SET

PRODUCT NUMBER	DESCRIPTION	FEATURES	QUANTITIES
06-2911	Scalpel Handle	#9	1
17-1335	Hartmann Mosquito Forceps	Curved, Serrated, 3½"	2
21-8040	TC Castroviejo Needle Holder	Straight, Smooth, with Lock, 5½"	1
47-1145	Iris Scissor	Straight, Sharp, 4½"	1
47-2935	Backhaus Towel Clamps	3½"	2
64-1342	Stevens Tenotomy Scissor	Curved, Blunt/Blunt, 4½"	1
64-1960	McPherson Vannas Scissor	Straight, 3"	1
64-3142	Westcott Tenotomy Scissor	Right, Blunt, 5"	1
64-3144	Westcott Tenotomy Scissor	Left, Blunt, 5"	1
65-1742	Barraq Wire Speculum	Large, Fenestrated Blades, 15mm	1
65-1840	Desmarres Lid Retractors	10mm	2
65-1843	Desmarres Lid Retractors	16mm	2
65-3170	Meyhoff Chalazion Curette	#0, 1.5mm	1
65-3171	Meyhoff Chalazion Curette	#1, 1.8mm	1
65-3172	Meyhoff Chalazion Curette	#2, 2.2mm	1
65-6358	Castroviejo Needle Holder	Curved, Smooth, with Lock, 5½"	1
66-1036	Desmarres Chalazion Forceps	Medium, 3 ½"	1
66-1137	Heath Chalazion Forceps	16mm, 3½"	1
66-1236	Lambert Chalazion Forceps	11mm, 3½"	1
66-2640	Castroviejo Fixation Forceps	1x2 Teeth, .3mm, 4"	1
66-4032	Bishop-Harmon Eye Forceps	Serrated, 3½"	1
66-4132	Bishop-Harmon Eye Forceps	1x2 Teeth, 3½"	1
66-6115	Castroviejo Suture Forceps	1x2 Teeth, .5mm, 4¼"	1
66-6900	Air Injection Cannula	27 Gauge	1
75-5460	Metzenbaum Scissor	Straight, 5¾"	1
97-1450	Scalpel Handle	#3K For Miniature Edge Blades	1

### 98-1033 ENUCLEATION SET

PRODUCT NUMBER	DESCRIPTION	FEATURES	QUANTITIES
17-1550	Halsted Mosquito Forceps	Curved, 5"	2
64-1150	Enucleation Scissor	Curved, 5"	1
64-1242	Stevens Tenotomy Scissor	Straight, Blunt/Blunt, 4½"	1
64-1342	Stevens Tenotomy Scissor	Curved, Blunt/Blunt, 4½"	1
65-1532	Lancaster Eye Speculum	3¼"	1
65-3195	Jamison Strabismus Hook	10mm, 5"	1
65-8151	Bunge Evisceration Spoon	Small	1
65-8155	Bunge Evisceration Spoon	Large	1
66-2742	Sklar LiteGrip™ Iris Forceps	Straight, Serrated, Fenestrated Handle, 4"	1

### 98-1035 EYE PREP SET

PRODUCT NUMBER	DESCRIPTION	FEATURES	QUANTITIES
10-1497	Emesis Basin	10oz.	1
10-1670	Iodine Cups	6oz., 37/16" x 2"	2
10-1675	Medicine Cups	2oz., Graduated Measure	2
10-1691	Mayo Tray	13 <sup>11</sup> / <sub>16</sub> " x 9 <sup>13</sup> / <sub>16</sub> " x ¾"	1
15-1567	Mayo Dissecting Scissor	Straight, 6¾"	1
74-1470	Ballenger Sponge Forceps	Straight, Serrated, 7"	2

# SURGICAL INSTRUMENT SETS

## ENT SETS



### 98-1091 BASIC NASAL SET

PRODUCT NUMBER	DESCRIPTION	FEATURES	QUANTITIES
06-2907	Scalpel Handle	#7	1
06-2910	Scalpel Handle	#3 With Metric Scale	1
07-1805	Yankauer Suction Tube	Stainless Steel	1
16-1605	Sklar Edge™ Mayo Dissecting Scissor	TC, Curved, 5½"	1
16-1905	Sklar Edge™ Metzenbaum Lahey Scissor	TC, Delicate, Curved, 5¾"	1
16-2105	Sklar Edge™ Metzenbaum Scissor	TC, Delicate, Curved, 7"	1
17-1450	Halsted Mosquito Forceps	Straight, 5"	6
21-8001	TC Halsey Needle Holder	Serrated, 5¼"	1
22-6157	Allis Tissue Forceps	4x5 Teeth, 5½"	2
41-1050	Joseph Scissor	Straight, 5¾"	1
41-1054	Joseph Scissor	Curved, 5¾"	1
41-1198	Sklar Black™ Cottle Septal Speculum	2"	1
41-1410	Aufricht Retractor	Solid Blade, 6½"	1
47-1058	Wagner Scissor	Curved, Sharp/Sharp, 4½"	1
47-2500	Joseph Hook	1 Sharp Prong, 6¼"	1
47-2502	Joseph Hook	2 Sharp Prongs, 2mm, 6¼"	1
47-2507	Joseph Hook	2 Sharp Prongs, 7mm, 6¼"	1
47-2935	Backhaus Towel Clamps	3½"	4
50-2007	Frazier Suction Tubes	7 French	2
50-3047	Adson Tissue Forceps	1x2 Teeth, 4¾"	2
60-1085	US Army Retractor	Set of 2, Double End, 8¼"	1
60-6162	Senn Retractors	Double End, Sharp, 6¼"	2
66-1940	Graefe Fixation Forceps	Without Catch, 4mm, 4½"	1
68-1765	Farrell Applicator	Twist End, 6½"	1
70-1030	Killian Nasal Speculum	Medium with Set Screw, 3"	1
70-1071	Vienna Nasal Speculum	Child Size	1
70-4470	Wilde Ear/Nasal Forceps	Serrated, Angled, 7"	1

**SURGICAL INSTRUMENT SETS**



**ENT SETS**

**98-1092 MAJOR NASAL SET (TO BE USED WITH BASIC NASAL SET)**

PRODUCT NUMBER	DESCRIPTION	FEATURES	QUANTITIES
06-2860	Ruler	Steel, 6"	1
16-1905	Sklar Edge™ Metzenbaum Lahey Scissor	TC, Delicate, Curved, 5¾"	1
16-2105	Sklar Edge™ Metzenbaum Scissor	TC, Delicate, Curved, 7"	1
21-8007	TC Crile-Wood Needle Holder	Serrated, 7"	1
40-5870	Sklar Mallet	With Replaceable Plastic Discs	1
40-9815	Maltz Rasp	Backward Cutting, 7"	1
40-9825	Joseph Rasp	Straight, Fine Cross Serrations, 6½"	1
40-9841	Aufricht Glabellar Rasp	Backward Cutting, 8"	1
41-1169	Cottle Dorsal Scissor	Angled, 6"	1
41-1198	Sklar Black™ Cottle Septal Speculum	2"	2
41-1235	Cottle Elevator	Centimeter Graduations, Double End, 9"	1
41-1240	Joseph Periosteal Elevator	6.5mm, 7"	1
41-1245	Joseph Periosteal Elevator	4.5mm, 6¼"	1
41-1255	Cottle Nasal Knife	4mm, 5½"	1
41-1340	Cottle Nasal Osteotome	Curved, 6½"	1
41-1370	Cinelli Osteotome	Guarded Both Sides Straight, 10mm, 6½"	1
41-1382	Cottle Knife Guard and Retractor	5mm Wide Slotted Hook, 8"	1
41-1383	Neivert Knife Guide and Retractor	Double End, 6½"	1
41-1385	Cottle Retractor	Two Recessed Center Prongs, 5½"	1
41-1396	Fomon Retractor	Double Ball Ends, 6¼"	1
41-1398	Converse Alar Retractor	Double End, 4½"	1
47-1135	Iris Scissor	Straight, Sharp/Sharp, 3½"	1
47-2380	Freer Elevator	Double End, Sharp/Blunt, 7¼"	1
47-2500	Joseph Hook	1 Sharp Prong, 6¼"	1
47-2505	Joseph Hooks	2 Sharp Prongs, 5mm, 6¼"	2
47-2570	Gilles Skin Hook	3mm, 7"	1
50-3147	Adson Dressing Forceps	Serrated, 4¾"	1
64-1442	Strabismus Scissor	Straight, Blunt/Blunt, 4½"	1
64-1542	Strabismus Scissor	Curved, Blunt/Blunt, 4½"	1
65-1841	Desmarres Lid Retractor	12mm	1
65-6732	Castroviejo Caliper	3¼"	1
66-1040	Cottle Columella Forceps	4½"	1
67-1050	Hartmann Alligator Ear Forceps	Serrated	1
67-1465	Jansen Bayonet Forceps	6½"	1
67-4622	Sheehan Osteotome	Straight, 4mm, 6¼"	1
67-4626	Sheehan Osteotome	Straight, 8mm, 6¼"	1
67-4628	Sheehan Osteotome	Straight, 10mm, 6¼"	1
67-4630	Sheehan Osteotome	Straight, 12mm, 6¼"	1
70-1030	Killian Nasal Speculum	Medium with Set Screw, 3"	1
70-4352	Fomon Nasal Scissor	Curved, 5¼"	1
70-5190	Ash Septum Straightening Forceps	9"	1
70-7504	Ballenger Swivel Knife	Straight, 4mm, 7¾"	1
70-7805	Joseph Bone Saw	Straight, 7½"	1
74-3075	Schmidt Tonsil Forceps	Half Curved Jaws, 7½"	2
97-1505	TC Maltz Rasp	Single End, Fine Serrations	1
97-1506	TC Maltz Rasp	Single End, Medium Serrations	1

# SURGICAL INSTRUMENT SETS

## ENT SETS



### 98-1472 ENT SET

PRODUCT NUMBER	DESCRIPTION	FEATURES	QUANTITIES
47-1145	Iris Scissor	Straight, Sharp/Sharp, 4½"	1
47-1245	Iris Scissor	Curved, Sharp/Sharp, 4½"	1
50-1953	Baron Suction Tube	3 French	1
50-1955	Baron Suction Tube	5 French	1
50-1957	Baron Suction Tube	7 French	1
64-1442	Strabismus Scissor	Straight, Blunt/Blunt, 4½"	1
64-1542	Strabismus Scissor	Curved, Blunt/Blunt, 4½"	1
67-1020	Hartmann Ear Forceps	2.5mm Round Cup, 3½"	1
67-1038	Hartmann Ear Forceps	Alligator Type, 5½"	1
67-1150	Wilde Ear Dressing Forceps	Angled, Serrated, 5"	1
67-1455	Lucae Bayonet Forceps	5 ½"	1
67-2490	Buck Ear Curette	Size 0, Straight, Blunt	1
67-2491	Buck Ear Curette	Size 1, Straight, Blunt	1
67-2492	Buck Ear Curette	Size 2, Straight, Blunt	1
67-2515	Buck Ear Curette	Size 0, Straight, Sharp	1
67-2516	Buck Ear Curette	Size 1, Straight, Sharp	1
67-2517	Buck Ear Curette	Size 2, Straight, Sharp	1
67-2521	Billeau Ear Loop	Small, 6½"	1
67-2522	Billeau Ear Loop	Medium, 6½"	1
67-2523	Billeau Ear Loop	Large, 6½"	1
67-2525	Shapleigh Ear Curette	Small, Straight, 5¼"	1
67-2526	Shapleigh Ear Curette	Medium, Straight, 5¼"	1
67-2550	Day Ear Hook	Small, 6½"	1
67-2552	Day Ear Hook	Large, 6½"	1
67-8040	Micro Alligator Ear Forceps	Cup Type, Straight, 4mm	1
67-8170	Micro Alligator Ear Forceps	Serrated, Straight, 0.6mm	1
67-8174	Micro Alligator Ear Forceps	Serrated, Straight, 0.8mm	1
70-1070	Vienna Nasal Speculum	Small	1
70-1071	Vienna Nasal Speculum	Medium	1
70-1072	Vienna Nasal Speculum	Large	1
70-5332	Noyes Alligator Ear Forceps	Serrated, 3½"	1

### 98-1093 BASIC EAR SET

PRODUCT NUMBER	DESCRIPTION	FEATURES	QUANTITIES
06-2910	Scalpel Handle	#3 With Metric Scale	1
16-1605	Sklar Edge™ Mayo Dissecting Scissor	TC, Curved, 5½"	1
16-1905	Sklar Edge™ Metzenbaum Lahey Scissor	TC, Delicate, Curved, 5¾"	1
16-2105	Sklar Edge™ Metzenbaum Scissor	TC, Delicate, Curved, 7"	1
17-1450	Halsted Mosquito Forceps	Straight, 5"	6
17-2055	Kelly Forceps	Straight, 5½"	2
21-8001	TC Halsey Needle Holder	Serrated, 5¼"	1
24-2342	Suture Wire Cutting Scissor	Angled, Serrated, 4¾"	1
36-2160	Allis Tissue Forceps	4x5 Teeth, 6"	2
42-1824	Wullstein Endaural Retractor	3x3 Teeth, Sharp, 5"	1
47-2380	Freer Elevator	Double End, Sharp/Blunt, 7¼"	1
47-2500	Joseph Hooks	1 Sharp Prong, 6¼"	2
47-2832	Jansen Retractor	3x3 Teeth, Blunt, 4"	1
47-2935	Backhaus Towel Clamps	3½"	4
50-2007	Frazier Suction Tube	7 French	1

## SURGICAL INSTRUMENT SETS



## ENT SETS

## 98-1093 BASIC EAR SET (CONTINUED)

PRODUCT NUMBER	DESCRIPTION	FEATURES	QUANTITIES
50-2009	Frazier Suction Tube	9 French	1
50-3047	Adson Tissue Forceps	1x2 Teeth, 4¾"	1
50-3147	Adson Dressing Forceps	Serrated, 4¾"	1
60-1891	Langenbeck Retractor	Small, ¾" x 1½" Blade, 9"	1
60-1892	Langenbeck Retractor	Medium, ½" x 1¼" Blade, 9"	1
60-6162	Senn Retractors	Double End, Sharp, 3 Prongs, 6¼"	2
60-6320	Allport Retractor	4x4 Teeth, Sharp, 4"	1
64-1542	Strabismus Scissor	Curved, Blunt/Blunt, 4½"	1
66-1940	Graefe Fixation Forceps	Without Catch, 4mm, 4½"	1
67-1465	Jansen Bayonet Forceps	6½"	1
67-2514	Buck Ear Curette	#00, Straight, Sharp	1
67-2516	Buck Ear Curette	#1, Straight, Sharp	1
67-6011	Boucheron Ear Speculum	5mm, Chrome	1
67-6012	Boucheron Ear Speculum	6mm, Chrome	1
67-6013	Boucheron Ear Speculum	7mm, Chrome	1
67-6014	Boucheron Ear Speculum	8mm, Chrome	1

## 98-1475 MIDDLE EAR SET

PRODUCT NUMBER	DESCRIPTION	FEATURES	QUANTITIES
06-2903	Scalpel Handle	#3	2
15-2567	Mayo Dissecting Scissor	Curved, 6¾"	1
16-1905	Sklar Edge™ Metzenbaum Lahey Scissor	TC, Curved, Delicate, 5¾"	1
16-2105	Sklar Edge™ Metzenbaum Scissor	TC, Curved, Delicate, 7"	1
17-1450	Halsted Mosquito Forceps	Straight, 5"	6
17-2055	Kelly Forceps	Straight, 5½"	2
21-2240	TC Webster Needle Holder	Smooth, 4¼"	1
21-8001	TC Halsey Needle Holder	Serrated, 5¼"	1
24-2342	Suture Wire Cutting Scissor	Angled, 4¾"	1
36-2160	Allis Tissue Forceps	4x5 Teeth, 6"	1
47-2380	Freer Elevator	Double End, Sharp/Blunt, 7¼"	1
47-2500	Joseph Hooks	1 Sharp Prong, 6¼"	2
47-2507	Joseph Hook	2 Sharp Prongs, 7mm, 6¼"	1
47-2832	Jansen Retractor	3x3 Teeth, Blunt, 4"	1
47-2935	Backhaus Towel Clamps	3½"	8
50-1953	Baron Suction Tube	3 French	1
50-1955	Baron Suction Tube	5 French	1
50-1957	Baron Suction Tube	7 French	1
50-2008	Frazier Suction Tube	8 French	1
50-2010	Frazier Suction Tube	10 French	1
50-3047	Adson Tissue Forceps	1x2 Teeth, 4¾"	1
60-1891	Langenbeck Retractor	Small, ¾" x 1½" Blade, 9"	1
60-1893	Langenbeck Retractor	Large, ⅝" x 1¼" Blade, 9"	1
60-6162	Senn Retractor	Double-End, Sharp, 3 Prongs, 6¼"	1
64-1442	Strabismus Scissor	Straight, Blunt/Blunt, 4½"	1
64-1542	Strabismus Scissor	Curved, Blunt/Blunt, 4½"	1
65-3221	Rosen Knife	2mm	1
65-3223	Rosen Pick	Curved, 6¼"	1
66-1940	Graefe Fixation Forceps	Without Catch, 4mm, 4½"	1



# SURGICAL INSTRUMENT SETS

## ENT SETS



### 98-1475 MIDDLE EAR SET (CONTINUED)

PRODUCT NUMBER	DESCRIPTION	FEATURES	QUANTITIES
67-1455	Lucae Bayonet Forceps	5½"	1
67-2450	House Curette	Double-End, Curved, 1.0/1.2mm Tips	1
67-2451	House Curette	Double-End, Curved, 1.5/1.8mm Tips	1
67-2452	House Curette	Double-End, Sharp Curve, 1.0/1.2mm Tips	1
67-2453	House Curette	Double-End, Sharp Curve, 1.5/1.8mm Tips	1
67-2499	Buck Ear Curette	Size 00, Angled, Sharp, 6½"	1
67-2501	Buck Ear Curette	Size 1, Angled, Sharp, 6½"	1
67-2521	Billeau Ear Loop	Small, 6½"	1
67-2522	Billeau Ear Loop	Medium, 6½"	1
67-2523	Billeau Ear Loop	Large, 6½"	1
67-6043	Farrior Ear Speculum	Size 1	1
67-6045	Farrior Ear Speculum	Size 3	1
67-6047	Farrior Ear Speculum	Size 5	1
67-6049	Farrior Ear Speculum	Size 7	1
67-8004	Micro Alligator Ear Forceps	Straight, Smooth, 4mm	1
67-8007	Micro Alligator Ear Forceps	Curved Up, Serrated, 4mm	1
67-8170	Micro Alligator Ear Forceps	Serrated, Straight, 0.6mm	1
67-8187	Bellucci Ear Scissor	Straight, 4mm, 3"	1
67-8189	Bellucci Ear Scissor	Curved Right, 4mm, 3"	1
67-8191	Bellucci Ear Scissor	Curved Left, 4mm, 3"	1
70-5150	Dieter Ear Forceps	Up Bite, 1.3mm, 3"	1
70-7058	Wullstein Sickle Knife	6"	1

### 98-1036 TONSIL SET

PRODUCT NUMBER	DESCRIPTION	FEATURES	QUANTITIES
06-2907	Scalpel Handle	#7	1
07-1805	Yankauer Suction Tube	Stainless Steel	1
15-2567	Mayo Dissecting Scissor	Curved, 6¾"	1
17-2262	Rochester-Pean Forceps	Curved, 6¼"	2
20-1270	Crile-Wood Needle Holder	7"	1
36-2275	Allis Tissue Forceps	5x6 Teeth, 7½"	1
47-2955	Backhaus Towel Clamp	5¼"	1
74-2575	White Tonsil Forceps	Curved, 7½"	2
74-3075	Schmidt Tonsil Forceps	Half Curved Jaws, 7½"	2
75-1015	Jennings Mouth Gag	Small, 3½"	1
75-1016	Jennings Mouth Gag	Medium, 4¼"	1
75-1017	Jennings Mouth Gag	Large, 5"	1
75-2160	Wieder Tongue Depressor	Small	1
75-2161	Wieder Tongue Depressor	Large	1
75-2320	Love Uvula Retractor	20mm Wide	1
75-5570	Metzenbaum Scissor	Straight, 7"	1
75-6387	Hurd Dissector and Pillar Retractor	8¾"	1
75-9070	Eves Tonsil Snare	Plain	1
75-9250	Tyding Tonsil Snare	Includes 1 Straight Tip, 1 doz wires	1
75-9612	Hartman Tonsil Punch	Size 2, 5½"	1
87-2195	Foerster Sponge Forceps	Straight, Serrated, 9½"	1

# SURGICAL INSTRUMENT SETS



## ORTHOPEDIC SETS

### 98-1006 BASIC ORTHOPEDIC SURGERY SET

PRODUCT NUMBER	DESCRIPTION	FEATURES	QUANTITIES
06-2860	Ruler	Steel, 6"	1
06-2903	Scalpel Handle	#3	1
06-2904	Scalpel Handle	#4	1
11-1060	Lister Bandage Scissor	One Large Ring, 8"	1
13-1055	Operating Scissor	Straight, Sharp/Sharp, 5½"	1
14-1055	Operating Scissors	Straight, Sharp/Blunt, 5½"	2
14-2055	Operating Scissor	Curved, Sharp/Blunt, 5½"	1
15-1355	Littauer Stitch Scissor	5½"	1
15-1567	Mayo Dissecting Scissor	Straight, 6¾"	1
15-2567	Mayo Dissecting Scissors	Curved, 6¾"	2
16-2800	TC Wire Cutting Scissor	Angled, 4¾"	1
17-1772	Mixer Forceps	Right Angle, 7¼"	4
17-2055	Kelly Forceps	Straight, 5½"	12
17-2155	Kelly Forceps	Curved, 5½"	12
17-2272	Rochester-Pean Forceps	Curved, 7¼"	3
17-2472	Rochester-Pean Forceps	Straight, 7¼"	3
19-1055	Dressing Forceps	Serrated, 5½"	2
19-1080	Dressing Forceps	Serrated, 8"	2
19-1255	Tissue Forceps	1x2 Teeth, 5½"	2
19-1280	Tissue Forceps	1x2 Teeth, 8"	2
21-8032	TC Mayo-Hegar Needle Holder	Serrated, 7"	1
21-8033	TC Mayo-Hegar Needle Holder	Serrated, 8"	1
36-2160	Allis Tissue Forceps	4x5 Teeth, 6"	2
36-2275	Allis Tissue Forceps	5x6 Teeth, 7½"	2
40-1775	Needle Nose Plier	5½"	1
40-2275	Bone/Cartilage Clamp	Curved, 8"	1
40-2480	Kern Bone Forceps	Without Ratchet, Extra-Small, 5¾"	1
40-2485	Kern Bone Forceps	Without Ratchet, 8½"	1
40-2670	Lewin Bone Forceps	Serrated, 7"	1
40-2922	Lowman Clamp	1x2 Prongs, 7¼" x 1½" Jaw	1
40-2925	Lowman Clamp	1x1 Prongs, 4¾" x ¾" Jaw	1
40-3177	Liston Bone Forceps	Angled, 7¾"	1
40-3710	Stille-Liston Bone Forceps	Straight, 10½"	1
40-4270	Beyer Rongeur	Curved on Flat, 7"	1
40-4272	Ruskin Rongeur	Straight, 7¼"	1
40-5780	Hajek Bone Mallet	8"	1
40-6667	Hibbs Osteotome	10mm, 9½"	1
40-6668	Hibbs Osteotome	13mm, 9½"	1
40-6711	Hibbs Chisel	10mm, 9½"	1
40-6715	Hibbs Chisel	13mm, 9½"	1
40-7400	Key Elevator	¼" x 7½"	1
40-7402	Key Elevator	½" x 7½"	1
40-9365	Sayre Elevator	Double End, Blunt, 6½"	1
42-1765	Weitlaner-Beckman Retractor	3x4 Prong, Sharp, 6"	1
42-1965	Weitlaner Retractor	3x4 Prong, Sharp, 6½"	1
47-2935	Backhaus Towel Clamps	3½"	4
47-2955	Backhaus Towel Clamps	5¼"	12
50-2008	Frazier Suction Tube	8 French	1
50-2010	Frazier Suction Tube	10 French	1

# SURGICAL INSTRUMENT SETS

## ORTHOPEDIC SETS



### 98-1006 BASIC ORTHOPEDIC SURGERY SET (CONTINUED)

PRODUCT NUMBER	DESCRIPTION	FEATURES	QUANTITIES
50-2012	Frazier Suction Tube	12 French	1
55-7175	Hibbs Retractors	2" x 5/8" Blade, 9"	2
60-6162	Senn Retractors	Double End, Sharp, 3 Prongs, 6 1/4"	2
60-6164	Senn Retractors	Double End, Blunt, 3 Prongs, 6 1/4"	2
75-5670	Metzenbaum Scissor	Curved, 7"	1

### 98-1011 BASIC TOTAL HIP SET

PRODUCT NUMBER	DESCRIPTION	FEATURES	QUANTITIES
06-2860	Ruler	Steel, 6"	1
06-2904	Scalpel Handles	#4	2
06-2907	Scalpel Handle	#7, 6 1/2"	1
07-1805	Yankauer Suction Tubes	Stainless Steel	3
15-1567	Mayo Dissecting Scissors	Straight, 6 3/4"	2
15-2567	Mayo Dissecting Scissor	Curved, 6 3/4"	1
17-1450	Halsted Mosquito Forceps	Straight, 5"	6
17-2280	Rochester-Pean Forceps	Curved, 8"	2
17-2880	Rochester-Ochsner Forceps	Straight, 1x2 Teeth, 8"	2
17-3162	Crile Forceps	Curved, 6 1/4"	6
19-1255	Tissue Forceps	1x2 Teeth, 5 1/2"	2
19-1655	Tissue Forceps	3x4 Teeth, 5 1/2"	2
19-2280	Russian Tissue Forceps	8"	2
20-1270	Crile-Wood Needle Holders	7"	2
20-2480	Mayo-Hegar Needle Holders	Serrated, 8"	2
36-2275	Allis Tissue Forceps	5x6 Teeth, 7 1/2"	2
40-3188	Beyer Rongeur	Curved, 7"	1
40-3985	Stille-Luer Rongeur	Straight, 8 1/2", Double Action	1
40-4085	Stille-Luer Rongeur	Curved, 8 1/2", Double Action	1
40-5765	Gerzog Bone Mallet	7 1/2"	1
40-6666	Hibbs Osteotome	6mm, 9 1/2"	1
40-6667	Hibbs Osteotome	10mm, 9 1/2"	1
40-6668	Hibbs Osteotome	13mm, 9 1/2"	1
40-6855	Bone Hook	Large "T" Handle	1
40-7451	Mini Hohmann Bone Elevator	8mm, 6 1/2"	1
40-7453	Hohmann Bone Elevator	43mm, 9 1/2"	1
40-7455	Hohmann Bone Elevator	20mm, 10"	1
40-9712	Putti Bone Rasp	Flat End/Conic End, 12"	1
42-1965	Weitlaner Retractors	3x4 Prongs, Sharp, 6 1/2"	2
47-2935	Backhaus Towel Clamps	3 1/2"	6
47-2955	Backhaus Towel Clamps	5 1/4"	2
50-1472	Adson Forceps	Curved, 7 1/4"	4
55-7175	Hibbs Retractors	2" x 5/8" Blade, 9"	2
55-9080	Metzenbaum-Nelson Scissor	Curved, 8"	1
60-1699	Richardson-Eastman Retractor	Double End, Small, 9 1/2"	1
60-5604	Volkman Retractors	4 Prongs, Sharp, 8 1/2"	2
60-5606	Volkman Retractors	6 Prongs, Sharp, 8 1/2"	2
60-6570	Gelpi Retractor	7"	1
75-5670	Metzenbaum Scissor	Curved, 7"	1
87-2195	Foerster Sponge Forceps	Straight, Serrated, 9 1/2"	2
90-1690	Mayo Dissecting Scissor	Curved, 9"	1
98-2047	Micro Adson Forceps	1x2 Teeth, 4 3/4"	2

## SURGICAL INSTRUMENT SETS



## ORTHOPEDIC SETS

## 98-1013 KNEE SET

PRODUCT NUMBER	DESCRIPTION	FEATURES	QUANTITIES
06-2903	Scalpel Handles	#3	2
06-2904	Scalpel Handle	#4	1
06-2907	Scalpel Handle	#7	1
11-1055	Lister Bandage Scissor	5½"	1
15-1567	Mayo Dissecting Scissors	Straight, 6¾"	2
15-2567	Mayo Dissecting Scissor	Curved, 6¾"	1
17-2655	Rochester-Ochsner Forceps	Curved, 1x2 Teeth, 5½"	2
17-2662	Rochester-Ochsner Forceps	Curved, 1x2 Teeth, 6¼"	4
17-3055	Crile Forceps	Straight, 5½"	4
17-3162	Crile Forceps	Curved, 6¼"	4
19-1255	Tissue Forceps	1x2 Teeth, 5½"	2
19-1655	Tissue Forceps	3x4 Teeth, 5½"	2
20-1270	Crile-Wood Needle Holders	7"	2
22-8255	Weitlaner Retractors	3x4 Teeth, Sharp, 5½"	2
36-2060	Allis Tissue Forceps	3x4 Teeth, 6"	4
40-2275	Bone/Cartilage Clamp	Curved, 8"	1
40-2290	Smillie Meniscus Hook	5¾"	1
40-2660	Dingman Bone/Cartilage Clamp	Small, 2x2 Teeth, 7½"	1
40-7400	Key Elevator	¼" x 7½"	1
40-7402	Key Elevator	½" x 7½"	1
40-8250	Blount Knee Retractors	7"	2
40-8272	Adson Elevator	Round 6¾"	1
40-9685	Bone File	Bayonet Handle, 8½"	1
41-1120	Martin Scissor	Curved, Serrated, Heavy, 8"	1
47-2380	Freer Elevator	Double-Ended, Sharp/Blunt, 7¼"	1
47-2955	Backhaus Towel Clamps	5¼"	6
47-3415	Downing Cartilage Knife	10"	1
47-3420	Smillie Cartilage Knife	Straight, 6¾"	1
47-3422	Smillie Cartilage Knife	Left, 6¾"	1
47-3424	Smillie Cartilage Knife	Right, 6¾"	1
50-2008	Frazier Suction Tube	8 French	1
60-1085	US Army Retractor	Set of 2, Double End, 8¼"	1
60-5602	Volkman Retractors	2 Prong, Sharp, 8½"	2
60-5604	Volkman Retractors	4 Prong, Sharp, 8½"	2
60-6164	Senn Retractors	Double End, Blunt, 3 Prongs, 6¼"	2
75-5670	Metzenbaum Scissor	Curved, 7"	1
98-2047	Micro Adson Forceps	1x2 Teeth, 4¾"	2

**SURGICAL INSTRUMENT SETS**  
**ORTHOPEDIC SETS**



**98-1032 LAMINECTOMY SET**

PRODUCT NUMBER	DESCRIPTION	FEATURES	QUANTITIES
06-2903	Scalpel Handle	#3	1
06-2904	Scalpel Handle	#4	1
06-2907	Scalpel Handle	#7	1
14-1055	Operating Scissor	Straight, Sharp/Blunt, 5½"	1
14-2055	Operating Scissor	Curved, Sharp/Blunt, 5½"	1
15-1567	Mayo Dissecting Scissor	Straight, 6¾"	1
15-2567	Mayo Dissecting Scissor	Curved, 6¾"	1
17-1450	Halsted Mosquito Forceps	Straight, 5"	12
17-1550	Halsted Mosquito Forceps	Curved, 5"	12
17-3062	Crile Forceps	Straight, 6¼"	12
17-3162	Crile Forceps	Curved, 6¼"	12
19-1055	Dressing Forceps	Serrated, 5½"	1
19-1080	Dressing Forceps	Serrated, 8"	2
19-1255	Tissue Forceps	1x2 Teeth, 5½"	1
19-1280	Tissue Forceps	1x2 Teeth, 8"	2
22-6770	Cushing Forceps	Serrated, Delicate, 7"	1
22-6870	Cushing Forceps	1x2 Teeth, Delicate, 7"	1
36-2260	Allis Tissue Forceps	5x6 Teeth, 6"	4
40-3670	Luer Bone Forceps	Curved, 7"	1
40-3710	Stille-Liston Bone Forceps	Straight, 10½"	1
40-3910	Stille-Horsley Rongeur	Double Action, Angled, 10½"	1
40-3985	Stille Luer Rongeur	Double Action, Straight, 8½"	1
40-4090	Stille Luer Rongeur	Double Action, Angled, 8½"	1
40-4092	Leksell Rongeur	Double Action, Curved, 8mm x 16mm, 9"	1
40-7000	Bruns Bone Curette	#000, Oval, 6¾"	1
40-7100	Bruns Bone Curette	#00, Oval, 6¾"	1
40-7110	Bruns Bone Curette	#0, Oval, 6¾"	1
40-7111	Bruns Bone Curette	#1, Oval, 6¾"	1
40-7112	Bruns Bone Curette	#2, Oval, 6¾"	1
40-7113	Bruns Bone Curette	#3, Oval, 6¾"	1
40-7114	Bruns Bone Curette	#4, Oval, 6¾"	1
40-7115	Bruns Bone Curette	#5, Oval, 6¾"	1
40-7116	Bruns Bone Curette	#6, Oval, 6¾"	1
42-1975	Weitlaner Retractors	3x4 Teeth, Sharp, 8"	2
42-3150	Love-Gruenwald Rongeur	Straight, 3mm x 10mm, 5"	1
42-3156	Love-Gruenwald Rongeur	Straight, 3mm x 10mm, 7"	1
42-3158	Love-Gruenwald Rongeur	Up-Bite, 3mm x 10mm, 7"	1
42-3160	Love-Gruenwald Rongeur	Down-Bite, 3mm x 10mm, 7"	1
42-3418	Love-Kerrison Rongeur	Up-Bite, 5mm, 6"	1
42-3429	Love-Kerrison Rongeur	Down-Bite, 5mm, 6"	1
47-2955	Backhaus Towel Clamps	5¼"	12
50-3371	Adson Bayonet Forceps	Serrated, 7½"	1
57-1322	Beckman-Adson Retractors	Sharp, 12½"	2
75-5570	Metzenbaum Scissor	Straight, 7"	1
87-2195	Foerster Sponge Forceps	Straight, Serrated, 9½"	6

# SURGICAL INSTRUMENT SETS



## ORTHOPEDIC SETS

### 98-1017 AMPUTATION SET

PRODUCT NUMBER	DESCRIPTION	FEATURES	QUANTITIES
06-2903	Scalpel Handles	#3	2
06-2904	Scalpel Handle	#4	1
16-1510	Sklar Edge™ Mayo Dissecting Scissor	TC, Straight, 6¾"	1
16-1610	Sklar Edge™ Mayo Dissecting Scissor	TC, Curved, 6¾"	1
16-2110	Sklar Edge™ Metzenbaum Scissor	TC, Curved, 7"	1
17-2262	Rochester-Pean Forceps	Curved, 6¼"	6
17-2280	Rochester-Pean Forceps	Curved, 8"	2
17-2862	Rochester-Ochsner Forceps	Straight, 1x2 Teeth, 6¼"	4
17-2880	Rochester-Ochsner Forceps	Straight, 1x2 Teeth, 8"	2
17-3155	Crile Forceps	Curved, 5½"	12
19-1060	Dressing Forceps	Serrated, 6"	2
19-1260	Tissue Forceps	1x2 Teeth, 6"	1
21-8001	TC Halsey Needle Holder	Serrated, 5¼"	1
21-8031	TC Mayo-Hegar Needle Holders	Serrated, 6"	2
21-8032	TC Mayo-Hegar Needle Holders	Serrated, 7"	2
36-2260	Allis Tissue Forceps	5x6 Teeth, 6"	4
40-3055	Liston Bone Forceps	Straight, 5½"	1
40-3077	Liston Bone Forceps	Straight, 7¾"	1
40-3810	Stille-Liston Bone Forceps	Curved, 10½"	1
40-4085	Stille Luer Rongeur	Double Action, Curved, 8½"	1
40-4092	Leksell Rongeur	Double Action, Curved, 8mm x 16mm, 9"	1
40-4095	Leksell Rongeur	Double Action, Curved, 3mm x 16mm, 9"	1
40-4268	Beyer Rongeur	Double Action, Curved, 3mm x 14mm, 7"	1
40-5520	Gigli Saw Handles	Solid Bar, Set of 2	1
40-5551	Percy Amputation Retractor		1
40-6857	Bone Hook	Medium, 8mm x 25mm, 9"	1
40-7402	Key Elevator	½" x 7½"	1
40-7404	Key Elevator	¾" x 7½"	1
40-7406	Key Elevator	1" x 7½"	1
40-9812	Putti Bone Rasp	Straight & Curved, 10¾"	1
47-2500	Joseph Hooks	1 Sharp Prong, 6¼"	2
47-2955	Backhaus Towel Clamps	5¼"	4
50-3047	Adson Tissue Forceps	1x2 Teeth, 4¾"	2
60-1085	US Army Retractor	Set of 2, Double End, 8¼"	1
60-5826	Volkman Retractors	Ring Handle, Sharp, 6 Prongs, 8½"	2
60-6162	Senn Retractors	Double-End, Sharp, 3 Prongs, 6¼"	2
87-2195	Foerster Sponge Forceps	Straight, Serrated, 9½"	2

**98-1453 MAJOR PLASTIC SURGERY SET**

PRODUCT NUMBER	DESCRIPTION	FEATURES	QUANTITIES
06-2903	Scalpel Handles	#3	2
06-2907	Scalpel Handle	#7	1
10-2010	Weinstein Instrument Holder	10"	1
15-3565	Supercut Sklarhone™ Mayo Scissor	Curved, 6¾"	1
15-3570	Supercut Sklarhone™ Lahey Scissor	Curved, 5¾"	1
15-3585	Sklarcut™ Iris Scissor	Straight, Sharp/Sharp, 4½"	1
15-3590	Sklarcut™ Iris Scissor	Curved, Sharp/Sharp, 4½"	1
16-1510	Sklar Edge™ Mayo Dissecting Scissor	TC, Straight, 6¾"	1
16-1905	Sklar Edge™ Metzenbaum Lahey Scissor	TC, Delicate, Curved, 5¾"	1
16-2105	Sklar Edge™ Metzenbaum Scissor	TC, Curved, Delicate, 7"	1
17-1225	Micro Mosquito Forceps	Curved, Delicate, 4¾"	20
17-1450	Halsted Mosquito Forceps	Straight, 5"	4
17-2262	Rochester-Pean Forceps	Curved, 6¼"	4
17-2862	Rochester-Ochsner Forceps	Straight, 1x2 Teeth, 6¼"	4
17-3055	Crile Forceps	Straight, 5½"	4
17-3155	Crile Forceps	Curved, 5½"	20
19-1060	Dressing Forceps	Serrated, 6"	2
19-1260	Tissue Forceps	1x2 Teeth, 6"	2
21-8000	TC Halsey Needle Holders	Smooth, 5¼"	2
21-8002	TC Webster Needle Holders	Smooth, 5¼"	2
21-8031	TC Mayo-Hegar Needle Holders	Serrated, 6"	2
21-8032	TC Mayo-Hegar Needle Holders	Serrated, 7"	2
22-8255	Weitlaner Retractor	2x3 Teeth, Sharp, 4½"	1
23-2521	Sklarlite XD™ Mixer Forceps	Right Angle, 5½"	2
30-1060	Director & Tongue Tie	6"	1
30-1960	Probe	With Eye, 6"	1
36-2260	Allis Tissue Forceps	5x6 Teeth, 6"	4
47-1447	Adson Brown Forceps	9x9 Teeth Side Grasping, 4¾"	2
47-2382	Freer Elevator	Double-Ended, Sharp/Blunt, 7¾"	1
47-2502	Joseph Hooks	2 Prong, Sharp, 2mm, 6¼"	2
47-2572	Gillies Skin Hooks	4mm, 7"	2
47-2655	Blair-Rollet Retractors	4 Prong, Sharp, Delicate, 5½"	2
47-2852	Lorna-Edna Towel Clamps	5½"	4
50-1290	Cushing Vein Retractors	9"	2
50-1472	Adson Forceps	Curved, 7½"	2
50-3047	Adson Tissue Forceps	1x2 Teeth, 4¾"	2
51-3447	TC Adson Dressing Forceps	Serrated, 4¾"	2
52-5177	DeBakey Atraumatic Tissue Forceps	2mm, 7¾"	2
60-1676	Richardson Retractors	SklarGrip Handle, Small, 9½", ¾" x 1"	2
60-1681	Richardson Retractors	SklarGrip Handle, Medium, 9½", 1" x 1¼"	2
60-5604	Volkman Retractors	4 Prong, Sharp, 8½"	2
60-6162	Senn Retractors	Double-End, Sharp, 3 Prongs, 6¼"	2
64-1242	Stevens Tenotomy Scissor	Straight, Blunt/Blunt, 4½"	1
64-1342	Stevens Tenotomy Scissor	Curved, Blunt/Blunt, 4½"	1
65-1842	Desmarres Lid Retractors	14mm	2
87-2195	Foerster Sponge Forceps	Straight, Serrated, 9½"	4

## SURGICAL INSTRUMENT SETS



### PLASTIC SURGERY SETS

#### 98-1030 BASIC PLASTIC SURGERY SET

PRODUCT NUMBER	DESCRIPTION	FEATURES	QUANTITIES
21-8000	TC Halsey Needle Holder	Smooth, 5¼"	1
22-2652	Ragnell Dissecting Scissor	Curved, Flat Tips, 5"	1
22-4150	Semken Dressing Forceps	Serrated, Narrow, 5"	1
22-4350	Semken Tissue Forceps	1x2 Teeth, Narrow, 5"	1
22-9027	Alm Retractor	4x4 Teeth, Blunt, 2¾"	1
47-1145	Iris Scissor	Straight, Sharp/Sharp, 4½"	1
47-1245	Iris Scissor	Curved, Sharp/Sharp, 4½"	1
50-1953	Baron Suction Tube	3 French	1
50-1955	Baron Suction Tube	5 French	1
50-2007	Frazier Suction Tube	7 French	1
50-3047	Adson Tissue Forceps	1x2 Teeth, 4¾"	1
50-3147	Adson Dressing Forceps	Serrated, 4¾"	1
65-6357	Castroviejo Needle Holder	Straight, Smooth with Lock, 5½"	1

#### 98-1440 ABDOMINOPLASTY (TUMMY TUCK) SET

PRODUCT NUMBER	DESCRIPTION	FEATURES	QUANTITIES
06-2860	Ruler	Steel, 6"	1
06-2903	Scalpel Handle	#3	1
15-1342	Sklarhone™ Stevens Tenotomy Scissor	Supercut, Curved, Delicate, 4½"	1
15-1567	Mayo Dissecting Scissor	Straight, 6¾"	1
15-3406	Sklarhone™ Metzenbaum Scissor	Supercut, Curved, Serrated, 5¾"	1
15-3451	Sklarhone™ Gorney-Freeman Dissecting Scissor	Supercut, Curved, 9"	1
16-2405	TC Iris Scissor	Straight, 4½"	1
17-1550	Halsted Mosquito Forceps	Curved, 5"	4
17-3562	Lahey Traction Forceps	6¼"	3
19-1260	Tissue Forcep	1x2 Teeth, 6"	1
21-8002	TC Webster Needle Holder	Smooth, 5¼"	1
21-8031	TC Mayo-Hegar Needle Holders	Serrated, 6"	2
36-2260	Allis Tissue Forceps	5x6 Teeth, 6"	2
36-3610	Lockwood Abdominal Demarcator		1
42-2095	Meyerding Retractors	Large, 2" x 3½" Blade, 9½"	2
47-1447	Adson Brown Forceps	9x9 Teeth Side Grasping, 4¾"	1
47-2510	Joseph Hooks	2 Prongs, Sharp, 10mm, 6½"	2
50-3048	Adson Tissue Forceps	1x2 Teeth, Cross Serrated, 4¾"	2
60-1085	US Army Retractor	Set of 2, Double End, 8¼"	1
60-1785	Yancoskie Retractor	6 Prongs	1
60-2028	Freeman Retractor	4 Prongs, 1½"	1
60-2030	Freeman Retractor	5 Prongs, 7⁄8"	1



# SURGICAL INSTRUMENT SETS

## PLASTIC SURGERY SETS



### 98-1437 MAMMAPLASTY SET

PRODUCT NUMBER	DESCRIPTION	FEATURES	QUANTITIES
06-2907	Scalpel Handle	#7	1
06-3103	Scalpel Blade	No. 15, 100/Pk, Stainless Steel	1
10-1670	Iodine Cup	6oz., 3 <sup>7</sup> / <sub>16</sub> " x 2"	1
15-3590	Sklarcut™ Iris Scissor	Curved, Sharp/Sharp, 4 <sup>1</sup> / <sub>2</sub> "	1
15-3595	Sklarhone™ Jabaley Scissor	Supercut, Curved, Delicate, 5"	1
20-1265	Crile-Wood Needle Holder	Serrated, 6", Narrow	1
21-8006	TC Crile-Wood Needle Holder	Serrated, 6"	1
40-7620	Marx Breast Retractor	125mm x 30mm, 10 <sup>1</sup> / <sub>2</sub> "	1
40-7630	Solz Breast Dissector	Non-Traumatical, 13 <sup>1</sup> / <sub>4</sub> "	1
40-7632	Solz Breast Dissector	Non-Traumatical, 14 <sup>1</sup> / <sub>2</sub> "	1
47-1030	Jabaley Scissor	Curved, Delicate, 5"	1
47-2535	Solz Breast Dissector	14"	1
55-9080	Metzenbaum-Nelson Scissor	Curved, 8"	1
60-1461	Baby Farabeuf Retractor	Double-Ended, 10/12mm, 4 <sup>3</sup> / <sub>4</sub> ", Set of 2	1
60-1909	Kocher-Langenbeck Retractor	15x80mm, 8 <sup>1</sup> / <sub>4</sub> "	1
60-8122	Marx Breast Retractor	140x30mm, 10 <sup>1</sup> / <sub>2</sub> "	1
70-4385	Jansen Bayonet Forceps	8 <sup>1</sup> / <sub>2</sub> "	1
98-2047	Micro Adson Forceps	1x2 Teeth, Delicate, 4 <sup>3</sup> / <sub>4</sub> "	1

### 98-1439 MAMMAPLASTY SET II

PRODUCT NUMBER	DESCRIPTION	FEATURES	QUANTITIES
06-2862	Measuring Instrument	mm and inches	1
06-2903	Scalpel Handle	#3	1
06-2904	Scalpel Handle	#4	1
06-2907	Scalpel Handle	#7	1
14-2065	Operating Scissor	Curved, Sharp/Blunt, 6 <sup>1</sup> / <sub>2</sub> "	1
17-1225	Micro-Mosquito Forceps	Curved, Delicate, 4 <sup>3</sup> / <sub>4</sub> "	8
17-2280	Rochester-Pean Forceps	Curved, 8"	2
17-2680	Rochester-Ochsner Forceps	Curved, 1x2 Teeth, 8"	2
17-3562	Lahey Traction Forceps	6 <sup>1</sup> / <sub>4</sub> "	1
19-1050	Dressing Forceps	Serrated, 5"	2
19-1250	Tissue Forceps	1x2 Teeth, 5"	2
20-1265	Baby Crile-Wood Needle Holder	Serrated, 6"	1
20-2060	Mayo-Hegar Needle Holder	6"	1
20-2070	Mayo-Hegar Needle Holder	7"	1
22-1070	Metzenbaum Scissor	Curved, Blunt/Blunt, Delicate, 7"	1
22-3455	Baby Mixer Dissecting Forceps	Curved, Partially Serrated, 7"	1
22-4154	Semken Dressing Forceps	Serrated, Straight, 6"	1
22-4354	Semken Tissue Forceps	1x2 Teeth, Straight, 6"	1
26-1280	Deschamps Needle	Blunt, Curved Right, 8"	1
26-1480	Deschamps Needle	Sharp, Curved Right, 8"	1
36-2298	Allis Tissue Seizing Forceps	Atraumatic, 6"	6
42-1792	Anderson-Adson Retractor	4x4 Teeth, Sharp, 8"	1
47-1040	Nerve Dissecting Scissor		1
47-1042	Kilner Dissecting Scissor		1
47-1360	Metzenbaum Scissor	Curved, 5 <sup>3</sup> / <sub>4</sub> "	1
47-2552	Delicate Hooks	2 Prongs	2

## SURGICAL INSTRUMENT SETS



### PLASTIC SURGERY SETS

#### 98-1439 MAMMAPLASTY SET II (CONTINUED)

PRODUCT NUMBER	DESCRIPTION	FEATURES	QUANTITIES
47-2558	Graefe Hooks	Delicate	2
47-2945	Backhaus Towel Clamp	4½"	1
50-1369	Baby Adson Forceps	Curved, 7"	1
50-3047	Adson Tissue Forceps	1x2 Teeth, 4¾"	2
60-1100	Roux Retractor	Double-Ended, Set/3	1
60-2012	Fritsch Retractors	45mm x 40mm, 9 ½"	2
60-5622	Volkman Retractors	2 Prong Sharp, 8 ½"	2
90-8140	Gross Maier Dressing Forceps	Without Ratchet, Straight, 10"	2
90-8142	Gross Maier Dressing Forceps	Without Ratchet, Curved, 10"	4
98-2034	Micro-Mosquito Forceps	1x2 Teeth, Straight, 4"	8

#### 98-1095 BREAST AUGMENTATION/REDUCTION SET

PRODUCT NUMBER	DESCRIPTION	FEATURES	QUANTITIES
06-2860	Ruler	Steel, 6"	1
06-2908	Scalpel Handles	#3R, Straight, Round Handle	2
10-1497	Emesis Basin	10oz., 6¾" x 3½" x 1½"	1
15-2567	Mayo Dissecting Scissor	Curved, 6¾"	1
17-1235	Hartmann Mosquito Forceps	Straight, Serrated, 3½"	4
17-1450	Halsted Mosquito Forceps	Straight, 5"	2
17-2855	Rochester-Ochsner Forceps	Straight, 1x2 Teeth, 5½"	2
19-1245	Tissue Forceps	1x2 Teeth, 4½"	2
20-1350	Webster Needle Holders	Smooth, Delicate, 5¼"	2
20-1450	Baumgartner Needle Holders	Serrated, 5½"	2
20-2755	Olsen-Hegar Needle Holders	5½"	3
20-4682	Heaney Needle Holder	8¼"	1
22-2520	Goldman-Fox Scissor	Curved, Serrated, 5"	1
36-2160	Allis Tissue Forceps	4x5 Teeth, 6"	2
47-1145	Iris Scissor	Straight, Sharp/Sharp, 4½"	1
47-1245	Iris Scissor	Curved, Sharp/Sharp, 4½"	1
47-2502	Joseph Hook	2 Sharp Prongs, 2mm, 6¼"	1
47-2505	Joseph Hook	2 Sharp Prongs, 5mm, 6¼"	1
47-2935	Backhaus Towel Clamps	3½"	4
50-2008	Frazier Suction Tube	8 French	1
50-3047	Adson Tissue Forceps	1x2 Teeth, 4¾"	2
50-3147	Adson Dressing Forceps	Serrated, 4¾"	1
52-5177	DeBakey Atraumatic Forceps	2mm, 7¾"	1
60-1085	US Army Retractors	Set of 2, Double End, 8¼"	2
60-3312	Deaver Retractors	#4, 2" x 12"	2
60-3596	Zalkind Ribbon Retractors	Malleable, ½" x 7¾"	3
60-6162	Senn Retractor	Double End, Sharp, 3 Prongs, 6¼"	1
64-1242	Stevens Tenotomy Scissor	Straight, Blunt/Blunt, 4½"	1
64-1342	Stevens Tenotomy Scissor	Curved, Blunt/Blunt, 4½"	1
65-4107	Bowman Lachrymal Probe	Size 7/8	1
74-3075	Schmidt Tonsil Forceps	Half Curved Jaws, 7½"	1
75-5570	Metzenbaum Scissor	Straight, 7"	1
75-5670	Metzenbaum Scissor	Curved, 7"	1
91-6100	Bipolar Adson Forceps	1mm, 4¾"	1

**98-1004 PLASTIC SURGERY SET**

PRODUCT NUMBER	DESCRIPTION	FEATURES	QUANTITIES
17-1235	Hartmann Mosquito Forceps	Straight, Serrated, 3½"	3
17-1335	Hartmann Mosquito Forceps	Curved, Serrated, 3½"	3
17-1450	Halsted Mosquito Forceps	Straight, 5"	6
17-1550	Halsted Mosquito Forceps	Curved, 5"	6
20-2070	Mayo-Hegar Needle Holder	7"	1
21-1260	TC Crile-Murray Needle Holder	Serrated, 6"	1
21-8013	TC Ryder Micro Needle Holder	Serrated, 6"	1
22-2652	Ragnell Dissecting Scissor	Curved, 5"	1
22-2760	Reynolds Scissor	Curved, Narrow Tip, 6"	1
22-4150	Semken Dressing Forceps	Serrated, Narrow, 5"	2
22-4350	Semken Tissue Forceps	1x2 Teeth, Narrow, 5"	2
22-8360	Miller-Senn Retractor	Double End, Sharp, 6"	1
22-8460	Miller-Senn Retractor	Double End, Blunt, 6"	1
22-9027	Alm Retractor	4x4 Teeth, Blunt, 2¾"	1
23-1106	Sklarlite™ Operating Scissors	Straight, Sharp/Blunt, 5½"	2
23-1158	Sklarlite™ Strabismus Scissor	Straight, 4½"	1
23-1164	Sklarlite™ Mayo Dissecting Scissor	Straight, 5½"	1
23-1167	Sklarlite™ Mayo Dissecting Scissor	Curved, 6¾"	1
23-1280	Sklarlite™ Sklarcut Scissor	Curved, Blunt, 5¾"	1
23-2510	Sklarlite XD™ Crile Forceps	Straight, 5½"	12
23-2513	Sklarlite XD™ Crile Forceps	Curved, 5½"	12
47-1047	Wagner Scissors	Straight, Sharp/Sharp, 4¾"	2
47-1068	Wagner Scissor	Curved, Sharp/Blunt, 4¾"	1
47-1447	Adson Brown Forceps	9x9 Teeth, Side Grasping, 4¾"	2
47-2834	Jansen Retractor	3x3 Teeth, Sharp, 4"	1
50-1372	Adson Forceps	Straight, 7¼"	3
50-1472	Adson Forceps	Curved, 7¼"	3
50-2012	Frazier Suction Tubes	12 French	2
50-3047	Adson Tissue Forceps	1x2 Teeth, 4¾"	1
50-3147	Adson Dressing Forceps	Serrated, 4¾"	1
55-2855	Gemini Clamps	Angled, Delicate, 5½"	2
57-1445	Crile Retractors	Double End, Small, 4½"	2
60-3598	Zalkind Ribbon Retractors	Malleable, ¾" x 7¾"	2

**98-1462 MAJOR RHINOPLASTY SET**

PRODUCT NUMBER	DESCRIPTION	FEATURES	QUANTITIES
06-2903	Scalpel Handle	#3	1
06-2908	Scalpel Handle	#3R	1
06-2911	Scalpel Handle	#9	1
15-1359	Buck Suture Scissor	7"	1
16-1510	Sklar Edge™ Mayo Dissecting Scissor	TC, Straight, 6¾"	1
16-1805	Sklar Edge™ Metzenbaum Scissor	TC, Straight, Blunt/Blunt, 5½"	1
16-2105	Sklar Edge™ Metzenbaum Scissor	TC, Curved, Blunt/Blunt, Delicate, 7"	1
16-3615	Sklar Edge™ Goldman-Fox Scissor	TC, Serrated, Curved, Sharp/Sharp, 5"	1
16-3630	Sklar Edge™ Cottle Dorsal Scissor	TC, Angled, 6¼"	1
16-3632	Sklar Edge™ Fomon Dorsal Scissor	TC, Angled, 5½"	1
17-1650	Halsted Mosquito Forceps	1x2 Teeth, 5"	1
17-3062	Crile-Rankin Forceps	Straight, 6¼"	1
21-2240	TC Webster Needle Holder	Smooth, 4¾"	1

## SURGICAL INSTRUMENT SETS



## PLASTIC SURGERY SETS

### 98-1462 MAJOR RHINOPLASTY SET (CONTINUED)

PRODUCT NUMBER	DESCRIPTION	FEATURES	QUANTITIES
21-2660	TC Foster-Gillies Needle Holder	6"	1
21-8001	TC Halsey Needle Holder	Serrated, 5¼"	1
21-8031	TC Mayo-Hegar Needle Holder	Serrated, 6"	1
21-8075	TC Crile-Wood Needle Holder	Serrated, 6"	1
40-5700	Partsch Mallet	6oz., 7"	1
40-5769	Mallet	Interchangeable Ends, 7"	1
40-5960	Anderson Neivert Osteotome	Right, 8"	1
40-5961	Anderson Neivert Osteotome	Left, 8"	1
40-5990	Cottle Crusher	2½"	1
40-6038	Neivert-Anderson Osteotome	Single Guard, Straight, 8"	1
40-6500	Rubin Osteotome	With Stabilizer, 10mm, 7"	1
40-6502	Rubin Osteotome	With Stabilizer, 14mm, 7"	1
40-9688	Fomon Rasp	4 Sided, Course/Fine, 8½"	1
40-9692	Fomon Rasp	Fine Teeth, 8¼"	1
40-9693	Fomon Rasp	Coarse Teeth, 8¼"	1
40-9815	Maltz Rasp	Backward Cutting, 7"	1
40-9816	Maltz Rasp	Forward Cutting, 6¾"	1
40-9825	Joseph Rasp	Straight, Fine Cross Serrations, 6½"	1
40-9835	Parkes Rasp	20 Concave Teeth, Fine, 7¾"	1
40-9837	Wiener Rasp	Trocar Tip, 7"	1
40-9840	Aufricht Glabellar Rasp	Forward Cutting, 8"	1
40-9841	Aufricht Glabellar Rasp	Backward Cutting, 8"	1
41-1145	Caplan Septal Scissor	Serrated, Angled, 8"	1
41-1192	Cottle Nasal Speculum	2" Blade, With Screw, 6"	1
41-1230	Goldman Septum Elevator	8¼"	1
41-1235	Cottle Elevator	Graduated, Double-End, 4mm Wide, 9"	1
41-1240	Joseph Periosteal Elevator	6.5mm, 7"	1
41-1255	Cottle Nasal Knife	4mm, 5½"	1
41-1300	Joseph Nasal Knife	Straight, Button End, 6"	1
41-1318	Fomon Knife	Double Edge, 6½"	1
41-1326	Ballenger Chisel	V-Shaped, 6mm, 6"	1
41-1330	Freer Septum Chisel	4mm Tip, 6½"	1
41-1340	Cottle Osteotome	Curved, 6½"	1
41-1342	Cottle Osteotome	4mm, 7"	1
41-1344	Cottle Osteotome	7mm, 7"	1
41-1346	Cottle Osteotome	9mm, 7"	1
41-1348	Cottle Osteotome	12mm, 7"	1
41-1350	Parkes Osteotome	With Guard, Straight, 5mm, 7"	1
41-1355	Silver Osteotome	Curved, Open Right, 7"	1
41-1360	Silver Osteotome	Curved, Open Left, 7"	1
41-1370	Cinelli Osteotome	Guarded Both Sides Straight 10mm, 6½"	1
41-1385	Cottle Retractor	Two Recessed Center Prongs, 5½"	1
41-1395	Fomon Retractor	Single Ball End, 6¾"	1
41-1396	Fomon Retractor	Double Ball Ends, 6¼"	1
41-1401	Converse Retractor	Size 1, 3¾"	1
41-1402	Converse Retractor	Size 2, 3¾"	1

**SURGICAL INSTRUMENT SETS**  
**PLASTIC SURGERY SETS**



**98-1462 MAJOR RHINOPLASTY SET (CONTINUED)**

PRODUCT NUMBER	DESCRIPTION	FEATURES	QUANTITIES
41-1403	Converse Retractor	Size 3, 3¾"	1
41-1404	Converse Retractor	6¼"	1
41-1407	Converse Nasal Retractor	4¼"	1
41-1410	Aufricht Nasal Retractor	Solid Blade, 6½"	1
47-1447	Adson Brown Forceps	9x9 Teeth, Side Grasping, 4¾"	1
47-2380	Freer Elevator	Double End, Sharp/Blunt, 7¼"	1
47-2385	McKenty Septum Elevator	Curved, 4mm, 6"	1
47-2389	Cottle Septum Elevator	9"	1
47-2502	Joseph Hook	2 Sharp Prongs, 2mm, 6¼"	1
47-2505	Joseph Hook	2 Sharp Prongs, 5mm, 6¼"	1
47-2507	Joseph Hook	2 Sharp Prongs, 7mm, 6¼"	1
47-2510	Joseph Hook	2 Sharp Prongs, 10mm, 6½"	1
47-2760	Freer Double Hook	2 Sharp Prongs, 6"	1
50-3047	Adson Tissue Forceps	1x2 Teeth, 4¾"	1
51-1447	TC Adson-Brown Tissue Forceps	Side Grasping, 4¾"	1
51-4398	TC Cushing Bayonet Forceps	Gutch Handle, 7"	1
65-6350	Castroviejo Needle Holder	Straight, Smooth, 5¼"	1
66-6119	Castroviejo Suture Forceps	Wide Handle, 1x2 Teeth With Tying Platform, 4¼"	1
67-4619	Sheehan Osteotome	Straight, 1mm, 6¼"	1
67-4620	Sheehan Osteotome	Straight, 2mm, 6¼"	1
67-4621	Sheehan Osteotome	Straight, 3mm, 6¼"	1
67-4625	Sheehan Osteotome	Straight, 7mm, 6¼"	1
70-1020	Killian Septum Speculum	With Set Screw, 2"	1
70-1040	Tieck Halle Nasal Speculum	Small, 6"	1
70-1041	Tieck Halle Nasal Speculum	Large, 6"	1
70-1052	Tieck Halle Nasal Speculum	Medium, 6"	1
70-4075	Heymann Knight Nasal Forceps	7"	1
70-4262	Knight Nasal Scissor	6¼"	1
70-4267	Killian Septum Scissor	Serrated, 8"	1
70-4270	Heymann Nasal Forceps	7"	1
70-4348	Cinelli Lower Lateral Scissor	Strong Curve, 4¼"	1
70-4352	Fomon Nasal Scissor	Strong Curve, 5¼"	1
70-4395	Taylor Bayonet Forceps	1x2 Teeth, 7"	1
70-5190	Ash Septum Straightening Forceps	9"	1
70-5290	Walsham Septum Forceps	Straight, 9"	1
70-5674	Jansen-Middleton Forceps	Cup Jaw, 7½"	1
70-5680	Rubin Septum Forceps	8¼"	1
70-7503	Ballenger Swivel Knife	Bayonet, 3mm	1
70-7801	Joseph Bayonet Nasal Saw	Right, 7½"	1
70-7802	Joseph Bayonet Nasal Saw	Left, 7½"	1
70-7805	Joseph Nasal Saw	Straight, 7½"	1
75-5670	Metzenbaum Scissor	Curved, 7"	1
97-1520	Peet (Cottle) Rasp	Straight, 7½", Diamond Coated	1
97-1521	Peet (Cottle) Rasp	Curved, 7½", Diamond Coated	1

## SURGICAL INSTRUMENT SETS



## PLASTIC SURGERY SETS

**98-1450 GRUBER RHINOPLASTY SET**

PRODUCT NUMBER	DESCRIPTION	FEATURES	QUANTITIES
21-8026	TC Olsen-Hegar Needle Holder	Smooth, Delicate, 4¾"	1
21-8027	TC Olsen-Hegar Needle Holder	Serrated, 5½"	1
22-8560	Ragnell Retractor	Double End, 6"	1
40-5990	Cottle Crusher	2¾"	1
40-6038	Neivert-Anderson Osteotome	Single Guard, Straight, 8"	1
40-6540	Lambotte Osteotome	10mm, 5"	1
40-9688	Fomon Rasp	4 Sided, Convex/Flat, 8½"	1
41-1235	Cottle Elevator	Graduated, Double-Ended, 4mm Wide, 9"	1
41-1245	Joseph Periosteal Elevator	4.5mm, 6¼"	1
41-1412	Malianiac Nasal Retractor	4"	1
47-1447	Adson Brown Forceps	9x9 Teeth Side Grasping, 4¾"	1
47-2147	Adson Forceps	Serrated, 4¾"	1
47-2505	Joseph Hooks	2 Sharp Prongs, 5mm, 6¼"	1
47-2510	Joseph Hook	2 Sharp Prongs, 10mm, 6½"	1
64-1342	Stevens Tenotomy Scissor	Curved, Blunt/Blunt, 4½"	1
65-6735	Thorpe Caliper	Inch & mm, 4½"	1
67-1455	Lucae Bayonet Forceps	5½"	1
70-1020	Killian Septum Speculum	With Set Screw, 2"	1
70-1035	Killian Septum Speculum	With Set Screw, 3½"	1
70-5680	Rubin Septum Forceps	8¼"	1
70-7067	Freer Septum Knife	9.5mm x 5mm Blade, 7¼"	1
70-7801	Joseph Bayonet Nasal Saw	Right, 7½"	1
70-7802	Joseph Bayonet Nasal Saw	Left, 7½"	1
70-7805	Joseph Nasal Saw	Straight, 7½"	1
90-1045	Gillies Skin Hook	2.5mm, 7"	1

**98-1096 BLEHPAROPLASTY SET**

PRODUCT NUMBER	DESCRIPTION	FEATURES	QUANTITIES
06-2860	Ruler	Steel, 6"	1
06-2910	Scalpel Handle	#3 With Metric Scale	1
15-3585	Sklarcut™ Iris Scissor	Straight, Sharp/Sharp, 4½"	1
15-3590	Sklarcut™ Iris Scissor	Curved, Sharp/Sharp, 4½"	1
17-1450	Halsted Mosquito Forceps	Straight, 5"	2
17-1550	Halsted Mosquito Forceps	Curved, 5"	2
21-8002	TC Webster Needle Holders	Smooth, 5"	2
22-2653	Ragnell Scissor	Straight, 5"	1
47-2502	Joseph Hooks	2 Sharp Prongs, 2mm, 6¼"	2
47-2935	Backhaus Towel Clamps	3½"	4
50-3047	Adson Tissue Forceps	1x2 Teeth, 4¾"	1
65-1842	Desmarres Lid Retractor	14mm	1
65-6732	Castroviejo Caliper	3¼"	1
66-4132	Bishop-Harmon Eye Forceps	1x2 Teeth, 3½"	1

# SURGICAL INSTRUMENT SETS

## PLASTIC SURGERY SETS



### 98-1097 RHYTIDECTOMY / FACELIFT SET

PRODUCT NUMBER	DESCRIPTION	FEATURES	QUANTITIES
06-2860	Ruler	Steel, 6"	1
06-2907	Scalpel Handle	#7	1
06-2910	Scalpel Handle	#3 With Metric Scale	1
15-3549	Sklarcut™ Castanares Facelift Scissor	Straight, 6¼"	1
15-3585	Sklarcut™ Iris Scissor	Straight, Sharp/Sharp, 4½"	1
15-3590	Sklarcut™ Iris Scissor	Curved, Sharp/Sharp, 4½"	1
16-1510	Sklar Edge™ Mayo Dissecting Scissor	TC, Straight, 6¾"	1
16-1905	Sklar Edge™ Metzenbaum Lahey Scissor	TC, Delicate, Curved, 5¾"	1
17-1450	Halsted Mosquito Forceps	Straight, 5"	2
17-1550	Halsted Mosquito Forceps	Curved, 5"	2
21-8002	TC Webster Needle Holder	Smooth, 5"	1
21-8006	TC Crile-Wood Needle Holder	Serrated, Narrow, 6"	1
21-8080	TC Webster Needle Holders	Serrated, 5¼"	2
22-1063	Tissue Forceps	1x2 Teeth, Delicate, 5½"	1
22-1162	Dressing Forceps	Serrated, Delicate, 5"	1
22-2653	Ragnell Scissor	Straight, 5"	1
22-2835	Spencer Stitch Scissor	3½"	1
36-2160	Allis Tissue Forceps	4x5 Teeth, 6"	2
41-1105	Rhytidectomy Scissor	Double End, Curved, 6½"	1
47-1147	Blepharoplasty Scissor	Curved, Serrated, 4¾"	1
47-1447	Adson Brown Forceps	9x9 Teeth, Side Grasping, 4¾"	1
47-2510	Joseph Hooks	2 Prongs, Sharp, 10mm, 6½"	2
47-2935	Backhaus Towel Clamps	3½"	2
47-2955	Backhaus Towel Clamps	5¼"	2
50-2008	Frazier Suction Tube	8 French	1
50-3047	Adson Tissue Forceps	1x2 Teeth, 4¾"	1
52-3370	Potts-Smith Tissue Forceps	1x2 Teeth, 7"	1
52-5062	Debakey Atraumatic Forceps	1.5mm, 6¼"	1
52-5162	Debakey Atraumatic Forceps	2mm, 6¼"	1
60-1085	US Army Retractor	Set of 2, Double End, 8¼"	2
60-1676	Richardson Retractor	SklarGrip Handle, Small, 9½", 1" x ¾"	1
60-2812	Deaver Retractor	#3, 1½" x 12" with SklarGrip Handle	1
60-6162	Senn Retractors	Double-End, Sharp, 3 Prongs, 6¼"	2

### 98-1008 BASIC HAND SURGERY SET

PRODUCT NUMBER	DESCRIPTION	FEATURES	QUANTITIES
06-2860	Ruler	Steel, 6"	1
06-2903	Scalpel Handle	#3	1
06-2904	Scalpel Handle	#4	1
16-2800	TC Wire Cutting Scissor	Angled, 4¾"	1
17-2655	Rochester-Ochsner Forceps	Curved, 1x2 Teeth, 5½"	1
17-2855	Rochester-Ochsner Forceps	Straight, 1x2 Teeth, 5½"	1
18-2257	Barrett Tenaculum Forceps	Delicate, 6½"	2
21-8004	TC Derf Needle Holder	Serrated, 4¾"	1
21-8006	TC Crile-Wood Needle Holder	Serrated, Narrow, 6"	1
21-8013	TC Ryder Micro Needle Holder	Serrated, 6"	1
22-1241	Stevens Tenotomy Scissor	Curved, Delicate, Sharp/Sharp, 4½"	1
22-1342	Stevens Tenotomy Scissor	Curved, Delicate, Blunt/Blunt, 4½"	1
22-2545	Metzenbaum Scissor	Curved, 4¾"	1

## SURGICAL INSTRUMENT SETS



## PLASTIC SURGERY SETS

### 98-1008 BASIC HAND SURGERY SET (CONTINUED)

PRODUCT NUMBER	DESCRIPTION	FEATURES	QUANTITIES
22-2760	Reynolds Scissor	Curved, Narrow Tip, 6"	1
22-4250	Semken Dressing Forceps	Serrated, Delicate, 5"	1
22-4450	Semken Tissue Forceps	1x2 Teeth, Delicate, 5"	2
22-8360	Miller-Senn Retractor	Double End, Sharp, 6"	1
23-1153	Skarlite XD™ Iris Scissor	Straight, Sharp/Sharp, 4½"	1
23-1155	Skarlite XD™ Iris Scissor	Curved, Sharp/Sharp, 4½"	1
23-1168	Skarlite XD™ Iris Scissor	Straight, 5½"	1
23-1170	Skarlite XD™ Mayo Scissor	Curved, 5½"	1
23-1175	Skarlite™ Metzenbaum Scissor	Curved, 6"	1
23-2100	Skarlite™ Hartmann Mosquito Forceps	Straight, 3½"	3
23-2101	Skarlite™ Hartmann Mosquito Forceps	Curved, 3½"	3
23-2105	Skarlite™ Halsted Mosquito Forceps	Straight, 5"	6
23-2106	Skarlite™ Halsted Mosquito Forceps	Curved, 5"	6
23-2600	Skarlite™ Adson Dressing Forceps	Serrated, 4¾"	1
23-2602	Skarlite™ Adson Tissue Forceps	1x2 Teeth, 4¾"	2
23-2603	Skarlite™ Adson Brown Forceps	Side Grasping, 4¾"	1
23-2851	Skarlite™ Allis Forceps	4x5 Teeth, 6"	1
23-2861	Skarlite XD™ Allis Forceps	4x5 Teeth, 5"	1
47-2380	Freer Elevator	Double End, Sharp/Blunt, 7¼"	1
47-2500	Joseph Hooks	1 Sharp Prong, 6¼"	2
47-2502	Joseph Hooks	2 Sharp Prongs, 2mm, 6¼"	2
47-2935	Backhaus Towel Clamps	3½"	2
47-2955	Backhaus Towel Clamps	5¼"	6
50-1290	Cushing Vein Retractor	9"	1
50-2007	Frazier Suction Tube	7 French	1
50-2008	Frazier Suction Tube	8 French	1
57-1445	Crile Retractor	Double End, Small, 4½"	1
60-1085	US Army Retractor	Set of 2, Double End, 8¼"	1
60-6162	Senn Retractor	Double-End, Sharp, 3 Prongs, 6¼"	1
74-1470	Ballenger Sponge Forceps	Straight, Serrated, 7"	2
74-1670	Ballenger Sponge Forceps	Curved, Serrated, 7"	2
87-2195	Foerster Sponge Forceps	Straight, Serrated, 9½"	2

### 98-1038 MYRINGOTOMY SET

PRODUCT NUMBER	DESCRIPTION	FEATURES	QUANTITIES
47-1145	Iris Scissor	Straight, Sharp/Sharp, 4½"	1
50-1953	Baron Suction Tube	3 French	1
50-1955	Baron Suction Tube	5 French	1
50-1957	Baron Suction Tube	7 French	1
67-1036	Hartmann Ear Forceps	Delicate, 3½"	1
67-1150	Wilde Ear Dressing Forceps	Angled, Serrated, 5"	1
67-2005	Politzer Tympanum Perforator	Straight	1
67-2490	Buck Ear Curette	Size 0, Straight, Blunt	1
67-2491	Buck Ear Curette	Size 1, Straight, Blunt	1
67-2515	Buck Ear Curette	Size 0, Straight, Sharp	1
67-2516	Buck Ear Curette	Size 1, Straight, Sharp	1
67-6010	Boucheron Ear Speculum	Set of 4	1
67-6025	Gruber Ear Speculum	Infant	1
68-1765	Farrell Applicator	Twist End, 6½"	1
68-1865	Farrell Applicator	Triangle End, 6½"	1



# SURGICAL INSTRUMENT SETS

## PLASTIC SURGERY SETS



### 98-1444 SKIN GRAFT SET

PRODUCT NUMBER	DESCRIPTION	FEATURES	QUANTITIES
06-2907	Scalpel Handle	#7	1
06-6300	Schink Dermatome	Complete	1
14-2050	Operating Scissor	Curved, Sharp/Blunt, 5"	1
21-8001	TC Halsey Needle Holders	Serrated, 5¼"	2
22-1057	Metzenbaum Scissor	Curved, Delicate, 5¾"	1
40-7140	Volkman Bone Curette	#4-0	1
40-7141	Volkman Bone Curette	#3-0	1
40-7142	Volkman Bone Curette	#2-0	1
40-7143	Volkman Bone Curette	#0	1
40-7144	Volkman Bone Curette	#1	1
40-7145	Volkman Bone Curette	#2	1
40-7146	Volkman Bone Curette	#3	1
40-7147	Volkman Bone Curette	#4	1
40-7148	Volkman Bone Curette	#5	1
40-7149	Volkman Bone Curette	#6	1
47-1245	Iris Scissor	Curved, Sharp/Sharp, 4½"	1
50-3047	Adson Tissue Forceps	1x2 Teeth, 4¾"	2
50-3147	Adson Dressing Forceps	Serrated, 4¾"	2
64-1542	Strabismus Scissor	Curved, Blunt/Blunt, 4½"	1
98-2036	Micro-Mosquito Forceps	1x2 Teeth, Straight, 4¾"	6

### 98-1457 CLEFT PALATE SET

PRODUCT NUMBER	DESCRIPTION	FEATURES	QUANTITIES
06-2907	Scalpel Handle	#7	1
21-8000	TC Halsey Needle Holder	Smooth, 5¼"	1
21-8075	TC Crile-Wood Needle Holder	Serrated, 6"	1
40-4270	Beyer Rongeur	Curved on Flat, 7"	1
40-9340	Salzer Periosteal Elevator	Slight Curve, 7"	1
40-9341	Salzer Periosteal Elevator	Right Angle, Long, 7"	1
40-9342	Salzer Periosteal Elevator	Right Angle, Short, 7"	1
41-1235	Cottle Elevator	Graduated, Double-Ended, 4mm Wide, 9"	1
41-1395	Fomon Retractor	Single Ball End, 6¾"	1
41-1470	Salzer Cleft Palate Retractor	Short, 7"	1
41-1471	Salzer Cleft Palate Retractor	Long, 7"	1
47-2372	Pennington Septum Elevator	8½"	1
47-2570	Gillies Skin Hook	3mm, 7"	1
49-0955	Woodson Elevator	#1, Double-Ended, 7"	1
50-2670	Cushing Dressing Forceps	Serrated, 6¾"	1
51-4235	TC Semken Tissue Forceps	1x2 Teeth, 7"	1
51-4239	TC Micro Semken Tissue Forceps	1x2 Teeth, 7"	1
51-4240	TC Jaboma Tissue Forceps	Serrated, Straight, 7"	1
51-4242	TC Jaboma Tissue Forceps	1x2 Teeth, Straight, 7"	1
51-4244	TC Jaboma Tissue Forceps	1x2 Teeth, Angled, 7"	1
70-4352	Fomon Nasal Scissor	Curved, 5¼"	1
75-1040	Dingman Mouth Gag	Complete with 3 Blades	1
75-5267	Dean Scissors	Serrated, Angled, 6¾"	1
97-0530	Molt Periosteal Elevator	#9	1

# SURGICAL INSTRUMENT SETS

## PLASTIC SURGERY SETS



### 98-1464 TMJ SURGERY SET

PRODUCT NUMBER	DESCRIPTION	FEATURES	QUANTITIES
16-3616	TC Ragnell-Kilner Scissor	Curved, Blunt/Blunt, 4¾"	1
21-2250	TC Martini Needle Holder	Smooth, 5½"	1
21-8001	TC Halsey Needle Holder	Serrated, 5¼"	1
21-8048	TC Castroviejo Needle Holder	7"	1
22-1163	Dressing Forceps	Serrated, Delicate, 5½"	1
40-5769	Mallet	Interchangeable Ends, 7"	1
40-6536	Lambotte Osteotome	6mm, Delicate, 5"	1
40-6622	Jr. Lambotte Osteotome	2mm, 7"	1
40-6624	Jr. Lambotte Osteotome	4mm, 7"	1
40-7070	Dunn-Dautrey Elevator	6mm x 48mm, 6"	1
40-7071	Dunn-Dautrey Elevator	6mm x 56mm, 6"	1
40-7244	Epstein Curette	#2, 4.5mm, 8" Oval	1
47-2380	Freer Elevator	Double End, Sharp/Blunt, 7¼"	1
47-2510	Joseph Hook	2 Prongs, Sharp, 10mm, 6½"	1
51-1447	TC Adson-Brown Tissue Forceps	Side Grasping, 4¾"	1
51-3447	TC Adson Dressing Forceps	Serrated, 4¾"	1
52-6579	Bulldog DeBakey Atraumatic Forceps	Ring Handle, 90° Angle, 4¾"	1
52-6580	Bulldog DeBakey Atraumatic Forceps	Ring Handle, 45° Angle, 5"	1
64-1342	Stevens Tenotomy Scissor	Curved, Blunt/Blunt, 4½"	1
97-0530	Molt Periosteal Elevator	#9	1

# SURGICAL INSTRUMENT SETS

## OB/GYN SETS



### 98-1014 D AND C SET

PRODUCT NUMBER	DESCRIPTION	FEATURES	QUANTITIES
06-2903	Scalpel Handle	#3	1
06-2907	Scalpel Handle	#7	1
06-2915	Scalpel Handle	#3L	1
17-3062	Crile Forceps	Straight, 6¼"	6
17-3162	Crile Forceps	Curved, 6¼"	6
19-1080	Dressing Forceps	Serrated, 8"	1
19-1280	Tissue Forceps	1x2 Teeth, 8"	1
21-1260	TC Crile-Murray Needle Holder	Serrated, 6"	1
21-8032	TC Mayo-Hegar Needle Holder	Serrated, 7"	1
47-2955	Backhaus Towel Clamps	5¼"	6
80-1410	Bozeman Forceps	Double Curved, 10¼"	1
87-2395	Foerster Sponge Forceps	Curved, Serrated, 9½"	2
90-3130	Jackson Retractor	Small Blade, 3" x 1½"	1
90-3135	Jackson Retractor	Medium Blade, 3½" x 1½"	1
90-3526	Auvar Weighted Speculum	Medium, 2½ lbs., 2¾" x 1½"	1
90-3701	Graves Vaginal Speculum	Medium, 1¼" x 4"	1
90-3702	Graves Vaginal Speculum	Large, 1⅜" x 4½"	1
90-3710	Pederson Vaginal Speculum	Small, ½" x 3"	1
90-3995	Kogan Endocervical Speculum	Wide Wire Blades, With Gauge and Screws	1
90-4713	Goodell Dilator	Large, 13"	1
90-4826	Hegar Dilator	Set of 8	1
90-5312	Sims Sound	Plain, 12½"	1
90-5422	Sims Curette	#2, Sharp, 11"	1
90-5423	Sims Curette	#3, Sharp, 11"	1
90-5424	Sims Curette	#4, Sharp, 11"	1
90-5425	Sims Curette	#5, Sharp, 11"	1
90-6612	Kevorkian-Younger Endocervical Curette	With Basket, 12"	1
91-1290	Schroeder Braun Tenaculum Forceps	10"	1
92-5095	Javerts Forceps	Serrated, 9½"	1

### 98-1016 GYNECOLOGICAL SURGERY SET

PRODUCT NUMBER	DESCRIPTION	FEATURES	QUANTITIES
06-2903	Scalpel Handle	#3	1
06-2904	Scalpel Handle	#4	1
06-2915	Scalpel Handle	#3L	1
06-2920	Scalpel Handle	#4L	1
07-1805	Yankauer Suction Tube	Stainless Steel	1
14-2065	Operating Scissor	Curved, Sharp/Blunt, 6½"	1
17-1055	Pratt T-Shaped Clamps	Straight, 6"	2
17-2280	Rochester-Pean Forceps	Curved, 8"	3
17-2480	Rochester-Pean Forceps	Straight, 8"	3
17-2680	Rochester-Ochsner Forceps	Curved, 1x2 Teeth, 8"	3
17-2880	Rochester-Ochsner Forceps	Straight, 1x2 Teeth, 8"	3
17-3062	Crile Forceps	Straight, 6¼"	6
17-3162	Crile Forceps	Curved, 6¼"	6
19-1080	Dressing Forceps	Serrated, 8"	1
19-1280	Tissue Forceps	1x2 Teeth, 8"	2
19-2280	Russian Tissue Forceps	8"	1
19-2310	Russian Tissue Forceps	10"	1

# SURGICAL INSTRUMENT SETS



## OB/GYN SETS

### 98-1016 GYNECOLOGICAL SURGERY SET (CONTINUED)

PRODUCT NUMBER	DESCRIPTION	FEATURES	QUANTITIES
20-2480	Mayo-Hegar Needle Holder	Serrated, 8"	1
20-4682	Heaney Needle Holders	8¼"	2
21-8032	TC Mayo-Hegar Needle Holders	Serrated, 7"	2
21-8033	TC Mayo-Hegar Needle Holders	Serrated, 8"	2
23-1102	Sklarlite™ Operating Scissor	Straight, Sharp/Sharp, 5½"	1
23-1106	Sklarlite™ Operating Scissor	Straight, Sharp/Blunt, 5½"	1
34-2023	Poole Suction Tubes	23 French, Slip on End	2
36-2275	Allis Tissue Forceps	5x6 Teeth, 7½"	2
36-2295	Allis Tissue Forceps	5x6 Teeth, 9½"	2
47-2955	Backhaus Towel Clamps	5¼"	8
51-4382	TC Potts-Smith Dressing Forceps	8¼"	1
55-9090	Metzenbaum-Nelson Scissor	Curved, 9"	1
55-9190	Metzenbaum-Nelson Scissor	Straight, 9"	1
80-1410	Bozeman Forceps	Double Curved, 10¼"	2
87-2195	Foerster Sponge Forceps	Straight, Serrated, 9½"	2
90-1590	Mayo Dissecting Scissor	Straight, 9"	1
90-1690	Mayo Dissecting Scissor	Curved, 9"	1
90-1977	Heaney Forceps	Light, Single Tooth, 7¾"	2
90-2177	Heaney Forceps	Heavy, Single Tooth, 8¼"	2
90-2680	Phaneuf Forceps	Angled, 8¼"	2
90-2782	DeAlvarez Forceps	Double Curved, 7¾"	2
90-3030	Eastman Retractor	Small Blade, 3" x 1½"	1
90-3035	Eastman Retractor	Medium Blade, 3½" x 1½"	1
90-3040	Eastman Retractor	Large Blade, 4" x 1½"	1
90-3526	Auvard Weighted Speculum	Medium, 2½ lbs., 2¾" x 1½"	1
90-3700	Graves Vaginal Speculum	Small, ¾" x 3"	1
90-3701	Graves Vaginal Speculum	Medium, 1¼" x 4"	1
90-3702	Graves Vaginal Speculum	Large, 1¾" x 4½"	1
90-4926	Hank Dilator	Set of 6	1
90-5413	Simpson Uterine Sound	CM Graduation	1
90-7995	Schweizer Uterine Forceps	Straight, 9½"	1
91-1290	Schroeder Braun Tenaculum Forceps	10"	2
97-1560	TC Allis Grasping Forceps	7½"	2

### 98-1018 GYNECOLOGICAL BIOPSY SET

PRODUCT NUMBER	DESCRIPTION	FEATURES	QUANTITIES
80-1410	Bozeman Forceps	Double Curved, 10¼"	1
87-2195	Foerster Sponge Forceps	Straight, Serrated, 9½"	2
87-2395	Foerster Sponge Forceps	Curved, Serrated, 9½"	2
90-3526	Auvard Weighted Speculum	Medium, 2½ lbs., 2¾" x 1½"	1
90-3700	Graves Vaginal Speculum	Small, ¾" x 3"	1
90-3701	Graves Vaginal Speculum	Medium, 1¼" x 4"	1
90-3702	Graves Vaginal Speculum	Large, 1¾" x 4½"	1
90-3995	Kogan Endocervical Speculum	Wide Wire Blades, With Gauge and Screws	1
90-5413	Simpson Uterine Sound	CM Graduation	1
90-5423	Sims Curette	#3, Sharp, 11"	1
90-6292	Novak Endometrial Curette	4mm, 9½"	1
90-6612	Kevorkian-Young Endocervical Curette	With Basket, 12"	1
90-6887	Tischler Kevorkian Biopsy Forceps	3mm x 9.5mm, 8½"	1
90-7492	Gellhorn Biopsy Forceps	9½"	1
90-7710	Bozeman Forceps	Double Curved (One Large Ring), 10¼"	1
91-1290	Schroeder Braun Tenaculum Forceps	10"	1

# SURGICAL INSTRUMENT SETS

## OB/GYN SETS



### 98-1019 GYNECOLOGICAL X-LONG SET

PRODUCT NUMBER	DESCRIPTION	FEATURES	QUANTITIES
07-1807	Yankauer Suction Tube	15"	1
16-4008	TC Z-Type Parametrium Scissor	Slight Curve, 12"	1
16-4009	TC Z-Type Parametrium Scissor	Curved, 12"	1
16-4010	TC Z-Type Parametrium Scissor	Full Curve, 12"	1
19-1114	Dressing Forceps	Serrated, 14"	1
19-1314	Tissue Forceps	1x2 Teeth, 14"	1
19-2314	Russian Tissue Forceps	14"	1
21-2914	TC Mayo Hegar Needle Holders	Serrated, Curved, 14"	2
34-2232	Poole Suction Tube	Straight, 32 French	1
52-5199	DeBakey Atraumatic Forceps	Straight, 2mm, 14"	1
61-0021	Sklarhone™ Metzenbaum Scissor	Serrated, Curved, 14"	1
61-0051	Carmalt Forceps	Curved, 12"	2
61-0080	Singley Tissue Forceps	14"	1
90-2796	Z-Type Hysterectomy Forceps	Straight, 12"	2
90-2797	Z-Type Hysterectomy Forceps	Slight Curve, 12"	2
90-2798	Z-Type Hysterectomy Forceps	Curved, 12"	2
90-2799	Z-Type Hysterectomy Forceps	Angled, 12"	2
90-2801	Z-Type Hysterectomy Forceps	Straight, 14"	2
90-2802	Z-Type Hysterectomy Forceps	Slight curve, 14"	2
90-2803	Z-Type Hysterectomy Forceps	Curved, 14"	2
90-2804	Z-Type Hysterectomy Forceps	Angled, 14"	2
90-2641	Bridge Forceps	Curved, Delicate, 11"	2

### 98-1020 OBSTETRICAL SET

PRODUCT NUMBER	DESCRIPTION	FEATURES	QUANTITIES
14-1060	Operating Scissor	Straight, Sharp/Blunt, 6"	1
14-2060	Operating Scissor	Curved, Sharp/Blunt, 6"	1
15-1567	Mayo Dissecting Scissor	Straight, 6¾"	1
16-1610	Sklar Edge™ Mayo Dissecting Scissor	TC, Curved, 6¾"	1
17-2272	Rochester-Pean Forceps	Curved, 7¼"	3
17-2472	Rochester-Pean Forceps	Straight, 7¼"	3
17-2880	Rochester-Ochsner Forceps	Straight, 1x2 Teeth, 8"	1
17-3062	Crile Forceps	Straight, 6¼"	3
17-3162	Crile Forceps	Curved, 6¼"	6
19-1060	Dressing Forceps	Serrated, 6"	2
19-1260	Tissue Forceps	1x2 Teeth, 6"	2
19-2280	Russian Tissue Forceps	8"	2
21-8032	TC Mayo-Hegar Needle Holders	Serrated, 7"	2
21-8033	TC Mayo-Hegar Needle Holder	Serrated, 8"	1
36-2380	Allis-Thoms Forceps	6x7 Teeth, 8"	1
47-2955	Backhaus Towel Clamps	5¼"	12
87-2395	Foerster Sponge Forceps	Curved, Serrated, 9½"	2
90-1755	Braun Episiotomy Scissor	Angled, 5½"	1
90-3035	Eastman Retractor	Medium Blade, 3½" x 1½"	1
90-3040	Eastman Retractor	Large Blade, 4" x 1½"	1
91-4310	Iowa Puncturing Forceps	10"	1
92-1114	Simpson OB Forceps	Long, 14¼"	1
92-2215	McLane-Tucker-Luikart OB Forceps	15½"	1
92-2314	Simpson-Luikart OB Forceps	14"	1
92-2912	Laufe Divergent OB Forceps	12½"	1

# SURGICAL INSTRUMENT SETS



## OB/GYN SETS

### 98-1024 HYSTERECTOMY SET (FOR USE WITH MAJOR BASIC SET)

PRODUCT NUMBER	DESCRIPTION	FEATURES	QUANTITIES
06-2915	Scalpel Handle	#3L	1
15-2567	Mayo Dissecting Scissor	Curved, 6¾"	1
17-2680	Rochester-Ochsner Forceps	Curved, 1x2 Teeth, 8"	4
17-2880	Rochester-Ochsner Forceps	Straight, 1x2 Teeth, 8"	8
19-2280	Russian Tissue Forceps	8"	1
20-4682	Heaney Needle Holders	8¼"	2
36-2295	Allis Tissue Forceps	5x6 Teeth, 9½"	2
52-5195	DeBakey Tissue Forceps	Straight, 2mm, 9½"	1
55-2894	Mixer Right Angle Forceps	Longitudinal Serrations, 10½"	2
55-9080	Metzenbaum-Nelson Scissor	Curved, 8"	1
60-3090	Deaver Retractor	#0, 1" x 9"	1
60-3112	Deaver Retractor	#1, 1" x 12"	1
60-3212	Deaver Retractor	#3, 1½" x 12"	1
74-3075	Schmidt Tonsil Forceps	Half Curved Jaws, 7½"	2
87-2195	Foerster Sponge Forceps	Straight, Serrated, 9½"	2
90-2280	Heaney Clamps	Double Tooth, 8"	6
90-2480	Heaney-Ballantine Clamps	Straight, Serrated, 8"	2
90-2580	Heaney-Ballantine Clamp	Curved, Serrated, 8"	1

### 98-1026 SMALL GYN BIOPSY SET

PRODUCT NUMBER	DESCRIPTION	FEATURES	QUANTITIES
90-3990	Kogan Endocervical Speculum	Narrow Wire Blades, With Gauge and Screws	1
90-6612	Kevorkian-Younger Endocervical Curette	With Basket, 12"	1
90-7525	Sklar Oval Biopsy Forceps	3mm x 5mm	1
90-8335	Iris Hook	Quick Release, 3mm, 9"	1
91-1290	Schroeder Braun Tenaculum Forceps	10"	1

### 90-8557 COLPOSCOPY SET

PRODUCT NUMBER	DESCRIPTION	FEATURES	QUANTITIES
90-3995	Kogan Endocervical Speculum	Wide Wire Blades, With Gauge and Screws	1
90-6612	Kevorkian-Younger Endocervical Curette	With Basket, 12"	1
90-7520	Tischler Oval Biopsy Forceps	3mm x 7mm	1
90-8334	Iris Hook	Quick Release, 4mm, 9"	1

### 98-1028 CESAREAN SECTION SET (FOR USE WITH MAJOR BASIC SET)

PRODUCT NUMBER	DESCRIPTION	FEATURES	QUANTITIES
20-2910	Masson Needle Holder	Serrated, 10½"	1
21-8060	TC Heaney Needle Holder	Curved, Serrated, 8¼"	1
87-2195	Foerster Sponge Forceps	Straight, Serrated, 9½"	1
90-1590	Mayo Dissecting Scissor	Straight, 9"	1
90-1690	Mayo Dissecting Scissor	Curved, 9"	1
90-2680	Phaneuf Forceps	Angled, 8¼"	2
90-3135	Jackson Retractor	Medium Blade, 3½" x 1½"	1
92-1012	DeLee OB Forceps	12"	1

# SURGICAL INSTRUMENT SETS

## OB/GYN SETS



### 98-1400 GYN ABDOMINAL SET

PRODUCT NUMBER	DESCRIPTION	FEATURES	QUANTITIES
10-1808	E-Z Lock Instrument Stringer	8" x 2½"	1
10-4394	SklarLite™ Mid-Size Container	18¼" x 11" x 6" Non-Perforated Bottom	1
10-4484	SklarLite™ Mid-Size Wire Basket	16" x 10" x 4"	1
16-1615	Sklar Edge™ Mayo Dissecting Scissor	TC, Curved, 9"	1
19-2280	Russian Tissue Forceps	8"	2
34-1414	Ochsner Trocar	14 French, 10 Fr Catheter	1
36-2275	Allis Tissue Forceps	5x6 Teeth, 7½"	8
52-2970	Jorgenson Scissor	Strong Curve, 9"	1
90-2680	Phaneuf Forceps	Angled, 8¼"	4
90-3025	O'Sullivan O'Connor Abdominal Retractor	With 3 Interchangeable Blades, 2 Small / 1 Large	1
90-5500	Sims Curettes	#0, Sharp	2
91-1070	Barrett Tenaculum Forceps	Straight, 7"	2
91-1298	Schroeder Tenaculum Forceps	Rounded Tips, 10"	2
91-1465	Staude-Moore Tenaculum Forceps	6½"	2
91-2282	Jacobs Vulsellum Forceps	Straight, 8¼"	2

### 98-1401 RADICAL VULVECTOMY SET

PRODUCT NUMBER	DESCRIPTION	FEATURES	QUANTITIES
06-2903	Scalpel Handles	#3	2
06-2907	Scalpel Handle	#7	1
10-1810	E-Z Lock Instrument Stringers	10" x 2½"	2
10-4096	SklarLite™ Full Size Container	23" x 11" x 6" Non-Perforated Bottom	1
10-4290	SklarLite™ Full Size Wire Basket	21¼" x 10" x 4"	1
16-1510	Sklar Edge™ Mayo Dissecting Scissor	TC, Straight, 6¾"	1
16-1610	Sklar Edge™ Mayo Dissecting Scissor	TC, Curved, 6¾"	1
16-1905	Sklar Edge™ Metzenbaum Lahey Scissor	TC, Delicate, Curved, 5¾"	1
16-2110	Sklar Edge™ Metzenbaum Scissor	TC, Curved, 7"	1
17-1550	Halsted Mosquito Forceps	Curved, 5"	4
17-2262	Rochester-Pean Forceps	Curved, 6¼"	16
17-2862	Rochester-Ochsner Forceps	Straight, 1x2 Teeth, 6¼"	8
17-2880	Rochester-Ochsner Forceps	Straight, 1x2 Teeth, 8"	10
17-3055	Crile Forceps	Straight, 5½"	4
17-3155	Crile Forceps	Curved, 5½"	18
19-1060	Dressing Forceps	Serrated, 6"	2
19-1080	Dressing Forceps	Serrated, 8"	2
19-1260	Tissue Forceps	1x2 Teeth, 6"	2
19-1280	Tissue Forceps	1x2 Teeth, 8"	2
21-8031	TC Mayo Hegar Needle Holders	Serrated, 6"	2
21-8032	TC Mayo Hegar Needle Holders	Serrated, 7"	2
36-2160	Allis Tissue Forceps	4x5 Teeth, 6"	10
42-1865	Weitlaner Retractors	3x4 Teeth, Blunt, 6½"	2
47-2852	Lorna-Edna Towel Clamps	5½"	2
47-2955	Backhaus Towel Clamps	5¼"	2
50-1290	Cushing Vein Retractors	9"	2
50-1472	Adson Forceps	Curved, 7¼"	4
50-3047	Adson Tissue Forceps	1x2 Teeth, 4¾"	2
52-5177	DeBakey Atraumatic Forceps	2mm, 7¾"	2
55-2880	Gemini Clamps	Delicate, Angled, 8"	4

## SURGICAL INSTRUMENT SETS

### OB/GYN | LAPAROSCOPIC



#### 98-1401 RADICAL VULVECTOMY SET (CONTINUED)

PRODUCT NUMBER	DESCRIPTION	FEATURES	QUANTITIES
60-1085	US Army Retractor	Set of 2, Double End, 8¼"	1
60-1661	Kelly Retractors	9½", 2" x 2½"	2
60-1676	Richardson Retractors	SklarGrip Handle, Small, 9½", ¾" x 1"	2
60-1681	Richardson Retractors	SklarGrip Handle, Medium, 9½", 1" x 1¼"	2
87-2195	Foerster Sponge Forceps	Straight, Serrated, 9½"	4
91-1070	Barrett Tenaculum Forceps	Straight, 7"	2
91-1298	Schroeder Tenaculum Forceps	Rounded Tips, 10"	2
91-1465	Staude-Moore Tenaculum Forceps	6½"	2

#### 98-1021 DELIVERY ROOM TUBAL LIGATION SET

PRODUCT NUMBER	DESCRIPTION	FEATURES	QUANTITIES
06-2903	Scalpel Handles	#3	2
16-1510	Sklar Edge™ Mayo Dissecting Scissor	TC, Straight, 6¾"	1
16-2110	Sklar Edge™ Metzenbaum Scissor	TC, Curved, 7"	1
17-3055	Crile Forceps	Straight, 5½"	1
17-3155	Crile Forceps	Curved, 5½"	1
19-1060	Dressing Forceps	Serrated, 6"	1
19-1260	Tissue Forceps	1x2 Teeth, 6"	1
21-8007	TC Crile-Wood Needle Holder	Serrated, 7"	1
21-8032	TC Mayo-Hegar Needle Holder	Serrated, 7"	1
36-1677	Babcock Intestinal Forceps	8"	1
60-1676	Richardson Retractors	SklarGrip Handle, Small, 9½", 1" x ¾"	2
60-1681	Richardson Retractors	SklarGrip Handle, Medium, 9½", 1" x 1¼"	2

#### 98-1354 LAP BAND SET

PRODUCT NUMBER	DESCRIPTION	FEATURES	QUANTITIES
31-2238-45	Suction/Irrigation System	With 5mm Cannula, Dual Trumpet Valve	1
31-4565	Esophagus Retractor	5.5mm, 33 cm	1
31-9012XC-45	Metzenbaum Scissor	Curved, 5mm, 45 cm, Non-Ratchet Handle	1
31-9030XC-45	Maryland Dissector	5mm, 45 cm, Non-Ratchet Handle	1
31-9090XC-45	Fenestrated Grasper	5mm, 45 cm, Non-Ratchet Handle	1
31-9095XC-45	Fenestrated Grasper	5mm, 45 cm, Non-Ratchet Handle, Long Jaw	1



**98-1355 CHOLECYSTECTOMY SET**

PRODUCT NUMBER	DESCRIPTION	FEATURES	QUANTITIES
31-2227	Suction Control Valves	With Single Trumpet	2
31-2235	Spatula Electrode	With Suction, 5mm	1
31-2237	L Hook Electrode	With Suction, 5mm	1
31-2239	High Volume Suction Irrigation System	Dual Trumpet Value (5mm and 10mm), 33cm	1
31-2355	Needle For Injection & Irrigation	2mm Hollow Needle, 5mm, Luer Lock, 33cm	1
31-9005XC	Metzenbaum Scissor	Straight, 5mm, 33 cm, Non-Ratchet Handle	1
31-9010XC	Metzenbaum Scissor	Curved, 5mm, 33 cm, Non-Ratchet Handle	1
31-9015XC	Hook Scissor	5mm, 33 cm, Non-Ratchet Handle	1
31-9025XC	Micro Scissor	Curved, 5mm, 33 cm, Non-Ratchet Handle	1
31-9030XC	Maryland Dissector	5mm, 33 cm, Non-Ratchet Handle	1
31-9035XC	Mixer Forceps	Diamond Serrations, 5mm, 33cm, Non-Ratchet	1
31-9040XC	Dolphin Forceps	With Spoon, 5mm, 33cm, Non-Ratchet Handle	1
31-9050YC	Standard Grasping Forceps	5mm, 33cm, Ratchet Handle	1
31-9060YC	Wave Grasper	5mm, 33cm, Ratchet Handle	1
31-9100YC	Maxi (Fundus) Grasper	5mm, 33cm, Ratchet Handle	1
31-9125XC	Mixer Forceps	10mm, 33cm, Non-Ratchet Handle	1
31-9130XC	Claw Forceps	10mm, 33cm, Non-Ratchet Handle	1
31-9135XC	Spoon Forceps	10mm, 33cm, Non-Ratchet Handle	1

**98-1356 APPENDECTOMY SET**

PRODUCT NUMBER	DESCRIPTION	FEATURES	QUANTITIES
31-2239	High Volume Suction Irrigation System	Dual Trumpet Value (5mm and 10mm), 33 cm	1
31-2552	TC Needle Holder	Curved Left, 5mm, 33 cm	1
31-9010XC	Metzenbaum Scissor	Curved, 5mm, 33cm, Non-Ratchet Handle	1
31-9025XC	Micro Scissor	Curved, 5mm, 33 cm, Non-Ratchet Handle	1
31-9050YC	Standard Grasping Forceps	5mm, 33cm, Ratchet Handle	1
31-9085YC	Grasping Forceps	Pointed with Spoon, 5mm, 33 cm, Ratchet Handle	1
31-9100YC	Maxi (Fundus) Grasper	5mm, 33cm, Ratchet Handle	1
31-9125XC	Mixer Forceps	10mm, 33cm, Non-Ratchet Handle	1
31-9130XC	Claw Forceps	10mm, 33cm, Non-Ratchet Handle	1

**98-1357 BOWEL RESECTION SET**

PRODUCT NUMBER	DESCRIPTION	FEATURES	QUANTITIES
31-2227	Suction Control Valve	With Single Trumpet	1
31-2235	Spatula Electrode	With Suction, 5mm	1
31-2552	TC Needle Holder	Curved Left, 5mm, 33cm	1
31-9010XC	Metzenbaum Scissor	Curved, 5mm, 33cm, Non-Ratchet Handle	1
31-9025XC	Micro Scissor	Curved, 5mm, 33cm, Non-Ratchet Handle	1
31-9040XC	Dolphin Forceps	With Spoon, 5mm, 33cm, Non-Ratchet Handle	1
31-9051YC	Grasping Forceps	Tapered, 5mm, 33cm, Ratchet Handle	1
31-9067YC	Allis Forceps	5mm, 33cm, Ratchet Handle	1
31-9080YC	Grasping Forceps	With Spoon, 5mm, 33cm, Ratchet Handle	1
31-9095YC	Fenestrated Grasper	Long Jaw, 5mm, 33cm, Ratchet Handle	1
31-9140YC	Babcock Forceps	10mm, 33cm, Ratchet Handle	1

## SURGICAL INSTRUMENT SETS

### CARDIOVASCULAR



#### 98-1041 AV FISTULA SET

PRODUCT NUMBER	DESCRIPTION	FEATURES	QUANTITIES
06-2903	Scalpel Handles	#3	2
06-2907	Scalpel Handle	#7	1
10-1675	Medicine Cup	2oz., Graduated Measure	1
16-1510	Sklar Edge™ Mayo Dissecting Scissor	TC, Straight, 6¾"	1
16-1905	Sklar Edge™ Metzenbaum Lahey Scissor	TC, Delicate, Curved, 5¾"	1
17-1225	Micro-Mosquito Forceps	Curved, Delicate, 4¾"	6
17-1450	Halsted Mosquito Forceps	Straight, 5"	4
17-1550	Halsted Mosquito Forceps	Curved, 5"	10
17-2262	Rochester-Pean Forceps	Curved, 6¼"	4
17-2862	Rochester-Ochsner Forceps	Straight, 1x2 Teeth, 6¼"	2
17-3155	Crile Forceps	Curved, 5½"	10
21-8001	TC Halsey Needle Holder	Serrated, 5¼"	1
21-8006	TC Baby Crile-Wood Needle Holders	Serrated, 6"	2
21-8040	TC Castroviejo Needle Holders	Straight with Lock, 5½"	2
21-8087	TC DeBakey Cardiovascular Needle Holder	7"	1
22-8345	Weitlaner Retractor	2x3 Teeth, Blunt, 4½"	1
22-9027	Alm Retractor	4x4 Teeth, Blunt, 2¾"	1
23-2521	Sklarlite XD™ Mixter Forceps	Right Angle, 5½"	2
36-2160	Allis Tissue Forceps	4x5 Teeth, 6"	2
36-2790	Rochester-Pean Forceps	Curved, 9"	1
47-2572	Gillies Skin Hooks	4mm, 7"	2
47-2655	Blair-Rollet Retractors	4 Prong, Sharp, Delicate, 5½"	2
47-2852	Lorna-Edna Towel Clamps	5½"	2
50-2008	Frazier Suction Tube	8 French	1
50-3047	Adson Tissue Forceps	1x2 Teeth, 4¾"	2
50-3147	Adson Dressing Forceps	Serrated, 4¾"	2
51-4370	TC Potts-Smith Dressing Forceps	Serrated, 7"	1
52-2802	DeBakey Vascular Scissor	45° Angle, 7"	1
52-5162	DeBakey Atraumatic Forceps	2mm, 6¼"	2
52-6575	Bulldog DeBakey Atraumatic Forceps	Straight, 5"	2
52-6577	Bulldog DeBakey Atraumatic Forceps	Curved, 5"	2
52-6580	Bulldog DeBakey Atraumatic Forceps	Ring Handle, 45° Angle, 5"	2
52-6670	Garrett Vascular Dilator Set	8½", Set of 9	1
60-1085	US Army Retractor	Set of 2, Double End, 8¼"	1
60-1676	Richardson Retractors	SklarGrip Handle, Small, 9½", 1" x ¾"	2
60-6164	Senn Retractors	Double End, Blunt, 3 Prongs, 6¼"	2
64-1342	Stevens Tenotomy Scissor	Curved, Blunt/Blunt, 4½"	1
64-3142	Westcott Tenotomy Scissor	Right, Blunt, 5"	1
65-1842	Desmarres Lid Retractors	14mm	2
66-6852	Heparin Needle	Luer Lock, 3mm, 2½"	1
80-1410	Bozeman Forceps	Double Curved, 10¼"	1
98-4108	Diethrich Bulldog Clamps	Angled, 8mm	4

**98-1043 PACEMAKER SET**

PRODUCT NUMBER	DESCRIPTION	FEATURES	QUANTITIES
06-2903	Scalpel Handles	#3	2
06-2907	Scalpel Handle	#7	1
16-1510	Sklar Edge™ Mayo Dissecting Scissor	TC, Straight, 6¾"	1
16-1610	Sklar Edge™ Mayo Dissecting Scissor	TC, Curved, 6¾"	1
16-1905	Sklar Edge™ Metzenbaum Lahey Scissor	TC, Delicate, Curved, 5¾"	1
16-2110	Sklar Edge™ Metzenbaum Scissor	TC, Curved, 7"	1
17-1550	Halsted Mosquito Forceps	Curved, 5"	4
17-1762	Mixer Forceps	Right Angle, 6¼"	2
17-2262	Rochester-Pean Forceps	Curved, 6¼"	4
17-2862	Rochester-Ochsner Forceps	Straight, 1x2 Teeth, 6¼"	4
17-3055	Crile Forceps	Straight, 5½"	4
17-3155	Crile Forceps	Curved, 5½"	10
19-1060	Dressing Forceps	Serrated, 6"	2
19-1260	Tissue Forceps	1x2 Teeth, 6"	2
21-8001	TC Halsey Needle Holders	Serrated, 5¼"	2
21-8031	TC Mayo Hegar Needle Holders	Serrated, 6"	2
22-8255	Weitlaner Retractor	2x3 Teeth, Sharp, 4½"	1
23-2521	Sklarlite XD™ Mixer Forceps	Right Angle, 6½"	2
36-2160	Allis Tissue Forceps	4x5 Teeth, 6"	4
47-2955	Backhaus Towel Clamps	5¼"	2
50-1290	Cushing Vein Retractors	9"	2
50-1472	Adson Forceps	Curved, 7¼"	4
50-3047	Adson Tissue Forceps	1x2 Teeth, 4¾"	2
50-3147	Adson Dressing Forceps	Serrated, 4¾"	2
52-5162	Debakey Atraumatic Forceps	2mm, 6¼"	2
60-1085	US Army Retractor	Set of 2, Double End, 8¼"	1
60-1656	Kelly Retractors	9½", 2" x 1½"	2
60-1676	Richardson Retractors	SklarGrip Handle, Small, 9½", 1" x ¾"	2
60-5824	Volkman Retractors	Ring Handle, 4 Prongs, Sharp, 8½"	2
87-2195	Foerster Sponge Forceps	Straight, Serrated, 9½"	2

**98-1045 THORACTOMY SET I**

PRODUCT NUMBER	DESCRIPTION	FEATURES	QUANTITIES
06-2903	Scalpel Handles	#3	2
06-2907	Scalpel Handle	#7	1
06-2915	Scalpel Handle	#3L	1
16-1510	Sklar Edge™ Mayo Dissecting Scissor	TC, Straight, 6¾"	1
16-1610	Sklar Edge™ Mayo Dissecting Scissor	TC, Curved, 6¾"	1
16-2110	Sklar Edge™ Metzenbaum Scissor	TC, Curved, 7"	1
16-2310	Sklar Edge™ Metzenbaum Scissor	TC, Curved, 9"	1
16-2311	Sklar Edge™ Metzenbaum-Nelson Scissor	TC, Curved, 11"	1
17-1550	Halsted Mosquito Forceps	Curved, 5"	6
17-2262	Rochester-Pean Forceps	Curved, 6¼"	8
17-2280	Rochester-Pean Forceps	Curved, 8"	4
17-2862	Rochester-Ochsner Forceps	Straight, 1x2 Teeth, 6¼"	4
17-3055	Crile Forceps	Straight, 5½"	4
17-3155	Crile Forceps	Curved, 5½"	16

**SURGICAL INSTRUMENT SETS**



**CARDIOVASCULAR**

**98-1045 THORACTOMY SET I (CONTINUED)**

PRODUCT NUMBER	DESCRIPTION	FEATURES	QUANTITIES
19-1060	Dressing Forceps	Serrated, 6"	2
19-1080	Dressing Forceps	Serrated, 8"	2
19-1260	Tissue Forceps	1x2 Teeth, 6"	2
19-1280	Tissue Forceps	1x2 Teeth, 8"	2
19-2280	Russian Tissue Forceps	8"	2
21-8032	TC Mayo-Hegar Needle Holders	Serrated, 7"	2
21-8033	TC Mayo-Hegar Needle Holders	Serrated, 8"	2
21-8034	TC Mayo-Hegar Needle Holder	Serrated, 10½"	1
36-1677	Babcock Intestinal Forceps	8"	2
36-2160	Allis Tissue Forceps	4x5 Teeth, 6"	4
36-2275	Allis Tissue Forceps	5x6 Teeth, 7½"	2
36-2578	Duval Lung Forceps	1" Jaw, 8"	4
47-2852	Lorna-Edna Towel Clamps	5½"	2
47-2955	Backhaus Towel Clamps	5¼"	2
50-1290	Cushing Vein Retractors	9"	2
50-3047	Adson Tissue Forceps	1x2 Teeth, 4¾"	2
52-3310	Potts-Smith Dressing Forceps	Serrated, 10"	2
52-5177	DeBakey Atraumatic Forceps	2mm, 7¾"	2
52-5195	DeBakey Tissue Forceps	Straight, 2mm, 9½"	2
52-6624	DeBakey Atraumatic Tangential Clamp	10"	2
55-2892	Mixer Forceps	Right Angle, 9¼"	4
55-2898	Gemini Forcep	Right Angle, Delicate, 11"	4
60-1085	US Army Retractor	Set of 2, Double End, 8¼"	1
60-1661	Kelly Retractors	9½", 2" x 2½"	2
60-1676	Richardson Retractors	SklarGrip Handle, Small, 9½", 1" x ¾"	2
60-1681	Richardson Retractors	SklarGrip Handle, Medium, 9½", 1" x 1¼"	2
60-3615	Zalkind Ribbon Retractor	Malleable, 1½" x 13"	1
60-3620	Zalkind Ribbon Retractor	Malleable, 2" x 13"	1
60-7113	Balfour Retractor	2 Pair Interchangeable Arms, 10"	1
74-3075	Schmidt Tonsil Forceps	Half Curved Jaws, 7½"	3
87-2195	Foerster Sponge Forceps	Straight, Serrated, 9½"	3
90-2641	Bridge Forceps	Curved, Delicate, 11"	3

**98-1047 THORACTOMY SET II**

PRODUCT NUMBER	DESCRIPTION	FEATURES	QUANTITIES
55-1614	Bethune Rib Shears	14"	1
55-5980	Alexander Rasp	8"	1
55-6965	Doyen Rib Rasp	Right, 6½"	1
55-7065	Doyen Rib Rasp	Left, 6½"	1
55-7195	Davidson Spatula Retractor	Large, 3" x 3½"	1
55-7365	Bailey Rib Contractor	Child	1
55-7685	Finochietto Rib Spreader	Medium	1
55-7880	Burford-Finochietto Rib Spreader	Two Sets of Blades, 8" Spread	1

# SURGICAL INSTRUMENT SETS

## CARDIOVASCULAR



### 98-1057 BASIC OPEN HEART SET

PRODUCT NUMBER	DESCRIPTION	FEATURES	QUANTITIES
06-2903	Scalpel Handles	#3	2
06-2907	Scalpel Handle	#7	1
06-2915	Scalpel Handle	#3L	1
07-1805	Yankauer Suction Tube	Stainless Steel	1
07-1850	Cooley Suction Tube	8mm, 13¼"	1
11-1281	Utility Scissor	Serrated, Black, 7½"	1
15-3315	Sklarhone™ Metzenbaum Scissor	Smooth, Curved, 9"	1
16-1510	Sklar Edge™ Mayo Dissecting Scissor	TC, Straight, 6¾"	1
16-1610	Sklar Edge™ Mayo Dissecting Scissor	TC, Curved, 6¾"	1
16-2105	Sklar Edge™ Metzenbaum Scissor	TC, Curved, Blunt/Blunt, Delicate, 7"	1
16-2110	Sklar Edge™ Metzenbaum Scissor	TC, Curved, 7"	1
16-2310	Sklar Edge™ Metzenbaum Scissor	TC, Curved, 9"	1
17-1450	Halsted Mosquito Forceps	Straight, 5"	6
17-1550	Halsted Mosquito Forceps	Curved, 5"	6
17-2262	Rochester-Pean Forceps	Curved, 6¼"	6
17-2272	Rochester-Pean Forceps	Curved, 7¼"	6
17-2862	Rochester-Ochsner Forceps	Straight, 1x2 Teeth, 6¼"	8
17-3155	Crile Forceps	Curved, 5½"	12
17-3961	Vorse Tube Occluding Forceps	Serrated, 7"	6
19-1060	Dressing Forceps	Serrated, 6"	2
19-1260	Tissue Forceps	1x2 Teeth, 6"	2
19-1280	Tissue Forceps	1x2 Teeth, 8"	1
21-8010	TC Crile-Wood Needle Holders	Serrated, 10"	2
21-8015	TC Ryder Micro Needle Holders	Serrated, 8"	2
21-8031	TC Mayo Hegar Needle Holders	Serrated, 6"	2
21-8033	TC Mayo-Hegar Needle Holders	Serrated, 8"	2
21-9065	TC Sternal Wire Twisters	7"	2
23-2525	Sklarlite XD™ Mixer Forceps	Right Angle, 7¼"	1
36-2160	Allis Tissue Forceps	4x5 Teeth, 6"	8
36-2275	Allis Tissue Forceps	5x6 Teeth, 7½"	4
36-2578	Duval Lung Forceps	1" Jaw, 8"	2
36-2790	Rochester-Pean Forceps	Curved, 9"	2
40-1024	TC Pin Cutter	Angled, Double Action, 8½"	1
42-1875	Weitlaner Retractor	3x4 Teeth, Blunt, 8"	1
47-1180	Gerald Dressing Forceps	Straight, Serrated, 7"	2
47-2955	Backhaus Towel Clamps	5¼"	6
50-1290	Cushing Vein Retractors	9"	2
50-1472	Adson Forceps	Curved, 7¼"	4
50-1585	Adson Dura Hook	4mm, Blunt, 8"	1
50-2008	Frazier Suction Tube	8 French	1
50-3047	Adson Tissue Forceps	1x2 Teeth, 4¾"	2
52-1980	Patent Ductus Clamps	Straight, 8¼"	2
52-2073	Glover Coarctation Clamps	Angled, 10¼"	2
52-2845	Potts-Smith Scissor	Angled, 45° Angle, 7¼"	1
52-5177	DeBakey Atraumatic Forceps	2mm, 7¾"	2
52-5195	DeBakey Tissue Forceps	Straight, 2mm, 9½"	2
52-6614	DeBakey Atraumatic Vena Cava Clamp	Medium, 9¾"	1
52-6631	DeBakey Atraumatic Multi-Purpose Clamp	60° Angle, 10"	1
52-6634	DeBakey Atraumatic Multi-Purpose Clamp	60° Angle, 9½"	1

## SURGICAL INSTRUMENT SETS



## CARDIOVASCULAR

**98-1057 BASIC OPEN HEART SET (CONTINUED)**

PRODUCT NUMBER	DESCRIPTION	FEATURES	QUANTITIES
52-6652	DeBakey Derra Atraumatic Clamps	Medium, 6¾"	2
52-6778	Lambert-Kay Clamp	8"	1
52-6881	Harken Auricle Clamp	#1, 9½"	1
55-2892	Mixer Forceps	Right Angle, 9¼"	4
55-7685	Finochietto Rib Spreader	Medium	1
55-7990	Ankeney Sternal Retractor	Adult	1
57-1485	Green Retractors	Fenestrated, 8¼"	2
60-1695	Richardson-Eastman Retractor	Set of 3	1
87-2195	Foerster Sponge Forceps	Straight, Serrated, 9½"	2

**98-1059 VEIN SET**

PRODUCT NUMBER	DESCRIPTION	FEATURES	QUANTITIES
06-2903	Scalpel Handle	#3	1
16-2110	Sklar Edge™ Metzenbaum Scissor	TC, Curved, 7"	1
17-1550	Halsted Mosquito Forceps	Curved, 5"	10
19-1060	Dressing Forceps	Serrated, 6"	1
19-1260	Tissue Forceps	1x2 Teeth, 6"	1
21-8032	TC Mayo-Hegar Needle Holder	Serrated, 7"	1
42-1865	Weitlaner Retractor	3x4 Teeth, Blunt, 6½"	1
52-5162	Debakey Atraumatic Forceps	2mm, 6¼"	1
55-2894	Mixer Forceps	Right Angle, Longitudinal Serrations, 10½"	1
60-1085	US Army Retractor	Set of 2, Double End, 8¼"	1

DENTAL EXPLORERS



OCTAGONAL HANDLE - SINGLE END



OCTAGONAL HANDLE - DOUBLE END



AMALGAM PLUGGERS / CONDENSERS SINGLE END

PRODUCT NUMBER	TYPE	SIZE
49-0100	Black	1
49-0101	Black	2

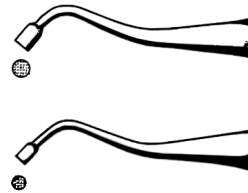

AMALGAM PLUGGERS / CONDENSERS DOUBLE END

PRODUCT NUMBER	TYPE	SIZE
49-0105	Andrews	1 / 2
49-0110	Back Action	11 / 12
49-0115	Behrman	1
49-0120	Black	0 / 1, Smooth
49-0125	Black	1 / 2, Smooth

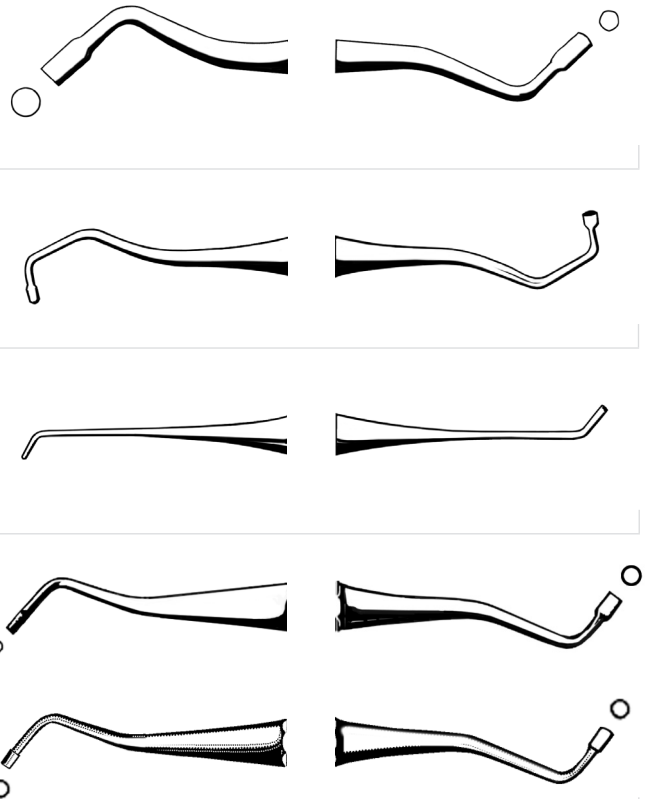

For a complete listing of our Dental product line, visit [www.sklarcorp.com](http://www.sklarcorp.com).

**AMALGAM PLUGGERS / CONDENSERS**

**DOUBLE END**

PRODUCT NUMBER	TYPE	SIZE		
49-0130	Black (Marquette)	0 / 1, Serrated		
48-321	Black (Marquette) Mid-Grade	0 / 1, Serrated		
49-0135	Black (Marquette)	1 / 2, Serrated		
49-0140	Hollenback	1, Smooth		
49-0145	Hollenback	2, Smooth		
49-0150	Hollenback	3, Smooth		
49-0155	Hollenback	4, Smooth		

**BURNISHERS**

**DOUBLE END, OCTAGONAL HANDLE**

PRODUCT NUMBER	TYPE	
49-0255	26 / 27S	
49-0260	27 / 29	
49-0265	28 / 29	
49-0270	University of Michigan 1	
49-0275	University of Michigan 2	

**For a complete listing of our Dental product line, visit [www.sklarcorp.com](http://www.sklarcorp.com).**



**BURNISHERS**

**SINGLE END, OCTAGONAL HANDLE**

PRODUCT NUMBER      TYPE

49-0200

2



49-0205

28



49-0210

29



49-0215

33



49-0220

34



**DOUBLE END, ROUND HANDLE**

PRODUCT NUMBER      TYPE

49-0225

18



49-0230

Ladmore 2



49-0235

Ladmore 3



49-0245

Acorn 21



49-0250

Acorn 21B



**DOUBLE END, OCTAGONAL HANDLE**

PRODUCT NUMBER      TYPE

49-0240

1



For a complete listing of our Dental product line, visit [www.sklarcorp.com](http://www.sklarcorp.com).



DENTAL  
EXCAVATORS

**EXCAVATORS**

**DOUBLE END, OCTAGONAL HANDLE**

PRODUCT NUMBER	TYPE	
49-0455	2, Glick	
49-0460	6	
49-0465	13	
49-0470	14	
49-0475	17	
49-0480	18	
49-0485	19	
49-0490	20	
49-0495	24	
49-0500	31L	

**EXCAVATORS**

**DOUBLE END, ROUND HANDLE**

PRODUCT NUMBER	TYPE	
49-0400	5	

For a complete listing of our Dental product line, visit [www.sklarcorp.com](http://www.sklarcorp.com).

DENTAL EXPLORERS



ROUND HANDLE – SINGLE END



OCTAGONAL HANDLE – SINGLE END



EXPLORERS

SINGLE END

PRODUCT NUMBER	TYPE	HANDLE	
49-0600	3	Round	
49-0605	3A	Round	
49-0610	3A	Octagonal	
49-0615	6	Octagonal	
49-0620	7	Octagonal	
49-0625	17	Round	
49-0630	17	Octagonal	
49-0635	23	Octagonal	
48-434	23, Mid-Grade	Round	

For a complete listing of our Dental product line, visit [www.sklarcorp.com](http://www.sklarcorp.com).

### ROUND HANDLE - DOUBLE END



### OCTAGONAL HANDLE - DOUBLE END



## EXPLORERS

### DOUBLE END

PRODUCT NUMBER	TYPE	HANDLE		
49-0640	1	Octagonal		
49-0645	2	Octagonal		
49-0650	3	Octagonal		
48-561	3, Mid-Grade	Round		
49-0655	3CH	Round		
49-0660	5	Round		
48-130	5, Mid-Grade	Round		
49-0665	5	Octagonal		
48-472	5, Mid-Grade	Octagonal		
49-0670	6	Octagonal		
49-0675	7	Octagonal		

For a complete listing of our Dental product line, visit [www.sklarcorp.com](http://www.sklarcorp.com).

**DENTAL  
PROBES / CHISELS**



**ROUND HANDLE – SINGLE END**



**OCTAGONAL HANDLE – SINGLE END**



**PROBES  
SINGLE END**

PRODUCT NUMBER	TYPE	HANDLE
49-0825	Williams 1-2-3-5-7-8-9-10mm	Round



49-0835	Coded Probe, 11 3-6-8-11mm, Color	Round
---------	--------------------------------------	-------



49-0840	Coded Probe, 12 3-6-9-12mm, Color	Round
---------	--------------------------------------	-------



**GARDNER CHISELS**

PRODUCT NUMBER	TYPE
49-3240	51



49-3245	52
---------	----



49-3250	53
---------	----











49-3255	54
---------	----



For a complete listing of our Dental product line, visit [www.sklarcorp.com](http://www.sklarcorp.com).

**PLASTIC FILLING INSTRUMENTS  
DOUBLE END**

PRODUCT NUMBER	TYPE	
49-0900	1	
49-0905	3	
49-0940	Ladmore 2	
49-0945	Ladmore 3	
49-0950	Smith Special	
49-0955	Woodson 1	
49-0960	Woodson 2	
49-0965	Woodson 3	
49-0970	W-3	

**For a complete listing of our Dental product line, visit [www.sklarcorp.com](http://www.sklarcorp.com).**

**P.K. THOMAS WAX PLACERS**

**DOUBLE END**

PRODUCT NUMBER

TYPE

49-1050

1



48-274

1, Mid-Grade

49-1055

2



48-278

2, Mid-Grade

49-1060

3



48-282

3, Mid-Grade

49-1065

4



48-288

4, Mid-Grade

49-1070

5



48-296

5, Mid-Grade

98-1480





1-5, Set of 5

**For a complete listing of our Dental product line, visit [www.sklarcorp.com](http://www.sklarcorp.com).**





**DENTAL  
CARVERS**

**CLEOID DISCOID CARVERS  
DOUBLE END, OCTAGONAL HANDLE**

PRODUCT NUMBER	TYPE	
49-1215	3 / 6	
49-1220	5T	
49-1225	89 / 92	
49-1230	90 / 93	
49-1235	Extra Large	

**HOLLENBACK CARVERS  
DOUBLE END**

PRODUCT NUMBER	TYPE	
49-1250	1 / 2	
49-1255	3	
48-228	3, Mid-Grade	
49-1260	3S	

For a complete listing of our Dental product line, visit [www.sklarcorp.com](http://www.sklarcorp.com).



**WALLS CARVERS**

**DOUBLE END**

PRODUCT NUMBER      TYPE

49-1280

1



49-1285

3



**WARD CARVERS**

**DOUBLE END**

PRODUCT NUMBER      TYPE

49-1290

1



49-1295

1S



49-1300

2



**VEHE PORCELAIN AND  
WAX CARVERS**

**DOUBLE END**

PRODUCT NUMBER      TYPE

49-1320

48-424

Mid-Grade



**ROACH PORCELAIN AND  
WAX CARVERS**

**DOUBLE END**

PRODUCT NUMBER      TYPE

49-1325

48-428

Mid-Grade



**For a complete listing of our Dental product line, visit [www.sklarcorp.com](http://www.sklarcorp.com).**

**LECRON PORCELAIN AND  
WAX CARVERS**

**DOUBLE END**

PRODUCT NUMBER	TYPE
49-1310	
48-422	Mid-Grade



**WAX SPATULAS**

**DOUBLE END**

PRODUCT NUMBER	TYPE
49-1350	5



49-1355	7
---------	---

48-542	7 Mid-Grade
--------	-------------

49-1360	7 Long
---------	--------



49-1365	7A
---------	----



49-1370	31
---------	----

48-572	31 Mid-Grade
--------	--------------



**For a complete listing of our Dental product line, visit [www.sklarcorp.com](http://www.sklarcorp.com).**

**CEMENT SPATULAS**

PRODUCT NUMBER	TYPE	
49-1800	5	
49-1805	7	
49-1810	11S	
49-1815	22	
49-1820	24	
48-526	24, Mid-Grade	
49-1825	24A	
48-524	24A, Mid-Grade	
49-1830	313	
49-1835	324	
48-538	324, Mid-Grade	
49-1840	Agathe 33	

For a complete listing of our Dental product line, visit [www.sklarcorp.com](http://www.sklarcorp.com).

**COLUMBIA CURETTES**

**DOUBLE END, ROUND HANDLE**

PRODUCT NUMBER	TYPE
49-2600	2L / 2R
49-2605	4L / 4R
49-2610	13 / 14



**McCALLS CURETTES**





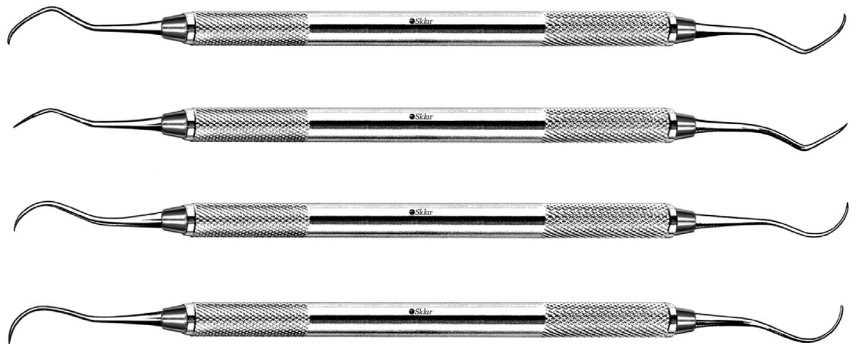



**DOUBLE END, ROUND HANDLE**

PRODUCT NUMBER	TYPE
49-2615	13 / 14
49-2620	13S / 14S
49-2625	17 / 18
49-2630	17S / 18S



**For a complete listing of our Dental product line, visit [www.sklarcorp.com](http://www.sklarcorp.com).**

**GRACEY CURETTES**  
**DOUBLE END, ROUND HANDLE**

PRODUCT NUMBER	TYPE	
49-2635	1 / 2	
49-2640	3 / 4	
49-2645	5 / 6	
49-2650	7 / 8	
49-2655	9 / 10	
49-2660	11 / 12	
49-2665	13 / 14	
49-2670	15 / 16	
49-2675	17 / 18	

For a complete listing of our Dental product line, visit [www.sklarcorp.com](http://www.sklarcorp.com).

**DENTAL  
SCALERS**



**CRANE-KAPLAN SCALER**  
DOUBLE END, ROUND HANDLE

PRODUCT NUMBER      TYPE

49-2700                      6



**GOLDMAN-FOX SCALERS**  
DOUBLE END, ROUND HANDLE

PRODUCT NUMBER      TYPE

49-2705                      1



49-2710                      2



49-2715                      3



49-2720                      4



49-2725                      5



49-2730                      6



**TOWNER SCALER**  
DOUBLE END, ROUND HANDLE

PRODUCT NUMBER      TYPE

49-2905                      U15 / 30



**TAYLOR SCALER**  
DOUBLE END, ROUND HANDLE

PRODUCT NUMBER      TYPE

49-2910                      2 / 3



For a complete listing of our Dental product line, visit [www.sklarcorp.com](http://www.sklarcorp.com).

**JACQUETTE SCALERS**  
**DOUBLE END, OCTAGONAL HANDLE**

PRODUCT NUMBER	TYPE
49-2800	1S / 1S
49-2805	1Y / 1Y
49-2810	1Y / 1YS
49-2815	2Y / 3Y
49-2820	2YS / 3YS
49-2825	2 / 3
49-2830	2S / 3S
49-2835	30 / 33
49-2840	31 / 32
49-2845	34 / 35

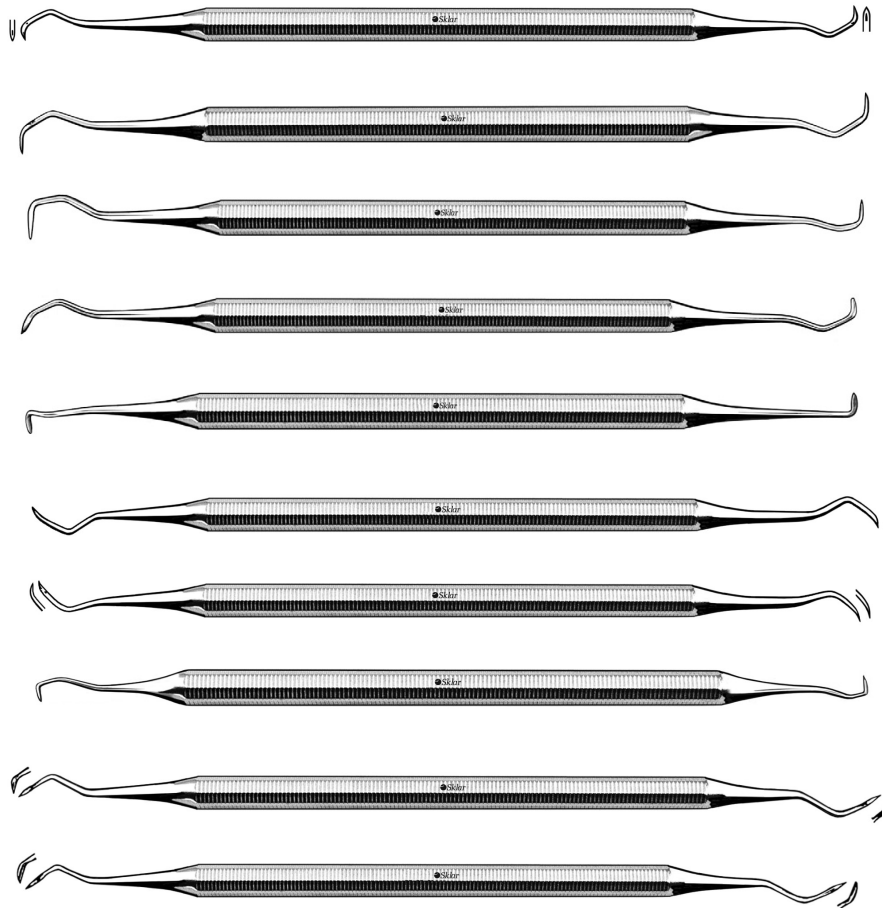

**JACQUETTE SCALERS**  
**SINGLE END, OCTAGONAL HANDLE**

PRODUCT NUMBER	TYPE
49-2870	1
49-2875	1S
49-2880	2S
49-2885	3S

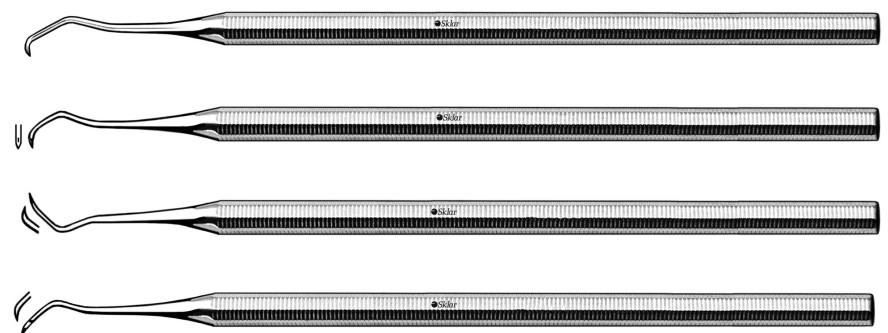

For a complete listing of our Dental product line, visit [www.sklarcorp.com](http://www.sklarcorp.com).



**DENTAL  
SCALERS**

**YOUNGER SCALER  
DOUBLE END, ROUND HANDLE**

PRODUCT NUMBER      TYPE

49-2930	7 / 8
---------	-------



**SCALERS  
DOUBLE END, OCTAGONAL HANDLE**

PRODUCT NUMBER      TYPE

49-2940	204
---------	-----



49-2945	204S
---------	------



49-2950	204SD
---------	-------



49-2955	H6 / H7
---------	---------



49-2960	12
---------	----



**SCALERS  
SINGLE END, OCTAGONAL HANDLE**

PRODUCT NUMBER      TYPE

49-2965	3
---------	---



49-2970	33
---------	----



49-2975	34
---------	----



For a complete listing of our Dental product line, visit [www.sklarcorp.com](http://www.sklarcorp.com).



**GOLDMAN-FOX KNIVES**

**DOUBLE END, ROUND HANDLE**

PRODUCT NUMBER	TYPE
49-3000	7
49-3005	8
49-3010	9
49-3015	10
48-922	10, Mid-Grade
49-3020	11
49-3025	21

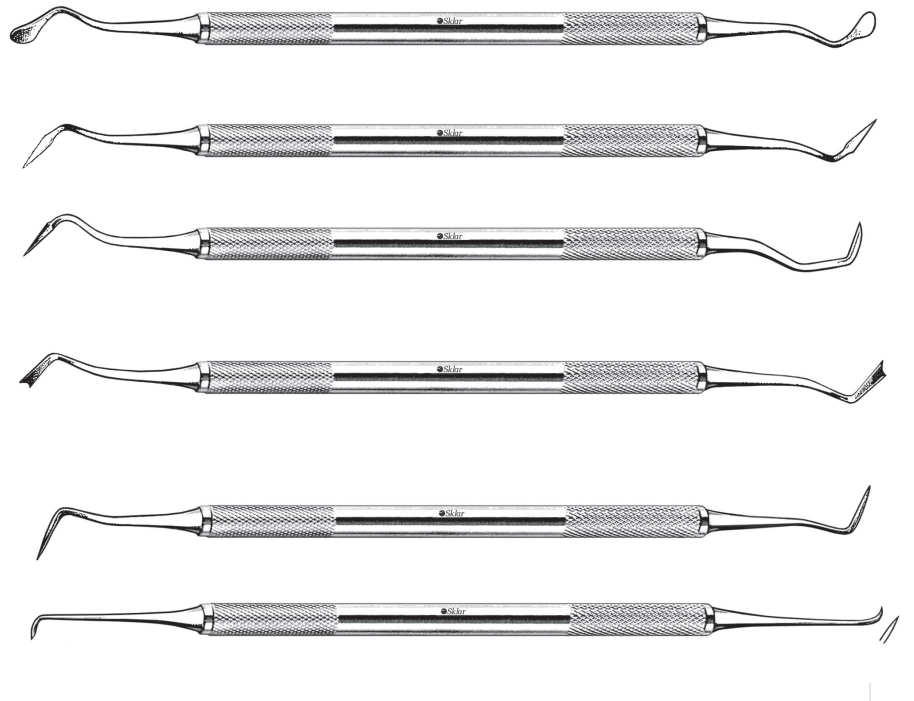

**ORBAN KNIFE**

**DOUBLE END**

PRODUCT NUMBER	TYPE
49-3055	1 / 2



For a complete listing of our Dental product line, visit [www.sklarcorp.com](http://www.sklarcorp.com).

DENTAL  
KNIVES



**BUCK KNIFE**  
**DOUBLE END**

PRODUCT NUMBER      TYPE

49-3060                  5 / 6



**KIRKLAND KNIFE**  
**DOUBLE END**

PRODUCT NUMBER      TYPE

49-3065                  15 / 16



**AKERS / EVANS KNIFE AND SPOON WITH HANDLE**  
**CONE SOCKET**

PRODUCT NUMBER      TYPE

49-3080                  Akers Complete Set

49-3081                  Akers Knife Only

49-3082                  Akers Spoon Only

49-3083                  Double End Handle  
Only



PRODUCT NUMBER      TYPE

49-3084                  Evans Complete Set

49-3085                  Evans Knife Only

49-3086                  Evans Spoon Only

49-3083                  Double End Handle  
Only



For a complete listing of our Dental product line, visit [www.sklarcorp.com](http://www.sklarcorp.com).

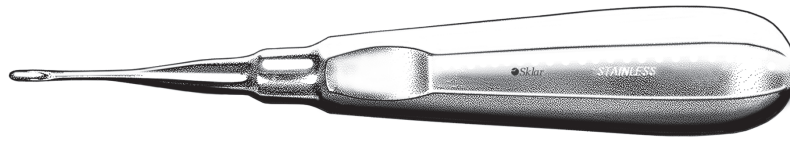

**ELEVATORS**

**APICAL**

PRODUCT NUMBER      TYPE

49-3640

301



49-3645

302



49-3650

303



49-3655

304



**SELDIN**

PRODUCT NUMBER      TYPE

49-3665

1L



49-3670

1R



49-3675

4L



49-3680

4R



**COGSWELL**

PRODUCT NUMBER      TYPE

49-3725

A



For a complete listing of our Dental product line, visit [www.sklarcorp.com](http://www.sklarcorp.com).

DENTAL  
GENERAL

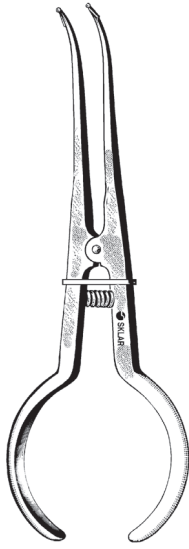

**RUBBER DAM FORCEPS**  
UNIVERSITY OF WASHINGTON  
49-1005  
48-236 Mid-Grade

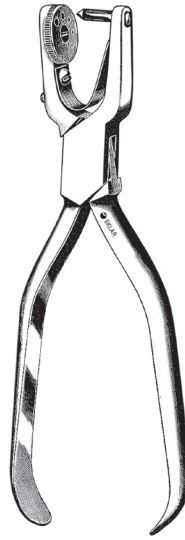

**RUBBER DAM PUNCH**  
W TYPE  
49-1030

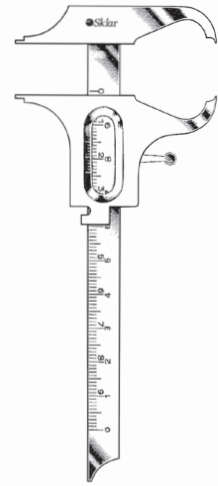

**BOLEY GAUGE**  
49-1605  
48-202 Mid-Grade



**MILLER GROOVELOK**  
**ARTICULATING PAPER FORCEPS**  
GROOVED TIPS  
49-1590  
48-388 Mid-Grade

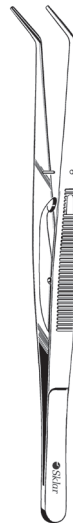

**SELF-LOCKING**  
**COLLEGE PLIERS**  
GROOVED  
49-1700  
48-378 Mid-Grade

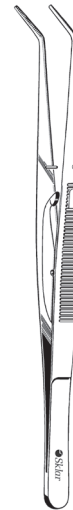

**SELF-LOCKING**  
**COLLEGE PLIERS**  
SERRATED  
49-1705  
48-128 Mid-Grade

For a complete listing of our Dental product line, visit [www.sklarcorp.com](http://www.sklarcorp.com).



**MERIAM PLIER 318**  
SERRATED  
49-1710



**PERRY PLIERS 312**  
SERRATED  
49-1720  
48-315 Mid-Grade



**COLLEGE PLIERS**  
**#317A, EXTRA FINE SERRATIONS**  
49-1750  
48-318 Mid-Grade  
**#317B, EXTRA FINE SERRATIONS, LONG**  
49-1755  
48-322 Mid-Grade



**NON-PINCH COLLEGE PLIERS**  
49-1760 Smooth  
49-1765 Serrated



**NON-PINCH COLLEGE PLIERS 49**  
SERRATED  
49-1770  
48-350 Mid-Grade



**TC HOW PLIER 110**  
49-1905

For a complete listing of our Dental product line, visit [www.sklarcorp.com](http://www.sklarcorp.com).

DENTAL  
PLIERS



**WIRE BENDING PLIERS 101**

49-1915  
48-796 Mid-Grade

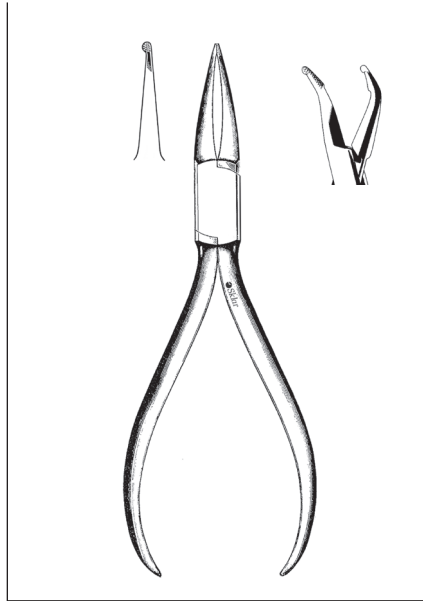

**HOW PLIERS 110**

**SERRATED**  
49-1930 Straight  
48-355 Straight, Mid-Grade  
49-1935 Angled

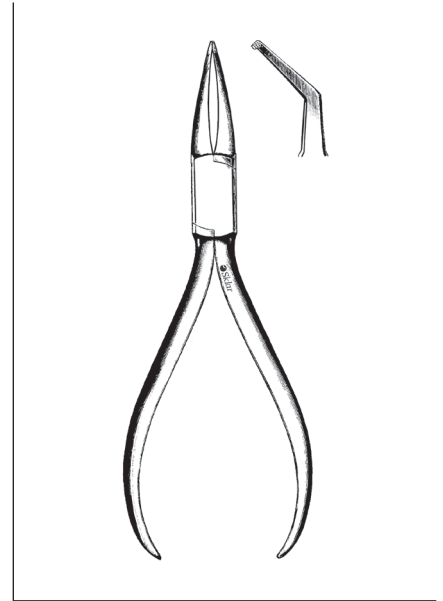

**HOW PLIERS 111**

**CURVED, SERRATED**  
49-1940  
48-356 Mid-Grade

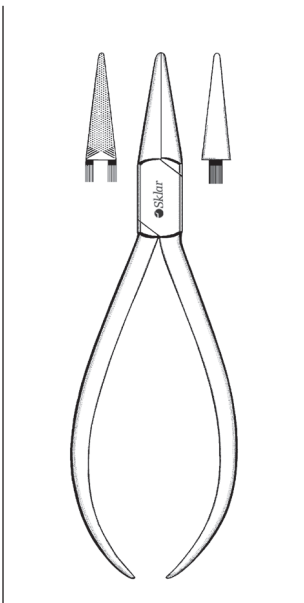

**GOSLEE CONTOURING PLIERS 136**

49-1990  
48-507 Mid-Grade



**GORDON CONTOURING PLIERS 137**

49-2000  
48-533 Mid-Grade  
49-2005 Chrome

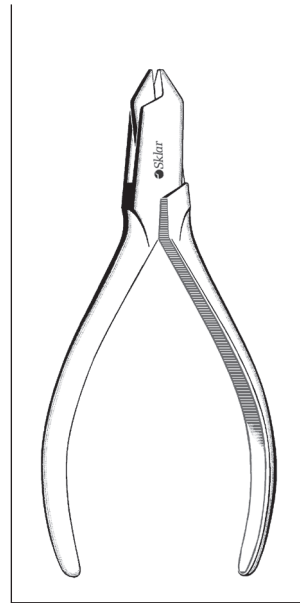

**CLASP ADJUSTING PLIERS 200**

49-2040  
48-738 Mid-Grade  
49-2045 Chrome

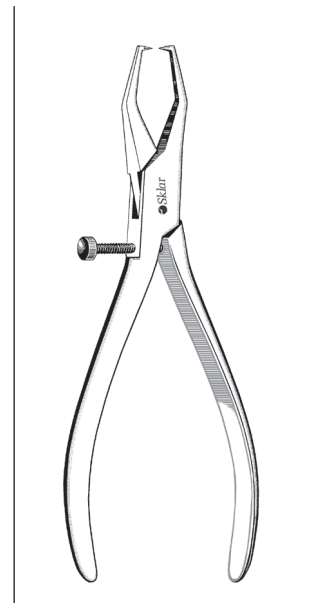

**BAADE CROWN & BAND REMOVING PLIERS 255**

49-2050  
48-835 Mid-Grade

For a complete listing of our Dental product line, visit [www.sklarcorp.com](http://www.sklarcorp.com).

**DENTAL  
ORTHODONTIC PLIERS**

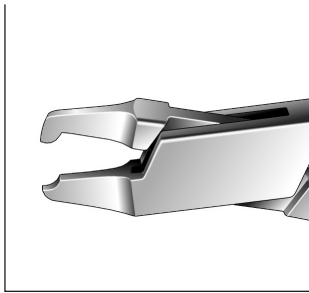

**BAND CRIMPING PLIER**  
49-2080

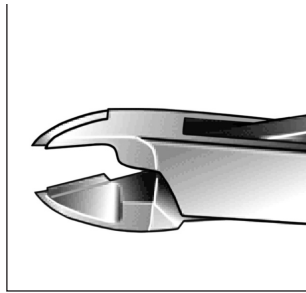

**BAND SLITTING PLIER**  
49-2085

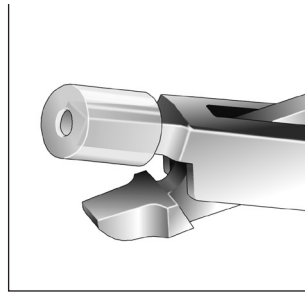

**BAND REMOVING  
PLIER**  
49-2090 Anterior



**BAND REMOVING  
PLIER 347**  
49-2100 Posterior



**BAND REMOVING  
PLIER**  
49-2095 Posterior

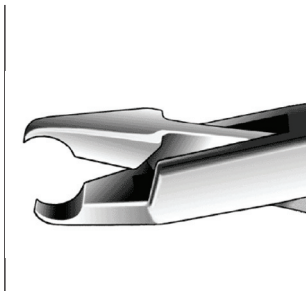

**BRACKET REMOVING  
PLIER**  
49-2105 Straight

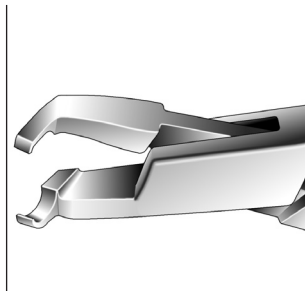

**BRACKET REMOVING  
PLIER**  
49-2110 60° Angle

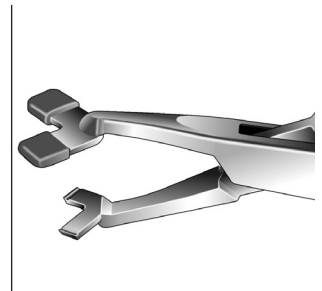

**BRACKET & BAND  
REMOVING PLIER**  
49-2115 Double Sided

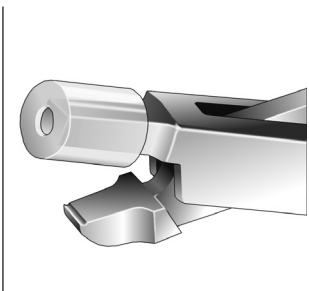

**BRACKET & ADHESIVE  
REMOVING PLIER**  
49-2120 Concave Lower Beak

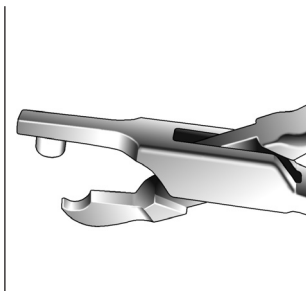

**BRACKET & ADHESIVE  
REMOVING PLIER**  
49-2125 Nylon Tipped  
Upper Beak

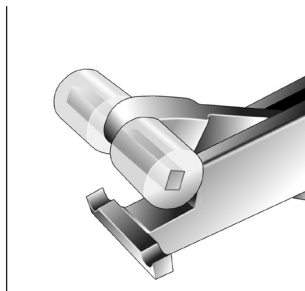

**BRACKET & ADHESIVE  
REMOVING PLIER**  
49-2130 Replaceable  
Vinyl Tips

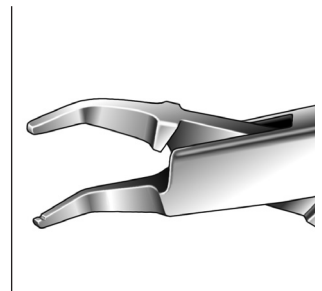

**LINGUAL ARCH  
REMOVING PLIER**  
49-2135

For a complete listing of our Dental product line, visit [www.sklarcorp.com](http://www.sklarcorp.com).

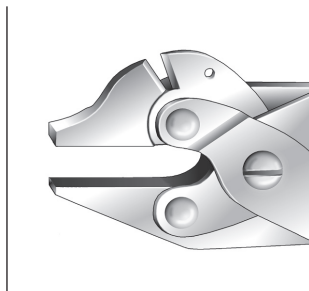

**BERNARD FACEBOW  
PLIER**  
49-2140 With Cutter

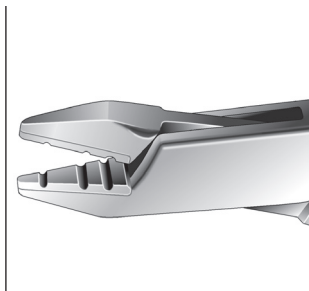

**FACEBOW ADJUSTING  
PLIER**  
49-2145 Narrow

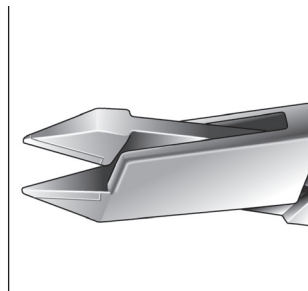

**ADAMS PLIER**  
49-2150

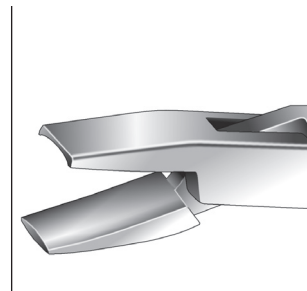

**ARCH FORMING PLIER**  
49-2155

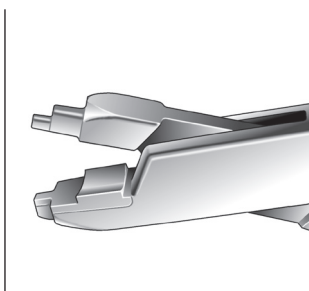

**HAWLEY RETAINER  
FORMING PLIER**  
49-2160 Non-Holding

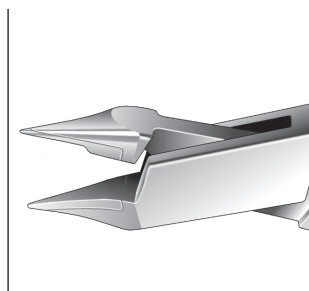

**LIGHT WIRE FORMING  
PLIERS**  
49-2165  
49-2170 With Cutter

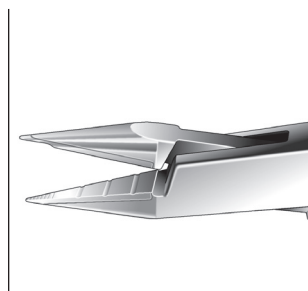

**JARABAK PLIER**  
49-2175 Three Grooves

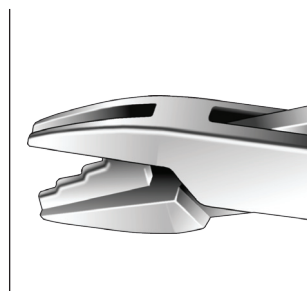

**FOUR STEP LOOP  
FORMING PLIER**  
49-2180 Automatic

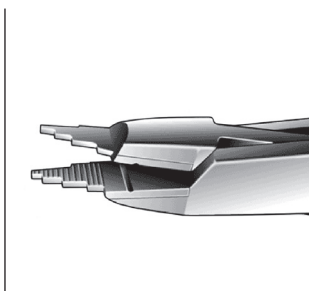

**FOUR STEP LOOP  
FORMING PLIER**  
49-2185

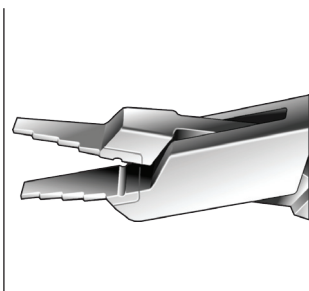

**LOOP FORMING  
& CLOSING PLIER**  
49-2190

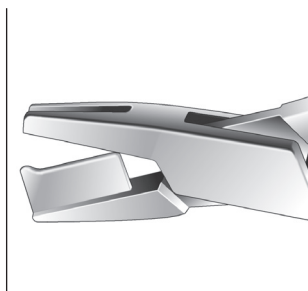

**LIGATURE FORMING  
PLIER**  
49-2195

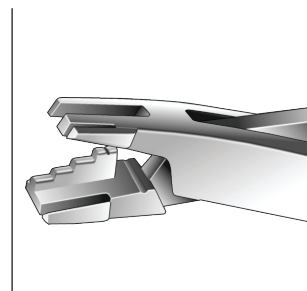

**LOOP TIE BACK PLIER**  
49-2200

For a complete listing of our Dental product line, visit [www.sklarcorp.com](http://www.sklarcorp.com).



**DENTAL  
ORTHODONTIC PLIERS**

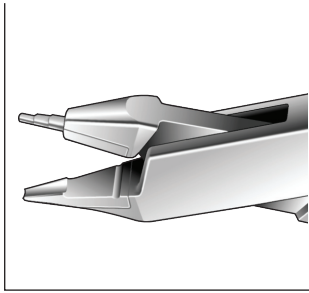

**TWEED LOOP &  
HELIX FORMING PLIER**  
49-2205

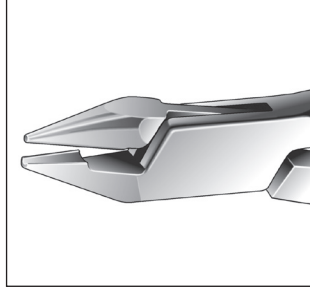

**OPTICAL PLIER**  
49-2210

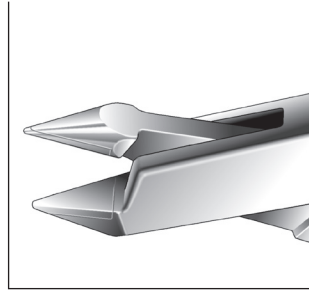

**BIRD BEAK BENDING  
PLIER**  
49-2215

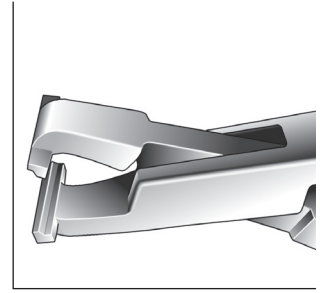

**BAYONET BENDING  
PLIERS**  
49-2220 .5mm  
49-2225 .75mm  
49-2230 1mm

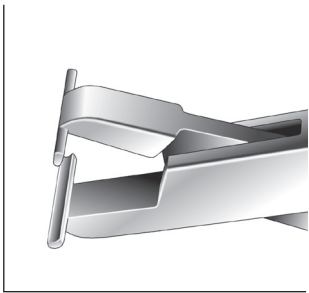

**STEP BENDING PLIER**  
49-2235

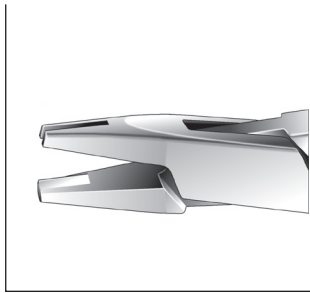

**STOP PLIER**  
49-2240

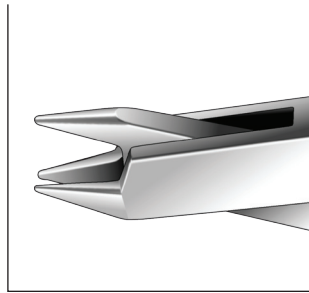

**THREE PRONG  
ADJUSTING  
PLIER**  
49-2245 Small Tips

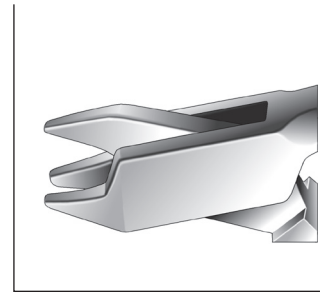

**THREE PRONG  
ADJUSTING  
PLIER**  
49-2250 With Clasp

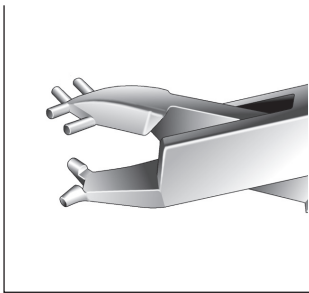

**THREE JAW OFFSET  
PLIER**  
49-2255

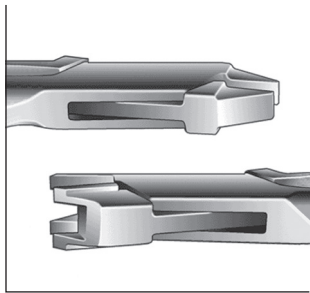

**TORQUING PLIER SET**  
49-2260 Keyless

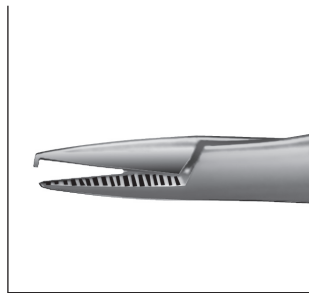

**MATHIEU ELASTICS  
INSERTING PLIER**  
49-2265 Hook Tip

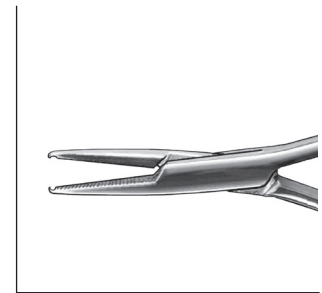

**MATHIEU ELASTICS  
INSERTING PLIER**  
49-2270 Grooved Tip

For a complete listing of our Dental product line, visit [www.sklarcorp.com](http://www.sklarcorp.com).



DENTAL  
ORTHODONTIC PLIERS

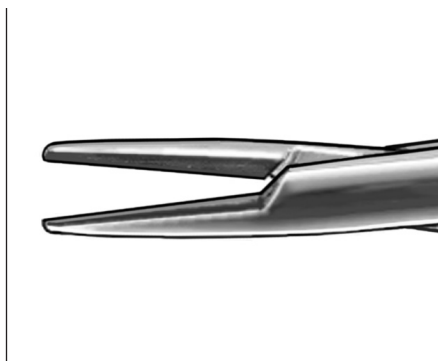

**MATHIEU ELASTICS  
INSERTING PLIER**  
49-2275 Ligating



**WEINGART UTILITY PLIER**  
49-2280 Narrow

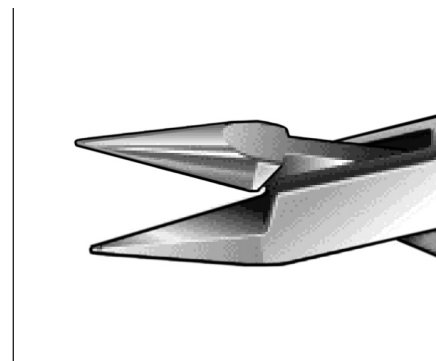

**ELASTICS INSERTING PLIER**  
49-2285 Grooved Tip

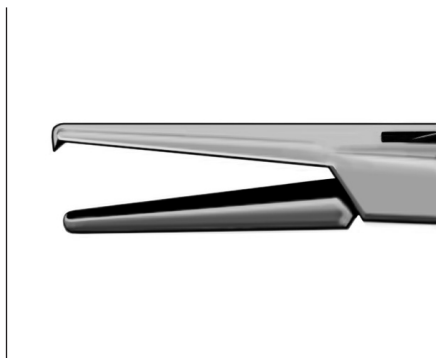

**ELASTICS INSERTING PLIER**  
49-2290 Hook Tip

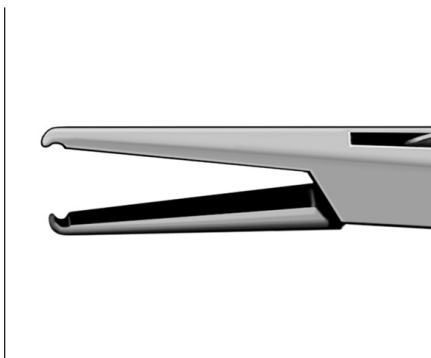

**ELASTICS INSERTING PLIER**  
49-2295 Grooved Tip

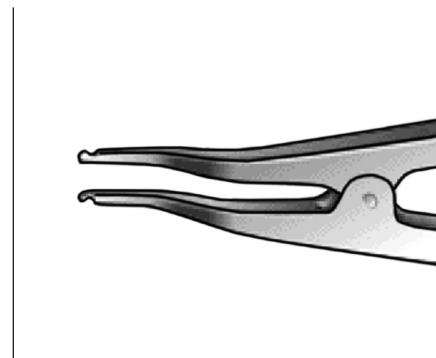

**ELASTOMERIC SEPARATING PLIER**  
49-2300

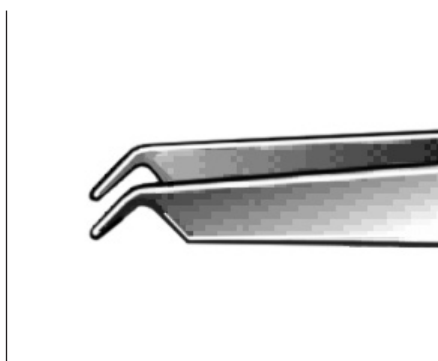

**BRACKET PLACEMENT PLIER**  
49-2305 Hook Tip

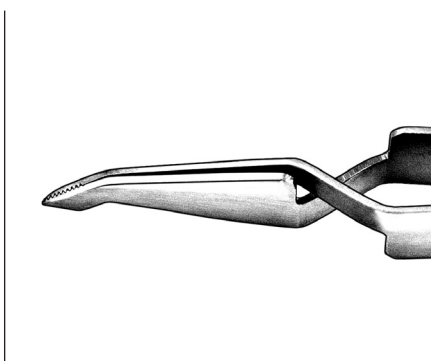

**BRACKET PLACEMENT PLIER**  
49-2310 Curved

For a complete listing of our Dental product line, visit [www.sklarcorp.com](http://www.sklarcorp.com).

# DENTAL ORTHODONTIC WIRE CUTTERS

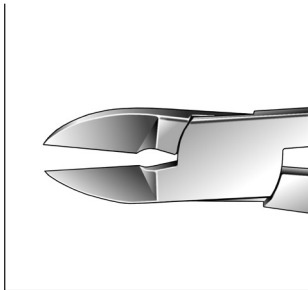

**HARD WIRE CUTTER**  
**CHROME**  
49-2460 Angled

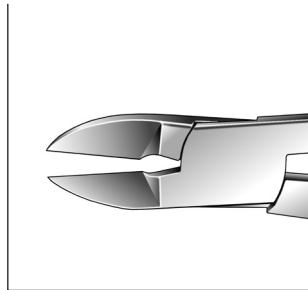

**HARD WIRE CUTTER**  
**TUNGSTEN CARBIDE INSERTS**  
49-2400 Straight

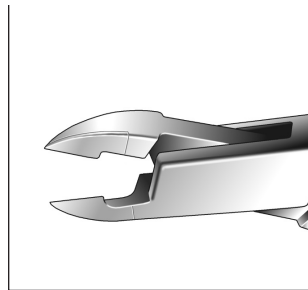

**PIN & LIGATURE**  
**WIRE CUTTERS**  
**TUNGSTEN CARBIDE INSERTS**  
49-2405 Straight  
49-2410 Straight, Small

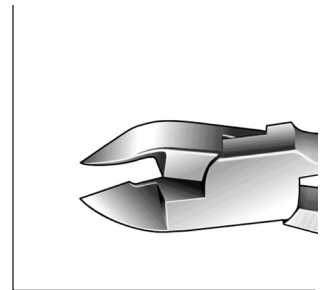

**PIN & LIGATURE**  
**WIRE CUTTER**  
49-2415 Small, For Soft Wire  
Only

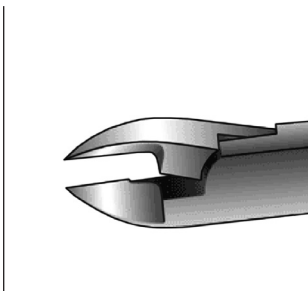

**PIN & LIGATURE**  
**WIRE CUTTER**  
49-2420 Long for Soft Wire  
Only

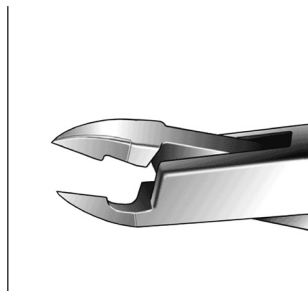

**PIN & LIGATURE**  
**WIRE CUTTER**  
49-2425 15° Angle for Soft Wire  
Only



**PIN & LIGATURE**  
**WIRE CUTTER**  
49-2430 Angled

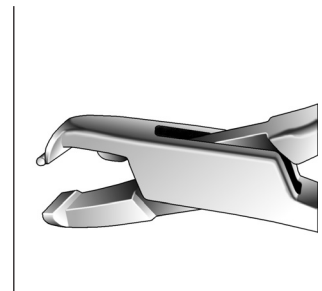

**DISTAL END CUTTERS**  
**CUT AND HOLD**  
49-2435 Flush Cut  
49-2440 Flush Cut Small  
49-2445 Long Handle

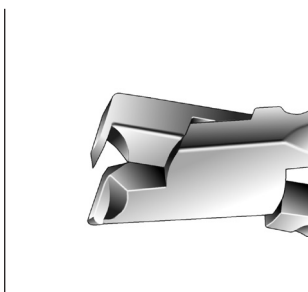

**DISTAL END CUTTER**  
**NON-HOLDING**  
49-2450

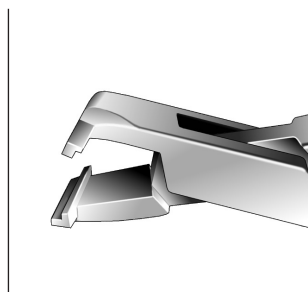

**SHEAR DISTAL END**  
**CUTTER**  
49-2455 With Safety Hold

For a complete listing of our Dental product line, visit [www.sklarcorp.com](http://www.sklarcorp.com).



EXTRACTING FORCEPS



**EXTRACTING  
FORCEPS 16**  
HOOK HANDLE  
49-4055  
48-264 Mid-Grade



**EXTRACTING  
FORCEPS 17**  
STRAIGHT HANDLE  
49-4060  
48-289 Mid-Grade



**EXTRACTING FORCEPS  
UPPER FIRST AND SECOND MOLAR**  
49-4075 18L  
48-752 18L, Mid-Grade  
49-4080 18R



**EXTRACTING  
FORCEPS 23**  
STRAIGHT HANDLE  
49-4095  
48-276 Mid-Grade

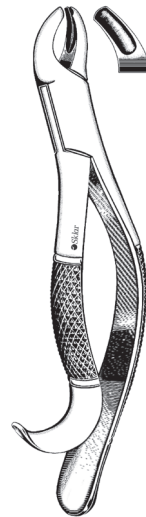

**EXTRACTING  
FORCEPS 24**  
HOOK HANDLE  
49-4100  
48-226 Mid-Grade

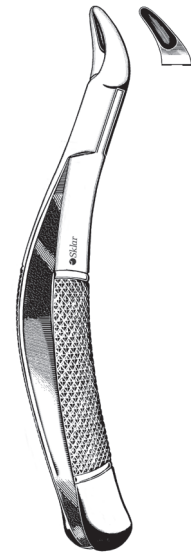

**EXTRACTING FORCEPS 62**  
49-4160  
48-339 Mid-Grade

For a complete listing of our Dental product line, visit [www.sklarcorp.com](http://www.sklarcorp.com).

**DENTAL  
EXTRACTING FORCEPS**

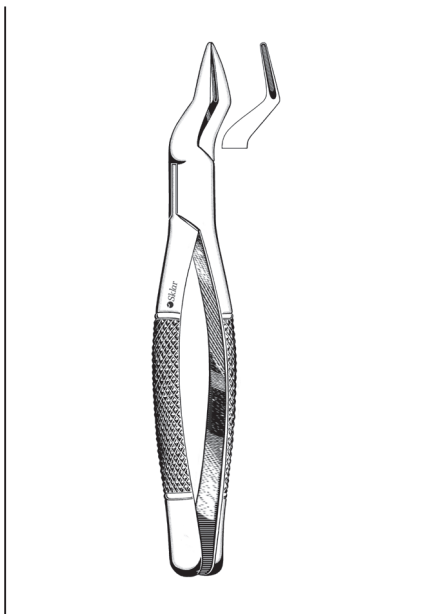

**EXTRACTING FORCEPS 65**

49-4165  
48-204 Mid-Grade

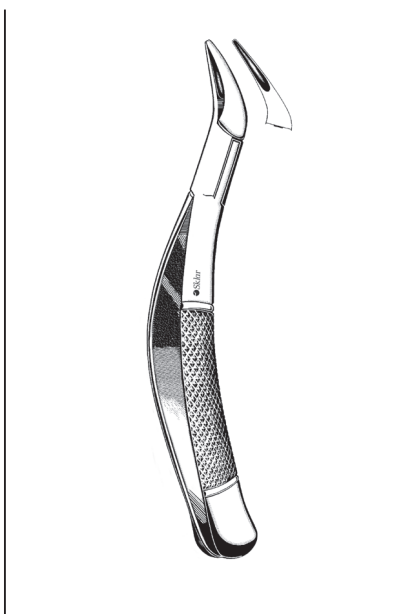

**EXTRACTING FORCEPS 69**

49-4170  
48-351 Mid-Grade

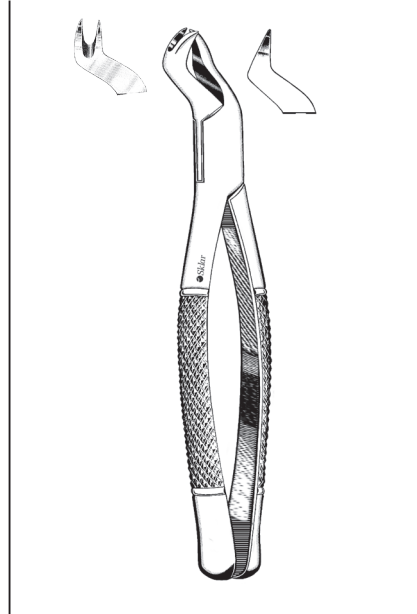

**EXTRACTING FORCEPS**

49-4220 88L  
48-252 88L, Mid-Grade  
49-4225 88R

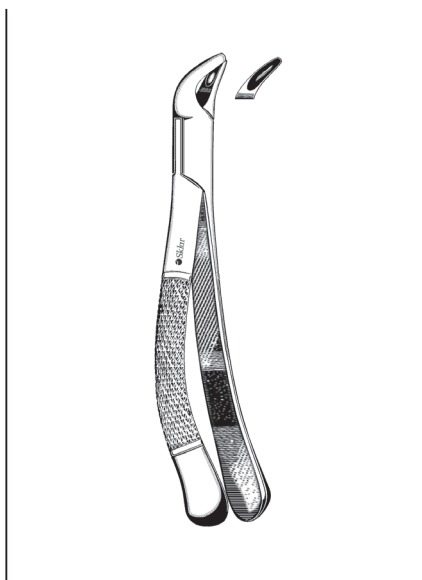

**EXTRACTING FORCEPS 151**

49-4280  
48-327 Mid-Grade

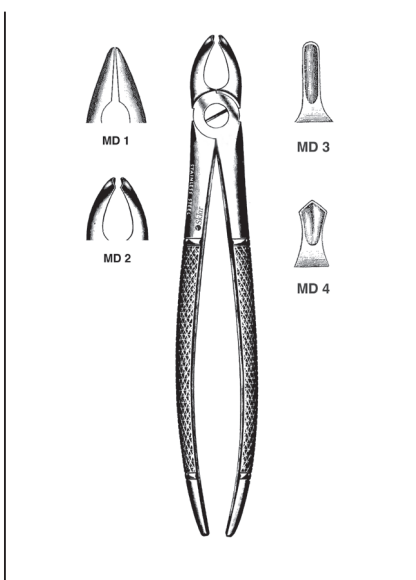

**MEAD EXTRACTING FORCEPS  
ENGLISH PATTERN**

49-4355 MD1  
49-4360 MD2  
49-4365 MD3  
48-109 MD3 Mid-Grade  
49-4370 MD4

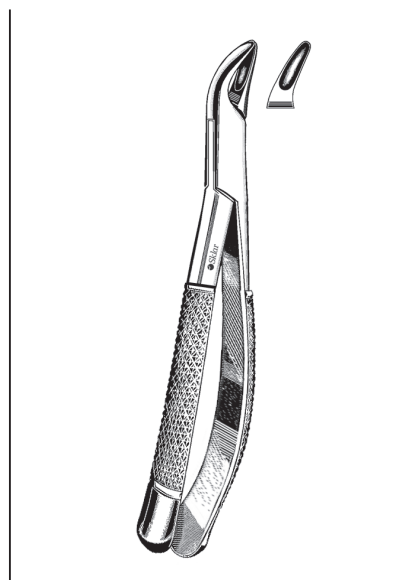

**CHILDRENS EXTRACTING  
FORCEPS 150S**

49-4430  
48-363 Mid-Grade

**For a complete listing of our Dental product line, visit [www.sklarcorp.com](http://www.sklarcorp.com).**

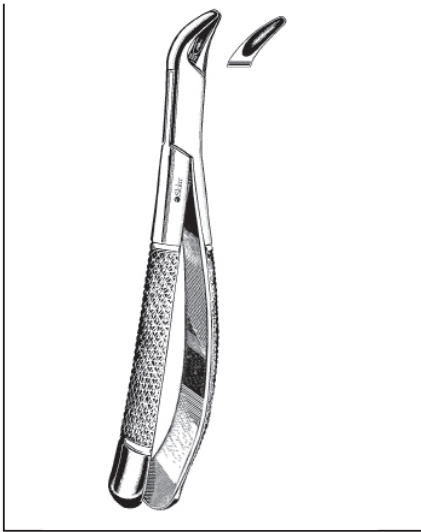

**CHILDRENS EXTRACTING  
FORCEPS 151S**

49-4440  
48-375 Mid-Grade

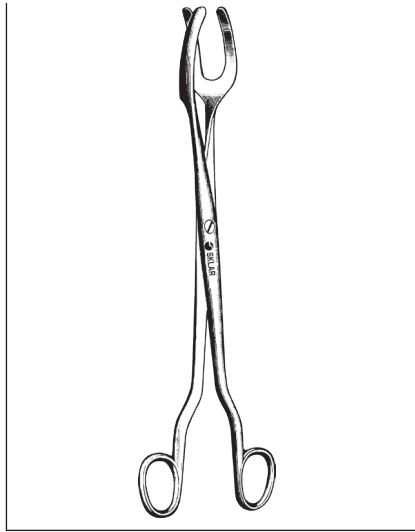

**STERILIZATION FORCEPS**

**3 PRONG, 8"**  
10-1280  
48-761 Mid-Grade



**DOYEN-JANSEN (MOLT)  
MOUTH GAGS**

**WITH CUSHIONS**  
22-8945 4" Child  
75-1025 5½" Adult  
**MID-GRADE**  
48-774 4" Child  
48-785 5½" Adult  
**REPLACEMENT CUSHIONS**  
22-8946 2/pk Child  
75-1026 2/pk Adult

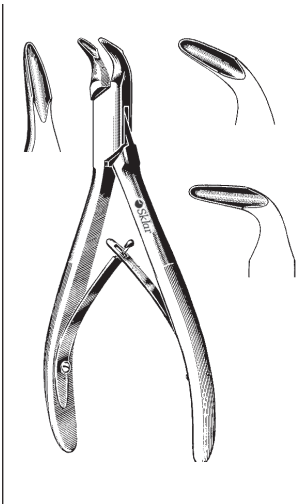

**BLUMENTHAL  
RONGEURS**

67-5990 6" 30° Angle  
67-5991 7" 30° Angle  
67-5992 6" 45° Angle  
67-5994 6" 90° Angle

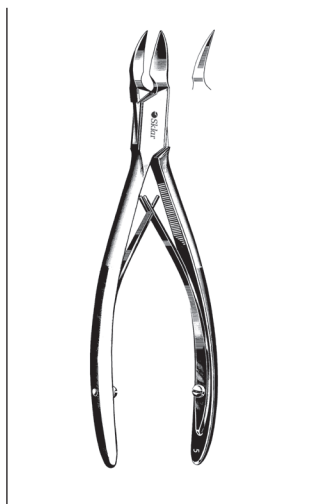

**CLEVELAND RONGEURS**  
**SIDE CUTTING, SLIGHTLY CURVED**

40-3196 5S 5¾"  
40-3198 5 6½"

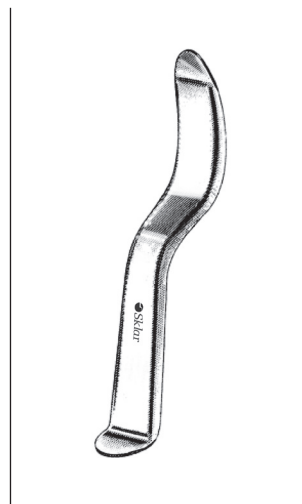

**UNIVERSITY OF  
MINNESOTA CHEEK  
RETRACTORS**

**DOUBLE END**  
75-1120 6"  
48-489 6" Mid-Grade

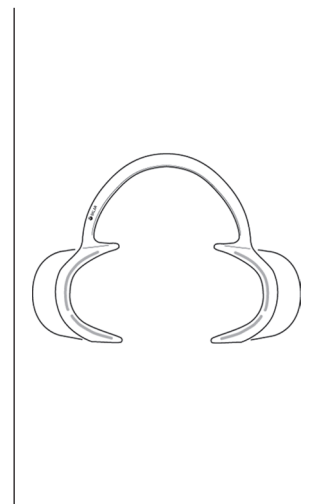

**CHEEK RETRACTORS**  
**CLEAR PLASTIC**

75-1141 Small, Set of 2  
75-1140 Large, Set of 2

For a complete listing of our Dental product line, visit [www.sklarcorp.com](http://www.sklarcorp.com).

# DENTAL ACCESSORIES



## ALLIGATOR NAPKIN CLIPS

PRODUCT NUMBER	FEATURES
49-3170	With Plastic Guard, Assorted Colors
49-3175	With Plastic Guard, Black
49-3180	Without Plastic Guard



## TOOTHBRUSHES

PRODUCT NUMBER	FEATURES	QUANTITIES
96-2445	Pre-Pasted	144/cs
96-2447	Junior	144/cs



## PLASTIC DENTAL MIRRORS

### STERILE

PRODUCT NUMBER	FEATURES	QUANTITIES
96-7887	1/2"	50/cs

### NON-STERILE

96-2452	1/2"	144/cs
---------	------	--------



## HINGED APPLIANCE CASES

### VENTED, ASSORTED COLORS

PRODUCT NUMBER	FEATURES	QUANTITIES
96-3290	Regular	25/pk
96-3292	Regular, Economy	50/pk
96-3291	Large	25/pk



## LIP RETRACTORS

PRODUCT NUMBER	FEATURES	QUANTITIES
96-3298	Child	2/pk
96-3299	Adult	2/pk
96-3300	Universal	2/pk

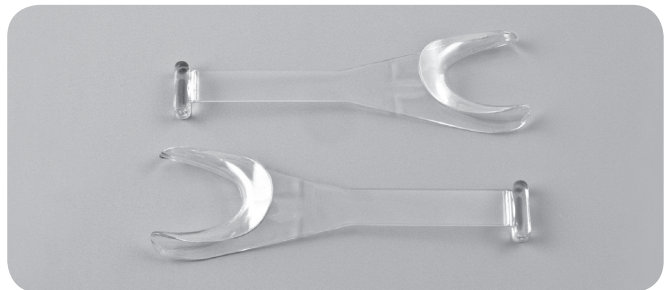

## TONGUE SHIELDS

PRODUCT NUMBER	FEATURES	QUANTITIES
96-3301	Small	3/pk
96-3302	Medium	3/pk
96-3303	Large	3/pk
96-3304	Extra Large	3/pk

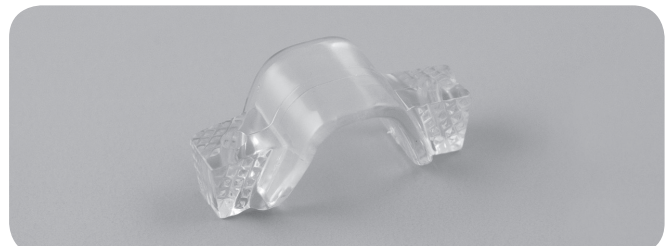



SURGI-OR™

MID-GRADE

SURGI-OR™

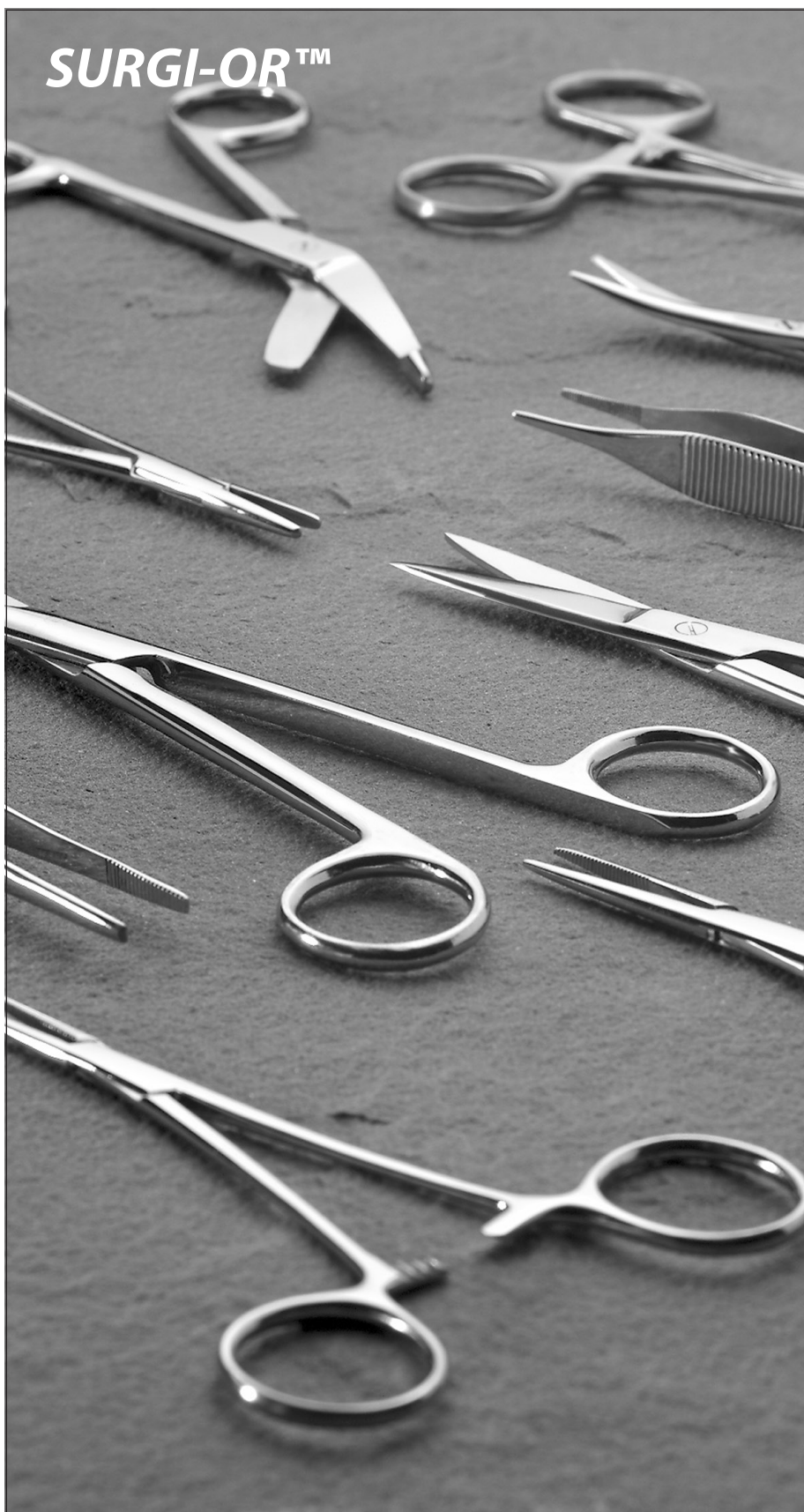

Surgi-OR™ is a full line of high-quality, Mid-Grade OR instruments, hand-crafted and forged from surgical grade stainless steel. This cost-effective line of instruments is designed to give you maximum performance at affordable cost and offers significant value to the Operating Room as well as other important surgical settings.

Sklar is pleased to offer Surgi-OR Tungsten Carbide Instruments that feature this extremely hard alloy resulting in a superior instrument.

Surgi-OR Needle Holders feature solid Tungsten Carbide insert jaws for exceptional control and unbeatable strength. These perfectly balanced instruments are readily identified by the dual gold finger rings and afford quality and performance you can trust in a variety of surgical settings.



**TUNGSTEN CARBIDE SCISSORS**

PRODUCT NUMBER	DESCRIPTION	FEATURES	LENGTH
95-124	Surgi-OR™ TC Iris Scissor	Straight, Sharp/Sharp	4½"
95-125	Surgi-OR™ TC Iris Scissor	Curved, Sharp/Sharp	4½"
95-112	Surgi-OR™ TC Mayo Dissecting Scissor	Straight	6¾"
95-113	Surgi-OR™ TC Mayo Dissecting Scissor	Curved	6¾"
95-114	Surgi-OR™ TC Metzenbaum Dissecting Scissor	Straight, Delicate	7"
95-115	Surgi-OR™ TC Metzenbaum Dissecting Scissor	Straight	7"
95-116	Surgi-OR™ TC Metzenbaum Dissecting Scissor	Curved, Delicate	7"
95-117	Surgi-OR™ TC Metzenbaum Dissecting Scissor	Curved	7"
95-118	Surgi-OR™ TC Metzenbaum Dissecting Scissor	Straight, Delicate	5¾"
95-119	Surgi-OR™ TC Metzenbaum Dissecting Scissor	Straight	5¾"
95-120	Surgi-OR™ TC Metzenbaum Dissecting Scissor	Curved, Delicate	5¾"
95-122	Surgi-OR™ TC Metzenbaum Dissecting Scissor	Curved	5¾"
95-110	Surgi-OR™ TC Operating Scissor	Straight, Sharp/Blunt	5½"
95-111	Surgi-OR™ TC Operating Scissor	Curved, Sharp/Blunt	5½"
95-126	Surgi-OR™ TC Strabismus Scissor	Straight, Blunt/Blunt	4½"
95-127	Surgi-OR™ TC Strabismus Scissor	Curved, Blunt/Blunt	4½"
95-128	Surgi-OR™ TC Wire Cutting Scissor	Angled, Serrated	4¾"

**SCISSORS**

PRODUCT NUMBER	DESCRIPTION	FEATURES	LENGTH
95-375	Surgi-OR™ Braun Episiotomy Scissor	Angled	5½"
95-103	Surgi-OR™ Iris Scissor	Straight	3½"
95-107	Surgi-OR™ Iris Scissor	Curved	3½"
95-104	Surgi-OR™ Iris Scissor	Straight	4½"
95-109	Surgi-OR™ Iris Scissor	Curved	4½"
95-254	Surgi-OR™ Knowles Bandage Scissor	-	5½"
95-222	Surgi-OR™ Lister Bandage Scissor	-	3½"
95-226	Surgi-OR™ Lister Bandage Scissor	-	4½"
95-231	Surgi-OR™ Lister Bandage Scissor	-	5½"
95-232	Surgi-OR™ Lister Bandage Scissor	With Pocket Clip	5½"
95-232B	Surgi-OR™ Lister Bandage Scissor	With Pocket Clip, Blue Ring Handle	5½"
95-232P	Surgi-OR™ Lister Bandage Scissor	With Pocket Clip, Pink Ring Handle	5½"
95-241	Surgi-OR™ Lister Bandage Scissor	-	7¼"
95-243	Surgi-OR™ Lister Bandage Scissor	-	8"
95-308	Surgi-OR™ Mayo Dissecting Scissor	Straight	5½"



## SCISSORS CONTINUED

PRODUCT NUMBER	DESCRIPTION	FEATURES	LENGTH
95-330	Surgi-OR™ Mayo Dissecting Scissor	Curved	5½"
95-321	Surgi-OR™ Mayo Dissecting Scissor	Straight	6¾"
95-329	Surgi-OR™ Mayo Dissecting Scissor	Straight, Serrated	6¾"
95-325	Surgi-OR™ Mayo Dissecting Scissor	Curved	6¾"
95-332	Surgi-OR™ Mayo Dissecting Scissor	Curved, Serrated	6¾"
95-327	Surgi-OR™ Mayo Dissecting Scissor	Straight	9"
95-328	Surgi-OR™ Mayo Dissecting Scissor	Curved	9"
95-335	Surgi-OR™ Metzenbaum Dissecting Scissor	Straight	5¾"
95-336	Surgi-OR™ Metzenbaum Dissecting Scissor	Curved	5¾"
95-339	Surgi-OR™ Metzenbaum Dissecting Scissor	Straight	7"
95-340	Surgi-OR™ Metzenbaum Dissecting Scissor	Curved	7"
95-354	Surgi-OR™ Metzenbaum Dissecting Scissor	Straight	9"
95-356	Surgi-OR™ Metzenbaum Dissecting Scissor	Curved	9"
95-265	Surgi-OR™ Operating Scissor	Straight, Sharp/Blunt	4½"
95-266	Surgi-OR™ Operating Scissor	Straight, Sharp/Sharp	4½"
95-294	Surgi-OR™ Operating Scissor	Curved, Sharp/Sharp	4½"
95-278	Surgi-OR™ Operating Scissor	Straight, Blunt/Blunt	5½"
95-299	Surgi-OR™ Operating Scissor	Curved, Blunt/Blunt	5½"
95-272	Surgi-OR™ Operating Scissor	Straight, Sharp/Blunt	5½"
95-292	Surgi-OR™ Operating Scissor	Curved, Sharp/Blunt	5½"
95-275	Surgi-OR™ Operating Scissor	Straight, Sharp/Sharp	5½"
95-295	Surgi-OR™ Operating Scissor	Curved, Sharp/Sharp	5½"
95-281	Surgi-OR™ Operating Scissor	Straight, Sharp/Blunt	6½"
95-284	Surgi-OR™ Operating Scissor	Straight, Sharp/Sharp	6½"
95-160	Surgi-OR™ Stevens Tenotomy Scissor	Straight, Blunt/Blunt	4⅛"
95-161	Surgi-OR™ Stevens Tenotomy Scissor	Curved, Blunt/Blunt	4⅛"
95-346	Surgi-OR™ Stitch Scissor	Spencer	3½"
95-352	Surgi-OR™ Stitch Scissor	Spencer	4½"
95-358	Surgi-OR™ Stitch Scissor	Littauer	5½"
95-360	Surgi-OR™ Strabismus Scissor	Straight	4½"
95-361	Surgi-OR™ Strabismus Scissor	Curved	4½"
95-369	Surgi-OR™ Suture Scissor	Shortbent	3½"
95-100	Surgi-OR™ Utility Scissor	Serrated	6"
95-105	Surgi-OR™ Utility Shears	Serrated, Black Handles	7½"
95-364	Surgi-OR™ Wire Cutting Scissor	Angled, Serrated	4¾"

**DRESSING AND TISSUE FORCEPS**

PRODUCT NUMBER	DESCRIPTION	FEATURES	LENGTH
95-188	Surgi-OR™ Adson Bayonet Forceps	Delicate	7½"
95-778	Surgi-OR™ Adson Brown Tissue Forceps	Side Grasping, 7x7 Teeth	4¾"
95-771	Surgi-OR™ Adson Dressing Forceps	Serrated	4¾"
95-772	Surgi-OR™ Adson Dressing Forceps	Serrated, Delicate	4¾"
95-775	Surgi-OR™ Adson Tissue Forceps	1x2 Teeth	4¾"
95-776	Surgi-OR™ Adson Tissue Forceps	1x2 Teeth, Delicate	4¾"
95-705	Surgi-OR™ Dressing Forceps	Serrated	4½"
95-710	Surgi-OR™ Dressing Forceps	Serrated	5"
95-727	Surgi-OR™ Dressing Forceps	Serrated	5½"
95-731	Surgi-OR™ Dressing Forceps	Serrated	6"
95-736	Surgi-OR™ Dressing Forceps	Serrated	8"
95-742	Surgi-OR™ Dressing Forceps	Serrated	10"
95-449	Surgi-OR™ Ferris Smith Tissue Forceps	1x2 Teeth	7"
95-605	Surgi-OR™ Jansen Nasal Forceps	Bayonet	6½"
95-182	Surgi-OR™ Lucae Forceps	Bayonet, Serrated	5½"
95-777	Surgi-OR™ Plain Splinter Forceps	Serrated	3½"
95-781	Surgi-OR™ Plain Splinter Forceps	Serrated	4½"
95-604	Surgi-OR™ Russian Tissue Forceps	-	6"
95-607	Surgi-OR™ Russian Tissue Forceps	-	8"
95-790	Surgi-OR™ Splinter Forceps	Fine Point	4"
95-753	Surgi-OR™ Tissue Forceps	1x2 Teeth	4½"
95-757	Surgi-OR™ Tissue Forceps	1x2 Teeth	5"
95-762	Surgi-OR™ Tissue Forceps	1x2 Teeth	5½"
95-766	Surgi-OR™ Tissue Forceps	1x2 Teeth	6"
95-770	Surgi-OR™ Tissue Forceps	1x2 Teeth	8"
95-774	Surgi-OR™ Tissue Forceps	1x2 Teeth	10"

**RING FORCEPS**

PRODUCT NUMBER	DESCRIPTION	FEATURES	LENGTH
95-930	Surgi-OR™ Allis Tissue Forceps	4x5 Teeth	6"
95-934	Surgi-OR™ Allis Tissue Forceps	5x6 Teeth	6"
95-938	Surgi-OR™ Allis Tissue Forceps	5x6 Teeth	7½"
95-952	Surgi-OR™ Babcock Grasping Forceps	-	6¼"
95-956	Surgi-OR™ Babcock Grasping Forceps	-	8"
95-374	Surgi-OR™ Bozeman Uterine Dressing Forceps	S-Curve	10¼"
95-447	Surgi-OR™ Crile Forceps	Straight	5½"
95-452	Surgi-OR™ Crile Forceps	Curved	5½"



## RING FORCEPS CONTINUED

PRODUCT NUMBER	DESCRIPTION	FEATURES	LENGTH
95-458	Surgi-OR™ Crile Forceps	Straight	6¼"
95-463	Surgi-OR™ Crile Forceps	Curved	6¼"
95-456	Surgi-OR™ Dunaway Dissecting Forceps	Straight, With Bead Tip	3½"
95-466	Surgi-OR™ Dunaway Dissecting Forceps	Straight, With Bead Tip	6"
95-467	Surgi-OR™ Dunaway Dissecting Forceps	Curved, With Bead Tip	6"
95-571	Surgi-OR™ Foerster Sponge Forceps	Straight, Serrated	7"
95-577	Surgi-OR™ Foerster Sponge Forceps	Straight, Serrated	9½"
95-586	Surgi-OR™ Foerster Sponge Forceps	Curved, Serrated	9½"
95-426	Surgi-OR™ Halsted Mosquito Forceps	Straight	5"
95-431	Surgi-OR™ Halsted Mosquito Forceps	Curved	5"
95-409	Surgi-OR™ Hartmann Mosquito Forceps	Straight	3½"
95-421	Surgi-OR™ Hartmann Mosquito Forceps	Curved	3½"
95-436	Surgi-OR™ Kelly Forceps	Straight	5½"
95-442	Surgi-OR™ Kelly Forceps	Curved	5½"
95-285	Surgi-OR™ Magill Catheter Forceps	Child	8"
95-289	Surgi-OR™ Magill Catheter Forceps	Adult	10"
95-465	Surgi-OR™ Rankin Kelly Forceps	Straight	6¼"
95-469	Surgi-OR™ Rankin Kelly Forceps	Curved	6¼"
95-500	Surgi-OR™ Rochester-Ochsner Forceps	Straight, 1x2 Teeth	5½"
95-501	Surgi-OR™ Rochester-Ochsner Forceps	Curved, 1x2 Teeth	5½"
95-504	Surgi-OR™ Rochester-Ochsner Forceps	Straight, 1x2 Teeth	6¼"
95-512	Surgi-OR™ Rochester-Ochsner Forceps	Curved, 1x2 Teeth	6¼"
95-521	Surgi-OR™ Rochester-Ochsner Forceps	Straight, 1x2 Teeth	7¼"
95-525	Surgi-OR™ Rochester-Ochsner Forceps	Curved, 1x2 Teeth	7¼"
95-513	Surgi-OR™ Rochester-Ochsner Forceps	Straight, 1x2 Teeth	8"
95-514	Surgi-OR™ Rochester-Ochsner Forceps	Curved, 1x2 Teeth	8"
95-515	Surgi-OR™ Rochester-Ochsner Forceps	Straight, 1x2 Teeth	9"
95-516	Surgi-OR™ Rochester-Ochsner Forceps	Curved, 1x2 Teeth	9"
95-517	Surgi-OR™ Rochester-Ochsner Forceps	Straight, 1x2 Teeth	10"
95-518	Surgi-OR™ Rochester-Ochsner Forceps	Curved, 1x2 Teeth	10"
95-470	Surgi-OR™ Rochester-Pean Forceps	Straight	5½"
95-471	Surgi-OR™ Rochester-Pean Forceps	Curved	5½"
95-473	Surgi-OR™ Rochester-Pean Forceps	Straight	6¼"
95-477	Surgi-OR™ Rochester-Pean Forceps	Curved	6¼"
95-481	Surgi-OR™ Rochester-Pean Forceps	Straight	7¼"

**RING FORCEPS CONTINUED**

PRODUCT NUMBER	DESCRIPTION	FEATURES	LENGTH
95-485	Surgi-OR™ Rochester-Pean Forceps	Curved	7¼"
95-492	Surgi-OR™ Rochester-Pean Forceps	Straight	8"
95-498	Surgi-OR™ Rochester-Pean Forceps	Curved	8"
95-483	Surgi-OR™ Rochester-Pean Forceps	Straight	9"
95-487	Surgi-OR™ Rochester-Pean Forceps	Curved	9"
95-494	Surgi-OR™ Rochester-Pean Forceps	Straight	10¼"
95-496	Surgi-OR™ Rochester-Pean Forceps	Curved	10¼"
95-434	Surgi-OR™ Schnidt Tonsil Forceps	Half Curved	7½"
95-386	Surgi-OR™ Schroeder Tenaculum Forceps	Straight	9½"
95-459	Surgi-OR™ Schroeder Tenaculum Forceps	Straight	10¼"
95-437	Surgi-OR™ Schweizer Forceps	Straight	9½"

**CLAMPS**

PRODUCT NUMBER	DESCRIPTION	FEATURES	LENGTH
95-606	Surgi-OR™ Backhaus Towel Clamp	-	3½"
95-611	Surgi-OR™ Backhaus Towel Clamp	-	5¼"
95-629	Surgi-OR™ Lorna Edna Towel Clamp	Non-Perforating	3½"
95-635	Surgi-OR™ Lorna Edna Towel Clamp	Non-Perforating	5¼"
95-592	Surgi-OR™ Presbyterian Tube Occluding Clamp	Straight, Smooth	7"

**TUNGSTEN CARBIDE NEEDLE HOLDERS**

PRODUCT NUMBER	DESCRIPTION	FEATURES	LENGTH
95-135	Surgi-OR™ TC Baumgartner Needle Holder	Serrated	5¼"
95-137	Surgi-OR™ TC Crile-Wood Needle Holder	Serrated	6"
95-138	Surgi-OR™ TC Crile-Wood Needle Holder	Serrated	7"
95-139	Surgi-OR™ TC Crile-Wood Needle Holder	Serrated	8"
95-136	Surgi-OR™ TC Derf Needle Holder	Serrated	4¾"
95-132	Surgi-OR™ TC Halsey Needle Holder	Smooth	5¼"
95-133	Surgi-OR™ TC Halsey Needle Holder	Serrated	5¼"
95-140	Surgi-OR™ TC Mayo-Hegar Needle Holder	Serrated	5¼"
95-141	Surgi-OR™ TC Mayo-Hegar Needle Holder	Serrated	6"
95-142	Surgi-OR™ TC Mayo-Hegar Needle Holder	Serrated	7"
95-143	Surgi-OR™ TC Mayo-Hegar Needle Holder	Serrated	8"
95-146	Surgi-OR™ TC Olsen-Hegar Needle Holder	Serrated, Delicate	4¾"
95-147	Surgi-OR™ TC Olsen-Hegar Needle Holder	Serrated	5½"
95-130	Surgi-OR™ TC Webster Needle Holder	Smooth	5¼"



## NEEDLE HOLDERS

PRODUCT NUMBER	DESCRIPTION	FEATURES	LENGTH
95-832	Surgi-OR™ Baumgartner Needle Holder	Serrated	5¼"
95-834	Surgi-OR™ Brown Needle Holder	Round	5¼"
95-885	Surgi-OR™ Collier Needle Holder	Fenestrated	5¼"
95-826	Surgi-OR™ Derf Needle Holder	Serrated	4¾"
95-810	Surgi-OR™ Halsey Needle Holder	Smooth	5¼"
95-842	Surgi-OR™ Mayo-Hegar Needle Holder	Serrated	5¼"
95-847	Surgi-OR™ Mayo-Hegar Needle Holder	Serrated	6"
95-853	Surgi-OR™ Mayo-Hegar Needle Holder	Serrated	7"
95-869	Surgi-OR™ Mayo-Hegar Needle Holder	Serrated	8"
95-872	Surgi-OR™ Olsen-Hegar Needle Holder	Serrated	5½"
95-813	Surgi-OR™ Webster Needle Holder	Serrated	5¼"
95-809	Surgi-OR™ Webster Needle Holder	Smooth	5¼"

## GYNECOLOGY

PRODUCT NUMBER	DESCRIPTION	FEATURES	LENGTH
95-304	Surgi-OR™ Graves Vaginal Speculum	Extra Small	2¾" x 5⁄8"
95-303	Surgi-OR™ Graves Vaginal Speculum	Small	3" x ¾"
95-312	Surgi-OR™ Graves Vaginal Speculum	Medium	4" x 1¼"
95-324	Surgi-OR™ Graves Vaginal Speculum	Large	4½" x 1⅜"
95-322	Surgi-OR™ Graves Vaginal Speculum	Extra Large	4¾" x 1½"
95-347	Surgi-OR™ Pederson Vaginal Speculum	Small	3" x ½"
95-348	Surgi-OR™ Pederson Vaginal Speculum	Medium	4" x 7⁄8"
95-362	Surgi-OR™ Pederson Vaginal Speculum	Large	4¾" x 1"

## HOOKS AND RETRACTORS

PRODUCT NUMBER	DESCRIPTION	FEATURES	LENGTH
95-390	Surgi-OR™ Joseph Hook	1 Sharp Prong	6¼"
95-392	Surgi-OR™ Joseph Hook	2 Sharp Prongs, 2mm	6¼"
95-394	Surgi-OR™ Joseph Hook	2 Sharp Prongs, 5mm	6¼"
95-365	Surgi-OR™ Senn Retractor	Double Ended, Blunt	6"
95-366	Surgi-OR™ Senn Retractor	Double Ended, Sharp	6"

**DERMAL, ENT AND PODIATRY**

PRODUCT NUMBER	DESCRIPTION	FEATURES	LENGTH
95-748	Surgi-OR™ Freer Elevator	Double Ended, Blunt/Sharp	7¼"
95-740	Surgi-OR™ Schamberg Comedone Extractor	Regular	-
95-741	Surgi-OR™ Schamberg Comedone Extractor	Extra Fine	-
95-743	Surgi-OR™ Schamberg Comedone Extractor	Square	-
95-797	Surgi-OR™ Spatula & Packer	Double Ended	5¾"

**DIAGNOSTICS**

PRODUCT NUMBER	DESCRIPTION	FEATURES	LENGTH
95-499	Surgi-OR™ Probe	With Eye	5"
95-502	Surgi-OR™ Probe	With Eye	6"
95-008	Surgi-OR™ Taylor Hammer	Small	7"
95-010	Surgi-OR™ Taylor Hammer	Large	7½"

**SCALPELS**

PRODUCT NUMBER	DESCRIPTION	FEATURES	LENGTH
95-033	Surgi-OR™ Scalpel Handle	#3	-
95-038	Surgi-OR™ Scalpel Handle	#4	-
95-042	Surgi-OR™ Scalpel Handle	#7	-

**CUTTERS**

PRODUCT NUMBER	DESCRIPTION	FEATURES	LENGTH
95-486	Surgi-OR™ Nail Nipper	Barrel Spring	4½"
95-472	Surgi-OR™ Nail Nipper	Barrel Spring	5½"
95-493	Surgi-OR™ Nail Nipper	Double Spring With Lock	5½"
95-482	Surgi-OR™ Nail Nipper	Double Spring, Concave	5½"
95-479	Surgi-OR™ Nail Splitter Forceps	English Anvil	5"

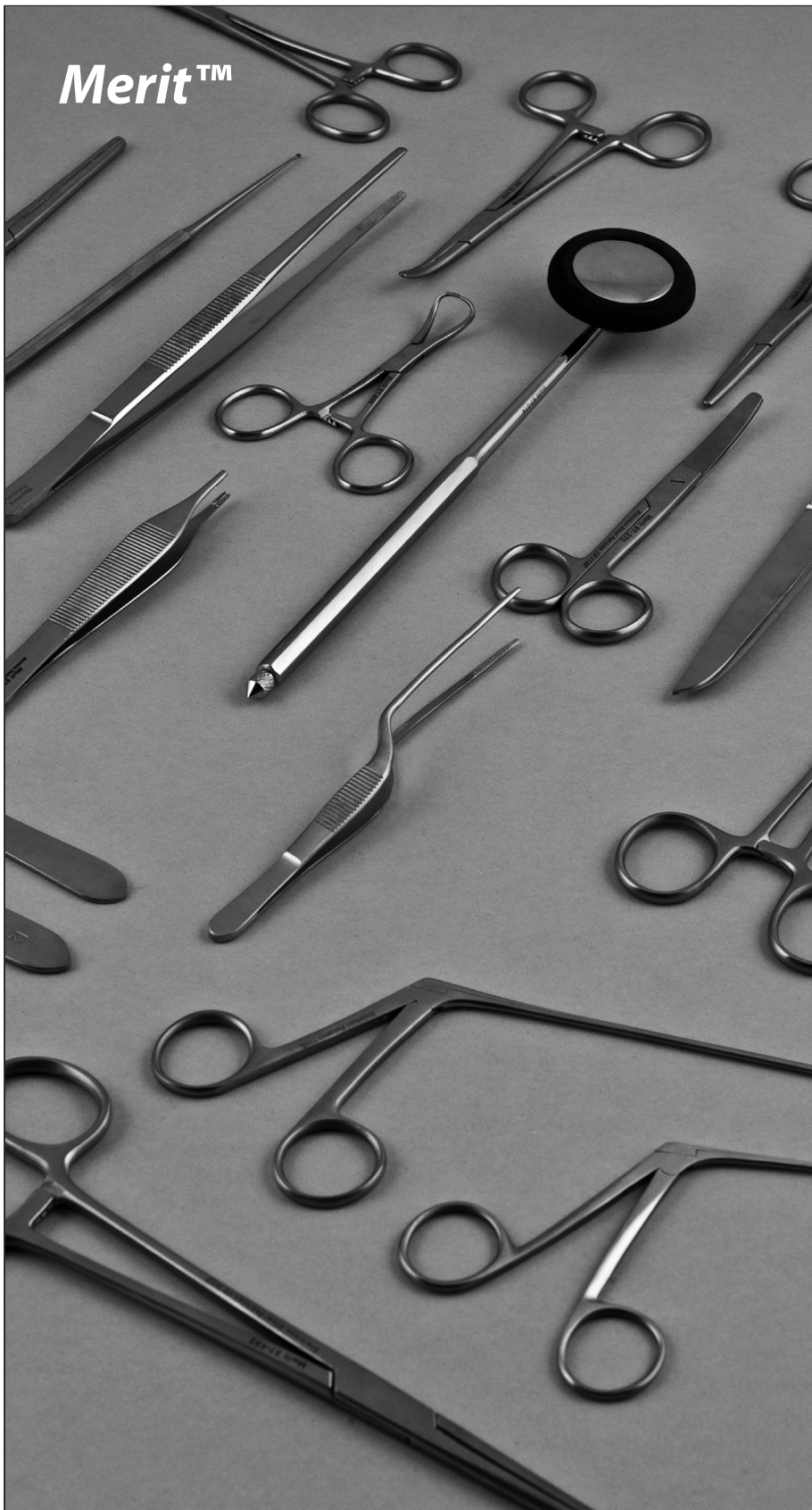

**The most cost-effective line of quality instruments, Merit Instruments are designed for routine surgical or diagnostic use in the office setting.**

- All instruments are forged from surgical grade stainless steel
- Crafted in FDA registered manufacturing facilities by skilled instrument makers
- Designed to meet OR tolerances for surgical quality
- 10 year guarantee
- Reliable performance
- Economical solution



**SCISSORS**

PRODUCT NUMBER	DESCRIPTION	FEATURES	LENGTH
97-258	Merit™ Army Gauze Scissors	–	8"
97-375	Merit™ Braun Episiotomy Scissors	Angled	5½"
98-495	Merit™ Cuticle Nail Scissors	–	3½"
98-496	Merit™ Cuticle Nail Scissors	–	4"
97-256	Merit™ Bruns Plaster Shears	–	8"
97-121	Merit™ First Aid Shears	–	8¼"
98-110	Merit™ Gradle Eye Suture Scissors	Delicate, Curved	4¼"
98-103	Merit™ Iris Scissors	Straight	3½"
98-107	Merit™ Iris Scissors	Curved	3½"
98-104	Merit™ Iris Scissors	Straight	4½"
98-109	Merit™ Iris Scissors	Curved	4½"
97-254	Merit™ Knowles Bandage Scissors	–	5½"
97-222	Merit™ Lister Bandage Scissors	–	3½"
97-226	Merit™ Lister Bandage Scissors	–	4½"
97-231	Merit™ Lister Bandage Scissors	–	5½"
97-237	Merit™ Lister Bandage Scissors	With Clip	5½"
97-241	Merit™ Lister Bandage Scissors	–	7¼"
97-245	Merit™ Lister Bandage Scissors	Large Ring	8"
97-243	Merit™ Lister Bandage Scissors	–	8"
97-308	Merit™ Mayo Dissecting Scissors	Straight	5½"
97-312	Merit™ Mayo Dissecting Scissors	Curved	5½"
97-321	Merit™ Mayo Dissecting Scissors	Straight	6¾"
97-325	Merit™ Mayo Dissecting Scissors	Curved	6¾"
97-327	Merit™ Mayo Dissecting Scissors	Straight	9"
97-328	Merit™ Mayo Dissecting Scissors	Curved	9"
97-335	Merit™ Metzenbaum Dissecting Scissors	Straight	5¾"
97-336	Merit™ Metzenbaum Dissecting Scissors	Curved	5¾"
97-339	Merit™ Metzenbaum Dissecting Scissors	Straight	7"
97-340	Merit™ Metzenbaum Dissecting Scissors	Curved	7"
97-354	Merit™ Metzenbaum Dissecting Scissors	Straight	9"
97-356	Merit™ Metzenbaum Dissecting Scissors	Curved	9"
98-490	Merit™ Nail Splitting Scissors	Serrated	6½"

**SCISSORS CONTINUED**

PRODUCT NUMBER	DESCRIPTION	FEATURES	LENGTH
97-269	Merit™ Operating Scissors	Straight, Blunt/Blunt	4½"
97-270	Merit™ Operating Scissors	Curved, Blunt/Blunt	4½"
97-263	Merit™ Operating Scissors	Straight, Sharp/Blunt	4½"
97-291	Merit™ Operating Scissors	Curved, Sharp/Blunt	4½"
97-266	Merit™ Operating Scissors	Straight, Sharp/Sharp	4½"
97-294	Merit™ Operating Scissors	Curved, Sharp/Sharp	4½"
97-278	Merit™ Operating Scissors	Straight, Blunt/Blunt	5½"
97-299	Merit™ Operating Scissors	Curved, Blunt/Blunt	5½"
97-272	Merit™ Operating Scissors	Straight, Sharp/Blunt	5½"
97-292	Merit™ Operating Scissors	Curved, Sharp/Blunt	5½"
97-275	Merit™ Operating Scissors	Straight, Sharp/Sharp	5½"
97-295	Merit™ Operating Scissors	Curved, Sharp/Sharp	5½"
97-288	Merit™ Operating Scissors	Straight, Blunt/Blunt	6½"
97-300	Merit™ Operating Scissors	Curved, Blunt/Blunt	6½"
97-281	Merit™ Operating Scissors	Straight, Sharp/Blunt	6½"
97-293	Merit™ Operating Scissors	Curved, Sharp/Blunt	6½"
97-284	Merit™ Operating Scissors	Straight, Sharp/Sharp	6½"
97-297	Merit™ Operating Scissors	Curved, Sharp/Sharp	6½"
97-346	Merit™ Stitch Scissors	Spencer	3½"
97-352	Merit™ Stitch Scissors	Spencer	4½"
97-358	Merit™ Stitch Scissors	Littauer	5½"
98-160	Merit™ Stevens Tenotomy Scissors	Straight, Blunt/Blunt	4⅞"
98-161	Merit™ Stevens Tenotomy Scissors	Curved, Blunt/Blunt	4⅞"
97-360	Merit™ Strabismus Scissors	Straight	4½"
97-361	Merit™ Strabismus Scissors	Curved	4½"
97-369	Merit™ Suture Scissors	Shortbent	3½"
98-367	Merit™ Umbilical Scissors	–	4"
97-100	Merit™ Utility Scissors	Black	6"
97-105	Merit™ Utility Scissors	Black	7½"
97-107	Merit™ Utility Scissors	Blue	7½"
97-109	Merit™ Utility Scissors	Green	7½"
97-108	Merit™ Utility Scissors	Purple	7½"
97-364	Merit™ Wire Cutting Scissors	Angled, Serrated	4¾"

**DRESSING & TISSUE FORCEPS**

PRODUCT NUMBER	DESCRIPTION	FEATURES	LENGTH
98-188	Merit™ Adson Bayonet Forceps	Delicate	7½"
97-778	Merit™ Adson Brown Tissue Forceps	7x7 Teeth, Side Grasping	4¾"
97-771	Merit™ Adson Dressing Forceps	Serrated	4¾"
97-772	Merit™ Adson Dressing Forceps	Serrated, Delicate	4¾"
97-775	Merit™ Adson Tissue Forceps	1x2 Teeth	4¾"
97-776	Merit™ Adson Tissue Forceps	1x2 Teeth, Delicate	4¾"
98-155	Merit™ Bergh Cilia Forceps	Horizontal Serrations	3½"
97-763	Merit™ Bishop-Harmon Forceps	Serrated	3½"
97-764	Merit™ Bishop-Harmon Forceps	1x2 Teeth	3½"
97-791	Merit™ Carmalt Splinter Forceps	Straight	4½"
97-793	Merit™ Carmalt Splinter Forceps	Curved	4½"
97-705	Merit™ Dressing Forceps	Serrated	4½"
97-710	Merit™ Dressing Forceps	Serrated	5"
97-727	Merit™ Dressing Forceps	Serrated	5½"
97-731	Merit™ Dressing Forceps	Serrated	6"
97-736	Merit™ Dressing Forceps	Serrated	8"
97-742	Merit™ Dressing Forceps	Serrated	10"
97-748	Merit™ Dressing Forceps	Serrated	12"
97-784	Merit™ Feilchenfeld Forceps	-	3"
97-787	Merit™ Feilchenfeld Forceps	-	4½"
97-449	Merit™ Ferris Smith Tissue Forceps	1x2 Teeth	7"
97-751	Merit™ Graefe Tissue Forceps	Fine Teeth	4¾"
98-123	Merit™ Iris Dressing Forceps	Straight, Serrated	4"
98-142	Merit™ Iris Tissue Forceps	Straight, 1x2 Teeth	4"
98-129	Merit™ Iris Dressing Forceps	Half Curve, Serrated	4"
98-146	Merit™ Iris Tissue Forceps	Half Curve, 1x2 Teeth	4"
98-135	Merit™ Iris Dressing Forceps	Full Curve, Serrated	4"
98-151	Merit™ Iris Tissue Forceps	Full Curve, 1x2 Teeth	4"
97-605	Merit™ Jansen Nasal Forceps	Bayonet	6¼"
98-276	Merit™ Michel Clip Forceps	Applying/Removing	5¼"
97-777	Merit™ Plain Splinter Forceps	Serrated	3½"
97-781	Merit™ Plain Splinter Forceps	Serrated	4½"
98-494	Merit™ Platypus Nail Forceps	Plier Handle	5¼"
97-604	Merit™ Russian Tissue Forceps	-	6"
97-607	Merit™ Russian Tissue Forceps	-	8"
97-749	Merit™ Semkin Forceps	Serrated	5"
97-747	Merit™ Semkin Forceps	1x2 Teeth	5"

**DRESSING & TISSUE FORCEPS CONTINUED**

PRODUCT NUMBER	DESCRIPTION	FEATURES	LENGTH
97-788	Merit™ Splinter Forceps	With Magnifier	3"
97-790	Merit™ Splinter Forceps	Fine Point	4"
97-753	Merit™ Tissue Forceps	1x2 Teeth	4½"
97-757	Merit™ Tissue Forceps	1x2 Teeth	5"
97-762	Merit™ Tissue Forceps	1x2 Teeth	5½"
97-769	Merit™ Tissue Forceps	2x3 Teeth	5½"
97-770	Merit™ Tissue Forceps	1x2 Teeth	8"
97-774	Merit™ Tissue Forceps	1x2 Teeth	10"
98-140	Merit™ Utility Forceps	Smooth	4"
97-795	Merit™ Virtus Splinter Forceps	Straight	6"
98-180	Merit™ Wilde Ear Forceps	Serrated	5"

**RING FORCEPS**

PRODUCT NUMBER	DESCRIPTION	FEATURES	LENGTH
97-930	Merit™ Allis Tissue Forceps	4x5 Teeth	6"
97-934	Merit™ Allis Tissue Forceps	5x6 Teeth	6"
97-938	Merit™ Allis Tissue Forceps	5x6 Teeth	7½"
97-952	Merit™ Babcock Grasping Forceps	–	6¼"
97-956	Merit™ Babcock Grasping Forceps	–	8"
98-374	Merit™ Bozeman Uterine Dressing Forceps	S-Curve	10¼"
97-447	Merit™ Crile Forceps	Straight	5½"
97-452	Merit™ Crile Forceps	Curved	5½"
97-458	Merit™ Crile Forceps	Straight	6¼"
97-463	Merit™ Crile Forceps	Curved	6¼"
97-561	Merit™ Doyen Intestinal Forceps	Straight	9"
97-563	Merit™ Doyen Intestinal Forceps	Curved	9"
97-571	Merit™ Foerster Sponge Forceps	Straight, Serrated	7"
97-577	Merit™ Foerster Sponge Forceps	Straight, Serrated	9½"
97-586	Merit™ Foerster Sponge Forceps	Curved, Serrated	9½"
97-426	Merit™ Halsted Mosquito Forceps	Straight	5"
97-431	Merit™ Halsted Mosquito Forceps	Curved	5"
97-409	Merit™ Hartmann Mosquito Forceps	Straight	3½"
97-421	Merit™ Hartmann Mosquito Forceps	Curved	3½"
97-546	Merit™ Jones Forceps	Straight Broad Jaw	5¼"

**RING FORCEPS CONTINUED**

PRODUCT NUMBER	DESCRIPTION	FEATURES	LENGTH
97-436	Merit™ Kelly Forceps	Straight	5½"
97-442	Merit™ Kelly Forceps	Curved	5½"
98-285	Merit™ Magill Catheter Forceps	Medium	8"
98-289	Merit™ Magill Catheter Forceps	Large	10"
97-465	Merit™ Rankin Kelly Forceps	Straight	6¼"
97-469	Merit™ Rankin Kelly Forceps	Curved	6¼"
97-528	Merit™ Rochester-Carmalt Forceps	Straight	6¼"
97-534	Merit™ Rochester-Carmalt Forceps	Curved	6¼"
97-537	Merit™ Rochester-Carmalt Forceps	Straight	8"
97-542	Merit™ Rochester-Carmalt Forceps	Curved	8"
97-500	Merit™ Rochester-Ochsner Forceps	Straight, 1x2 Teeth	5½"
97-501	Merit™ Rochester-Ochsner Forceps	Curved, 1x2 Teeth	5½"
97-504	Merit™ Rochester-Ochsner Forceps	Straight, 1x2 Teeth	6¼"
97-512	Merit™ Rochester-Ochsner Forceps	Curved, 1x2 Teeth	6½"
97-521	Merit™ Rochester-Ochsner Forceps	Straight, 1x2 Teeth	7¼"
97-525	Merit™ Rochester-Ochsner Forceps	Curved, 1x2 Teeth	7¼"
97-513	Merit™ Rochester-Ochsner Forceps	Straight, 1x2 Teeth	8"
97-514	Merit™ Rochester-Ochsner Forceps	Curved, 1x2 Teeth	8"
97-515	Merit™ Rochester-Ochsner Forceps	Straight, 1x2 Teeth	9"
97-516	Merit™ Rochester-Ochsner Forceps	Curved, 1x2 Teeth	9"
97-517	Merit™ Rochester-Ochsner Forceps	Straight, 1x2 Teeth	10"
97-518	Merit™ Rochester-Ochsner Forceps	Curved, 1x2 Teeth	10"
97-470	Merit™ Rochester-Pean Forceps	Straight	5½"
97-471	Merit™ Rochester-Pean Forceps	Curved	5½"
97-473	Merit™ Rochester-Pean Forceps	Straight	6¼"
97-477	Merit™ Rochester-Pean Forceps	Curved	6¼"
97-481	Merit™ Rochester-Pean Forceps	Straight	7¼"
97-485	Merit™ Rochester-Pean Forceps	Curved	7¼"
97-492	Merit™ Rochester-Pean Forceps	Straight	8"
97-498	Merit™ Rochester-Pean Forceps	Curved	8"
97-483	Merit™ Rochester-Pean Forceps	Straight	9"
97-487	Merit™ Rochester-Pean Forceps	Curved	9"
97-494	Merit™ Rochester-Pean Forceps	Straight	10¼"
97-496	Merit™ Rochester-Pean Forceps	Curved	10¼"
97-434	Merit™ Schnidt Tonsil Forceps	Half Curved	7½"
98-386	Merit™ Schroeder Tenaculum Forceps	Straight	9½"
97-459	Merit™ Schroeder Tenaculum Forceps	Straight	10¼"
97-437	Merit™ Schweizer Forceps	Straight	9½"

**CLAMPS**

PRODUCT NUMBER	DESCRIPTION	FEATURES	LENGTH
97-606	Merit™ Backhaus Towel Clamp	–	3½"
97-611	Merit™ Backhaus Towel Clamp	–	5¼"
97-601	Merit™ Jones Towel Clamp	–	3"
97-629	Merit™ Lorna Edna Towel Clamp	Non-Perforating	3½"
97-635	Merit™ Lorna Edna Towel Clamp	Non-Perforating	5¼"
97-639	Merit™ Peers Towel Clamp	Non-Perforating	5¾"
97-592	Merit™ Presbyterian Tube Occluding Clamp	Straight, Smooth	6½"
97-623	Merit™ Roeder Towel Clamp	With Stops	5¼"
97-587	Merit™ St. Vincent Tube Occluding Forceps	–	6½"
97-599	Merit™ Sterilizer Forceps	Three Prong	8"
97-645	Merit™ Vessells Towel Clamp	Non-Perforating	4½"
97-655	Merit™ Vessells Towel Clamp	Non-Perforating	5½"
97-598	Merit™ Vorse Tubing Clamp	Serrated With Guard	6"

**NEEDLE HOLDERS**

PRODUCT NUMBER	DESCRIPTION	FEATURES	LENGTH
97-894	Merit™ Abbey Needle Holder	–	5"
97-832	Merit™ Baumgartner Needle Holder	–	5¼"
97-834	Merit™ Brown Needle Holder	Rounded	5¼"
97-885	Merit™ Collier Needle Holder	Fenestrated	5¼"
97-838	Merit™ Crile–Wood Needle Holder	–	6"
97-826	Merit™ Derf Needle Holder	–	4¾"
97-810	Merit™ Halsey Needle Holder	Smooth	5¼"
97-883	Merit™ Mathieu Needle Holder	–	5½"
97-842	Merit™ Mayo–Hegar Needle Holder	–	5¼"
97-847	Merit™ Mayo–Hegar Needle Holder	–	6"
97-853	Merit™ Mayo–Hegar Needle Holder	–	7"
97-869	Merit™ Mayo–Hegar Needle Holder	–	8"
97-872	Merit™ Olsen Hegar Needle Holder	–	5½"
97-877	Merit™ Olsen Hegar Needle Holder	–	6½"
97-881	Merit™ Olsen Hegar Needle Holder	–	7½"
97-813	Merit™ Webster Needle Holder	Serrated	5¼"
97-809	Merit™ Webster Needle Holder	Smooth	5¼"

**GYNECOLOGY**

PRODUCT NUMBER	DESCRIPTION	FEATURES	LENGTH
98-303	Merit™ Graves Vaginal Speculum	Small	3" x ¾"
98-312	Merit™ Graves Vaginal Speculum	Medium	4" x 1¼"
98-324	Merit™ Graves Vaginal Speculum	Large	4½" x 1⅜"
98-325	Merit™ Graves Vaginal Speculum	X-Large	4¾" x 1½"
98-370	Merit™ Hegar Dilators	Set of 6	–
98-336	Merit™ Pederson Vaginal Speculum	Small	3" x ½"
98-364	Merit™ Pederson Vaginal Speculum	Slender	4" x ⅝"
98-348	Merit™ Pederson Vaginal Speculum	Medium	4" x ⅞"
98-362	Merit™ Pederson Vaginal Speculum	Large	4¾" x 1"
98-366	Merit™ Pederson Vaginal Speculum	X-Long	6½" x 1½"
98-382	Merit™ Simpson Sound	Graduated in Centimeters	12½"
98-384	Merit™ Sims Uterine Sound	Plain	12½"

**HOOKS, RETRACTORS & SPREADERS**

PRODUCT NUMBER	DESCRIPTION	FEATURES	LENGTH
97-384	Merit™ Alm Retractor	Blunt	2¾"
97-382	Merit™ Army Retractor	Set of 2	8"
98-179	Merit™ Cast Spreader	Three Prong	9"
97-380	Merit™ Cushing Nerve Retractor	–	8½"
97-388	Merit™ Gelpi Retractor	–	6¼"
97-390	Merit™ Joseph Hook	1 Prong Sharp	6¼"
97-392	Merit™ Joseph Hook	2 Prongs Sharp, 2mm	6¼"
97-394	Merit™ Joseph Hook	2 Prongs Sharp, 5mm	6¼"
98-178	Merit™ Plaster Spreader	–	11"
97-365	Merit™ Senn Retractor	Double End, Blunt	6¼"
97-366	Merit™ Senn Retractor	Double End, Sharp	6¼"
98-521	Merit™ Snook Hook	–	8"
97-391	Merit™ Tyrell Hook	Sharp	5"
97-371	Merit™ Weitlaner Retractor	2x3 Teeth, Blunt	4"
97-370	Merit™ Weitlaner Retractor	2x3 Teeth, Sharp	4"
97-373	Merit™ Weitlaner Retractor	3x4 Teeth, Blunt	5½"
97-372	Merit™ Weitlaner Retractor	3x4 Teeth, Sharp	5½"
97-376	Merit™ Weitlaner Retractor	3x4 Teeth, Blunt	6½"

**MERIT™**  
**OFFICE GRADE**
**DERMAL**

PRODUCT NUMBER	DESCRIPTION	FEATURES	LENGTH
98-755	Merit™ Comedone Extractor	Spear Point	–
98-413	Merit™ Fox Dermal Curette	#1, 3mm	5½"
98-414	Merit™ Fox Dermal Curette	#2, 4mm	5½"
98-415	Merit™ Fox Dermal Curette	#3, 5mm	5½"
98-416	Merit™ Fox Dermal Curette	#4, 6mm	5½"
98-402	Merit™ Keyes Cutaneous Punch	2mm	4"
98-403	Merit™ Keyes Cutaneous Punch	3mm	4"
98-404	Merit™ Keyes Cutaneous Punch	4mm	4"
98-405	Merit™ Keyes Cutaneous Punch	5mm	4"
98-406	Merit™ Keyes Cutaneous Punch	6mm	4"
98-425	Merit™ Ring Cutter	–	–
98-426	Merit™ Ring Cutter Blade	Replacement Blade for 98-425	–
98-740	Merit™ Shamberg Comedone Extractor	Regular	3¾"
98-741	Merit™ Shamberg Comedone Extractor	Fine	3¾"
98-742	Merit™ Shamberg Comedone Extractor	Square	3¾"
97-545	Merit™ Splinter Liberator	With Reversible Handle	–
97-799	Merit™ Splinter Removal Kit	4½" Carmalt Forcep, Liberator and Case	–
98-750	Merit™ Unna Comedone	Double End	–

**PODIATRY**

PRODUCT NUMBER	DESCRIPTION	FEATURES	LENGTH
98-503	Merit™ Curette Excavator	Single End, 1mm	5"
98-505	Merit™ Curette Excavator	Double End, 1mm and 2mm	6"
98-508	Merit™ Probe & Excavator	Double End	6"
98-797	Merit™ Spatula And Packer	Double End	–



**DIAGNOSTIC**

PRODUCT NUMBER	DESCRIPTION	FEATURES	LENGTH
97-014	Merit™ Babinski Percussion Hammer	Chrome	9"
97-021	Merit™ Buck Neuro Hammer	Chrome	7"
98-200	Merit™ Dental Probe	-	-
97-020	Merit™ EKG Caliper	-	4"
97-902	Merit™ Grooved Director	Probe End & Tongue Tie	6"
98-499	Merit™ Probe	With Eye	5"
98-502	Merit™ Probe	With Eye	6"
97-012	Merit™ Rabiner Neuro Hammer	Chrome	8"
97-008	Merit™ Taylor Hammer	Small	7"
97-010	Merit™ Taylor Hammer	Large	7½"
97-029	Merit™ Wartenberg Pinwheel	Chrome	-

**ENT**

PRODUCT NUMBER	DESCRIPTION	FEATURES	LENGTH
98-170	Merit™ Buck Ear Curette	Size 00, Blunt, Straight	-
98-162	Merit™ Buck Ear Curette	Size 00, Blunt, Angled	-
98-171	Merit™ Buck Ear Curette	Size 0, Blunt, Straight	-
98-164	Merit™ Buck Ear Curette	Size 0, Blunt, Angled	-
98-172	Merit™ Buck Ear Curette	Size 1, Blunt, Straight	-
98-165	Merit™ Buck Ear Curette	Size 1, Blunt, Angled	-
98-173	Merit™ Buck Ear Curette	Size 2, Blunt, Straight	-
98-166	Merit™ Buck Ear Curette	Size 2, Blunt, Angled	-
98-174	Merit™ Buck Ear Curette	Size 3, Blunt, Straight	-
98-167	Merit™ Buck Ear Curette	Size 3, Blunt, Angled	-
98-243	Merit™ Ear Syringe	Chrome, 2oz. With Tips and Shield	-
98-247	Merit™ Ear Syringe	Chrome, 3oz. With Tips and Shield	-
98-251	Merit™ Ear Syringe	Chrome, 4oz. With Tips and Shield	-
97-913	Merit™ Ear Syringe	Chrome, 4oz. Without Tips and Shield	-
98-257	Merit™ Ear Syringe Shield	Chrome	-
98-256	Merit™ Ear Syringe Tip	Chrome, Conical Tip	-
98-748	Merit™ Freer Elevator	Double End, Sharp/Blunt	7¼"
98-253	Merit™ Gruber Ear Speculum	Set of 3	-
98-209	Merit™ Hartmann Alligator Forceps	Serrated	3½"
98-224	Merit™ Hartmann Alligator Forceps	Serrated	5½"
98-232	Merit™ Hartmann Alligator Forceps	Serrated	6½"
98-252	Merit™ Knapp Eye Speculum	-	-

**ENT CONTINUED**

PRODUCT NUMBER	DESCRIPTION	FEATURES	LENGTH
98-182	Merit™ Lucae Forceps	Delicate, Bayonet	5½"
98-234	Merit™ Micro Alligator Forceps	1.0mm Cup	2¾"
98-236	Merit™ Micro Alligator Forceps	1.5mm Cup	2¾"
98-239	Merit™ Micro Alligator Forceps	Serrated	2¾"
98-268	Merit™ Vienna Nasal Speculum	Small	5¾"
98-267	Merit™ Vienna Nasal Speculum	Medium	5¾"
98-258	Merit™ Vienna Nasal Speculum	Large	5¾"

**SCALPELS**

PRODUCT NUMBER	DESCRIPTION	FEATURES	LENGTH
97-033	Merit™ Scalpel Handle	#3	–
97-038	Merit™ Scalpel Handle	#4	–
97-042	Merit™ Scalpel Handle	#7	–

**CUTTERS**

PRODUCT NUMBER	DESCRIPTION	FEATURES	LENGTH
98-201	Merit™ Kern Bone Forceps	With Ratchet	6½"
98-207	Merit™ Kern Bone Forceps	With Ratchet	9½"
98-211	Merit™ Liston Bone Cutting Forceps	Straight	5½"
98-475	Merit™ Littauer Cutting Forceps	Straight Back	4"
98-476	Merit™ Littauer Cutting Forceps	Straight Back	4½"
98-477	Merit™ Littauer Cutting Forceps	Straight Back	5"
98-478	Merit™ Littauer Cutting Forceps	Straight Back	6"
98-485	Merit™ Nail Nipper	Concave, Barrel Spring	4½"
98-472	Merit™ Nail Nipper	Concave, Barrel Spring	5½"
98-484	Merit™ Nail Nipper	Concave, Angled	5½"
98-482	Merit™ Nail Nipper	Concave With Lock	5½"
98-480	Merit™ Nail Nipper	Straight With Lock	5½"
98-493	Merit™ Nail Nipper	Double Spring With Lock	5½"
98-492	Merit™ Nail Splitter Forceps	English Anvil	5"
98-489	Merit™ Tissue Nipper	Convex Blade	4½"



## Econo Instruments

Econo instruments are made from the highest quality material to offer the identical function of a reusable instrument, but at an affordable cost. These disposable instruments are a convenient, dependable choice. They reduce the risk of cross contamination, saves labor cost and eliminates cleaning and sterilization processes.

- RELIABLE FUNCTION
- OVER 100 PATTERNS AVAILABLE
- FACTORY IS ISO 9000 CERTIFIED AND CGMP COMPLIANT



FLOOR GRADE SCISSORS



OPERATING SCISSORS

STRAIGHT

21-263	4½"	Sharp/Blunt	12/bx
21-266	4½"	Sharp/Sharp	12/bx
21-270	5"	Sharp/Blunt	12/bx
21-271	5"	Sharp/Sharp	12/bx
21-272	5½"	Sharp/Blunt	12/bx
21-275	5½"	Sharp/Sharp	12/bx
21-278	5½"	Blunt/Blunt	12/bx
21-281	6½"	Sharp/Blunt	12/bx
21-284	6½"	Sharp/Sharp	12/bx
21-288	6½"	Blunt/Blunt	12/bx



OPERATING SCISSORS

CURVED

21-291	4½"	Sharp/Blunt	12/bx
21-294	4½"	Sharp/Sharp	12/bx
21-299	5½"	Blunt/Blunt	12/bx
21-292	5½"	Sharp/Blunt	12/bx
21-295	5½"	Sharp/Sharp	12/bx
21-300	6½"	Blunt/Blunt	12/bx
21-293	6½"	Sharp/Blunt	12/bx



MAYO SCISSORS

21-308	5½"	Straight	12/bx
21-312	5½"	Curved	12/bx
21-321	6¾"	Straight	12/bx
21-325	6¾"	Curved	12/bx



MAYO DISSECTING SCISSORS

21-327	9"	Straight	12/bx
21-328	9"	Curved	12/bx



METZENBAUM SCISSORS

21-344	4½"	Curved	Lahey	12/bx
21-335	5½"	Straight	Lahey	12/bx
21-336	5½"	Curved	Lahey	12/bx
21-339	7"	Straight		12/bx
21-340	7"	Curved		12/bx
21-354	9"	Curved		12/bx

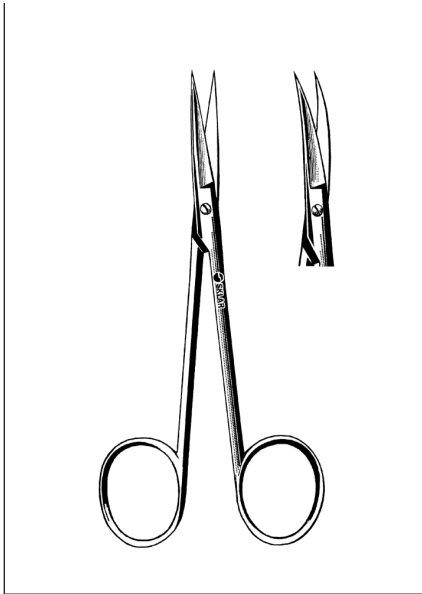

**IRIS SCISSORS**

21-102	2½"	Straight	12/bx
21-103	3½"	Straight	12/bx
21-107	3½"	Curved	12/bx
21-104	4½"	Straight	12/bx
21-109	4½"	Curved	12/bx



**SPENCER STITCH SCISSORS**

21-346	3½"	12/bx
21-352	4½"	12/bx

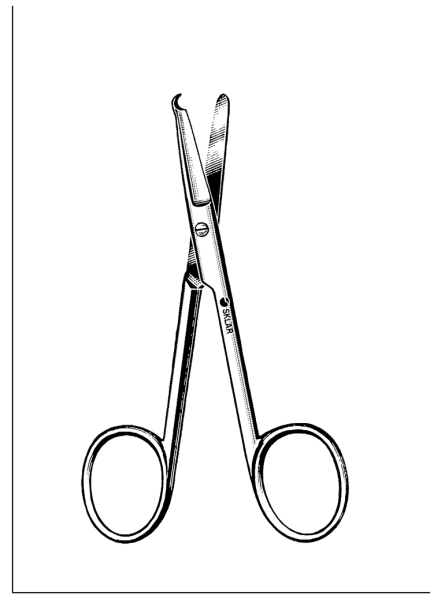

**LITTAUER STITCH SCISSOR**

21-358	5½"	12/bx
--------	-----	-------

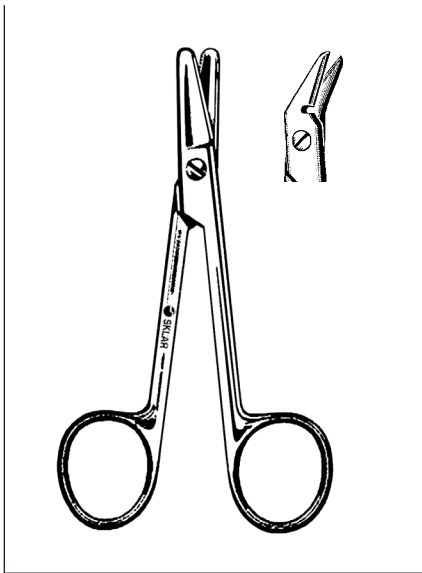

**WIRE CUTTING SCISSORS**

21-363	4½"	Straight	12/bx
21-364	4¾"	Angled	12/bx

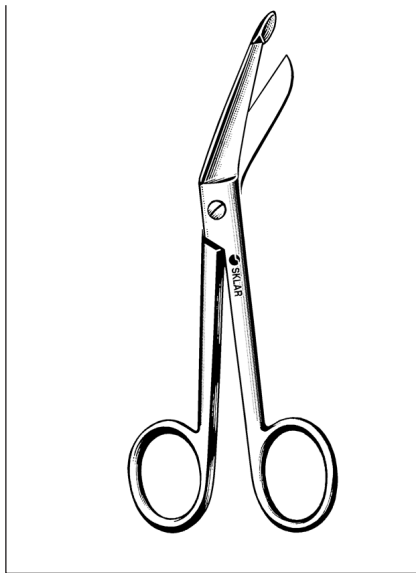

**LISTER BANDAGE SCISSORS**

21-222	3½"	12/bx
21-226	4½"	12/bx
21-231	5½"	12/bx
21-237	5½"	With Clip 12/bx
21-241	7¼"	12/bx
21-243	8"	12/bx
21-245	8"	Large Ring 12/bx

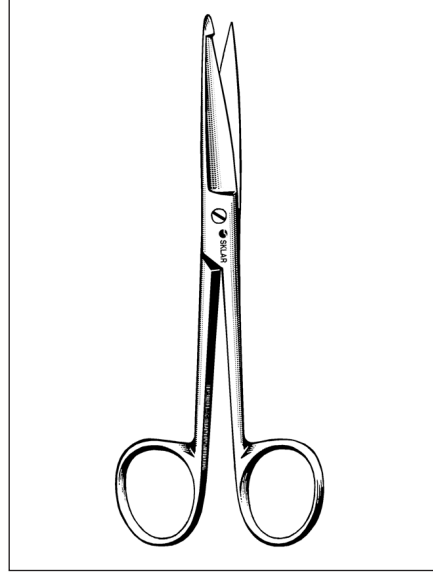

**KNOWLES BANDAGE SCISSOR**

21-254	5½"	12/bx
--------	-----	-------



FLOOR GRADE SCISSORS

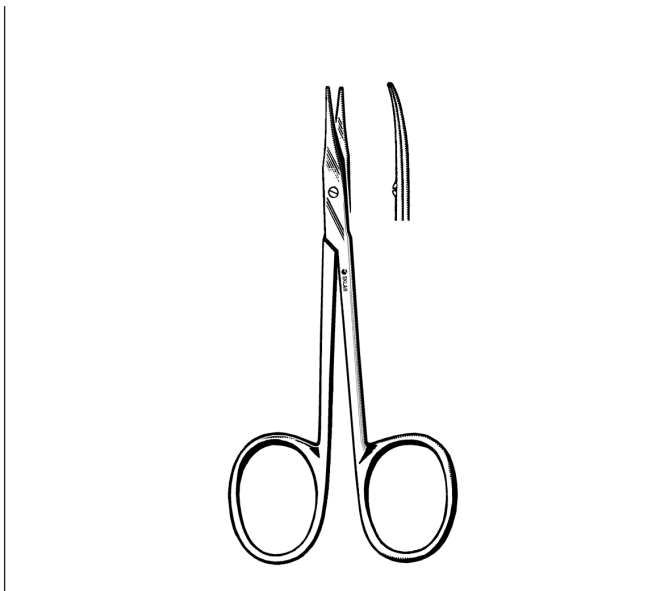

**STEVENS TENOTOMY SCISSORS**

21-160	4½"	Straight	Blunt/Blunt	12/bx
21-161	4½"	Curved	Blunt/Blunt	12/bx

**SUTURE SCISSOR**

21-369	3½"	Shortbent	12/bx
--------	-----	-----------	-------



**UTILITY SCISSORS**

21-101	5½"	Black	12/bx	21-105LG	7"	Lime Green	12/bx	21-105PR	7"	Purple	12/bx
21-100	6"	Blue	12/bx	21-105MG	7"	Magenta	12/bx	21-105RB	7"	Royal Blue	12/bx
21-105	7"	Black	12/bx	21-105NB	7"	Navy Blue	12/bx	21-105TB	7"	Teal Blue	12/bx
21-105BG	7"	Burgundy	12/bx	21-105OR	7"	Orange	12/bx	21-105YL	7"	Yellow	12/bx
21-105HG	7"	Hunter Green	12/bx								

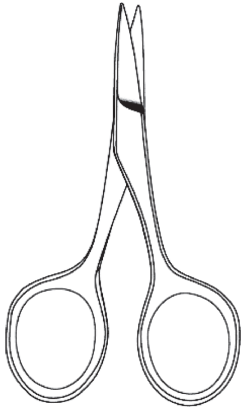

**SMALL UTILITY SCISSOR**

21-060 2½" 12/bx

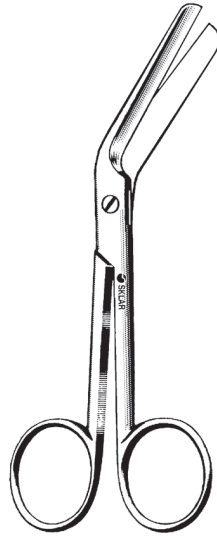

**BRAUN EPISIOTOMY SCISSOR**

21-375 5½" Angled 12/bx

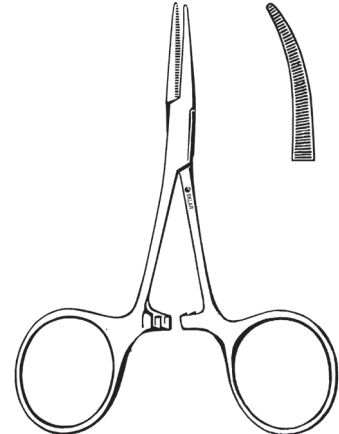

**HARTMANN MOSQUITO FORCEPS**

21-409 3½" Straight 12/bx  
21-421 3½" Curved 12/bx

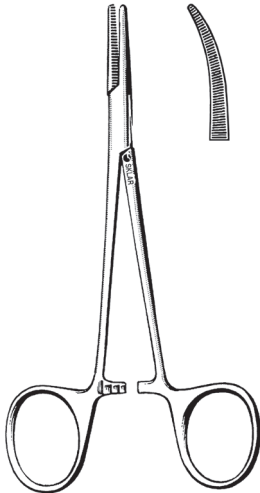

**HALSTED MOSQUITO FORCEPS**

21-426 5" Straight 12/bx  
21-431 5" Curved 12/bx

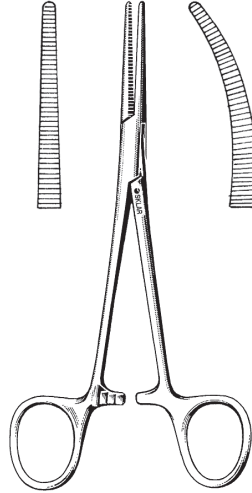

**CRILE HEMOSTATIC FORCEPS**

21-447 5½" Straight 12/bx  
21-452 5½" Curved 12/bx

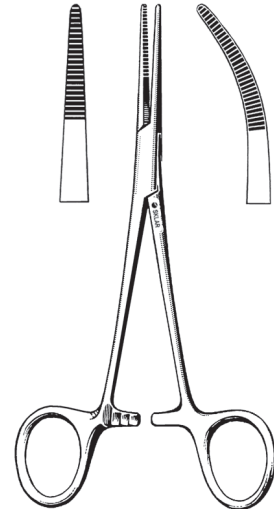

**KELLY HEMOSTATIC FORCEPS**

21-436 5½" Straight 12/bx  
21-442 5½" Curved 12/bx

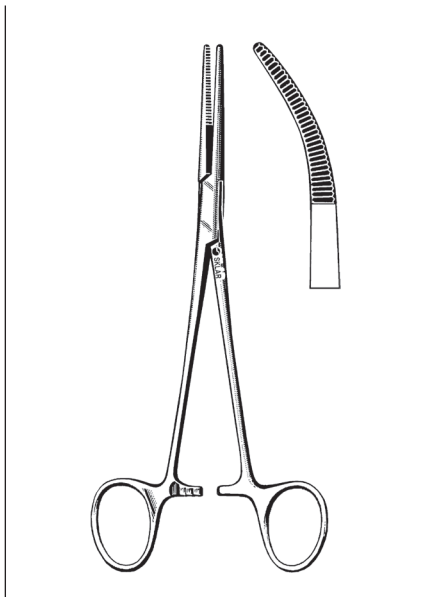

**RANKIN CRILE FORCEPS**

21-458	6¼"	Straight	12/bx
21-463	6¼"	Curved	12/bx

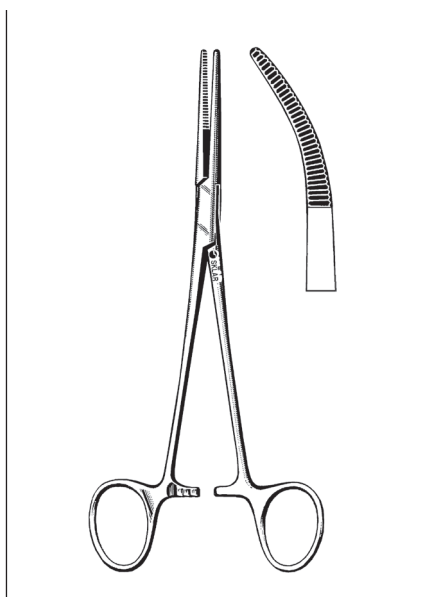

**RANKIN KELLY FORCEPS**

21-469	6¼"	Curved	12/bx
21-465	6½"	Straight	12/bx

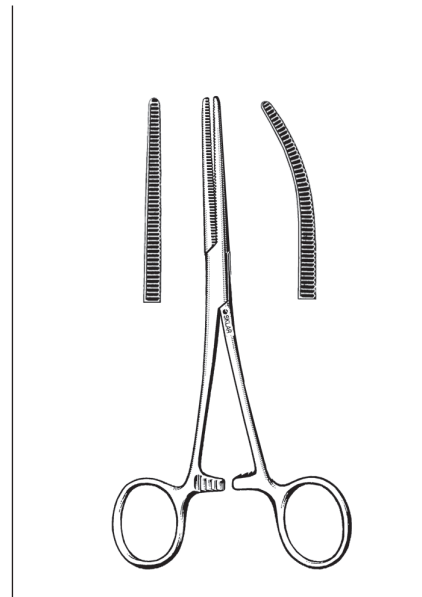

**ROCHESTER-PEAN FORCEPS**

STRAIGHT			CURVED		
21-470	5½"	12/bx	21-471	5½"	12/bx
21-473	6¼"	12/bx	21-477	6¼"	12/bx
21-481	7¼"	12/bx	21-495	6¾"	12/bx
21-492	8"	12/bx	21-485	7¼"	12/bx
			21-498	8"	12/bx
			21-487	9"	12/bx

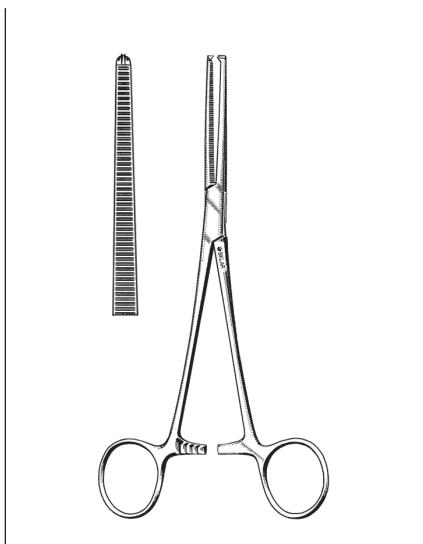

**ROCHESTER-OSHSNER FORCEPS**

**1X2 TEETH, STRAIGHT**

21-500	5½"	Kocher	12/bx
21-504	6¼"	Kocher	12/bx
21-488	7¼"		12/bx
21-513	8"		12/bx

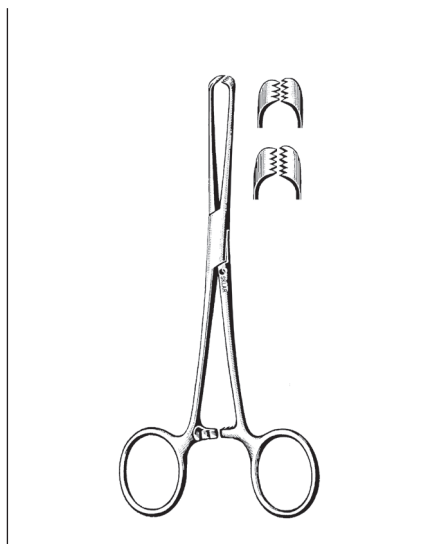

**ALLIS TISSUE FORCEPS**

21-930	6"	4x5 Teeth	12/bx
21-934	6"	5x6 Teeth	12/bx
21-941	6"	Atraumatic Jaw	12/bx
21-938	7¼"	6x7 Teeth	12/bx

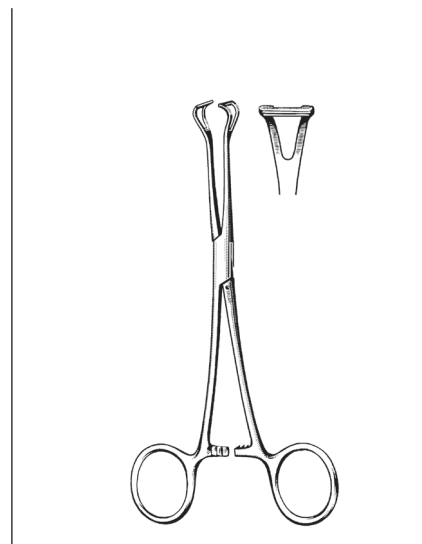

**BABCOCK FORCEPS**

21-952	6¼"	9mm	12/bx
21-441	8"	10mm	12/bx



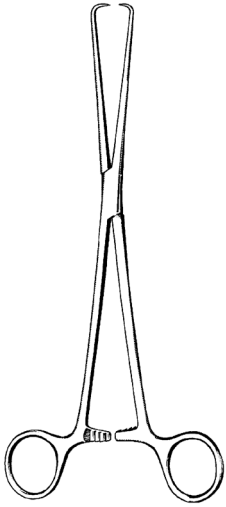

**SCHROEDER TENACULUM  
FORCEPS**

21-386 9¾" (Braun) 12/bx  
21-459 10¼" (Pozzi) 12/bx

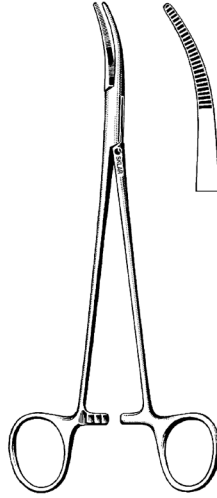

**SCHNIDT TONSIL  
HEMOSTATIC FORCEPS**

**HALF CURVE**  
21-434 7½" 12/bx

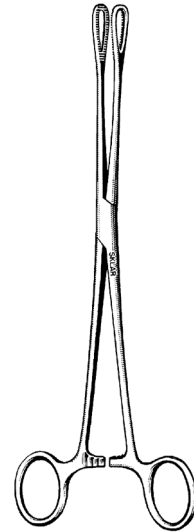

**SCHWEIZER FORCEPS**

21-437 9½" 12/bx

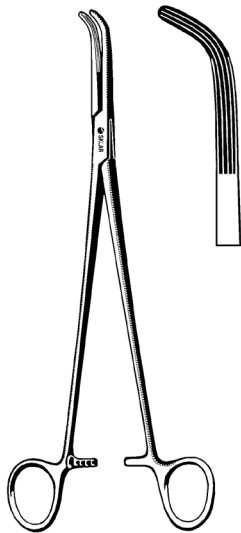

**LAHEY GALL DUCT FORCEPS**  
**LONGITUDINAL SERRATIONS**

21-453 7½" 12/bx

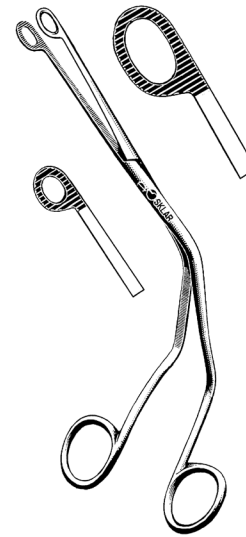

**MAGILL CATHETER FORCEPS**

21-285 7¼" 12/bx  
21-289 9¾" 12/bx

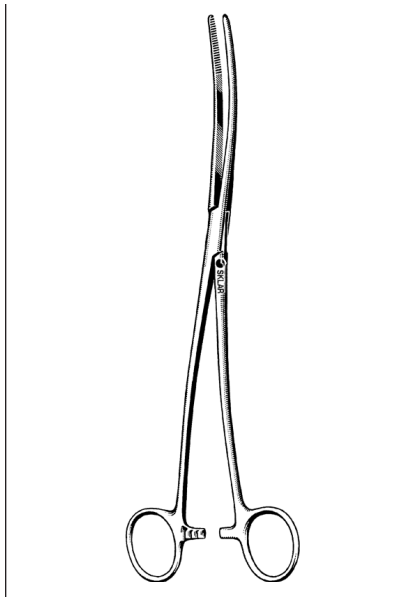

**BOZEMAN SPONGE FORCEPS**

21-374 10¼" S-Curve 12/bx

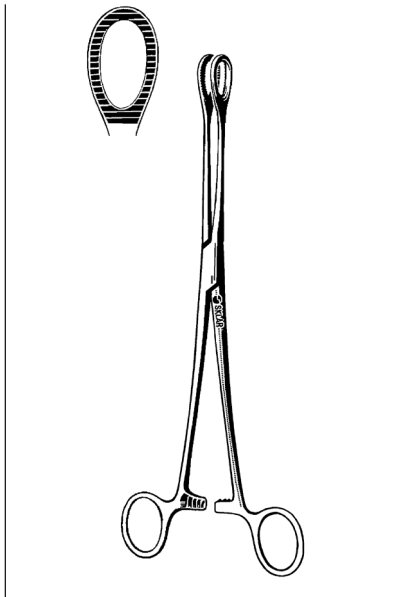

**BALLENGER SPONGE FORCEPS**

**STRAIGHT**

21-571 7" Serrated 12/bx

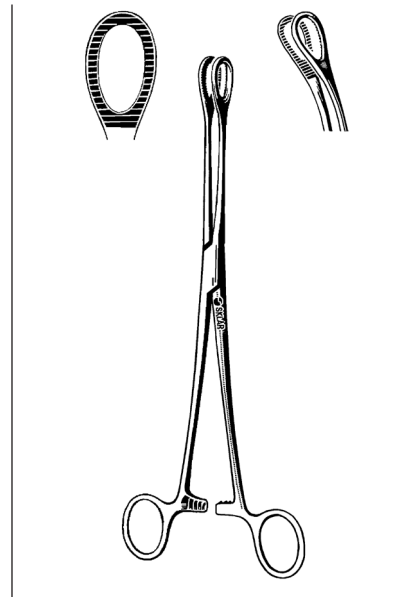

**FOERSTER SPONGE FORCEPS**

**SERRATED**

21-577 9½" Straight 12/bx  
21-586 9½" Curved 12/bx

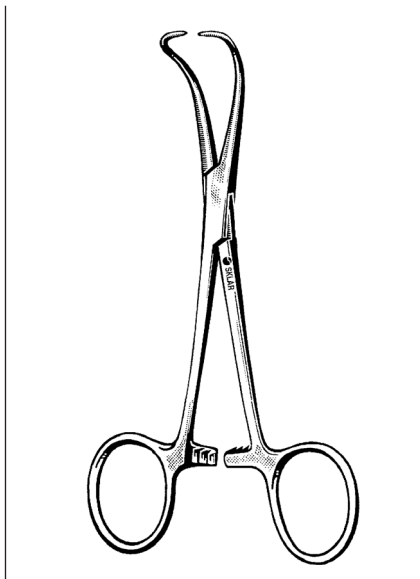

**BACKHAUS TOWEL FORCEPS**

21-606 3½" 12/bx  
21-608 5¼" 12/bx

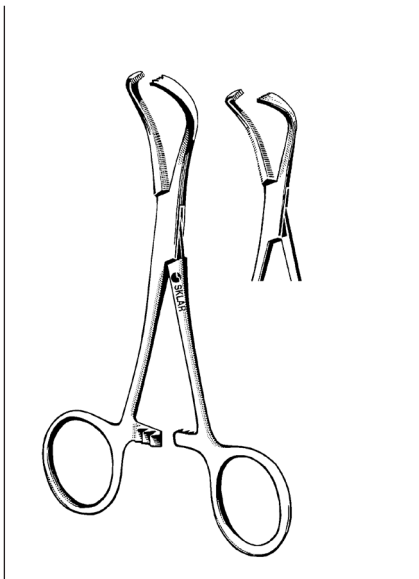

**LORNA-EDNA TOWEL CLAMPS**

21-604 3½" 12/bx  
21-635 5¼" 12/bx

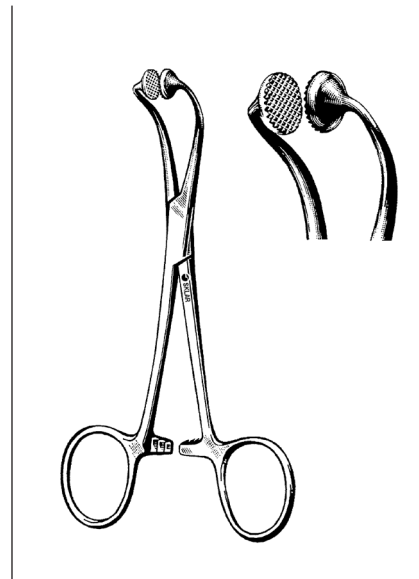

**HOFF TOWEL CLAMPS**

21-611 5¼" 12/bx  
21-655 6¼" 12/bx

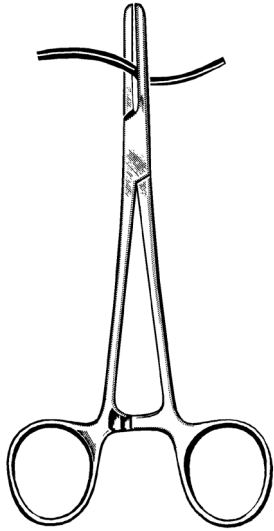

**TUBE OCCLUDING FORCEPS**

21-598	7"	Smooth	12/bx
21-599	7"	Serrated	12/bx

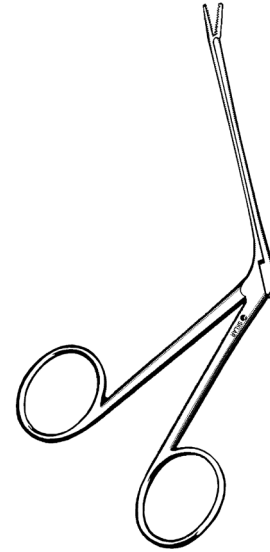

**HARTMANN ALLIGATOR FORCEPS**

21-209	3½"	Serrated	12/bx
21-224	5½"	Serrated	12/bx
21-232	6½"	Serrated	12/bx



**ADSON FORCEPS**

21-771	4¾"	Serrated	12/bx
21-772	4¾"	Serrated, Delicate	12/bx
21-775	4¾"	1x2 Teeth	12/bx
21-776	4¾"	1x2 Teeth, Delicate	12/bx

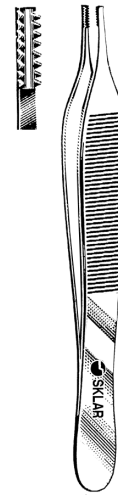

**ADSON BROWN FORCEPS**

<b>7X7 TEETH, SIDE GRASPING</b>			
21-778	4¾"		12/bx

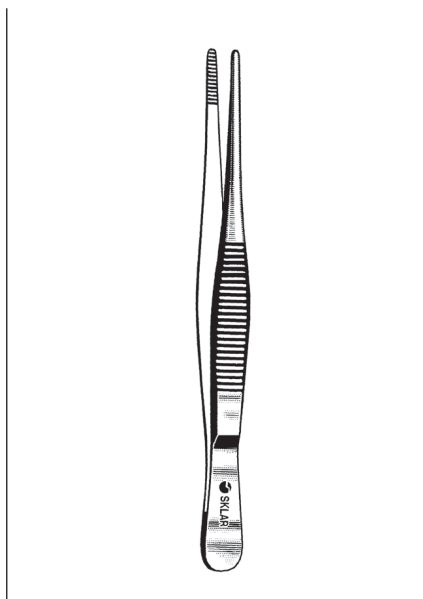

**DRESSING FORCEPS**

21-705	4½"	12/bx
21-710	5"	12/bx
21-727	5½"	12/bx
21-731	6"	12/bx
21-736	8"	12/bx
21-742	10"	12/bx

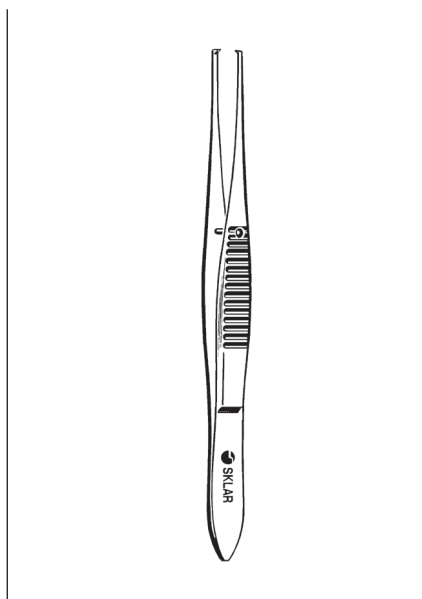

**TISSUE FORCEPS**

**1X2 TEETH**

21-142	4"	12/bx	21-762	5½"	12/bx
21-753	4½"	12/bx	21-766	6"	12/bx
21-757	5"	12/bx	21-770	8"	12/bx

**2X3 TEETH**

21-769	5½"	12/bx
--------	-----	-------

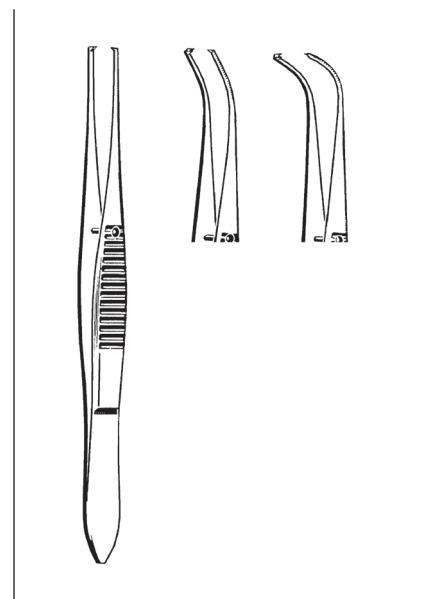

**IRIS FORCEPS**

21-128	2½"	Half Curve, Serrated	12/bx
21-123	4¼"	Straight, Serrated	12/bx
21-124	4¼"	Straight, 1x2 Teeth	12/bx
21-129	4¼"	Half Curve, Serrated	12/bx
21-135	4¼"	Full Curve, Serrated	12/bx
21-146	4¼"	Half Curve, 1x2 Teeth	12/bx
21-151	4¼"	Full Curve, 1x2 Teeth	12/bx
21-129TP	4¼"	Half Curve, Serrated With Tip Protector	12/bx

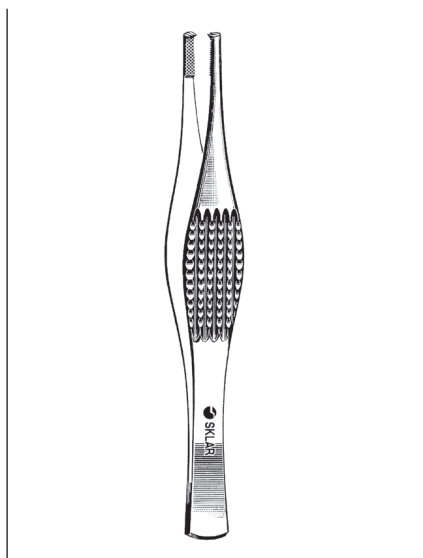

**FERRIS-SMITH TISSUE FORCEPS**

**SERRATED, PLATFORM TIPS**

21-449	7"	1x2 Teeth	12/bx
--------	----	-----------	-------

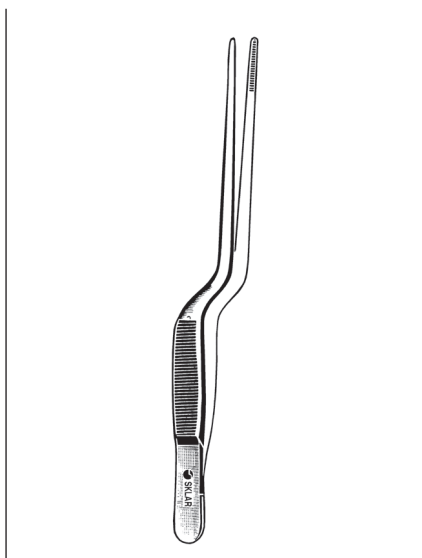

**ADSON BAYONET FORCEPS**

21-188	7½"	Delicate	12/bx
--------	-----	----------	-------

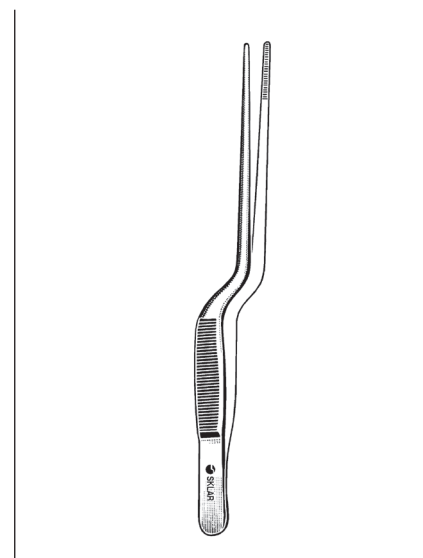

**LUCAE BAYONET EAR FORCEPS**

21-180	5½"	12/bx
--------	-----	-------

**ECONO**  
**FLOOR GRADE FORCEPS**

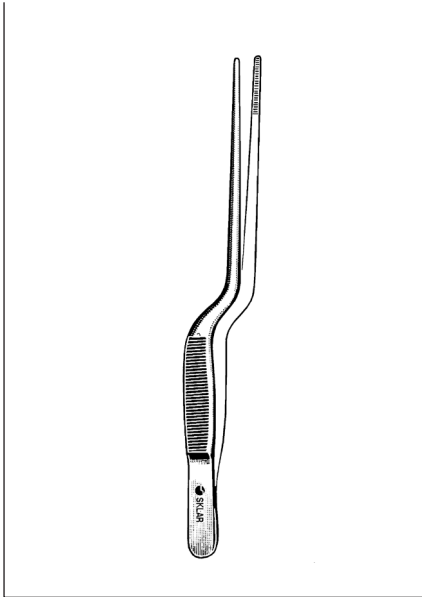

**JANSEN BAYONET FORCEPS**  
**SERRATED**  
21-605 6½" 12/bx

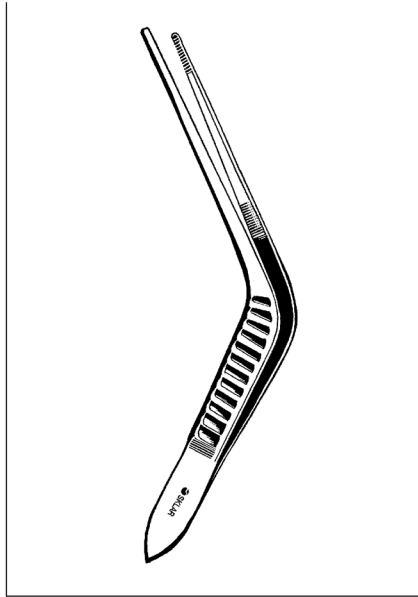

**WILDE EAR FORCEPS**  
**ANGULAR, SERRATED**  
21-227 5" 12/bx

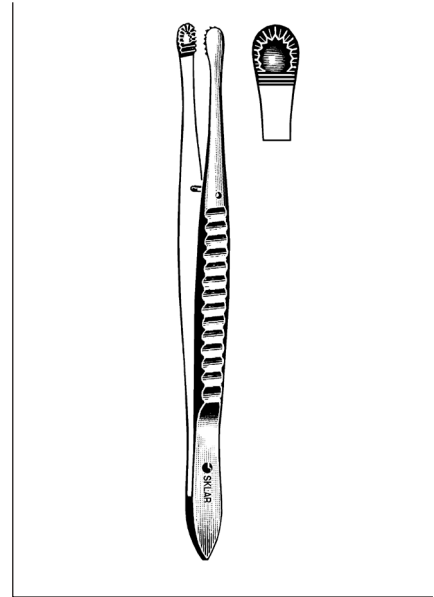

**RUSSIAN TISSUE FORCEPS**  
21-607 8" 12/bx

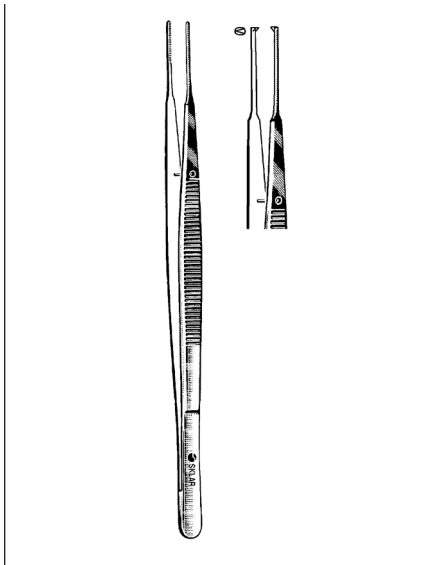

**GERALD FORCEPS**  
**STRAIGHT**  
21-610 7" Serrated 12/bx  
21-612 7" 1x2 Teeth 12/bx

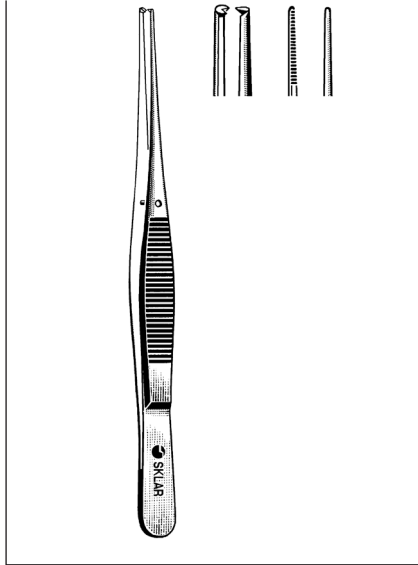

**SEMKIN FORCEPS**  
**SERRATED**  
21-478 5" Delicate 12/bx

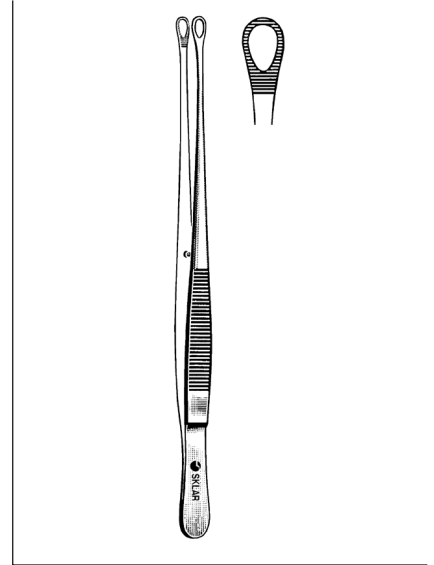

**TUTTLE FORCEPS**  
21-617 7" 12/bx



FLOOR GRADE FORCEPS

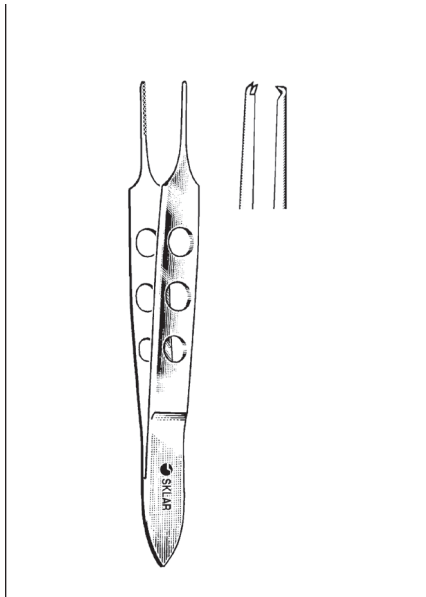

**BISHOP-HARMON IRIS FORCEPS**

21-764 3½" 1x2 Teeth 12/bx

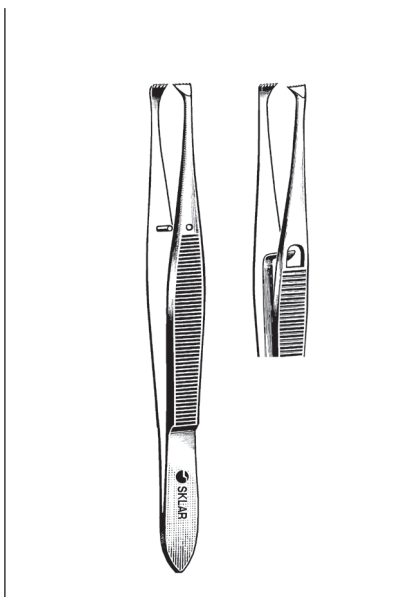

**GRAEFE FIXATION FORCEPS**

21-785 4½" Without Catch 12/bx  
21-788 4½" With Catch 12/bx



**PLAIN SPLINTER FORCEPS  
3" WITH MAGNIFIER, NON-AUTOCCLAVABLE**

21-708 3" 12/bx  
21-777 3½" 12/bx  
21-790 4" 12/bx  
21-781 4½" 12/bx



**CARMALT SPLINTER FORCEPS**

21-791 4½" Straight 12/bx  
21-793 4½" Angled 12/bx



**SWISS JEWELER STYLE  
FORCEPS**

NON-MAGNETIC, STAINLESS STEEL

21-817 4½" #5 Straight 12/bx  
21-819 4½" #7 Curved 12/bx

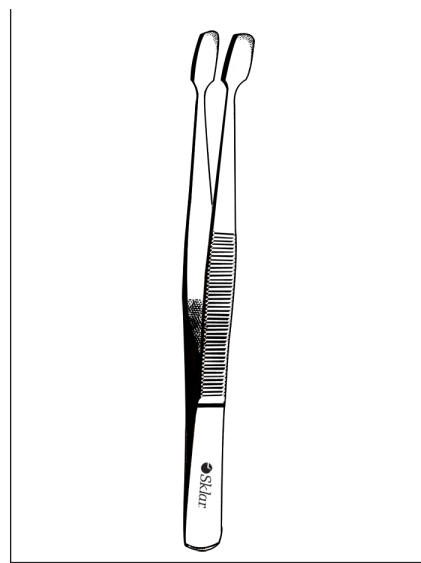

**COVER GLASS FORCEPS**

21-900 Angled 12/bx

**ECONO**  
**FLOOR GRADE NEEDLE HOLDERS**

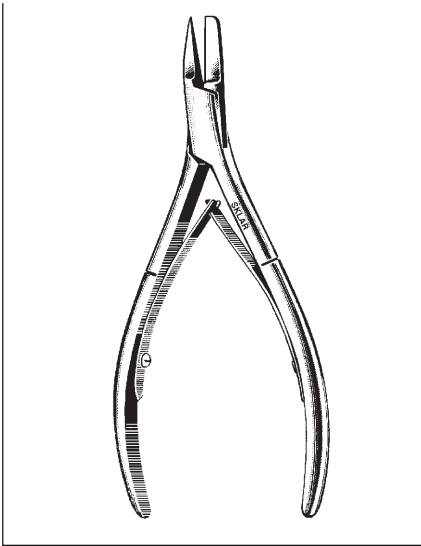

**NAIL SPLITTING FORCEPS**

ENGLISH ANVIL PATTERN

21-479 5" 12/bx

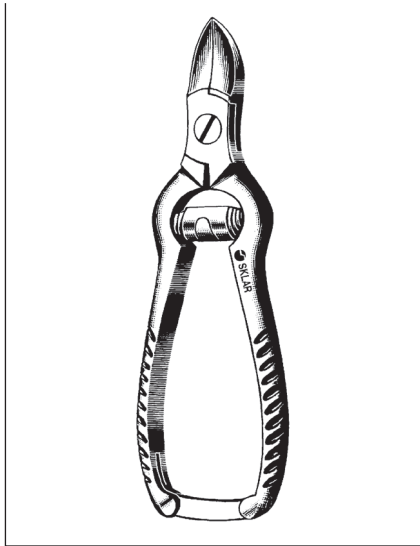

**NAIL NIPPER**

CONCAVE, 12/BX

- |        |     |               |       |
|--------|-----|---------------|-------|
| 21-482 | 5½" | Double Spring | 12/bx |
| 21-483 | 5½" |               | 12/bx |
| 21-484 | 5½" | Angled        | 12/bx |
| 21-486 | 4½" | Barrel Spring | 12/bx |
| 21-472 | 5½" | Barrel Spring | 12/bx |
| 21-493 | 5½" | Double Spring | 12/bx |
|        |     | with lock     |       |
| 21-497 | 4½" | Folding Lock  | 12/bx |

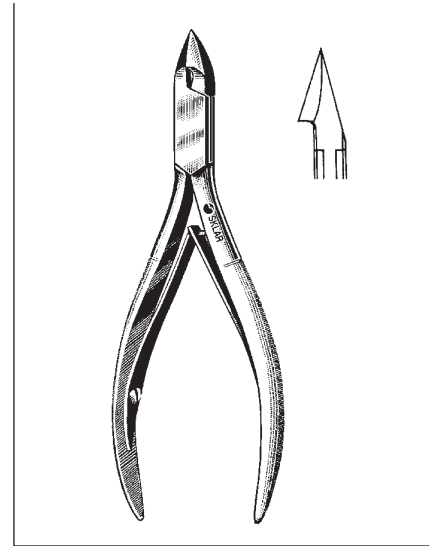

**TISSUE NIPPER**

CONVEX JAW

- |        |     |       |
|--------|-----|-------|
| 21-489 | 4½" | 12/bx |
| 21-491 | 5"  | 12/bx |



**BAUMGARTNER  
NEEDLE HOLDER**

21-832 5½" Serrated 12/bx

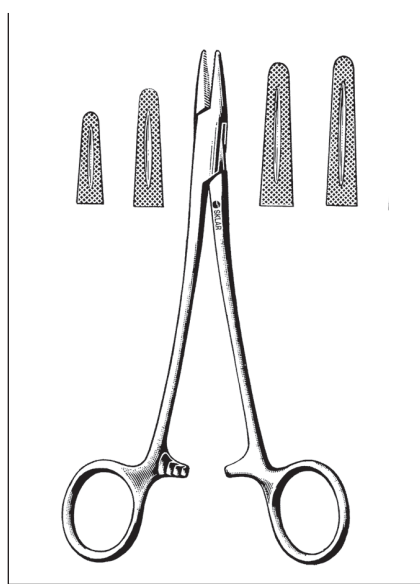

**MAYO-HEGAR NEEDLE HOLDERS**

SERRATED

- |        |    |       |
|--------|----|-------|
| 21-842 | 5" | 12/bx |
| 21-847 | 6" | 12/bx |
| 21-853 | 7" | 12/bx |
| 21-869 | 8" | 12/bx |

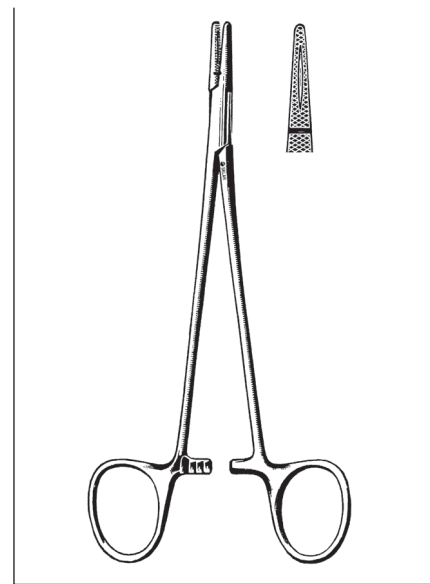

**CRILE-WOOD NEEDLE HOLDER**

SERRATED

21-838 6" 12/bx



**ECONO**

**FLOOR GRADE NEEDLE HOLDERS**

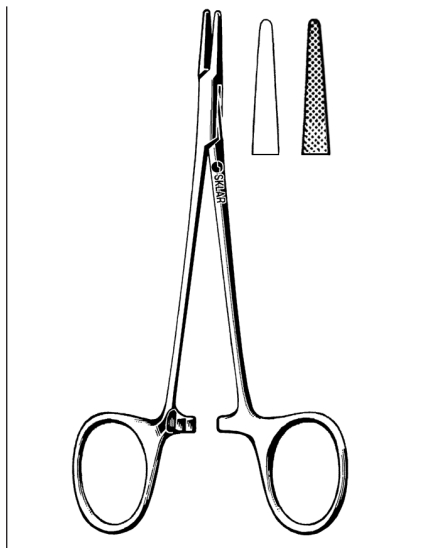

**WEBSTER NEEDLE HOLDERS**

21-809 5¼" Smooth 12/bx  
21-813 5¼" Serrated 12/bx

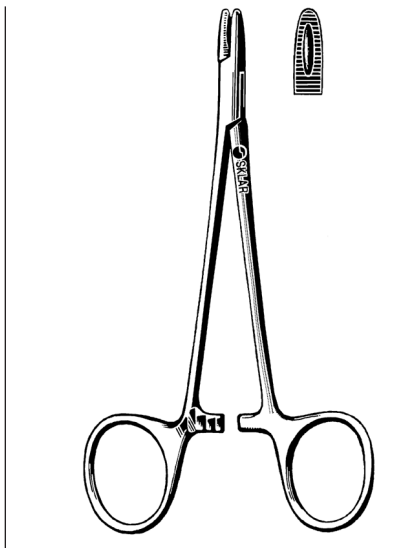

**DERF NEEDLE HOLDER**

21-826 4¾" Serrated 12/bx

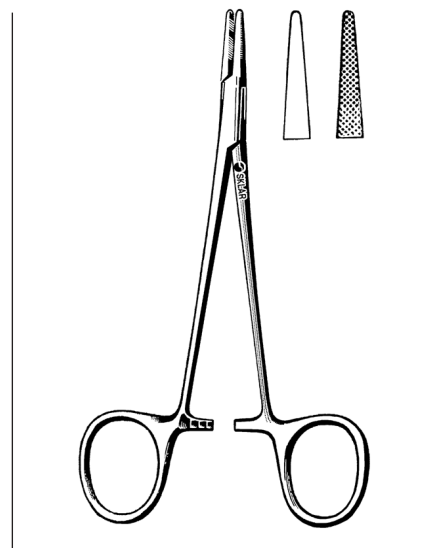

**HALSEY NEEDLE HOLDERS**

21-810 5" Smooth 12/bx  
21-812 5¼" Serrated 12/bx



**OLSEN-HEGAR NEEDLE HOLDERS**

**SCISSOR COMBINATION**

21-872 5½" 12/bx  
21-877 6" 12/bx



**COLLIER NEEDLE HOLDER**

21-885 5¼" Serrated, Fenestrated 12/bx



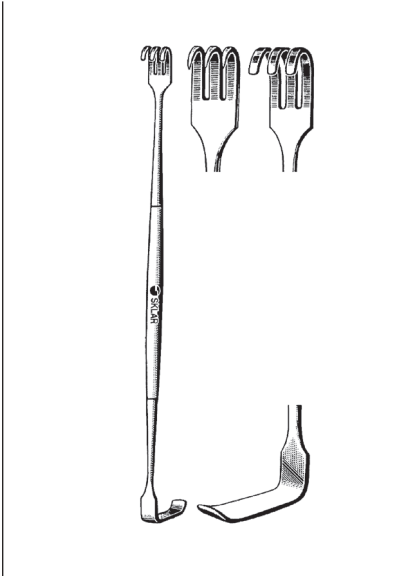

**SENN RETRACTORS**

**DOUBLE END**

21-366	6¼"	Sharp	12/bx
21-365	6¼"	Blunt	12/bx

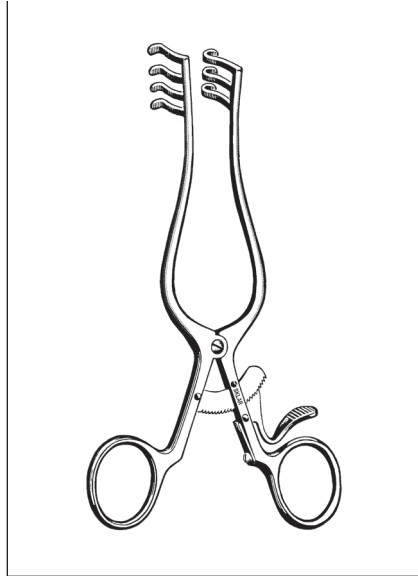

**WEITLANER RETRACTOR**

**BLUNT**

21-371	4½"	2x3 Prongs	12/bx
--------	-----	------------	-------

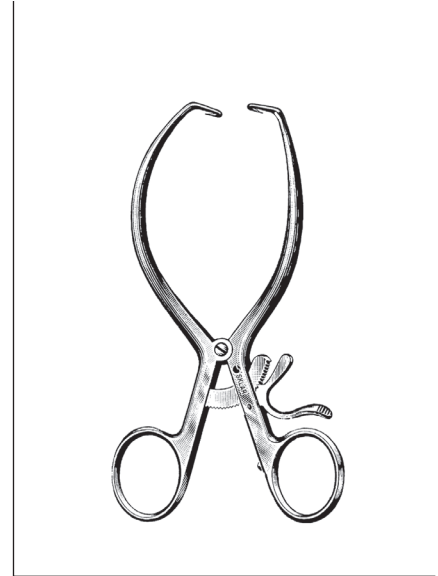

**GELPI RETRACTOR**

21-805	7"	12/bx
--------	----	-------

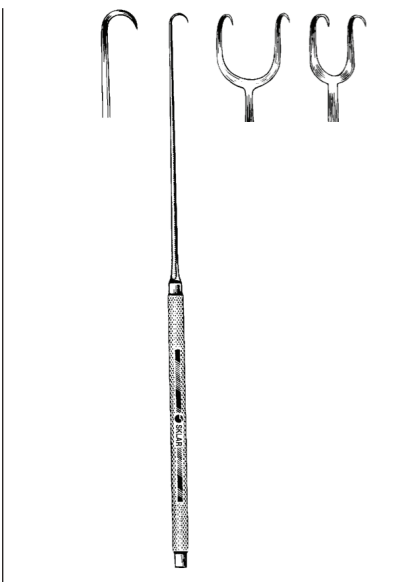

**JOSEPH SKIN HOOKS**

**SHARP**

21-390	6¼"	-	1 Prong	12/bx
21-392	6¼"	2 mm	2 Prong	12/bx
21-394	6¼"	5 mm	2 Prong	12/bx

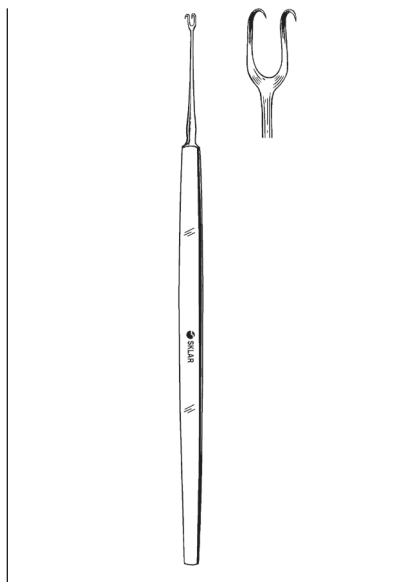

**GUTHRIE DOUBLE HOOK**

**SHARP**

21-821	5"	5mm	2 Large Prong	12/bx
--------	----	-----	---------------	-------

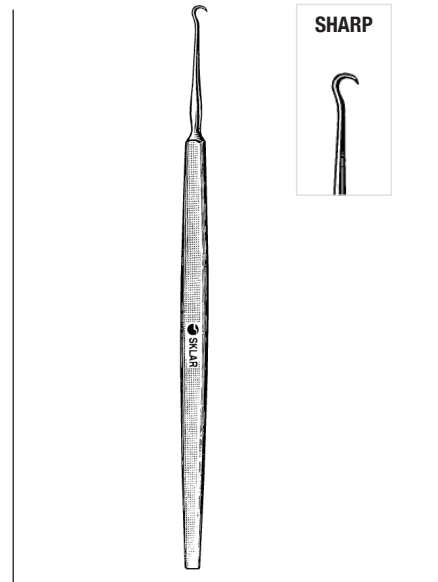

**FRAZIER TISSUE HOOK**

21-801	5"	Sharp	12/bx
--------	----	-------	-------

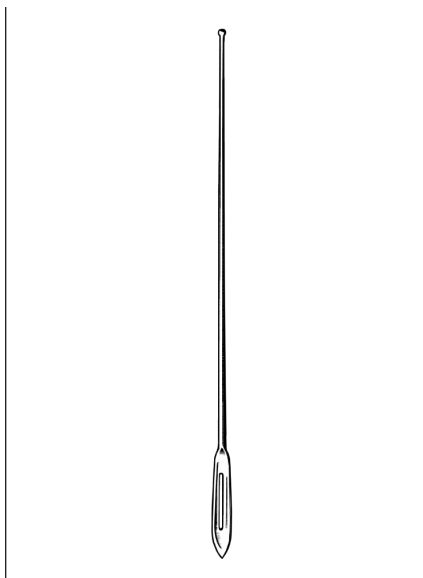

**PROBES  
WITH EYE**

21-499	5"	12/bx
21-502	6"	12/bx

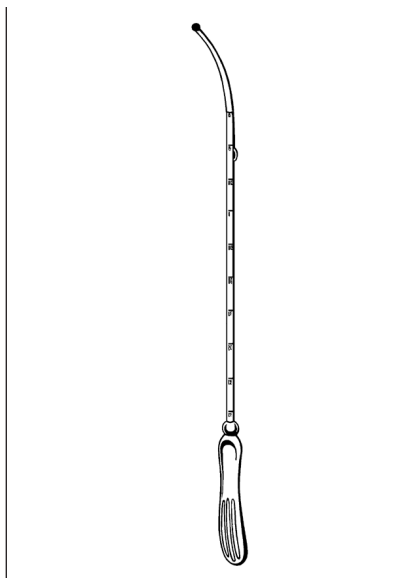

**SIMPSON UTERINE SOUND  
CM GRADUATION SILVER**

21-382	12/bx
--------	-------

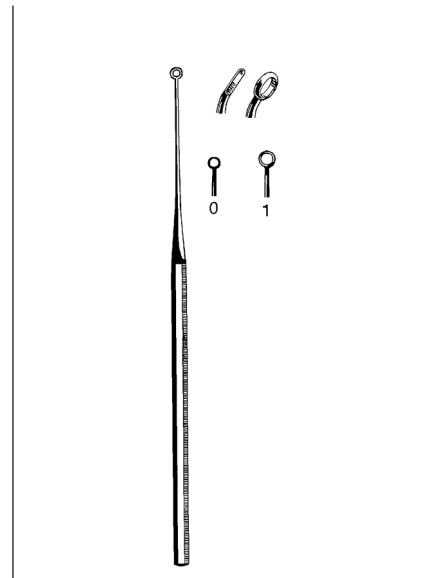

**BUCK EAR CURETTES**

**BLUNT, STRAIGHT**

21-171	#0	12/bx
21-172	#1	12/bx

**BLUNT, ANGLED**

21-165	#1	12/bx
--------	----	-------

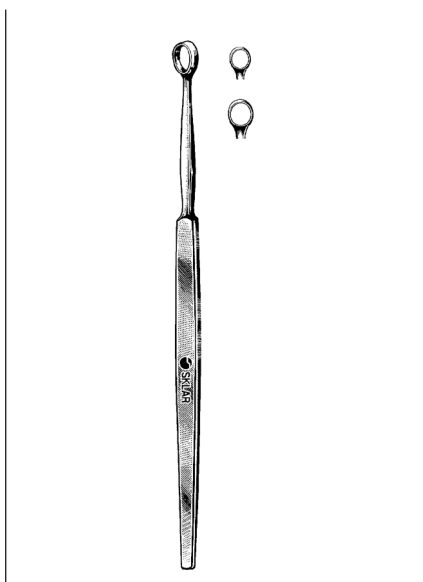

**FOX DERMAL CURETTES**

**ROUND**

21-184	5½"	3 mm	12/bx
21-186	5½"	4 mm	12/bx

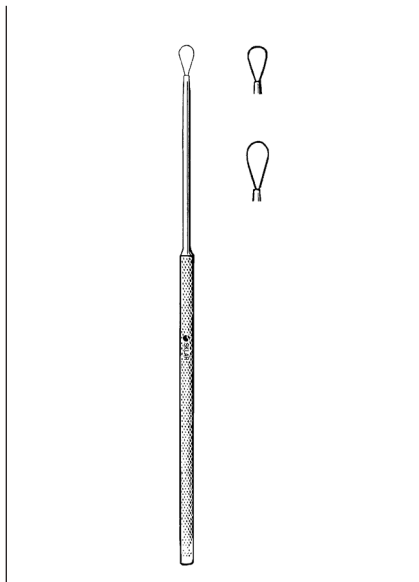

**BILLEAU EAR LOOPS**

21-176	Small	12/bx
21-177	Medium	12/bx

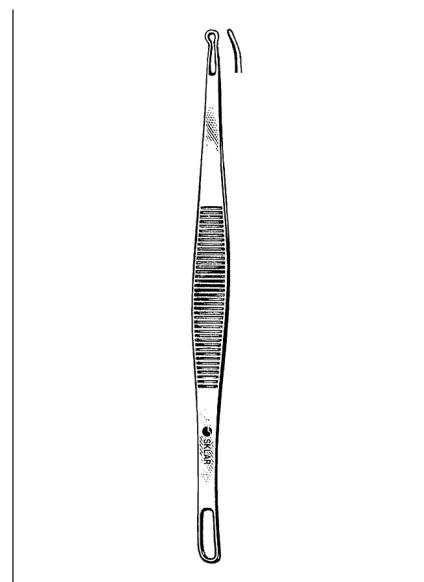

**SHAMBERG COMEDONE  
EXTRACTORS**

21-740	Regular	12/bx
21-741	Extra-Fine	12/bx
21-743	Square	12/bx

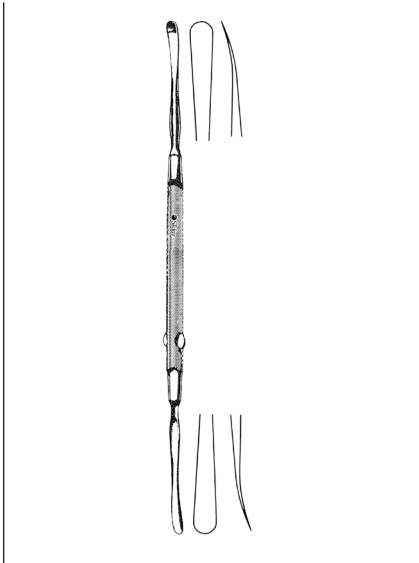

**FREER ELEVATOR**  
**DOUBLE END, SHARP/BLUNT**  
21-748 7¼" 12/bx

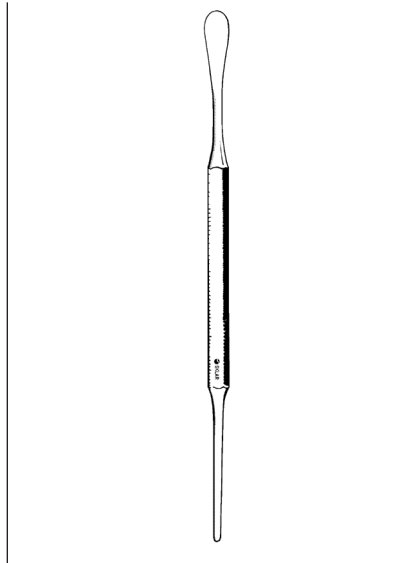

**SPATULA AND PACKER**  
**DOUBLE END**  
21-797 12/bx

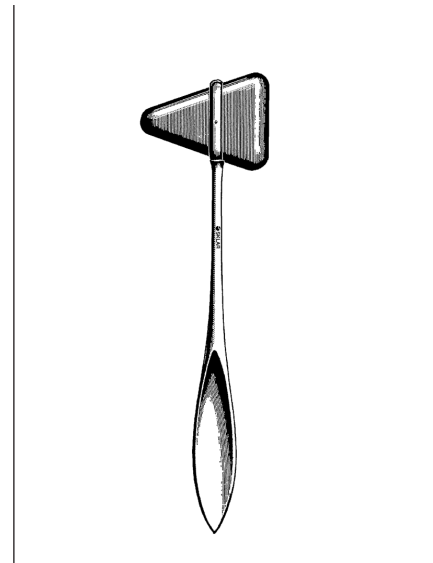

**TAYLOR HAMMERS**  
21-008 7" Small 12/bx  
21-010 7½" 12/bx



**GRAVES VAGINAL SPECULUMS**  
21-303 3" x ¾" Small 12/bx  
21-313 4" x 1¼" Medium 12/bx  
21-324 4½" x 1⅜" Large 12/bx  
21-322 4¾" x 1½" Extra 12/bx  
Large



**PEDERSON VAGINAL SPECULUMS**  
21-334 2¾" x ½" Extra Small 12/bx  
21-337 3" x ½" Small 12/bx  
21-348 4" x ¾" Medium 12/bx  
21-362 4¾" x 1" Large 12/bx  
21-368 4¾" x 1⅝" Extra Large 12/bx

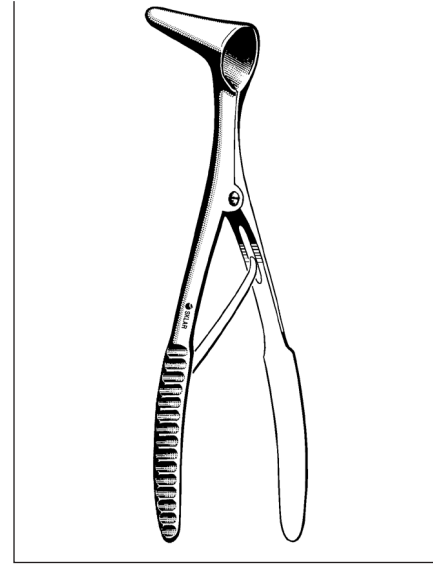

**VIENNA NASAL SPECULUMS**  
21-258 Adult Size 12/bx  
21-267 Pediatric Size 12/bx



## Econo™ Sterile Instruments



Ready to use Econo™ Sterile instruments are suitable in a number of surgical venues where economical choice with reliable performance is most important.

- Combines high quality with low cost
- Saves labor costs
- Convenient & Safe
- Eliminates costly cleaning, processing and sterilization
- Sterile one-time use

**CALL FOR PRICE  
QUOTES**

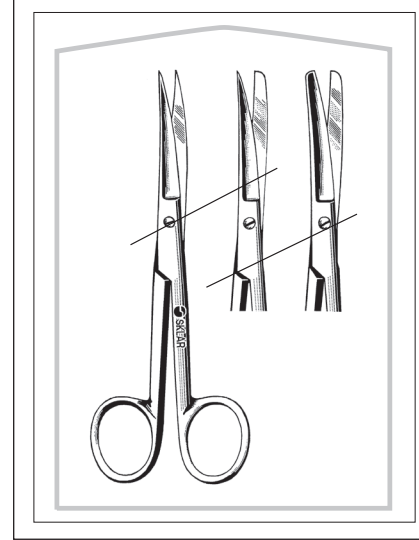

**OPERATING SCISSORS**

**STRAIGHT**

96-2597	4½"	Sharp/Blunt	25/bx
96-2592	4½"	Sharp/Sharp	25/bx
96-2521	5½"	Sharp/Blunt	25/bx
96-2523	5½"	Sharp/Sharp	25/bx
96-2728	4½"	Sharp/Blunt	50/bx
96-2593	4½"	Sharp/Sharp	50/bx

96-2514	5½"	Blunt/Blunt	50/bx
96-2520	5½"	Sharp/Blunt	50/bx
96-2522	5½"	Sharp/Sharp	50/bx
96-2726	6½"	Sharp/Blunt	50/bx
96-2649	5½"	Sharp/Blunt	100/bx

**OPERATING SCISSORS**

**CURVED**

96-2526	5½"	Sharp/Blunt	25/bx
96-2527	5½"	Sharp/Sharp	25/bx
96-2524	5½"	Sharp/Blunt	50/bx
96-2525	5½"	Sharp/Sharp	50/bx

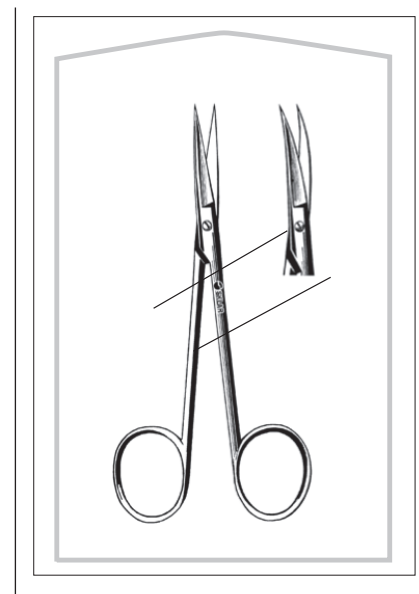
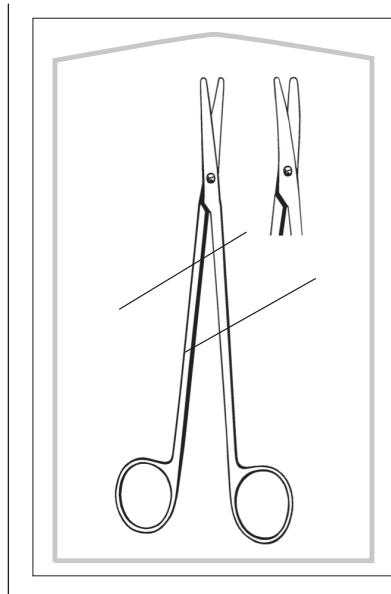
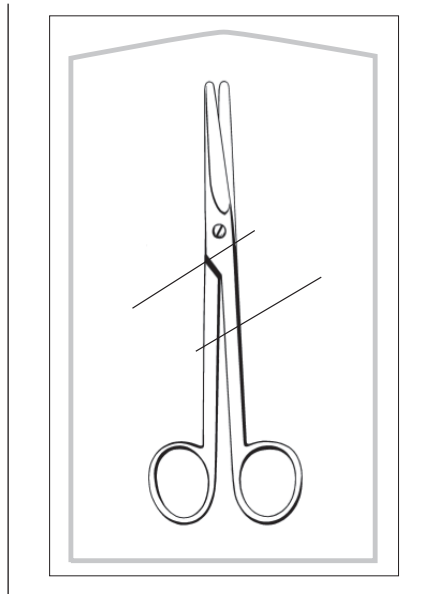

**MAYO SCISSORS**

96-2531	5½"	Straight	25/bx
96-2530	5½"	Straight	50/bx

**METZENBAUM SCISSORS**

96-2517	5½"	Straight	25/bx
96-2720	5½"	Curved	25/bx
96-2682	7"	Curved	25/bx
96-2516	5½"	Straight	50/bx
96-2721	5½"	Curved	50/bx
96-2680	7"	Curved	50/bx

**IRIS SCISSORS**

96-2505	4½"	Straight	25/bx
96-2507	4½"	Curved	25/bx
96-2497	3½"	Straight	50/bx
96-2499	3½"	Curved	50/bx
96-2504	4½"	Straight	50/bx
96-2506	4½"	Curved	50/bx
96-2650	4½"	Straight	100/bx
96-2651	4½"	Curved	100/bx



**ECONO-STERILE™**  
**DISPOSABLE SCISSORS**

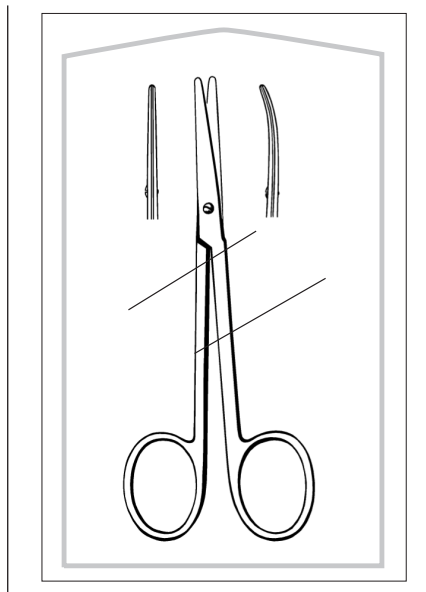

**STRABISMUS SCISSORS**

96-2542	4½"	Straight	25/bx
96-2543	4½"	Curved	25/bx
96-2540	4½"	Straight	50/bx
96-2541	4½"	Curved	50/bx

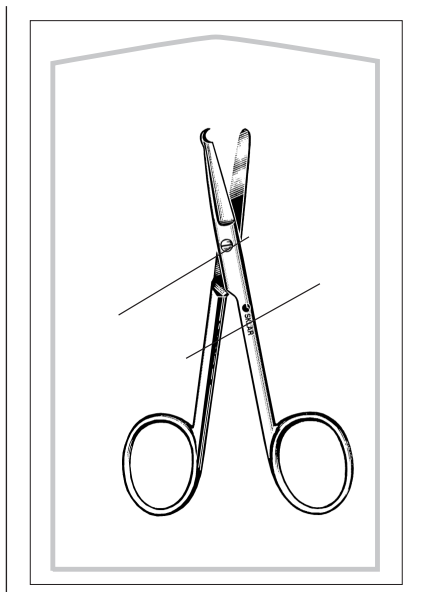

**SPENCER STITCH SCISSORS**

96-2598	4½"		25/bx
96-2672	3½"		50/bx
96-2596	4½"		50/bx

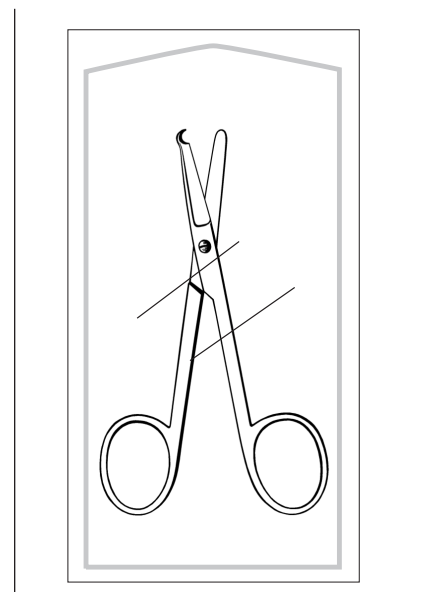

**LITTAUER SUTURE SCISSORS**

96-2511	3½"		25/bx
96-2513	5½"		25/bx
96-2510	3½"		50/bx
96-2512	5½"		50/bx
96-2663	3½"		100/bx
96-2662	5½"		100/bx

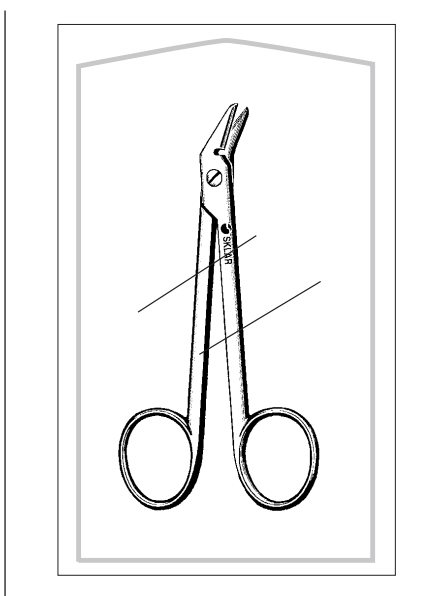

**WIRE CUTTING SCISSORS**

96-2519	4¾"	Angled	25/bx
96-2518	4¾"	Angled	50/bx

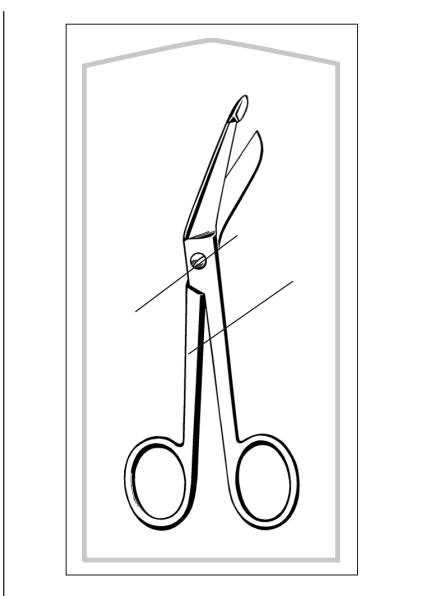

**LISTER BANDAGE SCISSORS**

96-2503	5½"		25/bx
96-2501	4½"		50/bx
96-2502	5½"		50/bx
96-2654	5½"		100/bx

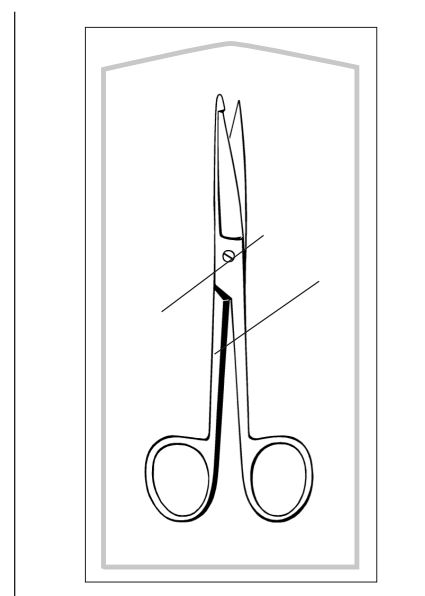

**KNOWLES BANDAGE SCISSORS**

96-2404	5½"		25/bx
96-2402	5½"		50/bx



**UTILITY SCISSORS**

96-2701	5½"	Black	25/bx	96-1223	7"	Burgundy	25/bx	96-1228	7"	Lime Green	25/bx
96-2703	7"	Black	25/bx	96-1224	7"	Magenta	25/bx	96-1229	7"	Hunter Green	25/bx
96-1220	7"	Yellow	25/bx	96-1225	7"	Navy Blue	25/bx	96-2702	5½"	Black	50/bx
96-1221	7"	Orange	25/bx	96-1226	7"	Royal	25/bx	96-2704	7"	Black	50/bx
96-1222	7"	Purple	25/bx	96-1227	7"	Teal Blue	25/bx				

**SKLAR  
DISINFECTANT™  
SURFACE WIPES**

READY-TO-USE, PRE-MOISTENED TOWELETTES

- Ready to use, non-toxic formula.
- Specially formulated for the control of cross contamination.
- Effective against a broad range of pathogens including H1N1, HIV-1, HSV, VRE, Rotaviruses, Hep B & C as well as TB, MRSA and A. Baumannii.
- Safe for all areas of the facility.
- Satisfies OSHA's Bloodborne Pathogen Standards.
- Destroys odor-causing bacteria.
- 7" x 10" non-woven, tear resistant towelette.
- EPA registered.





**ECONO-STERILE™**  
**DISPOSABLE FORCEPS**

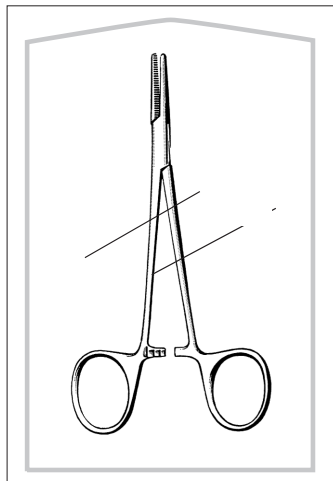

**HALSTED FORCEPS**

96-2537	5"	Straight	25/bx
96-2539	5"	Curved	25/bx
96-2536	5"	Straight	50/bx
96-2538	5"	Curved	50/bx
96-2657	5"	Straight	100/bx
96-2658	5"	Curved	100/bx

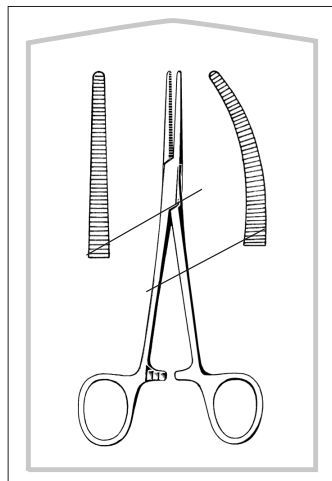

**CRILE FORCEPS**

96-2551	5½"	Straight	25/bx
96-2553	5½"	Curved	25/bx
96-2550	5½"	Straight	50/bx
96-2552	5½"	Curved	50/bx

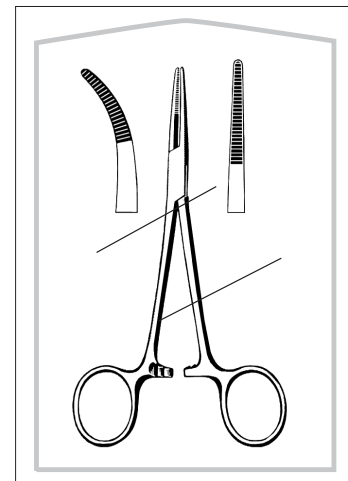

**KELLY FORCEPS**

96-2561	5½"	Straight	25/bx
96-2563	5½"	Curved	25/bx
96-2560	5½"	Straight	50/bx
96-2562	5½"	Curved	50/bx
96-2652	5½"	Straight	100/bx
96-2653	5½"	Curved	100/bx

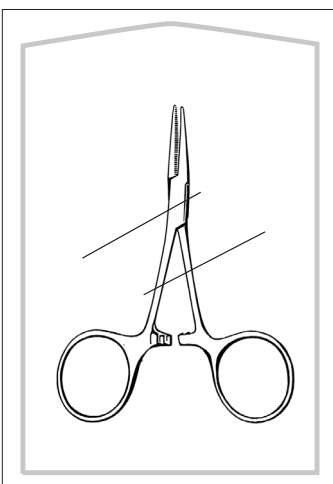

**HARTMANN FORCEPS**

96-2556	3½"	Straight	25/bx
96-2557	3½"	Curved	25/bx
96-2554	3½"	Straight	50/bx
96-2555	3½"	Curved	50/bx

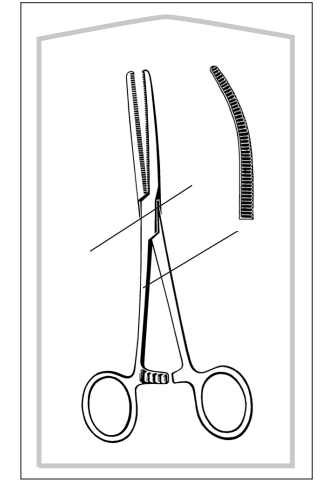

**ROCHESTER PEAN FORCEPS**

96-2545	6¼"	Straight	25/bx
96-2547	6¼"	Curved	25/bx
96-3006	7¼"	Straight	25/bx
96-3008	7¼"	Curved	25/bx
96-2548	8½"	Curved	25/bx
96-2544	6¼"	Straight	50/bx
96-2546	6¼"	Curved	50/bx
96-2549	8½"	Curved	50/bx
96-2664	8½"	Curved	100/bx

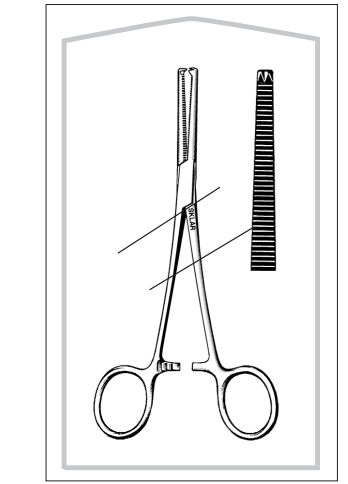

**ROCHESTER-OSHSNER FORCEPS**

96-2566	6¼"	Straight	25/bx
96-2567	6¼"	Curved	25/bx
96-2707	6¼"	Straight	50/bx
96-2708	6¼"	Curved	50/bx



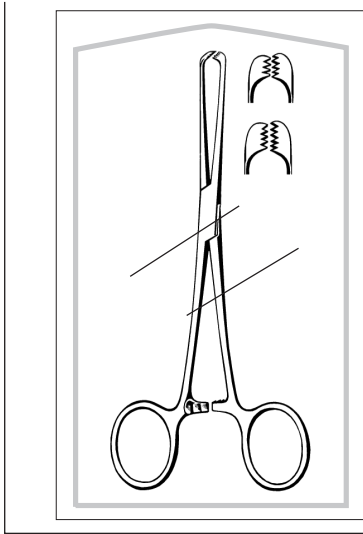

**ALLIS TISSUE FORCEPS**

96-2575	6"	4x5 Teeth	25/bx
96-2576	6"	4x5 Teeth	50/bx
96-2774	7¼"	6x7 Teeth	50/bx

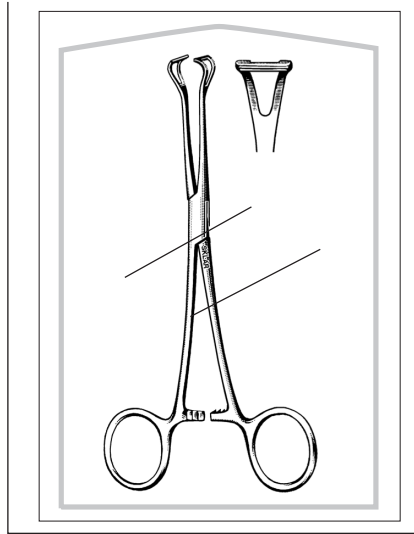

**BABCOCK FORCEPS**

96-2706	6¼"	Straight	25/bx
96-2705	6¼"	Straight	50/bx

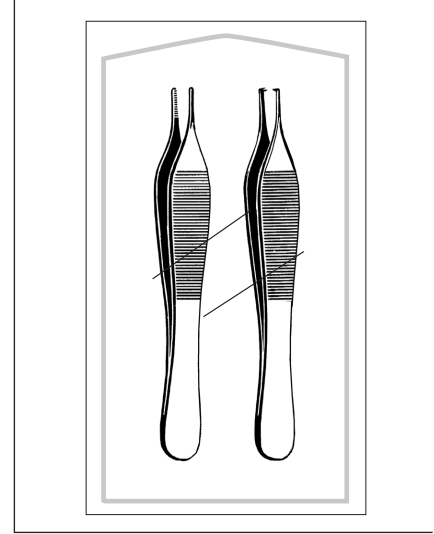

**ADSON FORCEPS**

96-2571	4¾"	Serrated	25/bx
96-2573	4¾"	1x2 Teeth	25/bx
96-2570	4¾"	Serrated	50/bx
96-2572	4¾"	1x2 Teeth	50/bx
96-2577	4¾"	Serrated Delicate	50/bx
96-2775	4¾"	1x2 Teeth Delicate	50/bx
96-2655	4¾"	Serrated	100/bx
96-2656	4¾"	1x2 Teeth	100/bx

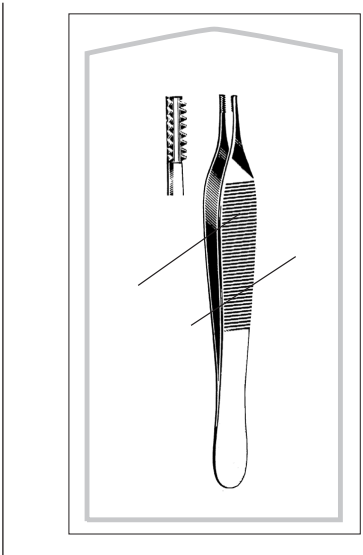

**ADSON-BROWN FORCEPS**

96-2559	4¾"	Side Grasping	25/bx
96-2558	4¾"	Side Grasping	50/bx

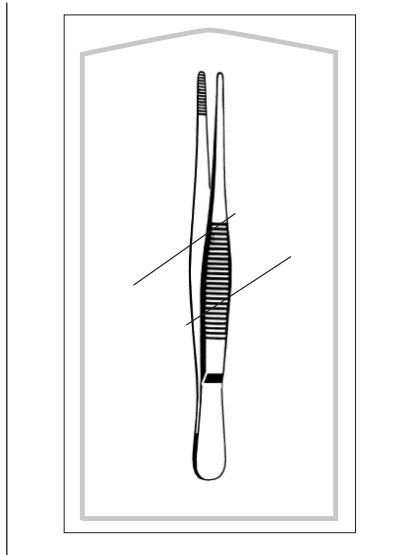

**DRESSING FORCEPS**

96-2569	5"	Serrated	25/bx
96-2921	8"	Serrated	25/bx
96-2688	4½"	Serrated	50/bx
96-2568	5"	Serrated	50/bx
96-2660	5"	Serrated	100/bx

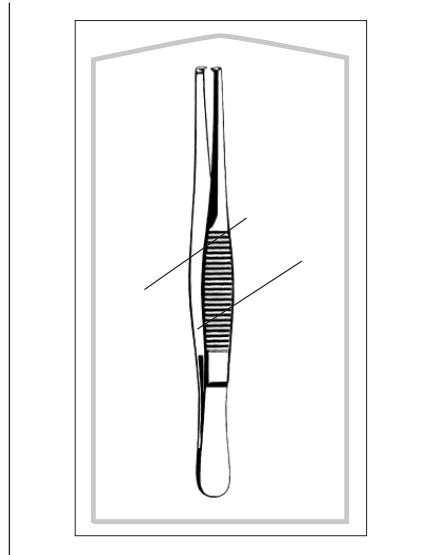

**TISSUE FORCEPS**

96-2579	5"	1x2 Teeth	25/bx
96-2578	5"	1x2 Teeth	50/bx
96-2661	5"	1x2 Teeth	100/bx



**ECONO-STERILE™**  
**DISPOSABLE FORCEPS**

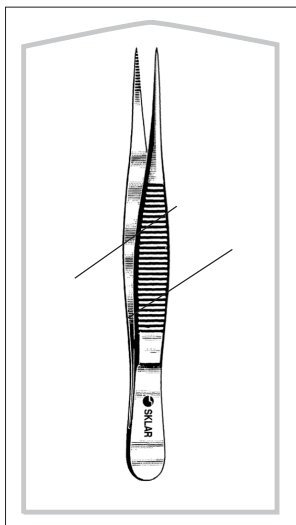

**FINE POINT SPLINTER FORCEPS**

96-2412 4½" 25/bx  
96-2410 4½" 50/bx

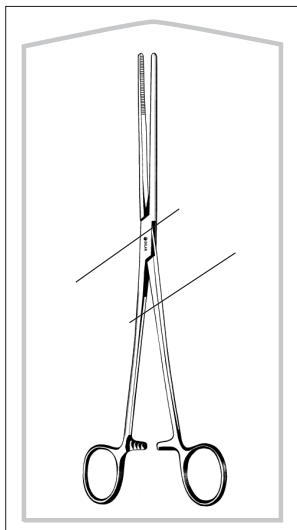

**BOZEMAN FORCEPS**

96-2622 10¼" S-Curve 25/bx  
96-2620 10¼" S-Curve 50/bx

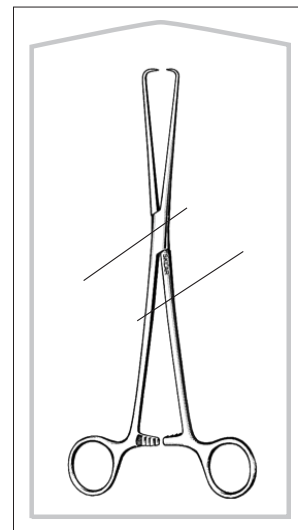

**SCHROEDER TENACULUM FORCEPS**

96-2624 9½" 25/bx  
96-2626 9½" 50/bx

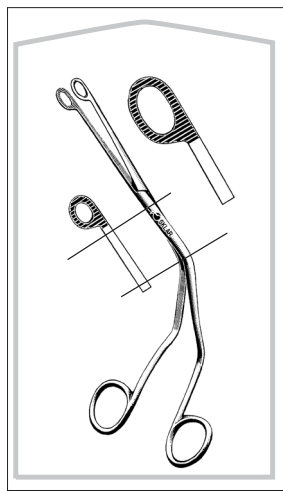

**MAGILL CATHETER FORCEPS**

**PEDIATRIC**  
96-2689 7¼" 50/bx  
**ADULT**  
96-2684 9¾" 50/bx

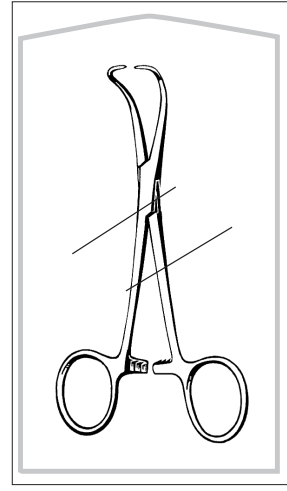

**BACKHAUS TOWEL CLAMPS**

96-2632 3½" 25/bx  
96-2636 5¼" 25/bx  
96-2630 3½" 50/bx  
96-2634 5¼" 50/bx

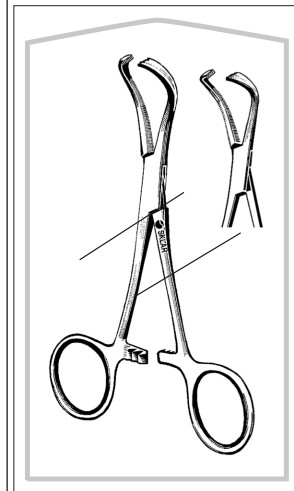

**LORNA EDNA TOWEL CLAMPS**

96-2529 3½" 25/bx  
96-2528 3½" 50/bx

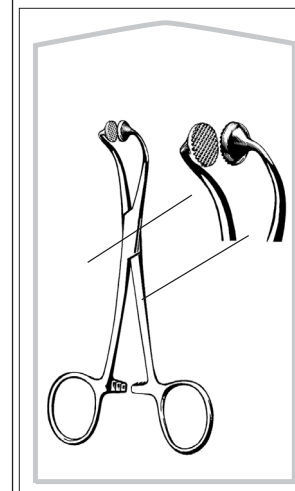

**HOFF TOWEL CLAMPS**

96-2565 5¼" 25/bx  
96-2564 5¼" 50/bx

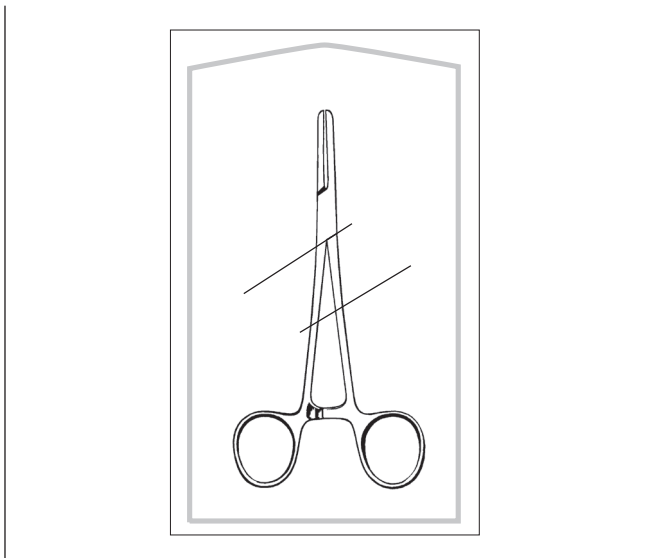

**PRESBYTERIAN TUBE OCCLUDING FORCEPS**

96-2408 7" Smooth 25/bx  
96-2406 7" Smooth 50/bx

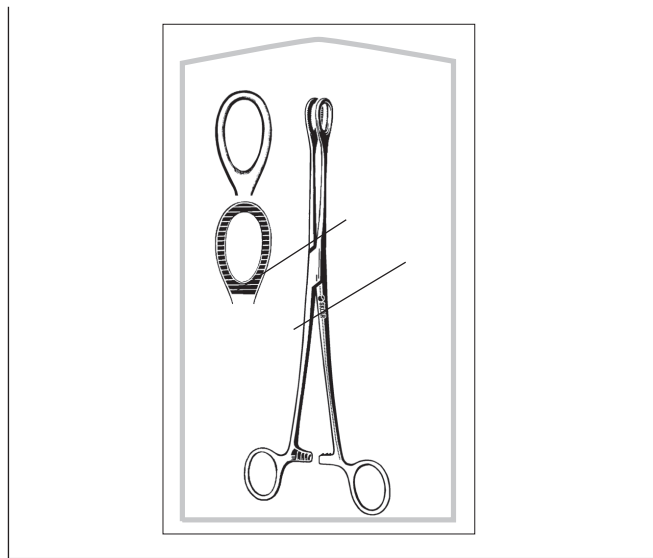

**SPONGE FORCEPS**

96-2533 9½" Straight, Serrated 25/bx  
96-2532 9½" Straight, Serrated 50/bx



**SKLAR SURGICAL SKIN MARKERS**

Sklar Surgical Skin markers are designed to allow the surgeon to conveniently demarcate selected sites prior to or during surgical procedures. Latex free.

- Scrub resistant ink
- Durable tip
- Non-smearing
- Sterile

**STERILE**

PRODUCT NUMBER	FEATURES	QUANTITIES
10-1440	Fine/Regular Tip Scrub Resistant	50/bx

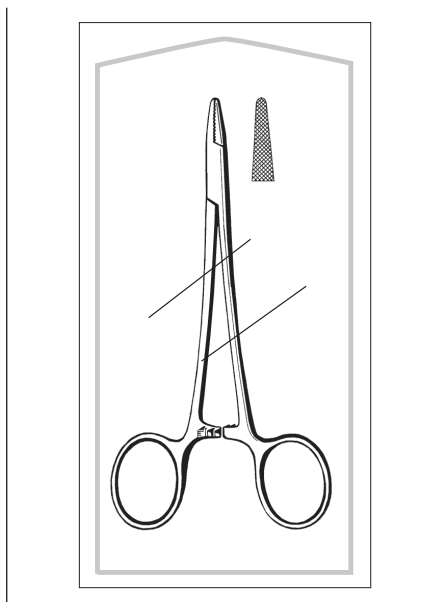

**BAUMGARTNER NEEDLE HOLDERS**

- 96-2581 5½" Serrated 25/bx
- 96-2580 5½" Serrated 50/bx

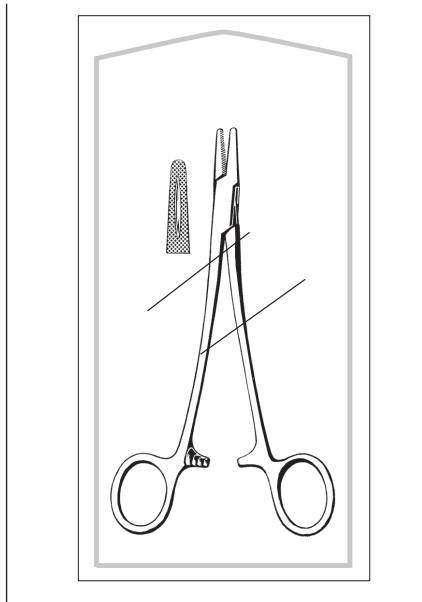

**MAYO-HEGAR NEEDLE HOLDERS**

- 96-2599 5" Serrated 25/bx
- 96-2595 6" Serrated 25/bx
- 96-2594 6" Serrated 50/bx
- 96-2710 7" Serrated 50/bx
- 96-2712 8" Serrated 50/bx

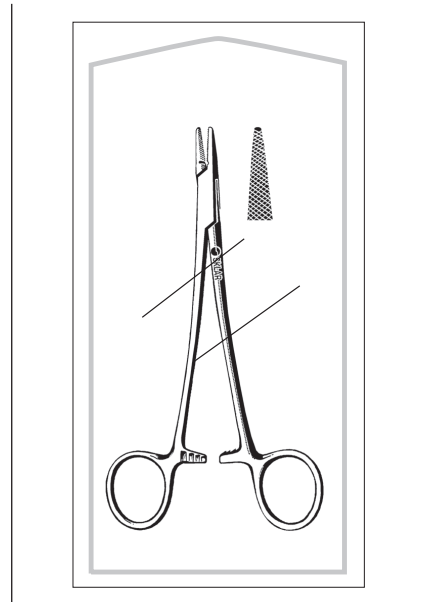

**CRILE-WOOD NEEDLE HOLDERS**

- 96-2591 6" Serrated 25/bx
- 96-2590 6" Serrated 50/bx

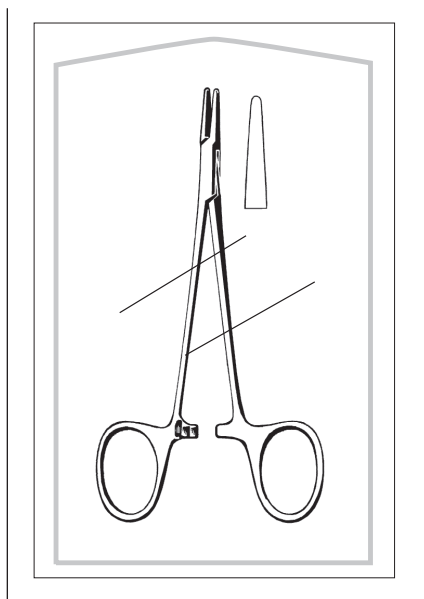

**WEBSTER NEEDLE HOLDERS**

- 96-2587 5¼" Smooth 25/bx
- 96-2586 5¼" Smooth 50/bx
- 96-2659 5¼" Smooth 100/bx

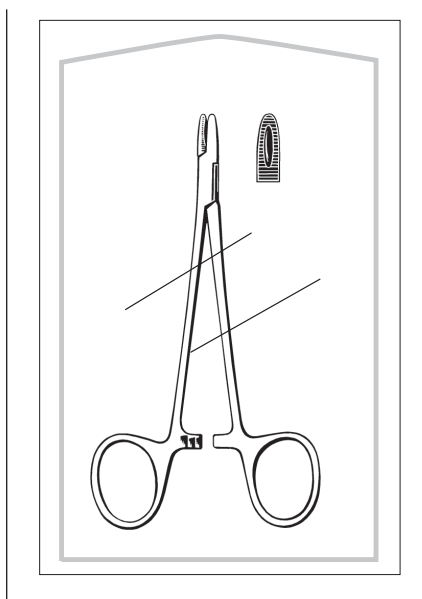

**DERF NEEDLE HOLDERS**

- 96-2583 4¾" Serrated 25/bx
- 96-2582 4¾" Serrated 50/bx

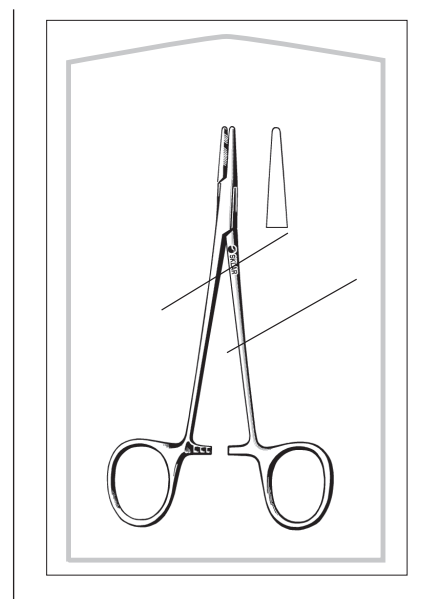

**HALSEY NEEDLE HOLDERS**

- 96-2585 5" Smooth 25/bx
- 96-2584 5" Smooth 50/bx

**ECONO-STERILE™**  
**DISPOSABLE SPECULUMS**

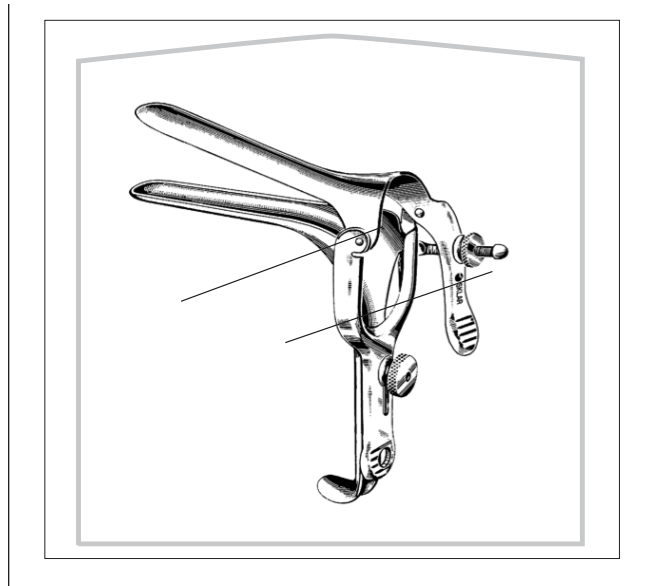
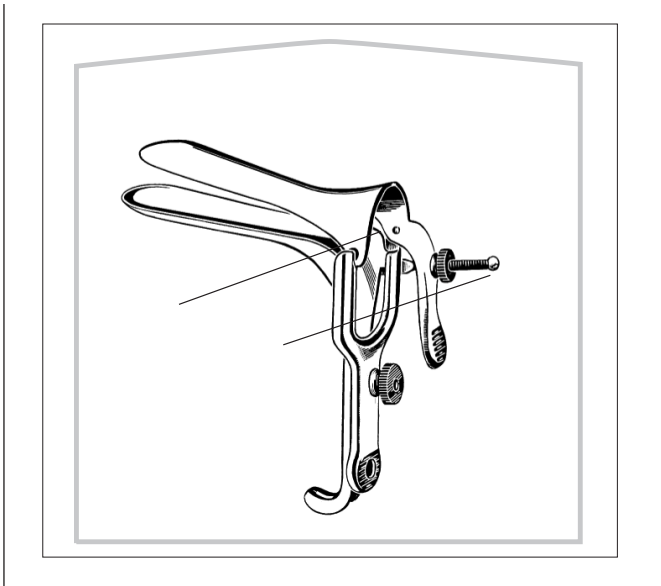

**GRAVES SPECULUMS**

- 96-2603 Small 25/bx
- 96-2605 Medium 25/bx
- 96-2607 Large 25/bx

- 96-3000 Small 50/bx
- 96-3001 Medium 50/bx
- 96-3002 Large 50/bx

**PEDERSON SPECULUMS**

- 96-2613 Small 25/bx
- 96-2615 Medium 25/bx
- 96-2617 Large 25/bx

- 96-2612 Small 50/bx
- 96-2614 Medium 50/bx
- 96-2616 Large 50/bx



**GAUZE SPONGES**

**WOVEN, NON-STERILE**

PRODUCT NUMBER	FEATURES	PLY	QUANTITIES
96-5281	2"x2"	12Ply	8000/bx
96-5283	3"x3"	12Ply	4000/bx
96-5284	4"x4"	8Ply	4000/bx

**NON-WOVEN, NON-STERILE**

PRODUCT NUMBER	FEATURES	PLY	QUANTITIES
96-5628	2"x2"	4Ply	5000/bx
96-5629	3"x3"	4Ply	4000/bx



**ECONO-STERILE™**  
**DISPOSABLE WIREFORMS**

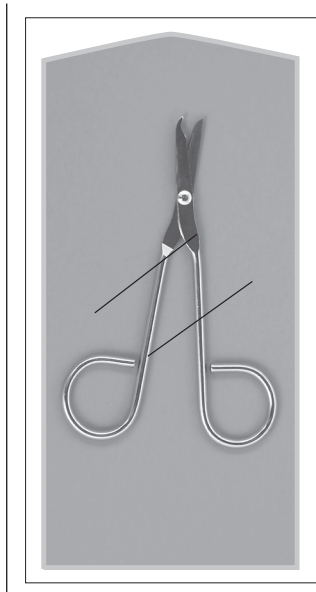

**STITCH SCISSORS**

- 96-8971 4½" Littauer 50/bx
- 96-8973 4½" Littauer S/B 50/bx
- 96-8972 5¼" Littauer S/B 50/bx
- 96-8975 5¼" Littauer S/S 50/bx

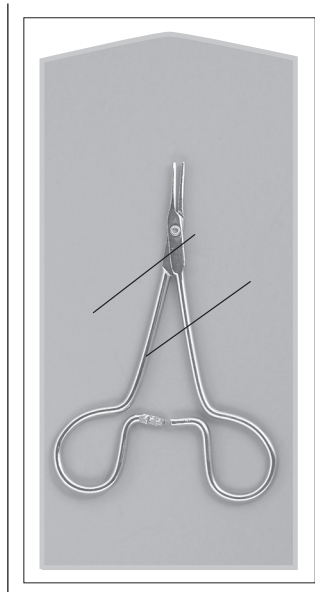

**HALSTED FORCEPS**

- 96-8964 5" Straight 50/bx
- 96-8965 5" Curved 50/bx

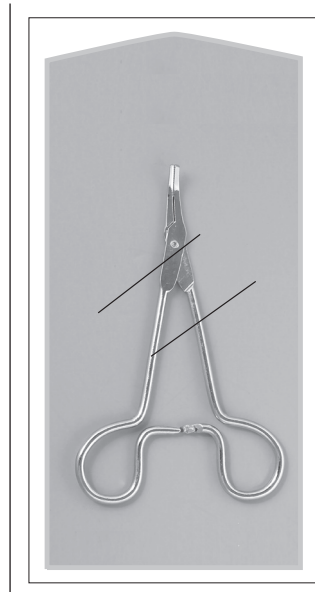

**KELLY FORCEPS**

- 96-8967 5½" Straight 50/bx
- 96-8966 5½" Curved 50/bx

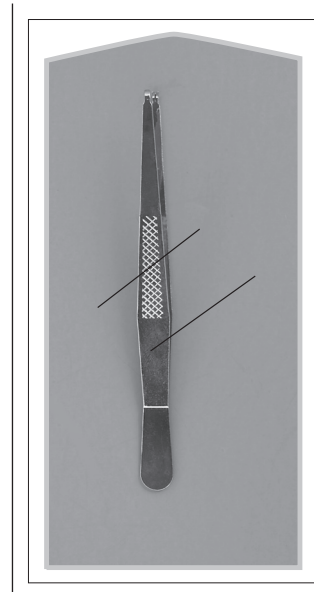

**THUMB FORCEPS**

- 96-8963 4½" 1x2 Teeth 50/bx

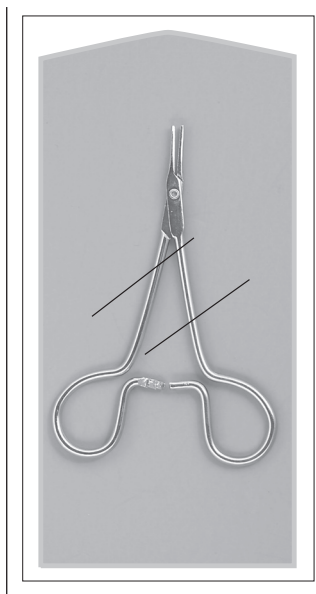

**TISSUE FORCEPS**

- 96-8976 5" 50/bx

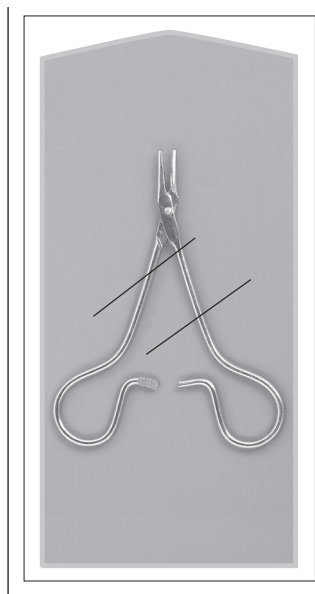

**NEEDLE HOLDERS**

- 96-8968 5¼" Smooth 50/bx
- 96-8974 5¼" Serrated 50/bx

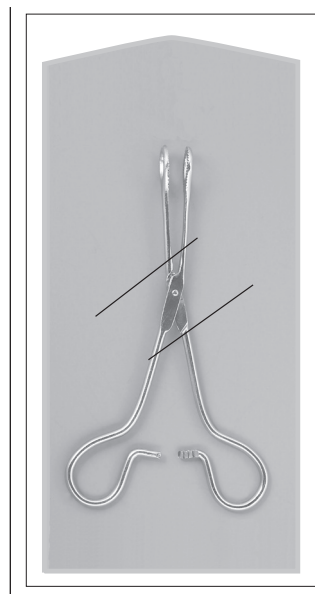

**SPONGE FORCEPS**

- 96-8969 7" Serrated 50/bx
- 96-8970 9½" Serrated 50/bx

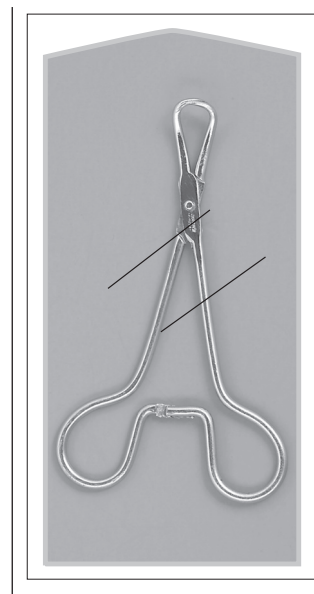

**TOWEL FORCEPS**

- 96-8962 5¼" 50/bx

**96-1710****MAJOR LACERATION TRAY****12/CASE**

DESCRIPTION	QUANTITIES
Adson Forceps, 1 x 2 Teeth, 4¾"	1
Adson Forceps, Serrated, 4¾"	1
Gauze, 12Ply, 2" x 2"	5
Gauze, 12Ply, 4" x 4"	10
Halsted Mosquito Forceps, Curved, 5"	1
Iris Scissor, Straight, 4½"	1
Lidocaine 1%, 30ml	1
Medicine Cup, 2oz.	2
Needle, 18GA x 1½"	1
Needle, 25GA x 5⁄8"	1
Needle, 27GA x 1½"	1
Needle, 30GA x 1"	1
OR Towel, 18" x 26", Fenestrated	1
OR Towel, Blue	2
Syringe, 10cc, Control, L/L	1
Webster Needle Holder, Smooth, 5"	1

**96-1715****MINOR LACERATION TRAY A****12/CASE**

DESCRIPTION	QUANTITIES
Adson Forceps, Serrated, 4¾"	1
Gauze, 12Ply, 2" x 2"	5
Gauze, 12Ply, 4" x 4"	10
Halsted Mosquito Forceps, Curved, 5"	1
Iris Scissor, Straight, 4½"	1
Medicine Cup, 2oz.	2
Needle, 18GA x ½"	1
Needle, 25GA x ⅞"	1
Needle, 27GA x 1¼"	1
OR Towel, 18" x 26", Fenestrated	1
OR Towel, Blue	2
Syringe, 10cc, L/L	1
Webster Needle Holder, Smooth, 5"	1

**96-1718****MINOR LACERATION TRAY B****12/CASE**

DESCRIPTION	QUANTITIES
Absorbent Towel, 3Ply, 17" x 19"	1
Adson Forceps, 1x2 Teeth, 4¾"	1
Baumgartner Needle Holder, 5"	1
Drape, 18" x 26", Fenestrated	1
Gauze, 12Ply, 2" x 2"	5
Gauze, 12Ply, 4" x 4"	10
OR Scissors, Straight, Sharp/Sharp, 5½"	1

**96-1725****SUTURE TRAY****10/CASE**

DESCRIPTION	QUANTITIES
Adson Forceps, 1x2 Teeth, 4¾"	1
Baumgartner Needle Holder, 5"	1
Drape, 18" x 26"	1
Drape, 18" x 26", Fenestrated	1
Gauze, 12Ply, 4" x 4"	20
Iris Scissor, Straight, 4½"	1
Lidocaine 1%, 5ml	1
Needle, 20GA x 1½"	1
Needle, 25GA x 5⁄8"	1
PVP Prep Packet, ¾oz.	1
Syringe, 5cc, L/L	1



## STERILE TRAYS

**96-1730**  
**WOUND CLOSURE TRAY**      **25/CASE**

DESCRIPTION	QUANTITIES
Absorbent Towel, 3Ply, 17" x 19"	1
Alcohol Swab Stick, Single	1
Drape, 18" x 26", Fenestrated	1
Gauze, 12Ply, 4" x 4"	4
Kelly Forceps, Curved, 5½"	1
OR Scissors, Straight, Sharp/Blunt, 5½"	1
PVP-I Swab Stick, Single	1
Refuse Bag, 12" x 18"	1
Tissue Forceps, 1x2 Teeth, 5"	1
Webster Needle Holder, Smooth, 5"	1

**96-1734**  
**SUTURE REMOVAL TRAY A**      **50/CASE**

DESCRIPTION	QUANTITIES
Alcohol Prep Pad, Large	1
Dressing Forceps, 4½"	1
Gauze, 12Ply, 4" x 4"	1
Iris Scissor, Straight, 4½"	1
PVP-I Prep Pad	1

**96-1740**  
**SUTURE REMOVAL TRAY D**      **50/CASE**

DESCRIPTION	QUANTITIES
Dressing Forceps, 5½"	1
Gauze, 12Ply, 4" x 4"	1
Iris Scissor, Straight, 4½"	1

**96-1700**  
**GENERAL PURPOSE TRAY**      **25/CASE**

DESCRIPTION	QUANTITIES
Adson Forceps, Serrated, 4¾"	1
Alcohol Swab Stick, Single	1
Cotton Tip Applicator, 3"	2
Gauze, 12Ply, 4" x 4"	2
Kelly Forceps, Curved, 5½"	1
OR Scissors, Straight, Sharp/Blunt, 5½"	1
PVP-I Swab Stick, Single	1
Safety Pin, No. 2	1

**96-0045**  
**GENERAL PURPOSE TRAY**      **20/CASE**

DESCRIPTION	QUANTITIES
Adson Forceps, 1x2 Teeth, 4¾"	1
Halsted Mosquito Forceps, Curved, 5"	1
Iris Scissor, Curved, 4½"	1
Safety Pin, No. 2	1
Webster Needle Holder, Smooth, 5"	1

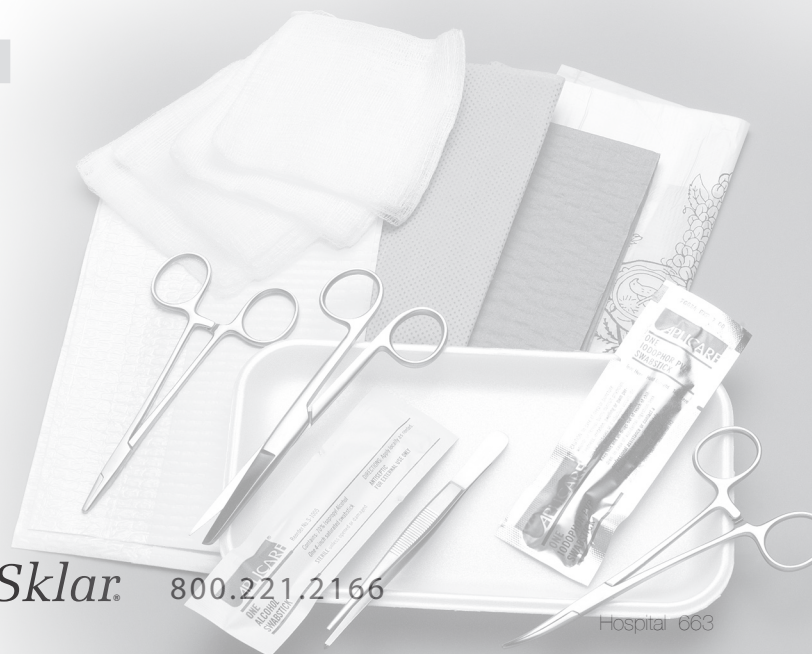



**96-1744****MINOR SURGERY TRAY****10/CASE**

DESCRIPTION	QUANTITIES
Adson Forceps, 1x2 Teeth, 4¾"	1
Dressing Forceps, 4½"	1
Gauze, 12Ply, 4" x 4"	15
Halsted Mosquito Forceps, Curved, 5"	3
Halsted Mosquito Forceps, Straight, 5"	2
Iris Scissor, Curved, 4½"	1
Kelly Forceps, Straight, 5½"	1
OR Scissors, Straight, Sharp/Blunt, 5½"	1
OR Towel, Blue	2
Scalpel, No. 15, Long	1
Utility Drape, Fenestrated, Clear, 24" x 36"	1
Webster Needle Holder, Smooth, 5"	1

**96-1713****INCISION & DRAINAGE TRAY****25/CASE**

DESCRIPTION	QUANTITIES
Alcohol Swab Stick, Triple	1
Drape, 18" x 26", Fenestrated	1
Drape/Towel, 4Ply, 17" x 19"	1
Dressing Forceps, 4½"	1
Gauze, 12Ply, 4" x 4"	4
Kelly Forceps, Straight, 5½"	1
OR Scissors, Straight, Sharp/Blunt, 5½"	1
PVP-I Swab Stick, Triple	1
Refuse Bag, 12" x 18"	1
Safety Scalpel, No. 11	1

**96-1746****CIRCUMCISION TRAY****20/CASE**

DESCRIPTION	QUANTITIES
Adson Forceps, Serrated, 4¾"	1
Gauze, 12Ply, 3" x 3"	10
Gloves, Synthetic, Powder Free, Walleted, Pair	1
Halsted Mosquito Forceps, Curved, 5"	1
Halsted Mosquito Forceps, Straight, 5"	2
Medicine Cup, 2oz.	1
OR Scissors, Straight, Sharp/Blunt, 5½"	1
OR Towel, 18" x 26", Fenestrated	1
OR Towel, Blue	1
Petroleum Gauze, 2" x 2"	1
Probe with Eye, 5½"	1
PVP Prep Packet, ¾ oz.	1
Safety Pin, No. 2	2
Scalpel, No. 10	1

**96-0351****CIRCUMCISION TRAY****10/CASE**

DESCRIPTION	QUANTITIES
Adson Forceps, 1x2 Teeth, 4¾"	1
Circumcision Strap	2
Cotton Tip Applicator, 6"	3
Drape, 18" x 26", Fenestrated	1
Gauze, 12Ply, 4" x 4"	10
Halsted Mosquito Forceps, Straight, 5"	3
Halsted Mosquito Forceps, Curved, 5"	2
OR Scissors, Straight, Sharp/Blunt, 5½"	1
Probe with Eye, 5½"	1
Safety Pin, No. 1	1
Safety Scalpel, No. 10	1



## STERILE TRAYS

**96-1929****SPINAL INJECTION TRAY****30/CASE**

DESCRIPTION	QUANTITIES
Bandage, Adhesive, 1" x 3"	1
Drape, 18" x 26", Fenestrated	1
Gauze, 12Ply, 3" x 3"	2
Gauze, 12Ply, 4" x 4"	2
Needle, 18GA x 1½"	3
Needle, 25GA x 1½"	1
PVP-I Swabstick, Triple	1
Syringe, 1cc, L/S	1
Syringe, 5cc, L/L	3

**96-0737****EPIDURAL TRAY****10/CASE**

DESCRIPTION	QUANTITIES
Applicator Prep Stick, 6"	2
Bandage, Adhesive, ¾" x 3"	1
Drape, 24" x 36", Fenestrated with Ply Patch	1
Needle, 18GA x 1½"	2
Needle, 20GA x 3½"	1
PVP Prep Packet, ¾oz.	1
Syringe, 10cc, L/L	1
Syringe, 7ml, L/S	1

**96-1918****UNIVERSAL BLOCK TRAY****10/CASE**

DESCRIPTION	QUANTITIES
Applicator Prep Stick, 6"	3
Drape, 18" x 26", Fenestrated	1
Gauze, 12Ply, 4" x 4"	8
Needle, 18GA x 1½"	1
Needle, 25GA x 1½"	1
PVP Prep Packet, ¾oz.	1
Saline .9%, 20ml Vial	1
Syringe, 3cc, L/S	1
Syringe, 5cc, L/L	1
Syringe, 10cc, L/L	2

**96-0095****CT BIOPSY TRAY****10/CASE**

DESCRIPTION	QUANTITIES
Absorbent Towel	2
Alcohol Swab Stick, Single	1
Bandage, Adhesive, 2" x 3¾"	1
Drape, 24" x 36", Fenestrated with Ply Patch	1
Gauze, 12Ply, 4" x 4"	10
Lidocaine, 1%, 5ml	2
Needle Counter, 15Ct	1
Needle, 19GA x 1½"	1
Needle, 22GA x 1½"	1
Needle, 25GA x 5/8"	1
PVP-I Swabstick, Triple	1
Ruler, Paper, 6"	1
Scalpel, No. 11, Long	1
Syringe, 10cc, L/L	2
Syringe, 20cc, L/L	2

**96-6652**  
**ARTHROGRAM TRAY** **10/CASE**

DESCRIPTION	QUANTITIES
Applicator Prep Stick, 6"	3
Bandage, Adhesive, ¾" x 3"	1
Drape, 24" x 36", Fenestrated with Ply Patch	1
Drape/Towel, 4Ply, 17" x 19"	1
Extension Set, 20"	1
Gauze, 12Ply, 4" x 4"	5
Lidocaine 1%, 5ml	1
Needle, 18GA x 1½"	1
Needle, 20GA x 1½"	1
Syringe, 10cc, L/L	2

**96-1745**  
**ARTHROGRAM TRAY** **10/CASE**

DESCRIPTION	QUANTITIES
Bandage, Adhesive, 1" x 3"	1
Drape/Towel, 4Ply, 17" x 19"	1
Extension Set, 20"	1
Drape, 24" x 36", Fenestrated with Ply Patch	1
Gauze, 12Ply, 3" x 3"	5
Lidocaine 1%, 5ml	1
Needle, 18GA x 1½"	1
Needle, 20GA x 1½"	1
Needle, 21GA x 1½"	1
Needle, 25GA x ⅝"	1
PVP-I Swab Stick, Triple	1
Stopcock, 3-way	1
Syringe, 10cc, L/L	2
Syringe, 20 cc, L/L	1

**96-1927**  
**TOE NAIL REMOVAL TRAY** **10/CASE**

DESCRIPTION	QUANTITIES
Adson Forcep, 1x2 Teeth, 4¾"	1
Cuticle Nipper, 4"	1
Gauze, 12Ply, 4" x 4"	10
Iris Scissor, Straight, 4½"	1
Kelly Forcep, Curved, 5½"	1
Kelly Forcep, Straight, 5½"	1
Probe with Eye, 5½"	1

**96-1806**  
**SHAVE PREP TRAY** **10/CASE**

DESCRIPTION	QUANTITIES
Absorbent Towel	2
Cotton Tip Applicator, 3"	2
Drape/Towel, 4Ply, 17" x 19"	1
Soap Sponge	1
Surgical Prep Razor, Double Edge	1

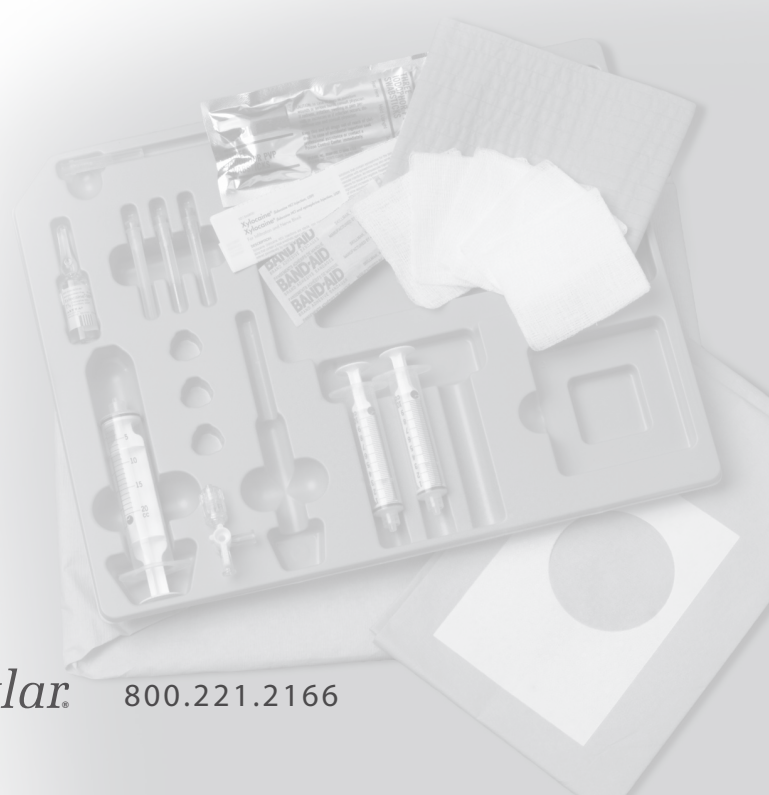

# BLADES AND SCALPELS HANDLES



## SCALPEL HANDLES

PRODUCT NUMBER      FEATURES

06-2910      #3 with metric scale

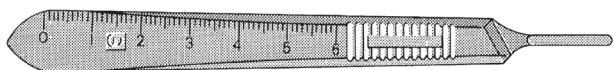

PRODUCT NUMBER      FEATURES

06-2903      #3 fits Blade #10, 11, 12, 15

06-2915      #3L

06-2916      #3XL



PRODUCT NUMBER      FEATURES

06-2904      #4 fits Blade #20, 21, 22, 23

06-2920      #4L



PRODUCT NUMBER      FEATURES

06-2907      #7 fits Blade #10, 11, 12, 15



PRODUCT NUMBER      FEATURES

06-2911      #9 fits Blade #10, 11, 12, 15



PRODUCT NUMBER      FEATURES

06-2912      #8 fits Blade #60



PRODUCT NUMBER      FEATURES

06-2925      Large Lab Type Handle #3

06-2930      Large Lab Type Handle #4

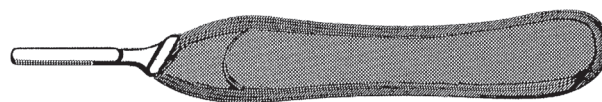

PRODUCT NUMBER      FEATURES

06-2908      Round Scalpel Handle, Straight  
#3R, fits Blade #10, 11, 12, 15

06-2909      Round Scalpel Handle, Angled  
Fits Blade #10, 11, 12, 15



PRODUCT NUMBER      FEATURES

06-3090      Blade Remover

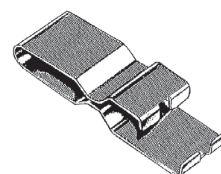

# BLADES AND SCALPELS

## GENERAL



### BLADES, STAINLESS STEEL

STERILE

PRODUCT NUMBER	FEATURES	QUANTITIES
06-3100	#10	100/box
06-3101	#11	100/box
06-3102	#12	100/box
06-3103	#15	100/box
06-3108	#15C	100/box
06-3104	#20	100/box
06-3105	#21	100/box
06-3106	#22	100/box
06-3107	#23	100/box

### BLADES, CARBON STEEL

STERILE

PRODUCT NUMBER	FEATURES	QUANTITIES
06-3010	#10	100/box
06-3011	#11	100/box
06-3012	#12	100/box
06-3013	#12D	100/box
06-3015	#15	100/box
06-3016	#15C	100/box
06-3020	#20	100/box
06-3021	#21	100/box
06-3022	#22	100/box
06-3023	#23	100/box

### SCALPELS, DISPOSABLE

STERILE

PRODUCT NUMBER	FEATURES	QUANTITIES
06-3110	#10	10/box
06-3111	#11	10/box
06-3112	#12	10/box
06-3115	#15	10/box
06-3120	#20	10/box
06-3121	#21	10/box
06-3122	#22	10/box
06-3123	#23	10/box





BLADES AND SCALPELS  
SAFETY

SKLARSAFE™ SAFETY SCALPELS



LATEX-FREE

- Protective, transparent sheath can be opened, closed, and locked with a single hand.
- Precision stainless steel blade made in England.
- Sturdy, “Sure-Grip” handle.
- Audible “click” when sheath advanced to locked position.
- OSHA Compliant.
- Individually sealed in sturdy film and Tyvek® pack.

STERILE

PRODUCT NUMBER	FEATURES	QUANTITIES
----------------	----------	------------

06-3094	#10	10/box
06-3095	#11	10/box
06-3096	#15	10/box

NON-STERILE

06-3130	#10	500/cs
06-3132	#11	500/cs
06-3134	#15	500/cs



**MINI BLADES AND SCALPELS**

STERILE

PRODUCT NUMBER	FEATURES	QUANTITIES
97-1822	#61	25/box
97-1821	#62	25/box
97-1820	#63	25/box
97-1826	#64	25/box
97-1825	#65	25/box
97-1824	#67	25/box
97-1823	#69	25/box



**MINI PODIATRY HANDLE**

NON-STERILE

PRODUCT NUMBER	FEATURES	QUANTITIES
97-1450	#3K	1 Each



**SPECIALTY BLADES**

NON-STERILE

PRODUCT NUMBER	FEATURES	QUANTITIES
97-1400	#318, Curved Edge	12/box
97-1405	#312, Curved Edge	12/box
97-1410	#313, Curved Edge	12/box
97-1420	#316, Straight Edge	12/box

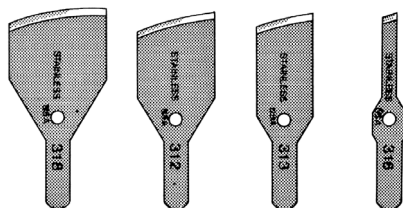

**SELF-LOCKING HANDLE**

NON-STERILE

PRODUCT NUMBER	FEATURES	QUANTITIES
97-1445	#6	1 Each



**CARBON P-M BLADE**

NON-STERILE

PRODUCT NUMBER	FEATURES	QUANTITIES
06-3024	#60	50/box

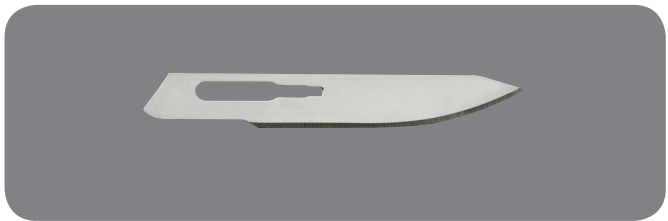

**MINI THUMB SCALPEL**

NON-STERILE

PRODUCT NUMBER	FEATURES	QUANTITIES
06-7052	#11	1500/cs

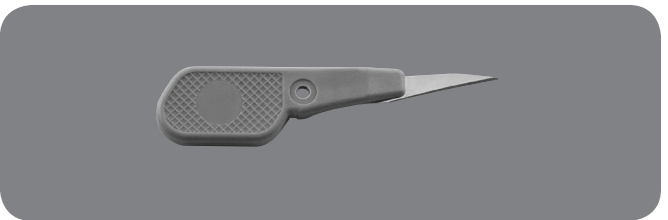

**STITCH CUTTER**

STERILE

PRODUCT NUMBER	FEATURES	QUANTITIES
06-3030	Stainless Steel	100/box



## DIAGNOSTIC INSTRUMENTS

### STETHOSCOPES



Designed to meet the exacting standards of health care professionals who demand precise acoustic response in various settings, Sklar offers a full range of Stethoscopes that feature superb craftsmanship and performance.

#### SPRAGUE RAPPAPORT STETHOSCOPES

- The most popular stethoscope style on the market, worldwide.
- Includes five easily interchangeable chest pieces: 3 Bells (Large, Medium and Small) and 2 Diaphragms (Small and Large) allowing for a full range of diagnostic capabilities. Also includes 3 different size ear tips.
- Superior high and low frequency sensitivity; designed to detect the entire range of heart and chest sounds. Clinically proven to deliver more faint heart sounds and murmurs than other stethoscopes.
- Chest piece is equipped with a full rotational dual-output acoustic valve mechanism that ensures smooth rotation and accurate acoustic transmission.
- All components are individually machined and precisely assembled to deliver the choice stethoscope of medical professionals.
- Comfortably angled, anatomically correct headset with patented soft ear tips and excellent acoustic seal.
- Latex Free.

#### SPRAGUE RAPPAPORT STETHOSCOPES

##### DUAL HEAD

PRODUCT NUMBER	FEATURES
06-1625	28" Gray
06-1627	28" Black
06-2304	28" Blue





**CARDIOLOGY STETHOSCOPES**

- Superb craftsmanship, construction and materials to offer the ultimate performance and sound transmission.
- Available in single-sided or dual-sided design with very high acoustic response.
- Offered as a double-lumen tube design in a variety of color choices to meet individual preferences.
- Comfortably angled, anatomically correct headset with patented soft ear tips and excellent acoustic seal.
- Latex Free.

**SINGLE-SIDED**

PRODUCT NUMBER	FEATURES
06-2750	27" Black
06-2800	28" Black
06-2802	28" Navy Blue
06-2803	28" Green

**DUAL HEAD**

Deluxe, two-sided traditional combination chest piece with patented tunable diaphragm to allow for high, medium and low frequency sounds to be heard.

PRODUCT NUMBER	FEATURES
06-2303	25" Black
06-1670	28" Black
06-1671	28" Burgundy
06-1672	28" Navy Blue
06-1673	28" Green

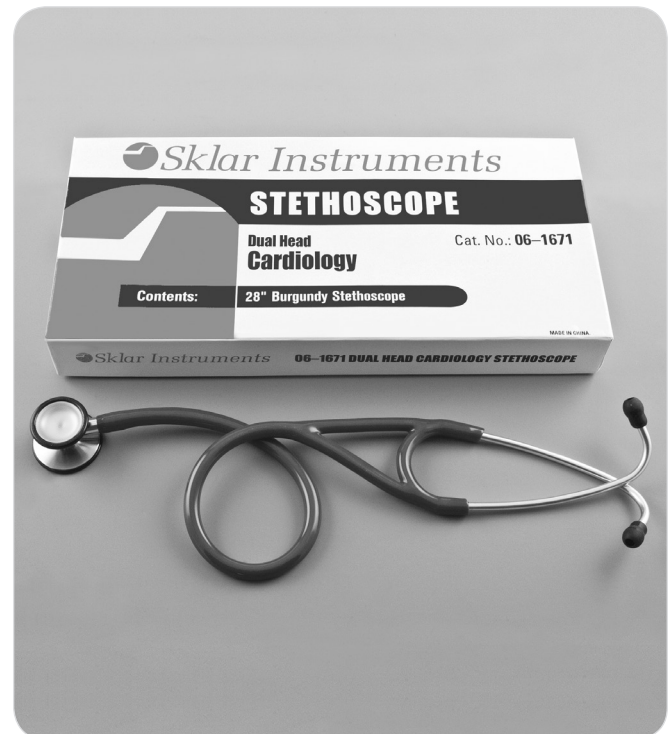



# DIAGNOSTIC INSTRUMENTS

## STETHOSCOPES

### ADULT STETHOSCOPES

- Unsurpassed quality and value.
- Available in single-sided or dual-sided design, in a variety of color choices, with very high acoustic response.
- Specifically designed, sized and acoustically precisioned for adults.
- Patient friendly non-chill rim and diaphragm, excellent acoustic seal and comfortable fit with patented soft ear tips and a comfortably angled, anatomically correct headset.
- Unlimited flexibility and portable convenience.
- Latex Free.

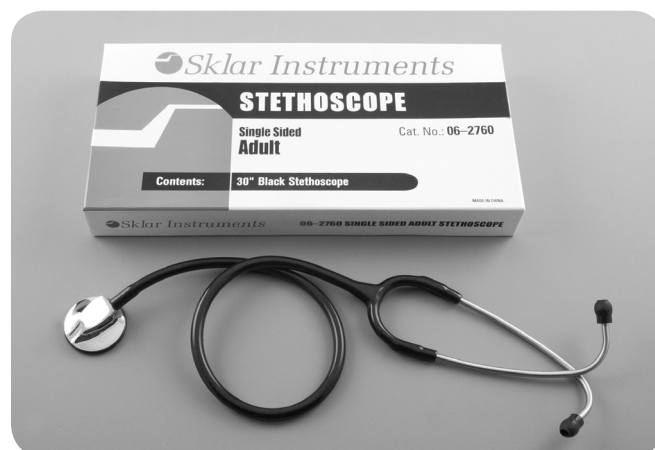

#### SINGLE-SIDED

PRODUCT NUMBER	FEATURES
06-2760	30" Black

#### DUAL HEAD

Deluxe, stainless steel, two-sided traditional combination chest piece with high and low frequency capabilities.

PRODUCT NUMBER	FEATURES
06-2300	30" Black
06-2301	30" Burgandy
06-2302	30" Blue
06-1601	30" Gray
06-2298	30" Purple



#### LIGHT ADULT STETHOSCOPES

##### DUAL HEAD

Lighter construction reduces fatigue while maintaining performance.

PRODUCT NUMBER	FEATURES
06-1630	30" Black
06-1632	30" Gray



**PEDIATRIC AND INFANT STETHOSCOPES**

- Traditional bell/diaphragm chest pieces are specifically designed, sized and acoustically precise for pediatric and infant applications.
- Features Solid Stainless Steel, dual-sided chest piece with traditional 1" Bell and smaller 3/4" Bell.
- Easy rotation between diaphragm or open bell side of stethoscope and sensitive to both high and low frequencies.
- Available in a variety of attractive colors.
- Excellent acoustic seal and comfortable fit with patented soft ear tips and a comfortably angled, anatomically correct headset.
- Latex Free.



**PEDIATRIC STETHOSCOPES**

**DUAL HEAD**

PRODUCT NUMBER	FEATURES
06-1640	30" Gray
06-2415	30" Pink
06-2417	30" Black
06-2418	30" Burgundy
06-2422	30" Blue



**INFANT STETHOSCOPES**

**DUAL HEAD**

PRODUCT NUMBER	FEATURES
06-1642	30" Gray
06-2426	30" Pink
06-2427	30" Light Blue
06-2428	30" Black

**FETAL STETHOSCOPE**

**CHROME-PLATED INNER SPRING BINAURAL AND VINYL COATED HEADREST**

PRODUCT NUMBER	FEATURES
06-1662	22" Y-Tubing Black





# DIAGNOSTIC INSTRUMENTS

## STETHOSCOPES

### NURSES STETHOSCOPES

#### SINGLE SIDED

- Economic solution for situations that require a quality listening device.
- Latex Free.

PRODUCT NUMBER	FEATURES
06-1004	30" Blue
06-1635	30" Black
06-1638	30" Gray
06-2606	Soft Rubber Ear Tips, 2/pk
06-2607	Plastic Ear Tips, 2/pk



### TEACHING TRAINING STETHOSCOPE

#### DUAL SIDED

- Specifically designed for multi-function teaching applications.
- Elongated tubing for comfortable two-person use.
- Latex Free.

PRODUCT NUMBER	FEATURES
06-1668	40" Black



### DISPOSABLE STETHOSCOPES

#### SINGLE SIDED

- Designed for single use to prevent cross contamination in infectious situations.
- Plastic, ultra sensitive chest piece with remarkable acoustic performance.
- Latex Free.

PRODUCT NUMBER	FEATURES
96-1201	30" Blue
96-1202	30" Yellow



**BOWLES STETHOSCOPE**

PRODUCT NUMBER

06-1000



**DELEE-HILLIS OBSTETRICAL STETHOSCOPE**

PRODUCT NUMBER

06-1301

FEATURES

Metal Headband



**MAGNATONE STETHOSCOPE**

PRODUCT NUMBER

06-1801

FEATURES

No Chill Chest Piece





## DIAGNOSTIC INSTRUMENTS STETHOSCOPES

### PINARD FETOSCOPE

PRODUCT NUMBER	FEATURES
----------------	----------

06-1101	Aluminum
---------	----------



### PERRELL FETOSCOPE

PRODUCT NUMBER	FEATURES
----------------	----------

06-1701	With Slip on Tubing Adaptor
---------	-----------------------------



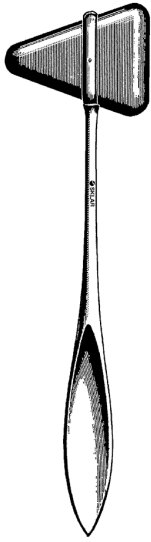

**TAYLOR PERCUSSION  
HAMMERS**

**SOLID HANDLE**

06-3170	Small	7"
95-008	Small	7"
06-3175	Large	7½"
95-010	Large	7½"

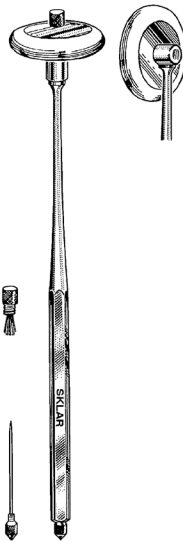

**RABINER NEUROLOGICAL  
HAMMER**

**WITH PIN AND BRUSH**

06-3290	Chrome
---------	--------



**BUCK NEUROLOGICAL  
HAMMER**

**WITH PIN AND BRUSH**

06-3370	6¾"
---------	-----



**WARTENBERG NEUROLOGICAL PINWHEEL**

**CHROME PLATED**

06-3375
---------

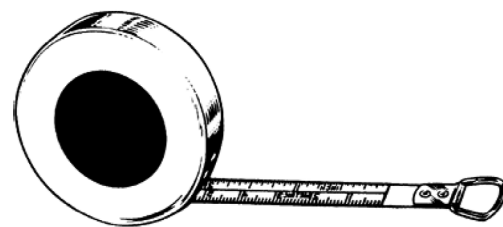

**TAPE MEASURE RETRACTABLE**

06-2852	60"
---------	-----

DIAGNOSTIC INSTRUMENTS

GENERAL



**STEEL RULER**

- 06-2860 6"
- 06-2862 8"
- 06-2861 12"
- 06-2863 20"

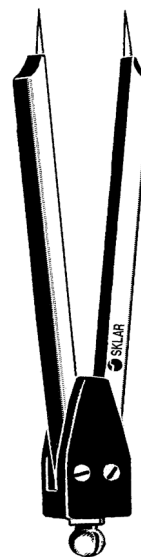

**EKG CALIPER**

- 06-2808 7"

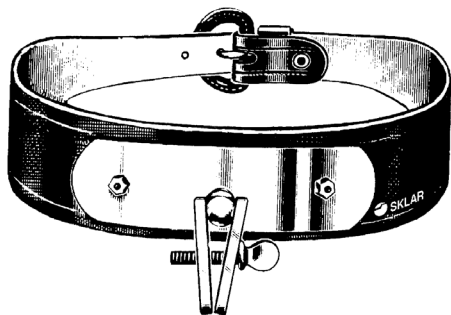

**JEFFERSON LEATHER HEADBAND**

- 73-1015 1½" With Pad
- PLASTIC HEADBAND**
- 73-1082

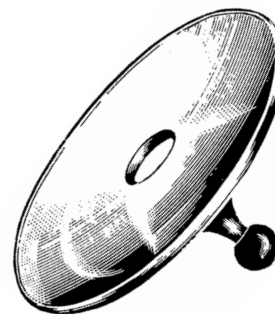

**HEAD MIRROR**

- BOILABLE, FOR USE WITH 73-1015 AND 73-1082**
- 73-1085 3½" ½" Hole Diameter
  - 73-1086 3" ⅝" Hole Diameter, Stainless Back



All Sklar Stainless Steelware is produced according to the strictest standards to ensure superior performance and durability.

\*All products are packaged individually however; select products are available in bulk. To order larger quantities, simply add the package quantity to the end of the product number when ordering, ie. 10-1670-12 for 12/cs or 10-1670-48 for 48/cs.

**IODINE CUP\***

PRODUCT NUMBER	DESCRIPTION	QUANTITIES
10-1670	6 oz., 3 <sup>7</sup> / <sub>16</sub> " x 2"	1, 12, 24 or 48/cs
10-1671	14 oz., 4 <sup>3</sup> / <sub>8</sub> " x 2 <sup>5</sup> / <sub>8</sub> "	1, 12, 24 or 48/cs



**MEDICINE CUP\***

PRODUCT NUMBER	DESCRIPTION	QUANTITIES
10-1675	2 oz., 2 <sup>1</sup> / <sub>8</sub> " x 2" Graduated Measure	1, 12, 24 or 48/cs



**TUMBLER\***

PRODUCT NUMBER	DESCRIPTION	QUANTITIES
10-1536	2 <sup>7</sup> / <sub>8</sub> " x 3 <sup>1</sup> / <sub>8</sub> "	1, 12/cs



**PITCHER / BEAKER\***

PRODUCT NUMBER	DESCRIPTION	QUANTITIES
10-1172	125ml, 2 <sup>1</sup> / <sub>8</sub> " x 2 <sup>5</sup> / <sub>8</sub> " w/o Handle	1 Each
10-1173	250ml, 2 <sup>5</sup> / <sub>8</sub> " x 3 <sup>1</sup> / <sub>4</sub> " w/o Handle	1 Each
10-1174	600ml, 3 <sup>3</sup> / <sub>8</sub> " x 4 <sup>5</sup> / <sub>8</sub> " w/o Handle	1 Each
10-1176	2000ml, 4 <sup>7</sup> / <sub>8</sub> " x 7 <sup>1</sup> / <sub>8</sub> " w/o Handle	1 Each
10-1177	3000ml, 5 <sup>1</sup> / <sub>2</sub> " x 8 <sup>1</sup> / <sub>4</sub> " w/o Handle	1 Each
10-1178	4000ml, 6 <sup>1</sup> / <sub>8</sub> " x 8 <sup>7</sup> / <sub>8</sub> " w/o Handle	1 Each
10-1175	1200ml, 4 <sup>1</sup> / <sub>8</sub> " x 6 <sup>1</sup> / <sub>16</sub> " with closed Handle	1 Each
10-1539	2000ml, 5 <sup>1</sup> / <sub>16</sub> " x 6 <sup>5</sup> / <sub>8</sub> " with closed Handle	1, 6 or 12/cs
10-1180	3000ml, 6 <sup>1</sup> / <sub>16</sub> " x 7" with closed Handle	1 Each
10-1181	4000ml, 6 <sup>7</sup> / <sub>8</sub> " x 8 <sup>7</sup> / <sub>8</sub> " with closed Handle	1 Each





**GRADUATED MEASURE\***

PRODUCT NUMBER	DESCRIPTION	QUANTITIES
10-1552	16 oz., 3¼" x 4½"	1, 6 or 12/cs
10-1510	32 oz., 4¾" x 5¼"	1, 6 or 12/cs
10-1674	64 oz., 5½" x 6½"	1, 6 or 12cs



**SPONGE BOWLS\***

PRODUCT NUMBER	DESCRIPTION	QUANTITIES
10-1496	12 oz., 4¼" x 2"	1 or 12/cs
10-1498	22 oz., 5" x 2¾"	1 or 12/cs
10-1484	29 oz., 5⅝" x 2⅞"	1 or 12/cs
10-1485	36 oz., 6¼" x 2¾"	1 or 12/cs
10-1483	48 oz., 7⅞" x 2¾"	1 or 12/cs
10-1486	64 oz., 7⅞" x 3"	1 or 12/cs



**MIXING/SOLUTION BOWLS\***

PRODUCT NUMBER	DESCRIPTION	QUANTITIES
10-1488	⅞ qt., 6⅝" x 2½"	1 or 12/cs
10-1491	1⅞ qt., 8⅞" x 3"	1 or 12/cs
10-1492	3 qt., 9¾" x 4"	1 or 12/cs
10-1493	5 qt., 11⅞" x 4½"	1 Each



**SOLUTION BASINS\***

PRODUCT NUMBER	DESCRIPTION	QUANTITIES
10-1489	4½ qt., 12" x 4¼"	1 or 12/cs
10-1505	7 qt., 13⅝" x 4⅝"	1, 6 or 12/cs
10-1507	9½ qt., 14½" x 5"	1, 6 or 12/cs



\*All products are packaged individually however; select products are available in bulk. Instrument trays and covers are sold separately unless otherwise noted. To order larger quantities, simply add the package quantity to the end of the product number when ordering, ie. 10-1670-12 for 12/cs or 10-1670-48 for 48/cs.

**EMESIS BASINS\***

PRODUCT NUMBER	DESCRIPTION	QUANTITIES
10-1497	10 oz., 6 $\frac{5}{8}$ " x 3 $\frac{1}{2}$ " x 1 $\frac{1}{2}$ "	1 or 12/cs
10-1698	12 oz., 8 $\frac{1}{8}$ " x 3 $\frac{3}{8}$ " x 1 $\frac{5}{8}$ "	1 or 12/cs
10-1699	26 oz., 9 $\frac{7}{8}$ " x 4 $\frac{1}{2}$ " x 2 $\frac{1}{8}$ "	1 or 12/cs
10-1487	48 oz., 12 $\frac{1}{8}$ " x 5 $\frac{3}{4}$ " x 2 $\frac{1}{4}$ "	1 Each



**HOSPITAL BUCKETS**

PRODUCT NUMBER	DESCRIPTION	QUANTITIES
10-1182	13 qt., 11 $\frac{5}{8}$ " x 9 $\frac{1}{4}$ " w/o lid	1 Each
10-1450	13 qt., 11 $\frac{5}{8}$ " x 9 $\frac{1}{4}$ " with lid	1 Each
10-1183	16 qt., 11 $\frac{3}{4}$ " x 10 $\frac{1}{8}$ " w/o lid	1 Each
10-1451	16 qt., 11 $\frac{3}{4}$ " x 10 $\frac{1}{8}$ " with lid	1 Each
10-1184	20 qt., 13 $\frac{3}{4}$ " x 11 $\frac{13}{16}$ " w/o lid	1 Each



**HOSPITAL KICK BUCKET WITHOUT LID**

PRODUCT NUMBER	DESCRIPTION	QUANTITIES
10-1551	13 qt., 11 $\frac{5}{8}$ " x 9 $\frac{1}{4}$ "	1 Each



**STORAGE CONTAINERS\***

PRODUCT NUMBER	DESCRIPTION	QUANTITIES
10-1540	$\frac{1}{2}$ gal., 5 $\frac{7}{16}$ " x 6 $\frac{5}{8}$ " no handles	1, 6 or 12/cs
10-1190	6 gal., 13" x 13"	1 Each



\*All products are packaged individually however; select products are available in bulk. Instrument trays and covers are sold separately unless otherwise noted. To order larger quantities, simply add the package quantity to the end of the product number when ordering, ie. 10-1670-12 for 12/cs or 10-1670-48 for 48/cs.



**DRESSING JAR WITH LID\***

PRODUCT NUMBER	DESCRIPTION	QUANTITIES
10-1523	½ qt., 4½" x 2¼"	1 or 12/cs
10-1533	1¼ qt., 4" x 5"	1 or 12/cs
10-1538	1⅞ qt., 4⅞" x 6¼"	1 or 12/cs
10-1527	3 qt., 5⅞" x 6¾"	1 or 12/cs
10-1543	4¾ qt., 6¾" x 7¾"	1 or 12/cs
10-1544	6 qt., 7¼" x 8⅞"	1, 6 or 12/cs
10-1547	8 qt., 8" x 9⅞"	1, 6 or 12/cs



**FORCEPS / THERMOMETER JAR\***

PRODUCT NUMBER	DESCRIPTION	QUANTITIES
10-1550	1½" x 3"	1, 6 or 12/cs
10-1541	2¼" x 4½"	1, 6 or 12/cs
10-1545	2¼" x 7"	1, 6 or 12/cs



**FUNNELS WITH HANGING HOOK**

PRODUCT NUMBER	DESCRIPTION	QUANTITIES
10-1157	2⅜ oz., 3" x 3¾"	1 Each
10-1158	6⅞ oz., 4⅞" x 4⅞"	1 Each
10-1159	13 oz., 5⅞" x 5⅞"	1 Each
10-1160	22¼ oz., 6¼" x 6⅞"	1 Each
10-1170	32 oz., 7" x 8⅞"	1 Each
10-1171	64 oz., 8⅞" x 9½"	1 Each



**LAB / UTILITY SCOOP**

PRODUCT NUMBER	DESCRIPTION	QUANTITIES
10-1192	5 oz., 5" x 2½" (Overall length 9½")	1 Each



\*All products are packaged individually however; select products are available in bulk. Instrument trays and covers are sold separately unless otherwise noted. To order larger quantities, simply add the package quantity to the end of the product number when ordering, ie. 10-1670-12 for 12/cs or 10-1670-48 for 48/cs.

**OINTMENT JAR WITH LID\***

PRODUCT NUMBER	DESCRIPTION	QUANTITIES
10-1525	9 oz., 3 1/8" x 2 3/4"	1 or 12/cs



**MINI TRAY WITH LID**

PRODUCT NUMBER	DESCRIPTION	QUANTITIES
10-1768	8 1/2" x 3" x 1 1/2"	1 Each



# SKLAR DISINFECTANT™ SURFACE WIPES

READY-TO-USE, PRE-MOISTENED TOWELETTES

SAME EFFECTIVE FORMULA AS  
SKLAR DISINFECTANT!

2 MINUTE KILL TIME

- Ready to use, non-toxic formula.
- Specially formulated for the control of cross contamination.
- Effective against a broad range of pathogens including H1N1, HIV-1, HPV, VRE, Norovirus, Hep B & C as well as TB, MRSA and A. Baumannii.
- Safe for all areas of the facility.
- Satisfies OSHA's Bloodborne Pathogen Standards.
- Destroys odor-causing bacteria.
- 7" x 10" non-woven, tear resistant towelette.
- Clean scent.
- EPA registered.

PRODUCT NUMBER	DESCRIPTION	QUANTITIES
10-1616	100 Towelettes/Canister	6/cs
10-1617	100 Towelettes/Canister	12/cs



Convenient  
Dispensing  
Canister



**STEELWARE  
INSTRUMENT TRAYS**

\*All products are packaged individually however; select products are available in bulk. Instrument trays and covers are sold separately unless otherwise noted. To order larger quantities, simply add the package quantity to the end of the product number when ordering, ie. 10-1670-12 for 12/cs or 10-1670-48 for 48/cs.

**MAYO TRAYS (SOLID)\***

PRODUCT NUMBER	DESCRIPTION	QUANTITIES
10-1690	10" x 6½" x ¾"	1, 6 or 12/cs
10-1691	13⅛" x 9⅜" x ¾"	1, 6 or 12/cs
10-1692	15⅞" x 10⅝" x ¾"	1, 6 or 12/cs
10-1693	17" x 11⅞" x ¾"	1, 6 or 12/cs
10-1694	19 ⅞" x 12⅝" x ¾"	1, 6 or 12/cs
10-1695	21¼" x 16¼" x ⅞"	1, 6 or 12/cs



**MAYO TRAYS (PERFORATED)\***

PRODUCT NUMBER	DESCRIPTION	QUANTITIES
10-1684	10" x 6½" x ¾"	1, 6 or 12/cs
10-1685	13¾" x 9¾" x ¾"	1, 6 or 12/cs
10-1686	15⅞" x 10⅝" x ¾"	1, 6 or 12/cs
10-1687	17" x 11⅞" x ¾"	1, 6 or 12/cs
10-1688	19⅞" x 12⅝" x ¾"	1, 6 or 12/cs
10-1689	21¼" x 16¼" x ⅞"	1 or 6/cs

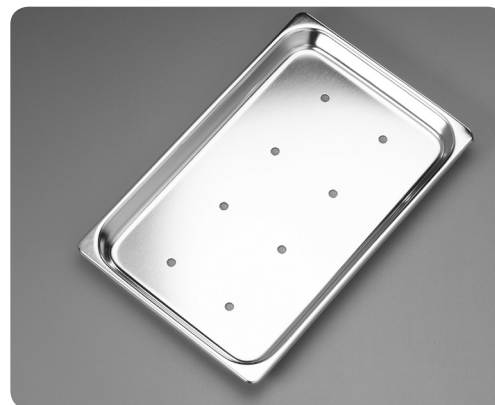

**CATHETER INSTRUMENT TRAYS\***

PRODUCT NUMBER	DESCRIPTION	COVERS	QUANTITIES
10-1955	8¾" x 3¼" x 1½"	10-1956 - Dome	1, 6 or 12/cs
10-1738	8⅞" x 5" x 2"	10-1722 - Dome	1, 6 or 12/cs
10-1760	8⅞" x 5" x 3"	10-1722 - Dome	1, 6 or 12/cs
10-1886	17¼" x 5" x 2"	10-1887 - Flat	1, 6 or 12/cs



**STEELWARE  
INSTRUMENT TRAYS**



**MESH CLEANING BASKETS\***

PRODUCT NUMBER	DESCRIPTION	QUANTITIES
10-1731	6" x 9" x 3"	1 Each
10-1733	9½" x 16" x 4"	1 Each
10-1734	12" x 21" x 5"	1 Each



**PERFORATED CLEANING BASKET**

PRODUCT NUMBER	DESCRIPTION	QUANTITIES
10-1560	12¾" x 10¾" x 6"	1 Each



**INSTRUMENT DRYING TRAYS\***

PRODUCT NUMBER	DESCRIPTION	QUANTITIES
10-1876	10" x 6½" x ¾"	1, 6 or 12/cs
10-1883	13⅛" x 9⅜" x ¾"	1, 6 or 12/cs
10-1683	17" x 11⅝" x ¾"	1, 6 or 12/cs
10-1888	19⅞" x 12⅝" x ¾"	1, 6 or 12/cs
10-1680	21¼" x 16¼" x ⅞"	1, 6 or 12/cs



\*All products are packaged individually however; select products are available in bulk. Instrument trays and covers are sold separately unless otherwise noted. To order larger quantities, simply add the package quantity to the end of the product number when ordering, ie. 10-1670-12 for 12/cs or 10-1670-48 for 48/cs.



# STEELWARE INSTRUMENT TRAYS

## INSTRUMENT TRAYS, PERFORATED BOTTOM

PRODUCT NUMBER	DESCRIPTION	QUANTITIES
10-1740	8 <sup>7</sup> / <sub>8</sub> " x 5" x 2"	1 Each
10-1874	10" x 6 <sup>1</sup> / <sub>2</sub> " x 2"	1 Each
10-1892	12" x 7 <sup>3</sup> / <sub>4</sub> " x 2"	1 Each
10-1879	12" x 7 <sup>3</sup> / <sub>4</sub> " x 2 <sup>1</sup> / <sub>2</sub> "	1 Each
10-1758	12 <sup>3</sup> / <sub>4</sub> " x 10 <sup>1</sup> / <sub>2</sub> " x 2 <sup>1</sup> / <sub>2</sub> "	1 Each
10-1862	12 <sup>3</sup> / <sub>4</sub> " x 10 <sup>1</sup> / <sub>2</sub> " x 4"	1 Each
10-1894	16 <sup>1</sup> / <sub>2</sub> " x 10" x 2 <sup>1</sup> / <sub>2</sub> "	1 Each
10-1895	20 <sup>3</sup> / <sub>4</sub> " x 12 <sup>3</sup> / <sub>4</sub> " x 2 <sup>1</sup> / <sub>2</sub> "	1 Each

## INSTRUMENT TRAYS , PERFORATED BOTTOM / SIDES\*

PRODUCT NUMBER	DESCRIPTION	QUANTITIES
10-1757	12 <sup>3</sup> / <sub>4</sub> " x 10 <sup>1</sup> / <sub>2</sub> " x 1 <sup>1</sup> / <sub>4</sub> "	1 Each
10-1697	12 <sup>3</sup> / <sub>4</sub> " x 10 <sup>1</sup> / <sub>2</sub> " x 2 <sup>1</sup> / <sub>2</sub> "	1 Each
10-1943	12 <sup>3</sup> / <sub>4</sub> " x 10 <sup>1</sup> / <sub>2</sub> " x 4"	1 Each
10-1944	12 <sup>3</sup> / <sub>4</sub> " x 10 <sup>1</sup> / <sub>2</sub> " x 6"	1 Each
10-1759	20 <sup>3</sup> / <sub>4</sub> " x 12 <sup>3</sup> / <sub>4</sub> " x 2 <sup>1</sup> / <sub>2</sub> "	1 Each
10-1949	20 <sup>3</sup> / <sub>4</sub> " x 12 <sup>3</sup> / <sub>4</sub> " x 4"	1, 6 or 12/cs
10-1942	20 <sup>3</sup> / <sub>4</sub> " x 12 <sup>3</sup> / <sub>4</sub> " x 6"	1 Each

## INSTRUMENT TRAYS, SOLID\*

PRODUCT NUMBER	DESCRIPTION	COVERS	QUANTITIES
10-1755	6 <sup>7</sup> / <sub>8</sub> " x 4 <sup>1</sup> / <sub>4</sub> " x 2"	10-1737	1, 6 or 12/cs
10-1741	6 <sup>7</sup> / <sub>8</sub> " x 6 <sup>3</sup> / <sub>8</sub> " x 4" Heavyweight	10-1835	1 or 6/cs
10-1764	10" x 6 <sup>1</sup> / <sub>2</sub> " x 2"	10-1766	1 Each
10-1742	10 <sup>3</sup> / <sub>8</sub> " x 6 <sup>3</sup> / <sub>8</sub> " x 2 <sup>1</sup> / <sub>2</sub> "	10-1542	1, 6 or 12/cs
10-1877	12" x 7 <sup>3</sup> / <sub>4</sub> " x 2 <sup>1</sup> / <sub>4</sub> "	10-1878	1, 6 or 12/cs
10-1744	12 <sup>3</sup> / <sub>4</sub> " x 6 <sup>7</sup> / <sub>8</sub> " x 2 <sup>1</sup> / <sub>2</sub> "	10-1724	1, 6 or 12/cs
10-1746	12 <sup>3</sup> / <sub>4</sub> " x 10 <sup>1</sup> / <sub>2</sub> " x 2 <sup>1</sup> / <sub>2</sub> "	10-1882	1, 6 or 12/cs
10-1950	12 <sup>3</sup> / <sub>4</sub> " x 10 <sup>1</sup> / <sub>2</sub> " x 2 <sup>1</sup> / <sub>2</sub> " Heavyweight	10-1882	1, 6 or 12/cs
10-1747	12 <sup>3</sup> / <sub>4</sub> " x 10 <sup>1</sup> / <sub>2</sub> " x 4"	10-1882	1, 6 or 12/cs
10-1952	12 <sup>3</sup> / <sub>4</sub> " x 10 <sup>1</sup> / <sub>2</sub> " x 4" Heavyweight	10-1882	1, 6 or 12/cs
10-1753	13 <sup>7</sup> / <sub>8</sub> " x 12 <sup>7</sup> / <sub>8</sub> " x 2 <sup>1</sup> / <sub>2</sub> "	10-1754	1, 6 or 12/cs
10-1748	16 <sup>1</sup> / <sub>2</sub> " x 10" x 2 <sup>1</sup> / <sub>2</sub> "	10-1756	1, 6 or 12/cs
10-1749	16 <sup>1</sup> / <sub>2</sub> " x 10" x 4"	10-1756	1 Each
10-1953	20 <sup>3</sup> / <sub>4</sub> " x 12 <sup>3</sup> / <sub>4</sub> " x 2 <sup>1</sup> / <sub>2</sub> " Heavyweight	10-1535	1, 6 or 12/cs
10-1954	20 <sup>3</sup> / <sub>4</sub> " x 12 <sup>3</sup> / <sub>4</sub> " x 4" Heavyweight	10-1535	1, 6 or 12/cs
10-1948	20 <sup>3</sup> / <sub>4</sub> " x 12 <sup>3</sup> / <sub>4</sub> " x 6"	10-1535	1, 6 or 12/cs



\*All products are packaged individually however; select products are available in bulk. Instrument trays and covers are sold separately unless otherwise noted. To order larger quantities, simply add the package quantity to the end of the product number when ordering, ie. 10-1670-12 for 12/cs or 10-1670-48 for 48/cs.



# STEELWARE

## INSTRUMENT TRAYS



### STERILIZATION TRAY / BATH SETS

PRODUCT NUMBER	DESCRIPTION	QUANTITIES
10-1947	Large Set Includes:	
	Solid Tray 10-1948 20¾" x 12¾" x 6"	1
	Perforated Tray 10-1949 20¾" x 12¾" x 4"	1
	Cover 10-1535 20¾" x 12¾"	1
10-1679	Small Set Includes:	
	Solid Tray 10-1747 12¾" x 10½" x 4"	1
	Perforated Tray 10-1697 12¾" x 10½" x 2½"	1
	Cover 10-1882 12¾" x 10½"	1



### STERILIZATION TRAYS\*

PRODUCT NUMBER	DESCRIPTION	COVERS	QUANTITIES
10-1850	4 qt., 12¾" x 10½" x 2½"	10-1864	1 Each
10-1860	7 qt., 12¾" x 10½" x 4"	10-1864	1 Each
10-1750	5 ¼ qt., 20¾" x 6¾" x 4"	10-1854	1, 6 or 12/cs
10-1752	9 qt., 20¾" x 6¾" x 6"	10-1854	1, 6 or 12/cs
10-1953	8 ½ qt., 20¾" x 12¾" x 2½", Heavyweight	10-1535	1, 6 or 12/cs
10-1954	14 ½ qt., 20¾" x 12¾" x 4", Heavyweight	10-1535	1, 6 or 12/cs
10-1948	24 qt., 20¾" x 12¾" x 6"	10-1535	1, 6 or 12/cs



### PERFORATED STERILIZATION TRAYS

PRODUCT NUMBER	DESCRIPTION	QUANTITIES
10-1710	10" x 6½" x 2½"	1 Each
10-1714	15" x 10½" x 3½"	1 Each
10-1720	20" x 10½" x 3½"	1 Each



\*All products are packaged individually however; select products are available in bulk. Instrument trays and covers are sold separately unless otherwise noted. To order larger quantities, simply add the package quantity to the end of the product number when ordering, ie. 10-1670-12 for 12/cs or 10-1670-48 for 48/cs.



# STEELWARE INSTRUMENT BASKETS

## FINE MESH BASKETS

Fine mesh baskets with hinged lid and locking clip are used for instrument washing, sterilization and handling. Baskets feature mesh openings of 1.6mm. Finely crafted with a burr free, smooth finish and electrolyte polish. Lids have removeable hinges to completely separate the lid from the basket as desired.

### 0.5 MM WIRE DIAMETER

PRODUCT NUMBER	DESCRIPTION	QUANTITIES
10-6600	5" x 6" x 1½"	1 Each
10-6602	9¼" x 6" x 1½"	1 Each
10-6604	15" x 10¾" x 1½"	1 Each
10-6606	11" x 7" x 1¼"	1 Each
10-6608	11" x 8" x 1¼"	1 Each



### 0.5 MM WIRE DIAMETER

PRODUCT NUMBER	DESCRIPTION	QUANTITIES
10-6610	9¼" x 3" x 1"	1 Each

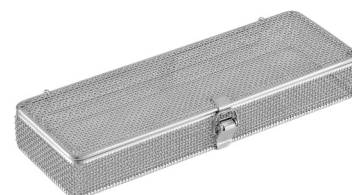

### 0.7 MM WIRE DIAMETER

PRODUCT NUMBER	DESCRIPTION	QUANTITIES
10-6612	3" x 1½" x ¾"	1 Each
10-6614	3" x 1½" x 1"	1 Each
10-6616	3" x 3" x 1¼"	1 Each
10-6618	3" x 3" x 1½"	1 Each
10-6620	4" x 2¾" x 1"	1 Each
10-6622	6" x 2" x 1½"	1 Each
10-6624	7½" x 3" x 4"	1 Each
10-6626	8" x 4" x 1½"	1 Each
10-6628	8¾" x 5½" x 2"	1 Each
10-6630	9¼" x 6" x 1½"	1 Each
10-6632	9½" x 3½" x 1½"	1 Each
10-6634	9½" x 5" x 1½"	1 Each
10-6636	11" x 7" x 1½"	1 Each

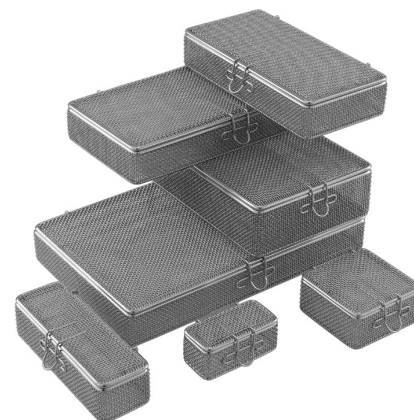

### 0.7 MM WIRE DIAMETER, WITH SILICONE PADS

PRODUCT NUMBER	DESCRIPTION	QUANTITIES
10-6729	9¼" x 3" x 1"	1 Each
10-6730	9¼" x 6" x 1½"	1 Each
10-6732	9½" x 3½" x 1½"	1 Each



**OPHTHALMIC BASKETS**

Perforated Ophthalmic baskets are specially designed for micro instruments. Silicone pads on the basket bottom accommodate micro instruments while silicone pads on the lid grip and hold instruments in place during transportation and processing.

- User Friendly Locking Handle
- Removable Lid
- Perforated Side Walls



**MICRO OPHTHALMIC BASKETS**

PRODUCT NUMBER	DESCRIPTION	QUANTITIES
10-6660	13" x 10" x 1½"	1 Each
10-6662	17" x 10" x 1½"	1 Each

**OPHTHALMIC BASKETS**

PRODUCT NUMBER	DESCRIPTION	QUANTITIES
10-6664	9½" x 10" x 1½"	1 Each
10-6666	19" x 10" x 1½"	1 Each



**WIRE NET BASKETS**

Wire net baskets are fabricated with 6.5mm grid openings. Ideal for instrument processing in ultrasonic washers and sterilizers. Baskets are stackable and feature a smooth finish with electrolyte polish. Clip on lid sold separately.

**WIRE NET BASKETS**

PRODUCT NUMBER	DESCRIPTION	QUANTITIES
10-6670	10" x 7" x 2¾"	1 Each
10-6672	13" x 10" x 2¾"	1 Each
10-6674	17¾" x 13" x 2¾"	1 Each

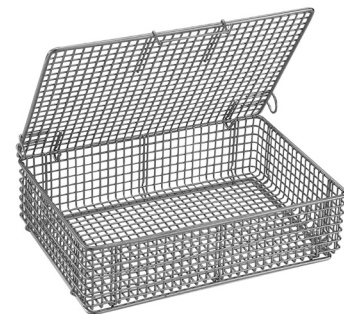

**WIRE NET BASKET LIDS**

PRODUCT NUMBER	DESCRIPTION	QUANTITIES
10-6680	10" x 7"	1 Each
10-6682	13" x 10"	1 Each
10-6684	17¾" x 13"	1 Each

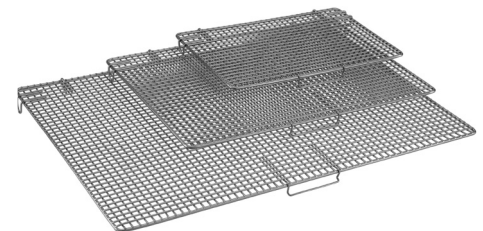



# STEELWARE INSTRUMENT BASKETS

## ENDOSCOPIC BASKETS

Protect costly endoscopic instruments during the cleaning & sterilization process with specially designed baskets to hold these instruments. Ideal for use in automatic washers and sterilizers. Silicone pads provide protection to endoscopes during handling and storage.

### ENDOSCOPE BASKET WITH SMALL LENS BASKET

PRODUCT NUMBER	DESCRIPTION	QUANTITIES
10-6690	25" x 6" x 3" 4/4 Pads	1 Each

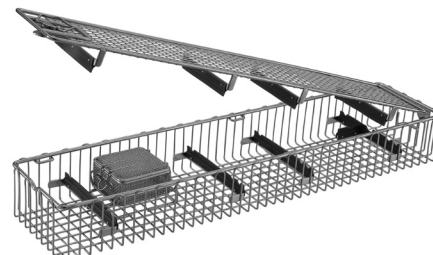

### ARTHROSCOPE BASKETS

PRODUCT NUMBER	DESCRIPTION	QUANTITIES
10-6692	11½" x 3¼" x 2" 2/2 Pads	1 Each
10-6694	11½" x 3¼" x 2" 3/3 Pads	1 Each

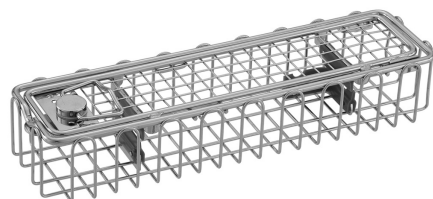

### ENDOSCOPE BASKETS

PRODUCT NUMBER	DESCRIPTION	QUANTITIES
10-6702	11½" x 6¼" x 2" 3/3 Pads	1 Each
10-6704	11½" x 6¼" x 2" 3/3 Pads	1 Each
10-6716	12¼" x 6" x 3" 3/3 Pads	1 Each
10-6696	18" x 3¼" x 2" 2/2 Pads	1 Each
10-6698	18" x 3¼" x 2" 3/3 Pads	1 Each
10-6706	18" x 6¼" x 2" 3/3 Pads	1 Each
10-6710	18" x 6¼" x 2" 3/3 Pads	1 Each
10-6708	18" x 6¼" x 2" 4/4 Pads	1 Each
10-6712	18" x 9" x 2" 3/3 Pads	1 Each
10-6714	18" x 9" x 2" 4/4 Pads	1 Each
10-6718	23" x 6¼" x 2" 4/4 Pads	1 Each
10-6720	23" x 6¼" x 2" 4/6 Pads	1 Each
10-6700	26½" x 3¼" x 2" 2/2 Pads	1 Each



**INSTRUMENT CASSETTE**

- Spring holders
- Removable/Locking lid
- Perforated sides

**WITH SPRING HOLDING**

PRODUCT NUMBER	DESCRIPTION	QUANTITIES
10-6740	8¾" x 5" x 1½"	1 Each
10-6742	10" x 8¾" x 1½"	1 Each

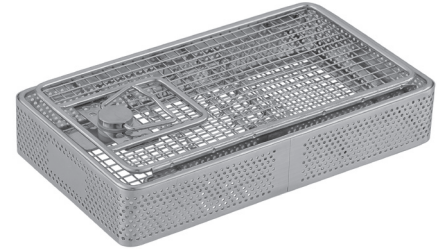

**TRINKET BOXES**

**PERFORATED LID**

PRODUCT NUMBER	DESCRIPTION	QUANTITIES
10-6750	3½" x 2¼" x 1"	1 Each
10-6752	4" x 2¾" x 1"	1 Each
10-6754	5" x 3" x 1"	1 Each



**TRINKET BOXES**

**WIRE MESH LID**

PRODUCT NUMBER	DESCRIPTION	QUANTITIES
10-6760	3½" x 2¼" x 1"	1 Each
10-6762	4" x 2¾" x 1"	1 Each
10-6764	5" x 3" x 1"	1 Each



# STEELWARE

## MICRO TRAYS



### LIFTING HANDLES

PRODUCT NUMBER	DESCRIPTION	QUANTITIES
10-1725	For Sterilization Trays	1 Pair



### FLASH STERILIZATION TRAY

PRODUCT NUMBER	DESCRIPTION	QUANTITIES
10-1711	10" x 6½" x 2"	1 Each
10-1712	Single Handle for Flash Sterilization Tray 10-1711	1 Each



### DOUBLE DECKER MICRO TRAY

PRODUCT NUMBER	DESCRIPTION	QUANTITIES
10-1717	10" x 15" x 2¼"	1 Each



### MICRO TRAY WITH HINGED LID

PRODUCT NUMBER	DESCRIPTION	QUANTITIES
10-1706	8½" x 8" x 1½" with 2½" x 2½" Compartment	1 Each
10-1707	8½" x 12" x 1½"	1 Each
10-1708	8½" x 14" x 1½"	1 Each
10-1702	10½" x 10" x 1½"	1 Each
10-1716	10½" x 20" x 2½" with 10½" x 5" Compartment	1 Each



PRODUCT NUMBER	DESCRIPTION	QUANTITIES
10-1700	8½" x 8" x 1¼"	1 Each
10-1703	10½" x 15" x 1¼"	1 Each



### STERILIZATION BOX (Not pictured)

PRODUCT NUMBER	DESCRIPTION	QUANTITIES
10-1705	6¾" x 3¾" x 1¾"	1 Each

# STEELWARE INSTRUMENT STRINGERS



## WEINSTEIN INSTRUMENT STRINGERS

PRODUCT NUMBER	DESCRIPTION	QUANTITIES
10-1800	5½" x 3¼"	1 Each
10-1805	11¼" x 3¼"	1 Each



## E-Z LOCK INSTRUMENT STRINGERS

PRODUCT NUMBER	DESCRIPTION	QUANTITIES
10-1806	2½" x 6"	1 Each
10-1808	2½" x 8"	1 Each
10-1810	2½" x 10"	1 Each
10-1812	2½" x 12"	1 Each
10-1814	2½" x 14"	1 Each
10-1816	2½" x 16"	1 Each
10-1818	2½" x 18"	1 Each
10-1826	5" x 6"	1 Each
10-1828	5" x 8"	1 Each
10-1830	5" x 10"	1 Each
10-1832	5" x 12"	1 Each
10-1834	5" x 14"	1 Each
10-1836	5" x 16"	1 Each
10-1838	5" x 18"	1 Each

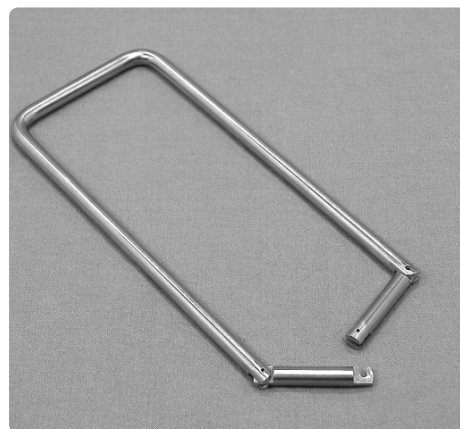

## INSTRUMENT STRINGERS

PRODUCT NUMBER	DESCRIPTION	QUANTITIES
10-1340	2½" x 6"	1 Each
10-1342	2½" x 8"	1 Each
10-1344	2½" x 10"	1 Each
10-1346	2½" x 12"	1 Each
10-1347	2½" x 14"	1 Each
10-1348	2½" x 16"	1 Each
10-1349	2½" x 18"	1 Each

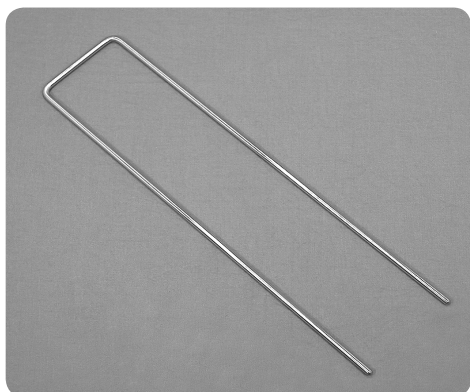

### WEISENBACH INSTRUMENT HOLDER

PRODUCT NUMBER	DESCRIPTION	QUANTITIES
10-1775	6"	1 Each
10-1776	12"	1 Each



### BUNT INSTRUMENT STRINGER

PRODUCT NUMBER	DESCRIPTION	QUANTITIES
10-1770	5¼" x 1½"	1 Each

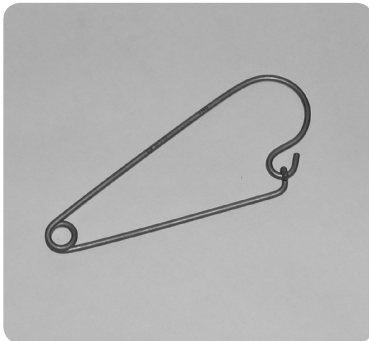

### MAYO INSTRUMENT HOLDER

PRODUCT NUMBER	DESCRIPTION	QUANTITIES
10-1772	5½"	1 Each

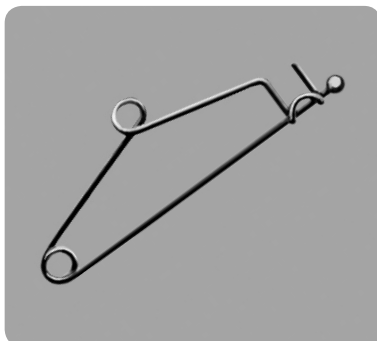

### WORCESTER INSTRUMENT HOLDER

PRODUCT NUMBER	DESCRIPTION	QUANTITIES
10-1839	13" x 3"	1 Each

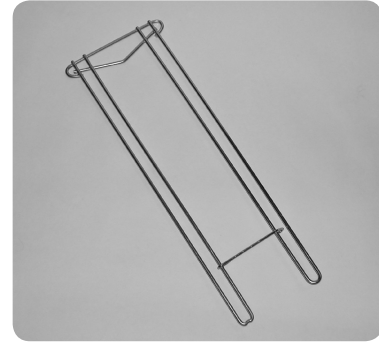

### SAUNDERS INSTRUMENT RACK

PRODUCT NUMBER	DESCRIPTION	QUANTITIES
10-1780	6" x 4"	1 Each

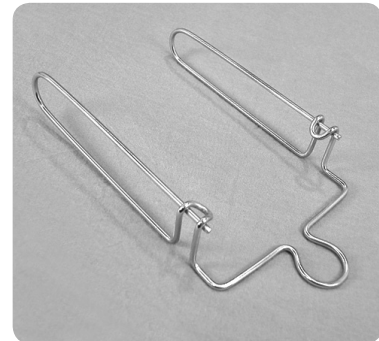

### POSILOCK INSTRUMENT RACK

PRODUCT NUMBER	DESCRIPTION	QUANTITIES
10-1763		1 Each





# SKLARLITE™

## STERILIZATION CONTAINER SYSTEM

### Pre-Vacuum Steam Sterilization

The SklarLite Rigid Sterilization Container System provides an organized, routine and secure approach to the sterilization of surgical instruments. Customize your SklarLite™ System by selecting colored lids and ID labels. Available in your choice of six vibrant colors for easy identification of instrument sets by procedure and/or department. Choose from various configurations to fit your surgery center needs.

- Anodized aluminum alloy is strong and durable yet lightweight and easy to handle.
- Stackable Containers maximizes space in the autoclave and storage shelf space; reduces cycle runs.
- Stackable Baskets provide ease of instrument transfer per procedure and maximizes space inside containers.
- Silicon mats secure delicate and laparoscopic instruments to minimize damage.
- Tamper evident seals prevent accidental sterile field breach.
- Long Lasting Sterilization.



#### STANDARD CONTAINERS



Consists of a body and perforated lid and used with Sklar's disposable filters and other compatible accessories for sterilization. Choose from either perforated or non-perforated bottoms. Lids available in six different colors for easy identification by procedure or department.

#### SAFE CONTAINERS



Consists of identical body and perforated lid, but features an additional solid cover that safeguards the perforation field and contents during transportation and storage. Choose from either perforated or non-perforated bottoms. Safety lids available in six different colors for easy identification by procedure or department.



**SKLARLITE™ HALF-SIZE CONTAINERS**

11¼" L X 11" W

STANDARD CONTAINERS			SAFE CONTAINERS		
Non-Perforated Bottom	Perforated Bottom	Size	Non-Perforated Bottom	Perforated Bottom	Color
10-4500	10-4512	4"	10-4524	10-4536	Silver
10-4502	10-4514	4"	10-4526	10-4538	Yellow
10-4504	10-4516	4"	10-4528	10-4540	Red
10-4506	10-4518	4"	10-4530	10-4542	Blue
10-4508	10-4520	4"	10-4532	10-4544	Green
10-4510	10-4522	4"	10-4534	10-4546	Black
10-4548	10-4560	5"	10-4572	10-4584	Silver
10-4550	10-4562	5"	10-4574	10-4586	Yellow
10-4552	10-4564	5"	10-4576	10-4588	Red
10-4554	10-4566	5"	10-4578	10-4590	Blue
10-4556	10-4568	5"	10-4580	10-4592	Green
10-4558	10-4570	5"	10-4582	10-4594	Black
10-4596	10-4608	6"	10-4620	10-4632	Silver
10-4598	10-4610	6"	10-4622	10-4634	Yellow
10-4600	10-4612	6"	10-4624	10-4636	Red
10-4602	10-4614	6"	10-4626	10-4638	Blue
10-4604	10-4616	6"	10-4628	10-4640	Green
10-4606	10-4618	6"	10-4630	10-4642	Black
10-4644	10-4656	8"	10-4668	10-4680	Silver
10-4646	10-4658	8"	10-4670	10-4682	Yellow
10-4648	10-4660	8"	10-4672	10-4684	Red
10-4650	10-4662	8"	10-4674	10-4686	Blue
10-4652	10-4664	8"	10-4676	10-4688	Green
10-4654	10-4666	8"	10-4678	10-4690	Black
10-4692	10-4704	10"	10-4716	10-4728	Silver
10-4694	10-4706	10"	10-4718	10-4730	Yellow
10-4696	10-4708	10"	10-4720	10-4732	Red
10-4698	10-4710	10"	10-4722	10-4734	Blue
10-4700	10-4712	10"	10-4724	10-4736	Green
10-4702	10-4714	10"	10-4726	10-4738	Black



**ACCESSORIES**

PRODUCT NUMBER	MODEL	FEATURES
10-4784	Half Size Wire Basket	9½" x 10" x 1"
10-4786	Half Size Wire Basket	9½" x 10" x 2"
10-4788	Half Size Wire Basket	9½" x 10" x 3"
10-4790	Half Size Wire Basket	9½" x 10" x 4"
10-4970	Half Size Silicon Mat	8½" x 9"



# STEELWARE STERILIZATION CONTAINERS



## SKLARLITE™ MID-SIZE CONTAINERS

18¼" L X 11" W

STANDARD CONTAINERS			SAFE CONTAINERS		
Non-Perforated Bottom	Perforated Bottom	Size	Non-Perforated Bottom	Perforated Bottom	Color
10-4300	10-4312	4"	10-4324	10-4336	Silver
10-4302	10-4314	4"	10-4326	10-4338	Yellow
10-4304	10-4316	4"	10-4328	10-4340	Red
10-4306	10-4318	4"	10-4330	10-4342	Blue
10-4308	10-4320	4"	10-4332	10-4344	Green
10-4310	10-4322	4"	10-4334	10-4346	Black
10-4348	10-4360	5"	10-4370	10-4382	Silver
10-4350	10-4361	5"	10-4372	10-4384	Yellow
10-4352	10-4362	5"	10-4374	10-4386	Red
10-4354	10-4364	5"	10-4376	10-4388	Blue
10-4356	10-4366	5"	10-4378	10-4390	Green
10-4358	10-4368	5"	10-4380	10-4392	Black
10-4394	10-4406	6"	10-4418	10-4430	Silver
10-4396	10-4408	6"	10-4420	10-4432	Yellow
10-4398	10-4410	6"	10-4422	10-4434	Red
10-4400	10-4412	6"	10-4424	10-4436	Blue
10-4402	10-4414	6"	10-4426	10-4438	Green
10-4404	10-4416	6"	10-4428	10-4440	Black



## ACCESSORIES

PRODUCT NUMBER	MODEL	FEATURES
10-4478	Mid Size Wire Basket	16" x 10" x 1"
10-4480	Mid Size Wire Basket	16" x 10" x 2"
10-4482	Mid Size Wire Basket	16" x 10" x 3"
10-4484	Mid Size Wire Basket	16" x 10" x 4"
10-4975	Mid Size Silicon Mat	15" x 9"



## GENERAL ACCESSORIES

Complete any SklarLite™ Container System by selecting disposable filters, indicators and labels to maximize security in preparation and maintenance of surgical sets and sterile materials.

PRODUCT NUMBER	MODEL	FEATURES
10-4900	Process Indicator Cards	Steam, 250/Bx
10-4910	Disposable Filters	100/Pk
10-4925	Security Seals	100/Pk
10-4930	ID Labels*	Silver
10-4930ENG	ID Labels*	Silver Custom Engraved, Max . 16 Characters



\*Choose from six vibrant colors including Silver, Yellow, Red, Blue, Green or Black. Contact your Sklar Account Manager for information on the complete product line.



**SKLARLITE™ FULL-SIZE CONTAINERS**

23" L X 11" W

STANDARD CONTAINERS			SAFE CONTAINERS		
Non-Perforated Bottom	Perforated Bottom	Size	Non-Perforated Bottom	Perforated Bottom	Color
10-4000	10-4012	4"	10-4024	10-4036	Silver
10-4002	10-4014	4"	10-4026	10-4038	Yellow
10-4004	10-4016	4"	10-4028	10-4040	Red
10-4006	10-4018	4"	10-4030	10-4042	Blue
10-4008	10-4020	4"	10-4032	10-4044	Green
10-4010	10-4022	4"	10-4034	10-4046	Black
10-4048	10-4060	5"	10-4072	10-4084	Silver
10-4050	10-4062	5"	10-4074	10-4086	Yellow
10-4052	10-4064	5"	10-4076	10-4088	Red
10-4054	10-4066	5"	10-4078	10-4090	Blue
10-4056	10-4068	5"	10-4080	10-4092	Green
10-4058	10-4070	5"	10-4082	10-4094	Black
10-4096	10-4108	6"	10-4120	10-4132	Silver
10-4098	10-4110	6"	10-4122	10-4134	Yellow
10-4100	10-4112	6"	10-4124	10-4136	Red
10-4102	10-4114	6"	10-4126	10-4138	Blue
10-4104	10-4116	6"	10-4128	10-4140	Green
10-4106	10-4118	6"	10-4130	10-4142	Black
10-4144	10-4156	8"	10-4168	10-4180	Silver
10-4146	10-4158	8"	10-4170	10-4182	Yellow
10-4148	10-4160	8"	10-4172	10-4184	Red
10-4150	10-4162	8"	10-4174	10-4186	Blue
10-4152	10-4164	8"	10-4176	10-4188	Green
10-4154	10-4166	8"	10-4178	10-4190	Black
10-4192	10-4204	10"	10-4216	10-4228	Silver
10-4194	10-4206	10"	10-4218	10-4230	Yellow
10-4196	10-4208	10"	10-4220	10-4232	Red
10-4198	10-4210	10"	10-4222	10-4234	Blue
10-4200	10-4212	10"	10-4224	10-4236	Green
10-4202	10-4214	10"	10-4226	10-4238	Black



**ACCESSORIES**

PRODUCT NUMBER	MODEL	FEATURES
10-4284	Full Size Wire Basket	21¼" x 10" x 1"
10-4286	Full Size Wire Basket	21¼" x 10" x 2"
10-4288	Full Size Wire Basket	21¼" x 10" x 3"
10-4290	Full Size Wire Basket	21¼" x 10" x 4"
10-4985	Full Size Silicon Mat	20½" x 9"

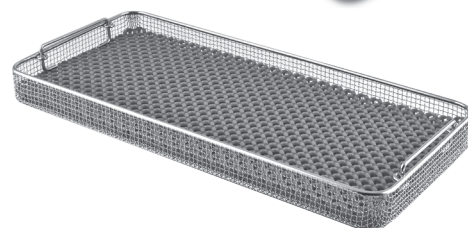

## INSTRUMENT CASSETTES

Organized Procedure Kits save time and improve safety! Sklar is pleased to introduce a new line of cassette trays to organize and protect instruments during handling and transportation. Removable, silicone instrument holders afford you the option of an open configuration in any cassette. Cassettes with detachable lids feature moveable instrument holders to customize instrument configuration. Choose from various cassette sizes and styles to fit your needs.

- High quality, heavy gauge stainless steel.
- Optimum slot position for effective cleaning and drainage.
- Easy open/closing latch system.
- Silicone Inserts for secure instrument placement.

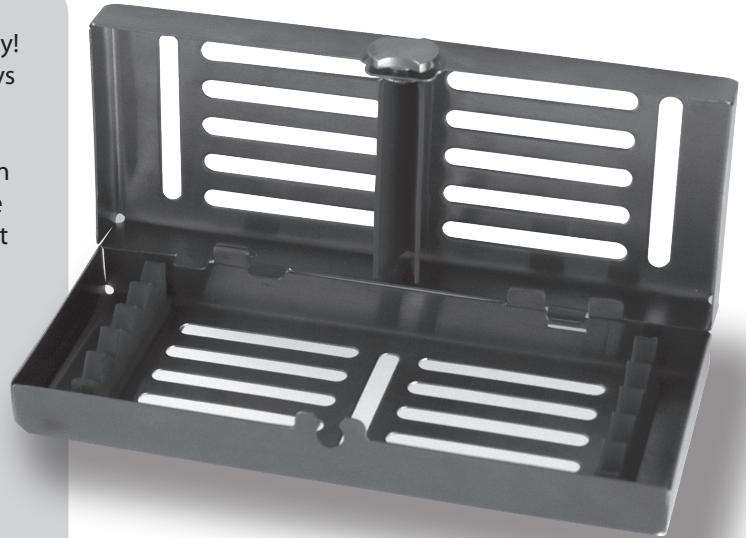

### SMALL CASSETTES

Typical Applications Include:

- Diagnostic Kit
- Root Planning Kit
- New Patient Kit
- Composite Kit

PRODUCT NUMBER	SIZE	CONFIGURATION	FEATURES
10-6500	7" x 2 <sup>3</sup> / <sub>4</sub> " x 1 <sup>1</sup> / <sub>3</sub> "	5 Instruments	Detachable Lid/Instrument Holders
10-6501	7" x 2 <sup>1</sup> / <sub>3</sub> " x <sup>9</sup> / <sub>7</sub> "	5 Instruments	Fixed Lid/Instrument Holders

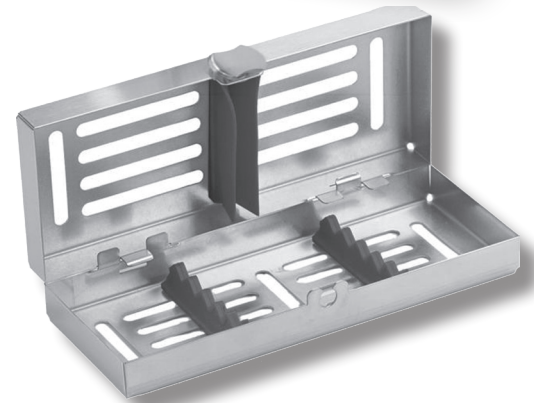

### MEDIUM CASSETTES

Typical Applications Include:

- Hygiene Kit
- Restoration Kit
- Cavity Prep Kit
- Endo Kit
- Crown & Bridge Kit

PRODUCT NUMBER	SIZE	CONFIGURATION	FEATURES
10-6505	7" x 4 <sup>1</sup> / <sub>3</sub> " x 1 <sup>1</sup> / <sub>3</sub> "	7 Instruments	Detachable Lid/Instrument Holders
10-6506	7" x 3 <sup>1</sup> / <sub>2</sub> " x <sup>6</sup> / <sub>7</sub> "	7 Instruments	Fixed Lid/Instrument Holders





# STEELWARE INSTRUMENT CASSETTES

## MEDIUM CASSETTES, CONTINUED

PRODUCT NUMBER	SIZE	CONFIGURATION	FEATURES
10-6510	7" x 5 <sup>3</sup> / <sub>4</sub> " x 1 <sup>1</sup> / <sub>3</sub> "	10 Instruments	Detachable Lid/Instrument Holders
10-6511	7" x 5" x <sup>6</sup> / <sub>7</sub> "	10 Instruments	Fixed Lid/Instrument Holders



## LARGE CASSETTES

Typical Applications Include:

- Periodontal Surgery
- Restoration Kit
- Extraction

PRODUCT NUMBER	SIZE	CONFIGURATION	FEATURES
10-6515	11 <sup>1</sup> / <sub>2</sub> " x 7" x 1 <sup>1</sup> / <sub>3</sub> "	20 Instruments	Detachable Lid/Instrument Holders
10-6516	11" x 7 <sup>1</sup> / <sub>4</sub> " x 1"	20 Instruments	Fixed Lid/Instrument Holders



## EXTRA LARGE CASSETTE

Available with specially designed silicone inserts to hold up to 12 extracting forceps. Or choose the open configuration recommended for large surgical instrument sets.

PRODUCT NUMBER	SIZE	CONFIGURATION	FEATURES
10-6520	15" x 8 <sup>1</sup> / <sub>4</sub> " x 1 <sup>1</sup> / <sub>2</sub> "	12 Forceps	Detachable Lid/Instrument Holders
10-6521	15" x 8 <sup>1</sup> / <sub>4</sub> " x 1 <sup>1</sup> / <sub>2</sub> "	Open	Detachable Lid

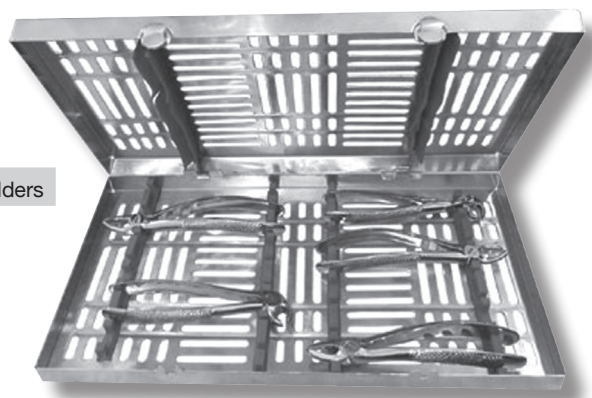

**INSTRUMENT HOLDERS**

**UNIVERSAL**

PRODUCT NUMBER	SIZE	CONFIGURATION	FEATURES
10-6531	5"	10 Instruments	3 pc Silicone Set, Blue
10-6536	10½"	20 Instruments	3 pc Silicone Set, Blue

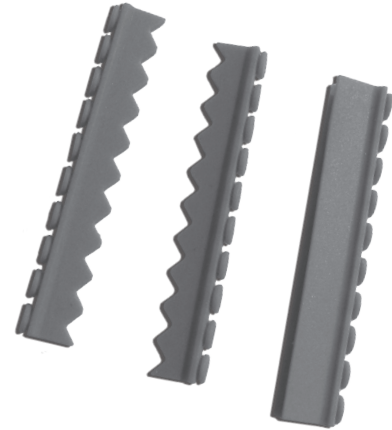

**CLIP IN CASSETTES**

PRODUCT NUMBER	SIZE	CONFIGURATION	FEATURES
10-6525	7" x 2⅓" x ⅞"	5 Instruments	Open top and bottom

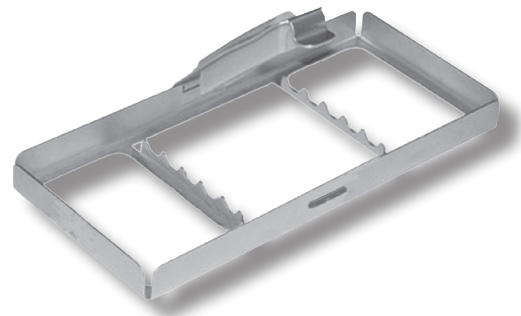

PRODUCT NUMBER	SIZE	CONFIGURATION	FEATURES
10-6526	7" x 3½" x 1"	10 Instruments	Open Top with Instrument Holders



Replacement instrument holders, in various colors are also available. Contact your Sklar Account Manager for more information.

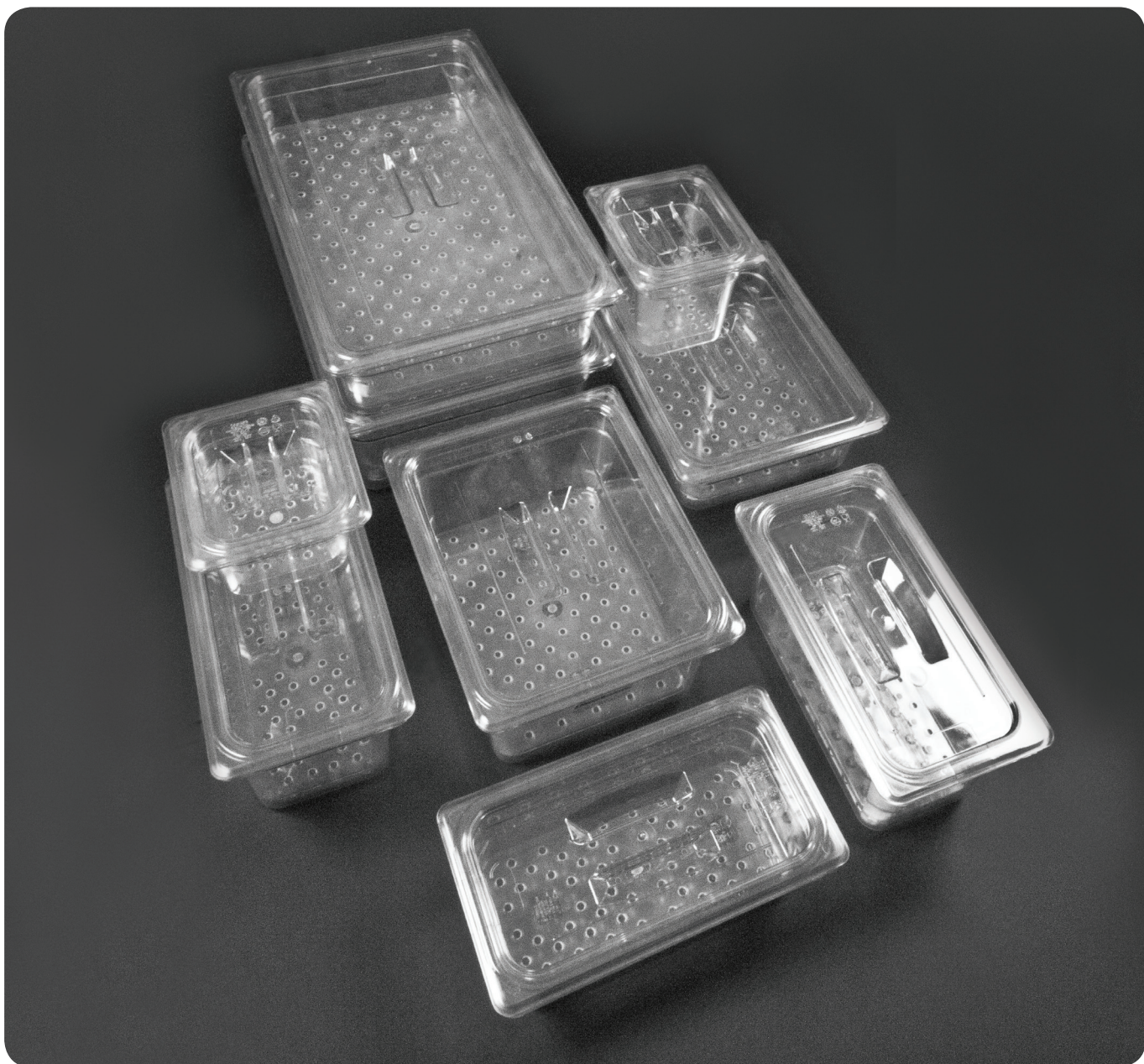

**INSTRUMENT SOAKING TRAYS**

Three piece set includes tray, strainer, and lid. Made of durable, clear plastic for the convenient storage, transportation and processing of your surgical instruments.

PRODUCT NUMBER	FEATURES	QUANTITIES	PRODUCT NUMBER	FEATURES	QUANTITIES
10-3050	6½" x 7" x 4" Deep	1 Each	10-3058	11" x 13" x 4" Deep	1 Each
10-3052	6½" x 7" x 6" Deep	1 Each	10-3060	11" x 13" x 6" Deep	1 Each
10-3054	7" x 13" x 4" Deep	1 Each	10-3062	12¾" x 21" x 4" Deep	1 Each
10-3056	7" x 13" x 6" Deep	1 Each	10-3064	12¾" x 21" x 6" Deep	1 Each



**PLASTIC TRAYS**

STERILE

PRODUCT NUMBER	FEATURES	QUANTITIES
96-7025	Small Shallow Prep	25/cs
96-7033	Half Shallow	25/cs
96-7024	Half Deep	25/cs
96-7175	Full Deep	25/cs
96-7177	2-Compartment	25/cs
96-7178	3-Compartment	25/cs

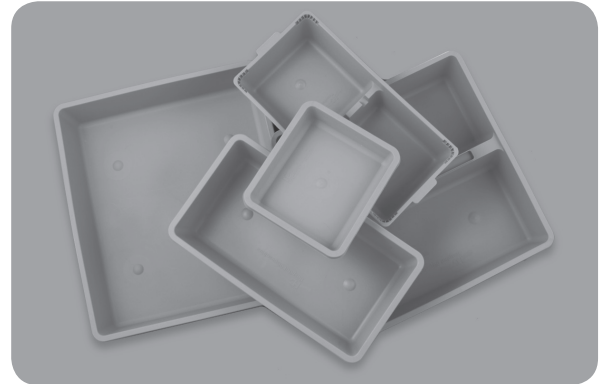

**PROCEDURE TRAYS\***

NON-STERILE

PRODUCT NUMBER	FEATURES	QUANTITIES
10-1960	Mini, Non-Perforated, Blue, 10 1/8" x 6 5/8"	1 Each
10-1965	Mini, Perforated, Blue, 10 1/8" x 6 5/8"	1, 6 or 12/cs
10-1961	Small, Non-Perforated, Blue, 10 7/16" x 13 9/16"	1 Each
10-1966	Small, Perforated, Blue, 10 7/16" x 13 9/16"	1, 6 or 12/cs
10-1962	Medium, Non-Perforated, Blue, 11 3/4" x 16"	1 Each
10-1967	Medium, Perforated, Blue, 11 3/4" x 16"	1, 6 or 12/cs

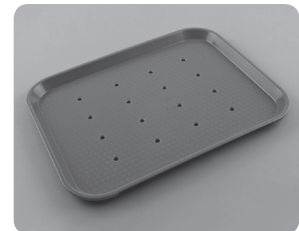
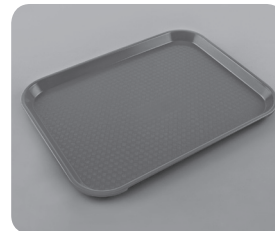
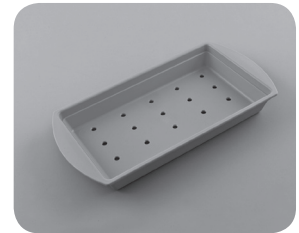
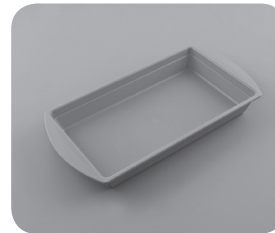

**SOAKING TRAYS WITH REMOVABLE BASKET**

NON-STERILE

PRODUCT NUMBER	FEATURES	QUANTITIES
10-2555	Small Instrument Tray, 8" x 3 1/2" x 2"	1 Each
10-2556	Large Instrument Tray, 10" x 5" x 2 1/2"	1 Each
10-2557 (not pictured)	Round Cup Size Tray, 3" x 3", 4 oz.	1 Each

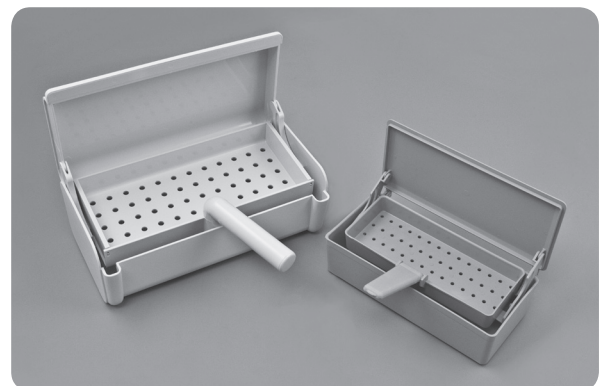

\*All products are packaged individually however; select products are available in bulk. To order larger quantities, simply add the package quantity to the end of the product number when ordering, ie. 10-1670-12 for 12/pk or 10-1670-48 for 48/pk.



## PLASTICWARE

### CUPS / BOWLS

#### MEDICINE CUPS

STERILE

PRODUCT NUMBER	FEATURES	QUANTITIES
96-7027	2 oz.	25/cs



#### PITCHERS\*

STERILE

PRODUCT NUMBER	FEATURES	QUANTITIES
96-7268	Open Handle, 1200 ml	5/cs

NON-STERILE

96-7270	Open Handle, 1200 ml	35/cs
---------	----------------------	-------



NON-STERILE

PRODUCT NUMBER	FEATURES	QUANTITIES
10-1546	Graduated Measure, 16 oz., Reusable	1 or 6/cs



#### SPECIMEN TUBES

STERILE

PRODUCT NUMBER	FEATURES	QUANTITIES
96-7459	3½" x 1½"	3/pk, 50pk/cs, 150/cs



#### PLASTIC BOWLS

STERILE

PRODUCT NUMBER	FEATURES	QUANTITIES
96-7028	8 oz.	25/cs
96-7020	16 oz.	10/cs
96-7174	32 oz.	20/cs
96-7451	48 oz.	5/cs



\*All products are packaged individually however; select products are available in bulk. To order larger quantities, simply add the package quantity to the end of the product number when ordering, ie. 10-1670-12 for 12/pk or 10-1670-48 for 48/pk.

# PLASTICWARE BOWLS



## EMESIS BASINS

NON-STERILE

PRODUCT NUMBER	FEATURES	QUANTITIES
96-7543	700 cc	25/cs



## OR BASINS

STERILE

PRODUCT NUMBER	FEATURES	QUANTITIES
96-1679	Round, 7 qt., Blue	5/cs

NON-STERILE

08-1011	Round, 5 qt., Pink	50/cs
---------	--------------------	-------

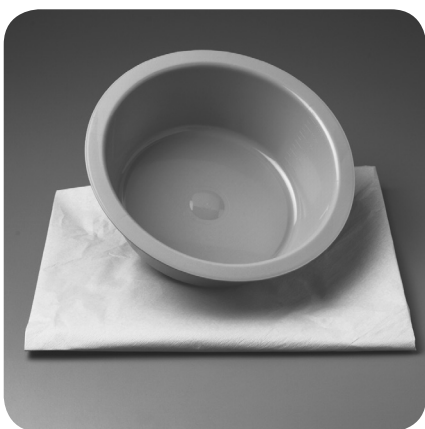

## GUIDEWIRE BOWLS

STERILE

PRODUCT NUMBER	FEATURES	QUANTITIES
96-1630	8 1/4" x 3"	10/cs

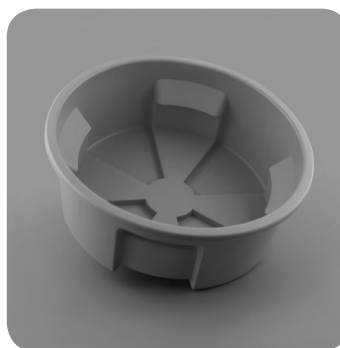

## UTILITY BOWLS\*

NON-STERILE

PRODUCT NUMBER	FEATURES	QUANTITIES
10-1502	Sponge/Utility Bowl, Aqua, 1 1/4 qt.	1 or 12/cs

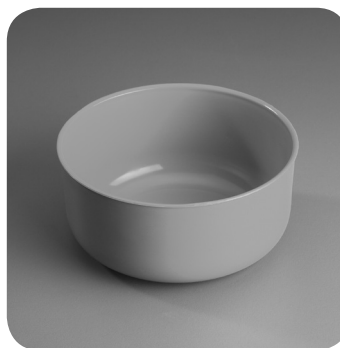

NON-STERILE

PRODUCT NUMBER	FEATURES	QUANTITIES
10-1504	Solution Bowl, Reusable, Lt Green, 7 qt.	1 or 12/cs



\*All products are packaged individually however; select products are available in bulk. To order larger quantities, simply add the package quantity to the end of the product number when ordering, ie. 10-1670-12 for 12/pk or 10-1670-48 for 48/pk.

# SKLARTIP™ INSTRUMENT PROTECTORS



Sklar Instrument Protectors provide a convenient, color-coded means of protecting surgical instrument tips and edges. Autoclavable, steam and gas permeable, and available in a wide variety of shapes and sizes, SklarTip™ Instrument Protectors provide exceptional protection during handling and sterilization. Latex Free.

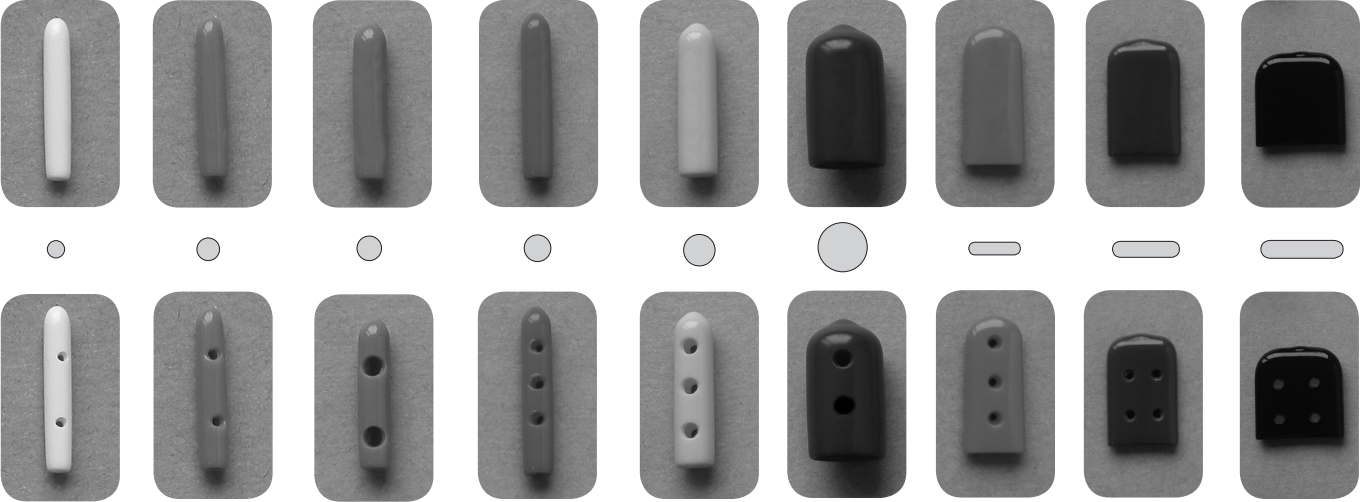

### INSTRUMENT PROTECTORS - NON-VENTED

PRODUCT NUMBER	FEATURES	QUANTITIES
96-1510	19 x 1.5mm, 3/4" x 1/16"	White 100/pk
96-1508	19 x 2.0mm, 3/4" x 5/64"	Blue 100/pk
96-1506	19 x 3.0mm, 3/4" x 1/8"	Green 100/pk
96-1504	25 x 3.0mm, 1" x 1/8"	Red 100/pk
96-1502	25 x 5.0mm, 1" x 3/16"	Yellow 100/pk
96-1500	19 x 1.0mm, 3/4" x 3/64"	Maroon 100/pk
96-1516	25 x 1.5mm, 1" x 3/8" x 1/16"	Orange 100/pk
96-1514	25 x 2.0mm, 1" x 5/8" x 5/64"	Brown 100/pk
96-1512	25 x 3.0mm, 1" x 1" x 1/8"	Black 100/pk
96-1518	Assorted	100/pk

### INSTRUMENT PROTECTORS - VENTED

PRODUCT NUMBER	FEATURES	QUANTITIES
96-1410	19 x 1.5mm, 3/4" x 1/16"	White 100/pk
96-1408	19 x 2.0mm, 3/4" x 5/64"	Blue 100/pk
96-1406	19 x 3.0mm, 3/4" x 1/8"	Green 100/pk
96-1404	25 x 3.0mm, 1" x 1/8"	Red 100/pk
96-1402	25 x 5.0mm, 1" x 3/16"	Yellow 100/pk
96-1400	19 x 1.0mm, 3/4" x 3/64"	Maroon 100/pk
96-1416	25 x 1.5mm, 1" x 3/8" x 1/16"	Orange 100/pk
96-1414	25 x 2.0mm, 1" x 5/8" x 5/64"	Brown 100/pk
96-1412	25 x 3.0mm, 1" x 1" x 1/8"	Black 100/pk
96-1418	Assorted	100/pk

### OSTEOTOME GUARDS - VENTED

PRODUCT NUMBER	FEATURES	QUANTITIES
96-1440	3/4" x 1/4"	50/pk
96-1442	1" x 3/8"	50/pk
96-1444	1" x 1/2"	50/pk
96-1446	1 1/2" x 1 1/2"	50/pk

### TIP GRIPS

PRODUCT NUMBER	FEATURES	QUANTITIES
96-1550	.062" Yellow	3pr/pk, 5pks
96-1552	.062" Yellow	5pr/pk, 5pks

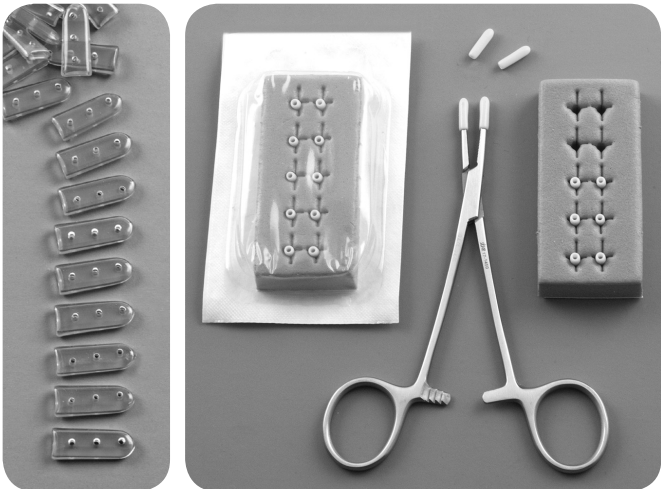

Instrument recognition is key to efficient processing in a busy clinical setting. Sklar Instrument ID products offer a convenient color coded system for identifying instruments. Offered in various combinations including tape sheets, tape rolls and tags, products last through many autoclaving and gas sterilization processes. Latex Free.

**ID SHEET TAPE**

PRODUCT NUMBER	FEATURES	QUANTITIES
96-1845	Blue with White Stripes	1 Each
96-1846	Green with White Stripes	1 Each
96-1847	Red with White Stripes	1 Each
96-1848	Yellow with White Stripes	1 Each
96-1849	Orange with White Stripes	1 Each
96-1850	Brown with White Stripes	1 Each
96-1851	Lavender with White Stripes	1 Each
96-1852	Light Blue with White Stripes	1 Each
96-1853	Pink with White Stripes	1 Each

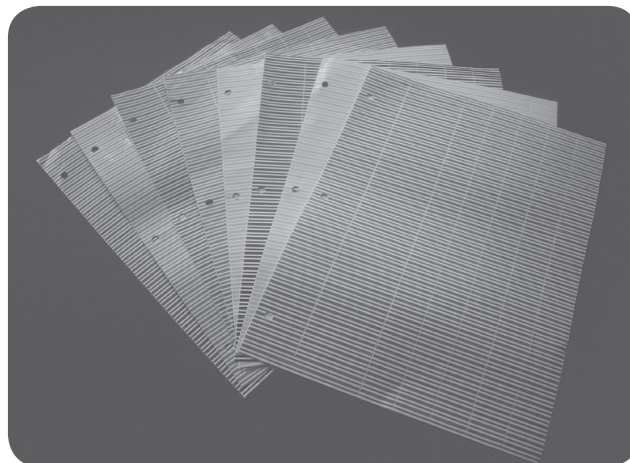

**ID ROLL TAPE**

PRODUCT NUMBER	FEATURES	QUANTITIES
96-1860	White 300" x 1/4"	1 Each
96-1862	Green 300" x 1/4"	1 Each
96-1864	Yellow 300" x 1/4"	1 Each
96-1866	Orange 300" x 1/4"	1 Each
96-1868	Black 300" x 1/4"	1 Each
96-1870	Purple 300" x 1/4"	1 Each
96-1872	Blue 300" x 1/4"	1 Each
96-1874	Red 300" x 1/4"	1 Each
96-1876	Brown 300" x 1/4"	1 Each

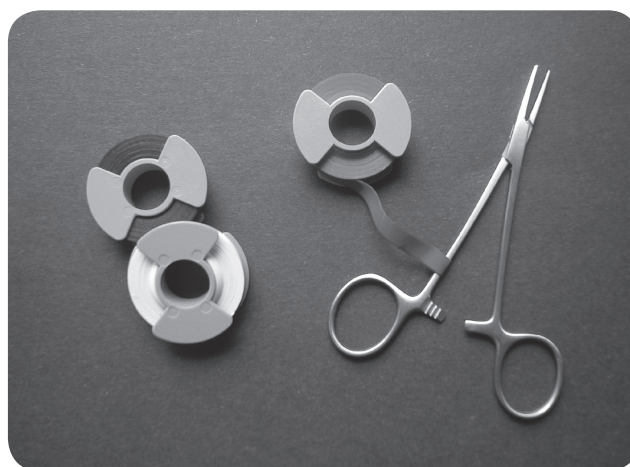

**INSTRUMENT ID TAGS**

PRODUCT NUMBER	FEATURES	QUANTITIES
96-1900	ID Repair Tags, Red	100/pk
96-1901	ID Repair Tags, Red	1000/pk
96-1903	Sklar Tags, White	100/pk
96-1905	ID Tags for Sharpen, Blue	100/pk
96-1906	ID Tags for Sharpen, Blue	1000/pk

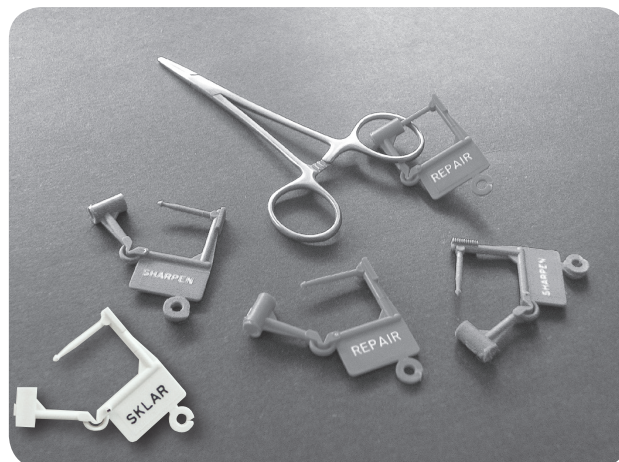

**CANNULA CLEANING BRUSHES**

PRODUCT NUMBER	FEATURES	QUANTITIES
10-1350	12" 2mm Diameter	3/pk
10-1660	12" 3mm Diameter	3/pk
10-1661	12" 3mm Diameter	12/pk
10-1663	12" 3mm Diameter	24/pk
10-1352	12" 4mm Diameter	3/pk
10-1354	12" 5mm Diameter	3/pk
10-1356	12" 6mm Diameter	3/pk
10-1664	15" 9mm Diameter	3/pk
10-1665	15" 9mm Diameter	12/pk
10-1666	15" 9mm Diameter	24/pk
10-1668	15" 25mm Diameter	3/pk
10-1669	15" 25mm Diameter	12/pk
10-1672	15" 25mm Diameter	24/pk
10-1362	18" 5mm Diameter	3/pk
10-1364	18" 10mm Diameter	3/pk
10-1366	18" 15mm Diameter	3/pk
10-1368	18" 20mm Diameter	3/pk
10-1369	18" 25mm Diameter	3/pk
78-2824	19" 8mm Diameter	3/pk
10-1370	24" 2.5mm Diameter	3/pk
10-1372	24" 5mm Diameter	3/pk
10-1374	24" 7mm Diameter	3/pk
10-1376	24" 10mm Diameter	3/pk

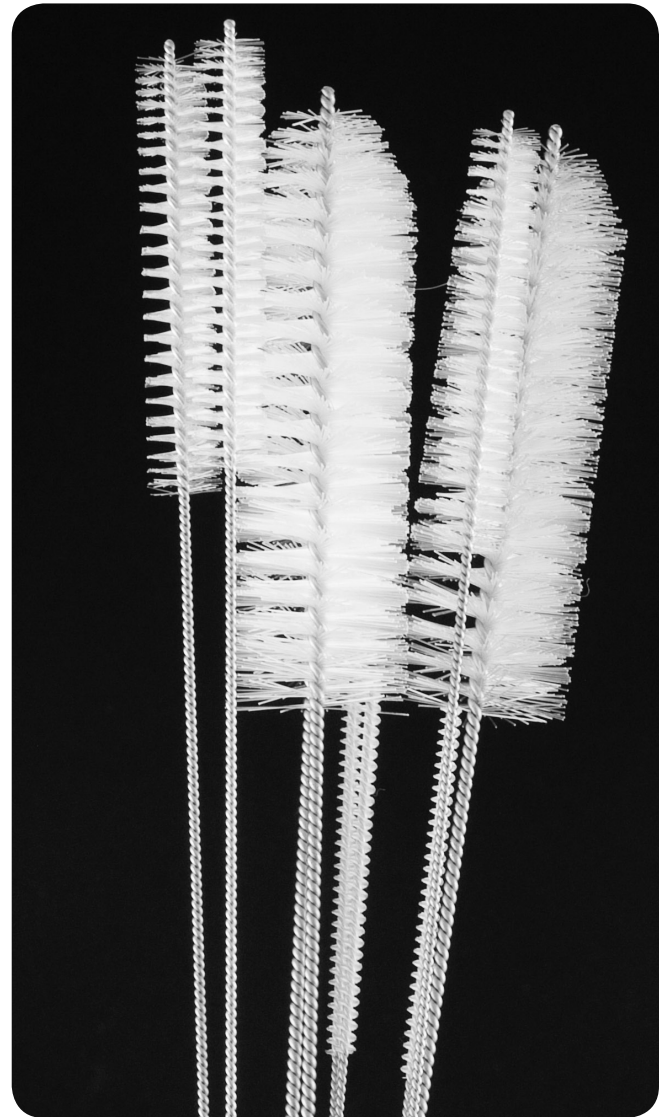

**TRACHEAL TUBE BRUSHES**

PRODUCT NUMBER	FEATURES	QUANTITIES
78-2821	Small, 6" x 1/2" Diameter	6/pk
78-2825	Small, 6" x 1/2" Diameter	12/pk
78-2822	Medium, 7" x 5/8" Diameter	6/pk



**DOUBLE TAPERED BRUSHES**

PRODUCT NUMBER	FEATURES	QUANTITIES
10-1384	6"	3/pk
10-1388	8"	3/pk
10-1389	18"	3/pk

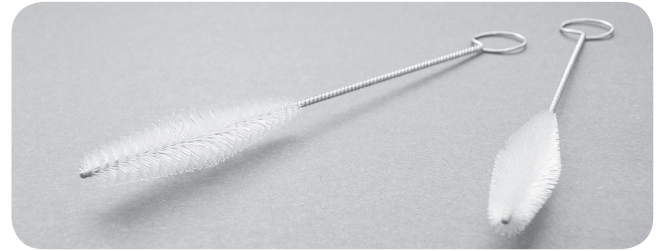

**STAINLESS STEEL BRISTLE BRUSHES**

PRODUCT NUMBER	FEATURES	QUANTITIES
10-1650	7¼"	3/pk
10-1652	7¼"	12/pk
10-1658	7¼"	24/pk
10-1655	7¼"	48/pk



**NYLON BRISTLE BRUSHES**

PRODUCT NUMBER	FEATURES	QUANTITIES
10-1651	7¼"	3/pk
10-1657	7¼"	12/pk
10-1659	7¼"	24/pk
10-1656	7¼"	48/pk



**DOUBLE ENDED BRUSHES**  
**NYLON BRISTLES**

PRODUCT NUMBER	FEATURES	QUANTITIES
10-1444	7", Small / Large Ends	3/pk
10-1446	7", Small / Large Ends	50/pk



**DISPOSABLE BRUSHES**  
**NYLON BRISTLES**

PRODUCT NUMBER	FEATURES	QUANTITIES
10-1465	6"	12/pk
10-1468	6"	24/pk





**SUCTION TUBE CLEANING BRUSHES  
(BARON & FRAZIER)**

PRODUCT NUMBER	FEATURES		QUANTITIES
10-1394	6"	1mm	3/pk
10-1396	6"	1.6mm	3/pk
10-1400	8"	2mm	3/pk
10-1401	8"	2.3mm	3/pk
10-1402	8"	2.6mm	3/pk
10-1403	8"	3mm	3/pk
10-1404	8"	3.3mm	3/pk
10-1405	8"	3.6mm	3/pk
10-1406	8"	4mm	3/pk

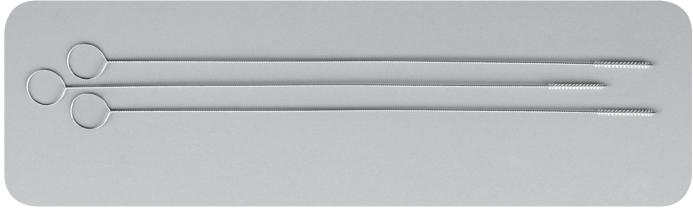

**SURGICAL SCRUB BRUSHES**

PRODUCT NUMBER	FEATURES	QUANTITIES
06-2880	With Channel Back	1 Each
06-2870	With Channel Back	12/pk
06-2882	With Nail Scrubber	1 Each
06-2873	With Nail Scrubber	12/pk
06-2881	Standard	1 Each
06-2872	Standard	12/pk

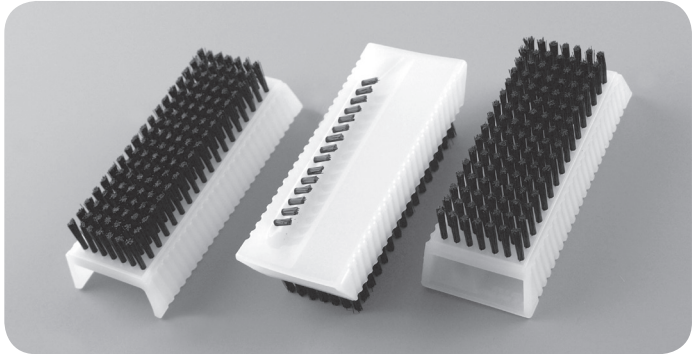

**CANNULA INSTRUMENT CLEANERS**

PRODUCT NUMBER	FEATURES	QUANTITIES
10-1470	12" Length 1/8" Diameter	3/pk
10-1472	12" Length 1/4" Diameter	3/pk

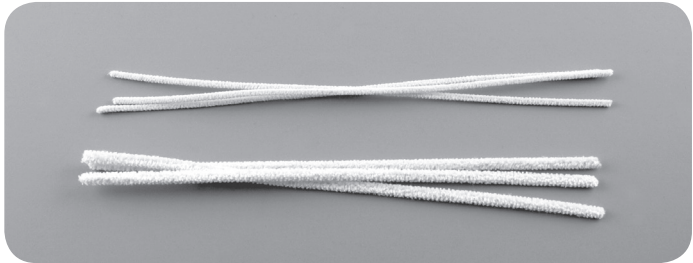

**DOUBLE END VALVE BRUSHES**

PRODUCT NUMBER	FEATURES	QUANTITIES
10-1398	5 3/4" Length 9mm and 5mm Diameter Nylon Tips	3/pk





**SURFACE CLEANING BRUSH**

FOR USE ON SINKS, AUTOCLAVES, ULTRASONIC CLEANERS,  
BOWLS, BASINS, ETC.

PRODUCT NUMBER	FEATURES	QUANTITIES
10-1418	3¼" L x 3" W Brush Head 4½" Plastic handle 2" White medical grade Nylon bristles	3/pk

**LARGE INSTRUMENT CLEANING BRUSH**

FOR USE ON RETRACTORS, SPECULA, ETC.

PRODUCT NUMBER	FEATURES	QUANTITIES
10-1420	7" L x 1¼" W Brush Head 7½" Plastic Handle Overall Length 14½" 1" White medical grade Nylon bristles	3/pk

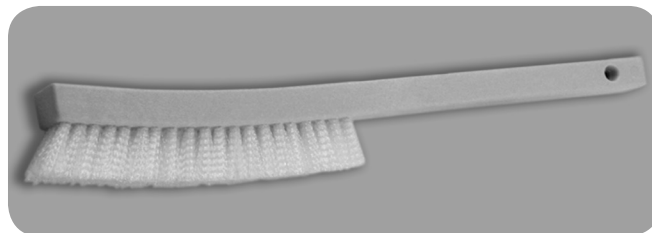
**AUTOCLAVE CLEANING BRUSH**

FOR USE ON AUTOCLAVE CHAMBERS AND DOORS, SINKS,  
CARTS, ETC.

PRODUCT NUMBER	FEATURES	QUANTITIES
10-1422	3¼" L x 3" W Brush Head 16" Plastic handle 2" White medical grade Nylon bristles	3/pk

**INSTRUMENT SPOT REMOVER PAD**

FOR USE ON O.R. GRADE SATIN FINISH INSTRUMENTS

PRODUCT NUMBER	FEATURES	QUANTITIES
10-1414	6" x 9"	1 Each
10-1415	6" x 9"	10/pk

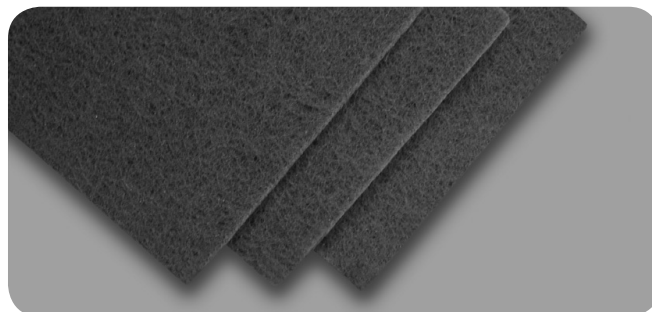
**BRUSH DRYING RACK & BRUSH HOLDER**

PRODUCT NUMBER	FEATURES	QUANTITIES
10-1399	Brush Rack	1 Each
10-1545	Brush Holder	1 Each

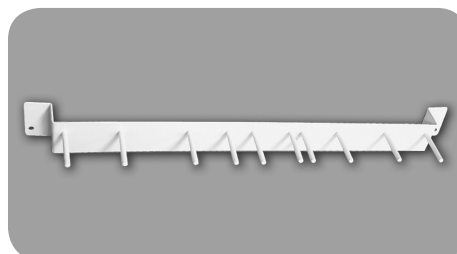



## BRUSHES

## SETS

### 10-1426—INSTRUMENT CLEANING BRUSH SET

PRODUCT NUMBER	DESCRIPTION	QUANTITIES
10-1660	Cannula Cleaning Brush 12" 3mm, 3/pk	1 pk
10-1362	Cannula Cleaning Brush 18" 5mm, 3/pk	1 pk
10-1374	Cannula Cleaning Brush 24" 7mm, 3/pk	1 pk
10-1376	Cannula Cleaning Brush 24" 10mm, 3/pk	1 pk
10-1396	Suction Tube Brush 6" 1.6mm, 3/pk	1 pk
10-1400	Suction Tube Brush 8" 2mm, 3/pk	1 pk
10-1402	Suction Tube Brush 8" 2.6mm, 3/pk	1 pk
10-1404	Suction Tube Brush 8" 3.3mm, 3/pk	1 pk
10-1406	Suction Tube Brush 8" 4mm, 3/pk	1 pk
10-1418	Surface Cleaning Brush, 3/pk	1 pk
10-1444	Double End Brush Nylon, 3/pk	2 pks
10-1650	Brush Stainless Steel Bristle, 3/pk	1 pk
10-1651	Brush Nylon Bristle, 3/pk	2 pks



### 10-1428—ENDOSCOPIC BRUSH SET

PRODUCT NUMBER	DESCRIPTION	QUANTITIES
10-1350	Cannula Cleaning Brush 12" 2mm, 3/pk	1 pk
10-1660	Cannula Cleaning Brush 12" 3mm, 3/pk	1 pk
10-1354	Cannula Cleaning Brush 12" 5mm, 3/pk	1 pk
10-1362	Cannula Cleaning Brush 18" 5mm, 3/pk	1 pk
10-1364	Cannula Cleaning Brush 18" 10mm, 3/pk	1 pk
10-1370	Cannula Cleaning Brush 24" 2.5mm, 3/pk	1 pk
10-1372	Cannula Cleaning Brush 24" 5mm, 3/pk	1 pk
10-1376	Cannula Cleaning Brush 24" 10mm, 3/pk	1 pk
10-1398	Double End Valve Brush Nylon, 3/pk	2 pks
10-1444	Double End Brush Nylon, 3/pk	2 pks



**10-1424—AUTOCLAVE CLEANING BRUSH SET**

PRODUCT NUMBER	DESCRIPTION	QUANTITIES
10-1424HDL	Telescopic Handle extends from 24" to 48"	1 Each
10-1424PBR	Large Cleaning Brush 7½" L x 5½" W with round corner bristles	1 Each
10-1424BHD	Surface Cleaning Brush, 4½" handle	1 Each

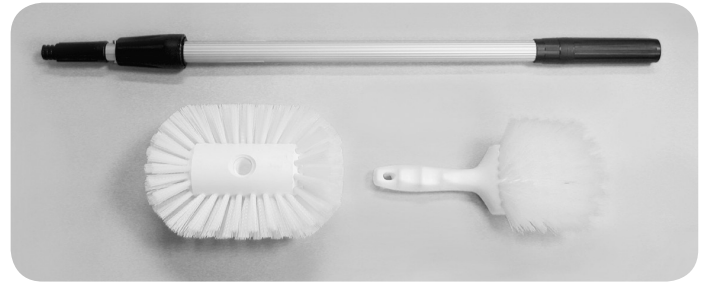

**10-1432—MICRO BRUSH SET**

PRODUCT NUMBER	DESCRIPTION	QUANTITIES
10-1350	Cannula Cleaning Brush 12" 2mm, 3/pk	1 pk
10-1660	Cannula Cleaning Brush 12" 3mm, 3/pk	1 pk
10-1396	Suction Tube Brush 6" 1.6mm, 3/pk	1 pk
10-1400	Suction Tube Brush 8" 2mm, 3/pk	1 pk
10-1402	Suction Tube Brush 8" 2.6mm, 3/pk	1 pk
10-1404	Suction Tube Brush 8" 3.3mm, 3/pk	1 pk
10-1406	Suction Tube Brush 8" 4mm, 3/pk	1 pk
10-1444	Double End Brush Nylon, 3/pk	1 pk

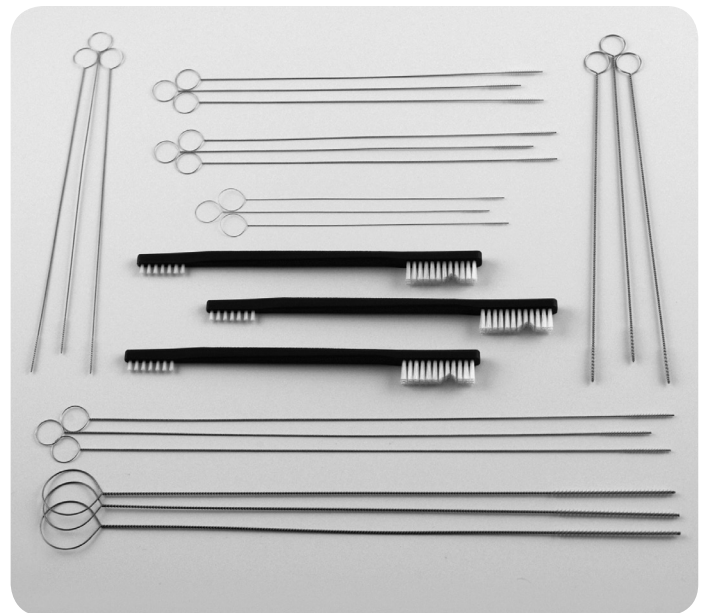

**10-1434—ALL PURPOSE BRUSH SET**

PRODUCT NUMBER	DESCRIPTION	QUANTITIES
10-1650	Brush Stainless Steel Bristle 3/pk	1 pk
10-1651	Brush Nylon Bristle 3/pk	1 pk
10-1420	Large Instrument Cleaning Brush 3/pk	1 pk
10-1418	Surface Cleaning Brush 3/pk	1 pk



## CARE AND CLEANING



Sklar is pleased to offer a full line of Care & Cleaning agents to disinfect, decontaminate, sterilize, lubricate and protect your stainless steel surgical instruments and equipment. For expert care of your surgical instruments at every stage of the cleaning process, trust Sklar to deliver the right cleaning agent for you.



### 3 EASY STEPS FOR THE CARE AND CLEANING OF YOUR INSTRUMENTS

#### 1 DECONTAMINATION

Sklar Disinfectants are a pre-cleaner and disinfectant for the safe decontamination of soiled surgical instruments, medical and surgical equipment and inanimate surfaces including plastics, stainless steel, chrome, glass, Plexiglas and baked on painted surfaces. Disinfectants are effective against a broad range of pathogens in as little as 2 minutes.



#### 2 CLEANING

Sklar carries a complete line of effective detergents and enzymatics for cleaning, not only for your surgical instruments, but also metals, glassware, plastic and rubber. Available in your choice of powder, liquid concentrate or spray foams.



#### 3 LUBRICATION

To guarantee extended life and performance of your surgical instruments, choose one of Sklar's lubricants or sprays as the final step in your instrument processing regimen. Specifically designed to protect against corrosion, rust and staining, Sklar offers several different types of lubricants to protect your investments.



# SKLAR-CIDE™

## HIGH LEVEL DISINFECTING/STERILIZING SOLUTION

**Sporicidal • Bactericidal • Virucidal • Fungicidal**

SKLAR-CIDE provides a safe and efficient means for the high-level disinfection or sterilization of medical, ophthalmic, dental and surgical devices including endoscopes and lensed instruments. It may be used as a standard soak solution or in automatic reprocessing units set at room temperature. Unlike other solutions, there is no need to increase the solution temperature to provide high-level disinfection in 25 minutes.

SKLAR-CIDE is a surfactant-free, activated glutaraldehyde liquid chemical sterilant and high-level disinfectant. Its active ingredient is glutaraldehyde in a nominal concentration of 3%. When the powdered activator is added, the solution turns green in color to indicate its readiness for use. In addition to the active ingredient, this ready-to-use solution contains buffers, wetting agents, and a rust and corrosion inhibitor and it has a pleasant fragrance.

SKLAR-CIDE produces high-level disinfection at room temperature in as little time as 25 minutes, and complete sterilization in 10 hours at room temperature.

- Reusable for 28 days instead of 14, safer and saves time and money.
- Surfactant free - Will not damage scope surfaces or cloud lenses.
- Can be used safely on all devices, including instruments and endoscopes. No need to stock several products.



PRODUCT NUMBER	FEATURES	QUANTITIES
10-1623	28 HLD 1 Gallon Bottles	4/case
10-1624	28 HLD 1 Gallon Bottle	1 bottle

### GLUTARALDEHYDE STRIPS

PRODUCT NUMBER	FEATURES	QUANTITIES
96-4106	.5 - 2.5% MEC 100 Strips / Bottle	1 bottle





# SKLAR DISINFECTANT™ 2 MINUTE KILL TIME

## READY-TO-USE SPRAY SURFACE DISINFECTANT

- Ready to use, non-toxic formula.
- Specially formulated for the control of cross contamination.
- Effective against a broad range of pathogens including H1N1, HIV-1, HSV, VRE, Rotaviruses, Hep B & C as well as TB, MRSA and A. Baumannii.
- Safe for all areas of the facility including the NICU, operating rooms, isolation rooms, patient care areas and laboratories.
- Satisfies OSHA's Bloodborne Pathogen Standards.
- Non-irritating formula.
- EPA registered.

PRODUCT NUMBER	FEATURES	QUANTITIES
10-1643	24 oz. Spray Bottles	6/case
10-1642	24 oz. Spray Bottle	1 bottle
10-1653	1 Gallon Bottles	4/case
10-1654	1 Gallon Bottle	1 bottle
10-1644	2.5 Gallon Bottles	2/case



# SKLAR DISINFECTANT™ SURFACE WIPES

READY-TO-USE, PRE-MOISTENED TOWELETTES

**SAME EFFECTIVE FORMULA AS  
SKLAR DISINFECTANT!**

- Ready to use, non-toxic formula.
- Specially formulated for the control of cross contamination.
- Effective against a broad range of pathogens including H1N1, HIV-1, HSV, VRE, Rotaviruses, Hep B & C as well as TB, MRSA and A. Baumannii.
- Safe for all areas of the facility.
- Satisfies OSHA's Bloodborne Pathogen Standards.
- Destroys odor-causing bacteria.
- 7" x 10" non-woven, tear resistant towelette.
- Clean scent.
- EPA registered.

PRODUCT NUMBER	FEATURES	QUANTITIES
10-1616	100 Towelettes / Canister	6/case
10-1617	100 Towelettes / Canister	12/case





# SKLAR SPRAY-ZYME™

## SURGICAL INSTRUMENT PRE-CLEANER

### Multi-Enzyme Based Instrument Presoak & Cleaner Foam Spray Cleaner

The newest product from Sklar for expert care of your surgical instruments. This multi-enzymatic spray creates a heavy foam which lasts for hours, keeping soiled instruments moist to avoid encrustation while also pre-cleaning prior to processing.

- Prevents Organic Encrustation - enzyme foam stops blood and bodily fluids from drying onto surgical instruments.
- No More Spills - messy spills between the operating room and central cleaning / processing department are eliminated.
- Neutral pH - safe and effective for stainless steel, tungsten carbide, aluminum and brass instruments.
- Bacteriostatic - microbiological control agents inhibit bacterial growth in the ready-to-use foam solution.
- Long Lasting Foam - saves time, foam lasts many hours after application.
- Multi-Enzymatic - contains a synergistic blend of lipase and protease enzymes.

PRODUCT NUMBER	FEATURES	QUANTITIES
10-2722	22 oz. Refillable Spray Bottles	12/case
10-2724	1 Gallon Bottles	4/case





# SKLAR SOAK™

## INSTRUMENT PRE-SOAK & DECONTAMINANT

### RUST RESISTANT!

Immersing soiled instruments in SKLAR SOAK™ effectively pre-cleans and decontaminates, without fear of rusting!

SKLAR SOAK is an effective pre-cleaner that breaks down bio-burden, lifting blood and other organic debris from the surface, while penetrating box locks and crevices. The rust inhibitor protects the delicate chromium oxide layer of the instrument, thus defending against rust and corrosion. Using SKLAR SOAK™ as a pre-cleaner is the first line of defense against rust, prolonging the life of the instrument and therefore protecting your investment!

Soaking for only two minutes thoroughly decontaminates instruments, reducing the risk of exposure to pathogens such as H1N1, HIV-1, HSV, VRE, Rotaviruses, Hep B & C as well as TB, MRSA and A. Baumannii. However, because SKLAR SOAK™ contains a rust inhibitor, instruments may soak for several hours without fear of rusting! Employees are protected from cross contamination, and at the same time can enjoy the freedom to reprocess instruments when it's convenient!

SKLAR SOAK™ is ideal for use on all stainless steel instruments:

- PH balanced, designed specifically for stainless steel instruments.
- Intermediate level disinfectant with broad spectrum of efficacy.
- Rust resistant.
- Non-caustic.
- Ready to use.
- No special handling or disposal.
- Fragrant, no offensive odors.
- Non-glutaraldehyde.

PRODUCT NUMBER	FEATURES	QUANTITIES
10-1603	1 Gallon Bottles	4/case
10-1609	1 Gallon Bottle	1 bottle





# SKLAR INSTRU-GUARD™ ONE STEP

**A “ONE STEP” INSTRUMENT  
CLEANER AND LUBRICANT**

**EXTENDS INSTRUMENT LIFE!**

SKLAR INSTRU-GUARD ONE STEP contains a penetrating lubricant that protects and helps extend the life of surgical instruments. The detergents and emulsifiers quickly break up and remove organic soils from box locks and other hard to reach places.

SKLAR INSTRU-GUARD ONE STEP contains four rust inhibitors to control corrosion and eliminate scaling and spotting. It does not contain phosphates and can reduce the time and cost involved in processing your instruments by cleaning and lubricating in one easy step.

PRODUCT NUMBER	FEATURES	QUANTITIES
10-2800	1 Gallon Bottles	4/case
10-2801	1 Gallon Bottle	1 bottle



# SKLAR INSTRU-GUARD™ LUBE

## SURGICAL INSTRUMENT LUBRICANT / RUST INHIBITOR

- Increase the Life of Instruments.
- Protects all Surgical Instruments.

SKLAR INSTRU-GUARD LUBE is an easy-to-use, water soluble, lubricant and rust inhibitor. When used daily as a rinse after every cleaning it keeps moving parts operating smoothly and remains effective after autoclaving, but without leaving an oily residue.

Regular lubrication is essential no matter which cleaning method is employed (including ultrasonic). SKLAR INSTRU-GUARD LUBE is ideal for maintaining instrument quality and performance.

PRODUCT NUMBER	FEATURES	QUANTITIES
10-1635	1 Gallon Containers Concentrated	4/case
10-1634	1 Gallon Container Concentrated	1 container
10-1636	8 oz. Spray Bottles	12/case
10-1637	8 oz. Spray Bottle	1 bottle





# SKLAR KLEEN™

## LOW FOAM, LIQUID DETERGENT AND POWDERED FORMULA

### Regular Formula for Manual and Ultrasonic Cleaning

SKLAR KLEEN is non-corrosive, non aggressive, phosphate free and biodegradable. We have specifically developed SKLAR KLEEN for manual and ultrasonic cleaning. It is moderately alkaline, affording optimum cleaning without etching glassware or attacking instrument metal.

### Low Foam Formula for Automatic Cleaning

The SKLAR KLEEN Low Foam Liquid is concentrated in order to provide a very cost-effective solution. It is especially formulated to maintain low foam, ensuring effective and trouble-free action in washer/sterilizers and tunnel washers. Dispersing quickly, the SKLAR KLEEN Low Foam formula is also well suited for automatic injection systems.

PRODUCT NUMBER	FEATURES	QUANTITIES
10-2701	Low Foam 1 Gallon Bottles	4/case
10-1608	Powdered 5 lb. Containers	4/case
10-1607	Powdered 5 lb. Container	1 container
10-1630	Powdered 3.5 lb. Pitchers	6/case
10-2765	Powdered 3.5 lb. Pitcher	1 pitcher
10-1612	Liquid 8 oz. Bottles	6/case
10-1614	Liquid 8 oz. Bottle	1 bottle
10-1613	Liquid 1 Gallon Bottles	4/case
10-1627	Liquid 1 Gallon Bottle	1 bottle



# SKLAR-SHEEN™

## AUTOCLAVE AND INSTRUMENT CLEANER AND CONDITIONER

With an efficacious phosphoric acid cleaning agent, Sklar Sheen is a robust spot, stain and rust remover. Ideal for dissolving hard water deposits, use in autoclaves to quickly cut through steam sterilizer scale and deposits.

Versatile and effective, SKLAR SHEEN couples powerful stain and rust removers with corrosion inhibitors, making it tough on stains but gentle on instruments. Recondition instruments to restore them to nearly brand new working condition.

Use to clean and recondition any stainless steel surface to its original luster, including carts, trays and basins.

- Conditions for lasting protection.
- Dissolves hard water deposits.
- Frees up frozen box locks.
- Restores and extends surgical instrument life.

PRODUCT NUMBER	FEATURES	QUANTITIES
10-2738	Spray Foam Autoclave Cleaner & Conditioner	12/case
10-2736	Spray Foam Autoclave Cleaner & Conditioner	22oz. bottle





# SKLAR ENZYMATIC™ DETERGENT

## MULTI-ENZYME DETERGENT CONCENTRATE

### 100% Biodegradable

SKLAR ENZYMATIC Detergent is a low-foaming, fast acting detergent specifically designed for use when instruments and/or cloth materials become soiled with organic debris.

SKLAR ENZYMATIC Detergent may be used as a manual instrument cleaner as well as a pre-soak for blood-contaminated linens, clothing and instruments. It is also used in ultrasonic units and in washer/sterilizer/decontaminators. When used as directed, the enzymatic pH neutral formula is safe for use on rubber, plastic, stainless steel instruments, and surgical equipment as well as cloth.

PRODUCT NUMBER	FEATURES	QUANTITIES
10-2777	1 Gallon Bottles	4/case
10-2775	1 Gallon Bottles	2/case
10-2776	1 Gallon Bottle	1 bottle





3 EASY STEPS FOR THE CARE AND CLEANING OF YOUR INSTRUMENTS

**DECONTAMINATION**

**1 SKLAR SPRAY DISINFECTANT™  
Disinfectant / Decontaminant Cleaner**

SKLAR DISINFECTANT is a pre-cleaner and disinfectant for the safe decontamination of soiled surgical instruments, medical and surgical equipment, and inanimate surfaces including plastics, stainless steel, chrome, glass, Plexiglas and baked on painted surfaces. The use of SKLAR DISINFECTANT for 2 minutes kills infectious organisms including H1N1, HIV-1, HPV, VRE, Norovirus, Hep B & C, as well as TB, MRSA, and A-Baumannii.

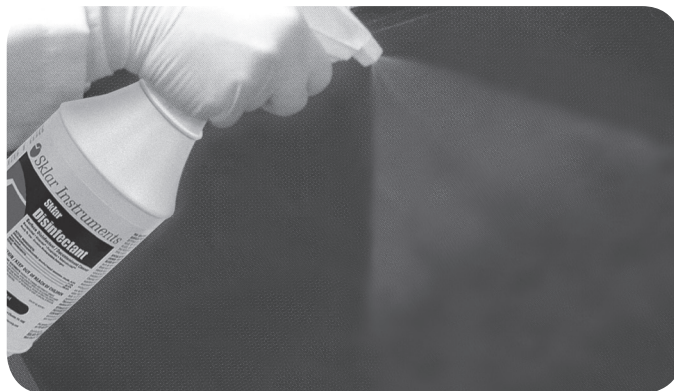

**CLEANING**

**2 SKLAR KLEEN™ DETERGENTS  
AND ENZYMATICS**

Sklar has an array of agents for effectively cleaning not only your surgical instruments, but also other metals, glassware, plastic, and rubber. SKLAR KLEEN detergent is available as a powder or liquid. Our enzymatic products, specially formulated for processing instruments heavily laden with organic debris, are concentrated and available in a variety of sizes. Sklar also offers SPRAY-ZYME™ a new foam spray pre-cleaner.



Choose The Cleaning Product Right For You!

**LUBRICATION**

**3 SKLAR LUBRICANT  
AND SPRAY LUBE™**

SKLAR LUBE should be a part of your instrument processing regimen to guarantee extending the life and performance of this very important investment. Sklar offers several different types of lubricant to suit your needs. All designed specifically for surgical instruments, they each contain rust inhibitors to protect against corrosion, rusting, and staining.



**YOUR FINAL STEP IS AUTOCLAVE STERILIZATION** Your Instruments Will Look And Work Like New!



# SKLAR FRESH™

## LIQUID SPRAY ODOR ABSORBER

SKLAR FRESH is an environmentally friendly blend of pure biodegradable organic essential oils and trace elements. It is a non-allergenic liquid spray that neutralizes odors at their source. Simply spray SKLAR FRESH directly in the air or on the source (i.e. bathrooms, refuse, soiled items from vomitus, incontinence odors, etc.)

PRODUCT NUMBER	FEATURES	QUANTITIES
10-2842	22 oz. Spray Bottles	12/case

# SKLAR POLISH™

## INSTRUMENT STAIN REMOVER

### Non-Abrasive

SKLAR POLISH is an effective stain remover for use on all your metal surgical instruments, including stainless steel, chrome and brass. It will brighten instrument trays, basins and racks and may also be used on porcelain and tile surfaces.



PRODUCT NUMBER	FEATURES	QUANTITIES
10-1626	8 oz. Jars	12/case
10-1629	8 oz. Jars	6/case
10-1927	8 oz. Jar	1 jar





# SKLAR INSTRUMENT CARE KIT

A Trio of Sklar's Care and Cleaning products to keep instruments in tiptop shape.

PRODUCT NUMBER	FEATURES	QUANTITIES
10-1625		
	Sklar Lube™ 8 oz. Spray Bottle	1 each
	Sklar Kleen™ Liquid 8 oz. Bottle	1 each
	Sklar Polish™ 8 oz. Jar	1 each
	Stainless Steel Bristle Cleaning Brush	1 each
	Nylon Bristle Cleaning Brush	1 each



## TROUBLE SHOOTING

### NO STEEL IS TRULY "STAINLESS"

It's a fact that so-called stainless steel is subject to both water-spotting and staining. However what many people identify as a "rust" problem usually turns out to be something else.

Most often the problem is actually a stain caused by a surface deposit. These deposits appear in a variety of colors depending upon the type of deposit involved. Once the cause is found and eliminated, most of the time the problem quickly diminishes or disappears completely.

As you probably know, stainless steel is ideally suited for the surgical suite because it is rust resistant, it can be honed to an extremely sharp edge or fine point,

and it can be hardened to maintain the delicate, yet precise, requirements of the surgeon. But it is this hardenable quality – the amount of carbon used during the manufacturing process – coupled with harsh chemicals and improper care that renders stainless steel susceptible to corrosion.

To protect your instrument investment, Sklar cleaning agents have been specifically formulated to provide cost effective instrument care solutions that help maintain the life and performance of your valuable stainless steel instruments.



## TROUBLE SHOOTING

### CORROSION

- Problem:** Debris and residue in box locks, serrations and ratchets.
- Solution:** Serrations, box locks and ratchets should be carefully cleaned and rinsed. A soft bristle brush is effective in these difficult areas.
- Problem:** Moisture remaining on the instruments within the sterile wrapped packs; excessive moisture in autoclave during sterilization and termination of cycle.
- Solution:** Preheat autoclave, drying time cannot be accelerated, open autoclave door slightly. Routinely inspect valves. Malfunctioning valves can precipitate corrosion.
- Problem:** Some local water supplies contain excessive quantities of alkali. This can manifest itself by depositing corrosive matter on the instruments.
- Solution:** It is generally accepted that cold distilled or demineralized water be used during sterilization. An alternative is to use the local water supply, while instituting a program of preventive maintenance. Carefully clean surfaces with SKLAR KLEEN™, using SKLAR POLISH™ to remove difficult stains and SKLAR LUBE™ for proper lubrication.

### PITTING

- Problem:** Instruments are inevitably exposed to chemical compounds that initiate pitting. The most common are saline solutions and blood.
- Solution:** It is essential that instruments be rinsed with distilled or demineralized water and then cleaned routinely.
- Problem:** Some Non-Sklar detergents contain a chloride or have an acid base. If rinsing is not thorough, the residual detergent can precipitate pitting. Hydrochloric acid can be formed by the combination of chloride in the cleaner and steam, causing the instrument to pit.
- Solution:** Evaluate detergents without a chloride base. SKLAR KLEEN™ is recommended.
- Problem:** Instruments may be pitted when the detergent used has an excessively high pH. If instruments are not rinsed thoroughly and then autoclaved, the heat increases the effect of the solution on the instruments.
- Solution:** Use only detergents specifically developed for instrument cleaning. SKLAR KLEEN™ products are pH balanced.

### BROWNISH STAIN

- Problem:** This stain is more obvious on dull finish instruments. Most likely, it is a deposit of chromium oxide. The thin hard layer protects stainless steel from corrosion precipitated by the atmosphere. The brownish film (sometimes dull blue) occurs naturally when stainless is heated. Occasionally this stain can be traced to the sterilizer. Improper cleaning compounds could contain poly phosphates that cause the copper components in the sterilizer to be deposited by electrolytic action on the stainless steel instruments.
- Solution:** Water supply to autoclave should be cold and demineralized. Use the correct amount of SKLAR KLEEN™ as recommended for best results.

### BLuish GRAY STAINS

- Problem:** Cold sterilizing solutions.
- Solution:** In the preparation of the solution make certain the manufacturer's directions are followed accurately. To minimize discoloration use distilled water and add a rust inhibitor. Using the solution beyond recommended time limitations will cause the solution to become corrosive.

### RUST DEPOSIT

- Problem:** Sterilizing instruments of different metals in the same cycle will cause rusting. An electrolytic action carries the carbon particles from the exposed metal and deposits them on the stainless steel instruments. The rapid oxidation of molecules results in a surface film of rust.
- Solution:** The ideal technique would be to sterilize the two types of instruments separately. It is recommended that chrome plated instruments that indicate signs of peeling or flaking be replaced with stainless steel instruments.
- Problem:** The rust film on the surface of stainless steel instruments can be caused by chemicals in the detergent. Excess amounts of iron or other minerals from the local water supply may cause the rust deposits.
- Solution:** It is recommended that instruments be rinsed with distilled or demineralized water. Surface rust can be removed by light buffing or an application of SKLAR POLISH™.

### LIGHT AND DARK COLORED SPOTS

- Problem:** Spotting caused by slow evaporation of water drops identified with the mineral content of the water.
- Solution:** Eliminate water droplets by adhering to autoclave manufacturer's operating instructions. Autoclave door should not be opened until steam has been completely vented.

# CONVERSIONS AND CALIBRATIONS

**ABBREVIATIONS**

**LENGTH**

mm = millimeter  
 m = meter  
 cm = centimeter  
 in = inch  
 ft = foot

**MASS**

kg = kilogram  
 g = gram  
 oz = ounce  
 lb = pound

**VOLUME**

ml = milliliter  
 l = liter  
 gal = gallon  
 pt = pint  
 qt = quart  
 oz = ounce  
 fl oz = fluid ounce  
 cm<sup>3</sup> = cubic centimeter

INCHES to MM		
Frac.	Dec.	MM
1/8	.125	3.175
1/4	.25	6.35
3/8	.375	9.525
1/2	.50	12.7
5/8	.625	15.875
3/4	.75	19.05
7/8	.875	22.225
1	1.0	25.40

CM INCHES	OZ. GRAMS
1 = .39	1 = 28.4
2 = .79	2 = 56.7
3 = 1.18	3 = 85.5
4 = 1.58	4 = 113.4
5 = 1.97	4 = 113.4
6 = 2.36	5 = 141.8
7 = 2.76	6 = 170.1
8 = 3.15	7 = 198.5
9 = 3.54	8 = 226.8
10 = 3.93	9 = 255.2
20 = 7.87	10 = 283.5
30 = 11.81	
40 = 15.75	

One milliliter = One gram  
 One centimeter = Ten millimeters  
 One millimeter = One cubic centimeter  
 One cubic centimeter = One gram (water)

CONVERSION FACTORS		
To Convert the following		Multiply By
millimeters	inches	0.03937
meters	feet	3.28
centimeters	inches	0.39
inches	millimeters	25.40
feet	millimeters	304.8
kilograms	pounds	2.2046
grams	pounds	0.0022046
ounces	cm <sup>3</sup> (cc)	29.5735
pounds	grams	453.59
cm <sup>3</sup> (cc)	grams	1.0
fluid ounces	milliliters	29.5735
pint	liters	0.47
quart	cm <sup>3</sup> (cc)	946.53
gallon	liters	3.79
liter	quarts	1.06
milliliter	fluid ounce	0.03

INCHES to CM		
Frac.	Dec.	MM
1	1.0	= 2.5
1 1/4	1.25	= 3.2
1 1/2	1.5	= 3.8
1 3/4	1.75	= 4.4
2	2.0	= 5.0
2 1/4	2.25	= 5.7
2 1/2	2.5	= 6.4
2 3/4	2.75	= 7.0
3	3.0	= 7.6
3 1/4	3.25	= 8.3
3 1/2	3.5	= 8.9
3 3/4	3.75	= 9.5
4	4.0	= 10.2
4 1/4	4.25	= 10.8
4 1/2	4.5	= 11.4
4 3/4	4.75	= 12
5	5.0	= 12.7
5 1/4	5.25	= 13.3
5 1/2	5.5	= 14
5 3/4	5.75	= 14.6
6	6.0	= 15.2
6 1/4	6.25	= 15.9
6 1/2	6.5	= 16.5
6 3/4	6.75	= 17.1
7	7.0	= 17.8
7 1/4	7.25	= 18.4
7 1/2	7.5	= 19.1
7 3/4	7.75	= 19.7
8	8.0	= 20.3
8 1/4	8.25	= 21
8 1/2	8.5	= 21.6
8 3/4	8.75	= 22.2
9	9.0	= 22.9
9 1/4	9.25	= 23.5
9 1/2	9.5	= 24.1
9 3/4	9.75	= 24.8
10	10.0	= 25.4
10 1/4	10.25	= 26
10 1/2	10.5	= 26.7
10 3/4	10.75	= 27.3
11	11.0	= 27.9
11 1/4	11.25	= 28.9
11 1/2	11.5	= 29.2
11 3/4	11.75	= 29.8
12	12.0	= 30.5

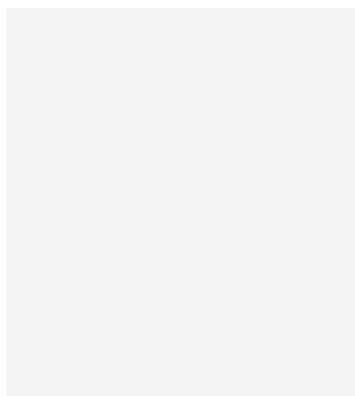

## GRADUATING TUBULAR SCALES AND GAUGES

The standard French, or Charriere, scale (abbreviated Fr.) is generally used in the size calibration of catheters and other tubular instruments. It is based on the metric system, with each unit being approximately (0.33mm) in diameter between consecutive sizes.

FR.	3	4	5	6	7	8	9	10	11	12	13	14	15	16	17	FR.
MM	1	1.35	1.67	2.0	2.3	2.7	3.0	3.3	3.7	4.0	4.3	4.7	5.0	5.3	5.7	MM
INCH	.039	.053	.066	.079	.092	.105	.118	.131	.144	.158	.170	.184	.197	.210	.223	INCH
DIAMETER																
INCH	.445	.419	.393	.367	.341	.315	.288	.263	.249	.236	INCH					
MM	11.3	10.7	10.0	9.3	8.7	8.0	7.3	6.7	6.3	6.0	MM					
FR.	34	32	30	28	26	24	22	20	19	18	FR.					

# NUMERICAL INDEX



06-1000	676	06-2930	667	06-4134	342, 535	07-1263	158
06-1004	675	06-3010	668	06-4135	342, 535	07-1264	158
06-1101	677	06-3011	539	06-4136	342, 535	07-1265	158
06-1301	676	06-3012	668	06-4137	535	07-1266	158
06-1601	673	06-3013	668	06-4138	342, 535	07-1267	158
06-1625	671	06-3015	539-540, 544, 668	06-4139	342, 535	07-1268	158
06-1627	671	06-3016	668	06-4140	342, 535	07-1269	158
06-1630	673	06-3020	668	06-4141	342, 535	07-1270	158
06-1632	673	06-3021	668	06-4142	363, 534	07-1271	158
06-1635	675	06-3022	668	06-4143	363, 534	07-1272	158
06-1638	675	06-3023	668	06-4144	363, 534	07-1273	158
06-1640	674	06-3024	670	06-4145	363, 534	07-1274	158
06-1642	674	06-3030	670	06-4146	363, 534	07-1374	161
06-1662	674	06-3090	667	06-4147	363, 534	07-1375	161
06-1668	675	06-3094	669	06-4148	363, 534	07-1376	161
06-1670	672	06-3095	669	06-4150	535	07-1400	160
06-1671	672	06-3096	669	06-4151	535	07-1401	160
06-1672	672	06-3100	668	06-4152	535	07-1402	160
06-1673	672	06-3101	668	06-4153	535	07-1420	160
06-1701	677	06-3102	668	06-4160	535	07-1422	160
06-1801	676	06-3103	560, 668	06-4161	535	07-1424	160
06-2298	673	06-3104	668	06-4191	534	07-1430	158
06-2300	673	06-3105	668	06-6250	177	07-1431	158
06-2301	673	06-3106	668	06-6300	568	07-1432	158
06-2302	673	06-3107	668	06-7052	670	07-1433	158
06-2303	672	06-3108	668	07-1170	160	07-1434	158
06-2304	671	06-3110	39, 668	07-1171	160	07-1435	158
06-2415	674	06-3111	39, 668	07-1175	160	07-1440	158
06-2417	674	06-3112	39, 668	07-1176	160	07-1441	158
06-2418	674	06-3115	39, 668	07-1200	159	07-1442	158
06-2422	674	06-3120	39, 668	07-1201	159	07-1443	158
06-2426	674	06-3121	39, 668	07-1202	159	07-1444	158
06-2427	674	06-3122	39, 668	07-1203	159	07-1445	158
06-2428	674	06-3123	39, 668	07-1205	159	07-1447	159
06-2606	675	06-3130	669	07-1206	159	07-1448	159
06-2607	675	06-3132	669	07-1207	159	07-1449	159
06-2750	672	06-3134	669	07-1208	159	07-1462	158
06-2760	673	06-3170	678	07-1210	159	07-1478	160
06-2800	672	06-3175	678	07-1211	159	07-1479	160
06-2802	672	06-3290	678	07-1212	159	07-1562	105
06-2803	672	06-3370	678	07-1213	159	07-1563	105
06-2808	679	06-3375	678	07-1214	159	07-1565	105
06-2852	678	06-4001	535	07-1215	159	07-1570	105
06-2860	213, 257, 536, 549, 553-554, 559, 561, 565-566, 679	06-4002	535	07-1216	159	07-1777	105
06-2861	213, 257, 679	06-4003	535	07-1218	159	07-1780	105
06-2862	213, 257, 560, 679	06-4004	535	07-1219	159	07-1797	105
06-2863	213, 257, 679	06-4005	535	07-1220	159	07-1801	154
06-2870	711	06-4006	535	07-1221	159	07-1802	154
06-2872	711	06-4007	535	07-1222	159	07-1805	154, 536-537, 548, 552, 554, 570, 580
06-2873	711	06-4053	535	07-1223	159	07-1806	154
06-2880	711	06-4058	535	07-1224	159	07-1807	572
06-2881	711	06-4059	535	07-1225	159	07-1820	544
06-2882	711	06-4060	535	07-1240	158	07-1850	580
06-2903	536-541, 543-545, 551, 553, 555-560, 562, 566, 570, 574-575, 577-578, 580-581, 667	06-4061	535	07-1241	158	08-1011	706
06-2904	536-537, 543, 553-557, 560, 566, 570, 667	06-4100	363, 534	07-1242	158	10-1080	127
06-2907	541, 545-546, 548, 552, 554-556, 558, 560, 566, 568, 570, 574, 577-578, 580, 667	06-4110	363, 534	07-1243	158	10-1081	127
06-2908	561-562, 667	06-4112	342	07-1244	158	10-1111	127
06-2909	667	06-4113	342	07-1245	158	10-1157	683
06-2910	546, 548, 550, 565-566, 667	06-4114	342	07-1246	158	10-1158	683
06-2911	547, 562, 667	06-4115	342	07-1247	158	10-1159	683
06-2912	667	06-4120	534, 538	07-1248	158	10-1160	683
06-2915	570, 573, 578, 580, 667	06-4121	534	07-1249	158	10-1170	683
06-2916	667	06-4122	534	07-1250	158	10-1171	683
06-2920	570, 667	06-4123	534	07-1251	159	10-1172	680
06-2925	667	06-4125	534, 538	07-1252	159	10-1173	680
		06-4126	534	07-1253	159	10-1174	680
		06-4128	534	07-1257	159	10-1175	680
		06-4130	342, 535	07-1258	159	10-1176	680
		06-4131	342, 535	07-1259	159	10-1177	680
		06-4132	342, 535	07-1260	159	10-1178	680
		06-4133	342, 535	07-1261	159		



10-1180.....	680	10-1486.....	681	10-1547-6.....	683	10-1680-12.....	686
10-1181.....	680	10-1486-12.....	681	10-1550.....	683	10-1680-6.....	686
10-1182.....	682	10-1487.....	682	10-1550-12.....	683	10-1683.....	686
10-1183.....	682	10-1488.....	681	10-1550-6.....	683	10-1683-12.....	686
10-1184.....	682	10-1488-12.....	681	10-1551.....	682	10-1683-6.....	686
10-1190.....	682	10-1489.....	681	10-1552.....	681	10-1684.....	685
10-1192.....	683	10-1489-12.....	681	10-1552-12.....	681	10-1684-12.....	685
10-1211.....	127	10-1491.....	681	10-1552-6.....	681	10-1684-6.....	685
10-1280.....	613	10-1491-12.....	681	10-1560.....	686	10-1685.....	685
10-1340.....	694	10-1492.....	681	10-1603.....	5, 233, 344, 533, 717	10-1685-12.....	685
10-1342.....	694	10-1492-12.....	681	10-1607.....	11, 723	10-1685-6.....	685
10-1344.....	694	10-1493.....	681	10-1608.....	11, 723	10-1686.....	685
10-1346.....	694	10-1493-12.....	681	10-1609.....	5, 233, 344, 533, 717	10-1686-12.....	685
10-1347.....	694	10-1496.....	681	10-1612.....	11, 723	10-1686-6.....	685
10-1348.....	694	10-1496-12.....	681	10-1613.....	11, 723	10-1687.....	685
10-1349.....	694	10-1497.....	547, 561, 682	10-1614.....	11, 723	10-1687-12.....	685
10-1350.....	709, 713-714	10-1497-12.....	682	10-1616.....	7, 200, 349, 392, 654, 684, 719	10-1687-6.....	685
10-1352.....	709	10-1498.....	681	10-1617.....	7, 200, 349, 392, 654, 684, 719	10-1688.....	685
10-1354.....	709, 713	10-1498-12.....	681			10-1688-12.....	685
10-1356.....	709	10-1502.....	706			10-1688-6.....	685
10-1362.....	709, 713	10-1502-12.....	706	10-1623.....	4, 716	10-1689.....	685
10-1364.....	709, 713	10-1504.....	706	10-1624.....	4, 716	10-1689-6.....	685
10-1366.....	709	10-1504-12.....	706	10-1625.....	16, 728	10-1690.....	685
10-1368.....	709	10-1505.....	681	10-1626.....	15, 727	10-1690-12.....	685
10-1369.....	709	10-1505-12.....	681	10-1627.....	11, 723	10-1690-6.....	685
10-1370.....	709, 713	10-1505-6.....	681	10-1629.....	15, 727	10-1691.....	547, 685
10-1372.....	709, 713	10-1507.....	681	10-1630.....	11, 723	10-1691-12.....	685
10-1374.....	709, 713	10-1507-12.....	681	10-1634.....	10, 722	10-1691-6.....	685
10-1376.....	709, 713	10-1507-6.....	681	10-1635.....	10, 722	10-1692.....	685
10-1384.....	710	10-1510.....	681	10-1636.....	10, 722	10-1692-12.....	685
10-1388.....	710	10-1510-12.....	681	10-1637.....	10, 722	10-1692-6.....	685
10-1389.....	710	10-1510-6.....	681	10-1642.....	5, 289, 332, 717	10-1693.....	685
10-1394.....	711	10-1523.....	683	10-1643.....	5, 289, 332, 388, 717	10-1693-12.....	685
10-1396.....	711, 713-714	10-1523-12.....	683	10-1644.....	5, 289, 332, 717	10-1693-6.....	685
10-1398.....	711, 713	10-1525.....	684	10-1650.....	710, 713-714	10-1694.....	685
10-1399.....	712	10-1525-12.....	684	10-1651.....	710, 713-714	10-1694-12.....	685
10-1400.....	711, 713-714	10-1527.....	683	10-1652.....	710	10-1694-6.....	685
10-1401.....	711	10-1527-12.....	683	10-1653.....	5, 289, 332, 388, 717	10-1695.....	685
10-1402.....	711, 713-714	10-1533.....	683	10-1654.....	5, 289, 332, 717	10-1695-12.....	685
10-1403.....	711	10-1533-12.....	683	10-1655.....	710	10-1695-6.....	685
10-1404.....	711, 713-714	10-1535.....	687-688	10-1656.....	710	10-1697.....	687
10-1405.....	711	10-1535-12.....	687-688	10-1657.....	710	10-1698.....	682
10-1406.....	711, 713-714	10-1535-6.....	687-688	10-1658.....	710	10-1698-12.....	682
10-1414.....	712	10-1536.....	680	10-1659.....	710	10-1699.....	682
10-1415.....	712	10-1536-12.....	680	10-1660.....	709, 713-714	10-1699-12.....	682
10-1418.....	712, 713-714	10-1538.....	683	10-1661.....	709	10-1700.....	693
10-1420.....	712, 714	10-1538-12.....	683	10-1663.....	709	10-1702.....	693
10-1422.....	712	10-1539.....	680	10-1664.....	709	10-1703.....	693
10-1424.....	714	10-1539-12.....	680	10-1665.....	709	10-1705.....	693
10-1424BHD.....	714	10-1539-6.....	680	10-1666.....	709	10-1706.....	693
10-1424HDL.....	714	10-1540.....	682	10-1668.....	709	10-1707.....	693
10-1424PBR.....	714	10-1540-12.....	682	10-1669.....	709	10-1708.....	693
10-1426.....	713	10-1540-6.....	682	10-1670.....	538, 547, 560, 680	10-1710.....	688
10-1428.....	713	10-1541.....	683	10-1670-12.....	680	10-1711.....	693
10-1432.....	714	10-1541-12.....	683	10-1670-24.....	680	10-1712.....	693
10-1434.....	714	10-1541-6.....	683	10-1670-48.....	680	10-1714.....	688
10-1440.....	658	10-1542.....	687	10-1671.....	680	10-1716.....	693
10-1444.....	710, 713-714	10-1542-12.....	687	10-1671-12.....	680	10-1717.....	693
10-1446.....	710	10-1542-6.....	687	10-1671-24.....	680	10-1720.....	688
10-1450.....	682	10-1543.....	683	10-1671-48.....	680	10-1722.....	685
10-1451.....	682	10-1543-12.....	683	10-1672.....	709	10-1722-12.....	685
10-1465.....	710	10-1544.....	683	10-1674.....	681	10-1722-6.....	685
10-1468.....	710	10-1544-12.....	683	10-1674-12.....	681	10-1724.....	687
10-1470.....	711	10-1544-6.....	683	10-1674-6.....	681	10-1724-12.....	687
10-1472.....	711	10-1545.....	683, 712	10-1675.....	538, 547, 577, 680	10-1724-6.....	687
10-1483.....	681	10-1545-12.....	683	10-1675-12.....	680	10-1725.....	693
10-1483-12.....	681	10-1545-6.....	683	10-1675-24.....	680	10-1731.....	686
10-1484.....	681	10-1546.....	705	10-1675-48.....	680	10-1733.....	686
10-1484-12.....	681	10-1546-6.....	705	10-1679.....	688	10-1734.....	686
10-1485.....	681	10-1547.....	683	10-1680.....	686	10-1737.....	687
10-1485-12.....	681	10-1547-12.....	683			10-1737-12.....	687

# NUMERICAL INDEX



10-1737-6	687	10-1835-6	687	10-1962	704	10-4076	699
10-1738	685	10-1836	694	10-1965	704	10-4078	699
10-1738-12	685	10-1838	694	10-1965-12	704	10-4080	699
10-1738-6	685	10-1839	695	10-1965-6	704	10-4082	699
10-1740	687	10-1850	688	10-1966	704	10-4084	699
10-1741	687	10-1854	688	10-1966-12	704	10-4086	699
10-1741-6	687	10-1854-12	688	10-1966-6	704	10-4088	699
10-1742	687	10-1854-6	688	10-1967	704	10-4090	699
10-1742-12	687	10-1860	688	10-1967-12	704	10-4092	699
10-1742-6	687	10-1862	687	10-1967-6	704	10-4094	699
10-1744	687	10-1864	688	10-2010	558	10-4096	574, 699
10-1744-12	687	10-1874	687	10-2555	704	10-4098	699
10-1744-6	687	10-1876	686	10-2556	704	10-4100	699
10-1746	687	10-1876-12	686	10-2557	704	10-4102	699
10-1746-12	687	10-1876-6	686	10-2701	11, 723	10-4104	699
10-1746-6	687	10-1877	687	10-2722	8, 530, 720	10-4106	699
10-1747	687	10-1877-12	687	10-2724	8, 530, 720	10-4108	699
10-1747-12	687	10-1877-6	687	10-2736	12, 724	10-4110	699
10-1747-6	687	10-1878	687	10-2738	12, 724	10-4112	699
10-1748	687	10-1878-12	687	10-2765	10, 723	10-4114	699
10-1748-12	687	10-1878-6	687	10-2775	13, 725	10-4116	699
10-1748-6	687	10-1879	687	10-2776	13, 725	10-4118	699
10-1749	687	10-1882	687	10-2777	13, 725	10-4120	699
10-1750	688	10-1882-12	687	10-2800	9, 721	10-4122	699
10-1750-12	688	10-1882-6	687	10-2801	9, 721	10-4124	699
10-1750-6	688	10-1883	686	10-3050	703	10-4126	699
10-1752	688	10-1883-12	686	10-3052	703	10-4128	699
10-1752-12	688	10-1883-6	686	10-3054	703	10-4130	699
10-1752-6	688	10-1886	685	10-3056	703	10-4132	699
10-1753	687	10-1886-12	685	10-3058	703	10-4134	699
10-1753-12	687	10-1886-6	685	10-3060	703	10-4136	699
10-1753-6	687	10-1887	685	10-3062	703	10-4138	699
10-1754	687	10-1887-12	685	10-3064	703	10-4140	699
10-1754-12	687	10-1887-6	685	10-4000	699	10-4142	699
10-1754-6	687	10-1888	686	10-4002	699	10-4144	699
10-1755	687	10-1888-12	686	10-4004	699	10-4146	699
10-1755-12	687	10-1888-6	686	10-4006	699	10-4148	699
10-1755-6	687	10-1892	687	10-4008	699	10-4150	699
10-1756	687	10-1894	687	10-4010	699	10-4152	699
10-1756-12	687	10-1895	687	10-4012	699	10-4154	699
10-1756-6	687	10-1927	15, 727	10-4014	699	10-4156	699
10-1757	687	10-1942	687	10-4016	699	10-4158	699
10-1758	687	10-1943	687	10-4018	699	10-4160	699
10-1759	687	10-1944	687	10-4020	699	10-4162	699
10-1760	685	10-1947	688	10-4022	699	10-4164	699
10-1760-12	685	10-1948	687-688	10-4024	699	10-4166	699
10-1760-6	685	10-1948-12	687-688	10-4026	699	10-4168	699
10-1763	695	10-1948-6	687-688	10-4028	699	10-4170	699
10-1764	687	10-1949	687	10-4030	699	10-4172	699
10-1766	687	10-1949-12	687	10-4032	699	10-4174	699
10-1768	684	10-1949-6	687	10-4034	699	10-4176	699
10-1770	695	10-1950	687	10-4036	699	10-4178	699
10-1772	695	10-1950-12	687	10-4038	699	10-4180	699
10-1775	695	10-1950-6	687	10-4040	699	10-4182	699
10-1776	695	10-1952	687	10-4042	699	10-4184	699
10-1780	695	10-1952-12	687	10-4044	699	10-4186	699
10-1800	694	10-1952-6	687	10-4046	699	10-4188	699
10-1805	536, 694	10-1953	687-688	10-4048	699	10-4190	699
10-1806	694	10-1953-12	687-688	10-4050	699	10-4192	699
10-1808	574, 694	10-1953-6	687-688	10-4052	699	10-4194	699
10-1810	574, 694	10-1954	687-688	10-4054	699	10-4196	699
10-1812	694	10-1954-12	687-688	10-4056	699	10-4198	699
10-1814	694	10-1954-6	687-688	10-4058	699	10-4200	699
10-1816	694	10-1955	685	10-4060	699	10-4202	699
10-1818	694	10-1955-12	685	10-4062	699	10-4204	699
10-1826	694	10-1955-6	685	10-4064	699	10-4206	699
10-1828	694	10-1956	685	10-4066	699	10-4208	699
10-1830	694	10-1956-12	685	10-4068	699	10-4210	699
10-1832	694	10-1956-6	685	10-4070	699	10-4212	699
10-1834	694	10-1960	704	10-4072	699	10-4214	699
10-1835	687	10-1961	704	10-4074	699	10-4216	699



10-4218	699	10-4410	698	10-4602	697	10-4788	697
10-4220	699	10-4412	698	10-4604	697	10-4790	697
10-4222	699	10-4414	698	10-4606	697	10-4900	698
10-4224	699	10-4416	698	10-4608	697	10-4910	698
10-4226	699	10-4418	698	10-4610	697	10-4925	698
10-4228	699	10-4420	698	10-4612	697	10-4930	698
10-4230	699	10-4422	698	10-4614	697	10-4930ENG	698
10-4232	699	10-4424	698	10-4616	697	10-4970	697
10-4234	699	10-4426	698	10-4618	697	10-4975	698
10-4236	699	10-4428	698	10-4620	697	10-4985	699
10-4238	699	10-4430	698	10-4622	697	10-6500	700
10-4284	699	10-4432	698	10-4624	697	10-6501	700
10-4286	699	10-4434	698	10-4626	697	10-6505	700
10-4288	699	10-4436	698	10-4628	697	10-6506	700
10-4290	574, 699	10-4438	698	10-4630	697	10-6510	701
10-4300	698	10-4440	698	10-4632	697	10-6511	701
10-4302	698	10-4478	698	10-4634	697	10-6515	701
10-4304	698	10-4480	698	10-4636	697	10-6516	701
10-4306	698	10-4482	698	10-4638	697	10-6520	701
10-4308	698	10-4484	574, 698	10-4640	697	10-6521	701
10-4310	698	10-4500	697	10-4642	697	10-6525	702
10-4312	698	10-4502	697	10-4644	697	10-6526	702
10-4314	698	10-4504	697	10-4646	697	10-6531	702
10-4316	698	10-4506	697	10-4648	697	10-6536	702
10-4318	698	10-4508	697	10-4650	697	10-6600	689
10-4320	698	10-4510	697	10-4652	697	10-6602	689
10-4322	698	10-4512	697	10-4654	697	10-6604	689
10-4324	698	10-4514	697	10-4656	697	10-6606	689
10-4326	698	10-4516	697	10-4658	697	10-6608	689
10-4328	698	10-4518	697	10-4660	697	10-6610	689
10-4330	698	10-4520	697	10-4662	697	10-6612	689
10-4332	698	10-4522	697	10-4664	697	10-6614	689
10-4334	698	10-4524	697	10-4666	697	10-6616	689
10-4336	698	10-4526	697	10-4668	697	10-6618	689
10-4338	698	10-4528	697	10-4670	697	10-6620	689
10-4340	698	10-4530	697	10-4672	697	10-6622	689
10-4342	698	10-4532	697	10-4674	697	10-6624	689
10-4344	698	10-4534	697	10-4676	697	10-6626	689
10-4346	698	10-4536	697	10-4678	697	10-6628	689
10-4348	698	10-4538	697	10-4680	697	10-6630	689
10-4350	698	10-4540	697	10-4682	697	10-6632	689
10-4352	698	10-4542	697	10-4684	697	10-6634	689
10-4354	698	10-4544	697	10-4686	697	10-6636	689
10-4356	698	10-4546	697	10-4688	697	10-6660	690
10-4358	698	10-4548	697	10-4690	697	10-6662	690
10-4360	698	10-4550	697	10-4692	697	10-6664	690
10-4361	698	10-4552	697	10-4694	697	10-6666	690
10-4362	698	10-4554	697	10-4696	697	10-6670	690
10-4364	698	10-4556	697	10-4698	697	10-6672	690
10-4366	698	10-4558	697	10-4700	697	10-6674	690
10-4368	698	10-4560	697	10-4702	697	10-6680	690
10-4370	698	10-4562	697	10-4704	697	10-6682	690
10-4372	698	10-4564	697	10-4706	697	10-6684	690
10-4374	698	10-4566	697	10-4708	697	10-6690	691
10-4376	698	10-4568	697	10-4710	697	10-6692	691
10-4378	698	10-4570	697	10-4712	697	10-6694	691
10-4380	698	10-4572	697	10-4714	697	10-6696	691
10-4382	698	10-4574	697	10-4716	697	10-6698	691
10-4384	698	10-4576	697	10-4718	697	10-6700	691
10-4386	698	10-4578	697	10-4720	697	10-6702	691
10-4388	698	10-4580	697	10-4722	697	10-6704	691
10-4390	698	10-4582	697	10-4724	697	10-6706	691
10-4392	698	10-4584	697	10-4726	697	10-6708	691
10-4394	574, 698	10-4586	697	10-4728	697	10-6710	691
10-4396	698	10-4588	697	10-4730	697	10-6712	691
10-4398	698	10-4590	697	10-4732	697	10-6714	691
10-4400	698	10-4592	697	10-4734	697	10-6716	691
10-4402	698	10-4594	697	10-4736	697	10-6718	691
10-4404	698	10-4596	697	10-4738	697	10-6720	691
10-4406	698	10-4598	697	10-4784	697	10-6729	689
10-4408	698	10-4600	697	10-4786	697	10-6730	689

# NUMERICAL INDEX



10-6732	689	14-1050	47, 368	15-3308	24	15-3536	28
10-6740	692	14-1055	47, 368, 541, 543, 553, 556	15-3309	24	15-3542	28, 72
10-6742	692			15-3310	24, 77	15-3547	30
10-6750	692	14-1060	47, 368, 572	15-3311	24, 77	15-3548	30
10-6752	692	14-1065	47, 368	15-3315	24, 77, 580	15-3549	30, 566
10-6754	692	14-1072	47, 368	15-3317	24	15-3550	27, 73
10-6760	692	14-1080	66	15-3318	24	15-3555	27, 73
10-6762	692	14-1155	49	15-3319	24	15-3560	27, 73
10-6764	692	14-2045	48, 368	15-3320	29, 72	15-3565	27, 73, 558
11-1035	66	14-2050	48, 368, 568	15-3325	23, 77	15-3566	27, 73
11-1045	66, 538	14-2055	48, 368, 553, 556	15-3326	23, 77	15-3567	28, 73
11-1055	66, 538, 540, 555	14-2060	48, 368, 572	15-3330	23, 77	15-3568	27, 73
11-1055LFT	66	14-2065	48, 368, 560, 570	15-3331	23, 77	15-3569	28, 73
11-1060	66, 553	14-2072	48, 368	15-3335	24	15-3570	28, 73, 558
11-1072	66	14-2155	49	15-3336	24	15-3571	28, 73
11-1072LFT	66	15-1045	47, 368	15-3340	25	15-3572	30
11-1080	66	15-1050	47, 368	15-3342	23, 76	15-3574	28, 73
11-1180	67, 317, 351	15-1055	47, 368	15-3343	23, 76	15-3575	28, 73
11-1252	66	15-1060	47, 368	15-3348	23, 76	15-3576	30
11-1255	67, 540	15-1065	47, 368	15-3349	23, 76	15-3577	30
11-1257	67	15-1142	25	15-3352	23, 77	15-3578	30
11-1278	67, 317	15-1155	49	15-3354	26	15-3579	30
11-1280	67, 317	15-1242	25	15-3355	26	15-3580	30
11-1281	67, 317, 580	15-1243	25	15-3356	26	15-3583	30
11-1282	67, 317	15-1282	69, 469	15-3357	23, 77	15-3584	30
11-1283	67, 317	15-1285	69, 469	15-3358	26	15-3585	27, 73, 558, 565-566
11-1284	67, 317	15-1307	53, 369, 469	15-3360	24	15-3586	28
11-1285	67, 317	15-1308	53, 369, 469	15-3361	24	15-3590	27, 73, 558, 560, 565-566
11-1286	67, 317	15-1342	25, 559	15-3364	26	15-3595	560
11-1287	67, 317	15-1343	25	15-3366	26	15-7032	26
11-1295	315, 352	15-1355	63, 167, 237, 540, 553	15-3368	26	15-9107	24
11-1297	315, 352	15-1358	167	15-3370	27	15-9108	24
11-1298	67, 315, 352	15-1359	562	15-3372	27	15-9109	24
11-1380	315, 352	15-1360	59	15-3405	24, 77	15-9117	24
11-1390	315, 352	15-1361	59	15-3406	24, 77, 559	15-9118	24
11-1490	315, 352	15-1555	50, 369, 468, 494, 536, 538, 543-544	15-3407	24, 77	15-9119	24
11-1495	66			15-3408	24, 77	16-1055	19, 74
11-1496	66	15-1567	50, 369, 468, 494, 547, 553-556, 559, 572	15-3409	24, 77	16-1056	19, 74
11-1525	314			15-3410	24, 77	16-1057	19, 74
11-1540	314, 353	15-1655	53, 369, 468	15-3411	24, 77	16-1155	19, 74
11-1550	316	15-1667	53, 369, 468	15-3412	24, 77	16-1156	19, 74
11-1610	316	15-1762	53, 468	15-3426	23, 77	16-1157	19, 74
11-1615	316	15-1862	53	15-3427	23, 77	16-1505	19, 74
11-1812	317	15-2045	48, 368	15-3429	23, 77	16-1510	19, 74, 538, 541, 557-558, 562, 566, 574-575, 577-578, 580
11-1910	317, 353	15-2050	48, 368	15-3430	23, 77	16-1515	19, 74
11-1990	317, 353	15-2055	48, 368	15-3434	23, 77	16-1520	459
11-2095	316, 353	15-2060	48, 368	15-3435	23, 77	16-1525	459
11-2098	316	15-2065	48, 368	15-3442	23, 76	16-1605	19, 74, 548, 550
11-2100	314, 353	15-2307	53, 369, 469	15-3443	23, 76	16-1610	19, 74, 541, 557, 572, 574, 578, 578, 580
11-2101	314, 353	15-2308	53, 369, 469	15-3444	25	16-1615	19, 74, 574
11-2105	314, 353	15-2426	52	15-3448	23, 76	16-1620	459
11-2110	314, 353	15-2428	52	15-3449	23, 76	16-1625	459
11-2112	314, 353	15-2436	52	15-3450	25	16-1805	19, 75, 562
11-2115	314, 353	15-2438	52	15-3451	25, 559	16-1810	19, 75
12-1065	308	15-2445	62	15-3452	23, 77	16-1815	19, 75
12-1080	308	15-2455	62	15-3457	23, 77	16-1905	19, 75, 538, 541, 548-551, 558, 566, 574, 577, 578
13-1045	47, 368	15-2555	50, 369, 468, 494, 537-538	15-3460	24	16-1910	19, 75
13-1050	47, 368	15-2567	50, 369, 468, 494, 536-537, 543, 551-556, 561, 573	15-3461	24	16-1915	19, 75
13-1055	47, 368, 540, 543, 553			15-3464	26	16-2005	20, 75
13-1060	47, 368	15-2655	53, 369, 468	15-3466	26	16-2010	20, 75
13-1065	47, 368	15-2667	53, 369, 468	15-3468	26	16-2015	20, 75
13-1072	47, 368	15-2762	53, 468	15-3500	27, 73	16-2105	20, 75, 548-551, 558, 562, 580
13-1155	49	15-2862	53	15-3505	27, 73	16-2110	20, 75, 541, 557, 574, 575, 578, 580, 581
13-2045	48, 368	15-3107	68	15-3507	24, 77	16-2115	20, 75
13-2050	48, 368	15-3150	64, 167	15-3508	24, 77	16-2205	20, 75
13-2055	48, 368	15-3172	70, 174	15-3509	24, 77		
13-2060	48, 368	15-3210	70, 174	15-3510	27, 73		
13-2065	48, 368	15-3244	29	15-3515	27, 73		
13-2072	48, 368	15-3305	24, 77	15-3520	29		
13-2155	49	15-3306	24, 77	15-3525	29		
14-1045	47, 368	15-3307	24	15-3535	29		





16-2210	20, 75	17-1080	84	17-2957	104, 485, 543	19-1260	111, 538, 541, 543, 557-559, 572, 574-575, 578-581
16-2211	20, 75	17-1155	85	17-2958	104, 485	19-1270	111
16-2215	20, 75	17-1162	84	17-2962	84	19-1280	111, 536, 542, 553, 556, 570, 574, 579-580
16-2305	20, 75	17-1180	84	17-3055	80, 536-538, 541, 555, 558, 574-575, 578	19-1310	111
16-2310	20, 75, 541, 578, 580	17-1220	87	17-3062	80, 556, 562, 570, 572	19-1312	111, 460
16-2311	20, 75, 578	17-1225	87, 558, 560, 577	17-3075	80	19-1314	460, 572
16-2312	20, 75	17-1230	82	17-3155	80, 536-538, 541, 544, 557-558, 574-575, 577-578, 580	19-1445	112
16-2405	19, 75, 559	17-1232	82	17-3162	80, 554-556, 570, 572	19-1450	112
16-2428	20	17-1235	82, 536, 538, 561, 562	17-3168	80	19-1455	112
16-2436	20	17-1250	87	17-3175	80	19-1460	112
16-2438	20	17-1255	85	17-3255	85	19-1480	112
16-2505	19, 75	17-1260	87	17-3265	84	19-1510	112
16-2605	20, 75	17-1262	84	17-3275	84	19-1512	112, 460
16-2610	20, 75	17-1272	478	17-3355	85	19-1514	460
16-2705	20, 75	17-1274	478	17-3365	84	19-1650	112
16-2730	21	17-1335	82, 536, 538, 547, 562	17-3375	84	19-1655	112, 554, 555
16-2731	21	17-1350	87	17-3455	84	19-1660	112
16-2800	21, 75, 166, 309, 351, 540, 553, 566	17-1355	85	17-3555	84	19-1712	460
16-2820	315, 352	17-1360	87	17-3562	105, 379, 485, 541, 559-560	19-1714	460
16-3503	22	17-1362	84	17-3660	484	19-1850	112
16-3504	22	17-1450	78, 536-538, 540, 541, 544, 548, 550, 551, 554, 556, 558, 561, 562, 565, 566, 577, 580	17-3670	484	19-1855	112
16-3505	22	17-1455	78	17-3760	484	19-1905	112
16-3506	22	17-1550	78, 536-538, 540, 541, 544, 547, 556, 559, 562, 565, 566, 574, 577, 578, 580, 581	17-3815	116, 517	19-1910	112
16-3507	22	17-1650	78, 544, 562	17-3817	116, 517	19-1950	112
16-3508	22	17-1750	78	17-3915	116, 517	19-1955	112
16-3509	22	17-1762	86, 174, 466, 578	17-3917	116, 517	19-1975	112
16-3510	22	17-1772	86, 174, 466, 553	17-3955	126	19-2050	112
16-3511	22	17-1855	85	17-3956	126	19-2070	112
16-3513	22	17-1955	85	17-3960	126	19-2170	113, 379
16-3514	22	17-2055	81, 466, 543, 550-551, 553	17-3961	580	19-2172	113
16-3515	22	17-2155	81, 466, 543, 553	17-3962	126	19-2180	108
16-3526	22	17-2255	83, 544	17-3965	126	19-2181	108
16-3527	22	17-2262	83, 536, 541, 552, 557-558, 574, 577-578, 580	17-3970	126	19-2182	108
16-3528	22	17-2267	83	17-3980	126	19-2260	113
16-3530	22	17-2272	83, 543, 553, 572, 580	17-3990	101	19-2280	113, 536, 554, 570, 572-574, 579
16-3531	22	17-2280	83, 536, 541, 554, 557, 560, 570, 578	17-3995	126	19-2310	113, 570
16-3532	22	17-2362	83	17-3996	126	19-2314	572
16-3533	22	17-2455	83	17-3997	126	19-2320	113
16-3540	22	17-2462	83, 536	18-1050	79, 544-545	19-2320	113
16-3541	22	17-2467	83	18-1150	79, 544-545	19-2460	112
16-3545	22	17-2472	83, 543, 553, 572	18-1250	86, 174, 466	19-2860	113
16-3546	22	17-2480	83, 536, 570	18-1352	85	19-2880	113
16-3552	19, 74	17-2550	85	18-1452	85	19-2910	113
16-3557	19, 74	17-2570	85	18-1552	81, 466	19-2930	121, 532
16-3562	19, 74	17-2580	85	18-1652	81, 466	19-2945	121, 532
16-3567	19, 74	17-2650	85	18-1752	84, 541	19-3030	121, 532
16-3572	22	17-2660	85	18-1852	84, 541	19-3035	121, 532, 538
16-3577	22	17-2670	85	18-1952	80	19-3040	121, 532
16-3582	22	17-2678	85	18-2052	80	19-3045	121, 532, 538, 540
16-3587	22	17-2685	84, 555, 566	18-2140	103, 345, 373	19-3055	533
16-3614	20	17-2688	84, 560, 570, 573	18-2155	103, 345, 373	19-3056	533
16-3615	20, 562	17-2690	84	18-2162	103, 345, 373	19-3147	533
16-3616	569	17-2762	84	18-2164	103, 345, 373	19-3155	533
16-3620	20	17-2766	84, 536, 555	18-2257	100, 372, 566	19-3160	533
16-3630	562	17-2872	84	19-1045	110	19-3161	533
16-3632	562	17-2880	84, 536, 541, 543, 554, 557, 570, 572-574	19-1050	110, 543, 560	19-3162	533
16-4000	21, 377	17-2885	84	19-1055	110, 536-538, 540, 553, 556	19-3240	121, 532
16-4001	21, 377	17-2888	84, 536, 541, 543, 554, 557, 570, 572-574	19-1060	110, 538, 541, 543, 557-558, 572, 574-575, 578-581	19-3340	121, 532
16-4002	21, 377	17-2890	84	19-1070	110	19-3350	121, 532
16-4004	21, 377	17-2955	84, 561, 566	19-1080	110, 536-537, 541, 553, 556, 570, 574, 579	19-3360	121, 532
16-4005	21, 377	17-2862	84, 536, 541, 557-558, 574, 577-578, 580	19-1110	110	19-3400	123
16-4006	21, 377	17-2872	84	19-1112	110, 460	20-1160	371
16-4008	21, 377, 459, 572	17-2880	84, 536, 541, 543, 554, 557, 570, 572-574	19-1114	460, 572	20-1260	128
16-4009	21, 377, 459, 572	17-2885	84	19-1230	114	20-1265	129, 370, 560
16-4010	21, 377, 459, 572	17-2888	84, 536, 541, 543, 554, 557, 570, 572-574	19-1245	111, 561	20-1270	129, 370, 552, 554-555
16-4012	21, 377, 459	17-2885	84	19-1250	111, 560	20-1280	129, 370
16-4013	21, 377, 459	17-2890	84	19-1255	111, 536-538, 540, 553-556	20-1290	129, 370
16-4014	21, 377, 459					20-1295	129, 370
17-1055	104, 174, 466, 543, 570					20-1350	128, 370, 538, 561
17-1062	84						

# NUMERICAL INDEX



20-1352	128, 370, 538	21-180	643	21-390	648	21-741	649
20-1450	128, 561	21-184	649	21-392	648	21-742	643
20-1547	128, 538	21-186	649	21-394	648	21-743	649
20-1750	128, 538-539, 544	21-188	643	21-409	638	21-748	650
20-1751	128, 538	21-209	642	21-421	638	21-753	643
20-1760	255, 271	21-222	636	21-426	638	21-757	643
20-1870	129	21-224	642	21-431	638	21-762	643
20-2052	129, 370	21-226	636	21-434	640	21-764	645
20-2060	129, 370, 560	21-227	644	21-436	638	21-766	643
20-2270	129, 370	21-231	636	21-437	640	21-769	643
20-2480	129, 370, 554, 571	21-232	642	21-441	639	21-770	643
20-2490	129, 370	21-237	636	21-442	638	21-771	642
20-2662	371	21-241	636	21-447	638	21-772	642
20-2747	129, 255, 370, 538	21-243	636	21-449	643	21-775	642
20-2748	129, 255, 370	21-245	636	21-452	638	21-776	642
20-2755	129, 255, 370, 538, 561	21-254	636	21-453	640	21-777	645
20-2765	129, 255, 370	21-258	650	21-458	639	21-778	642
20-2775	129, 255, 370	21-263	635	21-459	640	21-781	645
20-2910	129, 370, 573	21-266	635	21-463	639	21-785	645
20-2911	129, 370	21-267	650	21-465	639	21-788	645
20-3055	130, 371	21-270	635	21-469	639	21-790	645
20-3075	130, 371	21-271	635	21-470	639	21-791	645
20-3080	255	21-272	635	21-471	639	21-793	645
20-3090	370	21-275	635	21-472	646	21-797	650
20-3910	129	21-278	635	21-473	639	21-801	648
20-4170	129	21-281	635	21-477	639	21-805	648
20-4175	497	21-284	635	21-478	644	21-809	647
20-4178	497	21-285	640	21-479	646	21-810	647
20-4510	130, 370	21-288	635	21-481	639	21-812	647
20-4610	130	21-289	640	21-482	646	21-813	647
20-4682	130, 371, 561, 571, 573	21-291	635	21-483	646	21-817	645
20-4795	370	21-292	635	21-484	646	21-819	645
20-4852	128	21-293	635	21-485	639	21-821	648
20-4867	128	21-294	635	21-486	646	21-826	647
21-008	650	21-295	635	21-487	639	21-832	646
21-010	650	21-299	635	21-488	639	21-838	646
21-060	638	21-300	635	21-489	646	21-842	646
21-100	637	21-303	650	21-491	646	21-847	646
21-101	637	21-308	635	21-492	639	21-853	646
21-102	636	21-312	635	21-493	646	21-869	646
21-103	636	21-313	650	21-495	639	21-872	647
21-104	636	21-321	635	21-497	646	21-877	647
21-105	637	21-322	650	21-498	639	21-885	647
21-105BG	637	21-324	650	21-499	649	21-900	645
21-105HG	637	21-325	635	21-500	639	21-930	639
21-105LG	637	21-327	635	21-502	649	21-934	639
21-105MG	637	21-328	635	21-504	639	21-938	639
21-105NB	637	21-334	650	21-513	639	21-941	639
21-105OR	637	21-335	635	21-571	641	21-952	639
21-105PR	637	21-336	635	21-577	641	21-1260	132, 543, 545, 562, 570
21-105RB	637	21-337	650	21-586	641	21-2180	42, 135
21-105TB	637	21-339	635	21-598	642	21-2195	42, 135
21-105YL	637	21-340	635	21-599	642	21-2240	40, 551, 562
21-107	636	21-344	635	21-604	641	21-2250	569
21-109	636	21-346	636	21-605	644	21-2266	461
21-123	643	21-348	650	21-606	641	21-2570	133
21-124	643	21-352	636	21-607	644	21-2660	41, 563
21-128	643	21-354	635	21-608	641	21-2662	41
21-129	643	21-358	636	21-610	644	21-2664	41
21-129TP	643	21-362	650	21-611	641	21-2914	463, 572
21-135	643	21-363	636	21-612	644	21-3510	42, 132
21-142	643	21-364	636	21-617	644	21-4914	463
21-146	643	21-365	648	21-635	641	21-5112	132, 463
21-151	643	21-366	648	21-655	641	21-5114	463
21-160	637	21-368	650	21-705	643	21-7012	40
21-161	637	21-369	637	21-708	121, 532, 645	21-7013	40
21-165	649	21-371	648	21-710	643	21-8000	40, 133, 558-559, 568
21-171	649	21-374	641	21-727	643	21-8001	40, 133, 542, 548, 550-551, 557, 563, 568-569, 577-578
21-172	649	21-375	638	21-731	643	21-8002	40, 132, 538, 540, 558-559, 565-566
21-176	649	21-382	649	21-736	643		
21-177	649	21-386	640	21-740	649		



21-8003	40	21-8096	42	22-1645	48, 368	22-6577	154
21-8004	40, 132, 566	21-8097	42	22-1650	48, 368	22-6585	154, 541
21-8005	40, 133	21-8150	44	22-1655	48, 368	22-6586	154
21-8006	40, 133, 560, 566, 577	21-8151	44	22-2272	83	22-6590	155
21-8007	40, 133, 549, 575	21-8152	44	22-2280	83	22-6591	155
21-8008	40, 133	21-8156	44	22-2450	51	22-6770	109, 556
21-8009	40, 133	21-8157	44	22-2460	51	22-6870	109, 556
21-8010	40, 133, 580	21-8158	44	22-2520	60, 561	22-7470	113
21-8011	40, 133, 463	21-8159	44	22-2545	51, 539, 544, 566	22-7560	489
21-8012	41, 133	21-8160	44	22-2550	51	22-7660	489
21-8013	41, 133, 545, 562, 566	21-8250	44	22-2555	50	22-7760	489
21-8014	41, 133	21-8251	44	22-2567	50	22-7795	153, 491
21-8015	580	21-8253	44, 135	22-2645	168	22-7855	141, 488
21-8016	41, 133	21-8254	44, 135	22-2650	51	22-8067	145, 200
21-8019	41, 133	21-8255	44, 135	22-2652	62, 544-545, 559, 562	22-8075	145, 200
21-8020	41, 133	21-8257	44, 135	22-2653	62, 565, 566	22-8080	145
21-8021	41, 133	21-8258	44, 135	22-2657	62	22-8180	145
21-8022	41, 133	21-8259	44, 135	22-2722	60	22-8210	150
21-8023	41, 133	21-9012	43, 136	22-2742	54	22-8211	150
21-8024	41	21-9016	43, 136	22-2745	62	22-8212	150
21-8025	41, 134	21-9018	43, 136	22-2750	60	22-8213	150
21-8026	41, 134, 565	21-9030	43, 136, 544	22-2751	60	22-8214	150
21-8027	41, 134, 540, 565	21-9035	43, 136	22-2755	369	22-8215	150
21-8028	41, 134	21-9045	43, 136	22-2758	60	22-8245	137
21-8029	41, 134	21-9050	35, 166	22-2759	60	22-8255	137, 544, 555, 558, 578
21-8030	41, 133	21-9051	35, 166	22-2760	60, 545, 562, 567	22-8270	143
21-8031	41, 133, 536-537, 557-559, 563, 574, 578, 580	21-9052	35, 166	22-2762	60	22-8345	137, 577
21-8032	41, 133, 536, 542-543, 553, 557-558, 570-572, 574-575, 579, 581	21-9060	41, 166, 531	22-2768	60	22-8355	137
21-8033	41, 133, 542, 553, 571-572, 579-580	21-9065	41, 166, 531, 580	22-2770	60	22-8360	142, 541, 545, 562, 567
21-8034	41, 133, 579	22-1040	52	22-2772	60	22-8460	142, 541, 545, 562
21-8035	41, 133, 463	22-1042	52	22-2820	65	22-8560	143, 212, 565
21-8036	41, 134	22-1047	111	22-2822	65	22-8760	137
21-8037	41, 134	22-1054	66	22-2824	65	22-8832	138, 207
21-8039	42, 134	22-1057	51, 541, 568	22-2825	65	22-8834	138, 207
21-8040	44, 135, 546-547, 577	22-1061	111	22-2835	63, 167, 237, 543, 566	22-8835	219
21-8042	44, 135	22-1062	111	22-2837	167	22-8836	219
21-8043	44, 135, 546	22-1063	111, 566	22-2844	63, 167	22-8837	219
21-8044	44, 135	22-1064	111	22-2845	63, 167, 237, 544	22-8838	219
21-8045	44, 135	22-1070	52, 369, 530, 541, 560	22-2855	369	22-8839	219
21-8046	44, 135	22-1071	52, 369, 530	22-2934	64, 167	22-8842	219
21-8047	44, 135	22-1072	66	22-2935	64, 167, 237	22-8850	137
21-8048	569	22-1135	56, 236	22-2947	64, 167, 237, 544	22-8853	137
21-8051	41, 133	22-1145	47, 368	22-2950	64, 167	22-8855	137
21-8052	44	22-1150	47, 368	22-2955	62	22-8860	142
21-8054	44, 135	22-1155	47, 368	22-2957	168	22-8920	138, 207, 538
21-8056	44	22-1161	110	22-3047	85	22-8940	138, 207
21-8057	44, 135	22-1162	110, 566	22-3147	85	22-8945	198, 613
21-8058	44, 135	22-1163	110, 544, 569	22-3255	86, 174	22-8946	613
21-8059	44, 135	22-1164	110	22-3270	86, 174	22-9027	138, 207, 545, 559, 562, 577
21-8060	42, 134, 573	22-1235	56, 236	22-3452	87	22-9029	138, 207
21-8061	134	22-1240	58, 234	22-3455	87, 560	22-9030	139, 541
21-8062	42, 135, 371	22-1241	58, 234, 546, 566	22-3555	83, 541	22-9122	148
21-8064	44, 135, 371	22-1242	58, 234	22-3655	83, 541	22-9123	148
21-8065	42, 134, 370	22-1245	47, 368	22-3755	84	22-9124	148
21-8070	44, 135, 371	22-1250	47, 368	22-3855	84	22-9125	148
21-8071	44, 135, 371	22-1255	47, 368	22-4150	113, 541, 545, 559, 562	22-9126	148
21-8072	44	22-1342	58, 234, 566	22-4154	560	22-9127	148
21-8075	40, 132, 563, 568	22-1345	47, 368	22-4250	113, 567	22-9128	148
21-8079	42	22-1350	47, 368	22-4350	113, 541, 545, 559, 562	22-9129	148
21-8080	40, 132, 566	22-1354	63, 167	22-4354	560	22-9132	148, 212
21-8082	41, 134	22-1355	47, 368	22-4450	113, 567	22-9133	148, 212
21-8086	40	22-1442	57, 239	22-4550	113	22-9141	148, 212
21-8087	132, 577	22-1445	48, 368	22-4650	113	22-9142	148, 212
21-8088	132	22-1450	48, 368	22-5050	129	22-9143	148, 212
21-8089	132	22-1455	48, 368	22-6155	105, 375, 541	22-9144	148, 212
21-8090	132	22-1542	57, 239	22-6157	103, 345, 541, 548	22-9380	126
21-8092	132	22-1545	368	22-6160	88	22-9480	126
		22-1550	368	22-6162	104	23-1100	31, 47
		22-1555	48, 368	22-6260	91	23-1101	31, 47
		22-1556	50	22-6457	92	23-1102	31, 47, 537, 540, 571
		22-1567	50	22-6557	92		

# NUMERICAL INDEX



23-1104	31, 47	23-1266	27, 73	23-2608	36, 107	30-1080	172
23-1105	31, 47	23-1267	28, 73	23-2809	36, 111	30-1145	172
23-1106	31, 47, 536, 540, 545, 562, 571	23-1268	27, 73	23-2811	36, 111	30-1150	172
23-1112	31, 47	23-1270	27, 73	23-2819	36, 111	30-1155	172
23-1113	31, 47	23-1274	28, 73	23-2824	36, 110	30-1160	172
23-1114	31, 47	23-1278	28, 73	23-2826	36, 110	30-1170	172
23-1116	31, 47	23-1280	28, 28, 73, 545, 562	23-2828	36, 110	30-1180	172
23-1117	31	23-1290	33, 65	23-2830	36, 110	30-1450	172
23-1118	31, 47	23-1292	33, 65	23-2834	36, 110	30-1455	172
23-1124	31, 48	23-1294	33, 65	23-2836	36, 110	30-1460	172
23-1126	31, 48	23-1296	33, 65	23-2838	36, 110	30-1470	172
23-1128	31, 48	23-1300	33, 65	23-2840	36, 110	30-1480	172
23-1130	31, 48, 536	23-1302	33, 65	23-2851	38, 102, 345, 567	30-1502	172
23-1136	31, 48	23-1304	33, 65	23-2852	38, 102, 345	30-1504	172
23-1138	31, 48	23-1306	33, 65	23-2861	38, 103, 567	30-1506	172
23-1140	31, 48	23-2100	37, 82, 567	23-2862	38, 103	30-1508	172
23-1142	31, 48	23-2101	37, 82, 567	23-2864	38, 103	30-1510	172
23-1148	32, 55, 236	23-2105	37, 78, 567	23-2865	38, 103	30-1512	172
23-1149	32, 55, 236	23-2106	37, 78, 567	23-9250	39, 326	30-1514	172
23-1150	32, 55, 236	23-2107	37, 81	23-9251	39, 322	30-1518	172
23-1151	32, 55, 236	23-2108	37, 81	23-9255	39, 322	30-1520	172
23-1152	32, 56, 236	23-2110	37, 80, 540	23-9259	39, 322	30-1522	172
23-1153	32, 56, 236, 567	23-2111	37, 80	23-9273	39, 322	30-1524	172
23-1154	32, 56, 236	23-2112	37, 80	23-9275	39, 322	30-1526	172
23-1155	32, 56, 236, 567	23-2113	37, 80, 540	23-9276	39, 322	30-1528	172
23-1156	32, 58, 234	23-2120	45	23-9292	39, 325	30-1530	172
23-1157	32, 58, 234, 536	23-2124	45	24-1007	171	30-1545	172
23-1158	32, 57, 239, 545, 562	23-2125	45	24-1011	171	30-1550	172
23-1159	32, 57, 239	23-2128	46	24-1012	171	30-1555	172
23-1160	32, 58, 234	23-2130	45	24-1014	171	30-1560	172, 536-537
23-1161	234	23-2132	46	24-1016	171	30-1570	172
23-1162	32, 57, 239	23-2134	46	24-1018	171	30-1580	172
23-1163	32, 57, 239	23-2135	45	24-1018	171	30-1610	172
23-1164	31, 50, 468, 545, 562	23-2136	46	24-1022	171	30-1612	172
23-1165	31, 50, 468	23-2220	45	24-1116	171	30-1945	172, 538
23-1166	31, 50, 468, 537	23-2224	45	24-1150	123, 170	30-1950	172
23-1167	31, 50, 468, 537, 545, 562	23-2225	45	24-1250	170	30-1955	172, 538
23-1168	31, 50, 567	23-2228	46	24-1450	123, 170	30-1960	172, 536, 558
23-1169	31, 50	23-2230	45	24-1650	123, 170	30-1970	172, 542
23-1170	31, 50, 567	23-2232	46	24-1962	68, 168	30-1980	172
23-1171	31, 50	23-2234	46	24-1965	68	30-2010	172
23-1172	31, 51	23-2235	45	24-2047	171	30-2012	172
23-1173	31, 51	23-2236	46	24-2055	171	30-2145	172
23-1174	31, 51	23-2500	37, 82	24-2155	123, 544	30-2150	172
23-1175	31, 51, 567	23-2501	37, 82	24-2340	68, 169, 351	30-2155	172
23-1176	31, 51	23-2505	37, 79, 546	24-2341	68, 169, 351	30-2160	172
23-1177	31, 51	23-2506	37, 79, 546	24-2342	68, 169, 309, 351, 550-551	31-0001	433
23-1178	31, 51	23-2507	37, 81	24-2345	68, 169, 351	31-0002	433
23-1179	31, 51	23-2508	37, 81	24-2346	68, 169, 351	31-0003	433
23-1180	32, 52	23-2510	37, 80, 545, 562	24-2347	68, 169, 351	31-0004	432-433
23-1182	32, 52	23-2513	37, 80, 545, 562	26-1031	170	31-1001	432
23-1184	32, 52	23-2516	38, 86	26-1032	170	31-1004	432
23-1186	32, 52	23-2520	38, 86	26-1033	170	31-1007	432
23-1188	33, 63, 237	23-2521	38, 86, 558, 577-578	26-1280	169, 344, 560	31-1010	432-433
23-1189	33, 63, 237, 540	23-2525	38, 86, 580	26-1380	169, 344	31-1011	432-433
23-1190	33, 63, 237	23-2532	38, 83	26-1480	169, 344, 560	31-1015	432
23-1191	33, 64, 167, 237	23-2534	38, 83	26-1580	169, 344	31-1016	432
23-1193	33, 63	23-2538	38, 83	26-1585	170	31-1017	432
23-1194	33, 63	23-2542	38, 83	26-1586	170	31-1018	432
23-1195	33, 63	23-2552	38, 83	26-2005	170	31-1020	433
23-1196	33, 64	23-2554	38, 83	26-2006	170	31-1042	433
23-1199	33, 66	23-2560	38, 84	26-2007	170	31-2205	440
23-1200	33, 66	23-2561	38, 83	26-2009	170	31-2227	434, 442, 576
23-1202	33, 66	23-2563	38, 83	26-2010	170	31-2229	434
23-1203	33, 66	23-2568	38, 84	30-1030	184	31-2233	434
23-1250	29, 72	23-2577	38	30-1040	184	31-2235	434, 442, 576
23-1254	29, 72	23-2600	36, 106, 567	30-1045	172	31-2237	434, 442, 576
23-1260	27, 73	23-2602	36, 106, 540, 567	30-1050	172	31-2238	440
23-1262	27, 73	23-2603	36, 106, 567	30-1055	172	31-2238-45	440, 442, 575
23-1264	27, 73	23-2604	36, 107	30-1060	172, 558	31-2238OR	440
		23-2606	36, 107	30-1070	172	31-2239	440, 442, 576



31-2241.....	434	31-4562.....	439	31-9005.....	422	31-9065YC-45.....	428
31-2242.....	434, 437	31-4563.....	439	31-9005XC.....	422, 442, 576	31-9067.....	426
31-2243.....	434	31-4565.....	439, 442, 575	31-9005YC.....	422	31-9067YC.....	426, 442, 576
31-2244.....	434	31-7001XC.....	446	31-9010.....	422	31-9070.....	428
31-2253.....	434, 437	31-7002YC.....	446	31-9010-45.....	422	31-9070YC.....	428
31-2258.....	440	31-7007.....	447	31-9010XC.....	422, 442, 576	31-9075.....	428
31-2276.....	461	31-7007-45.....	447	31-9010XC-45.....	422	31-9075YC.....	428
31-2327.....	438	31-7012.....	447	31-9012.....	422	31-9080.....	427
31-2347.....	440	31-7012-45.....	447	31-9012-45.....	422	31-9080XC.....	427
31-2349.....	440	31-7012XC.....	448	31-9012XC.....	422	31-9080YC.....	427, 442, 576
31-2350.....	438	31-7016.....	447	31-9012XC-45.....	422, 442, 575	31-9085.....	427
31-2352.....	438	31-7016-45.....	447	31-9015.....	423	31-9085YC.....	427, 442, 576
31-2355.....	438, 442, 576	31-7030.....	447	31-9015-45.....	423	31-9090.....	429
31-2355-45.....	438	31-7030-45.....	447	31-9015XC.....	423, 442, 576	31-9090-45.....	429
31-2365.....	438	31-7030XC.....	448	31-9015XC-45.....	423	31-9090XC-45.....	429, 442, 575
31-2435.....	434	31-7035.....	447	31-9016.....	423	31-9090YC.....	429
31-2437.....	434	31-7035-45.....	447	31-9016XC.....	423	31-9095.....	429
31-2437-45.....	434	31-7040.....	447	31-9020.....	423	31-9095-45.....	429
31-2443.....	434	31-7040-45.....	447	31-9020XC.....	423	31-9095XC.....	429
31-2445.....	434	31-7055.....	447	31-9025.....	423	31-9095XC-45.....	429, 442, 575
31-2447.....	434	31-7055-45.....	447	31-9025XC.....	423, 442, 576	31-9095YC.....	429, 442, 576
31-2550.....	441	31-7055XC.....	448	31-9026.....	422	31-9095YC-45.....	429
31-2550-45.....	441	31-7055YC.....	448	31-9026XC.....	422	31-9096.....	425
31-2551.....	441	31-7061.....	447	31-9027.....	422	31-9096YC.....	425
31-2552.....	441, 442, 576	31-7061-45.....	447	31-9027XC.....	422	31-9097.....	429
31-2552-45.....	441	31-7070.....	447	31-9030.....	424	31-9097XC.....	429
31-2553.....	441	31-7070-45.....	447	31-9030-45.....	424	31-9097YC.....	429
31-4003.....	440	31-7073.....	447	31-9030XC.....	424, 442, 576	31-9098.....	429
31-4004.....	440	31-7073-45.....	447	31-9030XC-45.....	424, 442, 575	31-9098YC.....	429
31-4301.....	437	31-7107.....	447	31-9031.....	424	31-9100.....	427
31-4302.....	437	31-7107-45.....	447	31-9031XC.....	424	31-9100YC.....	427, 442, 576
31-4303.....	435	31-7200.....	449	31-9033.....	424	31-9105.....	426
31-4303XC.....	435	31-7205.....	449	31-9033XC.....	424	31-9105YC.....	426
31-4304.....	435	31-7210.....	449	31-9035.....	424	31-9110.....	430
31-4304XC.....	435	31-7215.....	449	31-9035XC.....	424, 442, 576	31-9110-45.....	430
31-4305.....	436	31-7220.....	449	31-9036.....	424	31-9110YC.....	430
31-4305XC.....	436	31-7225.....	449	31-9036XC.....	424	31-9110YC-45.....	430
31-4306.....	435	31-7230.....	449	31-9040.....	424	31-9111.....	425
31-4306XC.....	435	31-7235.....	449	31-9040XC.....	424, 442, 576	31-9111YC.....	425
31-4307.....	435	31-7240.....	449	31-9042.....	429	31-9112.....	426
31-4307XC.....	435	31-7245.....	449	31-9042XC.....	429	31-9112YC.....	426
31-4308.....	436	31-7250.....	449	31-9043.....	425	31-9113.....	425
31-4308YC.....	436	31-7255.....	449	31-9043XC.....	425	31-9113YC.....	425
31-4309.....	435	31-7260.....	449	31-9045.....	425	31-9115.....	430
31-4309XC.....	435	31-7300.....	443	31-9045XC.....	425	31-9115-45.....	430
31-4310.....	435	31-7301.....	443	31-9045YC.....	425	31-9115XC.....	430
31-4310XC.....	435	31-7302.....	443	31-9046.....	430	31-9115YC.....	430
31-4311.....	436	31-7303.....	443	31-9046XC.....	430	31-9115YC-45.....	430
31-4311XC.....	436	31-7305.....	444	31-9047.....	430	31-9120.....	424
31-4312.....	436	31-7306.....	444	31-9047XC.....	430	31-9120XC.....	424
31-4312YC.....	436	31-7307.....	444	31-9050.....	427	31-9125.....	424
31-4313.....	436	31-7308.....	444	31-9050-45.....	427	31-9125-45.....	424
31-4313YC.....	436	31-7309.....	444	31-9050XC.....	427	31-9125XC.....	424, 442, 576
31-4314.....	435	31-7310.....	444	31-9050YC.....	427, 442, 576	31-9125XC-45.....	424
31-4314YC.....	435	31-7311.....	444	31-9050YC-45.....	427	31-9128.....	425
31-4315.....	435	31-7312.....	444	31-9051.....	427	31-9128XC.....	425
31-4315XC.....	435	31-7313.....	444	31-9051YC.....	427, 442, 576	31-9130.....	425
31-4316.....	435	31-7314.....	444	31-9051YC-45.....	427	31-9130XC.....	425, 442, 576
31-4316XC.....	435	31-7315.....	444	31-9055.....	427	31-9135.....	425
31-4317.....	436	31-7316.....	444	31-9055YC.....	427	31-9135XC.....	425, 442, 576
31-4317YC.....	436	31-7317.....	444	31-9060.....	428	31-9140.....	426
31-4318.....	437	31-7318.....	444	31-9060-45.....	428	31-9140-45.....	426
31-4320.....	437	31-7319.....	444	31-9060YC.....	428, 442, 576	31-9140XC.....	426
31-4321.....	437	31-7320.....	444	31-9060YC-45.....	428	31-9140YC.....	426, 442, 576
31-4323.....	433	31-7321.....	445	31-9061.....	428	31-9140YC-45.....	426
31-4324.....	433	31-7322.....	445	31-9061YC.....	428	31-9142.....	428
31-4325.....	437	31-7323.....	445	31-9065.....	428	31-9142XC.....	428
31-4326.....	437	31-7324.....	445	31-9065-45.....	428	31-9144.....	426
31-4327.....	437	31-9001XC.....	431	31-9065XC.....	428	31-9144YC.....	426
31-4328.....	433	31-9002XYC.....	431	31-9065XC-45.....	428	31-9145.....	426
31-4329.....	433	31-9002YC.....	431	31-9065YC.....	428	31-9145YC.....	426

NUMERICAL INDEX



31-9150	431	34-1014	162	36-2990	88	40-1775	310, 348, 553
31-9150-45	431	34-1017	162	36-2995	88	40-1778	310, 348
31-9155	431	34-1410	162	36-3180	88	40-1790	297
31-9155-45	431	34-1414	162, 574	36-3195	88	40-1915	313, 348
31-9160	431	34-1417	162	36-3210	88	40-1916	313, 348
31-9360AX	436	34-1418	162	36-3310	88	40-1917	313, 348
31-9362AX	436	34-1420	162	36-3510	91	40-1918	313, 348
31-9364AX	436	34-1422	162	36-3590	88	40-1919	313, 348
31-9400	421	34-1424	162	36-3610	559	40-2085	297
31-9401	421	34-1428	162	36-3690	88	40-2275	297, 346, 553, 555
31-9402	421	34-2023	154, 571	36-4082	88	40-2276	305
31-9403	421	34-2230	154	36-4180	91	40-2285	296
31-9404	420	34-2232	572	36-4280	92	40-2290	301, 555
31-9405	421	34-2422	162	36-4311	92	40-2313	295
31-9406	421	34-2428	162	36-4313	92	40-2413	295
31-9407	421	34-2434	162	36-4320	92	40-2417	295
31-9408	421	34-2438	162	36-4411	91	40-2418	295
31-9409	421	34-2522	162	36-4490	90	40-2480	295, 343, 553
31-9410	421	34-2526	162	36-7010	92	40-2485	295, 343, 553
31-9411	420	34-2536	162	40-1010	311	40-2580	296, 343
31-9412	420	34-3620	162	40-1018	309	40-2585	296, 343
31-9415	420	34-3624	162	40-1023	309, 350	40-2590	296
31-9416	420	34-3626	162	40-1024	309, 350, 580	40-2595	296
31-9417	420	34-3628	162	40-1045	309, 350	40-2598	296
31-9418	420	36-1290	113	40-1048	309, 350	40-2599	296
32-1014	174	36-1362	89	40-1465	311, 347	40-2600	296
32-1015	174	36-1662	105, 375, 536, 542	40-1475	311, 347	40-2640	306
32-1016	174	36-1677	105, 375, 536, 542, 575, 579	40-1478	311, 347	40-2642	306
32-1037	175	36-1692	105, 375	40-1520	311	40-2650	298, 346
32-1040	175	36-1695	461	40-1530	311	40-2655	298, 346
32-1530	173	36-1697	461	40-1535	313, 347	40-2660	298, 555
32-1533	173	36-1765	101	40-1545	313, 347	40-2665	306
32-1534	173	36-1860	101	40-1562	313, 347	40-2670	297, 346, 553
32-1535	173	36-1865	104	40-1565	313, 347	40-2672	297
32-1536	173	36-1960	101	40-1566	313, 347	40-2675	297, 346
32-1537	173	36-1975	101	40-1567	313, 347	40-2678	298
32-1538	173	36-2060	102, 345, 539, 555	40-1568	313, 347	40-2705	297
32-1539	173	36-2160	102, 345, 536-537, 542-543, 550-551, 553, 561, 566, 574, 577-580	40-1569	313, 347	40-2708	296
32-1610	173	36-2260	102, 345, 538, 544, 556-559	40-1571	313	40-2810	295
32-1611	173	36-2265	461	40-1572	313	40-2820	295
32-1785	90, 173	36-2275	102, 345, 461, 536, 539, 543, 552-554, 571, 574, 579, 580	40-1580	313, 347	40-2830	295
32-1850	93	36-2280	96, 345, 373	40-1582	313, 347	40-2835	295
32-1870	90, 173	36-2295	103, 345, 373, 571, 573	40-1584	313, 347	40-2921	294, 343
32-1875	88, 173	36-2298	96, 345, 373, 560	40-1590	313, 347	40-2922	294, 343, 553
32-1890	88, 173	36-2380	101, 572	40-1591	313, 347	40-2923	294, 343
32-1990	88, 173	36-2385	96, 345, 373	40-1592	313, 347	40-2925	294, 343, 553
32-2070	88, 173	36-2390	461	40-1593	313, 347	40-2927	294, 343
32-2075	89, 173	36-2391	461	40-1594	313, 347	40-2928	294, 343
32-2090	88	36-2392	461	40-1595	313, 347	40-3040	335
32-2175	89, 173	36-2393	461	40-1596	313, 347	40-3050	317
32-2465	175	36-2477	104	40-1640	312	40-3052	317
32-2470	175, 486	36-2577	104, 175	40-1642	312	40-3055	272, 336, 557
32-2477	175, 486	36-2578	579, 580	40-1644	312	40-3077	272, 336, 557
32-2782	89	36-2595	104, 175	40-1645	312	40-3087	272, 336
32-2785	89	36-2607	175	40-1650	347	40-3155	272, 336
32-2880	89	36-2660	461	40-1715	309, 348	40-3167	272, 336
32-2980	89	36-2661	461	40-1720	310, 349	40-3177	272, 336, 553
32-3092	174	36-2662	461	40-1725	310, 350	40-3187	272, 336
32-3094	174	36-2663	461	40-1727	169	40-3188	276, 554
32-3096	174	36-2690	83	40-1730	310	40-3190	277, 338
32-3098	174	36-2710	83	40-1735	310	40-3192	277, 338
32-3194	174	36-2712	83, 461	40-1738	310	40-3196	337, 613
33-1001	89, 176	36-2714	461	40-1740	166	40-3198	337, 613
33-1002	89, 176	36-2790	83, 577, 580	40-1744	349	40-3200	338
33-1003	89, 176	36-2810	83	40-1745	349	40-3202	338
33-1004	89, 176	36-2812	83, 461	40-1750	312	40-3206	277, 338
33-1090	91, 176	36-2814	461	40-1752	312	40-3208	277, 338
33-1190	91, 176	36-2890	88	40-1754	312	40-3480	276
33-1290	176	36-2895	88	40-1762	309, 350	40-3570	275
33-1375	92, 176			40-1765	312	40-3670	275, 556
33-1376	92			40-1766	312	40-3710	272, 553, 556



40-3810	272, 557	40-6026	288	40-6550	195, 285, 340	40-6775	284
40-3910	273, 556	40-6028	288	40-6552	195, 285, 340	40-6776	284
40-3985	273, 554, 556	40-6038	563, 565	40-6560	285	40-6777	284
40-4085	273, 554, 557	40-6056	288	40-6561	285	40-6781	284
40-4086	274	40-6060	288	40-6562	285	40-6782	284
40-4090	273, 556	40-6072	288	40-6563	285	40-6783	284
40-4092	273, 556-557	40-6074	288	40-6564	285	40-6784	284
40-4095	273, 557	40-6076	288	40-6565	285	40-6785	284
40-4097	273	40-6078	288	40-6567	285	40-6786	284
40-4098	273	40-6079	288	40-6570	285	40-6787	284
40-4100	273	40-6080	288	40-6571	285	40-6791	284
40-4102	273	40-6082	288	40-6572	285	40-6792	284
40-4104	273	40-6084	288	40-6573	285	40-6793	284
40-4110	273	40-6085	288	40-6574	285	40-6794	284
40-4112	273	40-6086	288	40-6575	285	40-6795	284
40-4114	273	40-6088	288	40-6577	285	40-6796	284
40-4125	274	40-6092	288	40-6622	569	40-6797	284
40-4190	274	40-6093	288	40-6624	285, 340, 569	40-6799	284
40-4192	274	40-6106	284	40-6625	285, 340	40-6800	284
40-4194	274	40-6112	284	40-6626	285, 340	40-6801	284
40-4265	274, 338	40-6118	284	40-6628	285, 340	40-6802	284
40-4268	275, 557	40-6206	284	40-6630	285, 340	40-6803	284
40-4270	275, 553, 568	40-6212	284	40-6632	285, 340	40-6804	284
40-4272	274, 338, 553	40-6218	284	40-6636	285, 340	40-6805	284
40-4360	274, 338	40-6306	284	40-6639	285, 340	40-6828	286
40-4365	274, 338	40-6312	284	40-6642	285, 340	40-6829	286
40-4372	274, 338	40-6318	284	40-6645	285, 340	40-6830	286
40-4472	274, 338	40-6330	285	40-6666	286, 554	40-6831	286
40-4512	274, 338	40-6331	285	40-6667	286, 553-554	40-6832	286
40-4560	272, 336	40-6332	285	40-6668	286, 553-554	40-6833	286
40-4562	272, 336	40-6333	285	40-6669	286	40-6835	286
40-4572	272, 336	40-6334	285	40-6670	286	40-6836	286
40-4575	272, 336	40-6335	285	40-6671	286	40-6837	286
40-5210	307	40-6336	285	40-6672	286	40-6838	286
40-5212	307	40-6337	285	40-6673	286	40-6839	286
40-5213	307	40-6338	285	40-6674	286	40-6843	286
40-5215	307	40-6339	285	40-6675	286	40-6844	286
40-5218	307	40-6340	285	40-6680	286	40-6845	286
40-5311	307	40-6341	285	40-6681	286	40-6846	286
40-5395	308, 343	40-6450	194	40-6682	286	40-6847	286
40-5520	308, 557	40-6451	194	40-6683	286	40-6848	286
40-5535	308	40-6452	194	40-6684	286	40-6849	286
40-5540	308	40-6453	194	40-6685	286	40-6850	286
40-5542	308	40-6454	194	40-6686	286	40-6851	286
40-5543	308	40-6455	194	40-6687	286	40-6852	286
40-5544	308	40-6456	194	40-6688	286	40-6853	286
40-5546	308	40-6500	563	40-6689	286	40-6855	299, 554
40-5551	308, 557	40-6502	563	40-6701	286	40-6857	557
40-5665	339	40-6514	285	40-6711	286, 553	40-6914	299
40-5672	290, 339	40-6516	285	40-6715	286, 553	40-6920	287
40-5700	563	40-6518	285	40-6716	286	40-6921	287
40-5765	290, 339, 554	40-6520	285	40-6717	286	40-6922	287
40-5769	563, 569	40-6522	285	40-6723	286	40-6923	287
40-5780	553	40-6524	285	40-6724	286	40-6953	286, 340
40-5870	290, 339, 549	40-6525	285	40-6725	286	40-6954	286, 340
40-5871	290, 339	40-6528	285	40-6726	286	40-6956	286, 340
40-5875	290, 339	40-6529	285	40-6728	286	40-6958	286, 340
40-5885	290	40-6530	285	40-6731	286	40-6970	286, 340
40-5910	290	40-6532	195, 285, 340	40-6732	286	40-6973	286, 340
40-5925	290, 339	40-6533	195, 285, 340	40-6733	286	40-6976	286, 340
40-5926	290, 339	40-6534	195, 285, 340	40-6734	286	40-6979	286, 340
40-5960	563	40-6535	195, 285, 340	40-6735	286	40-6984	286, 340
40-5961	563	40-6536	195, 285, 340, 569	40-6736	286	40-6986	286, 340
40-5990	563, 565	40-6537	195, 285, 340	40-6737	286	40-6990	286, 340
40-6011	284	40-6538	195, 285, 340	40-6738	286	40-6993	286, 340
40-6012	284	40-6540	195, 285, 340, 565	40-6739	286	40-6996	286, 340
40-6013	284	40-6542	195, 285, 340	40-6740	286	40-6999	286, 340
40-6014	284	40-6544	195, 285, 340	40-6771	284	40-7000	293, 342, 556
40-6020	288	40-6545	195, 285, 340	40-6772	284	40-7070	569
40-6022	288	40-6548	195, 285, 340	40-6773	284	40-7071	569
40-6024	288	40-6549	195, 285, 340	40-6774	284	40-7100	293, 342, 556

# NUMERICAL INDEX



40-7110.....	293, 342, 556	40-7356.....	293	40-8137.....	293	41-1200.....	188
40-7111.....	293, 342, 556	40-7357.....	293	40-8138.....	293	41-1230.....	563
40-7112.....	293, 342, 556	40-7358.....	293	40-8175.....	300	41-1235.....	191, 549, 563, 565, 568
40-7113.....	293, 342, 556	40-7360.....	289	40-8238.....	300	41-1240.....	192, 549, 563
40-7114.....	293, 342, 556	40-7362.....	289	40-8250.....	300, 555	41-1245.....	192, 549, 565
40-7115.....	293, 342, 556	40-7364.....	289	40-8252.....	300	41-1250.....	192
40-7116.....	293, 342, 556	40-7366.....	289	40-8255.....	300	41-1255.....	191, 549, 563
40-7118.....	293, 342	40-7368.....	289	40-8265.....	299	41-1260.....	194
40-7120.....	293, 342	40-7370.....	289	40-8270.....	303	41-1262.....	194
40-7140.....	568	40-7372.....	289	40-8272.....	303, 555	41-1264.....	194
40-7141.....	568	40-7376.....	289	40-8275.....	304, 331	41-1266.....	194
40-7142.....	568	40-7380.....	192	40-8280.....	299	41-1270.....	194
40-7143.....	568	40-7381.....	192	40-8282.....	299	41-1272.....	194
40-7144.....	568	40-7382.....	192	40-8284.....	299	41-1274.....	194
40-7145.....	568	40-7383.....	192	40-8375.....	304, 331	41-1276.....	194
40-7146.....	568	40-7400.....	303, 553, 555	40-8675.....	303	41-1300.....	194, 563
40-7147.....	568	40-7401.....	303	40-8775.....	303	41-1305.....	194
40-7148.....	568	40-7402.....	303, 553, 555, 557	40-8962.....	301	41-1310.....	194
40-7149.....	568	40-7404.....	303, 557	40-9070.....	301	41-1318.....	563
40-7165.....	294, 341	40-7406.....	303, 557	40-9075.....	302	41-1320.....	308
40-7199.....	293, 342	40-7410.....	303, 341	40-9160.....	302	41-1326.....	563
40-7200.....	293, 342	40-7415.....	303, 341	40-9260.....	302	41-1330.....	194, 563
40-7201.....	293, 342	40-7420.....	303, 341	40-9265.....	304, 331	41-1332.....	194
40-7202.....	293, 342	40-7430.....	303	40-9280.....	191	41-1338.....	196
40-7203.....	293, 342	40-7435.....	303	40-9340.....	568	41-1340.....	195, 549, 563
40-7204.....	293, 342	40-7440.....	303	40-9341.....	568	41-1342.....	195, 563
40-7205.....	293, 342	40-7445.....	303	40-9342.....	568	41-1344.....	195, 563
40-7206.....	293, 342	40-7447.....	300, 341	40-9365.....	304, 331, 553	41-1346.....	195, 563
40-7207.....	293, 342	40-7448.....	300, 341	40-9370.....	301	41-1348.....	195, 563
40-7208.....	293, 342	40-7450.....	300, 341	40-9613.....	299	41-1350.....	194, 287, 563
40-7209.....	293, 342	40-7451.....	300, 341, 554	40-9685.....	291, 334, 555	41-1355.....	194, 287, 563
40-7210.....	293, 342	40-7452.....	300, 341	40-9686.....	197, 291, 334	41-1360.....	194, 287, 563
40-7219.....	293, 342	40-7453.....	300, 341, 554	40-9688.....	197, 291, 334, 563, 565	41-1361.....	196
40-7220.....	293, 342	40-7454.....	300, 341	40-9692.....	563	41-1362.....	196
40-7221.....	293, 342	40-7455.....	300, 341, 554	40-9693.....	563	41-1363.....	196
40-7222.....	293, 342	40-7456.....	300, 341	40-9812.....	292, 557	41-1365.....	195
40-7223.....	293, 342	40-7458.....	300, 341	40-9815.....	197, 291, 334, 549, 563	41-1366.....	195
40-7224.....	293, 342	40-7470.....	191	40-9816.....	563	41-1367.....	195
40-7225.....	293, 342	40-7472.....	191	40-9820.....	197, 291, 334	41-1368.....	195
40-7226.....	293, 342	40-7474.....	192	40-9825.....	197, 291, 334, 540, 549, 563	41-1370.....	194, 549, 563
40-7227.....	293, 342	40-7476.....	192	40-9835.....	563	41-1372.....	194
40-7228.....	293, 342	40-7478.....	192	40-9837.....	563	41-1374.....	194
40-7229.....	293, 342	40-7480.....	192	40-9840.....	196, 563	41-1376.....	194
40-7230.....	293, 342	40-7482.....	192	40-9841.....	196, 549, 563	41-1380.....	209
40-7244.....	569	40-7484.....	192	40-9841.....	196, 549, 563	41-1382.....	209, 549
40-7250.....	294, 341	40-7486.....	192	41-1050.....	60, 548	41-1383.....	210, 549
40-7265.....	294, 341	40-7620.....	560	41-1054.....	60, 548	41-1385.....	209, 549, 563
40-7280.....	294, 341	40-7630.....	560	41-1058.....	60	41-1395.....	149, 209, 563, 568
40-7282.....	294	40-7632.....	560	41-1060.....	60	41-1396.....	149, 209, 549, 563
40-7283.....	294	40-8100.....	293	41-1076.....	61	41-1398.....	209, 549
40-7284.....	294	40-8101.....	293	41-1077.....	61	41-1401.....	210, 563
40-7285.....	294	40-8102.....	293	41-1078.....	61	41-1402.....	147, 210, 563
40-7286.....	294	40-8103.....	293	41-1079.....	61	41-1403.....	147, 210, 564
40-7287.....	294	40-8104.....	293	41-1100.....	61	41-1404.....	564
40-7288.....	294	40-8105.....	293	41-1105.....	61, 566	41-1407.....	564
40-7330.....	293	40-8106.....	293	41-1120.....	60, 555	41-1410.....	146, 207, 548, 564
40-7331.....	293	40-8107.....	293	41-1125.....	60	41-1412.....	565
40-7332.....	293	40-8108.....	293	41-1140.....	305	41-1470.....	568
40-7333.....	293	40-8110.....	293	41-1145.....	563	41-1471.....	568
40-7334.....	293	40-8111.....	293	41-1163.....	168	41-1710.....	293, 342
40-7335.....	293	40-8112.....	293	41-1165.....	62	41-1711.....	293, 342
40-7336.....	293	40-8113.....	293	41-1167.....	61	41-1712.....	293, 342
40-7337.....	293	40-8114.....	293	41-1168.....	61	41-1713.....	293, 342
40-7338.....	293	40-8115.....	293	41-1169.....	61, 549	41-1714.....	293, 342
40-7349.....	289	40-8116.....	293	41-1170.....	335	41-1715.....	293, 342
40-7350.....	293	40-8117.....	293	41-1175.....	272, 335	41-1716.....	293, 342
40-7351.....	293	40-8118.....	293	41-1190.....	188	41-1717.....	293, 342
40-7352.....	293	40-8130.....	293	41-1192.....	188, 563	41-1718.....	293, 342
40-7353.....	293	40-8131.....	293	41-1194.....	188	41-1719.....	293, 342
40-7354.....	293	40-8132.....	293	41-1196.....	188	41-1720.....	293, 342
40-7355.....	293	40-8136.....	293	41-1198.....	188, 548, 549	41-1973.....	294





41-1974	294	42-3463	277	45-6212	319	47-1340	56
41-1975	294	42-3464	277	45-6214	319	47-1345	54
42-1247	140	42-3465	277	45-6216	319	47-1360	51, 539, 544, 560
42-1420	153, 298, 349	42-3573	278	45-6218	319	47-1440	56, 236
42-1421	298, 349	42-3574	277	45-6220	319	47-1441	55, 236
42-1422	298, 349	42-3575	277	45-6222	319	47-1442	55, 236
42-1425	153, 298, 349	42-3920	279	45-6224	319	47-1447	106, 536-537, 545, 558-559, 562, 564-566
42-1510	138	42-3921	279	45-6226	319	47-1448	108
42-1511	137	42-3922	279	45-6240	319	47-1450	107
42-1610	138	42-3925	279	45-6242	319	47-1470	112, 379
42-1611	137	42-3926	279	45-6244	319	47-2047	107, 539, 541, 544
42-1654	137, 208	42-3927	279	45-6246	319	47-2049	107
42-1655	137, 208, 282	42-4000	280	45-6248	319	47-2147	107, 536, 539, 541, 544, 565
42-1656	137, 208	42-4001	280	45-6250	319	47-2148	106
42-1657	137, 208	42-4002	280	45-6252	319	47-2255	305
42-1764	137, 208	42-4005	280	45-6254	319	47-2256	305
42-1765	137, 208, 553	42-4006	280	45-6256	319	47-2257	305
42-1766	137, 208	42-4007	280	45-6260	320	47-2258	305
42-1767	137, 208	42-4010	280	45-6266	320	47-2259	305
42-1775	138	42-4011	280	45-6268	320	47-2262	304
42-1785	138	42-4012	280	45-6272	320	47-2360	304
42-1792	560	42-4015	280	45-6274	320	47-2372	568
42-1820	208	42-4016	280	45-6276	320	47-2380	205, 304, 331, 540, 549-551, 555, 564, 567, 569
42-1822	208	42-4017	280	47-1030	560	47-2382	205, 558
42-1824	208, 550	42-4020	281	47-1040	560	47-2385	192, 564
42-1826	208	42-4022	281	47-1042	560	47-2388	192
42-1828	208	42-4024	281	47-1047	49, 545, 562	47-2389	564
42-1865	137, 574, 581	45-6050	321	47-1048	49	47-2447	107
42-1875	137, 580	45-6052	321	47-1049	49	47-2455	275
42-1895	137	45-6054	321	47-1058	49, 548	47-2462	143
42-1965	137, 553-554	45-6056	321	47-1059	49	47-2465	275, 337
42-1975	137, 556	45-6058	321	47-1060	49	47-2466	275, 337
42-1995	137	45-6060	321	47-1068	49, 545, 562	47-2467	275, 337
42-2085	145, 283, 491	45-6062	321	47-1069	49	47-2468	275, 337
42-2092	145, 283, 491	45-6064	321	47-1070	49	47-2480	276
42-2095	145, 283, 491, 559	45-6066	321	47-1071	49	47-2500	149, 212, 538, 542, 548-551, 557, 567
42-2130	301	45-6068	321	47-1072	49	47-2502	149, 212, 544, 548, 558, 561, 564-565, 567
42-2140	301	45-6070	321	47-1075	49	47-2505	149, 212, 544, 549, 561, 564-565
42-2255	278	45-6080	319	47-1080	49	47-2507	149, 212, 548, 551, 564
42-2355	278	45-6082	319	47-1081	49	47-2510	149, 212, 559, 564-566, 569
42-2680	278	45-6084	319	47-1084	58	47-2512	149, 212
42-2850	279	45-6086	319	47-1086	60	47-2514	209
42-2851	279	45-6088	319	47-1087	60	47-2516	209
42-2852	279	45-6089	319	47-1088	61	47-2535	560
42-2855	279	45-6090	319	47-1089	61	47-2550	150
42-2856	279	45-6092	319	47-1090	61	47-2552	560
42-2857	279	45-6094	319	47-1091	61	47-2555	150, 212
42-3150	279, 556	45-6096	319	47-1135	55, 236, 546, 549	47-2556	150, 212
42-3152	279	45-6098	319	47-1140	55, 236	47-2558	561
42-3154	279	45-6100	319	47-1143	55, 236	47-2570	149, 212, 544, 549, 568
42-3156	279, 556	45-6102	319	47-1144	55, 236	47-2572	149, 212, 544, 558, 577
42-3158	279, 556	45-6104	319	47-1145	55, 236, 539, 544-545, 547, 550, 559, 561, 567	47-2647	144
42-3160	279, 556	45-6112	319	47-1146	59	47-2650	149, 212, 226
42-3416	277	45-6114	319	47-1147	59, 566	47-2651	149, 212, 226
42-3417	277	45-6116	319	47-1148	21	47-2655	149, 538, 558, 577
42-3418	277, 556	45-6118	319	47-1173	109	47-2752	149
42-3425	277	45-6120	319	47-1175	109	47-2758	149
42-3427	277	45-6122	319	47-1180	109, 580	47-2760	149, 564
42-3429	277, 556	45-6124	319	47-1186	109	47-2832	138, 550-551
42-3430	277	45-6126	319	47-1235	55, 236, 544, 545, 546	47-2834	138, 545, 562
42-3431	277	45-6128	319	47-1240	55, 236	47-2836	138
42-3432	277	45-6140	319	47-1243	55, 236	47-2837	127
42-3435	278	45-6142	319	47-1244	55, 236	47-2838	138
42-3436	278	45-6144	319	47-1245	55, 236, 539, 545, 550, 559, 561, 568	47-2852	127, 558, 574, 577, 579
42-3437	278	45-6146	319	47-1246	56, 236, 539	47-2913	138, 207, 219, 270
42-3438	278	45-6148	319	47-1247	59	47-2925	127
42-3441	277	45-6150	319	47-1248	56, 236, 539		
42-3442	277	45-6152	319	47-1250	59, 238		
42-3453	277	45-6154	319	47-1255	59, 238		
42-3454	277	45-6156	319				
42-3455	277	45-6210	319				

# NUMERICAL INDEX



47-2927	127	48-774	613	49-0965	589	49-2130	606
47-2930	127	48-785	613	49-0970	589	49-2135	606
47-2935	127, 539-540, 544, 546-548, 550-551, 553-554, 561, 565-567	48-796	605	49-1005	603	49-2140	607
47-2937	123	48-835	605	49-1030	603	49-2145	607
47-3050	104	48-922	600	49-1050	590	49-2150	607
47-2955	127, 536-537, 539, 542-543, 545, 552-557, 566-567, 570-572, 574, 578-580	49-0100	582	49-1055	590	49-2155	607
47-2960	127	49-0101	582	49-1060	590	49-2160	607
47-3040	127	49-0105	582	49-1065	590	49-2165	607
47-3057	127	49-0110	582	49-1070	590	49-2170	607
47-3403	305	49-0115	582	49-1215	591	49-2175	607
47-3404	305	49-0120	582	49-1220	591	49-2180	607
47-3405	305	49-0125	582	49-1225	591	49-2185	607
47-3406	305	49-0130	583	49-1230	591	49-2190	607
47-3407	305	49-0135	583	49-1235	591	49-2195	607
47-3415	306, 555	49-0140	583	49-1250	591	49-2200	607
47-3418	306	49-0145	583	49-1255	591	49-2205	608
47-3420	306, 555	49-0150	583	49-1260	591	49-2205	608
47-3422	306, 555	49-0155	583	49-1280	592	49-2210	608
47-3424	306, 555	49-0200	584	49-1285	592	49-2215	608
47-3510	305	49-0205	584	49-1290	592	49-2220	608
48-109	612	49-0210	584	49-1295	592	49-2225	608
48-128	603	49-0215	584	49-1300	592	49-2230	608
48-130	587	49-0220	584	49-1310	593	49-2235	608
48-202	603	49-0225	584	49-1310	593	49-2240	608
48-204	612	49-0230	584	49-1320	592	49-2245	608
48-226	611	49-0235	584	49-1325	592	49-2250	608
48-228	591	49-0240	584	49-1350	593	49-2255	608
48-236	603	49-0245	584	49-1355	593	49-2260	608
48-252	612	49-0250	584	49-1360	593	49-2265	608
48-264	611	49-0255	583	49-1365	593	49-2270	608
48-274	590	49-0260	583	49-1370	593	49-2275	609
48-276	611	49-0265	583	49-1590	603	49-2280	609
48-278	590	49-0270	583	49-1605	603	49-2285	609
48-282	590	49-0275	583	49-1700	603	49-2290	609
48-288	590	49-0400	585	49-1705	603	49-2295	609
48-289	611	49-0455	585	49-1710	604	49-2300	609
48-296	590	49-0460	585	49-1720	604	49-2305	609
48-315	604	49-0465	585	49-1750	604	49-2310	609
48-318	604	49-0470	585	49-1755	604	49-2400	610
48-321	583	49-0475	585	49-1760	604	49-2405	610
48-322	604	49-0480	585	49-1765	604	49-2410	610
48-327	612	49-0485	585	49-1770	604	49-2415	610
48-339	611	49-0490	585	49-1800	594	49-2420	610
48-350	604	49-0495	585	49-1805	594	49-2425	610
48-355	605	49-0500	585	49-1810	594	49-2430	610
48-356	605	49-0600	586	49-1815	594	49-2435	610
48-363	612	49-0605	586	49-1820	594	49-2440	610
48-375	613	49-0610	586	49-1825	594	49-2445	610
48-378	603	49-0615	586	49-1830	594	49-2450	610
48-388	603	49-0620	586	49-1835	594	49-2455	610
48-422	593	49-0625	586	49-1840	594	49-2460	610
48-424	592	49-0630	586	49-1905	604	49-2600	595
48-428	592	49-0635	586	49-1915	605	49-2605	595
48-434	586	49-0640	587	49-1930	605	49-2610	595
48-472	587	49-0645	587	49-1935	605	49-2615	595
48-489	613	49-0650	587	49-1940	605	49-2620	595
48-507	605	49-0655	587	49-1990	605	49-2625	595
48-524	594	49-0660	587	49-2000	605	49-2630	595
48-526	594	49-0665	587	49-2005	605	49-2635	596
48-533	605	49-0670	587	49-2040	605	49-2640	596
48-538	594	49-0675	587	49-2045	605	49-2645	596
48-542	593	49-0825	588	49-2050	605	49-2650	596
48-561	587	49-0835	588	49-2080	606	49-2655	596
48-572	593	49-0840	588	49-2085	606	49-2660	596
48-738	605	49-0900	589	49-2090	606	49-2665	596
48-752	611	49-0905	589	49-2095	606	49-2670	596
48-761	613	49-0940	589	49-2100	606	49-2675	596
		49-0945	589	49-2105	606	49-2700	597
		49-0950	589	49-2110	606	49-2705	597
		49-0955	568, 589	49-2115	606	49-2710	597
		49-0960	589	49-2120	606	49-2715	597
				49-2125	606	49-2720	597



49-2725	597	49-4355	612	50-3970	348	52-1904	519
49-2730	597	49-4360	612	50-4157	171	52-1906	519
49-2800	598	49-4365	612	50-4190	171	52-1910	519
49-2805	598	49-4370	612	50-4200	171	52-1912	519
49-2810	598	49-4430	612	50-4202	171	52-1920	520
49-2815	598	49-4440	613	50-4292	93	52-1975	501
49-2820	598	50-1080	276	50-4392	171	52-1980	501, 580
49-2825	598	50-1280	143, 201, 492	50-4462	54	52-2073	580
49-2830	598	50-1290	143, 201, 542, 558, 567, 574, 578-580	50-4562	54, 369, 469	52-2080	501
49-2835	598			50-4563	469	52-2082	501
49-2840	598	50-1301	211	50-4655	62	52-2178	503
49-2845	598	50-1302	211	50-4662	54, 369, 469	52-2380	521
49-2870	598	50-1303	211	51-1446	34, 125	52-2382	521
49-2875	598	50-1304	211	51-1447	34, 125, 564, 569	52-2385	520
49-2880	598	50-1305	211	51-1448	34, 108	52-2800	529
49-2885	598	50-1307	544	51-3049	34, 125	52-2802	529, 577
49-2905	597	50-1355	87, 540	51-3050	34, 125	52-2804	529
49-2910	597	50-1357	87	51-3051	34, 125	52-2810	529
49-2930	599	50-1369	561	51-3447	34, 125, 558, 569	52-2812	529
49-2940	599	50-1372	85, 478, 545, 562	51-3448	34, 125	52-2814	529
49-2945	599	50-1472	85, 478, 545, 554, 558, 562, 574, 578, 580	51-3460	34, 125	52-2820	529
49-2950	599			51-3480	34, 125	52-2822	529
49-2955	599	50-1574	85, 478	51-4235	568	52-2824	529
49-2960	599	50-1585	150, 580	51-4239	568	52-2825	69, 528
49-2965	599	50-1685	150	51-4240	568	52-2845	69, 528, 580
49-2970	599	50-1790	149	51-4242	568	52-2860	69, 528
49-2975	599	50-1950	155, 211	51-4244	568	52-2885	530
49-3000	600	50-1953	154, 550-551, 559, 567	51-4360	34, 125	52-2888	530
49-3005	600	50-1955	154, 550-551, 559, 567	51-4370	34, 125, 577	52-2970	52, 574
49-3010	600	50-1957	154, 550, 551, 567	51-4382	34, 125, 577	52-2979	52, 459
49-3015	600	50-1982	155, 184	51-4395	34, 125	52-2980	52, 459
49-3020	600	50-1985	155, 184	51-4398	35, 564	52-2985	70
49-3025	600	50-2006	154, 540	51-4450	35	52-3225	529
49-3055	600	50-2007	154, 548, 550, 559, 567	51-4451	35	52-3245	529
49-3060	601	50-2008	154, 537, 551, 553, 555, 561, 566-567, 577, 580	52-1080	127	52-3260	529
49-3065	601			52-1277	144, 492	52-3270	114, 493, 496
49-3080	601	50-2009	154, 551	52-1390	518	52-3282	114, 493, 496
49-3081	601	50-2010	154, 543, 551, 553	52-1415	115, 517	52-3290	529
49-3082	601	50-2011	154	52-1416	115, 517	52-3295	529
49-3083	601	50-2012	154, 543, 545, 554, 562	52-1417	517	52-3310	114, 493, 496, 579
49-3084	601	50-2014	154	52-1420	115, 517	52-3312	114, 460, 493, 496
49-3085	601	50-2106	154	52-1421	115, 517	52-3314	460
49-3086	601	50-2108	154	52-1422	115, 517	52-3370	114, 493, 496, 566
49-3170	614	50-2109	154	52-1423	115, 517	52-3382	114, 493, 496
49-3175	614	50-2110	154	52-1425	115, 517	52-3410	114, 493, 496
49-3180	614	50-2112	154	52-1426	115, 517	52-3412	114, 460, 493, 496
49-3240	588	50-2206	154	52-1427	115, 517	52-3414	460
49-3245	588	50-2207	154	52-1428	115, 517	52-3510	114
49-3250	588	50-2208	154	52-1430	115, 517	52-3597	112, 493
49-3255	588	50-2210	154	52-1431	115, 517	52-3970	112, 379
49-3640	602	50-2212	154	52-1435	115, 517	52-4113	494
49-3645	602	50-2412	308	52-1436	115, 517	52-4260	114, 493
49-3650	602	50-2670	109, 568	52-1530	115, 516	52-4280	493
49-3655	602	50-2825	155	52-1531	115, 516	52-4310	114, 493
49-3665	602	50-2830	155	52-1532	115, 516	52-5062	115, 495, 566
49-3670	602	50-2831	155	52-1533	115, 516	52-5077	115, 495
49-3675	602	50-2870	109	52-1540	115, 516	52-5095	115, 495
49-3680	602	50-2970	109	52-1541	115, 516	52-5098	115, 460, 495
49-3725	602	50-3044	106	52-1542	115, 516	52-5099	460
49-4055	611	50-3046	106	52-1543	115, 516	52-5162	115, 495, 566, 577-578, 581
49-4060	611	50-3047	106, 538-539, 542, 544-545, 548, 551, 557-559, 561-562, 564-566, 568, 574, 577-580	52-1545	517	52-5177	115, 495, 542, 558, 561, 574, 579, 580
49-4075	611			52-1546	517	52-5182	460
49-4080	611	50-3048	109, 559	52-1547	517	52-5184	460
49-4095	611	50-3049	109	52-1548	517	52-5195	115, 495, 573, 579, 580
49-4100	611	50-3050	108	52-1549	517	52-5198	115, 460, 495
49-4160	612	50-3052	108	52-1550	517	52-5199	460, 572
49-4170	612	50-3147	106, 538-540, 544-545, 549, 551, 559, 561-562, 568, 577-578	52-1551	517	52-5202	495
49-4220	612			52-1595	506	52-5262	115, 495
49-4225	612	50-3148	108	52-1695	506	52-5277	115, 495
49-4280	612	50-3371	116, 182, 556	52-1900	519	52-5295	115, 495
				52-1902	519		

NUMERICAL INDEX



52-5297	115	52-6825	521	55-2352	484	55-8304	531
52-5307	495	52-6830	510	55-2395	93, 492	55-8306	531
52-5309	495	52-6832	510	55-2682	480	55-8310	69, 494
52-5312	460, 495	52-6840	510	55-2684	480	55-8390	531
52-5314	460	52-6842	510	55-2685	481	55-8391	531
52-5362	109	52-6850	513	55-2688	480	55-8392	531
52-6575	497, 577	52-6881	581	55-2775	90	55-8488	531
52-6577	497, 577	52-6900	522	55-2795	90	55-8495	69, 494
52-6579	498, 569	52-6902	522	55-2810	90	55-8611	50, 369, 468, 494
52-6580	498, 569, 577	52-6904	522	55-2820	462	55-8711	50, 369, 468, 494
52-6582	498	52-6910	522	55-2821	462	55-9080	52, 369, 468, 554, 560, 573
52-6585	496	52-6912	522	55-2822	462	55-9084	52, 369, 530
52-6587	496	52-6920	522	55-2823	462	55-9090	52, 369, 468, 536, 571
52-6588	496	52-6925	523	55-2855	90, 477, 545, 562	55-9094	52, 369, 530
52-6589	496	52-6930	523	55-2870	90, 477	55-9180	52, 369, 468
52-6600	499	52-6950	523	55-2880	90, 477, 542, 574	55-9184	52, 369, 530
52-6601	505	52-6955	524	55-2890	90, 174, 477	55-9190	52, 369, 468, 571
52-6602	500	52-6956	524	55-2892	86, 466, 579, 581	55-9194	52, 369, 530
52-6603	499	52-6957	524	55-2893	86	55-9210	52, 369, 468
52-6604	502	52-6960	524	55-2894	86, 466, 573, 581	55-9310	52, 369, 468
52-6605	502	52-6965	525	55-2898	90, 477, 579	55-9311	52, 369, 468
52-6612	506	52-6966	525	55-2912	174, 462, 492	55-9312	52, 459, 468
52-6614	580	52-6968	525	55-2914	462	55-9314	52, 459, 468
52-6620	505	52-6975	526	55-3012	86, 466, 492	55-9411	52, 369, 468
52-6622	505	52-6985	526	55-3080	93, 492	55-9414	52, 530
52-6624	505, 579	52-6990	527	55-3110	93, 492	55-9612	52, 369, 459, 468
52-6626	505	52-6991	527	55-3123	503	55-9614	52, 369, 459, 468
52-6628	505	52-6992	527	55-3125	503	57-1322	282, 556
52-6630	514	52-6993	527	55-3127	503	57-1325	208, 282
52-6631	514, 580	52-6994	527	55-3129	503	57-1445	147, 545, 562, 567
52-6634	514, 580	52-6995	527	55-3152	462	57-1475	143
52-6635	514	52-6996	527	55-3154	462	57-1485	143, 581
52-6640	515	52-7000	526	55-3162	462	60-1075	147, 201, 537
52-6644	515	52-7020	526	55-3164	462	60-1085	146, 536, 537, 542, 548, 555, 557, 559, 561, 566, 567, 575, 577-579, 581
52-6645	515	52-7046	523	55-4114	113, 493	60-1100	147, 561
52-6648	513	52-7048	523	55-4510	489	60-1101	147
52-6650	508	52-7050	523	55-5980	302, 489, 579	60-1102	147
52-6652	508, 581	55-1414	490	55-6492	344, 493	60-1103	147
52-6654	508	55-1514	490	55-6614	506	60-1104	147
52-6655	500	55-1530	275	55-6887	489	60-1160	147
52-6657	500	55-1614	490, 579	55-6965	489, 579	60-1170	147
52-6659	500	55-1685	490	55-7065	489, 579	60-1350	147, 541
52-6661	513	55-1687	490	55-7115	153, 491	60-1370	147
52-6662	513	55-1692	490	55-7125	153, 491	60-1460	147
52-6663	513	55-2010	490	55-7167	153, 491	60-1461	147, 560
52-6670	577	55-2011	490	55-7175	153, 491, 554, 554	60-1616	146
52-6680	511	55-2021	477	55-7192	153, 491	60-1617	146
52-6681	511	55-2022	477	55-7195	153, 491, 579	60-1618	146
52-6690	496	55-2023	477	55-7196	153, 491	60-1656	146, 578
52-6694	496	55-2025	477	55-7220	145, 491	60-1661	146, 575, 579
52-6696	496	55-2026	477	55-7230	145, 491	60-1666	146
52-6700	502	55-2027	477	55-7340	137	60-1671	146
52-6702	502	55-2028	477	55-7341	137	60-1676	146, 542, 558, 566, 575, 577-579
52-6704	502	55-2045	479	55-7355	139, 488	60-1681	146, 536, 542, 558, 575, 579
52-6706	502	55-2050	479	55-7360	489	60-1686	146, 542
52-6730	504	55-2060	479	55-7365	489, 579	60-1691	146, 536
52-6732	504	55-2112	93	55-7366	489	60-1695	146, 536, 581
52-6740	512	55-2187	93, 483	55-7445	141, 487	60-1697	146
52-6745	506	55-2190	93, 483	55-7465	141, 487	60-1699	146, 554
52-6750	507	55-2195	93, 483	55-7667	489	60-1785	559
52-6760	507	55-2310	462	55-7675	141, 487	60-1797	151
52-6775	508	55-2311	486	55-7680	487	60-1800	144
52-6778	508, 581	55-2314	462	55-7685	141, 487, 579, 581	60-1801	144
52-6780	510	55-2320	479	55-7785	140, 488	60-1802	144
52-6785	509	55-2322	479	55-7880	140, 487, 579	60-1803	144
52-6790	509	55-2324	479	55-7980	141, 487	60-1891	144, 492, 551, 551
52-6792	509	55-2330	483	55-7990	581	60-1892	144, 492, 551
52-6794	509	55-2334	483	55-8284	531	60-1893	144, 492, 551
52-6796	512	55-2340	481	55-8288	531		
52-6820	511	55-2342	481	55-8300	531		
52-6822	511	55-2350	484	55-8302	531		



60-1894	144, 492	60-6062	142, 210	61-0125	460	61-2112	462
60-1895	144, 492	60-6064	142, 210	61-0126	460	61-2113	460
60-1909	560	60-6130	433	61-0127	462	61-2114	462
60-2010	151	60-6162	142, 212, 537-538, 542, 548, 551, 554, 557-558, 561, 566-567	61-0128	462	61-2115	460
60-2012	561	60-6164	142, 212, 537, 537, 554, 555, 577	61-0200	463	61-2116	460
60-2028	559	60-6240	139, 488	61-0201	463	61-2117	460
60-2030	559	60-6280	150	61-0202	463	61-2118	460
60-2110	151	60-6320	551	61-1003	459	61-2119	462
60-2185	152, 359	60-6340	138, 207	61-1004	459	61-2120	462
60-2190	152, 359	60-6342	138, 207	61-1006	459	61-2121	460
60-2195	152, 359	60-6370	137	61-1008	459	61-2122	460
60-2395	153	60-6467	138	61-1009	459	61-2123	460
60-2710	145	60-6570	137, 554	61-1010	459	61-2124	462
60-2712	145	60-6580	137	61-1011	52, 459	61-2125	460
60-2713	145, 536	60-6670	139, 537	61-1012	459	61-2126	460
60-2812	145, 566	60-6710	139	61-1013	459	61-2127	462
60-2912	145	60-6870	139	61-1014	459	61-2128	462
60-3012	145	60-7070	139	61-1100	461	61-2200	463
60-3070	145	60-7110	139	61-1101	461	61-2201	463
60-3085	145	60-7112	139	61-1102	461	61-2202	463
60-3090	145, 536, 573	60-7113	139, 579	61-1103	461	64-1150	63, 547
60-3112	145, 573	60-7115	139	61-1104	461	64-1151	63
60-3113	145	60-7120	139	61-1105	461	64-1152	63
60-3114	145	60-7125	139	61-1106	461	64-1240	59
60-3212	145, 536, 573	60-7130	139	61-1107	461	64-1241	59, 238
60-3312	145, 536, 561	60-7200	283	61-1108	462	64-1242	58, 234, 539, 545, 547, 558, 561
60-3412	145	60-8122	560	61-1109	462	64-1243	58, 234
60-3594	145, 200	61-0001	459	61-1110	462	64-1250	234
60-3596	145, 200, 541, 561	61-0002	459	61-1111	461	64-1340	59
60-3598	145, 200, 536-537, 541, 545, 562	61-0003	459	61-1112	462	64-1341	59, 238
60-3607	145, 200	61-0004	459	61-1113	460	64-1342	58, 234, 538-539, 545, 547, 558, 561, 565, 569, 577
60-3610	145, 200, 537	61-0005	459	61-1114	462	64-1343	58, 234
60-3612	145, 200	61-0006	459	61-1115	460	64-1345	59, 168, 238
60-3615	145, 200, 537, 579	61-0007	459	61-1116	460	64-1348	168
60-3617	145, 200	61-0008	459	61-1117	460	64-1442	57, 239, 549-551
60-3620	145, 200, 579	61-0009	459	61-1118	460	64-1445	59, 168, 238
60-3625	145, 200	61-0010	459	61-1119	462	64-1542	57, 239, 549-551, 568
60-4242	142	61-0011	52, 459	61-1120	462	64-1735	62, 238, 264, 546
60-4243	142	61-0012	459	61-1121	460	64-1740	70
60-4244	142	61-0013	459	61-1122	460	64-1742	70, 238, 265
60-4246	142	61-0014	459	61-1123	460	64-1842	70, 238, 265
60-4252	142	61-0021	572	61-1124	462	64-1942	70, 238, 265
60-4253	142	61-0051	572	61-1125	460	64-1942	70, 238, 265
60-4254	142	61-0080	572	61-1126	460	64-1950	70, 237, 263, 546
60-4256	142	61-0100	461	61-1127	462	64-1951	70, 237, 263
60-5431	146	61-0101	461	61-1128	462	64-1952	70, 237, 263
60-5432	146	61-0102	461	61-1200	463	64-1955	70, 237, 263
60-5433	146	61-0103	461	61-1201	463	64-1958	237
60-5434	146	61-0104	461	61-1202	463	64-1960	71, 237, 263, 547
60-5435	146	61-0105	461	61-2003	459	64-1961	71, 237, 263
60-5472	143	61-0106	461	61-2004	459	64-2035	59
60-5502	142	61-0107	461	61-2006	459	64-2036	59
60-5503	142	61-0108	462	61-2008	459	64-2042	54, 235
60-5504	142	61-0109	462	61-2009	459	64-2142	54, 236
60-5506	142	61-0110	462	61-2010	459	64-2143	54
60-5602	142, 555	61-0111	461	61-2011	52, 459	64-2242	232, 263, 545-546
60-5603	142	61-0112	462	61-2012	459	64-2342	232, 263, 545-546
60-5604	142, 554, 555, 558	61-0113	460	61-2013	459	64-2442	71, 232, 263
60-5606	142, 554	61-0114	462	61-2014	459	64-2535	71, 232, 263
60-5622	561	61-0115	460	61-2100	461	64-3050	235, 263, 546
60-5812	142	61-0116	460	61-2101	461	64-3052	235, 263
60-5813	142	61-0117	460	61-2102	461	64-3142	71, 169, 233, 264, 546-547, 577
60-5814	142, 542	61-0118	460	61-2103	461	64-3144	71, 169, 233, 264, 547
60-5816	142, 542	61-0119	462	61-2104	461	64-3145	71, 169, 233, 264
60-5820	299	61-0120	462	61-2105	461	64-3146	71, 169, 233, 264
60-5821	299	61-0121	460	61-2106	461	64-3225	235, 264
60-5822	142	61-0122	460	61-2107	461	64-3228	235, 264
60-5823	142	61-0123	460	61-2108	462	64-3230	235
60-5824	142, 578	61-0124	462	61-2109	462	64-3235	235
60-5826	142, 557			61-2110	462		
				61-2111	461		

# NUMERICAL INDEX



64-3260	237, 265	65-3140	225	65-6357	131, 254, 270, 545, 559	66-1240	251
64-3270	232	65-3162	227	65-6358	131, 254, 270, 547	66-1250	251
64-3280	168, 238, 265, 544, 546	65-3169	227	65-6445	254, 271	66-1255	251
64-3284	238	65-3170	227, 547	65-6446	254, 271	66-1265	252
64-3285	238	65-3171	227, 547	65-6449	254, 271	66-1270	252
64-3288	238	65-3172	227, 547	65-6450	254, 271	66-1275	252
64-3294	232, 263	65-3173	227	65-6452	131, 254, 271	66-1280	252
64-3297	232	65-3174	227	65-6454	131, 254, 271	66-1282	252
64-3298	232	65-3180	227	65-6455	131, 254, 271	66-1435	252
64-3430	235	65-3181	227	65-6456	131, 254, 271	66-1535	122, 249
64-3435	235	65-3182	227	65-6457	131, 254, 271	66-1635	122, 249
65-1012	215	65-3183	227	65-6460	254, 271	66-1735	122, 249
65-1127	215	65-3191	226	65-6461	254	66-1740	122
65-1227	216	65-3192	226	65-6462	254, 271	66-1742	122, 249
65-1332	216	65-3195	226, 547	65-6470	255, 270	66-1745	249
65-1426	215	65-3198	226	65-6475	255, 270	66-1830	122, 249
65-1427	215	65-3200	226	65-6550	129	66-1930	243
65-1522	215	65-3205	149, 212, 226	65-6552	131	66-1940	118, 243, 546, 548, 551
65-1528	216, 546	65-3206	149, 212, 226	65-6730	213, 257	66-2005	243
65-1530	216	65-3215	226	65-6732	213, 257, 546, 549, 565	66-2009	243
65-1532	216, 545-547	65-3216	226, 546	65-6734	213, 257	66-2012	243
65-1535	216, 545-546	65-3217	226	65-6735	213, 257, 565	66-2040	119
65-1536	216	65-3221	551	65-6950	230	66-2140	118, 243
65-1540	214	65-3223	551	65-6952	230	66-2145	243
65-1545	215	65-3230	226	65-6960	184, 230	66-2340	119
65-1730	216	65-3232	226	65-6965	230	66-2350	243, 546
65-1740	214	65-3248	226	65-7000	230	66-2351	243
65-1742	214, 547	65-3250	226	65-7001	230	66-2352	243
65-1744	214	65-3255	226	65-7002	230	66-2355	243
65-1746	214	65-3258	210, 226	65-7003	230	66-2635	244
65-1748	214	65-3265	226	65-7254	222	66-2638	244
65-1750	214	65-3270	226	65-7255	222	66-2640	244, 546-547
65-1752	214	65-3295	225	65-7257	222	66-2734	117
65-1754	214	65-4025	222	65-7260	222	66-2736	117
65-1756	214	65-4026	222	65-7265	223	66-2738	117
65-1758	214	65-4030	222	65-7270	223	66-2740	117, 242, 545, 546
65-1765	214	65-4031	222	65-7272	223	66-2742	108, 242, 547
65-1766	214	65-4032	222	65-7275	223	66-2750	242
65-1790	214	65-4050	224	65-7360	215	66-2755	242
65-1815	138, 207, 219, 270	65-4055	224	65-7400	195	66-2760	242
65-1830	138, 207, 219, 270	65-4062	224, 546	65-7401	195	66-2840	117, 242
65-1831	219	65-4064	224	65-7402	195	66-2940	117, 242, 545-546
65-1835	218	65-4066	224	65-7403	195	66-2942	108, 242
65-1840	547	65-4068	224	65-7410	195	66-3140	117, 242
65-1841	144, 211, 218, 544, 549	65-4070	224	65-7411	195	66-3142	108, 242
65-1842	144, 211, 218, 545-546, 558, 565, 577	65-4072	224	65-7412	195	66-3240	117, 242, 546
65-1843	144, 211, 218, 547	65-4074	224	65-7422	222	66-3340	117, 242, 545-546
65-1844	144, 211, 218	65-4076	224	65-7425	222	66-3341	117
65-2950	223	65-4078	224	65-7523	258	66-3342	108, 242
65-2958	223	65-4080	222	65-7634	257	66-3450	244, 267
65-2959	223	65-4098	184, 230	65-7635	257, 546	66-3540	117, 242, 544, 546
65-2960	223, 546	65-4099	184, 230	65-8151	227, 547	66-3541	117
65-3267	150	65-4100	184, 230	65-8155	227, 547	66-3542	108, 242
65-3001	220	65-4101	184, 230	65-8185	225	66-3740	117, 242
65-3010	220	65-4103	184, 230	65-8195	225	66-3741	117
65-3016	221	65-4105	184, 230	65-8206	225	66-3742	108, 242
65-3017	221	65-4107	184, 230, 561	65-8215	225	66-3927	117, 241
65-3018	221	65-4120	184, 230	65-8216	225, 546	66-4032	118, 241, 547
65-3022	221	65-4121	184, 230	65-8350	218	66-4034	108
65-3025	221	65-4123	184, 230	65-8352	218	66-4132	118, 241, 547, 565
65-3028	221	65-4125	184, 230	65-8354	218	66-4133	118, 241
65-3030	220	65-4127	184, 230	65-9085	218, 546	66-4134	108
65-3035	220	65-4128	184, 230	66-1030	251	66-4230	118
65-3050	220	65-4129	184, 230	66-1035	252	66-4232	118, 241, 267
65-3051	220	65-6055	130, 254	66-1036	252, 546-547	66-4237	118, 243
65-3052	220	65-6255	130, 254	66-1037	251	66-4238	118, 243
65-3053	220	65-6265	130, 255, 271	66-1038	252	66-4525	117, 242
65-3060	220	65-6350	254, 270, 564	66-1040	213, 549	66-4526	117, 242
65-3062	220	65-6351	254, 270	66-1137	251, 547	66-4530	241, 267
65-3094	221	65-6352	254, 270	66-1235	251	66-4625	117, 242
		65-6354	254, 270	66-1236	251, 547	66-4626	117, 242



66-4840	118	66-6900	256, 547	66-7814	217	66-7937	231
66-4947	241	66-6902	256	66-7816	217	66-7938	231
66-4948	241	66-6910	256	66-7818	217	66-7939	231
66-4949	241	66-6912	256	66-7820	217	66-7940	231
66-4950	241	66-6914	256	66-7822	217	66-7941	231
66-4951	241	66-6916	256	66-7824	217	66-7943	231
66-4955	241	66-6920	256	66-7830	217	66-7950	231
66-4956	242	66-6922	256	66-7840	217	66-7951	231
66-5240	248	66-6925	256	66-7842	217	66-7952	231
66-5340	119, 248, 546	66-6930	256	66-7850	217	66-7953	231
66-5342	248	66-6932	256	66-7852	217	66-7954	231
66-5351	248	66-6955	250	66-7862	231	66-7955	231
66-5352	248	66-7130	118, 240, 266	66-7863	231	66-7956	231
66-5353	248	66-7230	118, 240, 266	66-7864	231	66-7957	231
66-5355	248	66-7238	240, 266	66-7865	231	66-7958	231
66-5530	248	66-7240	240, 266	66-7866	231	66-7959	231
66-5942	119, 213, 250	66-7244	240, 266	66-7867	231	66-7960	231
66-5950	250	66-7246	240, 266	66-7868	231	66-7961	231
66-5960	250	66-7250	240, 266	66-7869	231	66-7962	231
66-5962	250	66-7258	240, 267	66-7870	231	66-7963	231
66-6036	118, 247	66-7259	240, 266	66-7874	231	66-7964	231
66-6037	118, 247	66-7261	240, 266, 546	66-7875	231	66-7965	231
66-6038	118, 247	66-7347	117, 247	66-7876	231	66-7966	231
66-6039	118, 247	66-7436	120	66-7877	231	66-7968	231
66-6103	117, 245	66-7438	120	66-7878	231	67-1020	179, 550
66-6105	117, 245, 546	66-7440	120	66-7879	231	67-1021	179
66-6109	117, 245	66-7442	120, 253, 269	66-7880	231	67-1030	180
66-6110	119, 247	66-7443	120, 269	66-7881	231	67-1032	180
66-6112	119, 247	66-7446	269	66-7882	231	67-1033	180
66-6114	119, 247	66-7447	120, 253, 269	66-7883	231	67-1034	180
66-6115	117, 245, 268, 547	66-7542	120, 253, 269	66-7884	231	67-1035	179
66-6116	245, 268	66-7642	120, 253, 269	66-7885	231	67-1036	179, 567
66-6117	245, 268	66-7643	269	66-7886	231	67-1038	179, 550
66-6118	117, 245, 268	66-7644	120, 269	66-7887	231	67-1039	179
66-6119	117, 245, 564	66-7645	120, 269	66-7888	231	67-1040	179
66-6120	244	66-7655	253	66-7889	231	67-1045	179
66-6125	245, 268	66-7656	253	66-7890	231	67-1050	179, 549
66-6126	245, 268	66-7660	253	66-7891	231	67-1052	179
66-6130	244	66-7662	253	66-7892	231	67-1058	182
66-6131	244	66-7664	253	66-7893	231	67-1150	116, 182, 550, 567
66-6132	244	66-7700	227	66-7900	231	67-1250	116
66-6133	244	66-7702	227	66-7901	231	67-1350	116, 182
66-6140	245	66-7704	227	66-7902	231	67-1450	116, 182
66-6142	245	66-7710	227	66-7903	231	67-1455	116, 182, 550, 552, 565
66-6150	245	66-7712	227	66-7904	231	67-1465	116, 190, 549, 551
66-6152	245	66-7715	228	66-7905	231	67-1555	116
66-6160	245, 268	66-7718	228	66-7906	231	67-1732	183
66-6164	245	66-7720	228	66-7907	231	67-1734	183
66-6166	245	66-7721	228	66-7908	231	67-1750	184
66-6168	245	66-7722	228	66-7909	231	67-1752	184, 202
66-6175	246	66-7723	228	66-7910	231	67-1753	184, 202
66-6178	246, 268	66-7725	228	66-7911	231	67-2005	183, 567
66-6180	246, 268	66-7726	228	66-7912	231	67-2007	183
66-6182	246	66-7727	228	66-7913	231	67-2015	183
66-6190	246	66-7735	228	66-7914	231	67-2017	183
66-6192	246	66-7740	228	66-7915	231	67-2115	183
66-6194	246, 268	66-7742	228	66-7916	231	67-2145	183
66-6196	246, 268	66-7750	228	66-7917	231	67-2450	552
66-6240	247	66-7752	228	66-7918	231	67-2451	552
66-6242	247	66-7760	228	66-7925	231	67-2452	552
66-6250	247	66-7762	228	66-7926	231	67-2453	552
66-6268	247	66-7770	229	66-7927	231	67-2488	178
66-6330	247	66-7772	229	66-7928	231	67-2489	178
66-6338	119, 247	66-7775	229	66-7929	231	67-2490	178, 550, 567
66-6340	119, 247	66-7780	229	66-7930	231	67-2491	178, 550, 567
66-6342	213, 251	66-7782	229	66-7931	231	67-2492	178, 550
66-6810	256	66-7790	229	66-7932	231	67-2493	178
66-6811	256	66-7791	229	66-7933	231	67-2498	178
66-6812	256	66-7792	229	66-7934	231	67-2499	178, 552
66-6813	256	66-7793	229	66-7935	231	67-2500	178
66-6852	577	66-7795	229	66-7936	231	67-2501	178, 552

NUMERICAL INDEX



67-2502	178, 539	67-6033	177	70-1060	189	70-9101	203
67-2503	178	67-6042	177	70-1070	188	70-9102	203
67-2508	178	67-6043	552	70-1071	188, 548, 550	70-9103	203
67-2509	178	67-6045	552	70-1072	188, 550	70-9200	203
67-2510	178	67-6047	552	70-1075	188	70-9201	203
67-2511	178	67-6049	552	70-1081	189	70-9202	203
67-2512	178	67-6050	178	70-1082	189	70-9203	203
67-2513	178	67-6061	177	70-1083	189	70-9204	203
67-2514	178, 551	67-6062	177	70-1084	189	70-9210	203
67-2515	178, 550, 567	67-6063	177	70-1085	189	70-9220	203
67-2516	178, 550-551, 567	67-6064	177	70-1086	189	70-9221	203
67-2517	178, 539, 550	67-6065	177	70-1087	189	70-9222	203
67-2518	178	67-6066	177	70-1092	189	70-9223	203
67-2519	178	67-6067	177	70-1096	189	70-9224	203
67-2521	178, 550, 552	67-6200	177	70-2292	196, 291, 334	70-9301	178
67-2522	178, 550, 552	67-6202	177	70-2293	196, 291, 334	70-9302	178
67-2523	178, 550, 552	67-6204	177	70-4075	564	70-9303	178
67-2525	178, 550	67-6206	177	70-4080	189	70-9304	178
67-2526	178, 550	67-6250	177	70-4160	189	70-9305	178
67-2540	183	67-7064	185	70-4170	179	70-9306	178
67-2550	183, 550	67-7128	185	70-4262	62, 564	73-1015	199, 679
67-2552	183, 550	67-7256	185	70-4267	564	73-1075	199
67-3402	185	67-7512	185	70-4268	190	73-1082	199, 679
67-3404	185	67-7524	185	70-4270	190, 564	73-1085	199, 679
67-3413	185	67-7548	185	70-4348	564	73-1086	199, 679
67-3418	185	67-7596	185	70-4350	61	73-1188	199
67-3422	185	67-7605	185	70-4352	61, 549, 564, 568	73-1189	199
67-3423	185	67-8000	181	70-4375	116, 190	73-1190	199
67-3424	185	67-8004	552	70-4385	116, 190, 560	73-1191	199
67-4504	287	67-8006	181	70-4395	564	73-1192	199
67-4506	287	67-8007	552	70-4470	116, 182, 548	73-1193	199
67-4508	287	67-8008	181	70-4472	182	73-1194	199
67-4510	287	67-8010	181	70-5090	190	73-1195	199
67-4512	287	67-8014	181	70-5150	552	73-1196	199
67-4514	287	67-8016	181	70-5170	189	73-1197	199
67-4604	287	67-8018	181	70-5176	190	74-1202	200
67-4606	287	67-8020	181	70-5190	193, 549, 564	74-1370	126, 539
67-4608	287	67-8024	181	70-5232	190	74-1470	126, 538, 541, 547, 567
67-4610	287	67-8040	550	70-5235	190	74-1570	126
67-4612	287	67-8150	182	70-5290	193, 564	74-1670	126, 539, 544, 567
67-4614	287	67-8152	182	70-5292	193	74-1975	206
67-4619	564	67-8155	182	70-5294	193	74-2175	206
67-4620	287, 564	67-8170	182, 550, 552	70-5332	190, 550	74-2475	101, 206
67-4621	564	67-8172	182	70-5335	190	74-2575	104, 206, 552
67-4622	287, 549	67-8173	182	70-5336	190	74-2590	104, 206
67-4624	287	67-8174	182, 550	70-5410	190	74-3075	206, 482, 537, 542, 549, 552, 561, 573, 579
67-4625	564	67-8175	182	70-5411	190	74-3175	206, 482
67-4626	287, 549	67-8176	182	70-5420	281	74-3260	81, 466
67-4628	287, 549	67-8177	182	70-5421	281	74-3270	81, 466
67-4630	287, 549	67-8178	182	70-5422	281	75-1006	198
67-4632	287	67-8180	182	70-5423	193	75-1007	198
67-5175	276	67-8187	182, 552	70-5674	564	75-1010	198
67-5458	276	67-8188	182	70-5680	564, 565	75-1015	198, 552
67-5987	337	67-8189	182, 552	70-6165	191	75-1016	198, 552
67-5988	337	67-8191	182, 552	70-6166	191	75-1017	198, 552
67-5990	277, 337, 613	67-8193	182	70-6168	191	75-1020	197
67-5991	337, 613	68-1050	186	70-7058	552	75-1025	198, 613
67-5992	277, 337, 613	68-1257	186	70-7062	191	75-1026	198, 613
67-5994	277, 337, 613	68-1357	186	70-7067	565	75-1040	568
67-6010	177, 567	68-1557	186	70-7170	287	75-1120	201, 613
67-6011	177, 551	68-1665	186	70-7185	191	75-1122	201
67-6012	177, 551	68-1765	186, 548, 567	70-7503	193, 564	75-1124	201
67-6013	177, 551	68-1865	186, 567	70-7504	193, 549	75-1140	613
67-6014	177, 551	68-1890	186	70-7801	193, 307, 343, 564-565	75-1141	613
67-6020	177	68-2175	186	70-7802	193, 307, 343, 564-565	75-1400	198
67-6025	177, 567	70-1020	188, 564-565	70-7805	307, 343, 549, 564-565	75-2160	198, 552
67-6026	177	70-1030	188, 548-549	70-7821	193	75-2161	198, 552
67-6027	177	70-1035	188, 565	70-7822	193	75-2175	198
67-6030	177	70-1040	188, 564	70-9001	203	75-2182	569
67-6031	177	70-1041	188, 564	70-9002	203	75-2183	569
67-6032	177	70-1052	564	70-9003	203		





75-2184	569	78-1720	156	78-3136	157	85-1030	464
75-2315	201	78-2000	156	78-3137	157	85-1032	464
75-2318	210	78-2010	156	78-3138	157	85-1034	464
75-2320	210, 552	78-2011	156	78-3139	157	85-1036	464
75-2322	210	78-2012	156	78-3360	202	85-1038	464
75-5070	205	78-2013	156	78-3460	202	85-1040	464
75-5267	70, 568	78-2014	156	78-3545	148, 544	85-1065	464
75-5460	51, 539, 547	78-2015	156	78-3550	148	85-1070	464
75-5570	52, 369, 468, 552, 556, 561	78-2016	156	78-3570	148	85-1075	464
75-5670	52, 369, 468, 537, 543, 554-555, 561, 564	78-2017	156	78-3580	544	85-1076	464
75-6387	200, 552	78-2018	156	79-3230	474	85-1308	465
75-7282	204	78-2019	156	80-1082	475	85-1310	465
75-7482	204	78-2020	156	80-1260	475	85-1312	465
75-7492	204	78-2024	157	80-1410	96, 372, 473, 570-571, 577	85-1314	465
75-7575	205	78-2025	157	80-1565	70, 475	85-1316	465
75-7590	204	78-2026	157	80-1695	475	85-1318	465
75-9070	202, 552	78-2027	157	80-1728	474	85-1320	465
75-9075	202	78-2028	157	80-1735	474, 543	85-1322	465
75-9250	202, 552	78-2029	157	80-1742	474	85-1324	465
75-9405	202	78-2030	157	80-1872	470-471, 542	85-1326	465
75-9406	202	78-2031	157	80-1910	470, 542	85-1328	465
75-9407	202	78-2032	157	80-1911	470	85-1330	465
75-9408	202	78-2033	157	80-1912	470-472, 542	85-1332	465
75-9409	202	78-2100	156	80-1914	470, 542	85-1334	465
75-9505	202	78-2110	156	80-1918	470	85-1336	465
75-9506	202	78-2111	156	80-1930	472	85-1338	465
75-9507	202	78-2112	156	80-1931	472	85-1340	465
75-9508	202	78-2113	156	80-1940	474	85-1342	465
75-9509	202	78-2114	156	80-1945	471, 542	85-1345	465
75-9550	310, 348	78-2115	156	80-1950	471, 542	85-1408	465
75-9601	205	78-2116	156	80-1952	471	85-1410	465
75-9602	205	78-2117	156	80-1970	472	85-1412	465
75-9603	205	78-2118	156	80-1974	472	85-1414	465
75-9612	205, 552	78-2119	156	80-2100	473	85-1416	465
75-9613	205	78-2120	156	80-2120	473	85-1418	465
76-1390	119	78-2144	157	80-2125	473	85-1420	465
76-1490	119	78-2145	157	80-2132	473, 543	85-1422	465
78-1001	148	78-2146	157	80-2142	472	85-1424	465
78-1002	148	78-2147	157	80-2143	472	85-1426	465
78-1003	148	78-2148	157	80-2144	472	85-1428	465
78-1101	148	78-2150	157	80-2244	470-471	85-1430	465
78-1102	148	78-2214	156	80-2245	470-471, 542	85-1432	465
78-1103	148	78-2215	156	80-2260	472	85-1434	465
78-1113	148	78-2216	156	80-2261	472	85-1436	465
78-1201	148	78-2217	156	80-2274	472	85-1438	465
78-1202	148	78-2218	156	80-2275	472	85-1440	465
78-1203	148	78-2219	156	80-2688	472, 543	85-1442	465
78-1300	156	78-2254	157	80-2689	472, 543	85-1446	465
78-1310	156	78-2255	157	80-2690	472, 543	85-1608	465
78-1311	156	78-2256	157	80-2715	155, 474, 543	85-1610	465
78-1312	156	78-2257	157	80-2815	155, 474	85-1612	465
78-1313	156	78-2258	157	80-2870	172, 475, 543	85-1614	465
78-1314	156	78-2259	157	80-2910	172, 475	85-1616	465
78-1315	156	78-2260	157	80-3085	475	85-1618	465
78-1316	156	78-2284	157	80-3185	475, 543	85-1620	465
78-1317	156	78-2285	157	80-3285	475	85-1622	465
78-1318	156	78-2286	157	80-3510	475, 543	85-1624	465
78-1319	156	78-2287	157	80-3922	473	85-1626	465
78-1320	156	78-2288	157	80-3927	473, 543	85-1628	465
78-1700	156	78-2289	157	80-3935	473, 543	85-1630	465
78-1710	156	78-2290	157	85-1008	464	85-1632	465
78-1711	156	78-2821	709	85-1010	464	85-1635	465
78-1712	156	78-2822	709	85-1012	464	85-1636	465
78-1713	156	78-2824	709	85-1014	464	85-1637	465
78-1714	156	78-2825	709	85-1016	464	85-2010	362
78-1715	156	78-3130	157	85-1018	464	85-2012	362
78-1716	156	78-3131	157	85-1020	464	85-2014	362
78-1717	156	78-3132	157	85-1022	464	85-2016	362
78-1718	156	78-3133	157	85-1024	464	85-2018	362
78-1719	156	78-3134	157	85-1026	464	85-2020	362
		78-3135	157	85-1028	464	85-2022	362

# NUMERICAL INDEX



85-2024	362	90-1380	54, 469	90-2690	374	90-3711	355
85-2026	362	90-1480	54, 469	90-2782	96, 376, 571	90-3712	355
85-2028	362	90-1580	54, 469	90-2785	95, 377	90-3713	355
85-2030	362	90-1590	50, 369, 468, 494, 571, 573	90-2786	95, 377	90-3720	354
85-2032	362	90-1690	50, 369, 468, 494, 554, 571, 573	90-2787	95, 377	90-3721	354
85-2034	362			90-2788	95, 377	90-3722	354
85-2036	362	90-1755	69, 572	90-2790	95, 377	90-3730	354
85-2038	362	90-1770	69	90-2792	95, 377	90-3731	354
85-2210	362	90-1785	69	90-2793	95, 377	90-3732	354
85-2212	362	90-1790	399	90-2794	95, 377	90-3740	354
85-2214	362	90-1885	96, 375	90-2796	95, 377, 572	90-3741	354
85-2216	362	90-1890	399	90-2797	95, 377, 572	90-3750	354
85-2218	362	90-1977	97, 374, 571	90-2798	95, 377, 572	90-3751	355
85-2220	362	90-2114	398	90-2799	95, 377, 572	90-3752	354
85-2355	466	90-2116	398	90-2801	95, 377, 572	90-3754	395
85-2360	466	90-2118	398	90-2802	95, 377, 572	90-3755	395
85-2365	466	90-2120	398	90-2803	95, 377, 572	90-3800	354
85-4697	144, 467	90-2122	398	90-2804	95, 377, 572	90-3802	354
85-4780	144, 467	90-2124	398	90-3025	140, 574	90-3803	354
85-4970	140, 467	90-2126	398	90-3026	140	90-3804	395
85-5350	140, 467	90-2128	398	90-3030	152, 571	90-3806	395
85-6220	467	90-2131	398	90-3035	152, 571-572	90-3808	395
85-6221	467	90-2160	398	90-3040	152, 571-572	90-3810	395
85-6222	467, 543	90-2170	398	90-3045	358	90-3812	395
85-6223	467, 543	90-2171	398	90-3130	358, 570	90-3814	395
85-6224	467, 543	90-2172	398	90-3135	358, 570, 573	90-3815	395
85-6450	466	90-2173	398	90-3140	358	90-3833	395
85-6453	467	90-2174	398	90-3150	152, 358	90-3835	395
85-6460	467	90-2175	398	90-3151	152, 358	90-3837	395
85-6550	466	90-2177	97, 374, 571	90-3152	152, 358	90-3839	395
85-6551	466	90-2180	374	90-3153	152, 358	90-3841	395
85-6555	466	90-2242	399	90-3154	152, 358	90-3849	355
87-1052	127	90-2261	400	90-3155	152, 358	90-3851	355
87-1070	104	90-2270	400, 476	90-3225	152, 358	90-3865	356
87-2095	126	90-2272	400	90-3230	152, 358	90-3943	355
87-2195	126, 537, 542, 552, 554, 556-558, 567, 571, 573, 575, 578, 579, 581	90-2276	400, 476	90-3235	152, 358	90-3944	355
		90-2278	399, 476	90-3327	152, 358	90-3945	355
		90-2279	400	90-3330	152, 358	90-3946	396
87-2240	126	90-2280	97, 376, 573	90-3335	152, 358	90-3951	356
87-2295	126	90-2287	401	90-3422	152, 358	90-3952	356
87-2395	126, 537, 543, 570-572	90-2288	401	90-3427	152, 358	90-3953	356
87-2490	462	90-2292	400	90-3430	152, 358	90-3954	356
87-2491	462	90-2295	399	90-3452	151, 359	90-3955	356
87-2492	462	90-2298	399	90-3470	151, 359	90-3957	356
87-2493	462	90-2304	400	90-3510	151, 359	90-3959	356
90-1020	111	90-2306	400, 476	90-3520	359	90-3960	356
90-1021	111	90-2310	400	90-3521	359	90-3980	356
90-1022	111	90-2312	400	90-3522	359	90-3990	360, 573
90-1023	111	90-2313	400	90-3525	356	90-3994	360
90-1035	398	90-2325	399	90-3526	356, 570-571	90-3995	360, 570, 571, 573
90-1036	398	90-2326	399	90-3527	356	90-3996	360
90-1038	398	90-2330	401	90-3528	359	90-3997	360
90-1044	398	90-2340	399	90-3529	359	90-3998	360
90-1045	565	90-2342	399	90-3530	356	90-4713	365, 570
90-1046	398	90-2345	401	90-3535	357	90-4784	364
90-1050	398	90-2348	401	90-3536	357	90-4785	364
90-1051	398	90-2350	400	90-3537	357	90-4786	364
90-1052	398	90-2354	95, 379	90-3541	359	90-4787	364
90-1053	398	90-2379	375	90-3555	357	90-4788	364
90-1054	398	90-2387	97, 376	90-3558	357	90-4789	364
90-1055	398	90-2480	97, 374, 573	90-3559	357	90-4790	364
90-1060	400	90-2574	91	90-3560	396	90-4791	364
90-1061	400	90-2576	91	90-3561	396	90-4792	364
90-1063	110	90-2580	97, 374, 573	90-3562	396	90-4793	364
90-1064	110	90-2584	205	90-3610	359	90-4794	364
90-1065	110	90-2641	572, 579	90-3692	359	90-4795	364
90-1066	110	90-2650	462	90-3700	354, 571	90-4796	364
90-1080	54, 469	90-2651	462	90-3701	354, 570-571	90-4797	364
90-1180	54, 469	90-2660	462	90-3702	354, 570-571	90-4798	364
90-1280	54, 469	90-2680	97, 375, 571, 573-574	90-3705	354	90-4799	364
		90-2682	97, 375	90-3710	355, 570	90-4802	364



90-4804	364	90-5423	367, 570-571	90-7553	391	90-8948	386
90-4806	364	90-5424	367, 570	90-7554	391	90-8952	385
90-4808	364	90-5425	367, 570	90-7555	391	90-8960	387
90-4810	364	90-5426	367	90-7556	391	90-8962	387
90-4812	364	90-5428	367	90-7557	391	90-8964	387
90-4814	364	90-5431	367	90-7558	391	90-8966	387
90-4816	364	90-5432	367	90-7560	391	90-8970	387
90-4818	364	90-5433	367	90-7571	391	90-8972	387
90-4825	364	90-5434	367	90-7572	391	90-8974	387
90-4826	364, 570	90-5435	367	90-7573	391	90-8976	387
90-4828	364	90-5436	367	90-7574	391	90-8980	387
90-4832	364	90-5438	367	90-7575	391	90-8981	387
90-4902	365	90-5499	367	90-7576	391	90-8982	387
90-4908	364	90-5500	367, 574	90-7577	391	90-8983	387
90-4910	364	90-5566	366	90-7578	391	90-8984	387
90-4912	364	90-5610	366	90-7579	391	90-8985	387
90-4914	364	90-5611	366	90-7610	96, 372, 473	90-8986	387
90-4916	364	90-5612	366	90-7710	97, 372, 473, 571	90-8987	387
90-4918	364	90-5613	366	90-7895	94, 373	90-8988	387
90-4920	364	90-5614	366	90-7898	94, 375	90-8989	387
90-4925	364	90-5615	366	90-7910	95	90-9000	393
90-4926	364, 571	90-5616	366	90-7977	94, 374	90-9002	393
90-4927	364	90-5617	366	90-7995	94, 373, 571	90-9004	393
90-4928	364	90-5618	366	90-8010	386	90-9005	393
90-5215	364	90-5619	366	90-8065	96, 376	90-9006	393
90-5219	364	90-5620	366	90-8070	94	90-9015	393
90-5223	364	90-5621	366	90-8072	94	90-9016	393
90-5227	364	90-5622	366	90-8080	94	90-9018	393
90-5231	364	90-5623	366	90-8082	94	90-9020	393
90-5235	364	90-5624	366	90-8090	96, 376	90-9030	394
90-5239	364	90-5625	366	90-8110	94	90-9032	394
90-5243	364	90-5626	366	90-8111	94, 374	90-9034	394
90-5245	364	90-5627	366	90-8112	94	90-9035	394
90-5249	364	90-5628	366	90-8120	94	90-9038	394
90-5250	364	90-5629	366	90-8122	94	90-9040	394
90-5253	364	90-5630	366	90-8130	94	90-9042	394
90-5260	453	90-5631	366	90-8132	94	90-9044	394
90-5262	453	90-5632	366	90-8140	94, 561	90-9048	394
90-5264	453	90-5633	366	90-8142	94, 561	90-9050	394
90-5271	455	90-5710	365	90-8210	366	90-9054	395
90-5272	455	90-5713	367	90-8301	150, 361	90-9055	395
90-5273	455	90-5834	365	90-8302	150, 361	90-9057	393
90-5274	455	90-6095	366	90-8303	150, 361	90-9058	393
90-5275	455	90-6195	366	90-8304	150, 361	90-9064	401
90-5276	455	90-6280	363	90-8305	150, 361	90-9065	401
90-5282	455	90-6281	363	90-8306	150, 361	90-9066	401
90-5283	455	90-6285	366	90-8332	150, 361	90-9067	401
90-5284	455	90-6289	365	90-8333	150, 361	90-9068	401
90-5285	455	90-6290	365	90-8334	150, 361, 573	90-9069	401
90-5286	455	90-6291	365	90-8335	150, 361, 573	90-9070	401
90-5291	455	90-6292	365, 571	90-8336	150, 361	90-9100	396
90-5294	455	90-6295	365	90-8341	150, 361	90-9102	396
90-5295	455	90-6582	366	90-8342	150, 361	90-9103	396
90-5296	455	90-6590	366	90-8344	150, 361	90-9106	396
90-5297	375	90-6600	390	90-8346	150, 361	90-9108	396
90-5301	455	90-6602	390	90-8348	150, 361	90-9109	396
90-5302	455	90-6610	390	90-8557	573	90-9132	399
90-5303	455	90-6611	367	90-8845	396	90-9555	389
90-5304	455	90-6612	367, 570, 571, 573, 573	90-8850	397	90-9560	389
90-5305	455	90-6820	390	90-8855	397	90-9565	390
90-5312	363, 570	90-6887	389, 571	90-8858	397	90-9570	389
90-5314	363	90-7111	401	90-8860	397	90-9575	389
90-5392	455	90-7385	392	90-8862	397	91-1070	100, 372, 542, 574, 575
90-5393	455	90-7492	392, 571	90-8865	397	91-1111	99, 372
90-5397	455	90-7511	392	90-8900	386	91-1275	372
90-5412	363	90-7520	389, 573	90-8905	386	91-1280	94, 373
90-5413	363, 571	90-7525	390, 573	90-8920	385	91-1290	99, 372, 570, 571, 571, 573
90-5419	98, 378	90-7530	389	90-8925	388	91-1293	363
90-5420	98, 378	90-7540	389	90-8930	388	91-1298	99, 372, 574, 575
90-5421	367	90-7551	391	90-8940	385	91-1390	100
90-5422	367, 570	90-7552	391	90-8945	385	91-1455	105, 372

# NUMERICAL INDEX



91-1465	105, 372, 574, 575	91-5212	405	92-1915	380	93-1730-5	164
91-1590	100, 378	91-5215	405	92-2015	380	93-1731-1	165
91-1690	100, 378	91-5218	405	92-2115	381	93-1731-2	165
91-1890	100, 378	91-5220	405	92-2215	381, 572	93-1731-3	165
91-2080	105, 379, 485	91-5226	406	92-2314	381, 572	93-1731-4	165
91-2282	95, 378, 574	91-5228	406	92-2717	380	93-1732-1	165
91-2382	95, 378	91-5230	406	92-2812	380	93-1732-2	165
91-2482	95, 376	91-5232	406	92-2912	382, 572	93-1732-3	165
91-2585	95, 376	91-5234	406	92-2915	382	93-1732-4	165
91-2595	100	91-5235	406	92-3215	382	93-1740-1	165
91-2695	100, 373	91-5236	409	92-3350	382	93-1740-2	165
91-3095	99, 378	91-5238	409	92-3360	382	93-1740-3	165
91-3195	99, 378	91-5241	409	92-4100	384	93-1740-4	165
91-3740	403	91-5242	409	92-4130	384	93-1741-1	165
91-3741	403	91-5243	409	92-5012	98, 383	93-1741-2	165
91-3795	99, 379	91-5244	409	92-5095	98, 383, 570	93-1741-3	165
91-3810	99, 379	91-5245	409	92-5195	98, 383	93-1741-4	165
91-3822	98, 383	91-5246	409	92-5295	98, 383	93-1742-1	165
91-3823	383	91-5247	409	92-5298	383	93-1742-2	165
91-4210	383	91-5248	409	92-5310	98, 384	93-1742-3	165
91-4310	99, 383, 572	91-5250	409	92-5412	384	93-1742-4	165
91-5010	402	91-5251	409	92-5540	69	93-1750-1	165
91-5012	402	91-5252	409	92-5560	68	93-1750-2	165
91-5014	402	91-5253	409	92-5565	69	93-1750-3	165
91-5015	402	91-5254	409	93-1710-00	163	93-1750-4	165
91-5018	402	91-5255	409	93-1710-1	163	93-1750-5	165
91-5020	402	91-5268	407	93-1710-2	163	93-1751-1	165
91-5022	402	91-5270	407	93-1710-6	163	93-1751-2	165
91-5024	402	91-5278	407	93-1710-8	163	93-1751-3	165
91-5028	402	91-5300	408	93-1712-1	163	93-1751-4	165
91-5032	402	91-5302	408	93-1712-1-1/4	163	93-1751-5	165
91-5034	402	91-5307	408	93-1712-1-3/4	163	93-1760-1	163
91-5036	402	91-5308	408	93-1712-3/4	163	93-1760-10	163
91-5038	402	91-5310	408	93-1714-1-1/2	164	93-1760-12	163
91-5040	402	91-5400	407	93-1714-1-3/4	164	93-1760-14	163
91-5042	402	91-5404	407	93-1714-2	164	93-1760-16	163
91-5044	402	91-5408	407	93-1714-2-1/2	164	93-1760-2	163
91-5046	402	91-5411	408	93-1714-2-7/8	164	93-1760-4	163
91-5047	402	91-5412	408	93-1714-3-1/2	164	93-1760-6	163
91-5050	402	91-5413	408	93-1714-4	164	93-1760-8	163
91-5060	402	91-5414	408	93-1716-10	164	93-1762-1	163
91-5062	402	91-5420	408	93-1716-12	164	93-1762-10	163
91-5064	402	91-5422	408	93-1716-14	164	93-1762-11	163
91-5066	402	91-5424	408	93-1716-16	164	93-1762-12	163
91-5068	402	91-5428	408	93-1716-2	164	93-1762-13	163
91-5080	403	91-5440	407	93-1716-4	164	93-1762-14	163
91-5082	402	91-5450	407	93-1716-6	164	93-1762-16	163
91-5084	402	91-5452	407	93-1716-8	164	93-1762-17	163
91-5086	402	91-6100	418, 561	93-1718-1	164	93-1762-18	163
91-5088	402	91-6101	418	93-1718-2	164	93-1762-2	163
91-5092	402	91-6102	418	93-1718-3	164	93-1762-20	163
91-5120	404	91-6103	418	93-1718-4	164	93-1762-3	163
91-5122	404	91-6104	418	93-1718-5	164	93-1762-4	163
91-5130	404	91-6105	418	93-1718-6	164	93-1762-5	163
91-5132	404	91-6106	419	93-1718-7	164	93-1762-6	163
91-5140	404	91-6107	419	93-1720-1	164	93-1762-7	163
91-5142	404	91-6108	419	93-1720-2	164	93-1762-8	163
91-5150	403	91-6109	419	93-1720-3	164	93-1762-9	163
91-5152	403	91-6110	419	93-1720-4	164	93-1770-0	163
91-5154	403	91-6111	419	93-1722-1	164	93-1770-00	163
91-5160	403	91-6112	419	93-1722-2	164	93-1770-1	163
91-5161	403	91-6113	418	93-1722-3	164	93-1770-2	163
91-5162	403	92-1012	381, 573	93-1722-4	164	93-1770-3	163
91-5176	405	92-1014	381	93-1722-5	164	93-1770-4	163
91-5178	405	92-1112	381	93-1722-6	164	93-1770-5	163
91-5180	404	92-1114	381, 572	93-1722-7	164	93-1770-6	163
91-5185	404	92-1415	381	93-1722-8	164	93-1770-7	163
91-5190	405	92-1610	382	93-1730-1	164	93-1770-8	163
91-5200	405	92-1712	380	93-1730-2	164	93-1770-9	163
91-5202	405	92-1715	380	93-1730-3	164	93-1780-1	163
91-5210	405	92-1814	380	93-1730-4	164	93-1780-10	163



93-1780-11	163	95-278	617	95-481	619	95-872	621
93-1780-12	163	95-281	617	95-482	622	95-885	621
93-1780-2	163	95-284	617	95-483	620	95-930	618
93-1780-3	163	95-285	619	95-485	620	95-934	618
93-1780-4	163	95-289	619	95-486	622	95-938	618
93-1780-5	163	95-292	617	95-487	620	95-952	618
93-1780-6	163	95-294	617	95-492	620	95-956	618
93-1780-7	163	95-295	617	95-493	622	96-0045	663
93-1780-8	163	95-299	617	95-494	620	96-0095	430, 665
93-1780-9	163	95-303	621	95-496	620	96-0102	458
93-2160	395, 403	95-304	621	95-498	620	96-0160	458
94-7001	121, 532	95-308	616	95-499	622	96-0192	458
95-008	622, 678	95-312	621	95-500	619	96-0351	664
95-010	622, 678	95-321	617	95-501	619	96-0670	188
95-033	622	95-322	621	95-502	622	96-0737	665
95-038	622	95-324	621	95-504	619	96-0827	451
95-042	622	95-325	617	95-512	619	96-0837	451
95-100	617	95-327	617	95-513	619	96-0847	451
95-103	616	95-328	617	95-514	619	96-0857	450
95-104	616	95-329	617	95-515	619	96-0867	450
95-105	617	95-330	617	95-516	619	96-0877	450
95-107	616	95-332	617	95-517	619	96-0920	451
95-109	616	95-335	617	95-518	619	96-0921	451
95-110	616	95-336	617	95-521	619	96-0922	451
95-111	616	95-339	617	95-525	619	96-1000	187
95-112	616	95-340	617	95-571	619	96-1001	187
95-113	616	95-346	617	95-577	619	96-1002	187
95-114	616	95-347	621	95-586	619	96-1005	187
95-115	616	95-348	621	95-592	620	96-1006	187
95-116	616	95-352	617	95-604	618	96-1007	187
95-117	616	95-354	617	95-605	618	96-1010	187
95-118	616	95-356	617	95-606	620	96-1011	187
95-119	616	95-358	617	95-607	618	96-1012	187
95-120	616	95-360	617	95-611	620	96-1015	187
95-122	616	95-361	617	95-629	620	96-1016	187
95-124	616	95-362	621	95-635	620	96-1017	187
95-125	616	95-364	617	95-705	618	96-1020	187
95-126	616	95-365	621	95-710	618	96-1021	187
95-127	616	95-366	621	95-727	618	96-1022	187
95-128	616	95-369	617	95-731	618	96-1030	187
95-130	620	95-374	618	95-736	618	96-1031	187
95-132	620	95-375	616	95-740	622	96-1035	187
95-133	620	95-386	620	95-741	622	96-1036	187
95-135	620	95-390	621	95-742	618	96-1040	413
95-136	620	95-392	621	95-743	622	96-1060	413
95-137	620	95-394	621	95-748	622	96-1070	257
95-138	620	95-409	619	95-753	618	96-1071	257
95-139	620	95-421	619	95-757	618	96-1075	413
95-140	620	95-426	619	95-762	618	96-1085	413
95-141	620	95-431	619	95-766	618	96-1092	458
95-142	620	95-434	620	95-770	618	96-1097	458
95-143	620	95-436	619	95-771	618	96-1098	458
95-146	620	95-437	620	95-772	618	96-1099	413
95-147	620	95-442	619	95-774	618	96-1100	458
95-160	617	95-447	618	95-775	618	96-1102	458
95-161	617	95-449	618	95-776	618	96-1105	458
95-182	618	95-452	618	95-777	618	96-1110	458
95-188	618	95-456	619	95-778	618	96-1115	458
95-222	616	95-458	619	95-781	618	96-1120	458
95-226	616	95-459	620	95-790	618	96-1125	458
95-231	616	95-463	619	95-797	622	96-1130	458
95-232	616	95-465	619	95-809	621	96-1140	458
95-232B	616	95-466	619	95-810	621	96-1142	458
95-232P	616	95-467	619	95-813	621	96-1144	458
95-241	616	95-469	619	95-826	621	96-1146	458
95-243	616	95-470	619	95-832	621	96-1148	458
95-254	616	95-471	619	95-834	621	96-1150	458
95-265	617	95-472	622	95-842	621	96-1152	458
95-266	617	95-473	619	95-847	621	96-1160	458
95-272	617	95-477	619	95-853	621	96-1200	404, 452
95-275	617	95-479	622	95-869	621	96-1201	675

# NUMERICAL INDEX



96-1202	675	96-1850	708	96-2542	653	96-2630	657
96-1210	404, 452	96-1851	708	96-2543	653	96-2632	657
96-1220	654	96-1852	708	96-2544	655	96-2634	657
96-1221	654	96-1853	708	96-2545	655	96-2636	657
96-1222	654	96-1857	450	96-2546	655	96-2649	652
96-1223	654	96-1860	708	96-2547	655	96-2650	652
96-1224	654	96-1862	708	96-2548	655	96-2651	652
96-1225	654	96-1864	708	96-2549	655	96-2652	655
96-1226	654	96-1866	708	96-2550	655	96-2653	655
96-1227	654	96-1867	450	96-2551	655	96-2654	653
96-1228	654	96-1868	708	96-2552	655	96-2655	656
96-1229	654	96-1870	708	96-2553	655	96-2656	656
96-1340	530	96-1872	708	96-2554	655	96-2657	655
96-1341	530	96-1874	708	96-2555	655	96-2658	655
96-1342	530	96-1876	708	96-2556	655	96-2659	659
96-1343	530	96-1877	450	96-2557	655	96-2660	656
96-1344	530	96-1900	708	96-2558	656	96-2661	462, 656
96-1345	530	96-1901	708	96-2559	656	96-2662	653
96-1346	530	96-1903	708	96-2560	655	96-2663	653
96-1347	530	96-1905	708	96-2561	655	96-2664	655
96-1348	530	96-1906	708	96-2562	655	96-2672	653
96-1349	530	96-1918	665	96-2563	655	96-2680	652
96-1350	530	96-1927	666	96-2564	657	96-2682	652
96-1351	530	96-1929	665	96-2565	657	96-2684	657
96-1400	707	96-2402	653	96-2566	655	96-2688	656
96-1402	707	96-2404	653	96-2567	655	96-2689	657
96-1404	707	96-2406	658	96-2568	656	96-2701	654
96-1406	707	96-2408	658	96-2569	656	96-2702	654
96-1408	707	96-2410	657	96-2570	656	96-2703	654
96-1410	707	96-2412	657	96-2571	656	96-2704	654
96-1412	707	96-2445	614	96-2572	656	96-2705	656
96-1414	707	96-2447	614	96-2573	656	96-2706	656
96-1416	707	96-2452	614	96-2575	656	96-2707	655
96-1418	707	96-2497	652	96-2576	656	96-2708	655
96-1440	707	96-2499	652	96-2577	656	96-2710	659
96-1442	707	96-2501	653	96-2578	656	96-2712	659
96-1444	707	96-2502	653	96-2579	656	96-2720	652
96-1446	707	96-2503	653	96-2580	659	96-2721	652
96-1500	707	96-2504	652	96-2581	659	96-2726	652
96-1502	707	96-2505	652	96-2582	659	96-2728	652
96-1504	707	96-2506	652	96-2583	659	96-2774	656
96-1506	707	96-2507	652	96-2584	659	96-2775	656
96-1508	707	96-2510	653	96-2585	659	96-2921	656
96-1510	707	96-2511	653	96-2586	659	96-3000	660
96-1512	707	96-2512	653	96-2587	659	96-3001	660
96-1514	707	96-2513	653	96-2590	659	96-3002	660
96-1516	707	96-2514	652	96-2591	659	96-3006	655
96-1518	707	96-2516	652	96-2592	652	96-3008	655
96-1550	707	96-2517	652	96-2593	652	96-3290	614
96-1552	707	96-2518	653	96-2594	659	96-3291	614
96-1630	706	96-2519	653	96-2595	659	96-3292	614
96-1679	706	96-2520	652	96-2596	653	96-3298	614
96-1700	663	96-2521	652	96-2597	652	96-3299	614
96-1710	662	96-2522	652	96-2598	653	96-3300	614
96-1713	664	96-2523	652	96-2599	659	96-3301	614
96-1715	430, 662	96-2524	652	96-2602	450	96-3302	614
96-1718	662	96-2525	652	96-2603	660	96-3303	614
96-1725	430, 662	96-2526	652	96-2604	450	96-3304	614
96-1728	187	96-2527	652	96-2605	660	96-4100	457
96-1730	663	96-2528	657	96-2606	450	96-4106	4, 716
96-1734	663	96-2529	657	96-2607	660	96-4140	456
96-1740	663	96-2530	652	96-2612	660	96-4140NS	456
96-1744	664	96-2531	652	96-2613	660	96-4143	454
96-1745	666	96-2532	658	96-2614	660	96-4150	454
96-1746	664	96-2533	658	96-2615	660	96-4155	454
96-1806	666	96-2536	655	96-2616	660	96-4160	457
96-1845	708	96-2537	655	96-2617	660	96-4190	457
96-1846	708	96-2538	655	96-2620	657	96-4192	457
96-1847	708	96-2539	655	96-2622	657	96-4194	457
96-1848	708	96-2540	653	96-2624	657	96-4196	457
96-1849	708	96-2541	653	96-2626	657	96-5190	457



96-5192	457	96-9628	410	96-9706	417	97-372	630
96-5194	457	96-9629	410	96-9708	417	97-373	630
96-5196	457	96-9630	410	96-9710	417	97-375	624
96-5281	660	96-9632	411	97-008	632	97-376	630
96-5283	660	96-9633	411	97-010	632	97-380	630
96-5284	660	96-9634	411	97-012	632	97-382	630
96-5557	258	96-9635	411	97-014	632	97-384	630
96-5557A	258	96-9636	411	97-020	632	97-388	630
96-5557BNS	258	96-9637	411	97-021	632	97-390	630
96-5628	660	96-9638	411	97-029	632	97-391	630
96-5629	660	96-9639	411	97-033	633	97-392	630
96-6652	666	96-9640	411	97-038	633	97-394	630
96-7020	705	96-9641	411	97-042	633	97-409	627
96-7024	704	96-9642	411	97-100	625	97-421	627
96-7025	704	96-9643	411	97-105	625	97-426	627
96-7027	705	96-9644	411	97-107	625	97-431	627
96-7028	705	96-9645	411	97-108	625	97-434	628
96-7033	704	96-9646	411	97-109	625	97-436	628
96-7174	705	96-9647	411	97-121	624	97-437	628
96-7175	704	96-9648	411	97-222	624	97-442	628
96-7177	704	96-9649	411	97-226	624	97-447	627
96-7178	704	96-9650	411	97-231	624	97-449	626
96-7268	705	96-9651	411	97-237	624	97-452	627
96-7270	705	96-9652	412	97-241	624	97-458	627
96-7451	705	96-9653	412	97-243	624	97-459	628
96-7459	705	96-9654	412	97-245	624	97-463	627
96-7543	706	96-9655	412	97-254	624	97-465	628
96-7887	614	96-9656	412	97-256	624	97-469	628
96-8962	661	96-9657	412	97-258	624	97-470	628
96-8963	661	96-9658	412	97-263	625	97-471	628
96-8964	661	96-9659	412	97-266	625	97-473	628
96-8965	661	96-9660	412	97-269	625	97-477	628
96-8966	661	96-9661	412	97-270	625	97-481	628
96-8967	661	96-9662	412	97-272	625	97-483	628
96-8968	661	96-9663	412	97-275	625	97-485	628
96-8969	661	96-9664	414	97-278	625	97-487	628
96-8970	661	96-9665	414	97-281	625	97-492	628
96-8971	661	96-9666	414	97-284	625	97-494	628
96-8972	661	96-9667	414	97-288	625	97-496	628
96-8973	661	96-9668	414	97-291	625	97-498	628
96-8974	661	96-9669	414	97-292	625	97-500	628
96-8975	661	96-9670	414	97-293	625	97-501	628
96-8976	661	96-9671	414	97-294	625	97-504	628
96-9601	410	96-9672	414	97-295	625	97-512	628
96-9602	410	96-9673	414	97-297	625	97-513	628
96-9603	410	96-9674	414	97-299	625	97-514	628
96-9604	410	96-9675	414	97-300	625	97-515	628
96-9605	410	96-9676	415	97-308	624	97-516	628
96-9606	410	96-9677	415	97-312	624	97-517	628
96-9607	410	96-9678	415	97-321	624	97-518	628
96-9608	410	96-9679	415	97-325	624	97-521	628
96-9609	410	96-9680	415	97-327	624	97-525	628
96-9610	410	96-9681	415	97-328	624	97-528	628
96-9611	410	96-9682	415	97-335	624	97-534	628
96-9612	410	96-9683	415	97-336	624	97-537	628
96-9613	410	96-9684	415	97-339	624	97-542	628
96-9614	410	96-9685	415	97-340	624	97-545	631
96-9615	410	96-9686	415	97-346	625	97-546	627
96-9616	410	96-9687	415	97-352	625	97-561	627
96-9617	410	96-9688	416	97-354	624	97-563	627
96-9618	410	96-9690	416	97-356	624	97-571	627
96-9619	410	96-9692	416	97-358	625	97-577	627
96-9620	410	96-9694	416	97-360	625	97-586	627
96-9621	410	96-9696	416	97-361	625	97-587	629
96-9622	410	96-9698	417	97-364	625	97-592	629
96-9623	410	96-9700	417	97-365	630	97-598	629
96-9624	410	96-9701	417	97-366	630	97-599	629
96-9625	410	96-9702	417	97-369	625	97-601	629
96-9626	410	96-9703	417	97-370	630	97-604	626
96-9627	410	96-9704	417	97-371	630	97-605	626

# NUMERICAL INDEX



97-606	629	97-0017	330	97-1262	322, 539	98-161	625
97-607	626	97-0019	330	97-1280	322	98-162	632
97-611	629	97-0020	330	97-1285	322	98-164	632
97-623	629	97-0021	330	97-1286	322	98-165	632
97-629	629	97-0025	331	97-1300	325	98-166	632
97-635	629	97-0026	331	97-1308	323	98-167	632
97-639	629	97-0027	331	97-1309	323	98-170	632
97-645	629	97-0028	331	97-1315	326	98-171	632
97-655	629	97-0030	331	97-1318	326, 540	98-172	632
97-705	626	97-0035	329	97-1325	306	98-173	632
97-710	626	97-0036	329	97-1340	335	98-174	632
97-727	626	97-0040	330	97-1350	67, 352	98-178	630
97-731	626	97-0048	329	97-1351	67, 352	98-179	630
97-736	626	97-0050	304, 331	97-1400	670	98-180	627
97-742	626	97-0335	325, 540	97-1405	670	98-182	633
97-747	626	97-0503	327	97-1410	670	98-188	626
97-748	626	97-0505	327	97-1420	670	98-200	632
97-749	626	97-0507	327	97-1445	670	98-201	633
97-751	626	97-0509	327	97-1450	546, 547, 670	98-207	633
97-753	627	97-0512	327	97-1505	197, 334, 549	98-209	632
97-757	627	97-0522	327	97-1506	197, 334, 549	98-211	633
97-762	627	97-0524	327	97-1520	564	98-224	632
97-763	626	97-0527	304	97-1521	564	98-232	632
97-764	626	97-0528	327	97-1530	35, 124, 379	98-234	633
97-769	627	97-0530	568, 569	97-1531	35, 124, 379	98-236	633
97-770	627	97-0532	327, 540	97-1540	35, 124, 379	98-239	633
97-771	626	97-0536	327, 540	97-1541	35, 124, 379	98-243	632
97-772	626	97-0539	327	97-1555	35, 124, 345	98-247	632
97-774	627	97-0542	327, 540	97-1560	35, 124, 345, 571	98-251	632
97-775	626	97-0545	330, 540	97-1565	35, 124, 346	98-252	632
97-776	626	97-0546	328	97-1570	35, 124, 346	98-253	632
97-777	626	97-0548	328	97-1600	332	98-256	632
97-778	626	97-0552	328	97-1605	332	98-257	632
97-781	626	97-0554	328, 540	97-1610	332	98-258	633
97-784	626	97-0555	68, 326	97-1615	292, 333	98-267	633
97-787	626	97-0562	328	97-1620	292, 333	98-268	633
97-788	627	97-0564	327	97-1625	292, 333	98-276	626
97-790	627	97-0568	329	97-1635	292	98-285	628
97-791	626	97-0580	327	97-1640	292, 333	98-289	628
97-793	626	97-0581	327	97-1642	333	98-303	630
97-795	627	97-0582	328	97-1645	333	98-312	630
97-799	631	97-0583	328	97-1649	332	98-324	630
97-809	629	97-0601	329	97-1650	292	98-325	630
97-810	629	97-0604	329	97-1652	292	98-336	630
97-813	629	97-0606	329	97-1654	292	98-348	630
97-826	629	97-0623	329	97-1660	323	98-362	630
97-832	629	97-0634	329	97-1661	323	98-364	630
97-834	629	97-0640	331	97-1662	323, 539	98-366	630
97-838	629	97-0641	331	97-1663	323	98-367	625
97-842	629	97-1045	324	97-1820	670	98-370	630
97-847	629	97-1046	324, 539	97-1821	670	98-374	627
97-853	629	97-1055	323	97-1822	670	98-382	630
97-869	629	97-1056	324	97-1823	670	98-384	630
97-872	629	97-1057	324	97-1824	670	98-386	628
97-877	629	97-1145	323	97-1825	670	98-402	631
97-881	629	97-1148	323	97-1826	670	98-403	631
97-883	629	97-1150	326, 540	98-103	624	98-404	631
97-885	629	97-1156	324	98-104	624	98-405	631
97-894	629	97-1174	323	98-107	624	98-406	631
97-902	632	97-1185	323	98-109	624	98-413	631
97-913	632	97-1235	68, 325	98-110	624	98-414	631
97-930	627	97-1238	325	98-123	626	98-415	631
97-934	627	97-1241	325	98-129	626	98-416	631
97-938	627	97-1242	325, 539	98-135	626	98-425	631
97-952	627	97-1243	325	98-140	627	98-426	631
97-956	627	97-1245	68, 325	98-142	626	98-472	633
97-0006	330	97-1251	322	98-146	626	98-475	633
97-0010	330	97-1255	322, 539	98-151	626	98-476	633
97-0011	330	97-1259	322	98-155	626	98-477	633
97-0015	330	97-1261	322	98-160	625	98-478	633





98-480	633	98-1077	528	98-7758	259
98-482	633	98-1091	548	98-7782	260
98-484	633	98-1092	549	98-7784	260
98-485	633	98-1093	550	98-7786	260
98-489	633	98-1094	546	98-7788	260
98-490	624	98-1095	561	98-7794	260
98-492	633	98-1096	565	98-7796	260
98-493	633	98-1097	566	98-7810	265
98-494	626	98-1354	442, 575	98-7812	265
98-495	624	98-1355	442, 576	98-7815	265
98-496	624	98-1356	442, 576	98-7816	265
98-499	632	98-1357	442, 576	98-7817	265
98-502	632	98-1400	574	98-7820	260
98-503	631	98-1401	574	98-7836	260
98-505	631	98-1437	560	98-7892	261
98-508	631	98-1439	560	98-7894	261
98-521	630	98-1440	559	98-7898	261
98-740	631	98-1444	568	98-7920	262
98-741	631	98-1450	565	98-7924	262
98-742	631	98-1453	558	98-7930	262
98-748	632	98-1457	568	98-7936	262
98-750	631	98-1462	562	98-7950	262
98-755	631	98-1464	569	98-7952	262
98-797	631	98-1468	544	98-7954	262
98-1000	536	98-1472	550	98-7960	262
98-1002	537	98-1475	551		
98-1004	562	98-1480	590		
98-1005	538	98-2034	561		
98-1006	553	98-2036	568		
98-1007	541	98-2047	109, 554, 555, 560		
98-1008	566	98-2048	109		
98-1009	539	98-2050	87		
98-1010	540	98-2051	87		
98-1011	554	98-2070	87		
98-1012	543	98-2071	87		
98-1013	555	98-2072	114		
98-1014	570	98-2075	114		
98-1015	539	98-2076	114		
98-1016	570	98-2077	114		
98-1017	557	98-2080	123		
98-1018	571	98-2081	123		
98-1019	572	98-3055	266		
98-1020	572	98-3070	131		
98-1021	575	98-3085	131		
98-1022	541	98-3170	131		
98-1024	573	98-3171	131		
98-1026	573	98-3180	270		
98-1028	573	98-3182	270		
98-1030	559	98-3183	270		
98-1031	547	98-3184	270		
98-1032	556	98-3185	270		
98-1033	547	98-3186	271		
98-1034	545	98-3188	271		
98-1035	547	98-3190	271		
98-1036	552	98-3192	271		
98-1038	567	98-4008	115, 518		
98-1041	577	98-4012	115, 518		
98-1043	578	98-4020	115, 518		
98-1045	578	98-4108	115, 518, 577		
98-1046	543	98-4112	115, 518		
98-1047	579	98-4120	115, 518		
98-1052	71	98-7277	261		
98-1055	71	98-7278	261		
98-1057	580	98-7279	261		
98-1058	538	98-7704	259		
98-1059	581	98-7710	259		
98-1064	544	98-7720	259		
98-1067	71	98-7740	259		
98-1075	528	98-7744	259		
98-1076	528	98-7754	259		



Baby Lexer Scissors.....	52	Basic Podiatry Set.....	540	Biopsy Punch, Eppendorfer.....	390
Baby Mixer Forceps.....	87, 560	Basic Tissue Dissection Set.....	544	Biopsy Punch, Gaylor.....	392
Back Action Pluggers.....	582	Basic Total Hip Set.....	554	Biopsy Punch, Gellhorn.....	392, 571
Backhaus Towel Clamp.....	127, 536-537, 539-540, 542-548, 550-557, 561, 565-567, 570-572, 574, 578-580	Basin, Emesis, Stainless Steel.....	547, 561, 682	Biopsy Punch, Handle.....	391
Backhaus Towel Clamp, Econo-Sterile™.....	657	Basin, Plastic Emesis.....	706	Biopsy Punch, Kevorkian.....	389
Backhaus Towel Clamp, Econo™.....	641	Basin, Plastic OR.....	706	Biopsy Punch, Kevorkian-Youngue.....	390
Backhaus Towel Clamp, Surgi-OR™.....	620	Basin, Solution, Stainless Steel.....	681	Biopsy Punch, Keyes Cutaneous.....	363, 534
Backhaus Towel Forceps, Merit™.....	629	Basket, Arthroscope.....	691	Biopsy Punch, Laparoscopic.....	430
Bacon Rongeur.....	276	Basket, Cleaning, Stainless Steel.....	686	Biopsy Punch, Micro-Cut Cannula.....	387
Bailey Contractor.....	489, 579	Basket, Endoscope.....	691	Biopsy Punch, Micro-Cut Eppendorfer.....	386
Bailey Foreign Body Remover.....	222	Basket, Mesh.....	689	Biopsy Punch, Micro-Cut Gaylor.....	388
Bailey Gigli Bone Saw Guide.....	308	Basket, Ophthalmic.....	690	Biopsy Punch, Micro-Cut Gellhorn.....	388
Bailey-Gibbon Contractor.....	489	Basket, Sterilization, SklarLite™.....	574, 697-699	Biopsy Punch, Micro-Cut Handle.....	387
Bainbridge Forceps.....	484	Basket, Wire Net.....	690	Biopsy Punch, Micro-Cut Kevorkian.....	385
Baird Chalazion Forceps.....	251	Battery, Laryngoscope, Rechargeable.....	160	Biopsy Punch, Micro-Cut Kevorkian-Youngue.....	386
Baker Nail Cutter.....	328	Baumgartner Needle Holder.....	128, 561	Biopsy Punch, Micro-Cut Oval.....	386
Bakes Dilator.....	173	Baumgartner Needle Holder, Econo-Sterile™.....	659	Biopsy Punch, Micro-Cut Tischler Mini.....	385
Balfour Retractor.....	139, 537, 541, 579	Baumgartner Needle Holder, Econo™.....	646	Biopsy Punch, Micro-Cut Tischler Oval.....	385
Balfour Retractor Blade.....	139	Baumgartner Needle Holder, Mid-Grade.....	629	Biopsy Punch, Micro-Cut Tischler-Kevorkian.....	385
Ball & Socket Towel Clamp.....	104	Baumgartner Needle Holder, Sklarlite XD™.....	46	Biopsy Punch, Micro-Cut Universal.....	387
Ballenger Chisel.....	563	Baumgartner Needle Holder, Sklarlite™.....	46	Biopsy Punch, Micro-Cut Wittner Uterine.....	386
Ballenger Knife.....	193, 564	Baumgartner Needle Holder, Surgi-OR™.....	621	Biopsy Punch, Oval.....	390, 573
Ballenger Sponge Forceps.....	126, 538-539, 541, 544, 547, 567	Baumgartner Needle Holder, Surgi-OR™ TC.....	620	Biopsy Punch, Schubert.....	392
Ballenger Sponge Forceps, Econo™.....	641	Baumgartner Needle Holder, TC.....	40, 133	Biopsy Punch, Sharpening Stone.....	363, 534
Ballenger Swivel Knife.....	549	Bayonet Forceps, Adson.....	116, 182, 556	Biopsy Punch, Tischler Mini.....	389
Banana Knife.....	321	Bayonet Forceps, Adson, Merit™.....	626	Biopsy Punch, Tischler Oval.....	389, 573
Band Pliers.....	606	Bayonet Pliers.....	608	Biopsy Punch, Tischler-Kevorkian.....	389, 571
Band Set.....	442, 575	Beacham Amniotome.....	383	Biopsy Punch, Tru-Punch™, Disposable.....	458
Band Slitting Pliers.....	606	Bechert Rotator.....	229	Biopsy Punch, Universal.....	391
Bandage Scissors, Knowles.....	636	Bechert-McPherson Forceps.....	246, 268	Biopsy Punch, Wittner Uterine.....	390
Bandage Scissors, Lister.....	636	Beck Headband.....	199	Biopsy Punch, Yeoman.....	474, 543
Bandage, Cohesive.....	530	Beckman Eaton Retractor.....	282	Bipolar Cable, Electrosurgical.....	418
Bantam Bandage Scissors.....	67	Beckman-Adson Retractor.....	282, 556	Bipolar Forceps, Electrosurgical Adson.....	418, 561
Bar Fistula Probe.....	172, 475	Beckman-Eaton Retractor.....	208	Bipolar Forceps, Electrosurgical Coaptation.....	418
Barkan Knife.....	221	Beckmann Curette.....	203	Bipolar Forceps, Electrosurgical Cord.....	417
Barnhill Curette.....	203	Beckmann Speculum.....	189	Bipolar Forceps, Electrosurgical Cushing.....	418
Baron Alligator Forceps.....	474	Beeson Plaster Spreader.....	317	Bipolar Forceps, Electrosurgical Gerald.....	418
Baron Suction Tube.....	154, 550-551, 559, 567	Behman Pluggers.....	582	Bipolar Forceps, Electrosurgical Gerald Bayonet.....	418
Barr Crypt Hook.....	475	Bellucci Scissors, Micro.....	182, 552	Bipolar Forceps, Electrosurgical Hardy Bayonet.....	418
Barr Hook.....	543	Bengolea Forceps.....	479	Bipolar Forceps, Electrosurgical Jansen Bayonet.....	419
Barr Retractor.....	473	Benique Catheter Guide.....	466	Bipolar Forceps, Electrosurgical Jeweler.....	419
Barraquer Cilia Forceps.....	122, 249	Bennett Retractor.....	300	Bipolar Forceps, Electrosurgical Malis.....	419
Barraquer Needle Holder.....	131, 254, 271	Benson Pylorus Separator.....	92	Bipolar Forceps, Electrosurgical McPherson.....	419
Barraquer Spatula.....	224	Berens Keratome.....	220	Bipolar Forceps, Electrosurgical Semkin.....	419
Barraquer Wire Speculum.....	214, 547	Berens Scleral Hook.....	226	Bipolar Forceps, Electrosurgical Tenzel.....	419
Barraquer-Dewecker Iris Scissors.....	235, 264	Bergh Cilia Forceps.....	122, 249	Bird Beak Pliers.....	608
Barrett Placenta Forceps.....	98, 384	Bergh Cilia Forceps, Merit™.....	626	Biro Scissors.....	70
Barrett Tenaculum Forceps.....	100, 372, 542, 566, 574-575	Berke Ptosis Forceps.....	213, 251	Bishop-Harmon Cannula.....	256
Barth Curette.....	294	Berlind-Auvard Vaginal Speculum.....	357	Bishop-Harmon Forceps.....	118, 241, 267, 547, 565
Barton Forceps.....	380	Bernard Pliers.....	607	Bishop-Harmon Forceps, Econo™.....	645
Basic Dermal Excision Set.....	539	Bethune Shears.....	490, 579	Bishop-Harmon Forceps, LiteGrip™.....	108
Basic Dermal Instrument Set.....	538	Beyer Rongeur.....	275, 276, 553-554, 557, 568	Bishop-Harmon Forceps, Merit™.....	626
Basic Ear Set.....	550	Bierer Ovum Forceps.....	98, 383	Black Pluggers.....	582-583
Basic Eye Surgery Set.....	545	Bihrlle Needle Holder, TC.....	42	Blade Breaker, Castroviejo.....	223
Basic Hand Surgery Set.....	566	Bill Traction Handle.....	382	Blade Breaker, Swiss.....	223
Basic Nail Set.....	539	Billeau Ear Curette, Econo™.....	649	Blade Breaker, Troutman.....	223, 546
Basic Nasal Set.....	548	Billeau Loop.....	178, 550, 552	Blade Electrode Disposable, Electrosurgical.....	411
Basic Open Heart Set.....	580	Billroth Forceps.....	99, 379	Blade, Carbon P-M.....	670
Basic Orthopedic Surgery Set.....	553	Biopsy Punch Set, Tru-Punch™, Disposable.....	458	Blade, Corneal Trephine.....	231
Basic Plastic Surgery Set.....	559	Biopsy Punch Tray.....	430	Blade, Keyes Finger Ring Cutter.....	535
		Biopsy Punch, Cannula.....	391	Blade, LaForce Adenotome.....	203
				Blade, Laryngoscope, Macintosh.....	159
				Blade, Laryngoscope, Macintosh, F.O.....	158-159
				Blade, Laryngoscope, Miller.....	159

## ALPHABETICAL INDEX



Blade, Laryngoscope, Miller, F.O.....	158	Bone Hook, Volkman.....	299	Brown Needle Holder.....	128
Blade, Laryngoscope, Wisconsin, F.O.....	159	Bone Lever, Cottle.....	195	Brown Needle Holder, Merit™.....	629
Blade, Razor.....	223	Bone Mallet.....	290	Brown Needle Holder, Surgi-OR™.....	621
Blade, Remover.....	667	Bone Packer.....	289	Brown Scissors.....	61
Blade, Scalpel.....	670	Bone Pin Cutter.....	309, 348	Brown Tissue Forceps.....	113
Blade, Sklar Finger Ring Cutter.....	535	Bone Rasp, Putti.....	292, 554, 557	Bruening Otoscope.....	177
Blade, Surgical, Disposable.....	539-540, 544, 560, 668	Bone Rongeur.....	276	Bruening Otoscope Set.....	177
Blair-Roll Retractor.....	149, 538, 558, 577	Bone Saw Blade, Charriere.....	307	Bruns Curette.....	293, 342, 556
Blake Forceps.....	89, 182	Bone Saw Guide, Bailey Gigli.....	308	Bruns Plaster Shears.....	315, 352
Blakesley Forceps.....	190	Bone Saw Guide, Joseph.....	308	Bruns Plaster Shears, Merit™.....	624
Blepharoplasty Set.....	565	Bone Saw Handles, Gigli.....	273, 308, 556-557	Bruns Plaster Shears, TC.....	315, 352
Blepharoplasty Scissors.....	59, 566	Bone Saw Wire, Gigli.....	308	Brush Head.....	714
Blepharoplasty Scissors, Sklar Edge™ TC.....	21	Bone Saw, Charriere.....	307	Brush, Cleaning.....	711-714
Block, Corneal Cutting.....	231	Bone Saw, Joseph.....	193, 307, 343	Brush, Cleaning Set.....	713-714
Blount Retractor.....	300, 555	Bone Saw, Langenbeck.....	308, 343	Brush, Drying Rack.....	712
Blower, Chip.....	292	Bone Saw, Satterlee.....	307	Brush, Instrument Cleaning.....	709-710, 713-714
Blumenthal Rongeur.....	277, 337, 613	Bone Tamper.....	289	Brush, Suction Tube Cleaning.....	711, 713-714
Bodenhammer Speculum.....	473	Bone Wire Guide, Demel.....	170	Brush, Surgical Scrub.....	711
Boettcher Scissor.....	205	Bonn Iris Scissors.....	59	Brush, Tracheal Tube Cleaning.....	709
Bogsworth Tongue Depressor.....	198	Bonn Suture Forceps.....	245, 268	Brush, Utility.....	714
Bohler Traction Bows.....	312	Bonney Tissue Forceps.....	113, 379	Buck Applicator.....	186
Boley Gauge.....	603	Botvin Iris Forceps.....	240, 267	Buck Curette, Merit™.....	632
Boley Gauge, Mid-Grade.....	603	Boucheron Ear Speculum.....	177, 551, 567	Buck Ear Curette.....	178, 539, 550-552, 567
Bonaccolto Utility Forceps.....	119, 247	Boucheron Ear Speculum Set.....	177	Buck Ear Curette, Econo™.....	649
Bond Placenta Forceps.....	384	Bowel Resection Set.....	576	Buck Ear Probe.....	184
Bone & Cartilage Clamp.....	346, 553, 555	Bowl, Mixing/Solution, Stainless Steel.....	681	Buck Hammer.....	678
Bone & Cartilage Forceps.....	297	Bowl, Plastic Guidewire.....	706	Buck Hammer, Merit™.....	632
Bone Awl.....	312	Bowl, Plastic Multi-Purpose Utility.....	705	Buck Knife.....	601
Bone Awl, Perthes.....	312	Bowl, Plastic Utility.....	706	Buck Myringotome.....	183
Bone Clamp, Lowman.....	294, 343, 553	Bowl, Sponge, Stainless Steel.....	681	Buck Suture Scissors.....	562
Bone Clamp, Parham-Martin.....	298	Bowles Stethoscope.....	676	Buck-Gramcko Retrainer.....	306
Bone Curette, Cobbs.....	293	Bowman Lachrymal Probe.....	184, 230, 561	Bucket, Hospital Kick, Stainless Steel.....	682
Bone Curette, Martini.....	294	Bows, Kirschner.....	312	Bucket, Hospital, Stainless Steel.....	682
Bone Curette, Volkman.....	294, 341	Bows, Traction, Bohler.....	312	Buie Pile Clamp.....	475
Bone Curette, Volkman.....	568	Box, Trinket.....	692	Buie Suction Tube.....	155, 474, 543
Bone Curette, Williger.....	294	Boynton Needle Holder.....	255	Bulb, Chip Blower.....	292
Bone Drill.....	311, 347	Boys-Allis Forceps.....	101	Bulldog Clamp.....	518
Bone Drill Chuck Key.....	311, 347	Bozeman Forceps.....	96-97, 372, 473, 570-571, 577	Bulldog Clamp, DeBakey.....	115, 516
Bone Drill, Bunnell.....	311, 347	Bozeman Forceps, Econo-Sterile™.....	657	Bulldog Clamp, Dieffenbach.....	116, 517
Bone Drill, Kirschner.....	311	Bozeman Forceps, Econo™.....	641	Bulldog Clamp, Diethrich.....	115, 518, 577
Bone Drill, Moore.....	311	Bozeman Forceps, Merit™.....	627	Bulldog Clamp, Glover.....	517
Bone File.....	291-292, 332-334, 555	Bozeman Forceps, Sklar Black™.....	399	Bulldog Clamp, Johns Hopkins.....	115, 517
Bone File, Podi.....	332	Bozeman Forceps, Sklar Blue™.....	408	Bulldog Clamp, Santulli.....	517
Bone Forceps, Compression.....	297, 346	Bozeman Forceps, Surgi-OR™.....	618	Bulldog Forceps, DeBakey.....	569, 577
Bone Forceps, Farabeur-Lamotte.....	295	Bozemann Heaney Needle Holder, TC.....	42, 135, 371	Bunge Evisceration Spoon.....	227, 547
Bone Forceps, Ferguson.....	296	Bracket Pliers.....	606, 609	Bunnell Bone Drill.....	311, 347
Bone Forceps, Kern.....	295-296, 343, 553	Brantley-Turner Vaginal Retractor.....	151, 359	Bunnell Stripper.....	305
Bone Forceps, Kern, Merit™.....	633	Braun Episiotomy Scissors.....	69, 572	Burch Fixation Pick.....	226
Bone Forceps, Kleinert-Kutz.....	272, 336	Braun Epistomy Scissors, Econo™.....	638	Burford-Finochietto Spreader.....	140-141, 487, 579
Bone Forceps, Lambotte.....	295	Braun Epistomy Scissors, Merit™.....	624	Burnisher.....	583-584
Bone Forceps, Lane.....	295	Braun Epistomy Scissors, Surgi-OR™.....	616	Burnisher, Acorn.....	584
Bone Forceps, Langenbeck.....	297	Breaker, Castroviejo Blade.....	223	Burnisher, Ladmore.....	584
Bone Forceps, Lewin.....	272, 297, 335-336, 346, 553, 557	Breaker, Mason Cast.....	316	Burnisher, University of Michigan.....	583
Bone Forceps, Liston, Merit™.....	633	Breaker, Swiss Blade.....	223	Busch Umbilical Scissors.....	69
Bone Forceps, McIndoe.....	335	Breaker, Troutman Blade.....	223, 546	Button, Laparoscopic, Single Port.....	421
Bone Forceps, Plate &.....	297	Breaker, Wole-Boehler Cast.....	316, 353		
Bone Forceps, Rowland.....	272, 335	Breast Augmentation/Reduction Set.....	561		
Bone Forceps, Ruskin-Liston.....	272, 336	Breisky Retractor.....	359		
Bone Forceps, Self-Retaining.....	296	Brewster Retractor.....	146		
Bone Forceps, Semb.....	296	Bridge Forceps.....	462		
Bone Forceps, Stille-Luer.....	272, 553, 556-557	Bridge Thoracic Forceps.....	572, 579		
Bone Forceps, Verbrugge.....	296	Brinckerhoff Speculum.....	472		
Bone Hook.....	299, 554, 557	Brophy Scissors.....	369		
		Brown Applicator.....	186		

## C

Cable, Disposable, Electrosurgical.....	417
Cable, Electrosurgical.....	418
Caliper, Castroviejo.....	213, 257, 546, 549, 565
Caliper, EKG.....	679
Caliper, EKG, Merit™.....	632
Caliper, Thorpe.....	213, 257, 565

Campion Forceps, Sklar Black™	399	Castroviejo-Kalt Needle Holder	130, 254	Cilia Forceps, Ziegler	122, 249
Campion Uterine Forceps	94, 375	Cataract Surgery Set	546	Cinelli Osteotome	194, 549, 563
Cannon Curette	535	Catheter Guide	466	Cinelli Scissors	564
Cannula, Air Injection	547	Catheter Guide, Benique	466	Circumcision Probe	466
Cannula Biopsy Punch, Micro-Cut	387	Catheter Guide, Guyon	466	Circumcision Tray	664
Cannula, Air Injection	256	Catheter Instrument Tray Cover, Stainless Steel	685	Citelli Rongeur	195
Cannula, Biopsy Punch	391	Catheter Instrument Tray, Stainless Steel	685		
Cannula, Bishop-Harmon	256	Catheter Instrument Tray, Stainless Steel, Miniature	684		
Cannula, Endometrial, Disposable	457	Cava Clamp, Cooley	523		
Cannula, Holman-Mathieu	366	Cement Spatula	594		
Cannula, Laparoscopic	431	Cement Spatula, Agathe	594		
Cannula, Simcoe	256	Cement Spatula, Mid-Grade	594		
Capener Lamina Gouge	288	Cervix Brush, Disposable	456		
Capener Osteotome	288	Cesarean Section Set	573		
Caplan Scissors	563	Chalazion Curette, Meyhoff	547		
Carbon P-M Blade	670	Chalazion Forceps, Ayers	252		
Cardiology Stethoscope	672	Chalazion Forceps, Baird	251		
Carmalt Splinter Forceps	121, 532, 572	Chalazion Forceps, Desmarres	252, 546-547		
Carmalt Splinter Forceps, Econo™	645	Chalazion Forceps, Francis	251		
Carmalt Splinter Forceps, Merit™	626	Chalazion Forceps, Heath	251, 547		
Carrier, Cooley Ligature	526	Chalazion Forceps, Lambert	251		
Carrier, DeBakey-Semb Ligature	513	Chalazion Forceps, London	252		
Carrier, Dupuys-Weiss Ligature	170	Chalazion Forceps, Spencer	251		
Cartilage Clamp, Bone	346	Chalazion Forceps, Weis	252		
Cartilage Forceps, Bone &	297	Chalazion Set	547		
Carver, Cleoid & Discoid	591	Chandler Elevator	303		
Carver, Hollenback	591	Chandler Iris Forceps	117, 241		
Carver, Hollenback, Mid-Grade	591	Charriere Bone Saw	307		
Carver, Le Cron	593	Charriere Bone Saw Blade	307		
Carver, Le Cron, Mid-Grade	593	Cheek Retractor	201, 613		
Carver, Roach	592	Cheek Retractor, University of Minnesota	201, 613		
Carver, Roach, Mid-Grade	592	Chelsea Eaton Speculum	472		
Carver, Vehe	592	Cheron Forceps	95		
Carver, Vehe, Mid-Grade	592	Children's Extracting Forceps	612, 613		
Carver, Walls	592	Chip Blower	292		
Carver, Ward	592	Chip Blower Bulb	292		
Casanova Fixation Ring	217	Chip Blower Tip	292		
Case, Appliance	614	Chisel Knife	330		
Cassette, Instrument	692	Chisel, Alexander	287		
Cassette, Sterilization	700-702	Chisel, Army	284		
Cast Breaker, Mason	316	Chisel, Ballenger	563		
Cast Breaker, Wole-Boehler	316, 353	Chisel, Corn	330, 540		
Cast Spreader, Merit™	630	Chisel, Cottle	195		
Castanares Scissors	61	Chisel, Fomon	195		
Castanares Scissors, Sklarcut™	30, 566	Chisel, Foreign Body, Davis	222		
Castaneda Clamp	527	Chisel, Freer	194, 563		
Castroviejo Blade Breaker	223	Chisel, Gardner	588		
Castroviejo Caliper	213, 257, 546, 549, 565	Chisel, Hajek	196		
Castroviejo Corneal Scissors	71, 232, 263, 545-546	Chisel, Hibbs	286, 553		
Castroviejo Corneal Trepphine	231	Chisel, Hoke	286, 340		
Castroviejo Cyclodialysis Spatula	546	Chisel, Lebsche	490		
Castroviejo Dilator	230	Chisel, Lexer Mini	288		
Castroviejo Fixation Forceps	244, 546-547	Chisel, Stille	285		
Castroviejo Forceps	244, 267	Cholecystectomy Set	442, 576		
Castroviejo Forceps, Sklar Black™	400	Chuck Key, Bone Drill	311, 347		
Castroviejo Keratome	220	Chuck, Steinman Pin	312		
Castroviejo Lachrymal Probe	184	Cilia Forceps, Barraquer	122, 249		
Castroviejo Needle Holder	131, 254, 270, 545, 547, 559, 564	Cilia Forceps, Bergh	122, 249		
Castroviejo Needle Holder, TC	44, 135, 546, 547, 569, 577	Cilia Forceps, Bergh, Merit™	626		
Castroviejo Spatula	224	Cilia Forceps, Douglass	122, 249		
Castroviejo Speculum	216, 545, 546	Cilia Forceps, Gradle	249		
Castroviejo Suture Forceps	117, 245, 268, 546, 547, 564	Cilia Forceps, Littauer	122, 249		
		Cilia Forceps, Swiss	122		

## CLAMPS

Clamp, Allen	88
Clamp, Backhaus Towel	127, 536-537, 539-540, 542-548, 550-557, 561, 565-567, 570-572, 574, 578-580
Clamp, Backhaus Towel, Econo-Sterile™	657
Clamp, Backhaus Towel, Surgi-OR™	620
Clamp, Ball & Socket Towel	104
Clamp, Bone & Cartilage	346, 553, 555
Clamp, Buie Pile	475
Clamp, Bulldog	518
Clamp, Castaneda	527
Clamp, Coarctation	501
Clamp, Cooley	522, 524
Clamp, Cooley Cava	523
Clamp, Cooley Coarctation	523
Clamp, Cooley Neonatal	526
Clamp, Cooley Patent Ductus	523
Clamp, Cooley Satinsky	523
Clamp, Cooley-Derra	524
Clamp, DeBakey	504-506
Clamp, DeBakey Aneurysm	513
Clamp, DeBakey Angular	512
Clamp, DeBakey Bulldog	115, 516
Clamp, DeBakey Halsted	510
Clamp, DeBakey Pean	510
Clamp, DeBakey-Beck	506
Clamp, DeBakey-McQuigg Mixer	521
Clamp, Dieffenbach Bulldog	116, 517
Clamp, Diethrich	510
Clamp, Diethrich Bulldog	115, 518, 577
Clamp, Dingman	298, 555
Clamp, Gemini .90, 174, 477, 542, 545, 562, 574, 579	
Clamp, Glover	507
Clamp, Glover Bulldog	517
Clamp, Glover Coarctation	580
Clamp, Harken	581
Clamp, Herrick Kidney	176
Clamp, Hoff Towel	127
Clamp, Hoff Towel, Econo-Sterile™	657
Clamp, Johns Hopkins Bulldog	115, 517
Clamp, Jones Towel	127
Clamp, Jones Towel, Econo™	629
Clamp, Kay	508
Clamp, Lambert-Kay	508, 581
Clamp, Lees Bronchus	521
Clamp, Loma Edna Towel	127, 558, 574, 577, 579
Clamp, Loma Edna Towel, Econo-Sterile™	657
Clamp, Loma Edna Towel, Econo™	641
Clamp, Loma Edna Towel, Merit™	629
Clamp, Loma Edna Towel, Surgi-OR™	620
Clamp, Lowman Bone	294, 343, 553
Clamp, Mayo Guyon	91, 176
Clamp, Meniscus	305
Clamp, Mogen	466
Clamp, O'Hanlon	88

## ALPHABETICAL INDEX



Clamp, Patent Ductus.....	501, 580	Coaptation Bipolar Forceps, Electrosurgical .....	418	Cord Bipolar Forceps, Electrosurgical .....	417
Clamp, Payr Pylorus.....	92	Coarctation Clamp.....	501	Corey Ovum Forceps .....	98, 383
Clamp, Peers Towel, Merit™ .....	629	Coarctation Clamp, Cooley.....	523	Corn Chisel.....	330, 540
Clamp, Pemberton.....	90	Coartation Forceps, DeBakey .....	519	Corn Knife.....	329, 330
Clamp, Pennington.....	104, 485, 543	Cobb Gouge .....	287	Corneal Cutting Block.....	231
Clamp, Pratt.....	104, 174, 466, 543, 570	Cobbs Bone Curette.....	293	Corneal Forceps, Colibri.....	266
Clamp, Presbyterian Tube Occluding, Econo-Sterile™.....	658	Coded Probe .....	588	Corneal Forceps, Troutman Barraquer.....	240, 266
Clamp, Presbyterian Tube Occluding, Merit™ .....	629	Cogswell Elevator.....	602	Corneal Hook, Wiener .....	226
Clamp, Presbyterian Tube Occluding, Surgi-OR™.....	620	Cohan Needle Holder .....	255, 270	Corneal Trephine Blade.....	231
Clamp, Renal.....	525	Cohen Uterine Manipulator.....	363	Corneal Trephine Handle.....	231
Clamp, Roeder Towel .....	127	Cohesive Bandage.....	530	Corneal Trephine, Castroviejo.....	231
Clamp, Santuli Bulldog .....	517	Colclough Rongeur.....	278	Comeoscleral Forceps, Thorpe .....	117, 247
Clamp, Satinsky.....	506	Colibri Corneal Forceps.....	240, 266, 546	Corwin Wire Twister, TC .....	35, 166
Clamp, Schaedel Towel.....	123	Collar Button, Graether.....	229	Coryllos Shears .....	490
Clamp, Sesamoid .....	298, 346	Collar, Laparoscopic.....	431	Cottle Bone Lever.....	195
Clamp, Sklar Thoracic.....	93, 492	College Pliers .....	603, 604	Cottle Chisel .....	195
Clamp, Sklar Towel.....	104	College Pliers, Mid-Grade .....	604	Cottle Columella Forceps .....	213, 549
Clamp, Stille .....	91, 176	Coller Forceps .....	84	Cottle Crusher .....	563, 565
Clamp, Stockman .....	467	Collier Needle Holder .....	129	Cottle Dorsal Scissors .....	61, 549
Clamp, Stockman/Zipser .....	466	Collier Needle Holder, Econo™ .....	647	Cottle Dorsal Scissors, Sklar Edge™ TC .....	562
Clamp, Straus.....	467	Collier Needle Holder, Merit™ .....	629	Cottle Elevator.....	191, 549, 563, 565, 568
Clamp, Subramanian.....	520	Collier Needle Holder, Surgi-OR™ .....	621	Cottle Knife.....	549, 563
Clamp, Tendon .....	305	Collin Vaginal Speculum .....	355	Cottle Knife Guard & Retractor.....	209, 549
Clamp, Trexter .....	466	Collin Vaginal Speculum, Sklar Black™ .....	396	Cottle Knife Guard.....	191
Clamp, Tube Occluding.....	126	Collin Vaginal Speculum, Sklar Blue™ .....	404	Cottle Osteotome.....	195, 549, 563
Clamp, Tube Occluding, Econo™ .....	642	Collin-Duval Forceps .....	175	Cottle Periosteal Elevator.....	192
Clamp, Tube Occluding, Vorse.....	126, 580	Collins Forceps.....	104	Cottle Rasp.....	197, 291, 334
Clamp, Vasectomy Fixation .....	467	Collins Shears .....	490	Cottle Retractor .....	209, 549, 563
Clamp, Vorse Tubing, Merit™ .....	629	Collins Tongue Seizing Forceps .....	105	Cottle Scissors.....	61
Clamp, Weber.....	511	Collyer Pelvimeter Forceps .....	384	Cottle Scissors, Sklarcut™ .....	30
Clamp, Werthiem.....	92	Colposcopy Set .....	573	Cottle Septal Speculum, Sklar Black™ .....	548-549
Clark Forceps .....	95, 379	Columbia Curette.....	595	Cottle Septum Elevator.....	564
Clasp Adjusting Pliers.....	605	Columbia Lip Retractor.....	201	Cottle Speculum.....	188, 563
Clasp Adjusting Pliers, Mid-Grade.....	605	Colver Retractor .....	200	Cottle Speculum, Laser .....	188
Claw Forceps, Laparoscopic .....	425, 442, 576	Colver-Coakley Forceps.....	101, 206	Coupland Suction Tube .....	155
Clayman Guide.....	227	Comedone Extractor.....	534	Cover Glass Forceps, Econo™ .....	645
Clayman Iris Hook .....	229	Comedone Extractor, Merit™ .....	631	Crafoord Forceps.....	483
Cleaning Basket, Stainless Steel.....	686	Comedone, Unna, Merit™ .....	631	Crane Kaplan Scaler .....	597
Cleaning Brush .....	711-714	Commander Utility Scissors .....	67, 315, 352	Crego Elevator.....	303, 341
Cleaning Brush Set.....	713, 714	Common Duct Scoop, Mayo.....	174	Crile Forceps .....	80, 536-538, 541, 544, 554-558, 570, 572, 574-575, 577-578, 580
Cleaning Brush, Instrument.....	709-710, 713-714	Compression Bone Forceps.....	297, 346	Crile Forceps, Econo-Sterile™ .....	655
Cleaning Brush, Suction Tube.....	711, 713-714	Condenser, Hollenback .....	583	Crile Forceps, Econo™ .....	638
Cleaning, Instrument Brush.....	709-710, 713-714	Cone Ring Curette.....	294	Crile Forceps, Merit™ .....	627
Cleaning, Tracheal Tube Brush .....	709	Cone Wire Twister .....	348	Crile Forceps, Sklarlite XD™ .....	37, 80, 545, 562
Cleft Palate Retractor, Salyer .....	568	Container, Sterilization, SklarLite™ .....	574, 697, 698-699	Crile Forceps, Sklarlite™ .....	37, 80, 540
Cleft Palate Set.....	569	Container, Storage, Stainless Steel.....	682	Crile Forceps, Surgi-OR™ .....	618, 619
Clemetson Forceps .....	94, 373	Contractor, Bailey .....	489, 579	Crile Needle Holder .....	371
Clemetson Forceps, Sklar Black™ .....	401	Contractor, Bailey-Gibbon .....	489	Crile Retractor .....	147, 545, 562, 567
Clemetson Forceps, Sklar Blue™ .....	407	Converse Alar Retractor .....	549	Crile-Murray Needle Holder.....	128
Cleoid & Discoid Carver .....	591	Converse Retractor .....	147, 209-210, 563-564	Crile-Murray Needle Holder, TC.....	40, 132, 543, 545, 562, 570
Cleveland Rongeur.....	337-338, 613	Cook Eye Speculum.....	214	Crile-Rankin Forceps.....	562
Clip Applicators, Ligation.....	444, 445	Cooley Cava Clamp.....	523	Crile-Wood Needle Holder.....	129, 370, 552, 554-555, 560, 646
Clip Applying Forceps, Sklar.....	93	Cooley Clamp.....	522, 524	Crile-Wood Needle Holder, Econo-Sterile™ .....	659
Clip Forceps, Michel, Merit™ .....	626	Cooley Coarctation Clamp.....	523	Crile-Wood Needle Holder, Mid-Grade.....	629
Clip Rack, McKenzie .....	171	Cooley Forceps, DeBakey.....	519	Crile-Wood Needle Holder, Sklarlite XD™ .....	46
Clip, Ligation.....	443	Cooley Ligature Carrier.....	526	Crile-Wood Needle Holder, Sklarlite™ .....	46
Clip, McKenzie.....	171	Cooley Neonatal Clamp.....	526	Crile-Wood Needle Holder, Surgi-OR™ TC.....	620
Clip, Michel.....	171	Cooley Patent Ductus Clamp .....	523	Crile-Wood Needle Holder, TC .....	40, 133, 463, 549, 560, 563, 566, 568, 575, 577, 580
Clip, Tourniquet, N-1.....	313, 348	Cooley Retractor.....	531	Crile-Wood Needle Holder, TC, Left.....	43, 136, 544
Clip, Wachenfeldt.....	171	Cooley Satinsky Clamp .....	523	Crown Scissors.....	68, 169, 351
Coakley Curette .....	178	Cooley Suction Tube .....	580		
		Cooley Tissue Forceps.....	496		
		Cooley-Derra Clamp.....	524		



Crusher, Cottle..... 563, 565  
 CT Biopsy Tray..... 665  
 Cube Pessary..... 455  
 Culler Hook..... 226  
 Cup, Graduated Measure, Plastic..... 705  
 Cup, Graduated Measure, Stainless Steel..... 681  
 Cup, Iodine, Stainless Steel..... 538, 547, 560, 680  
 Cup, Medicine, Stainless Steel..... 538, 547, 577, 680  
 Cup, Plastic Medicine..... 705

**CURETTES**

Curette Excavator, Merit™..... 631  
 Curette, Barnhill..... 203  
 Curette, Barth..... 294  
 Curette, Beckmann..... 203  
 Curette, Billeau Ear, Econo™..... 649  
 Curette, Bruns..... 293, 342, 556  
 Curette, Buck Ear..... 178, 539, 550-552, 567  
 Curette, Buck Ear, Econo™..... 649  
 Curette, Buck, Merit™..... 632  
 Curette, Cannon..... 535  
 Curette, Coakley..... 178  
 Curette, Cobbs Bone..... 293  
 Curette, Columbia..... 595  
 Curette, Cone Ring..... 294  
 Curette, Daviel..... 225  
 Curette, Dermal..... 342  
 Curette, Ear, Disposable..... 187  
 Curette, Endocervical..... 366  
 Curette, Endocervical, Disposable..... 454  
 Curette, Epstein..... 569  
 Curette, Fox Dermal..... 342, 535  
 Curette, Fox Dermal, Econo™..... 649  
 Curette, Fox Dermal, Merit™..... 631  
 Curette, Gracey..... 596  
 Curette, Greene Uterine..... 366  
 Curette, Hatt..... 294  
 Curette, Heaney Uterine..... 366  
 Curette, Heath..... 227  
 Curette, Holden Uterine..... 365  
 Curette, House..... 552  
 Curette, Kevorkian-Young  
     Endocervical..... 367, 570, 571, 573  
 Curette, Laufe-Novak..... 365  
 Curette, Lounsbury Placenta..... 367  
 Curette, Martini Bone..... 294  
 Curette, McCall's..... 595  
 Curette, Meyhoef..... 227  
 Curette, Novak Endometrial..... 365, 571  
 Curette, Piffard..... 342, 535  
 Curette, Randall Endometrial Biopsy..... 365  
 Curette, Recamier Uterine..... 366  
 Curette, Rein..... 535  
 Curette, Ring..... 321  
 Curette, Rosen Knife..... 551  
 Curette, Shapleigh..... 178, 550  
 Curette, Sims Uterine..... 367, 570-571, 574  
 Curette, Skeele..... 227  
 Curette, Thomas Uterine..... 367  
 Curette, Verucca..... 327  
 Curette, Vogel..... 203  
 Curette, Volkman Bone..... 294, 341  
 Curette, Volkman Bone..... 568

Curette, Williger Bone..... 294  
 Curette/Excavator..... 327, 540  
 Cusco Vaginal Speculum..... 355, 356  
 Cusco Vaginal Speculum, Sklar Blue™..... 403  
 Cushing Bipolar Forceps, Electrosurgical..... 418  
 Cushing Dressing Forceps, TC..... 35, 564, 577  
 Cushing Forceps..... 109, 556, 568  
 Cushing Hook..... 544  
 Cushing Retractor..... 143, 201, 492,  
     542, 558, 567, 574, 578-580  
 Cushing Retractor, Merit™..... 630  
 Cushing Rongeur..... 279  
 Cushion, Mouth Gag, Doyen Jansen (Molt) ... 198, 613  
 Cutaneous Punch, Keyes, Merit™..... 631  
 Cuticle Nail Scissors, Merit™..... 624  
 Cutter Blade, Keyes Finger Ring..... 535  
 Cutter Blade, Ring, Merit™..... 631  
 Cutter Blade, Sklar Finger Ring..... 535  
 Cutter, Bone Pin..... 309, 348  
 Cutter, Diamond Pin..... 309, 350  
 Cutter, Giertz-Stille Rib..... 490  
 Cutter, Keyes Finger Ring..... 535  
 Cutter, Nail, Baker..... 328  
 Cutter, Pin..... 309, 350  
 Cutter, Pin, TC..... 309, 350, 580  
 Cutter, Ring, Merit™..... 631  
 Cutter, Sklar Finger Ring..... 535  
 Cutter, Stitch..... 670  
 Cutter, Wire & Pin, TC..... 309  
 Cystic Duct Forceps, Gray..... 88  
 Cystotome, Graefe..... 221  
 Cystotome, Kelman..... 256

**D**

D&C Set..... 570  
 Dale Forceps..... 509  
 Dale Rib Shears..... 275  
 Dandy Forceps..... 87, 540  
 Dandy Nerve Hook..... 149  
 Davidson Spatula Retractor..... 153, 491, 579  
 Daviel Curette..... 225  
 Davis Foreign Body Chisel..... 222  
 Day Hook..... 183, 550  
 De Alvarez Forceps..... 96, 376, 571  
 Dean Knife..... 204  
 Dean Rongeur..... 275  
 Dean Scissors..... 70, 568  
 Deaver Retractor..... 145, 536, 561, 566, 573  
 Deaver Scissors..... 49  
 DeBakey Aneurysm Clamp..... 513  
 DeBakey Angular Clamp..... 512  
 DeBakey Angular Forceps..... 519  
 DeBakey Bainbridge Forceps..... 502  
 DeBakey Bronchus Forceps..... 520  
 DeBakey Bulldog Clamp..... 115, 516  
 DeBakey Bulldog Forceps..... 569, 577  
 DeBakey Clamp..... 504-506  
 DeBakey Coarctation Forceps..... 519  
 DeBakey Cooley Forceps..... 519  
 DeBakey Dissecting & Ligature Forceps..... 511  
 DeBakey Enderarterectomy Scissors..... 531  
 DeBakey Forceps..... 115, 460, 495-496, 514-515,

542, 558, 561, 566, 572-574, 577-581  
 DeBakey Forceps, Laparoscopic..... 428  
 DeBakey Forceps, Sklar Black™..... 400  
 DeBakey Forceps, TC..... 35, 124, 379  
 DeBakey Halsted Clamp..... 510  
 DeBakey Leland Jones Forceps..... 500  
 DeBakey Needle Holder, TC..... 132, 463  
 DeBakey Patent Ductus Forceps..... 519  
 DeBakey Pean Clamp..... 510  
 DeBakey Peripheral Forceps..... 499, 500, 502  
 DeBakey Scissors..... 529-530, 577  
 DeBakey Tangential Forceps..... 505, 579  
 DeBakey Vascular Forceps..... 497, 498  
 DeBakey Vena Cava Forceps..... 580  
 DeBakey-Bahnon Forceps..... 512  
 DeBakey-Beck Clamp..... 506  
 DeBakey-Derra Forceps..... 508, 581  
 DeBakey-McQuigg Mixer Clamp..... 521  
 DeBakey-Semb Ligature Carrier..... 513  
 Decannulation Stoppers..... 157  
 Delee Obstetrical Forceps..... 381, 573  
 Delee Retractor..... 151, 359  
 Delee Uterine Forceps..... 94, 374  
 DeLee Uterine Forceps, Sklar Black™..... 401  
 DeLee-Hillis Headband..... 676  
 Delicate Hook..... 560  
 Delivery Room Tubal Ligation Set..... 575  
 Demarcator, Lockwood Abdominal..... 559  
 Demel Bone Wire Guide..... 170  
 Denhardt Mouth Gag..... 198  
 Dental Mirror, Disposable..... 614  
 Dental Probe, Merit™..... 632  
 Depressor, Tongue..... 198, 552  
 Depressor, Tongue, Wieder..... 198, 552  
 Depth Ruler, Sklar Black™..... 399  
 Derf Needle Holder..... 128, 538  
 Derf Needle Holder, Econo-Sterile™..... 659  
 Derf Needle Holder, Econo™..... 647  
 Derf Needle Holder, Mid-Grade..... 629  
 Derf Needle Holder, Sklarlite XD™..... 45  
 Derf Needle Holder, Sklarlite™..... 45  
 Derf Needle Holder, Surgi-OR™..... 621  
 Derf Needle Holder, Surgi-OR™ TC..... 620  
 Derf Needle Holder, TC..... 40, 132, 566  
 Dermal Curette..... 342  
 Dermal Curette, Fox, Merit™..... 631  
 Dermal Retractor..... 209  
 Dermal Retractors..... 148  
 Dermatome, Schink..... 568  
 Dermatoscope..... 177  
 Deschamp Needle..... 169, 560  
 Deschamp Needle..... 344  
 Desjardin Scoop..... 174  
 Desmarres Chalazion Forceps..... 252, 546-547  
 Desmarres Retractor..... 144, 211, 218, 544-547,  
     549, 558, 565, 577  
 Desmarres Retractor, Sklar Black™..... 398  
 Detergent, Sklar Enzymatic™..... 13, 725  
 Detergent, Sklar Kleen™ Liquid..... 11, 723  
 Detergent, Sklar Kleen™ Low Foam..... 11, 723  
 Detergent, Sklar Kleen™ Powder..... 11, 723  
 Devibiss Vaginal Speculum..... 356  
 Dewey Obstetrical Forceps..... 382  
 Diamond Dust Jeweler's Forceps..... 35







Econo-Sterile™ Adson Tissue Forceps.....	656	Econo™ Billeau Ear Curette.....	649	Econo™ Spencer Stitch Scissors.....	636
Econo-Sterile™ Adson-Brown Forceps.....	656	Econo™ Bishop-Harmon Forceps.....	645	Econo™ Splinter Forceps.....	645
Econo-Sterile™ Adson-Tissue Forceps.....	656	Econo™ Bozeman Forceps.....	641	Econo™ Stevens Tenotomy Scissors.....	637
Econo-Sterile™ Allis Tissue Forceps.....	656	Econo™ Braun Epistomy Scissors.....	638	Econo™ Suture Scissors.....	637
Econo-Sterile™ Babcock Forceps.....	656	Econo™ Buck Ear Curette.....	649	Econo™ Taylor Hammer.....	650
Econo-Sterile™ Backhaus Towel Clamp.....	657	Econo™ Carmalt Splinter Forceps.....	645	Econo™ Tenaculum Forceps.....	640
Econo-Sterile™ Baumgartner Needle Holder.....	659	Econo™ Collier Needle Holder.....	647	Econo™ Tissue Forceps.....	643
Econo-Sterile™ Bozeman Forceps.....	657	Econo™ Cover Glass Forceps.....	645	Econo™ Tissue Nipper.....	646
Econo-Sterile™ Crile Forceps.....	655	Econo™ Crile Forceps.....	638	Econo™ Tube Occluding Clamp.....	642
Econo-Sterile™ Crile-Wood Needle Holder.....	659	Econo™ Crile-Wood Needle Holder.....	646	Econo™ Tuttle Forceps.....	644
Econo-Sterile™ Derf Needle Holder.....	659	Econo™ Derf Needle Holder.....	647	Econo™ Utility Scissors.....	637-638
Econo-Sterile™ Dressing Forceps.....	656	Econo™ Dressing Forceps.....	643	Econo™ Utility Shears.....	637
Econo-Sterile™ Graves Vaginal Speculum.....	450, 660	Econo™ Ferris Smith Tissue Forceps.....	643	Econo™ Vienna Speculum.....	650
Econo-Sterile™ Halsey Needle Holder.....	659	Econo™ Foerster Sponge Forceps.....	641	Econo™ Webster Needle Holder.....	647
Econo-Sterile™ Halsted Forceps.....	655	Econo™ Fox Dermal Curette.....	649	Econo™ Weitlaner Retractor.....	648
Econo-Sterile™ Hartmann Forceps.....	655	Econo™ Frazier Tissue Hook.....	648	Econo™ Wilde Forceps.....	644
Econo-Sterile™ Hoff Towel Clamp.....	657	Econo™ Freer Elevator.....	650	Econo™ Wire Cutting Scissors.....	636
Econo-Sterile™ Iris Scissors.....	652	Econo™ Gelpi Retractor.....	648	EKG Caliper.....	679
Econo-Sterile™ Kelly Forceps.....	655	Econo™ Gerald Dressing Forceps.....	644	EKG Caliper, Merit™.....	632
Econo-Sterile™ Knowles Bandage Scissors.....	653	Econo™ Gerald Tissue Forceps.....	644	Elastic Pliers.....	609
Econo-Sterile™ Lister Bandage Scissors.....	653	Econo™ Graefe Fixation Forceps.....	645	Elastomeric Pliers.....	609
Econo-Sterile™ Littauer Suture Scissors.....	653	Econo™ Graves Speculum.....	650	Electrode, Disposable, Electrosurgical.....	411-415
Econo-Sterile™ Lorna Edna Towel Clamp.....	657	Econo™ Guthrie Double Hook.....	648	Electrode, Laparoscopic.....	434, 442, 576
Econo-Sterile™ Mayo Scissors.....	652	Econo™ Halsey Needle Holder.....	647	Electrode, Laparoscopic, Miniature.....	437
Econo-Sterile™ Mayo-Hegar Needle Holder.....	659	Econo™ Halsted Mosquito Forceps.....	638	Electrode, Laparoscopic, Single Port.....	421
Econo-Sterile™ Metzenbaum Scissors.....	652	Econo™ Hartmann Forceps.....	638, 642	Electrosurgical Blade Electrode, Disposable.....	411
Econo-Sterile™ Operating Scissors.....	652	Econo™ Hoff Towel Clamp.....	641	Electrosurgical Cable, Bipolar.....	418
Econo-Sterile™ Pederson Vaginal Speculum.....	660	Econo™ Iris Forceps.....	643	Electrosurgical Cable, Disposable.....	417
Econo-Sterile™ Presbyterian Tube Occluding Clamp.....	658	Econo™ Iris Scissors.....	636	Electrosurgical Cable, Laparoscopic.....	434, 437
Econo-Sterile™ Rochester Pean Forceps.....	655	Econo™ Jansen Nasal Forceps.....	644	Electrosurgical Cord, Bipolar Forceps.....	417
Econo-Sterile™ Rochester-Ochsner Forceps.....	655	Econo™ Jeweler's Forceps.....	645	Electrosurgical Forceps, Bipolar.....	418-419, 561
Econo-Sterile™ Schroeder Tenaculum Forceps.....	657	Econo™ Joseph Hook.....	648	Electrosurgical Grounding Pad, Disposable.....	416
Econo-Sterile™ Spencer Stitch Scissors.....	653	Econo™ Kelly Forceps.....	638	Electrosurgical Holster, Disposable.....	417
Econo-Sterile™ Splinter Forceps.....	657	Econo™ Kelly Rankin Forceps.....	639	Electrosurgical Lietz Electrode, Disposable.....	413
Econo-Sterile™ Sponge Forceps.....	658	Econo™ Knowles Bandage Scissors.....	636	Electrosurgical Loop Electrode, Disposable.....	412
Econo-Sterile™ Strabismus Scissors.....	653	Econo™ Lahey Gall Duct Forceps.....	640	Electrosurgical Pencil, Disposable.....	410
Econo-Sterile™ Tissue Forceps.....	656	Econo™ Lister Bandage Scissors.....	636	Electrosurgical Straight Electrode, Disposable.....	414-415
Econo-Sterile™ Utility Scissors.....	654	Econo™ Littauer Stitch Scissors.....	636	Electrosurgical Tip Cleaner, Disposable.....	417
Econo-Sterile™ Webster Needle Holder.....	659	Econo™ Lorna Edna Towel Clamp.....	641	Elevator.....	329, 602
Econo-Sterile™ Wire Cutting Scissors.....	653	Econo™ Lucae Forceps.....	643	Elevator, Adson.....	303, 555
Econo-Sterile™ Wireform Halsted Forceps.....	661	Econo™ Magill Catheter Forceps.....	640	Elevator, Apical.....	602
Econo-Sterile™ Wireform Kelly Forceps.....	661	Econo™ Mayo Scissors.....	635	Elevator, Chandler.....	303
Econo-Sterile™ Wireform Needle Holder.....	661	Econo™ Mayo-Hegar Needle Holder.....	646	Elevator, Cogswell.....	602
Econo-Sterile™ Wireform Scissors.....	661	Econo™ Metzenbaum Scissors.....	635	Elevator, Cottle.....	191, 549, 563, 565, 568
Econo-Sterile™ Wireform Sponge Forceps.....	661	Econo™ Metzenbaum Scissors, Econo™.....	635	Elevator, Cottle Periosteal.....	192
Econo-Sterile™ Wireform Stitch Scissors.....	661	Econo™ Nail Nipper.....	646	Elevator, Cottle Septum.....	564
Econo-Sterile™ Wireform Thumb Forceps.....	661	Econo™ Nail Splitter Forceps.....	646	Elevator, Crego.....	303, 341
Econo-Sterile™ Wireform Tissue Forceps.....	661	Econo™ Olsen-Hegar Needle Holder.....	647	Elevator, Dunn Dautrey.....	569
Econo-Sterile™ Wireform Towel Forceps.....	661	Econo™ Operating Scissors.....	635	Elevator, Freer.....	205, 304, 331, 540, 549, 550, 551, 555, 558, 564, 567, 569
		Econo™ Pederson Speculum.....	650	Elevator, Freer, Econo™.....	650
		Econo™ Plain Splinter Forceps.....	645	Elevator, Freer, Merit™.....	632
		Econo™ Probe.....	649	Elevator, Freer, Surgi-OR™.....	622
		Econo™ Rankin Crile Forceps.....	639	Elevator, Frost.....	331
		Econo™ Rochester Pean Forceps.....	639	Elevator, Goldman Septum.....	563
		Econo™ Rochester-Ochsner Forceps.....	639	Elevator, Hajek-Ballenger.....	191
		Econo™ Russian Tissue Forceps.....	644	Elevator, Hohmann.....	300, 341, 554
		Econo™ Schmidt Tonsil Forceps.....	640	Elevator, Joseph Periosteal.....	192, 549, 563, 565
		Econo™ Schroeder Tenaculum Forceps.....	640	Elevator, Key.....	303, 553, 555, 557
		Econo™ Schweizer Forceps.....	640	Elevator, Lane.....	304, 331
		Econo™ Semkin Dressing Forceps.....	644	Elevator, Langenbeck.....	303
		Econo™ Senn Retractor.....	648	Elevator, Lempert.....	191-192
		Econo™ Shamburg Comedone Extractor.....	649		
		Econo™ Simpson Uterine Sound.....	649		
		Econo™ Spatula & Packer.....	650		

**ECONO™**

Econo™ Adson Dressing Forceps.....	642
Econo™ Adson Forceps.....	643
Econo™ Adson Tissue Forceps.....	642
Econo™ Adson-Brown Tissue Forceps.....	642
Econo™ Alligator Forceps.....	642
Econo™ Allis Forceps.....	639
Econo™ Allis Tissue Forceps.....	639
Econo™ Babcock Forceps.....	639
Econo™ Backhaus Towel Clamp.....	641
Econo™ Ballenger Sponge Forceps.....	641
Econo™ Baumgartner Needle Holder.....	646





Forceps, Adson Bayonet, Merit™	626	Forceps, Ayers Chalazion.....	252	Forceps, Clemetson	94, 373
Forceps, Adson Bayonet, Surgi-OR™	618	Forceps, Babcock.....	105, 375, 461, 536, 541-542, 575, 579	Forceps, Clemetson, Sklar Black™	401
Forceps, Adson Dressing	106-107, 536, 539, 541, 544-545, 554, 558, 562, 565, 574, 578, 580	Forceps, Babcock, Econo-Sterile™	656	Forceps, Clemetson, Sklar Blue™	407
Forceps, Adson Dressing, Econo™	642	Forceps, Babcock, Econo™	639	Forceps, Colibri Corneal.....	240, 266, 546
Forceps, Adson Dressing, LiteGrip™	108	Forceps, Babcock, Merit™	627	Forceps, Coller	84
Forceps, Adson Dressing, Merit™	626	Forceps, Babcock, Sklar Black™	399, 476	Forceps, Collin-Duval	175
Forceps, Adson Dressing, Sklar Black™	400	Forceps, Babcock, Sklar Blue™	407	Forceps, Collins.....	104
Forceps, Adson Dressing, Sklarlite XD™	36, 107	Forceps, Babcock, Surgi-OR™	618	Forceps, Collins Tongue Seizing	105
Forceps, Adson Dressing, Sklarlite™	36, 106, 567	Forceps, Babcock, TC	35, 124, 346	Forceps, Collyer Pelvimeter	384
Forceps, Adson Dressing, Surgi-OR™	618	Forceps, Backhaus Towel, Merit™	629	Forceps, Colver-Coakley	101, 206
Forceps, Adson Dressing, TC	34, 125, 558, 569	Forceps, Bainbridge	484	Forceps, Compression Bone	297, 346
Forceps, Adson Tissue	106-107, 538-539, 541-542, 544-545, 548, 551, 557-559, 561-562, 564-566, 568, 574, 577-580	Forceps, Baird Chalazion	251	Forceps, Cooley Tissue	496
Forceps, Adson Tissue, Econo-Sterile™	656	Forceps, Ballenger Sponge	126, 538-539, 541, 544, 547, 567	Forceps, Corey Ovum	98, 383
Forceps, Adson Tissue, Econo™	642	Forceps, Ballenger Sponge, Econo™	641	Forceps, Cottle Columella	213, 549
Forceps, Adson Tissue, Merit™	626	Forceps, Baron Alligator	474	Forceps, Cover Glass, Econo™	645
Forceps, Adson Tissue, Sklarlite XD™	36, 107	Forceps, Barraquer Cilia	122, 249	Forceps, Craford	483
Forceps, Adson Tissue, Sklarlite™	36, 106, 540, 567	Forceps, Barrett	98, 384	Forceps, Crile	80, 536-538, 541, 544, 554-558, 570, 572, 574-575, 577-578, 580
Forceps, Adson Tissue, Surgi-OR™	618	Forceps, Barrett	100, 372, 542, 566, 574-575	Forceps, Crile-Rankin	562
Forceps, Adson Tissue, TC	34, 125	Forceps, Barton	380	Forceps, Crile, Econo-Sterile™	655
Forceps, Adson-Brown Tissue	106-107, 536-537, 545, 558-559, 562, 564-566	Forceps, Bechert-McPherson	246, 268	Forceps, Crile, Econo™	638
Forceps, Adson-Brown Tissue, Econo™	642	Forceps, Bengolea	479	Forceps, Crile, Merit™	627
Forceps, Adson-Brown Tissue, Merit™	626	Forceps, Bergh Cilia	122, 249	Forceps, Crile, Sklarlite XD™	37, 80, 545, 562
Forceps, Adson-Brown Tissue,		Forceps, Bergh Cilia, Merit™	626	Forceps, Crile, Sklarlite™	37, 80, 540
Sklarlite XD™	36, 107	Forceps, Berke Ptosis	213, 251	Forceps, Crile, Surgi-OR™	618-619
Forceps, Adson-Brown Tissue,		Forceps, Bierer Ovum	98, 383	Forceps, Cushing	109, 556, 568
Sklarlite™	36, 106, 567	Forceps, Billroth	99, 379	Forceps, Cushing Dressing, TC	35, 564, 577
Forceps, Adson-Brown Tissue, Surgi-OR™	618	Forceps, Bishop-Harmon	118, 241, 267, 547, 565	Forceps, Dale	509
Forceps, Adson-Brown Tissue,		Forceps, Bishop-Harmon, Econo™	645	Forceps, Dandy	87, 540
TC	34, 108, 125, 564, 569	Forceps, Bishop-Harmon, LiteGrip™	108	Forceps, De Alvarez	96, 376, 571
Forceps, Adson-Brown, Econo-Sterile™	656	Forceps, Bishop-Harmon, Merit™	626	Forceps, DeBakey	115, 460, 495-496, 514-515, 542, 558, 561, 566, 572-574, 577-581
Forceps, Adson-DeBakey	109	Forceps, Blake	89, 182	Forceps, DeBakey Angular	519
Forceps, Adson-Gomey Tissue, TC	34, 125	Forceps, Blakesley	190	Forceps, DeBakey Bainbridge	502
Forceps, Adson-Tissue, Econo-Sterile™	656	Forceps, Bonaccolto Utility	119, 247	Forceps, DeBakey Bronchus	520
Forceps, Adson, Baby	561	Forceps, Bond Placenta	384	Forceps, DeBakey Bulldog	569, 577
Forceps, Adson, Econo-Sterile™	656	Forceps, Bone & Cartilage	297	Forceps, DeBakey Coarctation	519
Forceps, Adson, Econo™	643	Forceps, Bonn Suture	245, 268	Forceps, DeBakey Cooley	519
Forceps, Adson, Sklar Blue™	408	Forceps, Bonney Tissue	113, 379	Forceps, DeBakey Dissecting & Ligature	511
Forceps, Alligator, Econo™	642	Forceps, Botvin Iris	240, 267	Forceps, DeBakey Leland Jones	500
Forceps, Allis	96, 345, 373, 560	Forceps, Boys-Allis	101	Forceps, DeBakey Patent Ductus	519
Forceps, Allis Tissue	102-103, 345, 373, 461, 536-539, 541-544, 548, 550-559, 561, 566, 571, 573-574, 577-580	Forceps, Bozeman	96-97, 372, 473, 570-571, 577	Forceps, DeBakey Peripheral	499-500, 502
Forceps, Allis Tissue, Econo-Sterile™	656	Forceps, Bozeman, Econo-Sterile™	657	Forceps, DeBakey Tangential	505, 579
Forceps, Allis Tissue, Econo™	639	Forceps, Bozeman, Econo™	641	Forceps, DeBakey Vascular	497, 498
Forceps, Allis Tissue, Merit™	627	Forceps, Bozeman, Merit™	627	Forceps, DeBakey Vena Cava	580
Forceps, Allis Tissue, Sklar Black™	400, 476	Forceps, Bozeman, Sklar Black™	399	Forceps, DeBakey-Bahnsen	512
Forceps, Allis Tissue, Sklar Blue™	407	Forceps, Bozeman, Sklar Blue™	408	Forceps, DeBakey-Derra	508, 581
Forceps, Allis Tissue, Sklarlite XD™	38, 103, 567	Forceps, Bozeman, Surgi-OR™	618	Forceps, DeBakey, Sklar Black™	400
Forceps, Allis Tissue, Sklarlite™	38, 102, 345, 567	Forceps, Bridge	462	Forceps, DeBakey, TC	35, 124, 379
Forceps, Allis Tissue, Surgi-OR™	618, 618	Forceps, Bridge Thoracic	572, 579	Forceps, Delee	381
Forceps, Allis Tissue, TC	35, 124, 345, 571	Forceps, Brown Tissue	113	Forceps, Delee Uterine	94, 374
Forceps, Allis-Adair	101	Forceps, Champion Uterine	94, 375	Forceps, DeLee Uterine, Sklar Black™	401
Forceps, Allis-Judd	101	Forceps, Champion, Sklar Black™	399	Forceps, Desmarres Chalazion	252, 546-547
Forceps, Allis-Thoms	101, 572	Forceps, Carmalt Splinter	121, 532, 572	Forceps, Dewey	382
Forceps, Allis, Econo™	639	Forceps, Carmalt Splinter, Merit™	626	Forceps, Dieter Ear	552
Forceps, Archer Splinter	533	Forceps, Carmalt Splitter Econo™	645	Forceps, Dougllass Cilia	122, 249
Forceps, Arruga Capsule	119, 248, 546	Forceps, Castroviejo	244, 267	Forceps, Doyen Intestinal	88
Forceps, Arthroscopic	319	Forceps, Castroviejo	117, 245, 268, 546-547, 564	Forceps, Doyen Intestinal, Merit™	627
Forceps, Ash Septum	193, 549, 564	Forceps, Castroviejo, Fixation	117, 245, 268, 546-547, 564	Forceps, Doyen Vulsellum	95, 376
		Forceps, Castroviejo, Sklar Black™	400	Forceps, Dressing	110, 460, 536-538, 540-541, 543-544, 553, 556-558, 560, 566, 569-570, 572, 574-575, 578-581
		Forceps, Chandler Iris	117, 241	Forceps, Dressing Eye	117, 242, 545-546
		Forceps, Cheron	95		
		Forceps, Clark	95, 379		

## ALPHABETICAL INDEX



Forceps, Dressing, Econo-Sterile™	656	Forceps, Gillies	112	Forceps, Jacobson Mosquito	87
Forceps, Dressing, Econo™	643	Forceps, Girard	244, 246	Forceps, James	114, 344
Forceps, Dressing, Merit™	626	Forceps, Glover	503	Forceps, Jameson	250
Forceps, Dressing, Sklar Black™	110	Forceps, Gradle Cilia	249	Forceps, Jansen Bayonet	560
Forceps, Dressing, Sklar Blue™	408	Forceps, Graefe Fixation	118, 243, 546, 548, 551	Forceps, Jansen Nasal	116, 190, 549, 551
Forceps, Dressing, Sklarlite XD™	36, 110	Forceps, Graefe Fixation, Econo™	645	Forceps, Jansen Nasal, Econo™	644
Forceps, Dressing, Sklarlite™	36, 110	Forceps, Graefe Iris	117, 242	Forceps, Jansen Nasal, Merit™	626
Forceps, Dressing, Surgi-OR™	618	Forceps, Graefe Tissue, Merit™	626	Forceps, Jansen Nasal, Surgi-OR™	618
Forceps, Dressing, TC	34, 125	Forceps, Gray Cystic Duct	88	Forceps, Jansen-Middleton	193, 564
Forceps, Dunaway Dissecting, Surgi-OR™	619	Forceps, Green	243	Forceps, Jarcho Tenaculum	372
Forceps, Duplay Tenaculum	99, 372	Forceps, Green Armytage	98, 378	Forceps, Javerts Placenta	98, 383, 570
Forceps, Duval	104, 175, 579-580	Forceps, Gunnar Hey	101	Forceps, Jeans	108
Forceps, Ear, Alligator	181-182, 550, 552	Forceps, Gutglass Cervix	96, 376	Forceps, Jeweler's	120, 253, 269
Forceps, Ear, Alligator, Noyes	550	Forceps, Hale	382	Forceps, Jeweler's, Diamond Dust	35
Forceps, Ear, Duckbill	180	Forceps, Halsted Mosquito	78-79, 536-538, 540-541, 544-545, 547-548, 550-551, 554, 556, 558-559, 561-562, 565-566, 574, 577-578, 580-581	Forceps, Jeweler's, Econo™	645
Forceps, Ear, Hoffman	180	Forceps, Halsted Mosquito, Econo™	638	Forceps, Johns Hopkins	85
Forceps, Ear, Littauer	179	Forceps, Halsted Mosquito, Mid-Grade	627	Forceps, Johns Hopkins Gall Bladder	93
Forceps, Ear, Struempel	180	Forceps, Halsted Mosquito, Sklarlite XD™	37, 79, 546	Forceps, Jones	85
Forceps, Ear, Weingartner	182	Forceps, Halsted Mosquito, Sklarlite™	37, 78, 567	Forceps, Jones, Merit™	627
Forceps, Econo-Sterile™, Wireform, Halsted Forceps	661	Forceps, Halsted Mosquito, Surgi-OR™	619	Forceps, Judd Martel	175
Forceps, Econo-Sterile™, Wireform, Kelly	661	Forceps, Halsted, Econo-Sterile™	655	Forceps, Kalt	248
Forceps, Econo-Sterile™, Wireform, Sponge	661	Forceps, Harmon	243	Forceps, Kantrowitz	90, 112, 493
Forceps, Econo-Sterile™, Wireform, Thumb	661	Forceps, Harms	245	Forceps, Kelly	81, 466, 543, 550-551, 553
Forceps, Econo-Sterile™, Wireform, Towel	661	Forceps, Harrington	93, 462, 486	Forceps, Kelly Placenta	98, 383
Forceps, Electrosurgical	418-419, 561	Forceps, Harrington-Mayo	113	Forceps, Kelly Rankin, Econo™	639
Forceps, Elliot	380	Forceps, Hartmann Alligator	179, 550, 567	Forceps, Kelly, Econo-Sterile™	655
Forceps, Elschmig	243, 546	Forceps, Hartmann Alligator, Merit™	632	Forceps, Kelly, Econo™	638
Forceps, Erhardt Lid	251	Forceps, Hartmann Ear	179, 549	Forceps, Kelly, Mid-Grade	628
Forceps, Essrig Tissue	112	Forceps, Hartmann Herzfeld	182	Forceps, Kelly, Sklarlite XD™	37, 81
Forceps, Extracting	611-612	Forceps, Hartmann Mosquito	82, 536, 538, 547, 561-562	Forceps, Kelly, Sklarlite™	37, 81
Forceps, Extracting, Children's	611-612	Forceps, Hartmann Mosquito, Mid-Grade	627	Forceps, Kelly, Surgi-OR™	619
Forceps, Extracting, Mead	612	Forceps, Hartmann Mosquito, Sklarlite™	37, 82, 567	Forceps, Kelman-McPherson	246, 268
Forceps, Extracting, Mid-Grade	611-612	Forceps, Hartmann Mosquito, Surgi-OR™	619	Forceps, Kern Bone	295-296, 343, 553
Forceps, Farabeur-Lamotte Bone	295	Forceps, Hartmann, Econo-Sterile™	655	Forceps, Kern Bone, Merit™	633
Forceps, Feichenfeld Splinter	121, 532	Forceps, Hartmann, Econo™	638, 642	Forceps, Kieland	380
Forceps, Feilchenfeld Splinter, Merit™	626	Forceps, Healy	123, 544	Forceps, Kieland-Luikart	381
Forceps, Ferguson	87, 296	Forceps, Heaney	97, 374, 376, 571, 573	Forceps, Kirby	242
Forceps, Ferris Smith Tissue	112, 379	Forceps, Heaney-Ballentine	97, 374, 573	Forceps, Kirby Iris	242
Forceps, Ferris Smith Tissue, Econo™	643	Forceps, Heaney-Kanter	375	Forceps, Kleinert-Kutz Bone	272, 336
Forceps, Ferris Smith Tissue, Merit™	626	Forceps, Heath Chalazion	251, 547	Forceps, Knight	189
Forceps, Ferris Smith Tissue, Surgi-OR™	618	Forceps, Hegenbarth	123, 170	Forceps, Kocher	91, 461
Forceps, Fine Point Splinter	121, 532, 538, 540	Forceps, Heiss	479	Forceps, Kraff-Utrata	248
Forceps, Fixation	119	Forceps, Henrotin Vulsellum	95, 376	Forceps, Kuehne	123
Forceps, Foerster	118, 247	Forceps, Heyman	190, 564	Forceps, Kuhnt Fixation	243
Forceps, Foerster Sponge	126, 537, 542-543, 552, 554, 556-558, 567, 570-573, 575, 578-579, 581	Forceps, Heyman-Knight	564	Forceps, Lahey	85
Forceps, Foerster Sponge, Econo™	641	Forceps, Hildebrandt	96, 376	Forceps, Lahey Gall Duct	88, 173
Forceps, Foerster Sponge, Merit™	627	Forceps, Hulka Tenaculum	94, 373	Forceps, Lahey Gall Duct, Econo™	640
Forceps, Foerster Sponge, Surgi-OR™	619	Forceps, Intestinal	92	Forceps, Lahey Traction	105, 379, 485, 541, 559-560
Forceps, Forester	462	Forceps, Iowa Puncturing	99, 383, 572	Forceps, Lambert Chalazion	251, 547
Forceps, Forester iris	241, 267	Forceps, Iris Dressing, Merit™	626	Forceps, Lambotte Bone	295
Forceps, Foss	91	Forceps, Iris LiteGrip™	547	Forceps, Lane	297
Forceps, Francis Chalazion	251	Forceps, Iris Tissue, Merit™	626	Forceps, Lane Bone	295
Forceps, Fuchs	248	Forceps, Iris, Econo™	643	Forceps, Lane Tissue	112
Forceps, Gavin Miller	91	Forceps, Iris, LiteGrip™	108, 242	Forceps, Langenbeck Bone	297
Forceps, Gelpi-Lowrie	96, 375	Forceps, Jaboma Tissue, TC	568	Forceps, Laparoscopic	424, 425-429, 442, 575-576
Forceps, Gemini Mixer	462	Forceps, Jackson	119	Forceps, Laparoscopic, Disposable	447, 448
Forceps, Gerald Dressing	109, 580	Forceps, Jacobs Vulsellum	95, 378, 574	Forceps, Laparoscopic, Single Port	421
Forceps, Gerald Dressing, Econo™	644	Forceps, Jacobson	114	Forceps, Laufe Divergent	382
Forceps, Gerald Tissue	109			Forceps, Laufe Uterine Polyp	94, 374
Forceps, Gerald Tissue, Econo™	644			Forceps, Laufe Uterine Polyp, Sklar Black™	401
Forceps, Gill Hess Iris	240, 266			Forceps, Laufe Uterine Polyp, Sklar Blue™	407
Forceps, Gill Iris	118, 240, 266			Forceps, Laufe-Piper	380
				Forceps, Lawrence	462, 481
				Forceps, Lawton	374
				Forceps, Leriche	478

Forceps, Lester.....	118, 243	Forceps, Nail Splitter, Econo™.....	646	Forceps, Rochester-Pean, Sklar Black™.....	400
Forceps, Lewin Bone.....	272, 335-336, 553, 557	Forceps, Nail Splitter, Surgi-OR™.....	622	Forceps, Rochester-Pean, Sklarlite XD™.....	38, 83
Forceps, Liston Bone, Merit™.....	633	Forceps, Nail Splitting, Sklarlite™.....	39	Forceps, Rochester-Pean, Sklarlite™.....	38, 83
Forceps, Littauer.....	322	Forceps, Nail, Sklarlite™.....	326	Forceps, Rochester-Pean, Surgi-OR™.....	619, 620
Forceps, Littauer Cilia.....	122, 249	Forceps, Negus.....	481	Forceps, Rowland Bone.....	272, 335
Forceps, Littauer Cutting.....	539	Forceps, Noyes.....	190	Forceps, Rubin.....	564, 565
Forceps, Littauer Sklar.....	323	Forceps, Noyes, Alligator.....	183	Forceps, Rumel Thoracic.....	503
Forceps, Littauer Sklar-Taper™.....	323	Forceps, Nugent Rectus.....	250	Forceps, Ruskin-Liston Bone.....	272, 336
Forceps, Littauer Sklarlite™.....	322	Forceps, Nugent Utility.....	247	Forceps, Russian Tissue.....	113, 536, 554, 570, 572-574, 579
Forceps, Littauer, Merit™.....	633	Forceps, O'Connor.....	242	Forceps, Russian Tissue, Merit™.....	626
Forceps, Littauer, Sklarlite™.....	39	Forceps, Occluding, Johns Hopkins.....	127	Forceps, Russian Tissue, Surgi-OR™.....	618
Forceps, Lochwood.....	89	Forceps, Overholt.....	93, 483	Forceps, Russian Tissue,, Econo™.....	644
Forceps, Locke.....	298, 346	Forceps, Overholt Geissendoerfer.....	484	Forceps, Sarot.....	461
Forceps, London Chalazion.....	252	Forceps, Pean Gastro-Intestinal.....	88	Forceps, Sauer Suture.....	247
Forceps, Long.....	374	Forceps, Peanut Sponge.....	126	Forceps, Sawtell.....	206, 482
Forceps, Lovelace Gall Bladder.....	175, 486	Forceps, Peet Splinter.....	533	Forceps, Scheizer, Econo™.....	640
Forceps, Lower Gall Duct.....	90, 173	Forceps, Penner.....	306	Forceps, Scheizer, Surgi-OR™.....	620
Forceps, Lubet Barbon.....	189	Forceps, Phaneuf Uterine Artery.....	97, 375, 571, 573-574	Forceps, Schmidt Tonsil.....	206, 482, 537, 542, 549, 552, 561, 573, 579
Forceps, Lucae.....	116, 182, 550, 552, 565	Forceps, Piper.....	380	Forceps, Schmidt Tonsil, Econo™.....	640
Forceps, Lucae, Econo™.....	643	Forceps, Plain Splinter, Econo™.....	645	Forceps, Schmidt Tonsil, Merit™.....	628
Forceps, Lucae, Merit™.....	633	Forceps, Plain Splinter, Merit™.....	626	Forceps, Schmidt Tonsil, Surgi-OR™.....	620
Forceps, Lucae, Surgi-OR™.....	618	Forceps, Plain Splinter, Surgi-OR™.....	618	Forceps, Schroeder Tenaculum.....	99, 372, 570-571, 573-575
Forceps, Luikart.....	380	Forceps, Plate & Bone.....	297	Forceps, Schroeder Tenaculum, Econo-Sterile™.....	657
Forceps, Magill Catheter.....	105, 657	Forceps, Platypus Nail.....	326, 540	Forceps, Schroeder Tenaculum, Econo™.....	640
Forceps, Magill Catheter, Econo™.....	640	Forceps, Platypus Nail, Merit™.....	626	Forceps, Schroeder Tenaculum, Merit™.....	628
Forceps, Magill Catheter, Merit™.....	628	Forceps, PNA.....	335	Forceps, Schroeder Tenaculum, Sklar Black™.....	399
Forceps, Magill Catheter, Surgi-OR™.....	619	Forceps, Potts-Smith Dressing.....	114, 460, 493, 496, 579	Forceps, Schroeder Tenaculum, Sklar Blue™.....	407
Forceps, Maier Gross Uterine Dressing.....	561	Forceps, Potts-Smith Dressing, TC.....	34, 125, 571, 577	Forceps, Schroeder Tenaculum, Surgi-OR™.....	620
Forceps, Maier-Gross.....	94	Forceps, Potts-Smith Tissue.....	114, 493, 496, 566	Forceps, Schroeder Vulsellum.....	100, 378
Forceps, Manhattan Suture.....	245, 247	Forceps, Potts-Smith, Sklar Black™.....	400, 476	Forceps, Schroeder Vulsellum, Sklar Black™.....	399
Forceps, Marcuse, Tubing.....	126	Forceps, Potts-Smith, Sklar Blue™.....	408	Forceps, Schweizer.....	94, 248, 373, 571
Forceps, Martin Pelvimeter.....	384	Forceps, Pratt.....	305	Forceps, Schweizer, Merit™.....	628
Forceps, Mathieu Foreign Body.....	474	Forceps, Preston.....	306	Forceps, Schweizer, Sklar Black™.....	400
Forceps, Mayo-Blake.....	89	Forceps, Prince.....	119, 213, 250	Forceps, Schweizer, Sklar Blue™.....	407
Forceps, Mayo-Robson.....	88	Forceps, Prince Trachoma.....	252	Forceps, Scudder.....	91
Forceps, McCullough Utility.....	119, 247	Forceps, Providence.....	85	Forceps, Segond (Collin).....	99, 378-379
Forceps, McIndoe.....	114	Forceps, Rampley Sponge.....	126	Forceps, Self-Retaining Bone.....	296
Forceps, McIndoe Bone.....	335	Forceps, Randall.....	176	Forceps, Selman.....	493
Forceps, McKenzie.....	171	Forceps, Randell.....	89	Forceps, Selman Tissue.....	114
Forceps, McLane-Tucker.....	381	Forceps, Rankin.....	84	Forceps, Semb.....	93, 492
Forceps, McLane-Tucker-Luikart.....	381	Forceps, Rankin Crile, Econo™.....	639	Forceps, Semb Bone.....	296
Forceps, McPherson.....	245	Forceps, Rankin Kelly, Merit™.....	628	Forceps, Semkin Tissue, TC Micro.....	568
Forceps, McPherson Iris.....	245	Forceps, Rankin Kelly, Surgi-OR™.....	619	Forceps, Semkin Dressing.....	113, 541, 545, 559-560, 562, 567
Forceps, Michel.....	171	Forceps, Rankin Kelly, Surgi-OR™.....	619	Forceps, Semkin Dressing, Econo™.....	644
Forceps, Michel Clip.....	123, 170	Forceps, Rhoton.....	266	Forceps, Semkin Tissue.....	113, 541, 545, 559, 560, 562, 567
Forceps, Michel Clip, Merit™.....	626	Forceps, Roberts.....	480	Forceps, Semkin, Merit™.....	626
Forceps, Michel Tissue.....	112	Forceps, Rochester Pean, Econo-Sterile™.....	655	Forceps, Shallcross.....	88, 173
Forceps, Micro.....	259	Forceps, Rochester Pean, Econo™.....	639	Forceps, Shephard.....	253
Forceps, Micro Adson Dressing.....	109	Forceps, Rochester-Carmalt.....	84	Forceps, Simcoe Nucleus.....	244
Forceps, Micro Adson Tissue.....	109, 554-555, 560	Forceps, Rochester-Carmalt, Merit™.....	628	Forceps, Simpson.....	381
Forceps, Micro Alligator, Merit™.....	633	Forceps, Rochester-Carmalt, Merit™.....	628	Forceps, Simpson-Luikart.....	381
Forceps, Micro Mosquito.....	87, 558, 560-561, 568, 577	Forceps, Rochester-Ochsner.....	84, 536, 541, 54-555, 557-558, 560-561, 566, 570, 572-574, 577-578, 580	Forceps, Single.....	113, 572
Forceps, Mikulicz.....	205	Forceps, Rochester-Ochsner, Econo-Sterile™.....	655	Forceps, Singley, Sklar Black™.....	400
Forceps, Miller Groovelok.....	603	Forceps, Rochester-Ochsner, Econo™.....	639	Forceps, Singley, Sklar Blue™.....	408
Forceps, Miller Groovelok, Mid-Grade.....	603	Forceps, Rochester-Ochsner, Merit™.....	628	Forceps, Skene Tenaculum.....	100
Forceps, Mixer.....	86, 174, 462, 466, 492, 553, 573, 578, 579, 581	Forceps, Rochester-Ochsner, Sklarlite XD™.....	38	Forceps, Sklar.....	310, 348
Forceps, Mixer, Baby.....	573, 578, 579, 581	Forceps, Rochester-Ochsner, Surgi-OR™.....	38, 84	Forceps, Sklar Clip Appying.....	93
Forceps, Mixer, Sklarlite XD™.....	38, 86, 558, 577, 578, 580	Forceps, Rochester-Pean.....	83, 461, 536, 541, 543-544, 552-554, 557-558, 560, 570, 572, 574, 577-578, 580	Forceps, Sklar Hemorrhoidal.....	470-471, 542
Forceps, Mixer, Sklarlite™.....	38, 86	Forceps, Rochester-Pean, Merit™.....	628	Forceps, Sklar-Allis.....	101
Forceps, Mosquito.....	477				
Forceps, Moynihan Gall Duct.....	90, 173				
Forceps, Nail.....	326				

## ALPHABETICAL INDEX



Forceps, Snellen Entropium.....	252	Forceps, Varco Gall Bladder.....	173	Frost Elevator.....	331
Forceps, Somer Uterine.....	375	Forceps, Vas Fixation.....	543	Fuchs Forceps.....	248
Forceps, Spencer Chalazion.....	251	Forceps, Vasectomy Piercing.....	467	Funnel, Stainless Steel.....	683
Forceps, Spencer Wells.....	85	Forceps, Verbrugge Bone.....	296		
Forceps, Splinter, Econo-Sterile™.....	657	Forceps, Vessells Towel, Merit™.....	629	<b>G</b>	
Forceps, Splinter, Econo™.....	645	Forceps, Virtus Splinter.....	533	Gag, Dingman Mouth.....	568
Forceps, Splinter, Merit™.....	627	Forceps, Virtus Splinter, Merit™.....	627	Gag, Mouth, Denhardt.....	198
Forceps, Splinter, Plain.....	121, 532	Forceps, Wachenfeldt.....	123, 170	Gag, Mouth, Doyen Jansen (Molt).....	198, 613
Forceps, Splinter, Plain, Econo™.....	645	Forceps, Waldeau Fixation.....	243	Gag, Mouth, Doyen Jansen (Molt), Mid-Grade.....	613
Forceps, Splinter, Surgi-OR™.....	618	Forceps, Walsham.....	193, 564	Gag, Mouth, Jennings.....	198, 552
Forceps, Sponge, Econo-Sterile™.....	658	Forceps, Walton Suture.....	246	Gag, Mouth, McIvor.....	197
Forceps, St. Vincent Occluding, Merit™.....	629	Forceps, Weis Chalazion.....	252	Gag, Mouth, Wesson.....	198
Forceps, St. Vincent, Tubing.....	126	Forceps, Wertheim-Cullen Pedicle.....	92, 176	Gall Bladder Forceps, Johns Hopkins.....	93
Forceps, Staude-Moore		Forceps, White.....	206	Gall Bladder Forceps, Lovelace.....	175, 486
Tenaculum.....	105, 372, 574-575	Forceps, White Tonsil.....	104, 552	Gall Bladder Forceps, Varco.....	173
Forceps, Sterilization.....	127	Forceps, Wilde.....	116, 182, 548, 550, 567	Gall Duct Forceps, Lahey.....	88, 173
Forceps, Sterilizer, Merit™.....	629	Forceps, Wilde, Econo™.....	644	Gall Duct Forceps, Lower.....	90, 173
Forceps, Sterilizing.....	613	Forceps, Wilde, Merit™.....	627	Gall Duct Forceps, Moynihan.....	90, 173
Forceps, Sterilizing, Mid-Grade.....	613	Forceps, Williams Splinter.....	533	Gallstone Scoop, Ferguson.....	175
Forceps, Stevens Iris.....	241	Forceps, Wills Utility.....	247	Gallstone Scoop, Mayo.....	175
Forceps, Stille-Luer Bone.....	272, 553, 556-557	Forceps, Wireform Tissue, Econo-Sterile™.....	661	Gardner Chisel.....	588
Forceps, Strabismus.....	118	Forceps, Wound Clip.....	171	Garrett Dilator Set.....	577
Forceps, Struycken.....	190	Forceps, Young Tongue Seizing.....	105	Garrigue Vaginal Speculum.....	357
Forceps, Suture Tying.....	123	Forceps, Z-Type Hysterectomy.....	95, 377, 572	Gastro-Intestinal Forceps, Pean.....	83, 88, 461
Forceps, Sweet Clip.....	171	Forceps, Ziegler Cilia.....	122, 249	Gauge, Boley.....	603
Forceps, Swiss Cilia.....	122			Gauge, Boley, Mid-Grade.....	603
Forceps, Takahashi.....	190	Foreign Body Chisel, Davis.....	222	Gauze Scissors, Army, Merit™.....	624
Forceps, Taylor.....	564	Foreign Body Needle.....	223	Gauze Sponge.....	660
Forceps, Teale Vulsellum.....	100, 373	Foreign Body Needle, Alvis.....	223	Gavin Miller Forceps.....	91
Forceps, Tenaculum, Econo™.....	640	Foreign Body Remover, Probe &.....	222	Gaylor Biopsy Punch.....	392
Forceps, Tennant.....	246, 268	Foreign Body Spud, Dix.....	222	Gaylor Biopsy Punch, Micro-Cut.....	388
Forceps, Tennant-Troutman.....	250	Foreign Body Spud, Francis.....	222	Gellhorn Biopsy Punch.....	392, 571
Forceps, Thoms-Gaylor.....	475	Forester Forceps.....	462	Gellhorn Biopsy Punch, Micro-Cut.....	388
Forceps, Thomson Mosquito.....	85	Forester Iris Forceps.....	241, 267	Gellhorn Pessary.....	455
Forceps, Thorpe Corneoscleral.....	117, 247	Foss Forceps.....	91	Gelpi Retractor.....	137, 554
Forceps, Tissue.....	111-112, 117, 242, 325, 460, 536-538, 540-546, 553-561, 566, 570, 572, 574-575, 578-581	Foss Retractor.....	153	Gelpi Retractor, Econo™.....	648
Forceps, Tissue, Econo-Sterile™.....	656	Fox Dermal Curette.....	342, 535	Gelpi Retractor, Merit™.....	630
Forceps, Tissue, Econo™.....	643	Fox Dermal Curette, Merit™.....	631	Gelpi-Lowrie Forceps.....	96, 375
Forceps, Tissue, Merit™.....	627	Fox Eye Shield.....	257, 546	Gemini Clamp... 90, 174, 477, 542, 545, 562, 574, 579	
Forceps, Tissue, Sklar Black™.....	111	Francis Chalazion Forceps.....	251	Gemini Mixer Forceps.....	462
Forceps, Tissue, Sklarlite XD™.....	36, 111	Francis Foreign Body Spud.....	222	General Purpose Tray.....	663
Forceps, Tissue, Sklarlite™.....	36, 111	Frazier Dissector.....	304	Gerald Bayonet Bipolar Forceps, Electrosurgical... 418	
Forceps, Tissue, Stille.....	112	Frazier Ferguson Suction Tube.....	154	Gerald Bipolar Forceps, Electrosurgical.....	418
Forceps, Tissue, Surgi-OR™.....	618	Frazier Suction Tube..... 154, 537, 540, 543, 545, 548, 550-551, 553-555, 559, 561-562, 566-567, 577, 580		Gerald Dressing Forceps.....	109, 580
Forceps, Tivnen.....	206	Frazier Tissue Hook.....	150, 212	Gerald Dressing Forceps, Econo™.....	644
Forceps, Troutman Barraquer Corneal.....	240, 266	Frazier Tissue Hook, Econo™.....	648	Gerald Tissue Forceps.....	109
Forceps, Tucker Hallux.....	298	Freeman Retractor.....	559	Gerald Tissue Forceps, Econo™.....	644
Forceps, Tumor Grasping.....	259	Freer Chisel.....	194, 563	Gerzog Knife.....	183
Forceps, Tuttle.....	113	Freer Elevator.....	205, 304, 331, 540, 549-551, 555, 558, 564, 567, 569	Gerzog Mallet.....	290, 339, 554
Forceps, Tuttle, Econo™.....	644	Freer Elevator, Econo™.....	650	Gerzog Speculum.....	189
Forceps, Tuttle, Sklar Black™.....	400, 476	Freer Elevator, Merit™.....	632	Giertz-Stille Rib Cutter.....	490
Forceps, Tuttle, Sklar Blue™.....	408	Freer Elevator, Surgi-OR™.....	622	Gigli Bone Saw Handles.....	273, 308, 556-557
Forceps, Tyding.....	206	Freer Hook.....	149, 564	Gigli Bone Saw Wire.....	308
Forceps, University of Washington, Rubber Dam.....	603	Freer Septum Knife.....	191, 565	Gill Hess Iris Forceps.....	240, 266
Forceps, University of Washington, Rubber Dam, Mid-Grade.....	603	Freeway Graves Vaginal Speculum.....	354	Gill Iris Forceps.....	118, 240, 266
Forceps, Utility, Merit™.....	627	Freeway Graves Vaginal Speculum, Sklar Black™.....	395	Gill Knife.....	221
Forceps, Van Buren.....	297	Freeway Graves Vaginal Speculum, Sklar Blue™.....	403	Gillies Forceps.....	112
Forceps, Vanderbilt University.....	480	Friedman Rongeur.....	277, 338	Gillies Hook.....	149, 212, 544, 549, 558, 568, 577
Forceps, Varco.....	89	Fritch Retractor.....	151, 561	Gillies Hook, Sklar Black™.....	565



Glassman Forceps, Laparoscopic.....	425	Grasping Forceps, Laparoscopic, Disposable.....	447	550-551, 557-559, 563, 568-569, 577-578
Glover Bulldog Clamp.....	517	Graves Speculum, Econo™.....	650	Halsted Forceps, Econo-Sterile™.....
Glover Clamp.....	507	Graves Vaginal Speculum.....	354-355, 570-571	655
Glover Coarctation Clamp.....	580	Graves Vaginal Speculum Lighted, SklarSpec™ Disposable.....	451	Halsted Forceps, Econo-Sterile™ Wireform.....
Glover Forceps.....	503	Graves Vaginal Speculum, Econo-Sterile™.....	450, 660	661
Gluck Shears.....	490	Graves Vaginal Speculum, Merit™.....	630	Halsted Mosquito Forceps.....
Gluteraldehyde Strips.....	4, 716	Graves Vaginal Speculum, Sklar Black™.....	393, 395	78-79, 536-538,
Goelet Retractor.....	147, 201, 537	Graves Vaginal Speculum, Sklar Blue™.....	402, 403	540-541, 544-545, 547-548, 550-551, 554, 556,
Goldman Septum Elevator.....	563	Graves Vaginal Speculum, SklarSpec™ Disposable.....	450	558-559, 561-562, 565-566, 574, 577-578, 580-581
Goldman-Fox Knife.....	600	Graves Vaginal Speculum, Surgi-OR™.....	621	Halsted Mosquito Forceps, Econo™.....
Goldman-Fox Knife, Mid-Grade.....	600	Gray Cystic Duct Forceps.....	88	638
Goldman-Fox Scaler.....	597	Green Armytage Forceps.....	98, 378	Halsted Mosquito Forceps, Sklarlite XD™.....
Goldman-Fox Scissors.....	60, 561	Green Forceps.....	243	37, 79, 546
Goldman-Fox Scissors, Sklar Edge™ TC.....	20, 562	Green Retractor.....	143, 581	Halsted Mosquito Forceps, Sklarlite™.....
Goldman-Fox Scissors, Sklarcut™.....	28	Green Spatula.....	224	37, 78, 567
Goldman-Fox Scissors, Sklarhone™.....	25	Green Strabismus Hook.....	226	Halsted Mosquito Forceps, Surgi-OR™.....
Goldstein Retractor.....	138, 207, 219, 270	Greene Uterine Curette.....	366	619
Golf Stick Knife.....	331	Grieshaber Keratome.....	220	Hammer, Babinski, Merit™.....
Goodell Dilator.....	365, 570	Gritman Wax Spatula.....	593	678
Gordon Pliers.....	605	Grooved Director, Merit™.....	632	Hammer, Buck.....
Gordon Pliers, Mid-Grade.....	605	Gross Hook and Spoon.....	183	678
Gorney Face Lift Scissors, Sklarcut™.....	30	Grounding Pad Disposable, Electrosurgical.....	416	Hammer, Buck, Merit™.....
Gorney Plastic Surgery Scissors, Sklarcut™.....	29	Gruber Ear Speculum.....	177, 567	632
Gorney Plastic Surgery Scissors, Sklarhone™.....	25, 559	Gruber Ear Speculum Set.....	177	Hammer, Rabiner.....
Gorney Scissors.....	61	Gruber Rhinoplasty Set.....	565	678
Goslee Pliers.....	605	Gruber Speculum, Merit™.....	632	Hammer, Rabiner, Merit™.....
Goslee Pliers, Mid-Grade.....	605	Guard, Osteotome.....	707	632
Gosset Retractor.....	139, 488	Guard, TipGrips™ Instrument Guard.....	707	Hammer, Taylor.....
Gouge, Alexander.....	287	Guide Catheter, Benique.....	466	678
Gouge, Army.....	284	Guide Catheter, Guyon.....	466	Hammer, Taylor, Econo™.....
Gouge, Capener Lamina.....	288	Guide, Catheter.....	466	632
Gouge, Cobb.....	287	Guide, Clayman.....	227	Hammer, Taylor, Surgi-OR™.....
Gouge, Hibbs.....	286	Guide, Demel Bone Wire.....	170	622, 678
Gouge, Lexer.....	288	Guidewire Bowl, Plastic.....	706	Hand, Lead.....
Gouge, Lexer Mini.....	288	Gunnar Hey Forceps.....	101	317
Gouge, Murphy.....	284	Gutglass Cervix Forceps.....	96, 376	Handle, Akers/Evans.....
Gouge, Smith Peterson.....	284	Guthrie Double Hook.....	149, 212, 226	601
Gouge, Stille.....	285	Guthrie Double Hook, Econo™.....	648	Handle, Bill Traction.....
Gouge, West.....	196	Guthrie Hook, Sklar Black™.....	398	382
Gracey Curette.....	596	Guyon Catheter Guide.....	466	Handle, Biopsy Punch.....
Gradle Cilia Forceps.....	249	Gynecological Abdominal Set.....	574	391
Gradle Scissors.....	168, 238, 265, 544, 546	Gynecological Biopsy Set.....	571	Handle, Biopsy Punch, Micro-Cut.....
Gradle Scissors, Merit™.....	624	Gynecological Surgery Set.....	570	387
Gradle Scissors, Sklarcut™.....	29	Gynecological X-Long Set.....	572	Handle, Corneal Trephine.....
Gradle Scissors, Sklarhone™.....	25			231
Graduated Measure Cup, Plastic.....	705			Handle, Dilator.....
Graduated Measure Cup, Stainless Steel.....	681			363
Graduated Probe, Laparoscopic.....	438			Handle, Dix Needle & Spud.....
Graefe Cystotome.....	221			222
Graefe Fixation Forceps.....	118, 243, 546, 548, 551			Handle, Laparoscopic.....
Graefe Fixation Forceps, Econo™.....	645			431, 446
Graefe Hook.....	561			Handle, Laryngoscope.....
Graefe Iris Forceps.....	117, 242			160
Graefe Knife.....	220			Handle, Laryngoscope, F.O.....
Graefe Strabismus Hook.....	226, 546			160
Graefe Tissue Forceps, Merit™.....	626			Handle, Laryngoscope, LED.....
Graether Collar Button.....	229			160
Graether Iris Retractor.....	256			Handle, Luikart-Bill Traction.....
Grasper, Arthroscopic, Atlantic.....	320			382
Grasper, Arthroscopic, Maxi.....	320			Handle, Scalpel.....
Grasper, Arthroscopic, Pacific.....	320			536-541, 543-548,
Grasping Forceps, Laparoscopic.....	427-429, 442, 576-575			550-562, 565-566, 568, 570, 573-575,
				577-578, 580-581, 667, 670
				Handle, Scalpel, Merit™.....
				633
				Handle, Scalpel, Surgi-OR™.....
				622
				Handle, Sterilization Tray, Stainless Steel.....
				693
				Handles, Lifting, Stainless Steel.....
				693
				Hank Uterine Dilator.....
				364, 571
				Hard Wire Cutter, TC.....
				610
				Hard Wire Cutters.....
				610
				Hardy Bayonet Bipolar Forceps, Electrosurgical.....
				418
				Harken Clamp.....
				581
				Harken Spreader.....
				140, 488
				Harmon Forceps.....
				243
				Harms Forceps.....
				245
				Harrington Forceps.....
				93, 462, 486
				Harrington Retractor.....
				153, 491
				Harrington-Mayo Forceps.....
				113, 493
				Harrington-Mayo Scissors.....
				50, 369, 468, 494
				Harris Wire Tightener.....
				311
				Harris-Sinsky Hook.....
				228
				Hartman Rongeur.....
				276
				Hartman Tonsil Punch.....
				552
				Hartmann (Mosher) Punch.....
				205
				Hartmann Alligator Forceps.....
				179, 550, 567
				Hartmann Alligator Forceps, Merit™.....
				632
				Hartmann Ear Forceps.....
				179, 549
				Hartmann Forceps, Econo-Sterile™.....
				655
				Hartmann Forceps, Econo™.....
				638, 642
				Hartmann Herzfeld Forceps.....
				182
				Hartmann Mosquito

H



## ALPHABETICAL INDEX

Forceps.....	82, 536, 538, 547, 561-562
Hartmann Mosquito Forceps, Sklarlite XD™.....	37, 82
Hartmann Mosquito Forceps, Sklarlite™.....	37, 82, 567
Hartmann Mosquito Forceps, Surgi-OR™.....	619
Hartmann Punch.....	180
Hartmann Speculum.....	189
Hatt Curette.....	294
Hawley Pliers.....	607
Hays Retractor.....	299
Head Mirror.....	199, 679
Headband, Beck.....	199
Headband, DeLee-Hillis.....	676
Headband, Jefferson.....	199, 679
Headband, Plastic.....	679
Headband, Sklar.....	199
Healy Forceps.....	123, 544
Heaney Forceps.....	97, 374, 376, 571, 573
Heaney Needle Holder.....	130, 371, 561, 571, 573
Heaney Needle Holder, Sklar Black™.....	401
Heaney Needle Holder, TC.....	42, 134, 573
Heaney Retractor.....	146
Heaney Uterine Curette.....	366
Heaney-Ballentine Forceps.....	97, 374, 573
Heaney-Kanter Forceps.....	375
Heath Chalazion Forceps.....	251, 547
Heath Curette.....	227
Heath Scissors.....	68, 168
Hegar Uterine Dilator.....	364, 570
Hegar Uterine Dilator, Merit™.....	630
Hegenbarth Forceps.....	123, 170
Heiss Forceps.....	479
Hemorrhoidal Forceps, Sklar.....	470-471, 542
Hemorrhoidal Ligator.....	472
Hemorrhoidal Ligator, Improved.....	472
Henly Retractor.....	137
Hennig Plaster Spreader.....	317, 353
Henrotin Vaginal Speculum.....	357
Henrotin Vulsellum Forceps.....	95, 376
Heparin Needle.....	577
Hercules Utility Scissors.....	315, 352
Hernia Retractor.....	142
Herrick Kidney Clamp.....	176
Heyman Forceps.....	190, 564
Heyman-Knight Forceps.....	564
Hi-Level Scissors.....	66
Hi-Level Bandage Scissors, Sklarhone™.....	26
Hibbs Chisel.....	286, 553
Hibbs Gouge.....	286
Hibbs Osteotome.....	286, 553-554
Hibbs Retractor.....	153, 491, 554
Hildebrandt Forceps.....	96, 376
Hill Scissors.....	62
Hinkle-James Speculum.....	472
Hirschman Anoscope.....	472, 543
Hoff Towel Clamp.....	127
Hoff Towel Clamp, Econo-Sterile™.....	657
Hoff Towel Clamp, Econo™.....	641
Hoffman Ear Forceps.....	180
Hohmann Elevator.....	300, 341, 554
Hoke Chisel.....	286, 340
Hoke Osteotome.....	286, 340
Holden Uterine Curette.....	365
Holder, Speculum, Shea.....	177
Hollenback Carver.....	591
Hollenback Carver, Mid-Grade.....	591
Hollenback Condenser.....	583
Holman-Mathieu Cannula.....	366
Holster Disposable, Electrosurgical.....	417
Holzheimer Retractor.....	138, 207, 538
Hoof Knife.....	321

## HOOKS

Hook & Expressor, Kirby.....	546
Hook & Spoon, Gross.....	183
Hook Probe.....	321
Hook Retractor, Volkman.....	299
Hook Scissors, Laparoscopic.....	423, 442, 576
Hook Scissors, Laparoscopic, Disposable.....	447
Hook, Adson.....	150
Hook, Adson Dura.....	150, 580
Hook, Azar.....	227
Hook, Barr.....	543
Hook, Barr Crypt.....	475
Hook, Berens Scleral.....	226
Hook, Bone.....	299, 554, 557
Hook, Clayman Iris.....	229
Hook, Culler.....	226
Hook, Cushing.....	544
Hook, Dandy Nerve.....	149
Hook, Day.....	183, 550
Hook, Delicate.....	560
Hook, Emmett.....	150, 361
Hook, Emmett, Sklar Black™.....	398
Hook, Emmett, Sklar Blue™.....	409
Hook, Fenzl.....	229
Hook, Frazier Tissue.....	150, 212
Hook, Frazier Tissue, Econo™.....	648
Hook, Freer.....	149, 564
Hook, Gillies.....	149, 212, 544, 549, 558, 568, 577
Hook, Gillies, Sklar Black™.....	565
Hook, Graefe.....	561
Hook, Graefe Strabismus.....	226, 546
Hook, Green Strabismus.....	226
Hook, Guthrie Double.....	149, 212, 226
Hook, Guthrie Double, Econo™.....	648
Hook, Guthrie, Sklar Black™.....	398
Hook, Harris-Sinskey.....	228
Hook, Iris.....	150, 229, 361, 573
Hook, Iris Set, Sklar Blue™.....	409
Hook, Iris, Sklar Black™.....	398
Hook, Iris, Sklar Blue™.....	409
Hook, Jaffe.....	228
Hook, Jamison.....	226
Hook, Jamison Strabismus.....	547
Hook, Joseph.....	149, 212, 538, 542, 544, 548-551, 557-559, 561, 564-567, 569
Hook, Joseph, Econo™.....	648
Hook, Joseph, Merit™.....	630
Hook, Joseph, Sklar Black™.....	398
Hook, Joseph, Surgi-OR™.....	621
Hook, Kirby, & Lens Expressor.....	218
Hook, Kuglen Iris.....	228
Hook, Lewicki.....	227
Hook, Meyerding.....	143
Hook, News.....	148, 544
Hook, Nugent Iris.....	226
Hook, O'Connor.....	226
Hook, Pratt.....	543
Hook, Pratt Crypt.....	475
Hook, Scleral Fixation.....	229
Hook, Shepards Crook.....	150
Hook, Sinskey.....	228
Hook, Sinskey Iris.....	227
Hook, Skin.....	150
Hook, Sklar.....	150
Hook, Smille Meniscus.....	301, 555
Hook, Snook, Merit™.....	630
Hook, Stevens Tenotomy.....	226
Hook, Tennant.....	228
Hook, Tyrell Iris.....	149, 212, 226
Hook, Tyrell, Merit™.....	630
Hook, Volkman.....	299
Hook, Wiener Corneal.....	226
Hospital Bucket, Stainless Steel.....	682
Hospital Kick Bucket, Stainless Steel.....	682
House Curette.....	552
How Pliers.....	605
How Pliers, Mid-Grade.....	605
How Pliers, TC.....	604
Hulka Tenaculum Forceps.....	94, 373
Hupp Retractor.....	148
Hurd Dissector & Retractor.....	200
Hurd Dissector and Pillar Retractor.....	552
Hurwitz Trocar.....	162
Hysterectomy Forceps, Z-Type.....	95, 377, 572
Hysterectomy Set.....	573

## I

ID Roll Tape, Sklar.....	708
ID Sheet Tape.....	708
ID Tags, Instrument.....	708
Improved Hemorrhoidal Ligator.....	472
Improved Rudd Ligator.....	470
Incision & Drainage Tray.....	664
Incision Scissors.....	66
Infant Dilator.....	230
Infant Laparotomy Set.....	541
Infant Stethoscope.....	674
Inge Retractor.....	153, 298, 349
Injection Cannula, Air.....	256
Instrument Care Kit, Sklar.....	16, 729
Instrument Cassette.....	692
Instrument Drying Tray, Stainless Steel.....	686
Instrument Guard, TipGrips™.....	707
Instrument Holder Set.....	702
Instrument Holder, Weinstein.....	558
Instrument ID Tags.....	708
Instrument Polish, Sklar.....	15, 727
Instrument Protectors, SklarTip™.....	707
Instrument Rack, Stainless Steel.....	695
Instrument Soaking Tray, Plastic.....	704
Instrument Spot Remover Pad.....	712
Instrument Stringer, Stainless Steel.....	536, 574, 694-695
Instrument Tray Cover, Stainless Steel.....	687, 688
Instrument Tray, Stainless Steel.....	687
Instrument, Cleaning Brush.....	709-710, 713-714
Instrument, Quire.....	183
Intestinal Forceps.....	92
Intestinal Forceps, Doyen.....	88





Intestinal Forceps, Doyen, Merit™ ..... 627  
 Iodine Cup, Stainless Steel ..... 538, 547, 560, 680  
 Iowa Puncturing Forceps ..... 99, 383, 572  
 Iris Dressing Forceps, Merit™ ..... 626  
 Iris Forceps, Econo™ ..... 643  
 Iris Forceps, LiteGrip™ ..... 108, 242, 547  
 Iris Hook ..... 150, 229, 361, 573  
 Iris Hook, Sklar Black™ ..... 398  
 Iris Hook, Sklar Blue™ ..... 409  
 Iris Micro Mini Scissors ..... 235, 263, 546  
 Iris Scissors ..... 54-56, 235-236, 539, 544-547, 549-550, 559, 561, 567-568  
 Iris Scissors, Econo-Sterile™ ..... 652  
 Iris Scissors, Econo™ ..... 636  
 Iris Scissors, Merit™ ..... 624  
 Iris Scissors, Mid-Grade ..... 624  
 Iris Scissors, Sklar Edge™ TC ..... 19, 75, 559  
 Iris Scissors, Sklarcut™ ..... 27, 73, 558, 560, 565-566  
 Iris Scissors, Sklarhone™ ..... 23, 77  
 Iris Scissors, Sklarhone™ TC ..... 22  
 Iris Scissors, Sklarlite XD™ ..... 32, 56, 236, 567  
 Iris Scissors, Sklarlite™ ..... 32, 55, 236  
 Iris Scissors, Sklarlite™ Sklarcut™ ..... 27, 73  
 Iris Scissors, Surgi-OR™ ..... 616  
 Iris Scissors, Surgi-OR™ TC ..... 616  
 Iris Tissue Forceps, Merit™ ..... 626  
 IUD Extractor ..... 366  
 Ives Speculum ..... 470-471, 542  
 Ives Speculum Obturator ..... 470-471

**J**

Jabaley Scissors ..... 560  
 Jabaley Scissors, Supercut Sklarhone™ ..... 560  
 Jaboma Tissue Forceps, TC ..... 568  
 Jackson Forceps ..... 119  
 Jackson Laryngectomy Tube ..... 157  
 Jackson Retractor ..... 148  
 Jackson Tracheotomy Tube ..... 156-157  
 Jackson Tracheotomy Tube Set ..... 157  
 Jackson Vaginal Retractor ..... 358, 570, 573  
 Jackson Vaginal Retractor, Sklar Black™ ..... 401  
 Jackson Vaginal Retractor, Sklar Blue™ ..... 405  
 Jacobs Vulsellum Forceps ..... 95, 378, 574  
 Jacobson Forceps ..... 114  
 Jacobson Mosquito Forceps ..... 87  
 Jacobson Needle Holder ..... 131  
 Jacobson Needle Holder, TC Micro ..... 44, 135  
 Jacobson Scissors ..... 71  
 Jacqueline Scaler ..... 598  
 Jaeger Retractor ..... 218  
 Jaffe Hook ..... 228  
 James Forceps ..... 114, 344  
 Jameson Forceps ..... 250  
 Jameson Scissors, Sklarhone™ ..... 26  
 Jamison Hook ..... 226  
 Jamison Strabismus Hook ..... 547  
 Jansen Bayonet Bipolar Forceps, Electrosurgical ..... 419  
 Jansen Bayonet Forceps ..... 560  
 Jansen Nasal Forceps ..... 116, 190, 549, 551  
 Jansen Nasal Forceps, Econo™ ..... 644  
 Jansen Nasal Forceps, Merit™ ..... 626  
 Jansen Nasal Forceps, Surgi-OR™ ..... 618  
 Jansen Retractor ..... 138, 545, 550-562

Jansen-Middleton Forceps ..... 193, 564  
 Jar, Dressing, Stainless Steel ..... 683  
 Jar, Forceps, Stainless Steel ..... 683, 712  
 Jar, Ointment, Stainless Steel ..... 684  
 Jarabak Pliers ..... 607  
 Jarcho Tenaculum Forceps ..... 372  
 Javerts Placenta Forceps ..... 98, 383, 570  
 Jeans Forceps ..... 108  
 Jefferson Headband ..... 199, 679  
 Jennings Mouth Gag ..... 198, 552  
 Jeweler Bipolar Forceps, Electrosurgical ..... 419  
 Jeweler's Forceps ..... 120, 253, 269  
 Jeweler's Forceps, Diamond Dust ..... 35  
 Jeweler's Forceps, Econo™ ..... 645  
 Johns Hopkins Bulldog Clamp ..... 115, 517  
 Johns Hopkins Forceps ..... 85  
 Johns Hopkins Gall Bladder Forceps ..... 93  
 Johns Hopkins Occluding Forceps ..... 127  
 Johnson Needle Holder ..... 130  
 Jones Forceps ..... 85  
 Jones Forceps, Merit™ ..... 627  
 Jones Towel Clamp ..... 127  
 Jones Towel Clamp, Merit™ ..... 629  
 Jorgenson Scissors ..... 52, 459, 574  
 Joseph Bone Saw ..... 149, 212, 538, 542, 544, 548-551, 557-559, 561, 564-567, 569  
 Joseph Bone Saw Guide ..... 308  
 Joseph Hook, Econo™ ..... 648  
 Joseph Hook, Merit™ ..... 630  
 Joseph Hook, Sklar Black™ ..... 398  
 Joseph Hook, Surgi-OR™ ..... 621  
 Joseph Knife ..... 194, 563  
 Joseph Nasal Saw ..... 549, 564-565  
 Joseph Periosteal Elevator ..... 192, 549, 563, 565  
 Joseph Rasp ..... 197, 291, 334, 540, 549, 563  
 Joseph Scissors ..... 60, 548  
 Jr. Lambotte Osteotome ..... 285, 340, 569  
 Judd Martel Forceps ..... 175  
 Judd-Masson Retractor ..... 140, 467  
 Julian Needle Holder, TC ..... 42  
 Junior Toothbrush ..... 614

**K**

Kalt Forceps ..... 248  
 Kantrowitz Forceps ..... 90, 112, 493  
 Kay Clamp ..... 508  
 Kaye Dissecting Scissors, Sklar Edge™ TC ..... 20  
 Kaye Face Lift Scissors, Sklarcut™ ..... 30  
 Kaye Scissor ..... 58  
 Kaye Scissors ..... 60  
 Keith Abdominal Needle ..... 164  
 Kelly Forceps ..... 81, 466, 543, 550-551, 553  
 Kelly Forceps, Econo-Sterile™ ..... 655  
 Kelly Forceps, Econo-Sterile™ Wireform ..... 661  
 Kelly Forceps, Econo™ ..... 638  
 Kelly Forceps, Laparoscopic ..... 425  
 Kelly Forceps, Mid-Grade ..... 628  
 Kelly Forceps, Sklarlite XD™ ..... 37, 81  
 Kelly Forceps, Sklarlite™ ..... 37, 81  
 Kelly Forceps, Surgi-OR™ ..... 619  
 Kelly Placenta Forceps ..... 98, 383  
 Kelly Rankin Forceps, Econo™ ..... 639  
 Kelly Retractor ..... 146, 575, 578-579

Kelly Scissors, Sklarcut™ ..... 30  
 Kelly-Adson Scissors ..... 54, 369, 469  
 Kelman Cystotome ..... 256  
 Kelman-McPherson Forceps ..... 246, 268  
 Keratome, Berens ..... 220  
 Keratome, Castroviejo ..... 220  
 Keratome, Grieshaber ..... 220  
 Kern Bone Forceps ..... 295-296, 343, 553  
 Kern Bone Forceps, Merit™ ..... 633  
 Kerrison Rongeur ..... 195  
 Kevorkian Biopsy Punch ..... 389  
 Kevorkian Biopsy Punch, Micro-Cut ..... 385  
 Kevorkian-Young Biopsy Punch ..... 390  
 Kevorkian-Young Biopsy Punch, Micro-Cut ..... 386  
 Kevorkian-Young Endocervical Curette ..... 367, 570-571, 573  
 Key Elevator ..... 303, 553, 555, 557  
 Keyes Cutaneous Biopsy Punch ..... 363, 534  
 Keyes Cutaneous Punch, Merit™ ..... 631  
 Keyes Finger Ring Cutter ..... 535  
 Keyes Finger Ring Cutter Blade ..... 535  
 Keyes Skin Biopsy Set ..... 363, 534  
 Khaki Roll ..... 364  
 Khaki Roll, Sound Set ..... 464  
 Kieland Obstetrical Forceps ..... 380  
 Kieland-Luikart Obstetrical Forceps ..... 381  
 Killian Speculum ..... 188, 548-549, 564-565  
 Kilner Scissors ..... 560  
 Kirby Forceps ..... 242  
 Kirby Hook & Expressor ..... 546  
 Kirby Hook & Lens Expressor ..... 218  
 Kirby Iris Forceps ..... 242  
 Kirk Mallet ..... 290, 339  
 Kirkland Knife ..... 601  
 Kirmission Raspatory ..... 301  
 Kirschner Bone Drill ..... 311  
 Kirschner Bows ..... 312  
 Kirschner Retractor ..... 283  
 Kirschner Wire ..... 313, 347  
 Kit, Sklar Instrument Care ..... 16, 729  
 Kit, Splinter Removal ..... 121, 532  
 Kleegman Dilator ..... 365  
 Kleinert-Kutz Bone Forceps ..... 272, 336  
 Kleinert-Kutz Rongeur ..... 274  
 Kleinert-Kutz Tenotomy Scissors ..... 234  
 Knapp Eye Speculum ..... 215  
 Knapp Iris Scissors ..... 235  
 Knapp Scoop ..... 225  
 Knapp Speculum, Merit™ ..... 632  
 Knee Set ..... 555  
 Knife Curette, Rosen ..... 551  
 Knife Guard & Retractor, Cottle ..... 209, 549  
 Knife Guard & Retractor, Neivert ..... 210, 549  
 Knife Needle, Von Graefe ..... 220  
 Knife Needle, Ziegler ..... 221  
 Knife, Akers ..... 601  
 Knife, Ballenger ..... 193, 564  
 Knife, Ballenger Swivel ..... 549  
 Knife, Banana ..... 321  
 Knife, Barkan ..... 221  
 Knife, Buck ..... 601  
 Knife, Chisel ..... 330  
 Knife, Corn ..... 329-330  
 Knife, Cottle ..... 549, 563

## ALPHABETICAL INDEX



Knife, Cottle Nasal.....	191
Knife, Dean.....	204
Knife, Douglas.....	204
Knife, Downing.....	306, 555
Knife, Evans.....	601
Knife, Fisher.....	204
Knife, Fomon.....	563
Knife, Freer Septum.....	191, 565
Knife, Gerzog.....	183
Knife, Gill.....	221
Knife, Goldman-Fox.....	600
Knife, Goldman-Fox, Mid-Grade.....	600
Knife, Golf-Stick.....	331
Knife, Graefe.....	220
Knife, Hook.....	321
Knife, Joseph.....	194, 563
Knife, Kirkland.....	601
Knife, Liston.....	308
Knife, Lothrop.....	205
Knife, Lowe-Breck.....	306
Knife, Murphy Plaster.....	314, 353
Knife, Nucleus.....	329
Knife, Orban.....	600
Knife, Reiner Plaster.....	316
Knife, Retrograde.....	321
Knife, Rosette.....	321
Knife, Smilie.....	321
Knife, Smillie.....	306, 555
Knife, Tooke.....	221
Knife, Traditional.....	321
Knife, Tyding.....	204
Knife, Wheeler.....	220
Knife, Wullstein Sickle.....	552
Knight Forceps.....	189
Knight Scissors.....	62, 564
Knowles Bandage Scissors.....	67, 540
Knowles Bandage Scissors, Econo-Sterile™.....	653
Knowles Bandage Scissors, Econo™.....	636
Knowles Bandage Scissors, Merit™.....	624
Knowles Bandage Scissors, Surgi-OR™.....	616
Kocher Forceps.....	91, 461
Kocher Forceps, Laparoscopic.....	425
Kocher-Langenbeck Retractor.....	560
Kogan Endocervical Speculum.....	360, 570-571, 573
Kogan Endocervical Speculum, Sklar Black™.....	397
Kogan Endocervical Speculum, Sklar Blue™.....	406
Kraff-Ultrata Forceps.....	248
Kraton O'Ring.....	470-471, 542
Kratz-Barraquer Wire Speculum.....	214
Krause Ear Snare.....	184
Krause Snare Wires.....	184, 191
Krause Snares.....	191
Kuehne Forceps.....	123
Kuglen Iris Hook.....	228
Kuhnt Fixation Forceps.....	243
Kyle Applicator.....	186

## L

L-Hook, Laparoscopic, Single Port.....	421
--	-----

Lab/Utility Scoop, Stainless Steel.....	683
LaBorde Dilator.....	202
Laceration Tray.....	430, 662
Lachrymal Probe, Bowman.....	184, 230, 561
Lachrymal Probe, Castroviejo.....	184
Lachrymal Probe, Williams.....	184
Ladmore Burnisher.....	584
Ladmore Filling Instrument.....	589
LaForce Adenotome.....	203
LaForce Adenotome Blade.....	203
LaForce Foreign Body Spud.....	222
Lagrange Scissors.....	62
Lahey Forceps.....	85
Lahey Gall Duct Forceps.....	88, 173
Lahey Gall Duct Forceps, Econo™.....	640
Lahey Retractor.....	144, 148, 492
Lahey Traction Forceps.....	105, 379, 485, 541, 559-560
Lambert Chalazion Forceps.....	251, 547
Lambert-Kay Clamp.....	508, 581
Lambotte Bone Forceps.....	295
Lambotte Osteotome.....	195, 285, 340, 565, 569
Lambotte Osteotome Set.....	195, 285, 340
Lambotte Osteotome, Jr.....	285, 340, 569
Laminectomy Set.....	556
Lamp, Laryngoscope, F.O.....	160
Lamp, Laryngoscope, LED.....	160
Lancaster Eye Speculum.....	216, 545-547
Lane Bone Forceps.....	295
Lane Cleft Palate Needle.....	165
Lane Elevator.....	304, 331
Lane Forceps.....	297
Lane Screw Driver.....	347
Lane Tissue Forceps.....	112
Langenbeck Bone Forceps.....	297
Langenbeck Bone Saw.....	308, 343
Langenbeck Elevator.....	303
Langenbeck Retractor.....	144, 492, 551
Lap Appendectomy Set.....	442
Lap Bowel Resection Set.....	442

## LAPAROSCOPIC

Laparoscopic Biopsy Punch.....	430
Laparoscopic Cannula.....	431
Laparoscopic Clip.....	443
Laparoscopic Clip Appliers.....	444-445
Laparoscopic Collar.....	431
Laparoscopic Electrode.....	434, 442, 576
Laparoscopic Electrode, Miniature.....	437
Laparoscopic Electrosurgical Cable.....	434, 437
Laparoscopic Endoscope, Miniature.....	437
Laparoscopic Forceps.....	424-429, 442, 575-576
Laparoscopic Forceps, Disposable.....	447-448
Laparoscopic Handle.....	431, 446
Laparoscopic Needle.....	438, 442, 576
Laparoscopic Needle Holder.....	426
Laparoscopic Needle Holder, Single Port.....	420
Laparoscopic Needle Holder, TC.....	441-442, 576
Laparoscopic Obturator.....	432-433
Laparoscopic Obturator, Miniature.....	437
Laparoscopic Punch, Miniature.....	436
Laparoscopic Reducer.....	433
Laparoscopic Retractor Esophagus.....	439, 442, 575
Laparoscopic Retractor Fan.....	439

Laparoscopic Retractor Graduated.....	438
Laparoscopic S-Retractor.....	433
Laparoscopic Scissors.....	422-423, 442, 575-576
Laparoscopic Scissors, Disposable.....	447-448
Laparoscopic Scissors, Miniature.....	435-436
Laparoscopic Set.....	442, 575-576
Laparoscopic Suction Irrigation System.....	440, 442, 575-576
Laparoscopic TC Needle Holder, Miniature.....	436
Laparoscopic Trocar.....	432-433
Laparoscopic Trocar Miniature.....	437
Laparoscopic Trocar Set, Miniature.....	437
Laparoscopic Trocar, Disposable.....	449
Laparoscopic Trocar, Single Port.....	420
Laparoscopic Valve.....	433-434, 442, 576
Laparoscopic, Single Port.....	420-421
Laparoscopic, Single Port, Suction Irrigation.....	420
Larry Rectal Probe.....	172, 475, 543
Laryngeal Mirror.....	199
Laryngectomy Tube, Jackson.....	157
Laryngoscope Battery, Rechargeable.....	160
Laryngoscope Blade, Macintosh.....	159
Laryngoscope Blade, Macintosh, F.O.....	158-159
Laryngoscope Blade, Miller.....	159
Laryngoscope Blade, Miller, F.O.....	158
Laryngoscope Blade, Wisconsin, F.O.....	159
Laryngoscope Handle.....	160
Laryngoscope Handle, F.O.....	160
Laryngoscope Handle, LED.....	160
Laryngoscope Lamp, F.O.....	160
Laryngoscope Lamp, LED.....	160
Laryngoscope Set, Disposable.....	161
Laryngoscope Set, Macintosh, F.O.....	161
Laryngoscope Set, Miller, F.O.....	161
Laser Speculum, Cottle.....	188
Lateral Vaginal Retractor.....	356
Lateral Vaginal Retractor, Sklar Black™.....	396
Lateral Vaginal Retractor, Sklar Blue™.....	405
Laufe Divergent Obstetrical Forceps.....	382, 572
Laufe Uterine Polyp Forceps.....	94, 374
Laufe Uterine Polyp Forceps, Sklar Black™.....	401
Laufe Uterine Polyp Forceps, Sklar Blue™.....	407
Laufe-Novak Curette.....	365
Laufe-Piper Obstetrical Forceps.....	380
Lawrence Forceps.....	462, 481
Lawton Forceps.....	374
Le Cron Carver.....	593
Lead Hand.....	317
Lebsche Chisel.....	490
Lecron Porcelain and Wax Carver, Mid-Grade.....	593
LED Laryngoscope Handle.....	160
LED Laryngoscope Lamp.....	160
Lees Bronchus Clamp.....	521
Leksell Rongeur.....	273, 556-557
Lemmon Approximator.....	489
Lemmon Intima Dissector.....	531
Lemmon Needle Holder.....	497
Lempert Elevator.....	191-192
Lempert Rongeur.....	275, 337
Lens Scoop, Wilder.....	546
Lerliche Forceps.....	478
Lester Forceps.....	118, 243
Lester Manipulator.....	228

Lever, Cottle Bone.....	195	Locke Elevator.....	329	Major Rhinoplasty Set.....	562
Lewicki Hook.....	227	Locke Forceps.....	298, 346	Malianiac Nasal Retractor.....	565
Lewin Bone Forceps.....	297, 346, 553	Lockwood Abdominal Demarcator.....	559	Malis Bipolar Forceps, Electrosurgical.....	419
Lewis Loop.....	225	Lockwood Forceps.....	89	Mallet.....	290, 339, 563, 569
Lewis Rasp.....	196, 291, 334	London Chalazion Forceps.....	252	Mallet Ends.....	290, 339
Lexer Gouge.....	288	Long Forceps.....	374	Mallet Ends, Sklar.....	290, 339
Lexer Mini Chisel.....	288	Long Stitch Scissors.....	167	Mallet, Gerzog.....	290, 339, 554
Lexer Mini Gouge.....	288	Loop Electrode Disposable, Electrosurgical.....	412	Mallet, Hajek.....	553
Lexer Scissors.....	52	Loop Pliers.....	607	Mallet, Kirk.....	290, 339
Lexer Scissors, Baby.....	52	Loop, Billeau.....	178, 550, 552	Mallet, Lucae.....	290, 339
Lexer Scissors, Sklar Edge™ TC.....	20	Loop, Foreign Body & Probe.....	222	Mallet, Meyerding.....	290
Liberator, Splinter, Merit™.....	631	Loop, Lewis.....	225	Mallet, Partsch.....	563
Lifting Handles, Stainless Steel.....	693	Loop, New Orleans.....	225	Mallet, Rush.....	339
Ligation Clip.....	443	Loop, Smoche Nucleus.....	225	Mallet, Sklar.....	290, 339, 549
Ligation Clip Appliers.....	444-445	Loop, Wilder.....	225	Mallet, Steel.....	290
Ligator Cone.....	472	Lorna Edna Towel Clamp.....	127, 558, 574, 577, 579	Maltz Rasp.....	197, 291, 334, 549, 563
Ligator Cone, McGivney.....	471	Lorna Edna Towel Clamp, Econo-Sterile™.....	657	Maltz Rasp, TC.....	197, 334, 549
Ligator Cone, Rudd Clinic.....	470	Lorna Edna Towel Clamp, Econo™.....	641	Mammoplasty Set.....	560
Ligator Set, McGivney.....	471, 542	Lorna Edna Towel Clamp, Merit™.....	629	Mammoplasty Set II.....	560
Ligator Set, Rudd Clinic.....	470, 542	Lorna Edna Towel Clamp, Surgi-OR™.....	620	Mandibular Awl, Obwegeser.....	170
Ligator, Hemorrhoidal.....	472	Lothrop Knife.....	205	Manhattan Suture Forceps.....	245, 247
Ligator, Hemorrhoidal, Improved.....	472	Lothrop Retractor.....	201	Manipulator, Cohen Uterine.....	363
Ligator, McGivney.....	471, 542	Lounsbury Placenta Curette.....	367	Manipulator, Lester.....	228
Ligator, Rudd Clinic.....	470, 542	Love Retractor.....	211	Marcuse Tubing Forceps.....	126
Ligator, Rudd, Improved.....	470	Love Uvula Retractor.....	210, 552	Marker, Skin, Surgical.....	658
Ligature Carrier, DeBaKey-Semb.....	513	Love-Gruenwald Rongeur.....	279, 556	Martin Pelvimeter Forceps.....	384
Ligature Carrier, Dupuys-Weiss.....	170	Love-Kerrison Rongeur.....	556	Martin Scissors.....	60, 555
Ligature Pliers.....	607	Love-Kerrison-Schlesinger-Colclough Rongeur.....	277	Martin's Uterine Needle.....	164
Light Wire Pliers.....	607	Lovelace Gall Bladder Forceps.....	175, 486	Martini Bone Curette.....	294
Lingual Pliers.....	606	Low Foam Detergent, Sklar Kleen™.....	11, 723	Martini Needle Holder, TC.....	569
Lip Retractor, Columbia.....	201	Low-Breck Knife.....	306	Marx Breast Retractor.....	560
Lip Retractor, Disposable.....	614	Lower Gall Duct Forceps.....	90, 173	Maryland Dissector, Laparoscopic...424, 442, 575-576	
Liquid Detergent, Sklar Kleen™.....	11, 723	Lowman Bone Clamp.....	294, 343, 553	Maryland Dissector, Laparoscopic, Disposable.....	447
Lister Bandage Scissors.....	66, 538, 540, 553, 555	Lube, Sklar Instru-Guard™.....	9, 722	Maryland Dissector, Laparoscopic, Single Port.....	421
Lister Bandage Scissors, Econo-Sterile™.....	653	Lubet Barbon Forceps.....	189	Maryland Scissors, Laparoscopic, Disposable.....	448
Lister Bandage Scissors, Econo™.....	636	Lucae Forceps.....	116, 182, 550, 552, 565	Mask, Face, Sklar.....	258
Lister Bandage Scissors, Merit™.....	624	Lucae Forceps, Econo™.....	643	Mason Cast Breaker.....	316
Lister Bandage Scissors, Mid-Grade.....	624	Lucae Forceps, Merit™.....	633	Mastectomy Set.....	541
Lister Bandage Scissors, Sklarhone™.....	26	Lucae Forceps, Surgi-OR™.....	618	Mat, Silicon, SklarLite™.....	697-699
Lister Bandage Scissors, Sklarlite XD™.....	33, 66	Lucae Mallet.....	290, 339	Mathieu Foreign Body Forceps.....	474
Lister Bandage Scissors, Sklarlite™.....	33, 66	Luer Rongeur.....	275, 556	Mathieu Needle Holder.....	130, 371
Lister Bandage Scissors, Surgi-OR™.....	616	Luethy Beck Needle Holder, TC.....	44, 135	Mathieu Needle Holder, Mid-Grade.....	629
Liston Bone Forceps.....	272, 335-336, 553, 557	Luethy-Beck Needle Holder, TC.....	371	Mathieu Needle Holder, TC.....	44, 135, 371
Liston Bone Forceps, Merit™.....	633	Lugols, Disposable.....	404, 452	Mathieu Pliers.....	608-609
Liston Knife.....	308	Luikart Obstetrical Forceps.....	380	Mathieu Raspatory.....	301
LiteGrip™ Adson Dressing Forceps.....	108	Luikart-Bill Traction Handle.....	382	Mathieu Retractor.....	142, 210
LiteGrip™ Bishop-Harmon Forceps.....	108	Lukens Retractor.....	544	Matson Stripper/Elevator.....	489
LiteGrip™ Iris Forceps.....	108, 242, 547			Maumenee Park Eye Speculum.....	216, 546
Littauer Cilia Forceps.....	122, 249			Maxi Grasper.....	320
Littauer Cutting Forceps.....	539			Maxi, Laparoscopic, Single Port.....	421
Littauer Ear Forceps.....	179			Mayo Abdominal Retractor.....	151
Littauer Forceps.....	322			Mayo Cat Gut Needle.....	164
Littauer Forceps, Merit™.....	633			Mayo Common Duct Scoop.....	174
Littauer Forceps, Sklar.....	323			Mayo Guyon Clamp.....	91, 176
Littauer Forceps, Sklar-Taper™.....	323			Mayo Intestinal Needle.....	163
Littauer Forceps, Sklarlite™.....	39, 322			Mayo Scissors.....	50, 369, 459, 468, 494, 536-538, 543-544, 547, 551-556, 559, 561, 571-573
Littauer Stitch Scissors.....	63, 167, 237, 540, 553			Mayo Scissors, Econo-Sterile™.....	652
Littauer Stitch Scissors, Econo™.....	636			Mayo Scissors, Econo™.....	635
Littauer Stitch Scissors, Mid-Grade.....	625			Mayo Scissors, Merit™.....	624
Littauer Stitch Scissors, Surgi-OR™.....	617			Mayo Scissors, Mid-Grade.....	624
Littauer Suture Scissors, Econo-Sterile™.....	653			Mayo Scissors, Sklar Edge™ TC.....	19, 74, 538, 541, 548, 550, 557-558, 562, 566, 572, 574-575, 577-578, 580
Little Retractor.....	143				
Littler Suture Scissors.....	168				
Lletz Electrode Disposable, Electrosurgical.....	413				

## M

Macintosh Laryngoscope Blade.....	159
Macintosh Laryngoscope Blade, F.O.....	158-159
Macintosh Laryngoscope Set, F.O.....	161
Magill Catheter Forceps.....	105, 657
Magill Catheter Forceps, Econo™.....	640
Magill Catheter Forceps, Merit™.....	628
Magill Catheter Forceps, Surgi-OR™.....	619
Magnatone Stethoscope.....	676
Maier Gross Uterine Dressing Forceps.....	561
Maier-Gross Forceps.....	94
Major Basic Surgery Set.....	536
Major Nasal Set.....	549
Major Plastic Surgery Set.....	558



## ALPHABETICAL INDEX

Mayo Scissors, Sklarcut™ .....	27, 73, 558	Measure, Tape.....	678	Merit™ Jansen Nasal Forceps .....	626
Mayo Scissors, Sklarhone™ .....	23, 77	Medicine Cup, Plastic.....	705	Merit™ Jones Forceps .....	627
Mayo Scissors, Sklarhone™ TC.....	22	Medicine Cup, Stainless Steel.....	538, 547, 577, 680	Merit™ Jones Towel Clamp.....	629
Mayo Scissors, Sklarlite XD™ .....	31, 50, 567	Meller Retractor.....	138, 207, 219, 270	Merit™ Joseph Hook.....	630
Mayo Scissors, Sklarlite™ .....	31, 50, 468, 537, 545, 562	Mellinger Eye Speculum.....	215	Merit™ Kern Bone Forceps .....	633
Mayo Scissors, Sklarlite™ Sklarcut™ .....	28, 73	Meniscus Clamp.....	305	Merit™ Keyes Cutaneous Punch .....	631
Mayo Scissors, Surgi-OR™.....	616-617	Meniscutome.....	321	Merit™ Knapp Speculum.....	632
Mayo Scissors, Surgi-OR™ TC.....	616	Meriam Pliers.....	604	Merit™ Knowles Bandage Scissors .....	624
Mayo Scoop.....	175			Merit™ Lister Bandage Scissors .....	624
Mayo Tray, Stainless Steel.....	547, 685			Merit™ Liston Bone Forceps.....	633
Mayo-Adams Retractor.....	138			Merit™ Littauer Forceps.....	633
Mayo-Blake Forceps.....	89			Merit™ Lorna Edna Towel Clamp.....	629
Mayo-Collin Retractor.....	147			Merit™ Lucae Forceps.....	633
Mayo-Hegar Needle Holder.....	129, 370, 545, 554, 560, 562, 571, 573			Merit™ Magill Catheter Forceps.....	628
Mayo-Hegar Needle Holder, Econo-Sterile™ .....	659			Merit™ Mayo Scissors.....	624
Mayo-Hegar Needle Holder, Econo™ .....	646			Merit™ Mayo-Hegar Needle Holder .....	629
Mayo-Hegar Needle Holder, Merit™ .....	629			Merit™ Metzenbaum Scissors.....	624
Mayo-Hegar Needle Holder, Mid-Grade .....	629			Merit™ Michel Clip Forceps .....	626
Mayo-Hegar Needle Holder, Sklar Black™ .....	401			Merit™ Micro Alligator Forceps .....	633
Mayo-Hegar Needle Holder, Sklarlite XD™ .....	46			Merit™ Nail Nipper .....	633
Mayo-Hegar Needle Holder, Sklarlite™ .....	46			Merit™ Nail Splitter.....	633
Mayo-Hegar Needle Holder, Surgi-OR™ .....	621			Merit™ Nail Splitting Scissors .....	624
Mayo-Hegar Needle Holder, Surgi-OR™ TC.....	620			Merit™ Olsen-Hegar Needle Holder.....	629
Mayo-Hegar Needle Holder, TC .....	41, 133, 463, 536-537, 542-543, 553, 557-559, 563, 570-572, 574-575, 578-581			Merit™ Operating Scissors.....	625
Mayo-Hegar Needle Holder, TC, Left .....	43, 136			Merit™ Pederson Vaginal Speculum .....	630
Mayo-Noble Scissors.....	53, 468			Merit™ Peers Vaginal Clamp.....	629
Mayo-Noble-Stille Scissors.....	53			Merit™ Plain Splinter Forceps.....	626
Mayo-Robson Forceps .....	88			Merit™ Plaster Spreader.....	630
Mayo-Stille Scissors .....	53, 369, 468			Merit™ Platypus Nail Forceps.....	626
Mayo-Stille Scissors, Sklar Edge™ TC .....	19, 74			Merit™ Presbyterian Tube Occluding Clamp .....	629
Mayo-Stille Scissors, Sklarhone™ TC.....	22			Merit™ Probe .....	632
McBurney Retractor.....	143			Merit™ Probe & Excavator.....	631
McCall's Curette .....	595			Merit™ Rabiner Hammer.....	632
McClure Iris Scissors.....	70, 238, 265			Merit™ Rankin Kelly Forceps.....	628
McCullough Utility Forceps.....	119, 247			Merit™ Ring Cutter.....	631
McDonald Elevator .....	191			Merit™ Ring Cutter Blade.....	631
McCannon Iris Retractor .....	210, 226			Merit™ Rochester-Carmalt Forceps.....	628
McGivney Ligator.....	471, 542			Merit™ Rochester-Ochsner Forceps.....	628
McGivney Ligator Cone.....	471			Merit™ Rochester-Pean Forceps.....	628
McGivney Ligator Set.....	471, 542			Merit™ Russian Tissue Forceps.....	626
McGlamry Elevators .....	192			Merit™ Scalpel Handle.....	633
McGuire Corneal Scissors.....	232			Merit™ Schmidt Tonsil Forceps.....	628
McIndoe Bone Forceps .....	335			Merit™ Schroeder Tenaculum Forceps .....	628
McIndoe Forceps.....	114			Merit™ Schweizer Forceps .....	628
McIvor Mouth Gag.....	197			Merit™ Semkin Forceps .....	626
McKenty Elevator .....	192			Merit™ Senn Retractor.....	630
McKenty Septum Elevator.....	564			Merit™ Shamberg Comedone Extractor .....	631
McKenzie Clip.....	171			Merit™ Simpson Sound.....	630
McKenzie Clip Rack .....	171			Merit™ Sims Uterine Sound .....	630
McKenzie Forceps.....	171			Merit™ Snook Hook .....	630
McLane-Tucker Obstetrical Forceps.....	381			Merit™ Spatula & Packer .....	631
McLane-Tucker-Luikart Obstetrical Forceps.....	381, 572			Merit™ Splinter Forceps.....	627
McNeil-Goldman Fixation Ring.....	217			Merit™ Splinter Liberator.....	631
McPherson Bipolar Forceps, Electrosurgical.....	419			Merit™ Splinter Removal Kit .....	631
McPherson Eye Speculum .....	215			Merit™ St. Vincent Tube Occluding Forceps.....	629
McPherson Forceps.....	245			Merit™ Sterilizer Forceps .....	629
McPherson Iris Forceps.....	245			Merit™ Stevens Scissors .....	625
McPherson Vannas Scissors.....	71, 237, 263, 547			Merit™ Strabismus Scissors .....	625
McReynolds Spatula.....	224			Merit™ Suture Scissors.....	625
Mead Extracting Forceps.....	612			Merit™ Taylor Hammer.....	632
Mead Rongeur.....	277, 338			Merit™ Tissue Forceps.....	627
				Merit™ Tissue Nipper.....	633
				Merit™ Tyrell Hook.....	630
				Merit™ Umbilical Scissors.....	625

## MERIT™

Merit™ Abbey Needle Holder.....	629
Merit™ Adson Bayonet Forceps.....	626
Merit™ Adson Dressing Forceps.....	626
Merit™ Adson Tissue Forceps.....	626
Merit™ Adson-Brown Tissue Forceps .....	626
Merit™ Allis Tissue Forceps.....	627
Merit™ Alm Retractor .....	630
Merit™ Army Gauze Scissors.....	624
Merit™ Army Retractor.....	630
Merit™ Babcock Forceps .....	627
Merit™ Babinski Hammer.....	632
Merit™ Backhaus Towel Forceps .....	629
Merit™ Bergh Cilia Forceps .....	626
Merit™ Bishop-Harmon Forceps .....	626
Merit™ Bizoman Forceps.....	627
Merit™ Braun Epistomy Scissors.....	624
Merit™ Brown Needle Holder.....	629
Merit™ Bruns Plaster Shears .....	624
Merit™ Buck Curette .....	632
Merit™ Buck Hammer .....	632
Merit™ Carmalt Splinter Forceps .....	626
Merit™ Cast Spreader.....	630
Merit™ Collier Needle Holder.....	629
Merit™ Comedone Extractor .....	631
Merit™ Crile Forceps.....	627
Merit™ Curette Excavator .....	631
Merit™ Cushing Retractor.....	630
Merit™ Cuticle Nail Scissors .....	624
Merit™ Dental Probe.....	632
Merit™ Doyen Intestinal Forceps .....	627
Merit™ Dressing Forceps.....	626
Merit™ Ear Syringe .....	632
Merit™ Ear Syringe Shield .....	632
Merit™ Ear Syringe Tip.....	632
Merit™ EKG Caliper .....	632
Merit™ Feilchenfeld Splinter Forceps .....	626
Merit™ Ferris Smith Tissue Forceps .....	626
Merit™ First Aid Shears.....	624
Merit™ Foerster Sponge Forceps .....	627
Merit™ Fox Dermal Curette.....	631
Merit™ Freer Elevator.....	632
Merit™ Gelpi Retractor.....	630
Merit™ Gradle Scissors.....	624
Merit™ Graefe Tissue Forceps.....	626
Merit™ Graves Vaginal Speculum.....	630
Merit™ Grooved Director.....	632
Merit™ Gruber Speculum.....	632
Merit™ Halsey Needle Holder .....	629
Merit™ Hartmann Alligator Forceps .....	632
Merit™ Hegar Uterine Dilator .....	630
Merit™ Iris Dressing Forceps.....	626
Merit™ Iris Scissors.....	624
Merit™ Iris Tissue Forceps.....	626

Merit™ Unna Comedone.....	631	Micro-Cut Cannula Biopsy Punch.....	387	Mid-Grade.....	603	
Merit™ Utility Forceps.....	627	Micro-Cut Eppendorfer Biopsy Punch.....	386	Miller Groovelok Forceps.....	603	
Merit™ Utility Scissors.....	625	Micro-Cut Gaylor Biopsy Punch.....	388	Miller Laryngoscope Blade.....	159	
Merit™ Vessells Towel Forceps.....	629	Micro-Cut Gellhorn Biopsy Punch.....	388	Miller Laryngoscope Blade, F.O.....	158	
Merit™ Vienna Speculum.....	633	Micro-Cut Kevorkian Biopsy Punch.....	385	Miller Laryngoscope Set, F.O.....	161	
Merit™ Virtus Splinter Forceps.....	627	Micro-Cut Kevorkian-Young Biopsy Punch.....	386	Miller Scissors.....	60, 70, 475	
Merit™ Vorse Tubing Clamp.....	629	Micro-Cut Oval Biopsy Punch.....	386	Miller Senn Retractor.....	142	
Merit™ Wartenberg Pinwheel.....	632	Micro-Cut Tischler Mini Biopsy Punch.....	385	Miller-Senn Retractor.....	541, 545, 562, 567	
Merit™ Webster Needle Holder.....	629	Micro-Cut Tischler Oval Biopsy Punch.....	385	Milulicz Forceps.....	205	
Merit™ Weitlaner Retractor.....	630	Micro-Cut Tischler-Kevorkian Biopsy Punch.....	385	Mini Minor Tray.....	538	
Merit™ Wilde Forceps.....	627	Micro-Cut Universal Biopsy Punch.....	387	Mini Thumb Scalpel.....	670	
		Micro-Cut Wittner Uterine Biopsy Punch.....	386	Miniature Catheter Instrument Tray, Stainless Steel.....	684	
Mesh Basket.....	689	Micro-Grip Scissors.....	262	Miniature Electrode, Laparoscopic.....	437	
Metzenbaum Scissors.....	51-52, 369, 459, 468, 530, 536-537, 539, 541, 543-544, 547, 552, 554-556, 560-561, 564, 566, 568, 571, 573	<b>MID-GRADE</b>			Miniature Endoscope, Laparoscopic.....	437
Metzenbaum Scissors, Econo-Sterile™.....	652	Mid-Grade Baade Pliers.....	605	Miniature Needle Holder, Laparoscopic TC.....	436	
Metzenbaum Scissors, Econo™.....	635	Mid-Grade Baumgartner Needle Holder.....	629	Miniature Obturator, Laparoscopic.....	437	
Metzenbaum Scissors, Econo™.....	635	Mid-Grade Black Pluggers.....	583	Miniature Punch, Laparoscopic.....	436	
Metzenbaum Scissors, Laparoscopic.....	422, 442, 575-576	Mid-Grade Boley Gauge.....	603	Miniature Scissors, Laparoscopic.....	435-436	
Metzenbaum Scissors, Laparoscopic, Disposable.....	447-448	Mid-Grade Cement Spatula.....	594	Miniature Trocar Set, Laparoscopic.....	437	
Metzenbaum Scissors, Merit™.....	624	Mid-Grade Cheek Retractor, University of Minnesota.....	613	Miniature Trocar, Laparoscopic.....	437	
Metzenbaum Scissors, Sklar Edge™ TC.....	19-20, 75, 538, 541, 548-551, 557-558, 562, 566, 574-575, 577-578, 580-581	Mid-Grade Children's Extracting Forceps.....	612-613	Minor Basic Surgery Set.....	537	
Metzenbaum Scissors, Sklarcut™.....	28, 73, 558	Mid-Grade Clasp Adjusting Pliers.....	605	Minor Surgery Tray.....	664	
Metzenbaum Scissors, Sklarhone™.....	24, 77, 559, 572, 580	Mid-Grade College Pliers.....	603-604	Mirror, Dental, Disposable.....	614	
Metzenbaum Scissors, Sklarhone™ Sklarlite™.....	24	Mid-Grade Crile-Wood Needle Holder.....	629	Mirror, Head.....	199, 679	
Metzenbaum Scissors, Sklarhone™ TC.....	22	Mid-Grade Derf Needle Holder.....	629	Mirror, Laryngeal.....	199	
Metzenbaum Scissors, Sklarlite XD™.....	31-32, 51-52	Mid-Grade Doyen Jansen (Molt) Mouth Gag.....	613	Mixing/Solution Bowl, Stainless Steel.....	681	
Metzenbaum Scissors, Sklarlite™.....	31-32, 51-52, 567	Mid-Grade Explorers.....	586-587	Mixer Forceps.....	86, 174, 462, 466, 492, 553, 573, 578-579, 581	
Metzenbaum Scissors, Sklarlite™ Sklarcut™.....	28, 73, 545, 562	Mid-Grade Extracting Forceps.....	611-612	Mixer Forceps, Baby.....	87, 560	
Metzenbaum Scissors, Surgi-OR™.....	617	Mid-Grade Goldman-Fox Knife.....	600	Mixer Forceps, Laparoscopic.....	424, 442, 576	
Metzenbaum Scissors, Surgi-OR™ TC.....	616	Mid-Grade Gordon Pliers.....	605	Mixer Forceps, Laparoscopic, Disposable.....	447	
Metzenbaum, Laparoscopic, Single Port.....	421	Mid-Grade Goslee Pliers.....	605	Mixer Forceps, Sklarlite XD™.....	38, 86, 558, 577-578, 580	
Meyering Hook.....	143	Mid-Grade Halsted Mosquito Forceps.....	627	Mixer Forceps, Sklarlite™.....	38, 86	
Meyering Mallet.....	290	Mid-Grade Hartmann Mosquito Forceps.....	627	Mixer Scissors.....	59	
Meyering Retractor.....	145, 150, 283, 491, 559	Mid-Grade Hollenback Carver.....	591	Mogen Clamp.....	466	
Meyering Skid.....	299	Mid-Grade How Pliers.....	605	Moleskin Scissors.....	67, 352	
Meyhofer Curette.....	227	Mid-Grade Iris Scissors.....	624	Molt Elevator.....	568-569	
Meyhoff Chalazion Curette.....	547	Mid-Grade Kelly Forceps.....	628	Monsels, Disposable.....	404, 452	
Michel Clip.....	171	Mid-Grade Le Cron Carver.....	593	Moore Bone Drill.....	311	
Michel Clip Forceps.....	123, 170	Mid-Grade Lister Bandage Scissors.....	624	Mosquito Forceps.....	477	
Michel Clip Forceps, Merit™.....	626	Mid-Grade Littauer Stitch Scissors.....	625	Mosquito Forceps, Halsted.....	78-79, 536-538, 540-541, 544-545, 547-548, 550-551, 554, 556, 558- 559, 561-562, 565-566, 574, 577-578, 580-581	
Michel Forceps.....	171	Mid-Grade Mathieu Needle Holder.....	629	Mosquito Forceps, Halsted, Mid-Grade.....	627	
Michel Tissue Forceps.....	112	Mid-Grade Mayo Scissors.....	624	Mosquito Forceps, Halsted, Sklarlite XD™.....	37, 79, 546	
Micro Adson Dressing Forceps.....	109	Mid-Grade Mayo-Hegar Needle Holder.....	629	Mosquito Forceps, Halsted, Sklarlite™.....	37, 78, 567	
Micro Adson Tissue Forceps.....	109, 554-555, 560	Mid-Grade Mead Extracting Forceps.....	612	Mosquito Forceps, Halsted, Surgi-OR™.....	619	
Micro Alligator Forceps, Merit™.....	633	Mid-Grade Miller Groovelok Forceps.....	603	Mosquito Forceps, Hartmann, Mid-Grade.....	627	
Micro Bellucci Scissors.....	182, 552	Mid-Grade Olsen-Hegar Needle Holder.....	629	Mosquito Forceps, Hartmann, Sklarlite XD™.....	37, 82	
Micro Forceps.....	259	Mid-Grade Operating Scissors.....	625	Mosquito Forceps, Hartmann, Sklarlite™.....	37, 82, 567	
Micro Mosquito Forceps.....	87, 558, 560-561, 568, 577	Mid-Grade P.K. Thomas Wax Placer.....	590	Mosquito Forceps, Hartmann, Surgi-OR™.....	619	
Micro Needle Holder.....	260	Mid-Grade Perry Pliers.....	604	Mosquito Forceps, Jacobson.....	87	
Micro Scissors.....	261, 262	Mid-Grade Roach Carver.....	592	Mosquito Forceps, Micro.....	87	
Micro Scissors, Laparoscopic.....	423, 442, 576	Mid-Grade Spencer Stitch Scissors.....	625	Mosquito Forceps, Thomson.....	85	
Micro Sterilization Tray Cover, Stainless Steel.....	693	Mid-Grade Sterilizing Forceps.....	613	Mouth Gag, Denhardt.....	198	
Micro Sterilization Tray, Stainless Steel.....	693	Mid-Grade University of Washington Rubber Dam Forceps.....	603	Mouth Gag, Dingman.....	568	
Micro Surgery Needle Holder.....	270, 271	Mid-Grade Vehe Carver.....	592	Mouth Gag, Doyen Jansen (Molt).....	198, 613	
Micro Surgery Scissors.....	265	Mid-Grade Webster Needle Holder.....	629	Mouth Gag, Doyen Jansen (Molt) Cushion.....	198, 613	
Micro-Cut Biopsy Punch Handle.....	387	Mid-Grade Wire Bending Pliers.....	605	Mouth Gag, Doyen Jansen (Molt), Mid-Grade.....	613	
		Mid-Grade Wire Cutting Scissors.....	625	Mouth Gag, Jennings.....	198, 552	
		Middle Ear Set.....	551	Mouth Gag, Mclvor.....	197	
		Miller Groovelok Articulating Paper Forceps,				

## ALPHABETICAL INDEX



Mouth Gag, Wesson.....	198
Moynihan Gall Duct Forceps.....	90, 173
Muldoon Dilator.....	230
Multi-Purpose Utility Bowl, Plastic.....	705
Murdock Eye Speculum.....	214
Murless Head Extractor.....	382
Murphy Gouge.....	284
Murphy Plaster Knife.....	314, 353
Murphy-Lane Skid.....	299
Murphy's Intestinal Needle.....	164
Mycotic Nail Nipper.....	324
Myringotome, Buck.....	183
Myringotomy Set.....	567

## N

N-1 Tourniquet.....	313, 348
N-1 Tourniquet Clip.....	313, 348
N-1 Tourniquet Tubing.....	313, 348
Nail Cutter, Baker.....	328
Nail Drill Points, Sklar.....	535
Nail Drill, Sklar.....	535
Nail Forceps.....	326
Nail Forceps, Platypus.....	326
Nail Forceps, Platypus, Merit™.....	626
Nail Forceps, Sklarlite™.....	326
Nail Nipper.....	323-324, 539
Nail Nipper, Econo™.....	646
Nail Nipper, Merit™.....	633
Nail Nipper, Mycotic.....	324
Nail Nipper, Surgi-OR™.....	622
Nail Scissors, Cuticle, Merit™.....	624
Nail Scissors, Sklar.....	68, 325
Nail Shaver.....	328, 540
Nail Splitter.....	323, 329, 539-540
Nail Splitter Forceps, Econo™.....	646
Nail Splitter Forceps, Surgi-OR™.....	622
Nail Splitter, Merit™.....	633
Nail Splitting Forceps, Sklarlite™.....	39
Nail Splitting Scissors.....	68, 326
Nail Splitting Scissors, Merit™.....	624
Nail/Bone File.....	292, 333
Napkin Clip, Alligator.....	614
Nasal Forceps, Jansen, Merit™.....	626
Nasal Rasp, Lewis.....	196, 291, 334
Nasal Saw, Joseph.....	549, 564-565
Nasal Speculum, Plastic.....	188
Nasal Speculum, Tieck Halle.....	188, 564
Nasal Speculum, Vienna, Merit™.....	633
Needle & Spud, Dix.....	222
Needle Extender.....	457

## NEEDLE HOLDERS

Needle Holder, Abbey, Merit™.....	629
Needle Holder, Barraquer.....	131, 254, 271
Needle Holder, Baumgartner.....	128, 561
Needle Holder, Baumgartner, Econo-Sterile™.....	659
Needle Holder, Baumgartner, Econo™.....	646
Needle Holder, Baumgartner, Mid-Grade.....	629
Needle Holder, Baumgartner, Sklarlite XD™.....	46
Needle Holder, Baumgartner, Sklarlite™.....	46
Needle Holder, Baumgartner, Surgi-OR™.....	621
Needle Holder, Baumgartner, Surgi-OR™ TC.....	620

Needle Holder, Baumgartner, TC.....	40, 133
Needle Holder, Bihrlé, TC.....	42
Needle Holder, Boynton.....	255
Needle Holder, Bozemann Heaney, TC.....	42, 135, 371
Needle Holder, Brown.....	128
Needle Holder, Brown, Merit™.....	629
Needle Holder, Brown, Surgi-OR™.....	621
Needle Holder, Castroviejo.....	131, 254, 270, 545, 547, 559, 564
Needle Holder, Castroviejo-Kalt.....	130, 254
Needle Holder, Castroviejo, TC.....	44, 135, 546-547, 569, 577
Needle Holder, Cohan.....	255, 270
Needle Holder, Collier.....	129
Needle Holder, Collier, Econo™.....	647
Needle Holder, Collier, Merit™.....	629
Needle Holder, Collier, Surgi-OR™.....	621
Needle Holder, Crile.....	371
Needle Holder, Crile-Murray.....	128
Needle Holder, Crile-Murray, TC.....	40, 132, 543, 545, 562, 570
Needle Holder, Crile-Wood.....	129, 370, 552, 554-555, 560
Needle Holder, Crile-Wood, Econo-Sterile™.....	659
Needle Holder, Crile-Wood, Econo™.....	646
Needle Holder, Crile-Wood, Mid-Grade.....	629
Needle Holder, Crile-Wood, Sklarlite XD™.....	46
Needle Holder, Crile-Wood, Sklarlite™.....	46
Needle Holder, Crile-Wood, Surgi-OR™ TC.....	620
Needle Holder, Crile-Wood, TC.....	40, 133, 463, 549, 560, 563, 566, 568, 575, 577, 580
Needle Holder, Crile-Wood, TC, Left.....	43, 136, 544
Needle Holder, DeBakey, TC.....	132, 463
Needle Holder, Derf.....	128, 538
Needle Holder, Derf, Econo-Sterile™.....	659
Needle Holder, Derf, Econo™.....	647
Needle Holder, Derf, Mid-Grade.....	629
Needle Holder, Derf, Sklarlite XD™.....	45
Needle Holder, Derf, Sklarlite™.....	45
Needle Holder, Derf, Surgi-OR™.....	621
Needle Holder, Derf, Surgi-OR™ TC.....	620
Needle Holder, Derf, TC.....	40, 132, 566
Needle Holder, Econo-Sterile™, Wireform.....	661
Needle Holder, Finochietto.....	130, 370
Needle Holder, Finochietto, TC.....	42, 134
Needle Holder, Gillies.....	371
Needle Holder, Gillies, TC.....	41, 563
Needle Holder, Halsey.....	128, 538-539, 544
Needle Holder, Halsey, Econo-Sterile™.....	659
Needle Holder, Halsey, Econo™.....	647
Needle Holder, Halsey, Merit™.....	629
Needle Holder, Halsey, Sklarlite XD™.....	45
Needle Holder, Halsey, Sklarlite™.....	45
Needle Holder, Halsey, Surgi-OR™.....	621
Needle Holder, Halsey, Surgi-OR™ TC.....	620
Needle Holder, Halsey, TC.....	40, 133, 542, 548, 550-551, 557-559, 563, 568-569, 577-578
Needle Holder, Heaney.....	130, 371, 561, 571, 573
Needle Holder, Heaney, Sklar Black™.....	401
Needle Holder, Heaney, TC.....	42, 134, 573
Needle Holder, Jacobson.....	131
Needle Holder, Jacobson, TC Micro.....	44, 135
Needle Holder, Johnson.....	130
Needle Holder, Julian, TC.....	42

Needle Holder, Laparoscopic.....	426
Needle Holder, Laparoscopic TC.....	441-442, 576
Needle Holder, Laparoscopic, Miniature TC.....	436
Needle Holder, Laparoscopic, Single Port.....	420
Needle Holder, Lemmon.....	497
Needle Holder, Luethy Beck, TC.....	44, 135
Needle Holder, Luethy-Beck, TC.....	371
Needle Holder, Martini, TC.....	569
Needle Holder, Mathieu.....	130, 371
Needle Holder, Mathieu, Mid-Grade.....	629
Needle Holder, Mathieu, TC.....	44, 135, 371
Needle Holder, Mayo-Hegar.....	129, 370, 545, 554, 560, 562, 571, 573
Needle Holder, Mayo-Hegar, Econo-Sterile™.....	659
Needle Holder, Mayo-Hegar, Econo™.....	646
Needle Holder, Mayo-Hegar, Merit™.....	629
Needle Holder, Mayo-Hegar, Mid-Grade.....	629
Needle Holder, Mayo-Hegar, Sklar Black™.....	401
Needle Holder, Mayo-Hegar, Sklarlite XD™.....	46
Needle Holder, Mayo-Hegar, Sklarlite™.....	46
Needle Holder, Mayo-Hegar, Surgi-OR™.....	621
Needle Holder, Mayo-Hegar, Surgi-OR™ TC.....	620
Needle Holder, Mayo-Hegar, TC.....	41, 133, 463, 536-537, 542-543, 553, 557-559, 563, 570-572, 574-575, 578-581
Needle Holder, Mayo-Hegar, TC, Left.....	43, 136
Needle Holder, Micro.....	260
Needle Holder, Micro Surgery.....	270, 271
Needle Holder, Neivert.....	255, 271
Needle Holder, Neivert, TC.....	40
Needle Holder, New Orleans.....	129
Needle Holder, New Orleans, TC.....	41, 134
Needle Holder, Olsen-Hegar.....	129, 255, 370, 538, 561
Needle Holder, Olsen-Hegar, Econo™.....	647
Needle Holder, Olsen-Hegar, Merit™.....	629
Needle Holder, Olsen-Hegar, Mid-Grade.....	629
Needle Holder, Olsen-Hegar, Sklarlite XD™.....	46
Needle Holder, Olsen-Hegar, Sklarlite™.....	46
Needle Holder, Olsen-Hegar, Surgi-OR™.....	621
Needle Holder, Olsen-Hegar, Surgi-OR™ TC.....	620
Needle Holder, Olsen-Hegar, TC.....	41, 134, 540, 565
Needle Holder, PAR, TC.....	40
Needle Holder, Ryder, TC.....	41, 133, 545, 562, 566, 580
Needle Holder, Ryder, TC, Left.....	43, 136
Needle Holder, Sarot.....	129
Needle Holder, Sarot, TC.....	41, 134
Needle Holder, Semken, TC.....	568
Needle Holder, Stangel-Barraquer.....	131
Needle Holder, Sternal Wire Twister, TC.....	41, 166, 531, 580
Needle Holder, Stevens.....	130, 255, 271
Needle Holder, Stratte.....	370
Needle Holder, Stratte, TC.....	42, 134, 370
Needle Holder, Swedish, TC.....	42
Needle Holder, Troutman.....	254, 271
Needle Holder, Wangenstein, TC.....	42, 132
Needle Holder, Webster.....	128, 370, 538, 561
Needle Holder, Webster, Econo-Sterile™.....	659
Needle Holder, Webster, Econo™.....	647
Needle Holder, Webster, Merit™.....	629
Needle Holder, Webster, Mid-Grade.....	629
Needle Holder, Webster, Sklarlite XD™.....	45



Needle Holder, Webster, Sklarlite™	45	O'Brien Stitch Scissors	167	Oral Surgery Suction System	544
Needle Holder, Webster, Surgi-OR™	621	O'Connor Forceps	242	Orban Knife	600
Needle Holder, Webster, Surgi-OR™ TC	620	O'Connor Hook	226	Orthodontic Pliers	604-609
Needle Holder, Webster, TC	40, 132, 538, 540, 551, 558-559, 562, 565-566	O'Hanlon Clamp	88	Orthodontic Pliers, Mid-Grade	605
Needle Holder, Webster, TC, Left	43, 136	O'Ring, Kraton	470, 471, 542	Os Dilator Set, Disposable	454
Needle Nose Pliers	310, 348, 553	O'Rings, Pomeroy Syringe	185	Os Dilator, Disposable	454
Needle, Alvis, Foreign Body	223	O'Sullivan-O'Conner Vaginal Retractor	358	Oscillating Plaster Saw	314, 353
Needle, Deschamp	344	O'Sullivan-O'Conner Retractor	140, 574	Oscillating Plaster Saw Blade	314, 353
Needle, Deschamp	169, 560	O'Sullivan-O'Conner Retractor Blade	140	Oscillating Plaster Saw Wrench	314, 353
Needle, Dix	222	Obstetrical Forceps, Delee	381, 573	Osteotome Guard	707
Needle, Eye	165	Obstetrical Forceps, Dewey	382	Osteotome, Army	284
Needle, Ferguson	164	Obstetrical Forceps, Elliot	380	Osteotome, Capener	288
Needle, Fistula	163	Obstetrical Forceps, Hale	382	Osteotome, Cinelli	194, 549, 563
Needle, Foreign Body	223	Obstetrical Forceps, Kieland	380	Osteotome, Cottle	195, 549, 563
Needle, Heparin	577	Obstetrical Forceps, Kieland-Luikart	381	Osteotome, Hibbs	286, 553-554
Needle, Keith Abdominal	164	Obstetrical Forceps, Laufe Divergent	382, 572	Osteotome, Hoke	286, 340
Needle, Lane Cleft Palate	165	Obstetrical Forceps, Laufe-Piper	380	Osteotome, Lambotte	195, 285, 340, 565, 569
Needle, Laparoscopic	438, 442, 576	Obstetrical Forceps, Luikart	380	Osteotome, Lambotte Set	195, 285, 340
Needle, Martin's Uterine	164	Obstetrical Forceps, McLane-Tucker	381	Osteotome, Lambotte, Jr.	285, 340, 569
Needle, Mayo Cat Gut	164	Obstetrical Forceps, McLane-Tucker-Luikart	381, 572	Osteotome, Neivert-Anderson	563, 565
Needle, Mayo Intestinal	163	Obstetrical Forceps, Piper	380	Osteotome, Parkes	563
Needle, Murphy's Intestinal	164	Obstetrical Forceps, Simpson	381, 572	Osteotome, Rubin	563
Needle, Nelson Ligature	344, 493	Obstetrical Forceps, Simpson-Luikart	381, 572	Osteotome, Sheehan	287, 549, 564
Needle, Post Mortem	164-165	Obstetrical Set	572	Osteotome, Silver	194, 287, 563
Needle, Regular Surgeon	163	Obturator, Ives Speculum	470-471	Osteotome, Sklar	287
Needle, Veterinary	165	Obturator, Laparoscopic	432-433	Osteotome, Smith Peterson	284
Needle, Von Graefe Needle	220	Obturator, Laparoscopic Miniature	437	Osteotome, Stille	285
Needle, Ziegler Knife	221	Obwegeser Mandibular Awl	170	Osteotomes, Epker	194
Negus Forceps	481	Obwegeser Maxillary Awl	170	Otis Bougie A Boule	465
Neivert Knife Guard & Retractor	210, 549	Occluding Forceps, Johns Hopkins	127	Otis Dittel Urethral Sound	465
Neivert Needle Holder	255, 271	Ochsner Trocar	162, 574	Otoscope	177
Neivert Needle Holder, TC	40	OHL Periosteal Elevator	304, 331	Otoscope Set, Bruening	177
Neivert-Anderson Osteotome	563, 565	Ophthalmic Basket	690	Otoscope, Bruening	177
Nelson Ligature Needle	344, 493	Ointment Jar, Stainless Steel	684	Oval Biopsy Punch	390, 573
Nelson Trocar	162	Olivecrona Rongeur	276	Oval Biopsy Punch, Micro-Cut	386
Nerve Dissecting Scissors	560	Olsen-Hegar Needle Holder	129, 255, 370, 538, 561	Overholt Forceps	93, 483
Nerve Retractor, Vessel &	531	Olsen-Hegar Needle Holder, Econo™	647	Overholt Geissendoerfer Forceps	484
New Orleans Loop	225	Olsen-Hegar Needle Holder, Merit™	629		
New Orleans Needle Holder	129	Olsen-Hegar Needle Holder, Mid-Grade	629		
New Orleans Needle Holder, TC	41, 134	Olsen-Hegar Needle Holder, Sklarlite XD™	46		
New's Suture Scissors	168	Olsen-Hegar Needle Holder, Sklarlite™	46		
Newport Probe, Sklar Black™	399	Olsen-Hegar Needle Holder, Surgi-OR™	621		
News Hook	148, 544	Olsen-Hegar Needle Holder, Surgi-OR™ TC	620		
Nipper, Nail	323-324, 539	Olsen-Hegar Needle Holder, TC	41, 134, 540, 565		
Nipper, Nail, Merit™	633	One Step, Sklar Instru-Guard™	8, 721		
Nipper, Nail, Mycotic	324	Operating Scissors	47-48, 368, 540-541, 543, 553, 556, 560, 568, 570, 572		
Nipper, Tissue	325, 539-540	Operating Scissors, Econo-Sterile™	652		
Nipper, Tissue, Econo™	646	Operating Scissors, Econo™	635		
Nipper, Tissue, Merit™	633	Operating Scissors, Laparoscopic	422		
Nipper, Tissue, SklarLite™	39, 325	Operating Scissors, Merit™	625		
Non-Pinch College Pliers, Mid-Grade	604	Operating Scissors, Mid-Grade	625		
Novak Endometrial Curette	365, 571	Operating Scissors, Sklar Edge™ TC	19, 74		
Noyes Alligator Ear Forceps	550	Operating Scissors, Sklarcut™	27, 73		
Noyes Alligator Forceps	183	Operating Scissors, Sklarhone™	23, 76		
Noyes Forceps	190	Operating Scissors, Sklarlite XD™	31, 47, 48		
Nucleus Knife	329	Operating Scissors, Sklarlite™	31, 47, 48, 536-537, 540, 545, 562, 571		
Nugent Iris Hook	226	Operating Scissors, Sklarlite™ Sklarcut™	27, 73		
Nugent Rectus Forceps	250	Operating Scissors, Surgi-OR™	617		
Nugent Utility Forceps	247	Operating Scissors, Surgi-OR™ TC	616		
Nurses Bandage Scissors	66	Optical Pliers	608		
Nurses Stethoscope	675	OR Basin, Plastic	706		
		Oral Screw	198		

**P**

P.K. Thomas Wax Placer	590
P.K. Thomas Wax Placer Set	590
P.K. Thomas Wax Placer, Mid-Grade	590
Pacemaker Set	578
Pacific Grasper	320
Packer, Bone	289
Packer, Excavator	328
Packer, Probe	327
Pad, Instrument Spot Remover	712
PAR Needle Holder, TC	40
Parallel Pliers	169
Parametrium Scissors, TC Z-Type	21, 377, 459, 572
Park Guyton Eye Speculum	216
Parker Retractor	147, 541
Parkes Osteotome	563
Parkes Rasp	563
Partsch Mallet	563
Patent Ductus Clamp	501, 580
Patent Ductus Clamp, Cooley	523
Patent Ductus Forceps, DeBaKey	519
Paul Retractor	144
Payr Pylorus Clamp	92
Pea Gastro-Intestinal Forceps	88
Peanut Sponge Forceps	126

## ALPHABETICAL INDEX



Pederson Speculum, Econo™	650	Plaster Saw, Oscilating	314, 353	Pliers, Ligature	607
Pederson Vaginal Speculum	355, 570	Plaster Shears, Bruns	315	Pliers, Light Wire	607
Pederson Vaginal Speculum, Econo-Sterile™	660	Plaster Shears, Bruns, Merit™	624	Pliers, Lingual	606
Pederson Vaginal Speculum, Merit™	630	Plaster Shears, Seutin	315, 352	Pliers, Loop	607
Pederson Vaginal Speculum, Sklar Black™	394-395	Plaster Shears, Stille	316	Pliers, Mathieu	608-609
Pederson Vaginal Speculum, Sklar Blue™	402	Plaster Spreader, Beeson	317	Pliers, Meriam	604
Pederson Vaginal Speculum, Surgi-OR™	621	Plaster Spreader, Hennig	317, 353	Pliers, Needle Nose	310, 348, 553
Pediatric Stethoscope	674	Plaster Spreader, Merit™	630	Pliers, Optical	608
Peers Towel Clamp, Merit™	629	Plaster Spreader, Walton	317, 353	Pliers, Parallel	169
Peet (Cottle) Rasp	564	Plastic Emesis Basin	706	Pliers, Perry	604
Peet Splinter Forceps	533	Plastic Filling Instrument	589	Pliers, Perry, Mid-Grade	604
Pemberton Clamp	90	Plastic Graduated Measure Cup	705	Pliers, Posterior	606
Pencil Disposable, Electrosurgical	410	Plastic Guidewire Bowl	706	Pliers, Step	608
Penfield Dissector	305	Plastic Headband	679	Pliers, Stop	608
Penner Forceps	306	Plastic Instrument Soaking Tray	704	Pliers, Three Jaw	608
Pennington Clamp	104, 485, 543	Plastic Multi-Purpose Utility Bowl	705	Pliers, Three Prong	608
Pennington Elevator	568	Plastic OR Basin	706	Pliers, Torquing	608
Percy Retractor	308, 557	Plastic Pitcher	705	Pliers, Tweed & Helix	608
Perforator, Politzer Tympanum	183, 567	Plastic Procedure Tray	704	Pliers, Weingart	609
Perforator, Royce Tympanum	183	Plastic Round Basin	706	Pliers, Wire Bending	605
Periosteal Elevator, Salyer	568	Plastic Solution Basin	706	Pliers, Wire Bending, Mid-Grade	605
Periosteal, Elevator, Cottle	192	Plastic Specimen Tube	705	Pliers, Wire Extracting	349
Periosteal, Elevator, Joseph	192, 549, 563, 565	Plastic Speculum, Nasal	188	Pluggers, Andrews	582
Periosteal, Elevator, OHL	304, 331	Plastic Sponge/Utility Bowl	706	Pluggers, Back Action	582
Periosteal, Elevator, Sedillot	301	Plastic Surgery Retractor	148, 212	Pluggers, Behrman	582
Periosteotome, Alexander	302	Plastic Surgery Scissors	54	Pluggers, Black	582, 583
Peripheral Forceps, DeBakey	499, 500, 502	Plastic Surgery Scissors, Sklarcut™	29	Pluggers, Black, Mid-Grade	583
Peritoneal Scissors, Laparoscopic	422	Plastic Surgery Scissors, Sklarcut™ Gorney	29	PNA Forceps	335
Perkins Retractor	208	Plastic Surgery Scissors, Sklarhone™	24	Podi Bone File	332
Perrell Fetoscope	677	Plastic Surgery Set	562	Pole	714
Perry Pliers	604	Plastic Tray	703-704	Polish, Sklar Instrument	15, 727
Perry Pliers, Mid-Grade	604	Plate & Bone Forceps	297	Politzer Tympanum Perforator	183, 567
Perthes Bone Awl	312	Platypus Nail Forceps	326, 540	Polokoff Rasp	333
Pessaries	455	Platypus Nail Forceps, Merit™	626	Pomeroy Syringe	185
Phaneuf Uterine Artery Forceps	97, 375, 571, 573-574			Pomeroy Syringe O'Rings	185
Pick, Burch Fixation	226			Pomeroy Syringe Shield	185
Pick, Rosen	551			Pomeroy Syringe Tip	185
Pick, Vanguard Splinter	121, 532			Poole Suction Tube	154, 571
Piercing Forceps, Vasectomy	467			Post Mortem Needle	164-165
Piffard Curette	342, 535			Posterior Pliers	606
Pin & Ligature Wire Cutters	610			Potts-Smith Dressing	
Pin Chuck, Steinman	312			Forceps	114, 460, 493, 496, 579
Pin Cutter	309, 350			Potts-Smith Dressing Forceps, TC	34, 125, 571, 577
Pin Cutter, TC	309, 350, 580			Potts-Smith Forceps, Sklar Black™	400, 476
Pin Puller, TC	166			Potts-Smith Forceps, Sklar Blue™	408
Pin, Steinmann	313, 347			Potts-Smith Scissors	69, 528, 580
Pinard Fetoscope	677			Potts-Smith Scissors, Sklarhone™	26
Pinwheel, Wartenberg	678			Potts-Smith Tissue Forceps	114, 493, 496, 566
Pinwheel, Wartenberg, Merit™	632			Powder Detergent, Sklar Kleen™	11, 723
Piper Obstetrical Forceps	380			Pratt Clamp	104, 174, 466, 543, 570
Pitcher, Plastic	705			Pratt Crypt Hook	475
Pitcher/Beaker, Stainless Steel	680			Pratt Forceps	305
Placer, Wax, P.K. Thomas	590			Pratt Hook	543
Placer, Wax, P.K. Thomas, Mid-Grade	590			Pratt Probe	475
Plain Splinter Forceps	121, 532			Pratt Speculum	473, 543
Plain Splinter Forceps, Econo™	645			Pratt Uterine Dilator	364
Plain Splinter Forceps, Merit™	626			Precision Suture Scissors	65
Plain Splinter Forceps, Surgi-OR™	618			Precision Suture Scissors, Sklarlite XD™	33, 65
Plaster Knife, Murphy	314, 353			Precision Suture Scissors, Sklarlite™	33, 65
Plaster Knife, Reiner	316			Presbyterian Tube Occluding Clamp, Econo-Sterile™	658
Plaster Saw Blade, Oscilating	314, 353			Presbyterian Tube Occluding Clamp, Merit™	629
Plaster Saw Wrench, Oscilating	314, 353				
Plaster Saw, Engel	314				

## PLIERS

Pliers, Adams	607
Pliers, Arch	607
Pliers, Baade	605
Pliers, Baade, Mid-Grade	605
Pliers, Band	606
Pliers, Band Slitting	606
Pliers, Bayonet	608
Pliers, Bernard	607
Pliers, Bird Beak	608
Pliers, Bracket	606, 609
Pliers, Clasp Adjusting	605
Pliers, Clasp Adjusting, Mid-Grade	605
Pliers, College	603-604
Pliers, College, Mid-Grade	603-604
Pliers, Elastic	609
Pliers, Elastomeric	609
Pliers, Facebow	607
Pliers, Flat Nose	310, 348
Pliers, Gordon	605
Pliers, Gordon, Mid-Grade	605
Pliers, Goslee	605
Pliers, Goslee, Mid-Grade	605
Pliers, Hawley	607
Pliers, How	605
Pliers, How, Mid-Grade	605
Pliers, How, TC	604
Pliers, Jarabak	607





Presbyterian Tube Occluding Clamp,  
Surgi-OR™ ..... 620

Preston Forceps ..... 306

Prince Forceps ..... 119, 213, 250

Prince Trachoma Forceps ..... 252

Probe ..... 172, 536-538, 542, 558

Probe & Excavator, Merit™ ..... 631

Probe & Foreign Body Loop ..... 222

Probe & Foreign Body Remover ..... 222

Probe & Packer ..... 327

Probe & Spatula ..... 328

Probe, Bar Fistula ..... 172, 475

Probe, Bowman Lachrymal ..... 184, 230, 561

Probe, Buck Ear ..... 184

Probe, Castroviejo Lachrymal ..... 184

Probe, Circumcision ..... 466

Probe, Coded ..... 588

Probe, Dental, Merit™ ..... 632

Probe, Econo™ ..... 649

Probe, Graduated Laparoscopic ..... 438

Probe, Hook ..... 321

Probe, Larry, Rectal ..... 172, 475, 543

Probe, Merit™ ..... 632

Probe, Newport, Sklar Black™ ..... 399

Probe, Pratt ..... 475

Probe, Stacke Ear ..... 184

Probe, Surgi-OR™ ..... 622

Probe, Williams ..... 230, 588

Probe, Williams Lachrymal ..... 184

Procedure Tray, Plastic ..... 704

Protectors, SklarTip™ Instrument ..... 707

Providence Forceps ..... 85

Pryor-Pean Retractor ..... 151, 359

Puller, Pin, TC ..... 166

Puller, Wire ..... 310

Puller, Wire, TC ..... 310

Punch, Biopsy, Laparoscopic ..... 430

Punch, Hartman Tonsil ..... 552

Punch, Hartmann ..... 180

Punch, Hartmann (Moshier) ..... 205

Punch, Keyes Cutaneous, Merit™ ..... 631

Punch, Laparoscopic, Miniature ..... 436

Punch, Rubber Dam ..... 603

Punch, Tru-Punch™ Disposable Biopsy ..... 458

Punches, Schmeden ..... 205

Pusher, Akers ..... 228

Putti Rasp ..... 292, 554, 557

**Q**

Quimby Scissors ..... 60

Quire Instrument ..... 183

**R**

Rabiner Hammer ..... 678

Rabiner Hammer, Merit™ ..... 632

Rack, Brush Drying ..... 712

Rack, Instrument, Stainless Steel ..... 695

Radical Vulvectomy Set ..... 574

Ragnell Retractor ..... 143, 212, 565

Ragnell Scissors ..... 62, 544-545, 559, 562, 565-566

Ragnell Scissors, Sklarcut™ ..... 29, 72

Ragnell Scissors, Sklarhone™ ..... 24

Ragnell Scissors, Sklarite™ Sklarcut™ ..... 29, 72

Ragnell-Kilner Scissors, TC ..... 569

Ramplay Sponge Forceps ..... 126

Randall Endometrial Biopsy Curette ..... 365

Randall Forceps ..... 176

Randell Forceps ..... 89

Rankin Crile Forceps, Econo™ ..... 639

Rankin Forceps ..... 84

Rankin Kelly Forceps, Merit™ ..... 628

Rankin Kelly Forceps, Surgi-OR™ ..... 619

Rasp, Aufricht ..... 196, 549, 563

Rasp, Cottle ..... 197, 291, 334

Rasp, Fomon ..... 197, 291, 334, 563, 565

Rasp, Joseph ..... 197, 291, 334, 540, 549, 563

Rasp, Lewis ..... 196, 291, 334

Rasp, Maltz ..... 197, 291, 334, 549, 563

Rasp, Maltz, TC ..... 197, 334, 549

Rasp, Parkes ..... 563

Rasp, Peet (Cottle) ..... 564

Rasp, Polokoff ..... 333

Rasp, Putti ..... 292, 554, 557

Rasp, Wiener ..... 563

Raspatory, Alexander ..... 489, 579

Raspatory, Doyen ..... 489, 579

Raspatory, Farbeuf ..... 302

Raspatory, Kirmission ..... 301

Raspatory, Mathieu ..... 301

Raspatory, Semb ..... 489

Razor Blade ..... 223

Recamier Uterine Curette ..... 366

Rechargeable Laryngoscope Battery ..... 160

Rectal Surgery Set ..... 543

Reducer, Laparoscopic ..... 433

Reeh Stitch Scissors ..... 168

Regular Surgeon Needle ..... 163

Rein Curette ..... 535

Reiner Plaster Knife ..... 316

Removal Kit, Splinter, Merit™ ..... 631

Remover, Bailey Foreign Body ..... 222

Remover, Blade ..... 667

Renal Clamp ..... 525

**RETRACTORS**

Retractor & Dissector, Hurd ..... 200

Retractor Blade, Balfour ..... 139

Retractor Blade, O'Sullivan-O'Connor ..... 140

Retractor Sawyer ..... 473

Retractor, Adson ..... 138

Retractor, Adson-Beckman ..... 137

Retractor, Allport ..... 551

Retractor, Alm ..... 138, 207, 545, 559, 562, 577

Retractor, Alm, Merit™ ..... 630

Retractor, Anderson-Adson ..... 560

Retractor, Ankeney Sternal ..... 581

Retractor, Army, Merit™ ..... 630

Retractor, Aufranc Cobra ..... 299

Retractor, Aufricht ..... 146, 207, 548, 564

Retractor, Balfour ..... 139, 537, 541, 579

Retractor, Barr ..... 473

Retractor, Beckman Eaton ..... 282

Retractor, Beckman-Adson ..... 282, 556

Retractor, Beckman-Eaton ..... 208

Retractor, Bennett ..... 300

Retractor, Blair-Roll ..... 149, 538, 558, 577

Retractor, Blount ..... 300, 555

Retractor, Brantley-Turner Vaginal ..... 151, 359

Retractor, Breisky ..... 359

Retractor, Brewster ..... 146

Retractor, Cheek ..... 201, 613

Retractor, Cheek, Mid-Grade ..... 613

Retractor, Cheek, University of Minnesota ..... 201, 613

Retractor, Cheek, University of Minnesota,  
Mid-Grade ..... 613

Retractor, Colver ..... 200

Retractor, Converse ..... 147, 209-210, 563-564

Retractor, Converse Alar ..... 549

Retractor, Cooley ..... 531

Retractor, Cottle ..... 209, 549, 563

Retractor, Cottle, & Knife Guard ..... 209

Retractor, Crile ..... 147, 545, 562, 567

Retractor, Cushing ..... 143, 201, 492, 542, 558,  
567, 574, 578-580

Retractor, Cushing, Merit™ ..... 630

Retractor, Davidson Spatula ..... 153, 491, 579

Retractor, Deaver ..... 145, 536, 561, 566, 573

Retractor, Delee ..... 151, 359

Retractor, Dermal ..... 148, 209

Retractor, Desmarres ..... 144, 211, 218, 544-547,  
549, 558, 565, 577

Retractor, Desmarres, Sklar Black™ ..... 398

Retractor, Doyen Abdominal ..... 151-152, 359

Retractor, Eastman ..... 152, 571-572

Retractor, Esophagus Laparoscopic ..... 439, 442, 575

Retractor, Fan Laparoscopic ..... 439

Retractor, Farbeuf ..... 147

Retractor, Farbeuf, Baby ..... 560

Retractor, Farr ..... 219

Retractor, Fomon ..... 149, 209, 549, 563, 568

Retractor, Foss ..... 153

Retractor, Freeman ..... 559

Retractor, Fritch ..... 151, 561

Retractor, Gelpi ..... 137, 554

Retractor, Gelpi, Econo™ ..... 648

Retractor, Gelpi, Merit™ ..... 630

Retractor, Goelet ..... 147, 201, 537

Retractor, Goldstein ..... 138, 207, 219, 270

Retractor, Gosset ..... 139, 488

Retractor, Graether Iris ..... 256

Retractor, Green ..... 143, 581

Retractor, Haight-Finocchio ..... 141, 488

Retractor, Harrington ..... 153, 491

Retractor, Hays ..... 299

Retractor, Heaney ..... 146

Retractor, Henly ..... 137

Retractor, Hernia ..... 142

Retractor, Hibbs ..... 153, 491, 554

Retractor, Holzheimer ..... 138, 207, 538

Retractor, Hupp ..... 148

Retractor, Hurd Dissector and Pillar ..... 552

Retractor, Inge ..... 153, 298, 349

Retractor, Jackson ..... 148

Retractor, Jackson Vaginal ..... 358, 570, 573

Retractor, Jackson Vaginal, Sklar Black™ ..... 401

Retractor, Jackson Vaginal, Sklar Blue™ ..... 405

Retractor, Jaeger ..... 218

Retractor, Jansen ..... 138, 545, 550-551, 562

## ALPHABETICAL INDEX



- Retractor, Judd-Masson ..... 140, 467  
 Retractor, Kelly ..... 146, 575, 578-579  
 Retractor, Kirschner ..... 283  
 Retractor, Kocher-Langenbeck ..... 560  
 Retractor, Lahey ..... 144, 148, 492  
 Retractor, Langenbeck ..... 144, 492, 551  
 Retractor, Lateral Vaginal ..... 356  
 Retractor, Lateral Vaginal, Sklar Black™ ..... 396  
 Retractor, Lateral Vaginal, Sklar Blue™ ..... 405  
 Retractor, Lip ..... 201  
 Retractor, Lip, Columbia ..... 201  
 Retractor, Lip, Disposable ..... 614  
 Retractor, Little ..... 143  
 Retractor, Lothrop ..... 201  
 Retractor, Love ..... 211  
 Retractor, Love Uvula ..... 210, 552  
 Retractor, Lukens ..... 544  
 Retractor, Malianiac Nasal ..... 565  
 Retractor, Marx Breast ..... 560  
 Retractor, Mathieu ..... 142, 210  
 Retractor, Mayo Abdominal ..... 151  
 Retractor, Mayo-Adams ..... 138  
 Retractor, Mayo-Collin ..... 147  
 Retractor, McBurney ..... 143  
 Retractor, McGannon Iris ..... 210, 226  
 Retractor, Meller ..... 138, 207, 219, 270  
 Retractor, Meyerding ..... 145, 150, 283, 491, 559  
 Retractor, Miller Senn ..... 142  
 Retractor, Miller-Senn ..... 541, 545, 562, 567  
 Retractor, Neivert, & Knife Guard ..... 210  
 Retractor, O'Sullivan-O'Conner Vaginal ..... 358  
 Retractor, O'Sullivan-O'Connor ..... 140, 574  
 Retractor, Parker ..... 147, 541  
 Retractor, Paul ..... 144  
 Retractor, Percy ..... 308, 557  
 Retractor, Perkins ..... 208  
 Retractor, Plastic Surgery ..... 148, 212  
 Retractor, Pryor-Pean ..... 151, 359  
 Retractor, Ragnell ..... 143, 212, 565  
 Retractor, Richardson ..... 146, 536, 542, 558, 566, 575, 577-579  
 Retractor, Richardson-Eastman ..... 146, 536, 554, 581  
 Retractor, Rigby ..... 137  
 Retractor, Rizzuti Iris, & Lens Expressor ..... 218  
 Retractor, Roux ..... 147, 561  
 Retractor, Salyer Cleft Palate ..... 568  
 Retractor, Sawyer ..... 543  
 Retractor, Schuknecht ..... 208  
 Retractor, Scoville ..... 211  
 Retractor, Senn ..... 142, 212, 537-538, 542, 548, 551, 554-555, 557-558, 561, 566-567, 577  
 Retractor, Senn, Econo™ ..... 648  
 Retractor, Senn, Merit™ ..... 630  
 Retractor, Senn, Surgi-OR™ ..... 621  
 Retractor, Sims Vaginal ..... 152, 358  
 Retractor, Sims Vaginal, Sklar Blue™ ..... 405  
 Retractor, Sims-Kelly ..... 152, 358  
 Retractor, Stevenson ..... 219  
 Retractor, Taylor ..... 301  
 Retractor, Temple-Ray ..... 140  
 Retractor, Tracheal ..... 148  
 Retractor, US Army ..... 146, 536-537, 542, 548, 555, 557, 559, 561, 566-567, 575, 577-579, 581  
 Retractor, Vessel & Nerve ..... 531  
 Retractor, Volkman ..... 142, 542, 554, 555, 557-558, 561, 578  
 Retractor, Weitlaner ..... 137, 544, 553-556, 558, 574, 577-578, 580-581  
 Retractor, Weitlaner-Beckman ..... 137, 208, 282, 553  
 Retractor, Weitlaner-Paparella ..... 208  
 Retractor, Weitlaner, Econo™ ..... 648  
 Retractor, Weitlaner, Merit™ ..... 630  
 Retractor, Wire Retaining ..... 138, 207  
 Retractor, Wullstein ..... 208  
 Retractor, Wullstein Endaural ..... 550  
 Retractor, Yancoskie ..... 559  
 Retractor, Young ..... 144, 467  
 Retractor, Zalkind ..... 491  
 Retractor, Zalkind Lung ..... 145  
 Retractor, Zalkind Ribbon ..... 145, 200, 536-537, 541, 545, 561-562, 579  
 Retriever, Buck-Gramcko ..... 306  
 Retrograde Knife ..... 321  
 Reynolds Scissors ..... 60, 545, 562, 567  
 Rhoton Forceps ..... 266  
 Rhytidectomy Scissors ..... 61, 566  
 Rhytidectomy Scissors, Sklarcut™ ..... 30  
 Rhytidectomy/Facelift Set ..... 566  
 Rib Cutter, Giertz-Stille ..... 490  
 Rib Retractor, Haight-Finocchio ..... 141  
 Rib Shears, Collins ..... 490  
 Rib Shears, Dale ..... 275  
 Rib Shears, Stille ..... 490  
 Rib Spreader, Burford-Finocchio ..... 140-141  
 Rib Spreader, Finocchio ..... 141  
 Rib Spreader, Harken ..... 140  
 Rib Spreader, Tuffier ..... 141, 487  
 Ribbon Iris Scissors ..... 59, 238  
 Ribbon Stevens Scissors ..... 59, 238  
 Ribbon Stitch Scissors ..... 59, 168, 238  
 Ribbon Strabismus Scissors ..... 59  
 Ribbon Utility Scissors ..... 59  
 Richardson Retractor ..... 146, 536, 542, 558, 566, 575, 577, 578, 579  
 Richardson-Eastman Retractor ..... 146, 536, 554, 581  
 Rigby Retractor ..... 137  
 Ring Curette ..... 321  
 Ring Cutter Blade, Merit™ ..... 631  
 Ring Cutter, Merit™ ..... 631  
 Ring Pessary ..... 455  
 Ring, Flieringa Casanova ..... 217  
 Ring, Flieringa Fixation ..... 217  
 Ring, Flieringa-LeGrand Fixation ..... 217  
 Ring, McNeil-Goldman Fixation ..... 217  
 Rizzuti Iris Retractor & Lens Expressor ..... 218  
 Roach Carver ..... 592  
 Roach Porcelain and Wax Carver, Mid-Grade ..... 592  
 Roberts Forceps ..... 480  
 Rochester Ochsner Forceps, Econo-Sterile™ ..... 655  
 Rochester Ochsner Forceps, Econo™ ..... 639  
 Rochester Pean Forceps, Econo-Sterile™ ..... 655  
 Rochester Pean Forceps, Econo™ ..... 639  
 Rochester-Carmalt Forceps ..... 84  
 Rochester-Carmalt Forceps, Merit™ ..... 628  
 Rochester-Ochsner Forceps ..... 84, 536, 541, 543, 554-555, 557-558, 560-561, 566, 570, 572-574, 577-578, 580  
 Rochester-Ochsner Forceps, Econo™ ..... 639  
 Rochester-Ochsner Forceps, Merit™ ..... 628  
 Rochester-Ochsner Forceps, Sklarlite XD™ ..... 38  
 Rochester-Ochsner Forceps, Sklarlite™ ..... 38, 84  
 Rochester-Ochsner Forceps, Surgi-OR™ ..... 619  
 Rochester-Pean Forceps ..... 83, 461, 536, 541, 543-544, 552-554, 557-558, 560, 570, 572, 574, 577-578, 580  
 Rochester-Pean Forceps, Merit™ ..... 628  
 Rochester-Pean Forceps, Sklar Black™ ..... 400  
 Rochester-Pean Forceps, Sklarlite XD™ ..... 38, 83  
 Rochester-Pean Forceps, Sklarlite™ ..... 38, 83  
 Rochester-Pean Forceps, Surgi-OR™ ..... 619, 620  
 Roeder Towel Clamp ..... 127  
 Rongeur, Adson ..... 276  
 Rongeur, Bacon ..... 276  
 Rongeur, Beyer ..... 275-276, 553-554, 557, 568  
 Rongeur, Blumenthal ..... 277, 337, 613  
 Rongeur, Bone ..... 276  
 Rongeur, Citelli ..... 195  
 Rongeur, Cleveland ..... 337-338, 613  
 Rongeur, Colclough ..... 278  
 Rongeur, Cushing ..... 279  
 Rongeur, Dean ..... 275  
 Rongeur, Echlin ..... 273  
 Rongeur, Ferris Smith ..... 280  
 Rongeur, Friedman ..... 277, 338  
 Rongeur, Hartman ..... 276  
 Rongeur, Kerrison ..... 195  
 Rongeur, Kleinert-Kutz ..... 274  
 Rongeur, Leksell ..... 273, 556-557  
 Rongeur, Lempert ..... 275, 337  
 Rongeur, Love-Gruenwald ..... 279, 556  
 Rongeur, Love-Kerrison ..... 556  
 Rongeur, Love-Kerrison-Schlesinger-Colclough ..... 277  
 Rongeur, Luer ..... 275, 556  
 Rongeur, Mead ..... 277, 338  
 Rongeur, Olivecrona ..... 276  
 Rongeur, Ruskin ..... 274, 338, 553  
 Rongeur, Schlesinger ..... 278  
 Rongeur, Smith-Petersen ..... 273  
 Rongeur, Spurling ..... 279  
 Rongeur, Stille ..... 274  
 Rongeur, Stille-Luer ..... 273, 554, 556-557  
 Rongeur, Stille-Luer Echlin ..... 274  
 Rongeur, Wilde ..... 281  
 Rongeur, Zaufel Jansen ..... 274, 338  
 Rongeur, Zielke ..... 281  
 Rosen Knife Curette ..... 551  
 Rosen Pick ..... 551  
 Rosette Knife ..... 321  
 Rotator, Bechert ..... 229  
 Roux Retractor ..... 147, 561  
 Rowland Bone Forceps ..... 272, 335  
 Royce Tympanum Perforator ..... 183  
 Rubber Dam Forceps, University of Washington ..... 603  
 Rubber Dam Forceps, University of Washington, Mid-Grade ..... 603  
 Rubber Dam Punch ..... 603  
 Rubin Forceps ..... 564-565  
 Rubin Osteotome ..... 563  
 Rudd Clinic Ligator ..... 470, 542



Rudd Clinic Ligator Cone..... 470  
 Rudd Clinic Ligator Set..... 470, 542  
 Ruedemann Dilator..... 230  
 Ruler, Sklar Black™ Depth..... 399  
 Ruler, Steel..... 213, 236, 257, 549, 553-554,  
 559-561, 565-566, 679  
 Rumel Thoracic Forceps..... 503  
 Rumel Tourniquet..... 494  
 Rush Mallet..... 339  
 Ruskin Rongeur..... 274, 338, 553  
 Ruskin-Liston Bone Forceps..... 272, 336  
 Russian Tissue Forceps..... 113, 536, 554, 570,  
 572-574, 579  
 Russian Tissue Forceps, Econo™..... 644  
 Russian Tissue Forceps, Merit™..... 626  
 Russian Tissue Forceps, Surgi-OR™..... 618  
 Ryder Needle Holder, TC..... 41, 133, 545, 562,  
 566, 580  
 Ryder Needle Holder, TC, Left..... 43, 136

**S**

S-Retractor, Laparoscopic..... 433  
 Safety Scalpel, SklarSafe™..... 669  
 Salyer Cleft Palate Retractor..... 568  
 Salyer Periosteal Elevator..... 568  
 Santinsky Scissors..... 494  
 Santulli Bulldog Clamp..... 517  
 Sarot Forceps..... 461  
 Sarot Needle Holder..... 129  
 Sarot Needle Holder, TC..... 41, 134  
 Satinsky Clamp..... 506  
 Satinsky Scissors..... 69  
 Satterlee Bone Saw..... 307  
 Sauer Eye Speculum..... 215  
 Sauer Suture Forceps..... 247  
 Saw Blade, Charriere Bone..... 307  
 Saw Blade, Oscillating..... 314, 353  
 Saw Guide, Bailey Gigli Bone..... 308  
 Saw Guide, Joseph Bone..... 308  
 Saw Handles, Gigli Bone..... 273, 308, 556-557  
 Saw Wire, Gigli Bone..... 308  
 Saw Wrench, Oscillating..... 314, 353  
 Saw, Charriere Bone..... 307  
 Saw, Engel Plaster..... 314  
 Saw, Joseph Bone..... 193, 307, 343  
 Saw, Joseph Nasal..... 549, 564-565  
 Saw, Langenbeck Bone..... 308, 343  
 Saw, Oscillating Plaster..... 314, 353  
 Saw, Oscillating Plaster..... 314, 353  
 Saw, Satterlee Bone..... 307  
 Sawtell Applicator..... 186  
 Sawtell Forceps..... 206, 482  
 Sawyer Retractor..... 473, 543  
 Sayre Elevator..... 304, 331, 553  
 Scaler, Crane Kaplan..... 597  
 Scaler, Goldman-Fox..... 597  
 Scaler, Jacqueline..... 598  
 Scaler, Taylor..... 597  
 Scaler, Towner..... 597  
 Scaler, Universal..... 599  
 Scaler, Younger Good..... 599  
 Scalpel Blade..... 670  
 Scalpel Handle..... 546-547, 670

Scalpel Handle, Merit™..... 633  
 Scalpel Handle, Surgi-OR™..... 622  
 Scalpel, Disposable..... 39, 668  
 Scalpel, Handle..... 536-541, 543-548, 550-562,  
 565-566, 568, 570, 573-575, 577-578, 580-581, 667  
 Scalpel, Mini Thumb..... 670  
 Scalpel, SklarSafe™ Safety..... 669  
 Schaedel Towel Clamp..... 123  
 Schamberg Comedone Extractor..... 534  
 Schink Dermatome..... 568  
 Schiötz Tonometer..... 258  
 Schlesinger Rongeur..... 278  
 Schmeden Punches..... 205  
 Schnidt Tonsil Forceps..... 206, 482, 537, 542,  
 549, 552, 561, 573, 579  
 Schnidt Tonsil Forceps, Econo™..... 640  
 Schnidt Tonsil Forceps, Merit™..... 628  
 Schnidt Tonsil Forceps, Surgi-OR™..... 620  
 Schroeder Tenaculum  
 Forceps..... 99, 372, 570-571, 573-575  
 Schroeder Tenaculum Forceps,  
 Econo-Sterile™..... 657  
 Schroeder Tenaculum Forceps, Econo™..... 640  
 Schroeder Tenaculum Forceps, Merit™..... 628  
 Schroeder Tenaculum Forceps, Sklar Black™..... 399  
 Schroeder Tenaculum Forceps, Sklar Blue™..... 407  
 Schroeder Tenaculum Forceps, Surgi-OR™..... 620  
 Schroeder Vulsellum Forceps..... 100, 378  
 Schroeder Vulsellum Forceps, Sklar Black™..... 399  
 Schubert Biopsy Punch..... 392  
 Schuknecht Retractor..... 208  
 Schumacher Umbilical Scissors..... 68  
 Schweizer Forceps..... 94, 248, 373, 571  
 Schweizer Forceps, Econo™..... 640  
 Schweizer Forceps, Merit™..... 628  
 Schweizer Forceps, Sklar Black™..... 400  
 Schweizer Forceps, Sklar Blue™..... 407  
 Schweizer Forceps, Surgi-OR™..... 620  
 Scissor, Boettcher..... 205  
 Scissor, Kaye..... 58

**SCISSORS**

Scissors, Aebli Corneal..... 232  
 Scissors, Alligator Ear..... 181  
 Scissors, Army Gauze, Merit™..... 624  
 Scissors, Arthroscopic..... 319  
 Scissors, Aufrecht..... 61  
 Scissors, Bantam Bandage..... 67  
 Scissors, Barraquer-Dewecker Iris..... 235, 264  
 Scissors, Biro..... 70  
 Scissors, Blepharoplasty..... 59, 566  
 Scissors, Blepharoplasty, Sklar Edge™ TC..... 21  
 Scissors, Bonn Iris..... 59  
 Scissors, Braun Episiotomy..... 69, 572  
 Scissors, Braun Epistomy, Econo™..... 638  
 Scissors, Braun Epistomy, Merit™..... 624  
 Scissors, Braun Epistomy, Surgi-OR™..... 616  
 Scissors, Brophy..... 369  
 Scissors, Brown..... 61  
 Scissors, Buck Suture..... 562  
 Scissors, Busch Umbilical..... 69  
 Scissors, Caplan..... 563  
 Scissors, Castanares..... 61

Scissors, Castanares, Sklarcut™..... 30, 566  
 Scissors, Castroviejo Corneal..... 71, 232, 263, 545-546  
 Scissors, Cinelli..... 564  
 Scissors, Commander Utility..... 67, 315, 352  
 Scissors, Cottle..... 61  
 Scissors, Cottle Dorsal..... 61, 549  
 Scissors, Cottle Dorsal, Sklar Edge™ TC..... 562  
 Scissors, Cottle, Sklarcut™..... 30  
 Scissors, Crown..... 68, 169, 351  
 Scissors, Cuticle Nail, Merit™..... 624  
 Scissors, Dean..... 70, 568  
 Scissors, Deaver..... 49  
 Scissors, DeBaKey..... 529-530, 577  
 Scissors, DeBaKey Endarterectomy..... 531  
 Scissors, Diethrich..... 529  
 Scissors, Dissecting, Sklar Edge™ TC..... 20, 75  
 Scissors, Doyen..... 53, 369, 469  
 Scissors, Dura..... 54  
 Scissors, Econo-Sterile™, Wireform..... 661  
 Scissors, Enterotome..... 69, 469  
 Scissors, Enucleation..... 63, 547  
 Scissors, Ferguson..... 68  
 Scissors, Finochietto..... 69, 494  
 Scissors, Fomon..... 61, 549, 564, 568  
 Scissors, Fomon Lateral, Sklarcut™..... 30  
 Scissors, Goldman-Fox..... 60, 561  
 Scissors, Goldman-Fox, Sklar Edge™ TC..... 20, 562  
 Scissors, Goldman-Fox, Sklarcut™..... 28  
 Scissors, Goldman-Fox, Sklarhone™..... 25  
 Scissors, Gorney..... 61  
 Scissors, Gorney Face Lift, Sklarcut™..... 30  
 Scissors, Gorney Plastic Surgery, Sklarcut™..... 29  
 Scissors, Gorney Plastic Surgery,  
 Sklarhone™..... 25, 559  
 Scissors, Gradle..... 168, 238, 265, 544, 546  
 Scissors, Gradle, Merit™..... 624  
 Scissors, Gradle, Sklarcut™..... 29  
 Scissors, Gradle, Sklarhone™..... 25  
 Scissors, Haimovici..... 70  
 Scissors, Harrington-Mayo..... 50, 369, 468, 494  
 Scissors, Heath..... 68, 168  
 Scissors, Hercules Utility..... 315, 352  
 Scissors, Hi-Level..... 66  
 Scissors, Hi-Level Bandage, Sklarhone™..... 26  
 Scissors, Hill..... 62  
 Scissors, Incision..... 66  
 Scissors, Iris..... 54-56, 235-236, 539, 544-547,  
 549-550, 559, 561, 567-568  
 Scissors, Iris Micro Mini..... 235, 263, 546  
 Scissors, Iris, Econo-Sterile™..... 652  
 Scissors, Iris, Econo™..... 636  
 Scissors, Iris, Merit™..... 624  
 Scissors, Iris, Mid-Grade..... 624  
 Scissors, Iris, Sklar Edge™ TC..... 19, 75, 559  
 Scissors, Iris, Sklarcut™..... 27, 73, 558, 560, 565-566  
 Scissors, Iris, Sklarhone™..... 23, 77  
 Scissors, Iris, Sklarhone™ TC..... 22  
 Scissors, Iris, Sklarlite XD™..... 32, 56, 236, 567  
 Scissors, Iris, Sklarlite™..... 32, 55, 236  
 Scissors, Iris, Sklarlite™ Sklarcut™..... 27, 73  
 Scissors, Iris, Surgi-OR™..... 616  
 Scissors, Iris, Surgi-OR™ TC..... 616  
 Scissors, Jabaley..... 560  
 Scissors, Jabaley, Sklarhone™ Supercut..... 560

## ALPHABETICAL INDEX



Scissors, Jacobson.....	71	Scissors, McClure Iris.....	70, 238, 265	Scissors, Rhytidectomy.....	61, 566
Scissors, Jameson, Sklarhone™.....	26	Scissors, McGuire Corneal.....	232	Scissors, Rhytidectomy, Sklarcut™.....	30
Scissors, Jorgenson.....	52, 459, 574	Scissors, McPherson Vannas.....	71, 237, 263, 547	Scissors, Ribbon Utility.....	59
Scissors, Joseph.....	60, 548	Scissors, Metzenbaum.....	51-52, 369, 459, 468, 530, 536-537, 539, 541, 543-544, 547, 552, 554-556, 560-561, 564, 566, 568, 571, 573	Scissors, Ribbon Iris.....	59, 238
Scissors, Kaye.....	60	Scissors, Metzenbaum, Econo-Sterile™.....	652	Scissors, Ribbon Stevens.....	59, 238
Scissors, Kaye Dissecting, Sklar Edge™ TC.....	20	Scissors, Metzenbaum, Econo™.....	635	Scissors, Ribbon Stitch.....	59, 168, 238
Scissors, Kaye Face Lift, Sklarcut™.....	30	Scissors, Metzenbaum, Merit™.....	624	Scissors, Ribbon Strabismus.....	59
Scissors, Kelly-Adson.....	54, 369, 469	Scissors, Metzenbaum, Sklar Edge™ TC ...	19-20, 75, 538, 541, 548- 551, 557-558, 562, 566, 574-575, 577-578, 580-581	Scissors, Santinsky.....	494
Scissors, Kelly, Sklarcut™.....	30	Scissors, Metzenbaum, Sklarcut™.....	28, 73, 558	Scissors, Satinsky.....	69
Scissors, Kilner.....	560	Scissors, Metzenbaum, Sklarhone™.....	24, 77, 559, 572, 580	Scissors, Schumacher Umbilical.....	68
Scissors, Kleinert-Kutz Tenotomy.....	234	Scissors, Metzenbaum, Sklarlite™.....	24	Scissors, Sealy.....	238
Scissors, Knapp Iris.....	235	Scissors, Metzenbaum, Sklarhone™ Sklarlite™.....	24	Scissors, Seiler.....	62
Scissors, Knight.....	62, 564	Scissors, Metzenbaum, Sklarhone™ TC.....	22	Scissors, Shortbent Suture, Sklarlite XD™.....	33, 64
Scissors, Knowles Bandage.....	67, 540	Scissors, Metzenbaum, Sklarlite XD™.....	31-32, 51-52	Scissors, Shortbent Suture, Sklarlite™.....	33, 64, 167, 237
Scissors, Knowles Bandage, Econo-Sterile™.....	653	Scissors, Metzenbaum, Sklarlite™.....	31-32, 51-52, 567	Scissors, Sims.....	54, 469
Scissors, Knowles Bandage, Econo™.....	636	Scissors, Metzenbaum, Sklarcut™.....	28, 73, 545, 562	Scissors, Sistrunk, Dissecting.....	62
Scissors, Knowles Bandage, Merit™.....	624	Scissors, Metzenbaum, Surgi-OR™.....	617	Scissors, Sklar.....	49
Scissors, Knowles Bandage, Surgi-OR™.....	616	Scissors, Metzenbaum, Surgi-OR™ TC.....	616	Scissors, Sklar Nail.....	68, 325
Scissors, Lagrange.....	62	Scissors, Micro.....	261-262	Scissors, Spencer Stitch.....	63, 167, 237, 543-544, 566
Scissors, Laparoscopic.....	422-423, 442, 575-576	Scissors, Micro Bellucci.....	182, 552	Scissors, Spencer Stitch, Econo-Sterile™.....	653
Scissors, Laparoscopic, Disposable.....	447-448	Scissors, Micro Surgery.....	265	Scissors, Spencer Stitch, Econo™.....	636
Scissors, Laparoscopic, Miniature.....	435-436	Scissors, Micro-Grip.....	262	Scissors, Spencer Stitch, Mid-Grade.....	625
Scissors, Laparoscopic, Single Port.....	421	Scissors, Miller.....	60, 70, 475	Scissors, Spencer Stitch, Sklarlite XD™.....	33, 63
Scissors, Lexer.....	52	Scissors, Mixter.....	59	Scissors, Spencer Stitch, Sklarlite™.....	33, 63, 237, 540
Scissors, Lexer Baby.....	52	Scissors, MoleSkin.....	67, 352	Scissors, Spencer Stitch, Surgi-OR™.....	617
Scissors, Lexer, Sklar Edge™ TC.....	20	Scissors, Nail Splitting.....	68, 326	Scissors, Stevens.....	58, 234, 538-539, 545-547, 558, 561, 565-566, 569, 577
Scissors, Lister Bandage.....	66, 538, 540, 553, 555	Scissors, Nail Splitting, Merit™.....	624	Scissors, Stevens Tenotomy, Econo™.....	637
Scissors, Lister Bandage, Econo-Sterile™.....	653	Scissors, Nerve Dissecting.....	560	Scissors, Stevens Tenotomy, Sklar Edge™ TC.....	21
Scissors, Lister Bandage, Econo™.....	636	Scissors, Nurses Bandage.....	66	Scissors, Stevens, Merit™.....	625
Scissors, Lister Bandage, Merit™.....	624	Scissors, Operating.....	47-48, 368, 540-541, 543, 553, 556, 560, 568, 570, 572	Scissors, Stevens, Sklarcut™.....	27
Scissors, Lister Bandage, Mid-Grade.....	624	Scissors, Operating, Econo-Sterile™.....	652	Scissors, Stevens, Sklarhone™.....	25, 559
Scissors, Lister Bandage, Sklarhone™.....	26	Scissors, Operating, Econo™.....	635	Scissors, Stevens, Sklarhone™ TC.....	22
Scissors, Lister Bandage, Sklarlite XD™.....	33, 66	Scissors, Operating, Merit™.....	625	Scissors, Stevens, Sklarlite XD™.....	32, 58, 234
Scissors, Lister Bandage, Sklarlite™.....	33, 66	Scissors, Operating, Mid-Grade.....	625	Scissors, Stevens, Sklarlite™.....	32, 58, 234, 536
Scissors, Lister Bandage, Surgi-OR™.....	616	Scissors, Operating, Sklar Edge™ TC.....	19, 74	Scissors, Stevens, Surgi-OR™.....	617
Scissors, Littauer Stitch.....	63, 167, 237, 540, 553	Scissors, Operating, Sklarcut™.....	27, 73	Scissors, Stitch.....	64, 167, 237, 265
Scissors, Littauer Stitch, Econo™.....	636	Scissors, Operating, Sklarhone™.....	23, 76	Scissors, Stitch, Long.....	167
Scissors, Littauer Stitch, Mid-Grade.....	625	Scissors, Operating, Sklarlite XD™.....	31, 47-48	Scissors, Stitch, O'Brien.....	167
Scissors, Littauer Stitch, Surgi-OR™.....	617	Scissors, Operating, Sklarlite™.....	31, 47-48, 536-537, 540, 545, 562, 571	Scissors, Stitch, Reeh.....	168
Scissors, Littauer Suture, Econo-Sterile™.....	653	Scissors, Operating, Sklarlite™ Sklarcut™.....	27, 73	Scissors, Strabismus.....	57, 239, 549-551, 568
Scissors, Martin.....	60, 555	Scissors, Operating, Surgi-OR™.....	617	Scissors, Strabismus, Econo-Sterile™.....	653
Scissors, Mayo.....	50, 369, 459, 468, 494, 536-538, 543-544, 547, 551-556, 559, 561, 571-573	Scissors, Operating, Surgi-OR™ TC.....	616	Scissors, Strabismus, Merit™.....	625
Scissors, Mayo Sklarhone™ TC.....	22	Scissors, Operating, Surgi-OR™ TC.....	616	Scissors, Strabismus, Sklar Edge™ TC.....	20, 75
Scissors, Mayo-Noble.....	53, 468	Scissors, Plastic Surgery.....	54	Scissors, Strabismus, Sklarlite XD™.....	32, 57, 239
Scissors, Mayo-Noble-Stille.....	53	Scissors, Plastic Surgery, Sklarcut™.....	29	Scissors, Strabismus, Sklarlite™.....	32, 57, 239, 545, 562
Scissors, Mayo-Stille.....	53, 369, 468	Scissors, Plastic Surgery, Sklarhone™.....	24	Scissors, Strabismus, Surgi-OR™.....	617
Scissors, Mayo-Stille, Sklar Edge™ TC.....	19, 74	Scissors, Potts-Smith.....	69, 528, 580	Scissors, Strabismus, Surgi-OR™ TC.....	616
Scissors, Mayo-Stille, Sklarhone™ TC.....	22	Scissors, Potts-Smith, Sklarhone™.....	26	Scissors, Suture.....	63-64, 167, 169, 237, 351, 544
Scissors, Mayo, Econo-Sterile™.....	652	Scissors, Precision Suture.....	65	Scissors, Suture Wire.....	68
Scissors, Mayo, Econo™.....	635	Scissors, Precision Suture, Sklarlite XD™.....	33, 65	Scissors, Suture, Econo™.....	637
Scissors, Mayo, Merit™.....	624	Scissors, Precision Suture, Sklarlite™.....	33, 65	Scissors, Suture, Littler.....	168
Scissors, Mayo, Mid-Grade.....	624	Scissors, Quimby.....	60	Scissors, Suture, Merit™.....	625
Scissors, Mayo, Sklar Edge™ TC.....	19, 74, 538, 541, 548, 550, 557-558, 562, 566, 572, 574-575, 577-578, 580	Scissors, Ragnell.....	62, 544-545, 559, 562, 565-566	Scissors, Suture, New's.....	168
Scissors, Mayo, Sklarcut™.....	27, 73, 558	Scissors, Ragnell-Kilner, TC.....	569	Scissors, Suture, Surgi-OR™.....	617
Scissors, Mayo, Sklarhone™.....	23, 77	Scissors, Ragnell, Sklarcut™.....	29, 72	Scissors, Taylor.....	62
Scissors, Mayo, Sklarlite XD™.....	31, 50, 567	Scissors, Ragnell, Sklarhone™.....	24	Scissors, TC Z-Type Parametrium ...	21, 377, 459, 572
Scissors, Mayo, Sklarlite™.....	31, 50, 468, 537, 545, 562	Scissors, Ragnell, Sklarlite™ Sklarcut™.....	29, 72	Scissors, Thorek.....	70, 174
Scissors, Mayo, Surgi-OR™.....	616-617	Scissors, Reynolds.....	60, 545, 562, 567	Scissors, Umbilical.....	69
Scissors, Mayo, Surgi-OR™ TC.....	616			Scissors, Umbilical, Merit™.....	625

Scissors, Utility, Econo-Sterile™	654	Sesamoid Clamp	298, 346	Set, Keyes Skin Biopsy	363, 534
Scissors, Utility, Econo™	637			Set, Knee	555
Scissors, Utility, Merit™	625			Set, Lachrymal Probe, Bowman	184
Scissors, Utility, Surgi-OR™	617			Set, Lambotte Osteotome	195, 285, 340
Scissors, Vannas	70, 237, 263, 546			Set, Laminectomy	556
Scissors, Wagner	49, 545, 548, 562			Set, Lap Appendectomy	442
Scissors, Wagner, Sklarlite™ Sklarcut™	29, 72			Set, Lap Bowel Resection	442
Scissors, Waldmann	69			Set, Laparoscopic	442, 575-576
Scissors, Wescott	71, 169, 233, 264, 546-547, 577			Set, Laparoscopic Trocar, Miniature	437
Scissors, Wilmer	62, 238, 264, 546			Set, Laryngoscope, Disposable	161
Scissors, Wire Cutting	68, 169, 309, 351, 550-551			Set, Laryngoscope, Macintosh, F.O.	161
Scissors, Wire Cutting, Econo-Sterile™	653			Set, Laryngoscope, Miller, F.O.	161
Scissors, Wire Cutting, Econo™	636			Set, Major Basic Surgery	536
Scissors, Wire Cutting, Mid-Grade	625			Set, Major Nasal	549
Scissors, Wire Cutting, Sklar Edge™ TC	21, 75, 166, 309, 351, 540, 553, 566			Set, Major Plastic Sugery	558
Scissors, Wire Cutting, Surgi-OR™	617			Set, Major Rhinoplasty	562
Scissors, Wire Cutting, Surgi-OR™ TC	616			Set, Mammoplasty	560
Scissors, Wagner, Sklarcut™	28, 72			Set, Mammoplasty II	560
				Set, Mastectomy	541
				Set, Mayo-Collin Retractor	147
Scleral Fixation Hook	229			Set, McGivney Ligator	471, 542
Scoop, Desjardin	174			Set, Middle Ear	551
Scoop, Ferguson	175			Set, Minor Basic Surgery	537
Scoop, Knapp	225			Set, Myringotomy	567
Scoop, Lab/Utility, Stainless Steel	683			Set, Obstetrical	572
Scoop, Mayo	175			Set, Os Dilator, Disposable	454
Scoop, Mayo Common Duct	174			Set, Otis Bougie A Boule	465
Scoville Retractor	211			Set, Otis Dittel Urethral Sound	465
Screw Driver	312			Set, Otoscope, Bruening	177
Screw Driver, Lane	347			Set, P.K. Thomas Wax Placer	590
Screw, Oral	198			Set, Pacemaker	578
Scudder Forceps	91			Set, Plastic Surgery	562
Sealy Scissors	238			Set, Pratt Uterine Dilator	364
Sedillot Periosteal Elevator	301			Set, Radical Vulvectomy	574
Segond (Collin) Forceps	99, 378-379			Set, Rectal Surgery	543
Segond Vaginal Spatula	359			Set, Rhytidectomy/Facelift	566
Segund Vaginal Spatula, Sklar Blue™	405			Set, Roux Retractor	147
Seiler Scissors	62			Set, Rudd Clinic Ligator	470, 542
Seldin Elevator	304, 602			Set, Sims Uterine Curette	367
Self-Locking College Pliers, Mid-Grade	603			Set, Skin Graft	568
Self-Retaining Bone Forceps	296			Set, Small Gynecological Biopsy	573
Selman Forceps	493			Set, Speculum, Boucheron Ear	177
Selman Tissue Forceps	114			Set, Speculum, Farrior Ear	177
Semb Bone Forceps	296			Set, Speculum, Gruber Ear	177
Semb Forceps	93, 492			Set, Speculum, Toynbee Ear	177
Semb Raspatory	489			Set, Suture Removal	543
Semken Needle Holder, TC	568			Set, Thomas Uterine Curette	367
Semken Tissue Forceps, TC Micro	568			Set, Thoractomy I	578
Semkin Bipolar Forceps, Electrosurgical	419			Set, Thoractomy II	579
Semkin Dressing Forceps	113, 541, 545, 559-560, 562, 567			Set, TMJ Surgery	568
Semkin Dressing Forceps, Econo™	644			Set, Tonsil	552
Semkin Forceps, Merit™	626			Set, Toynbee Ear Speculum	177
Semkin Tissue Forceps	113, 541, 545, 559-560, 562, 567			Set, Tracheotomy	544
Senn Retractor	142, 212, 537-538, 542, 548, 551, 554-555, 557-558, 561, 566-567, 577			Set, Trocar	162
Senn Retractor, Econo™	648			Set, Tru-Punch™ Disposable Biopsy Punch	458
Senn Retractor, Merit™	630			Set, Tuning Fork	185
Senn Retractor, Surgi-OR™	621			Set, Van Buren Sound	464
Separator, Benson Pylorus	92			Set, Van Buren Urethral Sound	464
Septum Knife, Freer	191, 565			Set, Vasectomy	467
Septum, Elevator, Cottle	564			Set, Vein	581
				Set, Walther Dilator	362
				Set, Wilson Vasectomy	543
				Seutin Plaster Shears	315, 352

## SETS

Set, Abdominoplasty	559
Set, Akers	601
Set, Amputation	557
Set, Appendectomy	576
Set, AV Fistula	577
Set, Band	442, 575
Set, Basic Dermal Excision	539
Set, Basic Dermal Instrument	538
Set, Basic Ear	550
Set, Basic Eye Surgery	545
Set, Basic Hand Surgery	566
Set, Basic Nail	539
Set, Basic Nasal	548
Set, Basic Open Heart	580
Set, Basic Orthopedic Surgery	553
Set, Basic Plastic Surgery	559
Set, Basic Podiatry	540
Set, Basic Tissue Dissection	544
Set, Basic Total Hip	554
Set, Blehparoplasty	565
Set, Boucheron Ear Speculum	177
Set, Bowel Resection	576
Set, Breast Augmentation/Reduction	561
Set, Brush, Cleaning	713, 714
Set, Cataract Surgery	546
Set, Cesarean Section	573
Set, Chalazion	547
Set, Cholecystectomy	442, 576
Set, Cleft Palate	569
Set, Colposcopy	573
Set, D&C	570
Set, Delivery Room Tubal Ligation	575
Set, Dilator	363
Set, Dittel Urethral Sound	465
Set, Emmett Hook	150, 361
Set, Emmett Hook, Sklar Black™	398
Set, Emmett Hook, Sklar Blue™	409
Set, Endometrial Sampling, Disposable	457
Set, ENT	550
Set, Enucleation	547
Set, Evans	601
Set, Eye Prep	547
Set, Farabeuf Retractor	147
Set, Garrett Dilator	577
Set, Gruber Ear Speculum	177
Set, Gruber Rhinoplasty	565
Set, Gynecological Abdominal	574
Set, Gynecological Biopsy	571
Set, Gynecological Surgery	570
Set, Gynecological X-Long	572
Set, Hank Uterine Dilator	364, 571
Set, Hegar Uterine Dilator	364, 570
Set, Hegar Uterine Dilator, Merit™	630
Set, Hysterectomy	573
Set, Infant Laparotomy	541
Set, Instrument Holder	702
Set, Iris Hook	150, 361
Set, Iris Hook, Sklar Black™	398
Set, Iris Hook, Sklar Blue™	409
Set, Jackson Tracheotomy Tube	157

## ALPHABETICAL INDEX



Shallcross Forceps.....	88, 173
Shamberg Comedone Extractor.....	538
Shamberg Comedone Extractor, Merit™.....	631
Shamburg Comedone Extractor, Econo™.....	649
Shamburg Comedone Extractor, Surgi-OR™.....	622
Shapleigh Curette.....	178, 550
Sharpening Stone, Biopsy Punch.....	363, 534
Shave Prep Tray.....	666
Shaver, Nail.....	328, 540
Shea Speculum Holder.....	178
Shears, Bethune.....	490, 579
Shears, Bruns Plaster.....	315, 352
Shears, Bruns Plaster, Merit™.....	624
Shears, Bruns Plaster, TC.....	315, 352
Shears, Collins.....	490
Shears, Coryllos.....	490
Shears, Dale Rib.....	275
Shears, Esmarch Plaster.....	352
Shears, First Aid, Merit™.....	624
Shears, Gluck.....	490
Shears, Seutin Plaster.....	315, 352
Shears, Stille.....	490
Shears, Stille Plaster.....	316
Shears, Utility, Econo™.....	637-638
Sheehan Osteotome.....	287, 549, 564
Shepards Crook Hook.....	150
Shephard Forceps.....	253
Shield, Ear Syringe, Merit™.....	632
Shield, Eye, Disposable.....	257
Shield, Fox, Eye.....	257, 546
Shield, Tongue, Disposable.....	614
Shortbent Suture Scissors, Sklarlite XD™.....	33, 64
Shortbent Suture Scissors, Sklarlite™.....	33, 64, 167, 237
Silicon Mat, SklarLite™.....	697-699
Silver Osteotome.....	194, 287, 563
Simcoe Cannula.....	256
Simcoe Nucleus Forceps.....	244
Simcoe Nucleus Loop.....	225
Simpson Obstetrical Forceps.....	381, 572
Simpson Sound, Merit™.....	630
Simpson Uterine Sound.....	363, 571
Simpson Uterine Sound, Econo™.....	649
Simpson-Luikart Obstetrical Forceps.....	381, 572
Sims Scissors.....	54, 469
Sims Speculum.....	473
Sims Uterine Curette.....	367, 570, 571, 574
Sims Uterine Sound.....	363, 570
Sims Uterine Sound, Merit™.....	630
Sims Vaginal Retractor.....	152, 358
Sims Vaginal Retractor, Sklar Blue™.....	405
Sims-Kelly Retractor.....	152, 358
Single Port Laparoscopic Electrode.....	421
Single Port Laparoscopic Forceps.....	421
Single Port Laparoscopic Needle Holder.....	420
Single Port Laparoscopic Scissors.....	421
Single Port Laparoscopic Suction Irrigation.....	420
Single Port Laparoscopic Trocar.....	420
Singley Forceps.....	113, 572
Singley Forceps, Sklar Black™.....	400
Singley Forceps, Sklar Blue™.....	408
Sinskey Hook.....	228
Sinskey Iris Hook.....	227
Sistrunk Dissecting Scissors.....	62
Skeelee Curette.....	227
Skene Tenaculum Forceps.....	100
Skid, Meyerding.....	299
Skid, Murphy-Lane.....	299
Skin Graft Set.....	568
Skin Hook.....	150
Skin Hook, Freer.....	564
Skin Marker, Surgical.....	658

<b>SKLAR BLACK™</b>	
Sklar Black™ Adson Dressing Forceps.....	400
Sklar Black™ Allis Tissue Forceps.....	400, 476
Sklar Black™ Auvard Vaginal Speculum.....	396
Sklar Black™ Babcock Forceps.....	399, 476
Sklar Black™ Bozeman Forceps.....	399
Sklar Black™ Campion Forceps.....	399
Sklar Black™ Castroviejo Forceps.....	400
Sklar Black™ Clemetson Forceps.....	401
Sklar Black™ Collin Vaginal Speculum.....	396
Sklar Black™ Cottle Septal Speculum.....	548-549
Sklar Black™ DeBaKey Forceps.....	400
Sklar Black™ DeLee Uterine Forceps.....	401
Sklar Black™ Depth Ruler.....	399
Sklar Black™ Desmarres Retractor.....	398
Sklar Black™ Dressing Forceps.....	110
Sklar Black™ Emmett Hook.....	398
Sklar Black™ Freeway Graves Vaginal Speculum.....	395
Sklar Black™ Gillies Hook.....	565
Sklar Black™ Graves Vaginal Speculum.....	393, 395
Sklar Black™ Guthrie Hook.....	398
Sklar Black™ Heaney Needle Holder.....	401
Sklar Black™ Iris Hook.....	398
Sklar Black™ Jackson Vaginal Retractor.....	401
Sklar Black™ Joseph Hook.....	398
Sklar Black™ Kogan Endocervical Speculum.....	397
Sklar Black™ Lateral Vaginal Retractor.....	396
Sklar Black™ Laufe Uterine Polyp Forceps.....	401
Sklar Black™ Mayo-Hegar Needle Holder.....	401
Sklar Black™ Newport Probe.....	399
Sklar Black™ Pederson Vaginal Speculum.....	394-395
Sklar Black™ Potts-Smith Forceps.....	400, 476
Sklar Black™ Rochester-Pean Forceps.....	400
Sklar Black™ Schroeder Tenaculum Forceps.....	399
Sklar Black™ Schroeder Vulsellum Forceps.....	399
Sklar Black™ Schweizer Forceps.....	400
Sklar Black™ Singley Forceps.....	400
Sklar Black™ Steiner-Auvard Vaginal Speculum.....	396
Sklar Black™ Tissue Forceps.....	111
Sklar Black™ Tuttle Forceps.....	400, 476

<b>SKLAR BLUE™</b>	
Sklar Blue™ Adson Forceps.....	408
Sklar Blue™ Allis Tissue Forceps.....	407
Sklar Blue™ Auvard Vaginal Speculum.....	404
Sklar Blue™ Babcock Forceps.....	407
Sklar Blue™ Bozeman Forceps.....	408
Sklar Blue™ Clemetson Forceps.....	407
Sklar Blue™ Collin Vaginal Speculum.....	404
Sklar Blue™ Cusco Vaginal Speculum.....	403
Sklar Blue™ Dressing Forceps.....	408
Sklar Blue™ Emmett Hook.....	409
Sklar Blue™ Freeway Graves Vaginal Speculum.....	403
Sklar Blue™ Graves Vaginal Speculum.....	402-403
Sklar Blue™ Iris Hook.....	409
Sklar Blue™ Jackson Vaginal Retractor.....	405
Sklar Blue™ Kogan Endocervical Speculum.....	406
Sklar Blue™ Lateral Vaginal Retractor.....	405
Sklar Blue™ Laufe Uterine Polyp Forceps.....	407
Sklar Blue™ Pederson Vaginal Speculum.....	402
Sklar Blue™ Potts-Smith Forceps.....	408
Sklar Blue™ Schroeder Tenaculum Forceps.....	407
Sklar Blue™ Schweizer Forceps.....	407
Sklar Blue™ Segund Vaginal Spatula.....	405
Sklar Blue™ Sims Vaginal Retractor.....	405
Sklar Blue™ Singley Forceps.....	408
Sklar Blue™ Steiner-Auvard Vaginal Speculum.....	404
Sklar Blue™ Tauber Vaginal Spatula.....	405
Sklar Blue™ Tuttle Forceps.....	408
Sklar Clip Applying Forceps.....	93
Sklar Disinfectant.....	5, 289, 332, 388, 717
Sklar Edge™ TC Blepharoplasty Scissors.....	21
Sklar Edge™ TC Cottle Dorsal Scissors.....	562
Sklar Edge™ TC Dissecting Scissors.....	20, 75
Sklar Edge™ TC Fomon Dorsal Scissors.....	562
Sklar Edge™ TC Goldman-Fox Scissors.....	20, 562
Sklar Edge™ TC Iris Scissors.....	19, 75, 559
Sklar Edge™ TC Kaye Dissecting Scissors.....	20
Sklar Edge™ TC Lexer Scissors.....	20
Sklar Edge™ TC Mayo Scissors.....	19, 74, 538, 541, 548, 550, 557-558, 562, 566, 572, 574-575, 577-578, 580
Sklar Edge™ TC Mayo-Stille Scissors.....	19, 74
Sklar Edge™ TC Metzenbaum Scissors.....	19-20, 75, 538, 541, 548-551, 557-558, 562, 566, 574-575, 577-578, 580-581
Sklar Edge™ TC Operating Scissors.....	19, 74
Sklar Edge™ TC Stevens Tenotomy Scissors.....	21
Sklar Edge™ TC Strabismus Scissors.....	20, 75
Sklar Edge™ TC Wire Cutting Scissors.....	21, 75, 166, 309, 351, 540, 553, 566
Sklar Enzymatic™ Detergent.....	13, 725
Sklar Face Mask.....	258
Sklar Finger Ring Cutter.....	535
Sklar Finger Ring Cutter Blade.....	535
Sklar Forceps.....	310, 348
Sklar Headband.....	199
Sklar Hemorrhoidal Forceps.....	470-471
Sklar Hook.....	150
Sklar ID Roll Tape.....	708
Sklar Instru-Guard™ Lube.....	10, 722
Sklar Instru-Guard™ One Step.....	9, 721
Sklar Instrument Care Kit.....	16, 728
Sklar Instrument Polish.....	15, 727
Sklar Kleen™ Liquid Detergent.....	11, 723
Sklar Kleen™ Low Foam Detergent.....	11, 723
Sklar Kleen™ Powder Detergent.....	11, 723
Sklar Littauer Forceps.....	323
Sklar Mallet.....	290, 339, 549
Sklar Nail Drill.....	535
Sklar Nail Drill Points.....	535
Sklar Nail Scissors.....	68, 325
Sklar Osteotome.....	287
Sklar Scissors.....	49



Sklar Sheen™ Foam Spray ..... 12, 724  
 Sklar Soak™ ..... 5, 233, 344, 533, 717  
 Sklar Spray-Zyme™ ..... 8, 530, 720  
 Sklar Surface Wipes Disinfectant ..... 7, 200, 349, 392, 654, 684, 719  
 Sklar Thoracic Clamp ..... 93, 492  
 Sklar Towel Clamp ..... 104  
 Sklar-Allis Forceps ..... 101  
 Sklar-Cide™ ..... 4, 716  
 Sklar-Taper™ Littauer Forceps ..... 323

**SKLARCUT™**

Sklarcut™ Castanares Scissors ..... 30, 566  
 Sklarcut™ Cottle Scissors ..... 30  
 Sklarcut™ Fomon Lateral Scissors ..... 30  
 Sklarcut™ Goldman-Fox Scissors ..... 28  
 Sklarcut™ Gorney Face Lift Scissors ..... 30  
 Sklarcut™ Gorney Plastic Surgery Scissors ..... 29  
 Sklarcut™ Gradle Scissors ..... 29  
 Sklarcut™ Iris Scissors ..... 27, 73, 558, 560, 565-566  
 Sklarcut™ Iris Scissors, Sklarlite™ ..... 27, 73  
 Sklarcut™ Kaye Face Lift Scissors ..... 30  
 Sklarcut™ Kelly Scissors ..... 30  
 Sklarcut™ Mayo Scissors ..... 27, 73, 558  
 Sklarcut™ Mayo Scissors, Sklarlite™ ..... 28, 73  
 Sklarcut™ Metzenbaum Scissors ..... 28, 73, 558  
 Sklarcut™ Metzenbaum Scissors, Sklarlite™ ..... 28, 73, 545, 562  
 Sklarcut™ Operating Scissors ..... 27, 73  
 Sklarcut™ Operating Scissors, Sklarlite™ ..... 27, 73  
 Sklarcut™ Plastic Surgery Scissors ..... 29  
 Sklarcut™ Ragnell Scissors ..... 29, 72  
 Sklarcut™ Ragnell Scissors, Sklarlite™ ..... 29, 72  
 Sklarcut™ Rhytidectomy Scissors ..... 30  
 Sklarcut™ Stevens Scissors ..... 27  
 Sklarcut™ Wagner Scissors ..... 28, 72  
 Sklarcut™ Wagner Scissors, Sklarlite™ ..... 29, 72

**SKLARHONE™**

Sklarhone™ Goldman-Fox Scissors ..... 25  
 Sklarhone™ Gorney Plastic Surgery Scissors ..... 25, 559  
 Sklarhone™ Gradle Scissors ..... 25  
 Sklarhone™ Hi-Level Bandage Scissors ..... 26  
 Sklarhone™ Iris Scissors ..... 23, 77  
 Sklarhone™ Jabaley Scissors, Supercut ..... 560  
 Sklarhone™ Jameson Scissors ..... 26  
 Sklarhone™ Lister Bandage Scissors ..... 26  
 Sklarhone™ Mayo Scissors ..... 23, 77  
 Sklarhone™ Metzenbaum Scissors ..... 24, 77, 559, 572, 580  
 Sklarhone™ Operating Scissors ..... 23, 76  
 Sklarhone™ Plastic Surgery Scissors ..... 24  
 Sklarhone™ Potts-Smith Scissors ..... 26  
 Sklarhone™ Ragnell Scissors ..... 24  
 Sklarhone™ Sklarlite™ Metzenbaum Scissors ..... 24  
 Sklarhone™ Stevens Scissors ..... 25, 559  
 Sklarhone™ TC Iris Scissors ..... 22  
 Sklarhone™ TC Mayo Scissors ..... 22  
 Sklarhone™ TC Mayo-Stille Scissors ..... 22

Sklarhone™ TC Metzenbaum Scissors ..... 22  
 Sklarhone™ TC Stevens Scissors ..... 22

**SKLARLITE™**

SklarLite™ Accessories ..... 698  
 Sklarlite™ Adson Dressing Forceps ..... 36, 106, 567  
 Sklarlite™ Adson Tissue Forceps ..... 36, 106, 540, 567  
 Sklarlite™ Adson-Brown Tissue Forceps ..... 36, 106, 567  
 Sklarlite™ Allis Tissue Forceps ..... 38, 102, 345, 567  
 Sklarlite™ Baumgartner Needle Holder ..... 46  
 Sklarlite™ Crile Forceps ..... 37, 80, 540  
 Sklarlite™ Crile-Wood Needle Holder ..... 46  
 Sklarlite™ Derf Needle Holder ..... 45  
 Sklarlite™ Dressing Forceps ..... 36, 110  
 Sklarlite™ Halsey Needle Holder ..... 45  
 Sklarlite™ Halsted Mosquito Forceps ..... 37, 78, 567  
 Sklarlite™ Hartmann Mosquito Forceps ..... 37, 82, 567  
 Sklarlite™ Iris Scissors ..... 32, 55, 236  
 Sklarlite™ Kelly Forceps ..... 37, 81  
 Sklarlite™ Lister Bandage Scissors ..... 33, 66  
 Sklarlite™ Littauer Forceps ..... 39, 322  
 Sklarlite™ Mayo Scissors ..... 31, 50, 468, 537, 545, 562  
 Sklarlite™ Mayo-Hegar Needle Holder ..... 46  
 Sklarlite™ Metzenbaum Scissors ..... 31-32, 51-52, 567  
 Sklarlite™ Metzenbaum Scissors, Sklarhone™ ..... 24  
 Sklarlite™ Mixer Forceps ..... 38, 86  
 Sklarlite™ Nail Forceps ..... 326  
 Sklarlite™ Nail Splitting Forceps ..... 39  
 Sklarlite™ Olsen-Hegar Needle Holder ..... 46  
 Sklarlite™ Operating Scissors ..... 31, 47-48, 536-537, 540, 545, 562, 571  
 Sklarlite™ Precision Suture Scissors ..... 33, 65  
 Sklarlite™ Rochester-Ochsner Forceps ..... 38, 84  
 Sklarlite™ Rochester-Pean Forceps ..... 38, 83  
 Sklarlite™ Shortbent Suture Scissors ..... 33, 64, 167, 237  
 SklarLite™ Silicon Mat ..... 697-699  
 Sklarlite™ Sklarcut™ Iris Scissors ..... 27, 73  
 Sklarlite™ Sklarcut™ Mayo Scissors ..... 28, 73  
 Sklarlite™ Sklarcut™ Metzenbaum Scissors ..... 28, 73, 545, 562  
 Sklarlite™ Sklarcut™ Operating Scissors ..... 27, 73  
 Sklarlite™ Sklarcut™ Ragnell Scissors ..... 29, 72  
 Sklarlite™ Sklarcut™ Wagner Scissors ..... 29, 72  
 Sklarlite™ Spencer Stitch Scissors ..... 33, 63, 237, 540  
 SklarLite™ Sterilization Basket ..... 574, 697-699  
 SklarLite™ Sterilization Container ..... 574, 697-699  
 Sklarlite™ Stevens Scissors ..... 32, 58, 234, 536  
 Sklarlite™ Strabismus Scissors ..... 32, 57, 239, 545, 562  
 Sklarlite™ Tissue Forceps ..... 36, 111  
 SklarLite™ Tissue Nipper ..... 39, 325  
 Sklarlite™ Webster Needle Holder ..... 45

**SKLARLITE XD™**

Sklarlite XD™ Adson Dressing Forceps ..... 36, 107  
 Sklarlite XD™ Adson Tissue Forceps ..... 36, 107  
 Sklarlite XD™ Adson-Brown Tissue Forceps ..... 36, 107

Sklarlite XD™ Allis Tissue Forceps ..... 38, 103, 567  
 Sklarlite XD™ Baumgartner Needle Holder ..... 46  
 Sklarlite XD™ Crile Forceps ..... 37, 80, 545, 562  
 Sklarlite XD™ Crile-Wood Needle Holder ..... 46  
 Sklarlite XD™ Derf Needle Holder ..... 45  
 Sklarlite XD™ Dressing Forceps ..... 36, 110  
 Sklarlite XD™ Halsey Needle Holder ..... 45  
 Sklarlite XD™ Halsted Mosquito Forceps ..... 37, 79, 546  
 Sklarlite XD™ Hartmann Mosquito Forceps ..... 37, 82  
 Sklarlite XD™ Iris Scissors ..... 32, 56, 236, 567  
 Sklarlite XD™ Kelly Forceps ..... 37, 81  
 Sklarlite XD™ Lister Bandage Scissors ..... 33, 66  
 Sklarlite XD™ Mayo Scissors ..... 31, 50, 567  
 Sklarlite XD™ Mayo-Hegar Needle Holder ..... 46  
 Sklarlite XD™ Metzenbaum Scissors ..... 31-32, 51-52  
 Sklarlite XD™ Mixer Forceps ..... 38, 86, 558, 577-578, 580  
 Sklarlite XD™ Olsen-Hegar Needle Holder ..... 46  
 Sklarlite XD™ Operating Scissors ..... 31, 47-48  
 Sklarlite XD™ Precision Suture Scissors ..... 33, 65  
 Sklarlite XD™ Rochester-Ochsner Forceps ..... 38  
 Sklarlite XD™ Rochester-Pean Forceps ..... 38, 83  
 Sklarlite XD™ Shortbent Suture Scissors ..... 33, 64  
 Sklarlite XD™ Spencer Stitch Scissors ..... 33, 63  
 Sklarlite XD™ Stevens Scissors ..... 32, 58, 234  
 Sklarlite XD™ Strabismus Scissors ..... 32, 57, 239  
 Sklarlite XD™ Tissue Forceps ..... 36, 111  
 Sklarlite XD™ Webster Needle Holder ..... 45  
 SklarSafe™ Safety Scalpel ..... 669  
 SklarSpec™ Graves Vaginal Speculum Lighted, Disposable ..... 451  
 SklarSpec™ Graves Vaginal Speculum, Disposable ..... 450  
 SklarTip™ Instrument Protectors ..... 707  
 Small Gynecological Biopsy Set ..... 573  
 Smilie Knife ..... 321  
 Smilie Meniscus Hook ..... 301, 555  
 Smillie Knife ..... 306, 555  
 Smith Peterson Gouge ..... 284  
 Smith Peterson Osteotome ..... 284  
 Smith Special Instrument ..... 589  
 Smith-Fisher Spatula ..... 224  
 Smith-Petersen Rongeur ..... 273  
 Smoke Evacuation Tubing, Disposable ..... 395, 403  
 Snap Lock Wire Extractor ..... 310, 350  
 Snare Wires ..... 202  
 Snare Wires, Krause ..... 184, 191  
 Snare, Eves Tonsil ..... 202, 552  
 Snare, Krause Ear ..... 184  
 Snare, Tyding ..... 202  
 Snare, Tyding Tonsil ..... 552  
 Snares, Krause ..... 191  
 Snellen Entropium Forceps ..... 252  
 Snook Hook, Merit™ ..... 630  
 Solution Basin, Stainless Steel ..... 681  
 Solz Breast Dissector ..... 560  
 Somer Uterine Forceps ..... 375  
 Sonnenschein Speculum ..... 189  
 Sound Set, Khaki Roll ..... 464  
 Sound Set, Van Buren ..... 464  
 Sound, Dittel Urethral ..... 465  
 Sound, Merit™ Simpson ..... 630

## ALPHABETICAL INDEX



Sound, Merit™ Sims Uterine.....	630	Speculum, Eye, Murdock.....	214	Spencer Chalazion Forceps.....	251
Sound, Otis Dittel Urethral.....	465	Speculum, Eye, Park Guyton.....	216	Spencer Stitch Scissors.....	63, 167, 237, 543-544, 566
Sound, Simpson Uterine.....	363, 571	Speculum, Eye, Sauer.....	215	Spencer Stitch Scissors, Econo-Sterile™.....	653
Sound, Simpson Uterine, Econo™.....	649	Speculum, Eye, Weeks.....	216	Spencer Stitch Scissors, Econo™.....	636
Sound, Sims Uterine.....	363, 570	Speculum, Eye, Wiener.....	214	Spencer Stitch Scissors, Mid-Grade.....	625
Sound, Van Buren.....	464	Speculum, Eye, Ziegler.....	215	Spencer Stitch Scissors, Sklarlite XD™.....	33, 63
Spatula.....	327-328	Speculum, Farrior Ear.....	177, 552	Spencer Stitch Scissors, Sklarlite™.....	33, 63, 237, 540
Spatula & Packer.....	327	Speculum, Freeway Graves Vaginal.....	354	Spencer Stitch Scissors, Surgi-OR™.....	617
Spatula & Packer, Econo™.....	650	Speculum, Garrigue Vaginal.....	357	Spencer Wells Forceps.....	85
Spatula & Packer, Merit™.....	631	Speculum, Gerzog.....	189	Spinal Injection Tray.....	665
Spatula & Packer, Surgi-OR™.....	622	Speculum, Graves Vaginal.....	354-355, 570-571	Splinter Forceps.....	121, 532, 645
Spatula and Packer.....	540	Speculum, Graves Vaginal, Surgi-OR™.....	621	Splinter Forceps, Archer.....	533
Spatula Retractor, Davidson.....	153	Speculum, Graves, Econo™.....	650	Splinter Forceps, Carmalt.....	121, 532, 572
Spatula, Barraquer.....	224	Speculum, Gruber Ear.....	177, 567	Splinter Forceps, Carmalt, Merit™.....	626
Spatula, Castroviejo.....	224	Speculum, Gruber, Merit™.....	632	Splinter Forceps, Econo-Sterile™.....	657
Spatula, Castroviejo Cycloclialysis.....	546	Speculum, Hartmann.....	189	Splinter Forceps, Econo™.....	645
Spatula, Cement.....	594	Speculum, Henrotin Vaginal.....	357	Splinter Forceps, Feichenfeld.....	121, 532
Spatula, Cement, Agathe.....	594	Speculum, Hinkle-James.....	472	Splinter Forceps, Feilchenfeld, Merit™.....	626
Spatula, Cement, Mid-Grade.....	594	Speculum, Ives.....	470-471, 542	Splinter Forceps, Merit™.....	627
Spatula, Elschmig.....	224	Speculum, Killian.....	188, 548-549, 564-565	Splinter Forceps, Peet.....	533
Spatula, Green.....	224	Speculum, Knapp, Merit™.....	632	Splinter Forceps, Surgi-OR™.....	618
Spatula, McReynolds.....	224	Speculum, Kogan Endocervical.....	360, 570-571, 573	Splinter Forceps, Virtus.....	533
Spatula, Probe.....	328	Speculum, Merit™ Graves Vaginal.....	630	Splinter Forceps, Virtus, Merit™.....	627
Spatula, Segond Vaginal.....	359	Speculum, Merit™ Pederson Vaginal.....	630	Splinter Forceps, Williams.....	533
Spatula, Segund Vaginal, Sklar Blue™.....	405	Speculum, Nasal, Plastic.....	188	Splinter Liberator, Merit™.....	631
Spatula, Smith-Fisher.....	224	Speculum, Pederson Vaginal.....	355, 570	Splinter Pick, Vanguard.....	121, 532
Spatula, Tauber Vaginal.....	359	Speculum, Pederson Vaginal, Surgi-OR™.....	621	Splinter Removal Kit.....	121, 532
Spatula, Tauber Vaginal, Sklar Blue™.....	405	Speculum, Pederson, Econo™.....	650	Splinter Removal Kit, Merit™.....	631
Spatula, Wax.....	593	Speculum, Pratt.....	473, 543	Splitter, Nail.....	323, 329, 539
Spatula, Wax, Gritman.....	593	Speculum, Sims.....	473	Splitter, Nail, Merit™.....	633
Special Instrument, Smith.....	589	Speculum, Sklar Black™ Auvard Vaginal.....	396	Sponge Bowl, Stainless Steel.....	681
Specimen Tube, Plastic.....	705	Speculum, Sklar Black™ Collin Vaginal.....	396	Sponge Forceps, Ballenger.....	126
		Speculum, Sklar Black™ Freeway Graves		Sponge Forceps, Econo-Sterile™.....	658
		Vaginal.....	395	Sponge Forceps, Econo-Sterile™ Wireform.....	661
		Speculum, Sklar Black™ Graves Vaginal.....	393, 395	Sponge Forceps, Foerster.....	126
		Speculum, Sklar Black™ Kogan Endocervical.....	397	Sponge Forceps, Peanut.....	126
		Speculum, Sklar Black™ Pederson Vaginal.....	394, 395	Sponge Forceps, Rampley.....	126
		Speculum, Sklar Black™ Steiner-Auvard Vaginal.....	396	Sponge, Gauze.....	660
		Speculum, Sklar Blue™ Auvard Vaginal.....	404	Spoon.....	321
		Speculum, Sklar Blue™ Collin Vaginal.....	404	Spoon & Needle, Fisher.....	224
		Speculum, Sklar Blue™ Cusco Vaginal.....	403	Spoon Forceps, Laparoscopic.....	425, 442, 576
		Speculum, Sklar Blue™ Freeway Graves		Spoon, Akers.....	601
		Vaginal.....	403	Spoon, Bunge Evisceration.....	227, 547
		Speculum, Sklar Blue™ Graves Vaginal.....	402-403	Spoon, Evans.....	601
		Speculum, Sklar Blue™ Kogan Endocervical.....	406	Sprague Rappaport Stethoscope.....	671
		Speculum, Sklar Blue™ Pederson Vaginal.....	402	Spray, Foam, Sklar Sheen™.....	12, 724
		Speculum, Sklar Blue™ Steiner-Auvard Vaginal.....	404	Spreader, Beeson Plaster.....	317
		Speculum, SklarSpec™ Disposable Graves		Spreader, Burford-Finochietto.....	140-141, 487, 579
		Vaginal.....	450	Spreader, Cast, Merit™.....	630
		Speculum, SklarSpec™ Disposable Graves		Spreader, Finochietto.....	141, 487, 579, 581
		Vaginal Lighted.....	451	Spreader, Harken.....	140, 488
		Speculum, Sonnenschein.....	189	Spreader, Hennig Plaster.....	317, 353
		Speculum, Steiner Auvard Vaginal.....	357	Spreader, Plaster, Merit™.....	630
		Speculum, Thudichum.....	189	Spreader, Tuffier.....	141, 487
		Speculum, Tieck Halle.....	188, 564	Spreader, Walton Plaster.....	317, 353
		Speculum, Toynbee Ear.....	177	Spud, Dix.....	222
		Speculum, Vienna.....	188, 548, 550	Spud, Ellis Foreign Body.....	223
		Speculum, Vienna, Econo™.....	650	Spud, Foreign Body, Dix.....	222
		Speculum, Vienna, Merit™.....	633	Spud, Foreign Body, Francis.....	222
		Speculum, Williams.....	216	Spud, LaForce Foreign Body.....	222
		Speculum, Wire.....	215	Spurling Rongeur.....	279
		Speculum, Wire, Barraquer.....	214, 547	St. Vincent Tube Occluding Forceps, Merit™.....	629
		Speculum, Wire, Kratz-Barraquer.....	214	St. Vincent Tubing Forceps.....	126

## SPECULA

Speculum Holder, Shea.....	178
Speculum Set, Boucheron Ear.....	177
Speculum Set, Farrior Ear.....	177
Speculum Set, Gruber Ear.....	177
Speculum Set, Toynbee Ear.....	177
Speculum, Auvard Vaginal.....	356, 570-571
Speculum, Beckmann.....	189
Speculum, Berind-Auvard Vaginal.....	357
Speculum, Bodenhammer.....	473
Speculum, Boucheron Ear.....	177, 551, 567
Speculum, Brinckerhoff.....	472
Speculum, Castroviejo.....	216, 545-546
Speculum, Chelsea Eaton.....	472
Speculum, Collin Vaginal.....	355
Speculum, Cottle.....	188, 563
Speculum, Cottle Laser.....	188
Speculum, Cottle Septal, Sklar Black™.....	548-549
Speculum, Cusco Vaginal.....	355-356
Speculum, Devilbiss Vaginal.....	356
Speculum, Disposable.....	451
Speculum, Econo-Sterile™ Graves Vaginal.....	450, 660
Speculum, Econo-Sterile™ Pederson Vaginal.....	660
Speculum, Eye, Cook.....	214
Speculum, Eye, Knapp.....	215
Speculum, Eye, Lancaster.....	216, 545-547
Speculum, Eye, Maumenee Park.....	216, 546
Speculum, Eye, McPherson.....	215
Speculum, Eye, Mellinger.....	215





Stabismus Scissors, Merit™ ..... 625  
 Stacke Ear Probe ..... 184

**STAINLESS STEEL**

Stainless Steel Catheter Instrument Tray ..... 685  
 Stainless Steel Catheter Instrument Tray Cover ..... 685  
 Stainless Steel Catheter Instrument Tray,  
     Miniature ..... 684  
 Stainless Steel Cleaning Basket ..... 686  
 Stainless Steel Dressing Jar ..... 683  
 Stainless Steel Emesis Basin ..... 547, 561, 682  
 Stainless Steel Forceps Jar ..... 683, 712  
 Stainless Steel Funnel ..... 683  
 Stainless Steel Graduated Measure Cup ..... 681  
 Stainless Steel Hospital Bucket ..... 682  
 Stainless Steel Hospital Kick Bucket ..... 682  
 Stainless Steel Instrument Drying Tray ..... 686  
 Stainless Steel Instrument Rack ..... 695  
 Stainless Steel Instrument  
     Stringer ..... 536, 574, 694-695  
 Stainless Steel Instrument Tray ..... 687  
 Stainless Steel Instrument Tray Cover ..... 687, 688  
 Stainless Steel Iodine Cup ..... 538, 547, 560, 680  
 Stainless Steel Lab/Utility Scoop ..... 683  
 Stainless Steel Lifting Handles ..... 693  
 Stainless Steel Mayo Tray ..... 547, 685  
 Stainless Steel Medicine Cup ..... 538, 547, 577, 680  
 Stainless Steel Micro Sterilization Tray ..... 693  
 Stainless Steel Micro Sterilization Tray Cover ..... 693  
 Stainless Steel Mixing/Solution Bowl ..... 681  
 Stainless Steel Ointment Jar ..... 684  
 Stainless Steel Pitcher/Beaker ..... 680  
 Stainless Steel Solution Basin ..... 681  
 Stainless Steel Sponge Bowl ..... 681  
 Stainless Steel Sterilization Tray ..... 688, 693  
 Stainless Steel Sterilization Tray Cover ..... 688  
 Stainless Steel Sterilization Tray Handle ..... 693  
 Stainless Steel Sterilization/Bath Set Tray ..... 688  
 Stainless Steel Sterilizing Tray ..... 687-688  
 Stainless Steel Storage Container ..... 682  
 Stainless Steel Tumbler ..... 680  
  
 Stangel-Barraquer Needle Holder ..... 131  
 Staude-Moore Tenaculum  
     Forceps ..... 105, 372, 574-575  
 Steel Mallet ..... 290  
 Steel Ruler ..... 213, 257, 536, 549, 553-554,  
     559-561, 565-566, 679  
 Steiner Auvard Vaginal Speculum ..... 357  
 Steiner-Auvard Vaginal Speculum, Sklar Black™ ..... 396  
 Steiner-Auvard Vaginal Speculum, Sklar Blue™ ..... 404  
 Steinman Pin Chuck ..... 312  
 Steinmann Pin ..... 313, 347  
 Step Pliers ..... 608  
 Sterilization Basket, SklarLite™ ..... 574, 697- 699  
 Sterilization Cassette ..... 700-702  
 Sterilization Container, SklarLite™ ..... 574, 697-699  
 Sterilization Forceps ..... 127  
 Sterilization Tray Cover, Stainless Steel ..... 688  
 Sterilization Tray Handle, Stainless Steel ..... 693  
 Sterilization Tray, Stainless Steel ..... 688, 693  
 Sterilization/Bath Set Tray, Stainless Steel ..... 688  
 Sterilizer Forceps, Merit™ ..... 629

Sterilizing Forceps ..... 613  
 Sterilizing Forceps, Mid-Grade ..... 613  
 Sterilizing Tray, Stainless Steel ..... 687-688  
 Sternal Wire Twister Needle Holder,  
     TC ..... 41, 166, 531, 580  
 Stethoscope, Adult ..... 673  
 Stethoscope, Bowles ..... 676  
 Stethoscope, Cardiology ..... 672  
 Stethoscope, Disposable ..... 675  
 Stethoscope, Fetal ..... 674  
 Stethoscope, Infant ..... 674  
 Stethoscope, Magnatone ..... 676  
 Stethoscope, Nurses ..... 675  
 Stethoscope, Pediatric ..... 674  
 Stethoscope, Sprague Rappaport ..... 671  
 Stethoscope, Teaching/Training ..... 675  
 Stevens Iris Forceps ..... 241  
 Stevens Needle Holder ..... 130, 255, 271  
 Stevens Scissors ..... 58, 234, 538-539, 545-547, 558,  
     561, 565-566, 569, 577  
 Stevens Scissors, Merit™ ..... 625  
 Stevens Scissors, Sklarcut™ ..... 27  
 Stevens Scissors, Sklarhone™ ..... 25, 559  
 Stevens Scissors, Sklarhone™ TC ..... 22  
 Stevens Scissors, Sklarlite XD™ ..... 32, 58, 234  
 Stevens Scissors, Sklarlite™ ..... 32, 58, 234, 536  
 Stevens Scissors, Surgi-OR™ ..... 617  
 Stevens Tenotomy Hook ..... 226  
 Stevens Tenotomy Scissors, Econo™ ..... 637  
 Stevens Tenotomy Scissors, Sklar Edge™ TC ..... 21  
 Stevenson Retractor ..... 219  
 Stille Chisel ..... 285  
 Stille Clamp ..... 91, 176  
 Stille Gouge ..... 285  
 Stille Osteotome ..... 285  
 Stille Plaster Shears ..... 316  
 Stille Rongeur ..... 274  
 Stille Shears ..... 490  
 Stille Tissue Forceps ..... 112  
 Stille-Luer Bone Forceps ..... 272, 553, 556-557  
 Stille-Luer Echlin Rongeur ..... 274  
 Stille-Luer Rongeur ..... 273, 554, 556-557  
 Stitch Cutter ..... 670  
 Stitch Scissors ..... 64, 167, 237, 265  
 Stitch Scissors, Econo-Sterile™, Wireform ..... 661  
 Stitch Scissors, Long ..... 167  
 Stitch Scissors, O'Brien ..... 167  
 Stitch Scissors, Reeh ..... 168  
 Stitch Scissors, Ribbon ..... 59, 168, 238  
 Stockman Clamp ..... 467  
 Stockman/Zipser Clamp ..... 466  
 Stop Pliers ..... 608  
 Stoppers, Decannulation ..... 157  
 Storage Container, Stainless Steel ..... 682  
 Strabismus Forceps ..... 118  
 Strabismus Hook, Graefe ..... 226, 546  
 Strabismus Hook, Green ..... 226  
 Strabismus Scissors ..... 57, 239, 549-551, 568  
 Strabismus Scissors, Econo-Sterile™ ..... 653  
 Strabismus Scissors, Sklar Edge™ TC ..... 20, 75  
 Strabismus Scissors, Sklarlite XD™ ..... 32, 57, 239  
 Strabismus Scissors,  
     Sklarlite™ ..... 32, 57, 239, 545, 562  
 Strabismus Scissors, Surgi-OR™ ..... 617

Strabismus Scissors, Surgi-OR™ TC ..... 616  
 Straight Electrode Disposable,  
     Electrosurgical ..... 414-415  
 Stratte Needle Holder ..... 370  
 Stratte Needle Holder, TC ..... 42, 134, 370  
 Straus Clamp ..... 467  
 Stringer, Instrument,  
     Stainless Steel ..... 536, 574, 694-695  
 Stripper, Bunnell ..... 305  
 Stripper/Elevator, Matso ..... 489  
 Strips, Gluteraldehyde ..... 4, 716  
 Struempel Ear Forceps ..... 180  
 Struycken Forceps ..... 190  
 Stylet ..... 191  
 Subramanian Clamp ..... 520  
 Suction Irrigation System,  
     Laparoscopic ..... 440, 442, 575-576  
 Suction Irrigation, Laparoscopic, Single Port ..... 420  
 Suction System, Oral Surgery ..... 544  
 Suction Tube Tip, Yankauer ..... 154  
 Suction Tube, Adson ..... 155  
 Suction Tube, Andrews-Pynchon ..... 155  
 Suction Tube, Anthony ..... 155  
 Suction Tube, Baron ..... 154, 550-551, 559, 567  
 Suction Tube, Buie ..... 155, 474, 543  
 Suction Tube, Cleaning Brush ..... 711, 713-714  
 Suction Tube, Cooley ..... 580  
 Suction Tube, Coupland ..... 155  
 Suction Tube, Ear ..... 155, 211  
 Suction Tube, Frazier ..... 154, 537, 540, 543, 545, 548,  
     550-551, 553-555, 559, 561-562, 566-567, 577, 580  
 Suction Tube, Frazier Ferguson ..... 154  
 Suction Tube, Poole ..... 154, 571-572  
 Suction Tube, Yankauer ..... 154, 536-537, 541,  
     548, 552, 554, 570, 572, 580  
 Supercut Sklarhone™ Jabaley Scissors ..... 560

**SURGI-OR™**

Surgi-OR™ Adson Bayonet Forceps ..... 618  
 Surgi-OR™ Adson Dressing Forceps ..... 618  
 Surgi-OR™ Adson Tissue Forceps ..... 618  
 Surgi-OR™ Adson-Brown Tissue Forceps ..... 618  
 Surgi-OR™ Allis Tissue Forceps ..... 618  
 Surgi-OR™ Babcock Forceps ..... 618  
 Surgi-OR™ Backhaus Towel Clamp ..... 620  
 Surgi-OR™ Baumgartner Needle Holder ..... 621  
 Surgi-OR™ Bozeman Forceps ..... 618  
 Surgi-OR™ Braun Epistomy Scissors ..... 616  
 Surgi-OR™ Brown Needle Holder ..... 621  
 Surgi-OR™ Collier Needle Holder ..... 621  
 Surgi-OR™ Crile Forceps ..... 618-619  
 Surgi-OR™ Derf Needle Holder ..... 621  
 Surgi-OR™ Dressing Forceps ..... 618  
 Surgi-OR™ Dunaway Dissecting Forceps ..... 619  
 Surgi-OR™ Ferris Smith Tissue Forceps ..... 618  
 Surgi-OR™ Foerster Sponge Forceps ..... 619  
 Surgi-OR™ Freer Elevator ..... 622  
 Surgi-OR™ Graves Vaginal Speculum ..... 621  
 Surgi-OR™ Halsey Needle Holder ..... 621  
 Surgi-OR™ Halsted Mosquito Forceps ..... 619  
 Surgi-OR™ Hartmann Mosquito Forceps ..... 619  
 Surgi-OR™ Iris Scissors ..... 616  
 Surgi-OR™ Jansen Nasal Forceps ..... 618

## ALPHABETICAL INDEX



Surgi-OR™ Joseph Hook .....	621	Suture Scissors, Econo™ .....	637	Thoractomy Set II .....	579
Surgi-OR™ Kelly Forceps .....	619	Suture Scissors, Littler .....	168	Thorek Scissors .....	70, 174
Surgi-OR™ Knowles Bandage Scissors .....	616	Suture Scissors, Merit™ .....	625	Thorpe Caliper .....	213, 257, 565
Surgi-OR™ Lister Bandage Scissors .....	616	Suture Scissors, New's .....	168	Thorpe Corneoscleral Forceps .....	117, 247
Surgi-OR™ Littauer Stitch Scissors .....	617	Suture Scissors, Surgi-OR™ .....	617	Three Jaw Pliers .....	608
Surgi-OR™ Lorna Edna Towel Clamp .....	620	Suture Tray .....	430, 662	Three Prong Pliers .....	608
Surgi-OR™ Lucae Forceps .....	618	Suture Tying Forceps .....	123	Thudichum Speculum .....	189
Surgi-OR™ Magill Catheter Forceps .....	619	Suture Wire Scissors .....	68	Thumb Forceps, Econo-Sterile™ Wireform .....	661
Surgi-OR™ Mayo Scissors .....	616-617	Swedish Needle Holder, TC .....	42	Tieck Halle Speculum .....	188, 564
Surgi-OR™ Mayo-Hegar Needle Holder .....	621	Sweet Clip Forceps .....	171	Tightener, Harris Wire .....	311
Surgi-OR™ Metzenbaum Scissors .....	617	Swiss Blade Breaker .....	223	Tip Cleaner Disposable, Electrosurgical .....	417
Surgi-OR™ Nail Nipper .....	622	Swiss Cilia Forceps .....	122	Tip, Chip Blower .....	292
Surgi-OR™ Nail Splitter Forceps .....	622	Syringe O'Rings, Pomeroy .....	185	Tip, Ear Syringe, Merit™ .....	632
Surgi-OR™ Olsen-Hegar Needle Holder .....	621	Syringe Shield, Ear, Merit™ .....	632	TipGrips™ Instrument Guard .....	707
Surgi-OR™ Operating Scissors .....	617	Syringe Shield, Pomeroy .....	185	Tischler Mini Biopsy Punch .....	389
Surgi-OR™ Pederson Vaginal Speculum .....	621	Syringe Tip, Ear, Merit™ .....	632	Tischler Mini Biopsy Punch, Micro-Cut .....	385
Surgi-OR™ Plain Splinter Forceps .....	618	Syringe Tip, Pomeroy .....	185	Tischler Oval Biopsy Punch .....	389, 573
Surgi-OR™ Presbyterian Tube Occluding Clamp ..	620	Syringe, Ear, Merit™ .....	632	Tischler Oval Biopsy Punch, Micro-Cut .....	385
Surgi-OR™ Probe .....	622	Syringe, Pomeroy .....	185	Tischler-Kevorkian Biopsy Punch .....	389, 571
Surgi-OR™ Rankin Kelly Forceps .....	619			Tischler-Kevorkian Biopsy Punch, Micro-Cut .....	385
Surgi-OR™ Rochester-Ochsner Forceps .....	619			Tissue Forceps .....	111-112, 117, 242, 325, 460, 536-538, 540-546, 553-561, 566, 570, 572, 574-575, 578-581
Surgi-OR™ Rochester-Pean Forceps .....	619-620			Tissue Forceps, Adson .....	106-107, 109, 538-539, 541-542, 544-545, 548, 551, 557-559, 561-562, 564-566, 568, 574, 577-580
Surgi-OR™ Russian Tissue Forceps .....	618			Tissue Forceps, Adson Sklarlite XD™ .....	36, 107
Surgi-OR™ Scalpel Handle .....	622			Tissue Forceps, Adson Sklarlite™ .....	36, 106, 540, 567
Surgi-OR™ Schmidt Tonsil Forceps .....	620			Tissue Forceps, Adson-Brown .....	106-107, 536-537, 545, 558-559, 562, 564-566
Surgi-OR™ Schroeder Tenaculum Forceps .....	620			Tissue Forceps, Adson-Brown Sklarlite XD™ .....	36, 107
Surgi-OR™ Schweizer Forceps .....	620			Tissue Forceps, Adson-Brown Sklarlite™ .....	36, 106, 567
Surgi-OR™ Senn Retractor .....	621			Tissue Forceps, Adson-Brown, Econo™ .....	642
Surgi-OR™ Shamburg Comedone Extractor .....	622			Tissue Forceps, Adson-Gorney, TC .....	34, 125
Surgi-OR™ Spatula & Packer .....	622			Tissue Forceps, Adson, Econo™ .....	642
Surgi-OR™ Spencer Stitch Scissors .....	617			Tissue Forceps, Adson, TC .....	34, 125
Surgi-OR™ Splinter Forceps .....	618			Tissue Forceps, Allis .....	102-103, 345, 373, 461, 536-539, 541-544, 548, 550-559, 561, 566, 571, 573-574, 578-580
Surgi-OR™ Stevens Scissors .....	617			Tissue Forceps, Allis Surgi-OR™ .....	618
Surgi-OR™ Strabismus Scissors .....	617			Tissue Forceps, Allis, TC .....	35, 124, 345, 571
Surgi-OR™ Suture Scissors .....	617			Tissue Forceps, Babcock, TC .....	35, 124, 346
Surgi-OR™ Taylor Hammer .....	622, 678			Tissue Forceps, Bonney .....	113, 379
Surgi-OR™ TC Baumgartner Needle Holder .....	620			Tissue Forceps, Brown .....	113
Surgi-OR™ TC Crile-Wood Needle Holder .....	620			Tissue Forceps, Cooley .....	496
Surgi-OR™ TC Derf Needle Holder .....	620			Tissue Forceps, Econo-Sterile™ .....	656
Surgi-OR™ TC Halsey Needle Holder .....	620			Tissue Forceps, Econo™ .....	643
Surgi-OR™ TC Iris Scissors .....	616			Tissue Forceps, Essrig .....	112
Surgi-OR™ TC Mayo Scissors .....	616			Tissue Forceps, Ferris Smith .....	112, 379
Surgi-OR™ TC Mayo-Hegar Needle Holder .....	620			Tissue Forceps, Ferris Smith, Merit™ .....	626
Surgi-OR™ TC Metzenbaum Scissors .....	616			Tissue Forceps, Gerald .....	109
Surgi-OR™ TC Olsen-Hegar Needle Holder .....	620			Tissue Forceps, Graefe, Merit™ .....	626
Surgi-OR™ TC Operating Scissors .....	616			Tissue Forceps, Lane .....	112
Surgi-OR™ TC Strabismus Scissors .....	616			Tissue Forceps, Merit™ .....	627
Surgi-OR™ TC Webster Needle Holder .....	620			Tissue Forceps, Michel .....	112
Surgi-OR™ TC Wire Cutting Scissors .....	616			Tissue Forceps, Potts-Smith .....	114, 460, 493, 496, 566
Surgi-OR™ Tissue Forceps .....	618			Tissue Forceps, Russian .....	113, 536, 554, 570, 572-574, 579
Surgi-OR™ Utility Scissors .....	617			Tissue Forceps, Russian, Surgi-OR™ .....	618
Surgi-OR™ Webster Needle Holder .....	621			Tissue Forceps, Selman .....	114
Surgi-OR™ Wire Cutting Scissors .....	617			Tissue Forceps, Semkin .....	113, 541, 545, 559-560, 562, 567
				Tissue Forceps, Sklar Black™ .....	111
				Tissue Forceps, Sklarlite XD™ .....	36, 111
Surgical Blade, Disposable .....	539-540, 544, 560, 668				
Surgical Scrub Brush .....	711				
Surgical Skin Marker .....	658				
Suture Forceps, Bonn .....	245, 268				
Suture Forceps, Castroviejo .....	117, 130, 245, 268, 546-547, 564				
Suture Forceps, Manhattan .....	245, 247				
Suture Forceps, Sauer .....	247				
Suture Removal Set .....	543				
Suture Removal Tray .....	663				
Suture Scissors .....	63-64, 167, 169, 237, 351, 544				
Tags, Instrument ID .....	708				
Takahashi Forceps .....	190				
Tamper, Bone .....	289				
Tangential Forceps, DeBakey .....	505, 579				
Tape Measure .....	678				
Tape, ID Roll, Sklar .....	708				
Tape, ID Sheet .....	708				
Tauber Vaginal Spatula .....	359				
Tauber Vaginal Spatula, Sklar Blue™ .....	405				
Taylor Forceps .....	564				
Taylor Hammer .....	678				
Taylor Hammer, Econo™ .....	650				
Taylor Hammer, Merit™ .....	632				
Taylor Hammer, Surgi-OR™ .....	622, 678				
Taylor Retractor .....	301				
Taylor Scaler .....	597				
Taylor Scissors .....	62				
Teaching/Training Stethoscope .....	675				
Teale Vulsellum Forceps .....	100, 373				
Temple-Ray Retractor .....	140				
Tenaculum Forceps, Adair Breast .....	104				
Tenaculum Forceps, Econo™ .....	640				
Tenaculum Forceps, Hulka .....	94, 373				
Tenaculum Forceps, Laparoscopic .....	425				
Tenaculum Forceps, Staude-Moore .....	105				
Tendon Clamp .....	305				
Tennant Forceps .....	246, 268				
Tennant Hook .....	228				
Tennant-Troutman Forceps .....	250				
Tenotomy Hook, Stevens .....	226				
Tenotomy Scissors, Kleinert-Kutz .....	234				
Tenotomy Scissors, Stevens .....	637				
Tenotomy Scissors, Wescott .....	169				
Tenzel Bipolar Forceps, Electrosurgical .....	419				
Thomas Uterine Curette .....	367				
Thoms-Gaylor Forceps .....	475				
Thomson Mosquito Forceps .....	85				
Thoracic Clamp, Sklar .....	93, 492				
Thoracic Forceps, Bridge .....	572, 579				
Thoracic Forceps, Rumel .....	503				
Thoracic Trocar .....	162				
Thoractomy Set I .....	578				

## T

Tissue Forceps, Sklarlite™	36, 111	Tray, Biopsy Punch	430	Tube, Poole Suction	154, 571-572
Tissue Forceps, Stille	112	Tray, Catheter Instrument, Stainless Steel	685	Tube, Suction, Anthony	155
Tissue Forceps, Surgi-OR™	618	Tray, Catheter Instrument, Stainless Steel, Miniature	684	Tube, Tracheotomy Set, Jackson	157
Tissue Forceps, Wireform Econo-Sterile™	661	Tray, Circumcision	664	Tube, Tracheotomy, Jackson	156-157
Tissue Nipper	325, 539-540	Tray, CT Biopsy	665	Tubing Clamp, Vorse, Merit™	629
Tissue Nipper, Econo™	646	Tray, Ear	187	Tubing Forceps, Marcuse	126
Tissue Nipper, Merit™	633	Tray, Epidural	665	Tubing Forceps, St. Vincent	126
Tissue Nipper, Sklarlite™	39, 325	Tray, General Purpose	663	Tubing Tourniquet, N-1	313, 348
Tivnen Forceps	206	Tray, Incision & Drainage	664	Tubing, Disposable Smoke Evacuation	395, 403
TMJ Surgery Set	568	Tray, Instrument Drying, Stainless Steel	686	Tucker Hallux Forceps	298
Toe Nail Removal Tray	666	Tray, Instrument, Stainless Steel	687		
Tongue Depressor, Bogsworth	198	Tray, Laceration	430, 662		
Tongue Depressor, Wieder	198, 552	Tray, Mayo, Stainless Steel	547, 685		
Tongue Seizing, Young, Forceps	105	Tray, Micro Sterilization, Stainless Steel	693		
Tongue Shield, Disposable	614	Tray, Mini Minor	538		
Tonometer, Schiötz	258	Tray, Minor Surgery	664		
Tonsil Forceps, Colver-Coakley	101, 206	Tray, Plastic	703-704		
Tonsil Forceps, Schmidt	206, 482, 537, 542, 549, 552, 561, 573, 579, 640	Tray, Plastic Instrument Soaking	704		
Tonsil Forceps, Schmidt, Merit™	628	Tray, Plastic Procedure	704		
Tonsil Forceps, Schmidt, Surgi-OR™	620	Tray, Shave Prep	666		
Tonsil Forceps, White	104	Tray, Spinal Injection	665		
Tonsil Set	552	Tray, Sterilization, Stainless Steel	688, 693		
Tooke Knife	221	Tray, Sterilization/Bath Set, Stainless Steel	688		
Toothbrush	614	Tray, Sterilizing, Stainless Steel	687-688		
Torquing Pliers	608	Tray, Suture	430, 662		
Tourniquet, N-1	313, 348	Tray, Suture Removal	663		
Tourniquet, N-1, Clip	313, 348	Tray, Toe Nail Removal	666		
Tourniquet, N-1, Tubing	313, 348	Tray, Universal Block	665		
Tourniquet, Rumel	494	Tray, Would Closure Tray	663		
Towel Clamp, Backhaus	127, 536-537, 539-540, 542-548, 550-557, 561, 565-567, 570-572, 574, 578-580	Trephine, Castroviejo Corneal	231		
Towel Clamp, Backhaus, Econo-Sterile™	657	Trexlor Clamp	466		
Towel Clamp, Backhaus, Econo™	641	Trinket Box	692		
Towel Clamp, Ball & Socket	104	Trocar Set	162		
Towel Clamp, Hoff	127	Trocar, Duke Improved	162		
Towel Clamp, Hoff, Econo-Sterile™	657	Trocar, Hurwitz	162		
Towel Clamp, Hoff, Econo™	641	Trocar, Laparoscopic	432-433		
Towel Clamp, Jones, Merit™	629	Trocar, Laparoscopic, Disposable	449		
Towel Clamp, Lorna Edna	127, 558, 574, 577, 579	Trocar, Laparoscopic, Miniature	437		
Towel Clamp, Lorna Edna, Econo-Sterile™	657	Trocar, Laparoscopic, Single Port	420		
Towel Clamp, Peers, Merit™	629	Trocar, Nelson	162		
Towel Clamp, Roeder	127	Trocar, Ochsner	162, 574		
Towel Clamp, Schaedel	123	Trocar, Set, Laparoscopic, Miniature	437		
Towel Clamp, Sklar	104	Trocar, Thoracic	162		
Towel Forceps, Econo-Sterile™ Wireform	661	Trousseau Dilator	202		
Towner Scaler	597	Troutman Barraquer Corneal Forceps	240, 266		
Toynbee Ear Speculum	177	Troutman Blade Breaker	223, 546		
Toynbee Ear Speculum Set	177	Troutman Needle Holder	254, 271		
Tracheal Hook, News	148, 544	Tru-Punch™ Biopsy Punch Set, Disposable	458		
Tracheal Retractor	148	Tru-Punch™ Biopsy Punch, Disposable	458		
Tracheal Tube, Cleaning Brush	709	Tube Occluding Clamp	126		
Tracheotomy Set	544	Tube Occluding Clamp, Econo™	642		
Tracheotomy Tube Set, Jackson	157	Tube Occluding Clamp, Presbyterian, Econo-Sterile™	658		
Tracheotomy Tube, Jackson	156, 157	Tube Occluding Clamp, Presbyterian, Merit™	629		
Trachoma Forceps, Prince	252	Tube Occluding Clamp, Presbyterian, Surgi-OR™	620		
Traction Bows, Bohler	312	Tube Occluding Clamp, Vorse	126, 580		
Traditional Knife	321	Tube Occluding Forceps, St. Vincent, Merit™	629		
Tray Cover, Catheter Instrument, Stainless Steel	685	Tube, Buie Suction	155, 474, 543		
Tray Cover, Instrument, Stainless Steel	687-688	Tube, Ear Suction	155, 211		
Tray Cover, Micro Sterilization, Stainless Steel	693	Tube, Laryngectomy, Jackson	157		
Tray Cover, Sterilization, Stainless Steel	688	Tube, Plastic Specimen	705		
Tray, Arthrogram	666				

### TUNGSTEN CARBIDE

TC Adson Dressing Forceps	34, 125, 558, 569
TC Adson Tissue Forceps	34, 125
TC Adson-Brown	
Tissue Forceps	34, 108, 125, 564, 569
TC Adson-Gorney Tissue Forceps	34, 125
TC Allis Tissue Forceps	35, 124, 345, 571
TC Babcock Forceps	35, 124, 346
TC Baumgartner Needle Holder	40, 133
TC Baumgartner Needle Holder, Surgi-OR™	620
TC Bihle Needle Holder	42
TC Blepharoplasty Scissors, Sklar Edge™	21
TC Bozemann Heaney Needle Holder	42, 135, 371
TC Bruns Plaster Shears	315, 352
TC Castroviejo	
Needle Holder	44, 135, 546-547, 569, 577
TC Corwin Wire Twister	35, 166
TC Cottle Dorsal Scissors, Sklar Edge™	562
TC Crile-Murray	
Needle Holder	40, 132, 543, 545, 562, 570
TC Crile-Wood Needle Holder	40, 133, 463, 549, 560, 563, 566, 568, 575, 577, 580
TC Crile-Wood Needle Holder, Left	43, 136, 544
TC Crile-Wood Needle Holder, Surgi-OR™	620
TC Cushing Dressing Forceps	35, 564, 577
TC DeBakey Forceps	35, 124, 379
TC DeBakey Needle Holder	132, 463
TC Derf Needle Holder	40, 132, 566
TC Derf Needle Holder, Surgi-OR™	620
TC Dissecting Scissors, Sklar Edge™	20, 75
TC Dressing Forceps	34, 125
TC Finochietto Needle Holder	42, 134
TC Gillies Needle Holder	41, 563
TC Goldman-Fox Scissors, Sklar Edge™	20, 562
TC Halsey Needle Holder	40, 133, 542, 548, 550-551, 557-559, 563, 568-569, 577-578
TC Halsey Needle Holder, Surgi-OR™	620
TC Hard Wire Cuter	610
TC Heaney Needle Holder	42, 134, 573
TC How Pliers	604
TC Iris Scissors, Sklar Edge™	19, 75, 559
TC Iris Scissors, Sklarhone™	22
TC Iris Scissors, Surgi-OR™	616
TC Jaboma Tissue Forceps	568
TC Jacobson Needle Holder, Micro	44, 135
TC Julian Needle Holder	42
TC Kaye Dissecting Scissors, Sklar Edge™	20
TC Lexer Scissors, Sklar Edge™	20
TC Luethy Beck Needle Holder	44, 135
TC Luethy-Beck Needle Holder	371
TC Maltz Rasp	197, 334, 549
TC Martini Needle Holder	569

## ALPHABETICAL INDEX



TC Mathieu Needle Holder.....	44, 135, 371	Tuttle Forceps, Econo™.....	644	Vaginal Speculum, Berliend-Auvar.....	357	
TC Mayo Scissors, Sklar Edge™.....	19, 74, 538, 541, 548, 550, 557-558, 562, 566, 572, 574-575, 577-578, 580	Tuttle Forceps, Sklar Black™.....	400, 476	Vaginal Speculum, Collin, Sklar Black™.....	396	
TC Mayo Scissors, Sklarhorne™.....	22	Tuttle Forceps, Sklar Blue™.....	408	Vaginal Speculum, Collin, Sklar Blue™.....	404	
TC Mayo Scissors, Surgi-OR™.....	616	Tweed & Helix Pliers.....	608	Vaginal Speculum, Cusco.....	355-356	
TC Mayo-Hegar Needle Holder.....	41, 133, 463, 536-537, 542-543, 553, 557-559, 563, 570-572, 574-575, 578-581	Twister, Corwin Wire, TC.....	35, 166	Vaginal Speculum, Cusco, Sklar Blue™.....	403	
TC Mayo-Hegar Needle Holder, Left.....	43, 136	Twister, Wire, Cone.....	348	Vaginal Speculum, Devilbiss.....	356	
TC Mayo-Hegar Needle Holder, Surgi-OR™.....	620	Tyding Forceps.....	206	Vaginal Speculum, Freeway Graves.....	354	
TC Mayo-Stille Scissors, Sklar Edge™.....	19, 74	Tyding Knife.....	204	Vaginal Speculum, Freeway Graves, Sklar Black™.....	395	
TC Mayo-Stille Scissors, Sklarhorne™.....	22	Tyding Snare.....	202	Vaginal Speculum, Freeway Graves, Sklar Blue™.....	403	
TC Metzenbaum Scissors, Sklar Edge™.....	19, 20, 75, 538, 541, 548-551, 557-558, 562, 566, 574-575, 577-578, 580-581	Tyding Tonsil Snare.....	552	Vaginal Speculum, Garrigue.....	357	
TC Metzenbaum Scissors, Sklarhorne™.....	22	Tyrell Hook, Merit™.....	630	Vaginal Speculum, Graves.....	354-355, 570-571	
TC Metzenbaum Scissors, Surgi-OR™.....	616	Tyrell Iris Hook.....	149, 212, 226	Vaginal Speculum, Graves, Econo-Sterile™.....	450, 660	
TC Micro Semken Tissue Forceps.....	568	<b>U</b>			Vaginal Speculum, Graves, Merit™.....	630
TC Needle Holder, Laparoscopic.....	441-442, 576	Umbilical Scissors.....	69	Vaginal Speculum, Graves, Sklar Black™.....	393, 395	
TC Needle Holder, Laparoscopic, Miniature.....	436	Umbilical Scissors, Busch.....	69	Vaginal Speculum, Graves, Sklar Blue™.....	402-403	
TC Neivert Needle Holder.....	40	Umbilical Scissors, Merit™.....	625	Vaginal Speculum, Graves, Surgi-OR™.....	621	
TC New Orleans Needle Holder.....	41, 134	Umbilical Scissors, Schumacher.....	68	Vaginal Speculum, Pederson.....	355, 570	
TC Olsen-Hegar Needle Holder.....	41, 134, 540, 565	Universal Biopsy Punch.....	391	Vaginal Speculum, Pederson, Econo-Sterile™.....	660	
TC Olsen-Hegar Needle Holder, Surgi-OR™.....	620	Universal Biopsy Punch, Micro-Cut.....	387	Vaginal Speculum, Pederson, Merit™.....	630	
TC Operating Scissors, Sklar Edge™.....	19, 74	Universal Block Tray.....	665	Vaginal Speculum, Pederson, Sklar Black™.....	394-395	
TC Operating Scissors, Surgi-OR™.....	616	Universal Scaler.....	599	Vaginal Speculum, Pederson, Sklar Blue™.....	402	
TC PAR Needle Holder.....	40	University of Michigan Burnisher.....	583	Vaginal Speculum, Pederson, Surgi-OR™.....	621	
TC Pin Cutter.....	309, 350, 580	University of Minnesota Cheek Retractor.....	201, 613	Vaginal Speculum, Steiner-Auvar.....	357	
TC Pin Puller.....	166	University of Washington Rubber Dam Forceps.....	603	Vaginal Speculum, Steiner-Auvar, Sklar Black™.....	396	
TC Potts-Smith Dressing Forceps.....	34, 125, 571, 577	University of Washington Rubber Dam Forceps, Mid-Grade.....	603	Vaginal Speculum, Steiner-Auvar, Sklar Blue™.....	404	
TC Ragnell-Kilner Scissors.....	569	Unna Comedone Extractor.....	534, 538	Vaginal, O'Sullivan-O'Conner Retractor.....	358	
TC Ryder Needle Holder.....	41, 133, 545, 562, 566, 580	Unna Comedone, Merit™.....	631	Vaginal, Segond Spatula.....	359	
TC Ryder Needle Holder, Left.....	43, 136	US Army Retractor.....	146, 536-537, 542, 548, 555, 557, 559, 561, 566-567, 575, 577-579, 581	Vaginal, Segond Spatula, Sklar Blue™.....	405	
TC Sarot Needle Holder.....	41, 134	US Army Scissors.....	67, 317, 351	Vaginal, Sims Retractor.....	152, 358	
TC Semken Needle Holder.....	568	Uterine Manipulator, Cohen.....	363	Vaginal, Sims Retractor, Sklar Blue™.....	405	
TC Sternal Wire Twister Needle Holder.....	41, 166, 531, 580	Utility Bowl, Plastic.....	706	Vaginal, Tauber Spatula.....	359	
TC Stevens Scissors, Sklarhorne™.....	22	Utility Brush.....	714	Vaginal, Tauber Spatula, Sklar Blue™.....	405	
TC Stevens Tenotomy Scissors, Sklar Edge™.....	21	Utility Forceps, Bonaccolto.....	119, 247	Valve, Laparoscopic.....	433-434, 442, 576	
TC Strabismus Scissors, Sklar Edge™.....	20, 75	Utility Forceps, Colibri Corneal.....	240, 546	Van Buren Forceps.....	297	
TC Strabismus Scissors, Surgi-OR™.....	616	Utility Forceps, McCullough.....	119, 247	Van Buren Sound.....	464	
TC Stratte Needle Holder.....	42, 134, 370	Utility Forceps, Merit™.....	627	Van Buren Sound Set.....	464	
TC Swedish Needle Holder.....	42	Utility Forceps, Nugent.....	247	Vanderbilt University Forceps.....	480	
TC Wangensteen Needle Holder.....	42, 132	Utility Forceps, Wills.....	247	Vanguard Splinter Pick.....	121, 532	
TC Webster Needle Holder.....	40, 132, 538, 540, 551, 558-559, 562, 565-566	Utility Scissors.....	59, 67, 317, 580	Vannas Scissors.....	70, 237, 263, 546	
TC Webster Needle Holder, Left.....	43, 136	Utility Scissors, Commander.....	67, 315, 352	Varco Forceps.....	89	
TC Webster Needle Holder, Surgi-OR™.....	620	Utility Scissors, Econo-Sterile™.....	654	Varco Gall Bladder Forceps.....	173	
TC Wire & Pin Cutter.....	309	Utility Scissors, Econo™.....	637	Vas Fixation Forceps.....	543	
TC Wire Cutting Scissors, Sklar Edge™.....	21, 75, 166, 309, 351, 540, 553, 566	Utility Scissors, Hercules.....	315, 352	Vascular Dilator.....	526	
TC Wire Cutting Scissors, Surgi-OR™.....	616	Utility Scissors, Merit™.....	625	Vascular Forceps, DeBakey.....	497, 498	
TC Wire Extractor.....	310	Utility Scissors, Ribbon.....	59	Vasectomy Fixation Clamp.....	467	
TC Wire Puller.....	310	Utility Scissors, Surgi-OR™.....	617	Vasectomy Piercing Forceps.....	467	
TC, Z-Type Parametrium Scissors.....	21, 377, 459, 572	Utility Shears, Econo™.....	637-638	Vasectomy Set.....	467	
Tuffier Spreader.....	141, 487	<b>V</b>			Vehe Carver.....	592
Tumbler, Stainless Steel.....	680	Vaginal Dilators, Disposable.....	453	Vehe Porcelain and Wax Carver, Mid-Grade.....	592	
Tummy Tuck Set.....	559	Vaginal Retractor, Jackson.....	358, 570, 573	Vein Set.....	581	
Tumor Grasping Forceps.....	259	Vaginal Retractor, Jackson, Sklar Black™.....	401	Vena Cava Forceps, DeBakey.....	580	
Tuning Fork Set.....	185	Vaginal Retractor, Jackson, Sklar Blue™.....	405	Verbrugge Bone Forceps.....	296	
Tuning Fork, Aluminum Alloy.....	185	Vaginal Retractor, Lateral.....	356	Vessel & Nerve Retractor.....	531	
Tuttle Forceps.....	113	Vaginal Retractor, Lateral, Sklar Black™.....	396	Vessels Towel Forceps, Merit™.....	629	
		Vaginal Retractor, Lateral, Sklar Blue™.....	405	Veterinary Needle.....	165	
		Vaginal Speculum, Auvar.....	356, 570-571	Vienna Speculum.....	188, 548, 550	
		Vaginal Speculum, Auvar, Sklar Black™.....	396	Vienna Speculum, Econo™.....	650	
		Vaginal Speculum, Auvar, Sklar Blue™.....	404	Vienna Speculum, Merit™.....	633	
				Virtus Splinter Forceps.....	533	

Virtus Splinter Forceps, Merit™	627
Vogel Curette	203
Volkman Bone Curette	294, 341
Volkman Hook	299
Volkman Retractor	142, 542, 554-555, 557-558, 561, 578
Volkman Bone Curette	568
Von Graefe Knife Needle	220
Vorse Tube Occluding Clamp	126, 580
Vorse Tubing Clamp, Merit™	629

## W

Wachenfeldt Forceps	123, 170
Wachenfeldt Clip	171
Wagner Scissors	49, 545, 548, 562
Wagner Scissors, Sklarcut™	28, 72
Wagner Scissors, Sklarlite™ Sklarcut™	29, 72
Waldeau Fixation Forceps	243
Waldmann Scissors	69
Walls Carver	592
Walsham Forceps	193, 564
Walther Dilator	362
Walton Plaster Spreader	317, 353
Walton Suture Forceps	246
Wangensteen Needle Holder, TC	42, 132
Ward Carver	592
Wartenberg Pinwheel	678
Wartenberg Pinwheel, Merit™	632
Wave Forceps, Laparoscopic, Disposable	447
Wax Carver, Hollenback	591
Wax Carver, Hollenback, Mid-Grade	591
Wax Carver, Le Cron	593
Wax Carver, Le Cron, Mid-Grade	593
Wax Carver, P.K. Thomas	590
Wax Carver, P.K. Thomas Set	590
Wax Carver, P.K. Thomas, Mid-Grade	590
Wax Carver, Roach	592
Wax Carver, Roach, Mid-Grade	592
Wax Carver, Vehe	592
Wax Carver, Vehe, Mid-Grade	592
Wax Carver, Walls	592
Wax Carver, Ward	592
Wax Spatula	593
Wax Spatula, Gritman	593
Weber Clamp	511
Webster Needle Holder	128, 370, 538, 561
Webster Needle Holder, Econo-Sterile™	659
Webster Needle Holder, Econo™	647
Webster Needle Holder, Merit™	629
Webster Needle Holder, Mid-Grade	629
Webster Needle Holder, Sklarlite XD™	45
Webster Needle Holder, Sklarlite™	45
Webster Needle Holder, Surgi-OR™	621
Webster Needle Holder, Surgi-OR™ TC	620
Webster Needle Holder, TC	40, 132, 538, 540, 551, 558-559, 562, 565-566
Webster Needle Holder, TC, Left	43, 136
Weeks Eye Speculum	216
Weingart Pliers	609
Weingartner Ear Forceps	182
Weinstein Instrument Holder	558
Weis Chalazion Forceps	252

Weitlaner Retractor	137, 544, 553-556, 558, 574, 577-578, 580-581
Weitlaner Retractor, Econo™	648
Weitlaner Retractor, Merit™	630
Weitlaner-Beckman Retractor	137, 208, 282, 553
Weitlaner-Paparella Retractor	208
Wertheim-Cullen Pedicle Forceps	92, 176
Werthiem Clamp	92
Wescott Scissors	71, 169, 233, 264, 546-547, 577
Wesson Mouth Gag	198
West Dissector	304
West Gouge	196
Wheeler Knife	220
White Forceps	206
White Tonisl Forceps	104
White Tonsil Forceps	552
Wieder Tongue Depressor	198, 552
Wiener Corneal Hook	226
Wiener Eye Speculum	214
Wiener Rasp	563
Wilde Forceps	116, 182, 548, 550, 567
Wilde Forceps, Econo™	644
Wilde Forceps, Merit™	627
Wilde Rongeur	281
Wildier Dilator	230
Wildier Lens Scoop	546
Wildier Loop	225
Williams Lachrymal Probe	184
Williams Probe	230, 588
Williams Speculum	216
Williams Splinter Forceps	533
Williger Bone Curette	294
Wills Utility Forceps	247
Wilmer Scissors	62, 238, 264, 546
Wilson Vasectomy Set	543
Wipes, Surface Disinfectant, Sklar	7, 200, 349, 392, 654, 684, 719
Wire & Pin Cutter, TC	309
Wire Bending Pliers	605
Wire Bending Pliers, Mid-Grade	605
Wire Cutter, Hard	610
Wire Cutter, Hard, TC	610
Wire Cutters, Pin & Ligature	610
Wire Cutting Scissors	68, 169, 309, 351, 550-551
Wire Cutting Scissors, Econo-Sterile™	653
Wire Cutting Scissors, Econo™	636
Wire Cutting Scissors, Mid-Grade	625
Wire Cutting Scissors, Sklar Edge™	TC
Wire Cutting Scissors, Surgi-OR™	21, 75, 166, 309, 351, 540, 553, 566
Wire Cutting Scissors, Surgi-OR™ TC	617
Wire Cutting Scissors, Suture	63, 169, 351
Wire Extracting Pliers	349
Wire Extractor, Snap Lock	310, 350
Wire Extractor, TC	310
Wire Net Basket	690
Wire Puller	310
Wire Puller, TC	310
Wire Retaining Retractor	138, 207
Wire Speculum	215
Wire Speculum, Barraquer	214, 547
Wire Speculum, Kratz-Barraquer	214
Wire Tightener, Harris	311

Wire Twister, Cone	348
Wire Twister, Corwin, TC	35, 166
Wire, Kirschner	313, 347
Wireform Halsted Forceps, Econo-Sterile™	661
Wireform Kelly Forceps, Econo-Sterile™	661
Wireform Needle Holder, Econo-Sterile™	661
Wireform Scissors, Econo-Sterile™	661
Wireform Sponge Forceps, Econo-Sterile™	661
Wireform Stitch Scissors, Econo-Sterile™	661
Wireform Thumb Forceps, Econo-Sterile™	661
Wireform Tissue Forceps, Econo-Sterile™	661
Wireform Towel Forceps, Econo-Sterile™	661
Wires, Krause Snare	184, 191
Wires, Snare	202
Wisconsin Laryngoscope Blade, F.O.	159
Wittner Uterine Biopsy Punch	390
Wittner Uterine Biopsy Punch, Micro-Cut	386
Wole-Boehler Cast Breaker	316, 353
Woodson Filling Instrument	568-589
Wound Closure Tray	663
Wound Clip Forceps	171
Wound Clip Forceps, Sklar	171
Wullstein Endaural Retractor	550
Wullstein Retractor	208
Wullstein Sickle Knife	552

## Y

Yancoskie Retractor	559
Yankauer Suction Tube	154, 536-537, 541, 548, 552, 554, 570, 572, 580
Yankauer Suction Tube Tip	154
Yeoman Biopsy Punch	474, 543
Young Retractor	144, 467
Young Tongue Seizing Forceps	105
Young, Forceps, Tongue Seizing	105
Younger Good Scaler	599

## Z

Z-Type Hysterectomy Forceps	95, 377, 572
Z-Type Parametrium Scissors, TC	21, 377, 459, 572
Zalkind Lung Retractor	145
Zalkind Retractor	491
Zalkind Ribbon Retractor	145, 200, 536-537, 541, 545, 561-562, 579
Zaufel Jansen Rongeur	274, 338
Ziegler Cilia Forceps	122, 249
Ziegler Dilator	230
Ziegler Eye Speculum	215
Ziegler Knife Needle	221
Zielke Rongeur	281

# SKLAR SPRAY-ZYME™

## SURGICAL INSTRUMENT PRE-CLEANER

### Multi-Enzyme Based Instrument Presoak & Foam Spray Cleaner

The newest product from Sklar for expert care of your surgical instruments. This multi-enzymatic spray creates a heavy foam which lasts for hours, keeping soiled instruments moist to avoid encrustation while also pre-cleaning prior to processing.

Prevents Organic Encrustation - enzyme foam stops blood and bodily fluids from drying onto surgical instruments.

No More Spills - messy spills between the operating room and central cleaning / processing department are eliminated.

Neutral pH - safe and effective for stainless steel, tungsten carbide, aluminum and brass instruments.

Bacteriostatic - microbiological control agents inhibit bacterial growth in the ready-to-use foam solution.

Long Lasting Foam - saves time, foam lasts many hours after application.

Multi-Enzymatic - contains a synergistic blend of lipase and protease enzymes.



PRODUCT NUMBER	FEATURES	QUANTITIES
10-2722	22 oz. Refillable Spray Bottles	12/case
10-2724	1 Gallon Bottles	4/case



**SKLAR Instruments**  
 889 South Matlack Street  
 West Chester, PA 19382

**Domestic**  
 Sales: 610.430.3200  
 Customer Service: 800.221.2166  
 Fast Fax Quote: 610.696.9007  
 Surgi@sklarcorp.com  
 www.sklarcorp.com

**International**  
 Sales: 1.610.430.3200  
 Fast Fax Quote: 1.610.430.3941  
 International@sklarcorp.com

Distributed By:



© Copyright 2016 Sklar Instruments, West Chester, PA. All rights reserved. No portion of this catalog may be reproduced without the written permission of Sklar Instruments. This catalog supersedes all previous versions.