



*Sklar*  
SCIENTIFIC

LABORATORY PRODUCTS



[www.sklarscientific.com](http://www.sklarscientific.com)

# Sklar has 5 choices of quality surgical instruments... more than any other company!

*For the first time ever in one surgical instrument catalog we offer you Sklar Operating Room quality, Mid-Grade value, Merit office instrumentation, the convenience of Floor Grade sterile instruments and Sklar Premium, our very best.*



OR GRADE



## Sklar OR Quality Instruments

Our best operating room quality instruments incorporating the highest grades of surgical steel, finely detailed craftsmanship and exacting standards of manufacturing. These instruments are imported from Germany.



PREMIUM GRADE



## Sklar Premium™ Instruments

Our finest OR grade instruments with the addition of a unique Sklar performance feature to meet the specific surgical needs of the clinician.

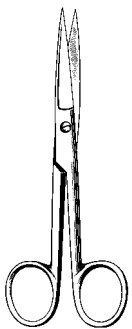

MID GRADE



## Surgi-OR™ Mid-Grade Quality Instruments

These mid-grade instruments are forged from surgical grade stainless steel and crafted to offer significant value at reduced costs for the operating room as well as other important surgical settings.



OFFICE INSTRUMENTATION



## Merit Office Instrumentation

A cost-effective line of instruments ideally suited for routine, minor surgical use in the office setting.

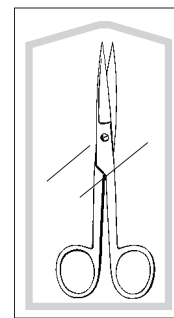

FLOOR GRADE, STERILE



## Econo Sterile™ Instruments

The added convenience and cost-savings of these ready-to-use sterile instruments make Econo Sterile an exceptional value.

*We invite you to take a closer look at Sklar Scientific and our many brands of surgical instruments, sterile disposables, diagnostics and thousands of new products. Visit us at [www.sklarscientific.com](http://www.sklarscientific.com).*



### • SKLARLITE™

SKLARLITE  
THE LIGHT TOUCH

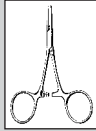

Our premium Operating Room quality instruments provide a lighter version from the standard pattern without sacrifice to strength and durability.

### • SKLARLITE XD™

SKLARLITE XD  
EXTRA DELICATE

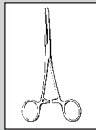

These instruments retain their structural integrity while providing the most delicate and sensitive instruments available.

### • SKLARHONE™ Scissors

MICRO-CUT

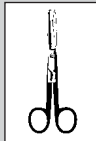

Scissors are constructed with one knife blade and a standard scissor edge, either smooth or serrated for additional surgical control.

### • SKLARCUT™ Scissors

SKLARCUT  
SERRATED BLADE



Cut cleanly and precisely due to ultra-fine serrations for improved grip throughout the entire cut.

### • SKLAR EDGE™

SKLAR EDGE  
TUNGSTEN CARBIDE



Tungsten Carbide scissors are the standard for performance and quality as well as durability. Sklar Edge blades have a 5 year warranty.

# TABLE OF CONTENTS



## INSTRUMENTS

**SCISSORS**  
2-22



**MICROSURGERY / DISSECTING**  
80-100

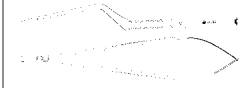

**HEMOSTATS / FORCEPS**  
23-53

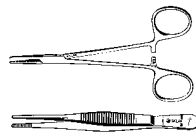

**DENTAL / PLIERS**  
101-103



**NEEDLEHOLDERS**  
54-61

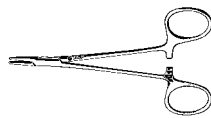

**BONE INSTRUMENTS**  
104-122

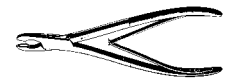

**PREMIUM GRADE SCISSORS**  
TUNGSTEN CARBIDE/HONE  
62-64

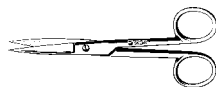

**EAR, NOSE, THROAT**  
123-134

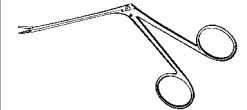

**PREMIUM GRADE**  
**NEEDLE HOLDERS**  
TUNGSTEN CARBIDE  
65-68

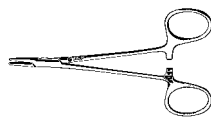

**GYNECOLOGICAL**  
135-141

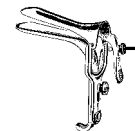

**PREMIUM GRADE**  
**FORCEPS**  
TUNGSTEN CARBIDE  
69-70



**LAPAROSCOPIC**  
142-155



**RETRACTORS**  
71-77

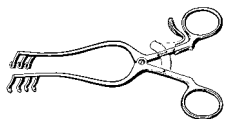

**DIAGNOSTIC INSTRUMENTS**  
156-160



**CALIPERS / RULERS**  
78

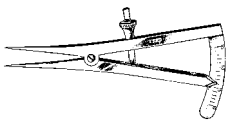

**NEEDLES & SYRINGES**  
161-165







**PROBES / DIRECTORS**  
79



**GLOVES**  
166-167



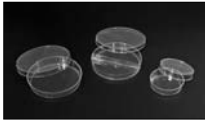
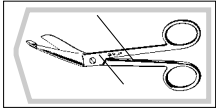

<b>STERILE PROCESSING</b> 168	
<b>BLADES / SCALPELS</b> 169-172	
<b>STERILE PROCEDURE KITS / COMPONENTS</b> 173-185	
<b>DISPOSABLE LAB PRODUCTS</b> 186-190	
<b>STERILE &amp; NON-STERILE ECONOMY INSTRUMENTS</b> 191-197	
<b>STERILIZATION &amp; INSTRUMENT TRAYS, CONTAINERS</b> 198-208	
<b>INSTRUMENT CARE &amp; CLEANING</b> 209-231	



*Your Resource  
For Research*

**S**klar Scientific is the newest division of Sklar Instruments and primarily serves the laboratory and research markets. In business for over 113 years, Sklar is a leading provider of quality surgical instruments and supplies to the healthcare industry.

[www.sklarscientific.com](http://www.sklarscientific.com)

# OPERATING SCISSORS/STRAIGHT

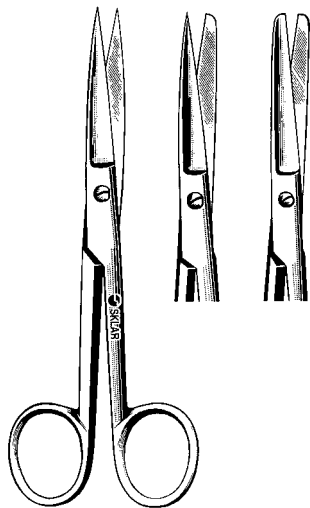

**OR GRADE**

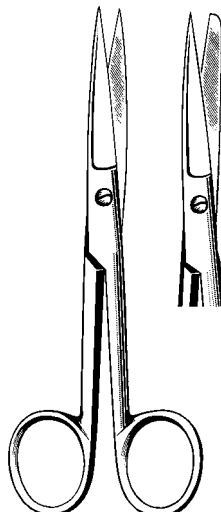

**MID-GRADE**

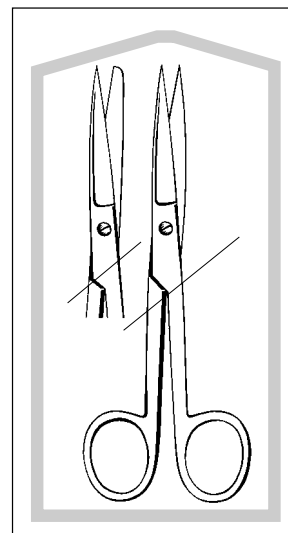

**FLOOR-GRADE, STERILE**

## OPERATING SCISSORS

Straight

S/S	S/B	B/B
13-1045 4 1/2"	14-1045 4 1/2"	15-1045 4 1/2"
13-1050 5"	14-1050 5"	15-1050 5"
13-1055 5 1/2"	14-1055 5 1/2"	15-1055 5 1/2"
13-1060 6"	14-1060 6"	15-1060 6"
13-1065 6 1/2"	14-1065 6 1/2"	15-1065 6 1/2"
14-1058 5 1/2"	S/B, Heavy Pattern	

## MID-GRADE OPERATING SCISSORS

Straight

S/S	S/B
95-275 5 1/2"	95-265 4 1/2"
95-284 6 1/2"	95-272 5 1/2"
	95-281 6 1/2"

## OPERATING SCISSORS, STERILE

Box/50

96-2520 5 1/2"	Str.	S/B
96-2522 5 1/2"	Str.	S/S

Box/25

96-2521 5 1/2"	Str.	S/B
96-2523 5 1/2"	Str.	S/S

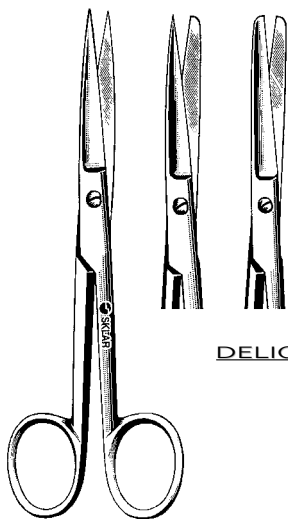

**DELICATE**

**PREMIUM GRADE**

## OPERATING SCISSORS DELICATE

Straight

S/S	S/B	B/B
22-1145 4 1/2"	22-1245 4 1/2"	22-1345 4 1/2"
22-1150 5"	22-1250 5"	22-1350 5"
22-1155 5 1/2"	22-1255 5 1/2"	22-1355 5 1/2"

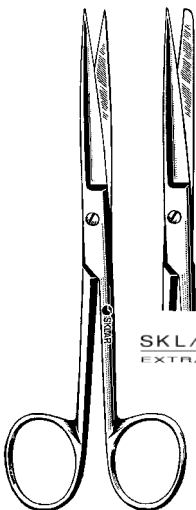

**SKLARLITE XD™  
EXTRA DELICATE**

**PREMIUM GRADE**

## SKLARLITE EXTRA DELICATE™ OPERATING SCISSORS

Straight

S/S	S/B
23-1112 4 1/2"	23-1116 4 1/2"
23-1113 5"	
23-1114 5 1/2"	23-1118 5 1/2"

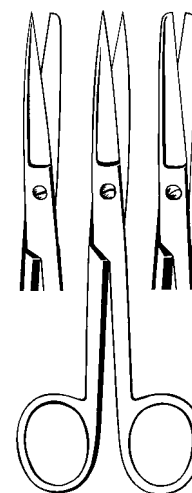

**ECONO**

## OPERATING SCISSORS, ECONO

Box/12

Straight-S/B	Straight-B/B
21-263 4 1/2"	21-278 5 1/2"
21-272 5 1/2"	21-288 6 1/2"
21-281 6 1/2"	

Straight-S/S

21-266 4 1/2"	21-275 5 1/2"
21-271 5"	21-284 6 1/2"

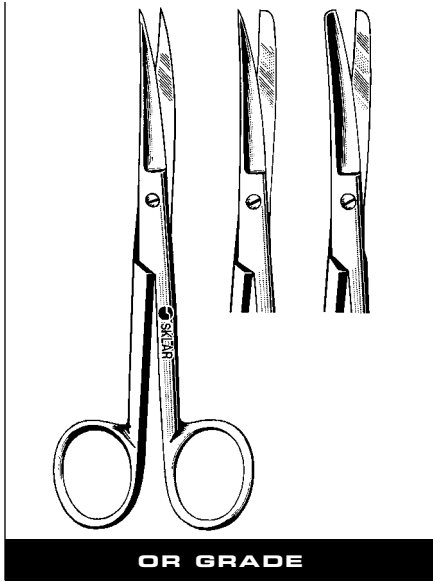

**OR GRADE**

### OPERATING SCISSORS

Curved

S/S	S/B	B/B
13-2045 4½"	14-2045 4½"	15-2045 4½"
13-2050 5"	14-2050 5"	15-2050 5"
13-2055 5½"	14-2055 5½"	15-2055 5½"
13-2060 6"	14-2060 6"	15-2060 6"
13-2065 6½"	14-2065 6½"	15-2065 6½"

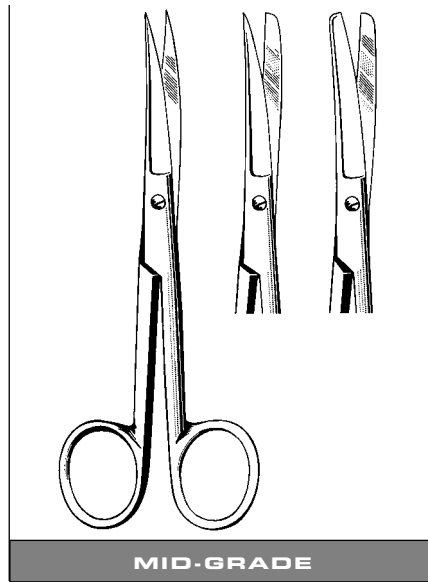

**MID-GRADE**

### MID-GRADE OPERATING SCISSORS

Curved

S/S	S/B	B/B
95-295 5½"	95-292 5½"	95-299 5½"

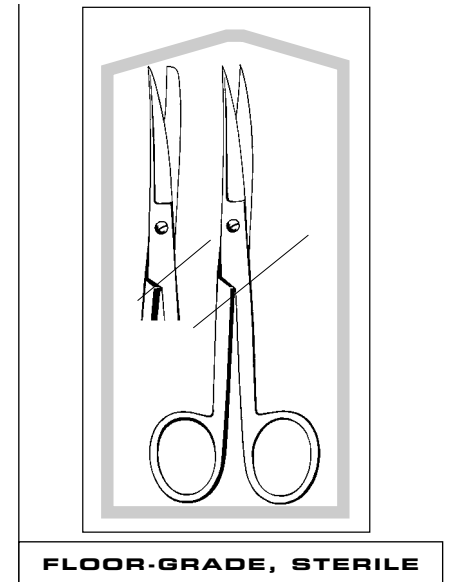

**FLOOR-GRADE, STERILE**

### OPERATING SCISSORS, STERILE

Box/50

96-2524 5½"	Cvd.	S/B
96-2525 5½"	Cvd.	S/S

Box/25

96-2526 5½"	Cvd.	S/B
96-2527 5½"	Cvd.	S/S



**PREMIUM GRADE**

### OPERATING SCISSORS DELICATE

Curved

S/S	S/B	B/B
22-1445 4½"	22-1545 4½"	22-1645 4½"
22-1450 5"	22-1550 5"	22-1650 5"
22-1455 5½"	22-1555 5½"	22-1655 5½"



**PREMIUM GRADE**

### SKLARLITE EXTRA DELICATE™ OPERATING SCISSORS

Curved

S/S	S/B
23-1138 5½"	23-1140 4½"
23-1138 5½"	23-1142 5½"

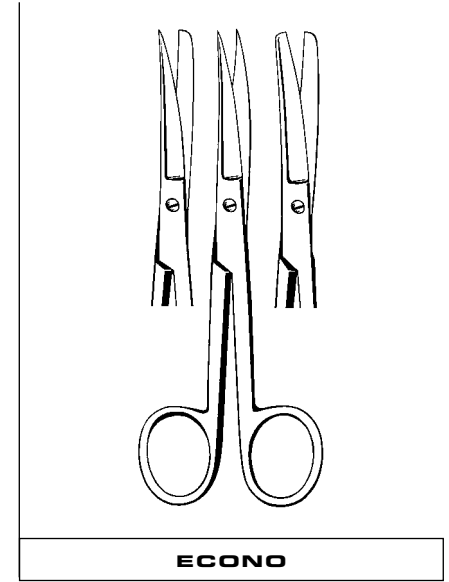

**ECONO**

### OPERATING SCISSORS, ECONO

Box/12

Curved-S/B	Curved-B/B
21-291 4½"	21-299 5½"
21-292 5½"	21-300 6½"
21-293 6½"	

Curved-S/S

21-294 4½"
21-295 5½"

# MAYO DISSECTING SCISSORS

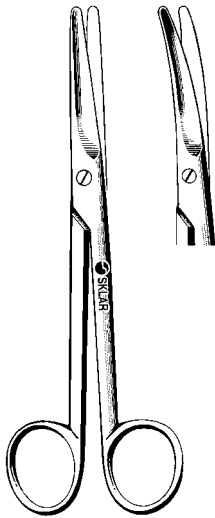

**OR GRADE**

## MAYO DISSECTING SCISSORS

Straight	Curved
15-1555 5½"	15-2555 5½"
15-1567 6¾"	15-2567 6¾"
90-1590 9"	90-1690 9"
15-2569 6¾"	Curved, Heavy Pattern

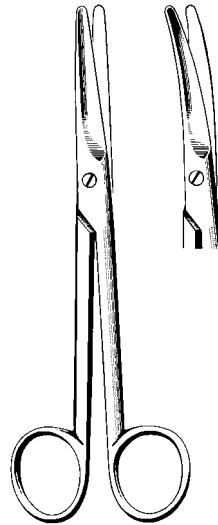

**MID-GRADE**

## MID-GRADE MAYO DISSECTING SCISSORS

Straight	Curved
95-308 5½"	95-330 5½"
95-321 6¾"	95-325 6¾"

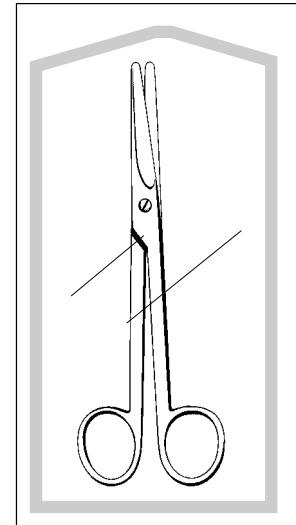

**FLOOR-GRADE, STERILE**

## MAYO DISSECTING SCISSORS, STERILE

Box/50		
96-2530	5½"	Str.
Box/25		
96-2531	5½"	Str.

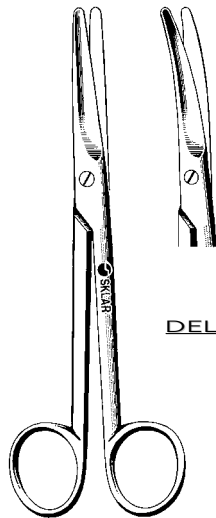

**DELICATE**

**PREMIUM GRADE**

## MAYO DISSECTING SCISSORS DELICATE

Straight	Curved
22-1556 5½"	22-2555 5½"
22-1567 6¾"	22-2567 6¾"

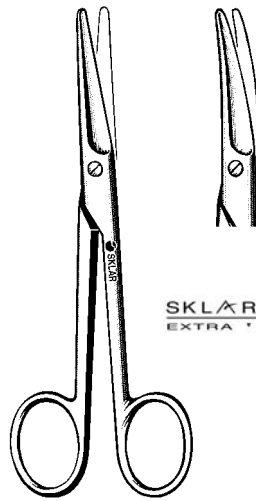

**SKLARLITE XD™  
EXTRA DELICATE**

**PREMIUM GRADE**

## SKLARLITE EXTRA DELICATE™ MAYO DISSECTING SCISSORS

Straight	Curved
23-1168 5½"	23-1170 5½"
23-1169 6¾"	23-1171 6¾"

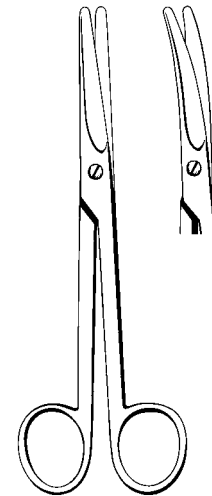

**ECONO**

## MAYO DISSECTING SCISSORS, ECONO

Box/12		
Straight		Curved
21-308 5½"		21-312 5½"
21-321 6¾"		21-325 6¾"



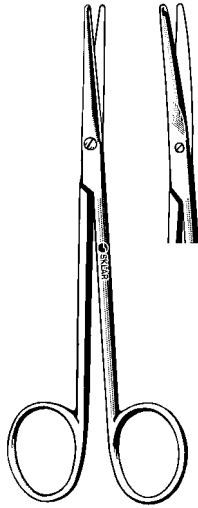

**OR GRADE**

**METZENBAUM (LAHEY)  
SCISSORS**

Straight	Curved		
22-2550 4½"	22-2545 4½"		
75-5460 5¾"	47-1360 5¾"		



**MID-GRADE**

**MID-GRADE  
METZENBAUM (LAHEY)  
SCISSORS**

Straight	Curved		
95-335 5¾"	95-336 5¾"		

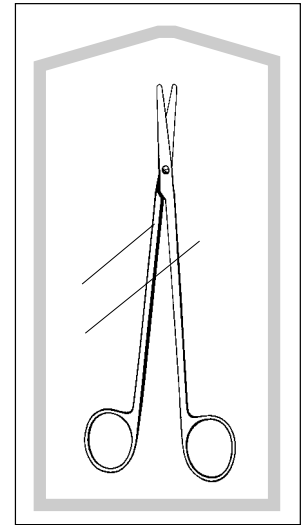

**FLOOR-GRADE, STERILE**

**METZENBAUM (LAHEY)  
SCISSORS, STERILE**

Box/50		
96-2516 5¾"	Str.	
Box/25		
96-2517 5¾"	Str.	

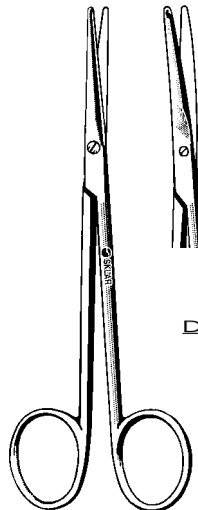

**DELICATE**

**PREMIUM GRADE**

**METZENBAUM (LAHEY)  
SCISSORS  
DELICATE**

Straight	Curved		
22-2450 4½"	22-2650 4½"		
22-2460 5¾"	22-1057 5¾"		

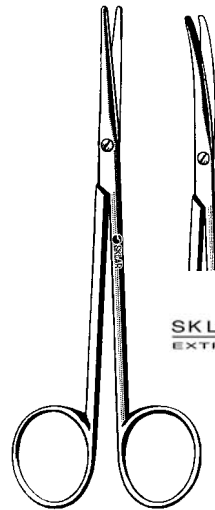

**SKLARLITE XD™  
EXTRA DELICATE**

**PREMIUM GRADE**

**SKLARLITE EXTRA DELICATE™  
METZENBAUM (LAHEY)  
SCISSORS**

Straight	Curved		
23-1176 4½"	23-1178 4½"		
23-1177 5¾"	23-1179 5¾"		

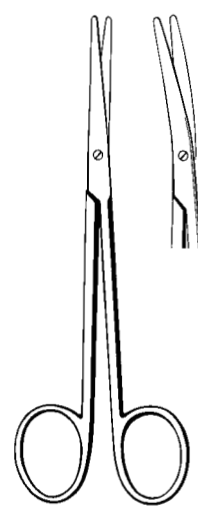

**ECONO**

**METZENBAUM (LAHEY)  
SCISSORS, ECONO**

Box/12		
Straight	Curved	
21-335 5¾"	21-336 5¾"	

# METZENBAUM DISSECTING SCISSORS

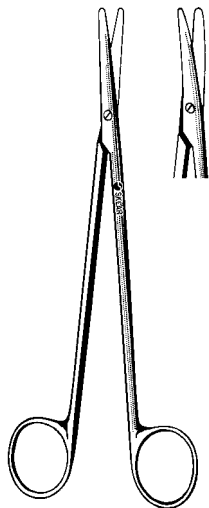

**OR GRADE**

## **METZENBAUM DISSECTING SCISSORS**

Straight		Curved	
75-5570	7"	75-5670	7"
55-9180	8"	55-9080	8"
55-9190	9" Nelson	55-9090	9" Nelson
55-9310	10" Nelson	55-9210	10" Nelson
55-9311	11" Nelson	55-9411	11" Nelson
		55-9612	12" Nelson
		55-9614	14" Nelson

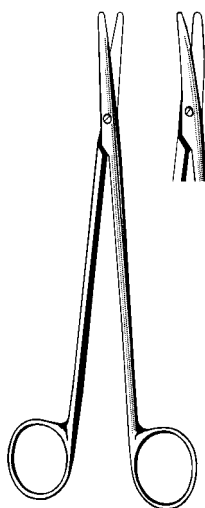

**MID-GRADE**

## **MID-GRADE METZENBAUM DISSECTING SCISSORS**

Straight		Curved	
95-339	7"	95-340	7"

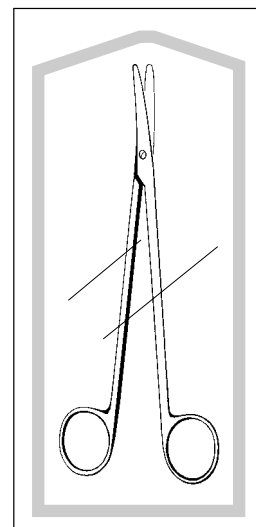

**FLOOR-GRADE, STERILE**

## **METZENBAUM DISSECTING SCISSORS, STERILE**

Box/50		
96-2680	7"	Cvd.
Box/25		
96-2682	7"	Cvd.

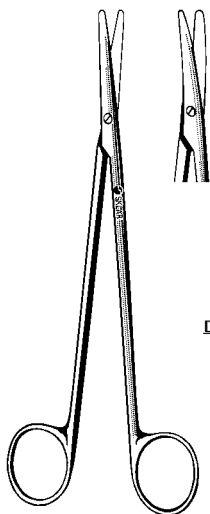

**DELICATE**

**PREMIUM GRADE**

## **METZENBAUM DISSECTING SCISSORS DELICATE**

Straight		Curved	
22-1071	7"	22-1070	7"
55-9184	8"	55-9084	8"
		55-9094	9" (Nelson)

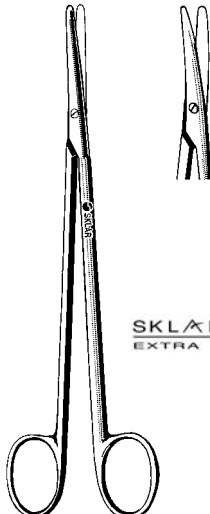

**SKLARLITE XD™  
EXTRA DELICATE**

**PREMIUM GRADE**

## **SKLARLITE EXTRA DELICATE™ METZENBAUM DISSECTING SCISSORS**

Straight		Curved	
23-1184	7"	23-1186	7"

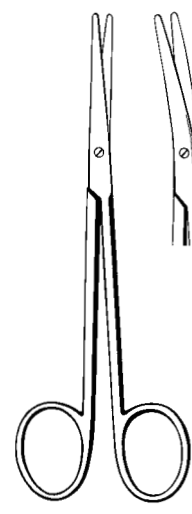

**ECONO**

## **METZENBAUM DISSECTING SCISSORS, ECONO**

Box/12		
21-339	7"	21-340
		7"

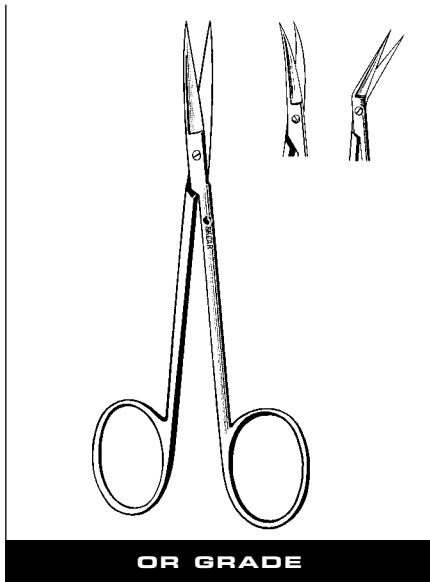

**OR GRADE**

### IRIS SCISSORS

Straight S/S	Curved S/S	Angular S/S
47-1135 3/2"	47-1235 3/2"	64-2142 4/2"
47-1145 4/2"	47-1245 4/2"	

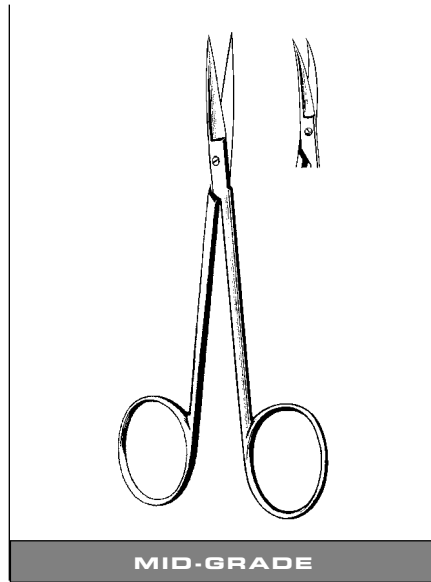

**MID-GRADE**

### MID-GRADE IRIS SCISSORS

Straight S/S	Curved S/S
95-103 3/2"	95-107 3/2"
95-104 4/2"	95-109 4/2"

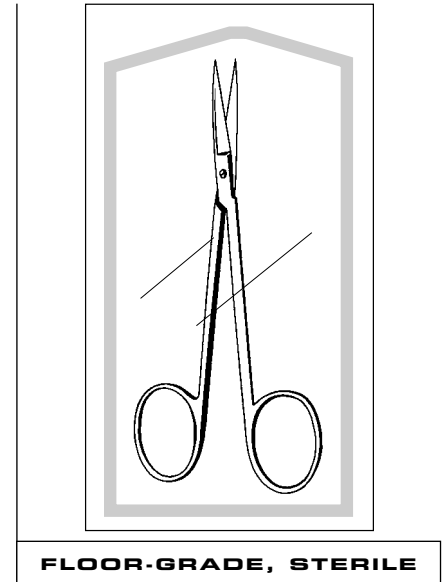

**FLOOR-GRADE, STERILE**

### IRIS SCISSORS, STERILE

Box/50		
96-2504 4/2"	Str.	
96-2506 4/2"	Cvd.	
Box/25		
96-2505 4/2"	Str.	
96-2507 4/2"	Cvd.	

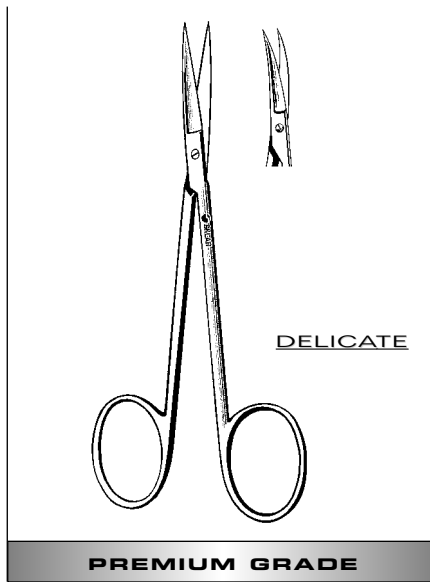

**PREMIUM GRADE**

### IRIS SCISSORS DELICATE

Straight S/S	Curved S/S
22-1135 3/2"	22-1235 3/2"
47-1246 4/2"	47-1248 4/2"



**PREMIUM GRADE**

### SKLARLITE EXTRA DELICATE™ IRIS SCISSORS

Straight S/S	Curved S/S
23-1152 3/2"	23-1154 3/2"
23-1153 4/2"	23-1155 4/2"

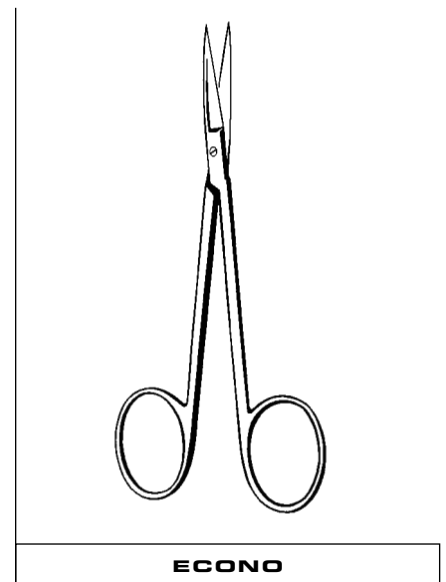

**ECONO**

### IRIS SCISSORS, ECONO

Box/12		
Straight		Curved
21-102 2/2"		21-107 3/2"
21-103 3/2"		21-109 4/2"
21-104 4/2"		

# STRABISMUS SCISSORS

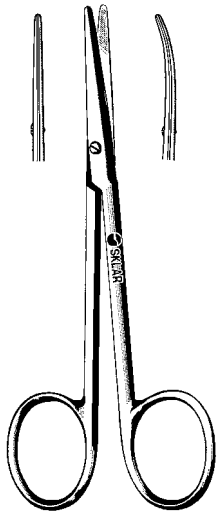

**OR GRADE**

## **STRABISMUS SCISSORS**

Straight	Curved
64-1442 4½"	64-1542 4½"

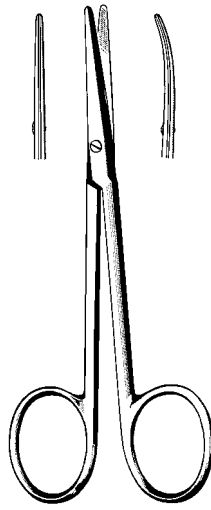

**MID-GRADE**

## **MID-GRADE STRABISMUS SCISSORS**

Straight	Curved
95-360 4½"	95-361 4½"

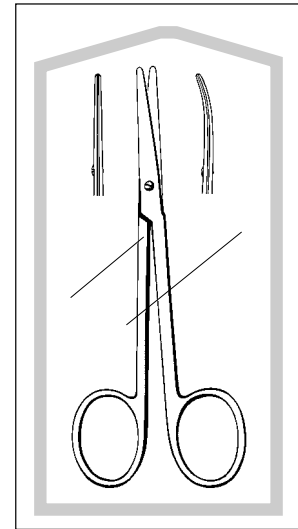

**FLOOR-GRADE, STERILE**

## **STRABISMUS SCISSORS, STERILE**

Box/50		
96-2540 4½"	Str.	
96-2541 4½"	Cvd.	

Box/25		
96-2542 4½"	Str.	
96-2543 4½"	Cvd.	

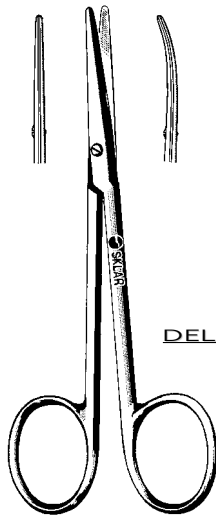

**DELICATE**

**PREMIUM GRADE**

## **STRABISMUS SCISSORS DELICATE**

Straight	Curved
22-1442 4½"	22-1542 4½"

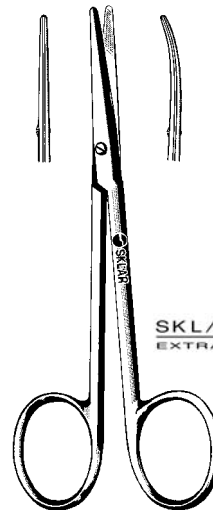

**SKLARLITE XD™  
EXTRA DELICATE**

**PREMIUM GRADE**

## **SKLARLITE EXTRA DELICATE™ STRABISMUS SCISSORS**

Straight	Curved
23-1162 4½"	23-1163 4½"



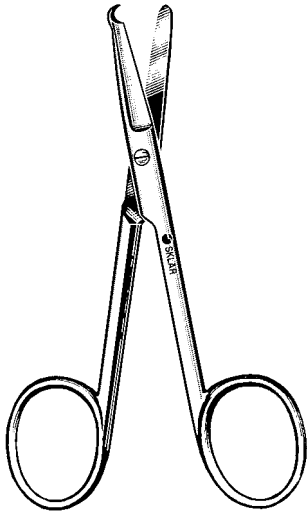

**OR GRADE**

**LITTAUER STITCH SCISSORS**

15-1355 5½"

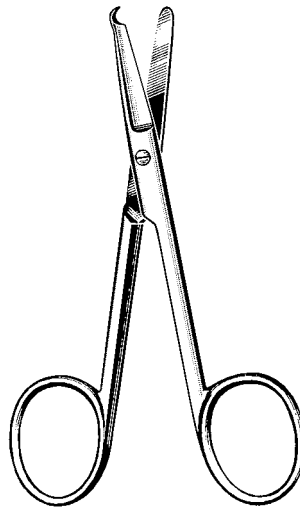

**MID-GRADE**

**MID-GRADE  
LITTAUER STITCH SCISSORS**

95-358 5½"

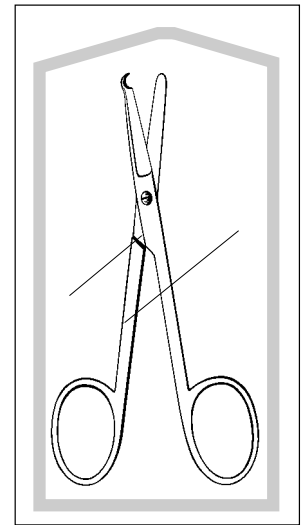

**FLOOR-GRADE, STERILE**

**LITTAUER STITCH SCISSORS,  
STERILE**

Box/50  
96-2512 5½"

Box/25  
96-2513 5½"

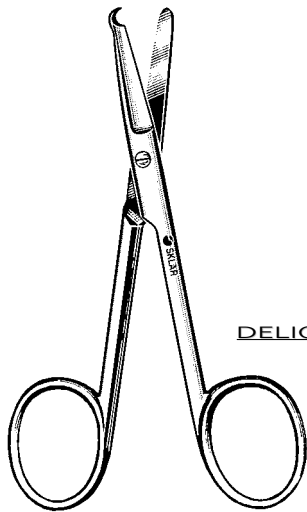

DELICATE

**PREMIUM GRADE**

**LITTAUER STITCH SCISSORS  
DELICATE**

22-1354 5½"

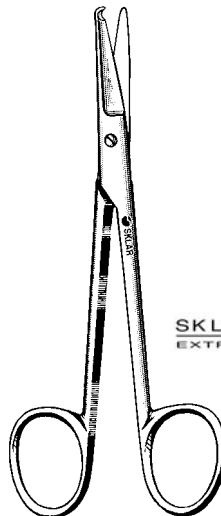

SKLARLITE XD™  
EXTRA DELICATE

**PREMIUM GRADE**

**SKLARLITE EXTRA DELICATE™  
LITTAUER STITCH SCISSORS**

23-1195 5½"

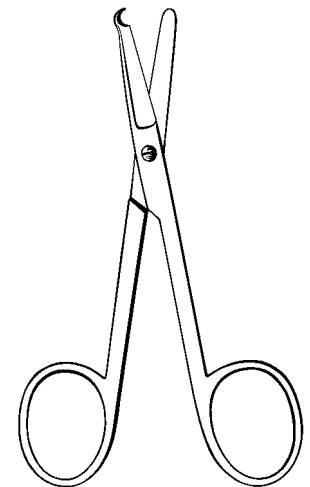

**ECONO**

**LITTAUER STITCH SCISSORS,  
ECONO**

Box/12  
21-358 5½"

# SUTURE & STITCH SCISSORS

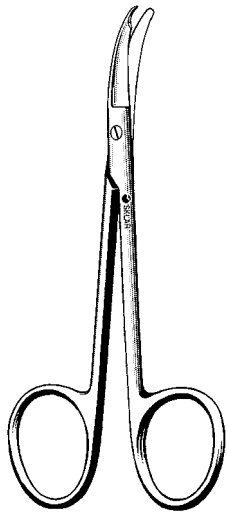

OR GRADE

## SUTURE SCISSORS

22-2935 3½" Shortbent  
22-2947 4¾" Northbent

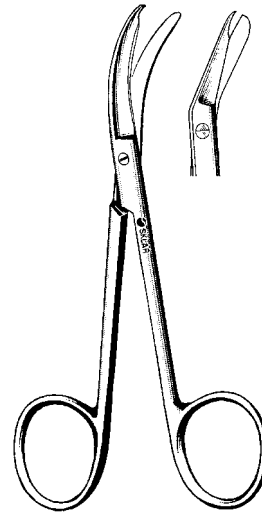

OR GRADE

## SKLAR STITCH SCISSORS

22-2950 5" Curved Sideways  
15-3150 5" Angular

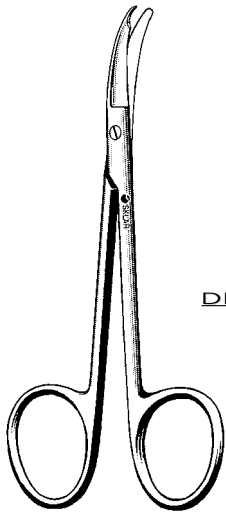

DELICATE

PREMIUM GRADE

## SUTURE SCISSORS DELICATE

22-2934 3½" Shortbent

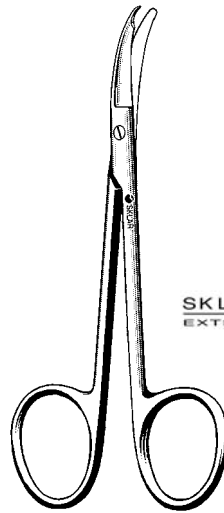

SKLARLITE XD™  
EXTRA DELICATE

PREMIUM GRADE

## SKLARLITE EXTRA DELICATE™ SUTURE SCISSORS

23-1196 3½" Shortbent

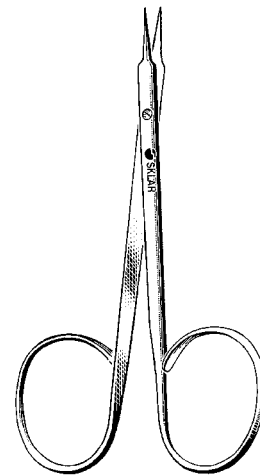

OR GRADE

## RIBBON STITCH SCISSORS

Straight Curved  
64-1345 4" 64-1445 4"

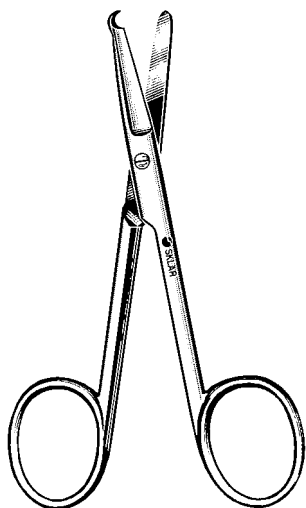

**OR GRADE**

**SPENCER STITCH SCISSORS**

22-2835 3½"  
22-2845 4½"

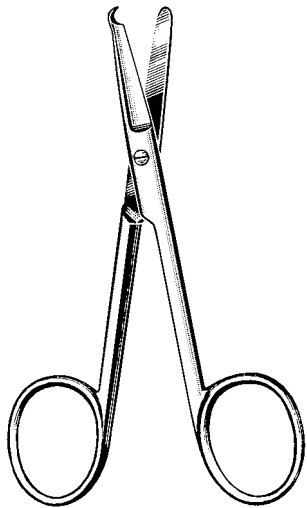

**MID-GRADE**

**MID-GRADE  
SPENCER STITCH SCISSORS**

95-346 3½"  
95-352 4½"

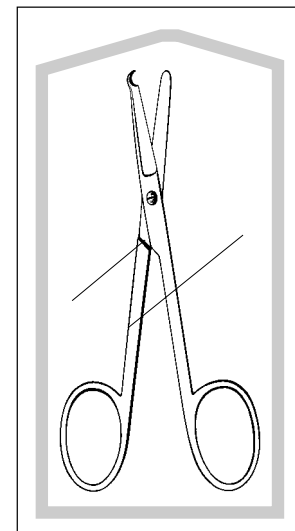

**FLOOR-GRADE, STERILE**

**SPENCER STITCH SCISSORS,  
STERILE**

Box/50  
96-2596 4½"  
Box/25  
96-2598 4½"

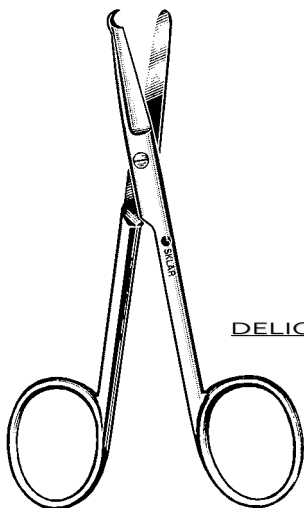

**DELICATE**

**PREMIUM GRADE**

**SPENCER STITCH SCISSORS  
DELICATE**

22-2834 3½"  
22-2844 4½"

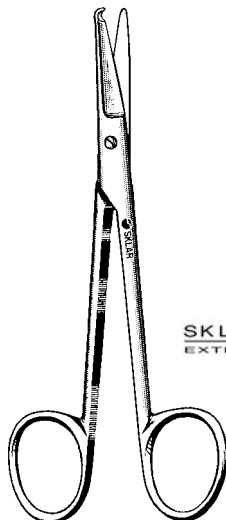

**SKLARLITE XD™  
EXTRA DELICATE**

**PREMIUM GRADE**

**SKLARLITE EXTRA DELICATE™  
SPENCER STITCH SCISSORS**

23-1193 3½"  
23-1194 4½"

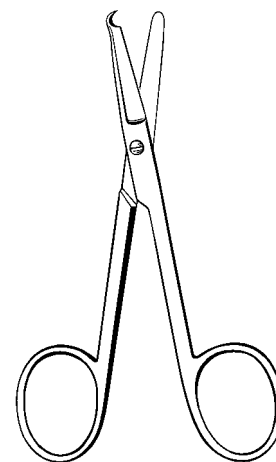

**ECONO**

**SPENCER STITCH SCISSORS,  
ECONO**

Box/12  
21-346 3½"  
21-352 4½"

# STEVENS TENOTOMY SCISSORS

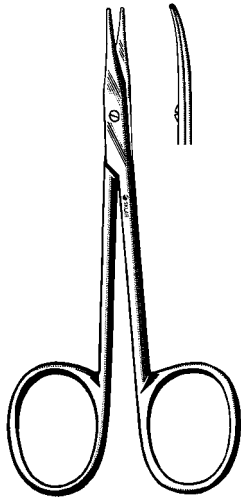

**OR GRADE**

## **STEVENS TENOTOMY SCISSORS**

Straight	Curved
B/B	B/B
64-1242 4½"	64-1342 4½"

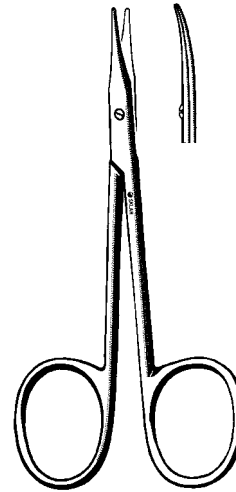

**DELICATE**

**PREMIUM GRADE**

## **STEVENS TENOTOMY SCISSORS DELICATE**

Straight	Curved
22-1242 4½" B/B	22-1342 4½" B/B
22-1240 4½" S/S	22-1241 4½" S/S

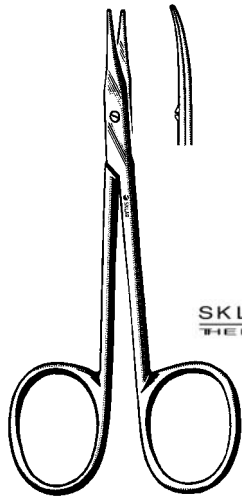

**SKLARLITE™**  
THE LIGHT TOUCH

**PREMIUM GRADE**

## **SKLARLITE™ STEVENS TENOTOMY SCISSORS**

Straight	Curved
B/B	B/B
23-1156 4½"	23-1157 4½"

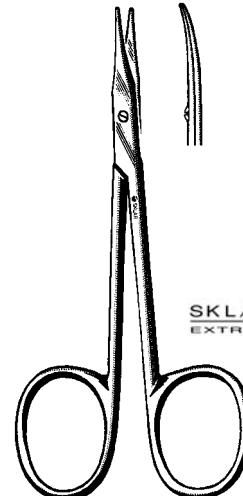

**SKLARLITE XD™**  
EXTRA DELICATE

**PREMIUM GRADE**

## **SKLARLITE EXTRA DELICATE™ STEVENS TENOTOMY SCISSORS**

Straight	Curved
B/B	B/B
23-1160 4½"	23-1161 4½"



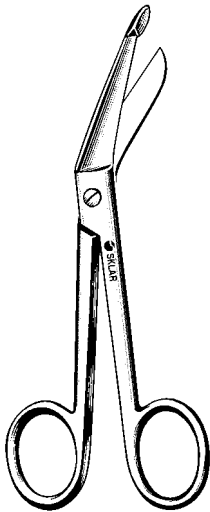

**OR GRADE**

**LISTER BANDAGE SCISSORS**

- 11-1035 3½"
- 11-1045 4½"
- 11-1055 5½"
- 11-1072 7¼"
- 11-1080 8"
- 11-1060 8" Large Ring
- 11-1078 8¼" Heavy Pattern

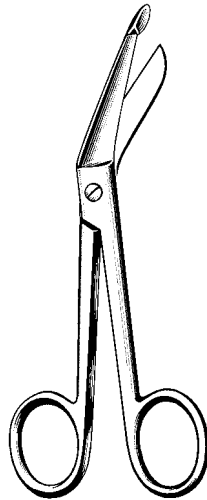

**MID-GRADE**

**MID-GRADE  
LISTER BANDAGE SCISSORS**

- 95-222 3½"
- 95-226 4½"
- 95-231 5½"
- 95-241 7¼"

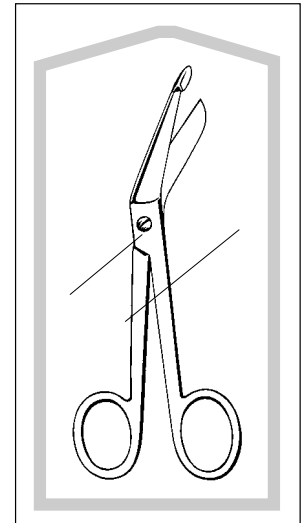

**FLOOR-GRADE, STERILE**

**LISTER BANDAGE SCISSORS  
STERILE**

- Box/50
- 96-2502 5½"
- Box/25
- 96-2503 5½"

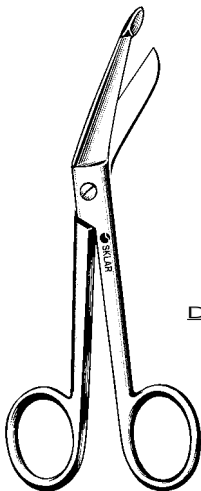

**DELICATE**

**PREMIUM GRADE**

**LISTER BANDAGE SCISSORS  
DELICATE**

- 22-1054 5½"
- 22-1072 7¼"

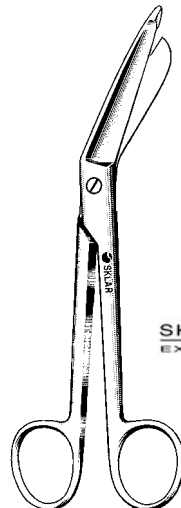

**SKLARLITE XD™  
EXTRA DELICATE**

**PREMIUM GRADE**

**SKLARLITE EXTRA DELICATE™  
LISTER BANDAGE SCISSORS**

- 23-1202 5½"
- 23-1203 7¼"

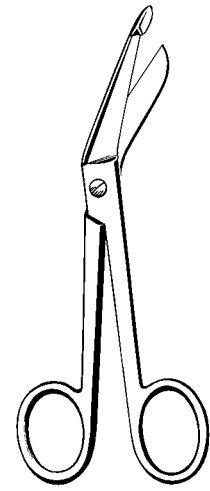

**ECONO**

**LISTER BANDAGE SCISSORS,  
ECONO**

- Box/12
- 21-222 3½"
- 21-226 4½"
- 21-231 5½"
- 21-237 5½" W/Clip
- 21-241 7¼"

# WIRE CUTTING SCISSORS

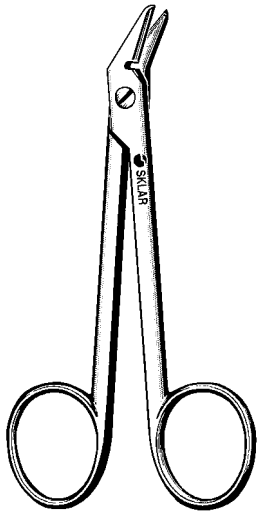

**OR GRADE**

## WIRE CUTTING SCISSORS

24-2342 4 3/4" Angular Serrated  
24-2349 4 3/4" Angular Serrated, Heavy Pattern

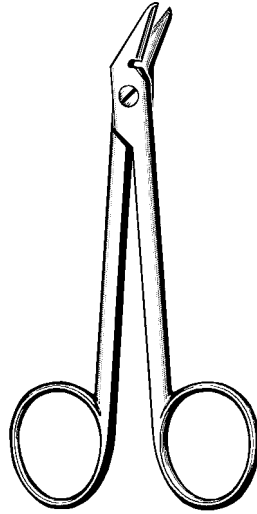

**MID-GRADE**

## MID-GRADE WIRE CUTTING SCISSORS

95-364 4 3/4" Angular Serrated

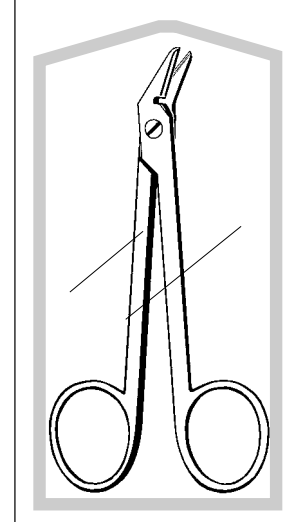

**FLOOR-GRADE, STERILE**

## WIRE CUTTING SCISSORS, STERILE

Box/50  
96-2518 4 3/4"  
Box/25  
96-2519 4 3/4"

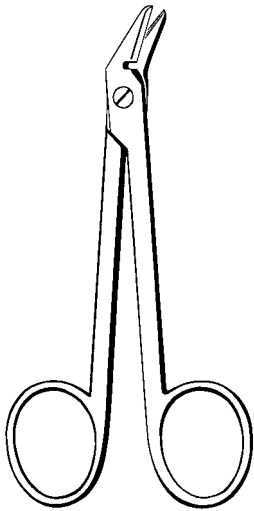

**ECONO**

## WIRE CUTTING SCISSORS, ECONO

Box/12  
Straight Angular  
21-363 4 1/2" 21-364 4 1/2"

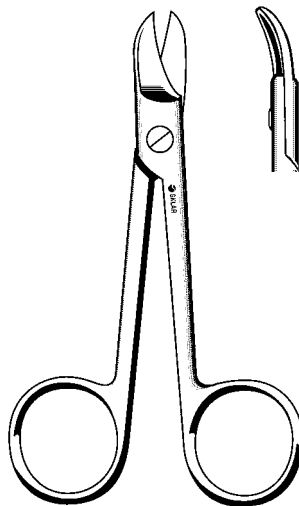

## CROWN & COLLAR CUTTING SCISSORS

Straight Curved  
24-2345 4" 24-2346 4"  
24-2340 4" Serr 24-2341 4" Serr

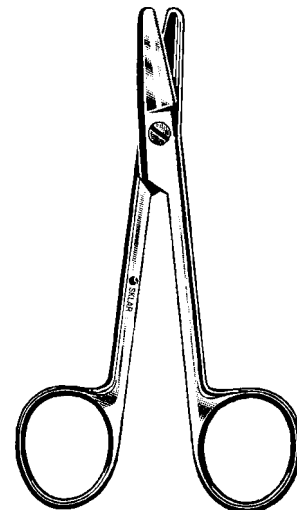

## SUTURE WIRE CUTTING SCISSORS

24-2347 4 3/4" Straight  
Serrated Edges

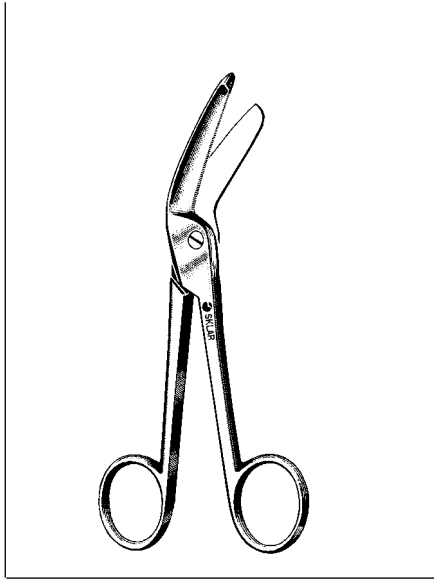

**HERCULES UTILITY SCISSORS**

11-1297 7½" Serrated

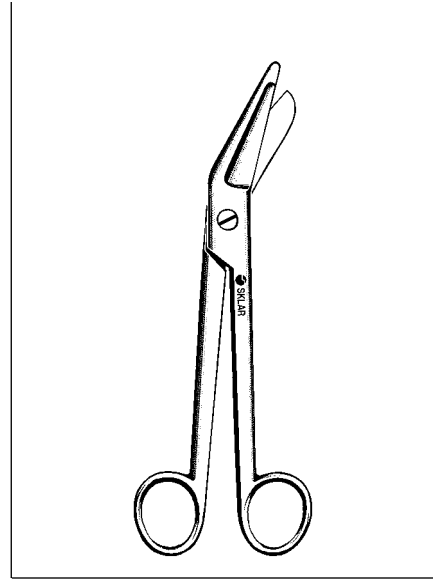

**ESMARCH PLASTER SHEARS**

Heavy Pattern

11-1380 8"

11-1390 9"

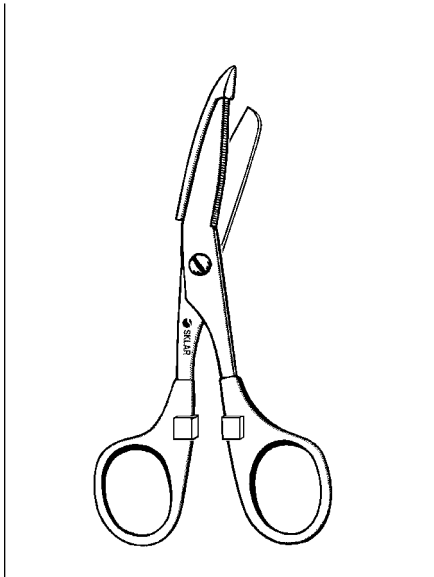

**NURSES' BANDAGE SCISSORS**

11-1495 5½" Pink finger rings with safety guards

11-1496 5½" Blue finger rings with safety guards

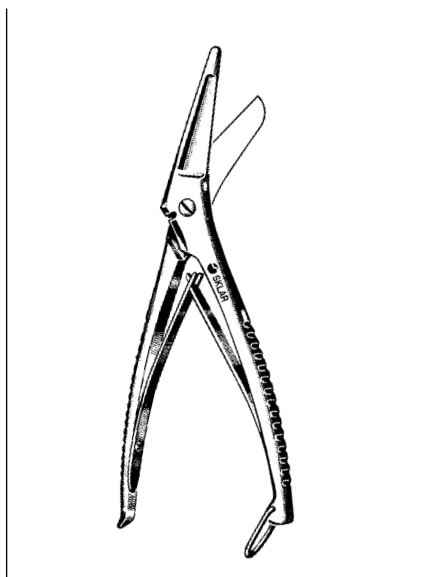

**COMMANDER UTILITY SHEARS**

Heavy Duty with Wire Cutting Notch

11-1298 8½"

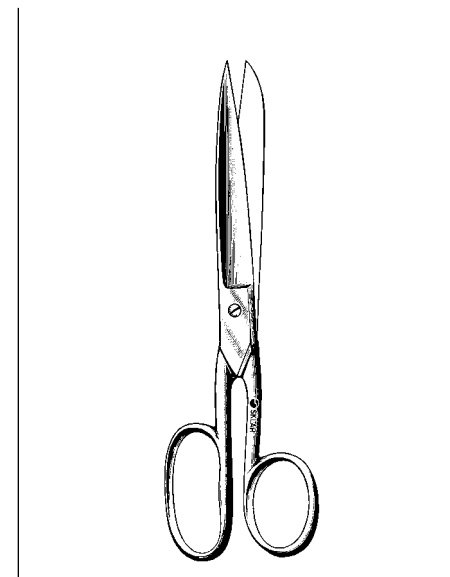

**USA PATTERN GAUZE SCISSORS**

11-1180 8"

# BANDAGE/UTILITY SCISSORS

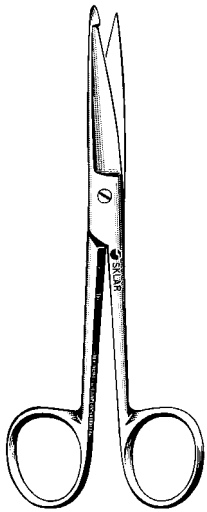

**OR GRADE**

## **KNOWLES BANDAGE SCISSORS**

11-1255 5½"

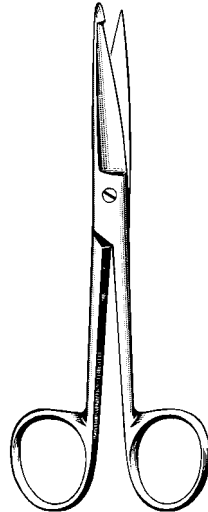

**MID-GRADE**

## **MID-GRADE KNOWLES BANDAGE SCISSORS**

95-254 5½"

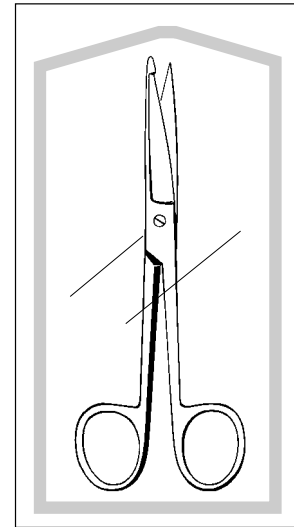

**FLOOR-GRADE, STERILE**

## **KNOWLES BANDAGE SCISSORS, STERILE**

Box/50  
96-2402 5½"  
Box/25  
96-2404 5½"

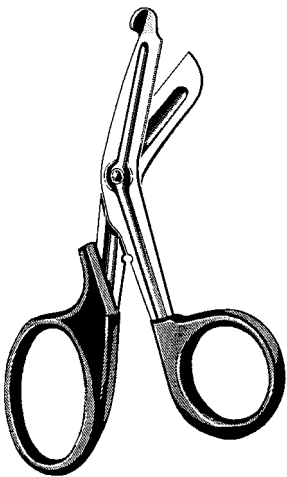

**OR GRADE**

## **MULTI-CUT UTILITY SCISSORS**

Serrated  
11-1278 6" Standard  
11-1280 7½" Standard  
11-1281 7½" Blue  
11-1282 7½" Green  
11-1283 7½" Red  
11-1284 7½" White

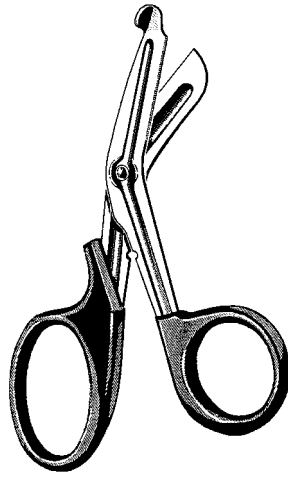

**MID-GRADE**

## **MID-GRADE MULTI-CUT UTILITY SCISSORS**

Serrated  
95-105 7½" Standard

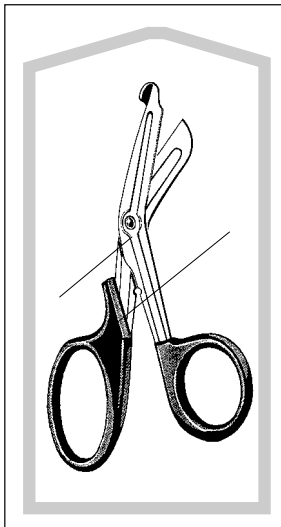

**FLOOR-GRADE, STERILE**

## **MULTI-CUT UTILITY SCISSORS, STERILE**

Box/50  
96-2702 5½"      Box/25  
96-2704 7"      96-2701 5½"  
96-2703 7"

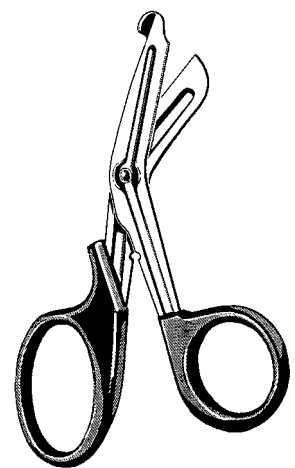

**ECONO**

## **MULTI-CUT UTILITY SCISSORS, ECONO**

Box/12  
21-101 5½"  
21-105 7"



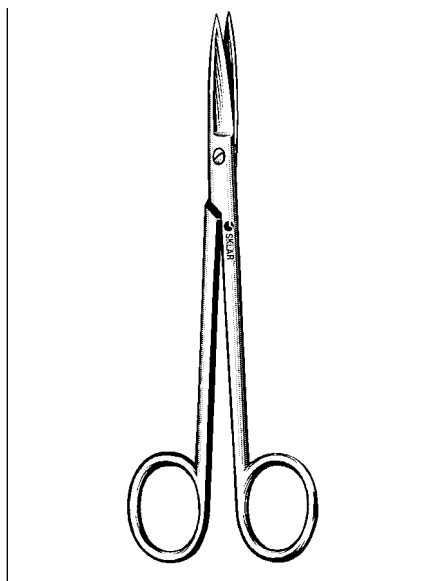

**JOSEPH SCISSORS**

41-1050 5 1/4" Straight  
41-1054 5 3/4" Curved

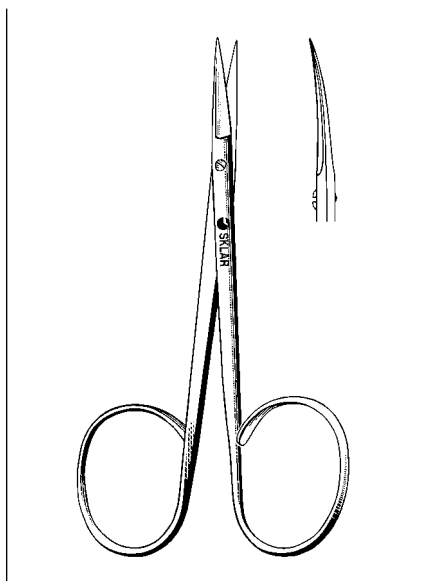

**RIBBON IRIS SCISSORS**

Straight Curved  
47-1250 4" 47-1255 4"

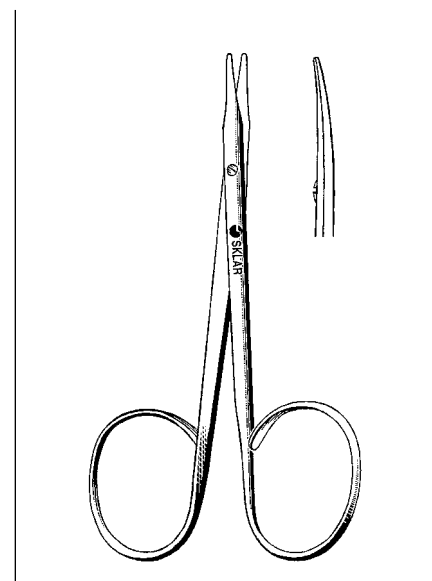

**RIBBON STEVENS  
TENOTOMY SCISSORS**

Straight Curved  
64-1241 4" 64-1341 4"

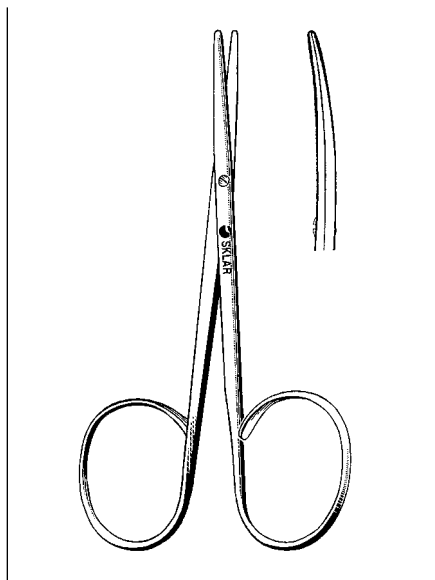

**RIBBON STRABISMUS  
SCISSORS**

Straight Curved  
64-1240 4" 64-1340 4"

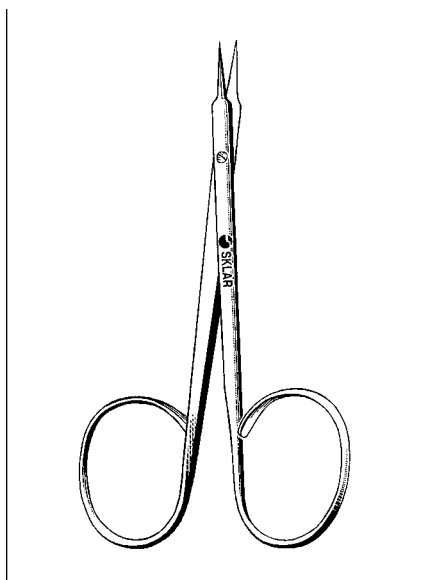

**RIBBON STITCH  
SCISSORS**

64-1345 4" Straight  
64-1445 4" Curved

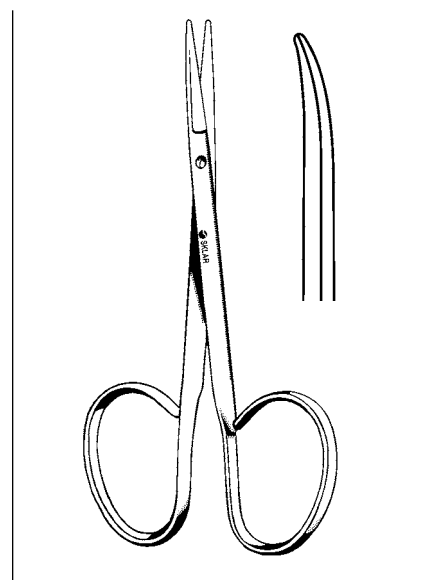

**RIBBON UTILITY  
SCISSORS**

47-1146 4" Straight  
47-1247 4" Curved

# DERMAL - SCISSORS

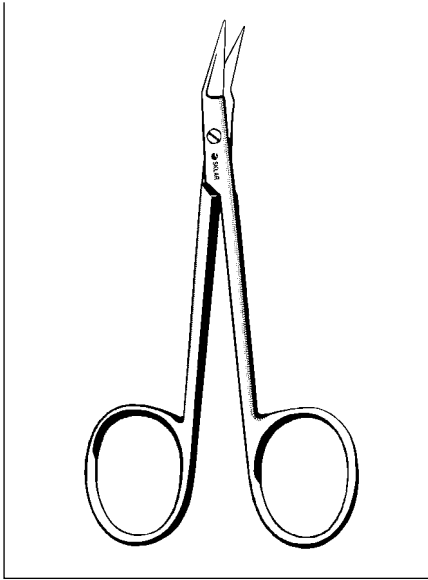

## **O'BRIEN STITCH SCISSORS**

Angled Blade  
 22-2837 3 1/4"  
 22-2838 4"

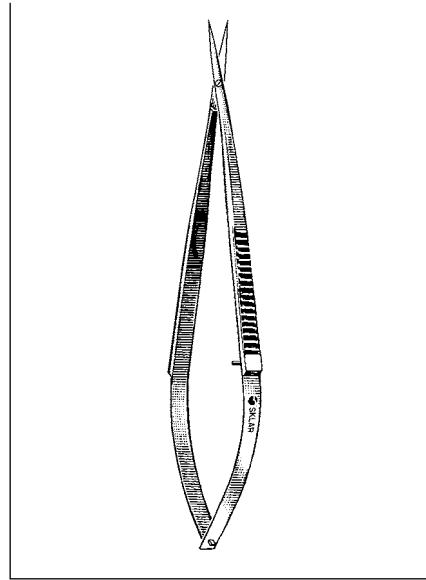

## **FINE STITCH SCISSORS**

64-3260 4 1/4" Delicate Sharp Blades

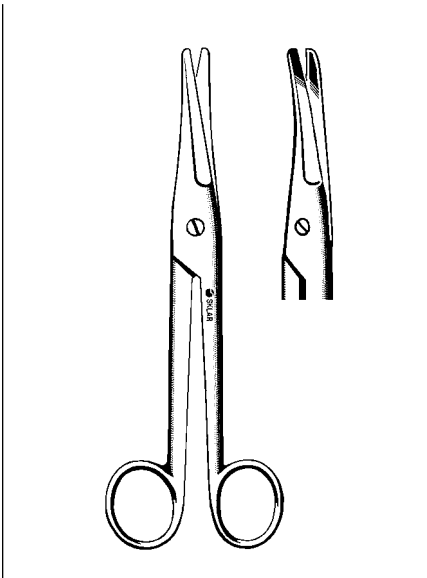

## **MAYO-NOBLE DISSECTING SCISSORS**

Beveled Blade  
 Straight  
 15-1762 6 1/2"  
 Curved  
 15-2762 6 1/2"

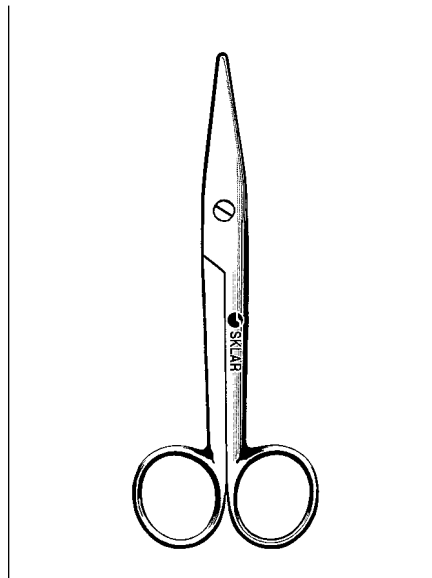

## **MAYO-NOBLE-STILLE DISSECTING SCISSORS**

Straight  
 15-1862 6"  
 Curved  
 15-2862 6"

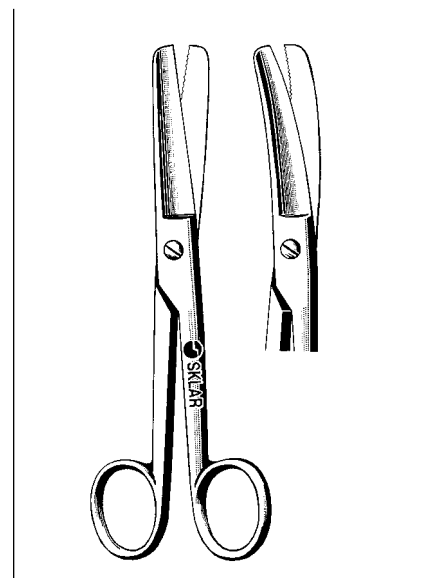

## **DOYEN SCISSORS**

Straight  
 15-1307 7"  
 15-1308 7" Serrated  
 Curved  
 15-2307 7"  
 15-2308 7" Serrated

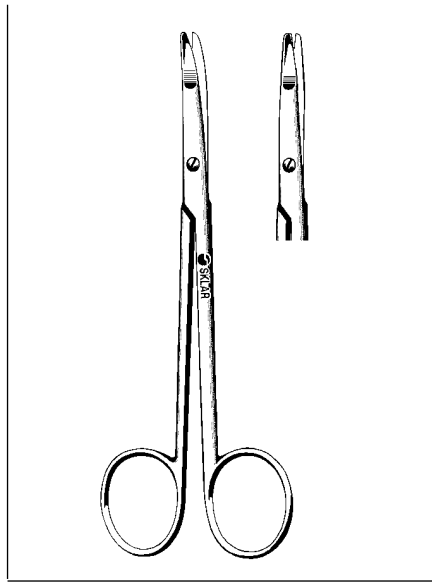

**RAGNELL DISSECTING  
SCISSORS (FLAT TIPS)**

22-2652 5" Half Curved  
22-2653 5" Straight

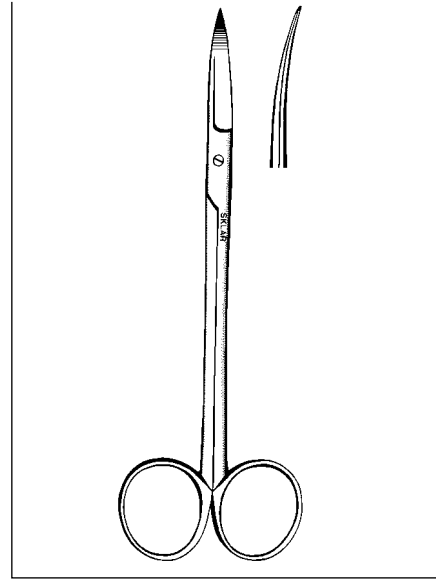

**RHYTIDECTOMY  
SCISSORS**

Double Edged Blade  
41-1105 6½" Curved

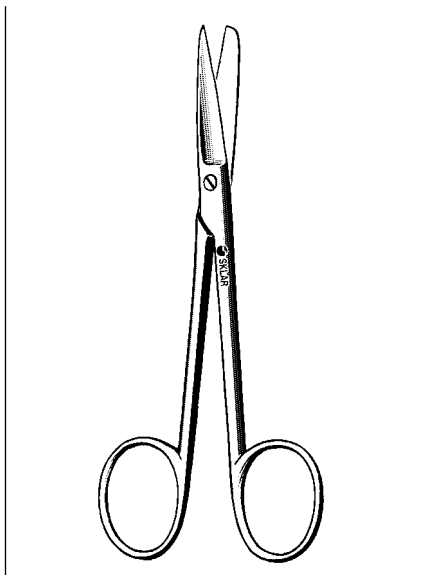

**WAGNER SCISSORS  
STRAIGHT**

Smooth  
47-1047 S/S 4½"  
47-1048 S/B 4½"  
47-1070 B/B 4½"  
Serrated  
47-1049 S/S 4½"

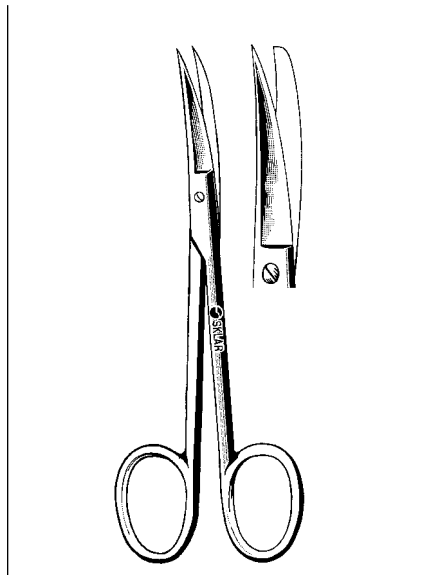

**WAGNER SCISSORS  
CURVED**

Smooth  
47-1058 S/S 4½"  
47-1068 S/B 4½"  
Serrated  
47-1059 S/S 4½"  
47-1069 S/B 4½"

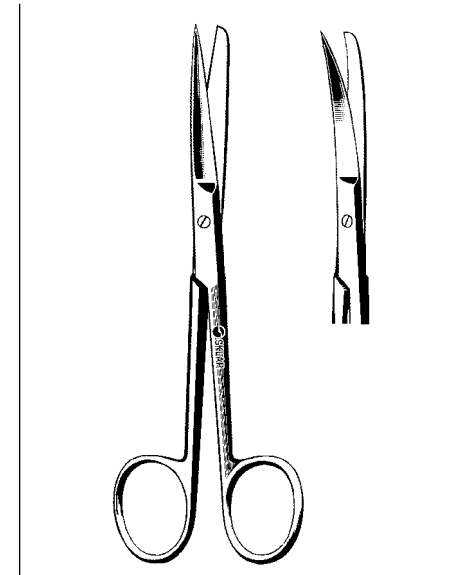

**DEAVER SCISSORS DELICATE**

Straight  
13-1155 S/S 5½"  
14-1155 S/B 5½"  
15-1155 B/B 5½"  
Curved  
13-2155 S/S 5½"  
14-2155 S/B 5½"

# ENT/PLASTIC SURGERY SCISSORS

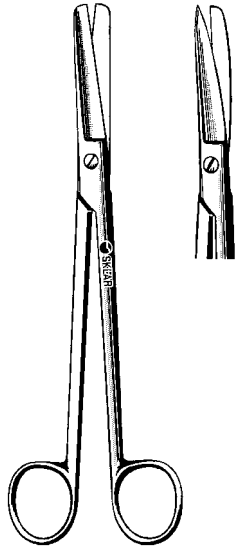

## **SIMS SCISSORS**

Straight		Curved	
90-1280	8" S/S	90-1580	8" S/S
90-1180	8" S/B	90-1480	8" S/B
90-1080	8" B/B	90-1380	8" B/B

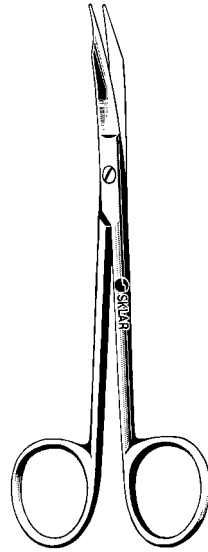

## **GOLDMAN-FOX SCISSORS**

Curved  
22-2520 5" Serrated

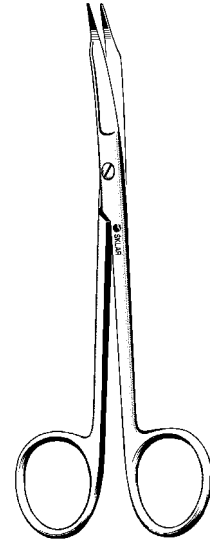

## **MILLER DISSECTING SCISSORS**

Back Edges Semi-Sharp  
41-1125 5" Serrated

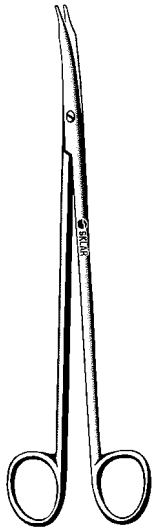

## **REYNOLDS SCISSORS**

Narrow Tip, Curved  
22-2760 6"  
22-2762 6" Serrated

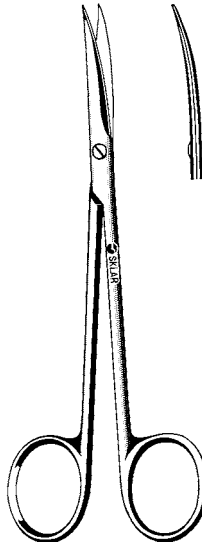

## **BROPHY (SULLIVAN) SCISSORS**

Curved Sharp Points  
22-2755 5 3/4" Serrated

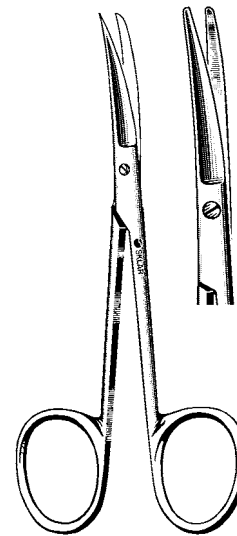

## **KNAPP IRIS SCISSORS**

Curved  
64-3230 4" Sharp/Blunt  
64-3235 4" Blunt/Blunt

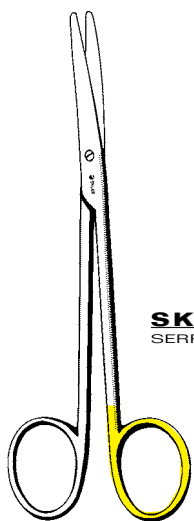

**SKLARCUT™**  
SERRATED BLADE

PREMIUM GRADE

**SKLARCUT™ METZENBAUM (LAHEY) SCISSORS**

Curved  
15-3570 5¼"

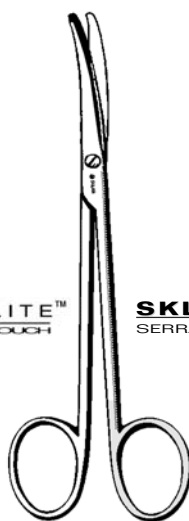

**SKLARLITE™**  
THE LIGHT TOUCH

**SKLARCUT™**  
SERRATED BLADE

PREMIUM GRADE

**SKLARLITE SKLARCUT™ METZENBAUM (LAHEY) SCISSORS**

Curved  
23-1280 5¼"



**SKLARCUT™**  
SERRATED BLADE

PREMIUM GRADE

**SKLARCUT™ METZENBAUM DISSECTING SCISSORS**

Curved  
15-3575 7"



**SKLARLITE™**  
THE LIGHT TOUCH

**SKLARCUT™**  
SERRATED BLADE

PREMIUM GRADE

**SKLARLITE SKLARCUT™ METZENBAUM DISSECTING SCISSORS**

Curved, Blunt  
23-1267 7"



**SKLARCUT™**  
SERRATED BLADE

PREMIUM GRADE

**SKLARCUT™ IRIS SCISSORS**

Straight 15-3585 4½"    Curved 15-3590 4½"



**SKLARLITE™**  
THE LIGHT TOUCH

**SKLARCUT™**  
SERRATED BLADE

PREMIUM GRADE

**SKLARLITE SKLARCUT™ IRIS SCISSORS**

Straight 23-1268 4½"    Curved 23-1270 4½"

# PREMIUM SKLARCUT™ SCISSORS

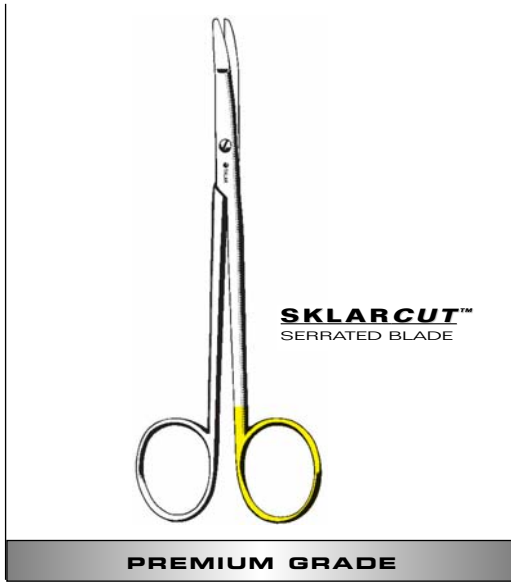

## **SKLARCUT™ RAGNELL DISSECTING SCISSORS**

Curved  
15-3320 5"

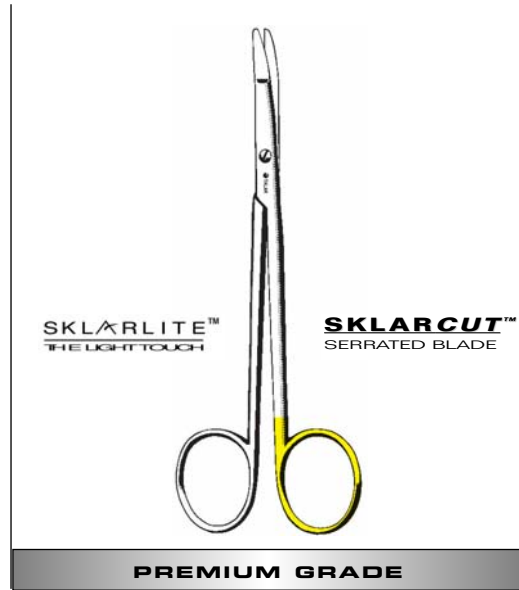

## **SKLARLITE SKLARCUT™ RAGNELL DISSECTING SCISSORS**

Curved  
23-1250 5"

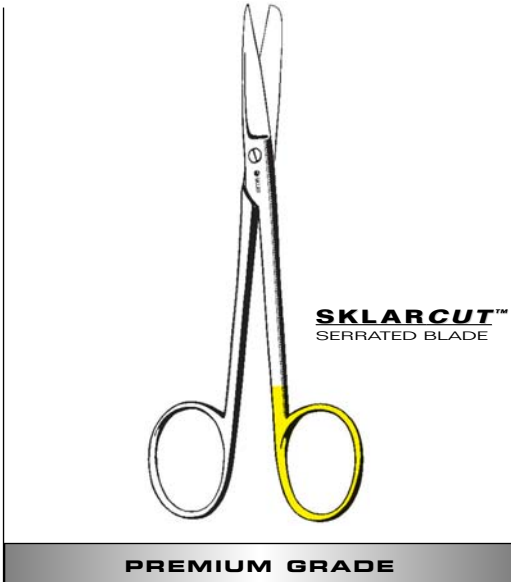

## **SKLARCUT™ WAGNER SCISSORS**

Straight  
15-3542 4½" S/B

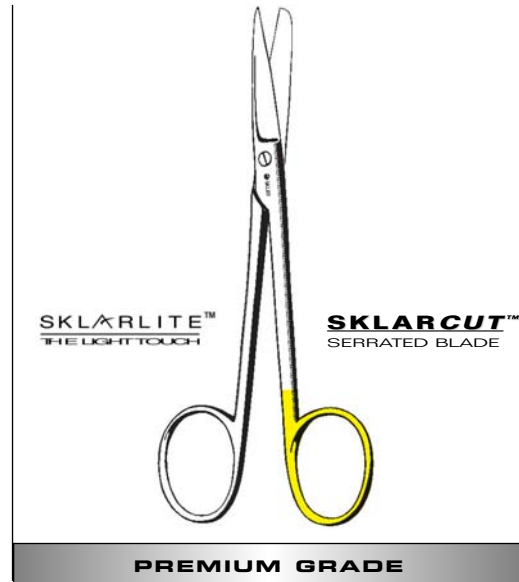

## **SKLARLITE SKLARCUT™ WAGNER SCISSORS**

Straight  
23-1254 4½" S/B

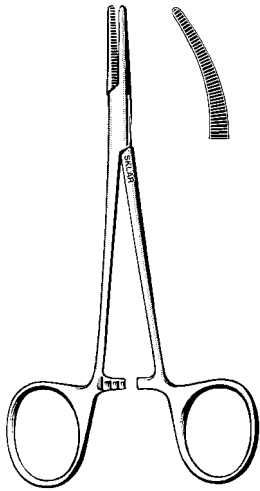

**OR GRADE**

**HALSTED MOSQUITO FORCEPS**

Straight	Curved
17-1450 5"	17-1550 5"
17-1650 1x2 5"	17-1750 1x2 5"
17-1459 5" Heavy Pattern	17-1559 5" Heavy Pattern

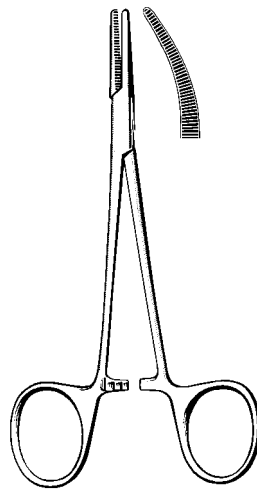

**MID-GRADE**

**MID-GRADE HALSTED MOSQUITO FORCEPS**

Straight	Curved
95-426 5"	95-431 5"

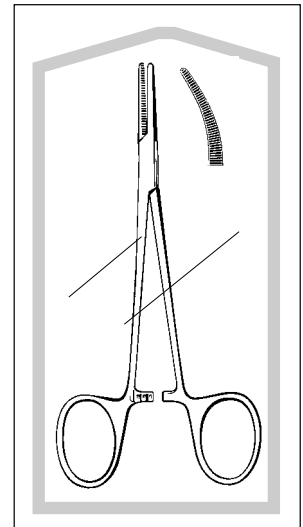

**FLOOR-GRADE, STERILE**

**HALSTED MOSQUITO FORCEPS, STERILE**

Box/50		
96-2536 5"	Str.	
96-2538 5"	Cvd.	
Box/25		
96-2537 5"	Str.	
96-2539 5"	Cvd.	

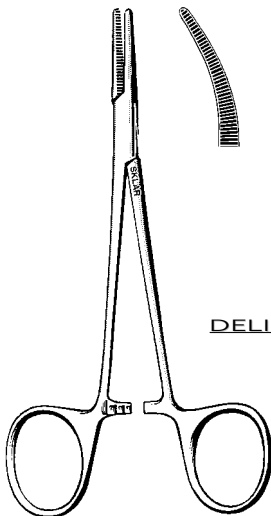

**DELICATE**

**PREMIUM GRADE**

**HALSTED MOSQUITO FORCEPS DELICATE**

Straight	Curved
18-1050 5"	18-1150 5"

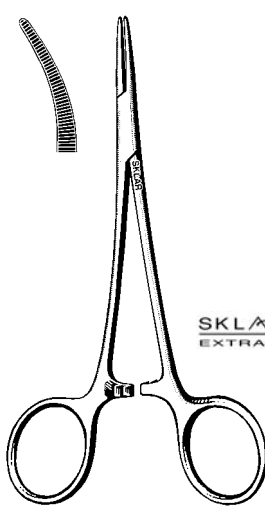

**SKLARLITE XD™ EXTRA DELICATE**

**PREMIUM GRADE**

**SKLARLITE EXTRA DELICATE™ HALSTED MOSQUITO FORCEPS**

Straight	Curved
23-2505 5"	23-2506 5"

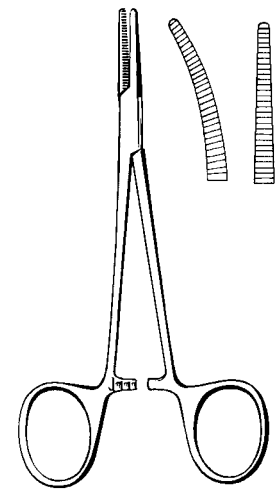

**ECONO**

**HALSTED MOSQUITO FORCEPS, ECONO**

Box/12		
Straight	Curved	
21-426 5"	21-431 5"	

# CRILE HEMOSTATIC FORCEPS

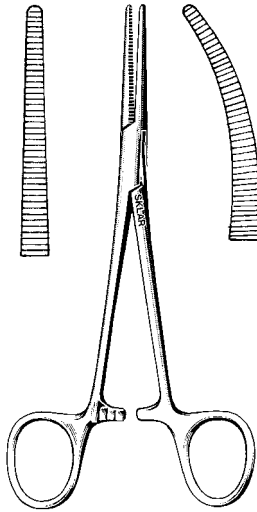

**OR GRADE**

## CRILE HEMOSTATIC FORCEPS

Straight		Curved	
17-3055	5½"	17-3155	5½"
17-3062	6¼"	17-3162	6¼"
17-3075	7½"	17-3175	7½"
17-3068	6¼" Heavy Pattern	17-3168	6¼" Heavy Pattern

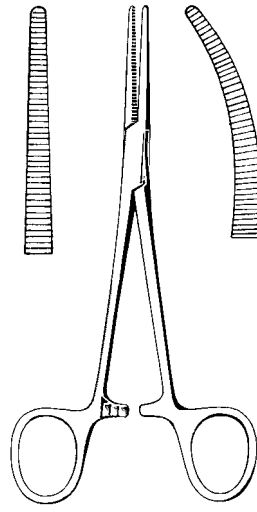

**MID-GRADE**

## MID-GRADE CRILE HEMOSTATIC FORCEPS

Straight		Curved	
95-447	5½"	95-452	5½"
95-458	6¼"	95-463	6¼"

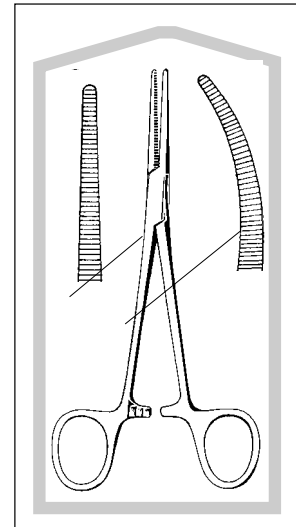

**FLOOR-GRADE, STERILE**

## CRILE HEMOSTATIC FORCEPS, STERILE

Box/50		
96-2550	5½"	Str.
96-2552	5½"	Cvd.
Box/25		
96-2551	5½"	Str.
96-2553	5½"	Cvd.

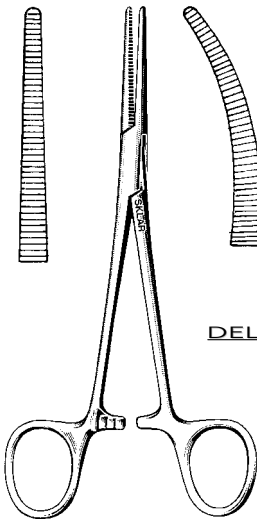

**DELICATE**

**PREMIUM GRADE**

## CRILE HEMOSTATIC FORCEPS DELICATE

Straight		Curved	
18-1952	5½"	18-2052	5½"

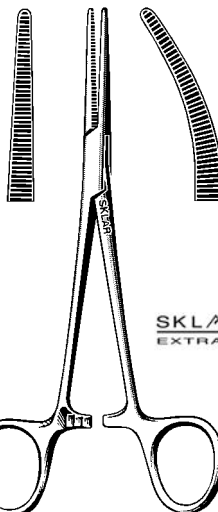

**SKLARLITE XD™  
EXTRA DELICATE**

**PREMIUM GRADE**

## SKLARLITE EXTRA DELICATE™ CRILE HEMOSTATIC FORCEPS

Straight		Curved	
23-2510	5½"	23-2513	5½"

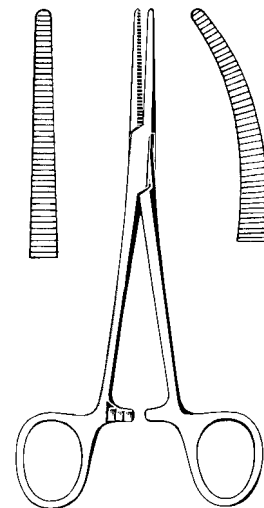

**ECONO**

## CRILE HEMOSTATIC FORCEPS, ECONO

Box/12			
Straight		Curved	
21-447	5½"	21-452	5½"



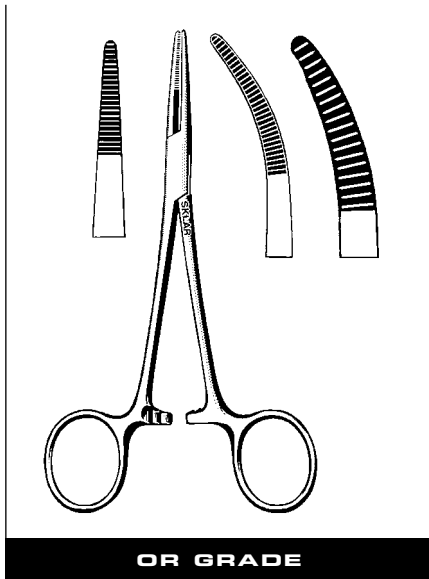

**OR GRADE**

### KELLY HEMOSTATIC FORCEPS

Straight	Curved
17-2055 5½"	17-2155 5½"
74-3260 7" Heavy Pattern	74-3270 7" Heavy Pattern

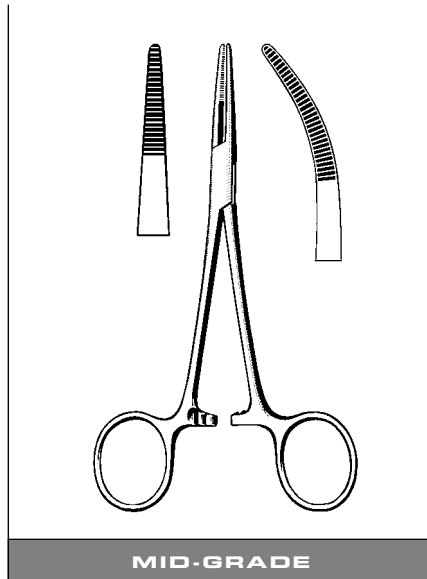

**MID-GRADE**

### MID-GRADE KELLY HEMOSTATIC FORCEPS

Straight	Curved
95-436 5½"	95-442 5½"

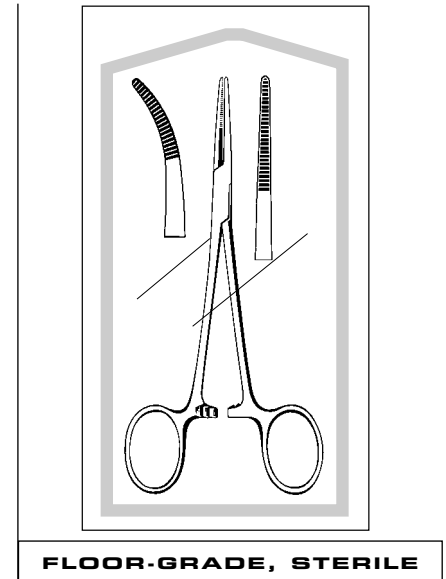

**FLOOR-GRADE, STERILE**

### KELLY HEMOSTATIC FORCEPS, STERILE

Box/50		
96-2560 5½"	Str.	
96-2562 5½"	Cvd.	
Box/25		
96-2561 5½"	Str.	
96-2563 5½"	Cvd.	

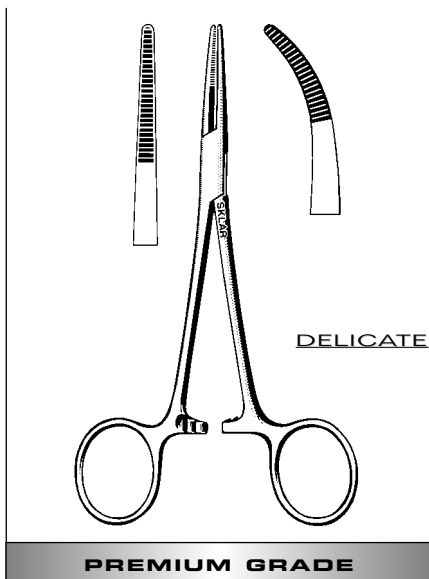

**PREMIUM GRADE**

### KELLY HEMOSTATIC FORCEPS DELICATE

Straight	Curved
18-1552 5½"	18-1652 5½"

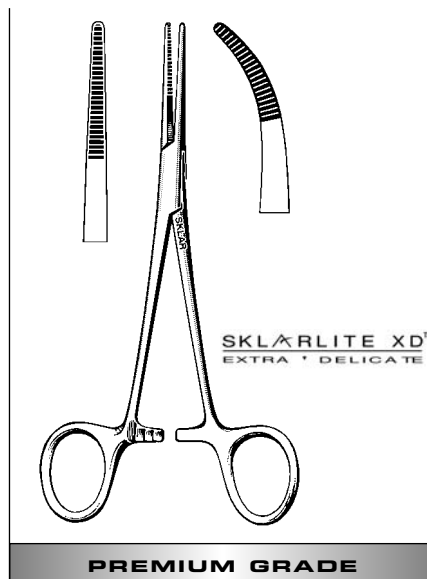

**PREMIUM GRADE**

### SKLARLITE EXTRA DELICATE™ KELLY HEMOSTATIC FORCEPS

Straight	Curved
23-2507 5½"	23-2508 5½"

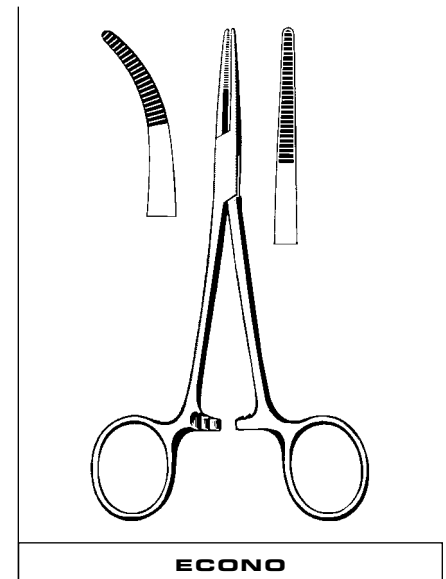

**ECONO**

### KELLY HEMOSTATIC FORCEPS, ECONO

Box/12		
Straight	Curved	
21-436 5½"	21-442 5½"	

# HARTMANN MOSQUITO HEMOSTATS

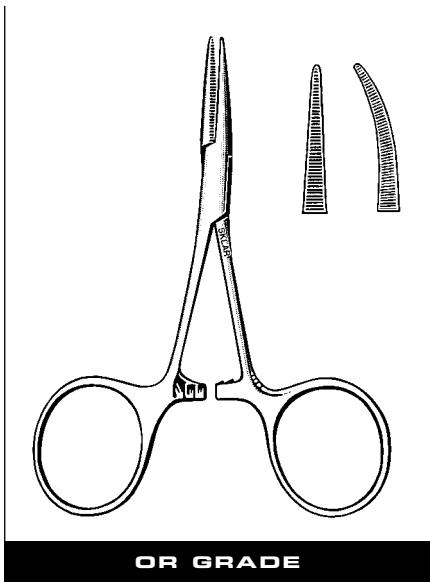

**OR GRADE**

## HARTMANN MOSQUITO HEMOSTATS

Straight	Curved
17-1235 3½" Serr.	17-1335 3½" Serr.

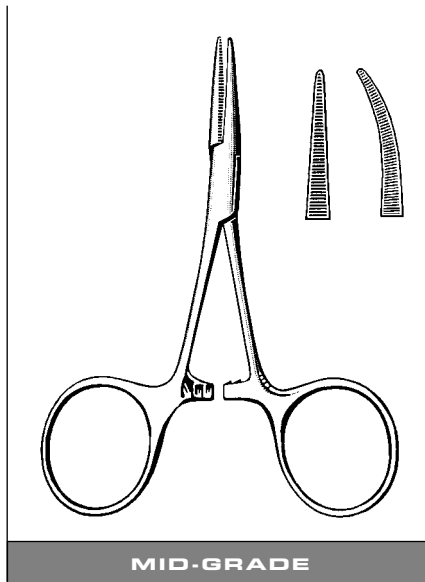

**MID-GRADE**

## MID-GRADE HARTMANN MOSQUITO HEMOSTATS

Straight	Curved
95-409 3½"	95-421 3½"

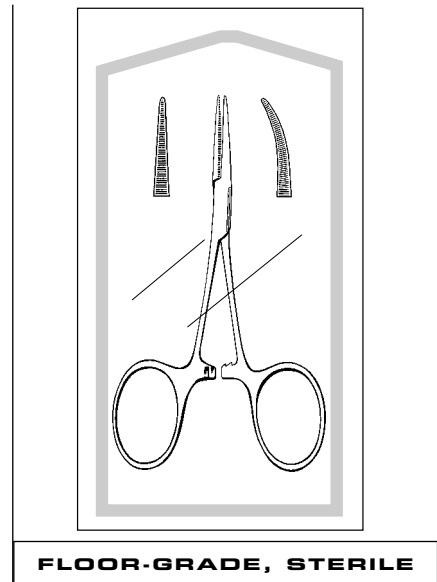

**FLOOR-GRADE, STERILE**

## HARTMANN MOSQUITO HEMOSTATS, STERILE

Box/50		
96-2554	3½"	Str.
96-2555	3½"	Cvd.
Box/25		
96-2556	3½"	Str.
96-2557	3½"	Cvd.

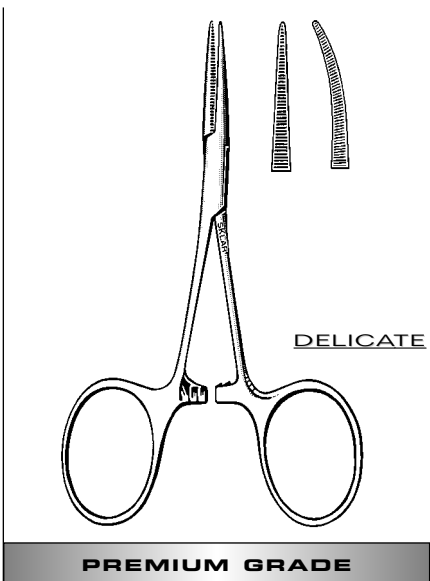

**DELICATE**

**PREMIUM GRADE**

## HARTMANN MOSQUITO HEMOSTATS DELICATE

Straight	Curved
17-1230 3½"	17-1232 3½"

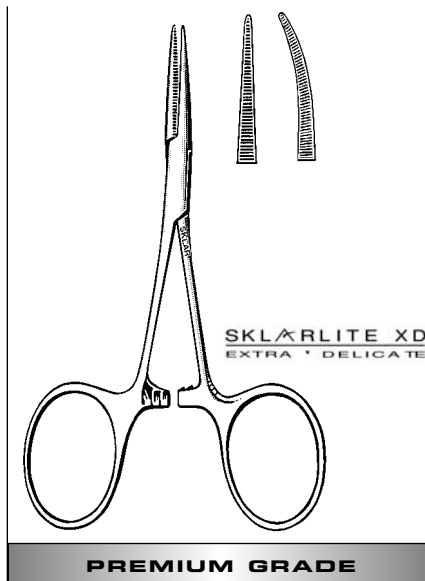

**SKLARLITE XD™  
EXTRA DELICATE**

**PREMIUM GRADE**

## SKLARLITE EXTRA DELICATE™ HARTMANN MOSQUITO HEMOSTATS

Straight	Curved
23-2500 3½"	23-2501 3½"

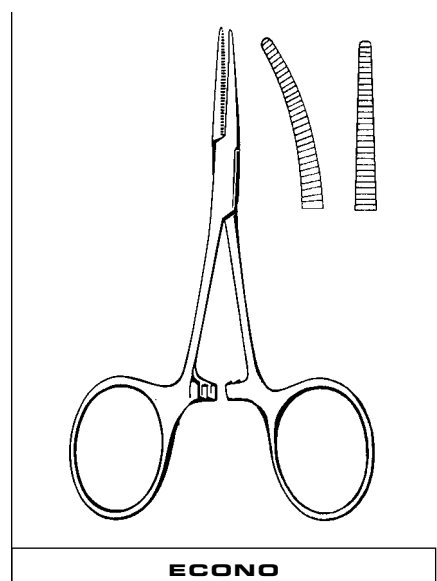

**ECONO**

## HARTMANN MOSQUITO HEMOSTATS, ECONO

Box/12		
Straight	Curved	
21-409 3½"	21-421 3½"	

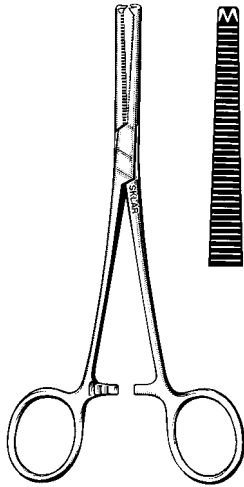

**OR GRADE**

### ROCHESTER-OCHSNER FORCEPS

Straight, 1x2 Teeth		Curved, 1x2 Teeth	
17-2855	5½" Kocher	17-2655	5½" Kocher
17-2862	6¼"	17-2662	6¼"
17-2872	7¼"	17-2672	7¼"
17-2880	8"	17-2680	8"
17-2890	10"	17-2690	10"
17-2878	7¼" Heavy Pattern		

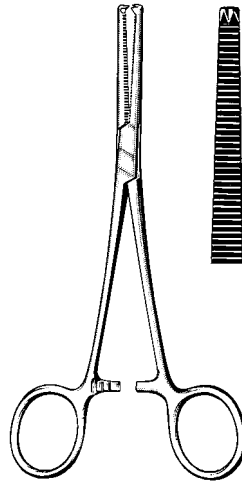

**MID-GRADE**

### MID-GRADE ROCHESTER-OCHSNER FORCEPS

Straight, 1x2 Teeth		Curved, 1x2 Teeth	
95-500	5½" Kocher	95-501	5½" Kocher
95-504	6¼"	95-512	6¼"
95-521	7¼"	95-525	7¼"
95-513	8"	95-514	8"
95-515	9"	95-516	9"
95-517	10"	95-518	10"

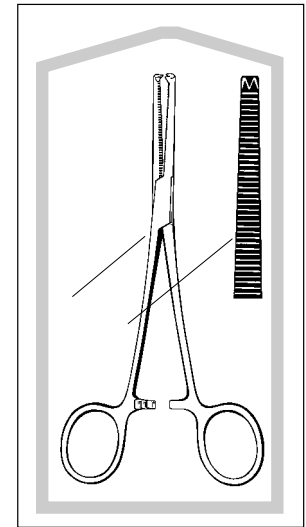

**FLOOR-GRADE, STERILE**

### ROCHESTER-OCHSNER FORCEPS, STERILE

Box/50		
96-2707	6¼"	Str.
96-2708	6¼"	Cvd.
Box/25		
96-2566	6¼"	Str.
96-2567	6¼"	Cvd.

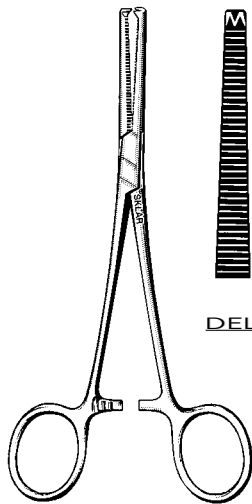

**DELICATE**

**PREMIUM GRADE**

### ROCHESTER-OCHSNER FORCEPS DELICATE

Straight, 1x2 Teeth		Curved, 1x2 Teeth	
22-3755	5½" Kocher	22-3855	5½" Kocher
17-2962	6¼"		
18-1752	5¼"	18-1852	5¼"

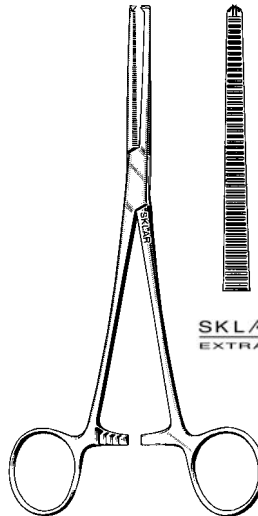

**SKLARLITE XD™  
EXTRA DELICATE**

**PREMIUM GRADE**

### SKLARLITE EXTRA DELICATE™ ROCHESTER-OCHSNER FORCEPS

Straight, 1x2 Teeth		Curved, 1x2 Teeth	
23-2577	6¼"	23-2585	6¼"

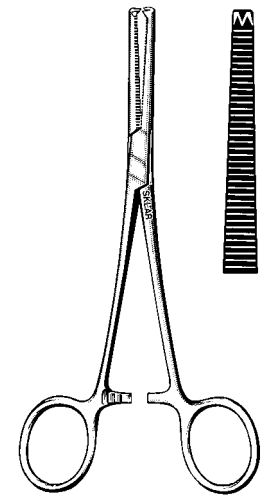

**ECONO**

### ROCHESTER-OCHSNER FORCEPS, ECONO

Box/12	
Straight, 1 x 2 Teeth	
21-488	7¼"

# ROCHESTER-PEAN FORCEPS

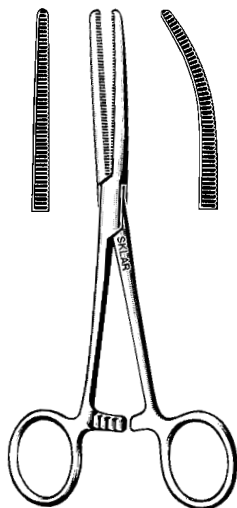

**OR GRADE**

## ROCHESTER-PEAN FORCEPS

Straight		Curved	
17-2455	5½"	17-2255	5½"
17-2462	6¼"	17-2262	6¼"
17-2467	6¾" Heavy	17-2267	6¾" Heavy
17-2472	7¼"	17-2272	7¼"
17-2480	8"	17-2280	8"
36-2690	9"	36-2790	9"
36-2710	10¼"	36-2810	10¼"

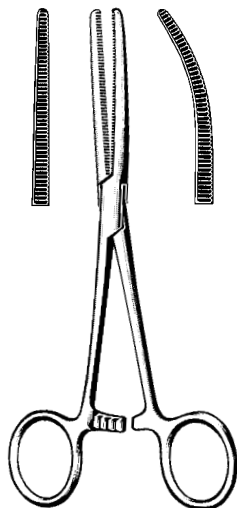

**MID-GRADE**

## MID-GRADE ROCHESTER-PEAN FORCEPS

Straight		Curved	
95-470	5½"	95-471	5½"
95-473	6¼"	95-477	6¼"
95-481	7¼"	95-485	7¼"
95-492	8"		
95-483	9"		
95-494	10¼"		

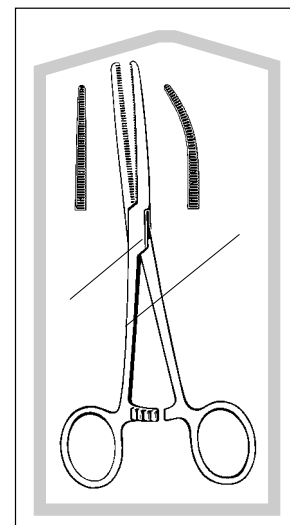

**FLOOR-GRADE, STERILE**

## ROCHESTER-PEAN FORCEPS, STERILE

Box/50		
96-2544	6¼"	Str.
96-2546	6¼"	Cvd.
Box/25		
96-2545	6¼"	Str.
96-2547	6¼"	Cvd.

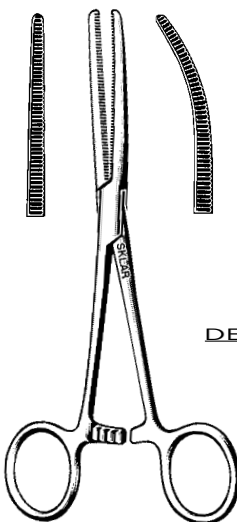

**DELICATE**

**PREMIUM GRADE**

## ROCHESTER-PEAN FORCEPS DELICATE

Straight		Curved	
22-3555	5½"	22-3655	5½"
		17-2362	6¼"
		22-2280	8"

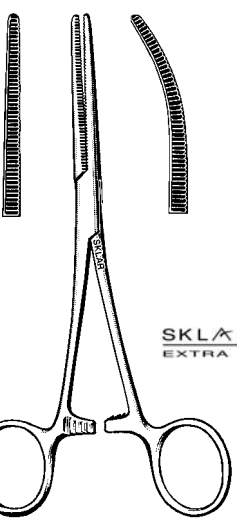

**SKLARLITE XD™  
EXTRA DELICATE**

**PREMIUM GRADE**

## SKLARLITE EXTRA DELICATE™ ROCHESTER-PEAN FORCEPS

Straight		Curved	
23-2552	6¼"	23-2561	6¼"
		23-2563	7¼"

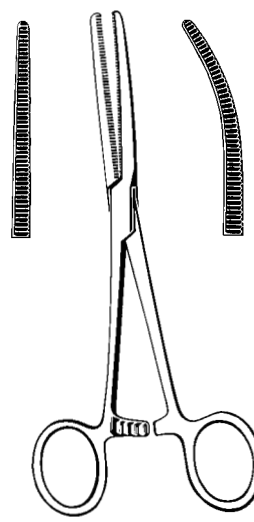

**ECONO**

## ROCHESTER-PEAN FORCEPS, ECONO

Box/12			
Straight		Curved	
21-470	5½"	21-471	5½"
21-473	6¼"	21-477	6¼"
21-481	7¼"	21-485	7¼"
21-492	8½"	21-498	8½"

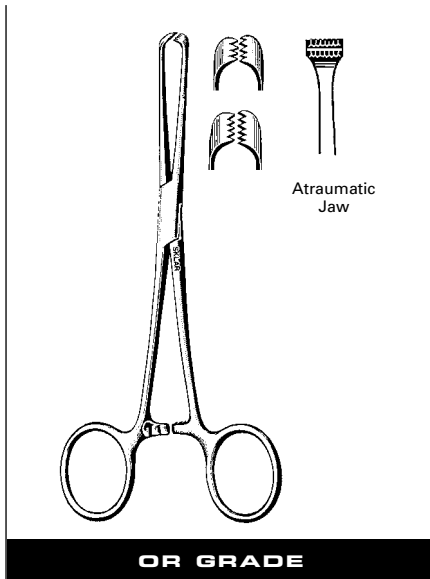

### ALLIS TISSUE FORCEPS

- |         |     |                   |         |     |        |
|---------|-----|-------------------|---------|-----|--------|
| 36-2060 | 6"  | 3x4               | 36-2298 | 6"  | AT Jaw |
| 36-2160 | 6"  | 4x5               | 36-2280 | 8"  | AT Jaw |
| 36-2260 | 6"  | 5x6               | 36-2385 | 10" | AT Jaw |
| 36-2275 | 7½" | 5x6               |         |     |        |
| 36-2295 | 9½" | 5x6               |         |     |        |
| 36-2278 | 7½" | 5x6 Heavy Pattern |         |     |        |

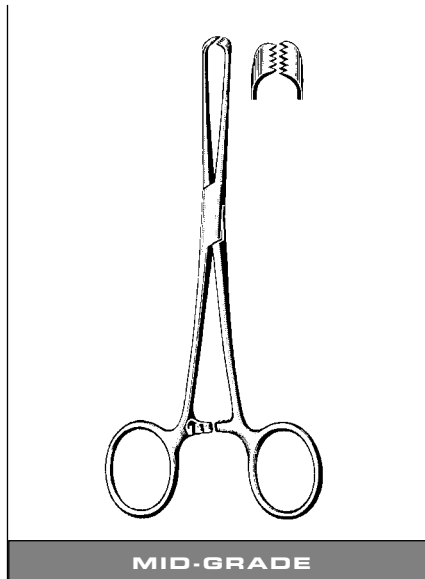

### MID-GRADE ALLIS TISSUE FORCEPS

- |        |     |     |
|--------|-----|-----|
| 95-934 | 6"  | 5x6 |
| 95-938 | 7½" | 5x6 |

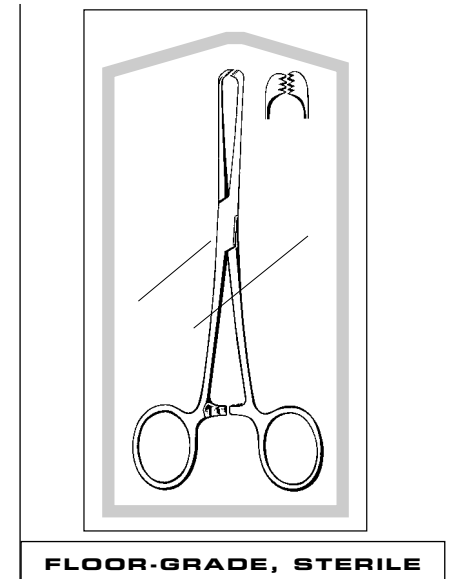

### ALLIS TISSUE FORCEPS, STERILE

- |         |    |
|---------|----|
| Box/50  |    |
| 96-2576 | 6" |
| Box/25  |    |
| 96-2575 | 6" |

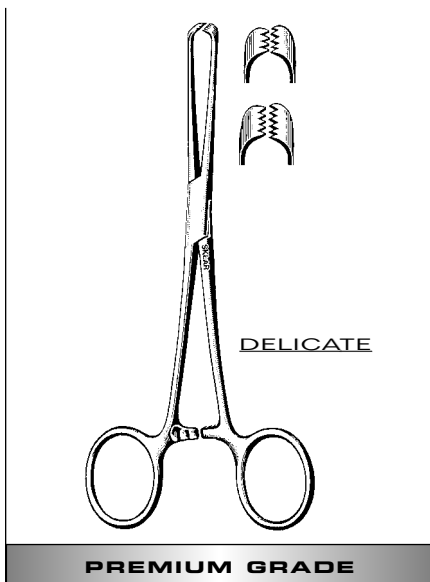

### ALLIS TISSUE FORCEPS DELICATE

- |         |     |     |
|---------|-----|-----|
| 18-2140 | 4"  | 4x5 |
| 18-2155 | 5"  | 4x5 |
| 22-6157 | 5½" | 4x5 |
| 18-2162 | 6"  | 4x5 |
| 18-2164 | 6"  | 5x6 |

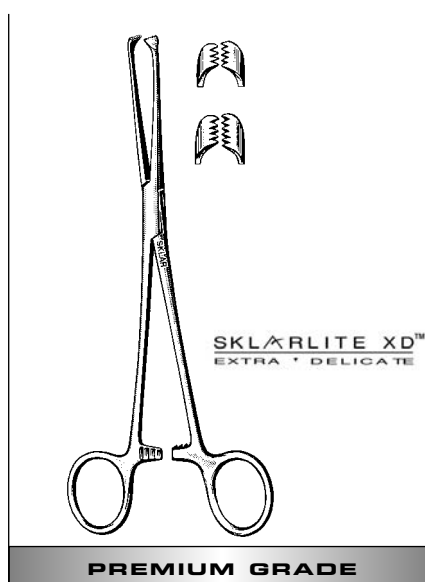

### SKLARLITE EXTRA DELICATE™ ALLIS TISSUE FORCEPS

- |         |     |     |
|---------|-----|-----|
| 23-2861 | 5"  | 4x5 |
| 23-2862 | 5½" | 4x5 |
| 23-2864 | 6"  | 4x5 |
| 23-2865 | 6"  | 5x6 |

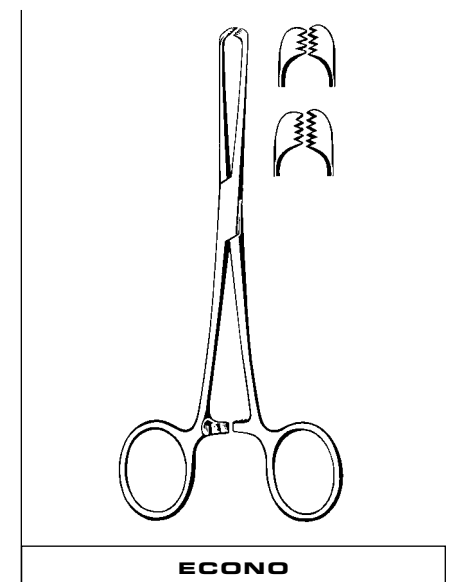

### ALLIS TISSUE FORCEPS, ECONO

- |        |         |
|--------|---------|
| Box/12 |         |
| 21-930 | 6" 4x5  |
| 21-934 | 6" 5x6  |
| 21-938 | 7¼" 6x7 |

# FORCEPS

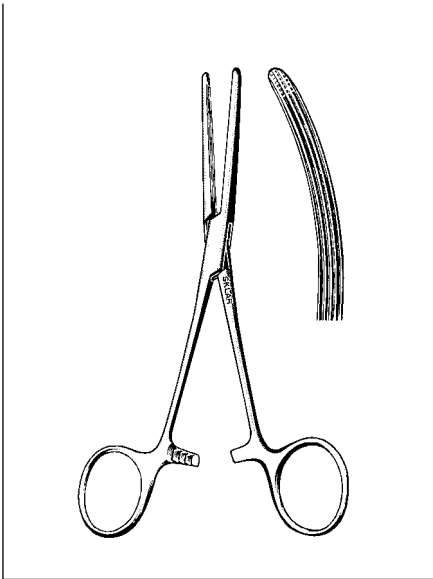

## **ROCHESTER-CARMALT FORCEPS**

Straight	Curved
17-1062 6¼"	17-1162 6¼"
17-1080 8"	17-1180 8"

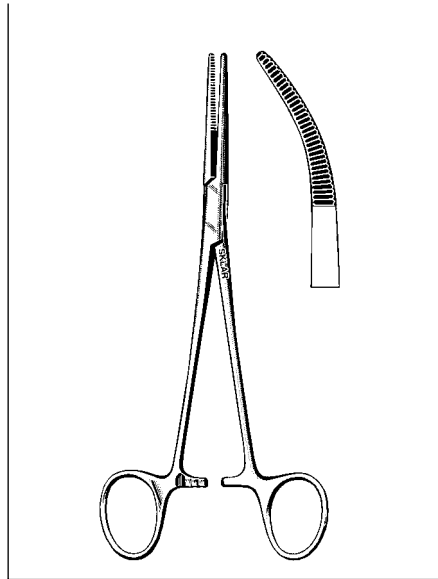

## **RANKIN HEMOSTATIC FORCEPS**

17-1262 6¼"	Straight
17-1362 6¼"	Curved

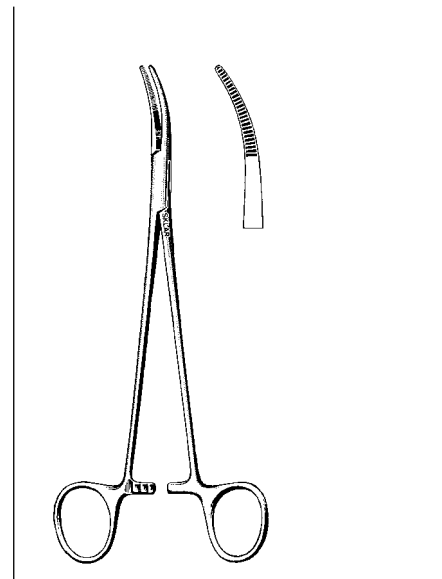

## **SCHNIDT FORCEPS**

74-3075 7½" Half Curved

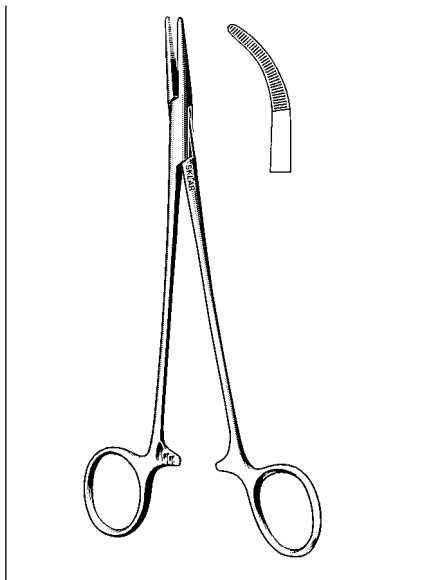

## **ADSON FORCEPS**

50-1372 7¼"	Straight
50-1472 7¼"	Curved

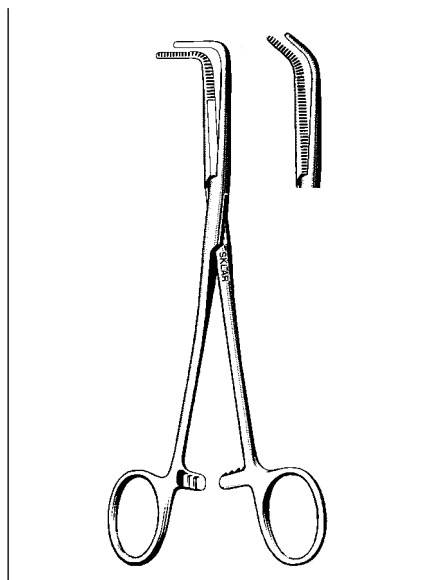

## **MIXTER FORCEPS**

Right Angle
18-1250 5½"
17-1762 6¼"
17-1772 7"
55-2892 9¼"

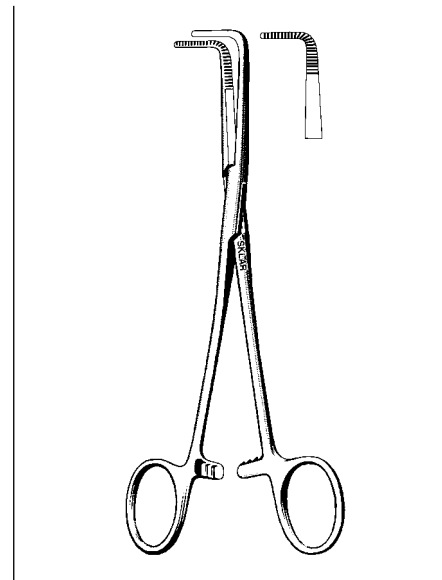

## **MIXTER FORCEPS DELICATE**

Right Angle
22-3255 5½"
22-3270 7½"

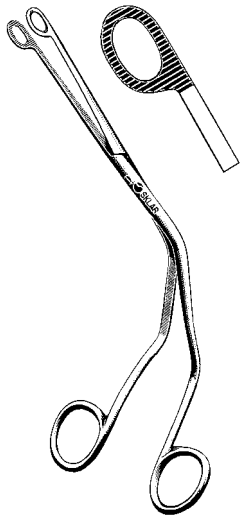

**OR GRADE**

### MAGILL CATHETER FORCEPS

07-1777 Infant 6½"  
 07-1780 Child 8"  
 07-1797 Adult 10"

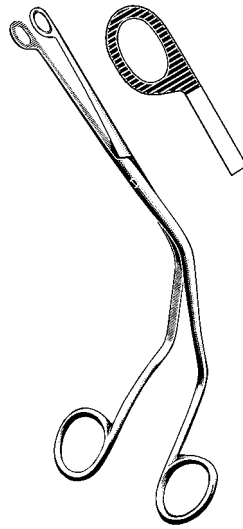

**MID-GRADE**

### MID-GRADE MAGILL CATHETER FORCEPS

95-289 Adult  
 95-285 Child

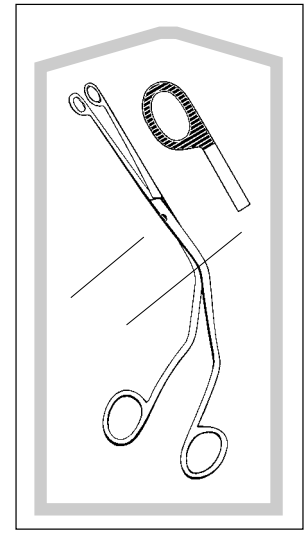

**FLOOR-GRADE, STERILE**

### MAGILL CATHETER FORCEPS, STERILE

Box/50  
 96-2684 Adult

Box/25  
 96-2685 Adult

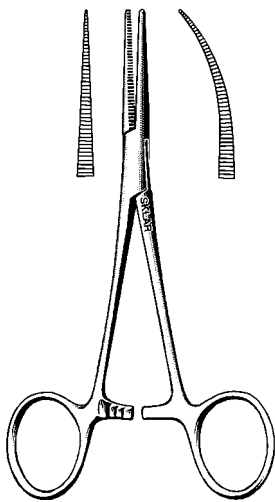

### MICRO MOSQUITO FORCEPS

17-1220 5" Straight  
 17-1225 5" Curved

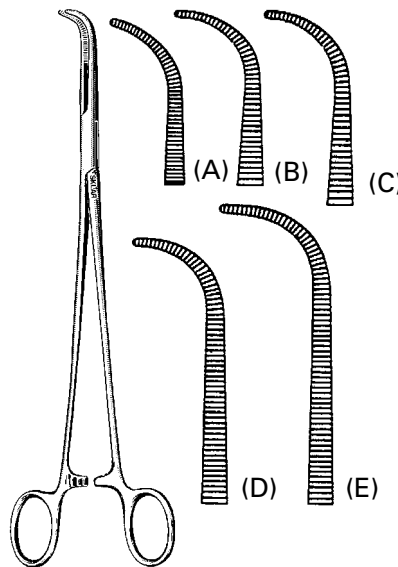

### GEMINI FORCEPS DELICATE RIGHT ANGLE

55-2855 5" (A)  
 55-2870 6¼" (B)  
 55-2880 8" (C)  
 55-2890 9" (D)  
 55-2898 11" (E)

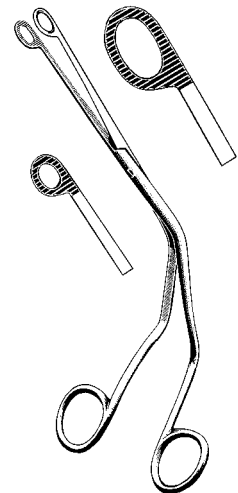

**ECONO**

### MAGILL CATHETER FORCEPS, ECONO

Box/12  
 21-285 7¼" Pediatric  
 21-289 9¼"

# FORCEPS

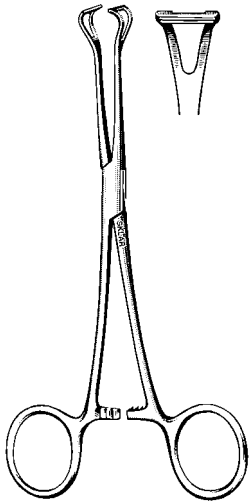

**OR GRADE**

## **BABCOCK FORCEPS**

- 22-6155 5½"
- 36-1662 6¼"
- 36-1677 8"
- 36-1692 9½"

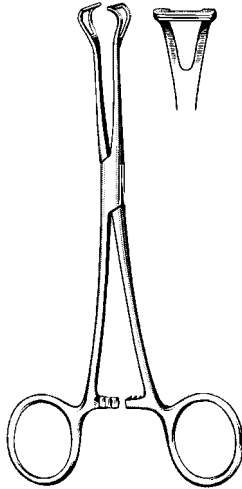

**MID-GRADE**

## **MID-GRADE BABCOCK FORCEPS**

- 95-952 6¼"

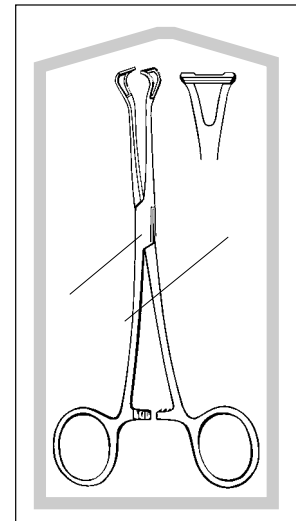

**FLOOR-GRADE, STERILE**

## **BABCOCK FORCEPS, STERILE**

- Box/50
- 96-2705 6¼"
- Box/25
- 96-2706 6¼"

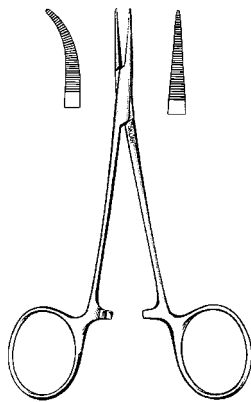

## **JACOBSON MOSQUITO FORCEPS**

- |            |            |
|------------|------------|
| Straight   | Curved     |
| 98-2050 5" | 98-2051 5" |

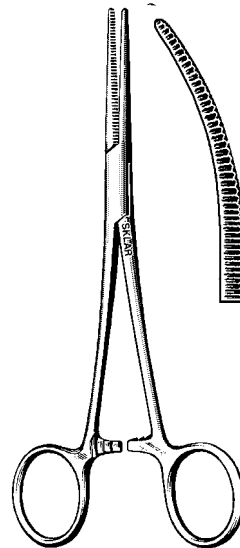

## **COLLER HEMOSTATIC FORCEPS**

- |             |             |
|-------------|-------------|
| Straight    | Curved      |
| 17-3455 5½" | 17-3555 5½" |
| 17-3265 6¼" | 17-3365 6¼" |
| 17-3275 7½" | 17-3375 7½" |



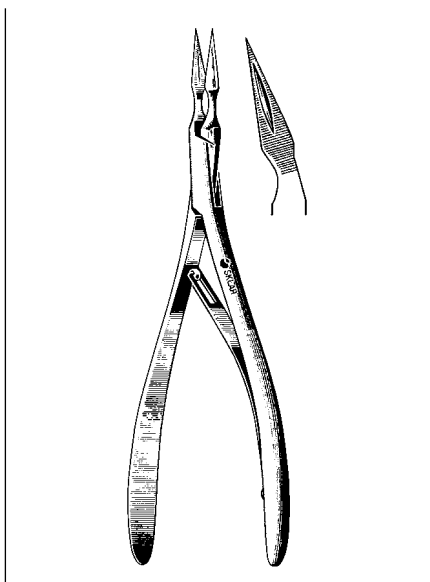

**VIRTUS SPLINTER FORCEPS**

19-3160 6" Straight  
19-3162 6" Angled

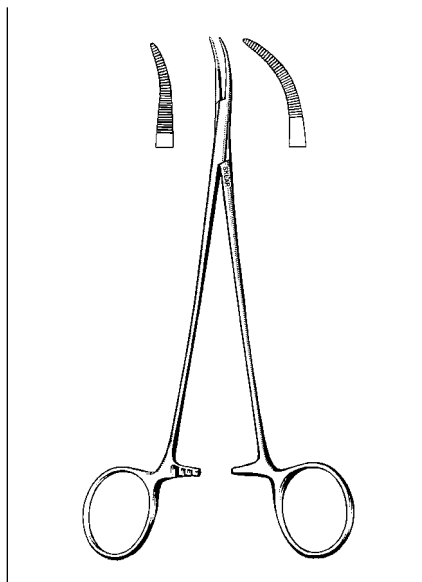

**JACOBSON MOSQUITO FORCEPS EXTRA DELICATE**

98-2070 7" Slight Curve  
98-2071 7" Full Curve

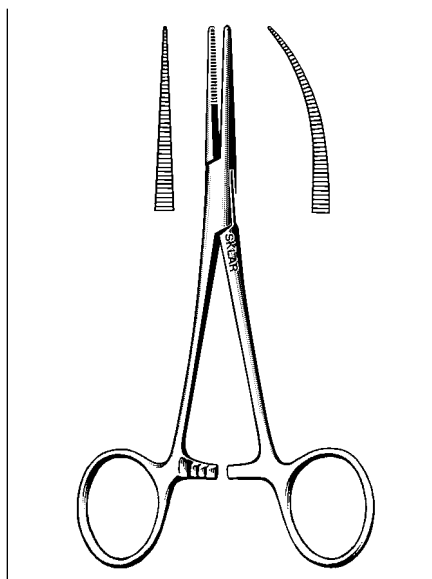

**MICRO MOSQUITO FORCEPS**

17-1220 5" Straight  
17-1225 5" Curved

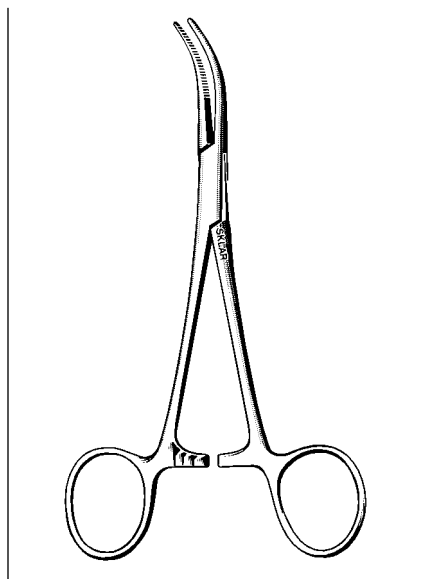

**DANDY SCALP HEMOSTAT**

Curved to Side  
50-1355 5½" Serrated  
50-1357 5½" Serrated 1 x 2 Teeth

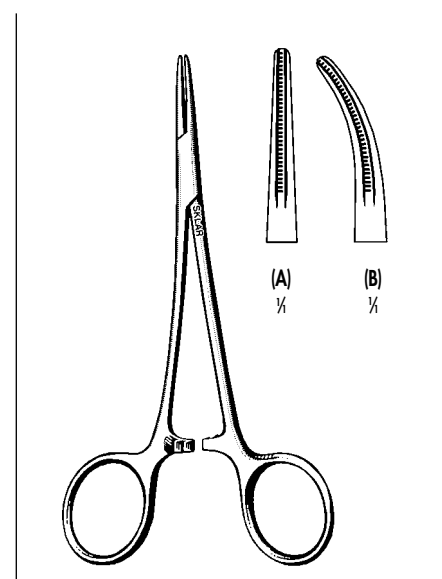

**DEBAKEY HALSTED MOSQUITO FORCEPS**

52-6830 5" Straight (A)  
52-6832 5" Curved (B)

# SPONGE FORCEPS & TOWEL CLAMPS

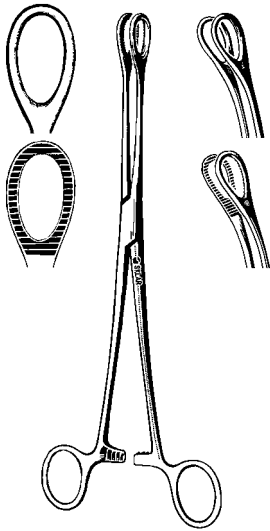

**OR GRADE**

## FOERSTER SPONGE FORCEPS

Straight

- 87-2095 9½" Smooth
- 87-2195 9½" Serrated
- 87-2199 9½" Serrated, Heavy Pattern

Curved

- 87-2295 9½" Smooth
- 87-2395 9½" Serrated

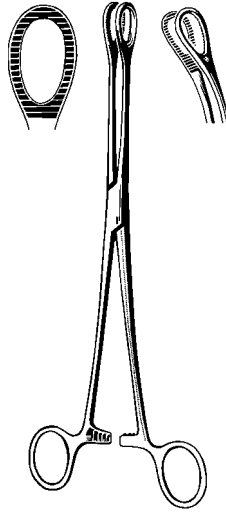

**MID-GRADE**

## MID-GRADE FOERSTER SPONGE FORCEPS

Serrated

- 95-571 7" Straight
- 95-577 9½" Straight
- 95-586 9½" Curved

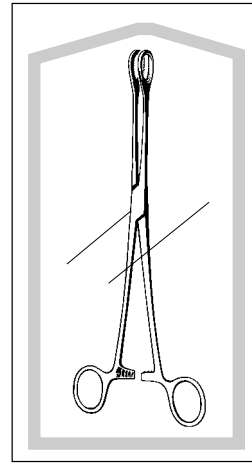

**FLOOR-GRADE, STERILE**

## FOERSTER SPONGE FORCEPS, STERILE

- Box/50, Straight
- 96-2532 9½" Serrated
- Box/25, Straight
- 96-2533 9½" Serrated

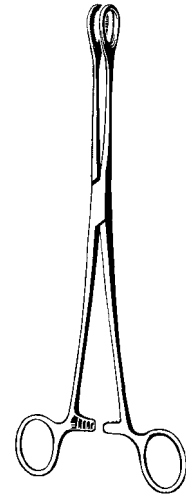

**ECONO**

## FOERSTER SPONGE FORCEPS, ECONO

- Box/12, Serrated
- 21-577 9½" Straight
- 21-586 9½" Curved

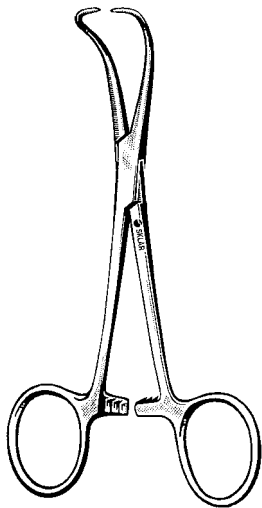

**OR GRADE**

## BACKHAUS TOWEL CLAMP

- 47-2935 3½"
- 47-2945 4½"
- 47-2955 5¼"
- 47-2960 6"
- 47-2959 5¼" Heavy Pattern

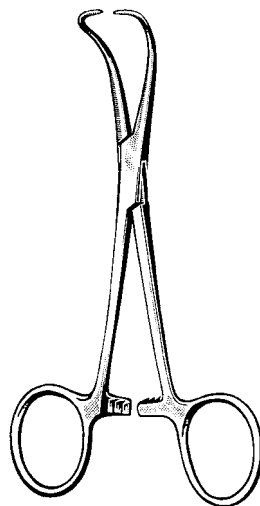

**MID-GRADE**

## MID-GRADE BACKHAUS TOWEL CLAMP

- 95-606 3½"
- 95-611 5¼"

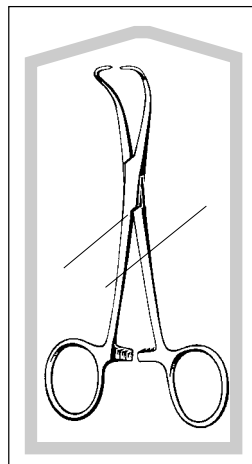

**FLOOR-GRADE, STERILE**

## BACKHAUS TOWEL CLAMP, STERILE

- Box/50
- 96-2630 3½"
- Box/25
- 96-2632 3½"

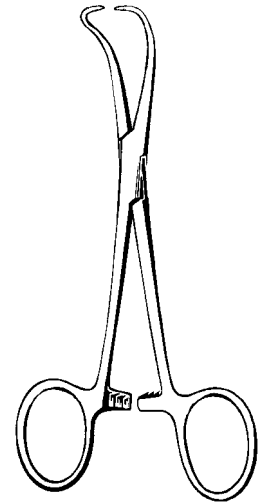

**ECONO**

## BACKHAUS TOWEL CLAMP, ECONO

- Box/12,
- 21-606 3½"
- 21-608 5¼"

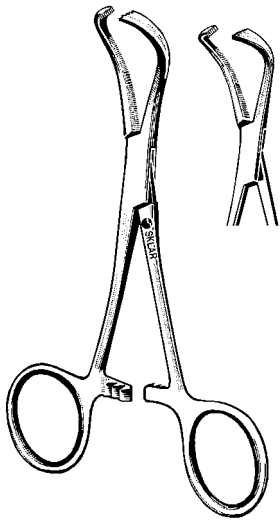

**OR GRADE**

**LORNA (EDNA)  
TOWEL CLAMP**

Non-Perforating

47-2837 3½"  
47-2852 5¼"

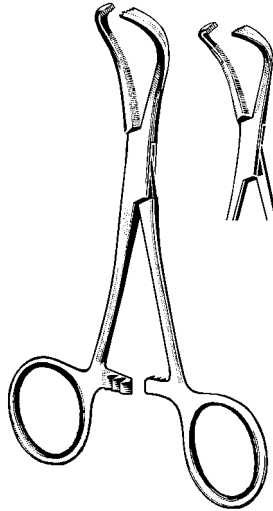

**MID-GRADE**

**MID-GRADE  
LORNA (EDNA)  
TOWEL CLAMP**

95-629 3½"  
95-635 5¼"

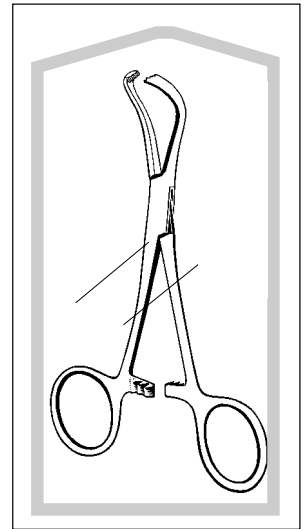

**FLOOR-GRADE, STERILE**

**LORNA (EDNA)  
TOWEL CLAMP, STERILE**

Box/50  
96-2528 3½"

Box/25  
96-2529 3½"

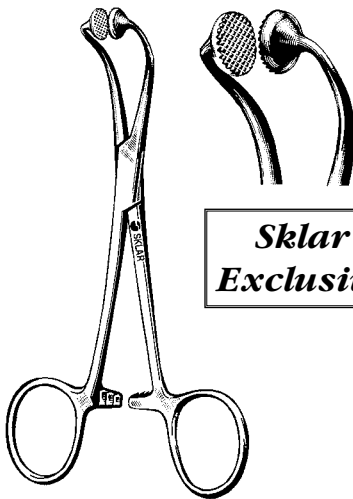

**Sklar  
Exclusive**

**HOFF TOWEL CLAMP**

47-3040 4"  
47-3057 5¼"

Serrated disc jaws effectively clamp— but will not tear or penetrate cloth or disposable drapes and towels. Can be removed and reapplied without contamination of the field. Also useful to secure cord and tubing to drapes.

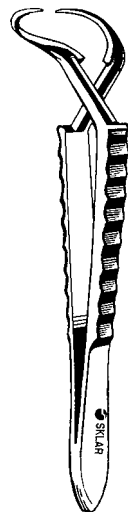

**JONES CROSS ACTION  
TOWEL CLAMP**

47-2925 2¼" Delicate  
47-2930 3½"

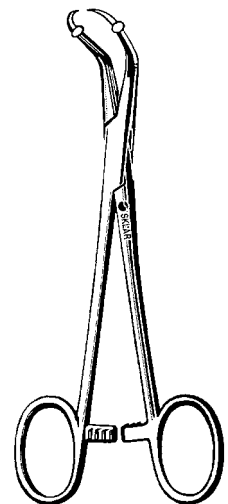

**ROEDER TOWEL CLAMP**

87-1052 5¼" With Ball Stops

# BOZEMAN FORCEPS / SCHROEDER TENACULUM FORCEPS

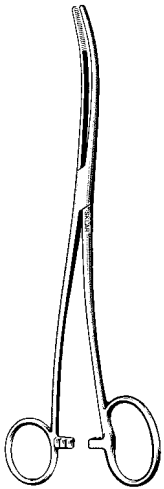

**OR GRADE**

## **BOZEMAN FORCEPS**

One Large Ring  
90-7710 10 1/4" S-Curve

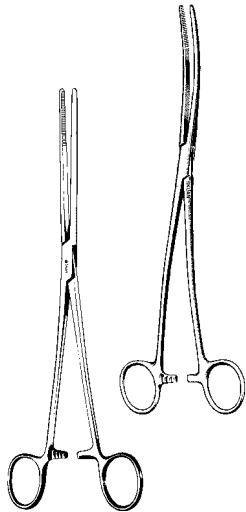

**OR GRADE**

## **BOZEMAN FORCEPS**

90-7610 10 1/2" Straight  
80-1410 10 1/4" S-Curve  
80-1419 10 1/4" S-Curve  
Heavy Pattern

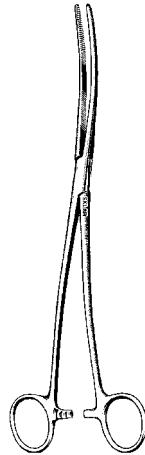

**MID-GRADE**

## **BOZEMAN FORCEPS**

95-374 10 1/4" S-Curve

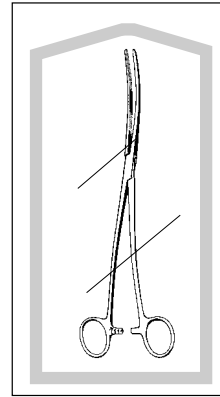

**FLOOR-GRADE  
STERILE**

## **BOZEMAN FORCEPS**

Box/50  
96-2620 10 1/4" S-Curve  
Box/25  
96-2622 10 1/4" S-Curve

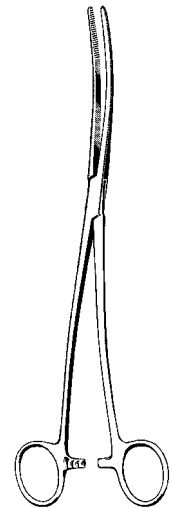

**ECONO**

## **BOZEMAN FORCEPS, ECONO**

Box/12  
21-374 10 1/4"

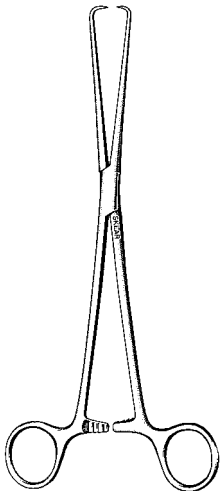

**OR GRADE**

## **SCHROEDER TENACULUM FORCEPS**

91-1290 9 1/2" (Braun)  
91-1298 10 1/4" (Pozzi)

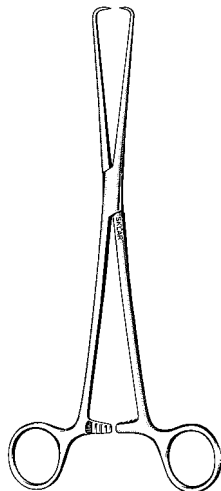

**MID-GRADE**

## **SCHROEDER TENACULUM FORCEPS**

95-386 9 1/2"

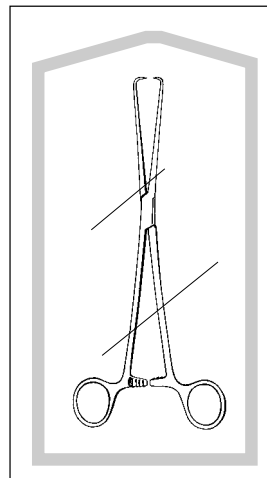

**FLOOR-GRADE, STERILE**

## **SCHROEDER TENACULUM FORCEPS, STERILE**

Box/50  
96-2626 9 1/2"  
Box/25  
96-2624 9 1/2"

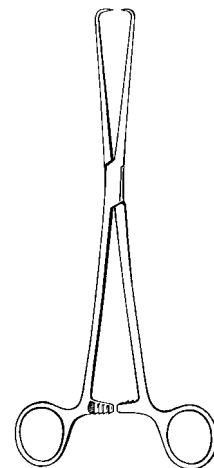

**ECONO**

## **SCHROEDER TENACULUM FORCEPS, ECONO**

Box/12  
21-386 9 1/2"

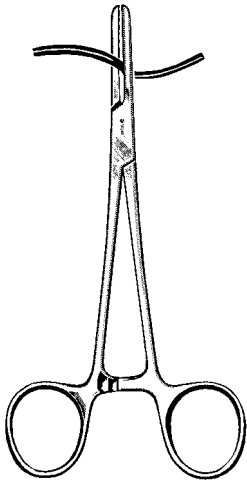

**OR GRADE**

**TUBE OCCLUDING FORCEPS**

Smooth Jaw, Straight

- 17-3995 5½"
- 17-3996 6½"
- 17-3997 7"

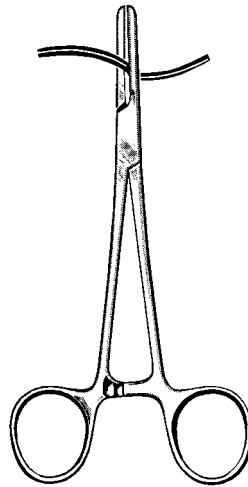

**MID-GRADE**

**MID-GRADE  
TUBE OCCLUDING FORCEPS**

Smooth Jaw, Straight

- 95-592 7"

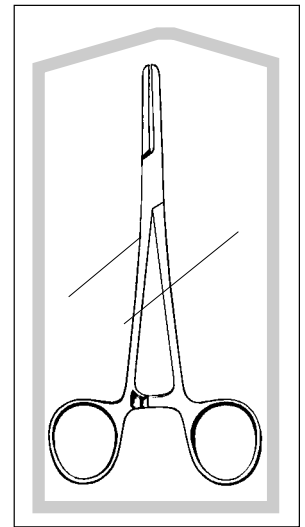

**FLOOR-GRADE, STERILE**

**TUBE OCCLUDING FORCEPS,  
STERILE**

Smooth Jaw, Straight

- Box/50
- 96-2406 7"
- Box/25
- 96-2408 7"

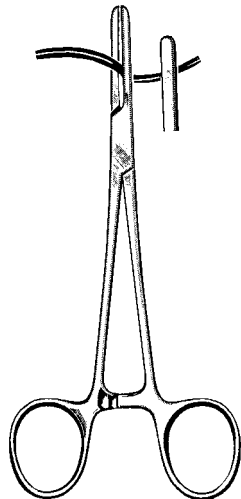

**ECONO**

**TUBE OCCLUDING FORCEPS,  
ECONO**

Box/12

- 21-598 7" Smooth
- 21-599 7" Serrated

Presbyterian

- 21-593 7" Smooth

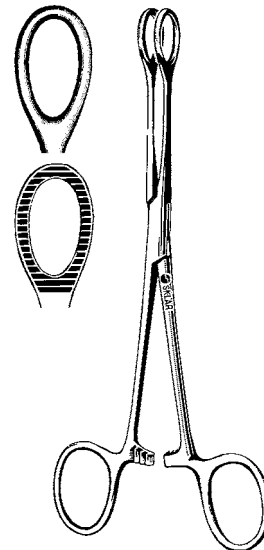

**BALLENGER SPONGE FORCEPS**

Straight

- 74-1370 7" Smooth
- 74-1470 7" Serrated

Curved

- 74-1570 7" Smooth
- 74-1670 7" Serrated

# DRESSING FORCEPS



**OR GRADE**

## DRESSING FORCEPS

Serrated

19-1045	4½"	19-1070	7"
19-1050	5"	19-1080	8"
19-1055	5½"	19-1110	10"
19-1060	6"	19-1112	12"
19-1058	5½" Heavy Pattern		



**MID-GRADE**

## MID-GRADE DRESSING FORCEPS

Serrated

95-705	4½"	95-731	6"
95-710	5"	95-736	8"
95-727	5½"		

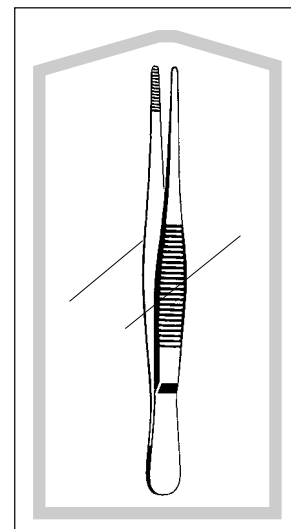

**FLOOR-GRADE, STERILE**

## DRESSING FORCEPS, STERILE

Box/50

96-2568	5"	Serrated
---------	----	----------

Box/25

96-2569	5"	Serrated
---------	----	----------



**DELICATE**

**PREMIUM GRADE**

## DRESSING FORCEPS DELICATE

Serrated

22-1161	4½"	22-1163	5½"
22-1162	5"	22-1164	6"



**SKLARLITE XD™  
EXTRA DELICATE**

**PREMIUM GRADE**

## SKLARLITE EXTRA DELICATE™ DRESSING FORCEPS

Serrated

23-2834	4½"	23-2838	5½"
23-2836	5"		



**ECONO**

## DRESSING FORCEPS, ECONO

Box/12

21-705	4½"	21-731	6"
21-710	5"	21-736	8"
21-727	5½"	21-742	10"



**OR GRADE**

**TISSUE FORCEPS**

1x2 Teeth

- |                           |             |
|---------------------------|-------------|
| 19-1245 4½"               | 19-1270 7"  |
| 19-1250 5"                | 19-1280 8"  |
| 19-1255 5½"               | 19-1310 10" |
| 19-1260 6"                | 19-1312 12" |
| 19-1258 5½" Heavy Pattern |             |



**MID-GRADE**

**MID-GRADE  
TISSUE FORCEPS**

1x2 Teeth

- |            |            |
|------------|------------|
| 95-753 4½" | 95-762 5½" |
| 95-757 5"  | 95-766 6"  |

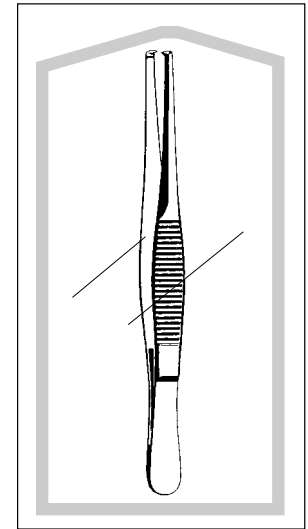

**FLOOR-GRADE, STERILE**

**TISSUE FORCEPS, STERILE**

Box/50

- |            |           |
|------------|-----------|
| 96-2578 5" | 1x2 Teeth |
|------------|-----------|

Box/25

- |            |           |
|------------|-----------|
| 96-2579 5" | 1x2 Teeth |
|------------|-----------|



**DELICATE**

**PREMIUM GRADE**

**TISSUE FORCEPS  
DELICATE**

1x2 Teeth

- |             |
|-------------|
| 22-1063 5½" |
|-------------|



**SKLARLITE XD™  
EXTRA DELICATE**

**PREMIUM GRADE**

**SKLARLITE  
EXTRA DELICATE™  
TISSUE FORCEPS**

1x2 Teeth

- |             |
|-------------|
| 23-2819 5½" |
|-------------|

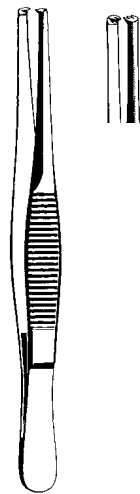

**ECONO**

**TISSUE FORCEPS,  
ECONO**

Box/12

- |            |     |
|------------|-----|
| 21-753 4½" | 1x2 |
| 21-757 5"  | 1x2 |
| 21-762 5½" | 1x2 |
| 21-766 6"  | 1x2 |
| 21-769 5½" | 2x3 |

# ADSON FORCEPS



**OR GRADE**

## ADSON (EWALD) FORCEPS

Dressing

- 50-3147 4 3/4" Serrated
- 50-3145 4 3/4" Serrated, Heavy Pattern

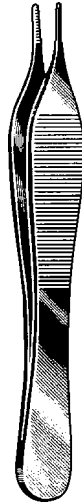

**MID-GRADE**

## MID-GRADE ADSON FORCEPS

- |                        |  |                        |
|------------------------|--|------------------------|
| Dressing               |  | Dressing-Delicate      |
| 95-771 4 3/4" Serrated |  | 95-772 4 3/4" Serrated |

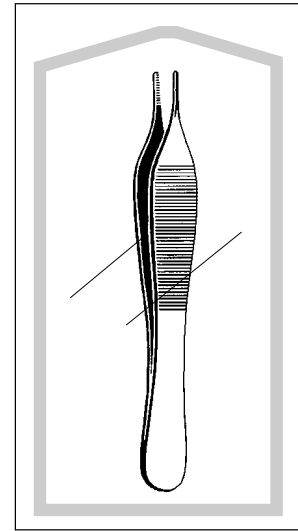

**FLOOR-GRADE, STERILE**

## ADSON FORCEPS, STERILE

- |                |                    |  |
|----------------|--------------------|--|
| Box/50         |                    |  |
| 96-2570 4 3/4" | Dressing, Serrated |  |
| Box/25         |                    |  |
| 96-2571 4 3/4" | Dressing, Serrated |  |



**DELICATE**

**PREMIUM GRADE**

## ADSON FORCEPS DELICATE

Dressing

- 47-2147 4 3/4" Serrated



**SKLARLITE XD™  
EXTRA DELICATE**

**PREMIUM GRADE**

## SKLARLITE EXTRA DELICATE™ ADSON FORCEPS

Dressing

- 23-2604 4 3/4" Serrated



**ECONO**

## ADSON FORCEPS, ECONO

Box/12

- 21-771 4 3/4" Serrated
- 21-772 4 3/4" Serrated Delicate





**OR GRADE**

### ADSON FORCEPS

Tissue

- 50-3047 4 1/4" 1x2 Teeth
- 50-3045 4 1/4" 1x2 Teeth, Heavy Pattern



**MID-GRADE**

### MID-GRADE ADSON FORCEPS

Tissue

- 95-775 4 1/4" 1x2 Teeth

Tissue-Delicate

- 95-776 4 1/4" 1x2 Teeth

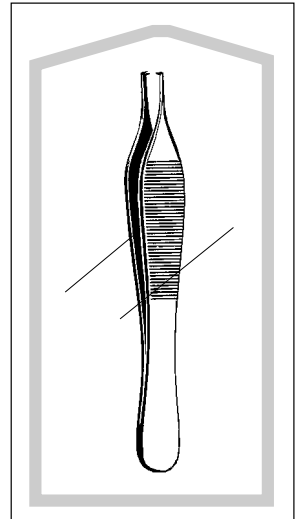

**FLOOR-GRADE, STERILE**

### ADSON FORCEPS, STERILE

Box/50

- 96-2572 4 1/4" Tissue, 1x2 Teeth

Box/25

- 96-2573 4 1/4" Tissue, 1x2 Teeth



**DELICATE**

**PREMIUM GRADE**

### ADSON FORCEPS DELICATE

Tissue

- 47-2047 4 1/4" 1x2 Teeth
- 47-2049 4 1/4" 2x3 Teeth



**SKLARLITE XD™  
EXTRA DELICATE**

**PREMIUM GRADE**

### SKLARLITE EXTRA DELICATE™ ADSON FORCEPS

Tissue

- 23-2606 4 1/4" 1x2 Teeth



**ECONO**

### ADSON FORCEPS, ECONO

Box/12

- 21-775 4 1/4" 1x2
- 21-776 4 1/4" 1x2 Delicate

# ADSON FORCEPS

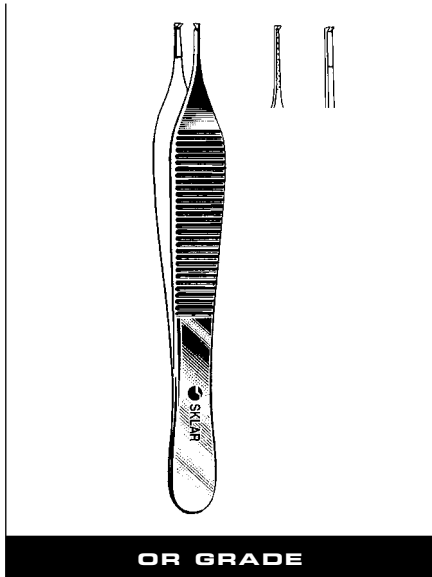

OR GRADE

## ADSON FORCEPS

- 50-3048 4 $\frac{3}{4}$ " Serrated, 1x2 Teeth
- 50-3049 4 $\frac{3}{4}$ " 1x2 Teeth w/Platform

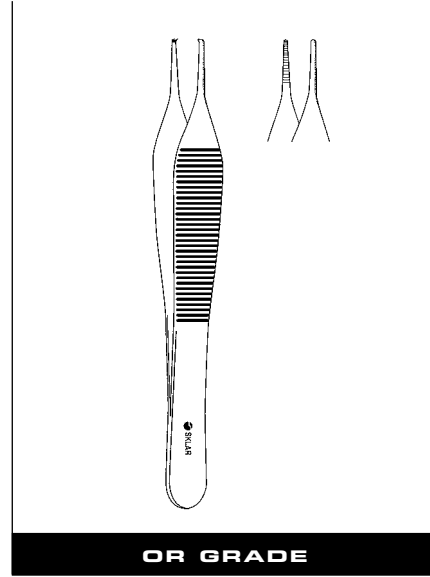

OR GRADE

## MICRO ADSON FORCEPS

- 98-2047 4 $\frac{3}{4}$ " 1x2 Teeth
- 98-2048 4 $\frac{3}{4}$ " Serrated

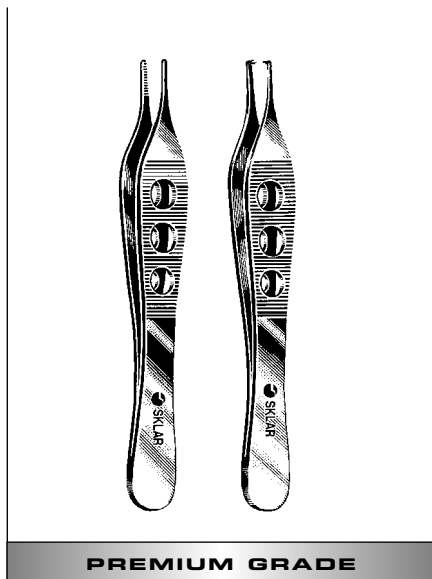

PREMIUM GRADE

## LITEGRIP™ ADSON FORCEPS

- Dressing and Tissue
- 50-3148 4 $\frac{3}{4}$ " Serrated
  - 50-3050 4 $\frac{3}{4}$ " 1x2 Teeth

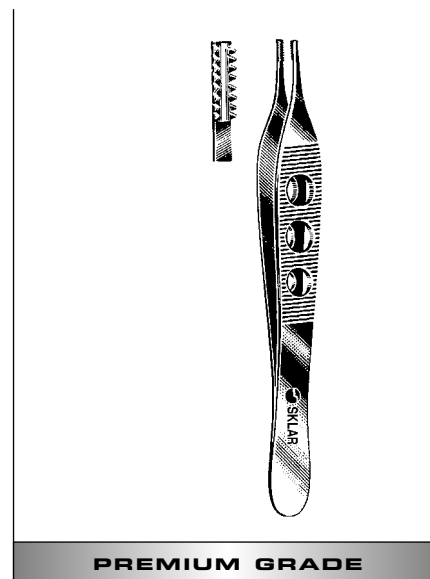

PREMIUM GRADE

## LITEGRIP™ ADSON-BROWN FORCEPS

- 47-1448 4 $\frac{3}{4}$ " Side Grasping

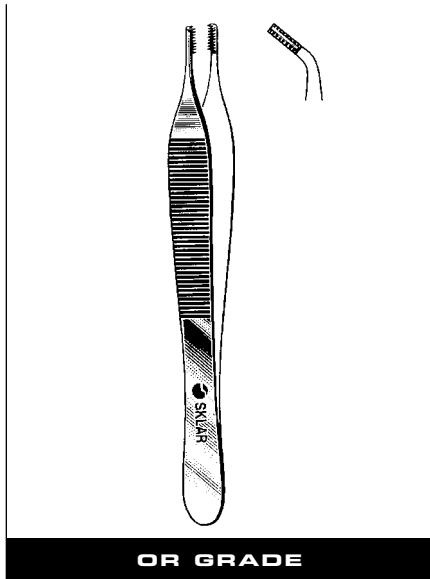

**OR GRADE**

### ADSON-BROWN FORCEPS

47-1447 4 3/4" Side Grasping  
47-1450 4 3/4" Adson Brown Angled

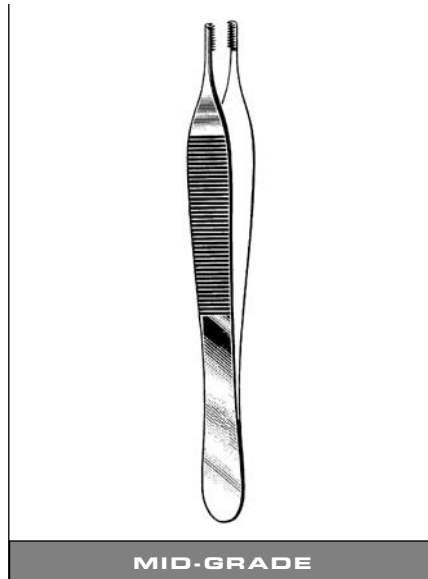

**MID-GRADE**

### MID-GRADE ADSON-BROWN FORCEPS

95-778 4 3/4" Side Grasping

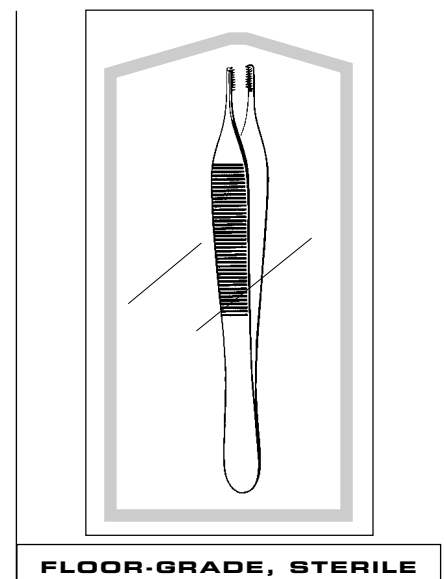

**FLOOR-GRADE, STERILE**

### ADSON-BROWN FORCEPS, STERILE

Box/50  
96-2558 4 3/4" Side Grasping  
Box/25  
96-2559 4 3/4" Side Grasping

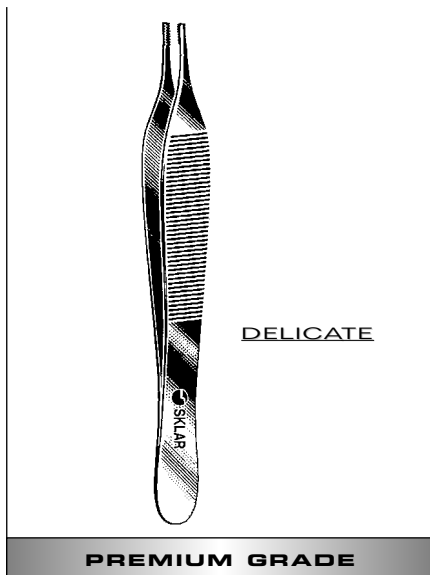

**PREMIUM GRADE**

### ADSON-BROWN FORCEPS DELICATE

47-2447 4 3/4" Side Grasping



**PREMIUM GRADE**

### SKLARLITE EXTRA DELICATE™ ADSON-BROWN FORCEPS

23-2608 4 3/4" Side Grasping

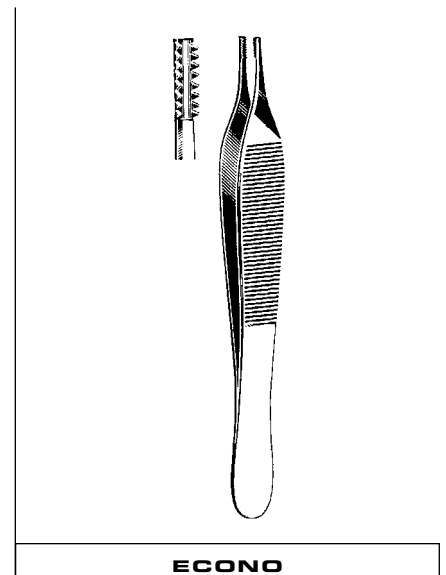

**ECONO**

### ADSON-BROWN FORCEPS, ECONO

Box/12  
21-778 4 3/4"

# SPLINTER FORCEPS



**OR GRADE**

## **FINE POINT SPLINTER FORCEPS**

19-3035 3½"  
19-3040 4"  
19-3045 4½"



**MID-GRADE**

## **MID-GRADE FINE POINT SPLINTER FORCEPS**

95-777 3½"  
95-781 4½"

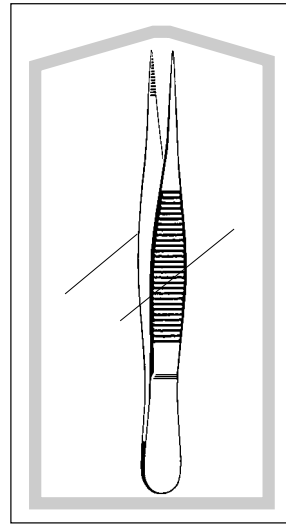

**FLOOR-GRADE, STERILE**

## **FINE POINT SPLINTER FORCEPS, STERILE**

Box/50  
96-2410 4½"  
Box/25  
96-2412 4½"



**ECONO**

## **FINE POINT SPLINTER FORCEPS, ECONO**

Box/12  
21-777 3½"  
21-781 4½"

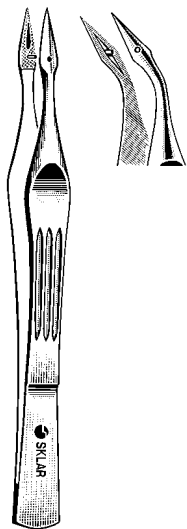

## **CARMALT SPLINTER FORCEPS**

19-3240 4¼" Straight  
19-3340 4¼" Curved

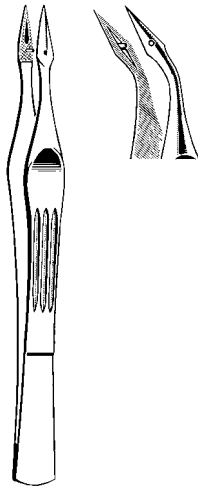

**ECONO**

## **CARMALT SPLINTER FORCEPS, ECONO**

Box/12  
21-791 4¼" Straight  
21-793 4¼" Angled



## **FEILCHENFELD SPLINTER FORCEPS**

19-2930 3"  
19-2945 4½"

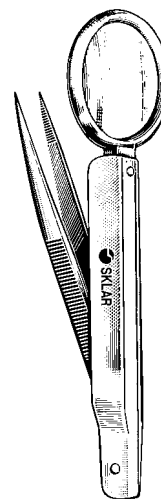

## **PLAIN SPLINTER FORCEPS WITH MAGNIFIER**

19-3030 3" Chrome  
Non-  
Autoclavable

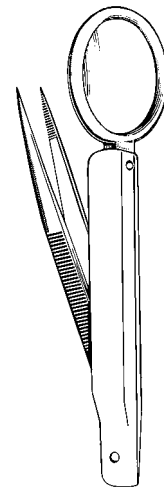

**ECONO**

## **PLAIN SPLINTER FORCEPS WITH MAGNIFIER, ECONO**

Box/12  
21-708 3"

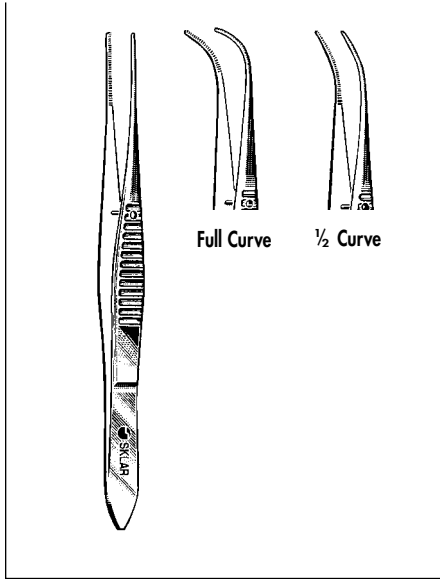

### EYE DRESSING FORCEPS

Serrated

- 66-2740 4" Straight
- 66-2940 4" Half Curve
- 66-3140 4" Full Curve

Non-Magnetic

- 66-2840 4" Straight

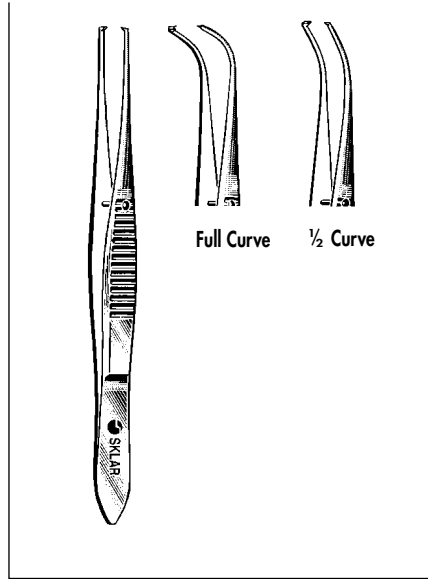

### EYE TISSUE FORCEPS

1 x 2 Teeth

- 66-3340 4" Straight
- 66-3540 4" Half Curve
- 66-3740 4" Full Curve

Non-Magnetic

- 66-3240 4" Straight

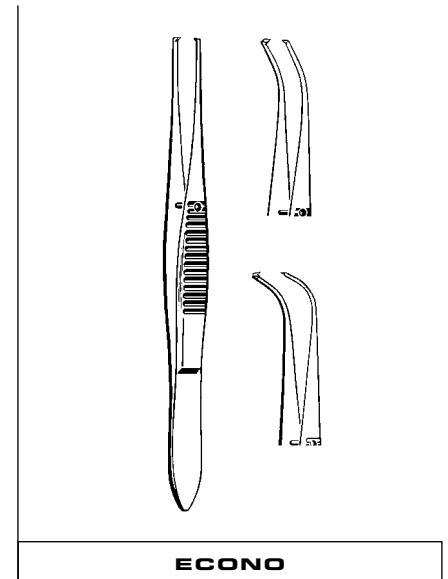

### EYE DRESSING & TISSUE FORCEPS, ECONO

Box/12

- |        |      |          |           |       |
|--------|------|----------|-----------|-------|
| 21-123 | 4/4" | Straight | Serrated  |       |
| 21-124 | 4/4" | Straight | 1x2       |       |
| 21-129 | 4/4" | Curved   | 1/2 Cvd.  | Serr. |
| 21-135 | 4/4" | Curved   | Full Cvd. | Serr. |
| 21-146 | 4/4" | Curved   | 1/2 Cvd.  | 1x2   |
| 21-151 | 4/4" | Curved   | Full Cvd. | 1x2   |

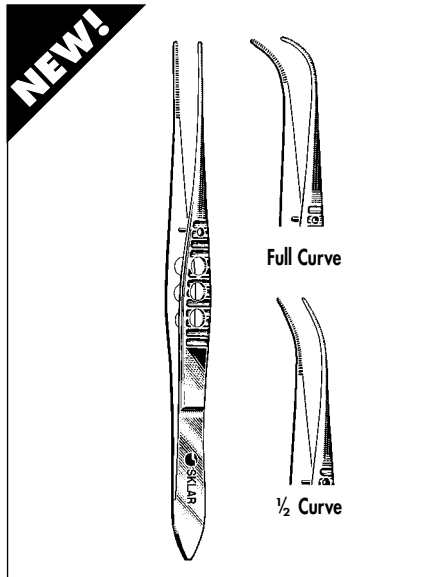

### SKLAR LITEGRIP™ EYE DRESSING FORCEPS

Serrated

- 66-2742 4" Straight
- 66-2942 4" 1/2 Curved
- 66-3142 4" Full Curve

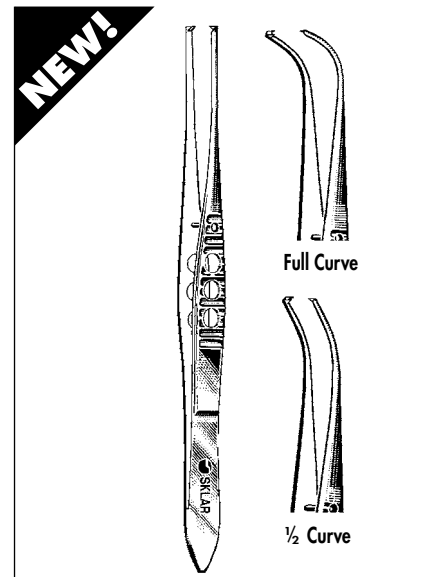

### SKLAR LITEGRIP™ EYE TISSUE FORCEPS

1 x 2 Teeth

- 66-3342 4" Straight
- 66-3542 4" 1/2 Curved
- 66-3742 4" Full Curve

# EYE INSTRUMENTS

## FORCEPS

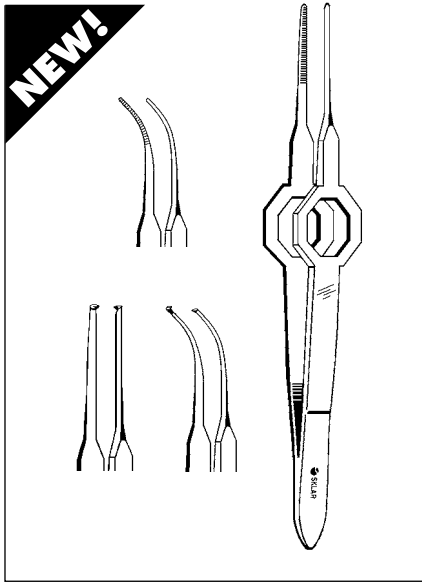

### FOERSTER FORCEPS

- 66-6036 3/4" Str.
- 66-6037 3/4" Cvd.
- 66-6038 3/4" Str. w/ 1x2 Teeth
- 66-6039 3/4" Cvd. w/ 1x2 Teeth

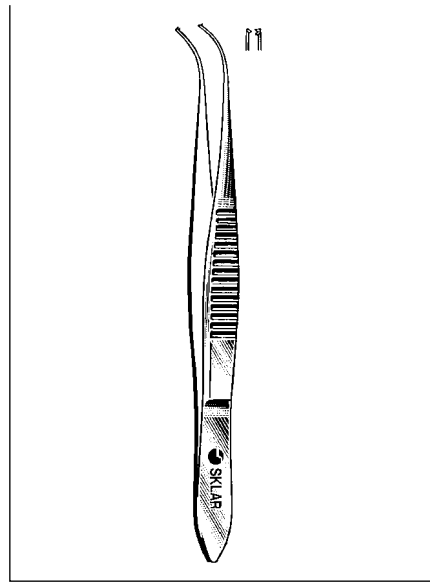

### FOERSTER IRIS FORCEPS

- 1 x 2 Teeth
- 66-4530 3/4" Curved Tips  
Standard Handle

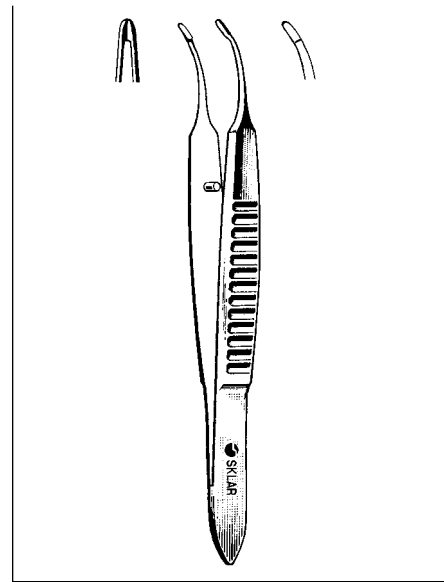

### CHANDLER IRIS FORCEPS

- 66-3927 2/4" Curved with  
Platform Tips

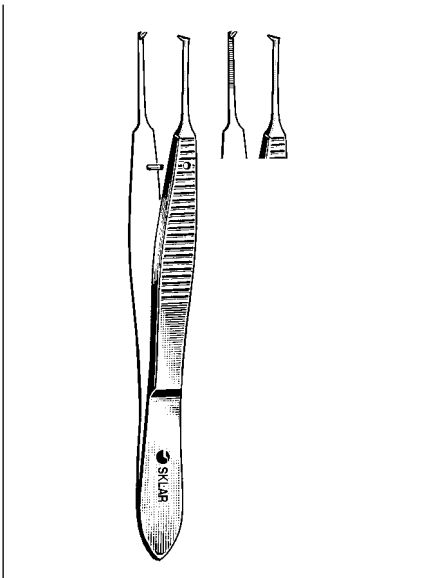

### GRAEFE FORCEPS

- 66-4525 2/4" Str. 1 x 2 teeth
- 66-4625 2/4" Cvd. 1 x 2 teeth
- 66-4526 2/4" Str. Serrated
- 66-4626 2/4" Cvd. Serrated

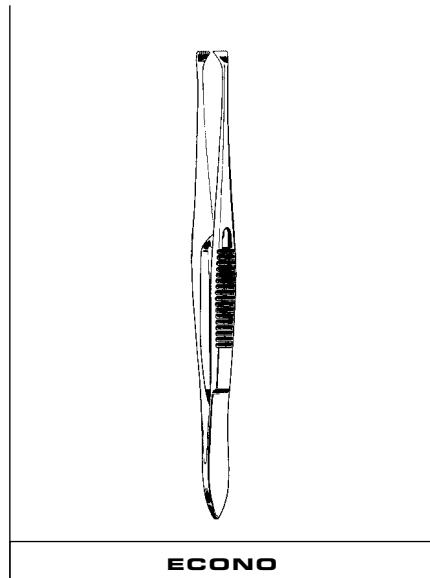

ECONO

### GRAEFE FORCEPS, ECONO

- Box/12
- 21-788 4/4" With Lock
- 21-785 4/4" Without Lock

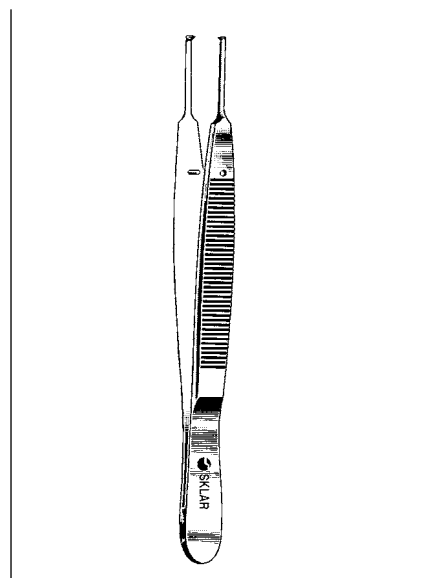

### LESTER CONJUNCTIVAL FORCEPS

- 66-4235 3/4" 1 x 2 teeth,  
non-magnetic

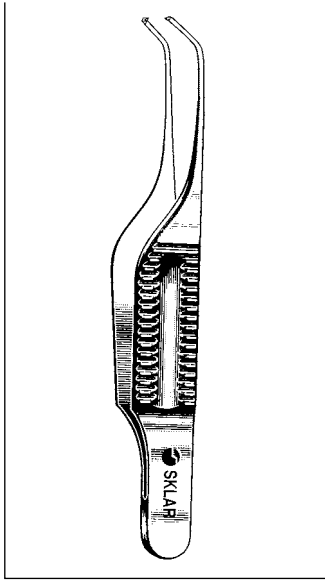

### GILL IRIS FORCEPS

66-7130 1 x 2 Curved,  
length 3"

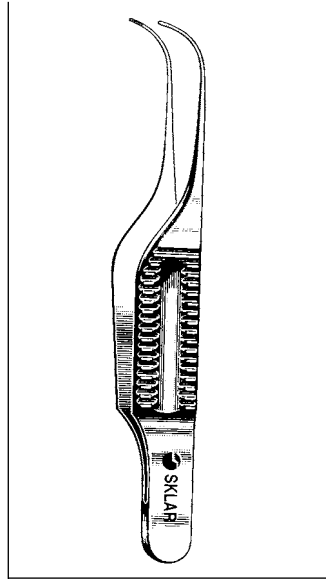

### GILL (CHANDLER) IRIS FORCEPS

66-7244 3" Fine cross serrated tips  
0.6 mm wide, Curved

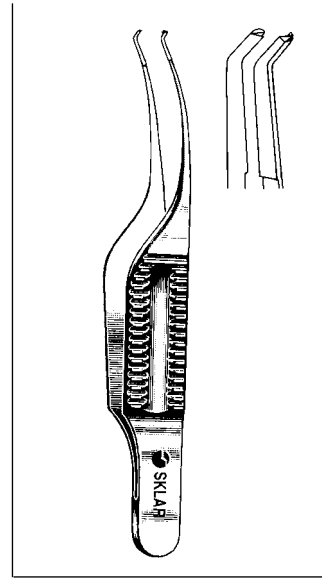

### TROUTMAN-BARRAQUER CORNEAL UTILITY FORCEPS

Colibri Type  
66-7250 1 x 2 0.5 mm teeth, set at  
45° with tying platform.

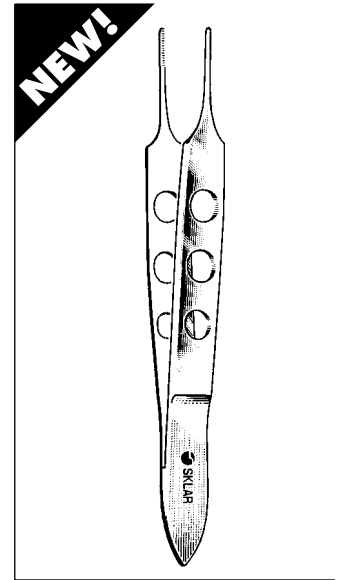

### NEW! SKLAR LITEGRIP™ BISHOP-HARMON FORCEPS

66-4034 3/4" Serrated  
66-4134 3/4" 1 x 2 Teeth

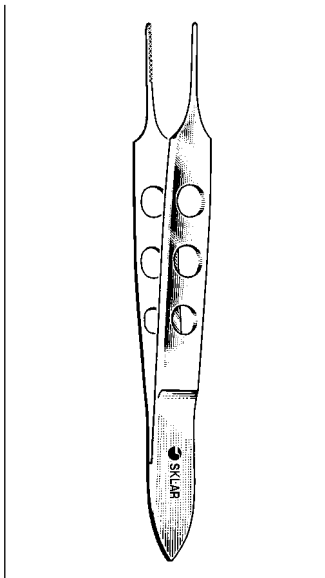

### BISHOP-HARMON EYE DRESSING FORCEPS

Serrated, straight tips  
66-4032 3/4"

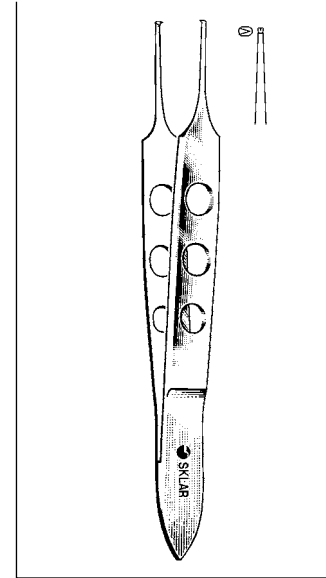

### BISHOP-HARMON EYE TISSUE FORCEPS

3/4" Straight, 1 x 2 Teeth  
66-4132 Standard pattern  
66-4133 Extra delicate for  
microsurgery

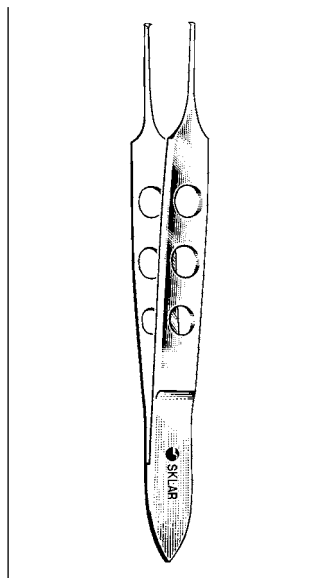

### BISHOP-HARMON FORCEPS (IOWA)

1 x 2 straight teeth, Micro tip  
66-4232 3/4"

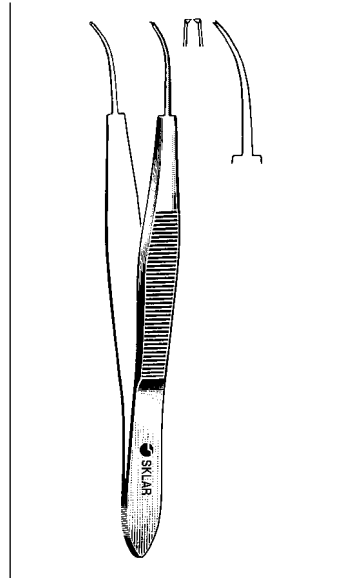

### STEVENS IRIS FORCEPS

4/4"  
66-4950 Straight without catch 1 x 2  
66-4951 Curved without catch 1 x 2

# EYE INSTRUMENTS

## FORCEPS

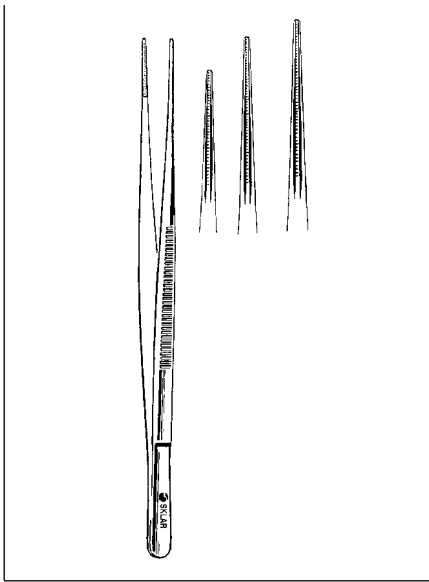

### DEBAKEY ATRAUMATIC TISSUE FORCEPS

- 1.5 mm Jaw  
 52-5062 6¼"  
 52-5077 7¼"  
 52-5095 9½"

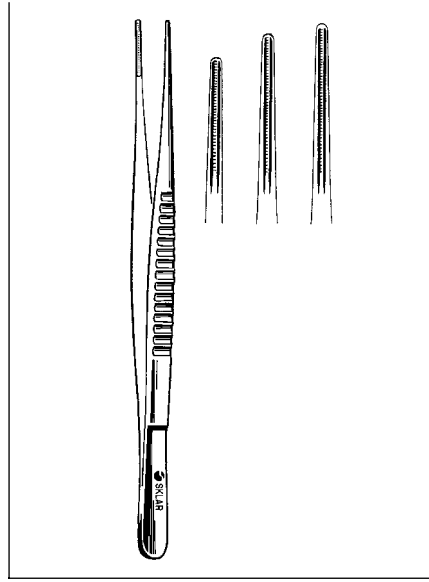

### DEBAKEY ATRAUMATIC TISSUE FORCEPS

- 2.0 mm Jaw  
 52-5162 6¼"  
 52-5177 7¼"  
 52-5195 9½"

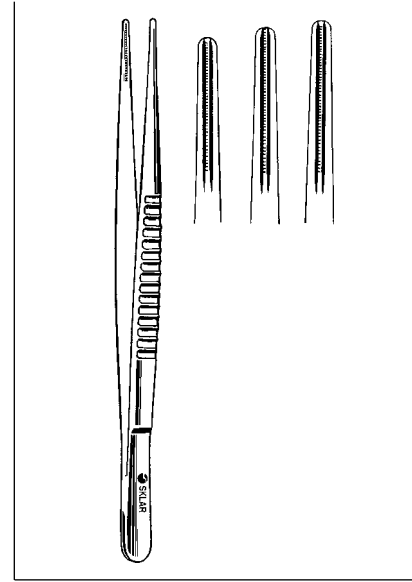

### DEBAKEY ATRAUMATIC TISSUE FORCEPS

- 3.5mm Jaw  
 52-5262 6¼"  
 52-5277 7¼"  
 52-5295 9½"

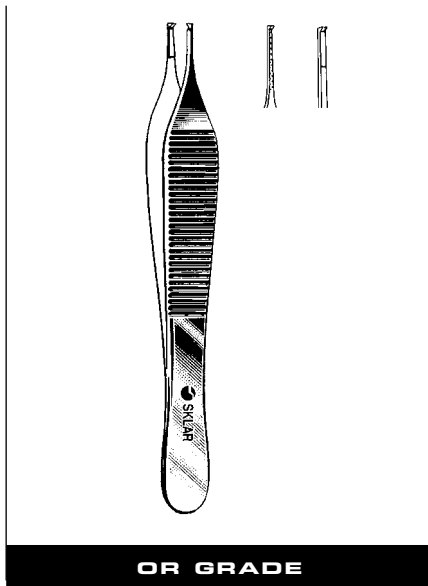

OR GRADE

### ADSON FORCEPS

- 50-3048 4¾" Serrated, 1x2 Teeth  
 50-3049 4¾" 1x2 Teeth w/Platform

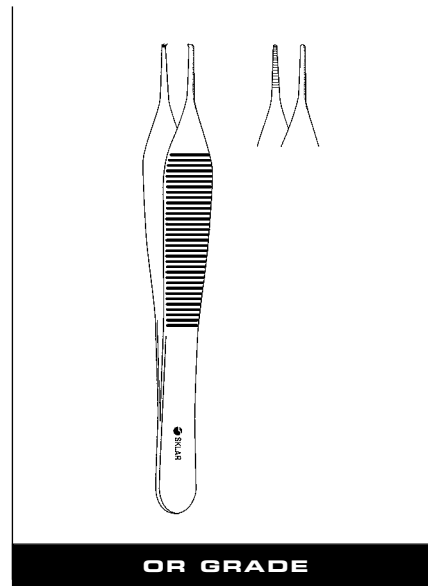

OR GRADE

### MICRO ADSON FORCEPS

- 98-2047 4¾" 1x2 Teeth  
 98-2048 4¾" Serrated



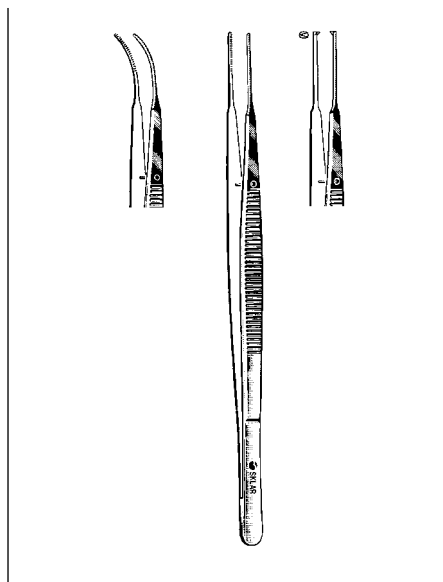

### **GERALD FORCEPS**

Serrated

47-1180 7" Straight

47-1175 7" Curved

1 x 2

47-1173 7" Straight

47-1186 7" Curved

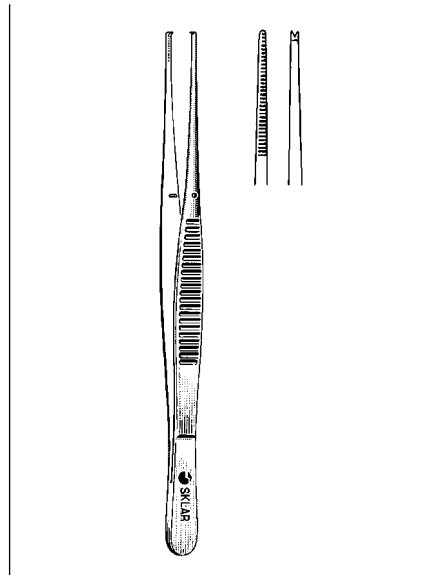

### **CUSHING FORCEPS DELICATE**

22-6770 7" Serr.

22-6870 7" 1x2

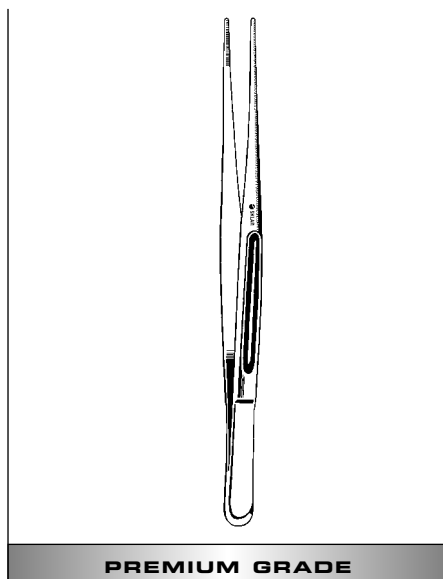

**PREMIUM GRADE**

### **CUSHING BRAIN FORCEPS DELICATE**

50-2670 7" Serrated Jaw  
Gutch Handle

50-2870 7" 1x2 Teeth  
Gutch Handle

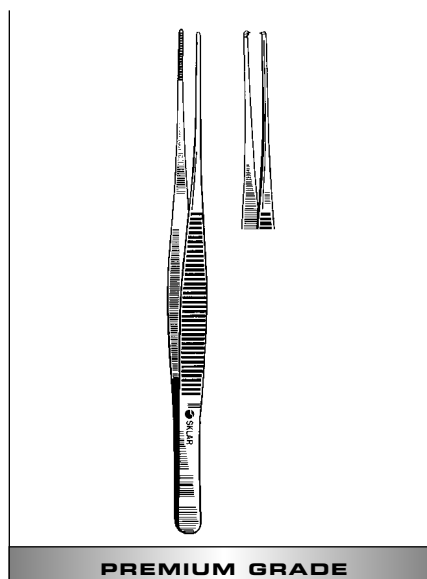

**PREMIUM GRADE**

### **CUSHING BRAIN FORCEPS DELICATE**

50-2770 7" Serrated Jaw  
Serrated Handle

50-2970 7" 1x2 Teeth  
Serrated Handle

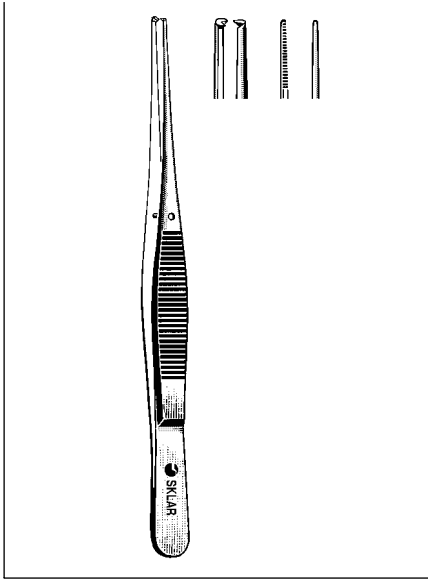

### SEMKIN DRESSING/ TISSUE FORCEPS

- 22-4150 5" Narrow Serrated
- 22-4250 5" Delicate Serrated
- 22-4350 5" Narrow 1x2 Teeth
- 22-4450 5" Delicate 1x2 Teeth

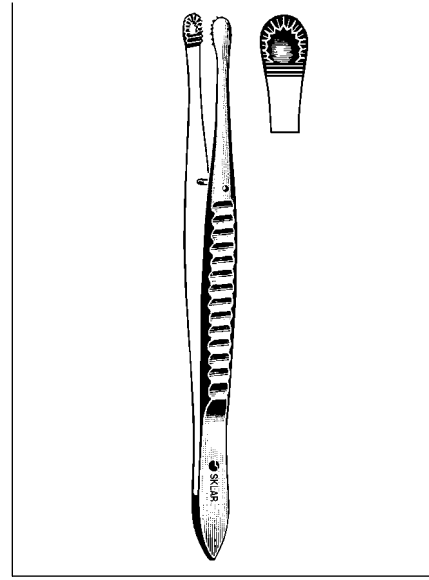

### RUSSIAN TISSUE FORCEPS

- 19-2260 6"
- 19-2280 8"
- 19-2310 10"

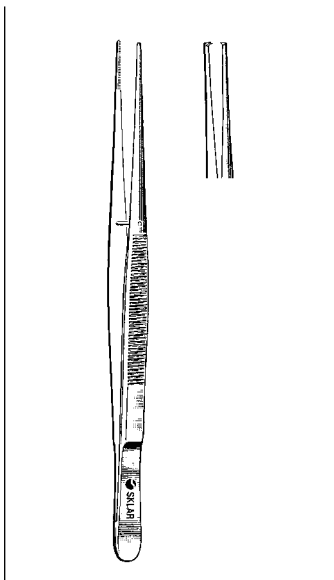

### POTTS-SMITH FORCEPS

- 52-3270 7" Serrated
- 52-3282 8 1/4" Serrated
- 52-3370 7" 1x2 Teeth
- 52-3382 8 1/4" 1x2 Teeth
- 52-3310 10" Serrated
- 52-3410 10" 1x2 Teeth

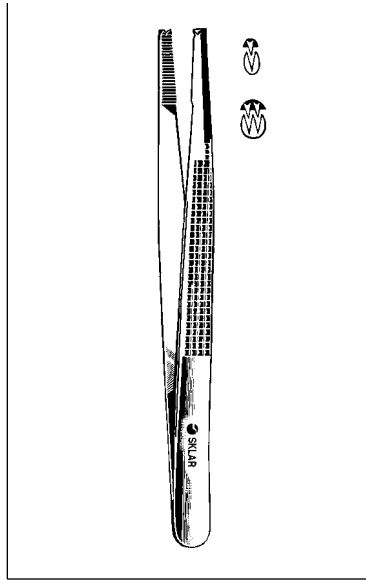

### BONNEY TISSUE FORCEPS

- 19-2170 7" 1x2 Teeth
- 19-2172 7" 2x3 Teeth

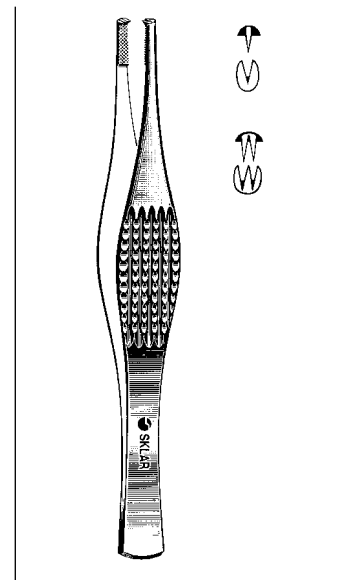

### FERRIS-SMITH FORCEPS

- 47-1470 7" 1x2 Teeth With Platform
- 52-3970 7" 2x3 Teeth With Platform

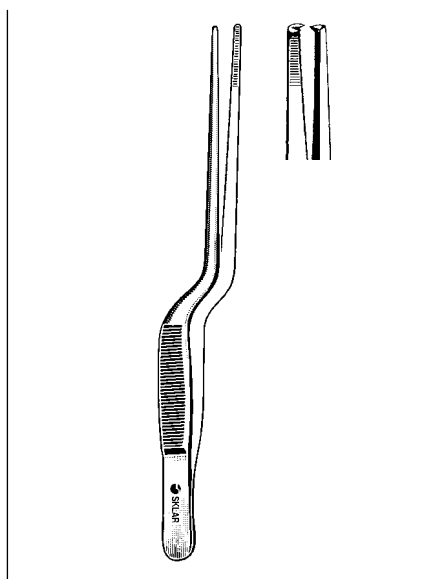

**LUCAE BAYONET FORCEPS**

67-1455 5½" Serrated  
67-1555 5½" w/1x2 Teeth

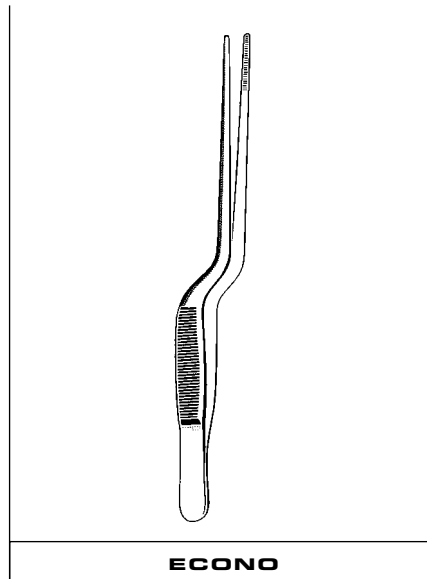

**ECONO**

**LUCAE BAYONET FORCEPS,  
ECONO**

Box/12  
21-180 5½"

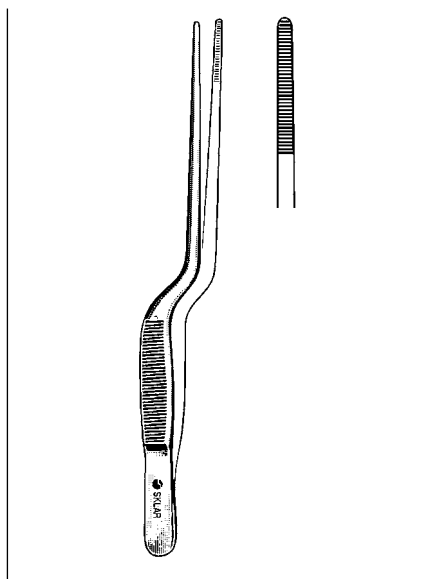

**JANSEN BAYONET NASAL  
FORCEPS**

67-1465 6½"  
70-4375 7½"  
70-4385 8½"

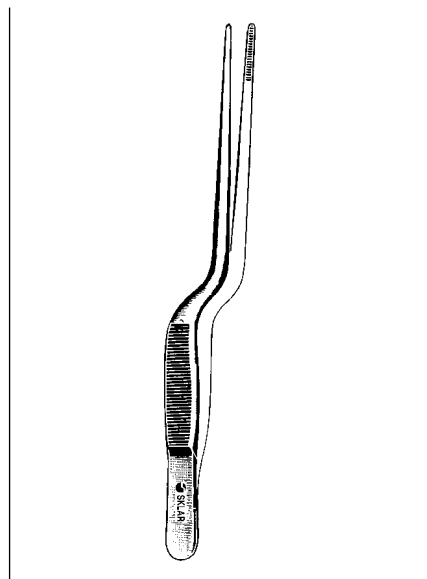

**ADSON BAYONET FORCEPS**

50-3371 7½" Delicate

# DERMAL - FORCEPS

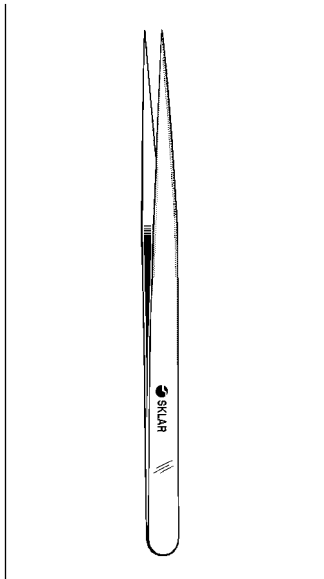

**JEWELERS STYLE  
FORCEPS**

66-7436 4 3/4" With extra fine  
tips, Style P

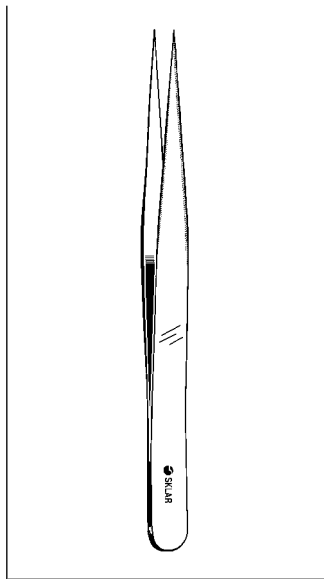

**JEWELERS STYLE  
FORCEPS**

66-7438 4 3/4" With fine  
tips, Style 1



**JEWELERS STYLE  
FORCEPS**

66-7440 4 3/4" With fine  
tips, Style 2

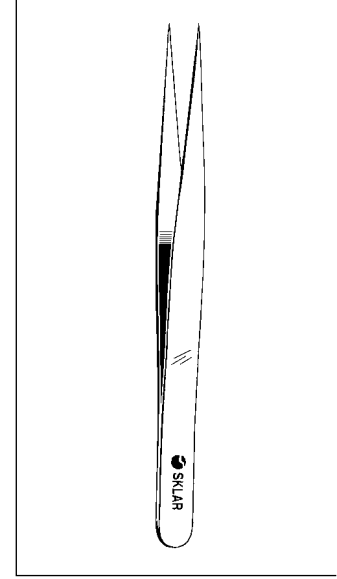

**JEWELERS STYLE  
FORCEPS**

66-7447 4 3/4" #3 Straight  
66-7442 4 3/4" #3C Straight Delicate

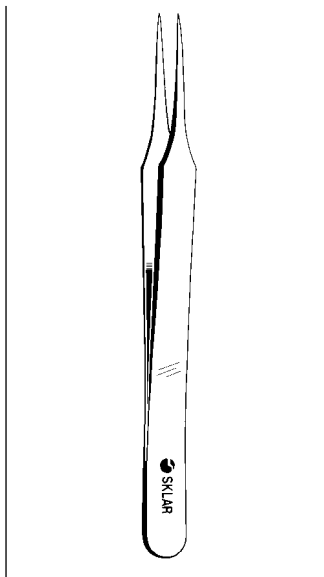

**JEWELERS STYLE  
FORCEPS**

66-7542 4 3/4" #4 Straight Delicate

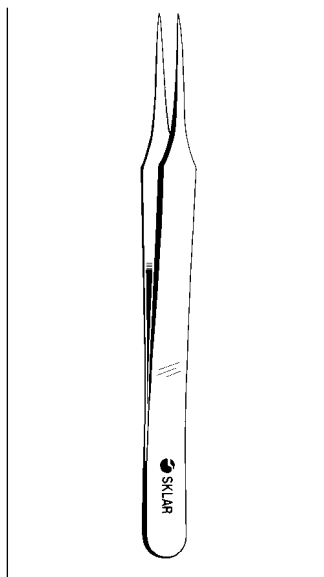

**JEWELERS STYLE  
FORCEPS**

66-7642 4 3/4" #5 Straight

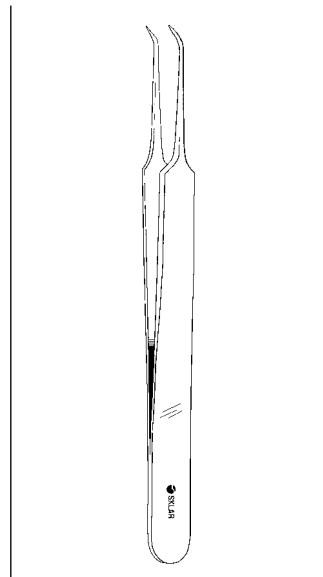

**JEWELERS STYLE  
FORCEPS**

66-7645 4 3/4" #5 Angled

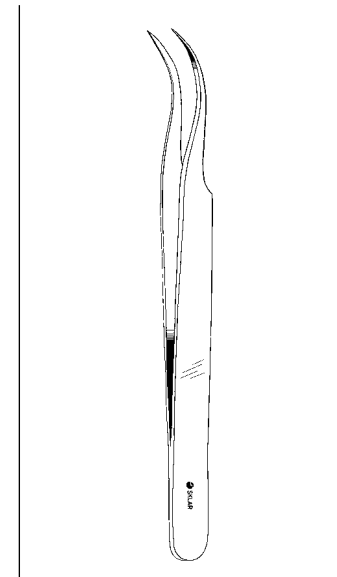

**JEWELERS STYLE  
FORCEPS**

66-7644 4 3/4" #7 Curved

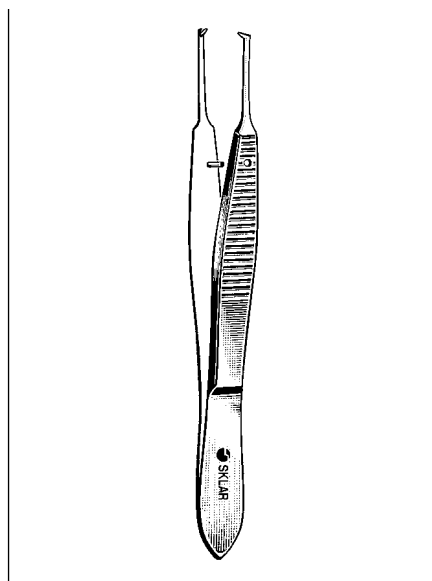

### GRAEFE IRIS FORCEPS

66-4525 2 3/4" Straight 1 x 2  
 66-4625 2 3/4" Full Curved 1 x 2

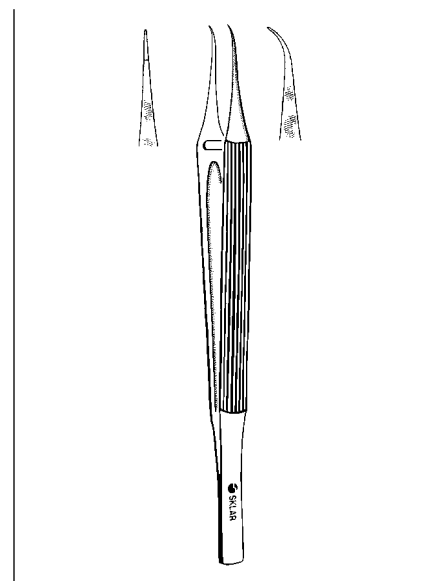

### MICRO SUTURE TYING FORCEPS

98-2080 6" Straight  
 98-2081 6" Curved

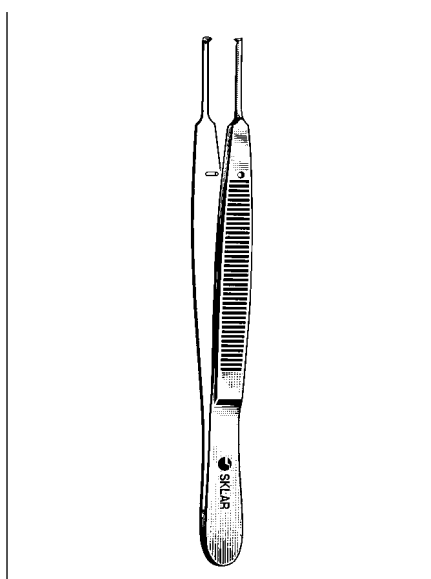

### LESTER CONJUNCTIVAL FORCEPS

66-4235 3 1/2" 1 x 2  
 Non-Magnetic

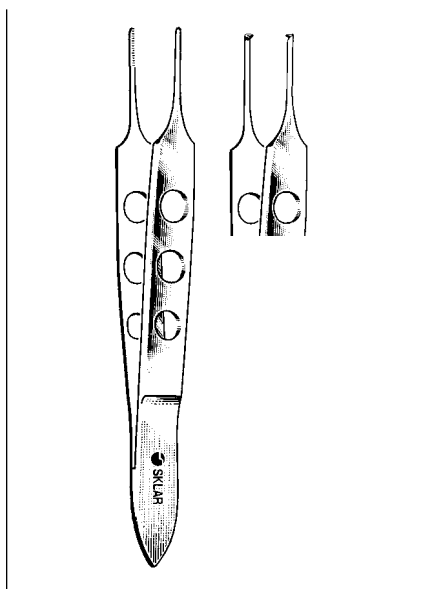

### BISHOP-HARMON FORCEPS

66-4032 3 1/2" Serrated  
 66-4132 3 1/2" 1 x 2  
 66-4232 3 1/2" 1 x 2 Micro (Iowa)  
 66-4234 3 1/2" 1 x 2 Delicate

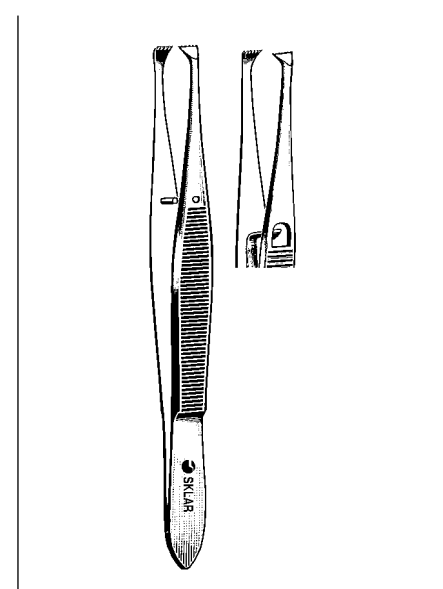

### GRAEFE FIXATION FORCEPS

66-1940 4 1/8" Without Lock  
 66-2140 4 1/8" With Lock

# MAYO-HEGAR NEEDLE HOLDERS

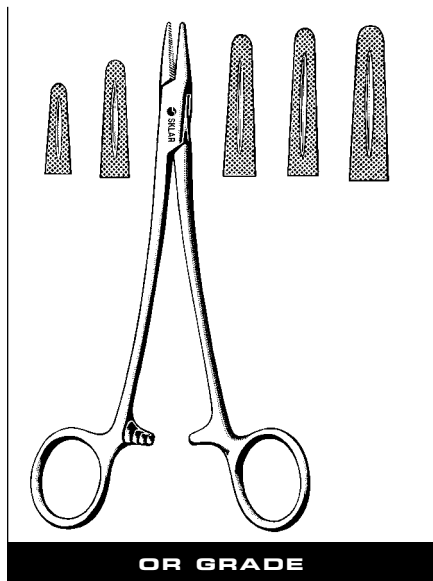

## MAYO-HEGAR NEEDLE HOLDER

Serrated

20-2052	5 1/4"	20-2480	8"
20-2060	6"	20-2490	9"
20-2070	7"	20-2910	10 1/2" Masson
20-2270	7" Broad Jaw	20-2911	11 1/2" Masson

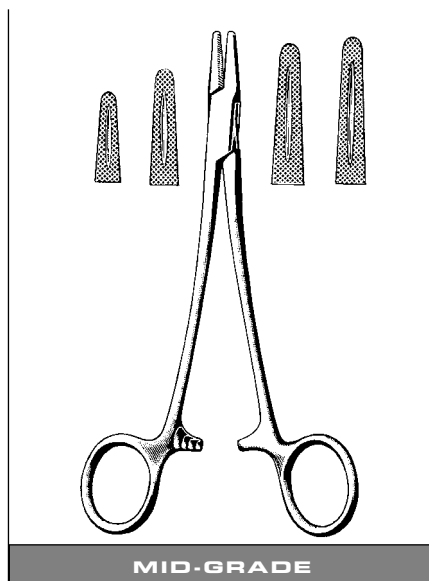

## MID-GRADE MAYO-HEGAR NEEDLE HOLDER

Serrated

95-842	5 1/4"
95-847	6"
95-853	7"
95-869	8"

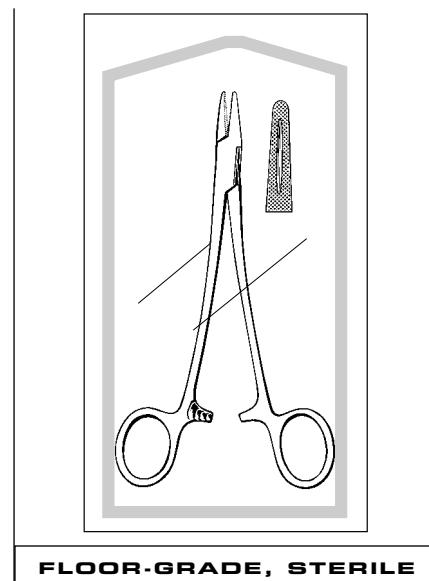

## MAYO-HEGAR NEEDLE HOLDER, STERILE

Box/50	
96-2594	6"
Box/25	
96-2595	6"

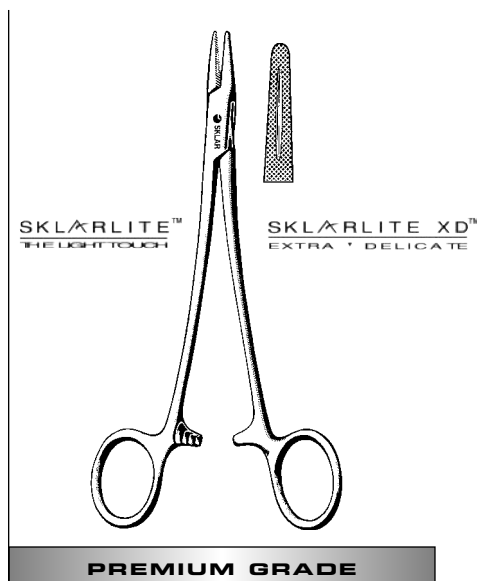

## SKLARLITE™ MAYO-HEGAR NEEDLE HOLDER

23-2128 7" Serrated

## SKLARLITE EXTRA DELICATE™ MAYO-HEGAR NEEDLE HOLDER

23-2228 7" Serrated

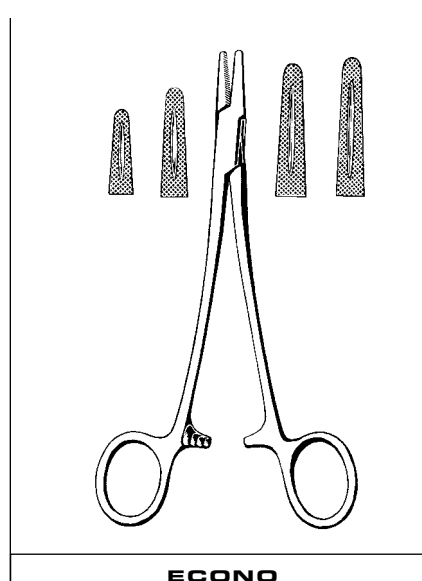

## MAYO-HEGAR NEEDLE HOLDER, ECONO

Box/12	
21-842	5"
21-847	6"
21-853	7"
21-869	8"

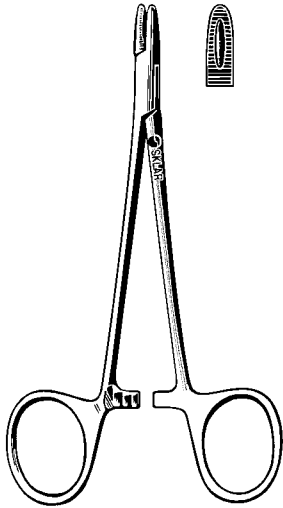

**OR GRADE**

**DERF NEEDLE HOLDER**

20-1547 4¾" Serrated

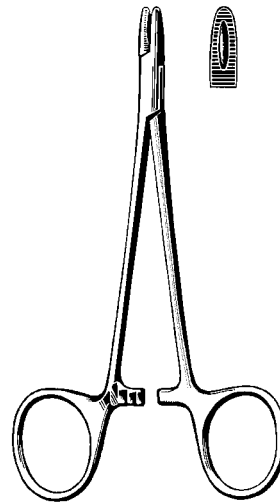

**MID-GRADE**

**MID-GRADE  
DERF NEEDLE HOLDER**

95-826 4¾" Serrated

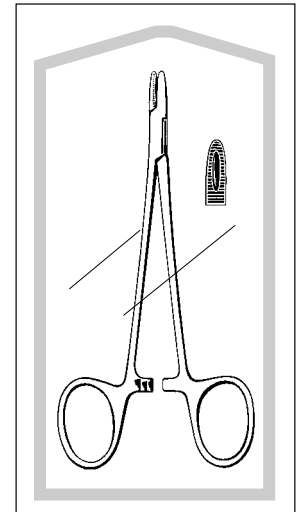

**FLOOR-GRADE, STERILE**

**DERF NEEDLE HOLDER,  
STERILE**

Box/50

96-2582 4¾" Serrated

Box/25

96-2583 4¾" Serrated

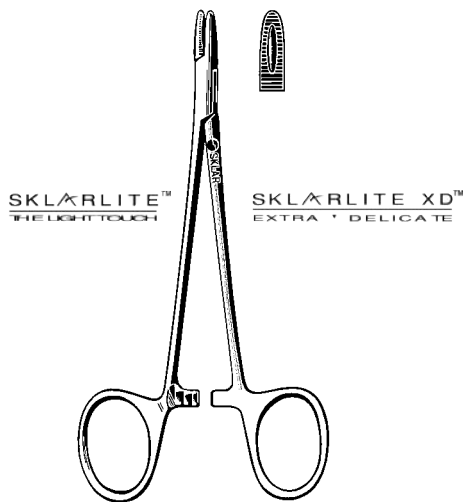

**PREMIUM GRADE**

**SKLARLITE™  
DERF NEEDLE HOLDER**

23-2124 4¾" Serrated

**SKLARLITE EXTRA DELICATE™  
DERF NEEDLE HOLDER**

23-2224 4¾" Serrated

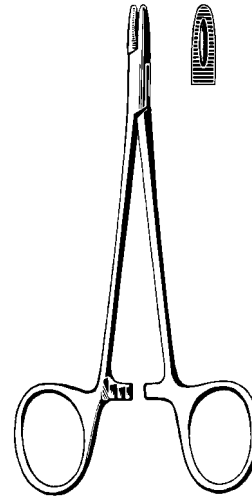

**ECONO**

**DERF NEEDLE HOLDER,  
ECONO**

Box/12

21-826 4¾"

# WEBSTER NEEDLE HOLDERS

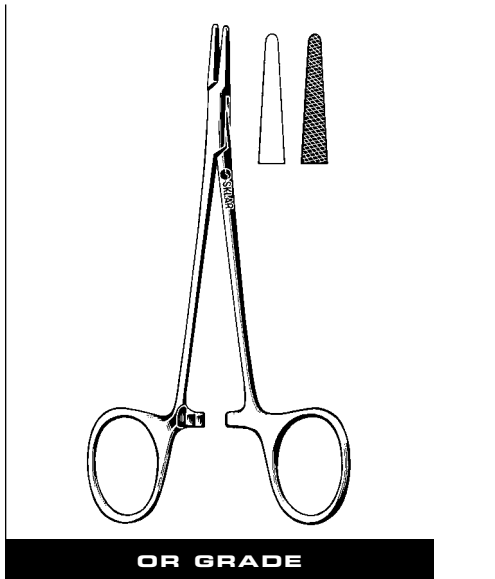

**OR GRADE**

## WEBSTER NEEDLE HOLDER

- 20-1350 5/4" Smooth
- 20-1352 5/4" Serrated
- 20-3090 5/4" Smooth, Heavy Pattern

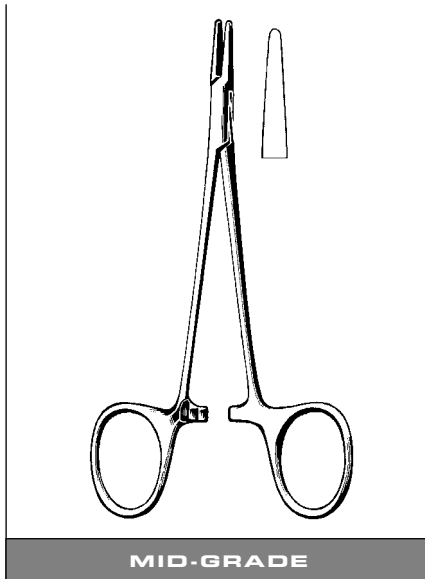

**MID-GRADE**

## MID-GRADE WEBSTER NEEDLE HOLDER

- 95-809 5/4" Smooth

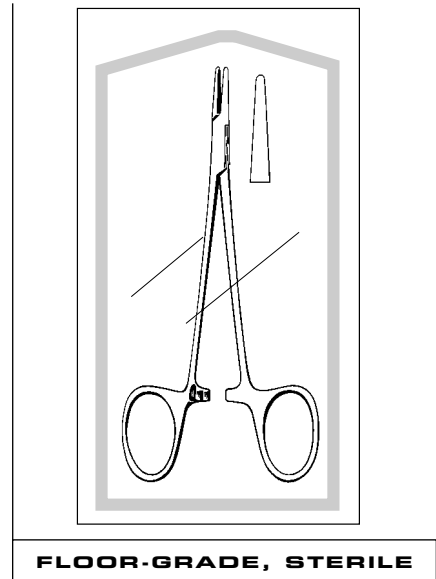

**FLOOR-GRADE, STERILE**

## WEBSTER NEEDLE HOLDER, STERILE

- Box/50
- 96-2586 5/4" Smooth
- Box/25
- 96-2587 5/4" Smooth

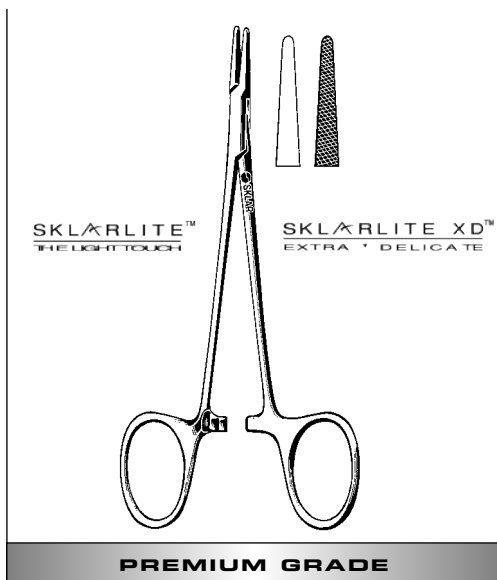

**PREMIUM GRADE**

## SKLARLITE™ WEBSTER NEEDLE HOLDER

- 23-2125 5/4" Smooth
- 23-2120 5/4" Serrated

## SKLARLITE EXTRA DELICATE™ WEBSTER NEEDLE HOLDER

- 23-2225 5/4" Smooth
- 23-2220 5/4" Serrated

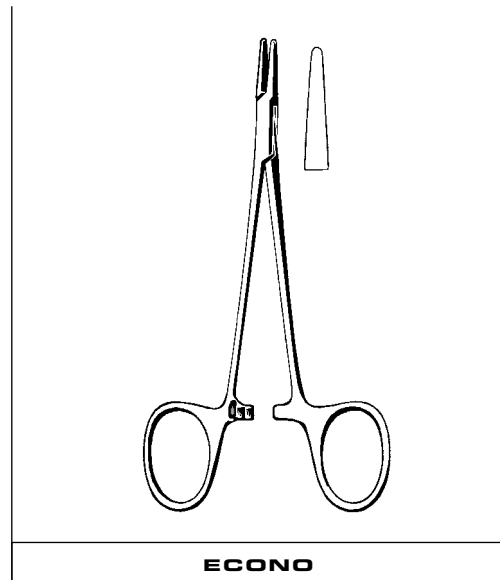

**ECONO**

## WEBSTER NEEDLE HOLDER, ECONO

- Box/12
- 21-809 5/4"



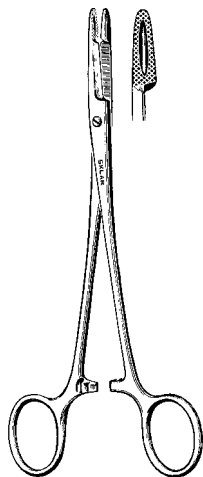

**OR GRADE**

### **OLSEN-HEGAR NEEDLE HOLDER**

Scissors Combination

20-2747	4 1/4"	Delicate
20-2755	5 1/2"	
20-2765	6 1/2"	
20-2775	7"	

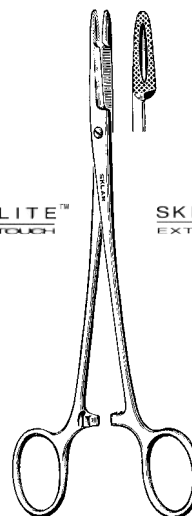

**SKLARLITE™**  
HEAVY DUTY

**SKLARLITE XD™**  
EXTRA DELICATE

**PREMIUM GRADE**

### **SKLARLITE™ OLSEN-HEGAR NEEDLE HOLDER**

Scissors Combination

23-2136	5 1/2"	Serrated
---------	--------	----------

### **SKLARLITE EXTRA DELICATE™ OLSEN-HEGAR NEEDLE HOLDER**

Scissors Combination

23-2236	5 1/2"	Serrated
---------	--------	----------

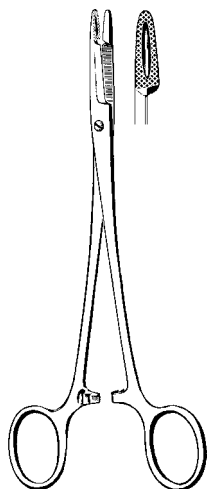

**ECONO**

### **OLSEN-HEGAR NEEDLE HOLDER, ECONO**

Box/12

21-877	6"
--------	----



**OR GRADE**

### **CASTROVIEJO NEEDLE HOLDER**

With Lock

65-6357	5 1/2"	Straight, Smooth
65-6358	5 1/2"	Curved, Smooth

# CRILE-WOOD NEEDLE HOLDERS

## CRILE-MURRAY NEEDLE HOLDERS

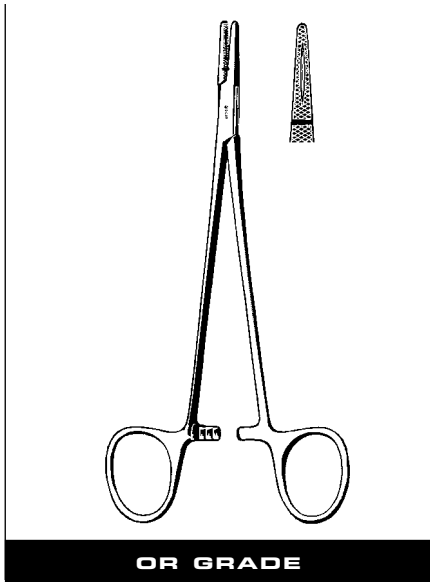

**OR GRADE**

### CRILE-WOOD NEEDLE HOLDER

- Serrated
- 20-1265 6" Narrow Jaw
  - 20-1270 7"
  - 20-1280 8"
  - 20-1290 9"
  - 20-1295 10½"

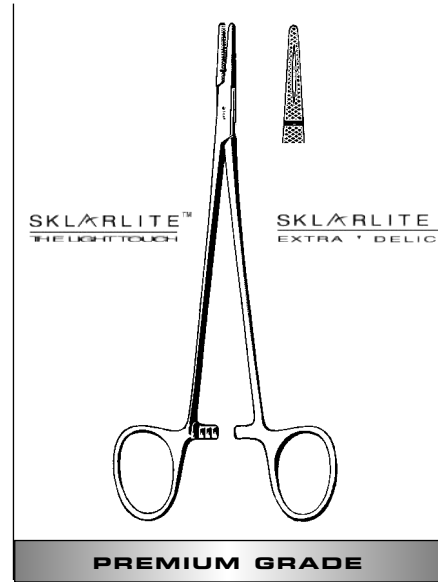

**PREMIUM GRADE**

### SKLARLITE™ CRILE-WOOD NEEDLE HOLDER

23-2134 6" Serrated

### SKLARLITE EXTRA DELICATE™ CRILE-WOOD NEEDLE HOLDER

23-2234 6" Serrated

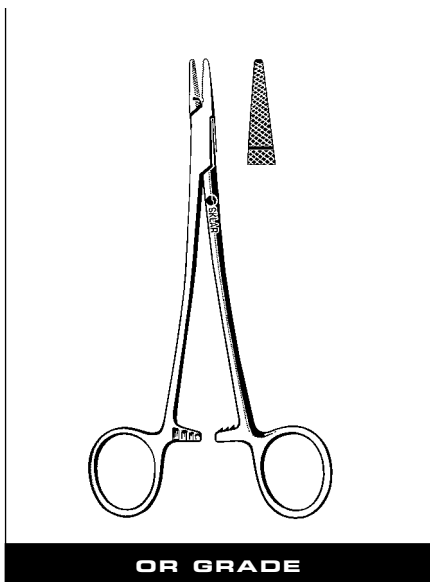

**OR GRADE**

### CRILE-MURRAY NEEDLE HOLDER

20-1260 6" Serrated

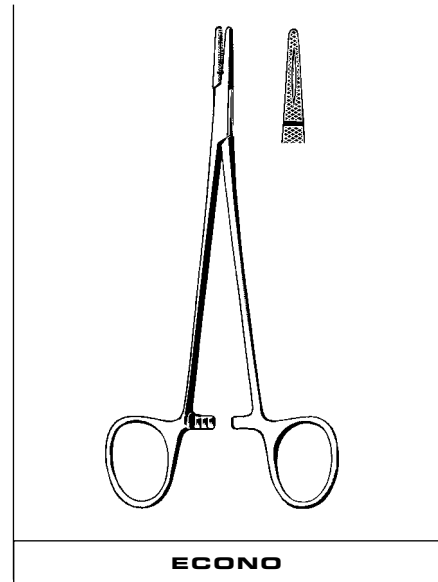

**ECONO**

### CRILE-WOOD NEEDLE HOLDER, ECONO

Box/12  
21-838 6"

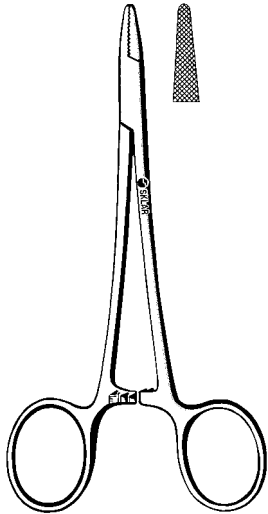

**OR GRADE**

**BAUMGARTNER  
NEEDLE HOLDER**

20-1450 5½" Serrated

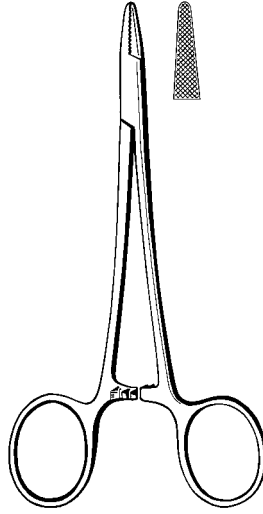

**MID-GRADE**

**MID-GRADE  
BAUMGARTNER NEEDLE HOLDER**

95-832 5½"

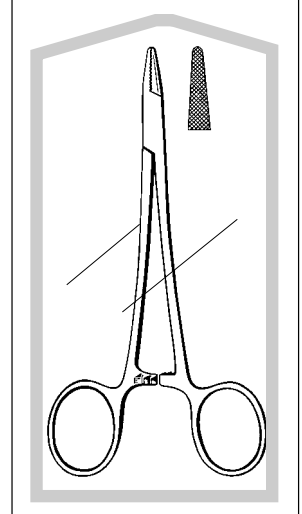

**FLOOR-GRADE, STERILE**

**BAUMGARTNER  
NEEDLE HOLDER, STERILE**

Box/50  
96-2580 5½"  
Box/25  
96-2581 5½"

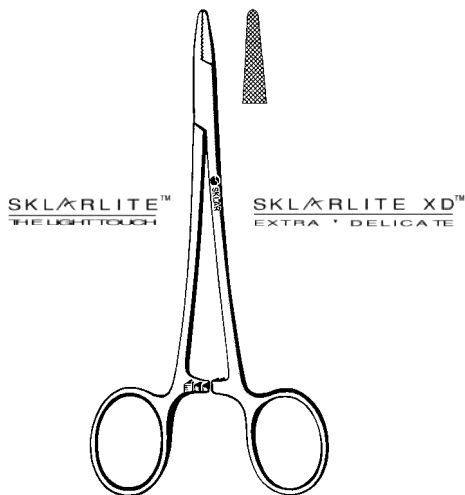

**PREMIUM GRADE**

**SKLARLITE™  
BAUMGARTNER NEEDLE HOLDER**

23-2132 5½" Serrated

**SKLARLITE EXTRA DELICATE™  
BAUMGARTNER NEEDLE HOLDER**

23-2232 5½" Serrated

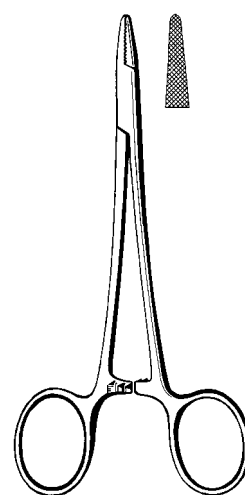

**ECONO**

**BAUMGARTNER  
NEEDLE HOLDER, ECONO**

Box/12  
21-832 5½"

# HALSEY NEEDLE HOLDER

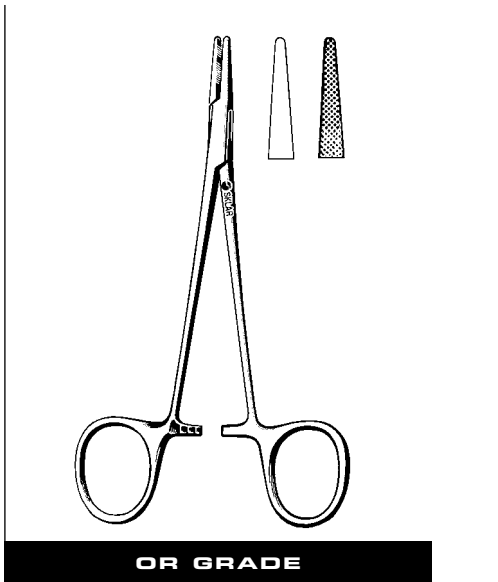

**OR GRADE**

## **HALSEY NEEDLE HOLDER**

20-1750 5¼" Smooth  
20-1751 5¼" Serrated

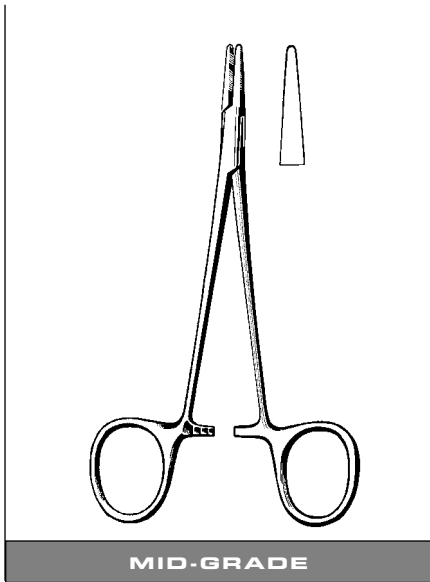

**MID-GRADE**

## **MID-GRADE HALSEY NEEDLE HOLDER**

95-810 5¼" Smooth

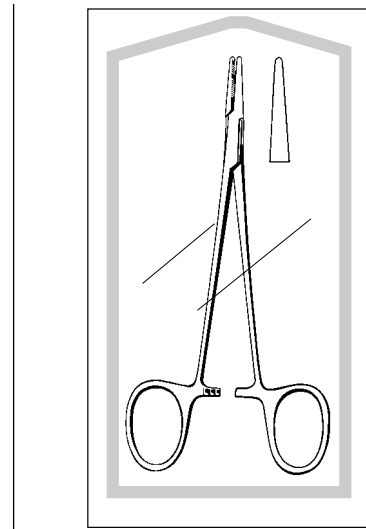

**FLOOR-GRADE, STERILE**

## **HALSEY NEEDLE HOLDER, STERILE**

Box/50  
96-2584 5¼" Smooth  
Box/25  
96-2585 5¼" Smooth

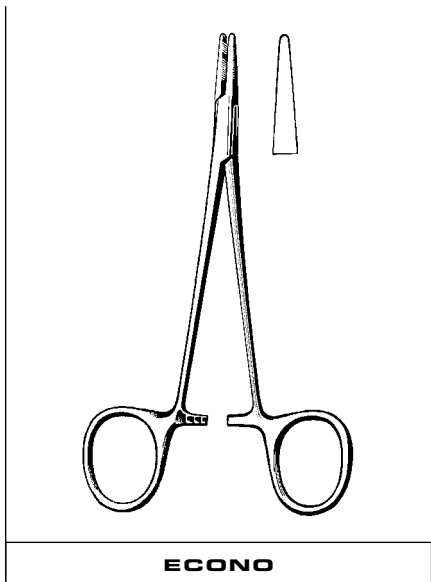

**ECONO**

## **HALSEY NEEDLE HOLDER, ECONO**

Box/12  
21-810 5¼" Smooth

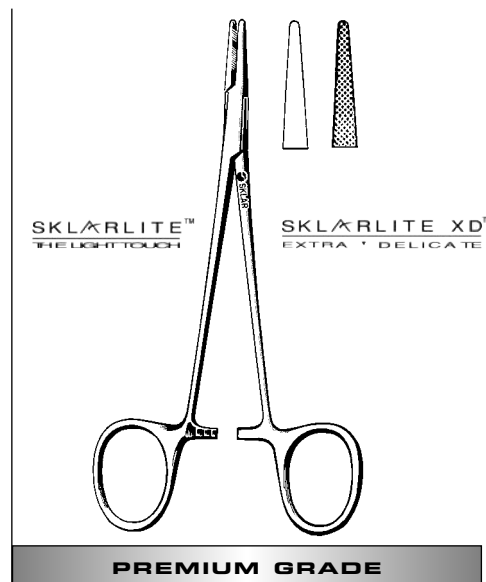

**SKLARLITE™**  
THE LIGHTTROUGH

**SKLARLITE XD™**  
EXTRA DELICATE

**PREMIUM GRADE**

## **SKLARLITE™ HALSEY NEEDLE HOLDER**

23-2135 5¼" Smooth    23-2130 5¼" Serrated

## **SKLARLITE EXTRA DELICATE™ HALSEY NEEDLE HOLDER**

23-2235 5¼" Smooth    23-2230 5¼" Serrated

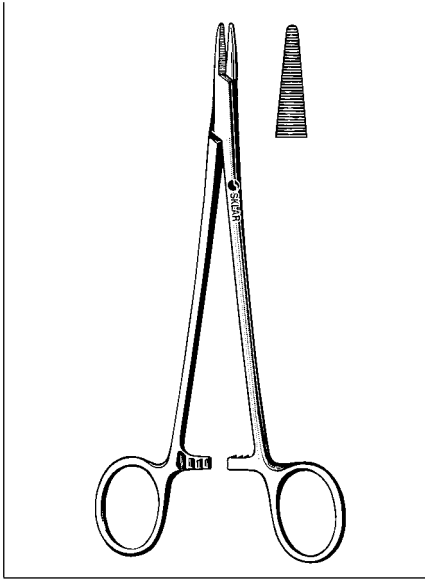

### **BROWN NEEDLE HOLDER**

Rounded Jaws  
 20-4852 5"  
 20-4867 6"

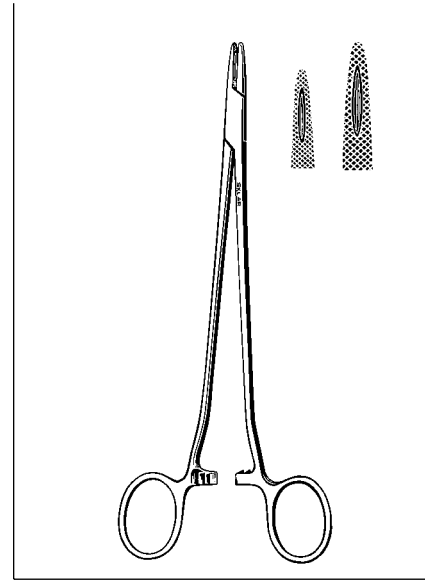

### **SAROT NEEDLE HOLDER**

Serrated  
 22-5050 5"  
 20-4170 7"  
 20-3910 10"

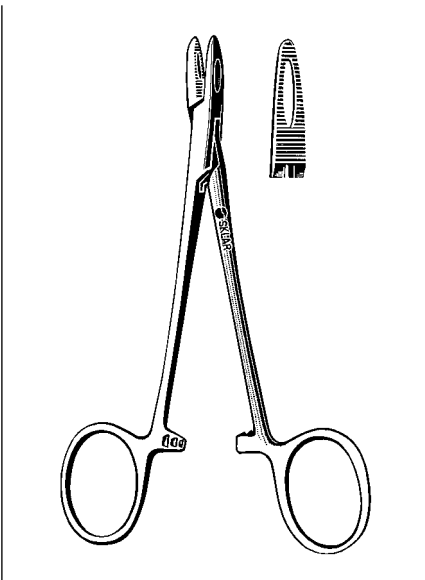

### **COLLIER NEEDLE HOLDER**

Fenestrated Jaw  
 65-6550 5" Serrated

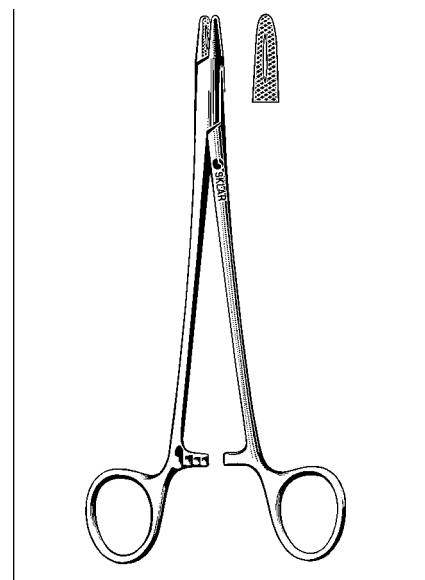

### **NEW ORLEANS NEEDLE HOLDER**

20-1870 7" Serrated

**NEW!**

# SKLAR EDGE™ PREMIUM SCISSORS

Sklar Edge™ scissors are manufactured using a Sklar exclusive edging process which permanently bonds tungsten carbide to the scissor blades.

Tungsten carbide is an extremely hard alloy providing an exceptionally strong and sharper edge while maintaining a Sklar 5 year guarantee of durability.

These perfectly balanced scissors are readily identified by the gold finger rings

**SKLAR EXCLUSIVE**



SKLAR EDGE™  
TUNGSTEN CARBIDE

**PREMIUM GRADE**

## SKLAR EDGE™ T-C OPERATING SCISSORS

Straight

S/S	S/B	B/B
16-1055 5½"	16-1056 5½"	16-1057 5½"



SKLAR EDGE™  
TUNGSTEN CARBIDE

**PREMIUM GRADE**

## SKLAR EDGE™ T-C OPERATING SCISSORS

Curved

S/B
16-1156 5½"

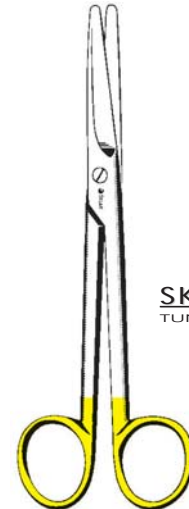

SKLAR EDGE™  
TUNGSTEN CARBIDE

**PREMIUM GRADE**

## SKLAR EDGE™ T-C MAYO DISSECTING SCISSORS

Straight

16-1505 5½"	16-1605 5½"
16-1510 6¾"	16-1610 6¾"
16-1515 9"	16-1615 9"

Curved



SKLAR EDGE™  
TUNGSTEN CARBIDE

**PREMIUM GRADE**

## SKLAR EDGE™ T-C METZENBAUM (LAHEY) SCISSORS

Straight

16-1805 5¾"	Delicate
16-1810 5¾"	Standard

Curved

16-1905 5¾"	Delicate
16-1910 5¾"	Standard



SKLAR EDGE™  
TUNGSTEN CARBIDE

**PREMIUM GRADE**

## SKLAR EDGE™ T-C METZENBAUM DISSECTING SCISSORS

16-2005 7"	Delicate, Straight
16-2010 7"	Standard, Straight
16-2210 9"	Standard Nelson, Straight
16-2105 7"	Delicate, Curved
16-2110 7"	Standard, Curved
16-2310 9"	Standard Nelson, Curved
16-2311 11"	Standard Nelson, Curved



SKLAR EDGE™  
TUNGSTEN CARBIDE

**PREMIUM GRADE**

## SKLAR EDGE™ T-C IRIS SCISSORS

Straight

16-2405 4½"	16-2505 4½"
-------------	-------------

Curved

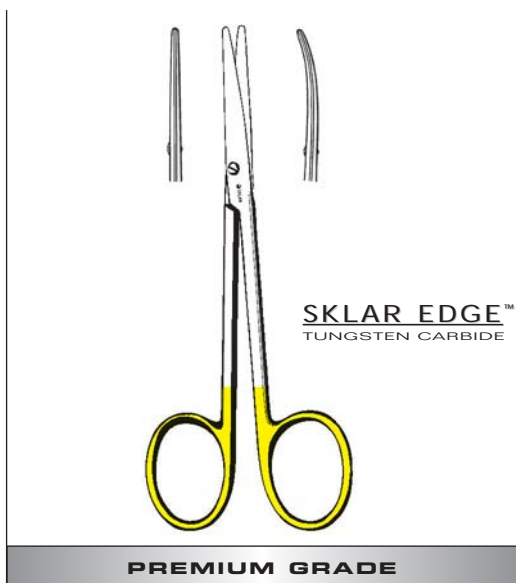

**SKLAR EDGE™  
T-C STRABISMUS SCISSORS**

Straight	Curved
B/B	B/B
16-2605 4½"	16-2705 4½"



**SKLAR EDGE™  
T-C WIRE CUTTING SCISSORS**

16-2800 4¾"	Tungsten Carbide
	Angular Serrated

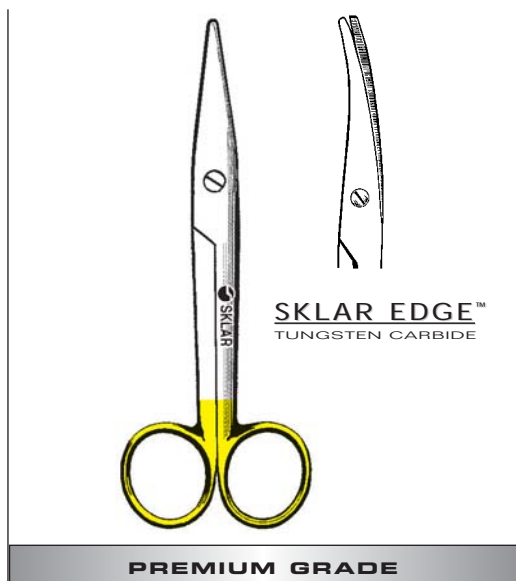

**SKLAR EDGE™  
T-C MAYO-STILLE DISSECTING  
SCISSORS ROUNDED BLADES**

Straight	Curved
16-3552 5½"	16-3562 5½"
16-3557 6¾"	16-3567 6¾"



**SKLAR EDGE™  
T-C DISSECTING SCISSORS**

Curved
16-2610 5"

**NEW!**

# SKLARHONE™ PREMIUM SCISSORS

Sklarhone™ scissors combine the cutting edge of a surgical knife with that of a standard scissor, either smooth or with a finely serrated edge.

These superior instruments employ the most sophisticated technology to create a smooth and clean cutting action whether for delicate surgery or when thick, coarse tissue is encountered.

Sklarhone™ scissors are distinctly identified by their black handles.

**SKLAR EXCLUSIVE**



SKLARHONE™  
MICRO - CUT

**PREMIUM GRADE**

## SKLARHONE™ OPERATING SCISSORS

Straight, Smooth  
S/S            S/B  
15-3342 5½"    15-3343 5½"



SKLARHONE™  
MICRO - CUT

**PREMIUM GRADE**

## SKLARHONE™ OPERATING SCISSORS

Curved, Smooth  
S/B  
15-3349 5½"

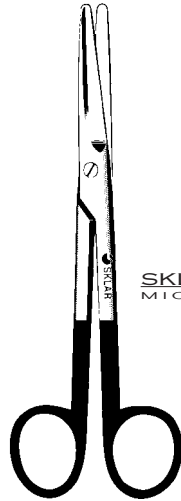

SKLARHONE™  
MICRO - CUT

**PREMIUM GRADE**

## SKLARHONE™ MAYO DISSECTING SCISSORS

Straight, Smooth    Curved, Smooth  
15-3325 5½"        15-3330 5½"  
15-3326 6¼"        15-3331 6¼"

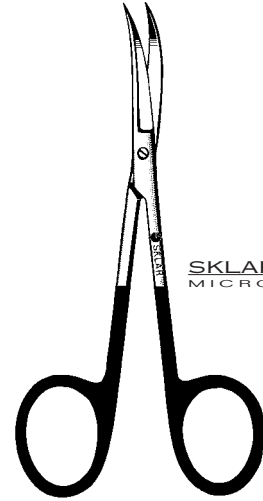

SKLARHONE™  
MICRO - CUT

**PREMIUM GRADE**

## SKLARHONE™ IRIS SCISSORS

Straight, Smooth    Serrated  
15-3352 4½"        15-3452 4½"  
Curved, Smooth    Serrated  
15-3357 4½"        15-3457 4½"



SKLARHONE™  
MICRO - CUT

**PREMIUM GRADE**

## SKLARHONE™ METZENBAUM (LAHEY) SCISSORS

Curved  
15-3306 5½"



SKLARHONE™  
MICRO - CUT

**PREMIUM GRADE**

## SKLARHONE™ METZENBAUM DISSECTING SCISSORS

Curved, Smooth    Serrated  
15-3310 7"            15-3410 7"  
15-3311 8"  
15-3315 9"



SKLARHONE™  
MICRO - CUT

**PREMIUM GRADE**

## SKLARHONE™ JAMESON SCISSORS

Curved  
15-7032 7"



**NEW!**

# SKLAR TC™ PREMIUM NEEDLE HOLDERS

Sklar TC™ needle holders utilize solid tungsten carbide insert jaws with a Sklar pyramid profile to hold suture needles far more securely than standard Needle Holders from any manufacturer.

All TC inserts are precisely ground and virtually indestructible and harder than any needle, eliminating needle rotation or slippage

Finely cut and evenly distributed ratchets on our handles further ensure exacting control over the suturing process.

**TC INSERTS ARE GUARANTEED FOR 5 YEARS!**

**SKLAR EXCLUSIVE**



SKLAR T-C™  
TUNGSTEN CARBIDE

**PREMIUM GRADE**

### T-C CRILE-MURRAY NEEDLE HOLDER

21-8075 6" Serrated

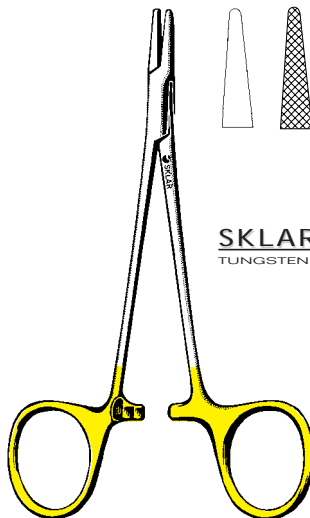

SKLAR T-C™  
TUNGSTEN CARBIDE

**PREMIUM GRADE**

### T-C WEBSTER NEEDLE HOLDER

21-8002 5¼" Smooth  
21-8080 5¼" Serrated

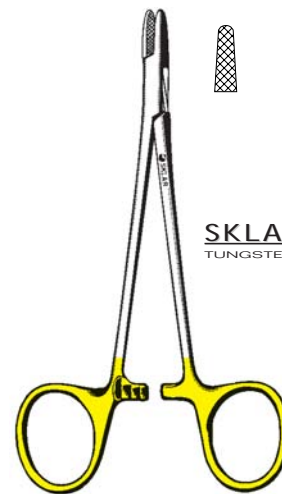

SKLAR T-C™  
TUNGSTEN CARBIDE

**PREMIUM GRADE**

### T-C DERF NEEDLE HOLDER

21-8004 4¾" Serrated

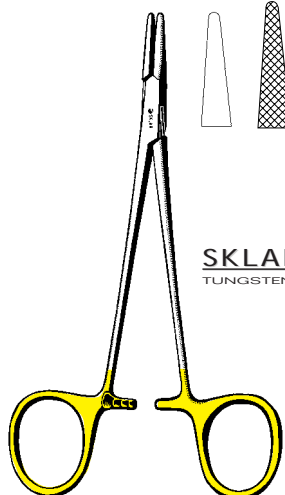

SKLAR T-C™  
TUNGSTEN CARBIDE

**PREMIUM GRADE**

### T-C HALSEY NEEDLE HOLDER

21-8000 5¼" Smooth  
21-8001 5¼" Serrated

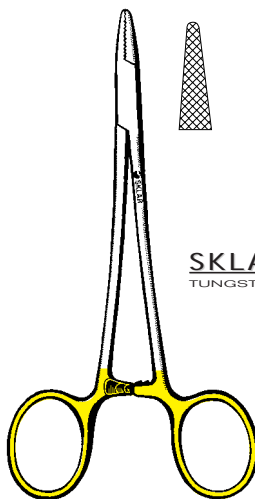

SKLAR T-C™  
TUNGSTEN CARBIDE

**PREMIUM GRADE**

### T-C BAUMGARTNER NEEDLE HOLDER

21-8005 5½" Serrated



SKLAR T-C™  
TUNGSTEN CARBIDE

**PREMIUM GRADE**

### T-C CRILE-WOOD NEEDLE HOLDER

Serrated  
21-8006 6" Narrow 21-8009 9"  
21-8007 7" 21-8010 10½"  
21-8008 8" 21-8011 12"

# PREMIUM SKLAR T-C™ NEEDLE HOLDERS

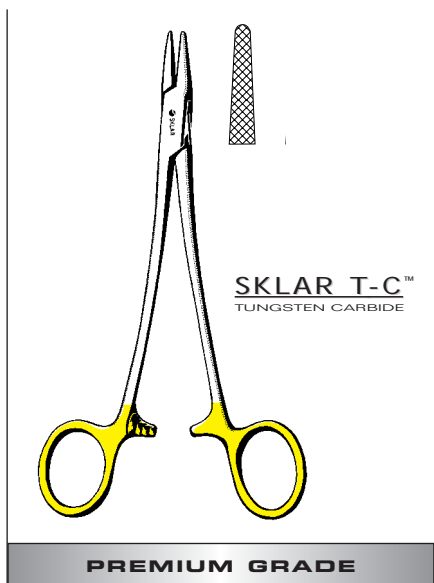

## T-C MAYO-HEGAR NEEDLE HOLDER

Serrated

- 21-8030 5¼"
- 21-8031 6"
- 21-8032 7"
- 21-8033 8"
- 21-8034 10½"
- 21-8035 12"

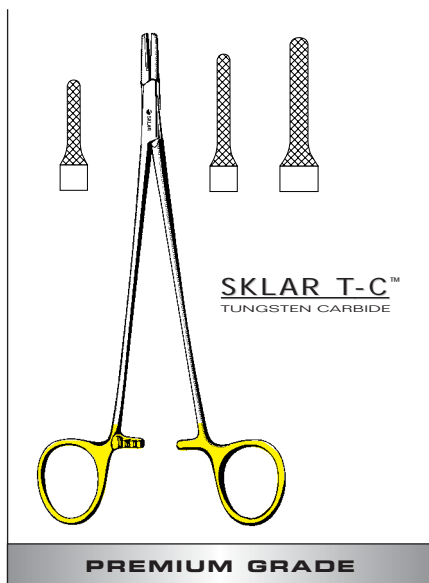

## T-C RYDER NEEDLE HOLDER

Serrated

- 21-8020 6"
- 21-8022 8"
- 21-8023 9"

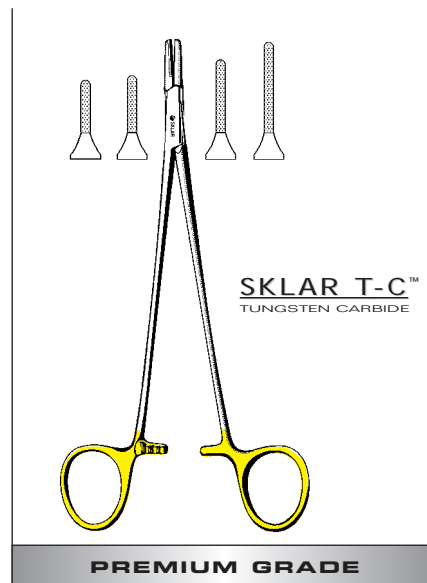

## T-C RYDER NEEDLE HOLDER

Micro-Serrated

- 21-8012 5"
- 21-8013 6"
- 21-8014 7"
- 21-8016 9"

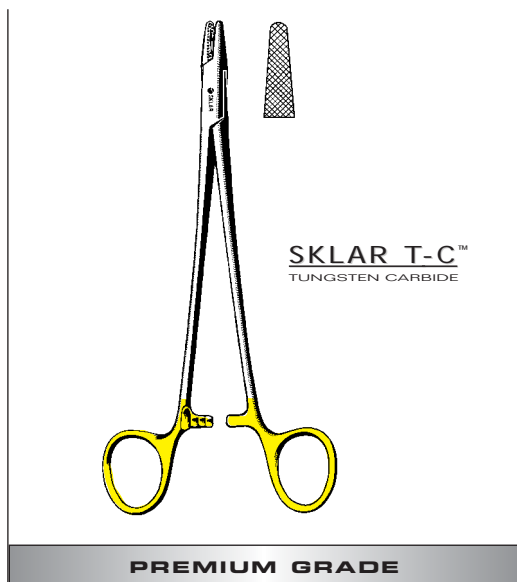

## T-C NEW ORLEANS NEEDLE HOLDER

21-8082 7" Serrated

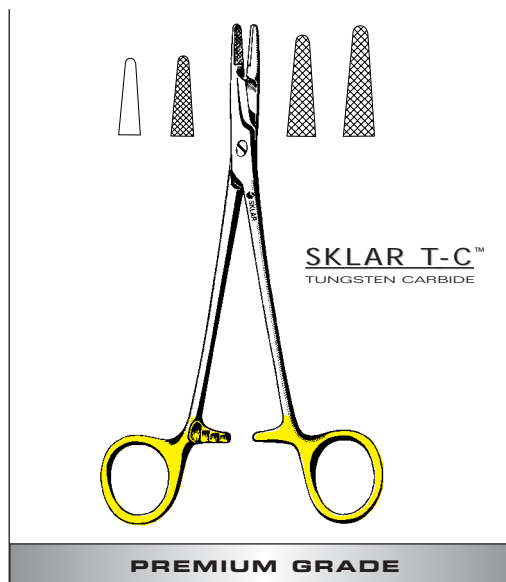

## T-C OLSEN-HEGAR NEEDLE HOLDER

Scissor Combination

- 21-8025 4¼" Serrated Delicate
- 21-8027 5½" Serrated
- 21-8028 6½" Serrated
- 21-8029 7½" Serrated
- 21-8026 4¾" Smooth Delicate

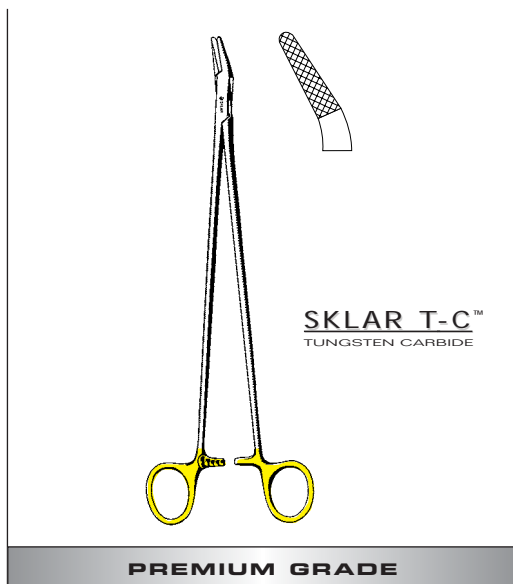

**T-C FINOCHIETTO  
NEEDLE HOLDER**

Angular  
21-8039 10½" Serrated

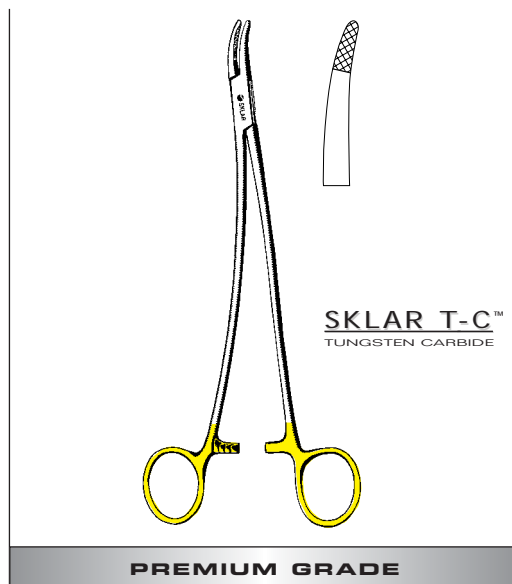

**T-C STRATTE  
NEEDLE HOLDER**

"S" Shaped  
21-8065 9" Serrated

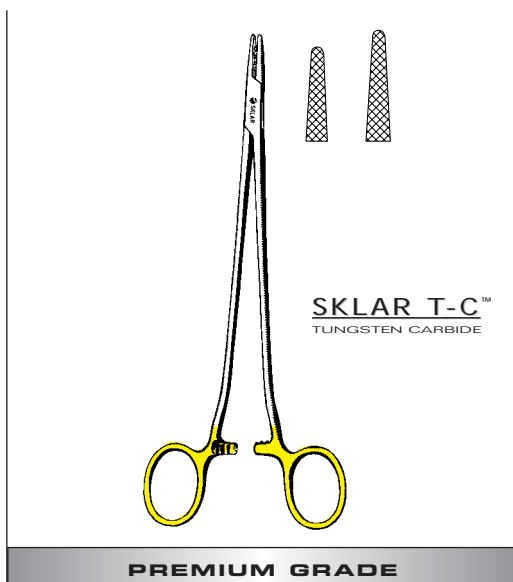

**T-C SAROT  
NEEDLE HOLDER**

21-8036 7½"  
Serrated  
21-8037 10½" Serrated

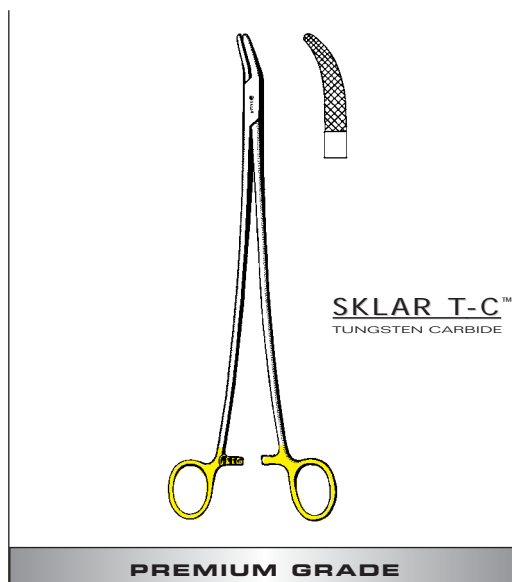

**T-C HEANEY  
NEEDLE HOLDER**

Curved  
21-8060 8¼" Serrated  
21-8061 10" Serrated

# PREMIUM SKLAR T-C™ NEEDLE HOLDERS

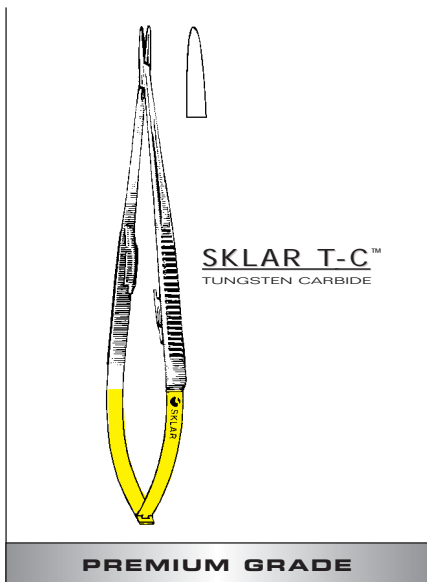

## T-C JACOBSON NEEDLE HOLDER

Straight-Delicate  
 21-8055 8 1/2" Smooth, With Lock  
 21-8058 8 1/2" Smooth, Without Lock

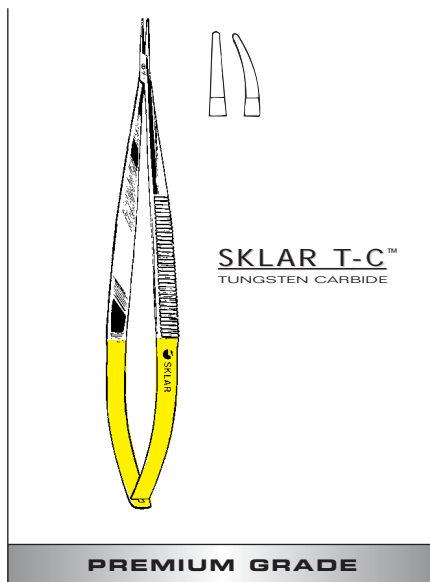

## T-C CASTROVIEJO NEEDLE HOLDER

Extra Delicate - Without Lock  
 21-8044 5 1/2" Straight, Smooth  
 21-8045 5 1/2" Curved, Smooth

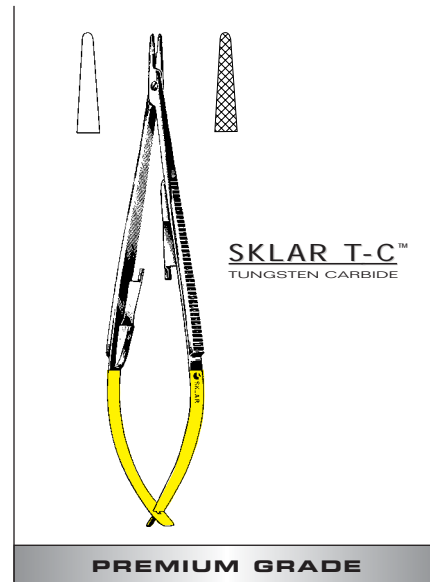

## T-C CASTROVIEJO NEEDLE HOLDER

Straight - With Lock  
 21-8040 5 1/2" Smooth  
 21-8046 5 1/2" Serrated

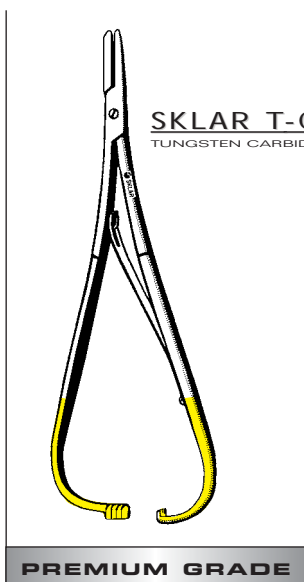

## T-C MATHIEU NEEDLE HOLDER

21-8070 5 1/2"  
 21-8071 6 1/2" Narrow Jaw

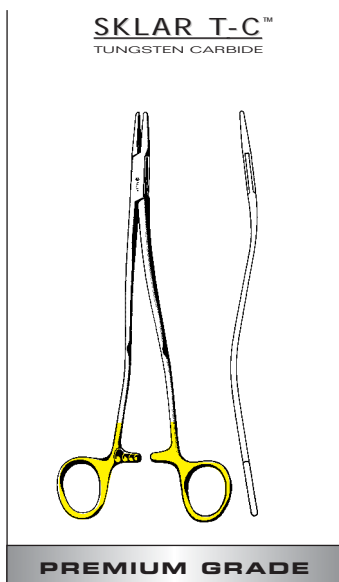

## T-C BOZEMAN-HEANEY NEEDLE HOLDER

21-8062 10 1/2" S-Curve

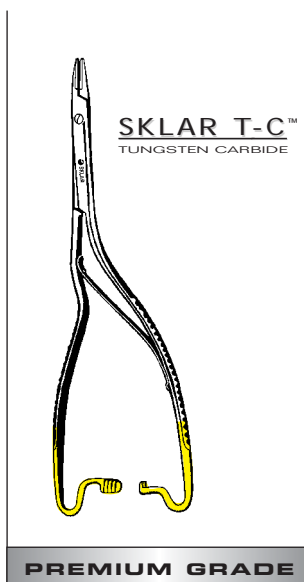

## T-C LUETHY BECK NEEDLE HOLDER

21-8064 8"

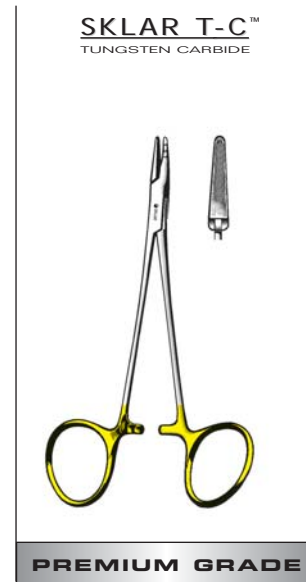

## T-C NEIVERT NEEDLE HOLDER

21-8086 5" Serrated,  
 One Offset  
 Finger Ring

**NEW!**

# SKLAR TC™ PREMIUM FORCEPS

Sklar TC™ Premium Forceps, which are manufactured with a tungsten carbide insert, are designed to provide a very positive grasping jaw surface.

This non-slip profile allows the user to apply the precise pressure necessary for handling tissue, dressings or tying sutures quickly and efficiently.

Our five-year guarantee applies to the tungsten carbide inserts on these gold handle instruments.

**SKLAR EXCLUSIVE**



SKLAR T-C™  
TUNGSTEN CARBIDE

**PREMIUM GRADE**

## T-C ALLIS FORCEPS

- 97-1555 6"
- 97-1560 7½"

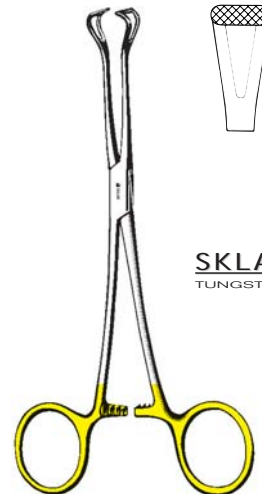

SKLAR T-C™  
TUNGSTEN CARBIDE

**PREMIUM GRADE**

## T-C BABCOCK FORCEPS

- 97-1565 6¼"
- 97-1570 8"

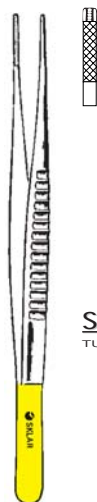

SKLAR T-C™  
TUNGSTEN CARBIDE

**PREMIUM GRADE**

## T-C DEBAKEY ATRAUMATIC FORCEPS

- 97-1530 6" 2.0 mm Tips
- 97-1531 6" 2.7mm Tips
- 97-1540 8" 2.0 mm Tips
- 97-1541 8" 2.7mm Tips



SKLAR T-C™  
TUNGSTEN CARBIDE

**PREMIUM GRADE**

## T-C POTTS-SMITH DRESSING FORCEPS

- 51-4360 6" Serrated
- 51-4370 7" Serrated
- 51-4382 8¼" Serrated
- 51-4395 9½" Serrated

# PREMIUM SKLAR T-C™ FORCEPS

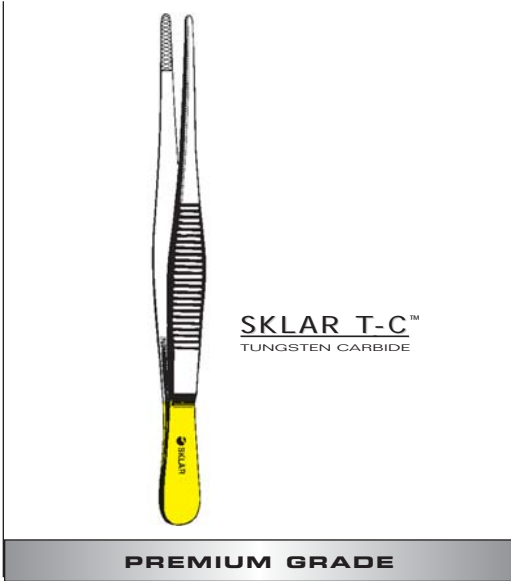

## T-C DRESSING FORCEPS

51-3460 6" Serrated  
51-3480 8" Serrated

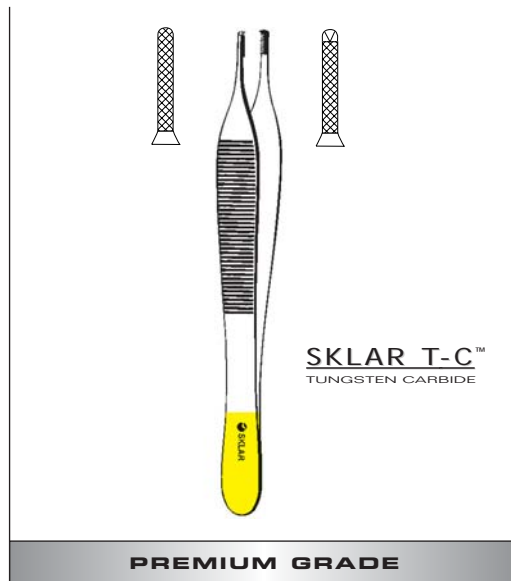

## T-C ADSON FORCEPS

51-3447 4 1/4" Serrated  
51-3049 4 1/4" 1x2 Teeth With Platform

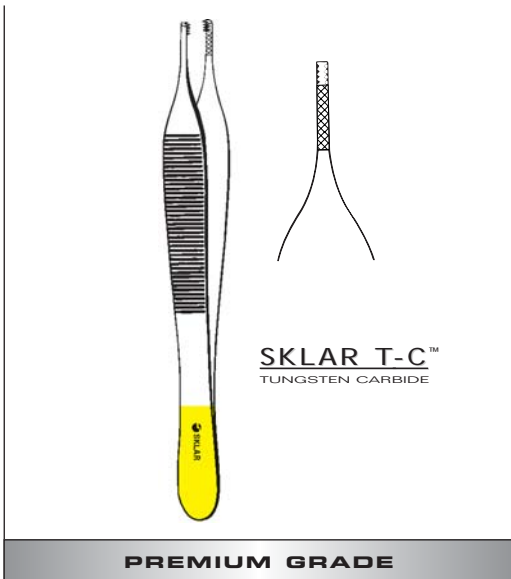

## T-C ADSON-BROWN FORCEPS

51-1447 4 1/4" Side Grasping

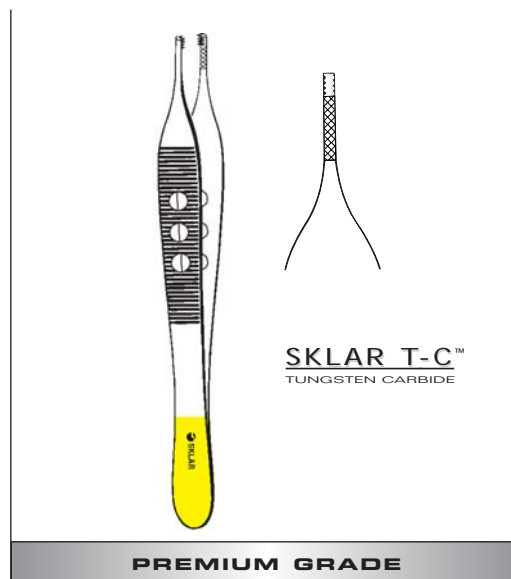

## LITEGRIP™ T-C ADSON-BROWN TISSUE AND SUTURE FORCEPS

51-1448 4 1/4" Side Grasping With Tungsten Carbide Insert

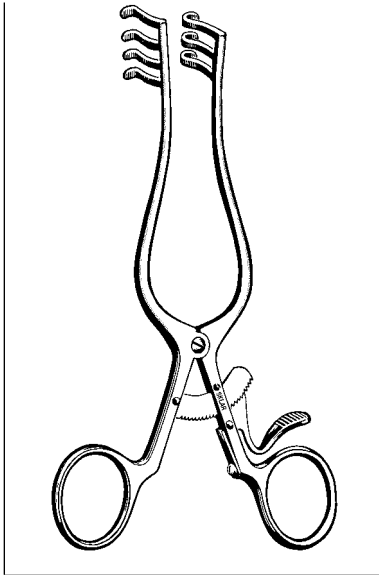

### **WEITLANER RETRACTOR**

Tru-Grip Ratchet  
Blunt

22-8345	4½"	2 x 3 Teeth
22-8355	5½"	3 x 4 Teeth
42-1865	6½"	3 x 4 Teeth
42-1875	8"	3 x 4 Teeth
42-1895	9½"	3 x 4 Teeth

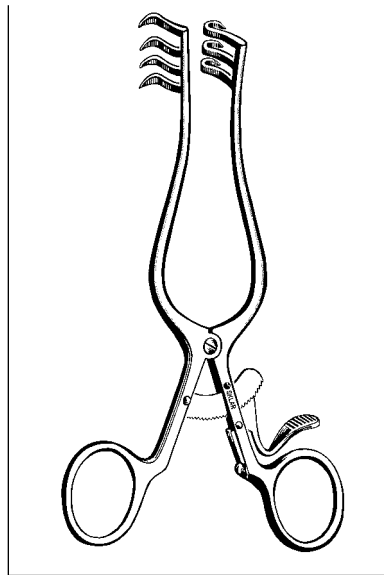

### **WEITLANER RETRACTOR**

Tru-Grip Ratchet  
Sharp

22-8245	4½"	2 x 3 Teeth
22-8255	5½"	3 x 4 Teeth
42-1965	6½"	3 x 4 Teeth
42-1975	8"	3 x 4 Teeth
42-1995	9½"	3 x 4 Teeth

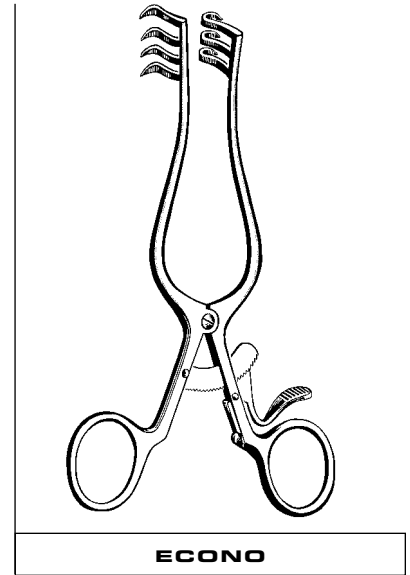

**ECONO**

### **WEITLANER RETRACTOR, ECONO**

Tru-Grip Ratchet

97-372	5½"	3 x 4 Teeth, Sharp
97-373	5½"	3 x 4 Teeth, Blunt

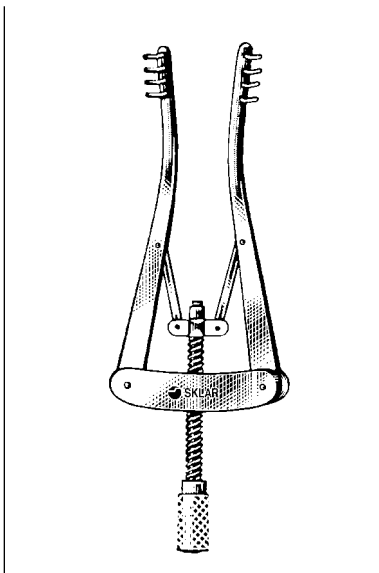

### **ALM RETRACTOR**

22-9027	2¾"	4 x 4 Blunt
60-6340	4"	4 x 4 Blunt
22-9029	2¾"	4 x 4 Sharp
60-6342	4"	4 x 4 Sharp

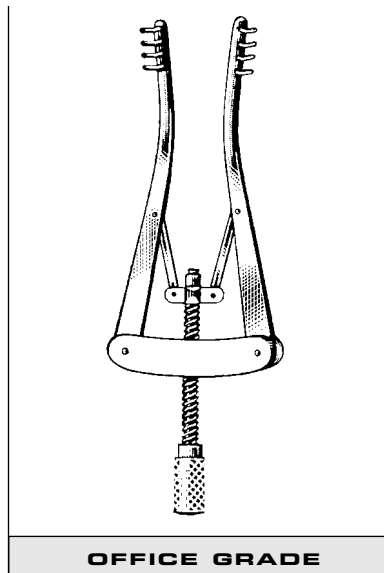

**OFFICE GRADE**

### **ALM RETRACTOR**

97-384	2¾"
--------	-----

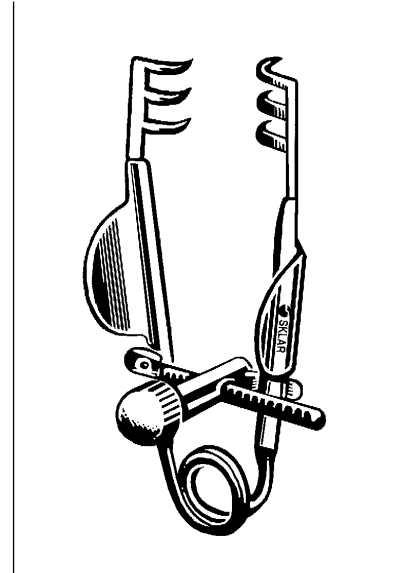

### **MELLER RETRACTOR**

Delicate

65-1815	1½"	3 x 3 Sharp Prongs
---------	-----	--------------------

# RETRACTORS - SELF-RETAINING / RAKE

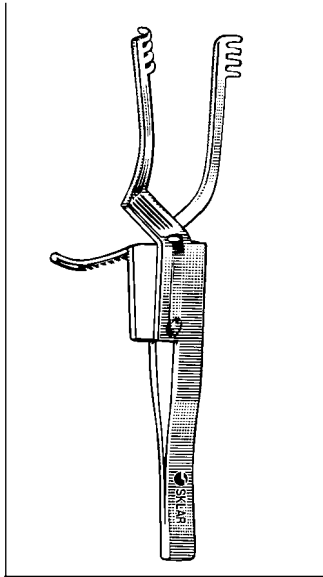

**HOLZHEIMER X-ACTION RETRACTOR**

Sharp  
22-8920 4" 4x4 Teeth  
Blunt  
22-8940 4" 4x4 Teeth

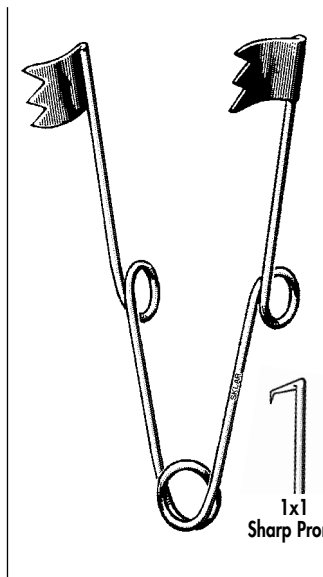

**WIRE RETAINING RETRACTOR**

Small  
22-8832 3/4" 3x3 Blade  
22-8834 3/4" 1x1 Sharp Prong

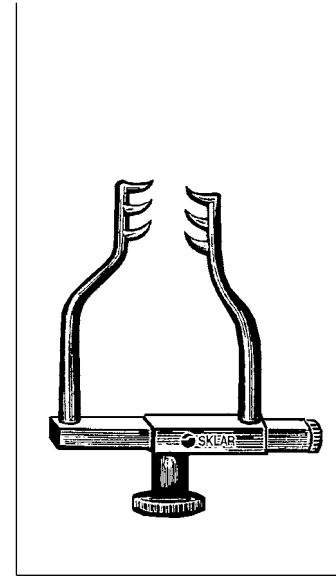

**GOLDSTEIN RETRACTOR**

47-2913 1 1/2" 3 x 3 Sharp Prongs

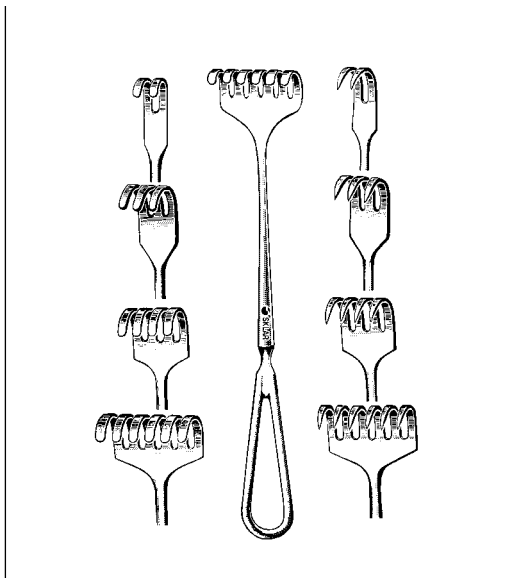

**VOLKMAN RETRACTOR (USA)**

8 1/2" Length  
Blunt  
60-5502 2 pr  
60-5503 3 pr  
60-5504 4 pr  
60-5506 6 pr  
Sharp  
60-5602 2 pr  
60-5603 3 pr  
60-5604 4 pr  
60-5606 6 pr

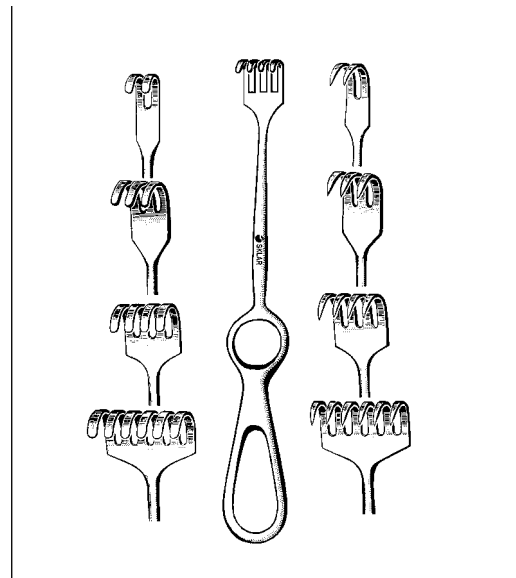

**VOLKMAN RETRACTOR (RING HANDLE)**

8 1/2" Length  
Blunt  
60-5812 2 pr  
60-5813 3 pr  
60-5814 4 pr  
60-5816 6 pr  
Sharp  
60-5822 2 pr  
60-5823 3 pr  
60-5824 4 pr  
60-5826 6 pr



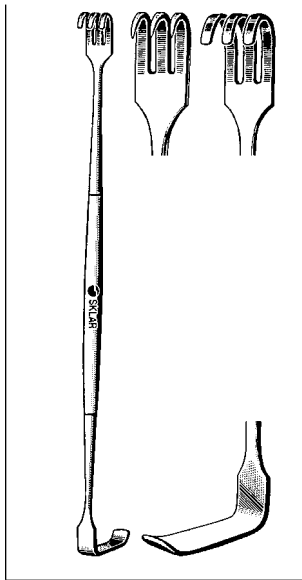

### **SENN RETRACTOR**

Double Ended  
 60-6162 6" Sharp  
 60-6164 6" Blunt

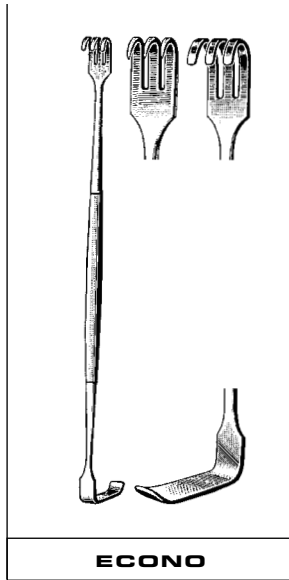

### **ECONO**

### **SENN RETRACTOR, ECONO**

Box/12  
 21-365 7" Blunt  
 21-366 7" Sharp

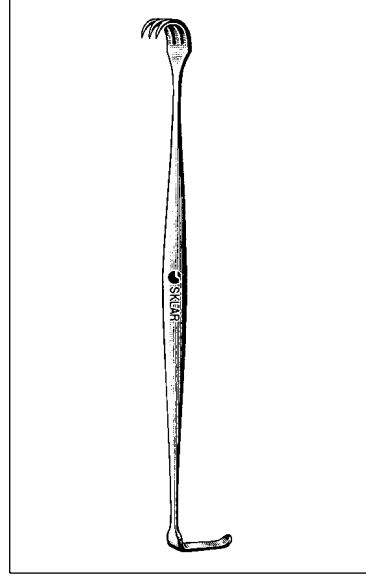

### **MILLER-SENN RETRACTOR**

Double Ended  
 22-8360 6" Sharp  
 Solid End 5 mm x 18 mm  
 22-8460 6" Blunt  
 Solid End 5 mm x 18 mm

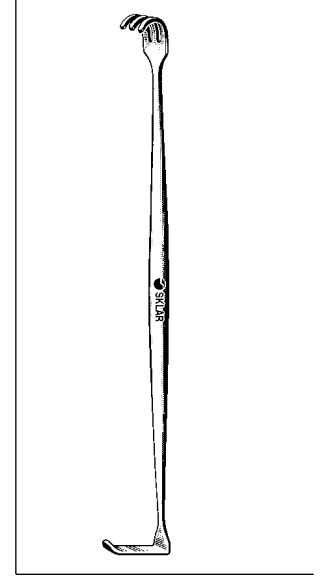

### **MATHIEU RETRACTOR**

Double Ended  
 60-6062 6 1/4" Blunt

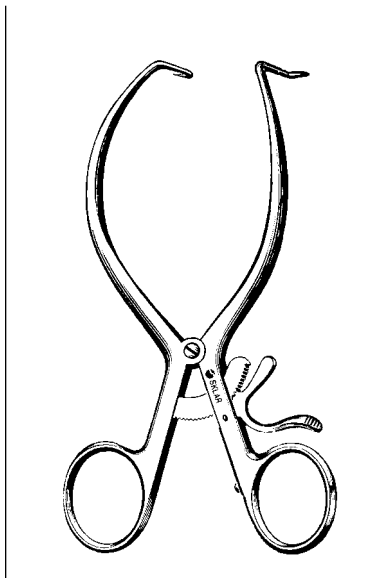

### **GELPI RETRACTOR**

Tru-Grip Ratchet  
 22-8850 3 1/2"  
 22-8853 5 1/2"  
 22-8855 6 1/4"  
 60-6570 7"  
 60-6580 7 1/2" With Stops

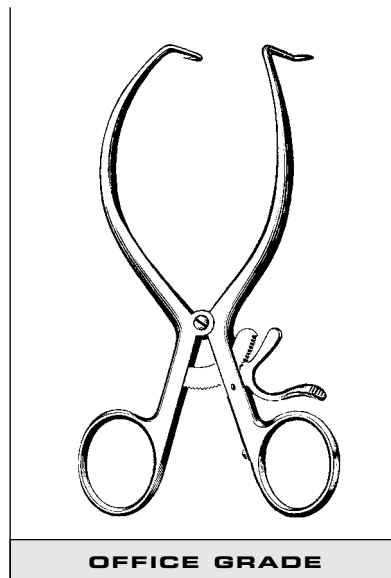

### **OFFICE GRADE**

### **GELPI RETRACTOR**

97-388 6 1/4"

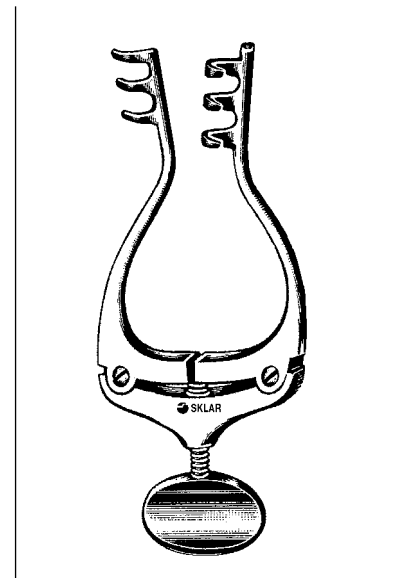

### **JANSEN RETRACTOR**

3 x 3 Blades  
 47-2832 4" Blunt  
 47-2834 4" Sharp

# RETRACTORS - SMALL BLADE / HOOK

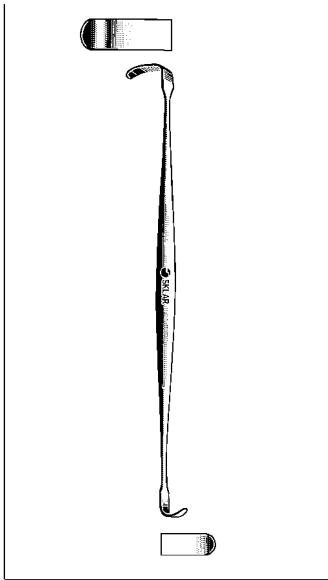

**RAGNELL RETRACTOR**

Double End  
22-8560 6"

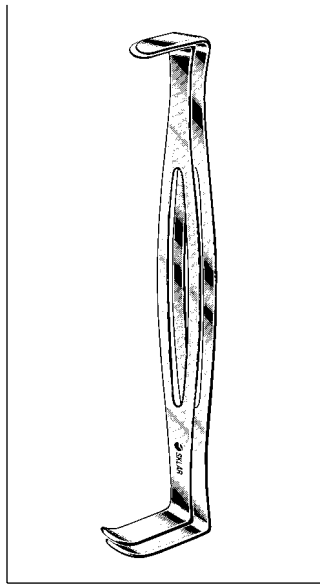

**U.S. ARMY PATTERN RETRACTOR**

Set of 2  
60-1085 8 1/4"

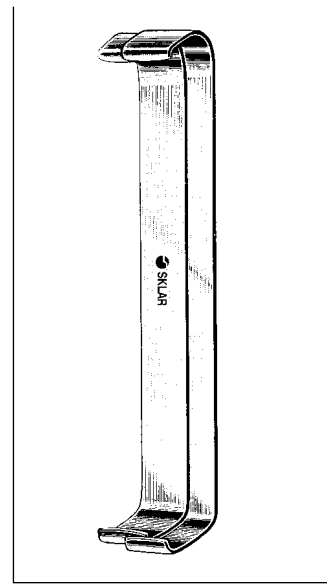

**FARABEUFR RETRACTOR**

Double End Set of 2  
60-1460 6" 5/8" x 1/8"  
5/8" x 1"

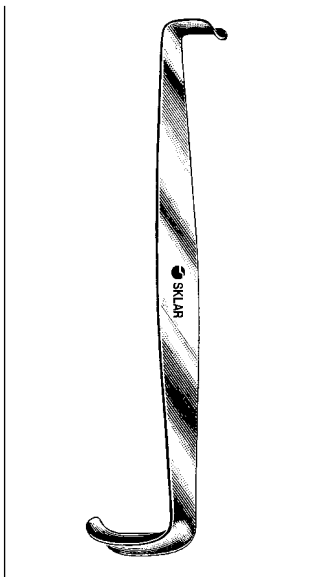

**CRILE RETRACTOR**

Double End  
57-1445 4 1/2"

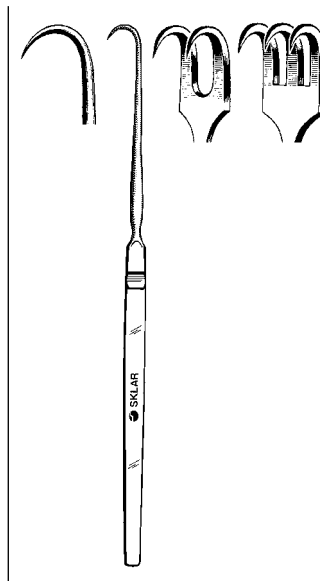

**TRACHEAL RETRACTOR**

6 1/2"  
78-1001 Sharp 1 prong  
78-1002 Sharp 2 prong  
78-1003 Sharp 3 prong  
78-1101 Blunt 1 prong  
78-1102 Blunt 2 prong  
78-1103 Blunt 3 prong

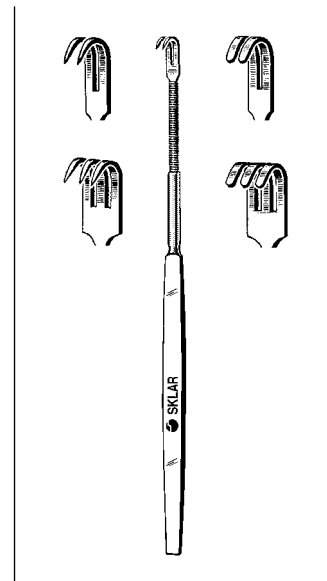

**PLASTIC SURGERY RETRACTOR**

6" - Flexible Shank  
22-9132 Sharp 2 Prong  
22-9133 Sharp 3 Prong  
22-9142 Blunt 2 Prong  
22-9143 Blunt 3 Prong

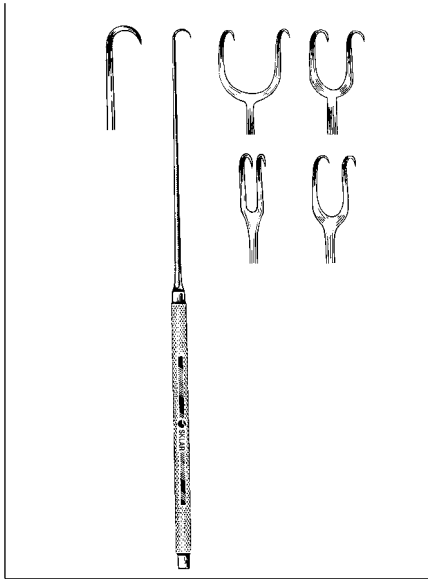

### JOSEPH SKIN HOOK

Sharp

47-2500	6¼"	1 Prong
47-2502	6¼"	2 Prong 2mm
47-2505	6¼"	2 Prong 5mm
47-2507	6¼"	2 Prong 7mm
47-2510	6¼"	2 Prong 10mm

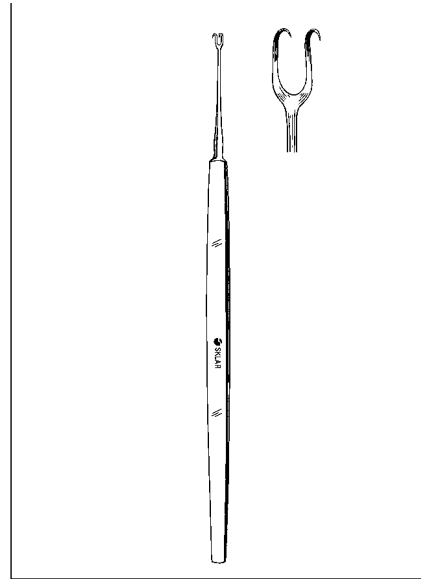

### GUTHRIE DOUBLE HOOK

47-2650	5"	Large	Sharp
47-2651	5"	Small	Sharp

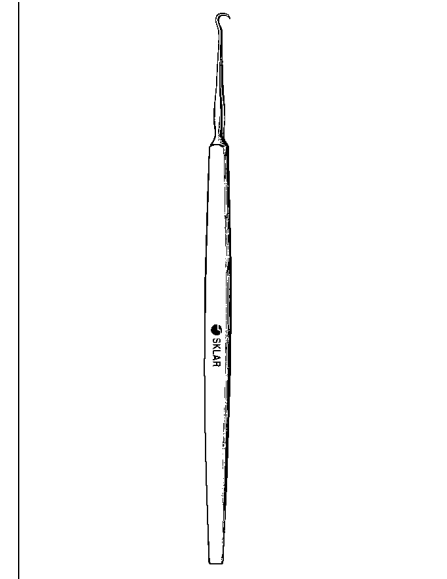

### FRAZIER TISSUE HOOK

47-2555	5"	Sharp
47-2556	5"	Blunt

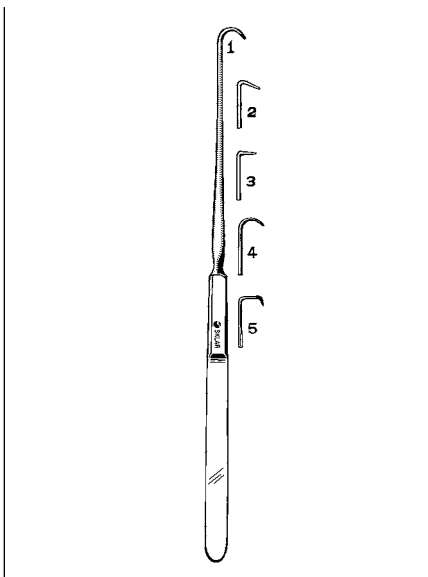

### EMMETT HOOK 9"

90-8301	Style 1
90-8302	Style 2
90-8303	Style 3
90-8304	Style 4
90-8305	Style 5

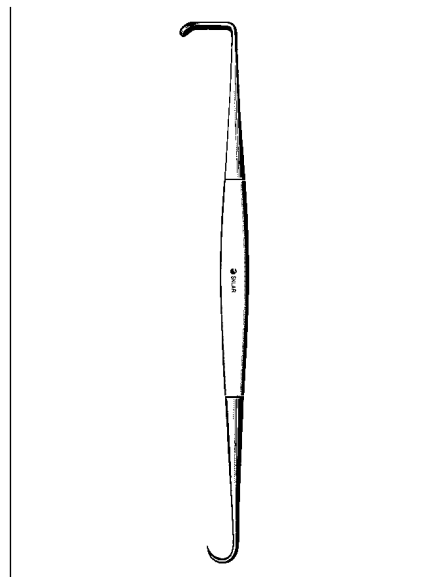

### MEYERDING SKIN HOOK AND RETRACTOR

Double End	
47-2462	6¼"

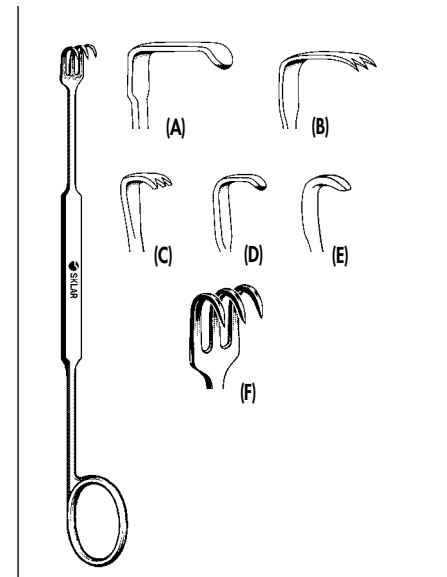

### MEYERDING RETRACTOR

7"

22-8210	A	1/16" deep
22-8211	B	3/16" deep
22-8212	C	1/4" deep
22-8213	D	3/8" deep
22-8214	E	1/2" deep
22-8215	F	3 prongs sharp

# RETRACTORS

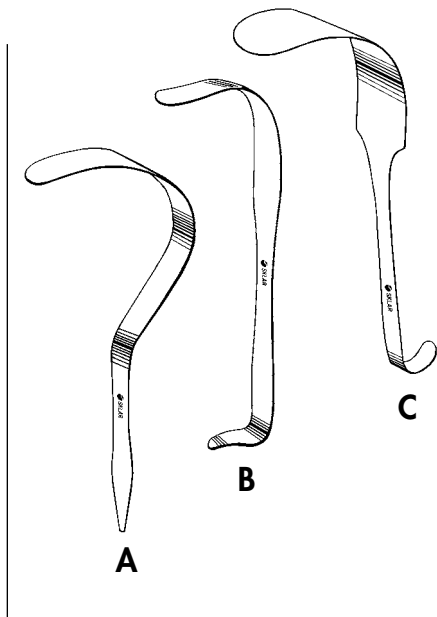

## DEAVER RETRACTOR WITHOUT HANDLE

- |             |               |             |              |
|-------------|---------------|-------------|--------------|
| (A) 60-3070 | 3/4" x 7"     | (C) 60-3114 | 1" x 14"     |
| (A) 60-3085 | 7/8" x 8 1/2" | (C) 60-3212 | 1 1/2" x 12" |
| (B) 60-3090 | 1" x 9"       | (C) 60-3312 | 2" x 12"     |
| (C) 60-3112 | 1" x 12"      | (C) 60-3412 | 3" x 12"     |
| (C) 60-3113 | 1" x 13"      |             |              |
| Pediatric   |               |             |              |
| (A) 22-8080 | 5/8" x 8"     | (A) 22-8180 | 1" x 8"      |

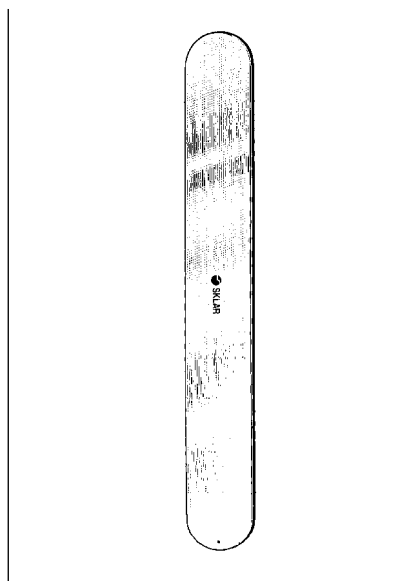

## ZALKIND (RIBBON) RETRACTOR

- Malleable
- |         |               |         |              |
|---------|---------------|---------|--------------|
| 60-3594 | 1/4" x 7 3/4" | 60-3607 | 3/4" x 13"   |
| 60-3596 | 1/2" x 7 3/4" | 60-3610 | 1" x 13"     |
| 22-8067 | 5/8" x 7 3/4" | 60-3612 | 1 1/4" x 13" |
| 60-3598 | 3/4" x 7 3/4" | 60-3615 | 1 1/2" x 13" |
| 22-8075 | 1" x 7 3/4"   | 60-3617 | 1 3/4" x 13" |
|         |               | 60-3620 | 2" x 13"     |
|         |               | 60-3625 | 2 1/2" x 13" |

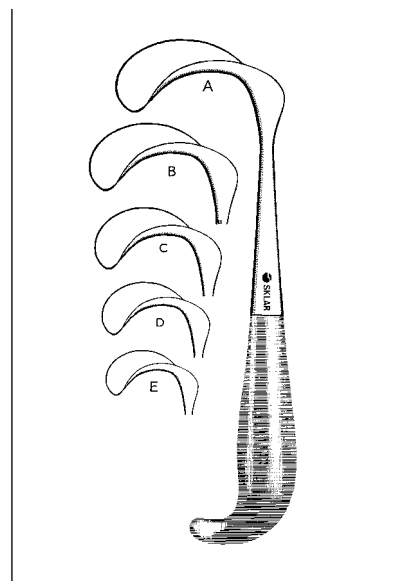

## BREWSTER RETRACTOR

- |         |           |                 |
|---------|-----------|-----------------|
| 60-5431 | Style 'A' | 2 1/2" x 1 1/8" |
| 60-5432 | Style 'B' | 2 1/4" x 1 3/4" |
| 60-5433 | Style 'C' | 2" x 1 3/8"     |
| 60-5434 | Style 'D' | 1 1/2" x 1"     |
| 60-5435 | Style 'E' | 3/4" x 1 1/2"   |

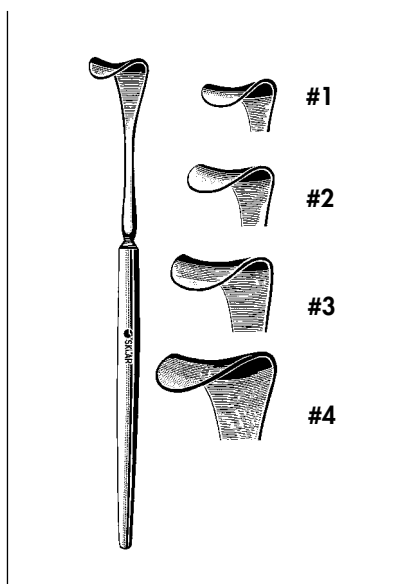

## DESMARRES LID RETRACTOR

- |         |    |        |                 |
|---------|----|--------|-----------------|
| 65-1841 | #1 | 5 1/2" | with 12mm Blade |
| 65-1842 | #2 | 5 1/2" | with 14mm Blade |
| 65-1843 | #3 | 5 1/2" | with 16mm Blade |
| 65-1844 | #4 | 5 1/2" | with 18mm Blade |

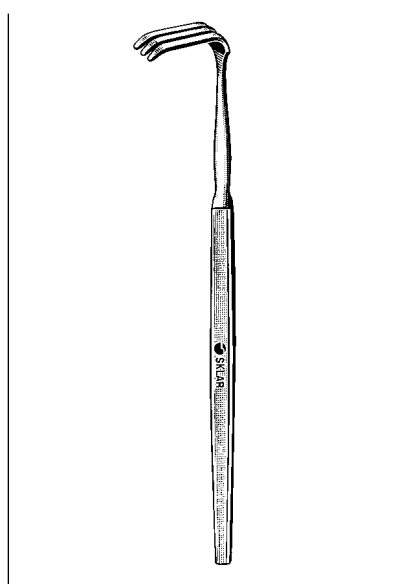

## PAUL RETRACTOR

- |         |        |               |
|---------|--------|---------------|
| 47-2647 | 4 3/4" | 3 Prong Blunt |
|---------|--------|---------------|

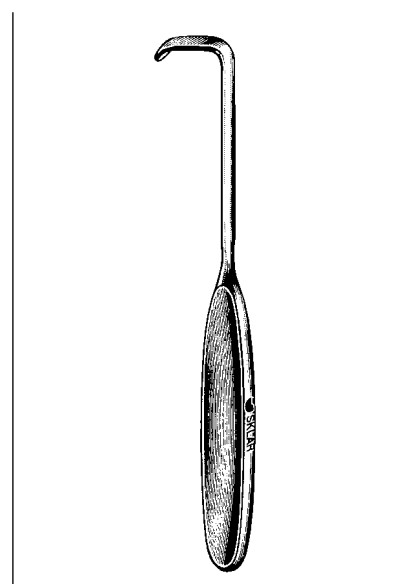

## LAHEY RETRACTOR

- |         |    |
|---------|----|
| 52-1277 | 7" |
|---------|----|

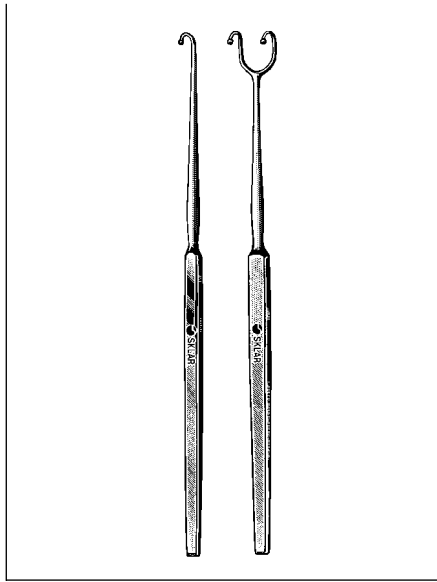

### FOMON RETRACTOR

Ball End

41-1395 6 1/4" Single

41-1396 6 1/4" Double

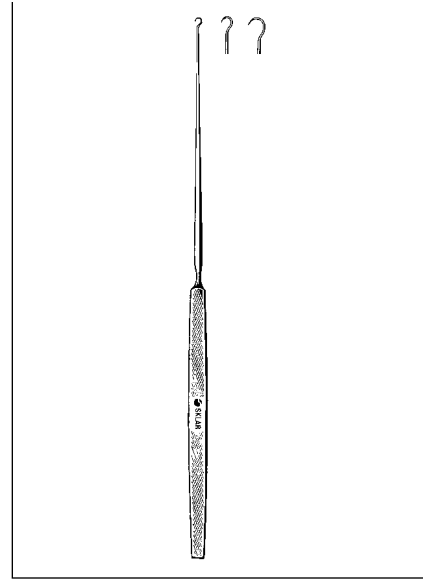

### GILLIES SKIN HOOK

47-2570 7" 3 mm

47-2572 7" 4 mm

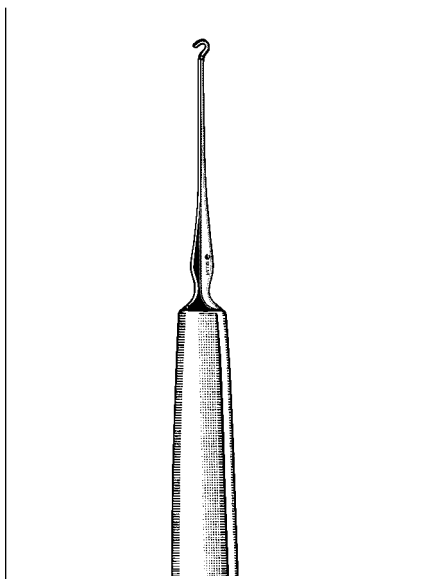

### TYRELL IRIS HOOK

65-3205 5" 3mm Blunt

65-3206 5" 3mm Sharp

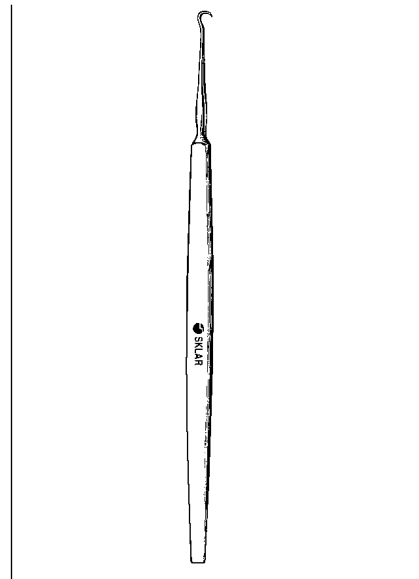

### FRAZIER TISSUE HOOK

Extra Delicate

47-2555 5" Sharp

47-2556 5" Blunt

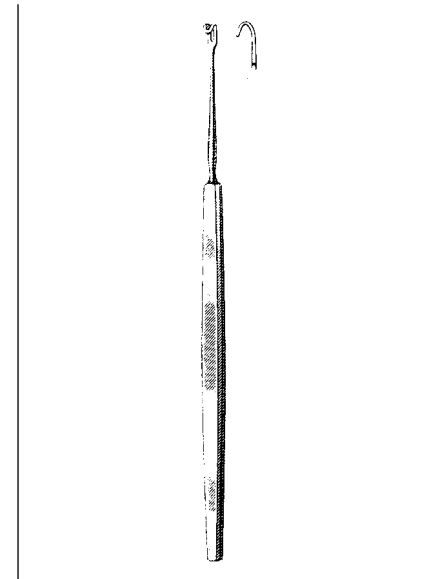

### MCGANNON IRIS RETRACTOR

65-3258 5 1/4"

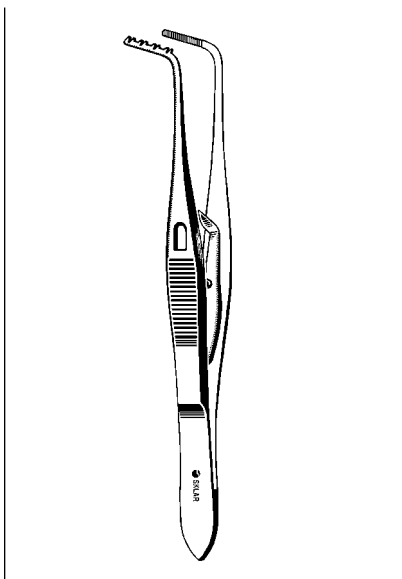

**PRINCE MUSCLE FORCEPS**

66-5942 4 1/4"

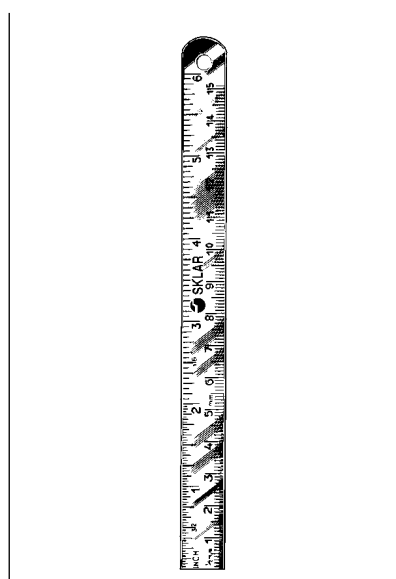

**STEEL RULER**

Graduated in inches and mm

06-2860 6"

06-2861 12"

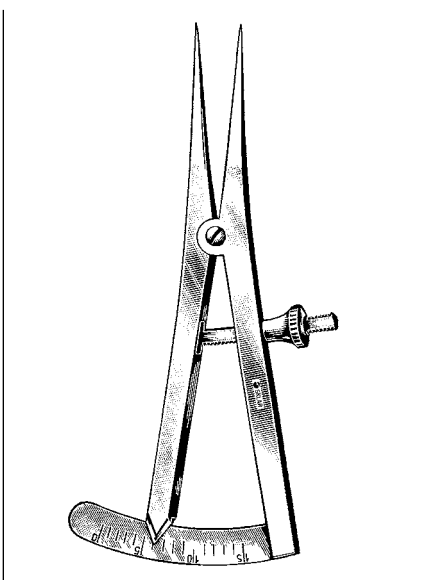

**CASTROVIEJO CALIPER**

65-6732 3 1/4"

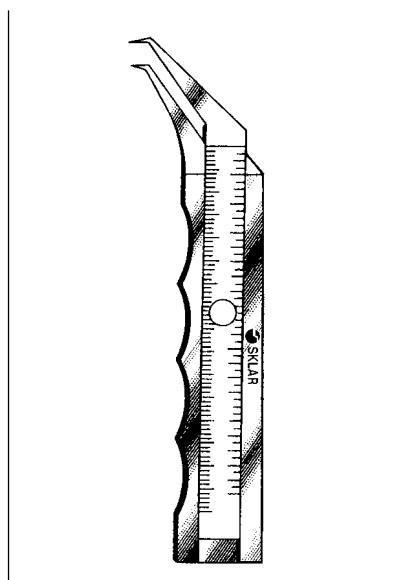

**THORPE CALIPER**

Graduated in inches and mm

65-6735 4 1/2"

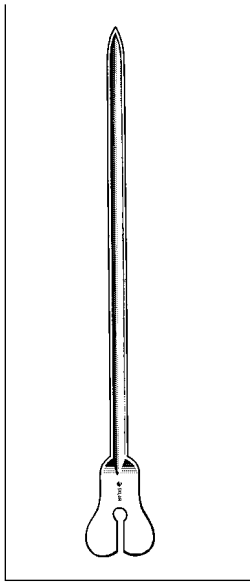

### **DIRECTOR AND TONGUE TIE**

Plain End

30-1045	4½"
30-1050	5"
30-1055	5½"
30-1060	6"
30-1070	7"
30-1080	8"

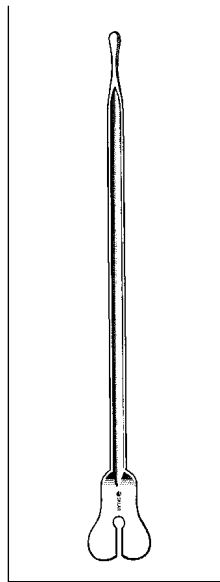

### **DIRECTOR AND TONGUE TIE**

Probe End

30-1145	4½"
30-1150	5"
30-1155	5½"
30-1160	6"
30-1170	7"
30-1180	8"

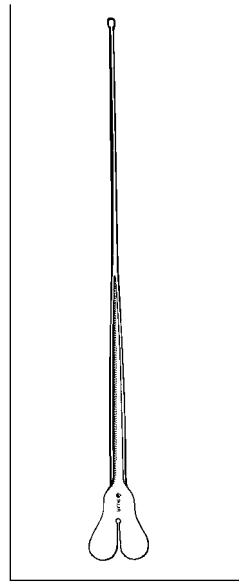

### **LARRY PROBE**

80-2870	7½" (18.1 cm)
80-2860	6"

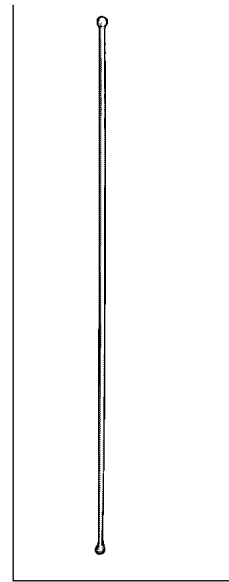

### **DOUBLE ENDED PROBE**

Stainless

30-1545	4½"
30-1550	5"
30-1555	5½"
30-1560	6"
30-1580	8"
30-1610	10"
30-1612	12"

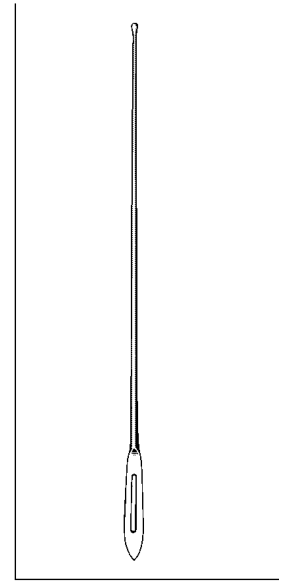

### **PROBE WITH EYE**

Stainless

30-1945	4½"
30-1950	5"
30-1955	5½"
30-1960	6"
30-1980	8"
30-2010	10"
30-2012	12"

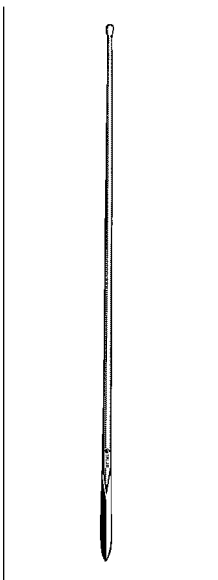

### **SPEAR POINT PROBE**

Stainless

30-2145	4½"
30-2150	5"
30-2155	5½"
30-2160	6"

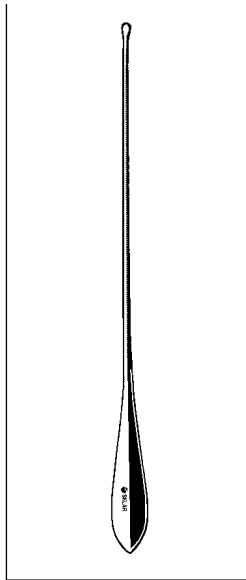

### **PROBE**

With Myrtle

Leaf End

Straight

30-1450	5" (12.7 cm)
---------	--------------

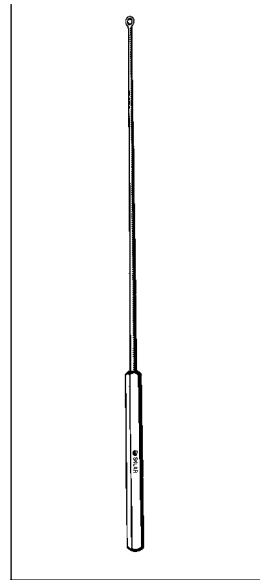

### **BARR FISTULA PROBE**

With Eye, Malleable

80-2910	10¾" (27.3 cm)
---------	----------------

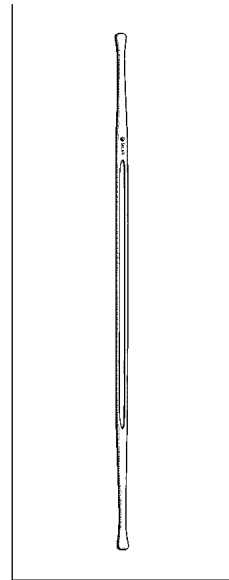

### **ESMARCH TIN BULLET PROBE**

30-1380	8" (20.3 cm)
---------	--------------

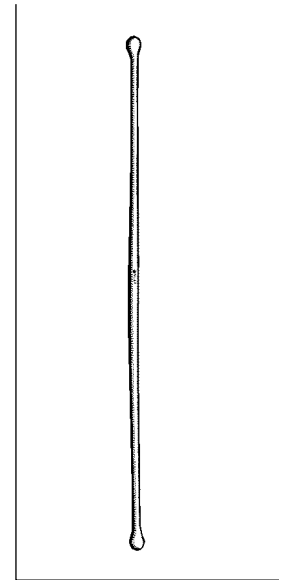

### **SKLAR MALLEABLE PROBE**

Double Ended

30-2580	8" (20.3 cm)
---------	--------------

Rectal Probe

Copper, not plated

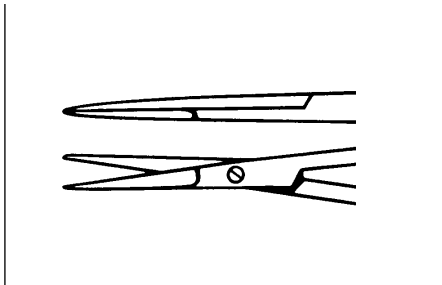
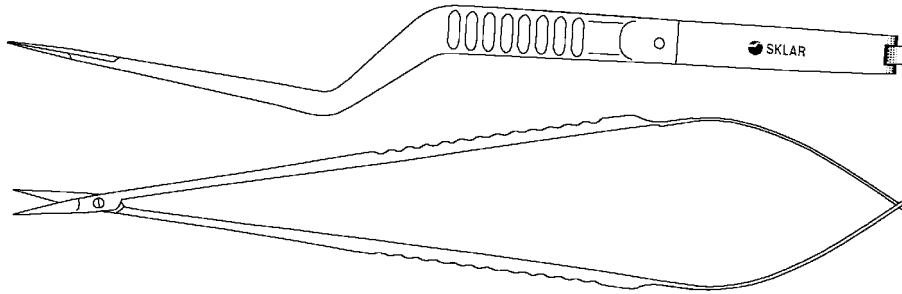

**MICRO SCISSORS**

Bayonet Flat Handle  
 Straight Tip  
 98-7922 8" Long  
 98-7924 9½" Long

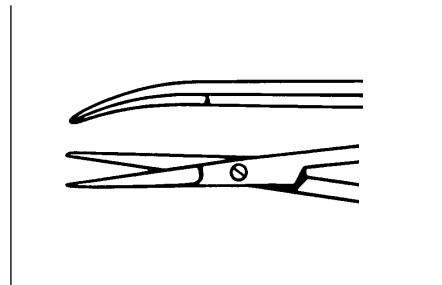

**MICRO SCISSORS**

Bayonet Flat Handle  
 Curved Tip  
 98-7928 8" Long  
 98-7930 9½" Long

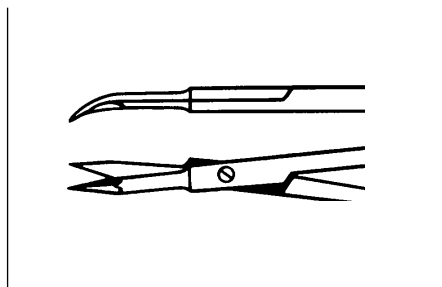

**MICRO SCISSORS**

Bayonet Flat Handle  
 Curved Tip Vannas Blades  
 98-7950 6¼" Long  
 98-7952 8" Long  
 98-7954 9½" Long

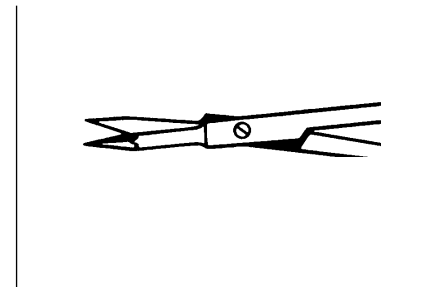

**MICRO SCISSORS**

Bayonet Flat Handle  
 Straight Tip Vannas Blades  
 98-7934 8" Long  
 98-7936 9½" Long



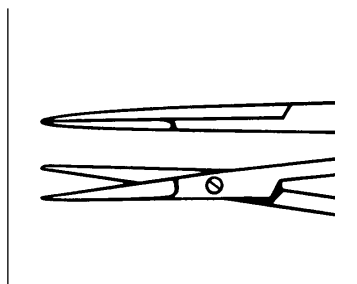
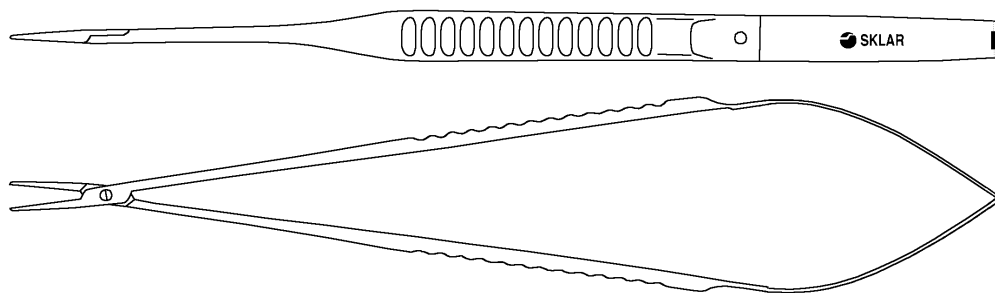

**MICRO SCISSORS**

Straight Flat Handle  
Straight Tip

98-7860 6 1/4" Long  
98-7862 8" Long

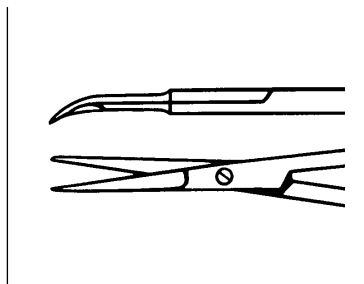

**MICRO SCISSORS**

Straight Flat Handle  
Curved Tip

98-7866 6 1/4" Long  
98-7868 8" Long

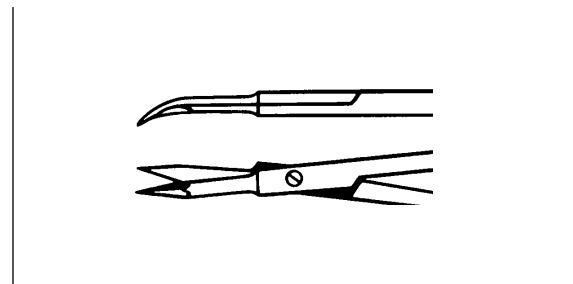

**MICRO SCISSORS**

Straight Flat Handle  
Curved Tip Vannas Blades

98-7872 6 1/4" Long  
98-7874 8" Long

Straight Flat Handle  
Straight Tip Vannas Blades

98-7277 6 1/4" Long  
98-7278 8" Long

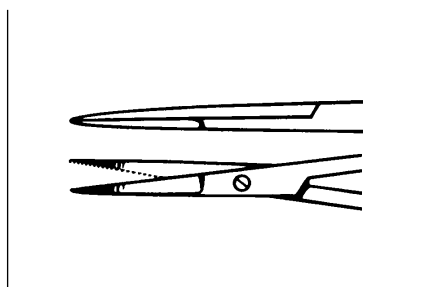
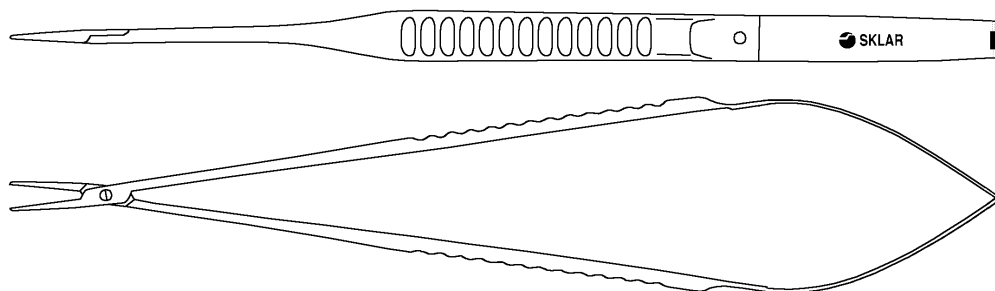

**MICRO SCISSORS**

Straight Flat Handle  
Straight Tip Toothed Blades

98-7890 6 1/4" Long  
98-7892 8" Long  
98-7894 9 1/2" Long

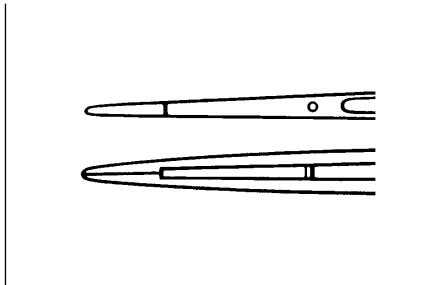
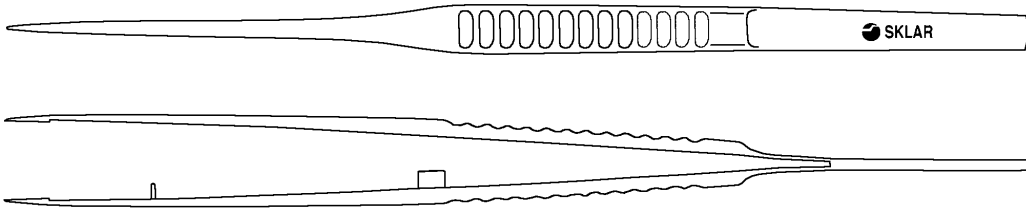

### **MICRO FORCEPS**

Straight Flat Handle

Straight Blunt Tip      Straight Pointed Tip

98-7700 6 1/4" Long

98-7702 8" Long

98-7706 6 1/4" Long

98-7708 8" Long

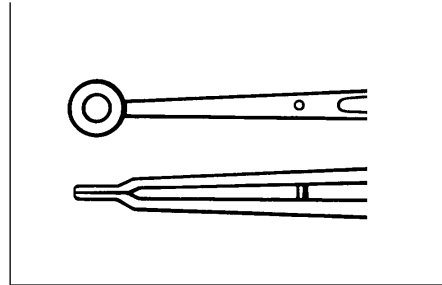

### **TUMOR GRASPING FORCEPS**

Straight Flat Tip

98-7718 8" Long

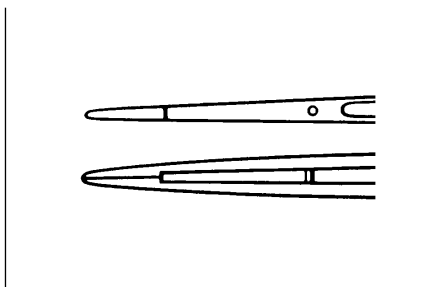
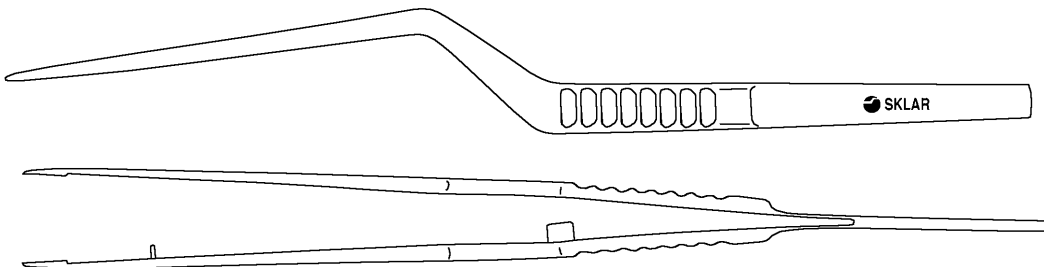

### **MICRO FORCEPS**

Bayonet Flat Handle

Straight Blunt Tip

98-7740 6 1/4" Long

98-7742 8" Long

98-7744 9 1/2" Long

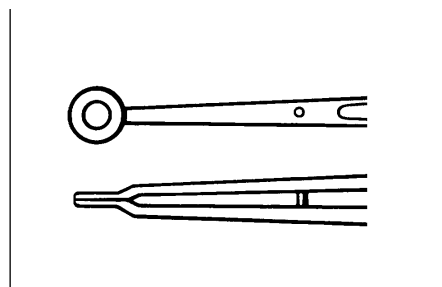

### **TUMOR GRASPING FORCEPS**

Bayonet Flat Handle

98-7758 8" Long

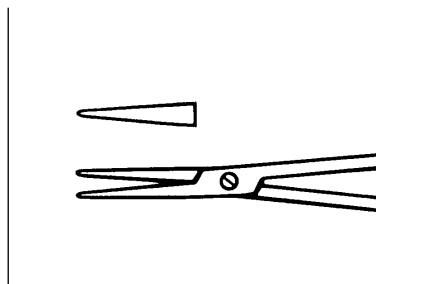
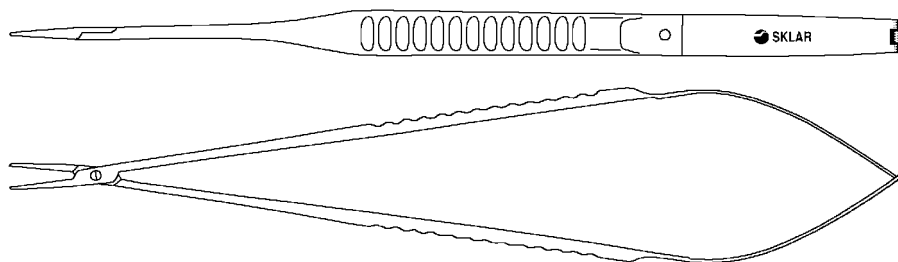

### **NEEDLE HOLDER**

Straight Flat Handle  
Straight Tip, without Lock

98-7780 6 1/4" Long  
98-7782 8" Long

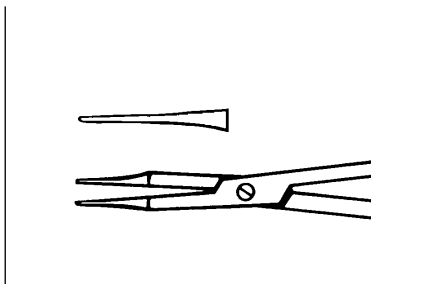

### **MICRO NEEDLE HOLDER**

Straight Flat Handle  
Straight Tip, without Lock

98-7786 6 1/4" Long  
98-7788 8" Long

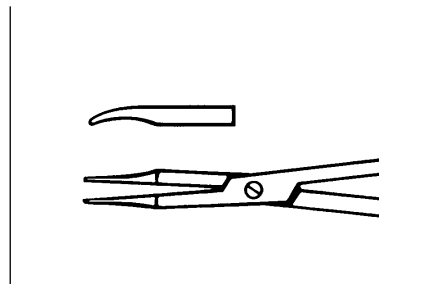

### **MICRO NEEDLE HOLDER**

Slightly Curved Tip, without Lock

98-7792 6 1/4" Long  
98-7794 8" Long

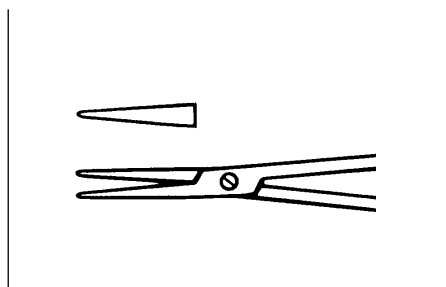
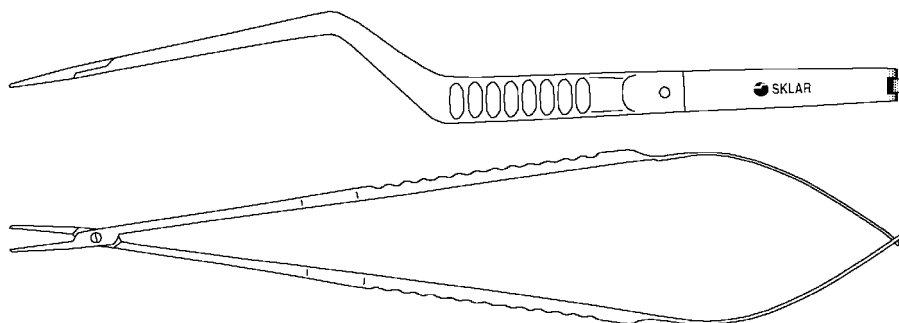

### **NEEDLE HOLDER**

Bayonet Flat Handle (without Lock)  
Straight Tip

98-7820 6 1/4" Long  
98-7822 8" Long

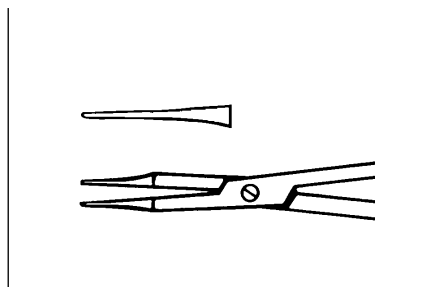

### **MICRO NEEDLE HOLDER**

Bayonet Flat Handle (without Lock)  
Straight Tip

98-7832 6 1/4" Long  
98-7834 8" Long

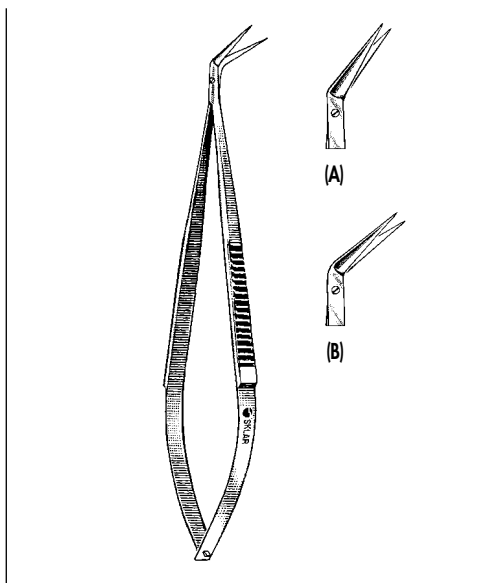

## POTTS-SMITH VASCULAR SCISSORS

With Spring Handle

- 98-1075 7" 25° Angle (A)
- 98-1076 7" 45° Angle (B)

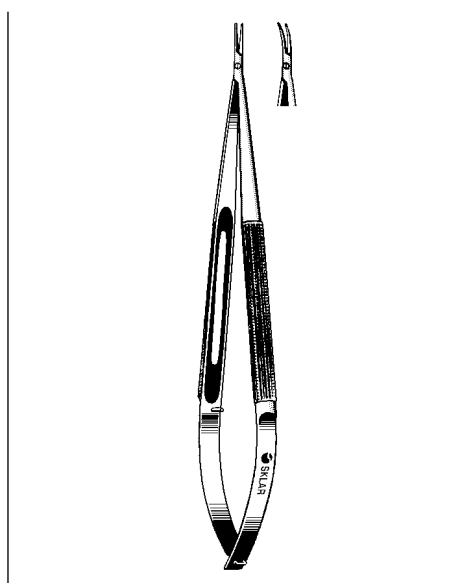

## MICRO SURGERY NEEDLE HOLDERS

7/8" With Round Handle

- 98-3186 Straight Jaws 0.6 mm tips
- 98-3188 Curved Jaws 0.6 mm tips

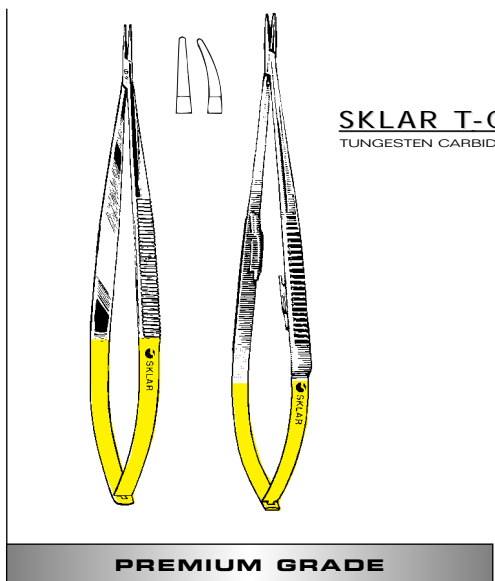

## T-C CASTROVIEJO NEEDLE HOLDER

Extra Delicate—Without Lock

- 21-8044 5 1/2" Straight, Smooth
- 21-8045 5 1/2" Curved, Smooth

Extra Delicate—With Lock

- 21-8042 5 1/2" Straight, Smooth
- 21-8043 5 1/2" Curved, Smooth

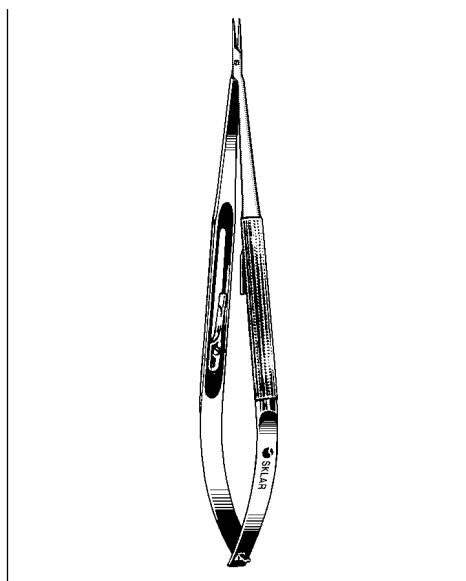

## MICRO SURGERY NEEDLE HOLDERS

7/8" With Round Handle

- 98-3190 Straight Jaws with Lock  
0.6 mm tips
- 98-3192 Curved Jaws with Lock  
0.6 mm tips

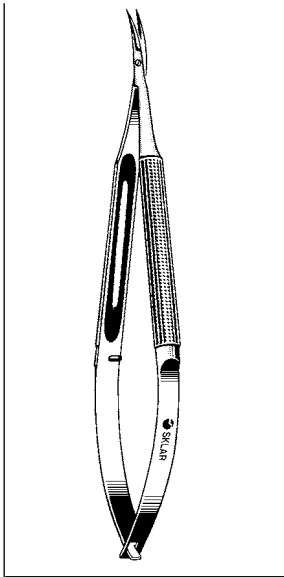

### **MICRO SURGERY SCISSORS**

6" Sharp Points  
Round Handle  
98-7815 Curved

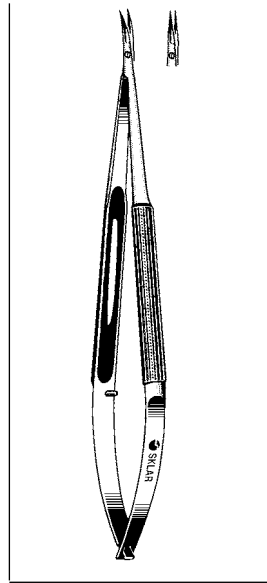

### **MICRO SURGERY SCISSORS**

7/8" Round Handle  
98-7816 Straight  
98-7817 Curved

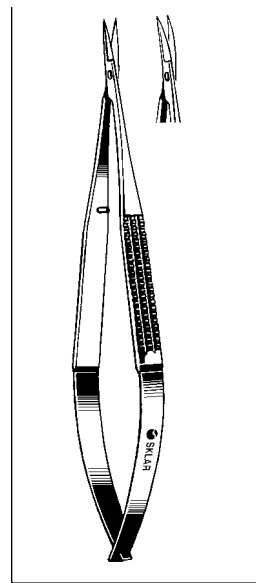

### **MICRO SURGERY SCISSORS**

6" Sharp Points  
Flat Handle  
98-7810 Straight  
98-7812 Curved

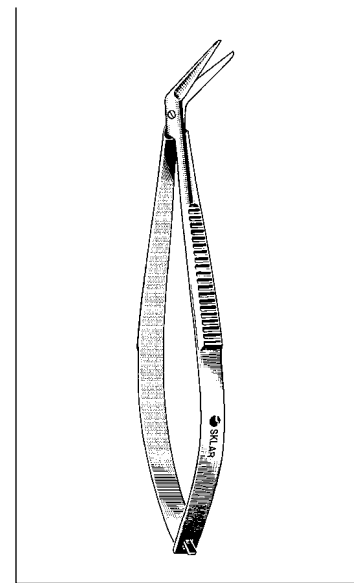

### **CASTROVIEJO CORNEAL SCISSORS**

64-2535 4" 13 mm  
blunt angled blades

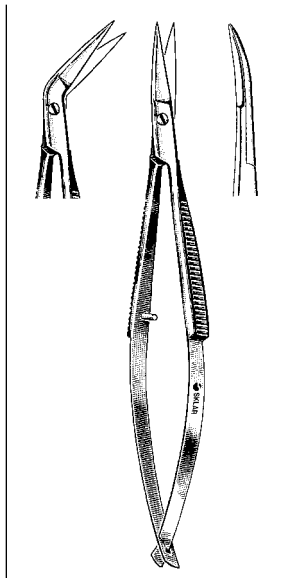

### **McCLURE IRIS SCISSORS**

Spring Handle  
64-1742 4/4" Angled To Side  
64-1842 4/4" Straight  
64-1942 4/4" Curved

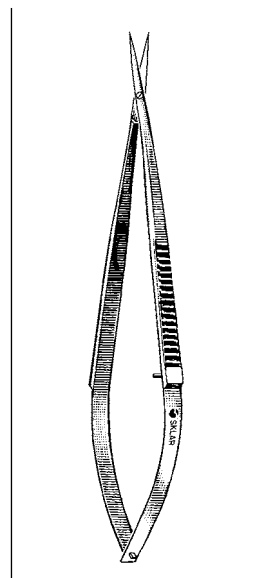

### **FINE STITCH SCISSORS**

64-3260 4/4" Delicate  
Sharp blades

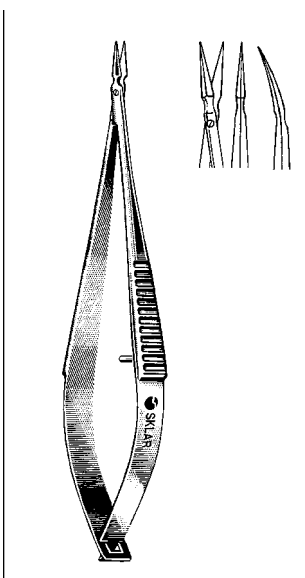

### **VANNAS SCISSORS**

Delicate Blades With  
Spring Handle  
64-1950 3" Straight  
64-1951 3" Curved

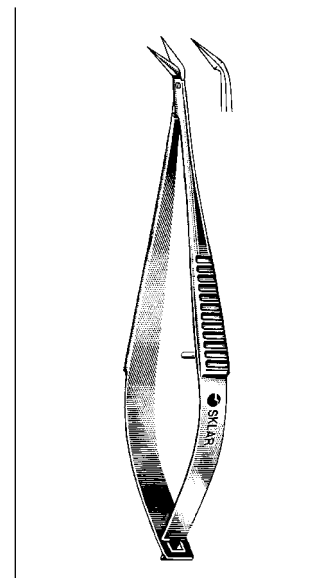

### **VANNAS SCISSORS**

Extremely Delicate Blades  
With Spring Handle  
64-1955 3" Angled on flat  
64-1958 3" Angled to side

# EYE INSTRUMENTS

## SCISSORS

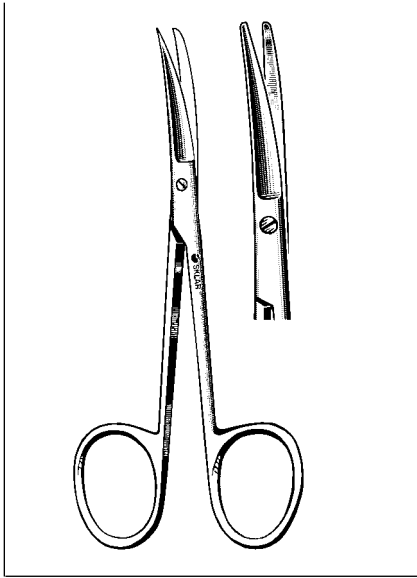

### **KNAPP IRIS SCISSORS**

Curved  
 64-3230 4" Sharp/Blunt  
 64-3235 4" Blunt/Blunt

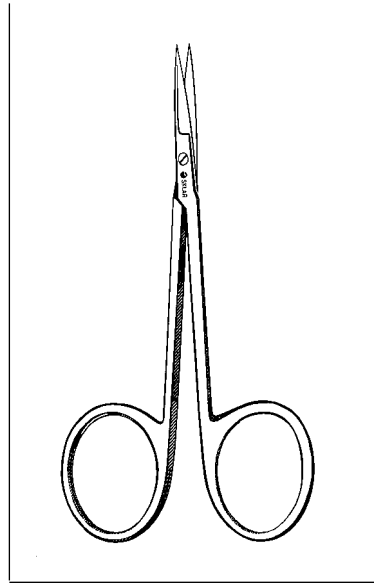

### **BONN SCISSORS**

Delicate  
 64-2035 S/S Straight 3½"  
 64-2036 S/S Curved 3½"

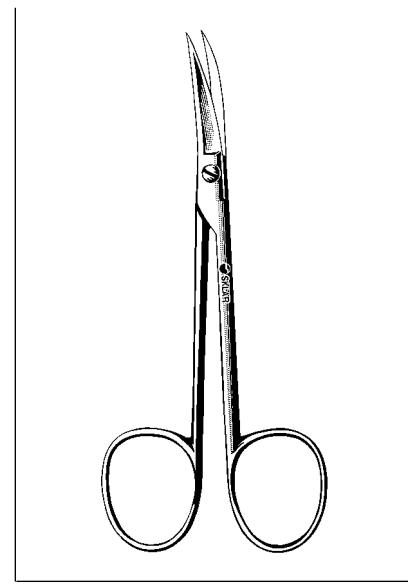

### **PLASTIC SURGERY SCISSORS**

Curved  
 47-1345 4½" S/S

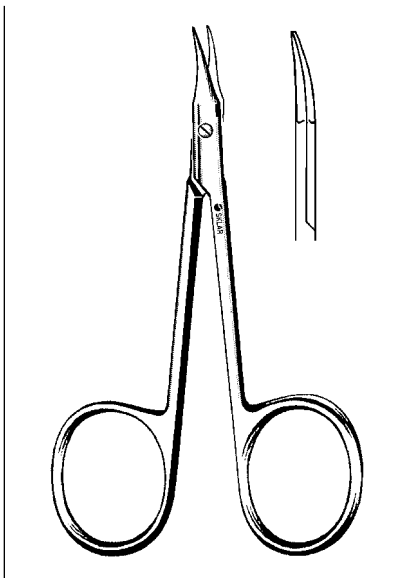

### **GRADLE SCISSORS**

Slightly curved, Sharp  
 64-3280 3¾"

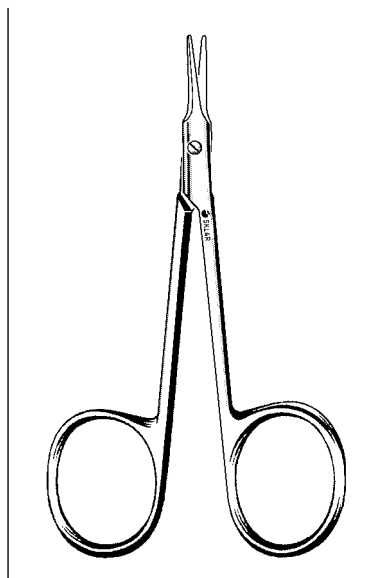

### **AEBLI CORNEAL SCISSORS**

64-3270 4" Straight

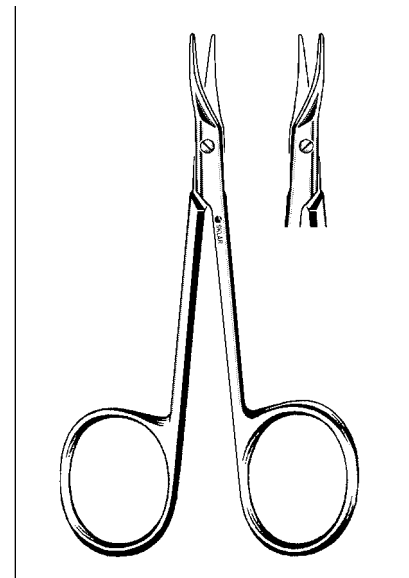

### **McGUIRE CORNEAL SCISSORS**

64-3297 4¼" 16 mm delicate sharp blades. Curved right.  
 64-3298 4¼" 16 mm delicate sharp blades. Curved left.

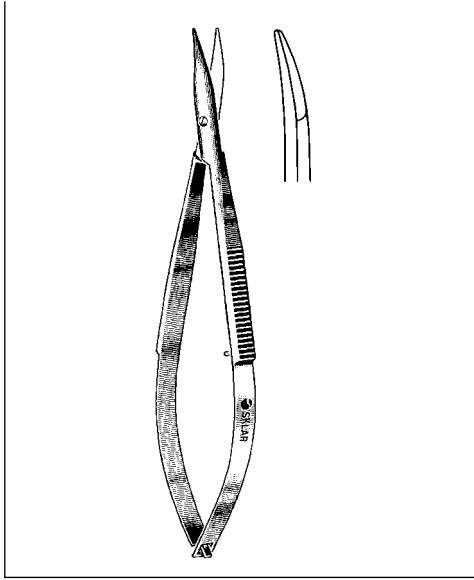

**WESTCOTT TENOTOMY SCISSORS**

64-3146 4 1/4" Blunt Tips With Spring Handle

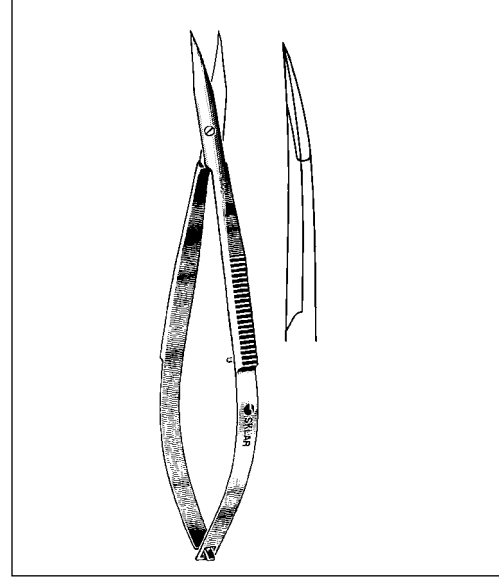

**WESTCOTT TENOTOMY SCISSORS**

64-3145 4 1/4" Sharp Tips With Spring Handle

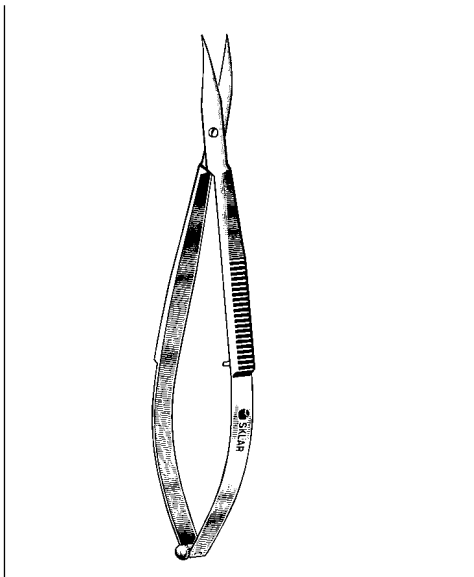

**WESTCOTT TENOTOMY SCISSORS**

64-3142 5" Right  
64-3144 5" Left

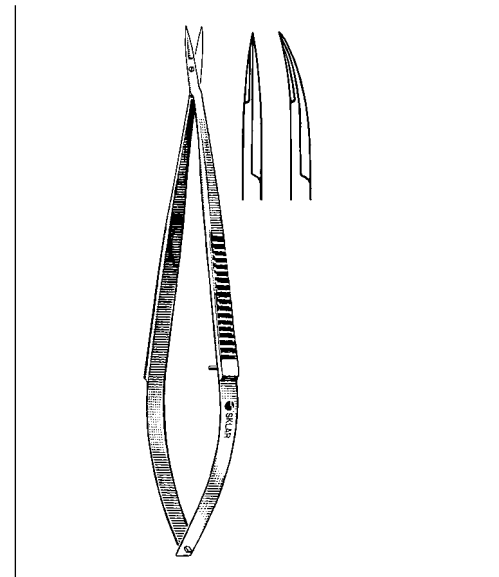

**IRIS MICRO-MINIATURE SCISSORS**

Extra delicate, sharp points  
64-3050 4" Straight  
64-3052 4" Curved

# EYE INSTRUMENTS

## DILATORS

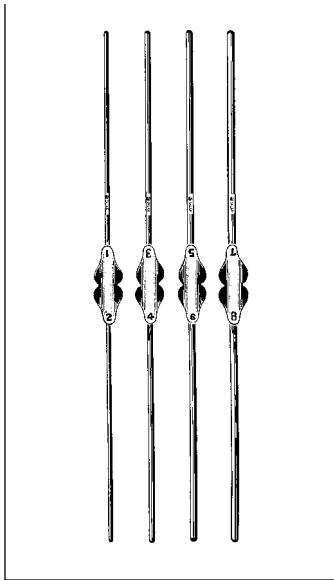

**BOWMAN LACHRYMAL  
DILATOR/PROBE**

Double Ended

- 65-4100 Set of 4 #1 thru #8
- 65-4098 #0000/000
- 65-4099 #00/0
- 65-4101 #1-2
- 65-4103 #3-4
- 65-4105 #5-6
- 65-4107 #7-8

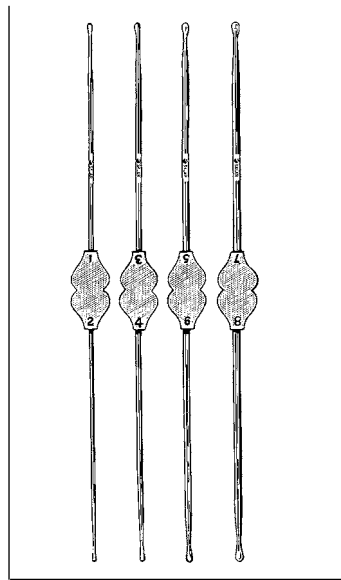

**WILLIAMS LACHRYMAL  
DILATOR/PROBE**

Double Ended Sterling Silver

- 65-4120 Set of 4 #1 thru #8
- 65-4121 #1-2
- 65-4123 #3-4
- 65-4125 #5-6
- 65-4127 #7-8

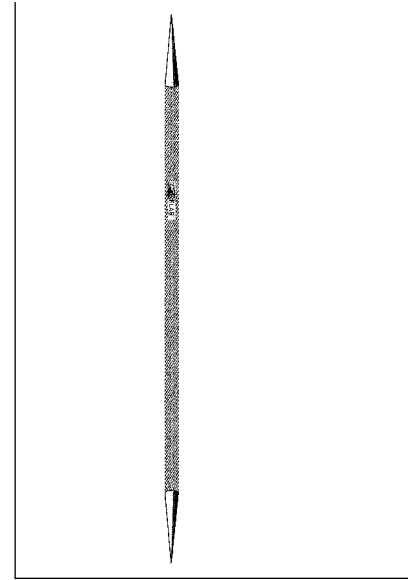

**CASTROVIEJO LACHRYMAL  
DILATOR**

Double Ended, Tapers  
22 mm x 18 mm 5½"

65-6960

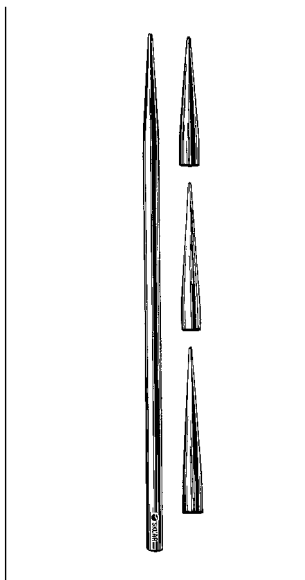

**WILDER LACHRYMAL  
DILATOR**

- 65-7001 Short Taper
- 65-7002 Medium Taper
- 65-7003 Long Taper

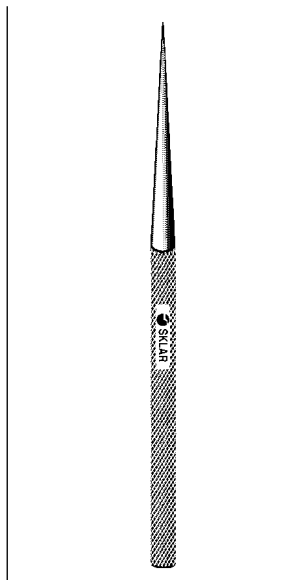

**INFANT LACHRYMAL  
DILATOR**

Extra Delicate 2¾"  
65-7000 0.5 mm at tip

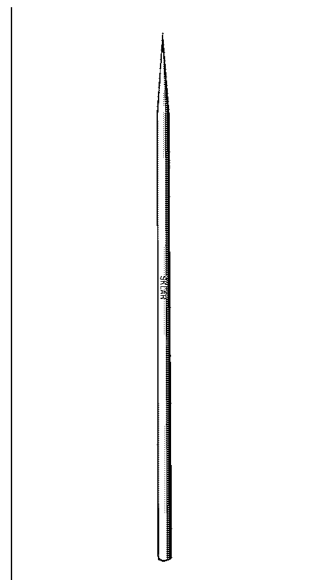

**RUEDEMANN  
LACHRYMAL DILATOR**

2¾"  
65-6950 Short delicate needle tip

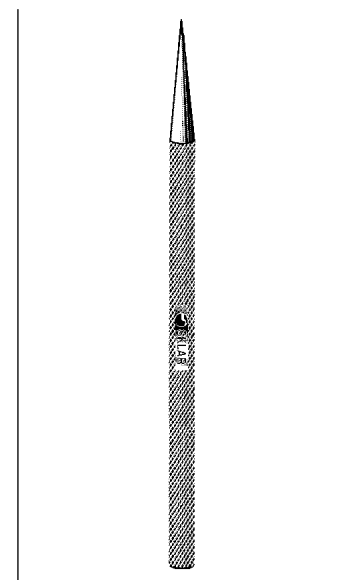

**MULDOON LACHRYMAL  
DILATOR**

With Straight Distal End to  
Guide Dilator 4"  
65-6952



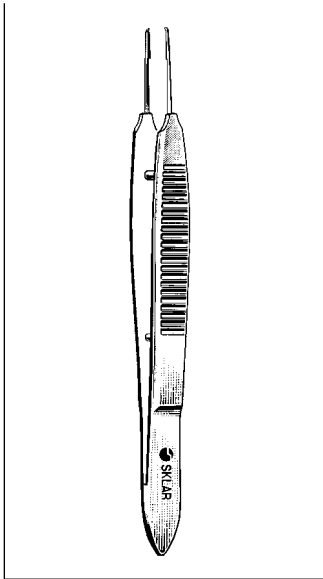

### CASTROVIEJO FORCEPS

66-6105 4" .5 mm teeth  
66-6109 4" .9 mm teeth

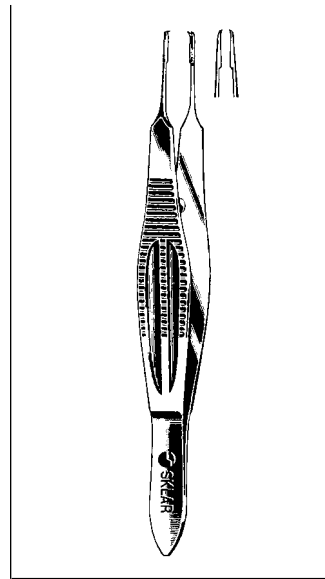

### CASTROVIEJO SUTURE FORCEPS

4 1/4" 1 x 2 Platform behind teeth limits depth of penetration.

Wide handle.

66-6115 0.5 mm delicate teeth  
66-6118 1.5 mm delicate teeth

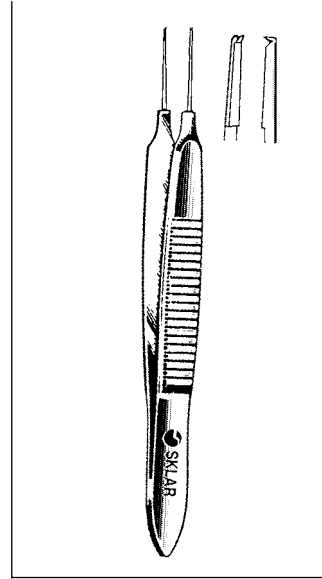

### BONN MICRO SUTURING FORCEPS

66-6125 2 3/4" 1 x 2 teeth  
0.12 mm with tying platform  
66-6126 3 3/4" 1 x 2 teeth  
0.12 mm with tying platform

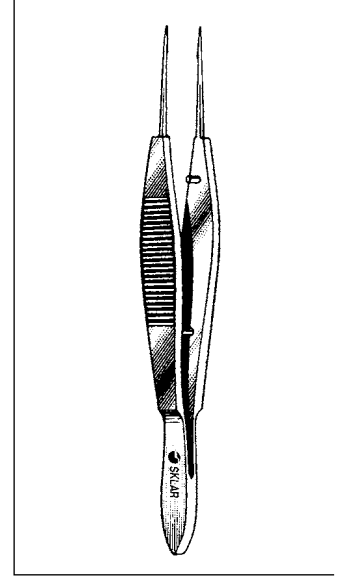

### BONN TYING FORCEPS

With tying platform 0.3 mm tip width  
66-6160 Straight 4"

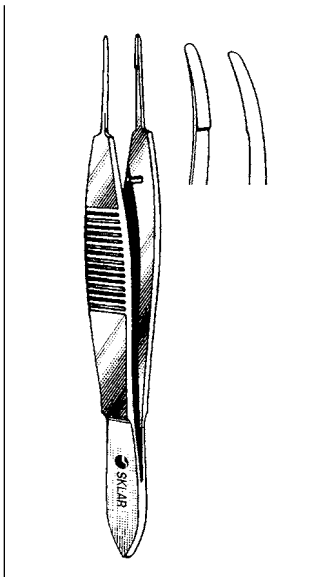

### HARMS TYING FORCEPS WITH TYING PLATFORM

0.5 mm tip width  
66-6140 4" Straight  
66-6142 4" Curved

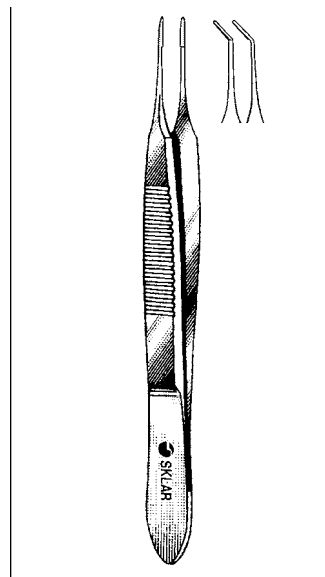

### McPHERSON TYING FORCEPS WITH TYING PLATFORM

0.3 mm tip width  
66-6150 4" Straight  
66-6152 4" Angled

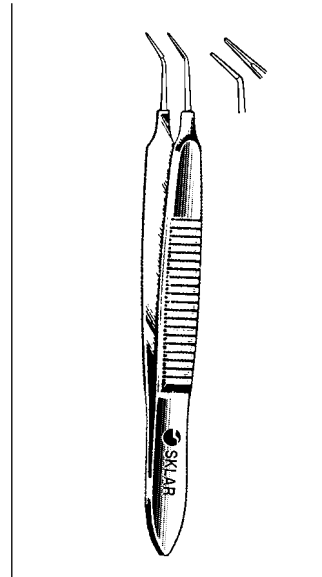

### McPHERSON MICRO IRIS SUTURING FORCEPS

Smooth platform 0.3 x 5 mm  
66-6164 3 1/2" Straight  
66-6166 3 1/2" Angled

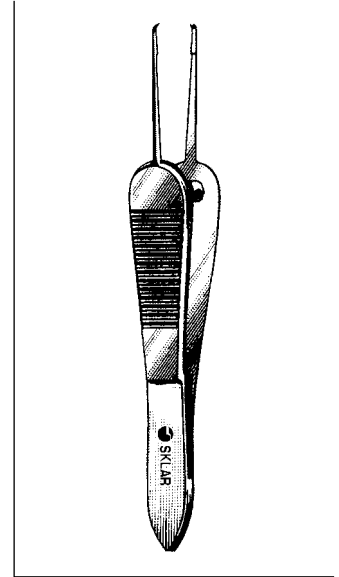

### MANHATTAN EYE & EAR SUTURING FORCEPS

3 1/2" with smooth platform  
1 x 2 curved teeth overlapping each other 0.7 mm wide  
66-6168

# EYE INSTRUMENTS

## FORCEPS

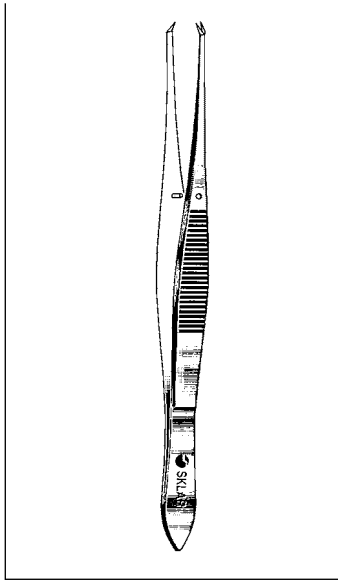

**O'BRIEN-ELSHNIG  
FORCEPS**

66-2540 4"

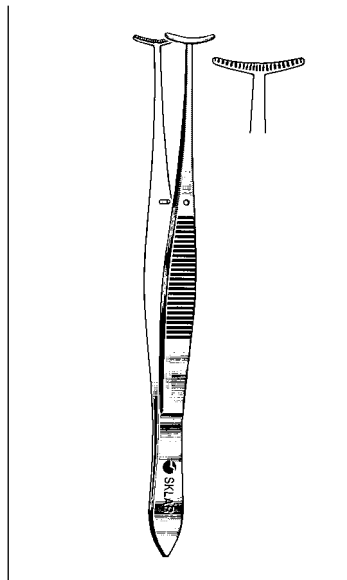

**GREEN FIXATION  
FORCEPS**

4"  
66-2009 9 mm jaws  
66-2012 12.5 mm jaws

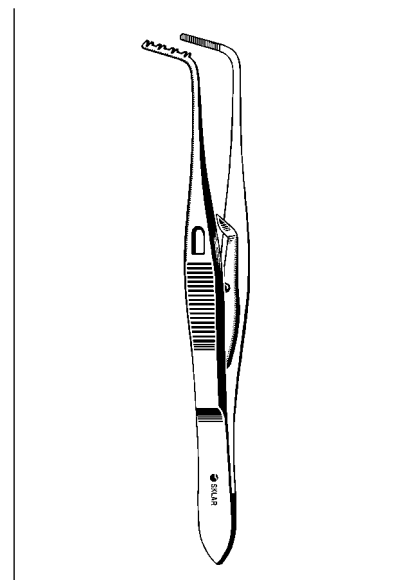

**PRINCE MUSCLE FORCEPS**

66-5942 4 1/4"

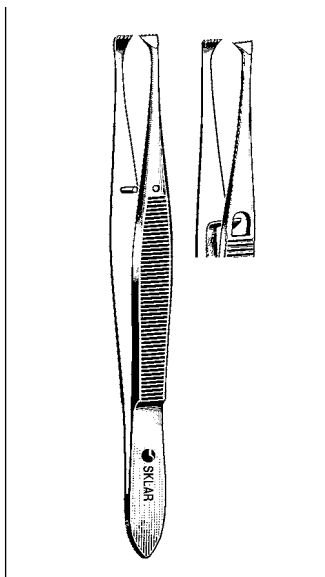

**GRAEFE FIXATION  
FORCEPS**

66-1940 4 1/4" Without Lock  
66-2140 4 1/4" With Lock  
66-2040 4 1/4" Without Lock  
Non-Magnetic

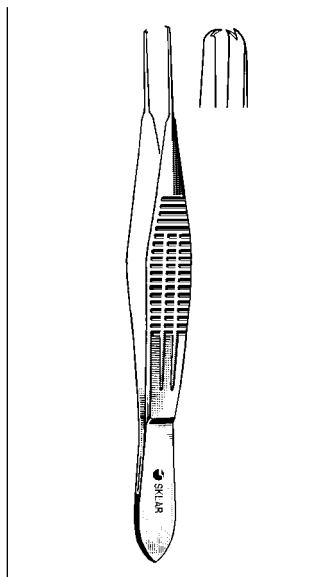

**CASTROVIEJO FIXATION  
FORCEPS**

4"  
66-2640 1 x 2 0.3 mm teeth  
without tying platform  
66-2635 1 x 2 0.5 mm teeth  
without tying platform

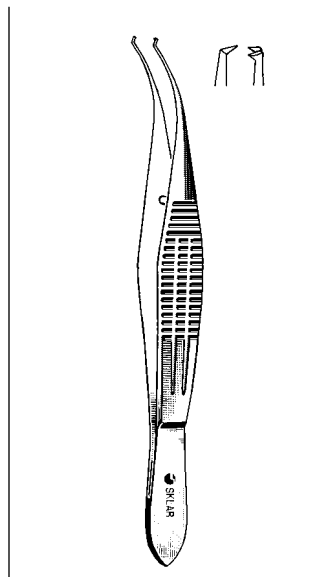

**CASTROVIEJO COLIBRI  
FORCEPS**

Wide Handle 4.25" Extra  
Delicate  
66-3450 1 x 2 0.12 mm teeth

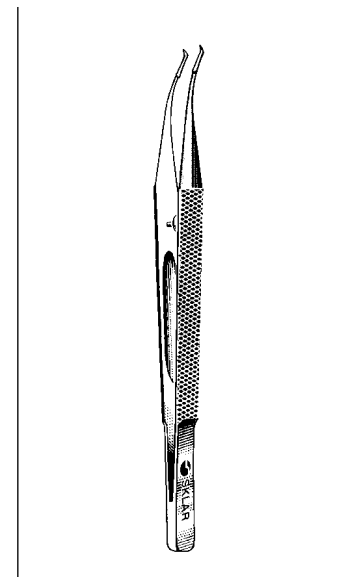

**GIRARD CORNEAL  
UTILITY FORCEPS**

4.0" with tying platform,  
smooth tip, 0.5 mm wide  
66-6120

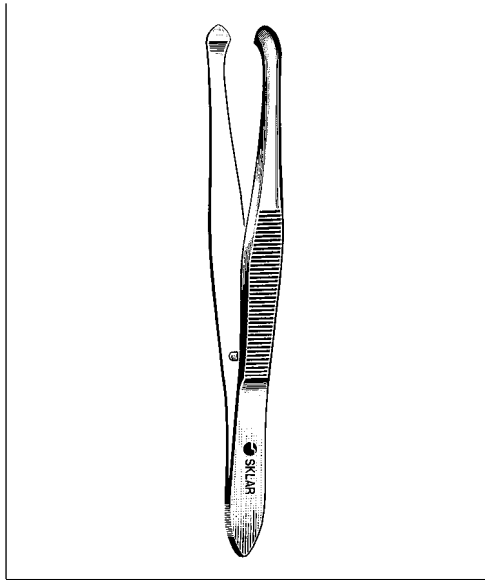

**ZIEGLER CILIA FORCEPS**

66-1535 3/2"

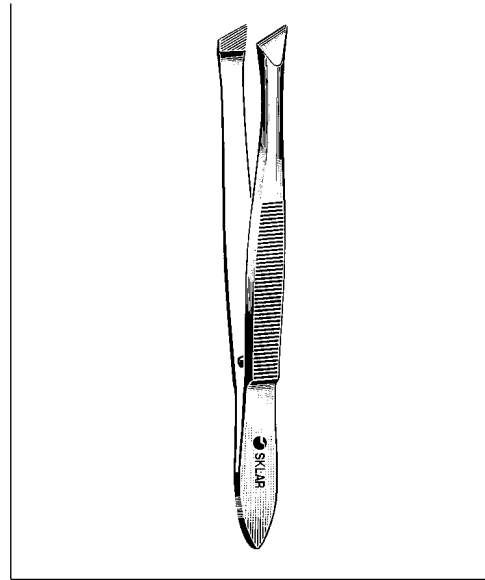

**BERGH CILIA FORCEPS**

66-1635 3/2"

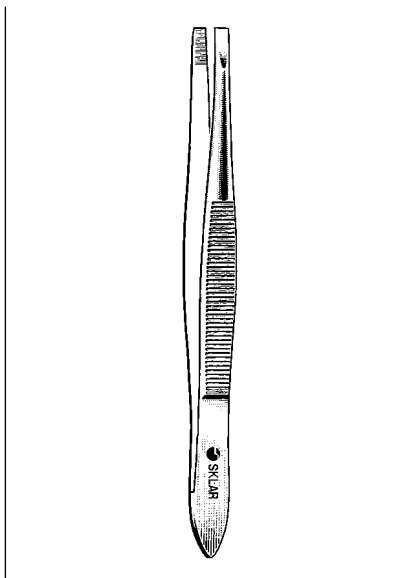

**DOUGLASS CILIA FORCEPS**

66-1830 3/2"

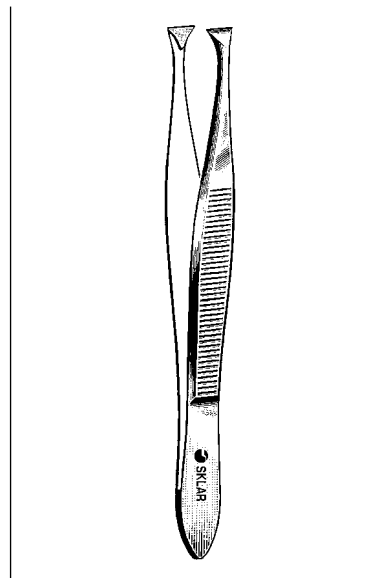

**LITTAUER CILIA FORCEPS**

66-1735 3/2"

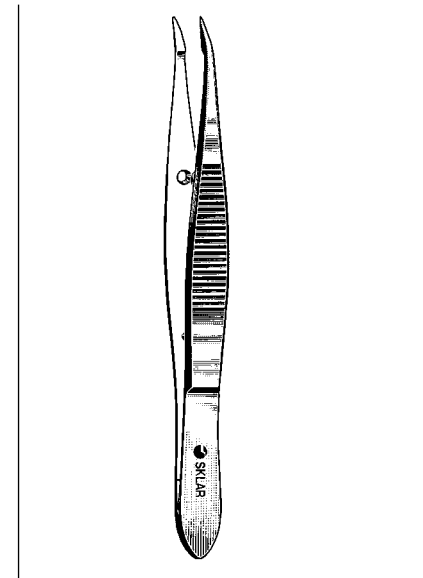

**BARRAQUER CILIA FORCEPS**

66-1742 4/4"

# EYE INSTRUMENTS

## FORCEPS

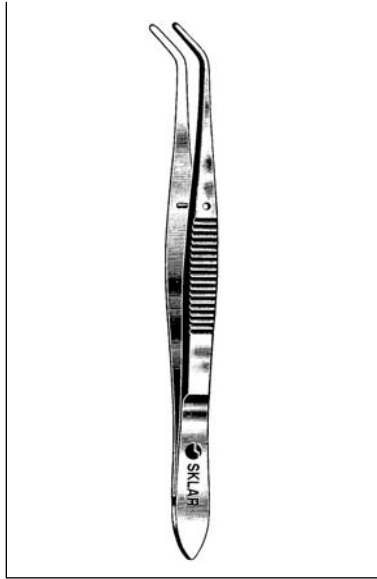

### **NUGENT UTILITY FORCEPS**

66-6240 4 1/4" Angular smooth tips  
66-6242 4 1/4" Angular serrated tips

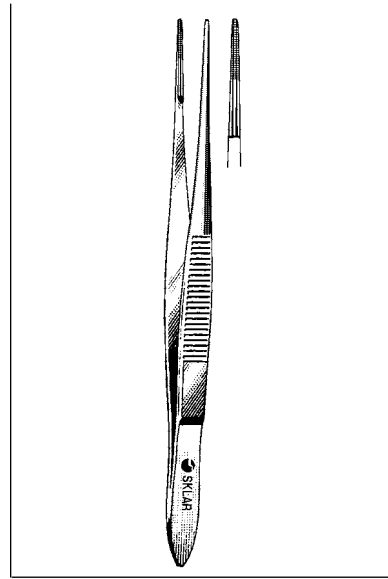

### **BONACCOLTO UTILITY FORCEPS**

Cross serrated at tips for better pick up Delicate pattern  
66-6340 4" 1.2 mm jaws  
66-6338 4" 1.7 mm jaws

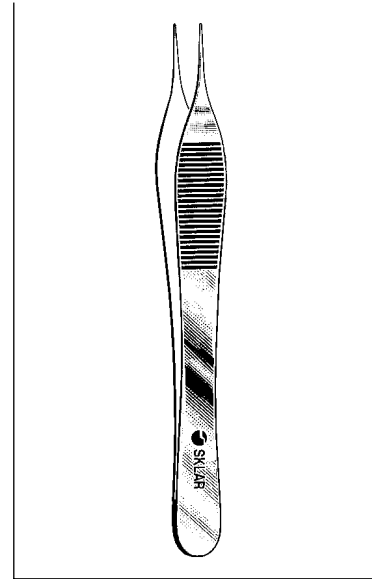

### **THORPE CORNEOSCLERAL FORCEPS**

66-7347 4 1/4"

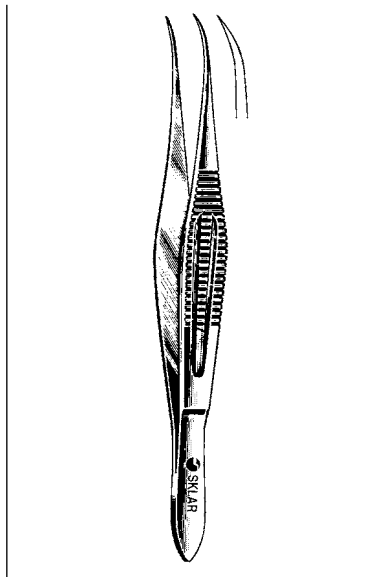

### **MANHATTAN EYE AND EAR SUTURE FORCEPS**

66-6250 4 1/4" with fine tips

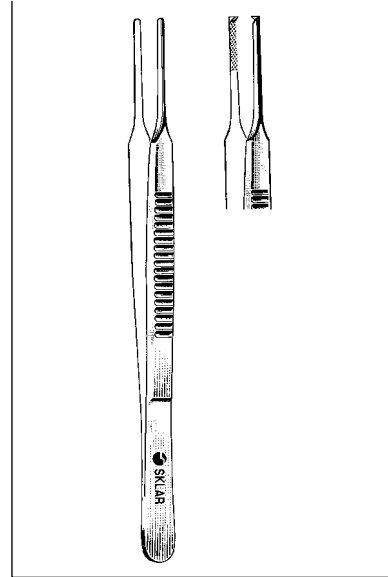

### **McCULLOUGH UTILITY FORCEPS**

66-6110 4" Serrated  
66-6112 4" Smooth  
66-6114 4" 1 x 2 teeth with serrations

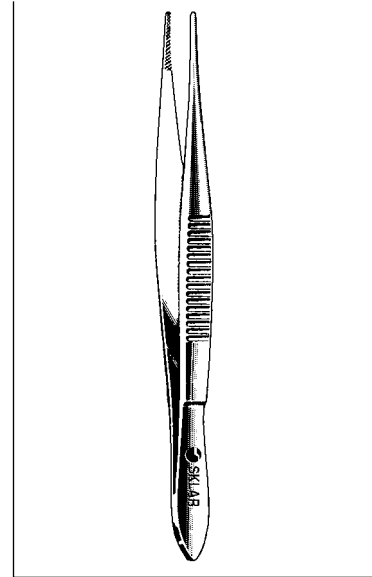

### **WILLS HOSPITAL UTILITY FORCEPS**

66-6268 4" cross serrations on tips

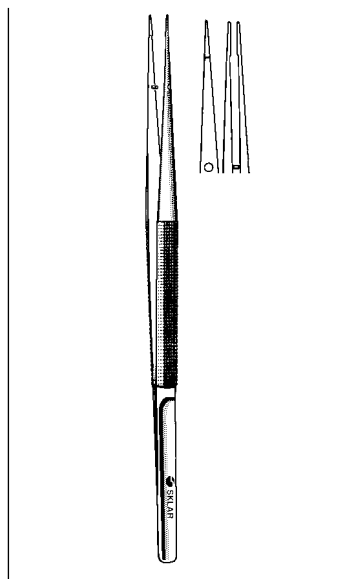

**RHOTON MICRO  
SUTURE FORCEPS**

7" 0.7 mm Tying Platform  
98-3055 Straight

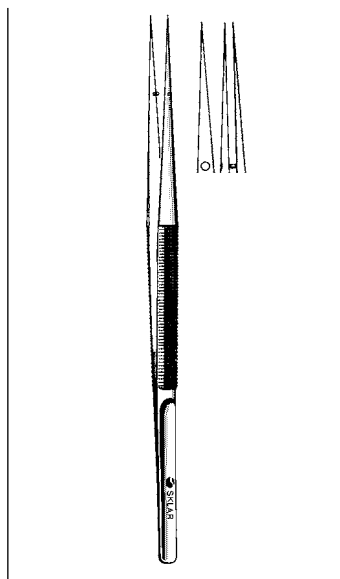

**RHOTON MICRO  
FORCEPS**

98-3056 7" Straight

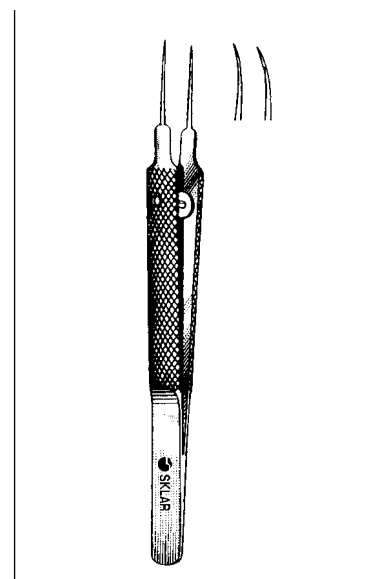

**TENNANT TYING FORCEPS**

Round Handle  
Extra delicate with tying platform  
6 mm x 0.3 mm tip width  
66-6194 Straight 4"  
66-6196 Curved 4"

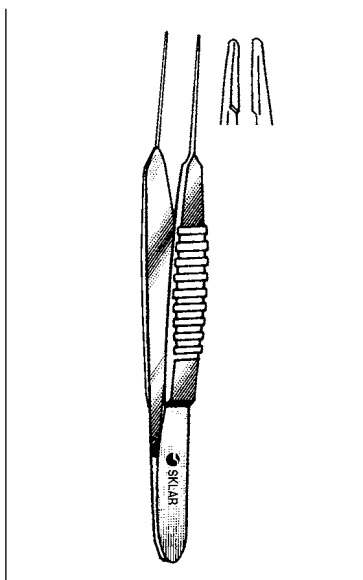

**KELMAN-McPHERSON  
TYING FORCEPS**

Straight 3/4"  
66-6175 Smooth

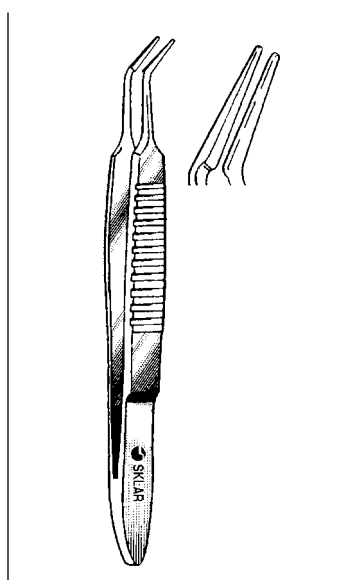

**BECHERT-McPHERSON  
TYING FORCEPS**

10 mm tying platform  
3/8"  
66-6178 Smooth jaws, angled

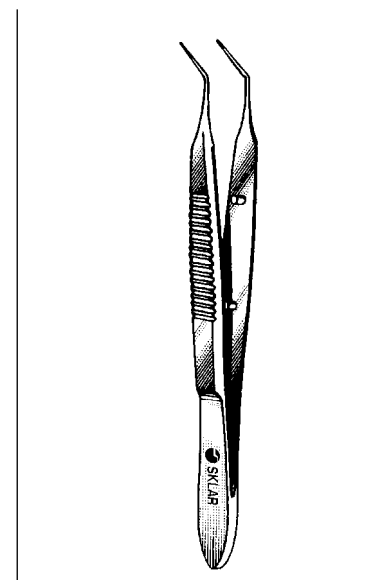

**KELMAN-McPHERSON  
TYING FORCEPS**

With tying platform 7.5 mm long  
0.3 mm tip width Angled 3/8"  
66-6180

# EYE INSTRUMENTS

## CURETTES / FORCEPS

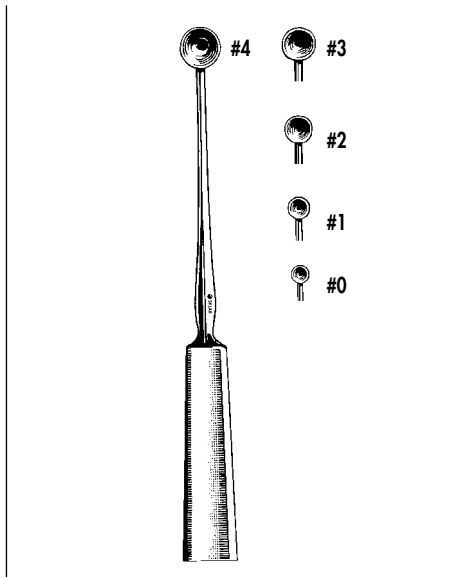

### MEYHOEFER CHALAZION CURETTE

65-3170	#0	1.5 mm
65-3171	#1	1.7 mm
65-3172	#2	2.2 mm
65-3173	#3	2.5 mm
65-3174	#4	3.0 mm

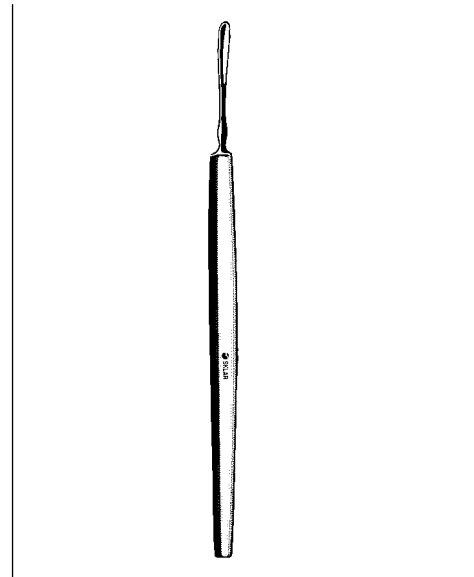

### DAVIEL CHALAZION CURETTE

65-3140 3 mm spoon

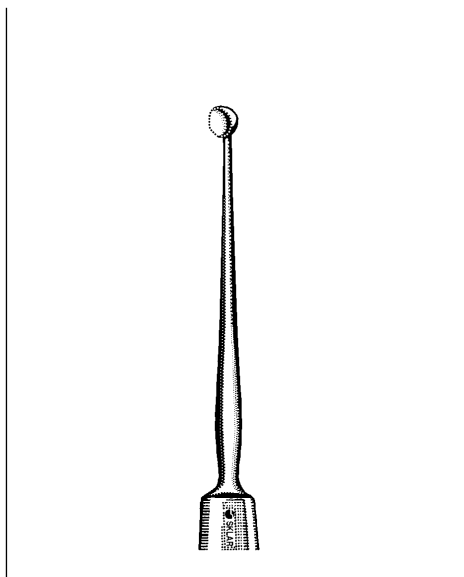

### SKEELE CHALAZION CURETTE

65-3162 Serrated, 2 mm

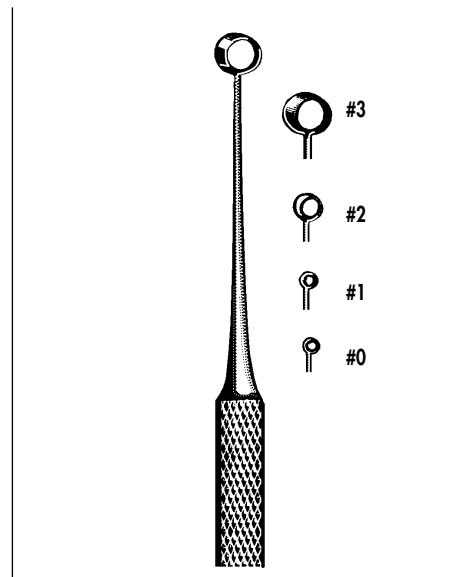

### HEATH CHALAZION CURETTE

One Sharp Edge and One  
Dull Edge

65-3180	#0	½ mm
65-3181	#1	1 mm
65-3182	#2	2 mm
65-3183	#3	3 mm

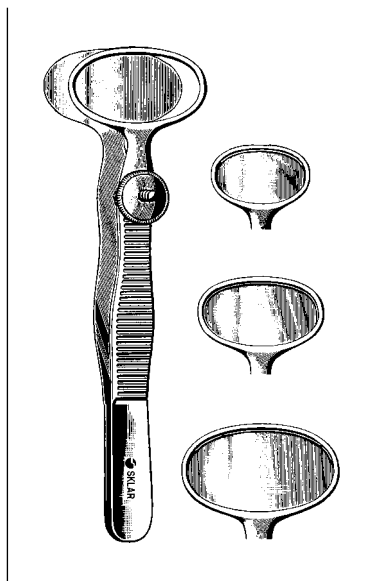

**DESMARRES CHALAZION  
FORCEPS**

66-1038 3/4" Small  
66-1036 3/4" Medium  
66-1035 3/4" Large

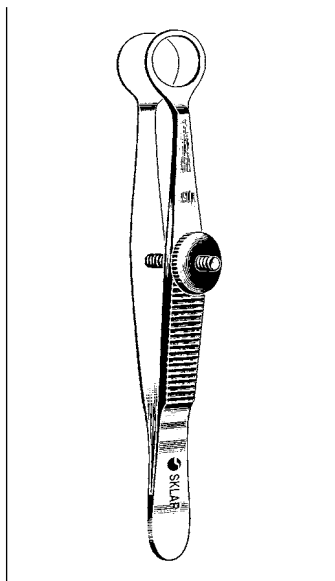

**LAMBERT CHALAZION  
FORCEPS**

Fenestrated Smooth jaws  
66-1235 3/4" 8.0 mm  
66-1236 3/4" 11.0 mm

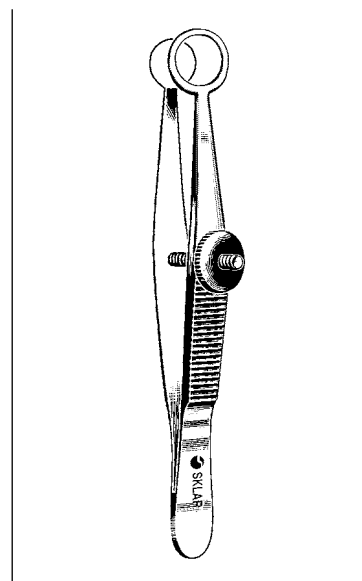

**AYERS CHALAZION  
FORCEPS**

66-1435 3/2" 9 mm inside diameter

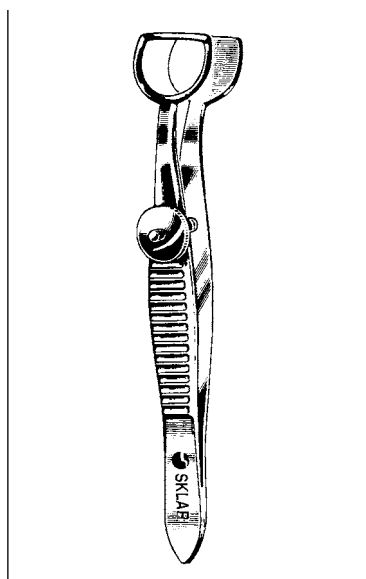

**WEIS CHALAZION  
FORCEPS**

Serrated and Fenestrated  
66-1265 4" 9 mm x 12 mm jaw

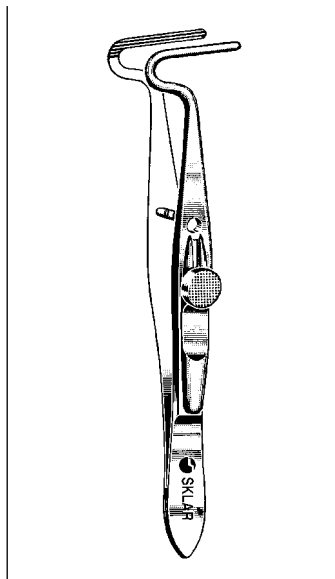

**BERKE PTOSIS FORCEPS**

66-6342 4/4"

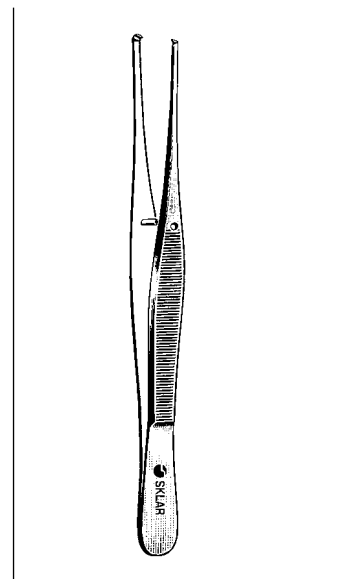

**STRABISMUS FORCEPS**

66-4840 4" Straight 1 x 2

# EYE INSTRUMENTS

## SPATULAS

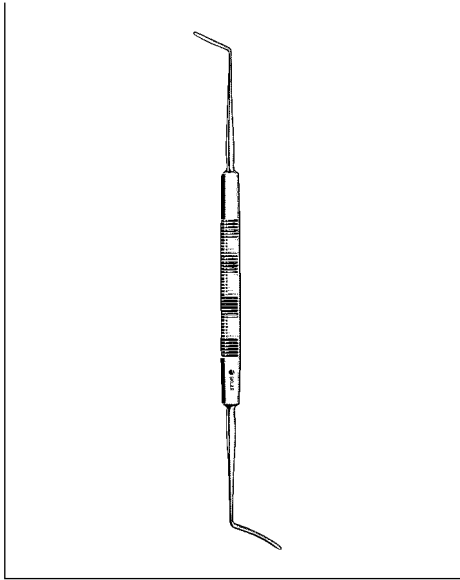

### **CASTROVIEJO CYCLODIALYSIS SPATULAS**

10 and 15 mm Blade Lengths

65-4062 0.5 mm wide

65-4064 .75 mm wide

65-4066 1 mm wide (Single End)

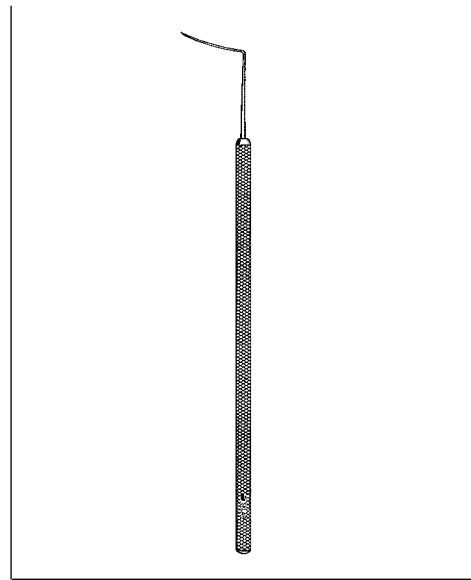

### **BARRAQUER CYCLODIALYSIS SPATULA**

12 cm

65-4068 .50 mm diameter round

15 mm angled blade

Smooth pointed tip

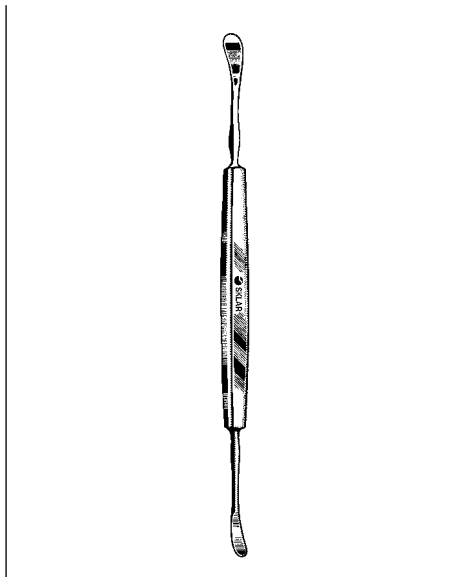

### **GREEN SPATULA**

Slightly Curved

65-4074 6"

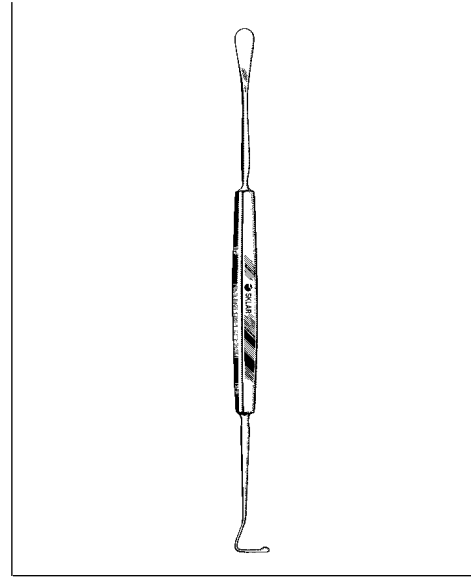

### **McREYNOLDS SPATULA AND HOOK**

Double Ended

65-4076 4 3/4"



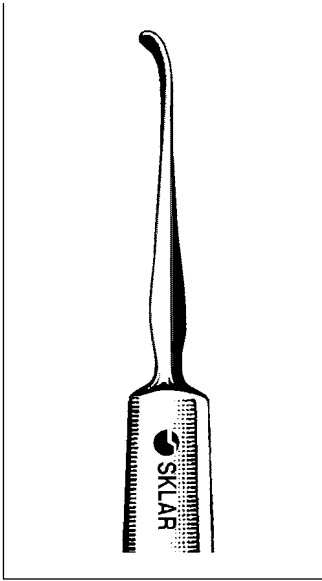

**ELLIS FOREIGN BODY  
SPUD**

Curved  
65-7265 4 1/2" 1.2 mm Blade

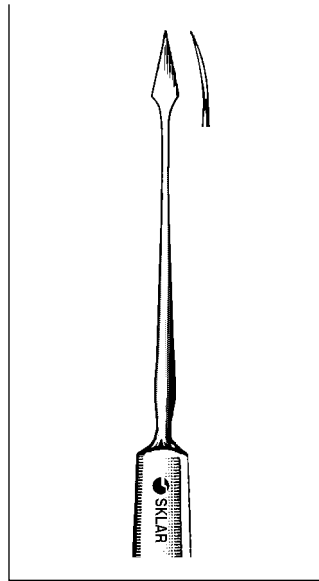

**FOREIGN BODY  
NEEDLES**

65-7270 Straight  
65-7272 Curved

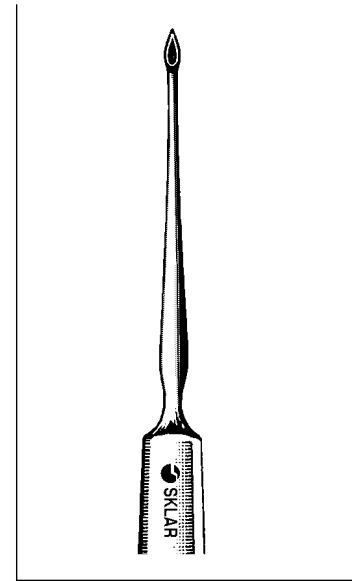

**ALVIS FOREIGN BODY  
SPUD**

With Fine Point  
65-7275 4 1/2" 1 mm x 3 mm  
Oval curette

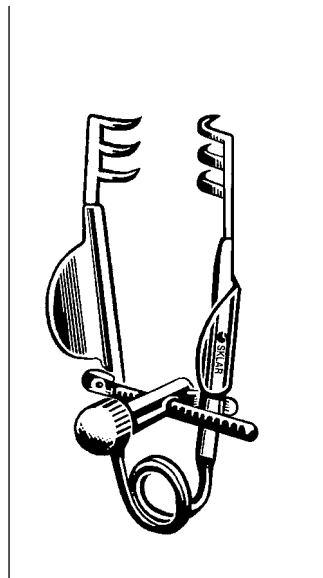

**SELF-RETAINING  
RETRACTOR DELICATE**

65-1815 1 1/2"

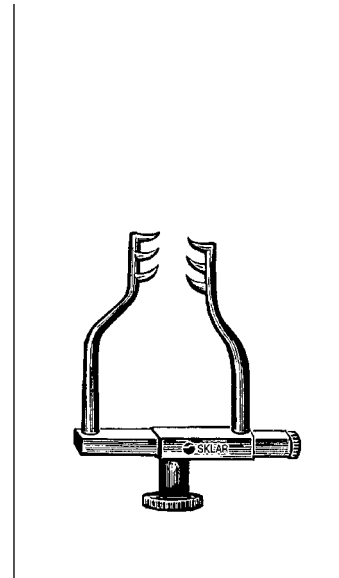

**GOLDSTEIN RETRACTOR**

47-2913 1 1/2"

# EYE INSTRUMENTS

## SPECULA

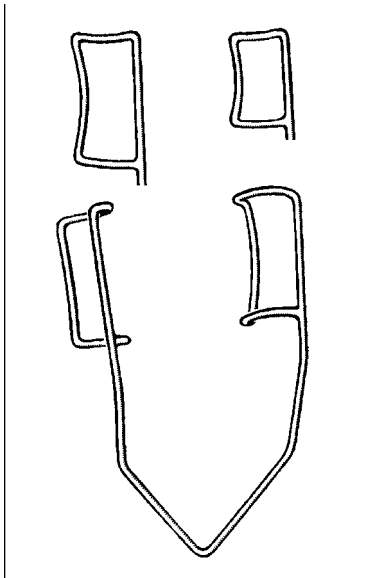

### **BARRAQUER WIRE SPECULUM**

1½" long

- 65-1740 10 mm loop, child
- 65-1742 15 mm loop, adult
- 65-1744 15 mm loop, adult, heavy wire
- 65-1746 8 mm loop, infant
- 65-1748 4 mm loop, infant, delicate

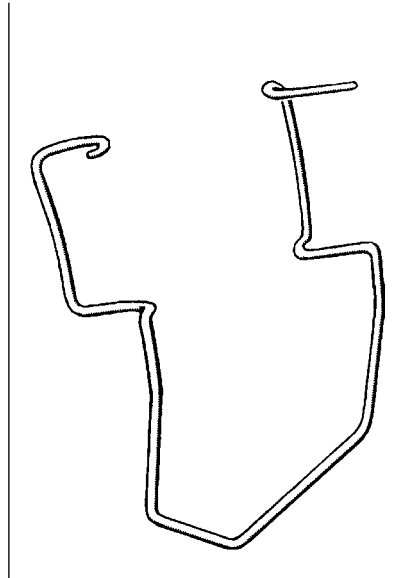

### **KRATZ-BARRAQUER WIRE EYE SPECULUM**

Blade width 14 mm

- 65-1750 18 mm blade spread adult
- 65-1752 15 mm blade spread child
- 65-1754 12 mm blade spread infant

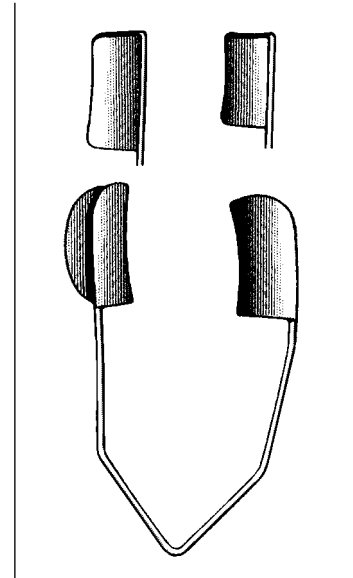

### **BARRAQUER BLADE SPECULUM**

1½" long

- 65-1756 10 mm solid blade child
- 65-1758 15 mm solid blade adult

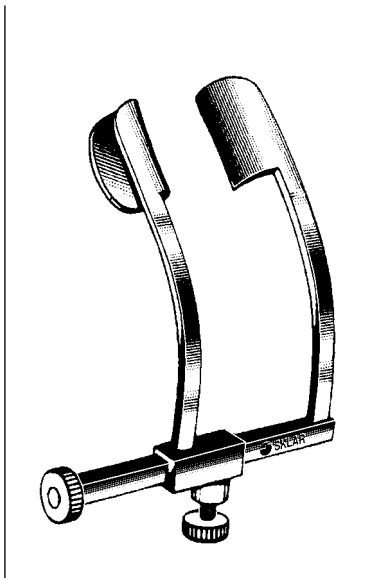

### **COOK EYE SPECULUM**

2" Long

- 65-1765 9 x 3 mm solid blade spread 25 mm

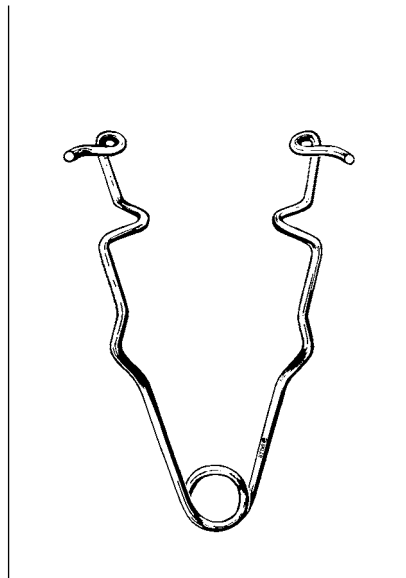

### **PLAIN WIRE SPECULUM**

- 65-1127 2¼" Adult

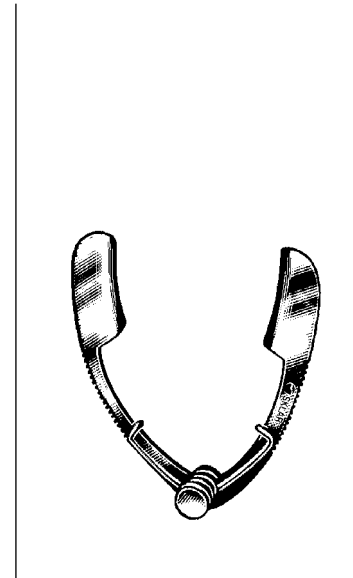

### **SAUER EYE SPECULUM**

Infant

- 65-1012 1¼" 10 mm

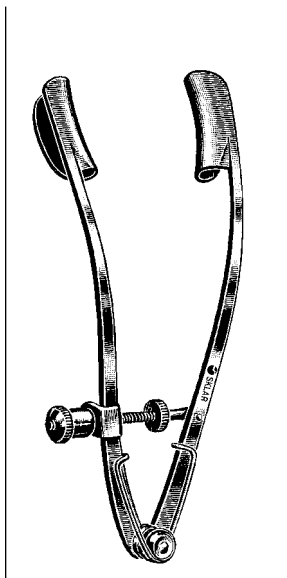

**LANCASTER EYE SPECULUM**

65-1532 3/4"

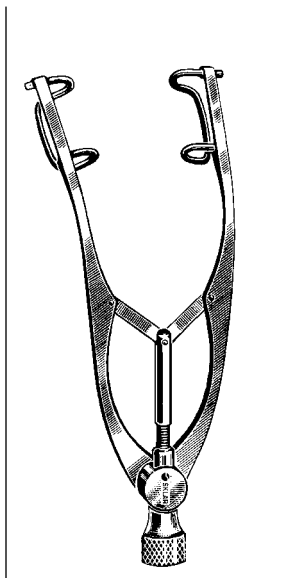

**CASTROVIEJO SPECULUM**

65-1535 3/4"

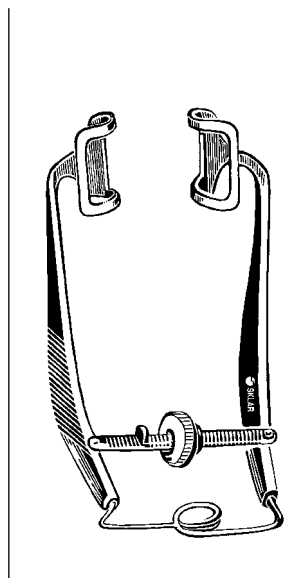

**ZIEGLER EYE SPECULUM**

65-1522 2/4"

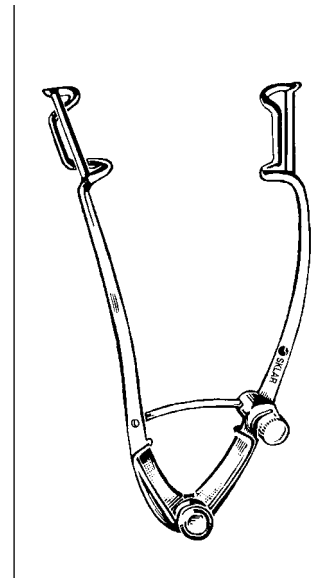

**WILLIAMS SPECULUM**

65-1227 2/4" Child  
65-1332 3/4" Adult

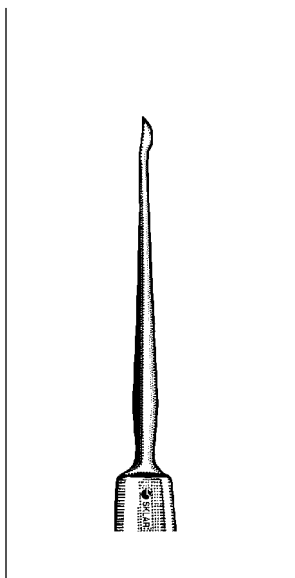

**BARKAN GONIOTOMY KNIFE**

65-3022 4/2"

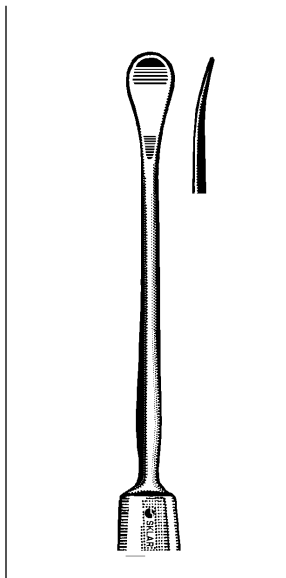

**GILL CORNEAL KNIFE**

65-3025 4/4" Blade is slightly curved

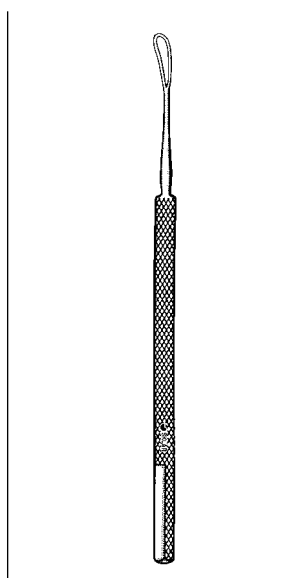

**WILDER LENS LOOP**

65-8215 Serrated

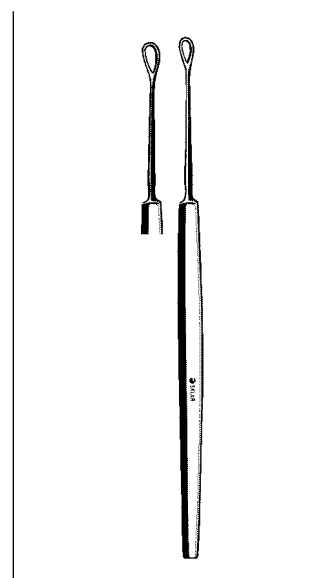

**LEWIS LENS LOOP**

65-8206 Smooth

# EYE INSTRUMENTS

## SPATULAS / HOOKS

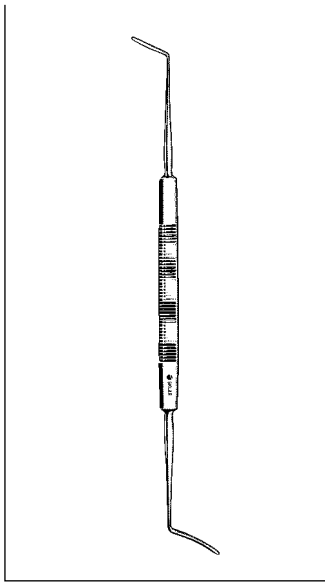

**CASTROVIEJO  
CYCLODIALYSIS  
SPATULAS**

10 and 15 mm Blade Lengths

- 65-4062 0.5 mm wide
- 65-4064 .75 mm wide
- 65-4066 1 mm wide (Single End)

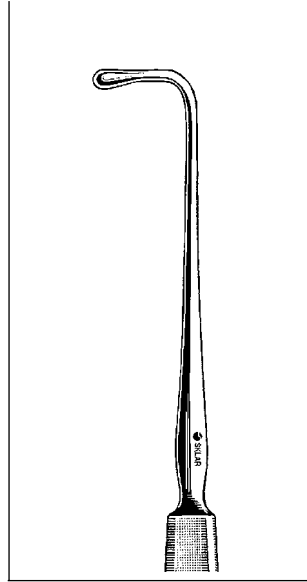

**GRAEFE  
STRABISMUS HOOK**

- 65-3215 Small
- 65-3216 Medium
- 65-3217 Large

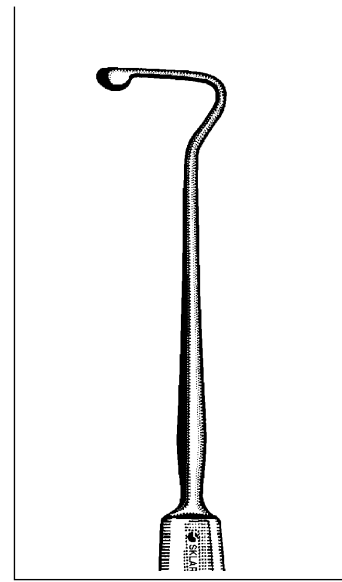

**JAMISON  
STRABISMUS HOOK**

- 65-3195 5"  
w/10 mm hook

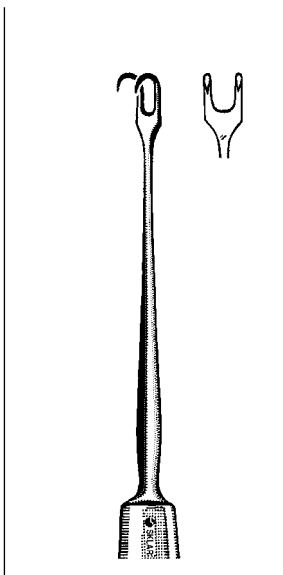

**GUTHRIE FIXATION  
HOOK**

- 47-2650 5" Two Large Sharp Prongs
- 47-2651 5" Two Small Sharp Prongs

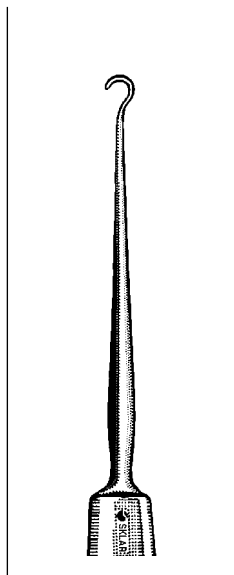

**TYRELL IRIS  
HOOK**

- 65-3205 5" Blunt
- 65-3206 5" Sharp

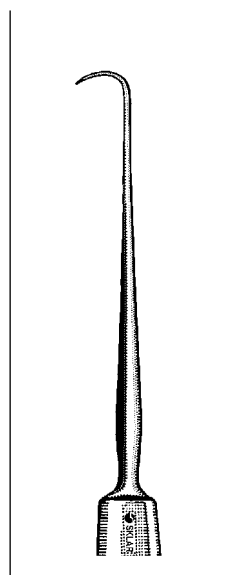

**WIENER SCLERAL  
HOOK**

- 65-3250 5" Sharp

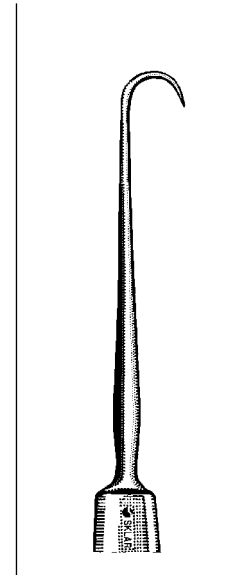

**O'CONNOR  
HOOK**

- 65-3265 5" Sharp

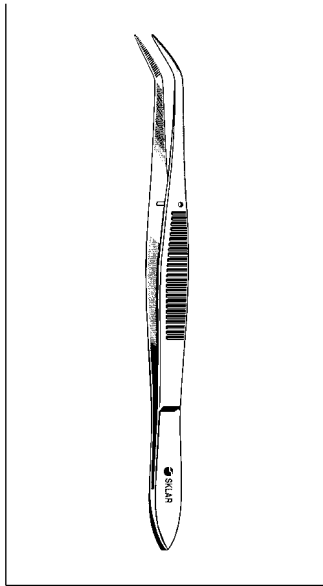

### **PERRY PLIERS**

No. 312  
Serrated Tips  
41-315 Sklar  
48-315 Mid-Grade

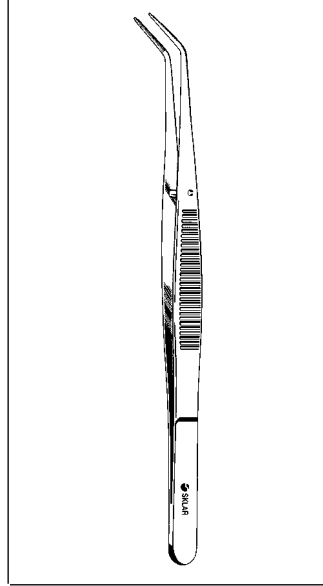

### **COLLEGE PLIERS**

No. 317A  
Extra Fine Serrated Tips  
41-318 Sklar  
48-318 Mid-Grade

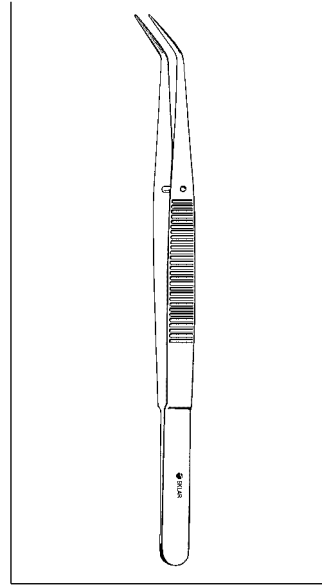

### **NON-PINCH COLLEGE PLIERS**

Serrated Tips  
41-330 Sklar  
48-330 Mid-Grade

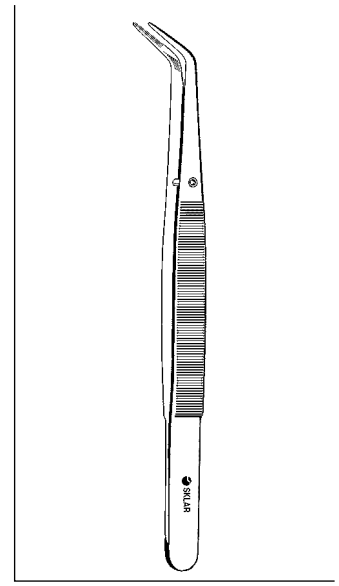

### **NON-PINCH COLLEGE PLIERS**

No. 49, Serrated Tips  
41-350 Sklar  
48-350 Mid-Grade

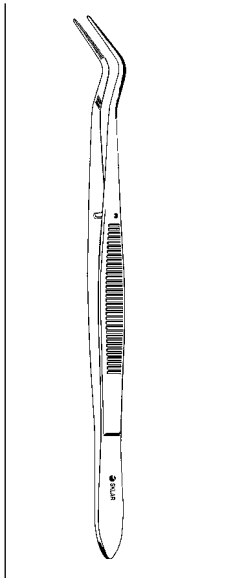

### **MERIAM PLIERS**

No. 318  
Serrated Tips  
41-368 Sklar  
48-368 Mid-Grade

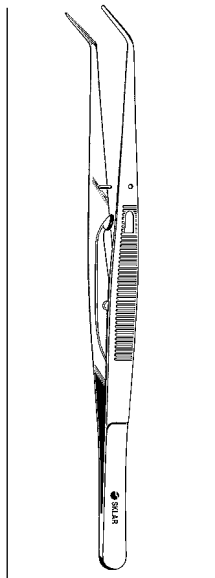

### **SELF-LOCKING COLLEGE PLIERS**

Serrated Tips  
41-372 Sklar  
48-128 Mid-Grade

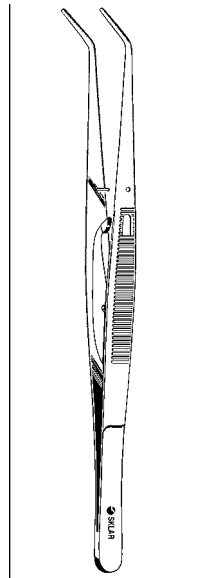

### **SELF-LOCKING COLLEGE PLIERS**

Grooved Tips  
41-378 Sklar  
48-378 Mid-Grade

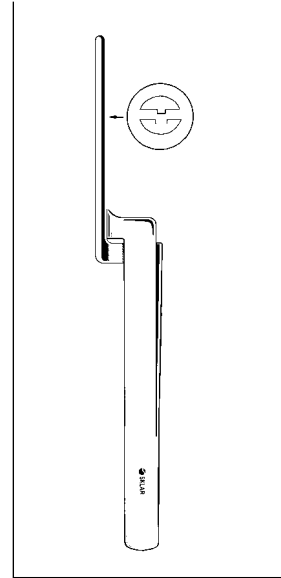

### **MILLER GROOVELOK**

Grooved Tips For  
Silver Point Holding  
41-388 Sklar  
48-388 Mid-Grade

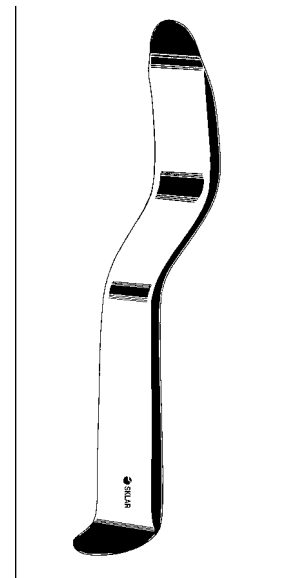

### **CHEEK RETRACTOR**

University of Minnesota  
44-489 Sklar  
48-489 Mid-Grade

# OR GRADE & MID-GRADE COLLEGE PLIERS / DENTAL INSTRUMENTS

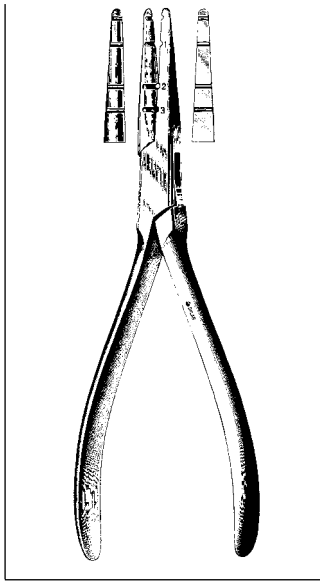

**WIRE BENDING PLIER**

No. 101  
45-796

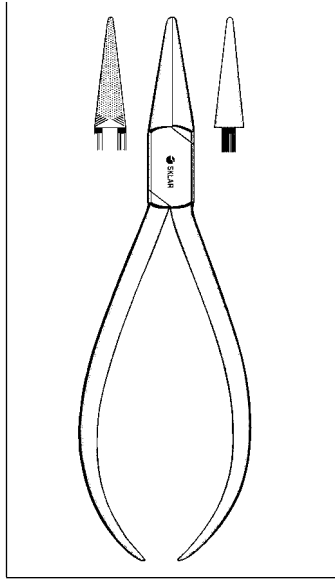

**GOSLEE CONTOURING  
PLIER**

No. 136  
One Beak Smooth, One  
Beak Serrated  
45-507 Sklar  
48-507 Mid-Grade

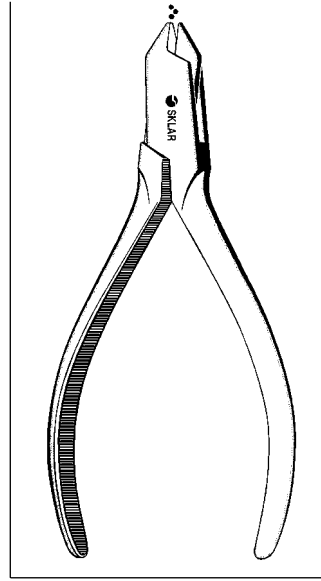

**CLASP ADJUSTING  
PLIER**

No. 200  
45-738 Sklar  
48-738 Mid-Grade

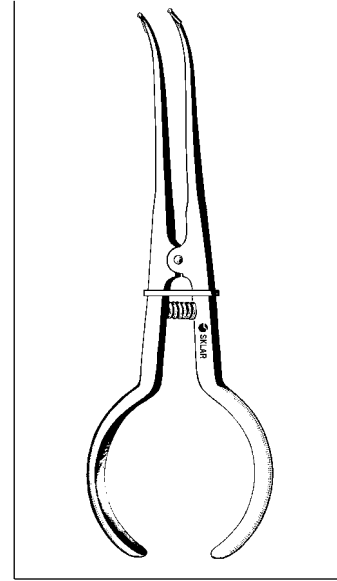

**RUBBER DAM FORCEPS**

University of Washington  
45-236 Sklar  
48-236 Mid-Grade

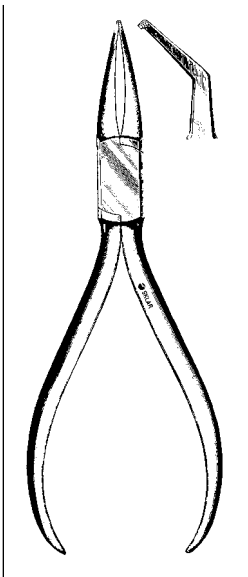

**HOW PLIER**

No. 111  
Curved, Serrated Tips  
46-356

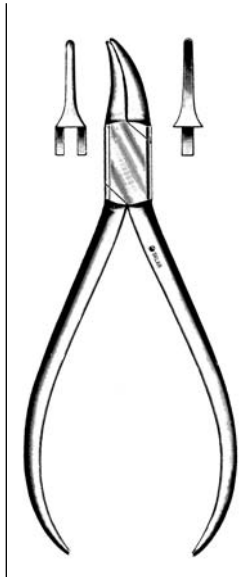

**GORDON PLIER**

No. 137C  
Chrome Plated  
45-545

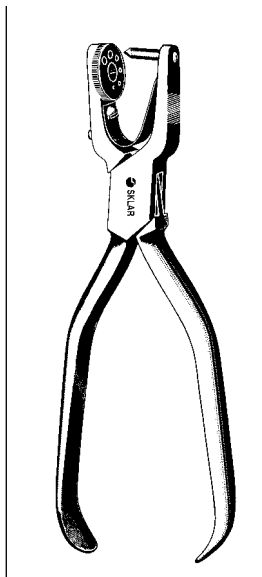

**RUBBER DAM  
PUNCH**

W-Type  
45-266 Sklar  
48-266 Mid-Grade

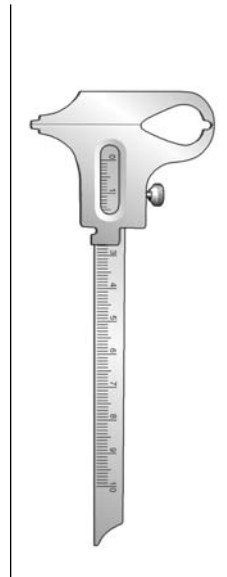

**BOLEY GAUGE**

45-202 Sklar  
48-202 Mid-Grade

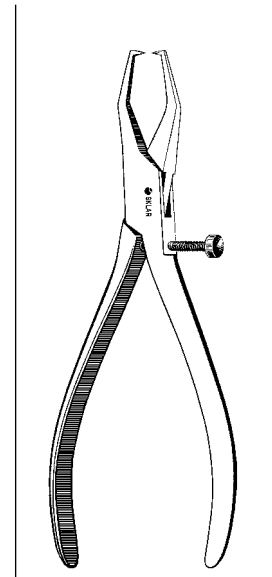

**BAADE CROWN  
PLIER**

No. 255  
45-835 Sklar  
48-835 Mid-Grade

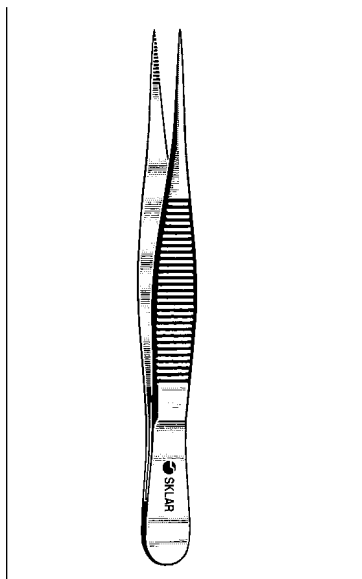

**FINE POINT SPLINTER  
FORCEPS**

19-3035 3½"  
19-3040 4"  
19-3045 4½"

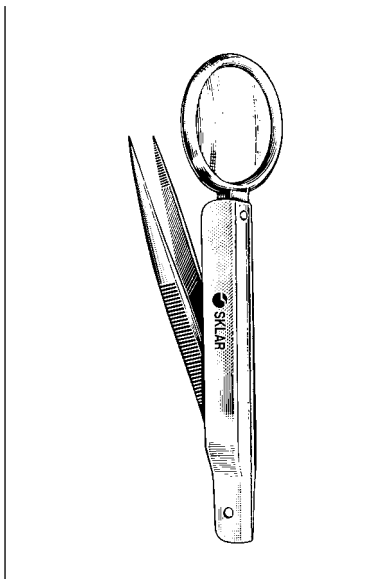

**PLAIN SPLINTER  
FORCEPS WITH MAGNIFIER**

19-3030 3" Chrome  
Non-Autoclavable

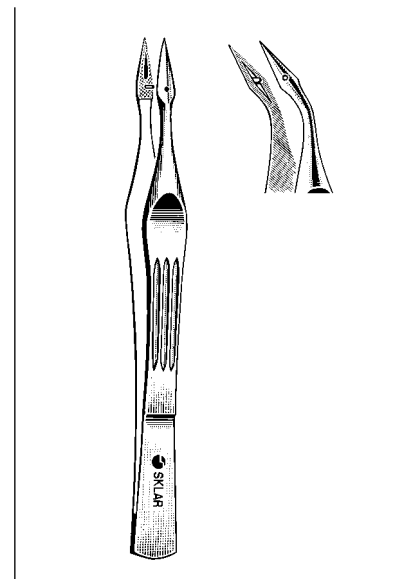

**CARMALT SPLINTER  
FORCEPS**

19-3240 4¼" Straight  
19-3340 4¼" Curved

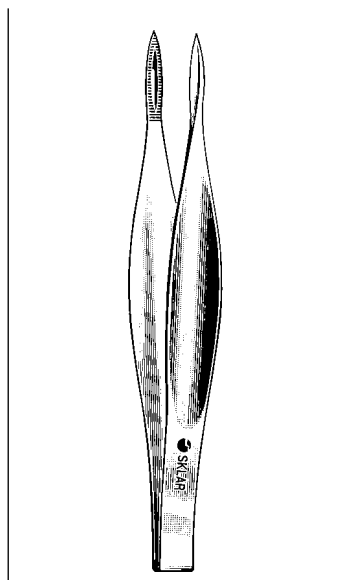

**FEILCHENFELD  
SPLINTER FORCEPS**

19-2930 3"  
19-2945 4½"

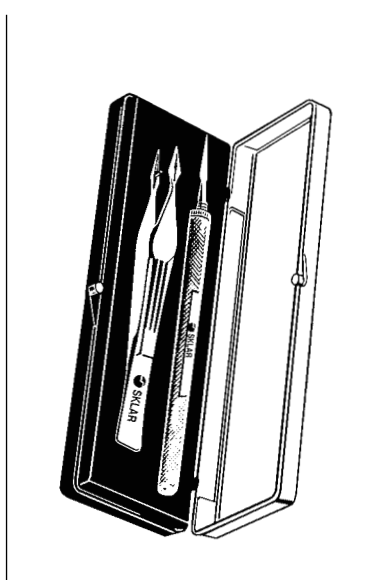

**SKLAR SPLINTER  
REMOVAL KIT**

19-3360 containing one 19-3240  
and one 19-3350 in a  
convenient  
storage case.

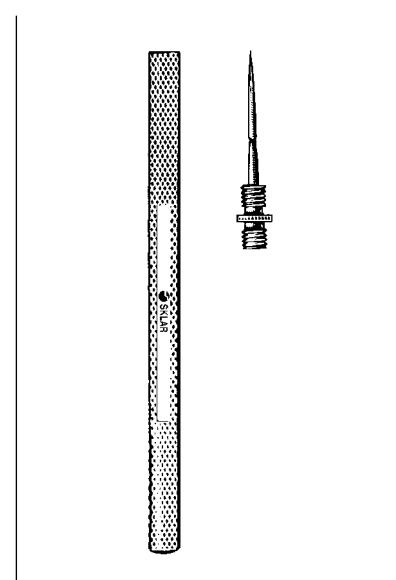

**VANGUARD SPLINTER PICK**

19-3350 3" Chrome  
Non-Autoclavable

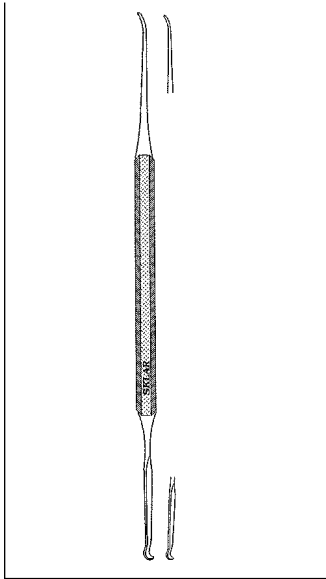

**EXCAVATOR & PROBE**

Double End  
97-0562 6"

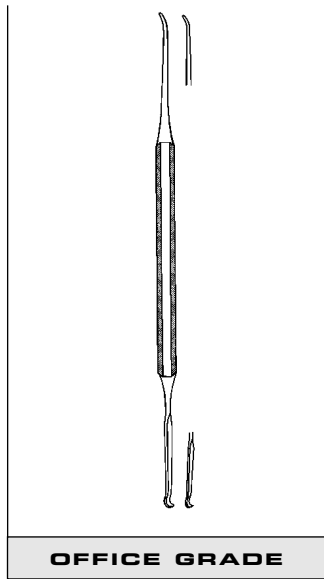

**EXCAVATOR & PROBE**

98-508 6" Double End

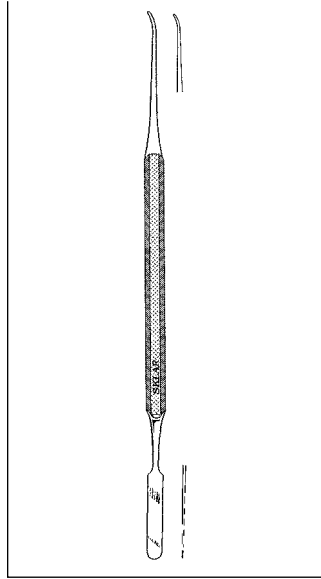

**PROBE & SPATULA**

Double End  
97-0548 6"

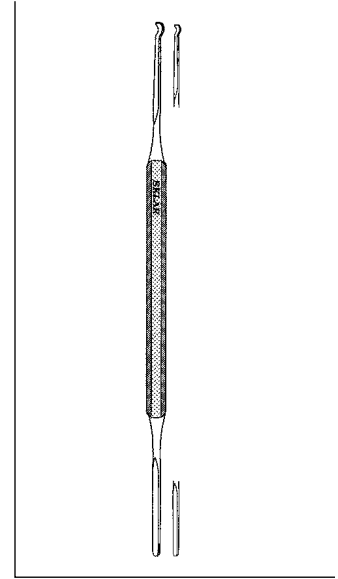

**EXCAVATOR & PACKER**

Double End 5 3/4"  
97-0546

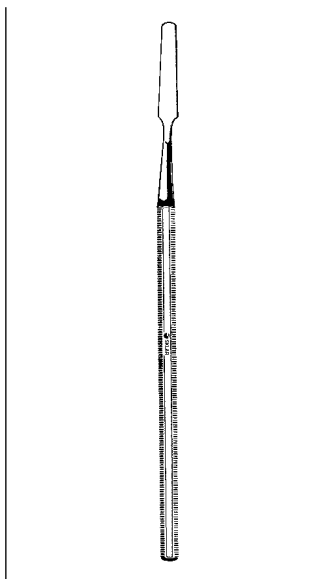

**SPATULA**

Rounded End  
97-0581 4 mm

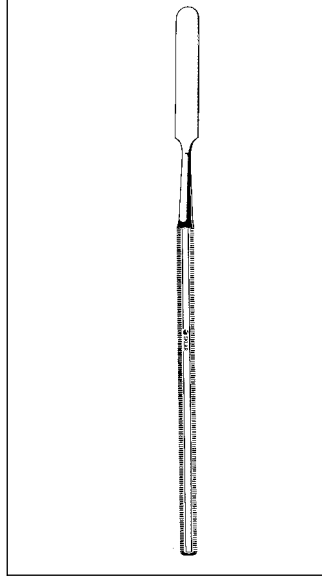

**SPATULA**

Rounded End  
97-0582 6 mm

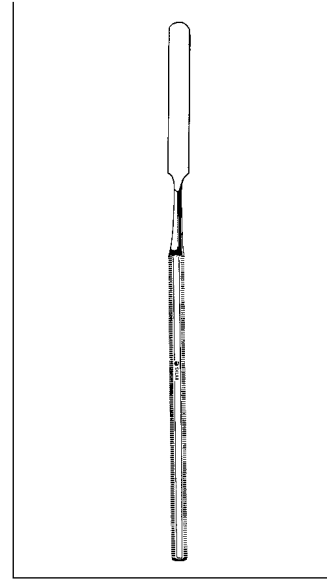

**SPATULA**

Rounded End  
97-0583 7 mm



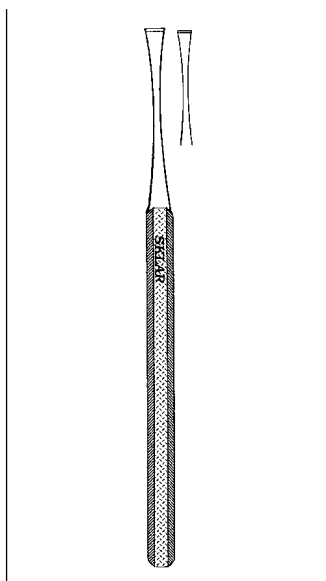

### **NAIL SPLITTER**

97-0601 Straight-Narrow 2mm  
97-0604 Straight-Wide 3.5mm

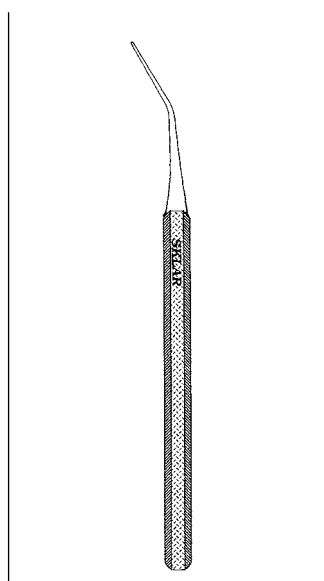

### **NAIL SPLITTER**

97-0606 Angular-Narrow 2mm

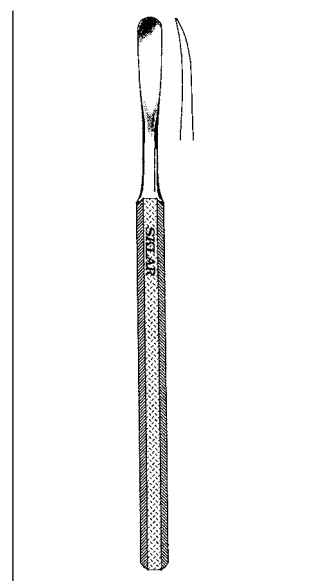

### **ELEVATOR**

Semi-Sharp, Curved Edge  
97-0048 5/2"

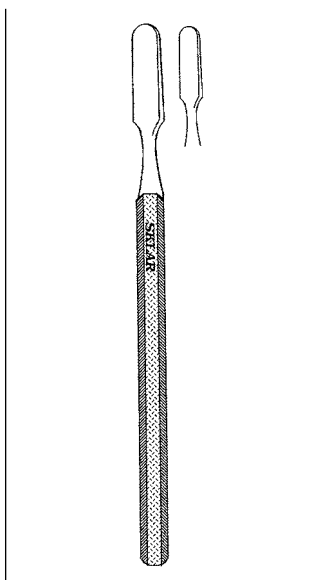

### **LOCKE ELEVATOR**

97-0623 Narrow 3 x 15mm  
97-0634 Wide 5 x 20mm

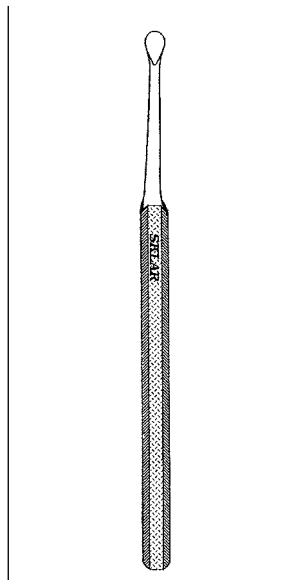

### **SOFT CORN KNIFE**

97-0035 Straight Blade

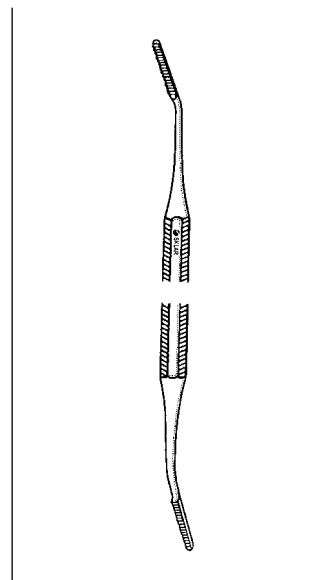

### **NAIL AND BONE FILE**

97-1610 Double End Inside/Outside Cut  
97-1600 Single End/Inside Cut  
97-1605 Single End/Outside Cut

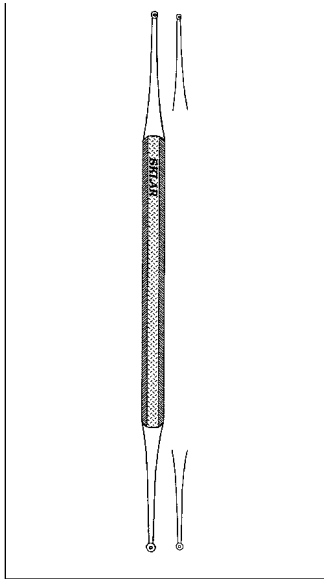

**CURETTE-EXCAVATOR**

Double End with Hole 5½"

- 97-0532 1.5-2.0 mm
- 97-0536 1.5-2.5 mm

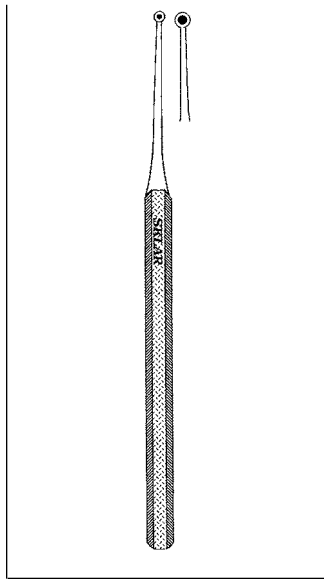

**CURETTE-EXCAVATOR**

Single End with Hole 5"

- 97-0512 1.0 mm
- 97-0522 1.5 mm
- 97-0524 2.0 mm
- 97-0528 2.5 mm

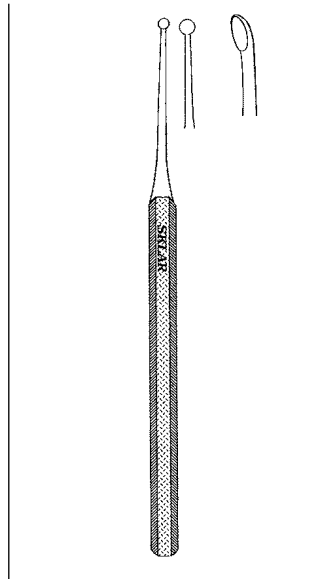

**CURETTE-EXCAVATOR**

Single End without Hole 5"

- 97-0503 1.0 mm
- 97-0505 1.5 mm
- 97-0507 2.0 mm
- 97-0509 2.5 mm

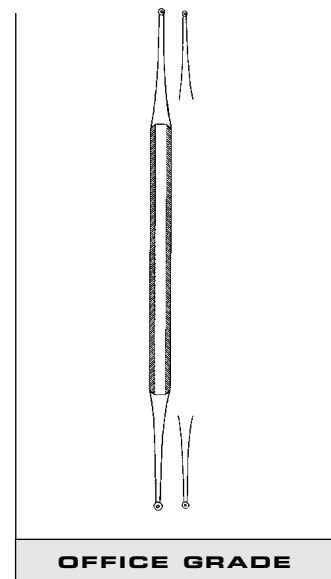

OFFICE GRADE

**CURETTE-EXCAVATOR**

Single Ended with Hole

- 98-503 5" 1.0mm
- Double Ended with Hole
- 98-505 5½" 1.0mm/2.0mm

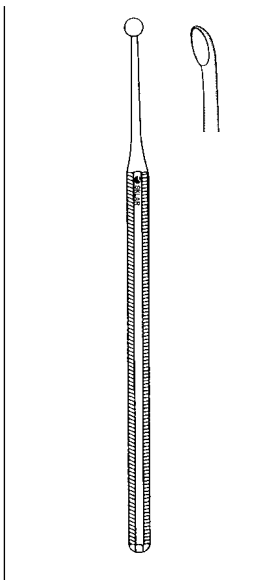

**VERUCCA CURETTE**

97-0564 4 mm Cup 5"

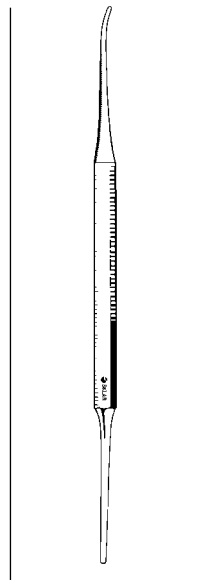

**PROBE AND PACKER**

Double End 6"  
97-0539 Blunt

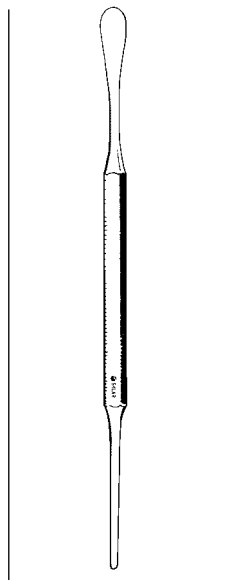

**SPATULA AND PACKER**

Double End 5¾"  
97-0542

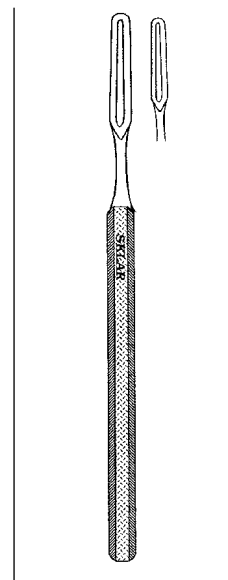

**INGROWN NAIL SHAVER**

Fenestrated  
97-0554

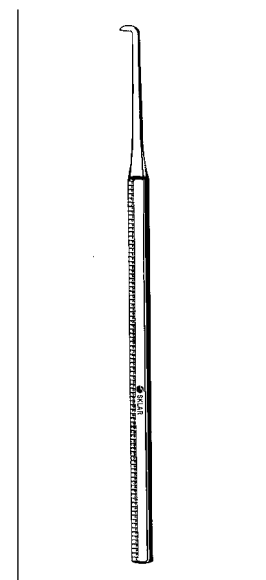

**BAKER INGROWN NAIL CUTTER**

97-0552 5"

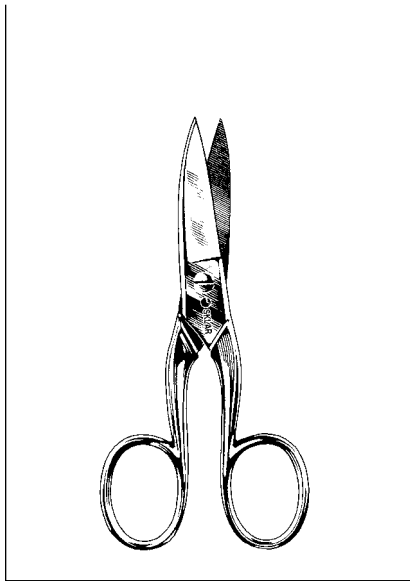

### CUTICLE AND NAIL SCISSORS

Ring Handle

97-1235 3½" Finger Nail, Straight  
97-1245 4½" Toe Nail, Curved

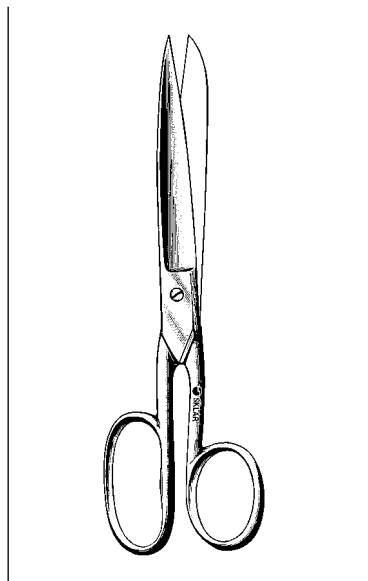

### U.S. ARMY PATTERN GAUZE SCISSORS

11-1180 8" Stainless

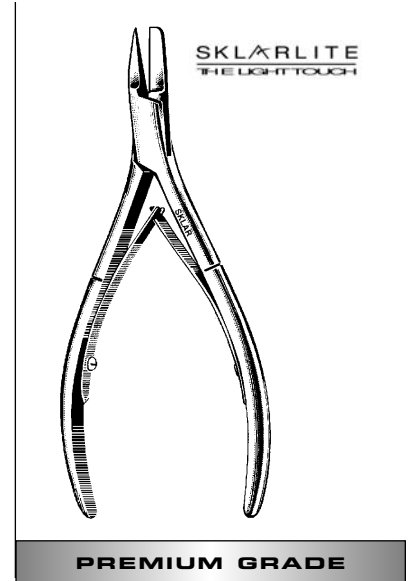

PREMIUM GRADE

### SKLARLITE NAIL SPLITTING FORCEPS

English (Anvil) Pattern  
23-9250 5" Stainless

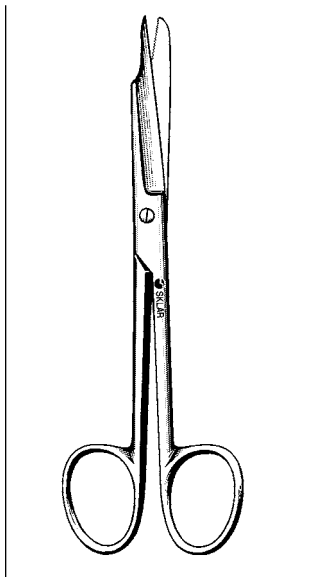

### NAIL SPLITTING SCISSORS

One Pointed Blade  
97-0555 6" One Blade Serrated

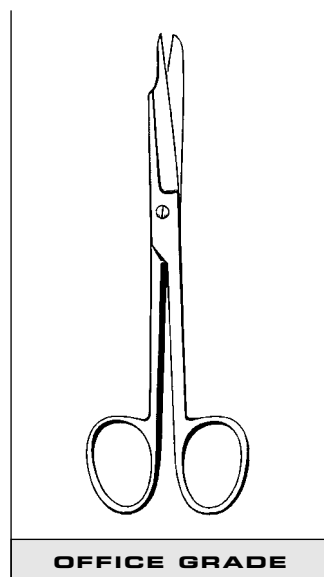

OFFICE GRADE

### NAIL SPLITTING SCISSORS

One Pointed Blade  
98-490 6" Serrated

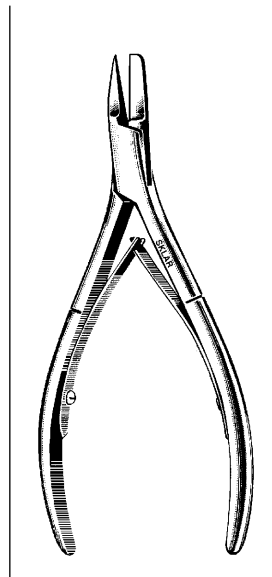

### NAIL SPLITTING FORCEPS

English (Anvil) Pattern  
97-1150 5" Stainless

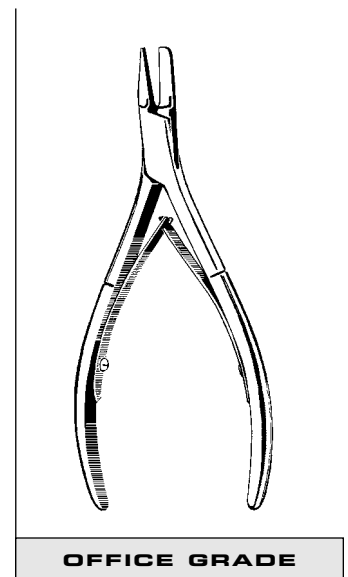

OFFICE GRADE

### NAIL SPLITTING FORCEPS

English (Anvil Pattern)  
98-492 5"

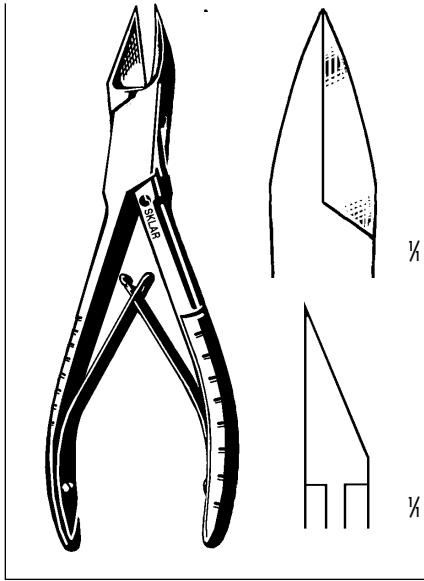

**LISTON-BLAU BONE FORCEPS**

Sharp Points, Heavy Pattern  
40-3040 5 1/2" Stainless

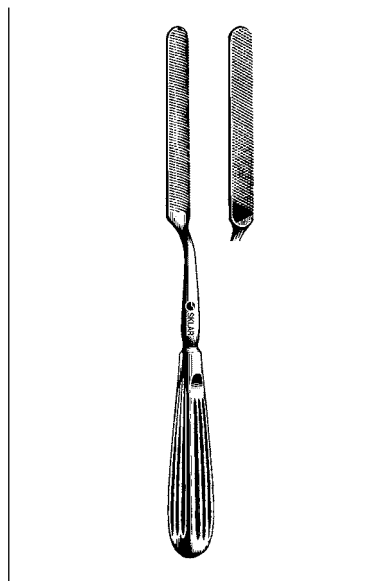

**BONE FILE**

Bayonet Handle  
40-9685 9"

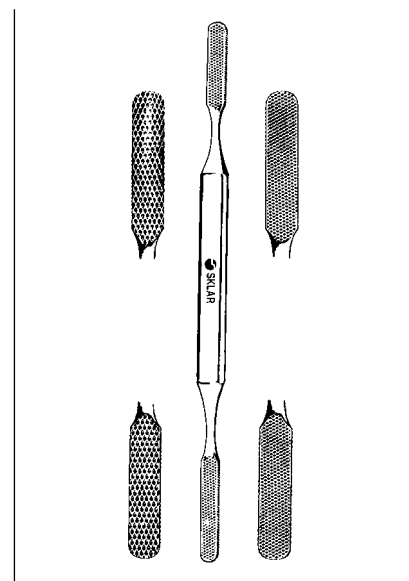

**FOMON RASP AND FILE**

Double End-4 Sided  
40-9688 8 1/2"

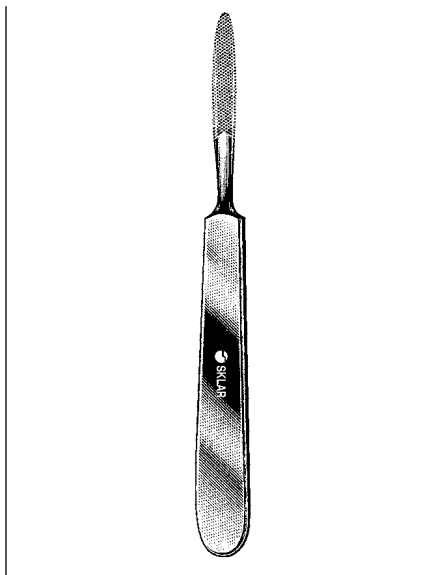

**JOSEPH RASP**

Straight Handle  
40-9825 6 1/4"

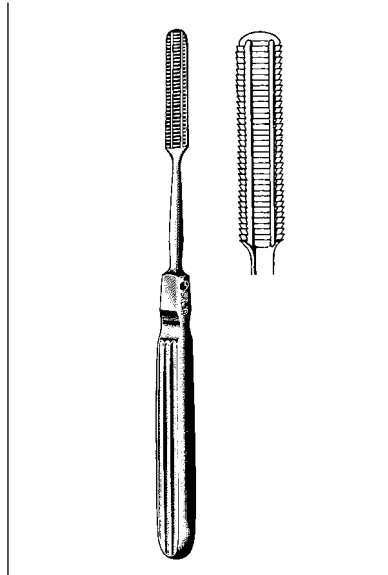

**MALTZ RASP**

40-9815 7"

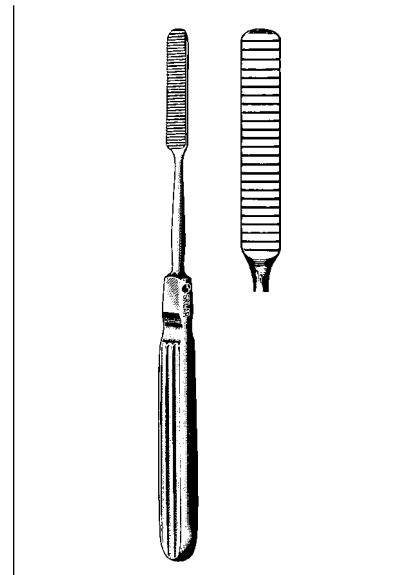

**COTTLE RASP**

40-9820 8"

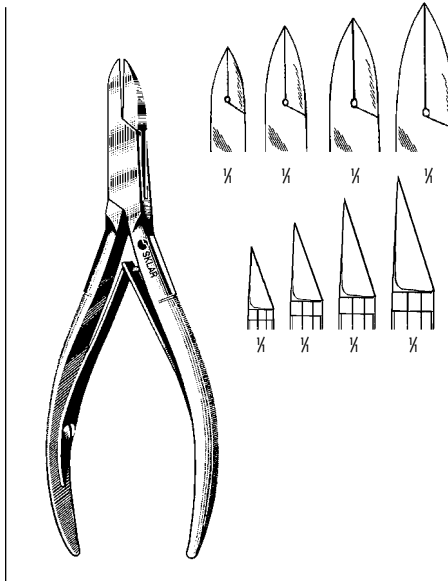

### LITTAUER CUTTING FORCEPS

Straight Back—Stainless

- 97-1251 4"
- 97-1255 4½"
- 97-1259 5"
- 97-1262 6"

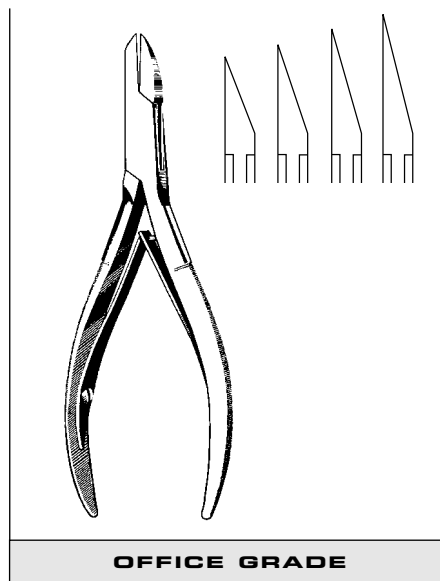

OFFICE GRADE

### LITTAUER CUTTING FORCEPS

- 98-475 4" Straight Back
- 98-476 4½" Straight Back
- 98-477 5" Straight Back
- 98-478 6" Straight Back

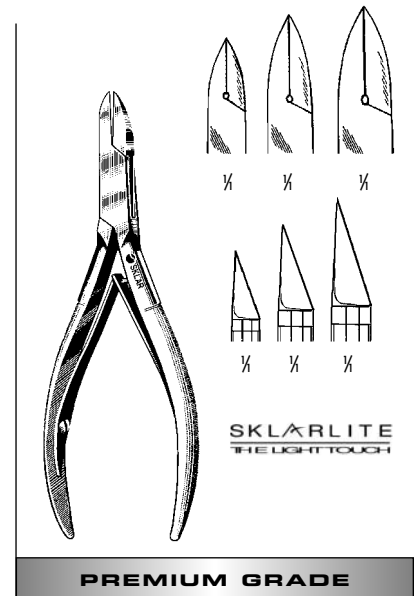

PREMIUM GRADE

### SKLARLITE™ LITTAUER CUTTING FORCEPS

- Straight Back—Stainless
- 23-9251 4"
- 23-9255 4½"
- 23-9259 5"

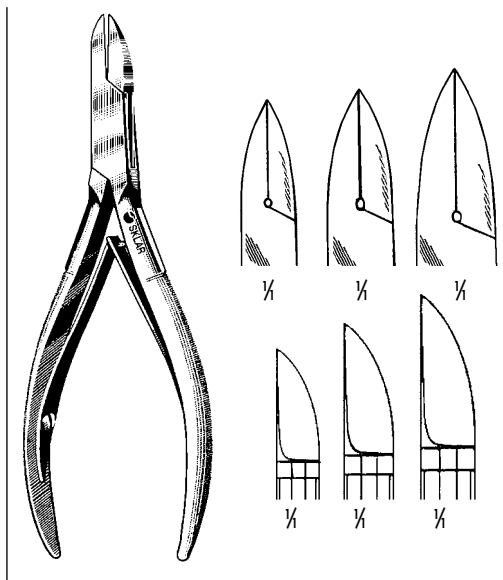

### LITTAUER CUTTING FORCEPS

Curved Back—Stainless

- 97-1280 4½"
- 97-1285 5"
- 97-1286 6"

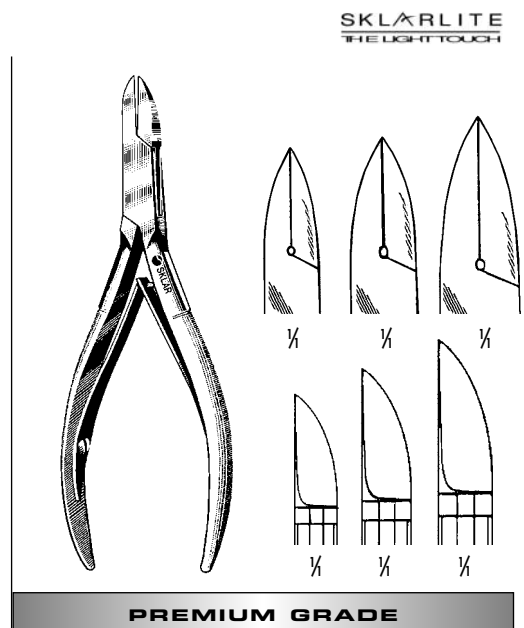

PREMIUM GRADE

### SKLARLITE™ LITTAUER CUTTING FORCEPS

- Curved Back—Stainless
- 23-9273 4½"
- 23-9275 5"
- 23-9276 6"

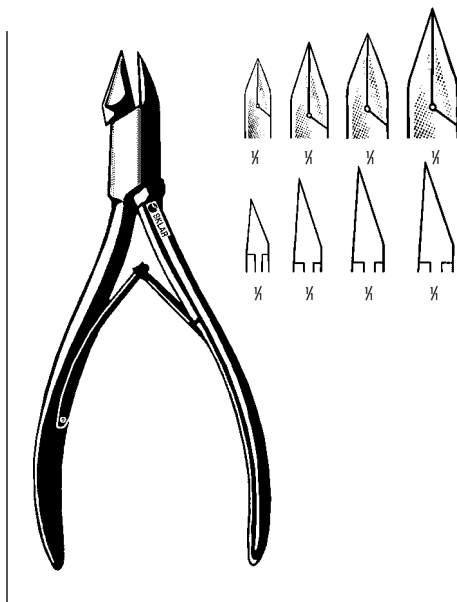

## NAIL SPLITTER

Tapered Jaw  
Straight Back—Stainless  
97-1660 4"  
97-1661 4½"  
97-1662 5"  
97-1663 6"

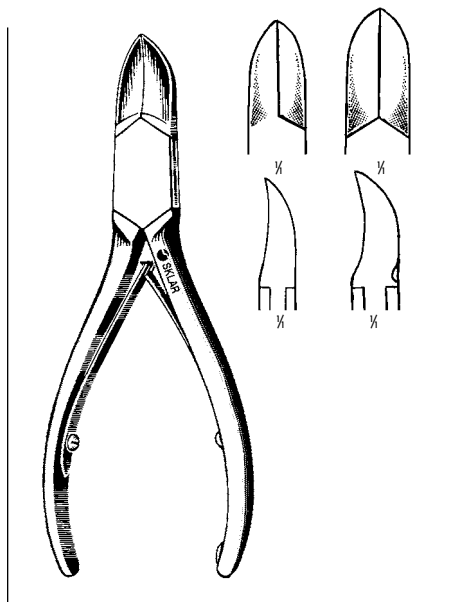

## NAIL NIPPER

Concave Blades, Double Spring  
97-1308 6" Stainless Narrow  
97-1309 5½" Stainless Heavy

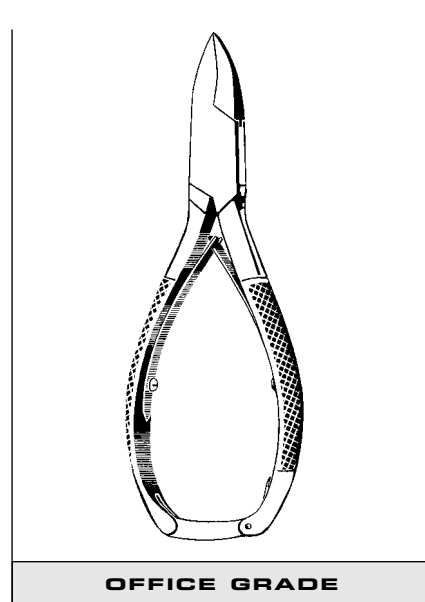

## NAIL NIPPER

98-483 5½" Curved w/Lock

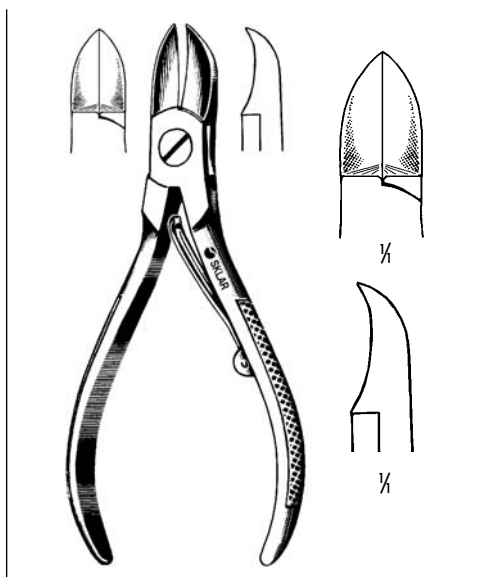

## NAIL NIPPER

Concave Blades—Folding Spring  
97-1146 4½" Stainless

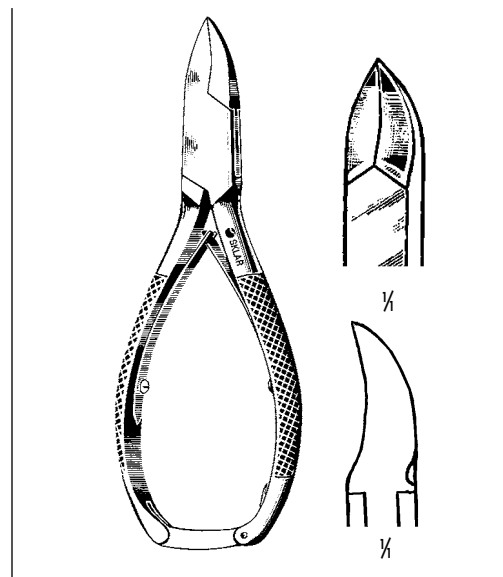

## NAIL NIPPER

Concave Blades, Double Spring with Lock  
97-0474 5½" Stainless

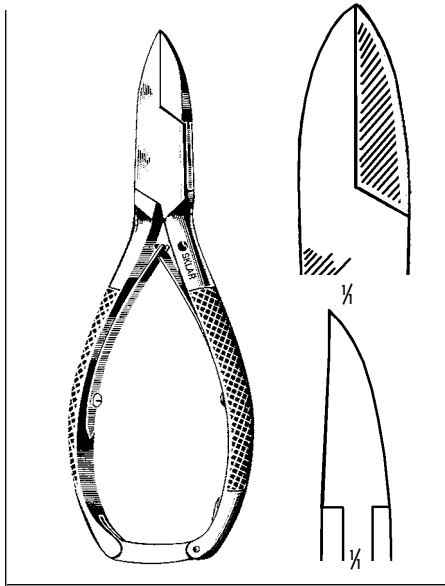

**NAIL NIPPER,  
DOUBLE SPRING WITH LOCK**

97-1056 5½" Straight Back, Stainless Steel

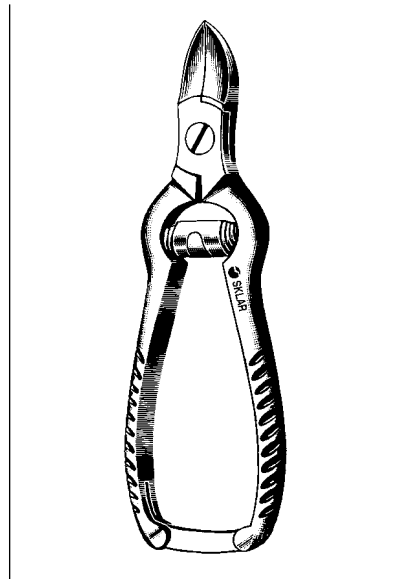

**NAIL NIPPER**

Concave Blades-Barrel Spring  
97-1045 4½"  
97-1046 5½"

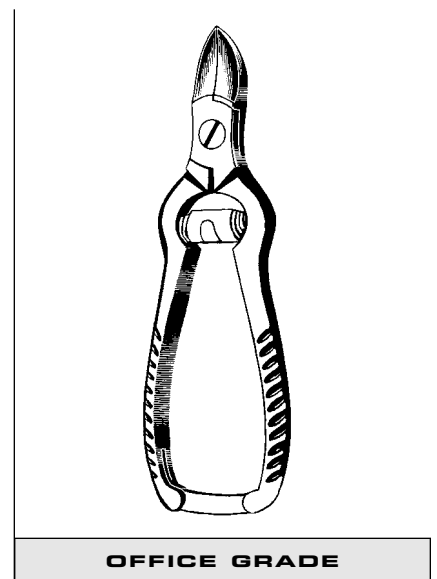

**NAIL NIPPER**

98-485 4½" Concave Jaw  
Barrel Spring  
98-472 5½" Concave Jaw  
Barrel Spring

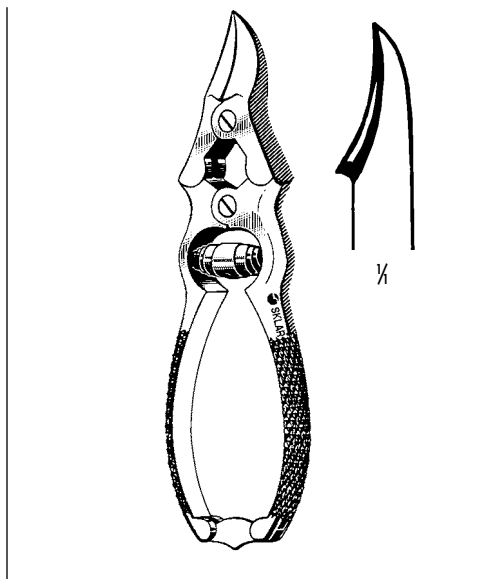

**MYCOTIC NAIL NIPPER**

Double Action-Barrel Spring  
97-1057 5¼" Stainless

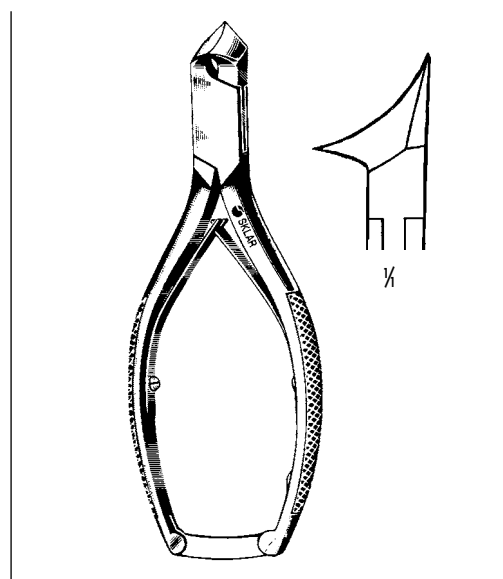

**NAIL NIPPER**

Angled Concave Blades  
97-1156 5½" Stainless

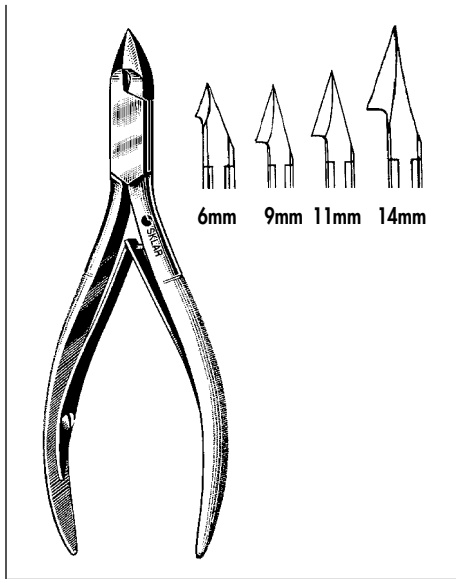

### TISSUE NIPPER

Convex Blades

- 97-1241 4" Stainless 6mm
- 97-0335 4" Stainless 9mm
- 97-1242 4½" Stainless 11mm
- 97-1243 5" Stainless 14mm

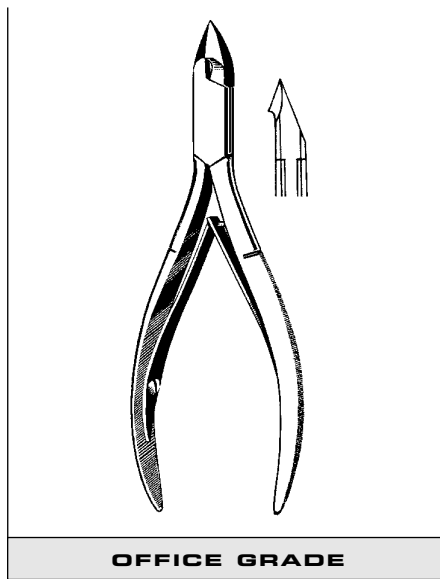

OFFICE GRADE

### TISSUE NIPPER

Convex Blade

- 98-489 4½"

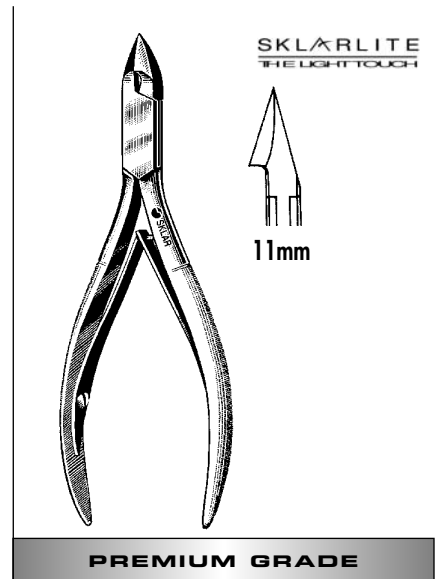

PREMIUM GRADE

### SKLARLITE TISSUE NIPPER

Convex Blades—Stainless

- 23-9292 4½" Double Spring 11mm

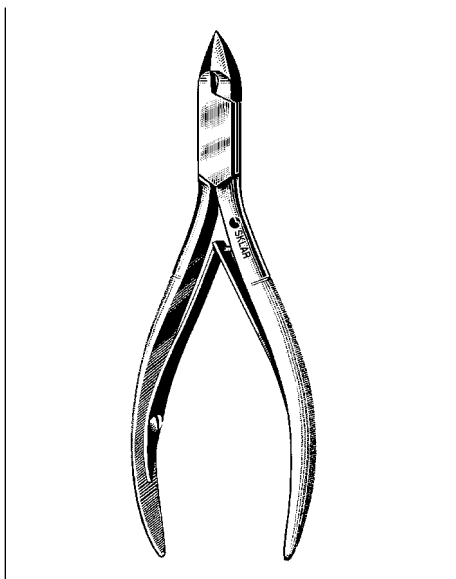

### CUTICLE NIPPER

Convex Blades

- 97-1240 4" Stainless 6mm

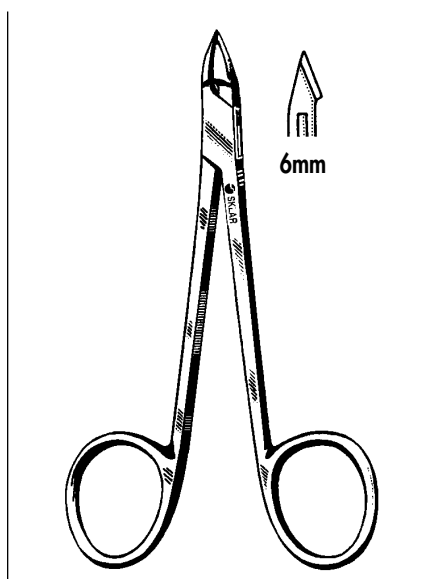

### TISSUE NIPPERS

Ring Handle—Straight Jaws

- 97-1238 Stainless 4"

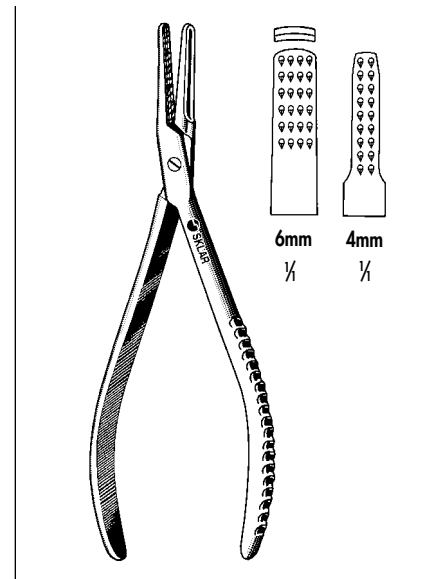

### PLATYPUS NAIL PULLING FORCEPS

Plier Handle

- 97-1318 5½" 6mm wide
- 97-1315 5½" 4mm wide



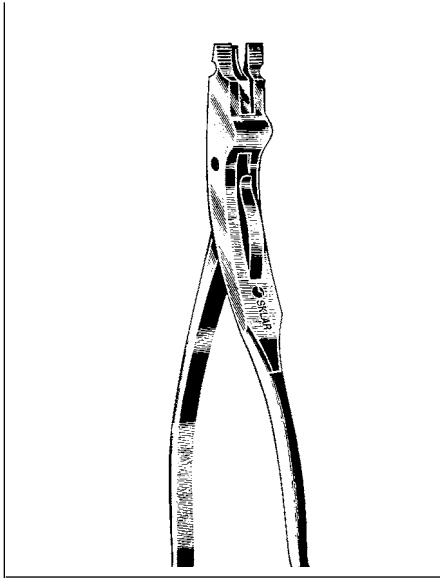

**WALTON PLASTER SPREADER**

3 Blade  
11-1990 9"

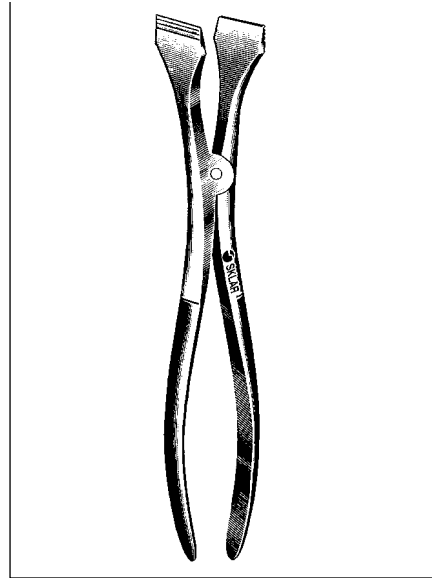

**HENNIG PLASTER SPREADER**

2 Blade  
11-1910 11"

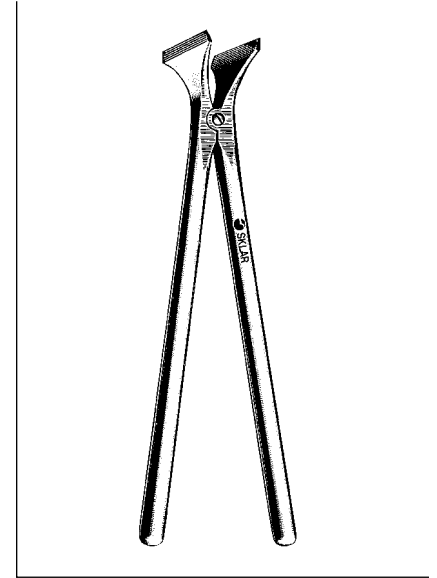

**BEESON PLASTER SPREADER**

2 Blade  
11-1812 12"

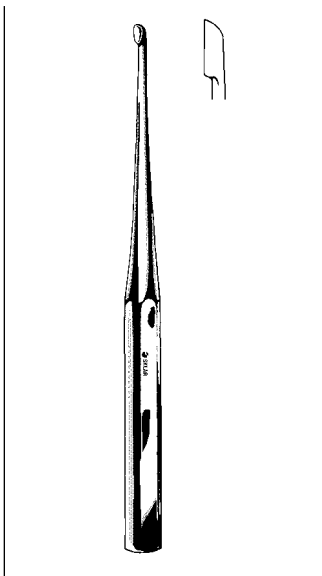

**BRUNS CURETTE**

Straight 9" with solid hexagonal handle

40-7330 #000	40-7335 #3
40-7331 #00	40-7336 #4
40-7332 #0	40-7337 #5
40-7333 #1	40-7338 #6
40-7334 #2	

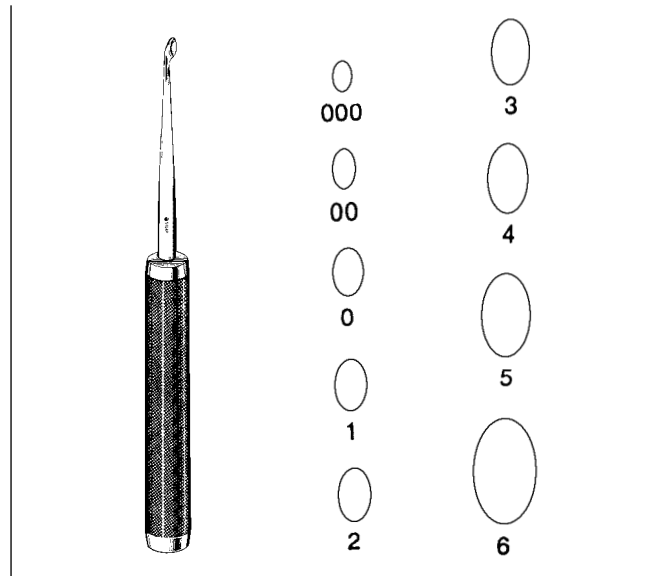

**COBB STYLE BONE CURETTE**

Straight 11" hollowed knurled handle, oval cup

40-8100 #000
40-8101 #00
40-8102 #0
40-8103 #1
40-8104 #2

Angled 11" hollowed knurled handle, oval cup

40-8110 #000
40-8111 #00
40-8112 #0
40-8113 #1
40-8114 #2

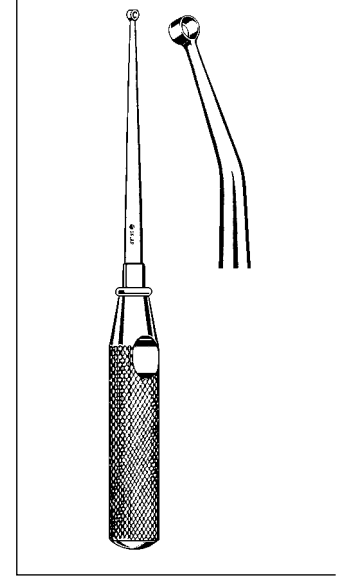

**CONE RING CURETTE**

40-8130	9"	Straight, 8mm diameter
40-8131	9"	Straight, 6mm diameter
40-8132	9"	Straight, 3mm diameter
40-8136	9"	Angular, 8mm diameter
40-8137	9"	Angular, 6mm diameter
40-8138	9"	Angular, 3mm diameter

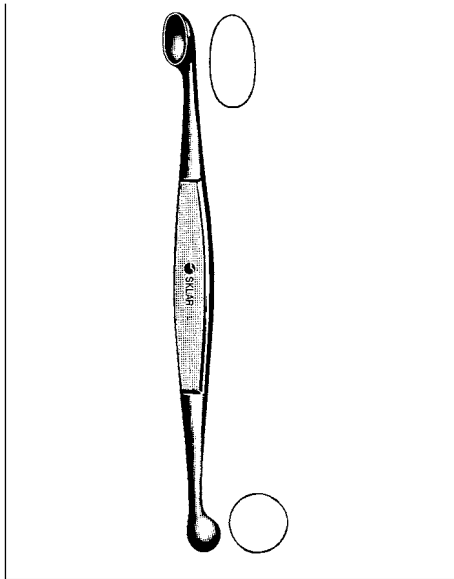

### **VOLKMAN CURETTE**

Double End  
 40-7250 5" Oval/Round  
 40-7265 6½" Oval/Round  
 40-7165 6½" Oval/Oval  
 40-7280 8" Oval/Round

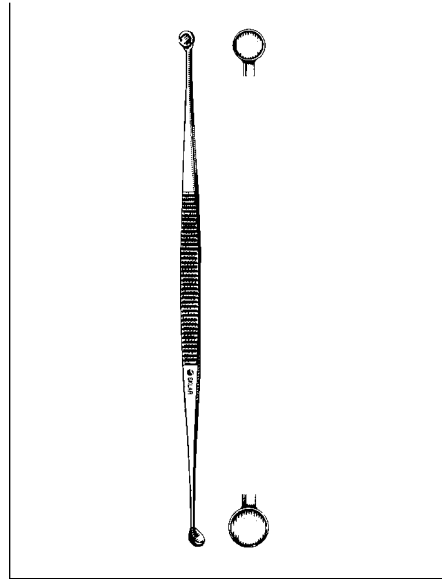

### **MARTINI BONE CURETTE**

Double End,  
 4 mm and 5 mm round cups  
 40-7284 5½"

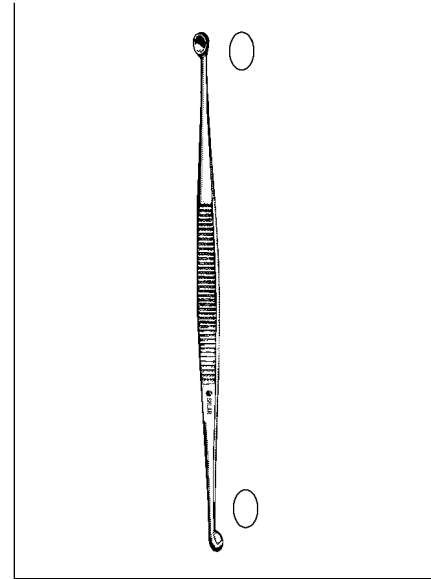

### **WILLIGER BONE CURETTE**

Double End,  
 3 mm and 4 mm round cups  
 40-7286 5½"

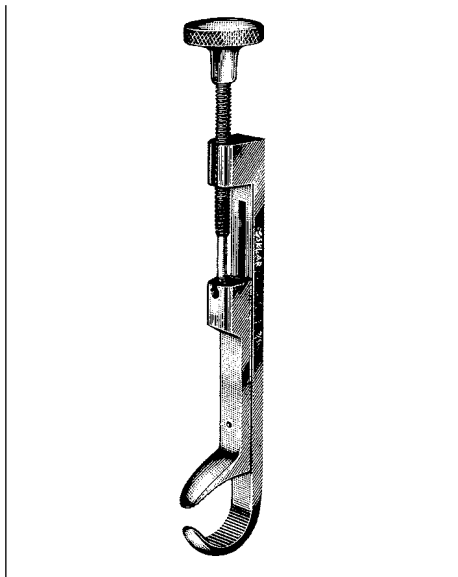

### **LOWMAN CLAMP**

1 x 1 Prongs  
 40-2925 4¾" x 1¾" Jaw  
 40-2927 7¾" x 1¾" Jaw  
 40-2928 8" x 1¾" Jaw

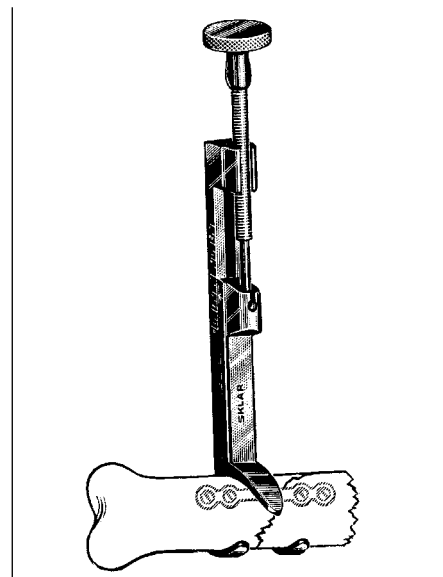

### **LOWMAN CLAMP**

1 x 2 Prongs  
 40-2921 4¾" x ¾" Jaw  
 40-2922 7¾" x 1¾" Jaw  
 40-2923 8" x 1½" Jaw

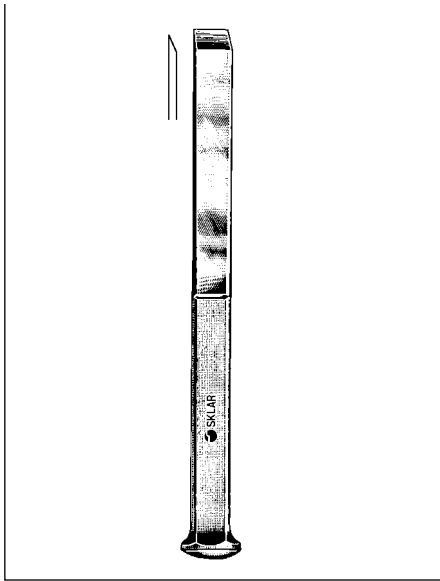

### ARMY PATTERN CHISEL

40-6106	6½"	6 mm
40-6112	6½"	12 mm
40-6118	6½"	18 mm

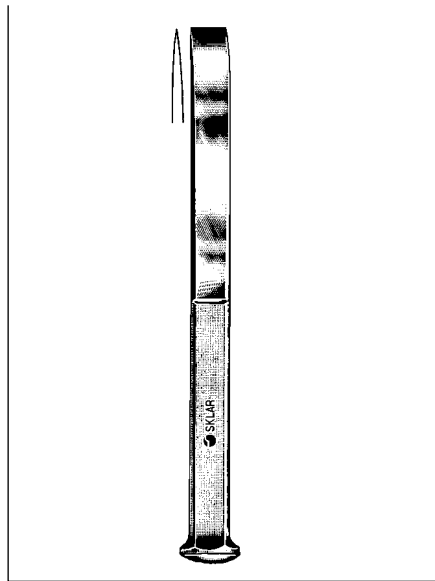

### ARMY PATTERN OSTEOTOME

40-6206	6½"	6 mm
40-6212	6½"	12 mm
40-6218	6½"	18 mm

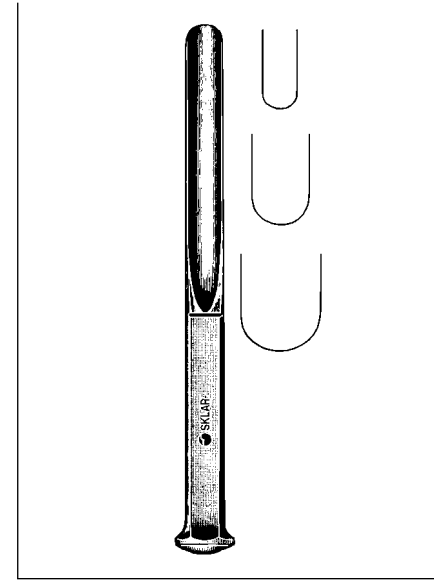

### ARMY PATTERN GOUGE

40-6306	6½"	6 mm
40-6312	6½"	10 mm
40-6318	6½"	14 mm

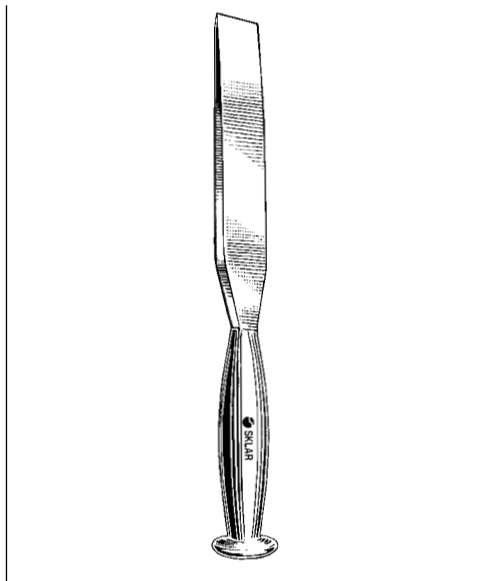

### SMITH PETERSON OSTEOTOME

8" Straight		8" Curved	
40-6771	¼" 6 mm	40-6781	¼" 6 mm
40-6772	⅜" 10 mm	40-6782	⅜" 10 mm
40-6773	½" 13 mm	40-6783	½" 13 mm
40-6774	⅝" 16 mm	40-6784	⅝" 16 mm
40-6775	¾" 19 mm	40-6785	¾" 19 mm
40-6776	1" 25 mm	40-6786	1" 25 mm
40-6777	1¼" 32 mm	40-6787	1¼" 32 mm

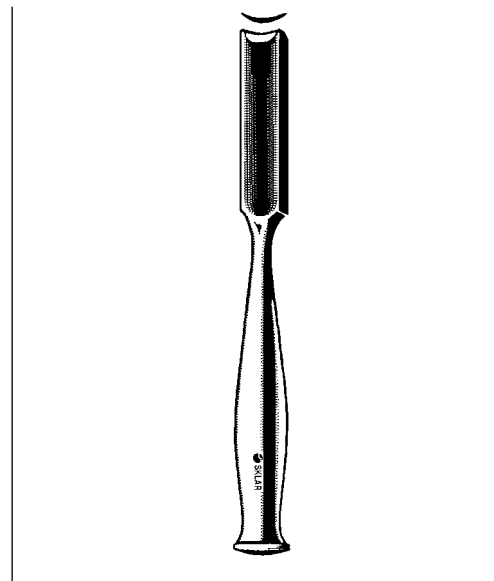

### SMITH PETERSON GOUGE

8" Straight		8" Curved	
40-6791	¼" 6 mm	40-6799	¼" 6 mm
40-6792	⅜" 10 mm	40-6800	⅜" 10 mm
40-6793	½" 13 mm	40-6801	½" 13 mm
40-6794	⅝" 16 mm	40-6802	⅝" 16 mm
40-6795	¾" 19 mm	40-6803	¾" 19 mm
40-6796	1" 25 mm	40-6804	1" 25 mm
40-6797	1¼" 32 mm	40-6805	1¼" 32 mm

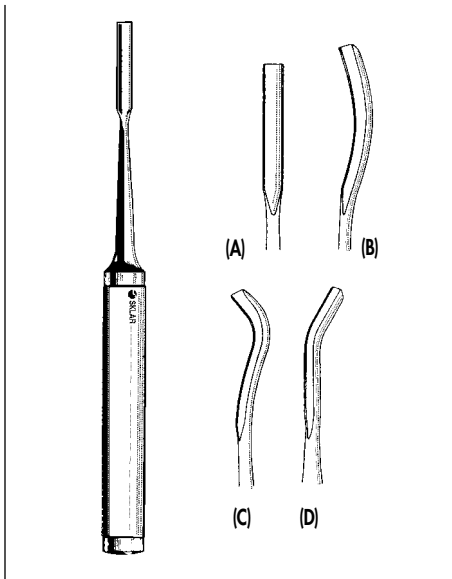

### **COBB TYPE SPINAL GOUGES**

- 11"  $\frac{5}{32}$ " Blade Width
- 9"  $\frac{5}{16}$ " Blade Width
- 40-6920 Straight (A)
- 40-6921 Medium (B)
- 40-6922 Strong Curve (C)
- 40-6923 Reverse Curve (D)

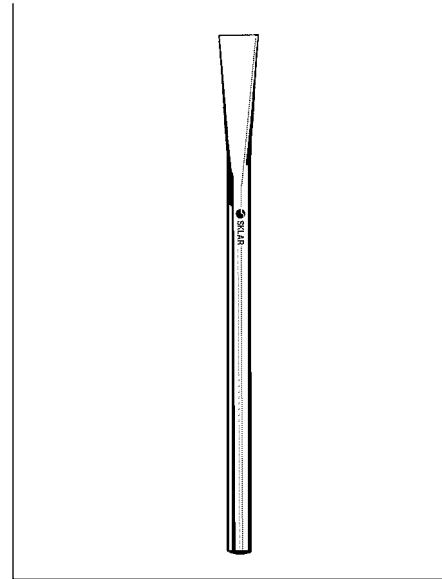

### **SHEEHAN OSTEOTOME**

- Straight  $6\frac{1}{4}$ "
- 67-4620 2 mm
- 67-4622 4 mm
- 67-4624 6 mm
- 67-4626 8 mm
- 67-4628 10 mm
- 67-4630 12 mm
- 67-4632 15 mm

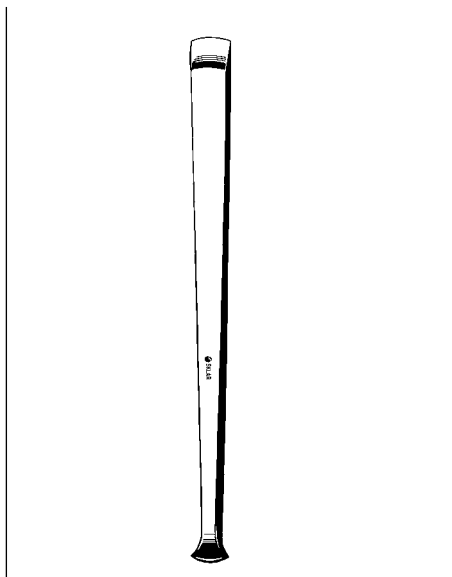

### **ALEXANDER CHISELS**

- 7"
- 67-4604 4 mm
- 67-4606 6 mm
- 67-4608 8 mm
- 67-4610 10 mm
- 67-4612 12 mm
- 67-4614 14 mm

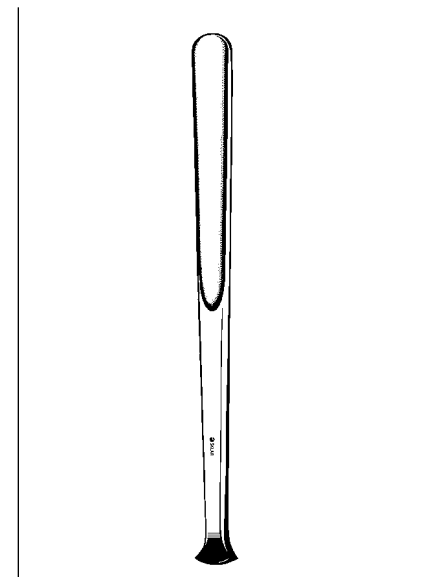

### **ALEXANDER GOUGES**

- 7"
- 67-4504 4 mm
- 67-4506 6 mm
- 67-4508 8 mm
- 67-4510 10 mm
- 67-4512 12 mm
- 67-4514 14 mm

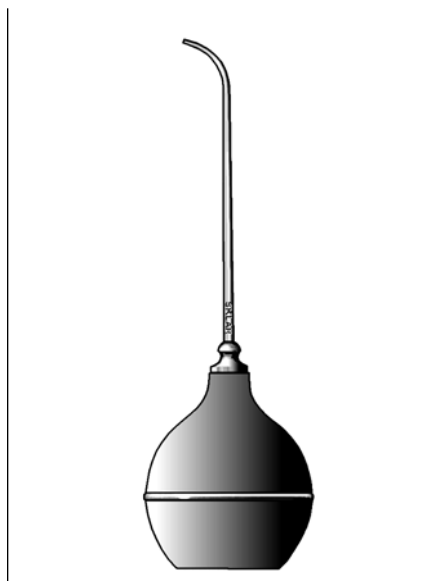

### CHIP BLOWER

- 97-1650 Chip Blower Complete
- 97-1652 Tip Only
- 97-1654 Bulb Only

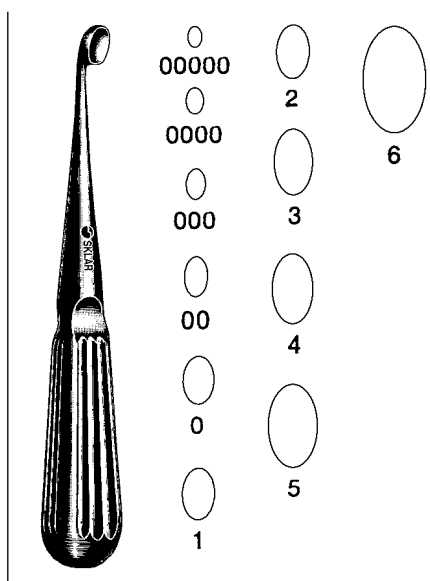

### BRUNS CURETTE

Single End-Oval Straight 6½"

- |                |            |
|----------------|------------|
| 40-7118 #00000 | 40-7113 #3 |
| 40-7120 #0000  | 40-7114 #4 |
| 40-7000 #000   | 40-7115 #5 |
| 40-7100 #00    | 40-7116 #6 |
| 40-7110 #0     |            |
| 40-7111 #1     |            |
| 40-7112 #2     |            |

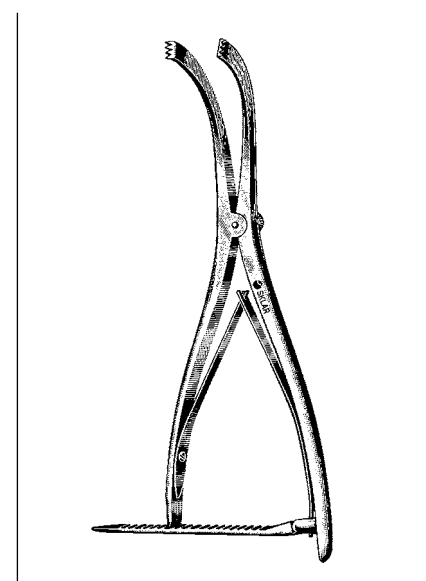

### INGE LAMINA RETRACTOR

- 42-1420 6½" with Teeth
- 42-1425 10½" with Teeth
- 42-1422 10½" without Teeth

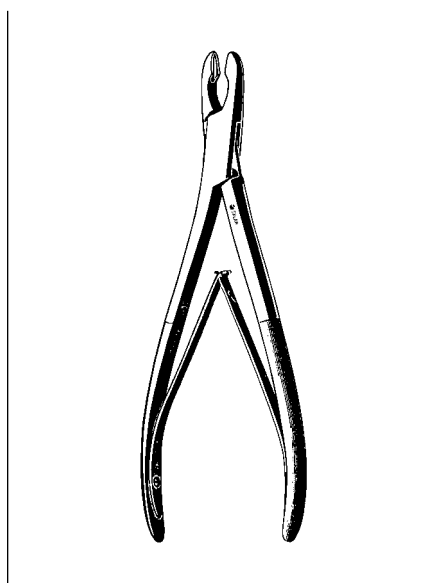

### ADSON RONGEUR

- 50-1080 8" Straight

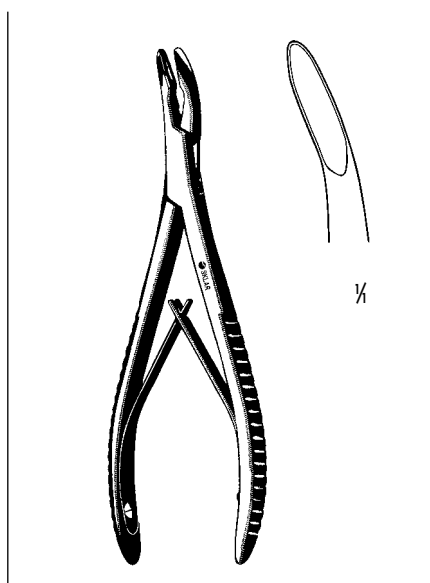

### BANE RONGEUR

- 67-5175 7" Curved 3 x 16 mm Bite

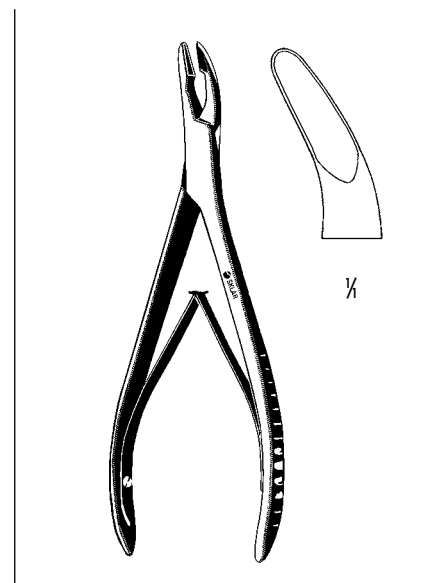

### HARTMANN RONGEUR

- 67-5458 5½" Full Curved 4 x 16 mm Bite

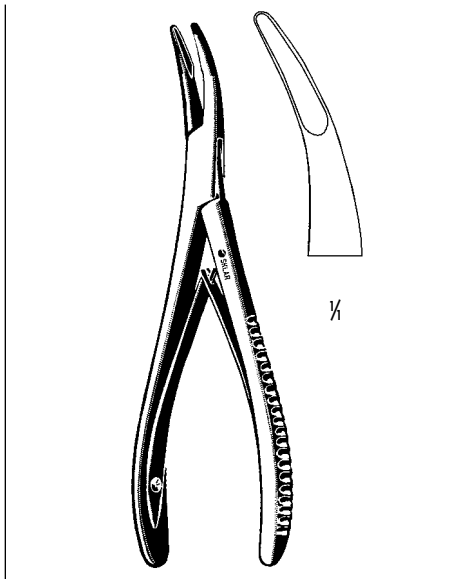

**BEYER RONGEUR**

40-3188 7" Curved

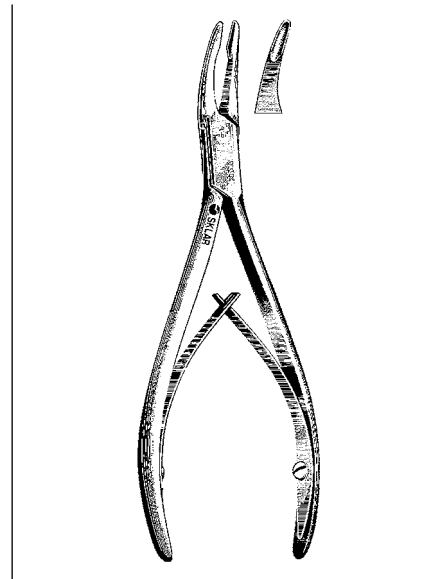

**FRIEDMAN BONE RONGEUR**

40-3190 5 1/2" Curved  
40-3192 6 1/2" Curved

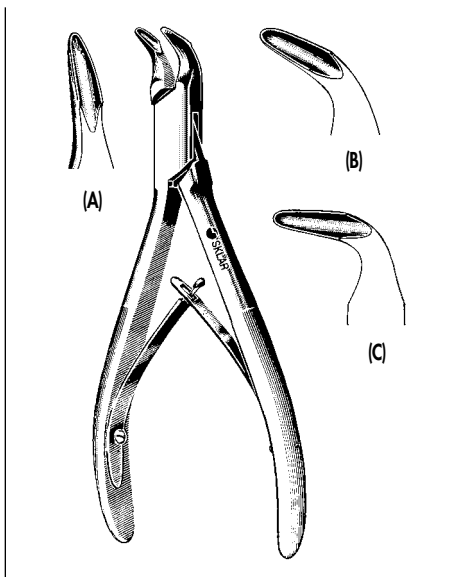

**BLUMENTHAL RONGEUR**

67-5987 4 3/4" 30° Angle (A) Delicate  
67-5990 6" 30° Angle (A)  
67-5992 6" 45° Angle (B)  
67-5994 6" 90° Angle (C)

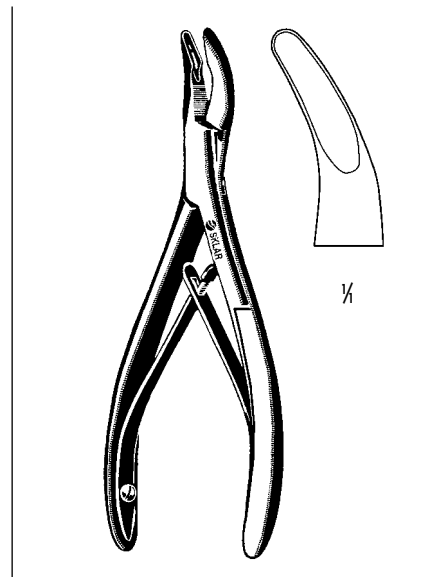

**MEAD RONGEUR**

40-3208 6 1/2" Curved 4 x 13 mm Bite

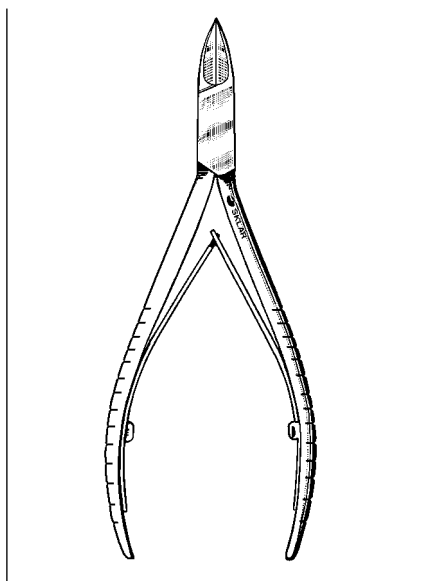

**P AND A FORCEPS**

97-1340 4½"

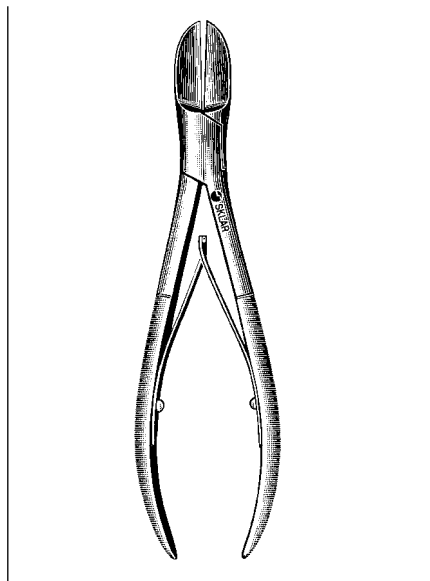

**LISTON BONE FORCEPS**

40-3055 5½" Straight  
40-3077 7¾" Straight  
40-3087 8" Straight

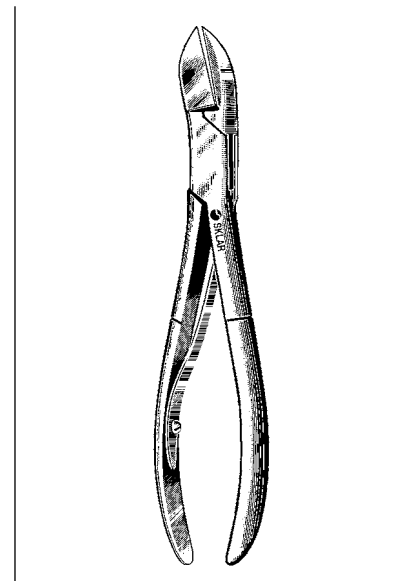

**LISTON BONE FORCEPS**

40-3155 5½" Angular  
40-3177 7¾" Angular

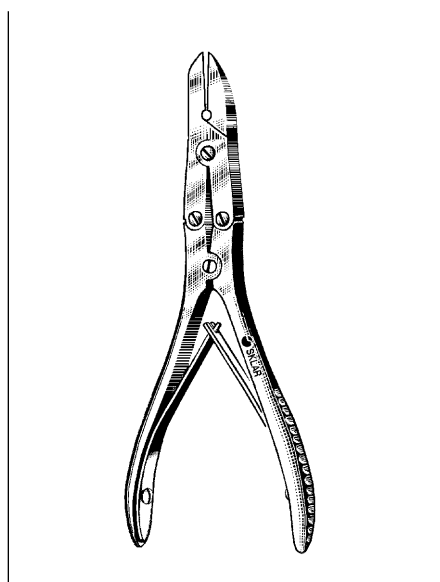

**KLEINERT-KUTZ BONE CUTTING FORCEPS**

Double Action  
40-4560 6" Straight

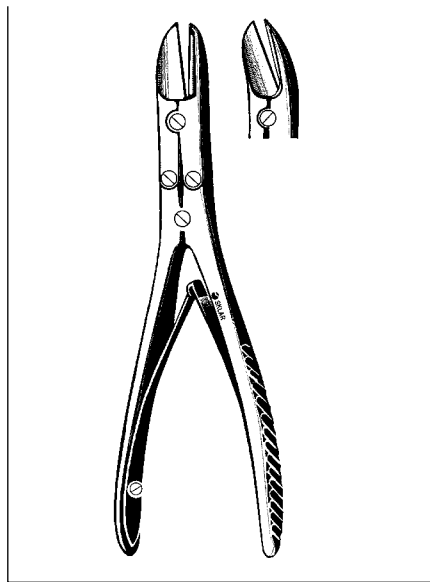

**RUSKIN-LISTON BONE CUTTING FORCEPS**

Double Action  
40-4572 7¼" Straight  
40-4575 7¼" Angular

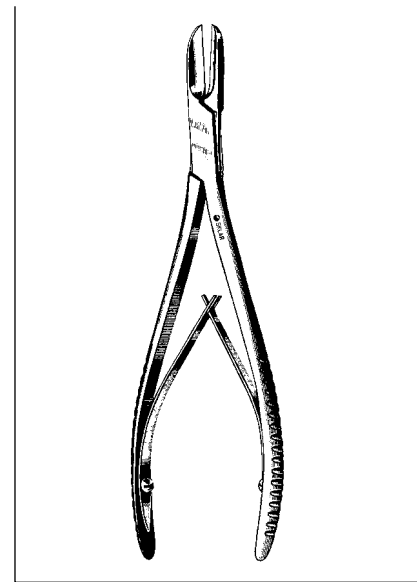

**LISTON BONE CUTTING FORCEPS**

41-1180 8" Slender Jaws

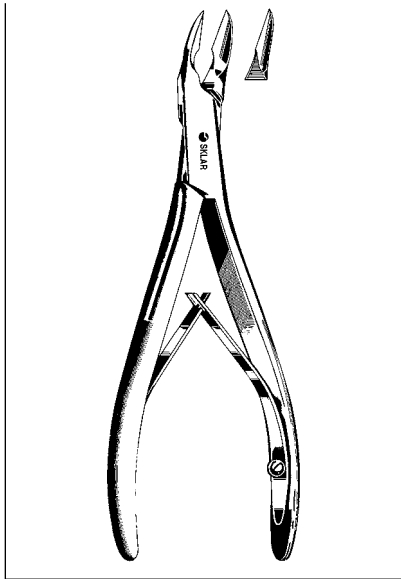

**CLEVELAND RONGEUR**

Curved  
 40-3200 5½"  
 40-3202 6½"

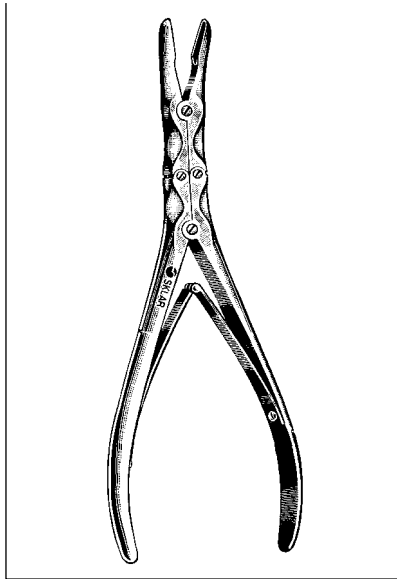

**ZAUFEL-JANSEN RONGEUR**

Double Action  
 40-4265 7" 5 x 15 mm Curved

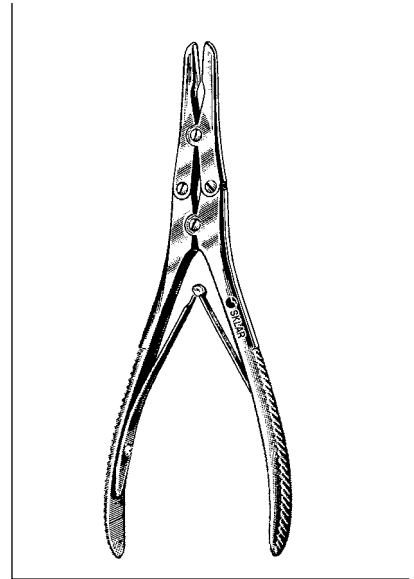

**RUSKIN RONGEUR**

Double Action  
 40-4360 6" Straight 2mm Bite  
 40-4365 6" Curved 2mm Bite  
 40-4272 7¼" Straight 5mm Bite  
 40-4372 7¼" Curved 5mm Bite

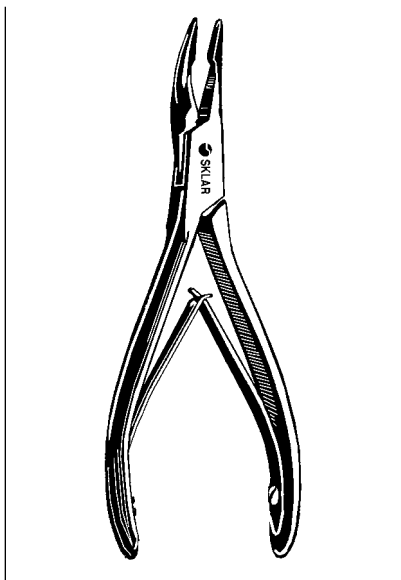

**MINI BLUMENTHAL RONGEUR**

Delicate  
 67-5987 4¼" 30° Angle

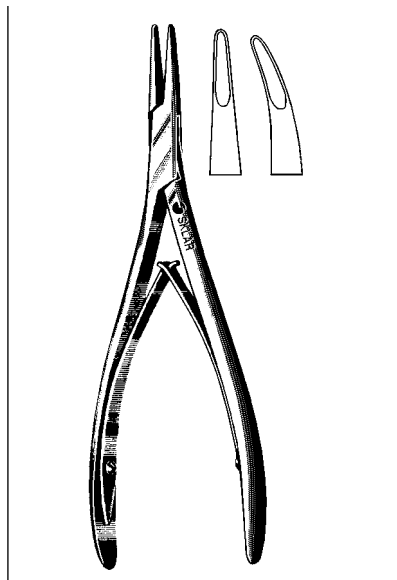

**LEMPERT RONGEUR**

6¼" Delicate  
 47-2467 2.5mm Straight  
 47-2468 2.5mm Curved

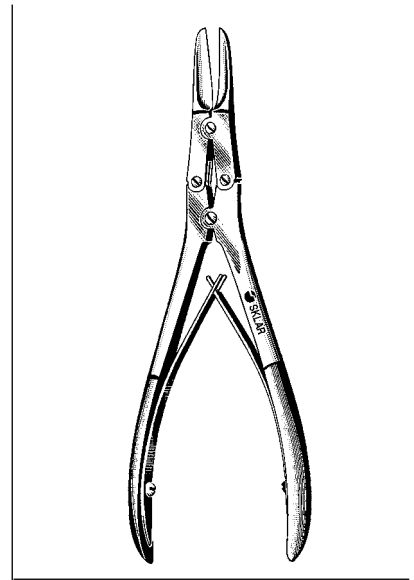

**ROWLAND BONE FORCEPS**

Double Action  
 41-1175 7" Narrow Jaws



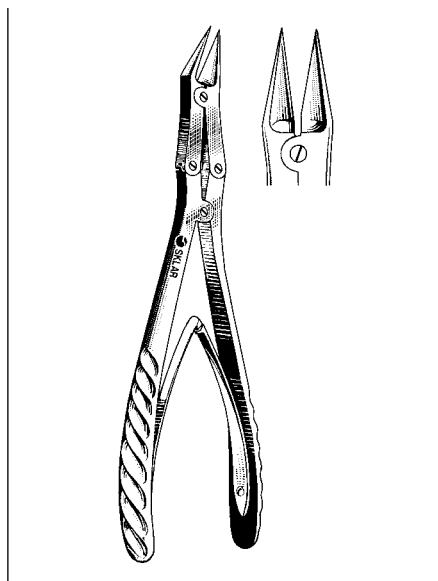

**McINDOE BONE CUTTING FORCEPS**

Double Action  
41-1170 7½" Slight Angle

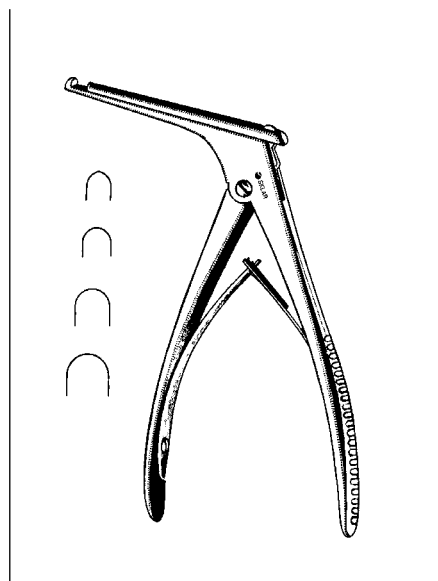

**KERRISON RONGEURS**

3" Shaft  
65-7400 Size 0 3.5 mm  
65-7401 Size 1 4.5 mm  
65-7402 Size 2 5.5 mm  
65-7403 Size 3 6.5 mm

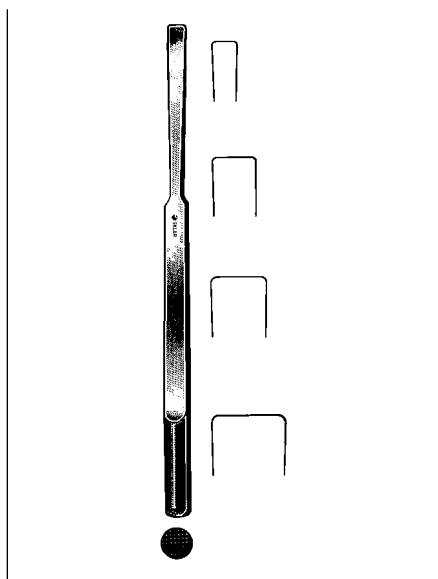

**COTTLE NASAL CHISEL**

7" With Rounded Corners  
41-1342 4 mm  
41-1344 7 mm  
41-1346 9 mm  
41-1348 12 mm

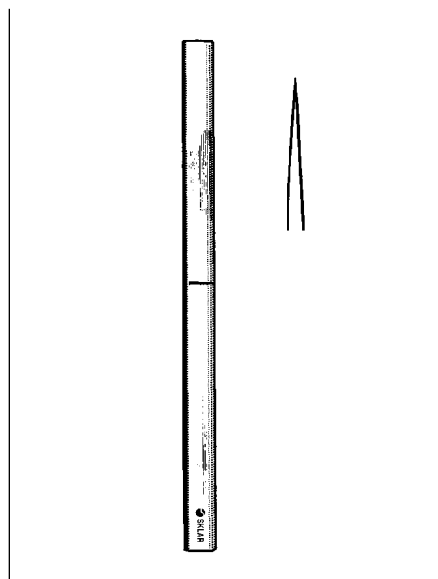

**LAMBOTTE OSTEOTOMES**

5½"  
40-6535 5 mm  
40-6537 7 mm

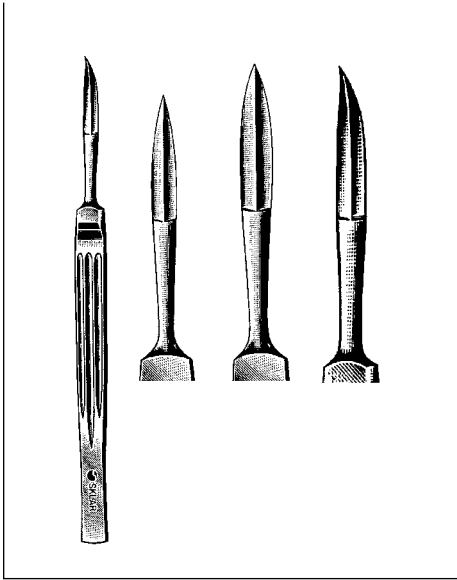

### JOSEPH KNIFE

Sharp Point

- 41-1260 6" Small, Straight
- 41-1262 6" Large, Straight
- 41-1264 6" Small, Curved
- 41-1266 6" Large, Curved

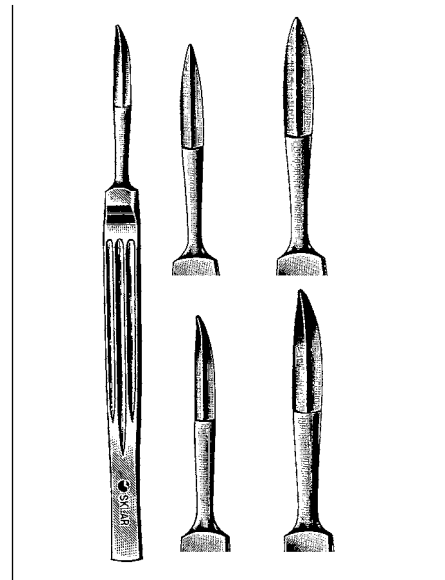

### JOSEPH KNIFE

Blunt Point

- 41-1270 6" Small, Straight
- 41-1272 6" Large, Straight
- 41-1274 6" Small, Curved
- 41-1276 6" Large, Curved

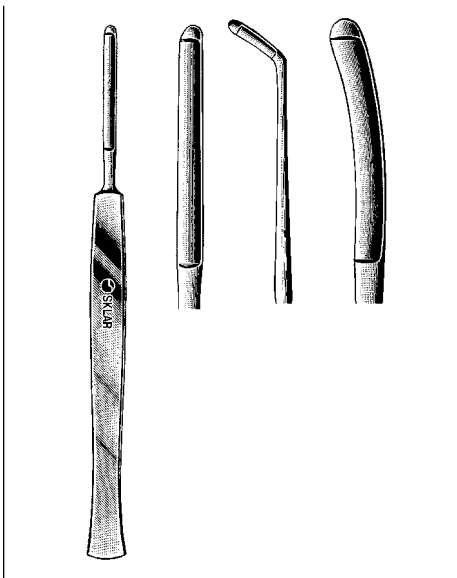

### JOSEPH BUTTON END KNIFE

- 41-1300 6" Straight
- 41-1305 6" Angular
- 41-1310 6" Curved

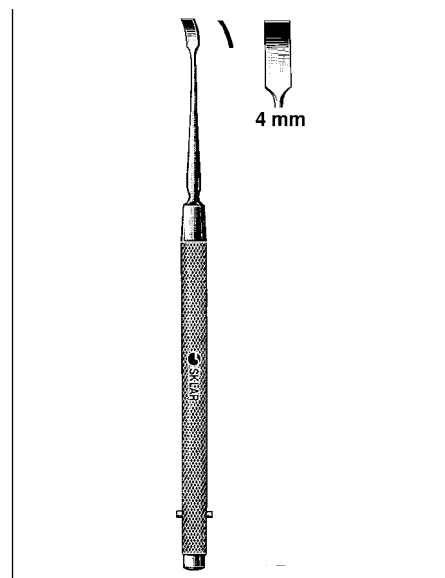

### FREER CHISEL

- 41-1330 6½" Straight 4 mm
- 41-1332 6½" Curved 4 mm

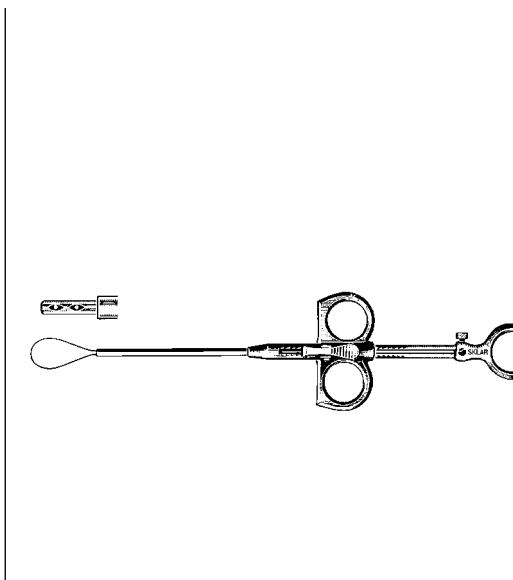

### **EVES TONSIL SNARE**

- 75-9070 Plain
- 75-9075 With Ratchet

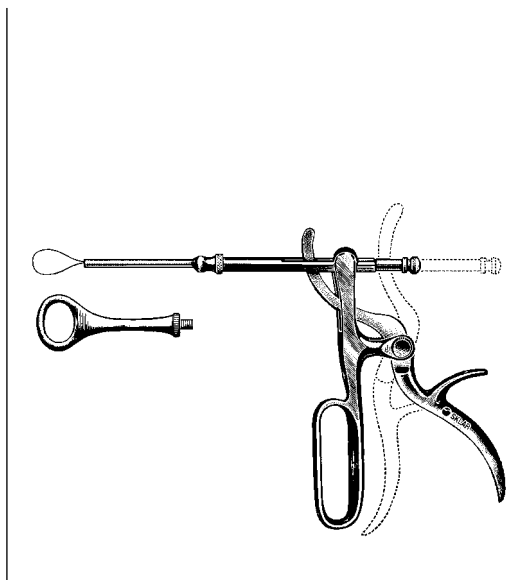

### **TYDING TONSIL SNARE**

Complete

- 75-9245 Includes One Straight Tip,  
One Vedder Tip,  
One Dozen Cut Snare Wires
- 75-9250 Includes One Straight Tip Only,  
One Dozen Cut Snare Wires
- 75-9155 One Dozen Twisted Wire Loops #8

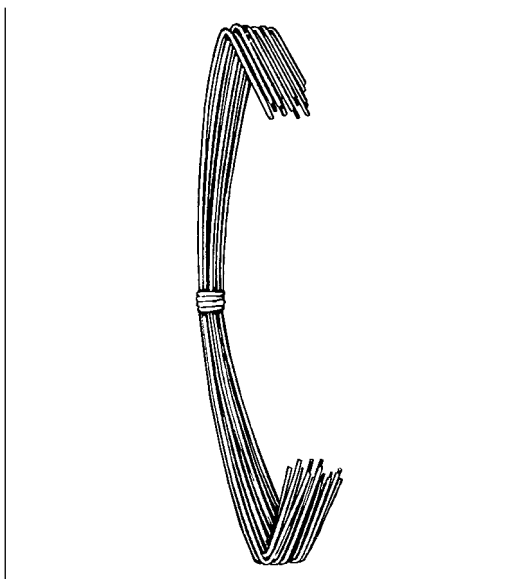

### **SNARE WIRES CUT & BENT**

1 Package of 12 (12 Wires)

- 75-9505 #5 4" Long
- 75-9506 #6 4" Long
- 75-9507 #7 4" Long
- 75-9508 #8 4" Long
- 75-9509 #9 4" Long

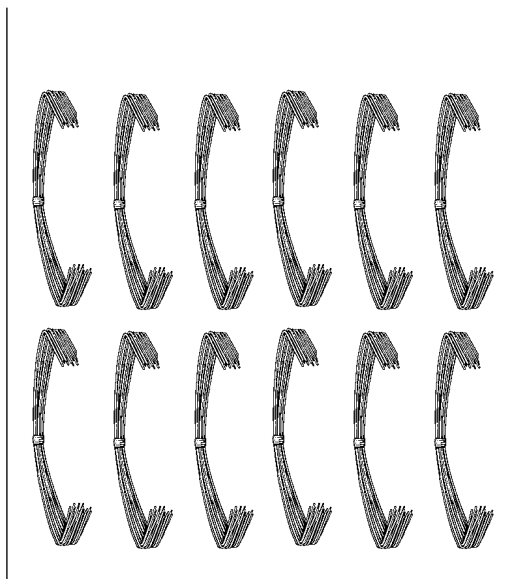

### **SNARE WIRES CUT & BENT**

12 Package of 12 (144 Wires)

- 75-9405 #5 4" Long
- 75-9406 #6 4" Long
- 75-9407 #7 4" Long
- 75-9408 #8 4" Long
- 75-9409 #9 4" Long

# ENT - PLASTIC SURGERY

## NASAL SPECULUM

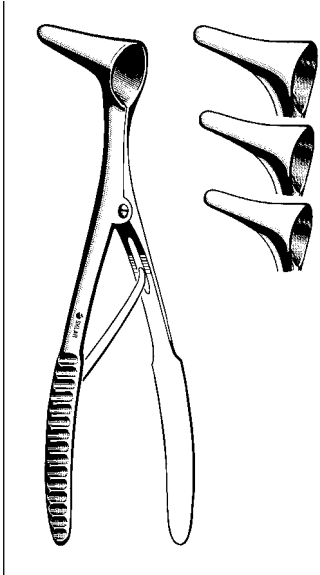

**VIENNA  
NASAL SPECULUM**

70-1070 Infant  
70-1071 Child  
70-1072 Adult

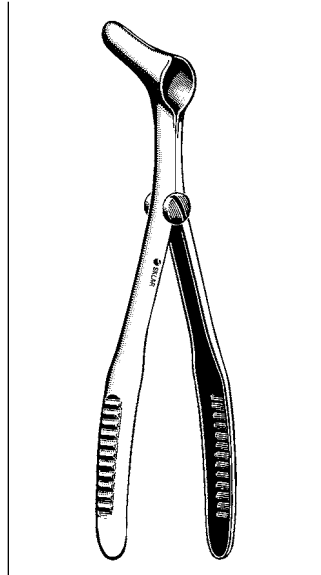

**VIENNA  
NASAL SPECULUM**

Wrought Metal-Lightweight  
70-1075 Adult

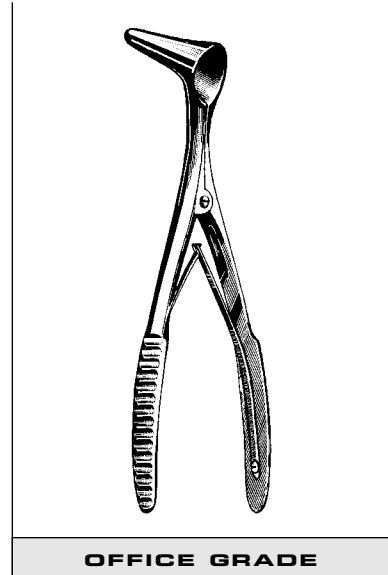

**OFFICE GRADE**

**VIENNA NASAL SPECULUM**

98-258 Adult  
98-267 Child  
98-268 Small

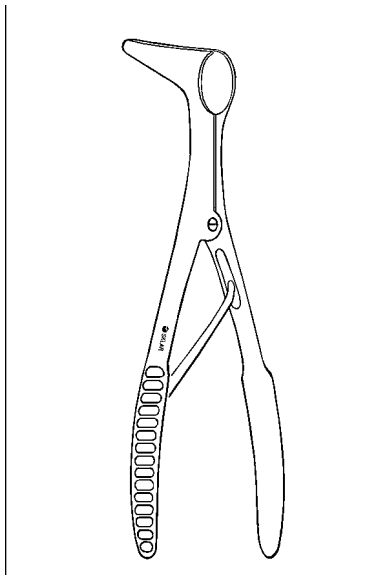

**NASAL SPECULUM,  
DISPOSABLE**

Pack/48, Plastic  
96-0670 6¼"

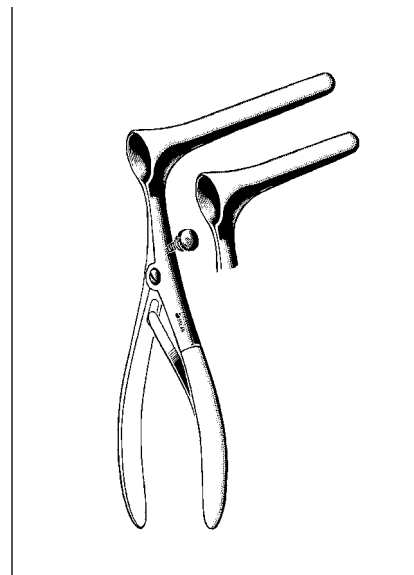

**KILLIAN NASAL SPECULUM**

70-1020 Small 2"  
70-1030 Medium 3"  
70-1035 Large 3½"

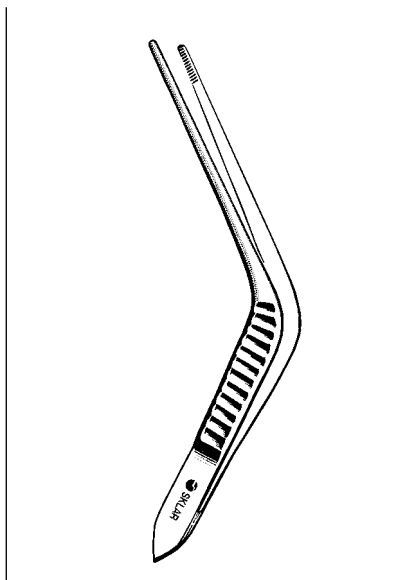

**WILDE DRESSING FORCEPS**

70-4470 7" Serrated  
67-1150 5" Serrated

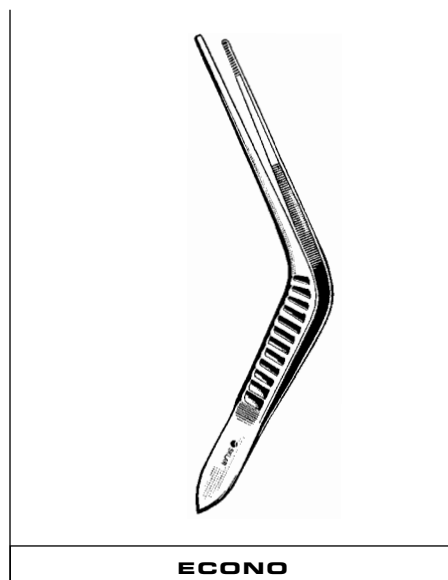

**ECONO**

**WILDE DRESSING FORCEPS,  
ECONO**

Box/12  
21-227 5"

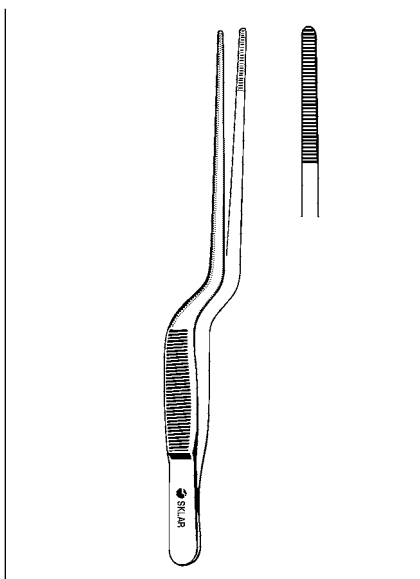

**JANSEN BAYONET  
NASAL FORCEPS**

67-1465 6½"  
70-4375 7½"  
70-4385 8½"

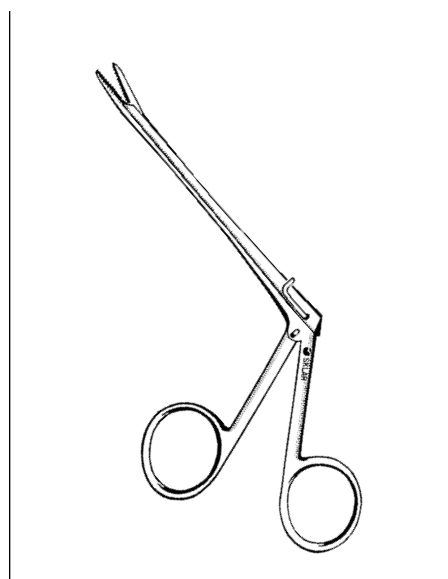

**NOYES ALLIGATOR FORCEPS**

70-5332 ¾" Serrated  
70-5335 ½" Serrated  
70-5232 ¾" 1 x 2 Teeth  
70-5235 ½" 1 x 2 Teeth

# ENT - PLASTIC SURGERY ELEVATORS

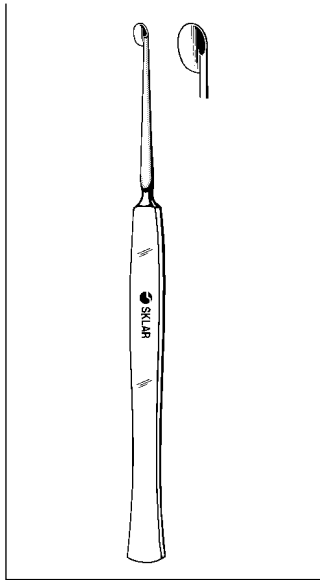

## **FREER SEPTUM KNIFE**

Half Round Blade  
70-7062 6 1/4"

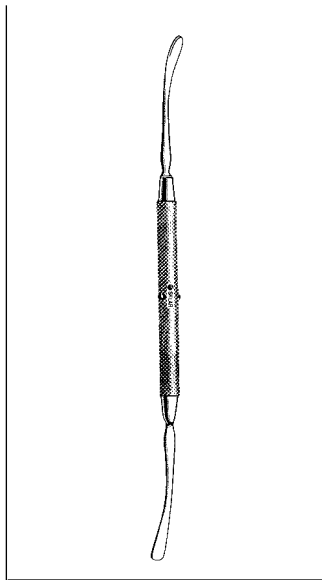

## **FREER SEPTUM ELEVATOR**

47-2380 7 1/4" Double End S/B

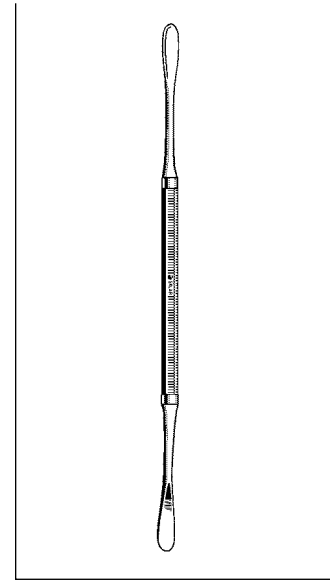

## **HAJEK-BALLENGER SEPTUM ELEVATOR**

Double Ended  
70-7185 8 1/2" S/B

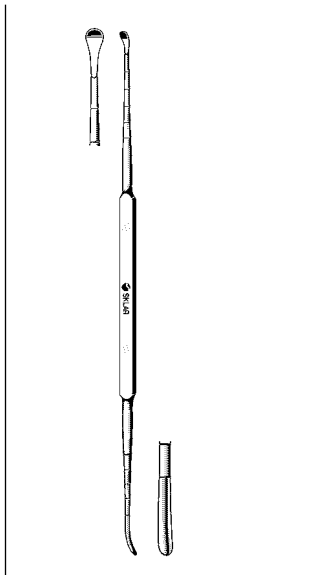

## **COTTLE ELEVATOR**

Shaft Graduated in cm  
41-1235 9" Double End

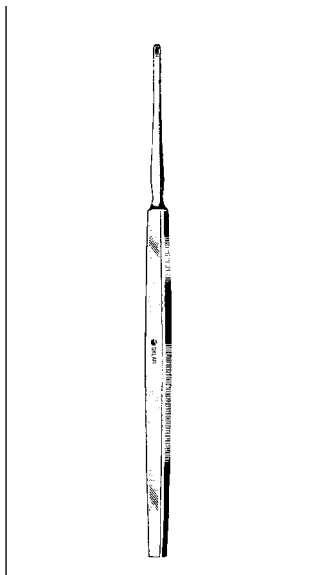

## **LEMPERT ELEVATOR**

Straight  
40-7470 7 1/4" 2mm Blade

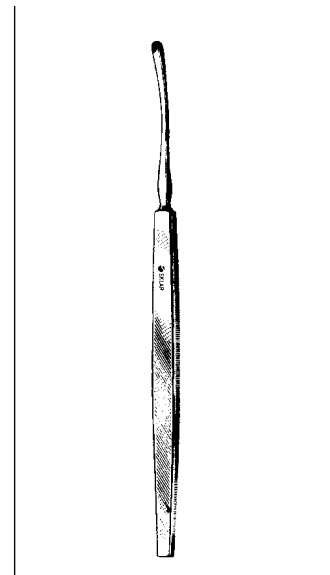

## **LEMPERT ELEVATOR**

Curved  
40-7472 7 1/4" 3mm Blade

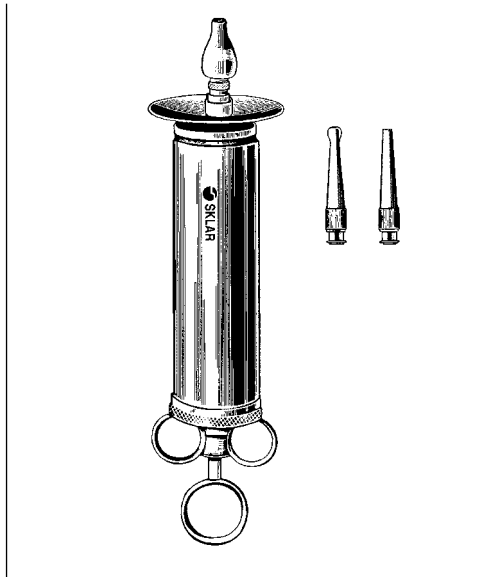

### POMEROY EAR SYRINGE

Chrome Plated

- 67-3402 Complete 2 oz. with Luer Lock
- 67-3404 Complete 4 oz. with Luer Lock
- 67-3424 Shield only for Ear Syringe
- 67-3411 Conical tip only for Ear Syringe
- 67-3412 Bulbous tip only for Ear Syringe
- 67-3418 Conical tip F/ Luer Lock
- 67-3420 Conical tip with bulb F/ Luer Lock

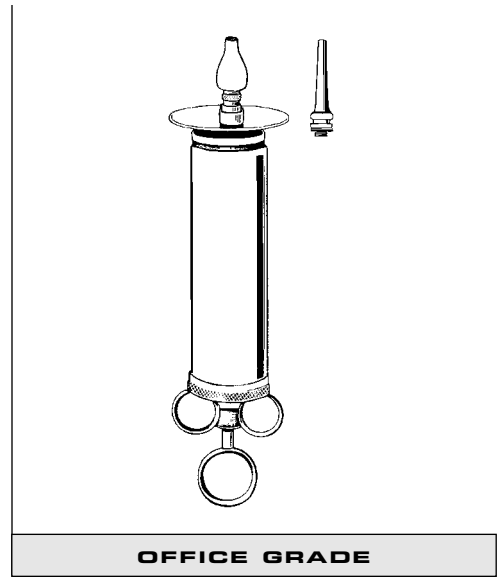

OFFICE GRADE

### POMEROY EAR SYRINGE

With Tips and Shield  
Chrome

- 98-243 2 oz.
- 98-247 3 oz.
- 98-251 4 oz.

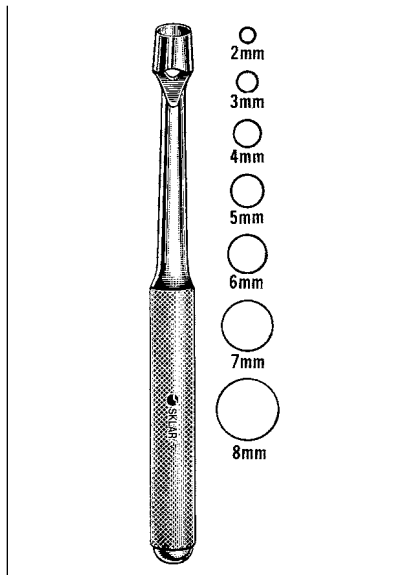

### KEYES CUTANEOUS PUNCH

- |         |     |         |     |
|---------|-----|---------|-----|
| 06-4142 | 2mm | 06-4146 | 6mm |
| 06-4143 | 3mm | 06-4147 | 7mm |
| 06-4144 | 4mm | 06-4148 | 8mm |
| 06-4145 | 5mm |         |     |

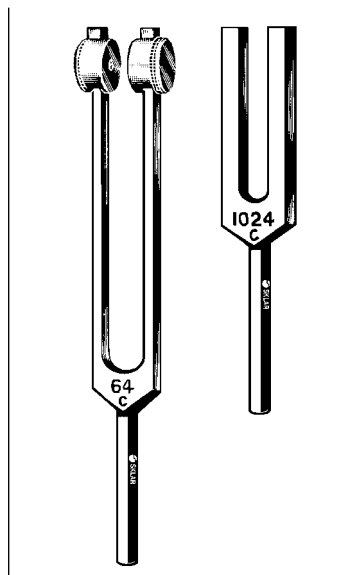

### ALUMINUM ALLOY TUNING FORK

- 67-7064 C-64
- 67-7128 C-128
- 67-7256 C-256
- 67-7512 C-512

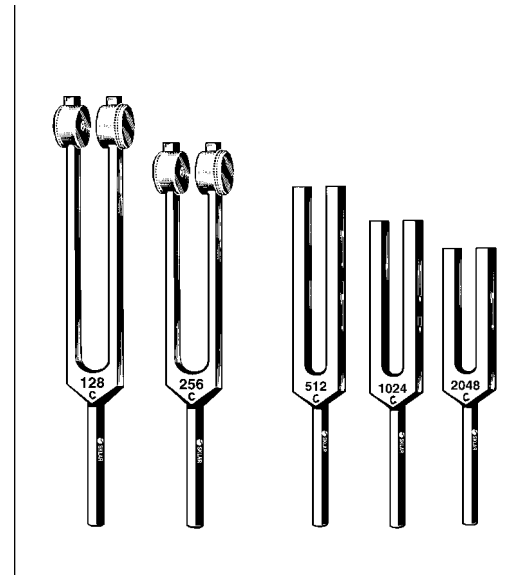

### TUNING FORK SET

Aluminum Alloy

Set of 5

- 67-7605 Including C-128 C-1024
- C-256 C-2048
- C-512

# ENT - PLASTIC SURGERY

## EAR CURETTES

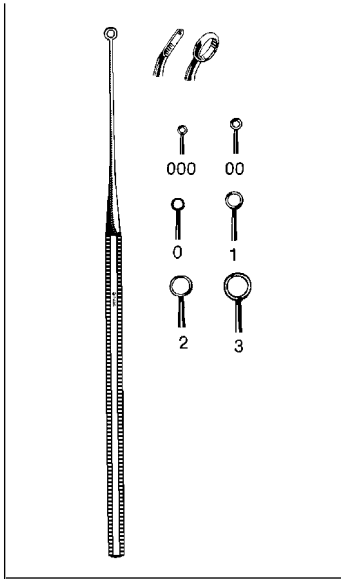

### BUCK EAR CURETTE

Blunt		Angled	
Straight			
67-2488 #000		67-2508 #000	
67-2489 #00		67-2509 #00	
67-2490 #0		67-2510 #0	
67-2491 #1		67-2511 #1	
67-2492 #2		67-2512 #2	
67-2493 #3		67-2513 #3	

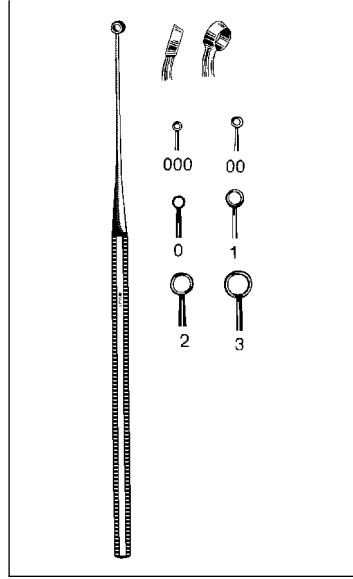

### BUCK EAR CURETTE

Sharp			
Straight		Angled	
67-2519 #000		67-2498 #000	
67-2514 #00		67-2499 #00	
67-2515 #0		67-2500 #0	
67-2516 #1		67-2501 #1	
67-2517 #2		67-2502 #2	
67-2518 #3		67-2503 #3	

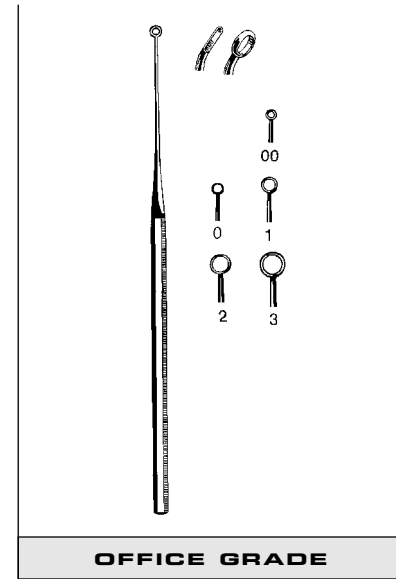

OFFICE GRADE

### BUCK EAR CURETTE

Angled Blunt		Straight Blunt	
98-162 Sz 00		98-170 Sz 00	
98-164 Sz 0		98-171 Sz 0	
98-165 Sz 1		98-172 Sz 1	
98-166 Sz 2		98-173 Sz 2	
98-167 Sz 3		98-174 Sz 3	



### EAR CURETTES, DISPOSABLE

96-1001 Cup	Box/50	96-1011 Child Ring - M	Box/50
96-1006 Loop	Box/50	96-1016 Adult Ring - L	Box/50
96-1031 Spoon	Box/50	96-1034 Angled Loop	Box/50
96-1021 Pedi-Ring - S	Box/50	96-1032 Curved Loop	Box/50

Assorted  
96-1035 10 Each of 96-1001, 96-1006, 96-1011, 96-1016, 96-1021 Box/50

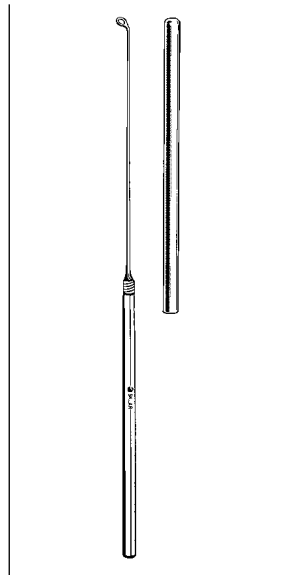

### WEISMAN INFANT EAR CURETTE

67-2480 Blunt	Size 0	2 mm
67-2481 Blunt	Size 1	3 mm

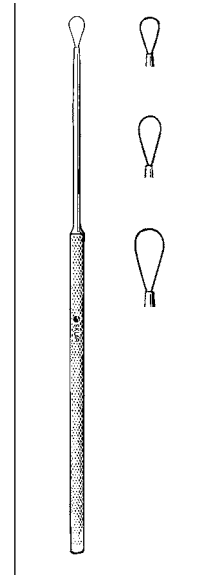

### BILLEAU EAR LOOP

67-2521	Small
67-2522	Medium
67-2523	Large

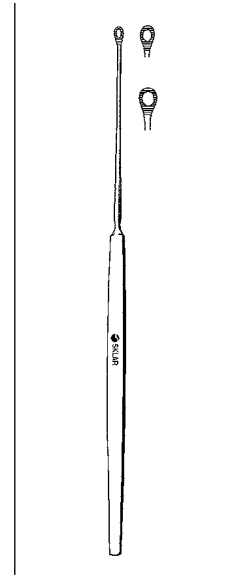

### SHAPLEIGH EAR CURETTES

6 1/4" Serrated Loop	
67-2525 Small	Size 1
67-2526 Large	Size 2



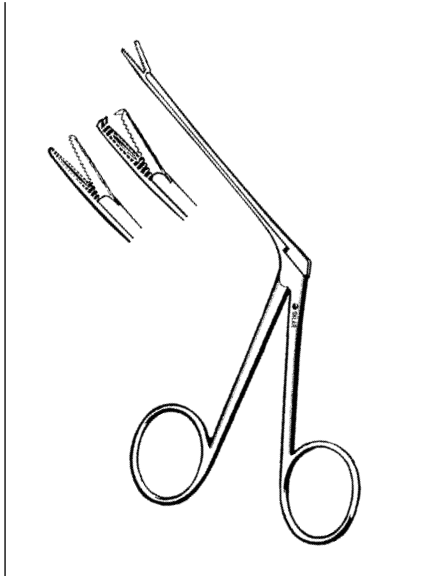

**HARTMANN ALLIGATOR  
GRASPING FORCEPS**

- 67-1035 3½" Serrated
- 67-1036 3½" Serrated Extra Delicate
- 67-1038 5½" Serrated
- 67-1039 6½" Serrated
- 67-1040 3½" 1 x 2 Teeth

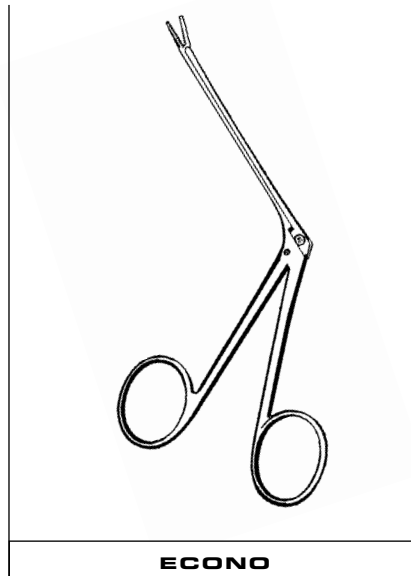

**ECONO**

**HARTMANN ALLIGATOR  
GRASPING FORCEPS, ECONO**

- Box/12
- Serrated Jaws
- 21-209 3½"
- 21-224 5½"
- 21-232 6½"

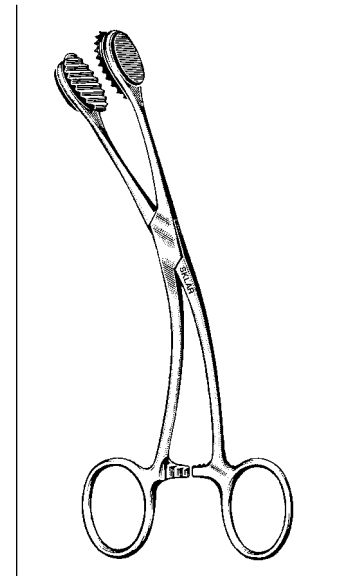

**YOUNG TONGUE  
SEIZING FORCEPS**

- 07-1562 6½"
- 07-1563 Jaw inserts only

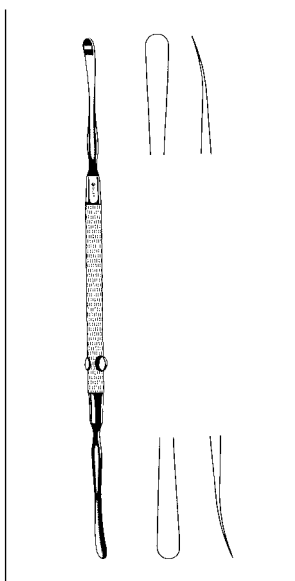

**FREER ELEVATOR**

- Double End
- 47-2380 7¼" S/B
- 47-2382 7¼" S/B

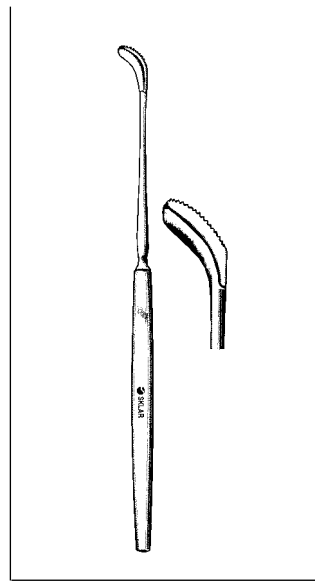

**FISHER TONSIL KNIFE**

- 75-7590 8½"

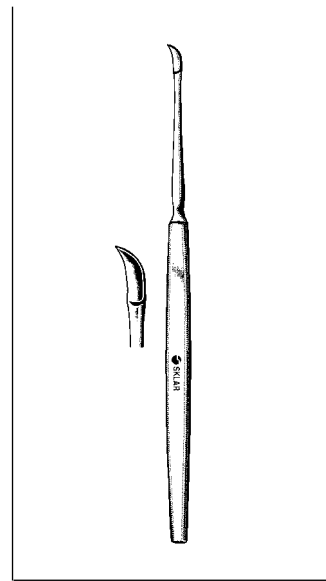

**ATKINS TONSIL KNIFE**

- 75-7077 7¼"

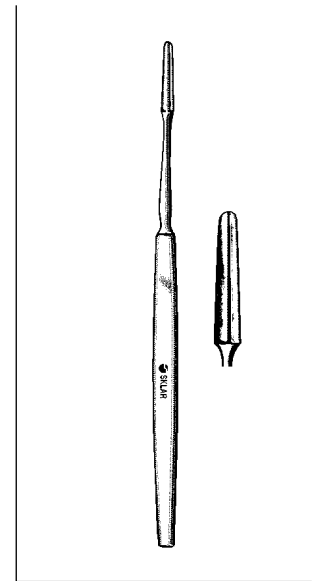

**DEAN TONSIL KNIFE**

- Double Edge
- 75-7492 7¼" Straight

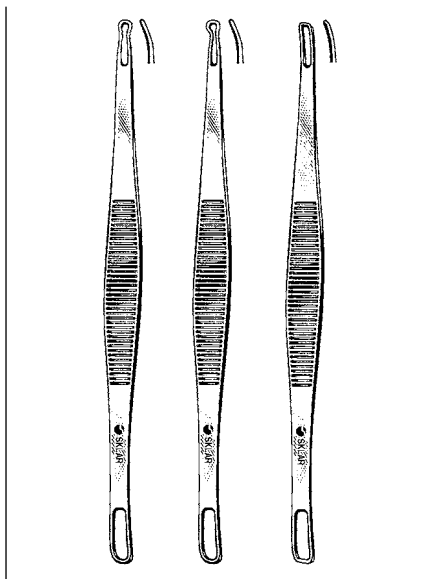

**SCHAMBERG COMEDONE EXTRACTOR**

- 06-4120 Regular Size
- 06-4121 One End Extra Fine
- 06-4122 Square Ends

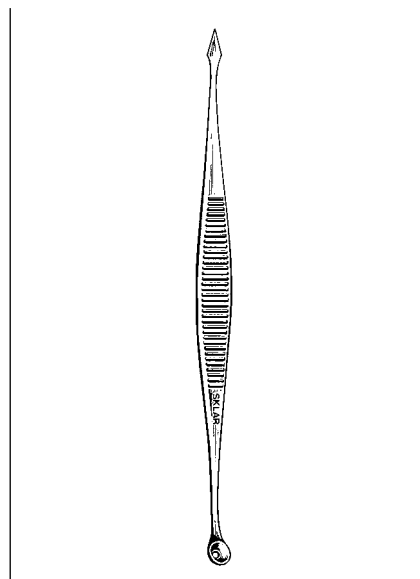

**COMEDONE EXTRACTOR**

- Spear Point
- 06-4126

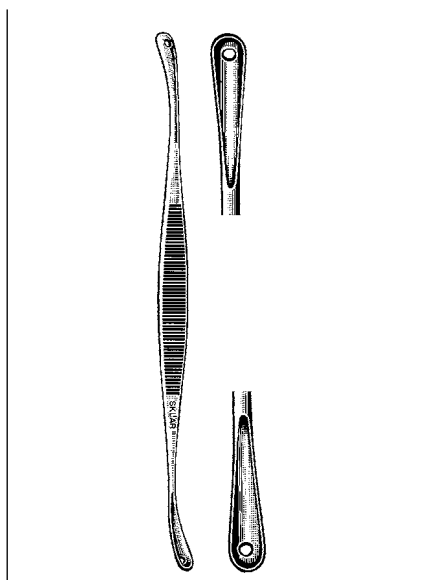

**UNNA COMEDONE EXTRACTOR**

- 5 1/4" Double End, Oval
- 06-4125

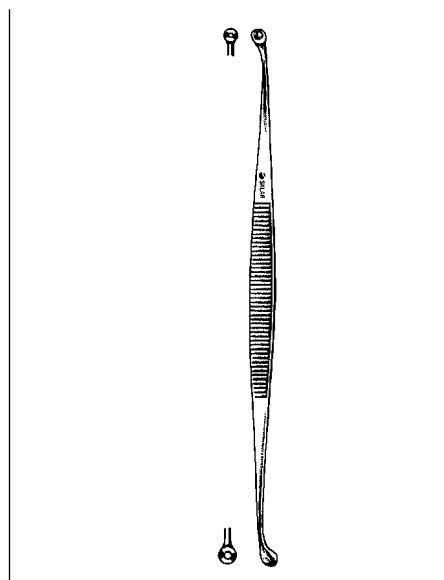

**UNNA COMEDONE EXTRACTOR**

- 5 1/4" Double End, Round
- 06-4191

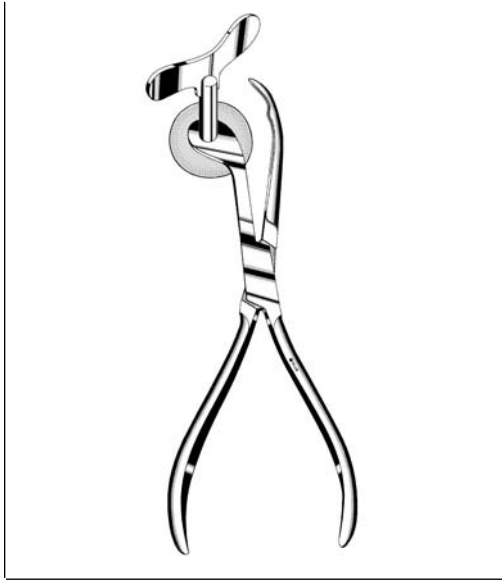

### KEYES FINGER RING CUTTER

Stainless Steel

- 06-4150 Ring Cutter Complete
- 06-4151 Blade w/Brass Bushing  
Attached for above ring cutter

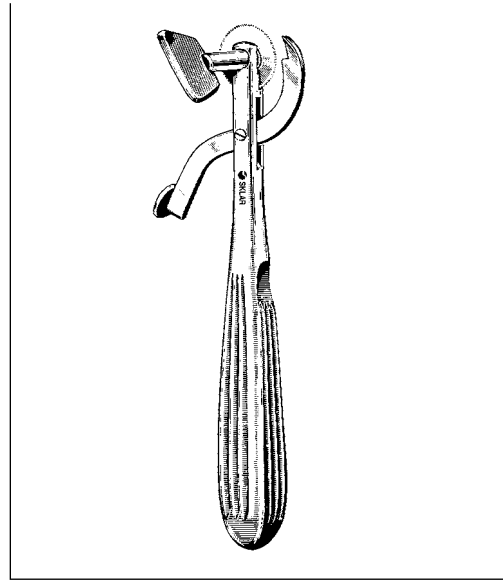

### SKLAR FINGER RING CUTTER

- 06-4152 6"
- 06-4153 Blade for Sklar Finger Ring Cutter

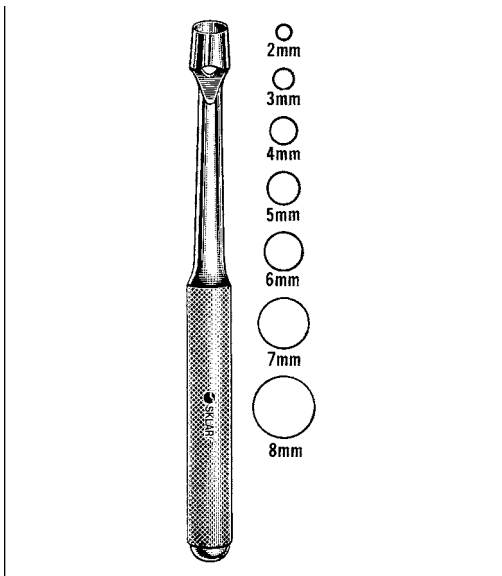

### KEYES CUTANEOUS PUNCH

- |         |     |         |     |
|---------|-----|---------|-----|
| 06-4142 | 2mm | 06-4146 | 6mm |
| 06-4143 | 3mm | 06-4147 | 7mm |
| 06-4144 | 4mm | 06-4148 | 8mm |
| 06-4145 | 5mm |         |     |

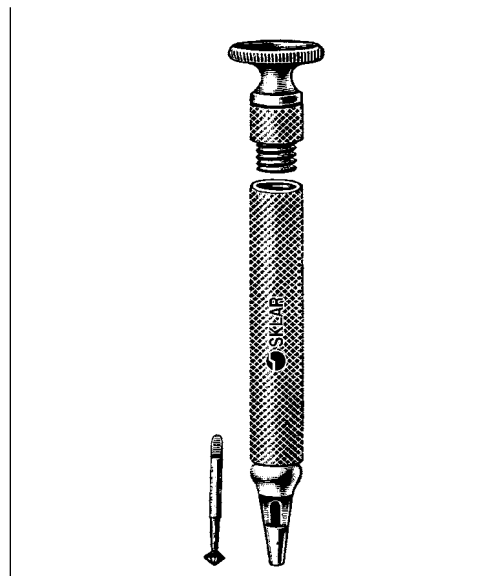

### SKLAR NAIL DRILL

- Three Drills in Handle
- 06-4160 Complete
- 06-4161 Set of Drill Points Only

# DERMAL - CURETTES / MIRRORS

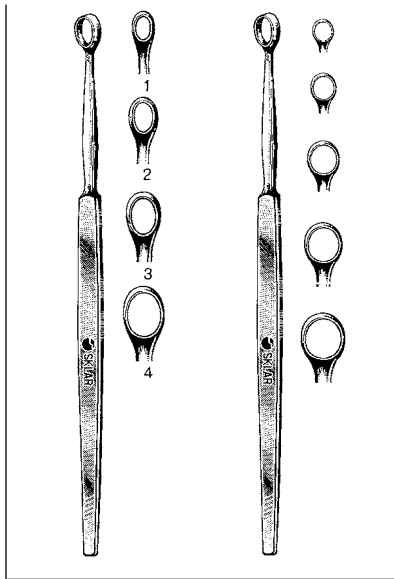

## FOX DERMAL CURETTE

Oval 5½"		Round 5½"	
06-4133	3 mm	06-4137	2 mm
06-4134	4 mm	06-4138	3 mm
06-4135	5 mm	06-4139	4 mm
06-4136	6 mm	06-4140	5 mm
		06-4141	6 mm

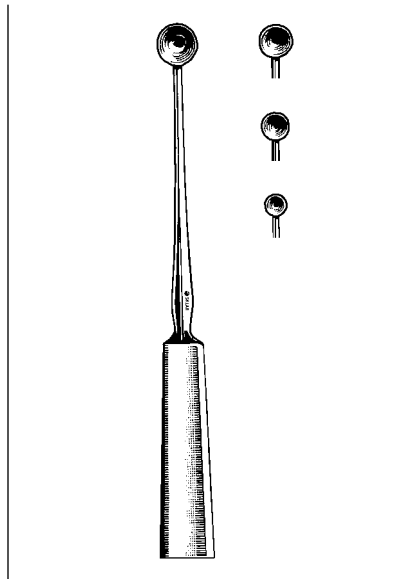

## MEYHOEFER CHALAZION CURETTE

65-3170	#0	1.5mm
65-3171	#1	1.7mm
65-3172	#2	2.2mm
65-3173	#3	2.5mm
65-3174	#4	3.0mm

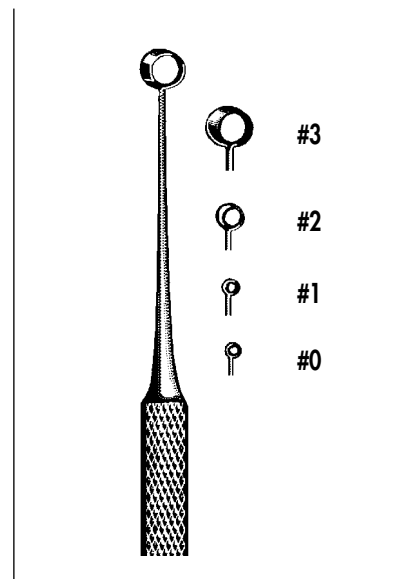

## HEATH CURETTE

One Sharp Edge and One Dull Edge

65-3180	#0	½mm
65-3181	#1	1mm
65-3182	#2	2mm
65-3183	#3	3mm

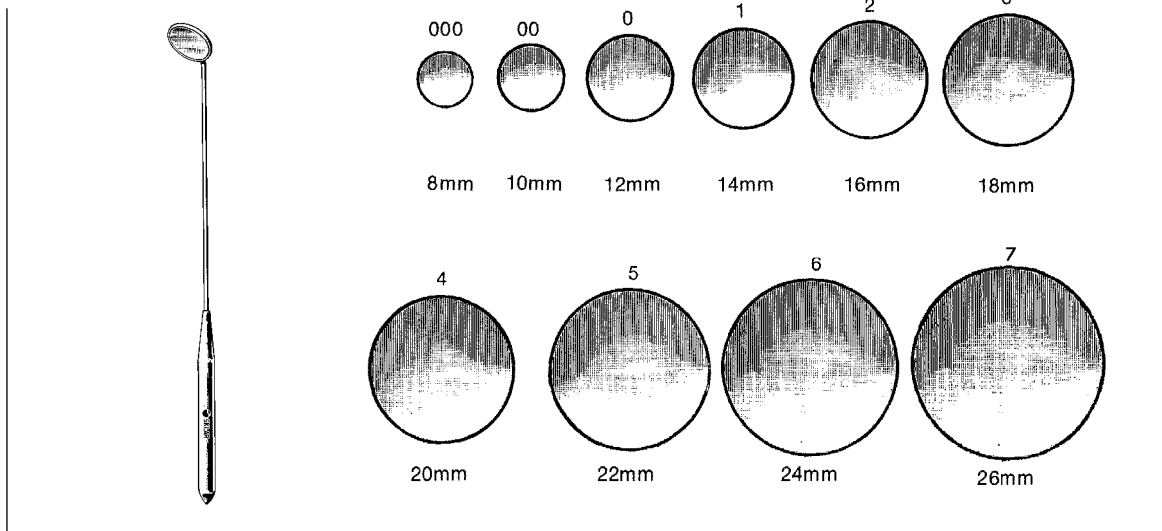

## LARYNGEAL MIRROR REGULAR

Chromeback Mirror With Stainless Steel Handle

73-1188	#000	73-1193	#3
73-1189	#00	73-1194	#4
73-1190	#0	73-1195	#5
73-1191	#1	73-1196	#6
73-1192	#2	73-1197	#7

## LARYNGEAL MIRROR EVERCLEAR

Chromeback Mirror With Stainless Steel Handle

73-1351	#1
73-1352	#2
73-1353	#3
73-1354	#4
73-1355	#5
73-1356	#6

## MAGNIFYING MIRROR

Tip Only

93-1153	#3
---------	----

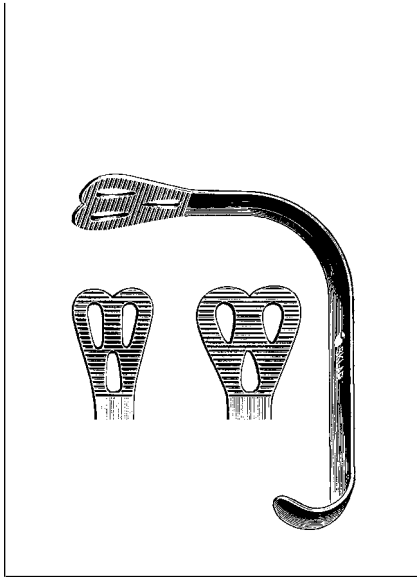

### WIEDER TONGUE DEPRESSOR

Fenestrated and Serrated Blade

75-2160 Small  
75-2161 Large

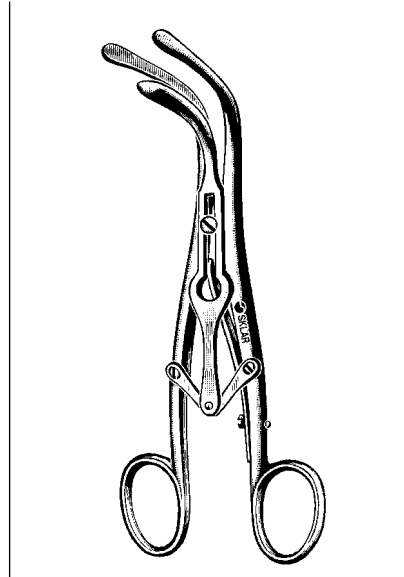

### LABORDE TRACHEAL DILATOR

3 Blade  
78-3460 6"

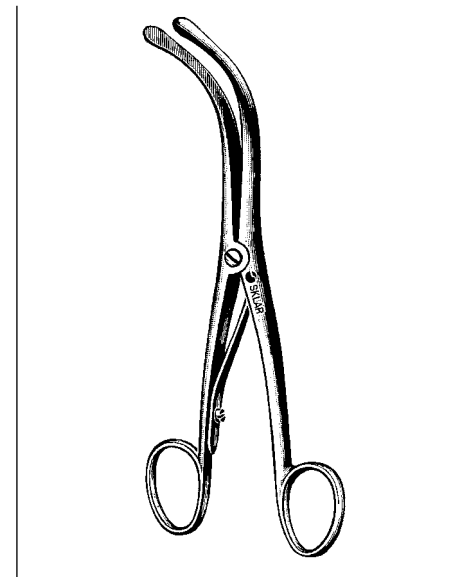

### TROUSSEAU TRACHEAL DILATOR

2 Blade  
78-3360 6"  
22-9155 5 1/2" Pediatric

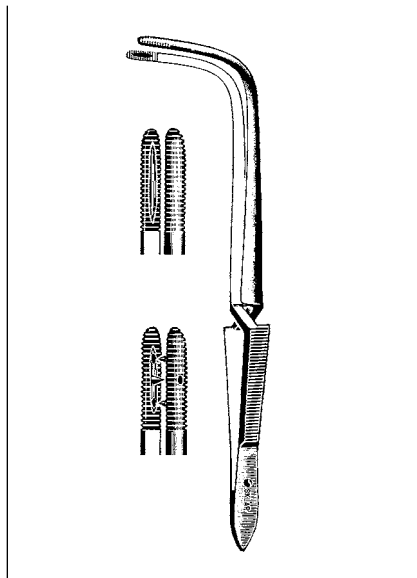

### JACKSON X-ACTION FORCEPS

76-1390 9" Serrated  
76-1490 9" With Teeth

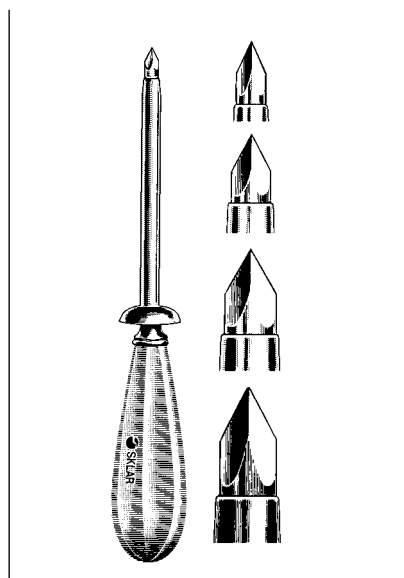

### NELSON TROCAR

34-2422	#1	8 1/4"	25 French
34-2428	#2	8 1/4"	30 French
34-2434	#3	8 1/4"	33 French
34-2438	#4	8 1/4"	35 French

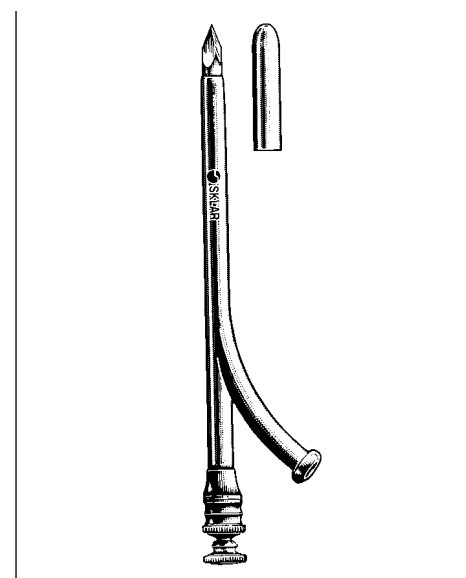

### OCHSNER TROCAR

34-1410	10 French	6 Fr Cath
34-1412	12 French	8 Fr Cath
34-1414	14 French	10 Fr Cath
34-1417	16 French	12 Fr Cath
34-1418	18 French	14 Fr Cath
34-1420	20 French	16 Fr Cath
34-1422	22 French	18 Fr Cath
34-1424	24 French	20 Fr Cath
34-1428	28 French	22 Fr Cath

# SUCTION TUBES

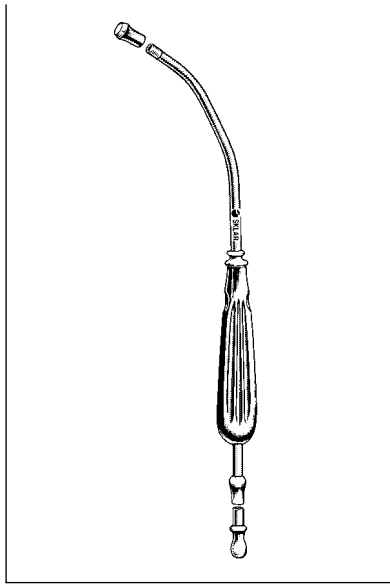

## YANKAUER SUCTION TUBE

- 07-1801 Standard size, Chrome
- 07-1802 Tip Only For 07-1801
- 22-6585 Pediatric size
- 07-1805 Standard size, Stainless Steel
- 07-1806 Tip Only For 07-1805

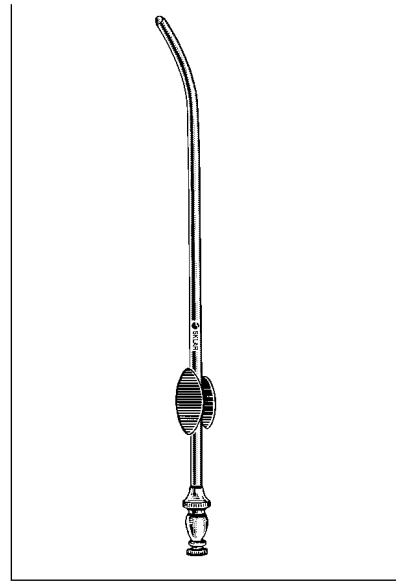

## ADSON SUCTION TUBE

- 50-1982 6" 12 French

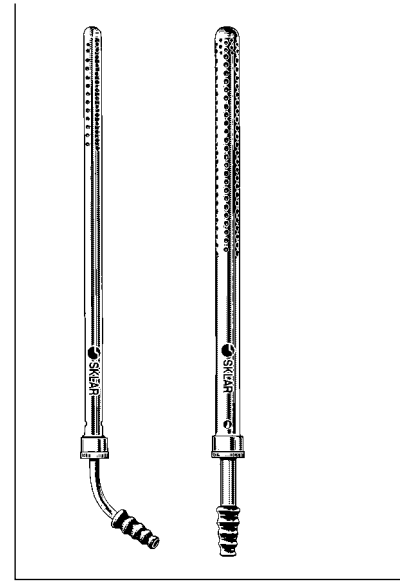

## POOLE SUCTION TUBE

- Slip on end
- 22-6577 16 French Curved Pediatric
- 34-2023 23 French Curved
- 34-2230 30 French Straight

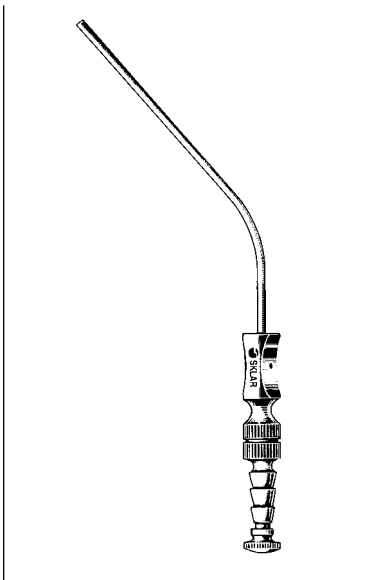

## FRAZIER SUCTION TUBE

- |         |          |         |           |
|---------|----------|---------|-----------|
| 50-2005 | 5 French | 50-2010 | 10 French |
| 50-2006 | 6 French | 50-2011 | 11 French |
| 50-2007 | 7 French | 50-2012 | 12 French |
| 50-2008 | 8 French | 50-2014 | 14 French |
| 50-2009 | 9 French |         |           |

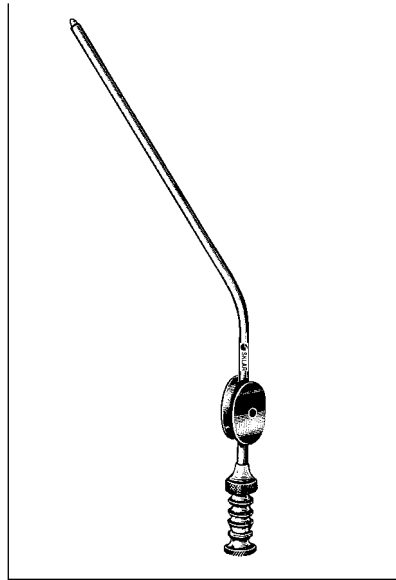

## BARON SUCTION TUBE

- 50-1953 3 French
- 50-1955 5 French
- 50-1957 7 French

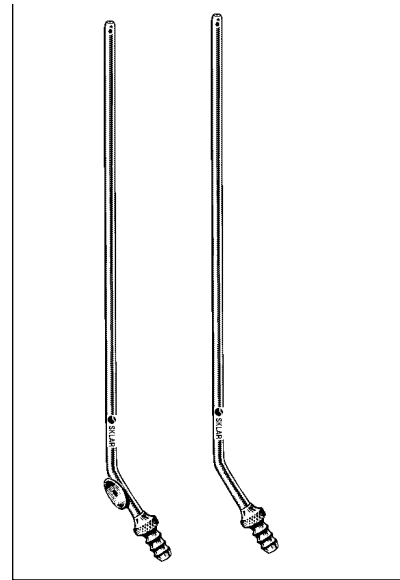

## BUIE SUCTION TUBE

- 80-2715 with Valve
- 80-2815 without Valve

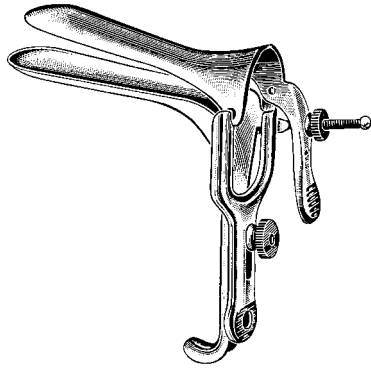

**OR GRADE**

### GRAVES VAGINAL SPECULUM

90-3700	3" x ¾"	Small
90-3701	4" x 1¼"	Medium
90-3702	4½" x 1¾"	Large
90-3800	2¾" x ¾"	Extra Small
90-3802	4¾" x 1½"	Extra Large

90-3803	6" x 1½"	Extra Long
---------	----------	------------

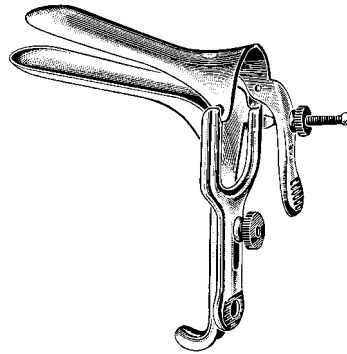

**MID-GRADE**

### GRAVES VAGINAL SPECULUM

95-303	3" x ¾"	Small
95-312	4" x 1¼"	Medium
95-324	4½" x 1¾"	Large

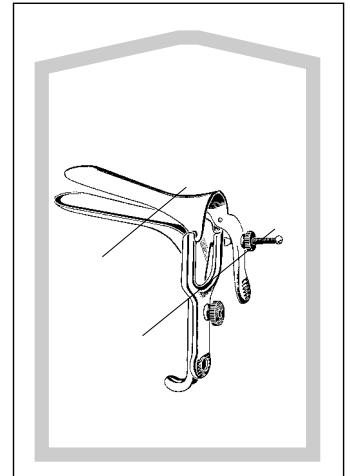

**FLOOR-GRADE, STERILE**

### GRAVES VAGINAL SPECULUM, STERILE

Box/25

96-2603	3" x ¾"	Small
96-2605	4" x 1¼"	Medium
96-2607	4½" x 1¾"	Large

### Sklar-Spec™

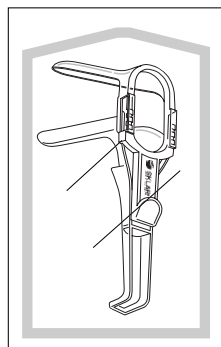
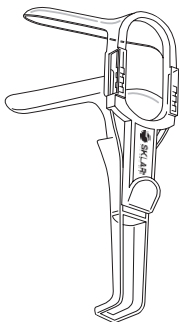

**STERILE**

### PLASTIC VAGINAL SPECULUM, GRAVES STYLE

Disposable (Non-Sterile)		
96-0857	Sm	Cs/100 10 Pks/10
96-0867	Md	Cs/100 10 Pks/10
96-0877	Lg	Cs/100 10 Pks/10

Disposable (Sterile)		
96-2602	Sm	Cs/50
96-2604	Md	Cs/50
96-2606	Lg	Cs/50

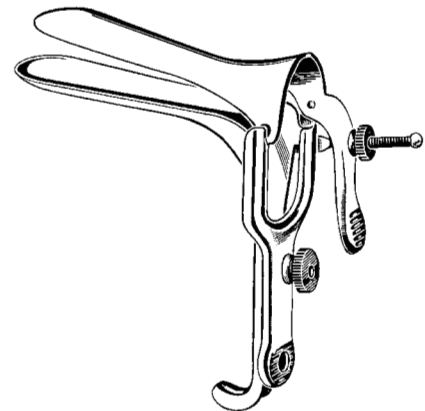

**ECONO**

### GRAVES VAGINAL SPECULUM, ECONO

Box/12	
21-324	Large
21-313	Medium
21-303	Small

# GYNECOLOGICAL INSTRUMENTS SPECULUM

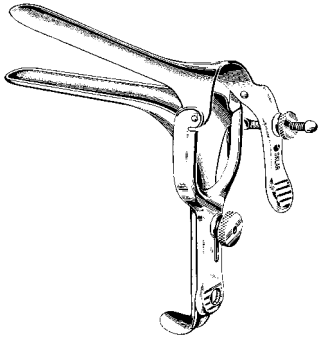

**OR GRADE**

## **PEDERSON VAGINAL SPECULUM**

Narrow Blades

90-3710	3" x ½"	Small
90-3713	4" x ¾"	Medium
90-3711	4¾" x 1"	Large
90-3849	2¾" x ½"	Extra Small
90-3851	4¾" x 1¾"	Extra Large
90-3712	4" x ¾"	Slender

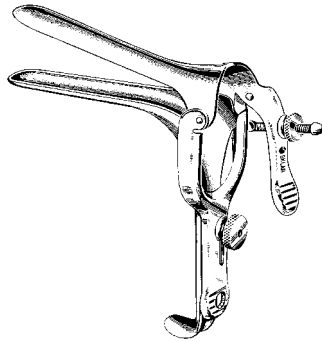

**MID-GRADE**

## **PEDERSON VAGINAL SPECULUM**

95-347	3" x ½"	Small
95-348	4" x ¾"	Medium
95-362	4¾" x 1"	Large

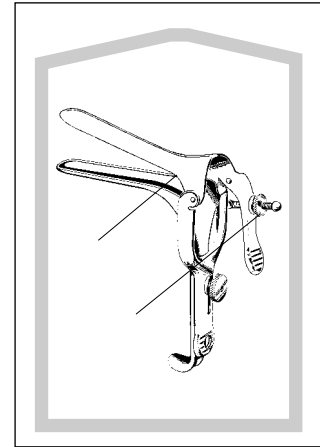

**FLOOR-GRADE, STERILE**

## **PEDERSON VAGINAL SPECULUM, STERILE**

Box/25		
96-2613	3" x ½"	Small
96-2615	4" x ¾"	Medium
96-2617	4¾" x 1"	Large

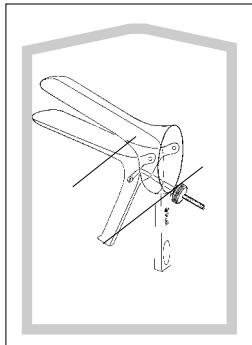
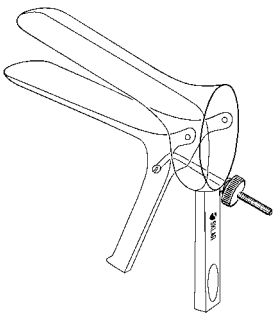

**STERILE**

## **PLASTIC VAGINAL SPECULUM, CUSCO STYLE**

Disposable (Non-Sterile)		
96-0557	Sm Cs/100	10 Pks/10
96-0567	Md Cs/100	10 Pks/10
96-0577	Lg Cs/100	10 Pks/10

Disposable (Sterile)		
96-2642	Sm Cs/50	
96-2644	Md Cs/50	
96-2648	Lg Cs/50	

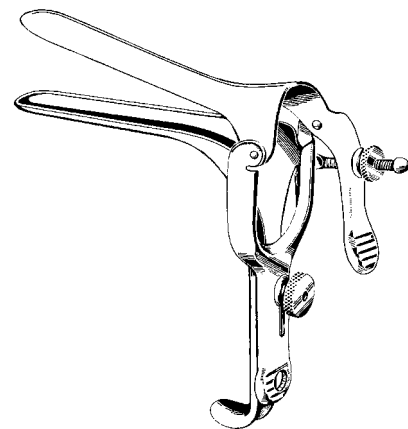

**ECONO**

## **PEDERSON VAGINAL SPECULUM, ECONO**

Box/12	
21-362	Large
21-348	Medium
21-337	Small



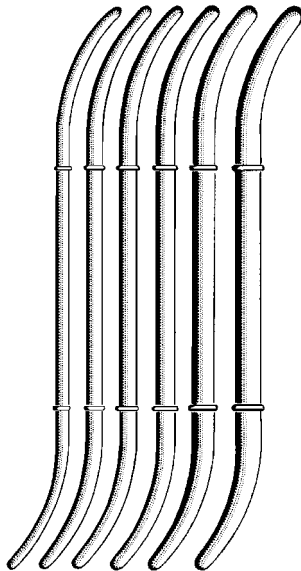
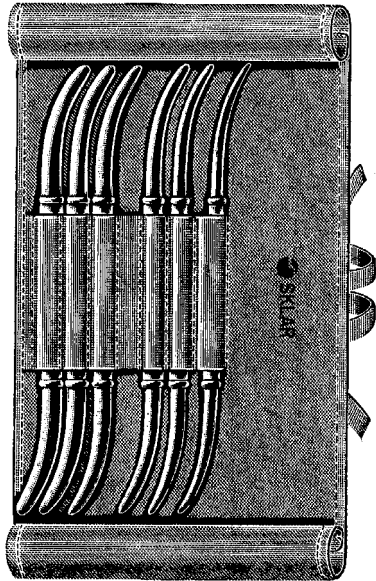

### HANK UTERINE DILATOR

90-4925 Set of 6 without Khaki Roll

90-4926 Set of 6 with Khaki Roll

#### American Scale

90-4910 9-10  
90-4912 11-12  
90-4914 13-14  
90-4916 15-16  
90-4918 17-18  
90-4920 19-20

90-4908 7-8 Narrow

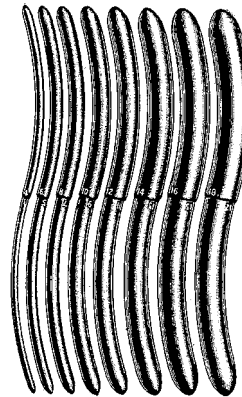
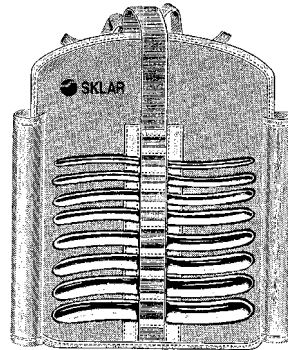
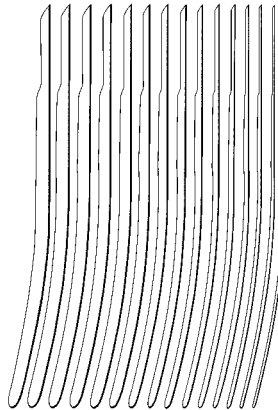

### HEGAR UTERINE DILATOR

90-4825 Set of 8 without Khaki Roll, Double End

90-4826 Set of 8 with Khaki Roll, Double End

#### Double End

90-4802 1-2 mm  
90-4804 3-4 mm  
90-4806 5-6 mm  
90-4808 7-8 mm  
90-4810 9-10 mm  
90-4812 11-12 mm  
90-4814 13-14 mm  
90-4816 15-16 mm  
90-4818 17-18 mm

#### Single End

90-4784 1.0 mm  
90-4785 1.5 mm  
90-4786 2.0 mm  
90-4787 2.5 mm  
90-4788 3.0 mm  
90-4789 3.5 mm  
90-4790 4.0 mm  
90-4791 4.5 mm  
90-4792 5.0 mm  
90-4793 5.5 mm  
90-4794 6.0 mm  
90-4795 6.5 mm  
90-4796 7.0 mm  
90-4797 7.5 mm  
90-4798 8.0 mm

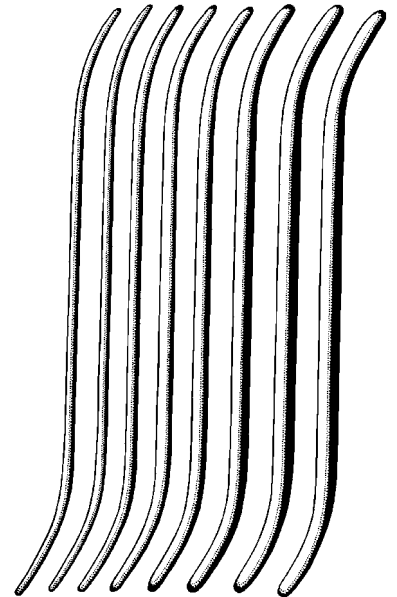
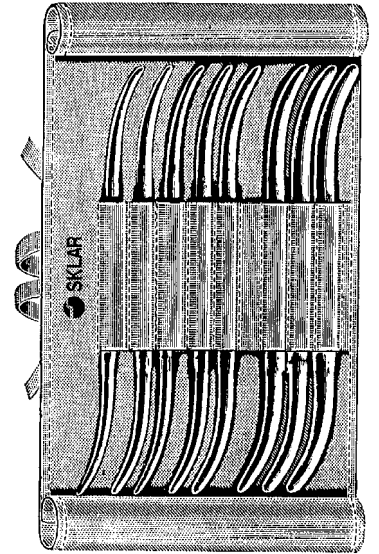

### PRATT UTERINE DILATOR

90-5250 Set of 8

90-5215 13-15 French

90-5219 17-19 French

90-5223 21-23 French

90-5227 25-27 French

90-5231 29-31 French

90-5235 33-35 French

90-5239 37-39 French

90-5243 41-43 French

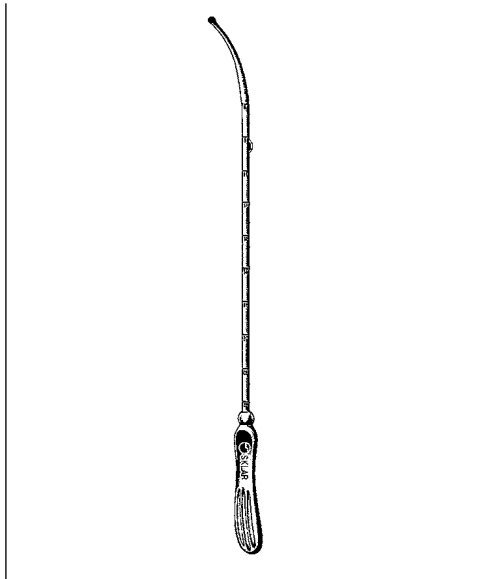

**SIMPSON UTERINE SOUND  
MALLEABLE**

Graduated - Silver Plated

90-5412 12½" Inch Markings

90-5413 12½" Cm Markings

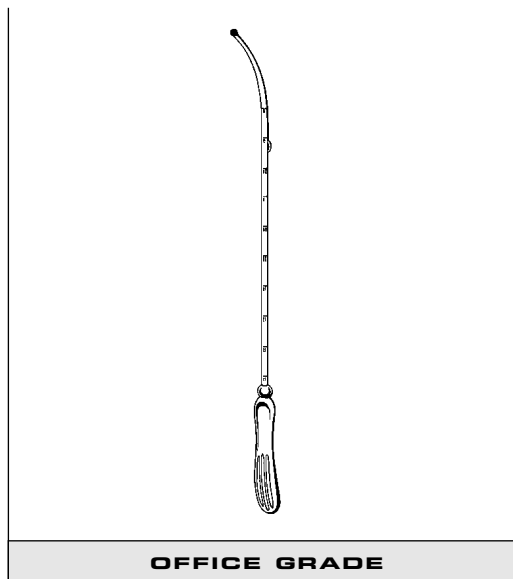

**OFFICE GRADE**

**SIMPSON UTERINE SOUND**

98-382 12½" with cm measurements

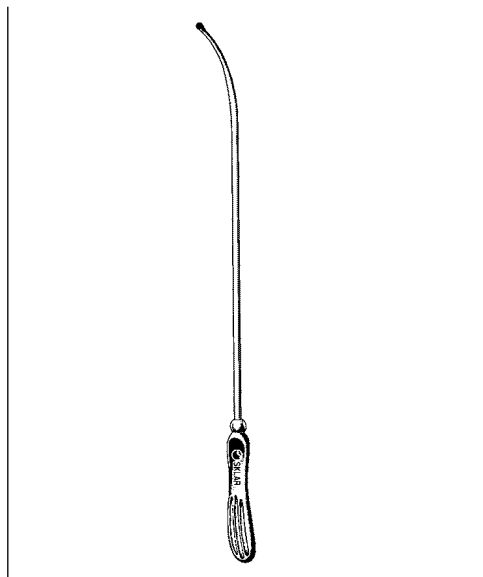

**SIMS UTERINE SOUND  
MALLEABLE**

Non-Graduated - Silver Plated

90-5312 12½"

Graduated - Silver Plated

90-5314 12½" Cm Markings

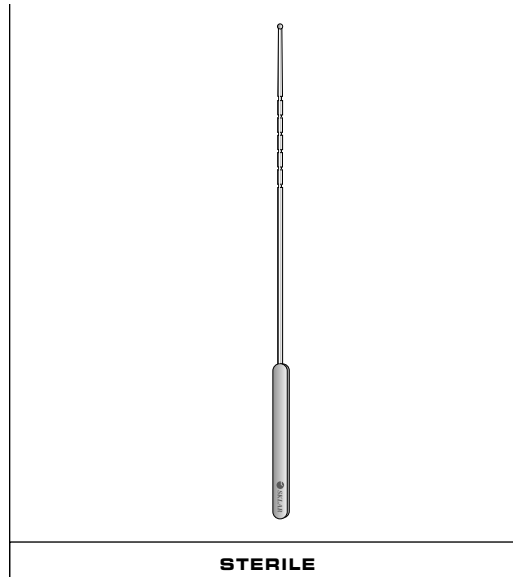

**STERILE**

**SKLAR INTRA-UTERINE SOUND,  
DISPOSABLE**

Malleable Box/50 Packaged Sterile  
96-4170



### SKLAR MINI-DILATOR/ OS FINDER SET

Small Size Dilator Uterine

- 90-6280 From 1mm to 3mm in .5mm increments. All five dilators interchange on a universal handle.  
90-6281 Handle Only

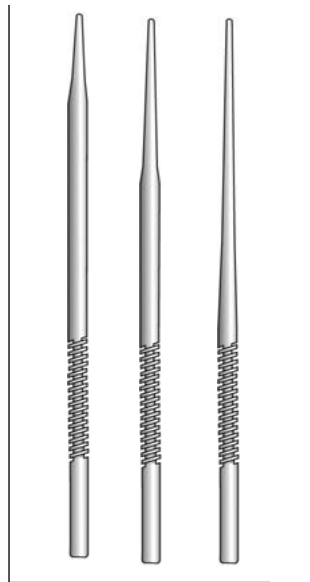

### OS DILATOR SET, TEFLON

- Reusable  
96-4150 Set of 3 Dilators

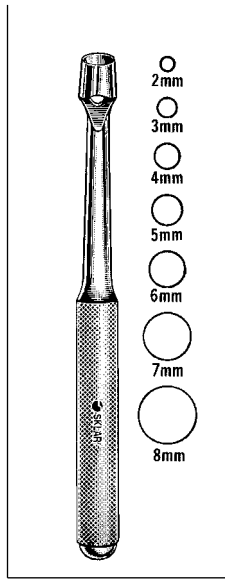

### KEYES BIOPSY PUNCH

- 06-4142 2mm  
06-4143 3mm  
06-4144 4mm  
06-4145 5mm  
06-4146 6mm  
06-4147 7mm  
06-4148 8mm

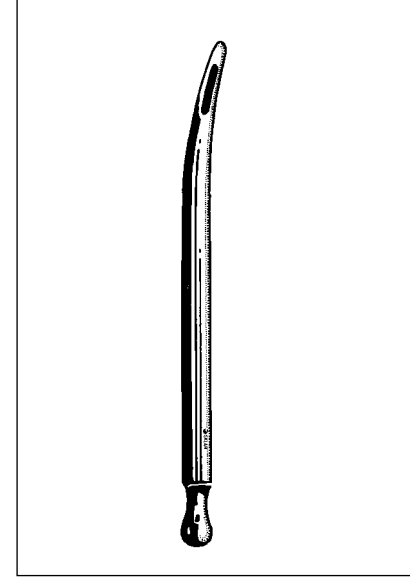

### WALTHER DILATOR-CATHETERS 5 1/4"

- |         |           |         |        |
|---------|-----------|---------|--------|
| 85-2010 | Set of 14 |         |        |
| 85-2012 | 12 Fr.    | 85-2026 | 26 Fr. |
| 85-2014 | 14 Fr.    | 85-2028 | 28 Fr. |
| 85-2016 | 16 Fr.    | 85-2030 | 30 Fr. |
| 85-2018 | 18 Fr.    | 85-2032 | 32 Fr. |
| 85-2020 | 20 Fr.    | 85-2034 | 34 Fr. |
| 85-2022 | 22 Fr.    | 85-2036 | 36 Fr. |
| 85-2024 | 24 Fr.    | 85-2038 | 38 Fr. |

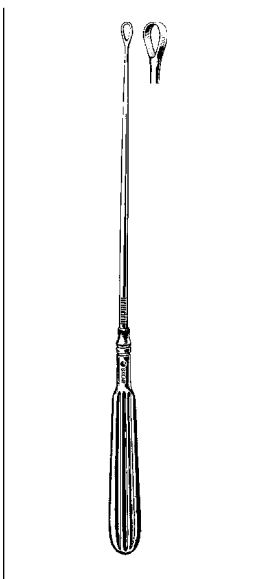

### HOLDEN UTERINE CURETTE

- Semi-Sharp  
90-5710 10 3/4" Extra Small

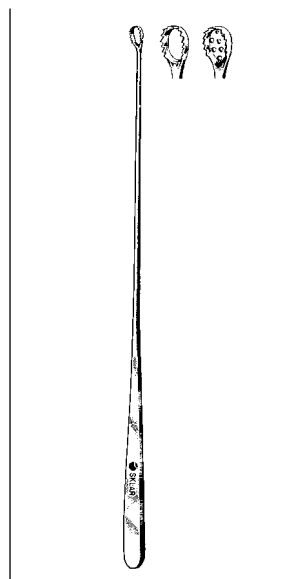

### HEANEY UTERINE CURETTE

- Serrated  
90-6095 9 1/2" Open Curette  
90-6195 9 1/2" With Basket

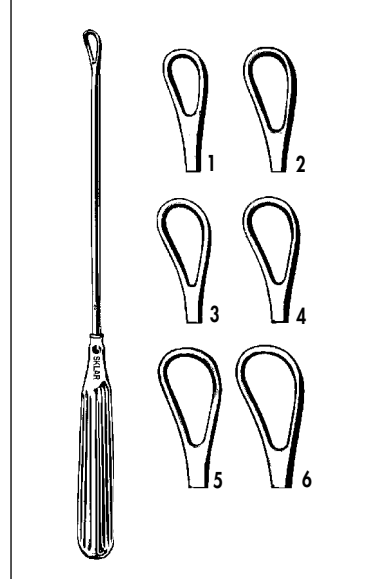

### THOMAS UTERINE CURETTES

- Blunt, 11"  
90-5431 No. 1    90-5435 No. 5  
90-5432 No. 2    90-5436 No. 6  
90-5433 No. 3    90-5438 Set of 6  
90-5434 No. 4

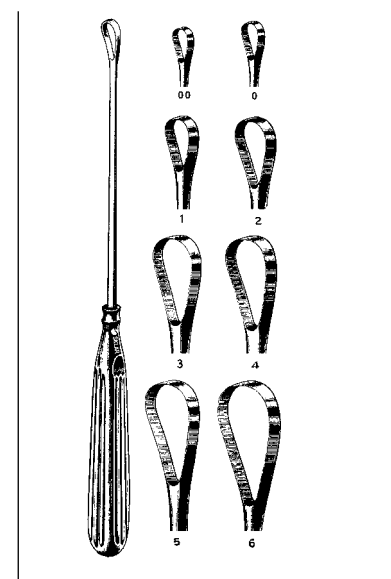

### SIMS UTERINE CURETTES

- Sharp, 11"  
90-5499 No. 00    90-5424 No. 4  
90-5500 No. 0    90-5425 No. 5  
90-5421 No. 1    90-5426 No. 6  
90-5422 No. 2    90-5428 Set of 6  
90-5423 No. 3

# GYNECOLOGICAL INSTRUMENTS

## BIOPSY FORCEPS

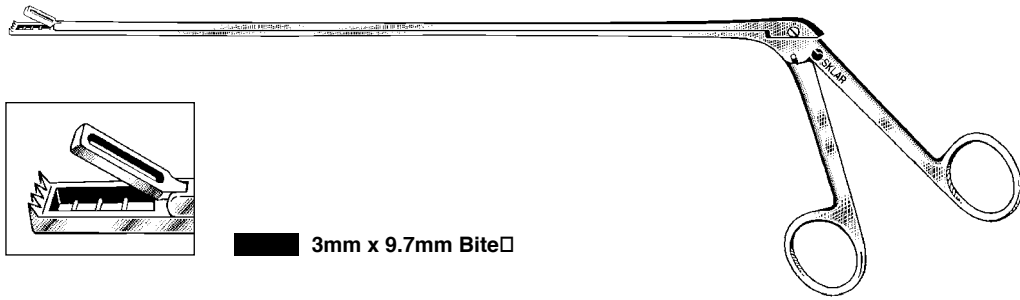

3mm x 9.7mm Bite

**KEVORKIAN-YOUNGE BIOPSY FORCEP**

90-6610 Teeth on lower jaw 3mm x 9.7mm Bite

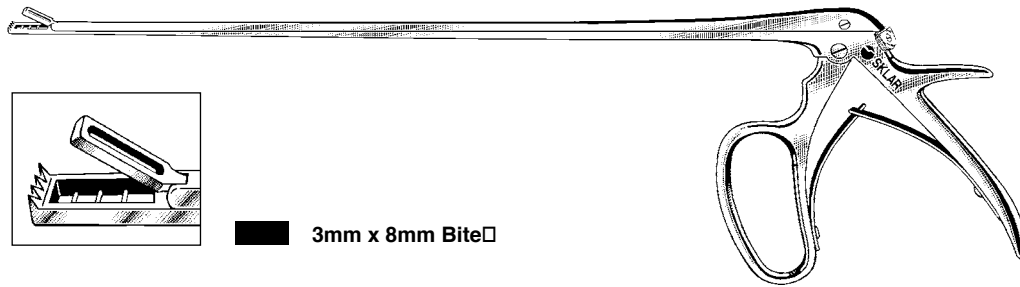

3mm x 8mm Bite

**KEVORKIAN BIOPSY FORCEP**

90-7540

3mm x 8mm Bite

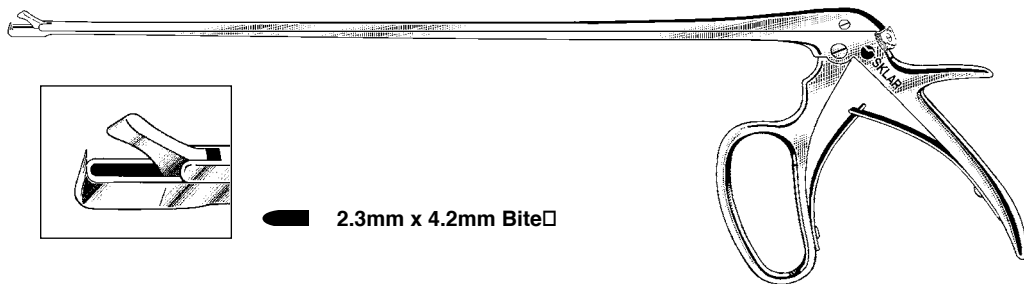

2.3mm x 4.2mm Bite

**MINI TISCHLER BIOPSY FORCEP**

90-7530

2.3mm x 4.2mm Bite (Baby Tischler)

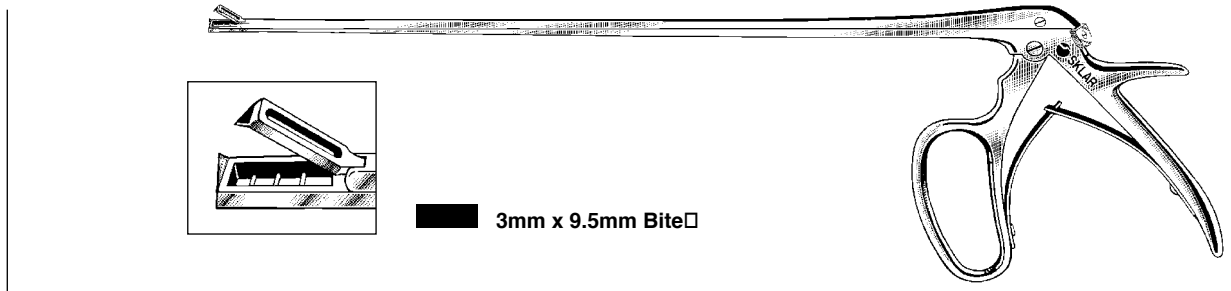

**TISCHLER CERVICAL BIOPSY FORCEP**  
With Kevorkian Style Bite

90-6887

3mm x 9.5mm Bite

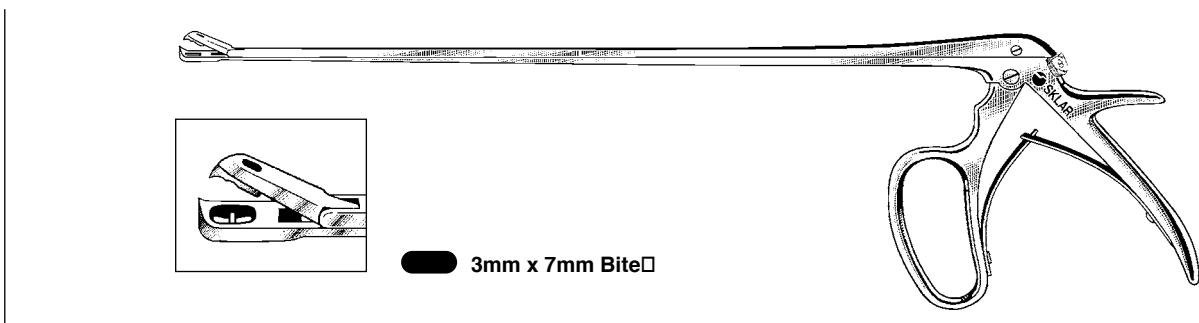

**TISCHLER OVAL BIOPSY FORCEP**

90-7520

3mm x 7mm Bite

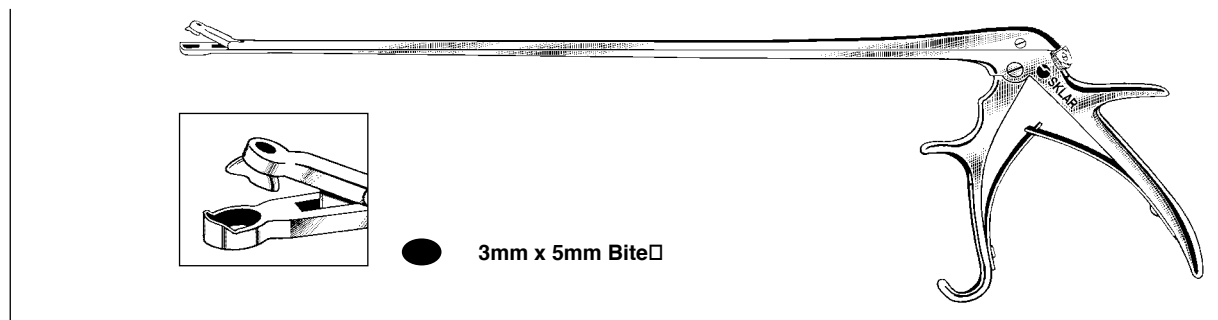

**OVAL BIOPSY FORCEP**

90-7525

3mm x 5mm Bite

# LAPAROSCOPIC INSTRUMENTS



SKLARTECH  
**5000**



## LAPAROSCOPIC SCISSORS

## LAPAROSCOPIC FORCEPS



### METZENBAUM SCISSORS STRAIGHT – 33CM 5MM

31-9005XC Complete Instrument  
31-9005 Replacement Insert



### MARYLAND DISSECTOR CROSS SERRATIONS - 33CM 5MM

31-9030XC Complete Instrument  
31-9030 Replacement Insert



### METZENBAUM SCISSORS CURVED – 33CM 5MM

31-9010XC Complete Instrument  
31-9010 Replacement Insert



### MIXTER FORCEPS DIAMOND SERRATIONS - 33CM 5MM

31-9035XC Complete Instrument  
31-9035 Replacement Insert



### HOOK SCISSORS 33CM 5MM

31-9015XC Complete Instrument  
31-9015 Replacement Insert



### DOLPHIN FORCEPS WITH SPOON - 33CM 5MM

31-9040XC Complete Instrument  
31-9040 Replacement Insert



### MICROSCISSOR STRAIGHT – 33CM 5MM

31-9020XC Complete Instrument  
31-9020 Replacement Insert



### CLAW FORCEPS 33CM 5MM

31-9045XC Complete Instrument  
31-9045 Replacement Insert



### MICROSCISSOR CURVED – 33CM 5MM

31-9025XC Complete Instrument  
31-9025 Replacement Insert



### STANDARD GRASPING FORCEPS 33CM 5MM

31-9050YC Complete Instrument  
31-9050 Replacement Insert

**COMPLETE  
INSTRUMENT:**  
INSERT WITH TIP  
INSULATED  
CANNULA  
HANDLE WITH  
COLLAR



When purchased as a complete instrument, SklarTech Laparoscopic Scissors, Dissectors and Forceps include the insert with tip, insulated cannula and handle with locking collar. The illustrated handle is a non-ratchet pattern which may be fully rotated. Featuring an electro-surgical connector, the "XC" handle is fully insulated.



SKLARTECH  
**5000**

## LAPAROSCOPIC FORCEPS

### ENDO CLINCH GRASPING FORCEPS 33CM 5MM

31-9055YC Complete Instrument    31-9055 Replacement Insert



### WAVE GRASPING FORCEPS 33CM 5MM

31-9060YC Complete Instrument    31-9060 Replacement Insert



### DEBAKEY FORCEPS 40MM JAWS - 33CM 5MM

31-9065YC Complete Instrument    31-9065 Replacement Insert



### ALLIGATOR GRASPING FORCEPS DOUBLE ACTION - 33CM 5MM

31-9070YC Complete Instrument    31-9070 Replacement Insert



### SHARP ATRAUMATIC GRASPING FORCEPS 33CM 5MM

31-9075YC Complete Instrument    31-9075 Replacement Insert



The grasping forceps illustrated above include all of the same important features found on the Sklar Laparoscopic scissors, however, these instruments have a Y handle which has a ratchet and ensures a delicate yet precise grasp of tissue.



"YC" Handle







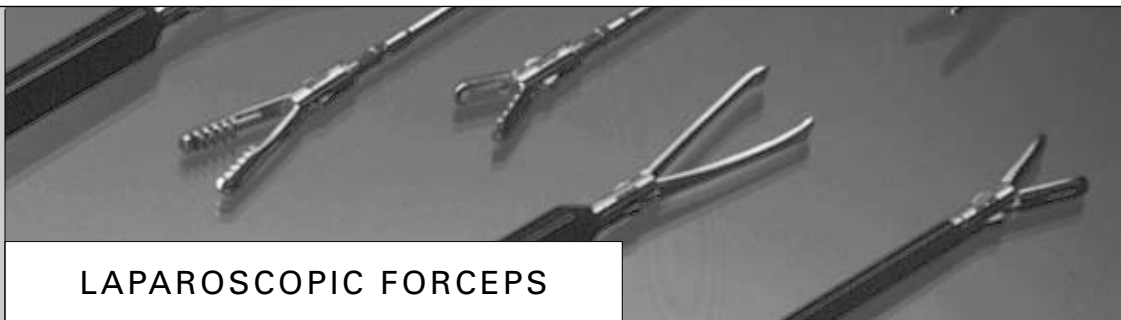

**COMPLETE INSTRUMENT:**  
INSERT WITH TIP  
INSULATED CANNULA  
HANDLE WITH COLLAR



SKLARTECH  
**5000**

## LAPAROSCOPIC FORCEPS



	<p><b>GRASPING FORCEPS WITH SPOON - 33CM 5MM</b></p> <p>31-9080YC Complete Instrument    31-9080 Replacement Insert</p>
	<p><b>POINTED GRASPING FORCEPS WITH SPOON - 33CM 5MM</b></p> <p>31-9085YC Complete Instrument    31-9085 Replacement Insert</p>
	<p><b>FENESTRATED GRASPING FORCEPS 33CM 5MM</b></p> <p>31-9090YC Complete Instrument    31-9090 Replacement Insert</p>
	<p><b>FENESTRATED GRASPING FORCEPS LONG JAWS - 33CM 5MM</b></p> <p>31-9095YC Complete Instrument    31-9095 Replacement Insert</p>
	<p><b>MAXI (FUNDUS) GRASPING FORCEPS 33CM 5MM</b></p> <p>31-9100YC Complete Instrument    31-9100 Replacement Insert</p>
	<p><b>BABCOCK FORCEPS 33CM 5MM</b></p> <p>31-9105YC Complete Instrument    31-9105 Replacement Insert</p>
	<p><b>BIOPSY PUNCH WITH TOOTH 33CM 5MM</b></p> <p>31-9110YC Complete Instrument    31-9110 Replacement Insert</p>
	<p><b>BIOPSY PUNCH WITH SPIKE 33CM 5MM</b></p> <p>31-9115YC Complete Instrument    31-9115 Replacement Insert</p>
	<p> </p>



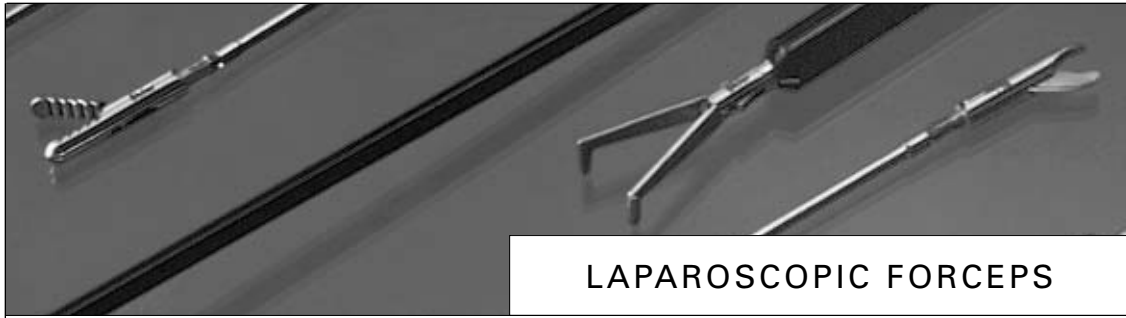

## LAPAROSCOPIC FORCEPS

SKLARTECH  
**5000**

### MARYLAND DISSECTOR DIAMOND SERRATIONS - 33CM 10MM

31-9120XC Complete Instrument    31-9120 Replacement Insert



### MIXTER FORCEPS 90° ANGLE - 33CM 10MM

31-9125XC Complete Instrument    31-9125 Replacement Insert



### CLAW FORCEPS 33CM 10MM

31-9130XC Complete Instrument    31-9130 Replacement Insert



### SPOON FORCEPS 33CM 10MM

31-9135XC Complete Instrument    31-9135 Replacement Insert

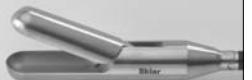

### BABCOCK FORCEPS 33CM 10MM

31-9140YC Complete Instrument    31-9140 Replacement Insert



**INSULATED CANNULA 33CM 10MM**  
31-9150 with permanent locking collar attached



**COMPLETE INSTRUMENT:**  
**INSERT WITH TIP**  
**INSULATED CANNULA**  
**HANDLE WITH COLLAR**

The replacement insert and insulated cannula are easily separated for cleaning and reprocessing by gently unscrewing the insert from the cannula. To re-attach these parts simply align the tip and cannula and screw back together.

As with all Sklar complete laparoscopic instruments, the handles and replacement inserts are easily interchangeable to perform as intended and required by the surgeon. A Sklartech 5000 instrument includes the handle, insert with tip, the insulating cannula and a locking collar which secures the insert/cannula to the handle while allowing full rotation.

SKLARTECH  
**5000**

**LAPAROSCOPIC HANDLES/CANNULAS**



**SKLAR "XC" CARBON HANDLE**

31-9001XC Lightweight, carbon fiber reinforced non-conductive safety handle with locking collar. Non-ratchet design and fully rotating as well as a proximally positioned high-frequency connector. "XC" handle used primarily with miniature instruments.



**SKLAR "YC" CARBON HANDLE**

31-9002YC Lightweight, carbon reinforced non-conductive safety handle with locking collar. Ratchet design and fully rotating as well as a proximally positioned high-frequency connector. "YC" handle used primarily with miniature instruments.



**REPLACEMENT LOCKING COLLAR**

31-9160



**INSULATED CANNULA 33CM 5MM**  
 31-9155



**INSULATED CANNULA 33CM 10MM**  
 31-9150 with permanent locking collar attached



SKLARTECH  
**5000**

**LAPAROSCOPIC NEEDLE HOLDERS**



**TC NEEDLE HOLDER**  
TUNGSTEN CARBIDE - 5MM SOLID SHAFT

31-2553 non-insulated, solid shaft with in-line handle, tungsten carbide jaw inserts



**TC NEEDLE HOLDER**  
TUNGSTEN CARBIDE - 5MM FLUSHABLE SHAFT

non-insulated, flushable shaft with in-line handle, tungsten carbide jaw inserts

- 31-2550 (A) straight
- 31-2551 (B) curved right
- 31-2552 (C) curved left

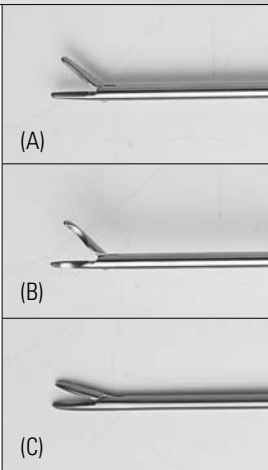

SKLARTECH  
**5000**

**LAPAROSCOPIC TROCARS**

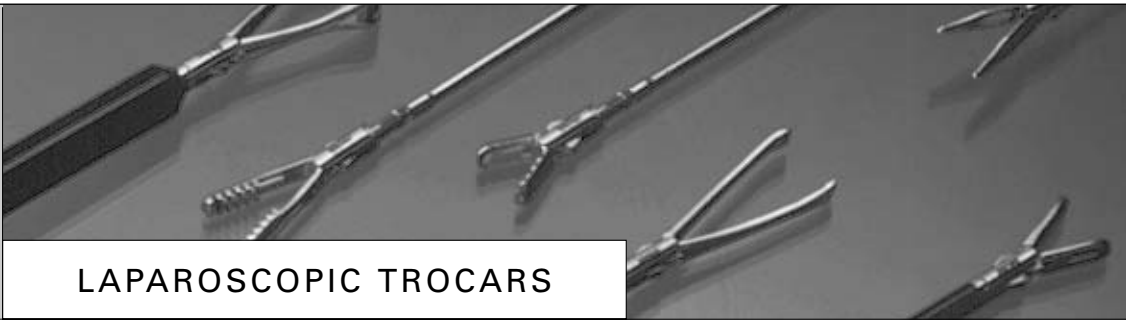

**HASSON TROCAR 11MM WITH OBTURATOR**

31-1002 Trumpet Valve – complete with 11mm obturator  
31-0004 Replacement Obturator



**S-RETRACTOR**

60-6130 Set of 2



**STANDARD TRUMPET VALVE CANNULA & TROCAR**

31-1007 Trumpet valve cannula with 5.5mm trocar



**THREADED CANNULA SLEEVE  
INTERCHANGEABLE WITH STANDARD SMOOTH CANNULA**

31-1020 5.5mm



**SNAP ON FLIP REDUCER**

31-1042 11mm to 5.5mm

**TROCAR CANNULA SEALS**

	3 mm	5.5 mm	11 mm	12 mm	Hasson 11 mm
<b>External Seal</b> For Use With Trap Door And Trumpet Valve Cannula	Red 31-4320	Red 31-0003	Blue 31-0001	Green 31-0010	Blue/Gray 31-0001/31-0002
<b>Internal Seal</b> For Use With Trap Door Cannula	Gray 31-4321	Gray 31-4323	Yellow 31-4324		Yellow 31-4324



SKLARTECH  
**5000**

**LAPAROSCOPIC ELECTROSURGERY**

**INSULATED ELECTRODES, WITH SUCTION**

- 31-2235 (A) Spatula Electrode 5mm
- 31-2237 (B) L-Hook Electrode 5mm
- 31-2241 (C) J-Hook Electrode 5mm
- 31-2243 (D) Blunt Electrode 5mm
- 31-2244 (E) Button Electrode 5mm

Each coagulating electrode (A through E) is able to connect to the suction control valve of choice listed below, choose from A, B, or C. Insulated electrode and valve ordered separately.

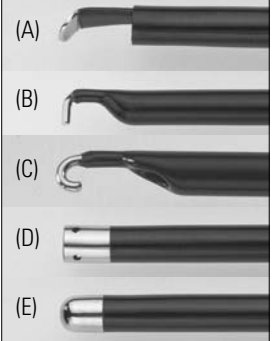

**HIGH FREQUENCY SUCTION CONTROL VALVES**

- 31-2227 (A) Insulated Suction Control with Single Trumpet Valve
- 31-2233 (B) Insulated Suction Control with Double Trumpet Valve
- 31-2229 (C) Insulated Suction Control with Double Trumpet Valve and Handle

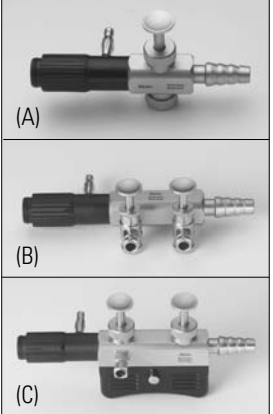

**ELECTROSURGICAL CABLE**

- 31-2242 Monopolar



**INSULATED ELECTRODES, WITHOUT SUCTION**

- 31-2435 (A) Spatula Electrode 5mm
- 31-2437 (B) L-Hook Electrode 5mm
- 31-2443 (C) J-Hook Electrode 5mm
- 31-2445 (D) Button Electrode 5mm
- 31-2447 (E) Cone Electrode 5mm

Each electrode has a permanently fitted adapter for connecting to the electro-surgical cable. Cable is ordered separately.

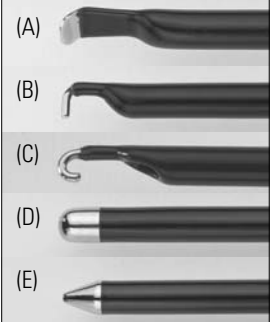

SKLARTECH  
**5000**

LAPAROSCOPIC SUCTION/IRRIGATION



**SUCTION IRRIGATION SYSTEM NON-INSULATED**

- 31-2238 (A) Dual Trumpet Valve – fits 5mm or 10mm Sheath (includes 5mm Sheath)
- 31-2258 (B) Single Trumpet Valve – fits 5mm or 10mm Sheath (includes 5mm Sheath)
- 31-4003 (C) 5mm Sheath only
- 31-4004 10mm Sheath only (not shown)



**HIGH VOLUME SUCTION IRRIGATION SYSTEM NON-INSULATED**

- 31-2239 (A) Dual Trumpet Valve – includes 5mm and 10mm Sheath (shown with 10mm Sheath)
- 31-2347 (B) 5mm Replacement Sheath
- 31-2349 (C) 10mm Replacement Sheath



SKLARTECH  
**5000**

**LAPAROSCOPIC ACCESSORIES**

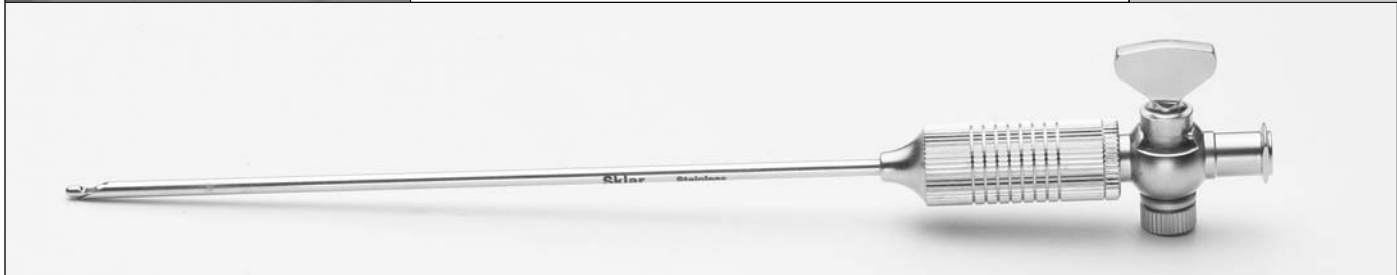

**VERRES NEEDLE WITH STOPCOCK**

- 31-2327 100mm
- 31-2350 120mm
- 31-2352 150mm



**NEEDLE FOR INJECTION & IRRIGATION**

- 31-2355 Luer Lock – 33CM 5mm



**GRADUATED PROBE**

- 31-2365 33CM 5mm

SKLARTECH  
**5000**  
 MINIATURE



**MINIATURE LAPAROSCOPIC SCISSORS**



**MINIATURE METZENBAUM SCISSORS**  
 STRAIGHT - 33CM 3MM

31-4306XC Complete Instrument    31-4306 Replacement Cannula/Insert (one piece)



**MINIATURE METZENBAUM SCISSORS**  
 CURVED - 33CM 3MM

31-4303XC Complete Instrument    31-4303 Replacement Cannula/Insert (one piece)



**MINIATURE HOOK SCISSORS**  
 33CM 3MM

31-4304XC Complete Instrument    31-4304 Replacement Cannula/Insert (one piece)



**MINIATURE PUNCH**  
 33CM 3MM

31-4305XC Complete Instrument    31-4305 Replacement Cannula/Insert (one piece)



"XC" Handle



"YC" Handle

Complete Instrument:  
 Handle with collar and  
 cannula/insert













The complete Miniature Laparoscopic instrument is provided with the much lighter carbon handle in either ratchet (YC) or non-ratchet (XC) pattern. However, unlike the standard laparoscopic instrument, the insert/cannula, either as part of a complete instrument or as a replacement, is a permanent one-piece construction.





SKLARTECH  
**5000**  
 MINIATURE

**MINIATURE LAPAROSCOPIC FORCEPS**

	<p><b>MINIATURE MARYLAND DISSECTOR</b>            CROSS SERRATIONS – 33CM 3MM</p> <p>31-4310XC Complete Instrument    31-4310 Replacement Cannula/Insert (one piece)</p>	
	<p><b>MINIATURE ATRAUMATIC DISSECTOR</b>            33CM 3MM</p> <p>31-4311XC Complete Instrument    31-4311 Replacement Cannula/Insert (one piece)</p>	
<p>Complete Instruments at right include "XC" Handle</p>	<p><b>MINIATURE SPOON FORCEPS</b>            33CM 3MM</p> <p>31-4315XC Complete Instrument    31-4315 Replacement Cannula/Insert (one piece)</p>	
	<p><b>MINIATURE KELLY FORCEPS</b>            33CM 3MM</p> <p>31-4309XC Complete Instrument    31-4309 Replacement Cannula/Insert (one piece)</p>	
	<p><b>MINIATURE DUCK NOSE FORCEPS</b>            33CM 3MM</p> <p>31-4314YC Complete Instrument    31-4314 Replacement Cannula/Insert (one piece)</p>	
	<p><b>MINIATURE FENESTRATED GRASPING FORCEPS</b>            33CM 3MM</p> <p>31-4317YC Complete Instrument    31-4317 Replacement Cannula/Insert (one piece)</p>	
<p>Complete Instruments at right include "YC" Handle</p>	<p><b>MINIATURE COBRA GRASPING FORCEPS</b>            33CM 3MM</p> <p>31-4313YC Complete Instrument    31-4313 Replacement Cannula/Insert (one piece)</p>	
	<p><b>MINIATURE NEEDLEHOLDER</b>            33CM 3MM</p> <p>31-9360AX Complete Instrument</p>	
	<p><b>MINIATURE NEEDLEHOLDER</b>            33CM 3MM</p> <p>31-9362AX Complete Instrument</p>	
<p>Complete Instruments at right include Axial Handle</p>	<p><b>MINIATURE NEEDLEHOLDER</b>            33CM 3MM</p> <p>31-9364AX Complete Instrument</p>	

SKLARTECH  
**5000**  
 MINIATURE

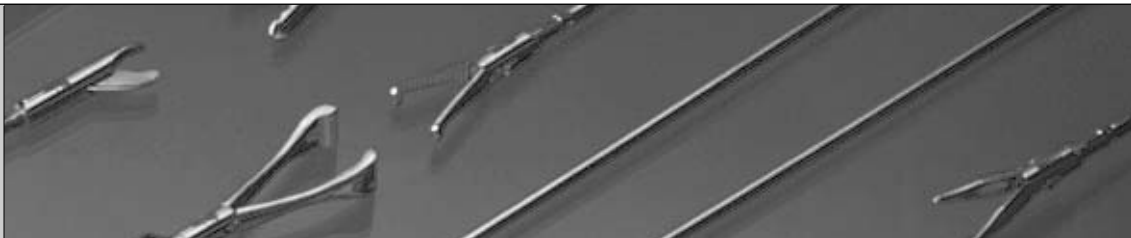

**MINIATURE LAPAROSCOPIC ACCESSORIES**



**SKLAR "XC" CARBON HANDLE**

31-9001XC Lightweight, carbon fiber reinforced non-conductive safety handle with locking collar. Non-ratchet design and fully rotating as well as a proximally positioned high-frequency connector.



**SKLAR "YC" HANDLE**

31-9002YC Lightweight, carbon fiber reinforced non-conductive safety handle with locking collar. Ratchet design and fully rotating as well as a proximally positioned high-frequency connector.

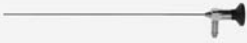

**MINIATURE ENDOSCOPE  
 AUTOCLAVABLE - 3MM**

31-4301



**MINIATURE TROCAR SET  
 REUSABLE - 3MM**

31-4302 Trocar Set  
 31-4318 Replacement Obturator 3mm

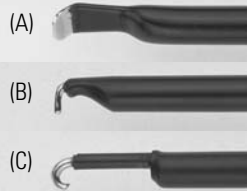

**MINIATURE ELECTRODES, WITHOUT SUCTION  
 HIGH FREQUENCY, INSULATED - 3MM**

31-4325 (A) Spatula Electrode  
 31-4326 (B) L-Hook Electrode  
 31-4327 (C) J-Hook Electrode

Each electrode has a permanently fitted adapter for connecting to the electro-surgical cable (ordered separately).



**ELECTROSURGICAL CABLE**

31-2242 Monopolar



# Sklar

## NEW! Sterile Disposable Laparoscopic Instruments

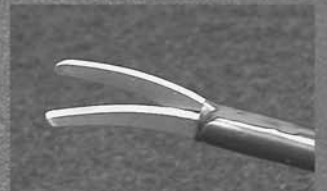
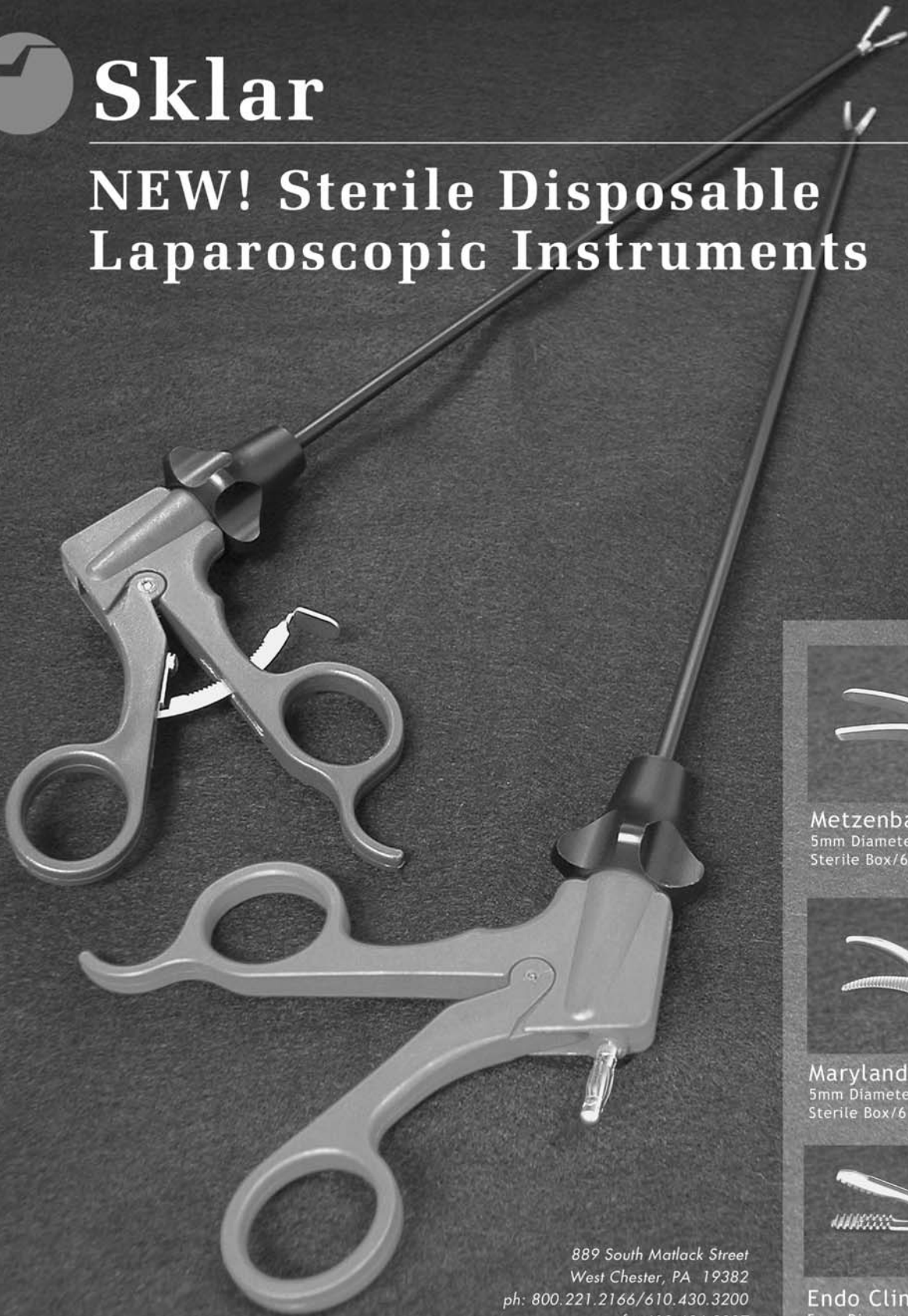

**Metzenbaum Scissor**  
5mm Diameter, 32cm Length  
Sterile Box/6 Item #31-5700



**Maryland Dissector**  
5mm Diameter, 32cm Length  
Sterile Box/6 Item #31-5701

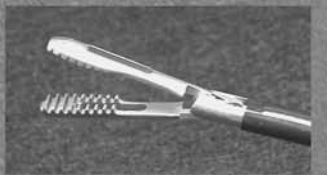

**Endo Clinch Grasper**  
5mm Diameter, 32cm Length  
Sterile Box/6  
Item #31-5702 w/ratchet  
Item #31-5703 w/o ratchet

889 South Mallack Street  
West Chester, PA 19382  
ph: 800.221.2166/610.430.3200  
fx: 610.696.9007  
e-mail: [surgi@sklarcorp.com](mailto:surgi@sklarcorp.com)

[www.sklarcorp.com](http://www.sklarcorp.com)

# DIAGNOSTIC INSTRUMENTS

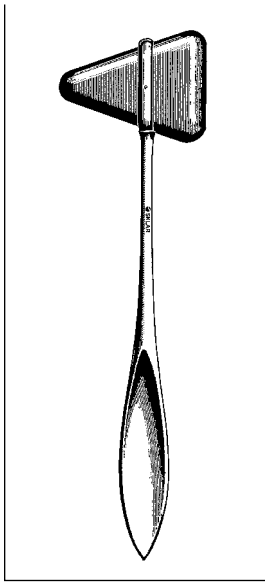

**TAYLOR PERCUSSION HAMMER**

Solid Handle  
06-3170 Small 7"  
06-3175 Large 7½"

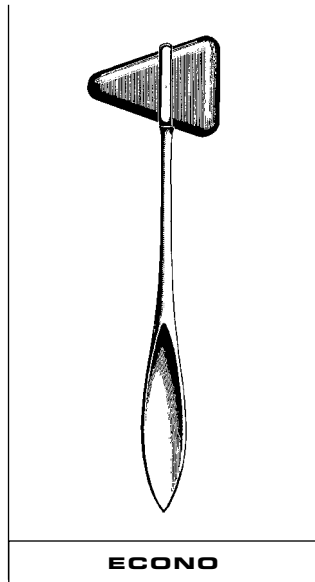

**ECONO**

**TAYLOR PERCUSSION HAMMER, ECONO**

Box/12  
21-010 Adult

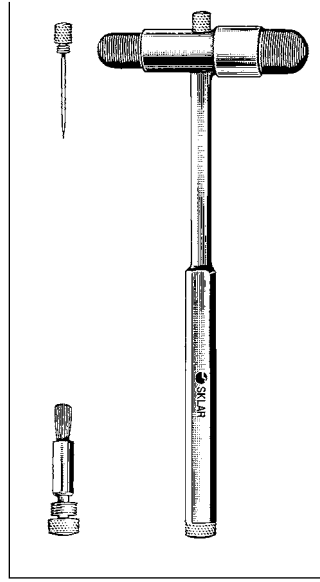

**BUCK NEUROLOGICAL HAMMER**

With Pin and Brush  
06-3370

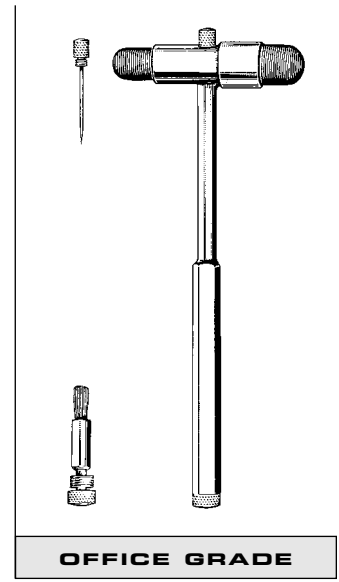

**OFFICE GRADE**

**BUCK NEUROLOGICAL HAMMER**

97-021 7" Chrome

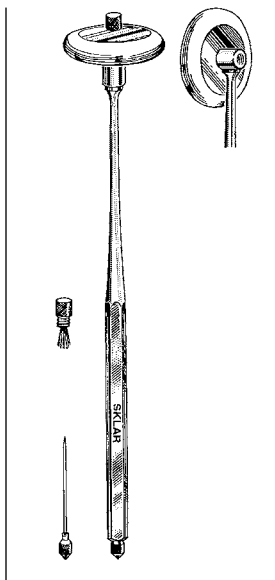

**RABINER NEUROLOGICAL HAMMER**

With Pin and Brush  
06-3290

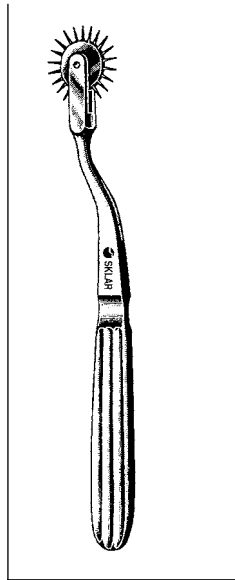

**WARTENBERG NEUROLOGICAL PINWHEEL**

06-3375

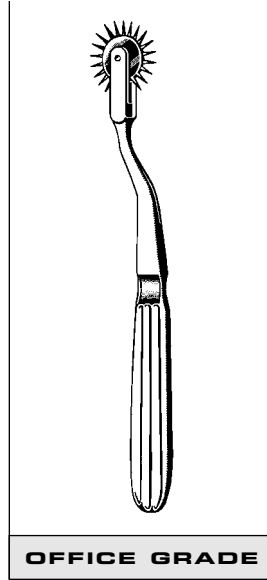

**OFFICE GRADE**

**WARTENBERG NEUROLOGICAL PINWHEEL**

97-029 Chrome

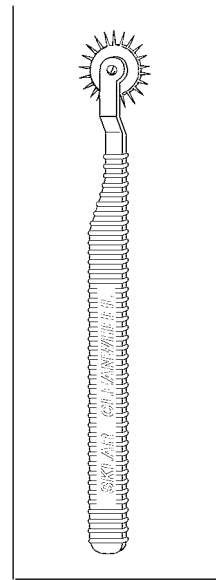

**SKLAR DISPOSABLE CLEANWHEEL**

96-7906 Pack/12  
96-7907 Pack/144

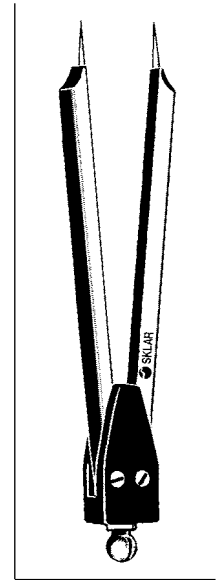

**EKG CALIPER**

06-2808 7"

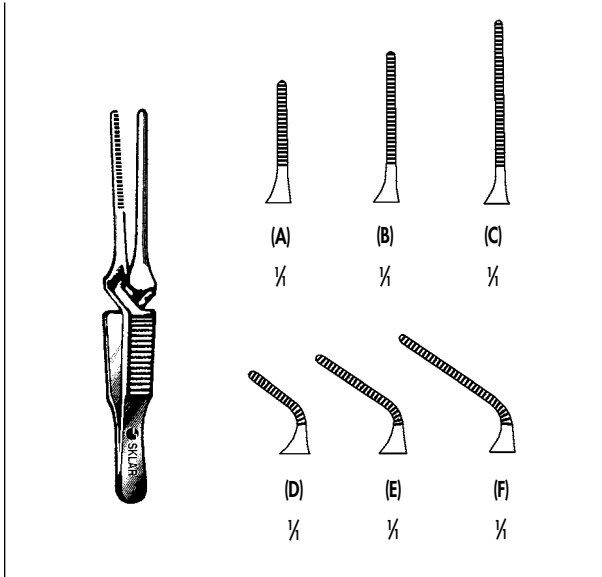

### DIETRICH MICROCORONARY BULLDOG CLAMP

- 98-4008 8 mm Straight (A)
- 98-4012 12 mm Straight (B)
- 98-4020 20 mm Straight (C)
- 98-4108 8 mm Angled (D)
- 98-4112 12 mm Angled (E)
- 98-4120 20 mm Angled (F)



### JOHNS HOPKINS BULLDOG CLAMP

- 52-1415 1½" (3.8 cm)
- 52-1417 1¾" (4.4 cm)
- 52-1420 2" (5.1 cm)
- 52-1422 2¼" (5.7 cm)
- 52-1425 2½" (6.4 cm)
- 52-1427 2¾" (7 cm)
- 52-1430 3" (7.6 cm)
- 52-1435 3½" (8.9 cm)

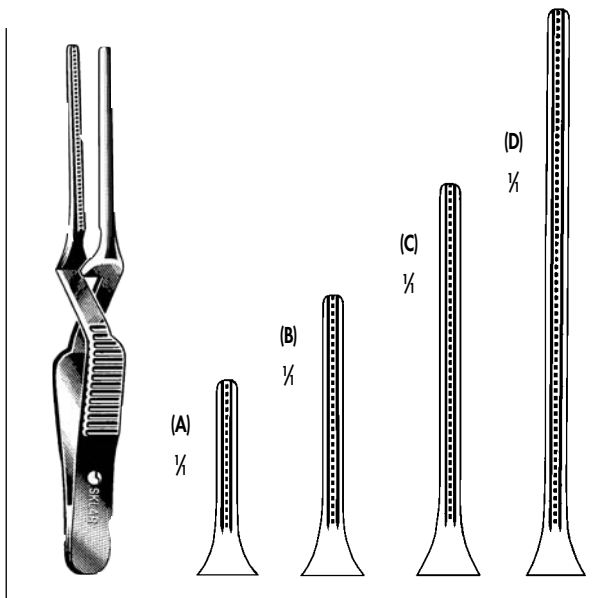

### DEBAKEY BULLDOG CLAMP

Straight Cross Action

- 52-1530 3" (7.6 cm) (A)
- 52-1531 3½" (8.9 cm) (B)
- 52-1532 4¼" (10.8 cm) (C)
- 52-1533 4¾" (12.1 cm) (D)

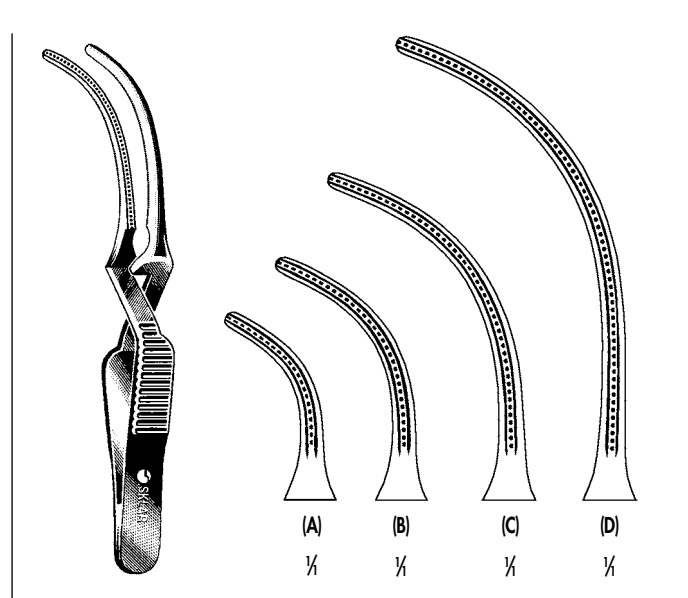

### DEBAKEY BULLDOG CLAMP

Curved Cross Action

- 52-1540 2¾" (7 cm) (A)
- 52-1541 3¼" (7.8 cm) (B)
- 52-1542 4" (10.2 cm) (C)
- 52-1543 4¾" (12.1 cm) (D)

# RECTAL INSTRUMENTS



## McGIVNEY HEMORRHOIDAL LIGATOR SET

The McGivney Hemorrhoidal Ligator Set provides the convenience of a plier handle elastic band applicator.

- It is supplied with a separate loading cone.
- A specially designed double bend forceps that provides better visualization.
- The Ives (Fansler) Rectal Speculum is the instrument of choice for Ligation procedures.

Also included are 100 elastic "O" Rings that can be reordered as 80-1951.

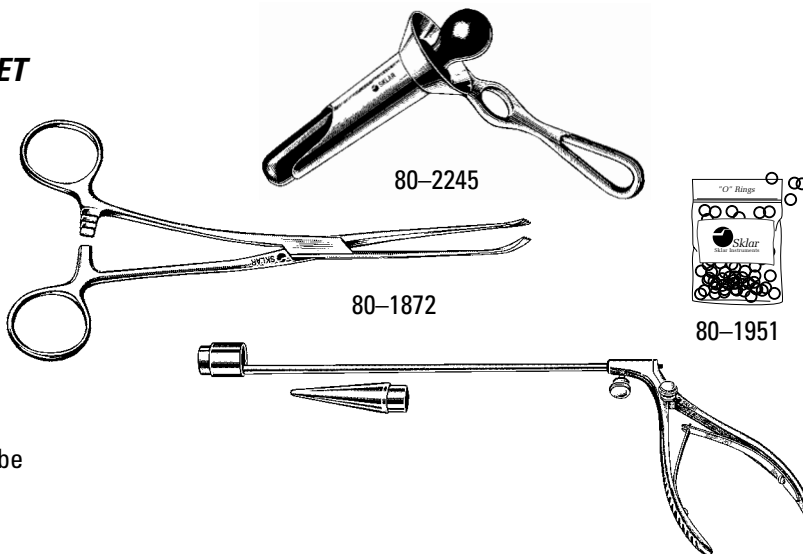

80-1945 Set Includes: Ligator, Forceps, 100 "O" Rings and Speculum

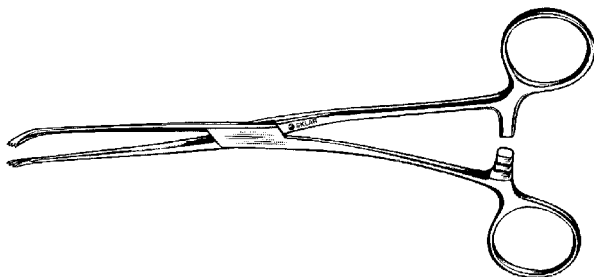

## HEMORRHOIDAL FORCEPS

- 80-1872 7 1/4"
- 80-1960 7 1/2" McGivney

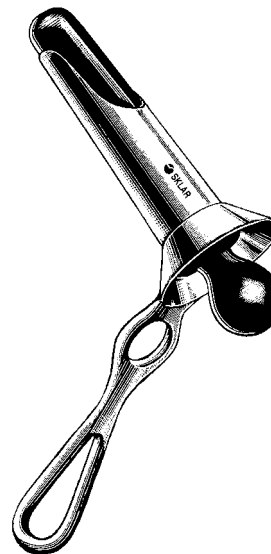

## IVES RECTAL SPECULUM (FANSLER)

- 80-2245 3 1/4" Long
- 80-2244 Obturator only (Autoclavable)

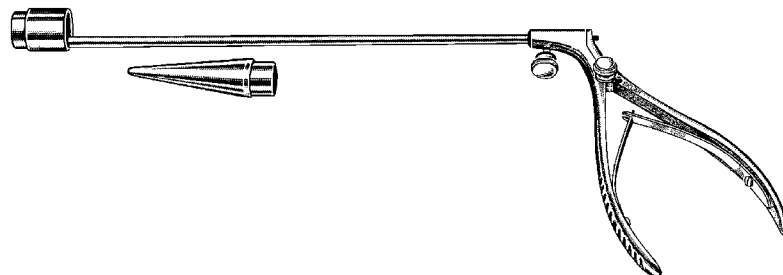

## McGIVNEY HEMORRHOIDAL LIGATOR

- 80-1950 7" Complete With Loading Cone and 100 "O" Rings
- 80-1952 Loading Cone Only for McGivney
- 80-1951 Elastic "O" Rings Package of 100

### **RUDD CLINIC LIGATOR SET**

The Rudd Clinic Hemorrhoidal Ligator is an improved instrument for elastic band ("O" Ring) ligation of hemorrhoids. It is simply designed with only one moving part for greater dependability and trouble-free performance. Separate loading cone facilitates loading "O" ring bands on cylinder.

Instead of suddenly releasing the band around entire hemorrhoid, the Rudd Ligator releases the band from one side of applicator for a more gradual encirclement of the hemorrhoid.

This instrument also features a shorter and wider cylinder to allow for use on larger hemorrhoids and mucosal prolapse. It provides better visibility ... before, during and after ligation to assure proper placement of bands.

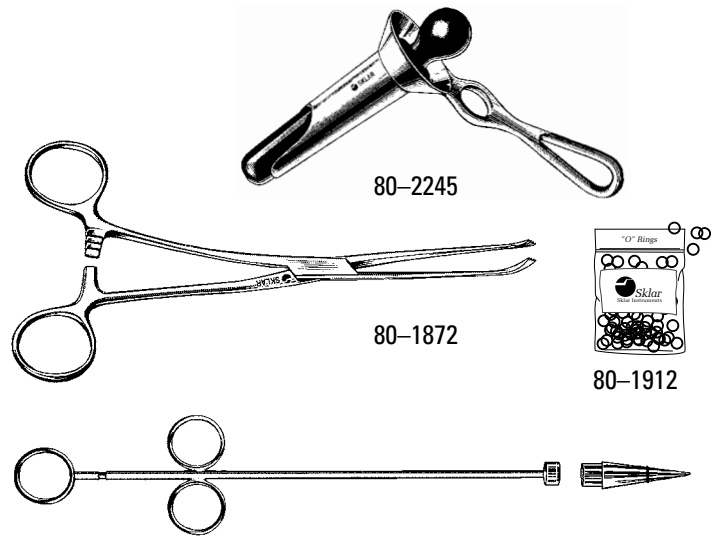

80-1914 Set Includes: Ligator, Forceps, 100 "O" Rings and Speculum

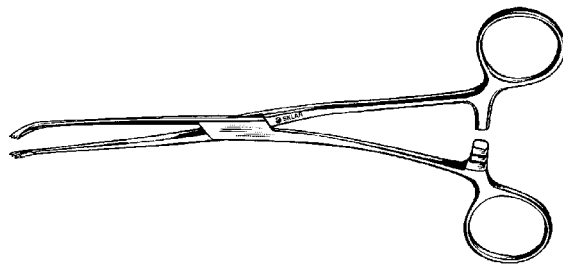

### **HEMORRHOIDAL FORCEPS**

80-1872 7 1/4"

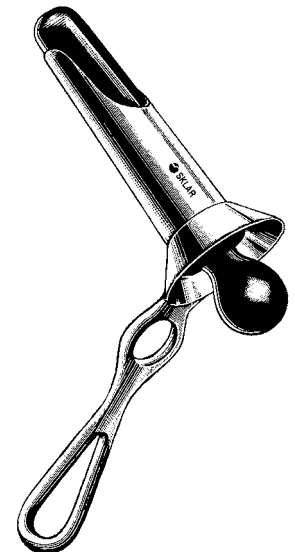

### **IVES RECTAL SPECULUM (FANSLER)**

80-2245 3 1/4" Long  
80-2244 Obturator only (Autoclavable)



### **RUDD CLINIC HEMORRHOIDAL LIGATOR**

With Loading Cone and 100 "O" Rings

80-1910 Complete  
80-1911 Loading Cone Only  
80-1912 Ligating "O" Rings  
Package of 100

# DIAGNOSTIC INSTRUMENTS DISPOSABLE



The Sklar Tru-Punch™ has a “seamless” steel tip carefully honed for a razor sharp incision and perfect sample. The ribbed and hollow handle permits tissue to be easily dislodged.

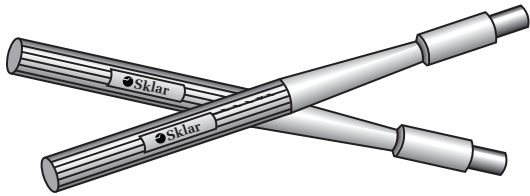

**Box/25**

## SKLAR TRU-PUNCH™ – DISPOSABLE DERMAL BIOPSY PUNCH

Box/25, Sterile  
 96-1140 2mm  
 96-1142 3mm  
 96-1144 3.5mm  
 96-1146 4mm  
 96-1148 5mm  
 96-1150 6mm  
 96-1152 8mm

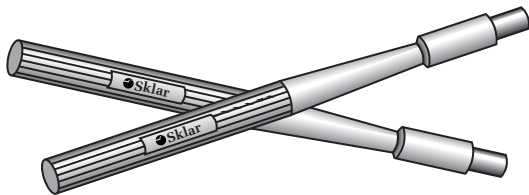

**Box/50**

## SKLAR TRU-PUNCH™ – DISPOSABLE DERMAL BIOPSY PUNCH

Box/50, Sterile  
 96-1100 2mm  
 96-1105 3mm  
 96-1110 3.5mm  
 96-1115 4mm  
 96-1120 5mm  
 96-1125 6mm  
 96-1130 8mm

## SKLAR TRU-PUNCH™ – DISPOSABLE DERMAL BIOPSY PUNCH

Box/25, Sterile  
 96-1160 Assorted  
 (5 of each - 2, 3, 3.5, 4, 5)

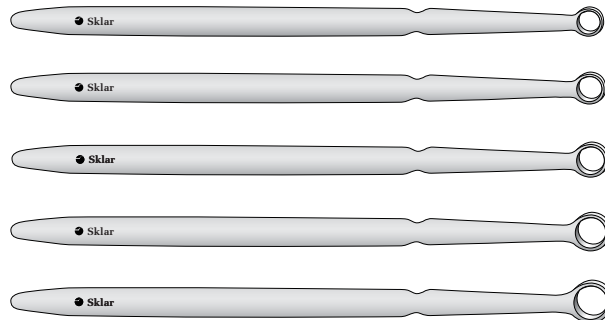

## SKLAR DISPOSABLE DERMAL CURETTES

Surgical Steel Tip with Plastic Handle, Box of 25  
 Individually Packaged in Sterile Pouches

96-1190	2mm	96-1194	4mm	96-1198	7mm
96-1192	3mm	96-1196	5mm	96-1199	Assorted 5 of Each

The surgical grade steel tip is mounted on a sturdy plastic handle and correctly positioned to efficiently affect curettage.



**NEW!**

## NEEDLESTICK PROTECTION!



**The Sklar Retractable Safety Syringe utilizes two separate features which guard against accidental needlesticks.**

- *After injection, the needle is easily retracted into the syringe barrel.*
- *Exposing a used needle is impossible once retracted since the plunger becomes unusable.*

### **RETRACTABLE SAFETY SYRINGES**

3cc Syringe L/L Needle, Box/100

62-3740	25g x 5/8 Needle	62-3755	Syringe only
62-3742	25g x 1 Needle		
62-3744	23g x 1 Needle		
62-3746	22g x 1 Needle		
62-3748	22g x 1-1/2 Needle		
62-3752	21g x 1-1/2 Needle		

5cc Syringe L/L Needle, Box/100

62-4720	21g x 1-1/2 Needle	62-4722	Syringe only
62-4721	22g x 1-1/2 Needle		

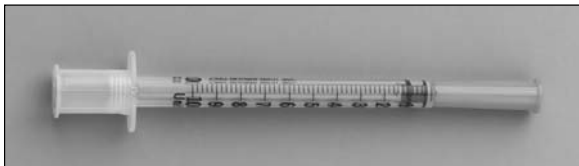

### **INSULIN SYRINGES**

Luer-Slip Cs/1,000 10 boxes/100

62-1648	27 ga. x 1/2 Needle	1cc	U100
	Needle-Dual Scale		

Luer-Slip Box of 100

62-1648m	27 ga. x 1/2 Needle	1cc	U100
	Needle-Dual Scale		

### **TUBERCULIN SYRINGES**

Luer-Slip 1cc Cs/1,000 10 boxes/100

62-1645	27 ga. x 1/2 Needle
62-1646	25 ga. x 3/8 Needle
62-1659	w/o Needle

Luer-Slip Box of 100

62-1645m	27 ga. x 1/2 Needle
62-1646m	25 ga. x 3/8 Needle
62-1659m	w/o Needle



## 3CC SYRINGES

Luer-Lock 3cc Cs/1000 10 boxes/100

62-3702	25 ga. x 3/8 Needle	62-3711	21 ga. x 1 Needle
62-3703	25 ga. x 1 Needle	62-3713	21 ga. x 1 1/2 Needle
62-3704	25 ga. x 1 1/2 Needle	62-3715	20 ga. x 1 Needle
62-3706	23 ga. x 1 Needle	62-3716	20 ga. x 1 1/2 Needle
62-3707	22 ga. x 3/8 Needle	62-3717	18 ga. x 1 1/2 Needle
62-3708	22 ga. x 1 Needle	62-3718	w/o Needle
62-3710	22 ga. x 1 1/2 Needle		

Luer-Lock 3cc Box of 100

62-3702m	25 ga. x 3/8 Needle	62-3711m	21 ga. x 1 Needle
62-3703m	25 ga. x 1 Needle	62-3713m	21 ga. x 1 1/2 Needle
62-3704m	25 ga. x 1 1/2 Needle	62-3715m	20 ga. x 1 Needle
62-3706m	23 ga. x 1 Needle	62-3716m	20 ga. x 1 1/2 Needle
62-3707m	22 ga. x 3/8 Needle	62-3717m	18 ga. x 1 1/2 Needle
62-3708m	22 ga. x 1 Needle	62-3718m	w/o Needle
62-3710m	22 ga. x 1 1/2 Needle		

Luer-Slip 3cc

Cs/1000	10 boxes/100
62-3602	w/o Needle
Luer-Slip	3cc
Box of 100	
62-3602m	w/o Needle



## 5CC SYRINGES

Luer-Lock 5cc Cs/1000 10 boxes/100

62-4701	22 ga. x 1 Needle	62-4701m	22 ga. x 1 Needle
62-4702	22 ga. x 1 1/2 Needle	62-4702m	22 ga. x 1 1/2 Needle
62-4703	21 ga. x 1 Needle	62-4703m	21 ga. x 1 Needle
62-4704	21 ga. x 1 1/2 Needle	62-4704m	21 ga. x 1 1/2 Needle
62-4705	20 ga. x 1 Needle	62-4705m	20 ga. x 1 Needle
62-4706	20 ga. x 1 1/2 Needle	62-4706m	20 ga. x 1 1/2 Needle
62-4707	w/o Needle	62-4707m	w/o Needle

Luer-Slip 5cc Cs/1000 10 boxes/100

62-4628 w/o Needle

Box of 100

62-4628m w/o Needle

Bulk Syringes

62-4714 Luer-Lock 5cc Cs/3000



## ALCOHOL PREP PAD

96-1681	Bx/200
96-1682	Cs/1000, 5 Bxs/200



## 10CC SYRINGES

Luer-Lock 10cc Cs/1000 10 boxes/100

62-6701 22 ga. x 1 Needle  
 62-6702 22 ga. x 1½ Needle  
 62-6703 21 ga. x 1 Needle  
 62-6704 21 ga. x 1½ Needle  
 62-6705 20 ga. x 1 Needle  
 62-6706 20 ga. x 1½ Needle  
 62-6707 w/o Needle

Luer-Lock 10cc Box of 100

62-6701m 22 ga. x 1 Needle  
 62-6702m 22 ga. x 1½ Needle  
 62-6703m 21 ga. x 1 Needle  
 62-6704m 21 ga. x 1½ Needle  
 62-6705m 20 ga. x 1 Needle  
 62-6706m 20 ga. x 1½ Needle  
 62-6707m w/o Needle

Bulk Syringes

62-6634 Luer-Slip 10cc Cs/1800  
 Eccentric Tip

Luer-Slip 10cc  
 Cs/1000 10 boxes/100

62-6633 w/o Needle  
 Luer-Slip 10cc  
 Box of 100  
 62-6633m w/o Needle



## 20CC SYRINGES

Luer-Lock 20cc Cs/500 10 boxes/50

62-7701 w/o Needle

Luer-Slip 20cc Cs/500 10 boxes/50

62-7625 w/o Needle  
 Eccentric Tip

Luer-Lock 20cc Box of 50

62-7701m w/o Needle

Luer-Slip 20cc Box of 50

62-7625m w/o Needle  
 Eccentric Tip

Bulk Syringes

62-7627 Luer-Slip 20cc Cs/900  
 Eccentric Tip

62-7706 Luer-Lock 20cc Cs/900



## ALCOHOL PREP PAD

96-1681 Bx/200

96-1682 Cs/1000, 5 Bxs/200

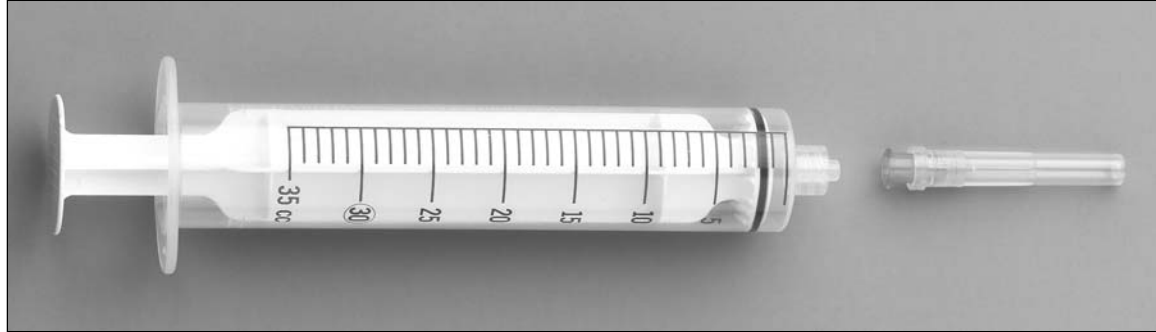

## 35CC SYRINGES

Luer-Lock 35cc Cs/200 10 boxes/20  
62-9553 w/o Needle

Luer-Slip 35cc Cs/200 10 boxes/20  
62-9503 w/o Needle

Luer-Lock 35cc Box of 20  
62-9553m w/o Needle

Luer-Slip 35cc Box of 20  
62-9503m w/o Needle

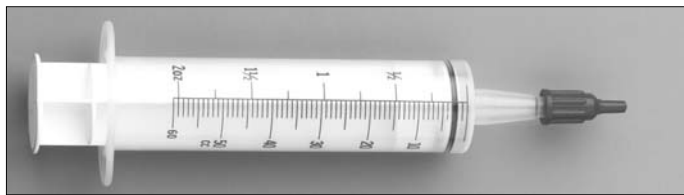

## 60CC SYRINGES

Luer-Lock 50/60cc Cs/100 4 boxes/25  
62-8453 w/o Needle

### Bulk Syringes

62-8464 Catheter Tip 60cc Cs/400  
62-8465 Luer-Lock 60cc Cs/400  
62-8485 w/o Needle Eccentric Tip Cs/400

Catheter Tip 50/60cc  
Cs/100 4 boxes/25  
62-8454 w/o Needle

Box/25  
62-8474 w/o Needle  
62-8494 w/o Needle Eccentric Tip

## ALCOHOL PREP PAD

96-1681 Bx/200  
96-1682 Cs/1000, 5 Bxs/200



### 100CC SYRINGES

Catheter Tip 100cc Cs/150 10 boxes/15 Box/15  
 62-8714 w/o Needle 62-8714m w/o Needle



### ALCOHOL PREP PAD

96-1681 Bx/200  
 96-1682 Cs/1000, 5 Bxs/200



### SUPERSOFT™ HYPODERMIC NEEDLES

Single Use Cs/1000 10 boxes/100

62-181000	18 ga. x 1	Needle	Pink
62-181500	18 ga. x 1½	Needle	Pink
62-200700	20 ga. x ¾	Needle	Yellow
62-201000	20 ga. x 1	Needle	Yellow
62-201500	20 ga. x 1½	Needle	Yellow
62-211000	21 ga. x 1	Needle	Green
62-211500	21 ga. x 1½	Needle	Green
62-220700	22 ga. x ¾	Needle	Black
62-221000	22 ga. x 1	Needle	Black
62-221500	22 ga. x 1½	Needle	Black
62-231000	23 ga. x 1	Needle	Blue
62-250600	25 ga. x ⅝	Needle	Orange
62-251000	25 ga. x 1	Needle	Orange
62-251500	25 ga. x 1½	Needle	Orange
62-261200	26 ga. x ½	Needle	Tan
62-270500	27 ga. x ½	Needle	Grey

Single Use Boxes/100

62-181000m	18 ga. x 1	Needle	Pink
62-181500m	18 ga. x 1½	Needle	Pink
62-200700m	20 ga. x ¾	Needle	Yellow
62-201000m	20 ga. x 1	Needle	Yellow
62-201500m	20 ga. x 1½	Needle	Yellow
62-211000m	21 ga. x 1	Needle	Green
62-211500m	21 ga. x 1½	Needle	Green
62-220700m	22 ga. x ¾	Needle	Black
62-221000m	22 ga. x 1	Needle	Black
62-221500m	22 ga. x 1½	Needle	Black
62-231000m	23 ga. x 1	Needle	Blue
62-250600m	25 ga. x ⅝	Needle	Orange
62-251000m	25 ga. x 1	Needle	Orange
62-251500m	25 ga. x 1½	Needle	Orange
62-261200m	26 ga. x ½	Needle	Tan
62-270500m	27 ga. x ½	Needle	Grey

# NITRILE EXAM / LATEX EXAM GLOVES



*Introducing the glove that goes beyond the ordinary and gives you protection and comfort you never thought possible. These new gloves will give you all you have been looking for in a Latex or Nitrile Glove.*

## SKLARTOUCH™ NITRILE EXAMINATION GLOVES, POWDERED

Box Of 100, Disposable, Non-Sterile, Dispensing Box  
Pre-Powdered, Ambidextrous, 10" Length

96-2170	Small	96-2176	X-Large
96-2172	Medium	96-2178	XX-Large
96-2174	Large		

Case Of 1000, (10 Boxes Of 100), Disposable,  
Non-Sterile, Pre-Powdered, Ambidextrous, 10" Length

96-3170	Small	96-3176	X-Large
96-3172	Medium	96-3178	XX-Large
96-3174	Large		

**"Caution: Powder should be removed from gloves after donning by wiping gloves thoroughly with a sterile wet sponge, sterile wet towel or other effective method."**

## SKLARTOUCH™ NITRILE EXAMINATION GLOVES, POWDER-FREE

Box Of 100, Disposable, Non-Sterile, Dispensing Box  
Powder-Free, Ambidextrous, 10" Length

96-2190	Small	96-2196	X-Large
96-2192	Medium	96-2198	XX-Large
96-2194	Large		

Case Of 1000, (10 Boxes Of 100), Disposable,  
Non-Sterile, Powder-Free, Ambidextrous, 10" Length

96-3190	Small	96-3196	X-Large
96-3192	Medium	96-3198	XX-Large
96-3194	Large		

## SKLARTOUCH™ LATEX EXAMINATION GLOVES, POWDERED

Box Of 100, Disposable, Non-Sterile, Dispensing Box  
Pre-Powdered, Ambidextrous, 10" Length

96-2180	Small	96-2184	Large
96-2182	Medium	96-2186	X-Large

Case Of 1000, (10 Boxes Of 100), Disposable,  
Non-Sterile, Pre-Powdered, Ambidextrous, 10" Length

96-3180	Small	96-3184	Large
96-3182	Medium	96-3186	X-Large

**"Caution: This product contains natural rubber latex, which may cause allergic reaction in some individuals."**

## SKLARTOUCH™ LATEX EXAMINATION GLOVES, POWDER-FREE

Box Of 100, Disposable, Non-Sterile, Dispensing Box  
Powder-Free, Ambidextrous, 10" Length

96-2160	Small	96-2164	Large
96-2162	Medium	96-2166	X-Large

Case Of 1000, (10 Boxes Of 100), Disposable,  
Non-Sterile, Powder-Free, Ambidextrous, 10" Length

96-3160	Small	96-3164	Large
96-3162	Medium	96-3166	X-Large

**"Caution: This product contains natural rubber latex, which may cause allergic reaction in some individuals."**

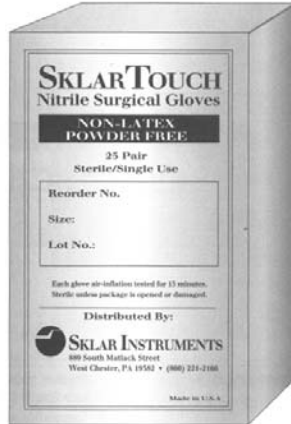

- Patented "thermal" responsive formula made from 100% nitrile.
- Ideal for individuals allergic to latex.
- Delivers excellent barrier protection against bloodborne pathogens.
- "Thermal responsive" nitrile compound quickly and comfortably conforms to the contour of the hand, yielding unparalleled tactile perception.
- Features strong puncture resistance without compromising enhanced tactile perception and dexterity.
- Powder free, latex-free and fragrance free.

### SKLARTOUCH™ NITRILE SURGICAL GLOVES

Case/100 (25 Pair Per Box), Nitrile Surgical Gloves, Powder Free

96-2100	6	96-2106	7.5
96-2102	6.5	96-2108	8
96-2104	7	96-2110	8.5

**Sterile, Hypoallergenic Non-Latex  
Gloves For Unparalleled Protection,  
Comfort and Performance**

### SKLARTOUCH™ LATEX SURGICAL GLOVES

Case/100 (25 Pair Per Box), Powder Free

96-2140	6	96-2146	7.5
96-2142	6.5	96-2148	8
96-2144	7	96-2150	8.5

**"Caution: This product contains  
natural rubber latex, which may  
cause allergic reaction in some  
individuals."**



### SKLAR GLOVE LINERS - CUT RESISTANT, STERILE

96-2136	(S)	Box of 10
96-2137	(M)	Box of 10
96-2138	(L)	Box of 10

**Sklar Glove Liners are manufactured  
of high performance fiber to ensure cut  
resistant hand protection.  
(Disposable)**

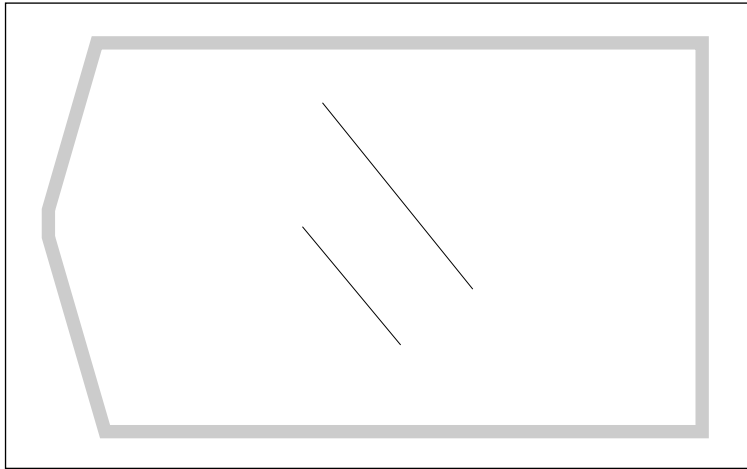

## STERILE POUCHES

Heat Sealed 200/Box

10-1928 3½" x 8½"

10-1930 6" x 10"

10-1931 7½" x 13"

10-1932 10" x 15"

Self Sealed 200/Box

10-1933 3½" x 8"

10-1934 5¼" x 10"

10-1935 7½" x 13"

10-1937 12" x 15"



### STEAM INDICATOR PEN

10-1114 1 Each

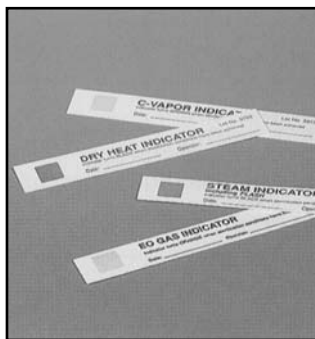

### INDICATOR STRIPS 4"

Box/100

10-1115 EO Gas

10-1117 Dry Heat

10-1119 C-Vapor

Box/250

10-1113 Steam

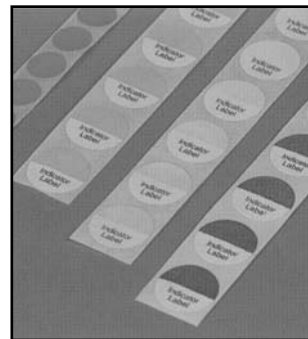

### INDICATOR LABELS

Roll/1000

10-1120 EO Gas

10-1122 Dry Heat

10-1124 C-Vapor

10-1126 Steam

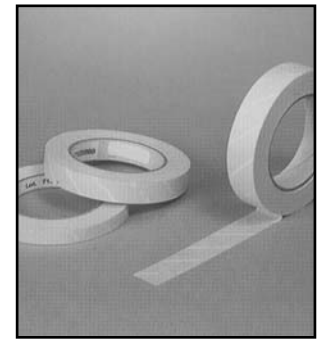

### INDICATOR TAPES

10-1130 Steam 1/2" x 60 yds.

10-1131 Steam 3/4" x 60 yds.

10-1132 Steam 1" x 60 yds.

10-1133 EO Gas 3/4" x 60 yds.

10-1134 Dry Heat 3/4" x 60 yds.

10-1135 C-Vapor 3/4" x 60 yds.



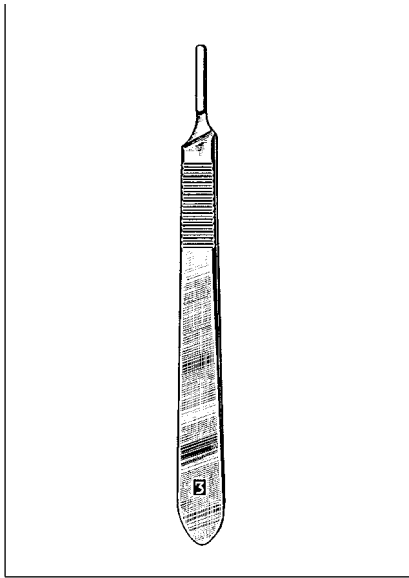

### **SCALPEL HANDLE**

06-2903 Scalpel Handle #3  
fits Blade #10, 11, 12, 15

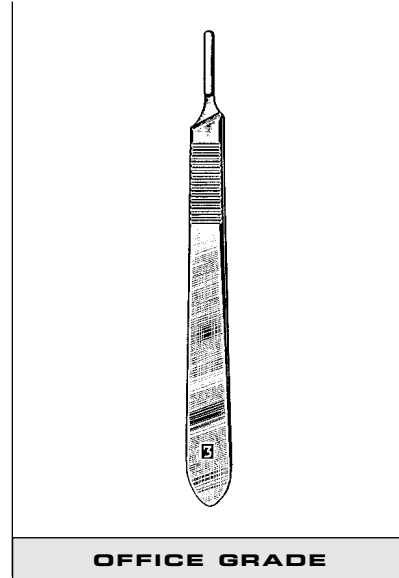

### **SCALPEL HANDLE, ECONO**

97-033 Scalpel Handle #3  
fits Blade #10, 11, 12, 15

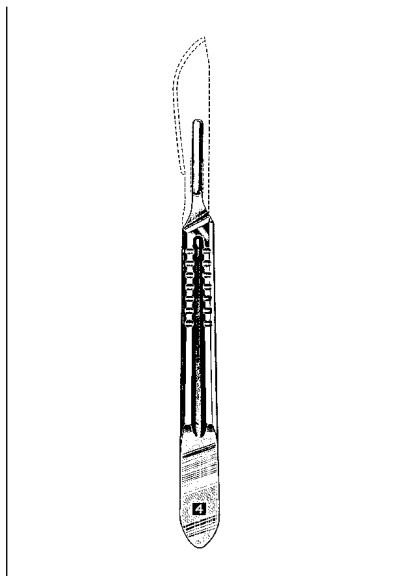

### **SCALPEL HANDLE**

06-2904 Scalpel Handle #4  
fits Blade #20, 21, 22, 23

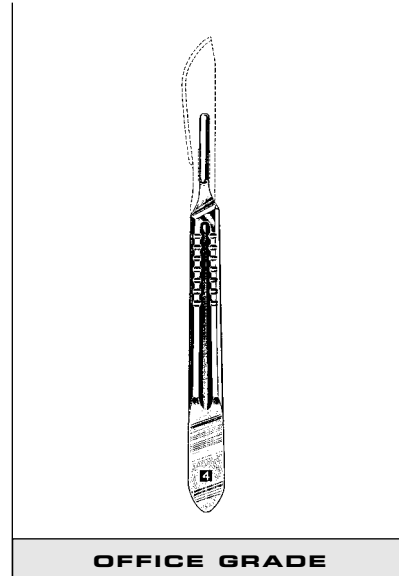

### **SCALPEL HANDLE, ECONO**

97-038 Scalpel Handle #4  
fits Blade #20, 21, 22, 23

# SCALPEL HANDLES

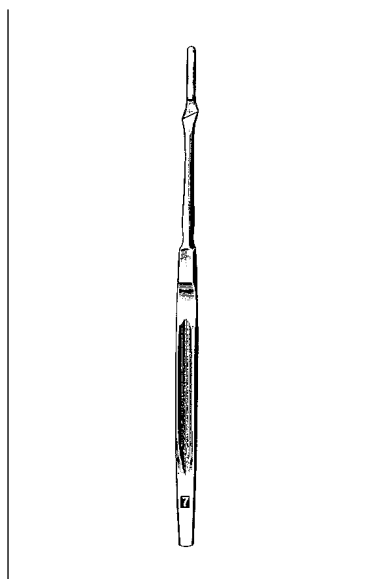

## SCALPEL HANDLE

06-2907 Scalpel Handle #7  
fits Blade #10, 11, 12, 15

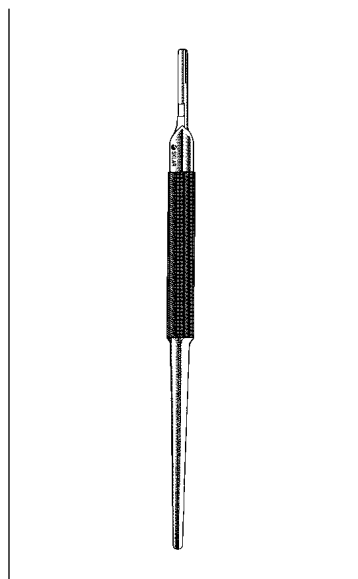

## SCALPEL HANDLE

06-2908 Round Handle  
Straight

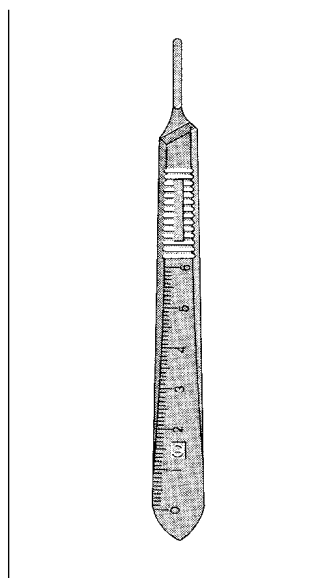

## SCALPEL HANDLE

06-2910 Scalpel Handle #3  
w/metric scale

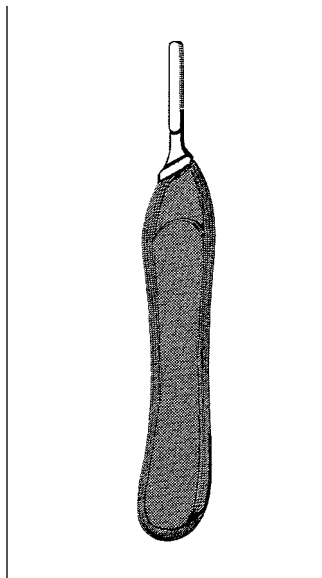

## SCALPEL HANDLE

06-2925 Large Lab Type  
Handle #3

06-2930 Large Lab Type  
Handle #4

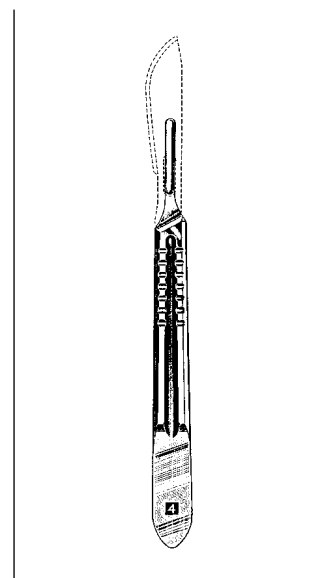

## SCALPEL HANDLE

06-2915 Scalpel Handle #3L  
06-2920 Scalpel Handle #4L

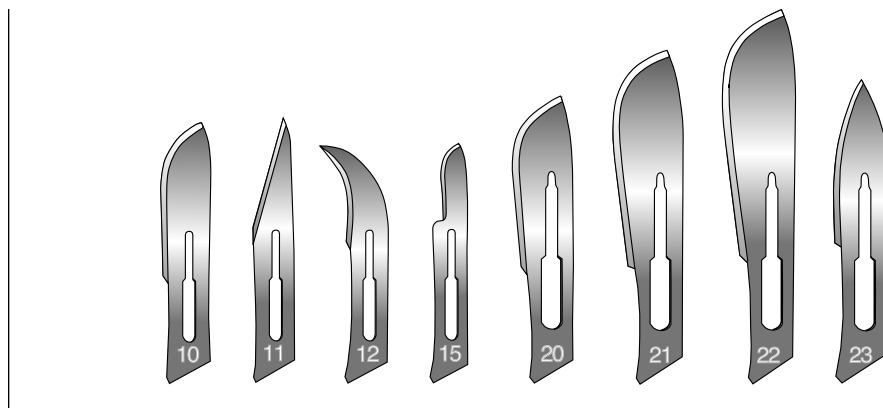

**DISPOSABLE CARBON STEEL SURGICAL BLADES** - Sterile, Box of 100

06-3010	#10	06-3012	#12	06-3020	#20	06-3022	#22
06-3011	#11	06-3015	#15	06-3021	#21	06-3023	#23

**Securely and safely packaged in heavy foil and packed in a dispenser box of 100 blades.**

**Made with English Steel.**

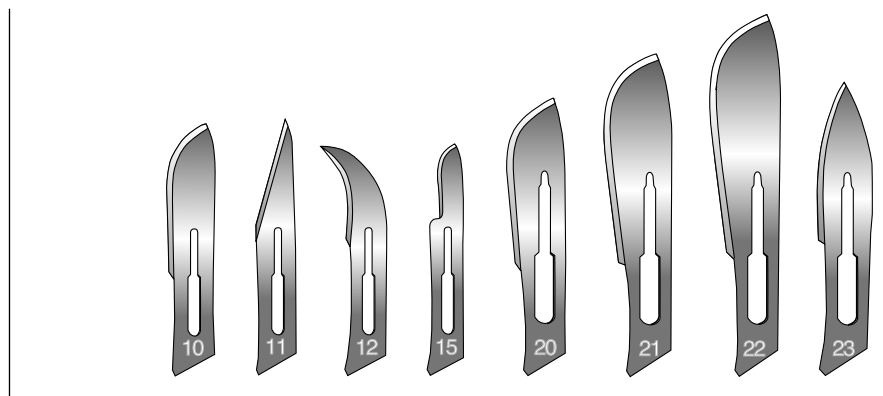

**DISPOSABLE STAINLESS STEEL SURGICAL BLADES** - Sterile, Box of 100

06-3100	#10	06-3102	#12	06-3104	#20	06-3106	#22
06-3101	#11	06-3103	#15	06-3105	#21	06-3107	#23

**Made with English Steel.**

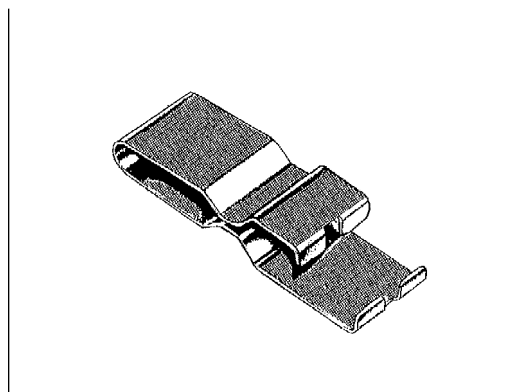

**BLADE REMOVER**

06-3090



**BLADE REMOVER, DISPOSABLE**

96-7460 Sterile, Box of 100

# DISPOSABLE SCALPELS

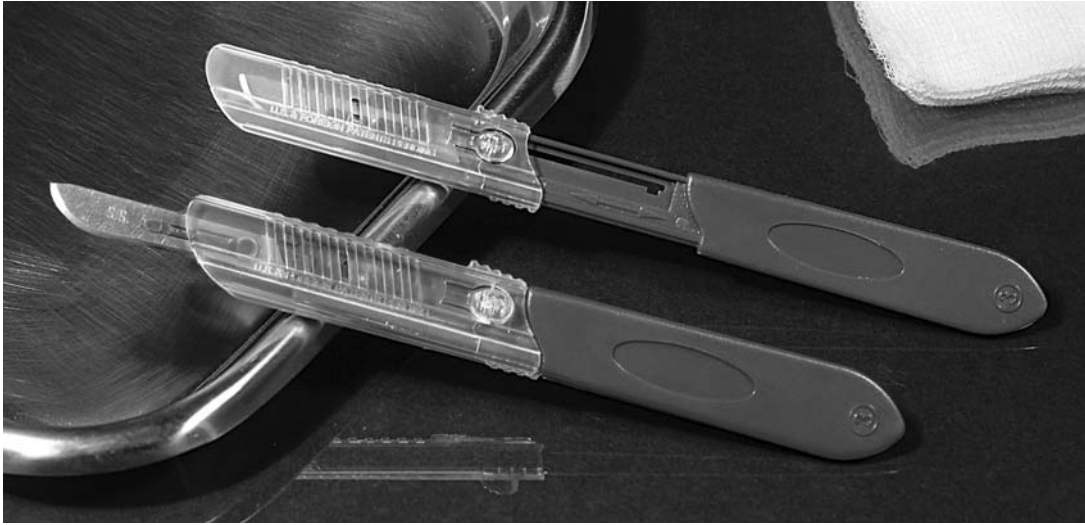

**DISPOSABLE SAFETY SCALPEL** - Sterile, Pack of 10, 25 or 50.

Pack 10		Pack 25		Pack 50	
06-2940	#10	06-2941	#10	06-2942	#10
06-2641	#11	06-2642	#11	06-2643	#11
06-2645	#15	06-2646	#15	06-2647	#15

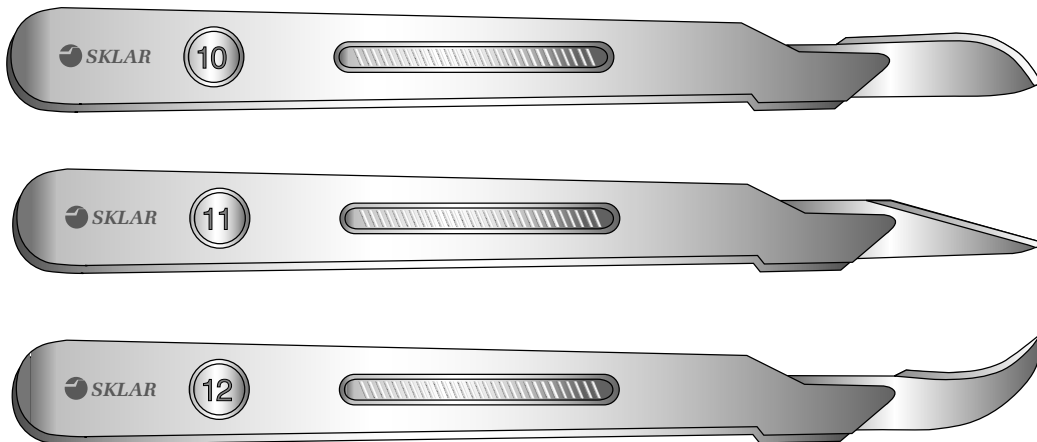

**DISPOSABLE SCALPEL** - Sterile, Pack of 10

06-3110	#10	06-3112	#12	06-3120	#20	06-3122	#22
06-3111	#11	06-3115	#15	06-3121	#21	06-3123	#23

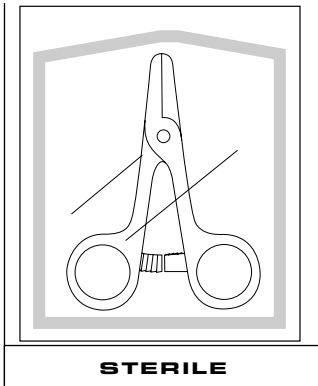

**TUBING CLAMP,  
PLASTIC**

Box of 100, Sterile  
96-2903 Small

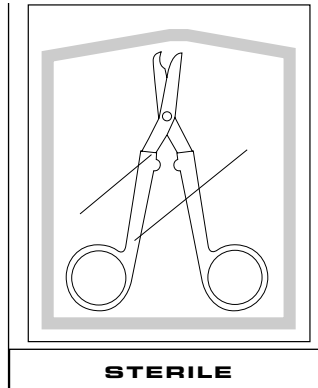

**LITTAUER SUTURE  
SCISSORS, PLASTIC**

Box of 100, Sterile  
96-2906 4½"

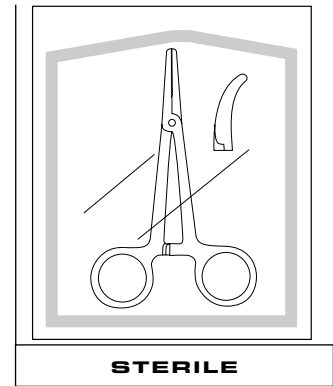

**HEMOSTAT, PLASTIC**

Box of 100, Sterile  
96-2909 5¼" Straight  
96-2910 5¼" Curved

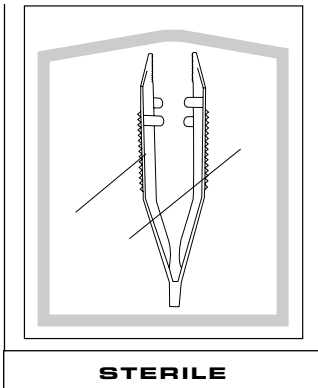

**UTILITY FORCEPS,  
PLASTIC**

Box of 100, Sterile  
96-2915 4" Narrow Jaw

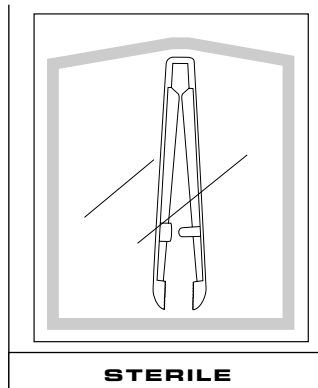

**DRESSING FORCEPS,  
PLASTIC**

Box of 100, Sterile  
96-2917 5"

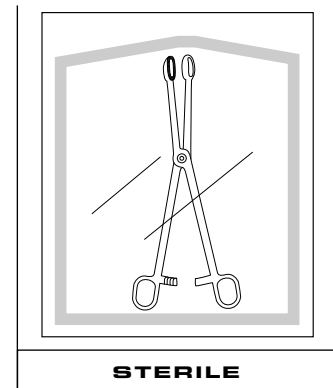

**SPONGE FORCEPS,  
PLASTIC**

Box of 100, Sterile  
96-2919 9½"

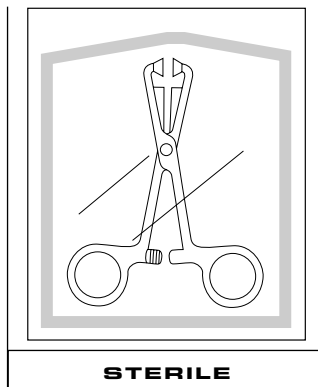

**TOWEL CLAMP, PLASTIC**

Box of 100, Sterile  
96-2931 5" Non-Perforating

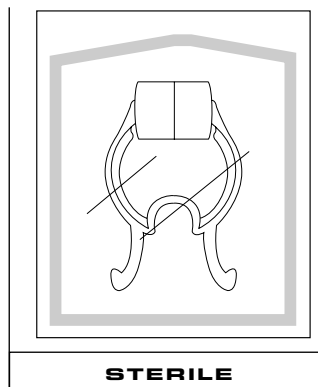

**NOSE CLIP, PLASTIC**

Box of 100, Sterile  
96-2951 Foam

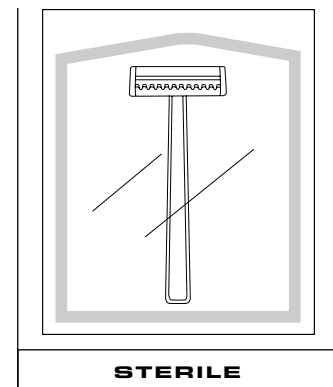

**SURGICAL PREP RAZOR,  
PLASTIC, DOUBLE EDGE**

Box of 100, Sterile  
96-2956



**GENERAL PURPOSE TRAY - Cs/25  
WITH ECONO FLOOR GRADE INSTRUMENTS**

96-1700 Contents:

- |                              |                        |
|------------------------------|------------------------|
| Tray                         | Tissue Forceps         |
| Kelly Hemostat, Curved       | OR Scissors S/B        |
| 2 Cotton Tip Applicators, 3" | Safety Pin, #2         |
| 2 Sponges, 4 x 4, 12 Ply     | CSR Wrap               |
| Iodophor Swabstick, 1's      | Alcohol Swabstick, 1's |
| Sterilization Pouch          |                        |



**SHAVE PREP TRAY - Cs/10**

96-1806 Contents:

- |                       |                            |
|-----------------------|----------------------------|
| Razor                 | Waterproof Underpad        |
| Pre-soaped Sponge Pad | (2) Cotton Tip Applicators |
| (4) Absorbent Towels  | Prep Tray                  |
| Sterilization Pouch   |                            |



**MINOR PREP TRAY - Cs/25**

96-1724 Contents:

- |              |                          |
|--------------|--------------------------|
| 16 Oz. Bowl  | (4) Gauze, 4 x 4, 12 Ply |
| CSR Wrap     | Sterilization Pouch      |
| PVP Prep Pad | Alcohol Prep Pad         |



**BASIC SKIN PREP TRAY - Cs/20**

96-1805 Contents:

- |                    |                           |
|--------------------|---------------------------|
| (3) 16 oz. Bowls   | (12) Gauze, 4 x 4, 12-Ply |
| (2) 6" Prep Sticks | PVP Scrub, 2 oz.          |
| PVP Paint, 2 oz.   | Absorbent Towel           |
| CSR Wrap           | Sterilization Pouch       |



**MINOR SURGERY TRAY - Cs/10**  
**WITH ECONO FLOOR GRADE INSTRUMENTS**

- 96-1744 Contents:
- |                                 |                                 |
|---------------------------------|---------------------------------|
| Utility Drape, Clear            | (2) OR Towels, Linen            |
| Scalpel, #15 Long Handle        | (2) Halsted Mosq. Fcps, Str. 5" |
| (3) Halsted Mosq. Fcps, Cvd. 5" | Kelly Fcps, Str. 5½"            |
| Webster Nd Hld, Sm. 5"          | Scissors, Str. SH/BL 5½"        |
| Iris Scissors, Cvd. 4½"         | Adson Fcps. 1 x 2, 4¾"          |
| (15) Gauze, 4 x 4, 12 Ply       | (2) Instrument Trays            |
| CSR Wrap                        | Sterilization Pouch             |



**MAJOR LACERATION TRAY - Cs/12**  
**WITH ECONO FLOOR GRADE INSTRUMENTS**

- 96-1710
- |                          |                             |                           |
|--------------------------|-----------------------------|---------------------------|
| Tray                     | Needle, 27ga. x 1½"         | (2) Medicine Cups         |
| Halsted Mosquito, Curved | Needle, 25ga. x ¾"          | (2) OR Towels (Cloth)     |
| Adson Forcep, Serr.      | Needle, 18ga. x 1½"         | CSR Wrap                  |
| Adson Forcep, 1 x 2      | Needle, 30ga. x ¾"          | Sterilization Pouch       |
| Webster Needle Holder    | Control Syringe, 10cc       | Fenestrated Drape (Cloth) |
| Iris Scissors, Str.      | (10) Sponges, 4 x 4, 12 Ply |                           |
| Lidocaine, 1%, 5ml       | (5) Sponges, 2 x 2, 12 Ply  |                           |



**WOUND CLOSURE TRAY - Cs/25**  
**WITH ECONO FLOOR GRADE INSTRUMENTS**

- 96-1730 Contents:
- |                          |                           |
|--------------------------|---------------------------|
| Tray                     | OR Scissors S/B           |
| (4) Sponges, 4x4, 12 Ply | Kelly Hemostat, Curved    |
| Iodophor Swabstick, 1's  | Fenestrated Drape (Paper) |
| Alcohol Swabstick, 1's   | Absorbent Towel           |
| Webster Needle Holder    | Refuse Bag w/Tie          |
| Tissue Forcep            | CSR Wrap                  |
| Sterilizer Pouch         |                           |



**MINOR LACERATION TRAY "A" - Cs/12**  
**WITH ECONO FLOOR GRADE INSTRUMENTS**

- 96-1715
- |                             |                            |                       |
|-----------------------------|----------------------------|-----------------------|
| Tray                        | (5) Sponges, 2 x 2, 12 Ply | (2) Medicine Cups     |
| Needle, 25ga. x ¾"          | Webster Needle Holder      | CSR Wrap              |
| Needle, 27ga. x 1½"         | Iris Scissors, Str         | (2) OR Towels (Cloth) |
| Needle, 18ga. x 1"          | Halsted Mosquito, Curved   | Sterilization Pouch   |
| Syringe, 10cc               | Adson Forcep, Serrated     |                       |
| (10) Sponges, 4 x 4, 12 Ply | Fenestrated Drape (Cloth)  |                       |

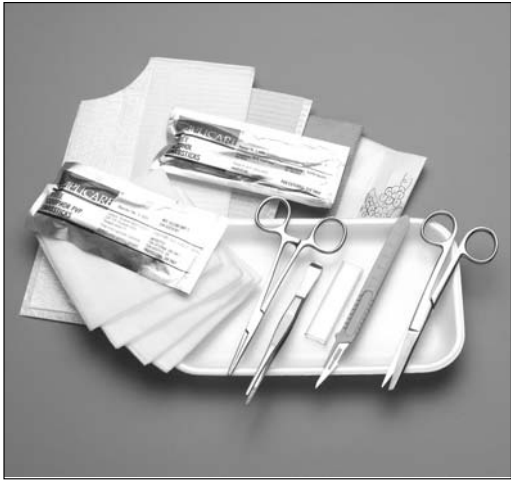

**INCISION AND DRAINAGE TRAY - Cs/25  
WITH ECONO FLOOR GRADE INSTRUMENTS**

- 96-1713 Contents:
- |                     |                              |
|---------------------|------------------------------|
| Foam Tray           | Iodophor PVP Swabsticks, 3's |
| Scissors, S/B       | Alcohol Swabsticks, 3's      |
| Dressing Forcep     | Fenestrated Drape (Paper)    |
| Kelly Hemostat      | Poly Back Towel (Drape)      |
| Scalpel, #11        | Refuse Bag w/Tie             |
| (4) Sponges, 4 x 4  | CSR Wrap                     |
| Sterilization Pouch |                              |



**NAIL TRAY - Cs/12**

- 96-1838 Contents:
- |                                |                         |
|--------------------------------|-------------------------|
| Small Blade #11                | Sterilization Pouch     |
| (3) 4 x 4, 12 Ply Gauze Sponge | Tissue Forceps, Plastic |
| Procedure Catch Pad/           | (2) Alcohol Prep Pads   |
| Prep Tray                      | Absorbent Towel         |
|                                | CSR Wrap                |



**TEGADERM™ DRESSING  
CHANGE TRAY - Cs/50**

- 94-4026
- |                     |                             |
|---------------------|-----------------------------|
| Towel/Drape, 3 Ply  | (2) Masks W/ Ear Loops      |
| Gloves, Pair        | Alcohol Swabsticks, 3's     |
| PVP Swabsticks, 3's | Benzoin Tincture Applicator |
| Tegaderm™ Dressing  | Dressing Change Label       |
| Sterilization Pouch |                             |
- Tegaderm is a trademark of 3M*



**MINOR DRESSING TRAY - Cs/25  
WITH PLASTIC/WIRE-FORM INSTRUMENTS  
WITH DURAPORE DRESSING™**

- 96-1704
- |                       |                                   |
|-----------------------|-----------------------------------|
| Towel/Drape, 3 Ply    | Foam Tray                         |
| Wire Formed Scissors  | Plastic Dressing Forcep           |
| Plastic Tissue Forcep | Micropore Tape™ 1 x 36            |
| Alcohol Prep Pad      | Sterilization Pouch               |
| Refuse Bag w/ Tie     | 3 Ea. Gauze Sponge, 4 x 4, 12 Ply |
| PVP Prep Pad          | CSR Wrap                          |
- Durapore is a trademark of 3M*





### CENTRAL LINE DRESSING TRAY - Cs/50 WITH DURAPORE™ DRESSING

- |         |   |   |
|---------|---|---|
| 94-4025 | Gloves, Pair<br>Towel/Drape, 3 Ply<br>(2) Mask W/ Ear Loops<br>Alcohol Swabstick, 3's<br>PVP Swabstick, 3's<br>(2) IV Split Sponge, 2 x 2<br>Durapore™ Dressing | (2) Gauze 2 x 2 12 Ply<br>Adhesive Patch<br>Dressing Change Label<br>Sterilization Pouch<br>PVP Ointment, 1 Gram<br>Benzoin Tincture Applicator |
|---------|---|---|

*Durapore is a trademark of 3M*



### IV START TRAY - Cs/50

- |         |   |   |
|---------|---|---|
| 96-1705 | Contents:<br>Tray<br>Dressing Change Label<br>Transpore Tape, 1 x 16<br>(2) Sponges<br>PVP Prep Pad | Transparent Tegaderm™ Dressing<br>Alcohol Prep Pad<br>Tourniquet<br>Gloves, Pair<br>Sterilization Pouch |
|---------|---|---|

*Tegaderm is a trademark of 3M*



### CUT DOWN TRAY - Cs/10 WITH ECONO FLOOR GRADE INSTRUMENTS

- |         |   |   |
|---------|---|---|
| 96-1747 | (2) Instrument Tray<br>Scissors, Str, SH/BL<br>Kelly Forceps, Str, 5½"<br>Thumb Fcps. Serr. 4¼"<br>Instrument Tray<br>(2) Halsted Mosq. Fcps, Str. 5"<br>Scalpel, #11 Long<br>Utility Drape, Clear<br>Sterilization Pouch | Adson Forcep, 1x2, 4¼"<br>Mayo Hegar Nd Hld. 6"<br>Webster Nd Hld. Sm. 5"<br>(2) OR Towels, Linen<br>Scalpel, #15 Long Handle<br>(3) Halsted Mosq. Fcps, Cvd. 5"<br>(15) Gauze, 4 x 4, 12 Ply<br>CSR Wrap |
|---------|---|---|



### DEBRIDEMENT TRAY - Cs/10 WITHOUT INSTRUMENTS

- |         |  |   |
|---------|--|---|
| 96-1804 | Contents:<br>Latex Gloves, Pair<br>Bag and Tie<br>2 oz. Medicine Cup<br>Tongue Blade<br>75cc, 0.9%, Sodium Chloride<br>ABD Pad<br>1" Transpore Tape<br>Protective Barrier Film<br>Tray | Sterilization Pouch<br>Absorption Dressing<br>Drape/Towel, 3 Ply<br>75cc Sterile Water<br>60cc Syringe<br>(6) 4 x 4, 12-Ply Gauze Sponge<br>Cotton Tipped Applicator<br>Measuring Device<br>Dressing Change Label<br>CSR Wrap |
|---------|--|---|



**DEBRIDEMENT TRAY - Cs/10  
WITHOUT INSTRUMENTS**

- |         |                             |                                |
|---------|-----------------------------|--------------------------------|
| 96-1804 | Contents:                   | Sterilization Pouch            |
|         | Latex Gloves, Pair          | Absorption Dressing            |
|         | Bag and Tie                 | Drape/Towel, 3 Ply             |
|         | 2 oz. Medicine Cup          | 75cc Sterile Water             |
|         | Tongue Blade                | 60cc Syringe                   |
|         | 75cc, 0.9%, Sodium Chloride | (6) 4 x 4, 12-Ply Gauze Sponge |
|         | ABD Pad                     | Cotton Tipped Applicator       |
|         | 1" Transpore Tape           | Measuring Device               |
|         | Protective Barrier Film     | Dressing Change Label          |
|         | Tray                        | CSR Wrap                       |



**DEBRIDEMENT TRAY - Cs/20  
WITH ECONO FLOOR GRADE INSTRUMENTS**

- |         |                         |                 |
|---------|-------------------------|-----------------|
| 96-1904 | Contents:               |                 |
|         | Gloves, Pair            | Iris Scissors   |
|         | Alcohol Prep Pad        | #15 Scalpel     |
|         | PVP Prep Pad            | Dressing Forcep |
|         | Gauze, 4 x 4, 12 Ply(2) | Tip Protectors  |



**TRACH CARE TRAY - Cs/20**

- |         |                              |                           |
|---------|------------------------------|---------------------------|
| 96-1703 | Contents:                    | Paper/Poly Drape          |
|         | 3 Trays                      | Gloves                    |
|         | Twill Tape, 1/2" x 30"       | CSR Wrap                  |
|         | Trach Brush                  | Sterilization Pouch       |
|         | Trach Dressing               | (3) Sponges, 4 x 4, 8 Ply |
|         | Cotton Tipped Applicator, 6" |                           |
|         | Sponge Forcep, Plastic       |                           |



**AMNIOCENTESIS TRAY - Cs/10**

- |         |                                    |                           |
|---------|------------------------------------|---------------------------|
| 96-1722 | Contents:                          |                           |
|         | Fenestrated Drape, 24 x 24 w/Patch | Needle, 22 ga. x 1 1/2"   |
|         | Absorbent Towel                    | Needle, 22 ga. x 3/2"     |
|         | Syringe, 5cc L/L NT                | PVP Swabsticks, 3's       |
|         | Syringe, 10cc L/L NT               | 6 Inch Ruler              |
|         | Syringe, 20cc L/L NT               | Ultrasound Gel Pack       |
|         | Needle, 25 ga. x 5/8"              | (8) Gauze, 4 x 4, 12 Ply  |
|         | (3) Specimen Tubes                 | Bandaid                   |
|         | Procedure Tray                     | CSR Wrap, 24 x 24         |
|         | Micron Filter Straw                | Lidocaine, 1%, 5ml Ampule |
|         | Sterilization Pouch                |                           |



### ULTRASOUND TRAY - Cs/10

- 96-1801 Contents:
- |                     |                          |
|---------------------|--------------------------|
| Procedure Tray      | Solution Cup             |
| Lidocaine, 1% 5ml   | Applicator Prep Stick 6" |
| CSR Wrap            | Gauze, 3 x 3, 12 Ply     |
| Needle, 20ga x 1½"  | Syringe, 10cc LL         |
| Needle, 25ga x 1½"  | Drape, Plain 18 x 26     |
| 6" Paper Ruler      | Drape, Minor Procedure   |
| Bandaid             |                          |
| Sterilization Pouch |                          |



### LABOR AND DELIVERY TRAY - Cs/5

- 96-3171 Contents:
- |                                   |                       |
|-----------------------------------|-----------------------|
| Needle, 21ga x 1"                 | Cord Clamp            |
| Utility Bowl w/ Lid               | Drape, 43 x 58        |
| 10cc Control Syringe              | Plastic Tube w/ Cap   |
| Table Cover, 44 x 76              | Vaginal Packing       |
| Bulb Syringe                      | Maternity Pad         |
| Underbuttocks Drape w/ Pouch      | Header Clamp, 17 x 30 |
| (10) Gauze Sponges, 4 x 4, 12-ply |                       |



### C-SECTION TRAY - Cs/5

- 96-3181 Contents:
- |                     |                              |
|---------------------|------------------------------|
| Bulb Syringe        | Plastic Tube w/ Cap          |
| Large Gown          | Table Cover, 44 x 78         |
| Poly Wrap, 24 x 24  | Header Bag, 17 x 30          |
| Gloves              | Maternity Pad                |
| ABD Pad             | Drape w/ Pouch               |
| Mayo Stand Cover    | Connector Tubing w/ Bulb Tip |
| Foam Needle Counter | (10) Lap Sponges, 18 x 18    |
| Prep Kit            |                              |



### BASIC BIOPSY TRAY - Cs/10

- 96-1726 Contents:
- |                      |                          |                            |
|----------------------|--------------------------|----------------------------|
| Fenestrated Drape    | (2) Absorbent Towels     | CSR Wrap                   |
| Syringe, 3cc L/L NT  | Needle, 25 ga. x 5/8"    | Sterilization Pouch        |
| Syringe, 5cc L/L NT  | Syringe, 20cc L/L NT     | Procedure Tray             |
| Needle, 20 ga. x 1½" | Needle, 22 ga. x 1½"     | PVP Swabsticks, 3's        |
| #11 Long Scalpel     | Lidocaine, 1%, 5ml       | (5) Micron Filter Straw    |
| (2) Specimen Tube    | Pocket Single, 10cc #12  | Bandaid                    |
| Plastic Ruler, 6"    | (4) Gauze, 4 x 4, 12 Ply | (6) Slides, Glass, Frosted |
| (1) Solution Cup     | (2) Angled Sponge Sticks |                            |



## STANDARD CT BIOPSY TRAY - Cs/10

- 96-1723 Contents:
- |                        |                            |
|------------------------|----------------------------|
| Prep Tray              | Plastic Needle Stop        |
| (2) Xylocaine, 1% 5ml  | Needle, 25 ga. x 5/8"      |
| 6" Paper Ruler         | Needle, 22 ga. x 1 1/2"    |
| Bandaid                | PVP Swabsticks, 3's        |
| Alcohol Prep Pad       | Gauze, 4 x 4, 12 Ply       |
| Mini Scalpel           | (2) Absorbent Towels       |
| (4) Syringes, 10cc L/L | Drape, Fenestrated w/Patch |
| CSR Wrap               |                            |



## BIOPSY PUNCH TRAY - Cs/25 WITH ECONO FLOOR GRADE INSTRUMENTS

- 96-1712 - With 4mm Biopsy Punch  
96-1714 - With 3mm Biopsy Punch
- Contents:
- |                            |                      |
|----------------------------|----------------------|
| Tray                       | CSR Wrap             |
| (4) Sponges, 3 x 3, 12 Ply | Needle, 30ga. x 1/2" |
| Iodophor Ointment          | Needle, 25ga. x 5/8" |
| Webster Needle Holder      | Syringe, 3cc         |
| Iris Scissor, Curved       | Alcohol Prep Pad     |
| Tissue Forcep              | (2) Band-aids        |
| Fenestrated Drape (Paper)  | Gloves, Pair         |
| Sterilization Pouch        |                      |



## SUTURE REMOVAL TRAY - "D" - Cs/50 WITH ECONO FLOOR GRADE INSTRUMENTS

- 96-1740 Contents:
- |                    |                     |
|--------------------|---------------------|
| Iris Scissors, Str | Sponge, 4x4         |
| (2) Tip Protector  | Sterilization Pouch |
| Dressing Forceps   |                     |



## SUTURE REMOVAL TRAY - "E" - Cs/50 WITH PLASTIC/WIRE-FORM INSTRUMENTS

- 96-1735 Contents:
- |                     |                           |
|---------------------|---------------------------|
| Alcohol Prep Pad    | Plastic Dressing Forcep   |
| PVP Prep Pad        | Gauze, 4 x 4, 12 Ply      |
| Sterilization Pouch | Plastic Littauer Scissors |



## SUTURE TRAY - Cs/10 WITH ECONO FLOOR GRADE INSTRUMENTS

- 96-1725 Contents:
- |                              |                                |
|------------------------------|--------------------------------|
| Tray, 2 Compartment          | (20) Gauze, 4 x 4, 12 Ply      |
| Lidocaine, 1%, 5ml           | Needle Holder, Baumg., 5 1/2"  |
| Forcep, Adson, 1 x 2, 4 1/2" | Syringe, 5cc L/L               |
| Iris Scissors, ST/SH, 4 1/2" | Needle, 25 ga. x 5/8"          |
| Needle, 20 ga. x 1 1/2"      | Drape, Plain, 18 x 26          |
| PVP Prep Packet              | CSR Wrap                       |
| Sterilization Pouch          | Drape, Blue, 18 x 26, W/Fenes. |

### ***CUSTOM PROCEDURE TRAYS IN 21 DAYS!***

---

- ***Let Sklar quote your custom procedure trays***
- ***If you don't see your tray in our catalog - we'll make it for you***
- ***Precisely what you need, when you need it, how you need it***



#### Standard Custom Procedure Trays / Surgical Disposables / Sterile Instruments

- Value -** Sklar Sterile provides high quality products at a competitively low cost to ensure your laboratory unsurpassed value.
- Convenience -** Made to order samples of custom procedure trays and fast delivery of finished product guarantees your convenience.
- Service -** Sklar Sterile and your Prime Vendor Distributor offer twice the service of any other source.

# STERILE PROCEDURE KITS FOR ANIMALS

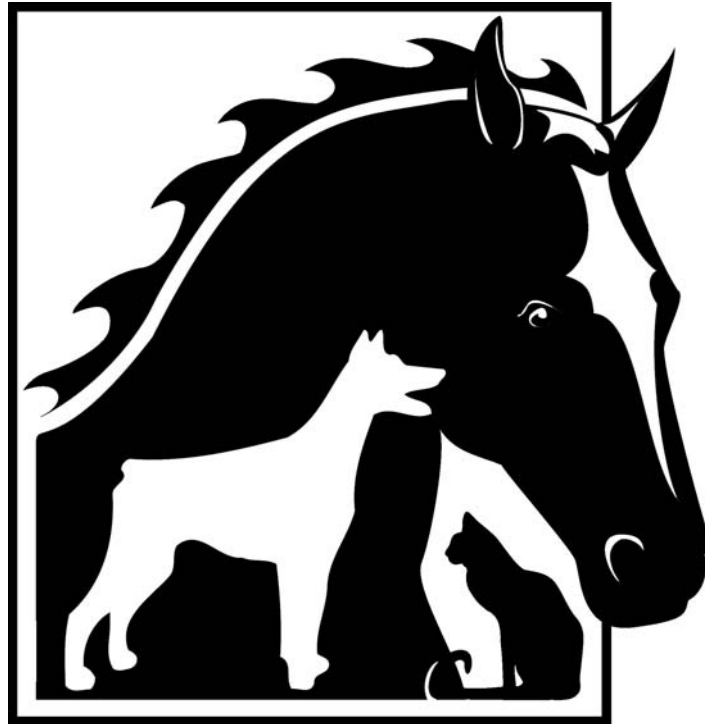

## **SPAY INSTRUMENT SET - Cs/10**

#96-0110

#3 Scalpel Handle  
Mayo Scis Str 6 3/4"  
Double sided safety razor  
Metz Scis Cvd 7"  
Tissue Fcp 5 1/2" 1x2 teeth  
Prep tray  
Adson Brown Fcp 4 3/4"  
Halsted Fcp Cvd 5"  
Soap sponge  
Kelly Fcp Cvd 5 1/2"  
Roch-Carmalt Fcp Cvd 6 1/4"  
Towel  
Backhaus 3 1/2"  
Olsen Hegar NH  
Allis Tissue Fcp 6" 4x5 teeth  
Snook Hook

## **GENERAL VETERINARIAN SURGERY SET - Cs/10**

# 96-0111

#3 Scalpel Handle  
Mayo Scis Str 6 3/4"  
Metz Scis Cvd 7"  
Adson Brown Fcp  
Mosq Hemostat Cvd 5"  
Kelly Fcp Str 5 1/2"  
Roch-Carmalt Fcp 6 1/2" Cvd  
Backhaus 5 1/4"  
Olsen Hegar NH 5 1/2"  
Snook Hook  
Double sided safety razor  
Prep tray  
Soap sponge  
Towels  
Gauze sponges

## **PHYSIOLOGY KIT 1 - Cs/10**

# 96-0112

Tenotomy Scis Cvd  
Blumenthal Ronguer 3mm jaw  
Utility Scis  
Oper Scis Str S/B 5 1/2"  
Jewelers Style Fcp #5  
Probe 5 1/2"

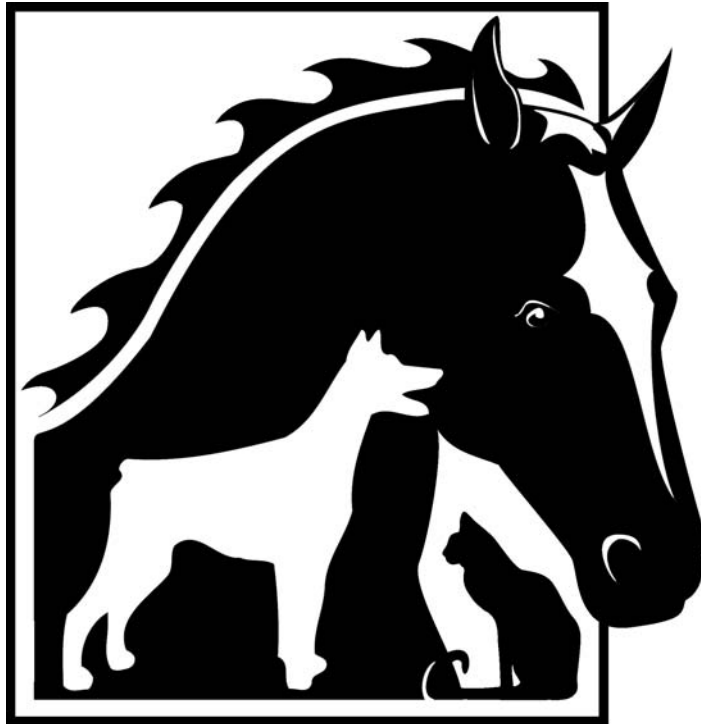

### **PHYSIOLOGY KIT 2 - Cs/10**

# 96-0113

Vannas Scis Str 3"  
Iris Scis Str 4"  
Friedman Ronguer 6 1/4"  
Utility Scis  
Oper Scis Str S/B 5 1/2"  
Jewelers Style Fcp #5  
Probe 5 1/2"  
Stevens Retr  
Iris Fcp Cvd  
Adson Fcp 1 x 2 teeth  
Olsen Hegar NH 5 1/2"

### **MOUSE KIT - Cs/1**

# 96-0115

Jewelers Fcp #5  
Vannas Scis Str 3"  
Iris Fcp Cvd Serr  
Dissect Scis Str 4"  
Wire Retractor 2"  
Webster NH 5" Serr  
Probe 5 1/2"

### **RAT KIT - Cs/1**

# 96-0116

Jewelers Style Fcp #5  
Vannas-McPhearson Scis Str 3"  
Iris Fcp Serr Cvd  
Iris Scis Str  
Alm Retractor 2 3/4"  
Crile-Murray NH 5 1/2"  
Probe 5 1/2"

# STERILE PROCEDURE COMPONENTS

## PROCEDURE TRAY COMPONENTS

All components are quality inspected by Sklar as well as by the original manufacturer to ensure the highest quality standards are met.

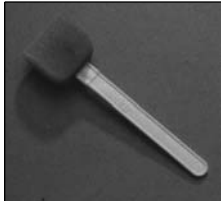

### APPLICATOR PREP STICKS, 6"

Case/100  
96-7040 50 pks/2



### ALCOHOL SWABSTICK

Case/50  
96-7581



### ALCOHOL TRIPLE SWABSTICK

Case/50  
96-7620



### ANGLED SPONGE STICKS

Case/100  
96-7187 50 pks/2



### BENZOIN TINCTURE APPLICATOR

Case/50  
96-7624



### SPECIMEN TUBE

10ml SCREW CAP

Case/150  
96-7459 50 pks/3



### FLUOROSCOPE COVERS

Case/25  
96-1640 Small  
96-1641 Medium  
96-1642 Large



### PLASTIC RULER

Case/100  
96-1674 6" plastic



### 20" EXT. SET WITH CLAMP

Case/25  
96-7725



### MASK WITH EAR LOOPS

Case/50  
96-7185



### PLASTIC DENTAL MIRROR

Case/50  
96-7887

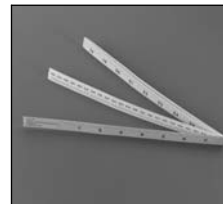

### TAPE MEASURE PAPER

Case/25  
96-7635



### SAFETY PINS

Case/100  
96-1667 #2 50 pks/2  
96-1668 #3 50 pks/2



### RUBBER BANDS

Case/100  
96-1671 #16 50 pks/2  
96-1672 #31 50 pks/2  
96-1673 #32 50 pks/2

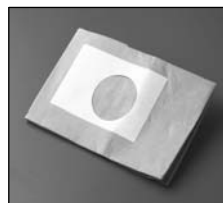

### FENESTRATED DRAPE

with Patch  
Case/25  
96-1627



### DRAPE / TOWEL

Case/50  
96-7412



### ANGIO DRAPE

Case/20  
96-7755



### UTILITY DRAPE, CLEAR

Case/25  
96-7712





**ESMARK BANDAGE**

LATEX - Case/20  
 96-1793 3" x 12'  
 96-1795 4" x 12'  
 96-1792 3" x 9'  
 96-1794 4" x 9'  
 96-1796 6" x 9'  
 96-1797 6" x 12'



**ELASTIC BANDAGE**

Case/20  
 96-1784 2"  
 96-1786 3"  
 96-1788 4"  
 96-1790 6"



**CONFORM™ STRETCH BANDAGES**

Case/20  
 96-1799 2" x 4.1 yds.  
 96-1811 3" x 4.1 yds.  
 96-1812 4" x 4.1 yds.  
 96-1813 6" x 4.5 yds.  
 Conform is a trademark of Kendall



**ESMARK BANDAGE**

LATEX FREE - Case/20  
 96-1680 3" x 12'  
 96-1651 4" x 12'  
 96-1649 3" x 9'  
 96-1650 4" x 9'  
 96-1652 6" x 9'  
 96-1653 6" x 12'



**COBAN™ BANDAGE**

Case/20  
 96-1780 4"  
 96-1782 6"  
 Coban is a trademark of 3M



**WEBRIL™**

Case/20  
 96-1818 2"  
 96-1819 3"  
 96-1820 4"  
 96-1821 6"  
 Webril is a trade mark of Kendall



**OR TOWELS**

Case/100  
 96-1662 50 pks/2  
 Case/80  
 96-1621 20 pks/4



**FENESTRATED OR TOWEL**

Case/25  
 96-7548



**XL GOWN WITH TOWEL**

Case/25  
 96-7072



**COTTON TIPPED APPLICATORS**

Case/500  
 96-1665 6" 50 pks/10  
 Case/250  
 96-1666 3" 25 pks/10



**8" RAYON SWABS**

Case/150  
 96-7051 50 pks/3



**COTTON BALLS**

Case/100  
 96-1669 Large 50 pks/2  
 96-1670 Small 50 pks/2



**SPONGE KIT**

Case/500  
 96-1830 2 x 2, 12 ply, 50 pks/10  
 96-1834 4 x 4, 12 ply, 50 pks/10  
 Case/1000  
 96-1832 2 x 2, 12 ply, 100 pks/10  
 96-1836 4 x 4, 12 ply, 100 pks/10



**KERLIX™ GAUZE ROLLS**

Case/20  
 96-1814 2.25" x 3 yds.  
 96-1815 3.4" x 3.6 yds.  
 96-1816 4.5" x 4.1 yds.  
 Kerlix is a trademark of Kendall



**ABSORBENT TOWELS**

Case/25  
 96-1664 Pks of 4



**MEDICINE CUP, 2 OZ.**

96-7027 Case/25



**32 OZ. BOWL**

Case/20  
 96-7174



**OR BASIN**

Case/5  
 96-1679 7 Quart



## TEST TUBES

88-0082	15 x 10mm, 10ml	Cs/2000
88-0083	13 x 100mm, 7ml	Cs/3000
88-0084	13 x 78mm, 5.5ml	Cs/4000
88-0085	12 x 60mm, 3.5ml	Cs/6000
88-0086	12 x 75mm, 5ml	Cs/4800
88-0087	12 x 78mm, 5.5ml	Cs/4800
88-0088	16 x 53mm flat bottom, 6ml w/cap	Cs/3000
88-0089	14 x 41mm flat bottom, 3ml w/cap	Cs/4500

88-0090	13 x 100mm, 7ml w/cap	Cs/3000
88-0091	12 x 75mm, 5ml	Cs/4800
88-0092	12 x 60mm, 3.5ml w/cap	Cs/6000
88-0093	12 x 75mm, 5ml	Cs/4000
88-0095	10 x 70mm, 2.8ml	Cs/6600
88-0096	15 x 100mm, 10ml graduated	Cs/2800
88-0097	12ml conical w/cap	Cs/2800
88-0098	12ml urine tube w/cap	Cs/1500

88-0099	12 x 75mm, 5.5ml	Cs/3600
88-0100	15 x 50mm, 4.5ml	Cs/3600
88-0101	13 x 78mm, 5.5ml	Cs/4800
88-0102	12 x 75mm, 5ml polypropylene	Cs/4800
88-0103	13 x 150mm w/swab	Cs/1800
88-0104	13 x 75mm w/swab	Cs/2200

## TEST TUBE RACKS

88-0105	40 wells 18mm	Cs/40
88-0106	50 wells 15mm	Cs/40
88-0107	50 wells 13mm	Cs/40
88-0108	pillar like 18mm	Cs/54
88-0109	pillar like 15mm	Cs/51
88-0110	18mm	Cs/40
88-0111	15mm	Cs/50
88-0112	13mm	Cs/50

## TUBE STOPPERS

88-0115	12mm	Cs/20000
88-0116	13mm	Cs/18000
88-0117	15mm	Cs/15000



## CENTRIFUGE TUBES

88-0017	50ml conical	Cs/500	88-0022	10ml rnd. bottom	Cs/2000
88-0019	15ml conical	Cs/1000	88-0023	7ml rnd. bottom	Cs/2400
88-0020	50ml rnd. bottom	Cs/1000	88-0024	5ml rnd. bottom with cap	Cs/2700
88-0021	15ml rnd. bottom	Cs/1500			



## SELF-STANDING CENTRIFUGE TUBES

88-0018	50ml	Cs/500	88-0032	1.8ml, w/grad.	Cs/5000
88-0030	5ml, w/cap	Cs/2000	88-0033	1.8ml	Cs/5000
88-0031	2.5ml, w/cap	Cs/2000			
88-0118	Rack for 50 & 15 ml centrifuge tubes Cs/50				



### PETRI DISHES

88-0123	150 x 15mm	Cs/110	88-0129	90 x 15mm w/ 3 vents	Cs/600	88-0130	70 x 15mm	Cs/600
88-0127	90 x 20mm	Cs/500	88-0131	65 x 15mm	Cs/650	88-0133	30 x 15mm	Cs/2100
88-0128	90 x 15mm w/ 2 compartments	Cs/500	88-0132	50 x 15mm	Cs/800			



### SPECIMEN CONTAINERS

88-0119	100 - 120ml	Cs/1000	88-0137	25ml culture bottle w/stick	Cs/650	88-0139	Stool sample stick	Cs/10000
88-0120	60ml	Cs/500	88-0138	60ml stool container w/stick	Cs/500	88-0140	30ml sputum container	Cs/500
88-0134	Urine Cup, White	Cs/7000	88-0141	40ml sputum container	Cs/500	88-0143	30ml sputum container, wide	Cs/1000
88-0135	Urine Cup, Transparent	Cs/7000	88-0142	25ml sputum container	Cs/650	88-0144	20ml sputum cassette	Cs/2000
88-0136	20ml stool container w/stick	Cs/1000						

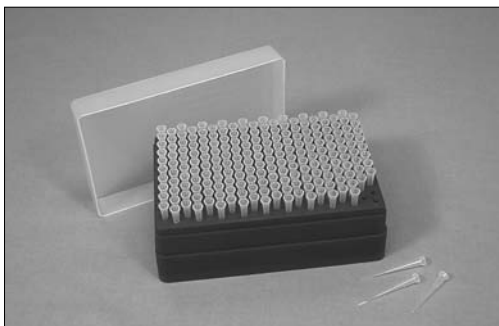

### PIPETTE TIPS & TRAYS

88-0044	200 - 1000 ul pipette for Eppendorf	Cs/10000	88-0049	10-200 ul pipette tip for Gilson	Cs/30000	88-0054	tips box, 100 wells for 1000 ul	Cs/30
88-0045	10 - 300 ul pipette for Eppendorf	Cs/30000	88-0051	200-1000 ul pipette tip for Gilson	Cs/10000	88-0055	tips box, 200 wells for 200 ul	Cs/40
88-0046	10 ul pipette for Eppendorf	Cs/60000	88-0052	10-1000 ul filter tip for Gilson	Cs/30000	88-0056	tips box, 96 wells for 200 ul	Cs/68
88-0047	10 ul pipette for Gilson	Cs/60000	88-0053	10-200 ul filter tip for Gilson	Cs/10000	88-0057	tips box, 96 wells for 200 & 10 ul	Cs/68
88-0048	10 ul filter tip for Gilson	Cs/60000						



## MICROCENTRIFUGE TUBES

88-0025	2.0 ml	Cs/5000	88-0034	1.5 ml w/attached green cap	Cs/6000	88-0038	105 well tube rack for .5 ml	Cs/40
88-0026	1.5 ml w/transparent cap	Cs/6000	88-0035	1.5 ml w/attached red cap	Cs/6000	88-0039	72 well tube rack for 1.5 ml	Cs/40
88-0027	0.5 ml	Cs/12000	88-0036	1.5 ml w/attached blue cap	Cs/6000	88-0040	81 well tube rack for .5 ml	Cs/40
88-0028	0.2 ml	Cs/30000	88-0037	1.5 ml w/attached red cap	Cs/6000	88-0042	1.5 ml tube rack	Cs/50
88-0029	1.5 ml w/conical cap	Cs/6000						



## COLORMETRIC & SAMPLE CUPS

88-0001	American colormetric cup MD2000/1800	Cs/960	88-0009	Beckman CX series sample cup, 0.5ml	Cs/8000
88-0002	American TECO colormetric cup	Cs/3200	88-0010	Beckman 700 sample cup, 1.5ml	Cs/8000
88-0003	Beckman colormetric cup	Cs/1500	88-0011	Corning 560,550 sample cup	Cs/18000
88-0004	Corning colormetric cup, 5 holes	Cs/2400	88-0012	100 hole sample cup rack	Cs/11
88-0005	Blood tube	Cs/3000	88-0013	Hitachi minimum sample cup	Cs/6000
88-0006	Color dilution plate	Cs/100	88-0014	Yapei CCX sample cup	Cs/5000
88-0007	Beckman protien ARRY-360 sample cup	Cs/400	88-0015	Hitachi conical sample cup	Cs/9000
88-0008	Hitachi 7150, 7060 series sample cup, 2ml	Cs/5000	88-0016	Kodak sample cup	Cs/12000

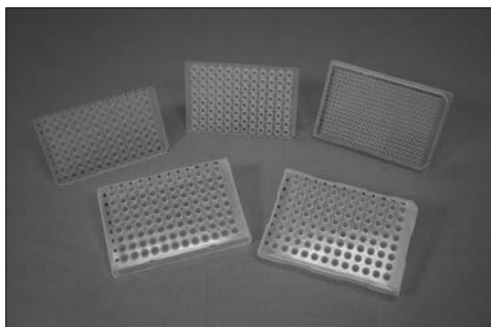

### CULTURE PLATES

88-0058	72 wells	Cs/800	88-0062	20 wells	Cs/180
88-0059	40 wells	Cs/600	88-0063	96 wells detachable	Cs/270
88-0060	96 wells	Cs/200	88-0074	52 wells reaction	Cs/260
88-0061	24 wells	Cs/170	88-0075	32 wells reaction	Cs/360

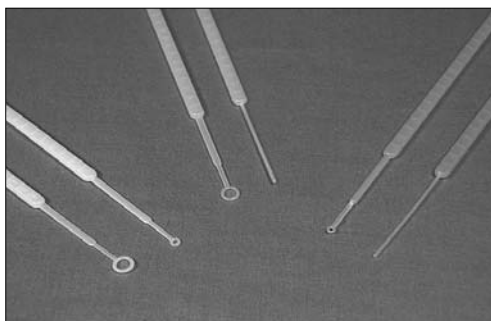

### INOCULATION LOOPS

88-0124	10 ul, moss green	Cs/3000
88-0125	1 ul, yellow	Cs/3000
88-0126	inoculating needle, white	Cs/3000

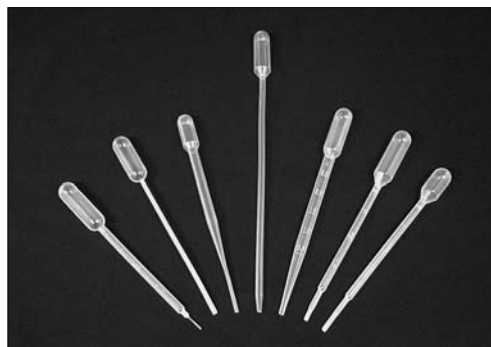

### TRANSFER PIPETTES

88-0064	1.5ml	Cs/5000	88-0070	5.0ml SPOID	Cs/4000
88-0065	1ml SPOID (blood collecting)	Cs/5000	88-0071	1ml fine tip	Cs/5000
88-0066	3.5ml	Cs/4000	88-0072	2.0ml SPOID	Cs/6000
88-0069	2.0ml	Cs/5000	88-0073	0.5ml	Cs/10000



## ENDOMETRIAL BIOPSY CANNULA



DISPOSABLE,  
STERILE  
Box/25  
96-4100

## PLASTIC VAGINAL SPECULUM GRAVES STYLE



DISPOSABLE,  
NON-STERILE  
Case/100  
96-0857 Small  
96-0867 Medium  
96-0877 Large

## CERVICAL CELL COLLECTOR



DISPOSABLE,  
STERILE  
Box/100  
96-4140

## DERMAL CURETTES WITH SURGICAL STEEL TIP



DISPOSABLE,  
STERILE  
Box/25  
96-1190 2mm  
96-1192 3mm  
96-1194 4mm  
96-1196 5mm  
96-1198 7mm  
96-1199 Asst.

## STAINLESS STEEL SCALPELS



DISPOSABLE,  
STERILE  
Box/10  
06-3110 #10  
06-3111 #11  
06-3115 #15

## DERMAL BIOPSY PUNCH



DISPOSABLE,  
STERILE  
Box/50  
96-1100 2mm  
96-1105 3mm  
96-1110 3.5mm  
96-1115 4mm  
96-1120 5mm  
96-1125 6mm  
96-1130 8mm  
96-1160 Asst.

## PLASTIC NASAL SPECULUM



DISPOSABLE,  
NON-STERILE  
Box/48  
96-0670 6-1/4"

## EAR CURETTES



DISPOSABLE,  
NON-STERILE  
Box/50  
96-1001 Cup  
96-1011 Child Ring  
96-1006 Loop  
96-1016 Adult Ring  
96-1031 Spoon  
96-1021 Pedi-Ring  
96-1035 Asst.

## EAR/ULCER SYRINGE



DISPOSABLE,  
STERILE  
Case/50  
96-9321 1oz.  
96-9256 2oz.  
96-9257 3oz.

ALL FLOOR GRADE STERILE INSTRUMENTS ARE PACKAGED IN A STERILE POUCH

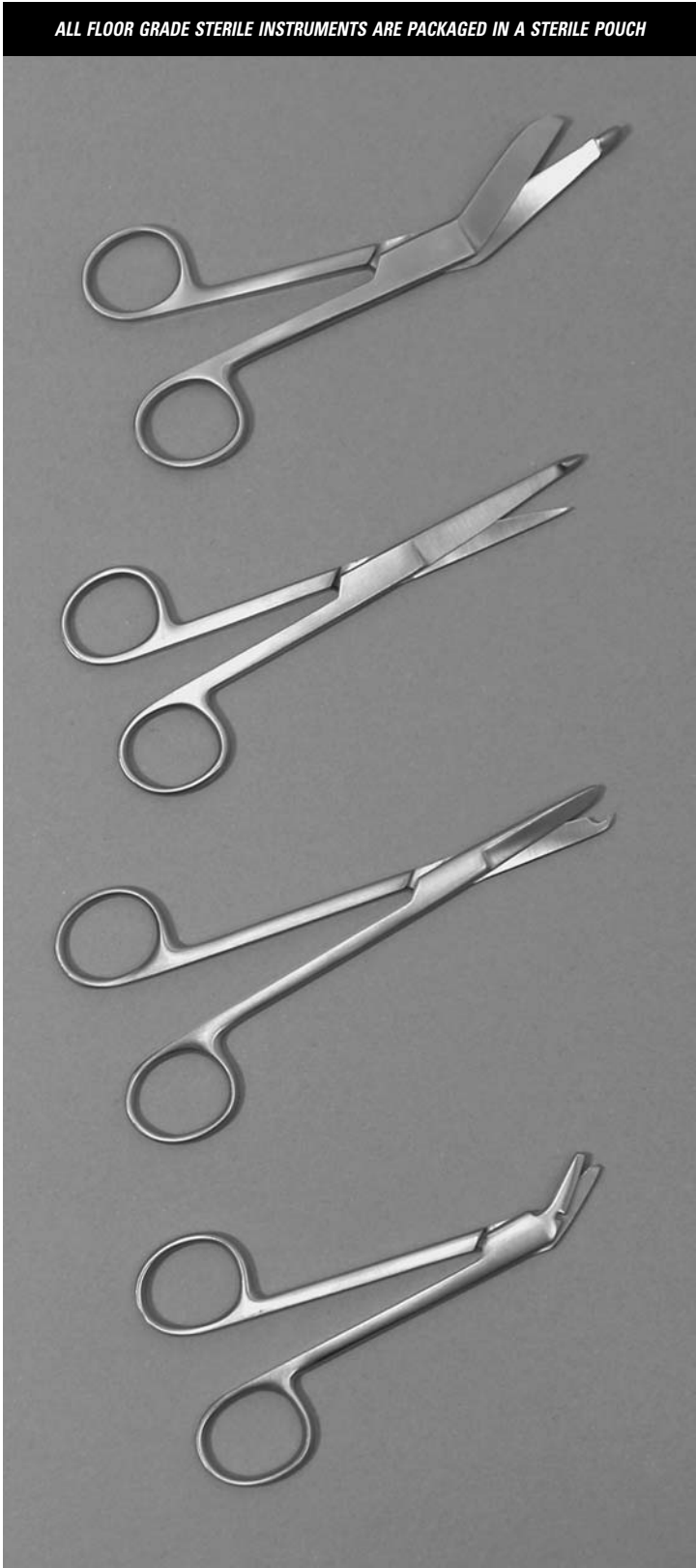

### LISTER BANDAGE SCISSORS

Box/50	96-2502	5-1/2"
Box/25	96-2503	5-1/2"
Box/100	96-2654	5-1/2"

#### NON-STERILE

Box/12	21-231	5-1/2"
--------	--------	--------

### KNOWLES BANDAGE SCISSORS

Box/50	96-2402	5-1/2"
Box/25	96-2404	5-1/2"

#### NON-STERILE

Box/12	21-254	5-1/2"
--------	--------	--------

### LITTAUER SUTURE SCISSORS

Box/50	96-2510	3-1/2"
	96-2512	5-1/2"
Box/25	96-2511	3-1/2"
	96-2513	5-1/2"
Box/100	96-2663	3-1/2"
	96-2662	5-1/2"

#### NON-STERILE

Box/12	21-358	5-1/2"
--------	--------	--------

### SPENCER STITCH SCISSORS

Box/50	96-2596	4-1/2"
Box/25	96-2598	4-1/2"

#### NON-STERILE

Box/12	21-352	4-1/2"
	21-346	3-1/2"

### WIRE CUTTING SCISSORS

Box/50	96-2518	4-3/4"
Box/25	96-2519	4-3/4"

#### NON-STERILE

Box/12	21-364	4-3/4"
--------	--------	--------





ALL FLOOR GRADE STERILE INSTRUMENTS ARE PACKAGED IN A STERILE POUCH

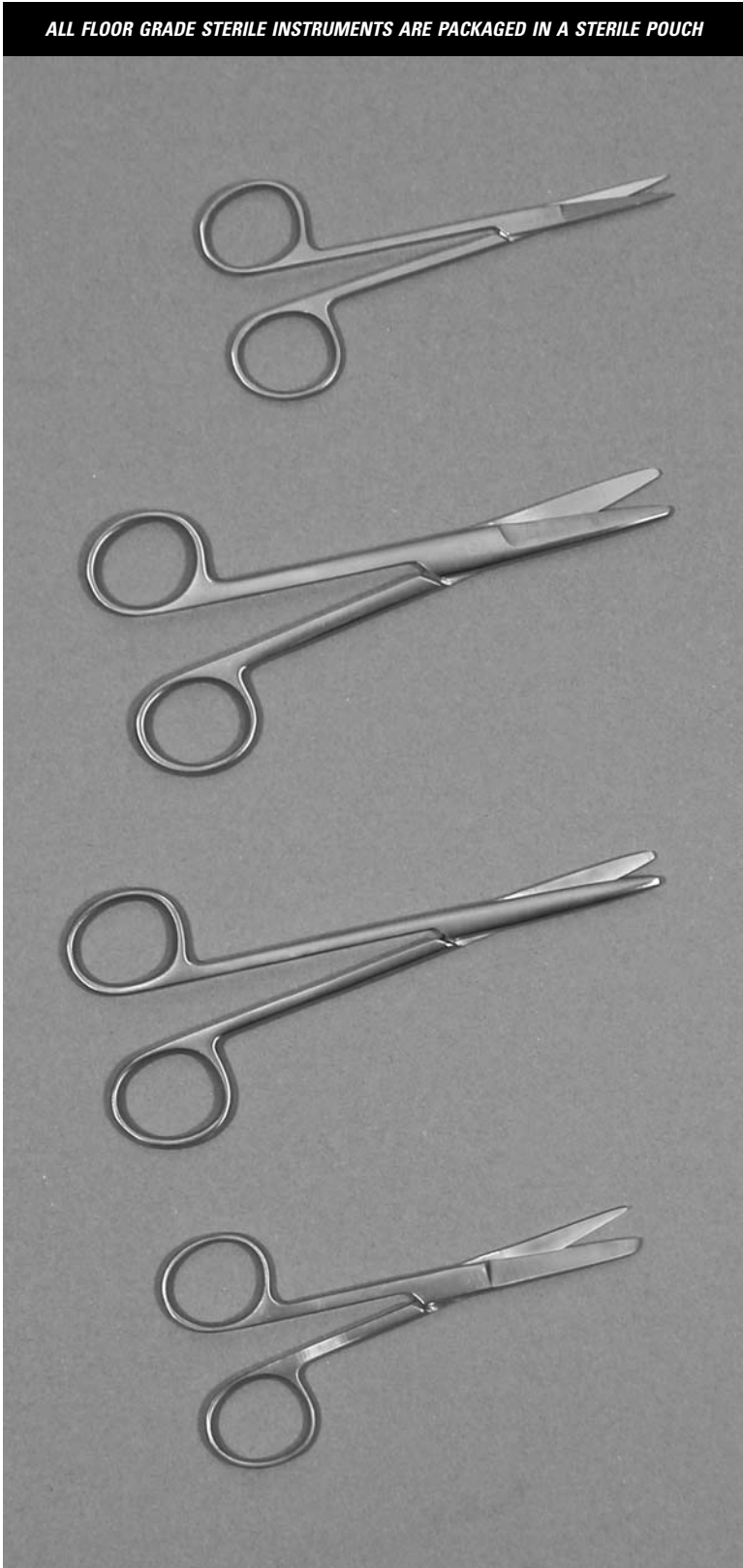

## IRIS SCISSORS

Box/50	96-2504	4-1/2"	Straight
	96-2506	4-1/2"	Curved
Box/25	96-2505	4-1/2"	Straight
	96-2507	4-1/2"	Curved
Box/100	96-2650	4-1/2"	Straight
	96-2651	4-1/2"	Curved

## NON-STERILE

Box/12	21-104	4-1/2"	Straight
	21-109	4-1/2"	Curved

## OPERATING SCISSORS

Box/50	96-2520	5-1/2"	Straight	S/B
	96-2522	5-1/2"	Straight	S/S
Box/25	96-2521	5-1/2"	Straight	S/B
	96-2523	5-1/2"	Straight	S/S
Box/100	96-2649	5-1/2"	Straight	S/B

## NON-STERILE

Box/12	21-272	5-1/2"	Straight	S/B
	21-275	5-1/2"	Straight	S/S

## METZENBAUM SCISSORS

Box/50	96-2516	5-3/4"	Straight
Box/25	96-2517	5-3/4"	Straight
Box/50	96-2680	7"	Curved
Box/25	96-2682	7"	Curved

## NON-STERILE

Box/12	21-335	5-1/2"	Straight
	21-336	5-1/2"	Curved
	21-339	7"	Straight
	21-340	7"	Curved

## MAYO SCISSORS

Box/50	96-2530	5-1/2"	Straight
Box/25	96-2531	5-1/2"	Straight

## NON-STERILE

Box/12	21-308	5-1/2"	Straight
--------	--------	--------	----------



ALL FLOOR GRADE STERILE INSTRUMENTS ARE PACKAGED IN A STERILE POUCH

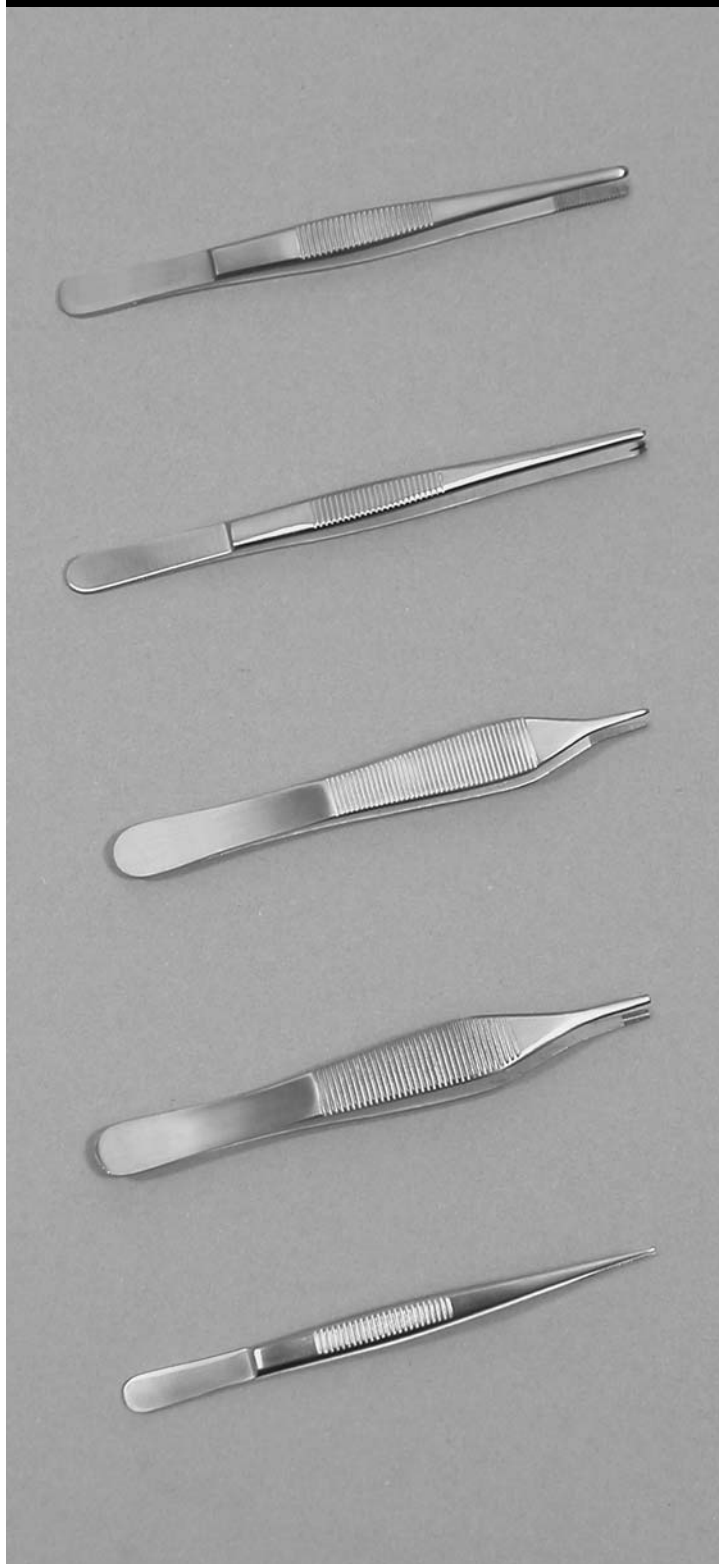

### DRESSING FORCEPS

Box/50	96-2568	5"
Box/25	96-2569	5"
Box/100	96-2660	5"

### NON-STERILE

Box/12	21-710	5"
--------	--------	----

### TISSUE FORCEPS

Box/50	96-2578	5"	1 x 2
Box/25	96-2579	5"	1 x 2
Box/100	96-2661	5"	1 x 2

### NON-STERILE

Box/12	21-757	5"	1 x 2
--------	--------	----	-------

### ADSON FORCEPS

Box/50	96-2570	4-3/4"	Serrated
	96-2572	4-3/4"	1 x 2
Box/25	96-2571	4-3/4"	Serrated
	96-2573	4-3/4"	1 x 2
Box/100	96-2655	4-3/4"	Serrated
	96-2656	4-3/4"	1 x 2

### NON-STERILE

Box/12	21-771	4-3/4"	Serrated
	21-775	4-3/4"	1 x 2

### ADSON-BROWN FORCEPS

Box/50	96-2558	4-3/4"	Side Grasping
Box/25	96-2559	4-3/4"	Side Grasping

### NON-STERILE

Box/12	21-778	4-3/4"	Side Grasping
--------	--------	--------	---------------

### FINE POINT SPLINTER FORCEPS

Box/50	96-2410	4-1/2"
Box/25	96-2412	4-1/2"

### NON-STERILE

Box/12	21-781	4-1/2"
--------	--------	--------



ALL FLOOR GRADE STERILE INSTRUMENTS ARE PACKAGED IN A STERILE POUCH



## HALSTEAD MOSQUITO HEMOSTATS

Box/50	96-2536	5"	Straight
	96-2538	5"	Curved
Box/25	96-2537	5"	Straight
	96-2539	5"	Curved
Box/100	96-2657	5"	Straight
	96-2658	5"	Curved

### NON-STERILE

Box/12	21-426	5"	Straight
	21-431	5"	Curved

## HARTMANN MOSQUITO HEMOSTATS

Box/50	96-2554	3-1/2"	Straight
	96-2555	3-1/2"	Curved
Box/25	96-2556	3-1/2"	Straight
	96-2557	3-1/2"	Curved

### NON-STERILE

Box/12	21-409	3-1/2"	Straight
	21-421	3-1/2"	Curved

## CRILE HEMOSTATS

Box/50	96-2550	5-1/2"	Straight
	96-2552	5-1/2"	Curved
Box/25	96-2551	5-1/2"	Straight
	96-2553	5-1/2"	Curved

### NON-STERILE

Box/12	21-447	5-1/2"	Straight
	21-452	5-1/2"	Curved

## KELLY HEMOSTATS

Box/50	96-2560	5-1/2"	Straight
	96-2562	5-1/2"	Curved
Box/25	96-2561	5-1/2"	Straight
	96-2563	5-1/2"	Curved
Box/100	96-2652	5-1/2"	Straight
	96-2653	5-1/2"	Curved

### NON-STERILE

Box/12	21-436	5-1/2"	Straight
	21-442	5-1/2"	Curved

## ROCHESTER-PEAN HEMOSTATS

Box/50	96-2544	6-1/4"	Straight
	96-2546	6-1/4"	Curved
Box/25	96-2545	6-1/4"	Straight
	96-2547	6-1/4"	Curved

### NON-STERILE

Box/12	21-473	6-1/4"	Straight
	21-477	6-1/4"	Curved

ALL FLOOR GRADE STERILE INSTRUMENTS ARE PACKAGED IN A STERILE POUCH

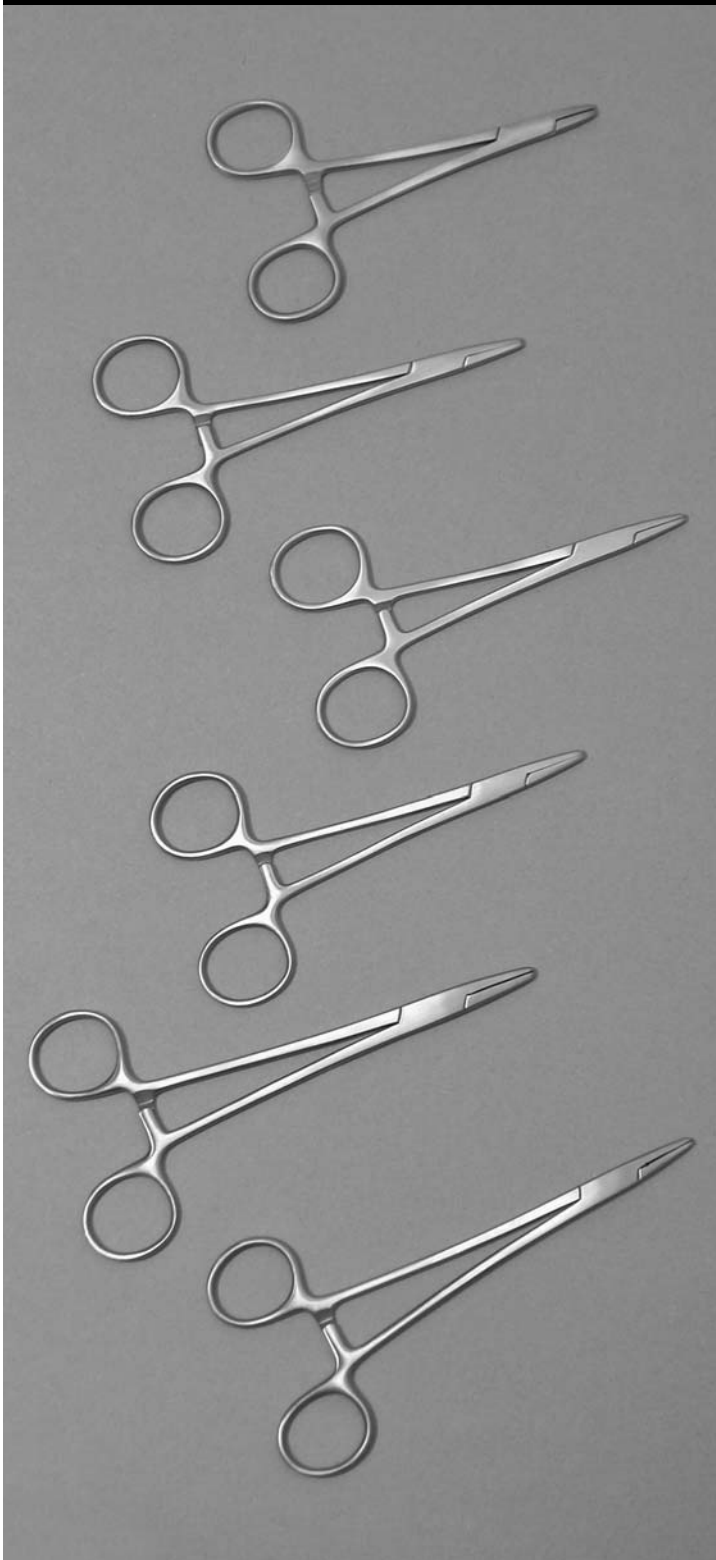

### DERF NEEDLE HOLDER

Box/50	96-2582	4-3/4"	Serrated
Box/25	96-2583	4-3/4"	Serrated

#### NON-STERILE

Box/12	21-826	4-3/4"	Serrated
--------	--------	--------	----------

### HALSEY NEEDLE HOLDER

Box/50	96-2584	5-1/4"	Smooth
Box/25	96-2585	5"	Smooth

#### NON-STERILE

Box/12	21-810	5"	
--------	--------	----	--

### BAUMGARTNER NEEDLE HOLDER

Box/50	96-2580	5-1/2"	
Box/25	96-2581	5-1/2"	

#### NON-STERILE

Box/12	21-832	5-1/2"	
--------	--------	--------	--

### WEBSTER NEEDLE HOLDER

Box/50	96-2586	5-1/4"	
Box/25	96-2587	5-1/4"	
Box/100	96-2659	5-1/4"	

#### NON-STERILE

Box/12	21-809	5-1/4"	
--------	--------	--------	--

### MAYO-HEGAR NEEDLE HOLDER

Box/50	96-2594	6"	
Box/25	96-2595	6"	

#### NON-STERILE

Box/12	21-847	6"	
--------	--------	----	--

### CRILE-WOOD NEEDLE HOLDER

Box/50	96-2590	6"	
Box/25	96-2591	6"	

#### NON-STERILE

Box/12	21-838	6"	
--------	--------	----	--



ALL FLOOR GRADE STERILE INSTRUMENTS ARE PACKAGED IN A STERILE POUCH



## BACKHAUS TOWEL FORCEPS

Box/50	96-2630	3-1/2"
	96-2634	5-1/4"
Box/25	96-2632	3-1/2"
	96-2636	5-1/4"

### NON-STERILE

Box/12	21-606	3-1/2"
	21-608	5-1/4"

## LORNA (EDNA) TOWEL FORCEPS

Box/50	96-2528	3-1/2"
Box/25	96-2529	3-1/2"

### NON-STERILE

Box/12	21-604	3-1/2"
--------	--------	--------

## SPONGE FORCEPS

Box/50	96-2532	9-1/2"	Straight/Serrated
Box/25	96-2533	9-1/2"	Straight/Serrated

### NON-STERILE

Box/12	21-577	9-1/2"	Straight/Serrated
--------	--------	--------	-------------------

## ALLIS TISSUE FORCEPS

Box/50	96-2576	6"	Straight
Box/25	96-2575	6"	Straight

### NON-STERILE

Box/12	21-930	6"	Straight
--------	--------	----	----------

ALL FLOOR GRADE STERILE INSTRUMENTS ARE PACKAGED IN A STERILE POUCH

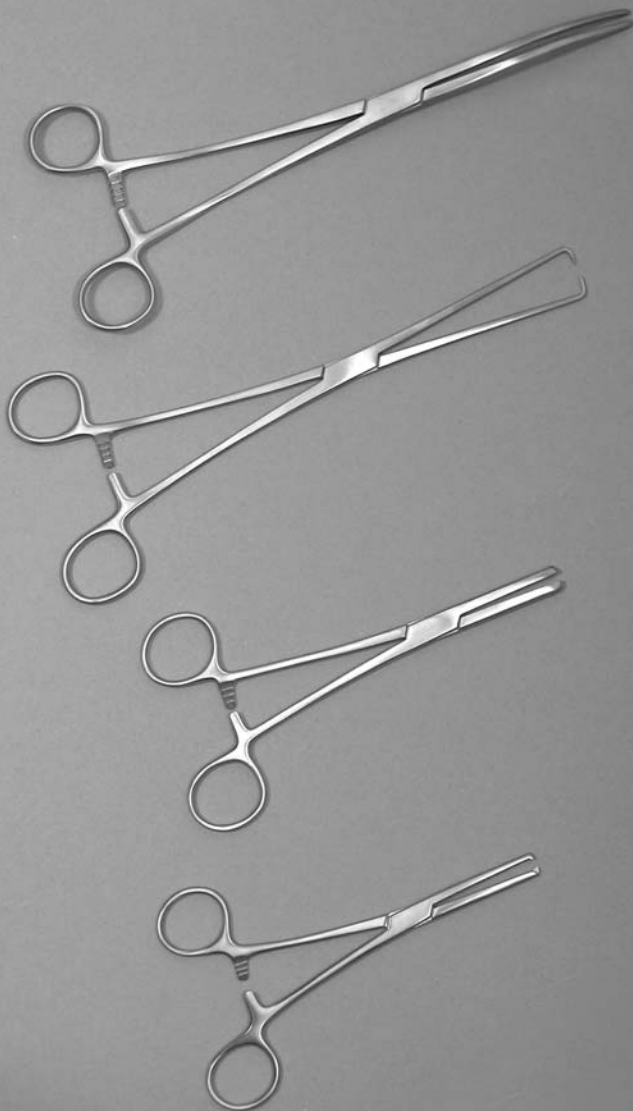

### BOZEMAN FORCEPS

Box/50	96-2620	10-1/4"	S-Curve
Box/25	96-2622	10-1/4"	S-Curve

### NON-STERILE

Box/12	21-374	10-1/4"	S-Curve
--------	--------	---------	---------

### SCHROEDER TENACULUM FORCEPS

Box/50	96-2626	9-1/2"
Box/25	96-2624	9-1/2"

### NON-STERILE

Box/12	21-386	9-1/2"
--------	--------	--------

### TUBE OCCLUDING FORCEPS

Box/50	96-2406	7"	Straight
Box/25	96-2408	7"	Straight

### NON-STERILE

Box/12	21-598	7"	Straight
--------	--------	----	----------

### ROCHESTER-OCHSNER FORCEPS









Box/50	96-2708	6-1/4"	Curved
	96-2707	6-1/4"	Straight
Box/25	96-2567	6-1/4"	Curved
	96-2566	6-1/4"	Straight

### NON-STERILE

Box/12	21-488	7-1/4"	Straight
--------	--------	--------	----------

# STAINLESS STEELWARE PRODUCTS



<p><b>IODINE CUP</b></p>  <table border="1"> <tr> <td>10-1670</td> <td>6 oz.</td> <td>3 7/16" x 2"</td> <td>10-1670-12 - Pk/12 10-1670-48 - Pk/48</td> </tr> <tr> <td>10-1671</td> <td>14 oz.</td> <td>4 3/8" x 2 5/8"</td> <td>10-1671-12 - Pk/12 10-1671-48 - Pk/48</td> </tr> </table>	10-1670	6 oz.	3 7/16" x 2"	10-1670-12 - Pk/12 10-1670-48 - Pk/48	10-1671	14 oz.	4 3/8" x 2 5/8"	10-1671-12 - Pk/12 10-1671-48 - Pk/48	<p><b>TUMBLER</b></p>  <table border="1"> <tr> <td>10-1536</td> <td>7 oz.</td> <td>2 7/8" x 3 1/8"</td> <td>10-1536-12 - Pk/12</td> </tr> </table>	10-1536	7 oz.	2 7/8" x 3 1/8"	10-1536-12 - Pk/12																															
10-1670	6 oz.	3 7/16" x 2"	10-1670-12 - Pk/12 10-1670-48 - Pk/48																																									
10-1671	14 oz.	4 3/8" x 2 5/8"	10-1671-12 - Pk/12 10-1671-48 - Pk/48																																									
10-1536	7 oz.	2 7/8" x 3 1/8"	10-1536-12 - Pk/12																																									
<p><b>MEDICINE CUP</b></p>  <p>Graduated Measure</p> <table border="1"> <tr> <td>10-1675</td> <td>2 oz.</td> <td>10-1675-12 - Pk/12 10-1675-48 - Pk/48</td> </tr> </table> <p>Graduated, Plastic Autoclavable</p> <table border="1"> <tr> <td>10-1585-12 - Pk/12 10-1585-48 - Pk/48</td> </tr> </table>	10-1675	2 oz.	10-1675-12 - Pk/12 10-1675-48 - Pk/48	10-1585-12 - Pk/12 10-1585-48 - Pk/48	<p><b>MEDICINE CUP</b></p>  <p>Disposable, Sterile</p> <table border="1"> <tr> <td>96-7027</td> <td>2 oz.</td> <td>Pk/25</td> </tr> </table>	96-7027	2 oz.	Pk/25																																				
10-1675	2 oz.	10-1675-12 - Pk/12 10-1675-48 - Pk/48																																										
10-1585-12 - Pk/12 10-1585-48 - Pk/48																																												
96-7027	2 oz.	Pk/25																																										
<p><b>OINTMENT JAR</b></p>  <p>With Cover</p> <table border="1"> <tr> <td>10-1525</td> <td>9 oz.</td> <td>3 1/8" x 2 3/4"</td> <td>10-1525-12 - Pk/12</td> </tr> </table>	10-1525	9 oz.	3 1/8" x 2 3/4"	10-1525-12 - Pk/12	<p><b>DRESSING JAR</b></p>  <p>With Cover</p> <table border="1"> <tr> <td>10-1523</td> <td>1/2 qt.</td> <td>4 1/8" x 2 1/4"</td> <td>10-1523-12 - Pk/12</td> </tr> <tr> <td>10-1533</td> <td>1 1/4 qt.</td> <td>4 1/8" x 5 1/2"</td> <td>10-1533-12 - Pk/12</td> </tr> <tr> <td>10-1538</td> <td>1 7/8 qt.</td> <td>4 7/8" x 6 1/4"</td> <td>10-1538-12 - Pk/12</td> </tr> <tr> <td>10-1527</td> <td>3 qt.</td> <td>5 7/8" x 6 3/4"</td> <td>10-1527-12 - Pk/12</td> </tr> <tr> <td>10-1543</td> <td>4 3/4 qt.</td> <td>6 3/4" x 7 3/4"</td> <td>10-1543-12 - Pk/12</td> </tr> <tr> <td>10-1544</td> <td>6 qt.</td> <td>7 1/4" x 8 3/8"</td> <td>10-1544-12 - Pk/12</td> </tr> <tr> <td>10-1547</td> <td>8 qt.</td> <td>8" x 9 3/8"</td> <td>10-1547-12 - Pk/12</td> </tr> </table>	10-1523	1/2 qt.	4 1/8" x 2 1/4"	10-1523-12 - Pk/12	10-1533	1 1/4 qt.	4 1/8" x 5 1/2"	10-1533-12 - Pk/12	10-1538	1 7/8 qt.	4 7/8" x 6 1/4"	10-1538-12 - Pk/12	10-1527	3 qt.	5 7/8" x 6 3/4"	10-1527-12 - Pk/12	10-1543	4 3/4 qt.	6 3/4" x 7 3/4"	10-1543-12 - Pk/12	10-1544	6 qt.	7 1/4" x 8 3/8"	10-1544-12 - Pk/12	10-1547	8 qt.	8" x 9 3/8"	10-1547-12 - Pk/12											
10-1525	9 oz.	3 1/8" x 2 3/4"	10-1525-12 - Pk/12																																									
10-1523	1/2 qt.	4 1/8" x 2 1/4"	10-1523-12 - Pk/12																																									
10-1533	1 1/4 qt.	4 1/8" x 5 1/2"	10-1533-12 - Pk/12																																									
10-1538	1 7/8 qt.	4 7/8" x 6 1/4"	10-1538-12 - Pk/12																																									
10-1527	3 qt.	5 7/8" x 6 3/4"	10-1527-12 - Pk/12																																									
10-1543	4 3/4 qt.	6 3/4" x 7 3/4"	10-1543-12 - Pk/12																																									
10-1544	6 qt.	7 1/4" x 8 3/8"	10-1544-12 - Pk/12																																									
10-1547	8 qt.	8" x 9 3/8"	10-1547-12 - Pk/12																																									
<p><b>PITCHER/BEAKER</b></p>  <table border="1"> <tr> <td>10-1172</td> <td>125 ml</td> <td>2 1/8" x 2 5/8"</td> </tr> <tr> <td>10-1173</td> <td>250 ml</td> <td>2 5/8" x 3 1/4"</td> </tr> <tr> <td>10-1174</td> <td>600 ml</td> <td>3 3/8" x 4 5/8"</td> </tr> <tr> <td>10-1175</td> <td>1200 ml</td> <td>4 1/8" x 6 1/16"</td> </tr> <tr> <td>10-1176</td> <td>2000 ml</td> <td>4 7/8" x 7 1/8"</td> </tr> <tr> <td>10-1177</td> <td>3000 ml</td> <td>5 1/2" x 8 1/4"</td> </tr> <tr> <td>10-1178</td> <td>4000 ml</td> <td>6 1/8" x 8 7/8"</td> </tr> </table> <p>With Closed Handle</p> <table border="1"> <tr> <td>10-1180</td> <td>3000 ml</td> <td>6 1/16" x 7"</td> </tr> <tr> <td>10-1181</td> <td>4000 ml</td> <td>6 7/8" x 8 7/8"</td> </tr> <tr> <td>10-1539</td> <td>2000 ml</td> <td>5 1/16" x 6 5/8"</td> <td>10-1539-12 - Pk/12</td> </tr> </table>	10-1172	125 ml	2 1/8" x 2 5/8"	10-1173	250 ml	2 5/8" x 3 1/4"	10-1174	600 ml	3 3/8" x 4 5/8"	10-1175	1200 ml	4 1/8" x 6 1/16"	10-1176	2000 ml	4 7/8" x 7 1/8"	10-1177	3000 ml	5 1/2" x 8 1/4"	10-1178	4000 ml	6 1/8" x 8 7/8"	10-1180	3000 ml	6 1/16" x 7"	10-1181	4000 ml	6 7/8" x 8 7/8"	10-1539	2000 ml	5 1/16" x 6 5/8"	10-1539-12 - Pk/12	<p><b>FORCEPS JAR</b></p>  <table border="1"> <tr> <td>10-1550</td> <td>1" x 4"</td> <td>Base 2 7/16"</td> <td>10-1550-12 - Pk/12</td> </tr> <tr> <td>10-1541</td> <td>2 1/4" x 4 1/2"</td> <td>Base 3 5/8"</td> <td>10-1541-12 - Pk/12</td> </tr> <tr> <td>10-1545</td> <td>2 1/4" x 7"</td> <td>Base 3 11/16"</td> <td>10-1545-12 - Pk/12</td> </tr> </table>	10-1550	1" x 4"	Base 2 7/16"	10-1550-12 - Pk/12	10-1541	2 1/4" x 4 1/2"	Base 3 5/8"	10-1541-12 - Pk/12	10-1545	2 1/4" x 7"	Base 3 11/16"	10-1545-12 - Pk/12
10-1172	125 ml	2 1/8" x 2 5/8"																																										
10-1173	250 ml	2 5/8" x 3 1/4"																																										
10-1174	600 ml	3 3/8" x 4 5/8"																																										
10-1175	1200 ml	4 1/8" x 6 1/16"																																										
10-1176	2000 ml	4 7/8" x 7 1/8"																																										
10-1177	3000 ml	5 1/2" x 8 1/4"																																										
10-1178	4000 ml	6 1/8" x 8 7/8"																																										
10-1180	3000 ml	6 1/16" x 7"																																										
10-1181	4000 ml	6 7/8" x 8 7/8"																																										
10-1539	2000 ml	5 1/16" x 6 5/8"	10-1539-12 - Pk/12																																									
10-1550	1" x 4"	Base 2 7/16"	10-1550-12 - Pk/12																																									
10-1541	2 1/4" x 4 1/2"	Base 3 5/8"	10-1541-12 - Pk/12																																									
10-1545	2 1/4" x 7"	Base 3 11/16"	10-1545-12 - Pk/12																																									

### STORAGE CONTAINER



10-1140	1 1/4 qt.	4 9/16" x 5 3/4"
10-1142	2 1/16 qt.	5 3/8" x 6 5/8"
10-1144	3 3/16 qt.	6 1/2" x 7"
10-1146	4 3/4 qt.	7 3/8" x 7 7/8"
10-1148	6 1/8 qt.	8" x 8 3/4"
10-1150	8 1/4 qt.	8 3/4" x 9 5/8"
10-1152	12 1/8 qt.	9 5/8" x 11"
10-1540	2 qt.	5 7/16" x 6 5/8"   10-1540-12 - Pk/12

### GRADUATED MEASURES



Stainless Steel

10-1552	16 oz.	3 3/4" x 4 5/8"	10-1552-12 - Pk/12
10-1510	32 oz.	4 3/4" x 5 1/4"	10-1510-12 - Pk/12
10-1674	64 oz.	5 1/2" x 6 1/2"	10-1674-12 - Pk/12

### MIXING/SOLUTION BOWL



10-1488	7/8 qt.	6 5/8" x 2 1/2"	10-1488-12 - Pk/12
10-1491	1 5/8 qt.	8 1/8" x 3"	10-1491-12 - Pk/12
10-1492	3 qt.	9 3/4" x 4"	10-1492-12 - Pk/12
10-1493	5 qt.	11 7/8" x 4 1/2"	10-1493-12 - Pk/12
10-1494	6 3/4 qt.	12 3/4" x 5 1/4"	
10-1495	8 qt.	13 5/16" x 5 7/16"	

### MIXING/SOLUTION BOWL



Disposable, Sterile

96-7174 | 32 oz. | Pk/20

### SPONGE BOWL



10-1496	12 oz.	4 1/2" x 2"	10-1496-12 - Pk/12
10-1498	22 oz.	5" x 2 3/8"	10-1498-12 - Pk/12
10-1484	29 oz.	5 9/16" x 2 9/16"	10-1484-12 - Pk/12
10-1485	36 oz.	6 1/4" x 2 3/4"	10-1485-12 - Pk/12
10-1483	48 oz.	7 1/8" x 2 3/4"	10-1483-12 - Pk/12
10-1486	64 oz.	7 9/16" x 3"	10-1486-12 - Pk/12

### SPONGE BOWL



Reusable Plastic, Autoclavable

10-1502 | 40 oz. | 6 3/8" x 3" | 10-1502-12 - Pk/12

### SOLUTION BASIN











10-1489	4 1/2 qt.	12" x 4 1/2"	10-1489-12 - Pk/12
10-1490	6 qt.	12 3/4" x 4 1/2"	10-1490-12 - Pk/12
10-1505	7 qt.	13 5/8" x 4 5/8"	10-1505-12 - Pk/12
10-1507	9 1/2 qt.	14 1/2" x 5"	10-1507-12 - Pk/12





<p><b>SOLUTION BASIN</b></p>  <p>Reusable Plastic, Autoclavable</p> <table border="1"> <tr> <td>10-1504</td> <td>7 qt.</td> <td>13 5/8" x 4 5/8"</td> <td>10-1504-12 - Pk/12</td> </tr> </table>	10-1504	7 qt.	13 5/8" x 4 5/8"	10-1504-12 - Pk/12	<p><b>SOLUTION BASIN</b></p>  <p>Disposable, Sterile with CSR Wrap</p> <table border="1"> <tr> <td>96-1679</td> <td>7 qt.</td> <td>Pk/5</td> <td></td> </tr> </table>	96-1679	7 qt.	Pk/5																													
10-1504	7 qt.	13 5/8" x 4 5/8"	10-1504-12 - Pk/12																																		
96-1679	7 qt.	Pk/5																																			
<p><b>EMESIS BASIN</b></p>  <table border="1"> <tr> <td>10-1497</td> <td>10 oz.</td> <td>6 5/8" x 3 1/2" x 1 1/2"</td> <td>10-1497-12 - Pk/12</td> </tr> <tr> <td>10-1698</td> <td>12 oz.</td> <td>8 1/8" x 3 5/8" x 1 5/8"</td> <td>10-1698-12 - Pk/12</td> </tr> <tr> <td>10-1699</td> <td>26 oz.</td> <td>9 7/8" x 4 1/2" x 2 1/8"</td> <td>10-1699-12 - Pk/12</td> </tr> <tr> <td>10-1487</td> <td>48 oz.</td> <td>12 1/8" x 5 3/4" x 2 1/4"</td> <td></td> </tr> </table>	10-1497	10 oz.	6 5/8" x 3 1/2" x 1 1/2"	10-1497-12 - Pk/12	10-1698	12 oz.	8 1/8" x 3 5/8" x 1 5/8"	10-1698-12 - Pk/12	10-1699	26 oz.	9 7/8" x 4 1/2" x 2 1/8"	10-1699-12 - Pk/12	10-1487	48 oz.	12 1/8" x 5 3/4" x 2 1/4"		<p><b>HOSPITAL KICK BUCKET</b></p>  <p>With Lid and Roll Stand</p> <table border="1"> <tr> <td>10-1551</td> <td>13 qt.</td> <td>11 5/8" x 9 1/4"</td> <td></td> </tr> </table>	10-1551	13 qt.	11 5/8" x 9 1/4"																	
10-1497	10 oz.	6 5/8" x 3 1/2" x 1 1/2"	10-1497-12 - Pk/12																																		
10-1698	12 oz.	8 1/8" x 3 5/8" x 1 5/8"	10-1698-12 - Pk/12																																		
10-1699	26 oz.	9 7/8" x 4 1/2" x 2 1/8"	10-1699-12 - Pk/12																																		
10-1487	48 oz.	12 1/8" x 5 3/4" x 2 1/4"																																			
10-1551	13 qt.	11 5/8" x 9 1/4"																																			
<p><b>HOSPITAL BUCKET</b></p>  <p>With Lid</p> <table border="1"> <tr> <td>10-1450</td> <td>13 qt.</td> <td>11 5/8" x 9 1/4"</td> <td></td> </tr> <tr> <td>10-1451</td> <td>16 qt.</td> <td>11 3/4" x 10 1/8"</td> <td></td> </tr> </table> <p>Without Lid</p> <table border="1"> <tr> <td>10-1182</td> <td>13 qt.</td> <td>11 5/8" x 9 1/4"</td> <td></td> </tr> <tr> <td>10-1183</td> <td>16 qt.</td> <td>11 3/4" x 10 1/8"</td> <td></td> </tr> <tr> <td>10-1184</td> <td>20 qt.</td> <td>13 3/4" x 11 3/16"</td> <td></td> </tr> </table>	10-1450	13 qt.	11 5/8" x 9 1/4"		10-1451	16 qt.	11 3/4" x 10 1/8"		10-1182	13 qt.	11 5/8" x 9 1/4"		10-1183	16 qt.	11 3/4" x 10 1/8"		10-1184	20 qt.	13 3/4" x 11 3/16"		<p><b>STORAGE CONTAINERS</b></p>  <p>With Lid</p> <table border="1"> <tr> <td>10-1186</td> <td>3 gal.</td> <td>10 3/16" x 9"</td> <td></td> </tr> <tr> <td>10-1188</td> <td>4 gal.</td> <td>13" x 9"</td> <td></td> </tr> <tr> <td>10-1189</td> <td>5 gal.</td> <td>13" x 11"</td> <td></td> </tr> <tr> <td>10-1190</td> <td>6 gal.</td> <td>13" x 13"</td> <td></td> </tr> </table>	10-1186	3 gal.	10 3/16" x 9"		10-1188	4 gal.	13" x 9"		10-1189	5 gal.	13" x 11"		10-1190	6 gal.	13" x 13"	
10-1450	13 qt.	11 5/8" x 9 1/4"																																			
10-1451	16 qt.	11 3/4" x 10 1/8"																																			
10-1182	13 qt.	11 5/8" x 9 1/4"																																			
10-1183	16 qt.	11 3/4" x 10 1/8"																																			
10-1184	20 qt.	13 3/4" x 11 3/16"																																			
10-1186	3 gal.	10 3/16" x 9"																																			
10-1188	4 gal.	13" x 9"																																			
10-1189	5 gal.	13" x 11"																																			
10-1190	6 gal.	13" x 13"																																			
<p><b>FUNNELS</b></p>  <p>With Hanging Hook</p> <table border="1"> <tr> <td>10-1157</td> <td>2 3/8 oz.</td> <td>3" x 3 3/4"</td> <td></td> </tr> <tr> <td>10-1158</td> <td>6 3/8 oz.</td> <td>4 1/8" x 4 7/8"</td> <td></td> </tr> <tr> <td>10-1159</td> <td>13 oz.</td> <td>5 1/8" x 5 5/8"</td> <td></td> </tr> <tr> <td>10-1160</td> <td>22 1/4 oz.</td> <td>6 1/4" x 6 5/8"</td> <td></td> </tr> <tr> <td>10-1170</td> <td>32 oz.</td> <td>7" x 8 3/8"</td> <td></td> </tr> <tr> <td>10-1171</td> <td>64 oz.</td> <td>8 3/8" x 9 1/2"</td> <td></td> </tr> </table>	10-1157	2 3/8 oz.	3" x 3 3/4"		10-1158	6 3/8 oz.	4 1/8" x 4 7/8"		10-1159	13 oz.	5 1/8" x 5 5/8"		10-1160	22 1/4 oz.	6 1/4" x 6 5/8"		10-1170	32 oz.	7" x 8 3/8"		10-1171	64 oz.	8 3/8" x 9 1/2"		<p><b>LAB / UTILITY SCOOPS</b></p>  <table border="1"> <tr> <td>10-1192</td> <td>5" x 2 1/2"</td> <td></td> <td></td> </tr> <tr> <td>10-1193</td> <td>5" x 7 1/2"</td> <td></td> <td></td> </tr> </table>	10-1192	5" x 2 1/2"			10-1193	5" x 7 1/2"						
10-1157	2 3/8 oz.	3" x 3 3/4"																																			
10-1158	6 3/8 oz.	4 1/8" x 4 7/8"																																			
10-1159	13 oz.	5 1/8" x 5 5/8"																																			
10-1160	22 1/4 oz.	6 1/4" x 6 5/8"																																			
10-1170	32 oz.	7" x 8 3/8"																																			
10-1171	64 oz.	8 3/8" x 9 1/2"																																			
10-1192	5" x 2 1/2"																																				
10-1193	5" x 7 1/2"																																				
<p><b>MAYO TRAY</b></p>  <p>Perforated</p> <table border="1"> <tr> <td>10-1684</td> <td>10" x 6 1/2" x 3/4"</td> <td>10-1684-12 - Pk/12</td> </tr> <tr> <td>10-1685</td> <td>13 3/4" x 9 3/4" x 3/4"</td> <td>10-1685-12 - Pk/12</td> </tr> <tr> <td>10-1686</td> <td>15 1/8" x 10 5/8" x 3/4"</td> <td>10-1686-12 - Pk/12</td> </tr> <tr> <td>10-1687</td> <td>17" x 11 5/8" x 3/4"</td> <td>10-1687-12 - Pk/12</td> </tr> <tr> <td>10-1688</td> <td>19 1/8" x 12 5/8" x 3/4"</td> <td>10-1688-12 - Pk/12</td> </tr> </table>	10-1684	10" x 6 1/2" x 3/4"	10-1684-12 - Pk/12	10-1685	13 3/4" x 9 3/4" x 3/4"	10-1685-12 - Pk/12	10-1686	15 1/8" x 10 5/8" x 3/4"	10-1686-12 - Pk/12	10-1687	17" x 11 5/8" x 3/4"	10-1687-12 - Pk/12	10-1688	19 1/8" x 12 5/8" x 3/4"	10-1688-12 - Pk/12	<p><b>MAYO TRAY</b></p>  <p>Non-Perforated</p> <table border="1"> <tr> <td>10-1690</td> <td>10" x 6 1/2" x 3/4"</td> <td>10-1690-12 - Pk/12</td> </tr> <tr> <td>10-1691</td> <td>13 3/4" x 9 3/4" x 3/4"</td> <td>10-1691-12 - Pk/12</td> </tr> <tr> <td>10-1692</td> <td>15 1/8" x 10 5/8" x 3/4"</td> <td>10-1692-12 - Pk/12</td> </tr> <tr> <td>10-1693</td> <td>17" x 10 5/8" x 3/4"</td> <td>10-1693-12 - Pk/12</td> </tr> <tr> <td>10-1694</td> <td>19 1/8" x 12 5/8" x 3/4"</td> <td>10-1694-12 - Pk/12</td> </tr> <tr> <td>10-1695</td> <td>21 1/4" x 16 1/4" x 7/8"</td> <td>10-1695-12 - Pk/12</td> </tr> </table>	10-1690	10" x 6 1/2" x 3/4"	10-1690-12 - Pk/12	10-1691	13 3/4" x 9 3/4" x 3/4"	10-1691-12 - Pk/12	10-1692	15 1/8" x 10 5/8" x 3/4"	10-1692-12 - Pk/12	10-1693	17" x 10 5/8" x 3/4"	10-1693-12 - Pk/12	10-1694	19 1/8" x 12 5/8" x 3/4"	10-1694-12 - Pk/12	10-1695	21 1/4" x 16 1/4" x 7/8"	10-1695-12 - Pk/12			
10-1684	10" x 6 1/2" x 3/4"	10-1684-12 - Pk/12																																			
10-1685	13 3/4" x 9 3/4" x 3/4"	10-1685-12 - Pk/12																																			
10-1686	15 1/8" x 10 5/8" x 3/4"	10-1686-12 - Pk/12																																			
10-1687	17" x 11 5/8" x 3/4"	10-1687-12 - Pk/12																																			
10-1688	19 1/8" x 12 5/8" x 3/4"	10-1688-12 - Pk/12																																			
10-1690	10" x 6 1/2" x 3/4"	10-1690-12 - Pk/12																																			
10-1691	13 3/4" x 9 3/4" x 3/4"	10-1691-12 - Pk/12																																			
10-1692	15 1/8" x 10 5/8" x 3/4"	10-1692-12 - Pk/12																																			
10-1693	17" x 10 5/8" x 3/4"	10-1693-12 - Pk/12																																			
10-1694	19 1/8" x 12 5/8" x 3/4"	10-1694-12 - Pk/12																																			
10-1695	21 1/4" x 16 1/4" x 7/8"	10-1695-12 - Pk/12																																			



<p><b>MAYO TRAY</b></p>  <p>Reusable Plastic, Autoclavable Features No-Slip Textured Surface</p> <p>Perforated</p> <table border="1"> <tr> <td>10-1965</td> <td>10 1/8" x 6 5/8"</td> <td>10-1965-12 - Pk/12</td> </tr> <tr> <td>10-1966</td> <td>10 7/16" x 13 9/16"</td> <td>10-1966-12 - Pk/12</td> </tr> <tr> <td>10-1967</td> <td>11 3/4" x 16"</td> <td>10-1967-12 - Pk/12</td> </tr> </table> <p>Non-Perforated</p> <table border="1"> <tr> <td>10-1960</td> <td>10 1/8" x 6 5/8"</td> </tr> <tr> <td>10-1961</td> <td>10 7/16" x 13 9/16"</td> </tr> </table>	10-1965	10 1/8" x 6 5/8"	10-1965-12 - Pk/12	10-1966	10 7/16" x 13 9/16"	10-1966-12 - Pk/12	10-1967	11 3/4" x 16"	10-1967-12 - Pk/12	10-1960	10 1/8" x 6 5/8"	10-1961	10 7/16" x 13 9/16"	<p><b>INSTRUMENT TRAY</b></p>  <p>With Rolled Bead Edge</p> <table border="1"> <tr> <td>10-1532</td> <td>25" x 15" x 7/8"</td> </tr> <tr> <td>10-1876</td> <td>10" x 6 1/2" x 3/4"</td> <td>10-1876-12 - Pk/12</td> </tr> <tr> <td>10-1883</td> <td>13 11/16" x 9 13/16" x 3/4"</td> <td>10-1883-12 - Pk/12</td> </tr> <tr> <td>10-1884</td> <td>15 1/8" x 10 5/8" x 3/4"</td> <td>10-1884-12 - Pk/12</td> </tr> <tr> <td>10-1683</td> <td>17" x 11 5/8" x 3/4"</td> <td>10-1683-12 - Pk/12</td> </tr> <tr> <td>10-1888</td> <td>19 1/8" x 12 5/8" x 3/4"</td> <td>10-1888-12 - Pk/12</td> </tr> <tr> <td>10-1680</td> <td>21 1/4" x 16 1/4" x 7/8"</td> <td>10-1680-12 - Pk/12</td> </tr> </table>	10-1532	25" x 15" x 7/8"	10-1876	10" x 6 1/2" x 3/4"	10-1876-12 - Pk/12	10-1883	13 11/16" x 9 13/16" x 3/4"	10-1883-12 - Pk/12	10-1884	15 1/8" x 10 5/8" x 3/4"	10-1884-12 - Pk/12	10-1683	17" x 11 5/8" x 3/4"	10-1683-12 - Pk/12	10-1888	19 1/8" x 12 5/8" x 3/4"	10-1888-12 - Pk/12	10-1680	21 1/4" x 16 1/4" x 7/8"	10-1680-12 - Pk/12
10-1965	10 1/8" x 6 5/8"	10-1965-12 - Pk/12																																
10-1966	10 7/16" x 13 9/16"	10-1966-12 - Pk/12																																
10-1967	11 3/4" x 16"	10-1967-12 - Pk/12																																
10-1960	10 1/8" x 6 5/8"																																	
10-1961	10 7/16" x 13 9/16"																																	
10-1532	25" x 15" x 7/8"																																	
10-1876	10" x 6 1/2" x 3/4"	10-1876-12 - Pk/12																																
10-1883	13 11/16" x 9 13/16" x 3/4"	10-1883-12 - Pk/12																																
10-1884	15 1/8" x 10 5/8" x 3/4"	10-1884-12 - Pk/12																																
10-1683	17" x 11 5/8" x 3/4"	10-1683-12 - Pk/12																																
10-1888	19 1/8" x 12 5/8" x 3/4"	10-1888-12 - Pk/12																																
10-1680	21 1/4" x 16 1/4" x 7/8"	10-1680-12 - Pk/12																																
<p><b>INSTRUMENT TRAY</b></p>  <p>Perforated</p> <table border="1"> <tr> <td>10-1758</td> <td>12 3/4" x 10 3/8" x 2 1/2"</td> </tr> <tr> <td>10-1757</td> <td>12 3/4" x 10 3/8" x 1 1/4"</td> </tr> <tr> <td>10-1759</td> <td>20 3/4" x 12 3/4" x 2 1/2"</td> </tr> <tr> <td>10-1941</td> <td>20 3/4" x 12 3/4" x 1 1/4"</td> </tr> <tr> <td>10-1942</td> <td>20 3/4" x 12 3/4" x 6"</td> </tr> </table>	10-1758	12 3/4" x 10 3/8" x 2 1/2"	10-1757	12 3/4" x 10 3/8" x 1 1/4"	10-1759	20 3/4" x 12 3/4" x 2 1/2"	10-1941	20 3/4" x 12 3/4" x 1 1/4"	10-1942	20 3/4" x 12 3/4" x 6"	<p><b>HIGH SIDED INSTRUMENT TRAY</b></p>  <p>Perforated</p> <table border="1"> <tr> <td>10-1879</td> <td>12 1/4" x 7 3/4" x 2 1/4"</td> </tr> <tr> <td>10-1892</td> <td>12" x 7 3/4" x 2"</td> </tr> <tr> <td>10-1874</td> <td>10" x 6 1/2" x 2"</td> </tr> <tr> <td>10-1943</td> <td>12 3/4" x 10 3/8" x 4"</td> </tr> </table> <p>Non-Perforated</p> <table border="1"> <tr> <td>10-1194</td> <td>16 1/2" x 10" x 2"</td> </tr> </table>	10-1879	12 1/4" x 7 3/4" x 2 1/4"	10-1892	12" x 7 3/4" x 2"	10-1874	10" x 6 1/2" x 2"	10-1943	12 3/4" x 10 3/8" x 4"	10-1194	16 1/2" x 10" x 2"													
10-1758	12 3/4" x 10 3/8" x 2 1/2"																																	
10-1757	12 3/4" x 10 3/8" x 1 1/4"																																	
10-1759	20 3/4" x 12 3/4" x 2 1/2"																																	
10-1941	20 3/4" x 12 3/4" x 1 1/4"																																	
10-1942	20 3/4" x 12 3/4" x 6"																																	
10-1879	12 1/4" x 7 3/4" x 2 1/4"																																	
10-1892	12" x 7 3/4" x 2"																																	
10-1874	10" x 6 1/2" x 2"																																	
10-1943	12 3/4" x 10 3/8" x 4"																																	
10-1194	16 1/2" x 10" x 2"																																	
<p><b>STERILIZATION TRAY</b></p>  <table border="1"> <tr> <td>10-1700</td> <td>8 1/2" x 8" x 1 1/4"</td> </tr> <tr> <td>10-1701</td> <td>10" x 6 1/2" x 3/4"</td> </tr> <tr> <td>10-1702</td> <td>10 1/2" x 10" x 1 1/2"</td> </tr> <tr> <td>10-1703</td> <td>15" x 10 1/2" x 1 1/4"</td> </tr> <tr> <td>10-1707</td> <td>8 1/2" x 12" x 1 1/4"</td> </tr> <tr> <td>10-1708</td> <td>8" x 14" x 1 1/4"</td> </tr> </table>	10-1700	8 1/2" x 8" x 1 1/4"	10-1701	10" x 6 1/2" x 3/4"	10-1702	10 1/2" x 10" x 1 1/2"	10-1703	15" x 10 1/2" x 1 1/4"	10-1707	8 1/2" x 12" x 1 1/4"	10-1708	8" x 14" x 1 1/4"	<p><b>STERILIZATION TRAYS/BATH SETS</b></p>  <p>Solid Tray</p> <table border="1"> <tr> <td>10-1948</td> <td>20 3/4" x 12 3/4" x 6"</td> <td>10-1948-12 - Pk/12</td> </tr> </table> <p>Perforated Tray</p> <table border="1"> <tr> <td>10-1949</td> <td>20 3/4" x 12 3/4" x 4"</td> <td>10-1949-12 - Pk/12</td> </tr> </table> <p>Cover</p> <table border="1"> <tr> <td>10-1535</td> <td></td> <td>10-1535-12 - Pk/12</td> </tr> </table>	10-1948	20 3/4" x 12 3/4" x 6"	10-1948-12 - Pk/12	10-1949	20 3/4" x 12 3/4" x 4"	10-1949-12 - Pk/12	10-1535		10-1535-12 - Pk/12												
10-1700	8 1/2" x 8" x 1 1/4"																																	
10-1701	10" x 6 1/2" x 3/4"																																	
10-1702	10 1/2" x 10" x 1 1/2"																																	
10-1703	15" x 10 1/2" x 1 1/4"																																	
10-1707	8 1/2" x 12" x 1 1/4"																																	
10-1708	8" x 14" x 1 1/4"																																	
10-1948	20 3/4" x 12 3/4" x 6"	10-1948-12 - Pk/12																																
10-1949	20 3/4" x 12 3/4" x 4"	10-1949-12 - Pk/12																																
10-1535		10-1535-12 - Pk/12																																
<p><b>DOUBLE DECK MICRO TRAY</b></p>  <table border="1"> <tr> <td>10-1717</td> <td>10" x 15" x 2 1/4"</td> </tr> </table>	10-1717	10" x 15" x 2 1/4"	<p><b>STERILIZATION TRAY</b></p>  <table border="1"> <tr> <td>10-1706</td> <td>8 1/2" x 8" x 1 1/4"</td> <td>With 2 1/2" x 2 1/2" Compartment</td> </tr> <tr> <td>10-1716</td> <td>10 1/2" x 20" x 2 1/2"</td> <td>With 10 1/2" x 5" Compartment</td> </tr> </table>	10-1706	8 1/2" x 8" x 1 1/4"	With 2 1/2" x 2 1/2" Compartment	10-1716	10 1/2" x 20" x 2 1/2"	With 10 1/2" x 5" Compartment																									
10-1717	10" x 15" x 2 1/4"																																	
10-1706	8 1/2" x 8" x 1 1/4"	With 2 1/2" x 2 1/2" Compartment																																
10-1716	10 1/2" x 20" x 2 1/2"	With 10 1/2" x 5" Compartment																																



## FLASH STERILIZATION TRAY



10-1711 | 10" x 6 1/2" x 2"

## RETRIEVING HANDLE



10-1712 | Single Handle For Flash Tray Pictured at Left

## STERILIZATION TRAYS



Sterilization Box (not pictured)  
10-1705 | 6 3/8" x 3 3/8" x 1 3/4"

Sterilization Trays (pictured)

10-1710 | 10" x 6 1/2" x 2 1/2"

10-1714 | 15" x 10 1/2" x 3 1/2"

10-1718 | 10" x 6 1/2" x 2"

10-1720 | 20" x 10 1/2" x 3 1/2"

## LIFTING HANDLES



10-1725 | One Pair For Trays Pictured at Left

## CLEANING BASKET



Perforated  
10-1560 | 12 3/4" x 10 3/8" x 6"

## INSTRUMENT TRAY



10-1870	12 3/4" x 10 1/2" x 6"	10-1870-6 - Pk/6
10-1746	12 3/4" x 10 3/8" x 2 1/2"	10-1746-6 - Pk/6
10-1747	12 3/4" x 10 3/8" x 4"	10-1747-6 - Pk/6
Cover For 10-1746 & 10-1747		
10-1882		10-1882-6 - Pk/6

## INSTRUMENT CATH TRAY



10-1738 | 8 7/8" x 5" x 2" | 10-1738-12 - Pk/12

10-1760 | 8 7/8" x 5" x 3" | 10-1760-12 - Pk/12









Flat Cover For 10-1738 (not pictured)  
10-1722 | | 10-1722-12 - Pk/12

Dome Cover For 10-1760 (pictured)  
10-1761 | | 10-1761-12 - Pk/12

## INSTRUMENT TRAY



Solid		
10-1850	12 3/4" x 10 1/2" x 2 1/2"	
10-1860	12 3/4" x 10 1/2" x 4"	
10-1877	12 1/4" x 7 3/4" x 2 1/4"	10-1877-12 - Pk/12
10-1744	12 3/4" x 6 7/8" x 2 1/2"	10-1744-12 - Pk/12
Perforated		
10-1852	12 3/4" x 10 1/2" x 2 1/2"	
10-1862	12 3/4" x 10 1/2" x 4"	
10-1864	Cover For Above Trays	
10-1878	Cover For 10-1877	10-1878-12 - Pk/12
10-1724	Cover For 10-1744	10-1724-12 - Pk/12

<p><b>STERILIZATION TRAY</b></p>  <table border="1"> <tr> <td>10-1750</td> <td>6 qt.   20 3/4" x 6 3/8" x 4"</td> <td>10-1750-12 - Pk/12</td> </tr> <tr> <td>10-1752</td> <td>9 qt.   20 3/4" x 6 3/8" x 6"</td> <td>10-1752-12 - Pk/12</td> </tr> <tr> <td>10-1854</td> <td colspan="2">Cover For Above Trays   10-1854-12 - Pk/12</td> </tr> </table>	10-1750	6 qt.   20 3/4" x 6 3/8" x 4"	10-1750-12 - Pk/12	10-1752	9 qt.   20 3/4" x 6 3/8" x 6"	10-1752-12 - Pk/12	10-1854	Cover For Above Trays   10-1854-12 - Pk/12		<p><b>CATHETER TRAY</b></p>  <table border="1"> <tr> <td>10-1955</td> <td>8 3/4" x 3 1/4" x 1 1/2"</td> <td>10-1955-12 - Pk/12</td> </tr> <tr> <td>10-1956</td> <td colspan="2">Cover For 10-1955   10-1956-12 - Pk/12</td> </tr> <tr> <td>10-1886</td> <td>17 1/4" x 4 1/2" x 2"</td> <td>10-1886-12 - Pk/12</td> </tr> <tr> <td>10-1887</td> <td colspan="2">Cover For 10-1886   10-1887-12 - Pk/12</td> </tr> </table>	10-1955	8 3/4" x 3 1/4" x 1 1/2"	10-1955-12 - Pk/12	10-1956	Cover For 10-1955   10-1956-12 - Pk/12		10-1886	17 1/4" x 4 1/2" x 2"	10-1886-12 - Pk/12	10-1887	Cover For 10-1886   10-1887-12 - Pk/12							
10-1750	6 qt.   20 3/4" x 6 3/8" x 4"	10-1750-12 - Pk/12																										
10-1752	9 qt.   20 3/4" x 6 3/8" x 6"	10-1752-12 - Pk/12																										
10-1854	Cover For Above Trays   10-1854-12 - Pk/12																											
10-1955	8 3/4" x 3 1/4" x 1 1/2"	10-1955-12 - Pk/12																										
10-1956	Cover For 10-1955   10-1956-12 - Pk/12																											
10-1886	17 1/4" x 4 1/2" x 2"	10-1886-12 - Pk/12																										
10-1887	Cover For 10-1886   10-1887-12 - Pk/12																											
<p><b>INSTRUMENT TRAY</b></p>  <table border="1"> <tr> <td>10-1742</td> <td>10 3/8" x 6 3/8" x 2 1/2"</td> <td>10-1742-12 - Pk/12</td> </tr> <tr> <td>10-1542</td> <td colspan="2">Cover For 10-1742   10-1542-12 - Pk/12</td> </tr> <tr> <td>10-1950</td> <td>12 3/4" x 10 3/8" x 2 1/2"</td> <td>10-1950-12 - Pk/12</td> </tr> <tr> <td>10-1952</td> <td>12 3/4" x 10 3/8" x 4"</td> <td>10-1952-12 - Pk/12</td> </tr> <tr> <td>10-1882</td> <td colspan="2">Cover For 10-1950 &amp; 10-1952   10-1882-12 - Pk/12</td> </tr> </table>	10-1742	10 3/8" x 6 3/8" x 2 1/2"	10-1742-12 - Pk/12	10-1542	Cover For 10-1742   10-1542-12 - Pk/12		10-1950	12 3/4" x 10 3/8" x 2 1/2"	10-1950-12 - Pk/12	10-1952	12 3/4" x 10 3/8" x 4"	10-1952-12 - Pk/12	10-1882	Cover For 10-1950 & 10-1952   10-1882-12 - Pk/12		<p><b>STERILIZATION TRAY</b></p>  <table border="1"> <tr> <td>10-1948</td> <td>20 3/4" x 12 3/4" x 6"</td> <td>10-1948-12 - Pk/12</td> </tr> <tr> <td>10-1953</td> <td>20 3/4" x 12 3/8" x 2 1/2"</td> <td>10-1953-12 - Pk/12</td> </tr> <tr> <td>10-1954</td> <td>20 3/4" x 12 3/4" x 4"</td> <td>10-1954-12 - Pk/12</td> </tr> <tr> <td>10-1535</td> <td colspan="2">Cover For Above Trays   10-1535-12 - Pk/12</td> </tr> </table>	10-1948	20 3/4" x 12 3/4" x 6"	10-1948-12 - Pk/12	10-1953	20 3/4" x 12 3/8" x 2 1/2"	10-1953-12 - Pk/12	10-1954	20 3/4" x 12 3/4" x 4"	10-1954-12 - Pk/12	10-1535	Cover For Above Trays   10-1535-12 - Pk/12	
10-1742	10 3/8" x 6 3/8" x 2 1/2"	10-1742-12 - Pk/12																										
10-1542	Cover For 10-1742   10-1542-12 - Pk/12																											
10-1950	12 3/4" x 10 3/8" x 2 1/2"	10-1950-12 - Pk/12																										
10-1952	12 3/4" x 10 3/8" x 4"	10-1952-12 - Pk/12																										
10-1882	Cover For 10-1950 & 10-1952   10-1882-12 - Pk/12																											
10-1948	20 3/4" x 12 3/4" x 6"	10-1948-12 - Pk/12																										
10-1953	20 3/4" x 12 3/8" x 2 1/2"	10-1953-12 - Pk/12																										
10-1954	20 3/4" x 12 3/4" x 4"	10-1954-12 - Pk/12																										
10-1535	Cover For Above Trays   10-1535-12 - Pk/12																											
<p><b>INSTRUMENT TRAY</b></p>  <table border="1"> <tr> <td>10-1748</td> <td>16 1/2" x 10" x 2 1/2"</td> <td>10-1748-12 - Pk/12</td> </tr> <tr> <td>10-1756</td> <td colspan="2">Cover For 10-1748   10-1756-12 - Pk/12</td> </tr> <tr> <td>10-1753</td> <td>13 7/8" x 12 7/8" x 2 1/2"</td> <td>10-1753-12 - Pk/12</td> </tr> <tr> <td>10-1754</td> <td colspan="2">Cover For 10-1753   10-1754-12 - Pk/12</td> </tr> <tr> <td>10-1755</td> <td>6 7/8" x 4 1/4" x 2"</td> <td>10-1755-12 - Pk/12</td> </tr> <tr> <td>10-1737</td> <td colspan="2">Cover For 10-1755   10-1737-12 - Pk/12</td> </tr> </table>	10-1748	16 1/2" x 10" x 2 1/2"	10-1748-12 - Pk/12	10-1756	Cover For 10-1748   10-1756-12 - Pk/12		10-1753	13 7/8" x 12 7/8" x 2 1/2"	10-1753-12 - Pk/12	10-1754	Cover For 10-1753   10-1754-12 - Pk/12		10-1755	6 7/8" x 4 1/4" x 2"	10-1755-12 - Pk/12	10-1737	Cover For 10-1755   10-1737-12 - Pk/12		<p><b>STERILIZATION TRAY</b></p>  <table border="1"> <tr> <td>10-1740</td> <td>8 7/8" x 5" x 2"</td> </tr> </table>	10-1740	8 7/8" x 5" x 2"							
10-1748	16 1/2" x 10" x 2 1/2"	10-1748-12 - Pk/12																										
10-1756	Cover For 10-1748   10-1756-12 - Pk/12																											
10-1753	13 7/8" x 12 7/8" x 2 1/2"	10-1753-12 - Pk/12																										
10-1754	Cover For 10-1753   10-1754-12 - Pk/12																											
10-1755	6 7/8" x 4 1/4" x 2"	10-1755-12 - Pk/12																										
10-1737	Cover For 10-1755   10-1737-12 - Pk/12																											
10-1740	8 7/8" x 5" x 2"																											
<p><b>MESH BOTTOM STERILIZATION TRAY</b></p>  <table border="1"> <tr> <td>10-1957</td> <td>20 3/4" x 12 3/4" x 4"</td> </tr> </table>	10-1957	20 3/4" x 12 3/4" x 4"	<p><b>CLEANING BASKET</b></p>  <table border="1"> <tr> <td>10-1729</td> <td>4 1/4" x 7 1/4" x 2"</td> </tr> <tr> <td>10-1731</td> <td>6" x 9" x 3"</td> </tr> <tr> <td>10-1732</td> <td>8 1/2" x 12 1/2" x 3 1/2"</td> </tr> <tr> <td>10-1733</td> <td>9 1/2" x 16" x 4"</td> </tr> <tr> <td>10-1734</td> <td>12" x 21" x 5"</td> </tr> <tr> <td>10-1736</td> <td>14" x 20" x 5"</td> </tr> </table>	10-1729	4 1/4" x 7 1/4" x 2"	10-1731	6" x 9" x 3"	10-1732	8 1/2" x 12 1/2" x 3 1/2"	10-1733	9 1/2" x 16" x 4"	10-1734	12" x 21" x 5"	10-1736	14" x 20" x 5"													
10-1957	20 3/4" x 12 3/4" x 4"																											
10-1729	4 1/4" x 7 1/4" x 2"																											
10-1731	6" x 9" x 3"																											
10-1732	8 1/2" x 12 1/2" x 3 1/2"																											
10-1733	9 1/2" x 16" x 4"																											
10-1734	12" x 21" x 5"																											
10-1736	14" x 20" x 5"																											



## WEINSTEIN STERILIZATION RACK



10-1800	5 1/2"
10-1805	11 1/4"

## WORCESTER INSTRUMENT HOLDER



10-1839	13" x 3"
---------	----------

## INSTRUMENT STRINGER



10-1340	6"
10-1342	8"
10-1344	10"
10-1346	12"
10-1347	14"
10-1348	16"

## INSTRUMENT STRINGER



10-1828	5" x 8"
10-1830	5" x 10"
10-1832	5" x 12"
10-1836	5" x 16"
10-1838	5" x 18"

## POSILOCK INSTRUMENT RACK



10-1763
---------

## BUNT INSTRUMENT HOLDER

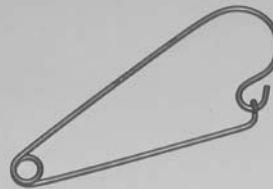

10-1770
---------

## WEISENBACH FORCEP HOLDER



10-1775	6"
10-1776	12"

## E-Z LOCK INSTRUMENT STRINGER



10-1806	6" x 2 1/2"
10-1808	8" x 2 1/2"
10-1810	10" x 2 1/2"
10-1812	12" x 2 1/2"
10-1816	16" x 2 1/2"

## SAUNDERS INSTRUMENT RACK

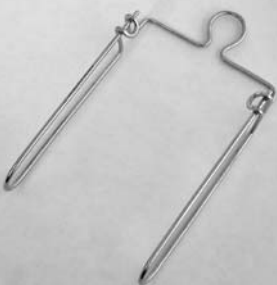

10-1780
---------

## INSTRUMENT CLEANING BRUSHES

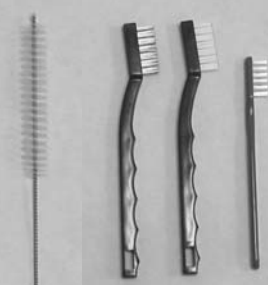

Bristle Brush		
10-1660	2 1/4" x 1/8" x 12"	Pk/3
10-1664	2 1/2" x 3/8" x 15"	Pk/3
10-1668	3 1/2" x 1" x 15"	Pk/3
Cleaning Brush		
10-1650	Stainless Steel Bristles	Pk/3
10-1651	Nylon Bristles	Pk/3
10-1652	Stainless Steel Bristles	Pk/12
10-1657	Nylon Bristles	Pk/12
Disposable		
10-1465	Nylon Bristles	Pk/12
10-1468	Nylon Bristles	Pk/24



### TEST TUBE BASKETS

Polypropylene. Ideal for rinsing, transport and storage.  
Steam autoclavable at 121°C (250°F)

- 88-0145 5" L x 4" W x 4" H
- 88-0146 5" L x 4" W x 4" H with Lid
- 88-0147 6" L x 6" W x 6" H
- 88-0148 6" L x 6" W x 6" H with Lid
- 88-0149 9" L x 9" W x 9" H
- 88-0150 9" L x 9" W x 9" H with Lid



### PROCESSING TRAYS

Lightweight polystyrene. Used for staining and developing film.

- 88-0154 9-1/2" L x 7-3/8" W x 1-5/8" H Film/Print Size 5 x 7"
- 88-0155 13-1/16" L x 10-1/16" W x 2-3/8" H Film/Print Size 8 x 10"



### STERILIZING TRAYS

Polypropylene. Ideal for sterilizing instruments and cleaning glassware. Steam autoclavable at 121°C (250°F)

- 88-0151 12" L x 7-3/4" W x 5-1/8" H Small
- 88-0152 19" L x 10-1/2" W x 5-1/8" H Medium
- 88-0153 20-1/4" L x 15-1/2" W x 5-1/8" H Large



### INSTRUMENT TRAYS WITH COVERS

Polypropylene. Steam autoclavable at 121°C (250°F)

- 88-0156 7-1/8" L x 4-1/4" W x 2-5/8" H Small
- 88-0157 9-3/8" L x 5-1/8" W x 3-1/4" H Medium
- 88-0158 11" L x 6" W x 5" H Large



## MOLDED TRAYS

Low-density polyethylene. Corrosion resistant.  
Withstands temperatures of up to 77°C (171°F).

- 88-0160 12" L x 16" W x 3" H
- 88-0161 16" L x 20" W x 3" H
- 88-0162 18" L x 22" W x 4" H
- 88-0163 21-1/2" L x 25-1/2" W x 4" H
- 88-0164 17-1/2" L x 23-1/2" W x 6" H

## TRAYS WITH FAUCET

Faucet provides easy and safe draining.

- 88-0165 12" L x 16" W x 3" H
- 88-0166 16" L x 20" W x 3" H
- 88-0167 18" L x 22" W x 4" H
- 88-0168 21-1/2" L x 25-1/2" W x 4" H
- 88-0169 17-1/2" L x 23-1/2" W x 6" H

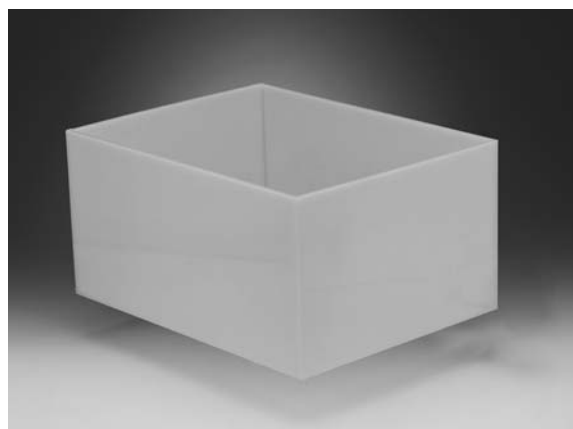

## LAB TRAYS

Polypropylene. Autoclavable up to 135°C (274°F)

- 88-0170 10" L x 15" W x 3" H
- 88-0171 12" L x 16" W x 8" H
- 88-0172 15" L x 20" W x 3" H
- 88-0173 18" L x 18" W x 4" H
- 88-0174 20" L x 20" W x 6" H
- 88-0175 22" L x 26" W x 4" H

## POLLY-CROCKS WITH LIDS

Heavy-duty polyethylene. Safely holds chemicals and hot liquids up to 52°C (125°F). Seamless wall is 4.8mm (3/16") thick. Resistant to rust, corrosion and dents.

- | with Faucet       | without Faucet    |
|-------------------|-------------------|
| 88-0176 3 Gallon  | 88-0180 3 Gallon  |
| 88-0177 6 Gallon  | 88-0181 6 Gallon  |
| 88-0178 10 Gallon | 88-0182 10 Gallon |
| 88-0179 15 Gallon | 88-0183 15 Gallon |

# SKLARTITE™ STERILIZATION CONTAINER SYSTEM

Sklar Surgical Instruments and Sklartite™ Containers provide a perfect combination of product and service to meet all surgical requirements.



## **SKLARTITE™ SEALED CONTAINERS**

**Perforated Top - Solid Bottom\***

### **Extra-Small - 8" W x 12" L**

10-1217	4" Height
10-1218	5" Height
10-1219	6" Height

### **Small - 12" W x 12" L**

10-1220	4" Height
10-1221	5" Height
10-1222	6" Height
10-1223	7" Height

### **Medium - 12" W x 17" L**

10-1226	4" Height
10-1227	5" Height
10-1228	6" Height
10-1229	7" Height

### **Large - 12" W x 23" L**

10-1232	4" Height
10-1233	5" Height
10-1234	6" Height
10-1235	7" Height



*\* Perforated Bottoms Are Also Available.  
Contact Your Sklar Account Manager For Details.*

The SklarTite™ line of sealed containers provides a simple yet effective system for the sterilization of operating room instruments. Designed for strength and light in weight, SklarTite™ containers are formed from an aircraft grade anodized aluminum alloy. The containers are available in a variety of sizes.

# STERILIZATION CONTAINERS

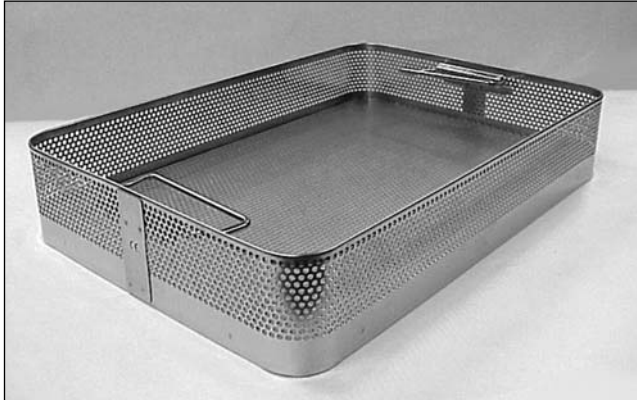

## SKLARTITE™ BASKETS

### Extra-Small

7-1/2" W x 11" L

- 10-1210 2" Height
- 10-1212 3" Height
- 10-1214 4" Height
- 10-1216 5" Height

### Small

11" W x 11" L

- 10-1240 2" Height
- 10-1242 3" Height
- 10-1244 4" Height
- 10-1245 5" Height
- 10-1247 6" Height

### Medium

11" W x 16" L

- 10-1248 2" Height
- 10-1250 3" Height
- 10-1252 4" Height
- 10-1253 5" Height
- 10-1255 6" Height

### Large

11" W x 22" L

- 10-1256 2" Height
- 10-1258 3" Height
- 10-1260 4" Height
- 10-1262 5" Height
- 10-1263 6" Height

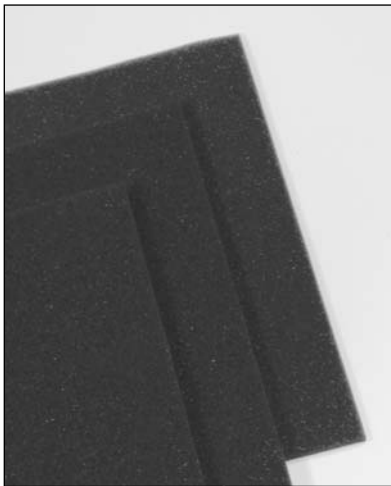

## FOAM INSERTS DISPOSABLE

Blue, Pack of 75

10-1205 3/8" x 20" x 10-1/2"

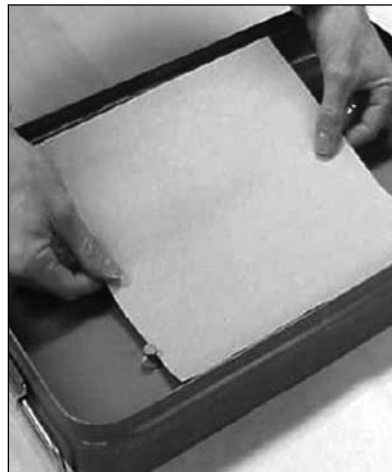

## REPLACEMENT FILTERS, DISPOSABLE

1,000 Per Case

- 10-1278 7-3/4" x 7-1/4"
- 10-1283 9-1/2" x 9-1/2"



## SILICONE MATS

- 10-1282 Extra Small 7-1/4" x 10-3/4"
- 10-1284 Small 11" x 11"
- 10-1286 Medium 11" x 16"
- 10-1288 Large 11" x 22"



# SKLAR-CIDE™

***High Level Disinfecting/Sterilizing Solution  
for Heat Sensitive Instruments & Devices***

- ***25 Minute Soak Time***
- ***28 Day Reuse - Saves Time and Money***
- ***Safe For Use on Lens and Optical Instrument Scopes***
- ***Color Indicator To Assure Readiness***

***Item# 10-1623***

***Case of 4 Gallons***

***Item# 96-4105***

***Glutaraldehyde Strip***

***2.1% MEC***

***See Page 222 for more Information!***

**NEW!**





AS **EASY** AS **1** DECONTAMINATION **2** CLEANING **3** LUBRICATION!



## STEP ONE - DECONTAMINATION

### SKLAR SPRAY SURFACE DISINFECTANT™

*Disinfectant/Decontaminant Cleaner with a 3 MINUTE KILL TIME!*

**SKLAR DISINFECTANT™** is a pre-cleaner and disinfectant for the safe decontamination of soiled surgical instruments, medical and surgical equipment, and inanimate surfaces including plastics, stainless steel, chrome, glass, Plexiglass® and baked on painted surfaces. The use of Sklar Disinfectant™ for **3 minutes** kills infectious organisms including Hepatitis B Virus, Hepatitis C Virus, TB, HIV-1 (AIDS), Herpes Simplex Virus 1 and 2 and Polio.

## STEP TWO - CLEANING

### SKLAR KLEEN™ DETERGENTS AND ENZYMATICS

Sklar has an array of agents for effectively cleaning not only your surgical instruments but for other metals, glassware, plastic and rubber. **SKLAR KLEEN™** detergent is available as a powder or liquid. Our **ENZYMATIC** products, for processing instruments heavily laden with organic debris, are packaged in gallon concentrates, convenient 1/2 ounce package, also concentrated, as well as a new foam spray pre-cleaner, **SPRAY-ZYME™**.



*CHOOSE THE CLEANING PRODUCT RIGHT FOR YOU!*



**YOUR INSTRUMENTS WILL LOOK AND WORK LIKE NEW!**

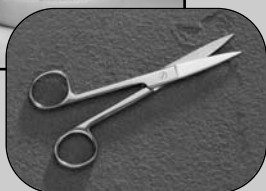

## STEP THREE - LUBRICATION

### SKLAR LUBRICANT AND SPRAY LUBE

**SKLAR LUBE™** should be a part of your instrument processing regimen to guarantee extending the life and performance of this very important investment. Sklar offers several different types of lubricant to suit your needs. All designed specifically for surgical instruments, they each contain rust inhibitors to protect against corrosion, rusting and staining.

**YOUR FINAL STEP IS AUTOCLAVE STERILIZATION**

**STEP ONE - DECONTAMINATE**

**SKLAR SPRAY SURFACE DISINFECTANT™**

***DISINFECTANT / DECONTAMINANT CLEANER***



**REFILLABLE BOTTLE**

**3 Minute Kill Time!**

**SKLAR DISINFECTANT™** is a ready-to-use, highly effective cleaner and decontaminant for use on soiled instruments and devices prior to handling during reprocessing.

**SKLAR DISINFECTANT™** Completely kills infectious disease causing microorganisms within 3 MINUTES, including:

**Gram Positive and Negative Bacteria**

- *Mycobacterium tuberculosis (TB)*
- *Staphylococcus aureus*
- *Pseudomonas aeruginosa*
- *Salmonella choleraesuis*

**Viruses**

- *Hepatitis B Virus (HBV)*
- *Hepatitis C Virus (HCV)*
- *Influenza A/2 Hong Kong Virus*
- *Rhinovirus*
- *Human Immunodeficiency Virus (HIV-1)*
- *Herpes Simplex Virus 1 and 2*
- *Polio Virus*

**Pathogenic Fungi**

- *Trichophyton mentagrophytes*



**SKLAR SPRAY DISINFECTANT™**

**Item# 10-1643 Case of 6, 24 oz. Spray Bottles**

**Item# 10-1653 Case of 4 Gallons**

**Item# 10-1644 Case of 2, 2.5 Gallon Jugs**



## STEP ONE - DECONTAMINATE

# SKLAR SOAK™ A NON-GLUTARALDEHYDE PRODUCT!



## Disinfectant / Decontaminant Cleaner

Immersing soiled instruments in **SKLAR SOAK™** for ten minutes substantially reduces the risk of exposure to many infectious organisms including TB and such viruses as HIV-1 (AIDS) as well as bacteria and fungi.

If full immersion is not possible then cover soiled instruments with **SKLAR SPRAY-ZYME** enzymatic foam to prevent harmful encrustation while also precleaning.

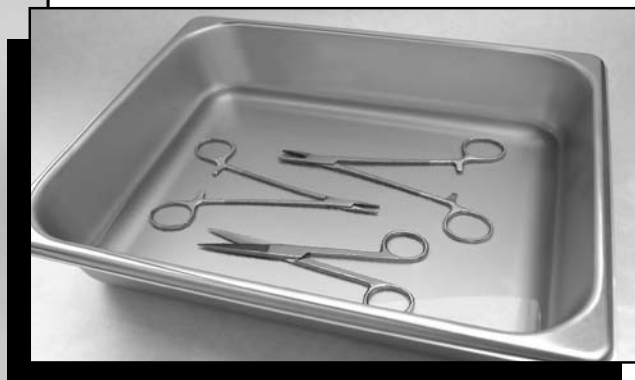

- *Non-Caustic Formula allows for use as a manual cleaner or in ultrasonic units.*
- *Effective Against: TB, HBV, HIV-1 (AIDS), virus (hydrophilic and Lipophilic), bacteria (including MRSA and VRE), and fungi.*
- *EPA Registered*
- *Meets all OSHA standards on blood borne pathogen destruction*
- *Ready to use*

**SKLAR SOAK™** is always effective as a decontaminant/disinfectant and this efficacy is without the irritating and caustic impact of glutaraldehydes, phenols and chlorine based products.

**SKLAR SOAK™** requires no special protection when handling nor are there any restrictive disposal guidelines.

## SKLAR SOAK™ LIQUID - Item# 10-1603 Case of 4 Gallons

### STEP TWO - CLEANING

# SKLAR KLEEN™ FOR MANUAL & ULTRASONIC CLEANING



## NEW SIZE!

**MORE SKLAR KLEEN™ - SAME LOW PRICE!**

**SKLAR KLEEN™** is an excellent way to reduce or eliminate the effects of corrosive minerals that are inherent in virtually all communities' water supplies. One 3-1/2 lb. container makes in excess of 150 gallons of cleaning solution.

- *Concentrated Powder - Economical & Convenient*
- *Superior wetting power to penetrate box locks, serrations and crevices of surgical instruments*
- *Safe for use on instruments, metals, plastic, glassware and rubber*

**NEWLY  
DESIGNED  
"SURE GRIP"  
HANDLE!**

### SKLAR KLEEN™ POWDER

**Item# 10-1607 5 lb. container**

**Item# 10-1608 Case of 4, 5 lb. container**

**Item# 10-1630 Case of 6, 3-1/2 lb. New Pitcher Design**



## STEP TWO - CLEANING

# SKLAR KLEEN™ LIQUID

**REGULAR FORMULA FOR MANUAL & ULTRASONIC CLEANING**



## Non-Corrosive

**SKLAR KLEEN™ LIQUID** is non-corrosive, non aggressive, phosphate free and biodegradable. We have specifically developed **SKLAR KLEEN™ LIQUID** for manual and ultrasonic cleaning. It is moderately alkaline, affording optimum cleaning without etching glassware or attacking instrument metal.

- *Appropriate for all metals, glassware, plastics & rubber*
- *Superior Wetting Power*
- *Concentrated*

Specially formulated for both manual and ultrasonic cleaning, **SKLAR KLEEN™** provides superior wetting power to penetrate locks, serrations and crevices of surgical instruments, glassware, plastics and rubber.

## SKLAR KLEEN™ LIQUID

**Item# 10-1612 Case of 6, 8 oz. container**

**Item# 10-1613 Case of 4 gallons**

**STEP TWO - CLEANING****SKLAR KLEEN LF™** *LOW FOAM FOR WASHERS*

## Economical

**SKLAR KLEEN LF™** (Low Foam) is an especially effective and economical liquid cleaner for surgical instruments and laboratory glassware. **SKLAR KLEEN LF™** maintains a low foam to ensure efficient and trouble free action in washer/sterilizers and tunnel washers. The low, non-aggressive pH ( $7.5 \pm 0.5$ ) is non-corrosive to surgical instrumentation and will not etch glassware. **SKLAR KLEEN LF™** is formulated to disperse quickly and is well suited for automatic injection systems. **SKLAR KLEEN LF™** is concentrated in order to provide a very cost-effective solution.

- For use in washer/sterilizers and mechanical washers
- Safe for all metals, glassware, plastics & rubber
- Non-corrosive to surgical instrument alloys; non-etching to glassware
- Concentrated

**SKLAR KLEEN LF™** - *Item# 10-2701 Case of 4, 1 Gallon*



## STEP TWO - CLEANING

# SKLAR-ZYME™ ENZYMATIC DETERGENT

## MULTI-ENZYME DETERGENT CONCENTRATE



## Convenient Value

Each packet of **SKLAR-ZYME™** produces one gallon of enzymatic detergent. This convenient, easy to use product guarantees very little waste and is ideal for the office or smaller surgical setting.

**SKLAR-ZYME'S™** unique multi-enzyme formula quickly dissolves and suspends all organic soils, even in crevices and hard to reach areas such as lumens, channels and is effective in cold water or in temperatures up to 130° F. The low pH formula ensures safe use on all surfaces including fiber optic equipment, rubber, plastic and stainless steel.

The multi-enzyme, low foaming formula is designed to serve as a presoak for manual decontamination, ultrasonic and scope washers.

**SKLAR-ZYME™** has a pleasant sea spray fragrance and each packet produces one gallon of Enzymatic.

## SKLAR-ZYME™

**Item# 10-2774 Box of 32, 1/2 oz. pouches**



## STEP TWO - CLEANING

# SKLAR ENZYMATIC™

## MULTI-ENZYME DETERGENT CONCENTRATE



## 100% Biodegradable

**SKLAR ENZYMATIC™ DETERGENT** is a low-foaming, fast acting detergent specifically designed for use when instruments and/or cloth materials become soiled with organic debris.

**SKLAR ENZYMATIC™ DETERGENT** may be used as a manual instrument cleaner as well as a pre-soak for blood-contaminated linens, clothing and instruments. It is also used in ultrasonic units and in washer/sterilizer/decontaminators. When used as directed, the enzymatic pH neutral formula is safe for use on rubber, plastic, stainless steel instruments, surgical equipment as well as cloth.



- *A manual cleaner and pre-soak to dissolve organic debris on instruments as well as on clothing.*
- *Used in ultrasonics, washer/sterilizers.*

## SKLAR ENZYMATIC™

**Item# 10-2777 Case of 4, 1 Gallon**

**Item# 10-3772 Case of 12, 32 oz. Bottles**



## STEP TWO - CLEANING

# SKLAR SPRAY-ZYME™

## MULTI-ENZYME BASED INSTRUMENT PRESOAK & CLEANER



## Foam Spray Cleaner

The newest product from Sklar for expert care of your surgical instruments. This multi-enzymatic spray creates a heavy foam which lasts for hours, keeping soiled instruments moist to avoid encrustation while also pre-cleaning prior to processing.



- *Prevents Organic Encrustation* - enzyme foam stops blood and bodily fluids from drying onto surgical instruments.
- *No More Spills* - messy spills between the operating room and central cleaning/processing department are eliminated.
- *Neutral pH* - safe and effective for stainless steel, tungsten carbide, aluminum and brass instruments.
- *Bacteriostatic* - microbiological control agents inhibit bacterial growth in the ready-to-use foam solution.
- *Long Lasting Foam* - saves time, foam lasts many hours after application
- *Multi-Enzymatic* - contains a synergistic blend of lipase and protease enzymes.

## SKLAR SPRAY-ZYME™

**Item# 10-2722 Case of 12, 22 fl. oz. Refillable Spray Bottles**

**Item# 10-2724 Case of 4, 1 Gallon**

**STEP TWO - CLEANING****SKLAR POLISH™** INSTRUMENT STAIN REMOVER**Non-Abrasive**

**SKLAR POLISH™** is an efficient stain remover for use on all of your metal surgical instruments, including stainless steel, chrome and brass. It will brighten instrument trays, basins and racks and may also be used on porcelain and tile surfaces.

**SKLAR POLISH™** removes stubborn corrosive stains to extend the life and give a like-new look to surgical instruments.

The true value in regular **SKLAR POLISH™** use is that it removes minerals from your instruments and other metal surfaces without changing the surface quality.

- Extends the life of surgical instruments by removing corrosive stains
- For use on surgical instruments, stainless sinks and countertops, as well as porcelain and tile.

**SKLAR POLISH™** Item# 10-1629 Case of 6, 8 oz. Jars



## STEP THREE - LUBRICATION

# SKLAR INSTRU-GUARD LUBE™

## SURGICAL INSTRUMENT LUBRICANT/RUST INHIBITOR



## Liquid Concentrate

**SKLAR INSTRU-GUARD LUBE™** is an easy-to-use, water soluble, non-silicone lubricant and rust inhibitor. When used daily as a rinse after every cleaning it keeps moving parts operating smoothly and remains effective after autoclaving, but without leaving an oily residue.

Regular lubrication is essential no matter which cleaning method is employed (including ultrasonic). **SKLAR INSTRU-GUARD LUBE™** is ideal for maintaining instrument quality and performance.

**SKLAR LUBE™ SPRAY** is economical and ideal for facilities that have a limited need for instrument lubrication. It comes in a convenient ready-to-use spray bottle.

## SKLAR INSTRU-GUARD LUBE™

**Item# 10-1635 Case of 4 Gallons, Concentrated**

**Item# 10-1636 Case of 12, 8 oz. Spray Bottles**

**Item# 10-2634 Case of 12, 22 oz. Spray Bottles**

**STEP THREE - LUBRICATION**

***SKLAR INSTRU-GUARD™ ONE STEP***

***A "ONE-STEP" INSTRUMENT CLEANER & LUBRICANT***



**Extends Instrument Life**

**SKLAR INSTRU-GUARD™** contains a penetrating lubricant that protects and helps extend the life of surgical instruments. The detergents and emulsifiers quickly break up and remove organic soils from box locks and other hard to reach places.

**SKLAR INSTRU-GUARD™** contains four rust inhibitors to control corrosion and eliminate scaling and spotting. It does not contain phosphates and can reduce the time and cost involved in processing your instruments by cleaning and lubricating in one easy step.

**SKLAR INSTRU-GUARD™** is chemically engineered for use as a presoak, for manual cleaning and in washer/sterilizers, washer/decontaminators, manual systems, and ultrasonic cleaners.

***SKLAR INSTRU-GUARD™***

***Item# 10-2800 Case of 4 Gallons, Concentrated***



## DISINFECTANT

# SKLAR-CIDE<sup>28</sup> HLD™ HIGH LEVEL DISINFECTING SOLUTION



## Sporicidal - Bactericidal - Virucidal - Fungicidal

**SKLAR-CIDE™** provides an efficient and safe means for the high-level disinfection or sterilization of medical, ophthalmic and surgical devices including endoscopes and lensed instruments.

**SKLAR-CIDE™** produces high-level disinfection at room temperature (25°C) in as little time as 25 minutes and complete sterilization in 10 hours at room temperature (25°C)

- 28 day reuse - saves time and money.
- 25 minute soak time.
- Safe for use on lens and optical instrument scopes.
- Color indicator to assure readiness.

### SKLAR-CIDE<sup>28</sup> HLD™

**Item# 10-1623 Case of 4 Gallons**

**Item# 96-4105 Glutaraldehyde Strip, 2.1% MEC**

# SKLAR SOAKING TRAYS FOR INSTRUMENTS



## 2 Convenient Sizes

All Sklar Instrument Soaking Trays are packaged individually and include a removable basket.

### SKLAR SOAKING TRAYS

**Item# 10-2555 Small**

**Item# 10-2556 Large**

**SANITIZING****SKLAR FRESH™****ODOR ABSORBER****A TRUE ODOR NEUTRALIZER, NOT A MASKING AGENT****Liquid Spray**

**SKLAR FRESH™** is an environmentally friendly blend of pure biodegradable organic essential oils and trace elements. It is a non-allergic liquid spray that neutralizes odors at their source. Simply spray **SKLAR FRESH™** directly in the air or on the source. (i.e. bathrooms, refuse, soiled items from vomitus, incontinence odors, etc.)

**SKLAR FRESH™***Item# 10-2842 Case of 12, 22 oz. Spray Bottles***SKLAR SANITIZING GEL™ WATERLESS HAND WASH****Kills Germs without Water**

A supplement to routine hand washing or when soap and water are not available. **SKLAR SANITIZING GEL™** leaves no residue or residual fragrance. Meets OSHA requirements for use as a hand wash. Excellent for the Physician office, clinic, ER or emergency vehicles.

**SKLAR SANITIZING GEL™***Item# 10-2850 Case of 12, 8 oz. Pumps*



## BRUSHES

### CANNULA INSTRUMENT CLEANING BRUSHES

Pack of 3

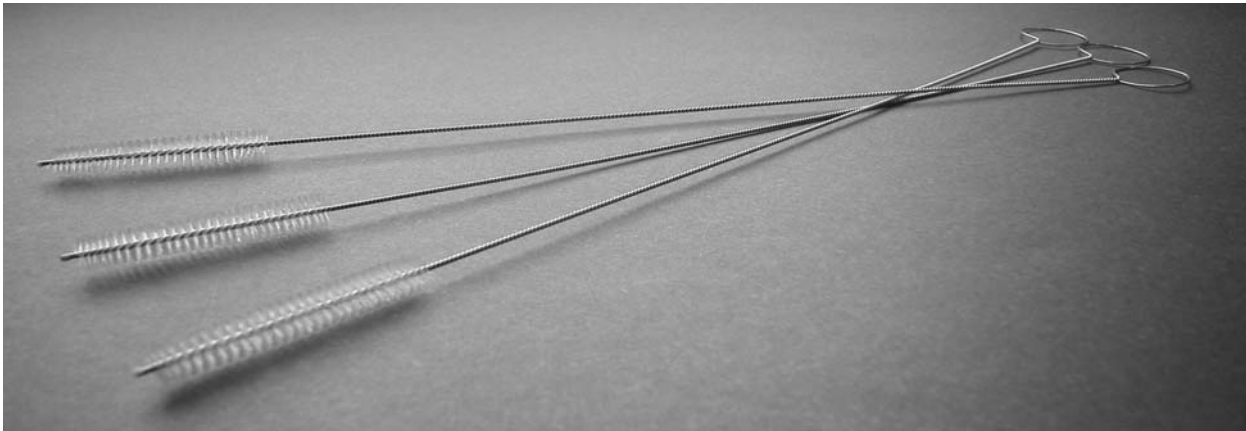

- Item# 10-1350 12" length 2mm diameter, Pack/3
- Item# 10-1660 12" length 3mm diameter, Pack/3
- Item# 10-1352 12" length 4mm diameter, Pack/3
- Item# 10-1354 12" length 5mm diameter, Pack/3
- Item# 10-1356 12" length 6mm diameter, Pack/3

- Item# 10-1362 18" length 5mm diameter, Pack/3
- Item# 10-1364 18" length 10mm diameter, Pack/3
- Item# 10-1366 18" length 15mm diameter, Pack/3

- Item# 10-2824 19" length 3mm diameter, Pack/3

- Item# 10-1664 15" length 9mm diameter, Pack/3
- Item# 10-1668 15" length 25mm diameter, Pack/3

- Item# 10-1370 24" length 2.5mm diameter, Pack/3
- Item# 10-1372 24" length 5mm diameter, Pack/3
- Item# 10-1374 24" length 7mm diameter, Pack/3
- Item# 10-1376 24" length 10mm diameter, Pack/3

\* Medical Nylon Bristles And Stainless Steel Wire Brushes Are Reusable.

### ASSORTED CLEANING BRUSHES

Pack of 3



**Wrap Handle Pack/3**  
Item# 10-1380 6" length

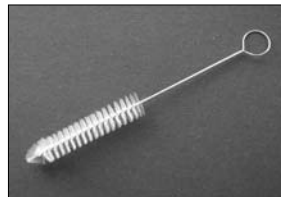

**Fan Shape Tip Pack/3**  
Item# 10-1382 6" length



**Double Tapered Pack/3**  
Item# 10-1384 6" length  
Item# 10-1386 7" length  
Item# 10-1388 8" length



**Plastic Handle Pack/3**  
Item# 10-1392 5-3/8" length



## BRUSHES

### TRACHEOSTOMY TUBE CLEANING BRUSHES

Pack of 3

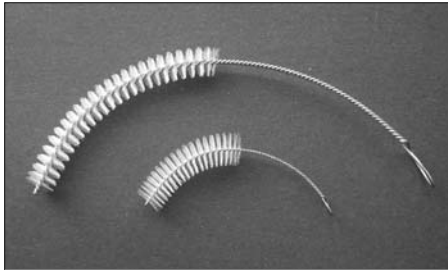

Item# 78-2831 large 8" for Trach Tube sizes 6-12  
3-3/4" x 1/2" bristle dimension Pack/3

Item# 78-2832 small 4" for Trach Tube sizes 000-5  
1-7/8" x 1/2" bristle dimension Pack/3

### ANGLED CLEANING BRUSHES

Pack of 6

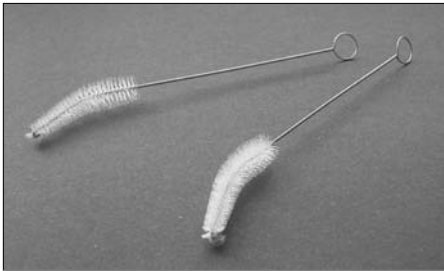

Item# 78-2821 small 6" x 1/2" diameter, Pack/6

Item# 78-2822 med. 7" x 5/8" diameter, Pack/6

Item# 78-2823 large 7-1/2" x 3/4" diameter, Pack/6

Item# 78-2813 1 each of small, medium and large, Pack/3

### CANNULA INSTRUMENT (PIPE) CLEANERS

Pack of 3

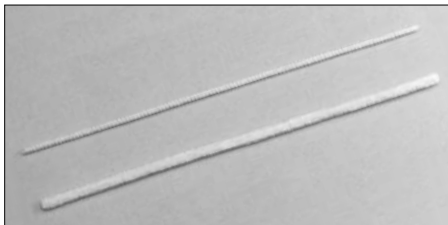

Item# 10-1470 12" length 1/8" diameter, Pack/3

Item# 10-1472 12" length 1/4" diameter, Pack/3

### INSTRUMENT SPOT REMOVER PAD

Pack of 10 and 1 Each

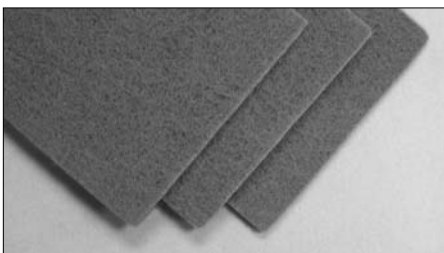

Use for OR Grade Finish (Satin) Instruments

Item# 10-1415 6" x 9" Pack/10

Item# 10-1414 6" x 9" 1 each



## BRUSHES

### SUCTION TUBE CLEANING BRUSHES (BARON & FRAZIER)

Pack of 3

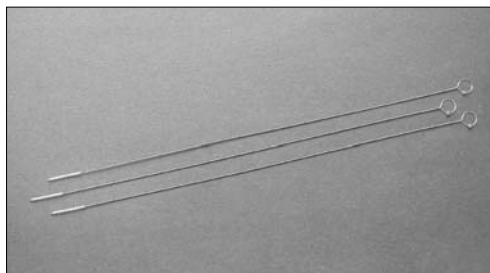

Item# 10-1394 1mm 6" Pack/3  
Item# 10-1396 1.6mm 6" Pack/3

Item# 10-1400 2mm 8" Pack/3  
Item# 10-1401 2.3mm 8" Pack/3  
Item# 10-1402 2.6mm 8" Pack/3  
Item# 10-1403 3mm 8" Pack/3  
Item# 10-1404 3.3mm 8" Pack/3  
Item# 10-1405 3.6mm 8" Pack/3  
Item# 10-1406 4mm 8" Pack/3

### BONE REAMER CLEANING BRUSHES

Pack of 3



Item# 10-1407 3mm Pack/3  
Item# 10-1408 5mm Pack/3  
Item# 10-1409 7mm Pack/3

### DOUBLE END VALVE BRUSHES

Pack of 3



Item# 10-1398 5-3/4" length  
9mm and 5mm diameter tips Pack/3

### BRUSH DRYING RACK & BRUSH HOLDER

1 Each



Item# 10-1399 1 each Brush Rack  
Item# 10-1545 1 each Brush Holder

## BRUSHES

### GENERAL INSTRUMENT CLEANING BRUSH

Packs of 3, 12, 24

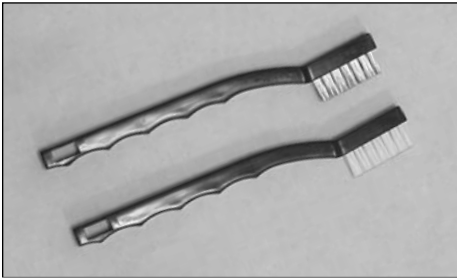

*Soft Stainless Steel*

Item# 10-1650

Pack/3

Item# 10-1652

Pack/12

Item# 10-1658

Pack/24

*Nylon*

Item# 10-1651

Item# 10-1657

Item# 10-1659

### DISPOSABLE INSTRUMENT CLEANING BRUSH

Packs of 12, 24

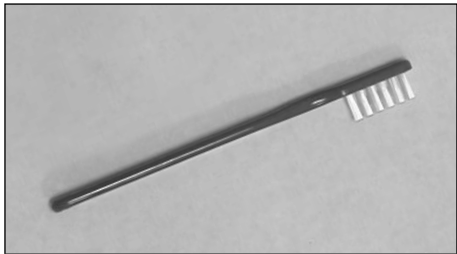

*Disposable*

Item# 10-1645

Pack/12

Item# 10-1648

Pack/24

### DOUBLE-END INSTRUMENT CLEANING BRUSH

Pack of 3



*Soft Stainless Steel*

Item# 10-1442 Pack/3

### DOUBLE-END INSTRUMENT CLEANING BRUSH

Pack of 3

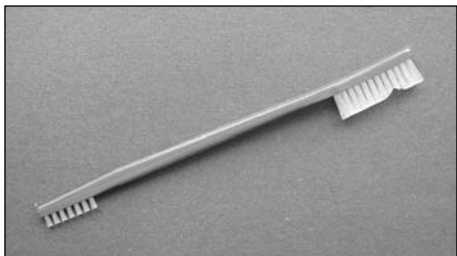

*Nylon*

Item# 10-1444 Pack/3



## BRUSHES

### STAINLESS STEELWARE CLEANING BRUSH

Pack of 3



Use for bowls, basins and any other stainless steelware.

2-1/2" wide x 2-1/2" long brush head. 5" plastic handle.  
White medical grade nylon bristles are 1-1/2" long.

Item# 10-1460 Pack/3

### MEDICAL SURFACE CLEANING BRUSH\*

Pack of 3



Use on sinks, autoclaves, ultrasonic cleaners, bowls, basins, etc.

3" wide x 3-1/4" long brush head. 4-1/2" plastic handle, white medical grade nylon bristles are 2" long

Pack/3

Item# 10-1418 White

Item# 10-1419 Yellow

Item# 10-1421 Red

\*Color Coded Brushes may be used in "critical control points" within the hospital, in a department or by utility as a means of controlling cross contamination or simply to identify ownership.

\*Sklar has modeled this product on the Food and Drug Administration HACCP program for prevention of cross contamination in food borne illness.

### LARGE INSTRUMENT CLEANING BRUSH\*

Pack of 3



Use on retractors, specula, etc.

1" wide x 5" long brush head. 5" plastic handle. White medical grade nylon bristles are 1" long

Item# 10-1420 Pack/3

### AUTOCLAVE CLEANING BRUSH

Pack of 3



Use on autoclave chambers and doors, sinks, carts, etc.

3" wide x 3-1/4" long brush head. 16" plastic handle. White medical grade nylon bristles are 2" long

Item# 10-1422 Pack/3

### AUTOCLAVE CLEANING BRUSH KIT

1 each

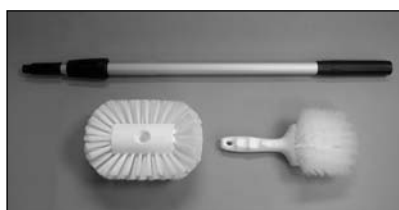

(1) telescopic handle extends from 24" to 48"

(1) large cleaning brush 5-1/2" wide x 7-1/2" long with round corner bristles.

(1) hand brush, 4-1/2" handle

Item# 10-1424 1 each

## INSTRUMENT STRINGERS/TRAYS

Call Sklar at 800.221.2166 for a comprehensive catalog of our stainless steelware products

### E-Z LOCK INSTRUMENT STRINGER



Item# 10-1806 6" x 2-1/2"  
Item# 10-1808 8" x 2-1/2"  
Item# 10-1810 10" x 2-1/2"  
Item# 10-1812 12" x 2-1/2"  
Item# 10-1816 16" x 2-1/2"

### WEINSTEIN INSTRUMENT STRINGER

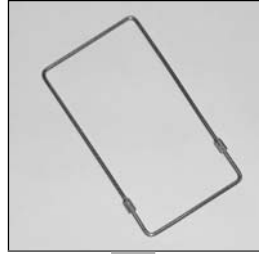

Item# 10-1800 5-1/2"  
Item# 10-1805 11-1/4"

### BUNT INSTRUMENT STRINGER

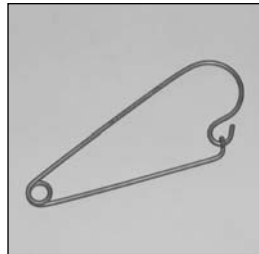

Item# 10-1770

### SAUNDERS INSTRUMENT RACK

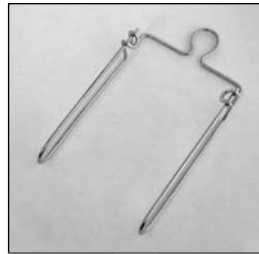

Item# 10-1780

### INSTRUMENT CATH TRAY



Item# 10-1738  
8-7/8" x 5" x 2"

### INSTRUMENT TRAY



Item# 10-1877  
12-1/4" x 7-3/4" x 2-1/4"

### STERILIZATION TRAYS



Item# 10-1705  
6-3/8" x 3-3/8" x 1-3/4"  
Item# 10-1710  
10" x 6-1/2" x 2-1/2"  
Item# 10-1720  
20" x 10-1/2" x 3-1/2"

### MAYO TRAY



Item# 10-1691  
13-11/16" x 9-13/16" x 3/4"  
Item# 10-1694  
19-1/8" x 12-5/8" x 3/4"



## NON-LATEX INSTRUMENT PROTECTORS

### SKLARTIP™ INSTRUMENT PROTECTORS - VENTED

Packs of 100



**Item# 96-1400**  
11.0mm - 1/32" x 3/4"  
Maroon Pack/100



**Item# 96-1402**  
6.0mm - 3/16" x 1"  
Yellow Pack/100

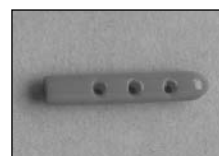

**Item# 96-1404**  
4.0mm - 1/8" x 1"  
Red Pack/100



**Item# 96-1406**  
3.0mm - 7/64" x 3/4"  
Green Pack/100

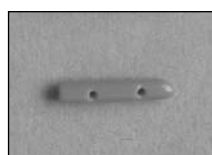

**Item# 96-1408**  
2.0mm - 5/64" x 3/4"  
Blue Pack/100

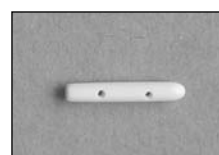

**Item# 96-1410**  
1.5mm - 1/16" x 3/4"  
White Pack/100



**Item# 96-1412**  
25 x 3.0mm  
1/8" x 1" x 1"  
Black Pack/100



**Item# 96-1414**  
18 x 3.0mm  
5/64" x 5/8" x 1"  
Brown Pack/100

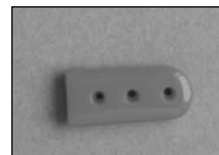

**Item# 96-1416**  
10 x 3.0mm  
1/16" x 3/8" x 1"  
Orange Pack/100

### SKLARTIP™ INSTRUMENT PROTECTORS - NON-VENTED

Packs of 100



**Item# 96-1500**  
11.0mm - 1/32" x 3/4"  
Maroon Pack/100



**Item# 96-1502**  
6.0mm - 3/16" x 1"  
Yellow Pack/100

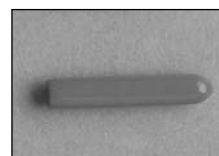

**Item# 96-1504**  
4.0mm - 1/8" x 1"  
Red Pack/100

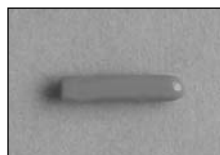

**Item# 96-1506**  
3.0mm - 7/64" x 3/4"  
Green Pack/100

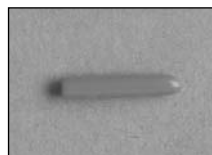

**Item# 96-1508**  
2.0mm - 5/64" x 3/4"  
Blue Pack/100

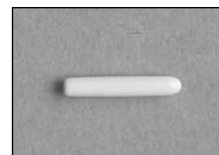

**Item# 96-1510**  
1.5mm - 1/16" x 3/4"  
White Pack/100



**Item# 96-1512**  
25 x 3.0mm  
1/8" x 1" x 1"  
Black Pack/100



**Item# 96-1514**  
18 x 3.0mm  
5/64" x 5/8" x 1"  
Brown Pack/100

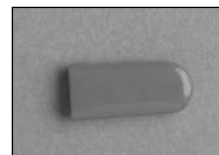

**Item# 96-1516**  
10 x 3.0mm  
1/16" x 3/8" x 1"  
Orange Pack/100

## INSTRUMENT IDENTIFICATION

### BOOTS

Packs of 3 & 5



**Item# 96-1550 Mini Package (3 pair)**

**Item# 96-1552 Standard Package (5 pair)**

Color-coded Sklar Suture Boots eliminate the use of cut tubing and catheters, while providing a firmer grip for tagging sutures. Conveniently sterile-packed, radiopaque and non-toxic, Sklar Boots will not damage even the most delicate suture materials.

### ID SHEET TAPE

1 Each

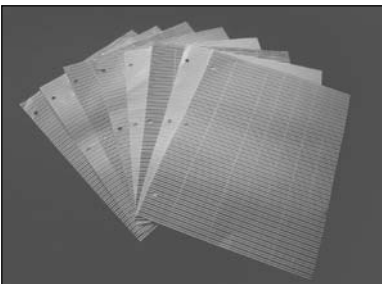

**Item# 96-1845 Dark Blue with White Stripes, 1 each**

**Item# 96-1846 Dark Green with White Stripes, 1 each**

**Item# 96-1847 Red with White Stripes, 1 each**

**Item# 96-1848 Yellow with White Stripes, 1 each**

**Item# 96-1849 Orange with White Stripes, 1 each**

**Item# 96-1850 Brown with White Stripes, 1 each**

**Item# 96-1851 Lavender with White Stripes, 1 each**

**Item# 96-1852 Light Blue with White Stripes, 1 each**

**Item# 96-1853 Pink with White Stripes, 1 each**

Color-coding is convenient with Sklar ID Sheet Tape. There are many combinations of tapes fixed to an easily removed backing. Each 8-1/2" x 11" sheet contains 374" of tape. Lasts through many autoclaving and gas sterilizing procedures.

### ID ROLL TAPE

1 Each

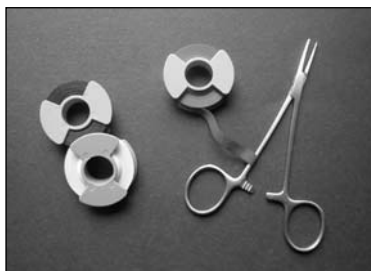

**Item# 96-1860 White, 1 each**

**Item# 96-1862 Green, 1 each**

**Item# 96-1864 Yellow, 1 each**

**Item# 96-1866 Orange, 1 each**

**Item# 96-1868 Black, 1 each**

**Item# 96-1870 Purple, 1 each**

**Item# 96-1872 Blue, 1 each**

**Item# 96-1874 Red, 1 each**

**Item# 96-1876 Brown, 1 each**

Sklar ID Roll Tape is a convenient color coding tape to make instruments easily recognized. It's autoclavable and available in 10 colors. Each roll length is 300" and 1/4" wide. Lasts through many autoclaving and gas sterilizing procedures.

### INSTRUMENT ID TAGS

Packs of 100 & Cases of 1000



**Item# 96-1900 "Repair Tag" Red Pack/100**

**Item# 96-1901 "Repair Tag" Red Case/1000**

**Item# 96-1905 "Sharpen Tag" Blue Pack/100**

**Item# 96-1906 "Sharpen Tag" Blue Case/1000**

Plastic Identification tags for serviced instruments and equipment



## TROUBLESHOOTING

### Corrosion

**Problem:** Debris and residue in box locks, serrations and ratchets.  
**Solution:** Serrations, box locks and ratchets should be carefully cleaned and rinsed. A soft bristle brush is effective in these difficult areas.

**Problem:** Moisture remaining on the instruments within the sterile wrapped packs; excessive moisture in autoclave during sterilization and termination of cycle.

**Solution:** Preheat autoclave, drying time cannot be accelerated, open autoclave door slightly. Routinely inspect valves. Malfunctioning valves can precipitate corrosion.

**Problem:** Some local water supplies contain excessive quantities of alkali. This can manifest itself by depositing corrosive matter on the instruments.

**Solution:** It is generally accepted that cold distilled or demineralized water be used during sterilization. An alternative is to use the local water supply, while instituting a program of preventive maintenance. Carefully clean surfaces with SKLAR KLEEN™, using SKLAR POLISH™ to remove difficult stains and SKLAR LUBE™ for proper lubrication.

### Pitting

**Problem:** Instruments are inevitably exposed to chemical compounds that initiate pitting. The most common are saline solutions and blood.

**Solution:** It is essential that instruments be rinsed with distilled or demineralized water and then cleaned routinely.

**Problem:** Some Non-Sklar detergents contain a chloride or have an acid base. If rinsing is not thorough, the residual detergent can precipitate pitting. Hydrochloric acid can be formed by the combination of chloride in the cleaner and steam, causing the instrument to pit.

**Solution:** Evaluate detergents without a chloride base. SKLAR KLEEN™ is recommended.

**Problem:** Instruments may be pitted when the detergent used has an excessively high PH. If instruments are not rinsed thoroughly, and then autoclaved, the heat increases the effect of the solution on the instruments.

**Solution:** Use only detergents specifically developed for instrument cleaning. Sklar Kleen™ products are pH balanced.

### **No Steel is Truly "Stainless"**

It's a fact that so-called stainless steel is subject to both water-spotting and staining. However what many people identify as a "rust" problem usually turns out to be something else.

Most often the problem is actually a stain caused by a surface deposit. These deposits appear in a variety of colors depending upon the type of deposit involved. Once the cause is found and eliminated, most of the time the problem quickly diminishes or disappears completely.

As you probably know, stainless steel is ideally suited for the surgical suite because it is rust resistant, it can be honed to an extremely sharp edge or fine point, and it can be hardened to maintain the delicate, yet precise, requirements of the surgeon. But it is this hardenable quality – the amount of carbon used during the manufacturing process – coupled with harsh chemicals and improper care that renders stainless steel susceptible to corrosion.

Sklar's products are specially formulated to provide cost effective instrument care.

### Brownish Stain

**Problem:** This stain is more obvious on dull finish instruments. Most likely, it is a deposit of chromium oxide. The thin hard layer protects stainless steel from corrosion precipitated by the atmosphere. The brownish film (sometimes dull blue) occurs naturally when stainless is heated. Occasionally this stain can be traced to the sterilizer. Improper cleaning compounds could contain polyphosphates that cause the copper components in the sterilizer to be deposited by electrolytic action on the stainless steel instruments.

**Solution:** Water supply to autoclave should be cold and demineralized. Use the correct amount of SKLAR KLEEN™ as recommended for best results.

### Bluish Gray Stains

**Problem:** Cold sterilizing solutions.

**Solution:** In the preparation of the solution make certain the manufacturer's directions are followed accurately. To minimize discoloration use distilled water and add a rust inhibitor. Using the solution beyond recommended time limitations will cause the solution to become corrosive.

### Rust Deposit

**Problem:** Sterilizing instruments of different metals in the same cycle will cause rusting. An electrolytic action carries the carbon particles from the exposed metal and deposits them on the stainless steel instruments. The rapid oxidation of molecules results in a surface film of rust.

**Solution:** The ideal technique would be to sterilize the two types of instruments separately. It is recommended that chrome plated instruments that indicate signs of peeling or flaking be replaced with stainless steel instruments.

**Problem:** The rust film on the surface of stainless steel instruments can be caused by chemicals in the detergent. Excess amounts of iron or other minerals from the local water supply may cause the rust deposits.

**Solution:** It is recommended that instruments be rinsed with distilled or demineralized water. Surface rust can be removed by light buffing or an application of SKLAR POLISH™.

### Light and Dark Colored Spots

**Problem:** Spotting caused by slow evaporation of water drops identified with the mineral content of the water.

**Solution:** Eliminate water droplets by adhering to autoclave manufacturer's operating instructions. Autoclave door should not be opened until steam has been completely vented.



Absorbent Towels, Sterile	185	Babcock Forceps, Floor-Grade, Sterile	32	Biopsy Tray, Basic, Sterile	179
Adson Bayonet Forceps	51	Babcock Forceps, Laparoscopic, Sklartech 4000	144	Biopsy Tray, Standard Ct, Sterile	180
Adson Brown Tissue Forceps, Floor-Grade Econo	43	Babcock Forceps, Mid-Grade	32	Bishop-harmon Eye Dressing Forceps	47,53
Adson Dressing Forceps, Delicate, Premium	40	Babcock Forceps, OR Grade	32	Bishop-harmon Eye Tissue Forceps	47,53
Adson Dressing Forceps, Floor-Grade, Econo	40,193	Babcock Forceps, T-C, Premium	69	Bishop-harmon Forceps, Litegrip, Premium	47
Adson Dressing Forceps, Floor-Grade, Sterile	40,193	Backhaus Towel Clamp, Floor-Grade, Econo	34,196	Bishop-harmon Iowa Forceps	47
Adson Dressing Forceps, Litegrip, Premium	42	Backhaus Towel Clamp, Floor-Grade, Sterile	34,196	Blade Remover	171
Adson Dressing Forceps, Micro	42	Backhaus Towel Clamp, Mid-Grade	34	Blades, Carbon Steel Surgical, Disposable	171
Adson Dressing Forceps, Mid-Grade	40	Backhaus Towel Clamp, OR Grade	34,34	Blades, Stainless Steel Surgical, Disposable	171
Adson Dressing Forceps, OR Grade	40	Baker Ingrown Nail Cutter	106	Blower, Chip	117
Adson Dressing Forceps, Sklarlite XD, Premium	40	Ballenger Sponge Forceps	37	Blumenthal Rongeur	118
Adson Dressing Forceps, T-C, Premium	70	Bandage Scissors, Knowles, Floor-Grade, Econo	191	Boley Gauge	102
Adson Hemostatic Forceps	30	Bandage Scissors, Knowles, Mid-Grade	16	Bonacolto Utility Forceps	92
Adson Rongeur	117	Bandage Scissors, Knowles, OR Grade	16	Bone And Nail File	105
Adson Suction Tube	134	Bandage Scissors, Knowles, Sterile Floor-Grade	16,191	Bone Curette, Cobb Style	113
Adson Tissue Forceps, Delicate, Premium	41	Bandage Scissors, Lister, Floor-Grade Sterile	13,191,	Bone Curette, Martini	114
Adson Tissue Forceps, Floor-Grade, Econo	41,193	Bandage Scissors, Lister, Floor-Grade, Econo	13,191	Bone Curette, Williger	114
Adson Tissue Forceps, Floor-Grade, Sterile	41,193	Bandage Scissors, Lister, Mid-Grade	13	Bone Cutting Forceps, Kleinert-kutz	119
Adson Tissue Forceps, Litegrip, Premium	42	Bandage Scissors, Lister, OR Grade	13	Bone Cutting Forceps, Mcindoe	121
Adson Tissue Forceps, Micro	42	Bandage Scissors, Lister, Premium Delicate	13	Bone Cutting Forceps, Ruskin-liston	119
Adson Tissue Forceps, Mid-Grade	41	Bandage Scissors, Lister, Sklarlite XD	13	Bone File	108
Adson Tissue Forceps, OR Grade	41,42,28	Bandage Scissors, Nurses	15	Bone Forceps, Liston	119
Adson Tissue Forceps, Sklarlite XD, Premium	41	Bandage, Coban, Sterile	185	Bone Forceps, Liston-blau	108
Adson Tissue Forceps, T-C, Premium	70	Bandage, Conform Stretch, Sterile	185	Bone Forceps, Rowland	120
Adson-brown Tissue Forcep Floor-Grade Sterile	43,193	Bandage, Elastic, Sterile	185	Bone Reamer Cleaning Brushes	226
Adson-brown Tissue Forceps, Delicate, Premium	43	Bandage, Esmark, Sterile	185	Bone Rongeur, Friedman	118
Adson-brown Tissue Forceps, Floor-Grade Econo	43,193	Bands, Rubber, Sterile	184	Bonn Micro Suturing Forceps	89
Adson-brown Tissue Forceps, Litegrip, Premium	42	Bane Rongeur	117	Bonn Scissors	86
Adson-brown Tissue Forceps, Mid-Grade	43	Barkan Goniotomy Knife	99	Bonn Tying Forceps	89
Adson-brown Tissue Forceps, OR Grade	43	Baron Suction Tube	134	Bonney Tissue Forceps	50
Adson-brown Tissue Forceps, Sklarlite Premium	43	Barr Fistula Probe	79	Boots	231
Adson-brown Tissue Forceps, T-C, Premium	70	Barraquer Blade Speculum	98	Bowl, Mixing/solution	199
Aebli Corneal Scissors	86	Barraquer Cilia Forceps	91	Bowl, Sponge	199
Alcohol Swabsticks, Sterile	184	Barraquer Cyclodialysis Spatula	96	Bowl, Sterile	185
Alcohol Triple Swabsticks, Sterile	184	Barraquer Wire Speculum	98	Bowman Lachrymal Dilator/probe	88
Alexander Chisel	116	Basic Biopsy Tray, Sterile	179	Bozeman Forceps, Floor-Grade, Econo	36,197,
Alexander Gouge	116	Basic Skin Prep Tray, Sterile	174	Bozeman Forceps, Floor-Grade, Sterile	36,197
Alligator Forceps Laparoscopic Sklartech 4000	145	Basin, Emesis	200	Bozeman Forceps, Mid-Grade	36
Alligator Forceps, Hartmann Floor-Grade Econo	129	Basin, OR, Sterile	185	Bozeman Forceps, OR Grade	36
Alligator Forceps, Noyes	125	Basin, Perforated Solution	199	Bozeman-heaney Needle Holder, T-C, Premium	68
Alligator Grasping Forceps, Hartmann OR Grade	129	Basin, Solution	199	Brewster Retractor	76
Allis Forceps, Laparoscopic, Sklartech 4000	145	Basket, Cleaning	202,203	Brophy Sullivan Scissors	20
Allis Forceps, T-C, Premium	69	Baumgartner Needle Holder Floor-Grade Sterile	59,195	Brown Needle Holder	61
Allis Tissue Forceps, Delicate, Premium	29	Baumgartner Needle Holder, Floor-Grade, Econo	59,195	Bruns Curette	113,117
Allis Tissue Forceps, Floor-Grade, Econo	29,196	Baumgartner Needle Holder, Mid-Grade	59	Brush Drying Rack	226
Allis Tissue Forceps, Floor-Grade, Sterile	29,196	Baumgartner Needle Holder, OR Grade	59	Brush Holder	226
Allis Tissue Forceps, Mid-Grade	29	Baumgartner Needle Holder, Sklarlite, Premium	59	Brush Kit, Autoclave Cleaning	228
Allis Tissue Forceps, OR Grade	29	Baumgartner Needle Holder, T-C, Premium	65	Brushes, Cannula Instrument Cleaning	224
Allis Tissue Forceps, Sklarlite, Premium	29	Bayonet Forceps, Adson	51	Brushes, Cleaning, Angled	225
Alm Retractor, Floor-Grade, Econo	71	Bayonet Forceps, Jansen Nasal	51,125	Brushes, Cleaning, Autoclave	228
Alm Retractor, OR Grade	71	Bayonet Forceps, Lucae	51	Brushes, Cleaning, Bone Reamer	226
Aluminum Alloy Tuning Fork	127	Bayonet Forceps, Lucae, Floor-Grade, Econo	51	Brushes, Cleaning, Double Tapered	224
Alvis Foreign Body Spud	97	Beaker/pitcher	198	Brushes, Cleaning, Double-ended Instrument	227
Amniocentesis Tray, Sterile	178	Bechert-mcpherson Tying Forceps	93	Brushes, Cleaning, Fan Shaped Tip	224
Angio Drape, Sterile	184	Beeson Plaster Spreader	113	Brushes, Cleaning, General Instrument	227
Angled Cleaning Brushes	225	Benzoin Tincture Applicator, Sterile	184	Brushes, Cleaning, Instrument, Disposable	227
Angled Sponge Sticks, Sterile	184	Bergh Cilia Forceps	91	Brushes, Cleaning, Large Instrument	228
Applicator Prep Sticks, Sterile	184	Berke Ptois Forceps	95	Brushes, Cleaning, Medical Surface	228
Applicator, Benzoin Tincture, Sterile	184	Beyer Rongeur	118	Brushes, Cleaning, Plastic Handle	224
Applicators, Cotton Tipped, Sterile	185	Billeau Ear Loop	128	Brushes, Cleaning, Stainless Steelware	228
Army Pattern Chisel	115	Biopsy Cannula Endometrial Disposable Sterile	190	Brushes, Cleaning, Suction Tube	226
Army Pattern Gouge	115	Biopsy Forceps, Kevorkian	140	Brushes, Cleaning, Tracheostomy Tube	225
Army Pattern Osteotome	115	Biopsy Forceps, Kevorkian-young	140	Brushes, Instrument Cleaning, Nylon	204
Atkins Tonsil Knife	129	Biopsy Forceps, Mini Tischler	140	Brushes, Instrument Cleaning, Stainless Steel	204
Atraumatic Dissectors Mini Lap Sklartech 5000	153	Biopsy Forceps, Oval	141	Brushes, Valve, Double Ended	226
Atraumatic Forceps, Laparoscopic, 4000	144,145	Biopsy Forceps, Tischler Cervical	141	Buck Ear Curette, Floor-Grade, Econo	128
Atraumatic Grasping Forceps Laparoscopic 4000	144,145	Biopsy Forceps, Tischler Oval	141	Buck Ear Curette, OR Grade	128
Autoclave Cleaning Brush Kit	228	Biopsy Punch Tray, Sterile	180	Buck Neurological Hammer, Floor-Grade, Econo	156
Autoclave Cleaning Brushes	228	Biopsy Punch, Dermal, Disposable	160	Buck Neurological Hammer, OR Grade	156
Ayers Chalazion Forceps	95	Biopsy Punch, Dermal, Disposable, Sterile	190	Bucket, Hospital	200
Baade Crown Pliers	102	Biopsy Punch, Keys	139	Bucket, Hospital Kick	200

# ALPHABETICAL INDEX



Buie Suction Tube	134	Clamp, Jones Cross Action Towel	35	Cottle Nasal Chisel	121
Bulldog Clamp, Debakey	157	Clamp, Lorna Edna Towel, Floor-Grade, Econo	35,196	Cottle Rasp	108
Bulldog Clamp, Diethrich	157	Clamp, Lorna Edna Towel, Floor-Grade, Sterile	35,196	Cotton Balls, Sterile	185
Bulldog Clamp, Johns Hopkins	157	Clamp, Lorna Edna Towel, Mid-Grade	35	Cotton Tipped Applicators, Sterile	185
Bunt Instrument Holder	204	Clamp, Lorna Edna Towel, OR Grade	35	Covers, Fluoroscope, Sterile	184
Bunt Instrument Stringer	229	Clamp, Lowman	114	Crile Hemostatic Forceps Sklarlite XD Premium	24
C-section Tray, Sterile	179	Clamp, Roeder Towel	35	Crile Hemostatic Forceps, Delicate, Premium	24
Cable Electrosurgical Mini Lap Sklartech 5000	154	Clamp, Towel, Plastic, Sterile	173	Crile Hemostatic Forceps, Floor-Grade Sterile	24,194
Cable, Electrosurgical, Laparoscopic, 4000	149	Clamp, Tube Occluding, Floor-Grade, Econo	37	Crile Hemostatic Forceps, Floor-Grade, Econo	24,194
Caliper, Castroviejo	78	Clamp, Tube Occluding, Floor-Grade, Sterile	37	Crile Hemostatic Forceps, Mid-Grade	24
Caliper, Ekg	156	Clamp, Tube Occluding, Mid-Grade	37	Crile Hemostatic Forceps, OR Grade	24
Caliper, Thorpe	78	Clamp, Tube Occluding, OR Grade	37	Crile Retractor	74
Cannula Endometrial Biopsy Disposable Sterile	190	Clamp, Tubing, Plastic, Sterile	173	Crile-murray Needle Holder, OR Grade	58
Cannula Instrument Cleaning Brushes	224	Clasp Adjusting Pliers	102	Crile-murray Needle Holder, T-C, Premium	65
Cannula Instrument Pipe Cleaners	225	Claw Forceps, Laparoscopic, Sklartech 4000	143	Crile-wood Needle Holder Sklarlite XD Premium	58
Cannula Insulated Laparoscopic Sklartech 4000	146	Cleaner, Spray-zyme, Sklar	218	Crile-wood Needle Holder, Floor-Grade Sterile	195,58
Carbon Handle, Xc Laparoscopic Sklartech 4000	146	Cleaners, Cannula Instrument Pipe	225	Crile-wood Needle Holder, Floor-Grade, Econo	58,195
Carbon Handle, Xc, Mini Lap, Sklartech 5000	154	Cleaning Basket	202,203	Crile-wood Needle Holder, Floor-Grade, Econo	58
Carbon Handle, Yc Laparoscopic Sklartech 4000	146	Cleaning Brush Kit, Autoclave	228	Crile-wood Needle Holder, Sklarlite, Premium	58
Carbon Handle, Yc, Mini Lap, Sklartech 5000	154	Cleaning Brushes, Angled	225	Crile-wood Needle Holder, T-C, Premium	65
Carbon Steel Surgical Blades, Disposable	171	Cleaning Brushes, Autoclave	228	Crown & Collar Cutting Scissors	14
Carmalt Splinter Forceps, Floor-Grade, Econo	44	Cleaning Brushes, Bone Reamer	226	Culture Plates, Disposable	189
Carmalt Splinter Forceps, OR Grade	44,103	Cleaning Brushes, Cannula Instrument	224	Cup, Iodine	198
Castroviejo Caliper	78	Cleaning Brushes, Double Tapered	224	Cup, Medicine	198
Castroviejo Colibri Forceps	90	Cleaning Brushes, Double-ended Instrument	227	Cup, Medicine, Sterile	185
Castroviejo Corneal Scissors	85	Cleaning Brushes, Fan Shaped Tip	224	Cups, Colorimetric, Disposable	188
Castroviejo Cyclodialysis Spatulas	96,100	Cleaning Brushes, General Instrument	227	Cups, Sample, Disposable	188
Castroviejo Eye Speculum	99	Cleaning Brushes, Instrument, Disposable	227	Curette, Bruns	113,117
Castroviejo Fixation Forceps	90	Cleaning Brushes, Instrument, Nylon	204	Curette, Buck Ear, Floor-Grade, Econo	128
Castroviejo Forceps	89	Cleaning Brushes, Instrument, Stainless Steel	204	Curette, Buck Ear, OR Grade	128
Castroviejo Lachrymal Dilator	88	Cleaning Brushes, Large Instrument	228	Curette, Cobb Style Bone	113
Castroviejo Needle Holder, OR Grade	57	Cleaning Brushes, Medical Surface	228	Curette, Cone Ring	113
Castroviejo Needle Holder, T-C, Premium	68,84	Cleaning Brushes, Plastic Handle	224	Curette, Daviel Chalazion	94
Castroviejo Suture Forceps	89	Cleaning Brushes, Stainless Steelware	228	Curette, Ear, Disposable	128
Cath Tray, Instrument	202,229	Cleaning Brushes, Suction Tube	226	Curette, Fox Dermal	132
Catheter Forceps, Magill, Floor-Grade Sterile	31	Cleaning Brushes, Tracheostomy Tube	225	Curette, Heaney Uterine	139
Catheter Forceps, Magill, Floor-Grade, Econo	31	Cleveland Rongeur	120	Curette, Heath	132
Catheter Forceps, Magill, Mid-Grade	31	Clinch Grasping Forceps, Laparoscopic, 4000	145	Curette, Heath Chalazion	94
Catheter Forceps, Magill, OR Grade	31	Clip, Nose, Plastic, Sterile	173	Curette, Holden Uterine	139
Catheter-dilators, Walther	139	Coban Bandage, Sterile	185	Curette, Martini Bone	114
Central Line Dressing Tray, Sterile	177	Cobb Style Bone Curette	113	Curette, Meyhoefer Chalazion	94
Centrifuge Tubes, Disposable	186	Cobb Type Spinal Gouge	116	Curette, Meyhoefer Chalazion	132
Cervical Cell Collector, Disposable, Sterile	190	Cobra Grasping Forcep Mini Lap Sklartech 5000	153	Curette, Shapleigh Ear	128
Chalazion Curette, Daviel	94	Cobra Grasping Forceps, Laparoscopic, 4000	145	Curette, Sims Uterine	139
Chalazion Curette, Heath	94	Colibri Forceps, Castroviejo	90	Curette, Skeeel Chalazion	94
Chalazion Curette, Meyhoefer	94,132	Collar, Replacement Locking Laparoscopic 4000	146	Curette, Thomas Uterine	139
Chalazion Curette, Skeeel	94	Collector, Cervical Cell, Disposable, Sterile	190	Curette, Verucca	106
Chalazion Forceps, Ayers	95	College Pliers	101	Curette, Volkman	114
Chalazion Forceps, Desmarres	95	Coller Hemostatic Forceps	32	Curette, Weisman Infant Ear	128
Chalazion Forceps, Lambert	95	Collier Needle Holder	61	Curette, Williger Bone	114
Chalazion Forceps, Weis	95	Colorimetric Cups, Disposable	188	Curette/excavator, Econo	106
Chandler Iris Forceps	46	Comedome Extractor, Schamberg	131	Curette/excavator, OR Grade	106
Cheek Retractor	101	Comedone Extractor	131	Curettes, Dermal, Disposable, Sterile	190
Chip Blower	117	Comedone Extractor, Unna	131	Curettes, Ear, Disposable	190
Chisel, Alexander	116	Commander Utility Shears	15	Curettes, Sklar Dermal, Disposable	160
Chisel, Army Pattern	115	Cone Ring Curette	113	Cushing Brain Forceps, Delicate, Premium	49
Chisel, Cottle Nasal	121	Cone, Loading	158	Cut Down Tray, Sterile	177
Chisel, Freer	122	Conform Stretch Bandage, Sterile	185	Cutaneous Punch, Keyes	127,130
Cilia Forceps, Barraquer	91	Conjunctival Forceps, Lester	53	Cuticle And Nail Scissors	107
Cilia Forceps, Bergh	91	Container, Storage	199	Cuticle Nipper	112
Cilia Forceps, Douglass	91	Containers, Specimen, Disposable	187	Cutter, Baker Ingrown Nail	106
Cilia Forceps, Littauer	91	Cook Eye Speculum	98	Cutter, Keyes Finger Ring	130
Cilia Forceps, Ziegler	91	Corn Knife, Soft	105	Cutter, Sklar Finger Ring	130
Clamp, Backhaus Towel, Floor-Grade, Econo	34,196	Corneal Forceps, Girard Utility	90	Cutting Forceps, Kleinert-kutz Bone	119
Clamp, Backhaus Towel, Floor-Grade, Sterile	34,196	Corneal Knife, Gill	99	Cutting Forceps, Littauer, Floor-Grade, Econo	109
Clamp, Backhaus Towel, Mid-Grade	34,196	Corneal Scissors, Aebli	86	Cutting Forceps, Littauer, OR Grade	109
Clamp, Backhaus Towel, OR Grade	34,196	Corneal Scissors, Castroviejo	85	Cutting Forceps, Littauer, Sklarlite, Premium	109
Clamp, Debakey Bulldog	157	Corneal Scissors, Mcquire	86	Cutting Forceps, Mcindoe Bone	121
Clamp, Diethrich Bulldog	157	Corneal Utility Forceps, Troutman-barraquer	47	Cutting Forceps, Ruskin-liston Bone	119
Clamp, Hoff Towel	35	Corneoscleral Forceps, Thorpe	92	Cyclodialysis Spatula, Barraquer	96
Clamp, Johns Hopkins Bulldog	157	Cottle Elevator	126	Cyclodialysis Spatula, Castroviejo	100,96

Dandy Scalp Forceps	33	Disposable Nasal Speculum	124	Ear Curette, Shapleigh	128
Daviel Chalazion Curette	94	Disposable Petri Dishes	187	Ear Curette, Weisman Infant	128
Dean Tonsil Knife	129	Disposable Pinwheel, Sklar	156	Ear Loop, Billeau	128
Deaver Retractor	76	Disposable Pipette Tips	187	Ear Syringe, Pomeroy, Floor-Grade, Econo	127
Deaver Scissors, Delicate	19	Disposable Plastic Nasal Speculum	190	Ear Syringe, Pomeroy, Stainless Steel	127
Debakey Atraumatic Forceps, T-C, Premium	69	Disposable Plastic Vaginal Speculum, Sterile	135	Ear/Ulcer Syringe, Disposable, Sterile	190
Debakey Atraumatic Tissue Forceps	48	Disposable Sample Cups	188	Econo Adson Dressing Forceps, Floor-Grade	40,193
Debakey Bulldog Clamp	157	Disposable Scalpels, Sterile	172	Econo Adson Tissue Forceps, Floor-Grade	41,193
Debakey Forceps, Laparoscopic, Sklartech 4000	145	Disposable Specimen Containers	187	Econo Adson-brown Tissue Forceps, Floor-Grade	43,193
Debakey Halsted Mosquito Forceps	33	Disposable Stainless Steel Scalpels, Sterile	190	Econo Allis Tissue Forceps, Floor-Grade	29,196
Debridement Tray, Sterile	177,178	Disposable Stainless Steel Surgical Blades	171	Econo Alm Retractor, Floor-Grade	71
Delicate Mayo Dissecting Scissors, Premium	4	Disposable Sterile Sklar Uterine Sound	138	Econo Backhaus Towel Clamp, Floor-Grade	34,196
Delicate Operating Scissors, Premium	2,3	Disposable Test Tube Stoppers	186	Econo Baumgartner Needle Holder, Floor-Grade	59,195
Depressor, Wieder Tongue	133	Disposable Test Tubes	186	Econo Bozeman Forceps, Floor-Grade	36,197
Derf Needle Holder, Floor-Grade, Econo	55,195	Disposable Transfer Pipettes	189	Econo Buck Ear Curette, Floor-Grade	128
Derf Needle Holder, Floor-Grade, Sterile	55,195	Disposable Vaginal Speculum, Plastic	135	Econo Buck Neurological Hammer, Floor-Grade	156
Derf Needle Holder, Mid-Grade	55	Dissecting Scissors, Mayo-noble	18	Econo Carmalt Splinter Forceps, Floor-Grade	44
Derf Needle Holder, OR Grade	55	Dissecting Scissors, Mayo-noble-stille	18	Econo Crile Hemostatic Forceps, Floor-Grade	24,194
Derf Needle Holder, Sklarlite XD, Premium	55	Dissecting Scissors, Miller	20	Econo Crile-wood Needle Holder, Floor-Grade	58,195
Derf Needle Holder, Sklarlite, Premium	55	Dissecting Scissors, Ragnell	19	Econo Derf Needle Holder, Floor-Grade	55,195
Derf Needle Holder, T-C, Premium	65	Dissecting Scissors, Ragnell Sklarcut Premium	22	Econo Dressing Forceps, Floor-Grade	38,193
Dermal Biopsy Punch, Disposable	160	Dissecting Scissors, T-C, Sklar Edge, Premium	63	Econo Excavator & Probe, Floor-Grade	104
Dermal Biopsy Punch, Disposable, Sterile	190	Dissectors Atraumatic Mini Lap Sklartech 5000	153	Econo Excavator/curette, Floor-Grade	106
Dermal Curette, Fox	132	Dissectors, Maryland, Lap, Disposable Sterile	155	Econo Eye Dressing Forceps, Floor-Grade	45
Dermal Curettes, Disposable, Sterile	190	Dissectors, Maryland, Mini Lap Sklartech 5000	153	Econo Eye Tissue Forceps, Floor-Grade	45
Dermal Curettes, Sklar, Disposable	160	Dolphin Forceps, Laparoscopic, Sklartech 4000	143	Econo Fine Point Splinter Forceps Floor-Grade	44,193
Desmarres Chalazion Forceps	95	Double Deck Micro Tray	201	Econo Foerster Sponge Forceps, Floor-Grade	34,196
Desmarres Lid Retractor	76	Double Ended Probe	79	Econo Gelpi Retractor, Floor-Grade	73
Detergent, Enzymatic, Sklar	217	Double Ended Valve Brushes	226	Econo Graefe Forceps, Floor-Grade	46
Detergent, Enzymatic, Sklar-zyme	216	Double Tapered Cleaning Brushes	224	Econo Graves Vaginal Speculum, Floor-Grade	135
Detergent, Instru-guard One-step, Sklar	212	Double-ended Instrument Cleaning Brushes	227	Econo Halsey Needle Holder, Floor-Grade	60,195
Detergent, Liquid, Sklar Kleen	212	Dougllass Cilia Forceps	91	Econo Halsted Mosquito Forceps, Floor-Grade	23,194
Detergent, Powder, Sklar Kleen	212	Doyen Scissors	18	Econo Hartmann Alligator Forceps, Floor-Grade	129
Diethrich Bulldog Clamp	157	Drape, Anglo, Sterile	184	Econo Hartmann Mosquito Forceps, Floor-Grade	26,194
Dilator Set, Os, Teflon	139	Drape, Fenestrated, Sterile	184	Econo Iris Scissors, Floor-Grade	192,7
Dilator, Castroviejo Lachrymal	88	Drape, Utility, Sterile	184	Econo Kelly Hemostatic Forceps, Floor-Grade	25,194
Dilator, Hank Uterine	137	Drape/towel, Sterile	184	Econo Knowles Bandage Scissors, Floor-Grade	16,191
Dilator, Hegar Uterine	137	Dressing Forceps, Adson Micro	42	Econo Kister Bandage Scissors, Floor-Grade	13,191
Dilator, Infant Lachrymal	88	Dressing Forceps, Adson, Delicate, Premium	40	Econo Littauer Stitch Scissors, Floor-Grade	9,109,191
Dilator, Laborde Tracheal	133	Dressing Forceps, Adson, Floor-Grade, Econo	40,193	Econo Lorna Edna Towel Clamps, Floor-Grade	196
Dilator, Muldoon Lachrymal	88	Dressing Forceps, Adson, Floor-Grade, Sterile	40,193	Econo Lucae Bayonet Forceps, Floor-Grade	51
Dilator, Pratt Uterine	137	Dressing Forceps, Adson, Litegrip, Premium	42	Econo Magill Catheter Forceps, Floor-Grade	31
Dilator, Ruedemann Lachrymal	88	Dressing Forceps, Adson, Mid-Grade	40	Econo Mayo Dissecting Scissors, Floor-Grade	4,192
Dilator, Trousseau Tracheal	133	Dressing Forceps, Adson, OR Grade	40	Econo Mayo Dissecting Scissors, Sterile	4,192
Dilator, Wilder Lachrymal	88	Dressing Forceps, Adson, Sklarlite XD Premium	40	Econo Mayo-hegar Needle Holder, Floor-Grade	54,195
Dilator-catheters, Walther	139	Dressing Forceps, Adson, T-C, Premium	70	Econo Metzenbaum Lahey Scissors	5,192
Dilator/probe, Bowman Lachrymal	88	Dressing Forceps, Adson, T-C, Premium	70	Econo Metzenbaum Scissors, Floor-Grade	192,6
Dilator/probe, Williams Lachrymal	88	Dressing Forceps, Bishop-harmon Eye	47,53	Econo Multi-cut Utility Scissors, Floor-Grade	16
Director And Tongue Tie	79	Dressing Forceps, Delicate, Premium	38	Econo Nail Nipper, Floor-Grade	110
Dishes, Petri, Disposable	187	Dressing Forceps, Eye, Floor-Grade, Econo	45	Econo Nail Splitting Forceps, Floor-Grade	107
Disinfectant, High Level, Sklar-cide	222,209	Dressing Forceps, Eye, Litegrip, Premium	45	Econo Nail Splitting Scissors, Floor-Grade	107
Disinfectant, Spray, Sklar	211	Dressing Forceps, Eye, OR Grade	45	Econo Olsen-hegar Needle Holder, Floor-Grade	57,57
Disposable Carbon Steel Surgical Blades	171	Dressing Forceps, Floor-Grade, Econo	38,193	Econo Operating Scissors, Floor-Grade	2,3,192
Disposable Centrifuge Tubes	186	Dressing Forceps, Floor-Grade, Sterile	38,193	Econo Pederson Vaginal Speculum, Floor-Grade	136
Disposable Cervical Cell Collector, Sterile	190	Dressing Forceps, Foerster	46	Econo Pomeroy Ear Syringe, Floor-Grade	127
Disposable Colormetric Cups	188	Dressing Forceps, Mid-Grade	38	Econo Rochester-ochsner Forceps, Floor-Grade	27,197
Disposable Culture Plates	189	Dressing Forceps, OR Grade	38	Econo Rochester-pean Forceps, Floor-Grade	28,194
Disposable Dermal Biopsy Punch	160	Dressing Forceps, Plastic, Sterile	173	Econo Scalpel Handle, Floor-Grade	169
Disposable Dermal Biopsy Punch, Sterile	190,160	Dressing Forceps, Potts-smith, T-C, Premium	69	Econo Schroeder Tenaculum Forceps Floor-Grade	36,197
Disposable Dermal Curettes, Sklar	160	Dressing Forceps, Semkin	50	Econo Senn Retractor, Floor-Grade	73
Disposable Dermal Curettes, Sterile	190,160	Dressing Forceps, Sklarlite XD, Premium	38	Econo Simpson Uterine Sound, Floor-Grade	138
Disposable Ear Curette	128,190	Dressing Forceps, T-C, Premium	70	Econo Spencer Stitch Scissors, Floor-Grade	11,191
Disposable Ear/ulcer Syringe, Sterile	190	Dressing Forceps, Wilde, Floor-Grade, Econo	125	Econo Splinter Forceps With Magnifier	44
Disposable Endometrial Biopsy Cannula Sterile	190	Dressing Forceps, Wilde, OR Grade	125	Econo Sponge Forceps, Floor-Grade	196
Disposable Graves Vaginal Speculum	190	Dressing Jar	198	Econo Sterile Adson Dressing Forceps	40,193
Disposable Inoculation Loops	189	Drill, Sklar Nail	130	Econo Sterile Adson Tissue Forceps	41,193
Disposable Instrument Cleaning Brushes	227	Drying Rack, Brush	226	Econo Sterile Adson-brown Tissue Forceps	43,193
Disposable Lap Endo Clinch Grasper Sterile	155	Duck Nose Forceps, Mini Lap, Sklartech 5000	153	Econo Sterile Allis Tissue Forceps	29,196
Disposable Lap Maryland Dissectors Sterile	155	E-z Lock Instrument Stringer	204,229	Econo Sterile Babcock Forceps, Floor-Grade	32
Disposable Laparoscopic Metz Scissors Sterile	155	Ear Curette, Buck, Floor-Grade, Econo	128	Econo Sterile Backhaus Towel Clamp	34,196
Disposable Laparoscopic Metz Scissors Sterile	155	Ear Curette, Buck, OR Grade	128	Econo Sterile Baumgartner Needle Holder	59,195
Disposable Microcentrifuge Tubes	188	Ear Curette, Disposable	128,190		

# ALPHABETICAL INDEX



Econo Sterile Bozeman Forceps	36,197	Exam Gloves, Nitrile, Sklartouch, Powdered	166	Floor-Grade Dressing Forceps, Econo	38,193
Econo Sterile Crile Hemostatic Forceps	24,194	Excavator & Packer	104	Floor-Grade Dressing Forceps, Sterile	193,38
Econo Sterile Crile-wood Needle Holder	58,195	Excavator & Probe, Floor-Grade, Econo	104	Floor-Grade Excavator & Probe, Econo	104
Econo Sterile Derf Needle Holder	55,195	Excavator & Probe, OR Grade	104	Floor-Grade Excavator/curette, Econo	106
Econo Sterile Dressing Forceps	38,193	Excavator/curette, Floor-Grade	106	Floor-Grade Eye Dressing Forceps, Econo	45
Econo Sterile Fine Splinter Forceps	44,193	Excavator/curette, OR Grade	106	Floor-Grade Eye Tissue Forceps, Econo	45
Econo Sterile Foerster Sponge Forceps	34,196	Extension Set With Clamp, Sterile	184	Floor-Grade Fine Point Splinter Forceps Econo	44,193
Econo Sterile Graves Vaginal Speculum	135	Extractor, Comedone	131	Floor-Grade Fine Point Splinter Forceps, Sterile	193,44
Econo Sterile Halsey Needle Holder	60,195	Extractor, Schamberg Comedone	131	Floor-Grade Foerster Sponge Forceps, Econo	34,196
Econo Sterile Halsted Mosquito Forceps	23,194	Extractor, Unna Comedone	131	Floor-Grade Foerster Sponge Forceps, Sterile	34,196
Econo Sterile Hartmann Mosquito Forceps	26,194	Eye Dressing Forceps, Bishop-harmon	47	Floor-Grade Gelpi Retractor, Econo	73
Econo Sterile Iris Scissors	7,192	Eye Dressing Forceps, Floor-Grade, Econo	45	Floor-Grade Graefe Forceps, Econo	46
Econo Sterile Kelly Hemostatic Forceps	25,194	Eye Dressing Forceps, Litegrip, Premium	45	Floor-Grade Graves Vaginal Speculum, Econo	135
Econo Sterile Knowles Bandage Scissors	16,191	Eye Dressing Forceps, OR Grade	45	Floor-Grade Halsey Needle Holder, Econo	60,195
Econo Sterile Lister Bandage Scissors	13,191	Eye Speculum, Castroviejo	99	Floor-Grade Halsey Needle Holder, Sterile	195,60
Econo Sterile Littauer Stitch Scissors	9,191	Eye Speculum, Cook	98	Floor-Grade Halsted Mosq Forceps, Sterile	194,23
Econo Sterile Lorna Edna Towel Clamp	35,196	Eye Speculum, Lancaster	99	Floor-Grade Halsted Mosquito Forceps, Econo	23,194
Econo Sterile Magill Catheter Forceps	31	Eye Speculum, Sauer	98	Floor-Grade Hartmann Alligator Forceps, Econo	129
Econo Sterile Mayo Dissecting Scissors	4,192	Eye Speculum, Williams	99	Floor-Grade Hartmann Mosq Hemostats, Sterile	194,26
Econo Sterile Mayo-hegar Needle Holder	54	Eye Speculum, Ziegler	99	Floor-Grade Hartmann Mosquito Forceps, Econo	26,194
Econo Sterile Metzenbaum Dissecting Scissors	6,192	Eye Tissue Forceps, Bishop-harmon	47	Floor-Grade Iris Scissors, Econo	7,192
Econo Sterile Metzenbaum Lahey Scissors	5,192	Eye Tissue Forceps, Floor-Grade, Econo	45	Floor-Grade Iris Scissors, Sterile	192,7
Econo Sterile Multi-cut Utility Scissors	16	Eye Tissue Forceps, Litegrip, Premium	45	Floor-Grade Kelly Hemostatic Forceps, Econo	25,194
Econo Sterile Operating Scissors	2,3,192	Eye Tissue Forceps, OR Grade	45	Floor-Grade Kelly Hemostats, Econo	194,25
Econo Sterile Pederson Vaginal Speculum	136	Fan Shaped Tip Cleaning Brushes	224	Floor-Grade Knowles Bandage Scissors, Econo	191,16
Econo Sterile Rochester-ochsner Forceps	27,197	Farabeuf Retractor	74	Floor-Grade Knowles Bandage Scissors, Sterile	191,16
Econo Sterile Rochester-pean Forceps	28,194	Feilchenfeld Splinter Forceps	44,103	Floor-Grade Lister Bandage Scissors, Econo	13,191
Econo Sterile Schroeder Tenaculum Forceps	36,197	Fenestrated Drape, Sterile	184	Floor-Grade Lister Bandage Scissors, Sterile	191,13
Econo Sterile Spencer Stitch Scissors	11,191	Fenestrated Forceps, Laparoscopic, 4000	143,144	Floor-Grade Littauer Cutting Forceps, Econo	109
Econo Sterile Strabismus Scissors	8	Fenestrated OR Towel, Sterile	185	Floor-Grade Littauer Stitch Scissors, Econo	9,191
Econo Sterile Tissue Forceps	39,193	Ferris-smith Tissue Forceps	50	Floor-Grade Littauer Suture Scissors, Sterile	191,9
Econo Sterile Tube Occluding Clamp	37,197	File And Rasp, Fomon	108	Floor-Grade Lorna Edna Towel Clamps, Econo	196,35
Econo Sterile Webster Needle Holder	56,195	File, Bone	108	Floor-Grade Lorna Edna Towel Clamps, Sterile	196,35
Econo Sterile Wire Cutting Scissors	14,191	File, Nail And Bone	105	Floor-Grade Lucae Bayonet Forceps, Econo	51
Econo Taylor Percussion Hammer, Floor-Grade	156	Fine Point Splinter Forceps Floor-Grade Econo	44,193	Floor-Grade Magill Catheter Forceps, Econo	31
Econo Tissue Forceps, Floor-Grade	39	Fine Point Splinter Forceps, Mid-Grade	44	Floor-Grade Mayo Dissecting Scissors, Econo	4,192
Econo Tissue Nipper, Floor-Grade	112	Fine Point Splinter Forceps, OR Grade	44,103	Floor-Grade Mayo Dissecting Scissors, Sterile	4,192
Econo Tube Occluding Clamp, Floor-Grade	37,197	Fine Splinter Forceps, Floor-Grade, Sterile	44,193	Floor-Grade Mayo-hegar Needle Holder, Econo	54,195
Econo Vienna Nasal Speculum, Floor-Grade	124	Fine Stitch Scissors	18,85	Floor-Grade Mayo-hegar Needle Holder, Sterile	195,54
Econo Wartenberg Neurological Pinwheel	156	Finger Ring Cutter, Keyes	130	Floor-Grade Metzenbaum Dissecting Scissors	6,192
Econo Webster Needle Holder, Floor-Grade	56,195	Finger Ring Cutter, Sklar	130	Floor-Grade Metzenbaum Lahey Scissors	5,192
Econo Weitlaner Retractor, Floor-Grade	71	Finocchio Needle Holder, T-C, Premium	67	Floor-Grade Metzenbaum Scissors, Sterile	192,6
Econo Wilde Dressing Forceps, Floor-Grade	125	Fisher Tonsil Knife	129	Floor-Grade Multi-cut Utility Scissors, Econo	16
Econo Wire Cutting Scissors, Floor-Grade	14,191	Fixation Forceps, Castroviejo	90	Floor-Grade Nail Nipper, Econo	110
Ekg Caliper	156	Fixation Forceps, Graefe	53,90	Floor-Grade Nail Splitting Scissors, Econo	107
Elastic Bandage, Sterile	185	Fixation Forceps, Green	90	Floor-Grade Olsen-hegar Needle Holder, Econo	57
Electrodes, Insulated, Laparoscopic, 4000	149	Fixation Hook, Guthrie	100	Floor-Grade Operating Scissors, Econo	2,3,192
Electrodes, Mini Lap, Sklartech 5000	154	Flash Sterilization Tray	202	Floor-Grade Operating Scissors, Sterile	2,3,192
Electrosurgical Cable Mini Lap Sklartech 5000	154	Floor-Grade Adson Dressing Forceps, Econo	40,193	Floor-Grade Pederson Vaginal Speculum, Econo	136
Electrosurgical Cable, Laparoscopic, 4000	149	Floor-Grade Adson Forceps, Sterile	193,40,41	Floor-Grade Pomeroy Ear Syringe, Econo	127
Elevator	105	Floor-Grade Adson Tissue Forceps, Econo	41,193	Floor-Grade Rochester-ochsner Forceps Sterile	197,27
Elevator, Cottle	126	Floor-Grade Adson-brown Forceps, Sterile	193	Floor-Grade Rochester-ochsner Forceps, Econo	27,197
Elevator, Freer	129,126	Floor-Grade Adson-brown Tissue Forceps, Econo	43,193	Floor-Grade Rochester-pean Forceps, Econo	28,194
Elevator, Hajek-ballenger Septum	126	Floor-Grade Allis Tissue Forceps, Econo	29,196	Floor-Grade Rochester-pean Hemostats, Sterile	194,28
Elevator, Lempert	126	Floor-Grade Allis Tissue Forceps, Sterile	196,29	Floor-Grade Scalpel Handle, Econo	169
Elevator, Locke	105	Floor-Grade Alm Retractor, Econo	71	Floor-Grade Schroeder Forceps, Sterile	197,36
Ellis Foreign Body Spud	97	Floor-Grade Backhaus Towel Clamp, Econo	34,196	Floor-Grade Schroeder Tenaculum Forceps Econo	36,197
Emesis Basin	200	Floor-Grade Backhaus Towel Clamps, Sterile	196,34	Floor-Grade Senn Retractor, Econo	73
Emmett Hook	75	Floor-Grade Baumgartner Needle Holder Sterile	195,59	Floor-Grade Simpson Uterine Sound, Econo	138
Endo Clinch Grasper Lap Disposable Sterile	155	Floor-Grade Baumgartner Needle Holder, Econo	59,195	Floor-Grade Spencer Stitch Scissors, Econo	11,191
Endometrial Biopsy Cannula Disposable Sterile	190	Floor-Grade Bozeman Forceps, Econo	36,197	Floor-Grade Spencer Stitch Scissors, Sterile	191,11
Endoscope, Mini Lap, Sklartech 5000	154	Floor-Grade Bozeman Forceps, Sterile	197,36	Floor-Grade Splinter Forceps With Magnifier	44
Enzymatic Detergent, Sklar	217,212	Floor-Grade Buck Ear Curette, Econo	128	Floor-Grade Sterile Adson Dressing Forceps	40,193
Enzymatic Detergent, Sklar-zyme	216,212	Floor-Grade Buck Neurological Hammer, Econo	156	Floor-Grade Sterile Adson Tissue Forceps	41,193
Esmarch Plaster Shears	15	Floor-Grade Carmalt Splinter Forceps, Econo	44	Floor-Grade Sterile Adson-brown Tissue Forcep	43,193
Esmarch Tin Bullet Probe	79	Floor-Grade Crile Hemostatic Forceps, Econo	24,194	Floor-Grade Sterile Allis Tissue Forceps	29,196
Esmarch Bandage, Sterile	185	Floor-Grade Crile Hemostats, Sterile	194,24	Floor-Grade Sterile Babcock Forceps	32
Eves Tonsil Snare	123	Floor-Grade Crile-wood Needle Holder, Econo	58,195	Floor-Grade Sterile Backhaus Towel Clamp	34,196
Exam Gloves, Latex, Sklartouch, Powder-free	166	Floor-Grade Crile-wood Needle Holder, Sterile	195,58	Floor-Grade Sterile Baumgartner Needle Holder	59,195
Exam Gloves, Latex, Sklartouch, Powdered	166	Floor-Grade Derf Needle Holder, Econo	55,195	Floor-Grade Sterile Bozeman Forceps	36,197
Exam Gloves, Nitrile, Sklartouch, Powder-free	166	Floor-Grade Derf Needle Holder, Sterile	195,55	Floor-Grade Sterile Crile Hemostatic Forceps	24,194

Floor-Grade Sterile Crile-wood Needle Holder . . . . .	58,195	Forceps, Adson Micro Dressing . . . . .	42	Forceps, Crile Hemostatic, Mid-Grade . . . . .	24
Floor-Grade Sterile Derf Needle Holder . . . . .	55,195	Forceps, Adson Micro Tissue . . . . .	42	Forceps, Crile Hemostatic, OR Grade . . . . .	24
Floor-Grade Sterile Dressing Forceps . . . . .	38,193	Forceps, Adson Tissue, Delicate, Premium . . . . .	41	Forceps, Cushing Brain, Delicate, Premium . . . . .	49
Floor-Grade Sterile Fine Splinter Forceps . . . . .	44,193	Forceps, Adson Tissue, Floor-Grade, Econo . . . . .	41,193	Forceps, Dandy Scalp . . . . .	33
Floor-Grade Sterile Foerster Sponge Forceps . . . . .	34,196	Forceps, Adson Tissue, Floor-Grade, Sterile . . . . .	41,193	Forceps, Debakey Atraumatic Tissue . . . . .	48
Floor-Grade Sterile Graves Vaginal Speculum . . . . .	135	Forceps, Adson Tissue, Litegrip, Premium . . . . .	42	Forceps, Debakey Atraumatic, T-C, Premium . . . . .	69
Floor-Grade Sterile Halsey Needle Holder . . . . .	60,195	Forceps, Adson Tissue, Mid-Grade . . . . .	41	Forceps, Debakey Halsted Mosquito . . . . .	33
Floor-Grade Sterile Halsted Mosquito Forceps . . . . .	23,194	Forceps, Adson Tissue, OR Grade . . . . .	41	Forceps, Debakey Laparoscopic Sklaritech 4000 . . . . .	145
Floor-Grade Sterile Hartmann Mosquito Forceps . . . . .	26,194	Forceps, Adson Tissue, Sklarlite XD, Premium . . . . .	41	Forceps, Desmarrés Chalazion . . . . .	95
Floor-Grade Sterile Iris Scissors . . . . .	7,192	Forceps, Adson Tissue, T-C, Premium . . . . .	70	Forceps, Dolphin, Laparoscopic Sklaritech 4000 . . . . .	143
Floor-Grade Sterile Kelly Hemostatic Forceps . . . . .	25,194	Forceps, Adson-brown Tissue Floor-Grade Econo . . . . .	43,193	Forceps, Douglass Cilia . . . . .	91
Floor-Grade Sterile Knowles Bandage Scissors . . . . .	16,191	Forceps, Adson-brown Tissue Sklarlite Premium . . . . .	43	Forceps, Dressing, Delicate, Premium . . . . .	38
Floor-Grade Sterile Lister Bandage Scissors . . . . .	13,191	Forceps, Adson-brown Tissue, Delicate Premium . . . . .	43	Forceps, Dressing, Floor-Grade, Econo . . . . .	38,193
Floor-Grade Sterile Littauer Stitch Scissors . . . . .	9,191	Forceps, Adson-brown Tissue, Litegrip Premium . . . . .	42	Forceps, Dressing, Floor-Grade, Sterile . . . . .	38,193
Floor-Grade Sterile Lorna Edna Towel Clamp . . . . .	35,196	Forceps, Adson-brown Tissue, Mid-Grade . . . . .	43	Forceps, Dressing, Mid-Grade . . . . .	38
Floor-Grade Sterile Magill Catheter Forceps . . . . .	31	Forceps, Adson-brown Tissue, OR Grade . . . . .	43	Forceps, Dressing, OR Grade . . . . .	38
Floor-Grade Sterile Mayo Dissecting Scissors . . . . .	4,192	Forceps, Adson-brown, Floor-Grade, Sterile . . . . .	193,43	Forceps, Dressing, Plastic, Sterile . . . . .	173
Floor-Grade Sterile Mayo-hegar Needle Holder . . . . .	54,195	Forceps, Adson-brown, T-C, Premium . . . . .	70	Forceps, Dressing, Sklarlite XD, Premium . . . . .	38
Floor-Grade Sterile Metzenbaum Lahey Scissors . . . . .	5,192	Forceps, Allis Tissue, Delicate, Premium . . . . .	29	Forceps, Dressing, T-C, Premium . . . . .	70
Floor-Grade Sterile Metzenbaum Scissors . . . . .	6,192	Forceps, Allis Tissue, Floor-Grade, Econo . . . . .	29,196	Forceps, Duck Nose, Mini Lap, Sklaritech 5000 . . . . .	153
Floor-Grade Sterile Multi-cut Utility Scissor . . . . .	16	Forceps, Allis Tissue, Floor-Grade, Sterile . . . . .	29,196	Forceps, Eye Dressing, Floor-Grade, Econo . . . . .	45
Floor-Grade Sterile Operating Scissors . . . . .	2,3,192	Forceps, Allis Tissue, Mid-Grade . . . . .	29	Forceps, Eye Dressing, Litegrip, Premium . . . . .	45
Floor-Grade Sterile Pederson Vaginal Speculum . . . . .	136	Forceps, Allis Tissue, OR Grade . . . . .	29	Forceps, Eye Dressing, OR Grade . . . . .	45
Floor-Grade Sterile Rochester-ochsner Forceps . . . . .	27,197	Forceps, Allis Tissue, Sklarlite, Premium . . . . .	29	Forceps, Eye Tissue, Floor-Grade, Econo . . . . .	45
Floor-Grade Sterile Rochester-pean Forceps . . . . .	28,194	Forceps, Allis, Laparoscopic, Sklaritech 4000 . . . . .	145	Forceps, Eye Tissue, Litegrip, Premium . . . . .	45
Floor-Grade Sterile Schroeder Tenaculum . . . . .	36,197	Forceps, Allis, T-C, Premium . . . . .	69	Forceps, Eye Tissue, OR Grade . . . . .	45
Floor-Grade Sterile Spencer Stitch Scissors . . . . .	11,191	Forceps, Atraumatic, Laparoscopic, 4000 . . . . .	144,145	Forceps, Feilchenfeld Splinter . . . . .	44,103
Floor-Grade Sterile Strabismus Scissors . . . . .	8	Forceps, Atraumatic, Mini Lap, Sklaritech 5000 . . . . .	153	Forceps, Fenestrated, Laparoscopic, 4000 . . . . .	143,144
Floor-Grade Sterile Tissue Forceps . . . . .	39,193	Forceps, Ayers Chalazion . . . . .	95	Forceps, Ferris-smith Tissue . . . . .	50
Floor-Grade Sterile Tube Occluding Clamp . . . . .	37,197	Forceps, Babcock, Floor-Grade, Sterile . . . . .	32	Forceps, Fine Point Splinter, Mid-Grade . . . . .	44
Floor-Grade Sterile Webster Needle Holder . . . . .	56	Forceps, Babcock, Laparoscopic Sklaritech 4000 . . . . .	144	Forceps, Fine Point Splinter, OR Grade . . . . .	44,103
Floor-Grade Sterile Wire Cutting Scissors . . . . .	14	Forceps, Babcock, Mid-Grade . . . . .	32	Forceps, Fine Splinter, Floor-Grade, Econo . . . . .	193,44
Floor-Grade Taylor Percussion Hammer, Econo . . . . .	156	Forceps, Babcock, OR Grade . . . . .	32	Forceps, Fine Splinter, Floor-Grade, Sterile . . . . .	44,193
Floor-Grade Tissue Forceps, Econo . . . . .	39,193	Forceps, Babcock, T-C, Premium . . . . .	69	Forceps, Foerster Dressing . . . . .	46
Floor-Grade Tissue Forceps, Sterile . . . . .	193,39	Forceps, Backhaus Towel, Floor-Grade, Econo . . . . .	196,34	Forceps, Foerster Iris Tissue . . . . .	46
Floor-Grade Tissue Nipper, Econo . . . . .	112	Forceps, Backhaus Towel, Floor-Grade, Sterile . . . . .	196,34	Forceps, Foerster Sponge, Floor-Grade Sterile . . . . .	34,196
Floor-Grade Tube Occluding Clamp, Econo . . . . .	37,197	Forceps, Backhaus Towel, Mid-Grade . . . . .	34	Forceps, Foerster Sponge, Floor-Grade, Econo . . . . .	34,196
Floor-Grade Tube Occluding Forceps, Sterile . . . . .	197,37	Forceps, Backhaus Towel, OR Grade . . . . .	34	Forceps, Foerster Sponge, Mid-Grade . . . . .	34
Floor-Grade Vienna Nasal Speculum, Econo . . . . .	124	Forceps, Ballenger Sponge . . . . .	37	Forceps, Foerster Sponge, OR Grade . . . . .	34
Floor-Grade Wartenberg Neurological Pinwheel . . . . .	156	Forceps, Barraquer Cilia . . . . .	91	Forceps, Foerster Tissue . . . . .	46
Floor-Grade Webster Needle Holder, Econo . . . . .	195,56	Forceps, Bayonet Lucae . . . . .	51	Forceps, Gemini . . . . .	31
Floor-Grade Webster Needle Holder, Sterile . . . . .	195,56	Forceps, Bechert-mcpherson Tying . . . . .	93	Forceps, Gerald . . . . .	49
Floor-Grade Weitlaner Retractor, Econo . . . . .	71	Forceps, Bergh Cilia . . . . .	91	Forceps, Gill Chandler Iris . . . . .	47
Floor-Grade Wilde Dressing Forceps, Econo . . . . .	125	Forceps, Berke Ptosis . . . . .	95	Forceps, Gill Iris . . . . .	47
Floor-Grade Wire Cutting Scissors, Econo . . . . .	14,191	Forceps, Bishop-harmon Eye Dressing . . . . .	47,53	Forceps, Girard Corneal Utility . . . . .	90
Floor-Grade Wire Cutting Scissors, Sterile . . . . .	191,14	Forceps, Bishop-harmon Eye Tissue . . . . .	47,53	Forceps, Graefe Fixation . . . . .	53,90
Fluoroscope Covers, Sterile . . . . .	184	Forceps, Bishop-harmon Iowa . . . . .	47	Forceps, Graefe Iris . . . . .	53
Foerster Dressing Forceps . . . . .	46	Forceps, Bishop-harmon, Litegrip, Premium . . . . .	47	Forceps, Graefe, Floor-Grade, Econo . . . . .	46
Foerster Iris Tissue Forceps . . . . .	46	Forceps, Bonaccolto Utility . . . . .	92	Forceps, Graefe, OR Grade . . . . .	46
Foerster Sponge Forceps, Floor-Grade, Econo . . . . .	34	Forceps, Bonn Micro Suturing . . . . .	89	Forceps, Grasping, Laparoscopic Sklaritech 4000 . . . . .	144,145
Foerster Sponge Forceps, Floor-Grade, Sterile . . . . .	34	Forceps, Bonn Tying . . . . .	89	Forceps, Grasping, Mini Lap, Sklaritech 5000 . . . . .	153
Foerster Sponge Forceps, Mid-Grade . . . . .	34	Forceps, Bonney Tissue . . . . .	50	Forceps, Green Fixation . . . . .	90
Foerster Sponge Forceps, OR Grade . . . . .	34	Forceps, Bozeman, Floor-Grade, Econo . . . . .	36,197	Forceps, Halsted Mosquito Floor-Grade Sterile . . . . .	23,194
Foerster Tissue Forceps . . . . .	46	Forceps, Bozeman, Floor-Grade, Sterile . . . . .	36,197	Forceps, Halsted Mosquito, Delicate, Premium . . . . .	23
Fomon Rasp And File . . . . .	108	Forceps, Bozeman, Mid-Grade . . . . .	36	Forceps, Halsted Mosquito, Floor-Grade, Econo . . . . .	23,194
Fomon Retractor . . . . .	77	Forceps, Bozeman, OR Grade . . . . .	36	Forceps, Halsted Mosquito, Mid-Grade . . . . .	23
Forcep Grasping Cobra Mini Lap Sklaritech 5000 . . . . .	153	Forceps, Carmalt Splinter . . . . .	103	Forceps, Halsted Mosquito, OR Grade . . . . .	23
Forcep Holder, Weisenbach . . . . .	204	Forceps, Carmalt Splinter, Floor-Grade, Econo . . . . .	44	Forceps, Halsted Mosquito, Sklarlite XD . . . . .	23
Forceps Alligator Laparoscopic Sklaritech 4000 . . . . .	145	Forceps, Castroviejo . . . . .	89	Forceps, Harms Tying . . . . .	89
Forceps Atraumatic Grasping Laparoscopic 4000 . . . . .	144,145	Forceps, Castroviejo Colibri . . . . .	90	Forceps, Hartmann Alligator Floor-Grade Econo . . . . .	129
Forceps Jar . . . . .	198	Forceps, Castroviejo Fixation . . . . .	90	Forceps, Hartmann Alligator Grasping OR Grade . . . . .	129
Forceps Schroeder Tenaculum Floor-Grade Econo . . . . .	36,197	Forceps, Castroviejo Suture . . . . .	89	Forceps, Hartmann Mosq, Floor-Grade, Sterile . . . . .	194,26
Forceps, Adson Bayonet . . . . .	51	Forceps, Chandler Iris . . . . .	46	Forceps, Hartmann Mosquito, Delicate, Premium . . . . .	26
Forceps, Adson Dressing, Delicate, Premium . . . . .	40	Forceps, Claw, Laparoscopic, Sklaritech 4000 . . . . .	143	Forceps, Hartmann Mosquito, Floor-Grade Econo . . . . .	26,194
Forceps, Adson Dressing, Floor-Grade, Econo . . . . .	40,193	Forceps, Clinch Grasping, Laparoscopic, 4000 . . . . .	145	Forceps, Hartmann Mosquito, Mid-Grade . . . . .	26
Forceps, Adson Dressing, Floor-Grade, Sterile . . . . .	40,193	Forceps, Cobra Grasping, Laparoscopic, 4000 . . . . .	145	Forceps, Hartmann Mosquito, OR Grade . . . . .	26
Forceps, Adson Dressing, Litegrip, Premium . . . . .	42	Forceps, Coller Hemostatic . . . . .	32	Forceps, Hartmann Mosquito, Sklarlite Premium . . . . .	26
Forceps, Adson Dressing, Mid-Grade . . . . .	40	Forceps, Crile Hemostatic Floor-Grade Sterile . . . . .	24,194	Forceps, Hemorrhoidal . . . . .	158
Forceps, Adson Dressing, OR Grade . . . . .	40	Forceps, Crile Hemostatic Sklarlite XD . . . . .	24	Forceps, Jackson X-action . . . . .	133
Forceps, Adson Dressing, Sklarlite XD Premium . . . . .	40	Forceps, Crile Hemostatic, Delicate, Premium . . . . .	24	Forceps, Jacobson Mosquito . . . . .	32
Forceps, Adson Dressing, T-C, Premium . . . . .	70	Forceps, Crile Hemostatic, Floor-Grade, Econo . . . . .	24,197	Forceps, Jacobson Mosquito, Extra Delicate . . . . .	33



# ALPHABETICAL INDEX



Forceps, Jansen Nasal Bayonet . . . . .	51,125	Forceps, Rochester-pean, Floor-Grade, Sterile . . . . .	28,194	Glove Liners, Sklar, Sterile . . . . .	167
Forceps, Jewelers Style . . . . .	52	Forceps, Rochester-pean, Mid-Grade . . . . .	28	Gloves, Latex Exam, Sklartouch, Powder-free . . . . .	166
Forceps, Kelly Hemostatic Floor-Grade Sterile . . . . .	25,194	Forceps, Rochester-pean, OR Grade . . . . .	28	Gloves, Latex Exam, Sklartouch, Powdered . . . . .	166
Forceps, Kelly Hemostatic, Delicate, Premium . . . . .	25	Forceps, Rochester-pean, Sklarlite, Premium . . . . .	28	Gloves, Latex Surgical, Sklartouch . . . . .	167
Forceps, Kelly Hemostatic, Floor-Grade, Econo . . . . .	25,194	Forceps, Rowland Bone . . . . .	120	Gloves, Nitrile Exam, Sklartouch, Powder-free . . . . .	166
Forceps, Kelly Hemostatic, Mid-Grade . . . . .	25	Forceps, Rubber Dam . . . . .	102	Gloves, Nitrile Exam, Sklartouch, Powdered . . . . .	166
Forceps, Kelly Hemostatic, OR Grade . . . . .	25	Forceps, Ruskin-liston Bone Cutting . . . . .	119	Gloves, Nitrile Surgical, Sklartouch . . . . .	167
Forceps, Kelly, Laparoscopic, Sklartech 4000 . . . . .	143	Forceps, Russian Tissue . . . . .	50	Goldman-fox Scissors . . . . .	20
Forceps, Kelly, Mini Lap, Sklartech 5000 . . . . .	153	Forceps, Schmidt . . . . .	30	Goldstein Retractor . . . . .	72,97
Forceps, Kelman-mcpherson Tying . . . . .	93	Forceps, Schroeder Tenaculum, Mid-Grade . . . . .	36	Gordon Pliers . . . . .	102
Forceps, Kevorkian Biopsy . . . . .	140	Forceps, Schroeder Tenaculum, OR Grade . . . . .	36	Goslee Contouring Pliers . . . . .	102
Forceps, Kevorkian-young Biopsy . . . . .	140	Forceps, Schroeder Tenaculum, Sterile, Econo . . . . .	36,197	Gouge, Alexander . . . . .	116
Forceps, Kleinert-kutz Bone Cutting . . . . .	119	Forceps, Semkin Dressing . . . . .	50	Gouge, Army Pattern . . . . .	115
Forceps, Lambert Chalazion . . . . .	95	Forceps, Semkin Tissue . . . . .	50	Gouge, Cobb Type Spinal . . . . .	116
Forceps, Lester Conjunctival . . . . .	46,53	Forceps, Splinter With Magnifier, Floor-Grade . . . . .	44	Gouge, Smith Peterson . . . . .	115
Forceps, Liston Bone . . . . .	119	Forceps, Sponge, Floor-Grade, Econo . . . . .	196,34	Gown, XI, Sterile . . . . .	185
Forceps, Liston-blau Bone . . . . .	108	Forceps, Sponge, Floor-Grade, Sterile . . . . .	196,34	Gradle Scissors . . . . .	86
Forceps, Littauer Cilia . . . . .	91	Forceps, Sponge, Plastic, Sterile . . . . .	173	Graduated Measures . . . . .	199
Forceps, Littauer Cutting, Floor-Grade, Econo . . . . .	109	Forceps, Spoon, Mini Lap, Sklartech 5000 . . . . .	153	Graduated Probe, Laparoscopic, Sklartech 4000 . . . . .	151
Forceps, Littauer Cutting, OR Grade . . . . .	109	Forceps, Stevens Iris . . . . .	47	Graefe Fixation Forceps . . . . .	53,90
Forceps, Littauer Cutting, Sklarlite, Premium . . . . .	109	Forceps, Strabismus . . . . .	95	Graefe Forceps, Floor-Grade, Econo . . . . .	46
Forceps, Lorna Edna Towel Floor-Grade Sterile . . . . .	196,35	Forceps, Tapered Grasping, Laparoscopic, 4000 . . . . .	144	Graefe Forceps, OR Grade . . . . .	46
Forceps, Lorna Edna Towel, Floor-Grade, Econo . . . . .	196,35	Forceps, Tennant Tying . . . . .	93	Graefe Iris Forceps . . . . .	53
Forceps, Lorna Edna Towel, Mid-Grade . . . . .	35	Forceps, Thorpe Corneoscleral . . . . .	92	Graefe Strabismus Hook . . . . .	100
Forceps, Lorna Edna Towel, OR Grade . . . . .	35	Forceps, Tischler Cervical Biopsy . . . . .	141	Grasper, Endo Clinch, Lap, Disposable Sterile . . . . .	155
Forceps, Lucae Bayonet, Floor-Grade, Econo . . . . .	51	Forceps, Tischler Oval Biopsy . . . . .	141	Grasping Forcep Cobra Mini Lap Sklartech 5000 . . . . .	153
Forceps, Lucae Bayonet, OR Grade . . . . .	51	Forceps, Tissue, Delicate, Premium . . . . .	39	Grasping Forceps Atraumatic Laparoscopic 4000 . . . . .	144,145
Forceps, Magill Catheter, Floor-Grade Sterile . . . . .	31	Forceps, Tissue, Floor-Grade, Econo . . . . .	39,193	Grasping Forceps, Clinch, Laparoscopic, 4000 . . . . .	145
Forceps, Magill Catheter, Floor-Grade, Econo . . . . .	31	Forceps, Tissue, Floor-Grade, Sterile . . . . .	39,193	Grasping Forceps, Cobra, Laparoscopic, 4000 . . . . .	145
Forceps, Magill Catheter, Mid-Grade . . . . .	31	Forceps, Tissue, Mid-Grade . . . . .	39	Grasping Forceps, Hartmann Alligator OR Grade . . . . .	129
Forceps, Magill Catheter, OR Grade . . . . .	31	Forceps, Tissue, OR Grade . . . . .	39	Grasping Forceps, Laparoscopic Sklartech 4000 . . . . .	144,145
Forceps, Manhattan Eye & Ear Suturing . . . . .	89	Forceps, Tissue, Sklarlite XD, Premium . . . . .	39	Grasping Forceps, Maxi, Laparoscopic, 4000 . . . . .	144
Forceps, Maryland Laparoscopic Sklartech 4000 . . . . .	143	Forceps, Troutman-barraquer Corneal Utility . . . . .	47	Grasping Forceps, Mini Lap, Sklartech 5000 . . . . .	153
Forceps, Maryland, Mini Lap, Sklartech 5000 . . . . .	153	Forceps, Tube Occluding, Floor-Grade, Econo . . . . .	197,37	Grasping Forceps, Pointed, Laparoscopic, 4000 . . . . .	144
Forceps, Maxi Grasping, Laparoscopic, 4000 . . . . .	144	Forceps, Tube Occluding, Floor-Grade, Sterile . . . . .	197,37	Grasping Forceps, Tapered, Laparoscopic, 4000 . . . . .	144
Forceps, Mccullough Utility . . . . .	92	Forceps, Tube Occluding, Mid-Grade . . . . .	37	Grasping Forceps, Wave, Laparoscopic, 4000 . . . . .	145
Forceps, Mcindoe Bone Cutting . . . . .	121	Forceps, Tube Occluding, OR Grade . . . . .	37	Graves Vaginal Speculum, Disposable . . . . .	190
Forceps, Mcpherson Micro Iris Suturing . . . . .	89	Forceps, Tumor Grasping . . . . .	82	Graves Vaginal Speculum, Floor-Grade, Econo . . . . .	135
Forceps, Mcpherson Tying . . . . .	89	Forceps, Utility, Plastic, Sterile . . . . .	173	Graves Vaginal Speculum, Floor-Grade, Sterile . . . . .	135
Forceps, Micro . . . . .	82	Forceps, Virtus Splinter . . . . .	33	Graves Vaginal Speculum, Mid-Grade . . . . .	135
Forceps, Micro Mosquito . . . . .	31	Forceps, Wave Grasping, Laparoscopic, 4000 . . . . .	145	Graves Vaginal Speculum, OR Grade . . . . .	135
Forceps, Micro Suture Tying . . . . .	53	Forceps, Weis Chalazion . . . . .	95	Green Fixation Forceps . . . . .	90
Forceps, Mini Tischler Biopsy . . . . .	140	Forceps, Wilde Dressing, Floor-Grade, Econo . . . . .	125	Green Spatula . . . . .	96
Forceps, Mixer . . . . .	30	Forceps, Wilde Dressing, OR Grade . . . . .	125	Groovelok, Miller . . . . .	101
Forceps, Mixer, Delicate . . . . .	30	Forceps, Wills Hospital Utility . . . . .	92	Guthrie Double Hook . . . . .	75
Forceps, Mixer, Laparoscopic, Sklartech 4000 . . . . .	143	Forceps, Young Tongue Seizing . . . . .	129	Guthrie Fixation Hook . . . . .	100
Forceps, Nail Splitting, Floor-Grade, Econo . . . . .	107	Forceps, Ziegler Cilia . . . . .	91	Hajek-ballenger Septum Elevator . . . . .	126
Forceps, Nail Splitting, OR Grade . . . . .	107	Foreign Body Needles . . . . .	97	Halsey Needle Holder, Floor-Grade, Econo . . . . .	60,195
Forceps, Nail Splitting, Sklarlite, Premium . . . . .	107	Foreign Body Spud, Alvis . . . . .	97	Halsey Needle Holder, Floor-Grade, Sterile . . . . .	60,195
Forceps, Noyes Alligator . . . . .	125	Foreign Body Spud, Ellis . . . . .	97	Halsey Needle Holder, Mid-Grade . . . . .	60
Forceps, Nugent Utility . . . . .	92	Fox Dermal Curette . . . . .	132	Halsey Needle Holder, OR Grade . . . . .	60
Forceps, O'brien-elschnig . . . . .	90	Frazier Suction Tube . . . . .	134	Halsey Needle Holder, Sklarlite XD, Premium . . . . .	60
Forceps, Oval Biopsy . . . . .	141	Frazier Tissue Hook . . . . .	75,77	Halsey Needle Holder, Sklarlite, Premium . . . . .	60
Forceps, P And A . . . . .	119	Freer Chisel . . . . .	122	Halsey Needle Holder, T-C, Premium . . . . .	65
Forceps, Plain Splinter With Magnifier . . . . .	44,103	Freer Septum Elevator . . . . .	126,129	Halsted Mosquito Forceps, Delicate, Premium . . . . .	23
Forceps, Platypus Nail Pulling . . . . .	112	Freer Septum Knife . . . . .	126	Halsted Mosquito Forceps, Floor-Grade Sterile . . . . .	23,194
Forceps, Pointed Grasping, Laparoscopic, 4000 . . . . .	144	Friedman Bone Rongeur . . . . .	118	Halsted Mosquito Forceps, Floor-Grade, Econo . . . . .	23,194
Forceps, Potts-smith . . . . .	50	Gauge, Boley . . . . .	102	Halsted Mosquito Forceps, Mid-Grade . . . . .	23
Forceps, Potts-smith Dressing, T-C, Premium . . . . .	69	Gauze Scissors, Us Army Pattern . . . . .	107,15	Halsted Mosquito Forceps, OR Grade . . . . .	23
Forceps, Prince Muscle . . . . .	78,90	Gel, Sanitizing, Sklar . . . . .	223,	Halsted Mosquito Forceps, Sklarlite XD . . . . .	23
Forceps, Rankin Hemostatic . . . . .	30	Gelpi Retractor, Floor-Grade, Econo . . . . .	73	Hammer, Buck Neurological, Floor-Grade, Econo . . . . .	156
Forceps, Rhoton Micro Suture . . . . .	93	Gelpi Retractor, OR Grade . . . . .	73	Hammer, Buck Neurological, OR Grade . . . . .	156
Forceps, Rochester-carmalt . . . . .	30	Gemini Forceps . . . . .	31	Hammer, Rabiner Neurological . . . . .	156
Forceps, Rochester-ochsner Sterile Econo . . . . .	27,197	General Instrument Cleaning Brushes . . . . .	227	Hammer, Taylor Percussion, Floor-Grade, Econo . . . . .	156
Forceps, Rochester-ochsner, Delicate, Premium . . . . .	27	General Purpose Tray, Sterile . . . . .	174	Hammer, Taylor Percussion, OR Grade . . . . .	156
Forceps, Rochester-ochsner, Floor-Grade Econo . . . . .	27,197	Gerald Forceps . . . . .	49	Handle, Carbon Xc Laparoscopic Sklartech 4000 . . . . .	146
Forceps, Rochester-ochsner, Mid-Grade . . . . .	27	Gill Chandler Iris Forceps . . . . .	47	Handle, Carbon Xc, Mini Lap, Sklartech 5000 . . . . .	154
Forceps, Rochester-ochsner, OR Grade . . . . .	27	Gill Corneal Knife . . . . .	99	Handle, Carbon Yc, Mini Lap, Sklartech 5000 . . . . .	154
Forceps, Rochester-ochsner, Sklarlite Premium . . . . .	27	Gill Iris Forceps . . . . .	47	Handle, Scalpel, Floor-Grade, Econo . . . . .	169
Forceps, Rochester-pean, Delicate, Premium . . . . .	28	Gillies Skin Hook . . . . .	77	Handle, Scalpel, OR Grade . . . . .	169,170
Forceps, Rochester-pean, Floor-Grade, Econo . . . . .	28,194	Girard Corneal Utility Forceps . . . . .	90	Handle, X, Laparoscopic, Sklartech 4000 . . . . .	146

Handle, Y, Laparoscopic, Sklartech 4000 . . . . .	146	Hemostats, Rochester-pean, Floor-Grade, Econo . . . . .	28,194	Instrument Tip Protectors, Non-vented . . . . .	230
Handle, Yc Carbon Laparoscopic Sklartech 4000 . . . . .	146	Hemostats, Rochester-pean, Mid-Grade . . . . .	28	Instrument Tip Protectors, Vented . . . . .	230
Handles, Lifting . . . . .	202	Hemostats, Rochester-pean, OR Grade . . . . .	28	Instrument Tray . . . . .	201,229
Handles, Retrieving . . . . .	202	Hemostats, Rochester-pean, Sklarlite, Premium . . . . .	28	Instrument Tray, Cath . . . . .	202
Hank Uterine Dilator . . . . .	137	Hemostats, Rochester-pean, Sterile, Econo . . . . .	28,194	Instrument Tray, High Sided . . . . .	201
Harms Tying Forceps . . . . .	89	Hemostats, Schmidt . . . . .	30	Instrument Tray, Non-perforated . . . . .	201
Hartmann Alligator Forceps, Floor-Grade Econo . . . . .	129	Hennig Plaster Spreader . . . . .	113	Instrument Tray, Perforated . . . . .	201
Hartmann Alligator Grasping Forceps, OR Grade . . . . .	129	Hercules Utility Scissors . . . . .	15	Insulated Cannula Laparoscopic Sklartech 4000 . . . . .	146
Hartmann Mosquito Forceps Floor-Grade Sterile . . . . .	26,194	High Level Disinfectant, Sklar-cide . . . . .	222,209	Insulated Electrodes, Laparoscopic, 4000 . . . . .	149
Hartmann Mosquito Forceps, Delicate, Premium . . . . .	26	High Sided Instrument Tray . . . . .	201	Iodine Cup . . . . .	198
Hartmann Mosquito Forceps, Floor-Grade, Econo . . . . .	26,194	Hoff Towel Clamp . . . . .	35	Iris Forceps, Chandler . . . . .	46
Hartmann Mosquito Forceps, Mid-Grade . . . . .	26	Holden Uterine Curette . . . . .	139	Iris Forceps, Gill . . . . .	47
Hartmann Mosquito Forceps, OR Grade . . . . .	26	Holder, Brush . . . . .	226	Iris Forceps, Gill Chandler . . . . .	47
Hartmann Mosquito Forceps, Sklarlite, Premium . . . . .	26	Holder, Bunt Instrument . . . . .	204	Iris Forceps, Graefe . . . . .	53
Hartmann Rongeur . . . . .	117	Holder, Weisenbach Forcep . . . . .	204	Iris Forceps, Stevens . . . . .	47
Hasson Trocar, Laparoscopic, Sklartech 4000 . . . . .	148	Holder, Worcester Instrument . . . . .	204	Iris Hook, Tyrell . . . . .	77,100
Heaney Needle Holder, T-C, Premium . . . . .	67	Holzheimer X-action Retractor . . . . .	72	Iris Micro-miniature Scissors . . . . .	87
Heaney Uterine Curette . . . . .	139	Hook And Spatula, Mcreynolds . . . . .	96	Iris Retractor, Mcgannon . . . . .	77
Heath Chalazion Curette . . . . .	94	Hook Scissors, Laparoscopic, Sklartech 4000 . . . . .	142	Iris Scissors, Floor-Grade, Econo . . . . .	7,192
Heath Curette . . . . .	132	Hook Scissors, Mini Lap, Sklartech 5000 . . . . .	152	Iris Scissors, Floor-Grade, Sterile . . . . .	192,7
Hegar Uterine Dilator . . . . .	137	Hook, Emmett . . . . .	75	Iris Scissors, Knapp . . . . .	20,86
Hemorrhoidal Forceps . . . . .	158	Hook, Frazier Tissue . . . . .	75,77	Iris Scissors, McClure . . . . .	85
Hemorrhoidal Ligator Set, MCGivney . . . . .	158	Hook, Gillies Skin . . . . .	77	Iris Scissors, Mid-Grade . . . . .	7
Hemorrhoidal Ligator Set, Rudd Clinic . . . . .	159	Hook, Graefe Strabismus . . . . .	100	Iris Scissors, OR Grade . . . . .	7
Hemorrhoidal Ligator, MCGivney . . . . .	158	Hook, Guthrie Double . . . . .	75	Iris Scissors, Premium Delicate . . . . .	7
Hemorrhoidal Ligator, Rudd Clinic . . . . .	159	Hook, Guthrie Fixation . . . . .	100	Iris Scissors, Ribbon . . . . .	17
Hemostats Hartmann Mosquito Delicate Premium . . . . .	26	Hook, Jamison Strabismus . . . . .	100	Iris Scissors, Sklarcut, Premium . . . . .	21
Hemostats Hartmann Mosquito Floor-Grade Econo . . . . .	26,194	Hook, Joseph Skin . . . . .	75	Iris Scissors, Sklarhone, Premium . . . . .	64
Hemostats Hartmann Mosquito Sklarlite Premium . . . . .	26	Hook, Meyerding Retractor And Skin . . . . .	75	Iris Scissors, Sklarlite XD, Premium . . . . .	7
Hemostats Rochester-ochsner Floor-Grade Econo . . . . .	27,197	Hook, O'conner . . . . .	100	Iris Scissors, Sklarlite, Sklarcut, Premium . . . . .	21
Hemostats Rochester-ochsner Floor-Grade Ster . . . . .	27,197	Hook, Tyrell Iris . . . . .	77,100	Iris Scissors, T-C, Sklar Edge, Premium . . . . .	62
Hemostats Rochester-ochsner Sklarlite Premium . . . . .	27	Hook, Wiener Scleral . . . . .	100	Iris Tissue Forceps, Foerster . . . . .	46
Hemostats Rochester-ochsner, Mid-Grade . . . . .	27	Hospital Kick Bucket . . . . .	200	Irrigation System, Suction, Laparoscopic 4000 . . . . .	150
Hemostats Rochester-ochsner, OR Grade . . . . .	27	How Pliers . . . . .	102	IV Start Tray, Sterile . . . . .	177
Hemostats, Adson . . . . .	30	ID Roll Tape . . . . .	231	Ives Rectal Speculum . . . . .	158
Hemostats, Collier . . . . .	32	ID Sheet Tape . . . . .	231	Jackson X-action Forceps . . . . .	133
Hemostats, Crile, Delicate, Premium . . . . .	24	ID Tags, Instrument . . . . .	231	Jacobson Mosquito Forceps . . . . .	33
Hemostats, Crile, Floor-Grade, Econo . . . . .	24,194	Incision And Drainage Tray, Sterile . . . . .	176	Jacobson Mosquito Forceps Extra Delicate . . . . .	33
Hemostats, Crile, Floor-Grade, Sterile . . . . .	24,194	Indicator Labels . . . . .	168	Jacobson Needle Holder, T-C, Premium . . . . .	68
Hemostats, Crile, Mid-Grade . . . . .	24	Indicator Pen, Steam . . . . .	168	Jameson Scissors, Sklarhone, Premium . . . . .	64
Hemostats, Crile, OR Grade . . . . .	24	Indicator Strips . . . . .	168	Jamison Strabismus Hook . . . . .	100
Hemostats, Crile, Sklarlite XD, Premium . . . . .	24	Indicator Tapes . . . . .	168	Jansen Bayonet Nasal Forceps . . . . .	51,125
Hemostats, Dandy Scalp . . . . .	33	Infant Ear Curette, Weisman . . . . .	128	Jansen Retractor . . . . .	73
Hemostats, Debakey Halsted Mosquito . . . . .	33	Infant Lachrymal Dilator . . . . .	88	Jar, Dressing . . . . .	198
Hemostats, Halsted Mosq Floor-Grade Sterile . . . . .	23,194	Inge Lamina Retractor . . . . .	117	Jar, Forceps . . . . .	198
Hemostats, Halsted Mosquito, Delicate Premium . . . . .	23	Ingrown Nail Cutter, Baker . . . . .	106	Jar, Ointment . . . . .	198
Hemostats, Halsted Mosquito, Floor-Grade . . . . .	23,194	Ingrown Nail Shaver . . . . .	106	Jewelers Style Forceps . . . . .	52
Hemostats, Halsted Mosquito, Mid-Grade . . . . .	23	Injection Needle, Laparoscopic Sklartech 4000 . . . . .	151	Johns Hopkins Bulldog Clamp . . . . .	157
Hemostats, Halsted Mosquito, OR Grade . . . . .	23	Innoculation Loops, Disposable . . . . .	189	Jones Cross Action Towel Clamp . . . . .	35
Hemostats, Halsted Mosquito, Sklarlite XD . . . . .	23	Instru-guard Lubricant, Sklar . . . . .	220	Joseph Button End Knife . . . . .	122
Hemostats, Hartmann Mosq, Floor-Grade Sterile . . . . .	194,26	Instru-guard One-step Detergent, Sklar . . . . .	212	Joseph Knife . . . . .	122
Hemostats, Hartmann Mosq, Floor-Grade, Econo . . . . .	194,26	Instrument Cath Tray . . . . .	202,229	Joseph Rasp . . . . .	108
Hemostats, Hartmann Mosquito, Mid-Grade . . . . .	26	Instrument Cleaning Brushes, Cannula . . . . .	224	Joseph Scissors . . . . .	17
Hemostats, Hartmann Mosquito, OR Grade . . . . .	26	Instrument Cleaning Brushes, Disposable . . . . .	227	Joseph Skin Hook . . . . .	75
Hemostats, Jacobson Mosquito . . . . .	32	Instrument Cleaning Brushes, Double-ended . . . . .	227	Kelly Forceps, Laparoscopic, Sklartech 4000 . . . . .	143
Hemostats, Jacobson Mosquito, Extra Delicate . . . . .	33	Instrument Cleaning Brushes, General . . . . .	227	Kelly Forceps, Mini Lap, Sklartech 5000 . . . . .	153
Hemostats, Kelly, Delicate, Premium . . . . .	25	Instrument Cleaning Brushes, Large . . . . .	228	Kelly Hemostatic Forceps Sklarlite XD Premium . . . . .	25
Hemostats, Kelly, Floor-Grade, Econo . . . . .	25,194	Instrument Cleaning Brushes, Nylon . . . . .	204	Kelly Hemostatic Forceps, Delicate, Premium . . . . .	25
Hemostats, Kelly, Floor-Grade, Sterile . . . . .	25,194	Instrument Cleaning Brushes, Stainless Steel . . . . .	204	Kelly Hemostatic Forceps, Floor-Grade Sterile . . . . .	25,194
Hemostats, Kelly, Mid-Grade . . . . .	25	Instrument Holder, Bunt . . . . .	204	Kelly Hemostatic Forceps, Floor-Grade, Econo . . . . .	25,194
Hemostats, Kelly, OR Grade . . . . .	25	Instrument Holder, Worcester . . . . .	204	Kelly Hemostatic Forceps, OR Grade . . . . .	25
Hemostats, Kelly, Sklarlite XD, Premium . . . . .	25	Instrument ID Tags . . . . .	231	Kelman-mcpherson Tying Forceps . . . . .	93
Hemostats, Micro Mosquito . . . . .	31	Instrument Pipe Cleaners, Cannula . . . . .	225	Kerlix Gauze Rolls, Sterile . . . . .	185
Hemostats, Plastic, Sterile . . . . .	173	Instrument Rack, Posilock . . . . .	204	Kerrison Rongeur . . . . .	121
Hemostats, Rankin . . . . .	30	Instrument Rack, Saunders . . . . .	204	Kevorkian Biopsy Forceps . . . . .	140
Hemostats, Rochester-carmalt . . . . .	30,	Instrument Rack, Saunders . . . . .	229	Kevorkian-young Biopsy Forceps . . . . .	140
Hemostats, Rochester-ochsner Delicate Premium . . . . .	27	Instrument Spot Remover Pad . . . . .	225	Keyes Biopsy Punch . . . . .	139
Hemostats, Rochester-ochsner, Mid-Grade . . . . .	27	Instrument Stringer . . . . .	204	Keyes Cutaneous Punch . . . . .	127,130
Hemostats, Rochester-ochsner, OR Grade . . . . .	27	Instrument Stringer, Bunt . . . . .	229	Keyes Finger Ring Cutter . . . . .	130
Hemostats, Rochester-pean Floor-Grade Sterile . . . . .	28,194	Instrument Stringer, E-z Lock . . . . .	204,229	Kick Bucket, Hospital . . . . .	200
Hemostats, Rochester-pean, Delicate, Premium . . . . .	28	Instrument Stringer, Weinstein . . . . .	229	Killian Nasal Speculum . . . . .	124

# ALPHABETICAL INDEX



Kit, Autoclave Cleaning Brush	228	Laparoscopic Suction Irrigation System, 4000	150	Magnifying Mirror, Tip Only	132
Kit, Sklar Splinter Removal	103	Laparoscopic Tapered Grasping Forceps, 4000	144	Major Laceration Tray, Sterile	175
Kit, Sponge, Sterile	185	Laparoscopic Verres Needle, Sklartech 4000	151	Maltz Rasp	108
Kleen Liquid Detergent, Sklar	212	Laparoscopic Wave Grasping Forceps, 4000	145	Manhattan Eye & Ear Suturing Forceps	89
Kleen Liquid, Sklar	214	Laparoscopic X Handle, Sklartech 4000	146	Martini Bone Curette	114
Kleen Low Foam Liquid, Sklar	215	Laparoscopic Xc Carbon Handle, Sklartech 4000	146	Maryland Dissectors Lap Disposable Sterile	155
Kleen Powder Detergent, Sklar	212	Laparoscopic Y Handle, Sklartech 4000	146	Maryland Dissectors, Mini Lap, Sklartech 5000	153
Kleen Powder, Sklar	213	Laparoscopic Yc Carbon Handle, Sklartech 4000	146	Maryland Forceps, Laparoscopic Sklartech 4000	143
Kleinert-kutz Bone Cutting Forceps	119	Large Instrument Cleaning Brushes	228	Mask With Ear Loops, Sterile	184
Knapp Iris Scissors	20,86	Larry Probe	79	Mathieu Needle Holder, T-C, Premium	68
Knife, Atkins Tonsil	129	Laryngeal Mirror, Everclear	132	Mathieu Retractor	73
Knife, Barkan Goniotomy	99	Laryngeal Mirror, Regular	132	Maxi Grasping Forceps, Laparoscopic, 4000	144
Knife, Dean Tonsil	129	Latex Exam Gloves, Sklartouch, Powder-free	166	Mayo Dissecting Scissors Sklarlite XD Premium	4
Knife, Fisher Tonsil	129	Latex Exam Gloves, Sklartouch, Powdered	166	Mayo Dissecting Scissors, Delicate, Premium	4
Knife, Freer Septum	126	Latex Surgical Gloves, Sklartouch	167	Mayo Dissecting Scissors, Floor-Grade Sterile	4,192
Knife, Gill Corneal	99	Lempert Elevator	126	Mayo Dissecting Scissors, Floor-Grade, Econo	4,192
Knife, Joseph	122	Lempert Rongeur	120	Mayo Dissecting Scissors, Mid-Grade	4
Knife, Soft Corn	105	Lens Loop, Lewis	99	Mayo Dissecting Scissors, OR Grade	4
Knowles Bandage Scissors, Floor-Grade, Econo	191,16	Lens Loop, Wilder	99	Mayo Dissecting Scissors, Sklarhone, Premium	64
Knowles Bandage Scissors, Mid-Grade	16	Lester Conjunctival Forceps	46,53	Mayo Scissors, T-C, Sklar Edge, Premium	62
Knowles Bandage Scissors, OR Grade	16	Lewis Lens Loop	99	Mayo Tray	229,200,201
Knowles Bandage Scissors, Sterile Floor-Grade	16,191	Lid Retractor, Desmarres	76	Mayo Tray, Non-perforated	200
Kratz-barraquer Wire Eye Speculum	98	Lifting Handles	202	Mayo Tray, Perforated	200
Labels, Indicator	168	Ligator Set, Mcgivney Hemorrhoidal	158	Mayo Tray, Plastic	201
Labor And Delivery Tray, Sterile	179	Ligator Set, Rudd Clinic Hemorrhoidal	159	Mayo-hegar Needle Holder Sklarlite XD Premium	54
Laborde Tracheal Dilator	133	Ligator, Mcgivney Hemorrhoidal	158	Mayo-hegar Needle Holder, Floor-Grade Sterile	54,195
Lahey Metz Scissors, Floor-Grade, Econo	5,192	Ligator, Rudd Clinic Hemorrhoidal	159	Mayo-hegar Needle Holder, Floor-Grade, Econo	54,195
Lahey Metz Scissors, Mid-Grade	5	Liners, Sklar Glove, Sterile	167	Mayo-hegar Needle Holder, OR Grade	54
Lahey Metz Scissors, Sterile, Floor-Grade	5,192	Liquid Detergent, Sklar Kleen	212	Mayo-hegar Needle Holder, OR Grade	54
Lahey Metz Scissors, Surgi OR	5	Liquid, Kleen, Low Foam, Sklar	215	Mayo-hegar Needle Holder, Sklarlite, Premium	54
Lahey Retractor	76	Liquid, Kleen, Sklar	214	Mayo-hegar Needle Holder, T-C, Premium	66
Lambert Chalazion Forceps	95	Lister Bandage Scissors, Floor-Grade, Econo	13,191	Mayo-noble Dissecting Scissors	18
Lambotte Osteotome	121	Lister Bandage Scissors, Floor-Grade, Sterile	13,191	Mayo-noble-stille Dissecting Scissors	18
Lamina Retractor, Inge	117	Lister Bandage Scissors, Mid-Grade	13	Mayo-stille Scissors, T-C Sklar Edge, Premium	63
Lancaster Eye Speculum	99	Lister Bandage Scissors, OR Grade	13	Mcclure Iris Scissors	85
Laparoscopic Alligator Forceps Sklartech 4000	145	Lister Bandage Scissors, Premium Delicate	13	Mccullough Utility Forceps	92
Laparoscopic Allis Forceps, Sklartech 4000	145	Lister Bandage Scissors, Sklarlite XD Premium	13	Mcgannon Iris Retractor	77
Laparoscopic Atraumatic Forceps, 4000	144,145	Liston Bone Forceps	119	Mcgivney Hemorrhoidal Ligator	158
Laparoscopic Atraumatic Grasping Forceps 4000	144,145	Liston-blau Bone Forceps	108	Mcgivney Hemorrhoidal Ligator Set	158
Laparoscopic Babcock Forceps, Sklartech 4000	144	Littauer Cilia Forceps	91	Mcguire Corneal Scissors	86
Laparoscopic Cannula, Sklartech 4000	148	Littauer Cutting Forceps, Floor-Grade, Econo	109	Mcindoe Bone Cutting Forceps	121
Laparoscopic Claw Forceps, Sklartech 4000	143	Littauer Cutting Forceps, OR Grade	109	Mcperson Micro Iris Suturing Forceps	89
Laparoscopic Clinch Grasping Forceps, 4000	145	Littauer Cutting Forceps, Sklarlite, Premium	109	Mcperson Tying Forceps	89
Laparoscopic Cobra Grasping Forceps, 4000	145	Littauer Stitch Scissors, Mid-Grade	9	Mcreynolds Spatula And Hook	96
Laparoscopic Debakey Forceps, Sklartech 4000	145	Littauer Stitch Scissors, OR Grade	9	Mead Rongeur	118
Laparoscopic Dolphin Forceps, Sklartech 4000	143	Littauer Stitch Scissors, Premium Delicate	9	Measure, Tape, Sterile	184
Laparoscopic Electrosurgical Cable, 4000	149	Littauer Stitch Scissors, Sklarlite XD	9	Measures, Graduated	199
Laparoscopic Endo Clinch Grasper Disp Sterile	155	Littauer Suture Scissors, Floor-Grade Sterile	191,9	Medical Surface Cleaning Brushes	228
Laparoscopic Fenestrated Forceps 4000	143,144	Littauer Suture Scissors, Floor-Grade, Econo	191,9	Medicine Cup	198,185
Laparoscopic Graduated Probe, Sklartech 4000	151	Littauer Suture Scissors, Plastic, Sterile	173	Medicine Cup, Sterile	185
Laparoscopic Grasping Forceps, Sklartech 4000	144,145	Loading Cone	158	Meller Retractor	71
Laparoscopic Hasson Trocar, Sklartech 4000	148	Locke Elevator	105	Meriam Pliers	101
Laparoscopic Hook Scissors, Sklartech 4000	142	Locking Collar, Replacement Laparoscopic 4000	146	Mesh Bottom Sterilization Tray	203
Laparoscopic Injection Needle, Sklartech 4000	151	Loop, Billeau Ear	128	Metz Scissors Laparoscopic Disposable Sterile	155
Laparoscopic Insulated Cannula Sklartech 4000	146	Loop, Lewis Lens	99	Metz-Lahey Scissors, Premium Sklarlite XD	5
Laparoscopic Insulated Electrodes, 4000	149	Loop, Wilder Lens	99	Metz-Lahey Scissors, T-C, Sklar Edge, Premium	62
Laparoscopic Kelly Forceps, Sklartech 4000	143	Loops, Inoculation, Disposable	189	Metzenbaum Dissecting Scissors, Floor-Grade	6,192
Laparoscopic Maryland Dissectors Disp Sterile	155	Lorna Edna Towel Clamp, Floor-Grade, Sterile	35,196	Metzenbaum Dissecting Scissors, Mid-Grade	6
Laparoscopic Maryland Forceps, Sklartech 4000	143	Lorna Edna Towel Clamp, Mid-Grade	35	Metzenbaum Dissecting Scissors, OR Grade	6
Laparoscopic Maxi Grasping Forceps, 4000	144	Lorna Edna Towel Clamp, OR Grade	35	Metzenbaum Dissecting Scissors, Sterile Econo	6,192
Laparoscopic Metz Scissors Disposable Sterile	155	Lorna Edna Towel Clamps, Floor-Grade, Econo	196,35	Metzenbaum Dissecting Scissors, Surgi OR	6
Laparoscopic Metzenbaum Scis, Sklartech 4000	142	Low Foam Liquid, Kleen, Sklar	215	Metzenbaum Lahey Scissors, Econo, Floor-Grade	5
Laparoscopic Micro Scissors, Sklartech 4000	142	Lowman Clamp	114	Metzenbaum Lahey Scissors, Mid-Grade	5
Laparoscopic Mixter Forceps, Sklartech 4000	143	Lubricant, Instru-guard, Sklar	220	Metzenbaum Lahey Scissors, OR Grade	5
Laparoscopic Needle Holder, Sklartech 4000	147	Lucae Bayonet Forceps	51	Metzenbaum Lahey Scissors, Premium Delicate	5
Laparoscopic Peritoneal Scis, Sklartech 4000	142	Lucae Bayonet Forceps, Floor-Grade, Econo	51	Metzenbaum Lahey Scissors, Sterile, Econo	5
Laparoscopic Pointed Grasping Forceps, 4000	144	Luethy Beck Needle Holder, T-C, Premium	68	Metzenbaum Scis, Laparoscopic, Sklartech 4000	142
Laparoscopic Probe Excision Punch, 4000	143	Magill Catheter Forceps, Floor-Grade, Econo	31	Metzenbaum Scissors, Floor-Grade, Sterile	6,192
Laparoscopic Replacement Locking Collar, 4000	146	Magill Catheter Forceps, Floor-Grade, Sterile	31	Metzenbaum Scissors, Mini Lap, Sklartech 5000	152
Laparoscopic S-retractor, Sklartech 4000	148	Magill Catheter Forceps, Mid-Grade	31	Metzenbaum Scissors, Premium Delicate	6
Laparoscopic Suction Control Valves, 4000	149	Magill Catheter Forceps, OR Grade	31	Metzenbaum Scissors, Premium Sklarlite XD	6



Metzenbaum Scissors, Sklarcut, Premium	21	Mini Lap Electrosurgical Cable Sklartech 5000	154	Nasal Speculum, Vienna, OR Grade	124
Metzenbaum Scissors, Sklarhone, Premium	64	Mini Lap Endoscope, Sklartech 5000	154	Needle Holder Baumgartner Floor-Grade Sterile	59,195
Metzenbaum Scissors, Sklarlite, Premium	21	Mini Lap Grasping Forceps, Sklartech 5000	153	Needle Holder, Baumgartner, Floor-Grade Econo	59,195
Metzenbaum Scissors, T-C, Sklar Edge, Premium	62	Mini Lap Hook Scissors, Sklartech 5000	152	Needle Holder, Baumgartner, Mid-Grade	59
Metzenbaum-lahey Scissors, Sklarhone, Premium	64	Mini Lap Kelly Forceps, Sklartech 5000	153	Needle Holder, Baumgartner, OR Grade	59
Metzenbaum-lahey Scissors, Sklarlite, Premium	21	Mini Lap Maryland Dissectors, Sklartech 5000	153	Needle Holder, Baumgartner, Sklarlite Premium	59
Meyerding Skin Hook And Retractor	75	Mini Lap Metzenbaum Scissors, Sklartech 5000	152	Needle Holder, Baumgartner, T-C, Premium	65
Meyhoefer Chalazion Curette	94,132	Mini Lap Punch, Sklartech 5000	152	Needle Holder, Bozeman-heaney, T-C, Premium	68
Micro Adson Dressing Forceps	42	Mini Lap Spoon Forceps, Sklartech 5000	153	Needle Holder, Brown	61
Micro Adson Tissue Forceps	42	Mini Lap Trocar Set, Sklartech 5000	154	Needle Holder, Castroviejo, OR Grade	57
Micro Forceps	82	Mini Lap Xc Carbon Handle, Sklartech 5000	154	Needle Holder, Castroviejo, T-C, Premium	68,84
Micro Forceps, Rhoton	93	Mini Lap Yc Carbon Handle, Sklartech 5000	154	Needle Holder, Collier	61
Micro Mosquito Forceps	31	Mini Tischler Biopsy Forceps	140	Needle Holder, Crile-murray, OR Grade	58
Micro Needle Holder	83	Minor Dressing Tray, Sterile	176	Needle Holder, Crile-murray, T-C, Premium	65
Micro Scissors	80,81	Minor Laceration Tray, Sterile	175	Needle Holder, Crile-wood Floor-Grade Sterile	195,58
Micro Scissors, Laparoscopic, Sklartech 4000	142	Minor Prep Tray, Sterile	174	Needle Holder, Crile-wood, Floor-Grade, Econo	58,195
Micro Surgery Needle Holder	84	Minor Surgery Tray, Sterile	175	Needle Holder, Crile-wood, Mid-Grade	58
Micro Surgery Scissors	85	Mirror, Laryngeal, Everclear	132	Needle Holder, Crile-wood, OR Grade	58
Micro Suture Forceps, Rhoton	93	Mirror, Laryngeal, Regular	132	Needle Holder, Crile-wood, Sklarlite, Premium	58
Micro Suture Tying Forceps	53	Mirror, Magnifying, Tip Only	132	Needle Holder, Crile-wood, T-C, Premium	65
Micro Tray, Double Deck	201	Mirror, Plastic Dental, Sterile	184	Needle Holder, Derf, Floor-Grade, Econo	55,195
Microcentrifuge Tubes, Disposable	188	Mixing/solution Bowl	199	Needle Holder, Derf, Floor-Grade, Sterile	55,195
Mid-Grade Adson Dressing Forceps	40	Mixer Forceps	30	Needle Holder, Derf, Mid-Grade	55
Mid-Grade Adson Tissue Forceps	41	Mixer Forceps, Laparoscopic, Sklartech 4000	143	Needle Holder, Derf, OR Grade	55
Mid-Grade Adson-brown Tissue Forceps	43	Mosquito Forceps Hartmann Floor-Grade Sterile	26	Needle Holder, Derf, Sklarlite XD, Premium	55
Mid-Grade Allis Tissue Forceps	29	Mosquito Forceps, Debakey Halsted	33	Needle Holder, Derf, Sklarlite, Premium	55
Mid-Grade Babcock Forceps	32	Mosquito Forceps, Halsted Floor-Grade Sterile	23,194	Needle Holder, Derf, T-C, Premium	65
Mid-Grade Backhaus Towel Clamp	34	Mosquito Forceps, Halsted, Delicate, Premium	23	Needle Holder, Finochietto, T-C, Premium	67
Mid-Grade Baumgartner Needle Holder	59	Mosquito Forceps, Halsted, Floor-Grade, Econo	23,194	Needle Holder, Halsey, Floor-Grade, Econo	60,195
Mid-Grade Bozeman Forceps	36	Mosquito Forceps, Halsted, Mid-Grade	23	Needle Holder, Halsey, Floor-Grade, Sterile	60,195
Mid-Grade Crile Hemostatic Forceps	24	Mosquito Forceps, Halsted, OR Grade	23	Needle Holder, Halsey, Mid-Grade	60
Mid-Grade Derf Needle Holder	55	Mosquito Forceps, Halsted, Sklarlite XD	23	Needle Holder, Halsey, OR Grade	60
Mid-Grade Dressing Forceps	38	Mosquito Forceps, Hartmann, Delicate, Premium	26	Needle Holder, Halsey, Sklarlite XD, Premium	60
Mid-Grade Fine Point Splinter Forceps	44	Mosquito Forceps, Hartmann, Floor-Grade Econo	26,194	Needle Holder, Halsey, Sklarlite, Premium	60
Mid-Grade Foerster Sponge Forceps	34	Mosquito Forceps, Hartmann, Mid-Grade	26	Needle Holder, Halsey, T-C, Premium	65
Mid-Grade Graves Vaginal Speculum	135	Mosquito Forceps, Hartmann, OR Grade	26	Needle Holder, Heaney, T-C, Premium	67
Mid-Grade Halsey Needle Holder	60	Mosquito Forceps, Hartmann, Sklarlite Premium	26	Needle Holder, Jacobson, T-C, Premium	68
Mid-Grade Halsted Mosquito Forceps	23	Mosquito Forceps, Hartmann, Sterile, Econo	26,194	Needle Holder, Laparoscopic, Sklartech 4000	147
Mid-Grade Hartmann Mosquito Forceps	26	Mosquito Forceps, Jacobson	32	Needle Holder, Luethy Beck, T-C, Premium	68
Mid-Grade Iris Scissors	7	Mosquito Forceps, Jacobson, Extra Delicate	33	Needle Holder, Mathieu, T-C, Premium	68
Mid-Grade Kelly Hemostatic Forceps	25	Mosquito Forceps, Micro	31	Needle Holder, Mayo-hegar Floor-Grade Sterile	54,195
Mid-Grade Knowles Bandage Scissors	16	Muldoon Lachrymal Dilator	88	Needle Holder, Mayo-hegar, Floor-Grade, Econo	54,195
Mid-Grade Lister Bandage Scissors	13	Multi-cut Utility Scissor Sterile Floor-Grade	16	Needle Holder, Mayo-hegar, Mid-Grade	54
Mid-Grade Littauer Stitch Scissors	9	Multi-cut Utility Scissors, Floor-Grade Econo	16	Needle Holder, Mayo-hegar, OR Grade	54
Mid-Grade Lorna Edna Towel Clamp	35	Multi-cut Utility Scissors, Mid-Grade	16	Needle Holder, Mayo-hegar, Sklarlite, Premium	54
Mid-Grade Magill Catheter Forceps	31	Multi-cut Utility Scissors, OR Grade	16	Needle Holder, Mayo-hegar, T-C, Premium	66
Mid-Grade Mayo Dissecting Scissors	4	Muscle Forceps, Prince	78	Needle Holder, Micro	83
Mid-Grade Mayo-hegar Needle Holder	54	Mycotic Nail Nipper	111	Needle Holder, Micro Surgery	84
Mid-Grade Metzenbaum Dissecting Scissors	6	Nail And Bone File	105	Needle Holder, Neivert, T-C, Premium	68
Mid-Grade Metzenbaum Lahey Scissors	5	Nail And Cuticle Scissors	107	Needle Holder, New Orleans	61
Mid-Grade Multi-cut Utility Scissors	16	Nail Cutter, Baker Ingrown	106	Needle Holder, New Orleans, T-C, Premium	66
Mid-Grade Operating Scissors	2,3	Nail Drill, Sklar	130	Needle Holder, Olsen-hegar, Floor-Grade Econo	57
Mid-Grade Pederson Vaginal Speculum	136	Nail Nipper, Double Spring	111	Needle Holder, Olsen-hegar, OR Grade	57
Mid-Grade Rochester-ochsner Forceps	27	Nail Nipper, Floor-Grade, Econo	110	Needle Holder, Olsen-hegar, Sklarlite Premium	57
Mid-Grade Rochester-pean Forceps	28	Nail Nipper, Mycotic	111	Needle Holder, Olsen-hegar, T-C, Premium	66
Mid-Grade Schroeder Tenaculum Forceps	36	Nail Nipper, OR Grade	110	Needle Holder, Ryder, T-C, Premium	66
Mid-Grade Spencer Stitch Scissors	11	Nail Pulling Forceps, Platypus	112	Needle Holder, Sarot	61
Mid-Grade Strabismus Scissors	8	Nail Shaver, Ingrown	106	Needle Holder, Sarot, T-C, Premium	67
Mid-Grade Tissue Forceps	39	Nail Splitter	105,110	Needle Holder, Stratte, T-C, Premium	67
Mid-Grade Tube Occluding Clamp	37	Nail Splitting Forceps, Floor-Grade, Econo	107	Needle Holder, Webster, Floor-Grade, Econo	195,56
Mid-Grade Webster Needle Holder	56	Nail Splitting Forceps, OR Grade	107	Needle Holder, Webster, Floor-Grade, Sterile	56,195
Mid-Grade Wire Cutting Scissors	14	Nail Splitting Scissors	107	Needle Holder, Webster, Mid-Grade	56
Miller Dissecting Scissors	20	Nail Splitting Scissors, Floor-Grade, Econo	107	Needle Holder, Webster, OR Grade	56
Miller Groovelok	101	Nail Tray, Sterile	176	Needle Holder, Webster, Sklarlite XD, Premium	56
Miller-senn Retractor	73	Nasal Chisel, Cottle	121	Needle Holder, Webster, Sklarlite, Premium	56
Mini Blumenthal Rongeur	120	Nasal Forceps, Jansen Bayonet	125	Needle Holder, Webster, T-C, Premium	65
Mini Dilator/os Finder Set	139	Nasal Speculum, Disposable	124	Needle, Injection Laparoscopic Sklartech 4000	151
Mini Lap Atraumatic Dissectors Sklartech 5000	153	Nasal Speculum, Killian	124	Needles, Verres, Laparoscopic, Sklartech 4000	151
Mini Lap Cobra Grasping Forcep Sklartech 5000	153	Nasal Speculum, Plastic	124,190	Needles, Foreign Body	97
Mini Lap Duck Nose Forceps, Sklartech 5000	153	Nasal Speculum, Plastic, Disposable	190	Neivert Needle Holder, T-C, Premium	68
Mini Lap Electrodes, Sklartech 5000	154	Nasal Speculum, Vienna, Floor-Grade, Econo	124	Nelson Trocar	133

# ALPHABETICAL INDEX



Neurological Hammer, Buck, Floor-Grade, Econo	156	Percussion Hammer, Taylor, OR Grade	156	Premium Delicate Crile Hemostatic Forceps	24
Neurological Hammer, Buck, OR Grade	156	Perforated Instrument Tray	201	Premium Delicate Crushing Brain Forceps	49
Neurological Hammer, Rabiner	156	Perforated Mayo Tray	200	Premium Delicate Dressing Forceps	38
Neurological Pinwheel, Wartenberg Floor-Grade	156	Perforated Solution Basin	199	Premium Delicate Halsted Mosquito Forceps	23
Neurological Pinwheel, Wartenberg, OR Grade	156	Peritoneal Scis, Laparoscopic, Sklartech 4000	142	Premium Delicate Hartmann Mosquito Forceps	26
New Orleans Needle Holder	61	Perry Pliers	101	Premium Delicate Iris Scissors	7
New Orleans Needle Holder, T-C, Premium	66	Petri Dishes, Disposable	187	Premium Delicate Kelly Hemostatic Forceps	25
Nipper, Cuticle	112	Pick, Vanguard Splinter	103	Premium Delicate Lister Bandage Scissors	13
Nipper, Mycotic Nail	111	Pins, Safety, Sterile	184	Premium Delicate Littauer Stitch Scissors	9
Nipper, Nail, Double Spring	111	Pinwheel, Sklar Disposable	156	Premium Delicate Metzenbaum Lahey Scissors	5
Nipper, Nail, Floor-Grade, Econo	110	Pinwheel, Wartenberg Neurological Floor-Grade	156	Premium Delicate Metzenbaum Scissors	6
Nipper, Nail, OR Grade	110	Pinwheel, Wartenberg Neurological, OR Grade	156	Premium Delicate Rochester-ochsner Forceps	27
Nipper, Tissue, Floor-Grade, Econo	112	Pipe Cleaners, Cannula Instrument	225	Premium Delicate Rochester-pearl Forceps	28
Nipper, Tissue, OR Grade	112	Pipette Tips, Disposable	187	Premium Delicate Spencer Stitch Scissors	11
Nipper, Tissue, Sklarlite, Premium	112	Pipette Trays	187	Premium Delicate Stevens Tenotomy Scissors	12
Nitrile Exam Gloves, Sklartouch Powdered	166	Pipettes, Transfer, Disposable	189	Premium Delicate Strabismus Scissors	8
Nitrile Exam Gloves, Sklartouch, Powder-free	166	Pitcher/beaker	198	Premium Delicate Suture Scissors	10
Nitrile Surgical Gloves, Sklartouch	167	Plain Splinter Forceps With Magnifier	44,103	Premium Delicate Tissue Forceps	39
Non-perforated Instrument Tray	201	Plain Wire Speculum	98	Premium Litegrip Adson Dressing Forcep	42
Non-perforated Mayo Tray	200	Plaster Shears, Esmarch	15	Premium Litegrip Adson Tissue Forceps	42
Non-pinch College Pliers	101	Plaster Spreader, Beeson	113	Premium Litegrip Adson-brown Tissue Forceps	42
Non-vented Instrument Tip Protectors	230	Plaster Spreader, Hennig	113	Premium Litegrip Bishop-harmon Forceps	47
Nose Clip, Plastic, Sterile	173	Plaster Spreader, Walton	113	Premium Litegrip Eye Dressing Forceps	45
Noyes Alligator Forceps	125	Plastic Dental Mirror, Sterile	184	Premium Litegrip Eye Tissue Forceps	45
Nugent Utility Forceps	92	Plastic Dressing Forceps, Sterile	173	Premium Mayo Dissecting Scissors, Delicate	4
Nurses Bandage Scissors	15	Plastic Handle Cleaning Brushes	224	Premium Operating Scissors, Delicate	2,3
Nylon Instrument Cleaning Brushes	204	Plastic Hemostats, Sterile	173	Premium Sklar Edge T-C Dissecting Scissors	63
O Rings	158	Plastic Littauer Suture Scissors, Sterile	173	Premium Sklar Edge T-C Iris Scissors	62
O'brien Stitch Scissors	18	Plastic Mayo Tray	201	Premium Sklar Edge T-C Mayo Scissors	62
O'brien-elschnig Forceps	90	Plastic Nasal Speculum, Disposable	190	Premium Sklar Edge T-C Mayo-stille Scissors	63
O'Conner Hook	100	Plastic Nose Clip, Sterile	173	Premium Sklar Edge T-C Metz-lahey Scissors	62
Occluding Clamp, Tube, Floor-Grade, Econo	37,197	Plastic Ruler, Sterile	184	Premium Sklar Edge T-C Metzenbaum Scissors	62
Occluding Clamp, Tube, Floor-Grade, Sterile	37,197	Plastic Sponge Forceps, Sterile	173	Premium Sklar Edge T-C Operating Scissors	62
Occluding Clamp, Tube, Mid-Grade	37	Plastic Surgery Retractor	74	Premium Sklar Edge T-C Strabismus Scissors	63
Occluding Clamp, Tube, OR Grade	37	Plastic Surgery Scissors	86	Premium Sklar Edge T-C Wire Cutting Scissors	63
Ochsner Trocar	133	Plastic Surgical Prep Razor, Sterile	173	Premium Sklarcut Iris Scissors	21
Ointment Jar	198	Plastic Towel Clamp, Sterile	173	Premium Sklarcut Metzenbaum Scissors	21
Olsen-hegar Needle Holder, Floor-Grade, Econo	57	Plastic Tubing Clamp, Sterile	173	Premium Sklarcut Ragnell Dissecting Scissors	22
Olsen-hegar Needle Holder, OR Grade	57	Plastic Utility Forceps, Sterile	173	Premium Sklarcut Scissors, Metzenbaum Lahey	21
Olsen-hegar Needle Holder, Sklarlite, Premium	57	Plastic Vaginal Speculum, Disposable	135	Premium Sklarcut Wagner Scissors	22
Olsen-hegar Needle Holder, T-C, Premium	66	Plastic Vaginal Speculum, Sterile, Disposable	135	Premium Sklarhone Iris Scissors	64
One-step Detergent, Instru-guard, Sklar	212	Plates, Culture, Disposable	189	Premium Sklarhone Jameson Scissors	64
Operating Scissors, Delicate, Premium	2,3	Platypus Nail Pulling Forceps	112	Premium Sklarhone Mayo Dissecting Scissors	64
Operating Scissors, Floor-Grade, Econo	2,3,192	Pliers, Baede Crown	102	Premium Sklarhone Metzenbaum Scissors	64
Operating Scissors, Mid-Grade	2,3	Pliers, Clasp Adjusting	102	Premium Sklarhone Metzenbaum-lahey Scissors	64
Operating Scissors, OR Grade	2,3	Pliers, College	101	Premium Sklarhone Operating Scissors	64
Operating Scissors, Sklarhone, Premium	64	Pliers, Gordon	102	Premium Sklarlite Adson-brown Tissue Forceps	43
Operating Scissors, Sklarlite XD, Premium	2,3	Pliers, Goslee Contouring	102	Premium Sklarlite Allis Tissue Forceps	29
Operating Scissors, Sterile, Floor-Grade	2,3,192	Pliers, How	102	Premium Sklarlite Baumgartner Needle Holder	59
Operating Scissors, T-C, Sklar Edge, Premium	62	Pliers, Meriam	101	Premium Sklarlite Crile-wood Needle Holder	58
OR Basin, Sterile	185	Pliers, Non-pinch College	101	Premium Sklarlite Derf Needle Holder	55
OR Towels, Sterile	185	Pliers, Perry	101	Premium Sklarlite Halsey Needle Holder	60
OS Dilator Set, Teflon	139	Pliers, Self-locking College	101	Premium Sklarlite Littauer Cutting Forceps	109
OS Finder/mini Dilator Set	139	Pliers, Wire Bending	102	Premium Sklarlite Mayo-hegar Needle Holder	54
Osteotome, Army Pattern	115	Pointed Grasping Forceps, Laparoscopic, 4000	144	Premium Sklarlite Nail Splitting Forceps	107
Osteotome, Lambotte	121	Polish, Sklar	219	Premium Sklarlite Olsen-hegar Needle Holder	57
Osteotome, Sheehan	116	Pomeroy Ear Syringe, Floor-Grade, Econo	127	Premium Sklarlite Rochester-ochsner Forceps	27
Osteotome, Smith Peterson	115	Pomeroy Ear Syringe, Stainless Steel	127	Premium Sklarlite Rochester-pearl Forceps	28
Oval Biopsy Forceps	141	Poole Suction Tube	134	Premium Sklarlite Sklarcut Iris Scissors	21
P And A Forceps	119	Posilock Instrument Rack	204	Premium Sklarlite Sklarcut Metz-lahey Scissor	21
Packer & Excavator	104	Potts-smith Dressing Forceps, T-C, Premium	69	Premium Sklarlite Sklarcut Ragnell Scissors	22
Packer & Probe	106	Potts-smith Forceps	50	Premium Sklarlite Sklarcut Wagner Scissors	22
Packer & Spatula	106	Potts-smith Vascular Scissors	84	Premium Sklarlite Stevens Tenotomy Scissors	12
Pad, Instrument Spot Remover	225	Pouches, Sterile	168	Premium Sklarlite Tissue Nipper	112
Paul Retractor	76	Powder Detergent, Sklar Kleen	212	Premium Sklarlite Webster Needle Holder	56
Pederson Vaginal Speculum Floor-Grade Sterile	136	Powder, Kleen, Sklar	213	Premium Sklarlite XD Adson Dressing Forceps	40
Pederson Vaginal Speculum, Floor-Grade, Econo	136	Pratt Uterine Dilator	137	Premium Sklarlite XD Adson Tissue Forceps	41
Pederson Vaginal Speculum, Mid-Grade	136	Premium Delicate Adson Dressing Forceps	40	Premium Sklarlite XD Crile Hemostatic Forceps	24
Pederson Vaginal Speculum, OR Grade	136	Premium Delicate Adson Tissue Forceps	41	Premium Sklarlite XD Crile-wood Needle Holder	58
Pen, Steam Indicator	168	Premium Delicate Adson-brown Tissue Forceps	43	Premium Sklarlite XD Derf Needle Holder	55
Percussion Hammer, Taylor, Floor-Grade, Econo	156	Premium Delicate Allis Tissue Forceps	29	Premium Sklarlite XD Dressing Forceps	38

Premium Sklarlite XD Halsey Needle Holder	60	Punch, Mini Lap, Sklartech 5000	152	Ring Cutter, Keyes Finger	130
Premium Sklarlite XD Halsted Mosquito Forceps	23	Punch, Probe Excision, Laparoscopic, 4000	143	Ring Cutter, Sklar Finger	130
Premium Sklarlite XD Hartmann Mosquito Forcep	26	Punch, Rubber Dam	102	Rings, O	158
Premium Sklarlite XD Iris Scissors	7	Rabiner Neurological Hammer	156	Rochester-carmalt Forceps	30
Premium Sklarlite XD Kelly Hemostatic Forceps	25	Rack, Brush Drying	226	Rochester-ochsner Forceps Floor-Grade Sterile	27,197
Premium Sklarlite XD Lister Bandage Scissors	13	Rack, Instrument, Saunders	229	Rochester-ochsner Forceps, Delicate, Premium	27
Premium Sklarlite XD Littauer Stitch Scissors	9	Rack, Posilock Instrument	204	Rochester-ochsner Forceps, Floor-Grade, Econo	27,197
Premium Sklarlite XD Mayo Dissecting Scissors	4	Rack, Saunders Instrument	204	Rochester-ochsner Forceps, Mid-Grade	27
Premium Sklarlite XD Mayo-hegar Needle Holder	54	Rack, Weinstein Sterilization	204	Rochester-ochsner Forceps, OR Grade	27
Premium Sklarlite XD Metz-lahey Scissors	5	Racks, Test Tube	186	Rochester-ochsner Forceps, Sklarlite, Premium	27
Premium Sklarlite XD Metzenbaum Scissors	6	Ragnell Dissecting Scissors	19	Rochester-pean Forceps, Delicate, Premium	28
Premium Sklarlite XD Operating Scissors	2,3	Ragnell Dissecting Scissors, Sklarcut Premium	22	Rochester-pean Forceps, Floor-Grade, Econo	28,194
Premium Sklarlite XD Spencer Stitch Scissors	11	Ragnell Retractor	74	Rochester-pean Forceps, Floor-Grade, Sterile	28,194
Premium Sklarlite XD Stevens Tenotomy Scissor	12	Ragnell Scissors, Sklarlite Sklarcut Premium	22	Rochester-pean Forceps, Mid-Grade	28
Premium Sklarlite XD Strabismus Scissors	8	Rankin Hemostatic Forceps	30	Rochester-pean Forceps, OR Grade	28
Premium Sklarlite XD Suture Scissors	10	Rasp And File, Fomon	108	Rochester-pean Forceps, Sklarlite, Premium	28
Premium Sklarlite XD Tissue Forceps	39	Rasp, Cottle	108	Roeder Towel Clamp	35
Premium Sklarlite XD Webster Needle Holder	56	Rasp, Joseph	108	Roll Tape, ID	231
Premium T-C Adson Dressing Forceps	70	Rasp, Maltz	108	Rolls, Kerlix Gauze, Sterile	185
Premium T-C Adson Tissue Forceps	70	Rayon Swabs, Sterile	185	Rongeur, Adson	117
Premium T-C Adson-brown Forceps	70	Razor, Surgical Prep, Plastic, Sterile	173	Rongeur, Bane	117
Premium T-C Allis Forceps	69	Rectal Speculum, Ives	158	Rongeur, Beyer	118
Premium T-C Babcock Forceps	69	Remover, Blade	171	Rongeur, Blumenthal	118
Premium T-C Baumgartner Needle Holder	65	Replacement Locking Collar, Laparoscopic 4000	146	Rongeur, Cleveland	120
Premium T-C Bozeman-heaney Needle Holder	68	Retractor, Alm, Floor-Grade, Econo	71	Rongeur, Friedman Bone	118
Premium T-C Castroviejo Needle Holder	68,84	Retractor, Alm, OR Grade	71	Rongeur, Hartmann	117
Premium T-C Crile-murray Needle Holder	65	Retractor, Brewster	76	Rongeur, Kerrison	121
Premium T-C Crile-wood Needle Holder	65	Retractor, Cheek	101	Rongeur, Lempert	120
Premium T-C Debaque Atraumatic Forceps	69	Retractor, Crile	74	Rongeur, Mead	118
Premium T-C Derf Needle Holder	65	Retractor, Deaver	76	Rongeur, Mini Blumenthal	120
Premium T-C Dressing Forceps	70	Retractor, Desmarres Lid	76	Rongeur, Ruskin	120
Premium T-C Finochietto Needle Holder	67	Retractor, Farabeuf	74	Rongeur, Zaufel-jansen	120
Premium T-C Halsey Needle Holder	65	Retractor, Fomon	77	Rowland Bone Forceps	120
Premium T-C Heaney Needle Holder	67	Retractor, Gelpi, Floor-Grade, Econo	73	Rubber Bands, Sterile	184
Premium T-C Jacobson Needle Holder	68	Retractor, Gelpi, OR Grade	73	Rubber Dam Forceps	102
Premium T-C Luethy Beck Needle Holder	68	Retractor, Goldstein	72,97	Rubber Dam Punch	102
Premium T-C Mathieu Needle Holder	68	Retractor, Holzheimer X-action	72	Rudd Clinic Hemorrhoidal Ligator	159
Premium T-C Mayo-hegar Needle Holder	66	Retractor, Inge Lamina	117	Rudd Clinic Hemorrhoidal Ligator Set	159
Premium T-C Neivert Needle Holder	68	Retractor, Jansen	73	Ruedemann Lachrymal Dilator	88
Premium T-C New Orleans Needle Holder	66	Retractor, Lahey	76	Ruler, Plastic, Sterile	184
Premium T-C Olsen-hegar Needle Holder	66	Retractor, Mathieu	73	Ruler, Steel	78
Premium T-C Potts-smith Dressing Forceps	69	Retractor, Mcgannon Iris	77	Ruskin Rongeur	120
Premium T-C Ryder Needle Holder	66	Retractor, Meller	71	Ruskin-liston Bone Cutting Forceps	119
Premium T-C Sarot Needle Holder	67	Retractor, Meyerding	75	Russian Tissue Forceps	50
Premium T-C Stratte Needle Holder	67	Retractor, Miller-senn	73	Ryder Needle Holder, T-C, Premium	66
Premium T-C Webster Needle Holder	65	Retractor, Paul	76	S-retractor, Laparoscopic, Sklartech 4000	148
Prep Sticks, Applicator, Sterile	184	Retractor, Plastic Surgery	74	Safety Pins, Sterile	184
Prince Muscle Forceps	78,90	Retractor, Ragnell	74	Sample Cups, Disposable	188
Probe	79	Retractor, S, Laparoscopic, Sklartech 4000	148	Sanitizer, Sklar Fresh	223
Probe & Excavator, Floor-Grade, Econo	104	Retractor, Self-retaining, Delicate	97	Sanitizing Gel, Sklar	223
Probe & Excavator, OR Grade	104	Retractor, Senn, Floor-Grade, Econo	73	Sarot Needle Holder	61
Probe & Packer	106	Retractor, Senn, OR Grade	73	Sarot Needle Holder, T-C, Premium	67
Probe & Spatula	104	Retractor, Tracheal	74	Sauer Eye Speculum	98
Probe Excision Punch, Lap, Sklartech 4000	143	Retractor, Us Army Pattern	74	Saunders Instrument Rack	204,229
Probe With Eye	79	Retractor, Volkman	72	Scalpel Handle, Floor-Grade, Econo	169
Probe, Barr Fistula	79	Retractor, Weitlaner, Floor-Grade, Econo	71	Scalpel Handle, OR Grade	169,170
Probe, Double Ended	79	Retractor, Weitlaner, OR Grade	71	Scalpels, Disposable, Sterile	172
Probe, Esmarch Tin Bullet	79	Retractor, Wire Retaining	72	Scalpels, Stainless Steel, Disposable Sterile	190
Probe, Graduated, Laparoscopic Sklartech 4000	151	Retractor, Zalkind Ribbon	76	Schamberg Comedome Extractor	131
Probe, Larry	79	Retrieving Handles	202	Schmidt Forceps	30
Probe, Sklar Malleable	79	Reynolds Scissors	20	Schroeder Tenaculum Forceps Floor-Grade Econo	36,197
Probe, Spear Point	79	Rhoton Micro Forceps	93	Schroeder Tenaculum Forceps, Mid-Grade	36
Probe/dilator, Bowman Lachrymal	88	Rhoton Micro Suture Forceps	93	Schroeder Tenaculum Forceps, OR Grade	36
Probe/dilator, Williams Lachrymal	88	Rhytidectomy Scissors	19	Schroeder Tenaculum, Floor-Grade, Sterile	36,197
Protectors, Instrument Tip, Non-vented	230	Ribbon Iris Scissors	17	Scissor Multi-cut Utility Sterile Floor-Grade	16
Protectors, Instrument Tip, Vented	230	Ribbon Retractor, Zalkind	76	Scissors Mayo Dissecting Sklarlite XD Premium	4
Ptosis Forceps, Berke	95	Ribbon Stevens Tenotomy Scissors	17	Scissors Metz Laparoscopic Disposable Sterile	155
Punch, Dermal Biopsy, Disposable	160	Ribbon Stitch Scissors	17,10	Scissors, Aebli Corneal	86
Punch, Dermal Biopsy, Disposable, Sterile	190,160	Ribbon Strabismus Scissors	17	Scissors, Bonn	86
Punch, Keyes Biopsy	139	Ribbon Utility Scissors	17	Scissors, Brophy Sullivan	20
Punch, Keyes Cutaneous	127,130	Ring Curette, Cone	113	Scissors, Castroviejo Corneal	85

# ALPHABETICAL INDEX



Scissors, Crown & Collar Cutting	14	Scissors, Metzenbaum, Premium Sklarlite XD	6	Scissors, Wire Cutting, Mid-Grade, Surgi OR	14
Scissors, Cuticle And Nail	107	Scissors, Metzenbaum, Sklarcut, Premium	21	Scissors, Wire Cutting, OR Grade	14
Scissors, Deaver, Delicate	19	Scissors, Metzenbaum, Sklarhone, Premium	64	Scissors, Wire Cutting, Sterile, Floor-Grade	14,191
Scissors, Dissecting, T-C Sklar Edge, Premium	63	Scissors, Metzenbaum, Sklarlite, Premium	21	Scleral Hook, Wiener	100
Scissors, Doyen	18	Scissors, Metzenbaum, T-C Sklar Edge, Premium	62	Seizing Forceps, Young Tongue	129
Scissors, Goldman-fox	20	Scissors, Metzenbaum-lahey, Sklarhone Premium	64	Self-locking College Pliers	101
Scissors, Gradle	86	Scissors, Metzenbaum-lahey, Sklarlite Premium	21	Self-retaining Retractor, Delicate	97
Scissors, Hercules Utility	15	Scissors, Micro	80,81	Semkin Dressing Forceps	50
Scissors, Hook, Laparoscopic, Sklartech 4000	142	Scissors, Micro Surgery	85	Semkin Tissue Forceps	50
Scissors, Hook, Mini Lap, Sklartech 5000	152	Scissors, Micro, Laparoscopic, Sklartech 4000	142	Senn Retractor, Floor-Grade, Econo	73
Scissors, Iris Knapp	20	Scissors, Miller Dissecting	20	Senn Retractor, OR Grade	73
Scissors, Iris Micro-miniature	87	Scissors, Multi-cut Utility Floor-Grade Econo	16	Septum Elevator, Freer	126
Scissors, Iris, Floor-Grade, Econo	7,192	Scissors, Multi-cut Utility, Mid-Grade	16	Septum Elevator, Hajek-ballenger	126
Scissors, Iris, Mid-Grade	7	Scissors, Multi-cut Utility, OR Grade	16	Septum Knife, Freer	126
Scissors, Iris, OR Grade	7	Scissors, Nail Splitting	107	Set, MCGivney Hemorrhoidal Ligator	158
Scissors, Iris, Premium Delicate	7	Scissors, Nail Splitting, Floor-Grade, Econo	107	Set, Os Dilator, Teflon	139
Scissors, Iris, Sklarcut, Premium	21	Scissors, Nurses Bandage	15	Set, Rudd Clinic Hemorrhoidal Ligator	159
Scissors, Iris, Sklarhone, Premium	64	Scissors, O'Brien Stitch	18	Set, Sklar Mini Dilator/os Finder	139
Scissors, Iris, Sklarlite XD, Premium	7	Scissors, Operating, Delicate, Premium	2,3	Set, Sterilization Tray/bath	201
Scissors, Iris, Sklarlite, Sklarcut, Premium	21	Scissors, Operating, Floor-Grade, Econo	2,3,192	Set, Trocar, Mini Lap, Sklartech 5000	154
Scissors, Iris, Sterile, Floor-Grade	7,192	Scissors, Operating, Floor-Grade, Sterile	2,3,192	Set, Tuning Fork	127
Scissors, Iris, T-C, Sklar Edge, Premium	62	Scissors, Operating, Mid-Grade	2,3	Shapleigh Ear Curette	128
Scissors, Jameson, Sklarhone, Premium	64	Scissors, Operating, OR Grade	2,3	Shave Prep Tray, Sterile	174
Scissors, Joseph	17	Scissors, Operating, Sklarhone, Premium	64	Shaver, Ingrown Nail	106
Scissors, Knapp Iris	86	Scissors, Operating, Sklarlite XD, Premium	2,3	Shears, Commander Utility	15
Scissors, Knowles Bandage Sterile Floor-Grade	16,191	Scissors, Operating, T-C, Sklar Edge, Premium	62	Shears, Esmarch Plaster	15
Scissors, Knowles Bandage, Floor-Grade, Econo	191,16	Scissors, Operating, T-C, Sklar Edge, Premium	62	Sheehan Osteotome	116
Scissors, Knowles Bandage, Mid-Grade	16	Scissors, Operating, Peritoneal, Lap, Sklartech 4000	142	Sheet Tape, Id	231
Scissors, Knowles Bandage, OR Grade	16	Scissors, Plastic Surgery	86	Simpson Uterine Sound, Floor-Grade, Econo	138
Scissors, Lister Bandage, Floor-Grade, Econo	13,191	Scissors, Potts-smith Vascular	84	Simpson Uterine Sound, Silver Plated	138
Scissors, Lister Bandage, Mid-Grade	13	Scissors, Ragnell Dissecting	19	Sims Scissors	20
Scissors, Lister Bandage, OR Grade	13	Scissors, Ragnell Dissecting Sklarcut Premium	22	Sims Uterine Curette	139
Scissors, Lister Bandage, Premium Delicate	13	Scissors, Ragnell, Sklarlite Sklarcut Premium	22	Sims Uterine Sound, Silver Plated	138
Scissors, Lister Bandage, Sklarlite XD	13	Scissors, Reynolds	20	Skeele Chalazion Curette	94
Scissors, Lister Bandage, Sterile Floor-Grade	13,191	Scissors, Rhytidectomy	19	Skin Hook, Gillies	77
Scissors, Littauer Stitch, Floor-Grade, Econo	9,191	Scissors, Ribbon Iris	17	Skin Hook, Joseph	75
Scissors, Littauer Stitch, Mid-Grade	9	Scissors, Ribbon Stevens Tenotomy	17	Skin Hook, Meyerding	75
Scissors, Littauer Stitch, OR Grade	9	Scissors, Ribbon Stitch	17,10	Sklar Disposable Dermal Curettes	160
Scissors, Littauer Stitch, Premium Delicate	9	Scissors, Ribbon Strabismus	17	Sklar Disposable Pinwheel	156
Scissors, Littauer Stitch, Sklarlite XD	9	Scissors, Ribbon Utility	17	Sklar Edge T-C Dissecting Scissors, Premium	63
Scissors, Littauer Stitch, Sterile, Econo	9	Scissors, Sims	20	Sklar Edge T-C Iris Scissors, Premium	62
Scissors, Littauer Suture Floor-Grade Sterile	191,9	Scissors, Sklar Stitch, OR Grade	10	Sklar Edge T-C Mayo Scissors, Premium	62
Scissors, Littauer Suture, Plastic, Sterile	173	Scissors, Spencer Stitch, Floor-Grade Sterile	191,11	Sklar Edge T-C Mayo-stille Scissors, Premium	63
Scissors, Mayo Dissecting Floor-Grade Sterile	4,192	Scissors, Spencer Stitch, Floor-Grade, Econo	11,191	Sklar Edge T-C Metz-lahey Scissors, Premium	62
Scissors, Mayo Dissecting, Delicate, Premium	4	Scissors, Spencer Stitch, Mid-Grade	11	Sklar Edge T-C Metz-lahey Scissors, Premium	62
Scissors, Mayo Dissecting, Floor-Grade, Econo	4,192	Scissors, Spencer Stitch, OR Grade	11	Sklar Edge T-C Metzenbaum Scissors, Premium	62
Scissors, Mayo Dissecting, Mid-Grade	4	Scissors, Spencer Stitch, Premium Delicate	11	Sklar Edge T-C Operating Scissors, Premium	62
Scissors, Mayo Dissecting, OR Grade	4	Scissors, Spencer Stitch, Sklarlite XD	11	Sklar Edge T-C Strabismus Scissors, Premium	63
Scissors, Mayo Dissecting, Sklarhone, Premium	64	Scissors, Stevens Tenotomy, OR Grade	12	Sklar Edge T-C Wire Cutting Scissors, Premium	63
Scissors, Mayo, T-C, Sklar Edge, Premium	62	Scissors, Stevens Tenotomy, Premium Delicate	12	Sklar Enzymatic	212
Scissors, Mayo-noble Dissecting	18	Scissors, Stevens Tenotomy, Premium Sklarlite	12	Sklar Enzymatic Detergent	217
Scissors, Mayo-noble-stille Dissecting	18	Scissors, Stevens Tenotomy, Sklarlite XD	12	Sklar Finger Ring Cutter	130
Scissors, Mayo-stille, T-C Sklar Edge Premium	63	Scissors, Strabismus, Floor-Grade, Sterile	8	Sklar Fresh Sanitizer	223
Scissors, Mcclure Iris	85	Scissors, Strabismus, Mid-Grade	8	Sklar Glove Liners, Sterile	167
Scissors, Mcguire Corneal	86	Scissors, Strabismus, OR Grade	8	Sklar Instru-guard Lubricant	220
Scissors, Metz, Laparoscopic, Sklartech 4000	142	Scissors, Strabismus, Premium Delicate	8	Sklar Instru-guard One-step Detergent	212
Scissors, Metz-lahey, Premium Sklarlite XD	5	Scissors, Strabismus, Sklarlite XD, Premium	8	Sklar Kleen Liquid	214
Scissors, Metz-lahey, T-C, Sklar Edge Premium	62	Scissors, Strabismus, T-C Sklar Edge, Premium	63	Sklar Kleen Liquid Detergent	212
Scissors, Metzenbaum Dissecting, Floor-Grade	6,192	Scissors, Strabismus, T-C, Sklar Edge, Premium	63	Sklar Kleen Low Foam Liquid	215
Scissors, Metzenbaum Dissecting, Mid-Grade	6	Scissors, Suture Wire Cutting	14,14	Sklar Kleen Powder	213
Scissors, Metzenbaum Dissecting, OR Grade	6	Scissors, Suture, OR Grade	10	Sklar Kleen Powder Detergent	212
Scissors, Metzenbaum Lahey, Floor-Grade	5,192	Scissors, Suture, Premium Delicate	10	Sklar Malleable Probe	79
Scissors, Metzenbaum Lahey, Mid-Grade	5	Scissors, Suture, Premium Sklarlite XD	10	Sklar Mini Dilator/os Finder Set	139
Scissors, Metzenbaum Lahey, OR Grade	5	Scissors, Us Army Pattern Gauze	107	Sklar Nail Drill	130
Scissors, Metzenbaum Lahey, Premium Delicate	5	Scissors, Usa Pattern Gauze	15	Sklar Polish	219
Scissors, Metzenbaum Lahey, Sklarcut, Premium	21	Scissors, Vannas	85	Sklar Sanitizing Gel	223
Scissors, Metzenbaum Lahey, Sterile, Econo	5,192	Scissors, Wagner	19	Sklar Soaking Trays	222
Scissors, Metzenbaum Lahey, Surgi OR	5	Scissors, Wagner, Sklarcut, Premium	22	Sklar Splinter Removal Kit	103
Scissors, Metzenbaum, Floor-Grade, Sterile	192,6	Scissors, Wagner, Sklarlite Sklarcut Premium	22	Sklar Spray Disinfectant	211
Scissors, Metzenbaum, Mini Lap Sklartech 5000	152	Scissors, Westcott Tenotomy	87	Sklar Spray-zyme Cleaner	218
Scissors, Metzenbaum, Premium Delicate	6	Scissors, Wire Cutting T-C Sklar Edge Premium	63	Sklar Spray-zyme Enzymatic	212
		Scissors, Wire Cutting, Floor-Grade, Econo	14,191	Sklar Stitch Scissors, OR Grade	10

Sklar Uterine Sound, Disposable, Sterile . . . . .	138	Sklartech 4000 Lap Pointed Grasping Forceps . . . . .	144	Spatula And Hook, McCreynolds . . . . .	96
Sklar-cide High Level Disinfectant . . . . .	222,209	Sklartech 4000 Lap Probe Excision Punch . . . . .	143	Spatula, Barraquer Cycloclialysis . . . . .	96
Sklar-zyme Enzymatic Detergent . . . . .	216	Sklartech 4000 Lap Replacement Locking Collar . . . . .	146	Spatula, Castroviejo Cycloclialysis . . . . .	100
Sklarcut Iris Scissors, Premium . . . . .	21	Sklartech 4000 Lap Suction Control Valves . . . . .	149	Spatula, Green . . . . .	96
Sklarcut Metzenbaum Scissors, Premium . . . . .	21	Sklartech 4000 Lap Suction Irrigation System . . . . .	150	Spatulas, Castroviejo Cycloclialysis . . . . .	96
Sklarcut Ragnell Dissecting Scissors, Premium . . . . .	22	Sklartech 4000 Lap Tapered Grasping Forceps . . . . .	144	Spear Point Probe . . . . .	79
Sklarcut Scissors, Metzenbaum Lahey, Premium . . . . .	21	Sklartech 4000 Lap Wave Grasping Forceps . . . . .	145	Specimen Containers, Disposable . . . . .	187
Sklarcut Sklarlite Iris Scissors, Premium . . . . .	21	Sklartech 4000 Laparoscopic Alligator Forceps . . . . .	145	Specimen Tube, Sterile . . . . .	184
Sklarcut Sklarlite Metz Scissors, Premium . . . . .	21	Sklartech 4000 Laparoscopic Allis Forceps . . . . .	145	Speculum Pederson Vaginal Floor-Grade Sterile . . . . .	136
Sklarcut Sklarlite Ragnell Scissors, Premium . . . . .	22	Sklartech 4000 Laparoscopic Babcock Forceps . . . . .	144	Speculum, Barraquer Blade . . . . .	98
Sklarcut Sklarlite Wagner Scissors, Premium . . . . .	22	Sklartech 4000 Laparoscopic Cannula . . . . .	148	Speculum, Barraquer Wire . . . . .	98
Sklarcut Wagner Scissors, Premium . . . . .	22	Sklartech 4000 Laparoscopic Claw Forceps . . . . .	143	Speculum, Castroviejo Eye . . . . .	99
Sklarhone Iris Scissors, Premium . . . . .	64	Sklartech 4000 Laparoscopic Debaquey Forceps . . . . .	145	Speculum, Cook Eye . . . . .	98
Sklarhone Jameson Scissors, Premium . . . . .	64	Sklartech 4000 Laparoscopic Dolphin Forceps . . . . .	143	Speculum, Graves Vaginal, Disposable . . . . .	190
Sklarhone Mayo Dissecting Scissors, Premium . . . . .	64	Sklartech 4000 Laparoscopic Graduated Probe . . . . .	151	Speculum, Graves Vaginal, Floor-Grade Sterile . . . . .	135
Sklarhone Metzenbaum Scissors, Premium . . . . .	64	Sklartech 4000 Laparoscopic Grasping Forceps . . . . .	144,145	Speculum, Graves Vaginal, Floor-Grade, Econo . . . . .	135
Sklarhone Metzenbaum-lahey Scissors, Premium . . . . .	64	Sklartech 4000 Laparoscopic Hasson Trocar . . . . .	148	Speculum, Graves Vaginal, OR Grade . . . . .	135
Sklarhone Operating Scissors, Premium . . . . .	64	Sklartech 4000 Laparoscopic Hook Scissors . . . . .	142	Speculum, Ives Rectal . . . . .	158
Sklarlite Adson-brown Tissue Forceps, Premium . . . . .	43	Sklartech 4000 Laparoscopic Injection Needle . . . . .	151	Speculum, Killian Nasal . . . . .	124
Sklarlite Allis Tissue Forceps, Premium . . . . .	29	Sklartech 4000 Laparoscopic Insulated Cannula . . . . .	146	Speculum, Kratz-barraquer Wire . . . . .	98
Sklarlite Baumgartner Needle Holder, Premium . . . . .	59	Sklartech 4000 Laparoscopic Kelly Forceps . . . . .	143	Speculum, Lancaster Eye . . . . .	99
Sklarlite Crile-wood Needle Holder, Premium . . . . .	58	Sklartech 4000 Laparoscopic Maryland Forceps . . . . .	143	Speculum, Nasal, Disposable . . . . .	124
Sklarlite Derf Needle Holder, Premium . . . . .	55	Sklartech 4000 Laparoscopic Metzenbaum Scis . . . . .	142	Speculum, Pederson Vaginal, Floor-Grade Econo . . . . .	136
Sklarlite Halsey Needle Holder, Premium . . . . .	60	Sklartech 4000 Laparoscopic Micro Scissors . . . . .	142	Speculum, Pederson Vaginal, Mid-Grade . . . . .	136
Sklarlite Hartmann Mosquito Forceps, Premium . . . . .	26	Sklartech 4000 Laparoscopic Mixer Forceps . . . . .	143	Speculum, Pederson Vaginal, OR Grade . . . . .	136
Sklarlite Littauer Cutting Forceps, Premium . . . . .	109	Sklartech 4000 Laparoscopic Needle Holder . . . . .	147	Speculum, Plain Wire . . . . .	98
Sklarlite Mayo-hegar Needle Holder, Premium . . . . .	54	Sklartech 4000 Laparoscopic Peritoneal Scis . . . . .	142	Speculum, Plastic Nasal, Disposable . . . . .	190
Sklarlite Metz-lahey Scissors, Premium . . . . .	21	Sklartech 4000 Laparoscopic S-retractor . . . . .	148	Speculum, Plastic Vaginal, Sterile Disposable . . . . .	135
Sklarlite Nail Splitting Forceps, Premium . . . . .	107	Sklartech 4000 Laparoscopic Verres Needle . . . . .	151	Speculum, Sauer Wire . . . . .	98
Sklarlite Olsen-hegar Needle Holder, Premium . . . . .	57	Sklartech 4000 Laparoscopic X Handle . . . . .	146	Speculum, Vaginal, Plastic, Disposable . . . . .	135
Sklarlite Rochester-ochsner Forceps, Premium . . . . .	27	Sklartech 4000 Laparoscopic Xc Carbon Handle . . . . .	146	Speculum, Vienna Nasal, Floor-Grade, Econo . . . . .	124
Sklarlite Rochester-pear Forceps, Premium . . . . .	28	Sklartech 4000 Laparoscopic Y Handle . . . . .	146	Speculum, Vienna Nasal, OR Grade . . . . .	124
Sklarlite Sklarcut Iris Scissors, Premium . . . . .	21	Sklartech 4000 Laparoscopic Yc Carbon Handle . . . . .	146	Speculum, Williams Eye . . . . .	99
Sklarlite Sklarcut Metz Scissors, Premium . . . . .	21	Sklartech 5000 Mini Lap Atraumatic Dissectors . . . . .	153	Speculum, Ziegler Eye . . . . .	99
Sklarlite Sklarcut Ragnell Scissors, Premium . . . . .	22	Sklartech 5000 Mini Lap Cobra Grasping Forcep . . . . .	153	Spencer Stitch Scissors, Floor-Grade, Econo . . . . .	11,191
Sklarlite Sklarcut Wagner Scissors, Premium . . . . .	22	Sklartech 5000 Mini Lap Duck Nose Forceps . . . . .	153	Spencer Stitch Scissors, Mid-Grade . . . . .	11
Sklarlite Stevens Tenotomy Scissors, Premium . . . . .	12	Sklartech 5000 Mini Lap Electrodes . . . . .	154	Spencer Stitch Scissors, OR Grade . . . . .	11
Sklarlite Tissue Nipper, Premium . . . . .	112	Sklartech 5000 Mini Lap Electrosurgical Cable . . . . .	154	Spencer Stitch Scissors, Premium Delicate . . . . .	11
Sklarlite Webster Needle Holder, Premium . . . . .	56	Sklartech 5000 Mini Lap Endoscope . . . . .	154	Spencer Stitch Scissors, Premium Sklarlite XD . . . . .	11
Sklarlite XD Adson Dressing Forceps, Premium . . . . .	40	Sklartech 5000 Mini Lap Grasping Forceps . . . . .	153	Spencer Stitch Scissors, Sterile, Floor-Grade . . . . .	11,191
Sklarlite XD Adson Tissue Forceps, Premium . . . . .	41	Sklartech 5000 Mini Lap Hook Scissors . . . . .	152	Spinal Gouge, Cobb Type . . . . .	116
Sklarlite XD Crile Hemostatic Forceps Premium . . . . .	24	Sklartech 5000 Mini Lap Kelly Forceps . . . . .	153	Splinter Forceps, Carmalt . . . . .	103,44
Sklarlite XD Crile-wood Needle Holder Premium . . . . .	58	Sklartech 5000 Mini Lap Maryland Dissectors . . . . .	153	Splinter Forceps, Carmalt, Floor-Grade, Econo . . . . .	44
Sklarlite XD Derf Needle Holder, Premium . . . . .	55	Sklartech 5000 Mini Lap Metzenbaum Scissors . . . . .	152	Splinter Forceps, Feilchenfeld . . . . .	44,103
Sklarlite XD Dressing Forceps, Premium . . . . .	38	Sklartech 5000 Mini Lap Punch . . . . .	152	Splinter Forceps, Fine Point . . . . .	103,44
Sklarlite XD Halsey Needle Holder, Premium . . . . .	60	Sklartech 5000 Mini Lap Spoon Forceps . . . . .	153,	Splinter Forceps, Fine Point, Mid-Grade . . . . .	44
Sklarlite XD Halsted Mosquito Forceps Premium . . . . .	23	Sklartech 5000 Mini Lap Trocar Set . . . . .	154	Splinter Forceps, Fine, Floor-Grade, Econo . . . . .	193,44
Sklarlite XD Iris Scissors, Premium . . . . .	7	Sklartech 5000 Mini Lap Xc Carbon Handle . . . . .	154	Splinter Forceps, Fine, Floor-Grade, Sterile . . . . .	44,193
Sklarlite XD Kelly Hemostatic Forceps Premium . . . . .	25	Sklartech 5000 Mini Lap Yc Carbon Handle . . . . .	154	Splinter Forceps, Plain With Magnifier . . . . .	44,103
Sklarlite XD Lister Bandage Scissors, Premium . . . . .	13	Sklartouch Latex Exam Gloves, Powder-free . . . . .	166	Splinter Forceps, Virtus . . . . .	33
Sklarlite XD Mayo Dissecting Scissors Premium . . . . .	4	Sklartouch Latex Exam Gloves, Powdered . . . . .	166	Splinter Forceps, With Magnifier, Floor-Grade . . . . .	44
Sklarlite XD Mayo-hegar Needle Holder Premium . . . . .	54	Sklartouch Latex Surgical Gloves . . . . .	167	Splinter Pick, Vanguard . . . . .	103
Sklarlite XD Metz-lahey Scissors, Premium . . . . .	5	Sklartouch Nitrile Exam Gloves, Powder-free . . . . .	166	Splinter Removal Kit, Sklar . . . . .	103
Sklarlite XD Metzenbaum Scissors, Premium . . . . .	6	Sklartouch Nitrile Exam Gloves, Powdered . . . . .	166	Splitter, Nail . . . . .	105,110
Sklarlite XD Operating Scissors, Premium . . . . .	2,3	Sklartouch Nitrile Surgical Gloves . . . . .	167	Splitting Forceps, Nail, Floor-Grade, Econo . . . . .	107
Sklarlite XD Spencer Stitch Scissors, Premium . . . . .	11	Smith Peterson Gouge . . . . .	115	Splitting Forceps, Nail, OR Grade . . . . .	107
Sklarlite XD Stevens Tenotomy Scissors . . . . .	12	Smith Peterson Osteotome . . . . .	115	Splitting Forceps, Nail, Sklarlite, Premium . . . . .	107
Sklarlite XD Strabismus Scissors, Premium . . . . .	8	Snare Wires . . . . .	123	Splitting Scissors, Nail . . . . .	107
Sklarlite XD Suture Scissors, Premium . . . . .	10	Snare, Eves Tonsil . . . . .	123	Splitting Scissors, Nail, Floor-Grade, Econo . . . . .	107
Sklarlite XD Tissue Forceps, Premium . . . . .	39	Snare, Tyding Tonsil . . . . .	123	Sponge Bowl . . . . .	199
Sklarlite XD Webster Needle Holder, Premium . . . . .	56	Soaking Trays, Sklar . . . . .	222	Sponge Forceps, Ballenger . . . . .	37
Sklarlite XD, Littauer Stitch Scis, Premium . . . . .	9	Soft Corn Knife . . . . .	105	Sponge Forceps, Foerster, Floor-Grade Sterile . . . . .	34,196
Sklarlite XD, Littauer Stitch Scissors . . . . .	9	Solution Basin . . . . .	199	Sponge Forceps, Foerster, Floor-Grade, Econo . . . . .	34,196
Sklartech 4000 Electrosurgical Cable . . . . .	149	Solution/mixing Bowl . . . . .	199	Sponge Forceps, Foerster, Mid-Grade . . . . .	34
Sklartech 4000 Lap Atraumatic Grasping Forcep . . . . .	144,145	Sound, Simpson Uterine, Floor-Grade, Econo . . . . .	138	Sponge Forceps, Foerster, OR Grade . . . . .	34
Sklartech 4000 Lap Clinch Grasping Forceps . . . . .	145	Sound, Simpson Uterine, Silver Plated . . . . .	138	Sponge Forceps, Plastic, Sterile . . . . .	173
Sklartech 4000 Lap Cobra Grasping Forceps . . . . .	145	Sound, Sims Uterine, Silver Plated . . . . .	138	Sponge Kit, Sterile . . . . .	185
Sklartech 4000 Lap Electrosurgical Cable . . . . .	149	Sound, Sklar Uterine, Disposable, Sterile . . . . .	138	Sponge Sticks, Angled, Sterile . . . . .	184
Sklartech 4000 Lap Fenestrated Forceps . . . . .	143,144	Spatula . . . . .	104	Spoon Forceps, Mini Lap, Sklartech 5000 . . . . .	153
Sklartech 4000 Lap Insulated Electrodes . . . . .	149	Spatula & Packer . . . . .	106	Spot Remover Pad, Instrument . . . . .	225
Sklartech 4000 Lap Maxi Grasping Forceps . . . . .	144	Spatula & Probe . . . . .	104	Spray Disinfectant, Sklar . . . . .	211



# ALPHABETICAL INDEX



Spray-zyme Cleaner, Sklar	218	Sterile Floor-Grade Lorna Edna Towel Clamps	196,35	Sterilization Tray, Mesh Bottom	203
Spray-zyme Enzymatic, Sklar	212	Sterile Floor-Grade Mayo Dissecting Scissors	192,4	Sterilization Tray/bath Set	201
Spreader, Beeson Plaster	113	Sterile Floor-Grade Mayo-hegar Needle Holder	195,54	Sterilization Trays	229
Spreader, Hennig Plaster	113	Sterile Floor-Grade Metzzenbaum Lahey Scissors	5,192	Stevens Iris Forceps	47
Spreader, Walton Plaster	113	Sterile Floor-Grade Metzzenbaum Scissors	192,6	Stevens Tenotomy Scissors, OR Grade	12
Spud, Alvis Foreign Body	97	Sterile Floor-Grade Multi-cut Utility Scissor	16,	Stevens Tenotomy Scissors, Premium Sklarlite	12
Spud, Ellis Foreign Body	97	Sterile Floor-Grade Operating Scissors	192,2,3	Stevens Tenotomy Scissors, Ribbon	17
Stainless Steel Instrument Cleaning Brushes	204	Sterile Floor-Grade Rochester-ochsner Forceps	197,27	Stevens Tenotomy Scissors, Sklarlite XD	12
Stainless Steel Scalpels, Disposable, Sterile	190	Sterile Floor-Grade Rochester-pean Hemostats	194,28	Sticks, Angled Sponge, Sterile	184
Stainless Steel Surgical Blades, Disposable	171	Sterile Floor-Grade Schroeder Tenaculum	197,36	Stitch Scissors, Fine	18,85
Stainless Steelware Cleaning Brushes	228	Sterile Floor-Grade Spencer Stitch Scissors	11,191	Stitch Scissors, Littauer, Floor-Grade, Econo	9
Standard Ct Biopsy Tray, Sterile	180	Sterile Floor-Grade Sponge Forceps	196	Stitch Scissors, Littauer, Mid-Grade	9
Steam Indicator Pen	168	Sterile Floor-Grade Strabismus Scissors	8	Stitch Scissors, Littauer, OR Grade	9
Steel Ruler	78	Sterile Floor-Grade Tissue Forceps	193,39	Stitch Scissors, Littauer, Premium Delicate	9
Sterile Absorbent Towels	185	Sterile Floor-Grade Tube Occluding Forceps	197,37	Stitch Scissors, Littauer, Sklarlite XD	9
Sterile Alcohol Swabsticks	184	Sterile Floor-Grade Webster Needle Holder	195,56	Stitch Scissors, Littauer, Sterile, Econo	9
Sterile Alcohol Triple Swabsticks	184	Sterile Floor-Grade Wire Cutting Scissors	14,191	Stitch Scissors, O'brien	18
Sterile Amniocentesis Tray	178	Sterile Fluoroscope Covers	184	Stitch Scissors, Ribbon	17,10
Sterile Angio Drape	184	Sterile General Purpose Tray	174	Stitch Scissors, Sklar, OR Grade	10
Sterile Angled Sponge Sticks	184	Sterile Incision And Drainage Tray	176	Stitch Scissors, Spencer, Floor-Grade, Econo	11,191
Sterile Applicator Prep Sticks	184	Sterile IV Start Tray	177	Stitch Scissors, Spencer, Mid-Grade	11
Sterile Basic Biopsy Tray	179	Sterile Kerlix Gauze Rolls	185	Stitch Scissors, Spencer, OR Grade	11
Sterile Basic Skin Prep Tray	174	Sterile Labor And Delivery Tray	179	Stitch Scissors, Spencer, Premium Delicate	11
Sterile Benzoin Tincture Applicator	184	Sterile Lap Endo Clinch Grasper Disposable	155	Stitch Scissors, Spencer, Sklarlite XD	11
Sterile Biopsy Punch Tray	180	Sterile Lap Maryland Dissectors Disposable	155	Stitch Scissors, Spencer, Sterile Floor-Grade	11,191
Sterile Bowl	185	Sterile Laparoscopic Maryland Forceps Sterile	155	Stoppers, Test Tube, Disposable	186
Sterile C-section Tray	179	Sterile Laparoscopic Metz Scissors Disposable	155	Storage Container	199
Sterile Central Line Dressing Tray	177	Sterile Magill Catheter Forceps, Floor-Grade	31	Strabismus Forceps	95
Sterile Coban Bandage	185	Sterile Major Laceration Tray	175	Strabismus Hook, Graefe	100
Sterile Conform Stretch Bandage	185	Sterile Mask With Ear Loops	184	Strabismus Hook, Jamison	100
Sterile Cotton Balls	185	Sterile Medicine Cup	185	Strabismus Scissors, Floor-Grade, Sterile	8
Sterile Cotton Tipped Applicators	185	Sterile Minor Dressing Tray	176	Strabismus Scissors, Mid-Grade	8
Sterile Cut Down Tray	177	Sterile Minor Laceration Tray	175	Strabismus Scissors, OR Grade	8
Sterile Debridement Tray	177,178	Sterile Minor Prep Tray	174	Strabismus Scissors, Premium Delicate	8
Sterile Disposable Cervical Cell Collector	190	Sterile Minor Surgery Tray	175	Strabismus Scissors, Ribbon	17
Sterile Disposable Dermal Biopsy Punch	190	Sterile Nail Tray	176	Strabismus Scissors, Sklarlite XD, Premium	8
Sterile Disposable Dermal Curettes	190	Sterile OR Basin	185	Strabismus Scissors, T-C, Sklar Edge, Premium	63
Sterile Disposable Ear/ulcer Syringe	190	Sterile OR Towels	185	Stratte Needle Holder, T-C, Premium	67
Sterile Disposable Endometrial Biopsy Cannula	190	Sterile Pederson Vaginal Speculum Floor-Grade	136	Stringer, E-z Lock Instrument	204,229
Sterile Disposable Scalpels	172	Sterile Plastic Dental Mirror	184	Stringer, Instrument	204
Sterile Disposable Sklar Uterine Sound	138	Sterile Plastic Dressing Forceps	173	Stringer, Instrument, Bunt	229
Sterile Disposable Stainless Steel Scalpels	190	Sterile Plastic Hemostats	173	Stringer, Instrument, Weinstein	229
Sterile Drape/towel	184	Sterile Plastic Littauer Suture Scissors	173	Strips, Indicator	168
Sterile Dressing Forceps, Floor-Grade	38	Sterile Plastic Nose Clip	173	Suction Control Valves, Laparoscopic, 4000	149
Sterile Elastic Bandage	185	Sterile Plastic Ruler	184	Suction Irrigation System, Laparoscopic, 4000	150
Sterile Esmark Bandage	185	Sterile Plastic Sponge Forceps	173	Suction Tube Cleaning Brushes	226
Sterile Extension Set With Clamp	184	Sterile Plastic Surgical Prep Razor	173	Suction Tube, Adson	134
Sterile Fenestrated Drape	184	Sterile Plastic Towel Clamp	173	Suction Tube, Baron	134
Sterile Fenestrated OR Towel	185	Sterile Plastic Tubing Clamp	173	Suction Tube, Buie	134
Sterile Floor-Grade Adson Forceps	193,40,41	Sterile Plastic Utility Forceps	173	Suction Tube, Frazier	134
Sterile Floor-Grade Adson-brown Forceps	193,43	Sterile Plastic Vaginal Speculum, Disposable	135	Suction Tube, Poole	134
Sterile Floor-Grade Allis Tissue Forceps	196,29	Sterile Pouches	168	Suction Tube, Yankauer	134
Sterile Floor-Grade Babcock Forceps	32	Sterile Rayon Swabs	185	Surgi OR Adson Dressing Forceps	40
Sterile Floor-Grade Backhaus Towel Clamps	196,34	Sterile Rubber Bands	184	Surgi OR Adson Tissue Forceps	41
Sterile Floor-Grade Baumgartner Needle Holder	195,59	Sterile Safety Pins	184	Surgi OR Adson-brown Tissue Forceps	43
Sterile Floor-Grade Bozeman Forceps	197,36	Sterile Shave Prep Tray	174	Surgi OR Allis Tissue Forceps	29
Sterile Floor-Grade Crile Hemostatic Forceps	194,24	Sterile Specimen Tube	184	Surgi OR Babcock Forceps	32
Sterile Floor-Grade Crile-wood Needle Holder	195	Sterile Sponge Kit	185	Surgi OR Backhaus Towel Clamp	34
Sterile Floor-Grade Derf Needle Holder	195,55	Sterile Standard Ct Biopsy Tray	180	Surgi OR Baumgartner Needle Holder	59
Sterile Floor-Grade Dressing Forceps	193	Sterile Suture Removal Tray	180	Surgi OR Bozeman Forceps	36
Sterile Floor-Grade Fine Splinter Forceps	193,44	Sterile Tape Measure	184	Surgi OR Derf Needle Holder	55
Sterile Floor-Grade Foerster Sponge Forceps	34,196	Sterile Tegaderm Dressing Change Tray	176	Surgi OR Dressing Forceps	38
Sterile Floor-Grade Graves Vaginal Speculum	135	Sterile Trach Care Tray	178	Surgi OR Fine Point Splinter Forceps	44
Sterile Floor-Grade Halsey Needle Holder	195,60	Sterile Ultrasound Tray	179	Surgi OR Foerster Sponge Forceps	34
Sterile Floor-Grade Halsted Mosquito Forceps	194,23	Sterile Utility Drape	184	Surgi OR Graves Vaginal Speculum	135
Sterile Floor-Grade Hartmann Mosquito Forceps	194,26	Sterile Webril	185	Surgi OR Halsey Needle Holder	60
Sterile Floor-Grade Iris Scissors	192,7	Sterile Wound Closure Tray	175	Surgi OR Halsted Mosquito Forceps	23
Sterile Floor-Grade Kelly Hemostatic Forceps	194,25	Sterile XI Gown	185	Surgi OR Hartmann Mosquito Forceps	26
Sterile Floor-Grade Knowles Bandage Scissors	16,191	Sterilization Rack, Weinstein	204	Surgi OR Iris Scissors	7
Sterile Floor-Grade Lister Bandage Scissors	13,191	Sterilization Tray	201,202	Surgi OR Kelly Hemostatic Forceps	25
Sterile Floor-Grade Littauer Stitch Scissors	9,191	Sterilization Tray, Flash	202	Surgi OR Knowles Bandage Scissors	16

Surgi OR Lister Bandage Scissors . . . . .	13	T-C Mayo Scissors, Sklar Edge, Premium . . . . .	62	Tissue Forceps, Debakey Atraumatic . . . . .	48
Surgi OR Littauer Stitch Scissors . . . . .	9	T-C Mayo-hegar Needle Holder, Premium . . . . .	66	Tissue Forceps, Delicate, Premium . . . . .	39
Surgi OR Lorna Edna Towel Clamp . . . . .	35	T-C Mayo-stille Scissors, Sklar Edge, Premium . . . . .	63	Tissue Forceps, Eye, Floor-Grade, Econo . . . . .	45
Surgi OR Magill Catheter Forceps . . . . .	31	T-C Metz-lahey Scissors, Sklar Edge, Premium . . . . .	62	Tissue Forceps, Eye, Litegrip, Premium . . . . .	45
Surgi OR Mayo Dissecting Scissors . . . . .	4	T-C Metzenbaum Scissors, Sklar Edge, Premium . . . . .	62	Tissue Forceps, Eye, OR Grade . . . . .	45
Surgi OR Mayo-hegar Needle Holder . . . . .	54	T-C Neivert Needle Holder, Premium . . . . .	68	Tissue Forceps, Ferris-smith . . . . .	50
Surgi OR Metzenbaum Dissecting Scissors . . . . .	6	T-C New Orleans Needle Holder, Premium . . . . .	66	Tissue Forceps, Floor-Grade, Econo . . . . .	39,193
Surgi OR Metzenbaum Lahey Scissors . . . . .	5	T-C Olsen-hegar Needle Holder, Premium . . . . .	66	Tissue Forceps, Floor-Grade, Sterile . . . . .	39,193
Surgi OR Multi-cut Utility Scissors . . . . .	16	T-C Operating Scissors, Sklar Edge, Premium . . . . .	62	Tissue Forceps, Foerster . . . . .	46
Surgi OR Operating Scissors . . . . .	2,3	T-C Potts-smith Dressing Forceps, Premium . . . . .	69	Tissue Forceps, Foerster Iris . . . . .	46
Surgi OR Pederson Vaginal Speculum . . . . .	136	T-C Ryder Needle Holder, Premium . . . . .	66	Tissue Forceps, Mid-Grade . . . . .	39
Surgi OR Rochester-ochsner Forceps . . . . .	27	T-C Sarot Needle Holder, Premium . . . . .	67	Tissue Forceps, OR Grade . . . . .	39
Surgi OR Rochester-pear Forceps . . . . .	28	T-C Strabismus Scissors, Sklar Edge, Premium . . . . .	63	Tissue Forceps, Russian . . . . .	50
Surgi OR Schroeder Tenaculum Forceps . . . . .	36	T-C Stratte Needle Holder, Premium . . . . .	67	Tissue Forceps, Semkin . . . . .	50
Surgi OR Spencer Stitch Scissors . . . . .	11	T-C Webster Needle Holder, Premium . . . . .	65	Tissue Forceps, Sklarlite XD, Premium . . . . .	39
Surgi OR Strabismus Scissors . . . . .	8	T-C Wire Cutting Scissors, Sklar Edge Premium . . . . .	63	Tissue Hook, Frazier . . . . .	75,77
Surgi OR Tissue Forceps . . . . .	39	Tags, Instrument Id . . . . .	231	Tissue Nipper, Floor-Grade, Econo . . . . .	112
Surgi OR Tube Occluding Clamp . . . . .	37	Tape Measure, Sterile . . . . .	184	Tissue Nipper, OR Grade . . . . .	112
Surgi OR Webster Needle Holder . . . . .	56	Tape, ID Roll . . . . .	231	Tissue Nipper, Sklarlite, Premium . . . . .	112
Surgi OR Wire Cutting Scissors . . . . .	14	Tape, ID Sheet . . . . .	231	Tissue Nippers . . . . .	112
Surgi-or Crile Hemostatic Forceps . . . . .	24	Tapered Grasping Forceps, Laparoscopic, 4000 . . . . .	144	Tongue Depressor, Wieder . . . . .	133
Surgical Blades, Carbon Steel, Disposable . . . . .	171	Tapes, Indicator . . . . .	168	Tongue Seizing Forceps, Young . . . . .	129
Surgical Blades, Stainless Steel, Disposable . . . . .	171	Taylor Percussion Hammer, Floor-Grade, Econo . . . . .	156	Tongue Tie, Director And . . . . .	79
Surgical Gloves, Latex, Sklartouch . . . . .	167	Taylor Percussion Hammer, OR Grade . . . . .	156	Tonsil Knife, Atkins . . . . .	129
Surgical Gloves, Nitrile, Sklartouch . . . . .	167	Tegaderm Dressing Change Tray, Sterile . . . . .	176	Tonsil Knife, Dean . . . . .	129
Surgical Prep Razor, Plastic, Sterile . . . . .	173	Tenaculum Forceps Schroeder Floor-Grade Econo . . . . .	36,197	Tonsil Knife, Fisher . . . . .	129
Suture Forceps, Bonn Micro . . . . .	89	Tenaculum Forceps, Schroeder, Mid-Grade . . . . .	36	Tonsil Snare, Eves . . . . .	123
Suture Forceps, Castroviejo . . . . .	89	Tenaculum Forceps, Schroeder, OR Grade . . . . .	36	Tonsil Snare, Tyding . . . . .	123
Suture Forceps, Manhattan Eye & Ear . . . . .	89	Tenaculum Forceps, Schroeder, Sterile, Econo . . . . .	36	Towel Clamp, Backhaus, Floor-Grade, Econo . . . . .	34,196
Suture Forceps, Mcpherson Micro Iris . . . . .	89	Tennant Tying Forceps . . . . .	93	Towel Clamp, Backhaus, Floor-Grade, Sterile . . . . .	34,196
Suture Forceps, Micro Tying . . . . .	53	Tenotomy Scissors, Ribbon Stevens . . . . .	17	Towel Clamp, Backhaus, Mid-Grade . . . . .	34
Suture Forceps, Rhoton Micro . . . . .	93	Tenotomy Scissors, Stevens, OR Grade . . . . .	12	Towel Clamp, Backhaus, OR Grade . . . . .	34
Suture Removal Tray, Sterile . . . . .	180	Tenotomy Scissors, Stevens, Premium Delicate . . . . .	12	Towel Clamp, Hoff . . . . .	35
Suture Scissors, Littauer Floor-Grade Sterile . . . . .	191,9	Tenotomy Scissors, Stevens, Sklarlite Premium . . . . .	12	Towel Clamp, Jones Cross Action . . . . .	35
Suture Scissors, Littauer, Floor-Grade, Econo . . . . .	191,9	Tenotomy Scissors, Stevens, Sklarlite XD . . . . .	12	Towel Clamp, Lorna Edna, Floor-Grade, Econo . . . . .	35,196
Suture Scissors, Littauer, Mid-Grade . . . . .	9	Tenotomy Scissors, Westcott . . . . .	87	Towel Clamp, Lorna Edna, Floor-Grade, Sterile . . . . .	35,196
Suture Scissors, Littauer, OR Grade . . . . .	9	Test Tube Racks . . . . .	186	Towel Clamp, Lorna Edna, Mid-Grade . . . . .	35
Suture Scissors, Littauer, Plastic, Sterile . . . . .	173	Test Tube Stoppers, Disposable . . . . .	186	Towel Clamp, Lorna Edna, OR Grade . . . . .	35
Suture Scissors, OR Grade . . . . .	10	Test Tubes, Disposable . . . . .	186	Towel Clamp, Plastic, Sterile . . . . .	173
Suture Scissors, Premium Delicate . . . . .	10	Thomas Uterine Curette . . . . .	139	Towel Clamp, Roeder . . . . .	35
Suture Scissors, Premium Sklarlite XD . . . . .	10	Thorpe Caliper . . . . .	78	Towel, Fenestrated OR, Sterile . . . . .	185
Suture Tying Forceps, Micro . . . . .	53	Thorpe Corneoscleral Forceps . . . . .	92	Towel/drape, Sterile . . . . .	184
Suture Wire Cutting Scissors . . . . .	14	Tip Protectors, Instrument, Non-vented . . . . .	230	Towels, Absorbent, Sterile . . . . .	185
Swabs, Rayon, Sterile . . . . .	185	Tip Protectors, Instrument, Vented . . . . .	230	Towels, OR, Sterile . . . . .	185
Swabsticks, Alcohol Triple, Sterile . . . . .	184	Tips, Pipette, Disposable . . . . .	187	Trach Care Tray, Sterile . . . . .	178
Swabsticks, Alcohol, Sterile . . . . .	184	Tischler Cervical Biopsy Forceps . . . . .	141	Tracheal Dilator, Laborde . . . . .	133
Syringe, Ear/ulcer, Disposable, Sterile . . . . .	190	Tischler Oval Biopsy Forceps . . . . .	141	Tracheal Dilator, Trousseau . . . . .	133
Syringe, Pomeroy Ear, Floor-Grade, Econo . . . . .	127	Tissue Forcep Adson-brown Floor-Grade Sterile . . . . .	43,193	Tracheal Retractor . . . . .	74
Syringe, Pomeroy Ear, Stainless Steel . . . . .	127	Tissue Forceps, Adson Micro . . . . .	42	Tracheostomy Tube Cleaning Brushes . . . . .	225
System, Suction Irrigation, Laparoscopic 4000 . . . . .	150	Tissue Forceps, Adson, Delicate, Premium . . . . .	41	Transfer Pipettes, Disposable . . . . .	189
T-C Adson Dressing Forceps, Premium . . . . .	70	Tissue Forceps, Adson, Floor-Grade, Econo . . . . .	41,193	Tray, Amniocentesis, Sterile . . . . .	178
T-C Adson Tissue Forceps, Premium . . . . .	70	Tissue Forceps, Adson, Floor-Grade, Sterile . . . . .	41,193	Tray, Basic Biopsy, Sterile . . . . .	179
T-C Adson-brown Forceps, Premium . . . . .	70	Tissue Forceps, Adson, Litegrip, Premium . . . . .	42	Tray, Basic Skin Prep, Sterile . . . . .	174
T-C Allis Forceps, Premium . . . . .	69	Tissue Forceps, Adson, Mid-Grade . . . . .	41	Tray, Biopsy Punch, Sterile . . . . .	180
T-C Babcock Forceps, Premium . . . . .	69	Tissue Forceps, Adson, OR Grade . . . . .	41	Tray, C-section, Sterile . . . . .	179
T-C Baumgartner Needle Holder, Premium . . . . .	65	Tissue Forceps, Adson, Sklarlite, Premium . . . . .	41	Tray, Central Line Dressing, Sterile . . . . .	177
T-C Bozeman-heaney Needle Holder, Premium . . . . .	68	Tissue Forceps, Adson, T-C, Premium . . . . .	70	Tray, Cut Down, Sterile . . . . .	177
T-C Castroviejo Needle Holder, Premium . . . . .	68,84	Tissue Forceps, Adson-brown Floor-Grade Econo . . . . .	43,193	Tray, Debridement, Sterile . . . . .	177,178
T-C Crile-murray Needle Holder, Premium . . . . .	65	Tissue Forceps, Adson-brown Sklarlite Premium . . . . .	43	Tray, Flash Sterilization . . . . .	202
T-C Crile-wood Needle Holder, Premium . . . . .	65	Tissue Forceps, Adson-brown, Delicate Premium . . . . .	43	Tray, General Purpose, Sterile . . . . .	174
T-C Debakey Atraumatic Forceps, Premium . . . . .	69	Tissue Forceps, Adson-brown, Litegrip Premium . . . . .	42	Tray, Incision And Drainage, Sterile . . . . .	176
T-C Derf Needle Holder, Premium . . . . .	65	Tissue Forceps, Adson-brown, Mid-Grade . . . . .	43	Tray, Instrument . . . . .	201,229
T-C Dissecting Scissors, Sklar Edge, Premium . . . . .	63	Tissue Forceps, Adson-brown, OR Grade . . . . .	43	Tray, Instrument, Cath . . . . .	229
T-C Dressing Forceps, Premium . . . . .	70	Tissue Forceps, Allis, Delicate, Premium . . . . .	29	Tray, Instrument, High Sided . . . . .	201
T-C Finochietto Needle Holder, Premium . . . . .	67	Tissue Forceps, Allis, Floor-Grade, Econo . . . . .	29,196	Tray, Instrument, Non-perforated . . . . .	201
T-C Halsey Needle Holder, Premium . . . . .	65	Tissue Forceps, Allis, Floor-Grade, Sterile . . . . .	29,196	Tray, Instrument, Perforated . . . . .	201
T-C Heaney Needle Holder, Premium . . . . .	67	Tissue Forceps, Allis, Mid-Grade . . . . .	29	Tray, IV Start, Sterile . . . . .	177
T-C Iris Scissors, Sklar Edge, Premium . . . . .	62	Tissue Forceps, Allis, OR Grade . . . . .	29	Tray, Labor And Delivery, Sterile . . . . .	179
T-C Jacobson Needle Holder, Premium . . . . .	68	Tissue Forceps, Allis, Sklarlite, Premium . . . . .	29	Tray, Major Laceration, Sterile . . . . .	175
T-C Luethy Beck Needle Holder, Premium . . . . .	68	Tissue Forceps, Bishop-harmon Eye . . . . .	47	Tray, Mayo . . . . .	229,200
T-C Mathieu Needle Holder, Premium . . . . .	68	Tissue Forceps, Bonney . . . . .	50	Tray, Mayo, Non-perforated . . . . .	200

# ALPHABETICAL INDEX



Tray, Mayo, Perforated . . . . .	200	Uterine Sound, Sims, Silver Plated . . . . .	138	Williams Eye Speculum . . . . .	99
Tray, Mayo, Plastic . . . . .	201	Uterine Sound, Sklar, Disposable, Sterile . . . . .	138	Williams Lachrymal Dilator/probe . . . . .	88
Tray, Micro Double Deck . . . . .	201	Utility Drape, Sterile . . . . .	184	Williger Bone Curette . . . . .	114
Tray, Minor Dressing, Sterile . . . . .	176	Utility Forceps, Bonaccolto . . . . .	92	Wills Hospital Utility Forceps . . . . .	92
Tray, Minor Laceration, Sterile . . . . .	175	Utility Forceps, Girard Corneal . . . . .	90	Wire Bending Pliers . . . . .	102
Tray, Minor Prep, Sterile . . . . .	174	Utility Forceps, Mccullough . . . . .	92	Wire Cutting Scissors, Floor-Grade, Econo . . . . .	14,191
Tray, Minor Surgery, Sterile . . . . .	175	Utility Forceps, Nugent . . . . .	92	Wire Cutting Scissors, Mid-Grade, Surgi OR . . . . .	14
Tray, Nail, Sterile . . . . .	176	Utility Forceps, Plastic, Sterile . . . . .	173	Wire Cutting Scissors, OR Grade . . . . .	14
Tray, Shave Prep, Sterile . . . . .	174	Utility Forceps, Troutman-barraquer Corneal . . . . .	47	Wire Cutting Scissors, Sterile, Floor-Grade . . . . .	14,191
Tray, Standard Ct Biopsy, Sterile . . . . .	180	Utility Forceps, Wills Hospital . . . . .	92	Wire Cutting Scissors, Suture . . . . .	14
Tray, Sterilization . . . . .	201,202,203	Utility Scissor Multi-cut Sterile Floor-Grade . . . . .	16	Wire Cutting Scissors, T-C Sklar Edge Premium . . . . .	63
Tray, Sterilization, Mesh Bottom . . . . .	203	Utility Scissors, Hercules . . . . .	15	Wire Retaining Retractor . . . . .	72
Tray, Suture Removal, Sterile . . . . .	180	Utility Scissors, Multi-cut Floor-Grade Econo . . . . .	16	Wire Speculum, Barraquer . . . . .	98
Tray, Tegaderm Dressing Change, Sterile . . . . .	176	Utility Scissors, Multi-cut, Mid-Grade . . . . .	16	Wire Speculum, Kratz-barraquer . . . . .	98
Tray, Trach Care, Sterile . . . . .	178	Utility Scissors, Multi-cut, OR Grade . . . . .	16	Wire Speculum, Plain . . . . .	98
Tray, Ultrasound, Sterile . . . . .	179	Utility Scissors, Ribbon . . . . .	17	Wires, Snare . . . . .	123
Tray, Wound Closure, Sterile . . . . .	175	Utility Shears, Commander . . . . .	15	Worcester Instrument Holder . . . . .	204
Trays, Pipette . . . . .	187	Vaginal Speculum Pederson Floor-Grade Sterile . . . . .	136	Wound Closure Tray, Sterile . . . . .	175
Trays, Soaking, Sklar . . . . .	222	Vaginal Speculum, Graves, Disposable . . . . .	190	X Handle, Laparoscopic, Sklartech 4000 . . . . .	146
Trays, Sterilization . . . . .	229	Vaginal Speculum, Graves, Floor-Grade Sterile . . . . .	135	Xc Carbon Handle, Laparoscopic Sklartech 4000 . . . . .	146
Trocar Set, Mini Lap, Sklartech 5000 . . . . .	154	Vaginal Speculum, Graves, Floor-Grade, Econo . . . . .	135	Xc Carbon Handle, Mini Lap, Sklartech 5000 . . . . .	154
Trocar, Hasson, Laparoscopic, Sklartech 4000 . . . . .	148	Vaginal Speculum, Graves, Mid-Grade . . . . .	135	Xi Gown, Sterile . . . . .	185
Trocar, Nelson . . . . .	133	Vaginal Speculum, Graves, OR Grade . . . . .	135	Y Handle, Laparoscopic, Sklartech 4000 . . . . .	146
Trocar, Ochsner . . . . .	133	Vaginal Speculum, Pederson, Floor-Grade Econo . . . . .	136	Yankauer Suction Tube . . . . .	134
Trousseau Tracheal Dilator . . . . .	133	Vaginal Speculum, Pederson, Mid-Grade . . . . .	136	Yc Carbon Handle, Laparoscopic Sklartech 4000 . . . . .	146
Troutman-barraquer Corneal Utility Forceps . . . . .	47	Vaginal Speculum, Pederson, OR Grade . . . . .	136	Yc Carbon Handle, Mini Lap, Sklartech 5000 . . . . .	154
Tru-punch Dermal Biopsy Punch, Disposable . . . . .	160	Vaginal Speculum, Plastic, Disposable . . . . .	135	Young Tongue Seizing Forceps . . . . .	129
Tube Occluding Clamp, Floor-Grade, Econo . . . . .	37,197	Vaginal Speculum, Plastic, Sterile Disposable . . . . .	135	Zalkind Ribbon Retractor . . . . .	76
Tube Occluding Clamp, Floor-Grade, Sterile . . . . .	37,197	Valve Brushes, Double Ended . . . . .	226	Zaufel-jansen Rongeur . . . . .	120
Tube Occluding Clamp, Mid-Grade . . . . .	37	Valves, Suction Control, Laparoscopic, 4000 . . . . .	149	Ziegler Cilia Forceps . . . . .	91
Tube Occluding Clamp, OR Grade . . . . .	37	Vanguard Splinter Pick . . . . .	103	Ziegler Eye Speculum . . . . .	99
Tube Racks, Test . . . . .	186	Vannas Scissors . . . . .	85		
Tube Stoppers, Test, Disposable . . . . .	186	Vascular Scissors, Potts-smith . . . . .	84		
Tube, Adson Suction . . . . .	134	Vented Instrument Tip Protectors . . . . .	230		
Tube, Baron Suction . . . . .	134	Verres Needle, Laparoscopic, Sklartech 4000 . . . . .	151		
Tube, Buie Suction . . . . .	134	Verucca Curette . . . . .	106		
Tube, Frazier Suction . . . . .	134	Vienna Nasal Speculum, Floor-Grade, Econo . . . . .	124		
Tube, Poole Suction . . . . .	134	Vienna Nasal Speculum, OR Grade . . . . .	124		
Tube, Specimen, Sterile . . . . .	184	Virtus Splinter Forceps . . . . .	33		
Tube, Yankauer Suction . . . . .	134	Volkman Curette . . . . .	114		
Tubes, Centrifuge, Disposable . . . . .	186	Volkman Retractor . . . . .	72		
Tubes, Microcentrifuge, Disposable . . . . .	188	Wagner Scissors . . . . .	19,22		
Tubes, Test, Disposable . . . . .	186	Wagner Scissors, Sklarcut, Premium . . . . .	22		
Tubing Clamp, Plastic, Sterile . . . . .	173	Wagner Scissors, Sklarlite Sklarcut, Premium . . . . .	22		
Tumbler . . . . .	198	Walther Dilator-catheters . . . . .	139		
Tumor Grasping Forceps . . . . .	82	Walton Plaster Spreader . . . . .	113		
Tuning Fork Set . . . . .	127	Wartenberg Neurological Pinwheel, Floor-Grade . . . . .	156		
Tuning Fork, Aluminum Alloy . . . . .	127	Wartenberg Neurological Pinwheel, OR Grade . . . . .	156		
Tyding Tonsil Snare . . . . .	123	Wave Grasping Forceps, Laparoscopic, 4000 . . . . .	145		
Tying Forceps, Bechert-mcpherson . . . . .	93	Webril, Sterile . . . . .	185		
Tying Forceps, Bonn . . . . .	89	Webster Needle Holder, Floor-Grade, Econo . . . . .	195,56		
Tying Forceps, Harms . . . . .	89	Webster Needle Holder, Floor-Grade, Sterile . . . . .	56,195		
Tying Forceps, Kelman-mcpherson . . . . .	93	Webster Needle Holder, Mid-Grade . . . . .	56		
Tying Forceps, Mcpherson . . . . .	89	Webster Needle Holder, OR Grade . . . . .	56		
Tying Forceps, Micro Suture . . . . .	53	Webster Needle Holder, Sklarlite XD, Premium . . . . .	56		
Tying Forceps, Tennant . . . . .	93	Webster Needle Holder, Sklarlite, Premium . . . . .	56		
Tyrell Iris Hook . . . . .	77,100	Webster Needle Holder, T-C, Premium . . . . .	65		
Ultrasound Tray, Sterile . . . . .	179	Weinstein Instrument Stringer . . . . .	229		
Unna Comedone Extractor . . . . .	131	Weinstein Sterilization Rack . . . . .	204		
Us Army Pattern Gauze Scissors . . . . .	107	Weis Chalazion Forceps . . . . .	95		
Us Army Pattern Retractor . . . . .	74	Weisenbach Forcep Holder . . . . .	204		
Usa Pattern Gauze Scissors . . . . .	15	Weisman Infant Ear Curette . . . . .	128		
Uterine Curette, Heaney . . . . .	139	Weitlaner Retractor . . . . .	71		
Uterine Curette, Holden . . . . .	139	Weitlaner Retractor, Floor-Grade, Econo . . . . .	71		
Uterine Curette, Sims . . . . .	139	Westcott Tenotomy Scissors . . . . .	87		
Uterine Curette, Thomas . . . . .	139	Wieder Tongue Depressor . . . . .	133		
Uterine Dilator, Hank . . . . .	137	Wiener Scleral Hook . . . . .	100		
Uterine Dilator, Hegar . . . . .	137	Wilde Dressing Forceps, Floor-Grade, Econo . . . . .	125		
Uterine Dilator, Pratt . . . . .	137	Wilde Dressing Forceps, OR Grade . . . . .	125		
Uterine Sound, Simpson, Floor-Grade, Econo . . . . .	138	Wilder Lachrymal Dilator . . . . .	88		
Uterine Sound, Simpson, Silver Plated . . . . .	138	Wilder Lens Loop . . . . .	99		



06-2808	156	06-4150	130	10-1205	208	10-1384	224
06-2860	78	06-4151	130	10-1207	208	10-1386	224
06-2861	78	06-4152	130	10-1210	208	10-1388	224
06-2903	169	06-4153	130	10-1212	208	10-1392	224
06-2904	169	06-4160	130	10-1214	208	10-1394	226
06-2907	170	06-4161	130	10-1216	208	10-1396	226
06-2908	170	06-4191	131	10-1217	207	10-1398	226
06-2910	170	07-1562	129	10-1218	207	10-1399	226
06-2915	170	07-1563	129	10-1219	207	10-1400	226
06-2920	170	07-1777	31	10-1220	207	10-1401	226
06-2925	170	07-1780	31	10-1221	207	10-1402	226
06-2930	170	07-1797	31	10-1222	207	10-1403	226
06-3010	171	07-1801	134	10-1223	207	10-1404	226
06-3011	171	07-1802	134	10-1226	207	10-1405	226
06-3012	171	07-1805	134	10-1227	207	10-1406	226
06-3015	171	07-1806	134	10-1228	207	10-1407	226
06-3020	171	10-1113	168	10-1229	207	10-1408	226
06-3021	171	10-1114	168	10-1232	207	10-1409	226
06-3022	171	10-1115	168	10-1233	207	10-1414	225
06-3023	171	10-1117	168	10-1234	207	10-1415	225
06-3090	171	10-1119	168	10-1235	207	10-1418	228
06-3100	171	10-1120	168	10-1240	208	10-1419	228
06-3101	171	10-1122	168	10-1242	208	10-1420	228
06-3102	171	10-1124	168	10-1244	208	10-1421	228
06-3103	171	10-1126	168	10-1245	208	10-1422	228
06-3104	171	10-1130	168	10-1247	208	10-1424	228
06-3105	171	10-1131	168	10-1248	208	10-1442	227
06-3106	171	10-1132	168	10-1250	208	10-1444	227
06-3107	171	10-1133	168	10-1252	208	10-1450	200
06-3110	172,190	10-1134	168	10-1253	208	10-1451	200
06-3111	172,190	10-1135	168	10-1255	208	10-1460	228
06-3112	172	10-1140	199	10-1256	208	10-1465	204
06-3115	172,190	10-1142	199	10-1258	208	10-1468	204
06-3120	172	10-1144	199	10-1260	208	10-1470	225
06-3121	172	10-1146	199	10-1262	208	10-1472	225
06-3122	172	10-1148	199	10-1263	208	10-1483	199
06-3123	172	10-1150	199	10-1278	208	10-1483-12	199
06-3170	156	10-1152	199	10-1279	208	10-1484	199
06-3175	156	10-1157	200	10-1281	208	10-1484-12	199
06-3290	156	10-1158	200	10-1282	208	10-1485	199
06-3370	156	10-1159	200	10-1283	208	10-1485-12	199
06-3375	156	10-1160	200	10-1284	208	10-1486	199
06-4120	131	10-1170	200	10-1286	208	10-1486-12	199
06-4121	131	10-1171	200	10-1288	208	10-1487	200
06-4122	131	10-1172	198	10-1340	204	10-1488	199
06-4125	131	10-1173	198	10-1342	204	10-1488-12	199
06-4126	131	10-1174	198	10-1344	204	10-1489	199
06-4133	132	10-1175	198	10-1346	204	10-1489-12	199
06-4134	132	10-1176	198	10-1347	204	10-1490	199
06-4135	132	10-1177	198	10-1348	204	10-1490-12	199
06-4136	132	10-1178	198	10-1350	224	10-1491	199
06-4137	132	10-1180	198	10-1352	224	10-1491-12	199
06-4138	132	10-1181	198	10-1354	224	10-1492	199
06-4139	132	10-1182	200	10-1356	224	10-1492-12	199
06-4140	132	10-1183	200	10-1362	224	10-1493	199
06-4141	132	10-1184	200	10-1364	224	10-1493-12	199
06-4142	127,130,139	10-1186	200	10-1366	224	10-1494	199
06-4143	130,127,139	10-1188	200	10-1370	224	10-1495	199
06-4144	127,130,139	10-1189	200	10-1372	224	10-1496	199
06-4145	127,130,139	10-1190	200	10-1374	224	10-1496-12	199
06-4146	127,130,139	10-1192	200	10-1376	224	10-1497	200
06-4147	127,130,139	10-1193	200	10-1380	224	10-1497-12	200
06-4148	127,130,139	10-1194	201	10-1382	224	10-1498	199

# NUMERICAL INDEX



10-1498-12	199	10-1630	.212,213	10-1706	.201	10-1806	.204,229
10-1502	199	10-1635	.220	10-1707	.201	10-1808	.204,229
10-1502-12	199	10-1636	.220	10-1708	.201	10-1810	.204,229
10-1504	.200	10-1643	.211	10-1710	.202,229	10-1812	.204,229
10-1504-12	.200	10-1644	.211	10-1711	.202	10-1816	.204,229
10-1505	199	10-1645	.227	10-1712	.202	10-1828	.204
10-1505-12	199	10-1648	.227	10-1714	.202	10-1830	.204
10-1506	199	10-1650	.204,227	10-1716	.201	10-1832	.204
10-1506-12	199	10-1651	.204,227	10-1717	.201	10-1836	.204
10-1507	199	10-1652	.204,227	10-1718	.202	10-1838	.204
10-1507-12	199	10-1653	.211	10-1720	.202,229	10-1839	.204
10-1510	199	10-1657	.204,227	10-1722	.202	10-1850	.202
10-1510-12	199	10-1658	.227	10-1722-12	.202	10-1852	.202
10-1523	198	10-1659	.227	10-1724	.202	10-1854	.203
10-1523-12	198	10-1660	.204,224	10-1724-12	.202	10-1854-12	.203
10-1525	198	10-1664	.204,224	10-1725	.202	10-1860	.202
10-1525-12	198	10-1668	.204,224	10-1729	.203	10-1862	.202
10-1527	198	10-1670	.198	10-1731	.203	10-1864	.202
10-1527-12	198	10-1670-12	.198	10-1732	.203	10-1870	.202
10-1532	.201	10-1670-48	.198	10-1733	.203	10-1870-6	.202
10-1533	198	10-1671	.198	10-1734	.203	10-1874	.201
10-1533-12	198	10-1671-12	.198	10-1736	.203	10-1876	.201
10-1535	.201,203	10-1671-48	.198	10-1737	.203	10-1876-12	.201
10-1535-12	.201,203	10-1674	.199	10-1737-12	.203	10-1877	.202,229
10-1536	198	10-1674-12	.199	10-1738	.202,229	10-1877-12	.202
10-1536-12	198	10-1675	.198	10-1738-12	.202	10-1878	.202
10-1538	198	10-1675-12	.198	10-1740	.203	10-1878-12	.202
10-1538-12	198	10-1675-48	.198	10-1742	.203	10-1879	.201
10-1539	198	10-1680	.201	10-1742-12	.203	10-1882	.202,203
10-1539-12	198	10-1680-12	.201	10-1744	.202	10-1882-12	.203
10-1540	199	10-1683	.201	10-1744-12	.202	10-1882-6	.202
10-1540-12	199	10-1683-12	.201	10-1746	.202	10-1883	.201
10-1541	198	10-1684	.200	10-1746-6	.202	10-1883-12	.201
10-1541-12	198	10-1684-12	.200	10-1747	.202	10-1884	.201
10-1542	.203	10-1685	.200	10-1747-6	.202	10-1884-12	.201
10-1542-12	.203	10-1685-12	.200	10-1748	.203	10-1886	.203
10-1543	198	10-1686	.200	10-1748-12	.203	10-1886-12	.203
10-1543-12	198	10-1686-12	.200	10-1750	.203	10-1887	.203
10-1544	198	10-1687	.200	10-1750-12	.203	10-1887-12	.203
10-1544-12	198	10-1687-12	.200	10-1752	.203	10-1888	.201
10-1545	.198,226	10-1688	.200	10-1752-12	.203	10-1888-12	.201
10-1545-12	198	10-1688-12	.200	10-1753	.203	10-1892	.201
10-1547	198	10-1690	.200	10-1753-12	.203	10-1928	.168
10-1547-12	198	10-1690-12	.200	10-1754	.203	10-1930	.168
10-1550	198	10-1691	.200,229	10-1754-12	.203	10-1931	.168
10-1550-12	198	10-1691-12	.200	10-1755	.203	10-1932	.168
10-1551	.200	10-1692	.200	10-1755-12	.203	10-1933	.168
10-1552	199	10-1692-12	.200	10-1756	.203	10-1934	.168
10-1552-12	199	10-1693	.200	10-1756-12	.203	10-1935	.168
10-1554	198	10-1693-12	.200	10-1757	.201	10-1937	.168
10-1554-12	198	10-1694	.200,229	10-1758	.201	10-1941	.201
10-1556	.202	10-1694-12	.200	10-1759	.201	10-1942	.201
10-1560	.202	10-1695	.200	10-1760	.202	10-1943	.201
10-1585	198	10-1695-12	.200	10-1760-12	.202	10-1948	.201,203
10-1585-12	198	10-1698	.200	10-1761	.202	10-1948-12	.201,203
10-1585-48	198	10-1698-12	.200	10-1761-12	.202	10-1949	.201
10-1607	.212,213	10-1699	.200	10-1763	.201	10-1949-12	.201
10-1608	.213,212	10-1699-12	.200	10-1770	.204,229	10-1950	.203
10-1612	.212,214	10-1700	.201	10-1775	.204	10-1950-12	.203
10-1613	.212,214	10-1701	.201	10-1776	.204	10-1952	.203
10-1623	.222	10-1702	.201	10-1780	.204,229	10-1952-12	.203
10-1626	.209	10-1703	.201	10-1800	.204,229	10-1953	.203
10-1629	.219	10-1705	.202,229	10-1805	.204,229	10-1953-12	.203

10-1954	.203	13-2060	.3	15-3590	.21	17-2655	.27
10-1954-12	.203	13-2065	.3	15-7032	.64	17-2662	.27
10-1955	.203	13-2155	.19	16-1055	.62	17-2672	.27
10-1955-12	.203	14-1045	.2	16-1056	.62	17-2680	.27
10-1956	.203	14-1050	.2	16-1057	.62	17-2690	.27
10-1956-12	.203	14-1055	.2	16-1156	.62	17-2855	.27
10-1957	.203	14-1058	.2	16-1505	.62	17-2862	.27
10-1959	.203	14-1060	.2	16-1510	.62	17-2872	.27
10-1960	.201	14-1065	.2	16-1515	.62	17-2878	.27
10-1961	.201	14-1155	.19	16-1605	.62	17-2880	.27
10-1965	.201	14-2045	.3	16-1610	.62	17-2890	.27
10-1965-12	.201	14-2050	.3	16-1615	.62	17-2962	.27
10-1966	.201	14-2055	.3	16-1805	.62	17-3055	.24
10-1966-12	.201	14-2060	.3	16-1810	.62	17-3062	.24
10-1967	.201	14-2065	.3	16-1905	.62	17-3068	.24
10-1967-12	.201	14-2155	.19	16-1910	.62	17-3075	.24
10-2555	.222	15-1045	.2	16-2005	.62	17-3155	.24
10-2556	.222	15-1050	.2	16-2010	.62	17-3162	.24
10-2634	.220	15-1055	.2	16-2105	.62	17-3168	.24
10-2701	.212,215	15-1060	.2	16-2110	.62	17-3175	.24
10-2722	.212,218	15-1065	.2	16-2210	.62	17-3265	.32
10-2724	.212,218	15-1155	.19	16-2310	.62	17-3275	.32
10-2774	.212,216	15-1307	.18	16-2311	.62	17-3365	.32
10-2777	.212,217	15-1308	.18	16-2405	.62	17-3375	.32
10-2800	.212,221	15-1355	.9	16-2505	.62	17-3455	.32
10-2801	.212	15-1555	.4	16-2605	.63	17-3555	.32
10-2824	.224	15-1567	.4	16-2610	.63	17-3995	.37
10-2842	.223	15-1762	.18	16-2705	.63	17-3996	.37
10-2850	.223	15-1862	.18	16-2800	.63	17-3997	.37
10-3772	.217	15-2045	.3	16-3552	.63	18-1050	.23
11-1035	.13	15-2050	.3	16-3557	.63	18-1150	.23
11-1045	.13	15-2055	.3	16-3562	.63	18-1250	.30
11-1055	.13	15-2060	.3	16-3567	.63	18-1552	.25
11-1060	.13	15-2065	.3	17-1062	.30	18-1652	.25
11-1072	.13	15-2307	.18	17-1080	.30	18-1752	.27
11-1078	.13	15-2308	.18	17-1162	.30	18-1852	.27
11-1080	.13	15-2555	.4	17-1180	.30	18-1952	.24
11-1180	.15,107	15-2567	.4	17-1220	.31,33	18-2052	.24
11-1255	.16	15-2569	.4	17-1225	.31,33	18-2140	.29
11-1278	.16	15-2762	.18	17-1230	.26	18-2155	.29
11-1280	.16	15-2862	.18	17-1232	.26	18-2162	.29
11-1281	.16	15-3150	.10	17-1235	.26	18-2164	.29
11-1282	.16	15-3306	.64	17-1262	.30	19-1045	.38
11-1283	.16	15-3310	.64	17-1335	.26	19-1050	.38
11-1284	.16	15-3311	.64	17-1362	.30	19-1055	.38
11-1297	.15	15-3315	.64	17-1450	.23	19-1058	.38
11-1298	.15	15-3320	.22	17-1459	.23	19-1060	.38
11-1380	.15	15-3325	.64	17-1650	.23	19-1070	.38
11-1390	.15	15-3326	.64	17-1762	.30	19-1080	.38
11-1495	.15	15-3330	.64	17-1772	.30	19-1110	.38
11-1496	.15	15-3331	.64	17-2055	.25	19-1112	.38
11-1812	.113	15-3342	.64	17-2155	.25	19-1245	.39
11-1910	.113	15-3343	.64	17-2255	.28	19-1250	.39
11-1990	.113	15-3349	.64	17-2262	.28	19-1255	.39
13-1045	.2	15-3352	.64	17-2267	.28	19-1258	.39
13-1050	.2	15-3357	.64	17-2272	.28	19-1260	.39
13-1055	.2	15-3410	.64	17-2280	.28	19-1270	.39
13-1060	.2	15-3452	.64	17-2362	.28	19-1280	.39
13-1065	.2	15-3457	.64	17-2455	.28	19-1310	.39
13-1155	.19	15-3542	.22	17-2462	.28	19-1312	.39
13-2045	.3	15-3570	.21	17-2467	.28	19-2170	.50
13-2050	.3	15-3575	.21	17-2472	.28	19-2172	.50
13-2055	.3	15-3585	.21	17-2480	.28	19-2260	.50

# NUMERICAL INDEX



19-2280	.50	21-227	.125	21-498	.28	21-8039	.67
19-2310	.50	21-231	.13,191	21-577	.34,196	21-8040	.68
19-2930	.44,103	21-232	.129	21-586	.34	21-8042	.84
19-2945	.44,103	21-237	.13	21-593	.37	21-8043	.84
19-3030	.44,103	21-241	.13	21-598	.37,197	21-8044	.68,84
19-3035	.44,103	21-254	.191	21-599	.37	21-8045	.68,84
19-3040	.44,103	21-263	.2	21-604	.196	21-8046	.68
19-3045	.44,103	21-266	.2	21-606	.34,196	21-8055	.68
19-3160	.33	21-271	.2	21-608	.34,196	21-8058	.68
19-3162	.33	21-272	.2,192	21-705	.38	21-8060	.67
19-3240	.44,103	21-275	.2,192	21-708	.44	21-8061	.67
19-3340	.44,103	21-278	.2	21-710	.38,193	21-8062	.68
19-3350	.103	21-281	.2	21-727	.38	21-8064	.68
19-3360	.103	21-284	.2	21-731	.38	21-8065	.67
20-1260	.58	21-285	.31	21-736	.38	21-8070	.68
20-1265	.58	21-288	.2	21-742	.38	21-8071	.68
20-1270	.58	21-289	.31	21-753	.39	21-8075	.65
20-1280	.58	21-291	.3	21-757	.39,193	21-8080	.65
20-1290	.58	21-292	.3	21-762	.39	21-8082	.66
20-1295	.58	21-293	.3	21-766	.39	21-8086	.68
20-1350	.56	21-294	.3	21-769	.39	21-809	.56,195
20-1352	.56	21-295	.3	21-771	.40,193	21-810	.60,195
20-1450	.59	21-299	.3	21-772	.40	21-826	.55,195
20-1547	.55	21-300	.3	21-775	.41,193	21-832	.59,195
20-1750	.60	21-303	.135	21-776	.41	21-838	.58,195
20-1751	.60	21-308	.4,192	21-777	.44	21-842	.54
20-1870	.61	21-312	.4	21-778	.43,193	21-847	.54,195
20-2052	.54	21-313	.135	21-781	.44,193	21-853	.54
20-2060	.54	21-321	.4	21-785	.46	21-869	.54
20-2070	.54	21-324	.135	21-788	.46	21-877	.57
20-2270	.54	21-325	.4	21-791	.44	21-930	.29,196
20-2480	.54	21-335	.5,192	21-793	.44	21-934	.29
20-2490	.54	21-336	.5,192	21-8000	.65	21-938	.29
20-2747	.57	21-337	.136	21-8001	.65	22-1054	.13
20-2755	.57	21-339	.6,192	21-8002	.65	22-1057	.5
20-2765	.57	21-340	.6,192	21-8004	.65	22-1063	.39
20-2775	.57	21-346	.11,191	21-8005	.65	22-1070	.6
20-2910	.54	21-348	.136	21-8006	.65	22-1071	.6
20-2911	.54	21-352	.11,191	21-8007	.65	22-1072	.13
20-3090	.56	21-358	.9,191	21-8008	.65	22-1135	.7
20-3910	.61	21-362	.136	21-8009	.65	22-1145	.2
20-4170	.61	21-363	.14	21-8010	.65	22-1150	.2
20-4852	.61	21-364	.14,191	21-8011	.65	22-1155	.2
20-4867	.61	21-365	.73	21-8012	.66	22-1161	.38
21-010	.156	21-366	.73	21-8013	.66	22-1162	.38
21-101	.16	21-374	.36,197	21-8014	.66	22-1163	.38
21-102	.7	21-386	.36,197	21-8016	.66	22-1164	.38
21-103	.7	21-409	.26,194	21-8020	.66	22-1235	.7
21-104	.7,192	21-421	.26,194	21-8022	.66	22-1240	.12
21-105	.16	21-426	.23,194	21-8023	.66	22-1241	.12
21-107	.7	21-431	.23,194	21-8025	.66	22-1242	.12
21-109	.192	21-436	.25,194	21-8026	.66	22-1342	.12
21-123	.45	21-442	.25,194	21-8027	.66	22-1354	.9
21-124	.45	21-447	.24,194	21-8028	.66	22-1442	.8
21-129	.45	21-452	.24,194	21-8029	.66	22-1445	.3
21-135	.45	21-470	.28	21-8030	.66	22-1450	.3
21-146	.45	21-471	.28	21-8031	.66	22-1455	.3
21-151	.45	21-473	.28,194	21-8032	.66	22-1542	.8
21-180	.51	21-477	.28,194	21-8033	.66	22-1545	.3
21-209	.129,7	21-481	.28	21-8034	.66	22-1550	.3
21-222	.13	21-485	.28	21-8035	.66	22-1555	.3
21-224	.129	21-488	.27,197	21-8036	.67	22-1556	.4
21-226	.13	21-492	.28	21-8037	.67	22-1567	.4

22-1645	.3	22-8850	.73	23-2225	.56	30-1560	.79
22-1650	.3	22-8853	.73	23-2228	.54	30-1580	.79
22-1655	.3	22-8855	.73	23-2230	.60	30-1610	.79
22-2280	.28	22-8920	.72	23-2232	.59	30-1612	.79
22-2450	.5	22-8940	.72	23-2234	.58	30-1945	.79
22-2460	.5	22-9027	.71	23-2235	.60	30-1950	.79
22-2520	.20	22-9029	.71	23-2236	.57	30-1955	.79
22-2545	.5	22-9132	.74	23-2500	.26	30-1960	.79
22-2550	.5	22-9133	.74	23-2501	.26	30-1980	.79
22-2555	.4	22-9142	.74	23-2505	.23	30-2010	.79
22-2567	.4	22-9143	.74	23-2506	.23	30-2012	.79
22-2650	.5	22-9155	.133	23-2507	.25	30-2145	.79
22-2652	.19	23-1112	.2	23-2508	.25	30-2150	.79
22-2653	.19	23-1113	.2	23-2510	.24	30-2155	.79
22-2755	.20	23-1114	.2	23-2513	.24	30-2160	.79
22-2760	.20	23-1116	.2	23-2552	.28	30-2580	.79
22-2762	.20	23-1118	.2	23-2561	.28	34-1410	.133
22-2834	.11	23-1138	.3	23-2563	.28	34-1412	.133
22-2835	.11	23-1140	.3	23-2577	.27	34-1414	.133
22-2837	.18	23-1142	.3	23-2585	.27	34-1417	.133
22-2838	.18	23-1152	.7	23-2604	.40	34-1418	.133
22-2844	.11	23-1153	.7	23-2606	.41	34-1420	.133
22-2845	.11	23-1154	.7	23-2608	.43	34-1422	.133
22-2934	.10	23-1155	.7	23-2819	.39	34-1424	.133
22-2935	.10	23-1156	.12	23-2834	.38	34-1428	.133
22-2947	.10	23-1157	.12	23-2836	.38	34-2023	.134
22-2950	.10	23-1160	.12	23-2838	.38	34-2230	.134
22-3255	.30	23-1161	.12	23-2861	.29	34-2422	.133
22-3270	.30	23-1162	.8	23-2862	.29	34-2428	.133
22-3555	.28	23-1163	.8	23-2864	.29	34-2434	.133
22-3655	.28	23-1168	.4	23-2865	.29	34-2438	.133
22-3755	.27	23-1169	.4	23-9250	.107	36-1662	.32
22-3855	.27	23-1170	.4	23-9251	.109	36-1677	.32
22-4150	.50	23-1171	.4	23-9255	.109	36-1692	.32
22-4250	.50	23-1176	.5	23-9259	.109	36-2060	.29
22-4350	.50	23-1177	.5	23-9273	.109	36-2160	.29
22-4450	.50	23-1178	.5	23-9275	.109	36-2260	.29
22-5050	.61	23-1179	.5	23-9276	.109	36-2275	.29
22-6155	.32	23-1184	.6	23-9292	.112	36-2278	.29
22-6157	.29	23-1186	.6	24-2340	.14	36-2280	.29
22-6577	.134	23-1193	.11	24-2341	.14	36-2295	.29
22-6585	.134	23-1194	.11	24-2342	.14	36-2298	.29
22-6770	.49	23-1195	.9	24-2345	.14	36-2385	.29
22-6870	.49	23-1196	.10	24-2346	.14	36-2690	.28
22-8067	.76	23-1202	.13	24-2347	.14	36-2710	.28
22-8075	.76	23-1203	.13	24-2349	.14	36-2790	.28
22-8080	.76	23-1250	.22	30-1045	.79	36-2810	.28
22-8180	.76	23-1254	.22	30-1050	.79	40-2921	.114
22-8210	.75	23-1267	.21	30-1055	.79	40-2922	.114
22-8211	.75	23-1268	.21	30-1060	.79	40-2923	.114
22-8212	.75	23-1270	.21	30-1070	.79	40-2925	.114
22-8213	.75	23-1280	.21	30-1080	.79	40-2927	.114
22-8214	.75	23-2120	.56	30-1145	.79	40-2928	.114
22-8215	.75	23-2124	.55	30-1150	.79	40-3040	.108
22-8245	.71	23-2125	.56	30-1155	.79	40-3055	.119
22-8255	.71	23-2128	.54	30-1160	.79	40-3077	.119
22-8345	.71	23-2130	.60	30-1170	.79	40-3087	.119
22-8355	.71	23-2132	.59	30-1180	.79	40-3155	.119
22-8360	.73	23-2134	.58	30-1380	.79	40-3177	.119
22-8460	.73	23-2135	.60	30-1450	.79	40-3188	.118
22-8560	.74	23-2136	.57	30-1545	.79	40-3190	.118
22-8832	.72	23-2220	.56	30-1550	.79	40-3192	.118
22-8834	.72	23-2224	.55	30-1555	.79	40-3200	.120

# NUMERICAL INDEX



40-3202	120	40-7120	117	41-1395	77	47-2462	75
40-3208	118	40-7165	114	41-1396	77	47-2467	120
40-4265	120	40-7250	114	41-315	101	47-2468	120
40-4272	120	40-7265	114	41-318	101	47-2500	75
40-4360	120	40-7280	114	41-330	101	47-2502	75
40-4365	120	40-7284	114	41-350	101	47-2505	75
40-4372	120	40-7286	114	41-368	101	47-2507	75
40-4560	119	40-7330	113	41-372	101	47-2510	75
40-4572	119	40-7331	113	41-378	101	47-2555	75,77
40-4575	119	40-7332	113	41-388	101	47-2556	75,77
40-6106	115	40-7333	113	42-1420	117	47-2570	77
40-6112	115	40-7334	113	42-1422	117	47-2572	77
40-6118	115	40-7335	113	42-1425	117	47-2647	76
40-6206	115	40-7336	113	42-1865	71	47-2650	75,100
40-6212	115	40-7337	113	42-1875	71	47-2651	75,100
40-6218	115	40-7338	113	42-1895	71	47-2832	73
40-6306	115	40-7470	126	42-1965	71	47-2834	73
40-6312	115	40-7472	126	42-1975	71	47-2837	35
40-6318	115	40-8100	113	42-1995	71	47-2852	35
40-6535	121	40-8101	113	44-489	101	47-2913	72,97
40-6537	121	40-8102	113	45-202	102	47-2925	35
40-6771	115	40-8103	113	45-236	102	47-2930	35
40-6772	115	40-8104	113	45-266	102	47-2935	34
40-6773	115	40-8110	113	45-507	102	47-2945	34
40-6774	115	40-8111	113	45-545	102	47-2955	34
40-6775	115	40-8112	113	45-738	102	47-2959	34
40-6776	115	40-8114	113	45-796	102	47-2960	34
40-6777	115	40-8130	113	45-835	102	47-3040	35
40-6781	115	40-8131	113	46-356	102	47-3057	35
40-6782	115	40-8132	113	47-1047	19	48-128	101
40-6783	115	40-8136	113	47-1048	19	48-202	102
40-6784	115	40-8137	113	47-1049	19	48-236	102
40-6785	115	40-8138	113	47-1058	19	48-266	102
40-6786	115	40-9685	108	47-1059	19	48-315	101
40-6787	115	40-9688	108	47-1068	19	48-318	101
40-6791	115	40-9815	108	47-1069	19	48-330	101
40-6792	115	40-9820	108	47-1070	19	48-350	101
40-6793	115	40-9825	108	47-1135	7	48-368	101
40-6794	115	41-1050	17	47-1145	7	48-378	101
40-6795	115	41-1054	17	47-1146	17	48-388	101
40-6796	115	41-1105	19	47-1173	49	48-489	101
40-6797	115	41-1125	20	47-1175	49	48-507	102
40-6799	115	41-1170	121	47-1180	49	48-738	102
40-6800	115	41-1175	120	47-1186	49	48-835	102
40-6801	115	41-1180	119	47-1235	7	50-1080	117
40-6802	115	41-1235	126	47-1245	7	50-1355	33
40-6803	115	41-1260	122	47-1246	7	50-1357	33
40-6804	115	41-1262	122	47-1247	17	50-1372	30
40-6805	115	41-1264	122	47-1248	7	50-1472	30
40-6920	116	41-1266	122	47-1250	17	50-1953	134
40-6921	116	41-1270	122	47-1255	17	50-1955	134
40-6922	116	41-1272	122	47-1345	86	50-1957	134
40-6923	116	41-1274	122	47-1360	5	50-1982	134
40-7000	117	41-1276	122	47-1447	43	50-2005	134
40-7100	117	41-1300	122	47-1448	42	50-2006	134
40-7110	117	41-1305	122	47-1450	43	50-2007	134
40-7111	117	41-1310	122	47-1470	50	50-2008	134
40-7112	117	41-1330	122	47-2047	41	50-2009	134
40-7113	117	41-1332	122	47-2049	41	50-2010	134
40-7114	117	41-1342	121	47-2147	40	50-2011	134
40-7115	117	41-1344	121	47-2380	126,129	50-2012	134
40-7116	117	41-1346	121	47-2382	129	50-2014	134
40-7118	117	41-1348	121	47-2447	43	50-2670	49

50-2770	.49	55-9080	.6	64-1240	.17	65-3172	.94,132
50-2870	.49	55-9084	.6	64-1241	.17	65-3173	.94,132
50-2970	.49	55-9090	.6	64-1242	.12	65-3174	.94,132
50-3045	.41	55-9094	.6	64-1340	.17	65-3180	.94,132
50-3047	.41	55-9180	.6	64-1341	.17	65-3181	.94,132
50-3048	.42,48	55-9184	.6	64-1342	.12	65-3182	.94,132
50-3049	.42,48	55-9190	.6	64-1345	.10,17	65-3183	.94,132
50-3050	.42	55-9210	.6	64-1442	.8	65-3195	.100
50-3145	.40	55-9310	.6	64-1445	.10,17	65-3205	.77,100
50-3147	.40	55-9311	.6	64-1542	.8	65-3206	.77,100
50-3148	.42	55-9411	.6	64-1742	.85	65-3215	.100
50-3371	.51	55-9612	.6	64-1842	.85	65-3216	.100
51-1447	.70	55-9614	.6	64-1942	.85	65-3217	.100
51-1448	.70	57-1445	.74	64-1950	.85	65-3250	.100
51-3049	.70	60-1085	.74	64-1951	.85	65-3258	.77
51-3447	.70	60-1460	.74	64-1955	.85	65-3265	.100
51-3460	.70	60-3070	.76	64-1958	.85	65-4062	.96,100
51-3480	.70	60-3085	.76	64-2035	.86	65-4064	.96,100
51-4360	.69	60-3090	.76	64-2036	.86	65-4066	.96,100
51-4370	.69	60-3112	.76	64-2142	.7	65-4068	.96
51-4382	.69	60-3113	.76	64-2535	.85	65-4074	.96
51-4395	.69	60-3114	.76	64-3050	.87	65-4076	.96
52-1277	.76	60-3212	.76	64-3052	.87	65-4098	.88
52-1415	.157	60-3312	.76	64-3142	.87	65-4099	.88
52-1417	.157	60-3412	.76	64-3144	.87	65-4100	.88
52-1420	.157	60-3594	.76	64-3145	.87	65-4101	.88
52-1422	.157	60-3596	.76	64-3146	.87	65-4103	.88
52-1425	.157	60-3598	.76	64-3230	.20,86	65-4105	.88
52-1427	.157	60-3607	.76	64-3235	.20,86	65-4107	.88
52-1430	.157	60-3610	.76	64-3260	.18,85	65-4120	.88
52-1435	.157	60-3612	.76	64-3270	.86	65-4121	.88
52-1530	.157	60-3615	.76	64-3280	.86	65-4123	.88
52-1531	.157	60-3617	.76	64-3297	.86	65-4125	.88
52-1532	.157	60-3620	.76	64-3298	.86	65-4127	.88
52-1533	.157	60-3625	.76	65-1012	.98	65-6357	.57
52-1540	.157	60-5431	.76	65-1127	.98	65-6358	.57
52-1541	.157	60-5432	.76	65-1227	.99	65-6550	.61
52-1542	.157	60-5433	.76	65-1332	.99	65-6732	.78
52-1543	.157	60-5434	.76	65-1522	.99	65-6735	.78
52-3270	.50	60-5435	.76	65-1532	.99	65-6950	.88
52-3282	.50	60-5502	.72	65-1535	.99	65-6952	.88
52-3310	.50	60-5503	.72	65-1740	.98	65-6960	.88
52-3370	.50	60-5504	.72	65-1742	.98	65-7000	.88
52-3382	.50	60-5506	.72	65-1744	.98	65-7001	.88
52-3410	.50	60-5602	.72	65-1746	.98	65-7002	.88
52-3970	.50	60-5603	.72	65-1748	.98	65-7003	.88
52-5062	.48	60-5604	.72	65-1750	.98	65-7265	.97
52-5077	.48	60-5606	.72	65-1752	.98	65-7270	.97
52-5095	.48	60-5812	.72	65-1754	.98	65-7272	.97
52-5162	.48	60-5813	.72	65-1756	.98	65-7275	.97
52-5177	.48	60-5814	.72	65-1758	.98	65-7400	.121
52-5195	.48	60-5816	.72	65-1765	.98	65-7401	.121
52-5262	.48	60-5822	.72	65-1815	.71,97	65-7402	.121
52-5277	.48	60-5823	.72	65-1841	.76	65-7403	.121
52-5295	.48	60-5824	.72	65-1842	.76	65-8206	.99
52-6830	.33	60-5826	.72	65-1843	.76	65-8215	.99
52-6832	.33	60-6062	.73	65-1844	.76	66-1035	.95
55-2855	.31	60-6162	.73	65-3022	.99	66-1036	.95
55-2870	.31	60-6164	.73	65-3025	.99	66-1038	.95
55-2880	.31	60-6340	.71	65-3140	.94	66-1235	.95
55-2890	.31	60-6342	.71	65-3162	.94	66-1236	.95
55-2892	.30	60-6570	.73	65-3170	.132,94	66-1265	.95
55-2898	.31	60-6580	.73	65-3171	.94,132	66-1435	.95

# NUMERICAL INDEX



66-1535	.91	66-6152	.89	67-3411	.127	73-1353	.132
66-1635	.91	66-6160	.89	67-3412	.127	73-1354	.132
66-1735	.91	66-6164	.89	67-3418	.127	73-1355	.132
66-1742	.91	66-6166	.89	67-3420	.127	73-1356	.132
66-1830	.91	66-6168	.89	67-3424	.127	74-1370	.37
66-1940	.53,90	66-6175	.93	67-4504	.116	74-1470	.37
66-2009	.90	66-6178	.93	67-4506	.116	74-1570	.37
66-2012	.90	66-6180	.93	67-4508	.116	74-3075	.30
66-2040	.90	66-6194	.93	67-4510	.116	74-3260	.25
66-2140	.53,90	66-6196	.93	67-4512	.116	74-3270	.25
66-2540	.90	66-6240	.92	67-4514	.116	75-2160	.133
66-2635	.90	66-6242	.92	67-4604	.116	75-2161	.133
66-2640	.90	66-6250	.92	67-4606	.116	75-5460	.5
66-2740	.45	66-6268	.92	67-4608	.116	75-5570	.6
66-2742	.45	66-6338	.92	67-4610	.116	75-5670	.6
66-2840	.45	66-6340	.92	67-4612	.116	75-7077	.129
66-2940	.45	66-6342	.95	67-4614	.116	75-7492	.129
66-2942	.45	66-7130	.47	67-4620	.116	75-7590	.129
66-3140	.45	66-7244	.47	67-4622	.116	75-9070	.123
66-3142	.45	66-7250	.47	67-4624	.116	75-9075	.123
66-3240	.45	66-7347	.92	67-4626	.116	75-9155	.123
66-3340	.45	67-1035	.129	67-4628	.116	75-9245	.123
66-3342	.45	67-1036	.129	67-4630	.116	75-9250	.123
66-3450	.90	67-1038	.129	67-4632	.116	75-9405	.123
66-3540	.45	67-1039	.129	67-5175	.117	75-9406	.123
66-3542	.45	67-1040	.129	67-5458	.117	75-9407	.123
66-3740	.45	67-1150	.125	67-5987	.118,120	75-9408	.123
66-3742	.45	67-1455	.51	67-5990	.118	75-9409	.123
66-3927	.46	67-1465	.51,125	67-5992	.118	75-9505	.123
66-4032	.47,53	67-1555	.51	67-5994	.118	75-9506	.123
66-4034	.47	67-2480	.128	67-7064	.127	75-9507	.123
66-4132	.47,53	67-2481	.128	67-7128	.127	75-9508	.123
66-4133	.47	67-2488	.128	67-7256	.127	75-9509	.123
66-4134	.47	67-2489	.128	67-7512	.127	76-1390	.133
66-4232	.47,53	67-2490	.128	67-7605	.127	76-1490	.133
66-4234	.53	67-2491	.128	70-1020	.124	78-1001	.74
66-4235	.53	67-2492	.128	70-1030	.124	78-1002	.74
66-4525	.46,53	67-2493	.128	70-1035	.124	78-1003	.74
66-4526	.46	67-2498	.128	70-1070	.124	78-1101	.74
66-4530	.46	67-2499	.128	70-1071	.124	78-1102	.74
66-4625	.46,53	67-2500	.128	70-1072	.124	78-1103	.74
66-4626	.46	67-2501	.128	70-1075	.124	78-2813	.225
66-4840	.95	67-2502	.128	70-4375	.51,125	78-2821	.225
66-4950	.47	67-2503	.128	70-4385	.51,125	78-2822	.225
66-4951	.47	67-2508	.128	70-4470	.125	78-2823	.225
66-5942	.90	67-2509	.128	70-5232	.125	78-2831	.225
66-6036	.46	67-2510	.128	70-5235	.125	78-2832	.225
66-6037	.46	67-2511	.128	70-5332	.125	78-3360	.133
66-6038	.46	67-2512	.128	70-5335	.125	78-3460	.133
66-6039	.46	67-2513	.128	70-7062	.126	80-1410	.36
66-6105	.89	67-2514	.128	70-7185	.126	80-1419	.36
66-6109	.89	67-2515	.128	73-1188	.132	80-1872	.158,159
66-6110	.92	67-2516	.128	73-1189	.132	80-1910	.159
66-6112	.92	67-2517	.128	73-1190	.132	80-1911	.159
66-6114	.92	67-2518	.128	73-1191	.132	80-1912	.159
66-6115	.89	67-2519	.128	73-1192	.132	80-1914	.159
66-6118	.89	67-2521	.128	73-1193	.132	80-1945	.158
66-6120	.90	67-2522	.128	73-1194	.132	80-1950	.158
66-6125	.89	67-2523	.128	73-1195	.132	80-1951	.158
66-6126	.89	67-2525	.128	73-1196	.132	80-1952	.158
66-6140	.89	67-2526	.128	73-1197	.132	80-1960	.158
66-6142	.89	67-3402	.127	73-1197	.132	80-2244	.158,159
66-6150	.89	67-3404	.127	73-1351	.132	80-2245	.158,159
				73-1352	.132		



80-2715	.134	88-0038	.188	88-0115	.186	88-0181	.206
80-2815	.134	88-0039	.188	88-0116	.186	88-0182	.206
80-2860	.79	88-0040	.188	88-0117	.186	88-0183	.206
80-2870	.79	88-0042	.188	88-0118	.186	90-1080	.20
80-2910	.79	88-0044	.187	88-0119	.187	90-1180	.20
85-2010	.139	88-0045	.187	88-0120	.187	90-1280	.20
85-2012	.139	88-0046	.187	88-0123	.187	90-1380	.20
85-2014	.139	88-0047	.187	88-0124	.189	90-1480	.20
85-2016	.139	88-0048	.187	88-0125	.189	90-1580	.20
85-2018	.139	88-0049	.187	88-0126	.189	90-1590	.4
85-2020	.139	88-0051	.187	88-0127	.187	90-1690	.4
85-2022	.139	88-0052	.187	88-0128	.187	90-3700	.135
85-2024	.139	88-0053	.187	88-0129	.187	90-3701	.135
85-2026	.139	88-0054	.187	88-0130	.187	90-3702	.135
85-2028	.139	88-0055	.187	88-0131	.187	90-3710	.136
85-2030	.139	88-0056	.187	88-0132	.187	90-3711	.136
85-2032	.139	88-0057	.187	88-0133	.187	90-3712	.136
85-2034	.139	88-0058	.189	88-0134	.187	90-3713	.136
85-2036	.139	88-0059	.189	88-0135	.187	90-3800	.135
85-2038	.139	88-0060	.189	88-0136	.187	90-3802	.135
87-1052	.35	88-0061	.189	88-0137	.187	90-3803	.135
87-2095	.34	88-0062	.189	88-0138	.187	90-3849	.135
87-2195	.34	88-0063	.189	88-0139	.187	90-3851	.136
87-2199	.34	88-0064	.189	88-0140	.187	90-4784	.137
87-2295	.34	88-0065	.189	88-0141	.187	90-4785	.137
87-2395	.34	88-0066	.189	88-0142	.187	90-4786	.137
88-0001	.188	88-0069	.189	88-0143	.187	90-4787	.137
88-0002	.188	88-0070	.189	88-0144	.187	90-4788	.137
88-0003	.188	88-0071	.189	88-0145	.205	90-4789	.137
88-0004	.188	88-0072	.189	88-0146	.205	90-4790	.137
88-0005	.188	88-0073	.189	88-0147	.205	90-4791	.137
88-0006	.188	88-0074	.189	88-0148	.205	90-4792	.137
88-0007	.188	88-0075	.189	88-0149	.205	90-4793	.137
88-0008	.188	88-0082	.186	88-0150	.205	90-4794	.137
88-0009	.188	88-0083	.186	88-0151	.205	90-4795	.137
88-0010	.188	88-0084	.186	88-0152	.205	90-4796	.137
88-0011	.188	88-0085	.186	88-0153	.205	90-4797	.137
88-0012	.188	88-0086	.186	88-0154	.205	90-4798	.137
88-0013	.188	88-0087	.186	88-0155	.205	90-4802	.137
88-0014	.188	88-0088	.186	88-0156	.205	90-4804	.137
88-0015	.188	88-0089	.186	88-0157	.205	90-4806	.137
88-0016	.188	88-0090	.186	88-0158	.205	90-4808	.137
88-0017	.186	88-0091	.186	88-0160	.206	90-4810	.137
88-0018	.186	88-0092	.186	88-0161	.206	90-4812	.137
88-0019	.186	88-0093	.186	88-0162	.206	90-4814	.137
88-0020	.186	88-0095	.186	88-0163	.206	90-4816	.137
88-0021	.186	88-0096	.186	88-0164	.206	90-4818	.137
88-0022	.186	88-0097	.186	88-0165	.206	90-4825	.137
88-0023	.186	88-0098	.186	88-0166	.206	90-4826	.137
88-0024	.186	88-0099	.186	88-0167	.206	90-4908	.137
88-0025	.188	88-0100	.186	88-0168	.206	90-4910	.137
88-0026	.188	88-0101	.186	88-0169	.206	90-4912	.137
88-0027	.188	88-0102	.186	88-0170	.206	90-4914	.137
88-0028	.188	88-0103	.186	88-0171	.206	90-4916	.137
88-0029	.188	88-0104	.186	88-0172	.206	90-4918	.137
88-0030	.186	88-0105	.186	88-0173	.206	90-4920	.137
88-0031	.186	88-0106	.186	88-0174	.206	90-4925	.137
88-0032	.186	88-0107	.186	88-0175	.206	90-4926	.137
88-0033	.186	88-0108	.186	88-0176	.206	90-5215	.137
88-0034	.188	88-0109	.186	88-0177	.206	90-5219	.137
88-0035	.188	88-0110	.186	88-0178	.206	90-5223	.137
88-0036	.188	88-0111	.186	88-0179	.206	90-5227	.137
88-0037	.188	88-0112	.186	88-0180	.206	90-5231	.137

# NUMERICAL INDEX



90-5235	.137	95-289	.31	95-629	.35	96-1196	.160,190
90-5239	.137	95-292	.3	95-635	.35	96-1198	.160,190
90-5243	.137	95-295	.3	95-705	.38	96-1199	.160,190
90-5250	.137	95-299	.3	95-710	.38	96-1400	.230
90-5312	.138	95-303	.135	95-727	.38	96-1402	.230
90-5314	.138	95-308	.4	95-731	.38	96-1404	.230
90-5412	.138	95-312	.135	95-736	.38	96-1406	.230
90-5413	.138	95-321	.4	95-753	.39	96-1408	.230
90-5421	.139	95-324	.135	95-757	.39	96-1410	.230
90-5422	.139	95-325	.4	95-762	.39	96-1412	.230
90-5423	.139	95-330	.4	95-766	.39	96-1414	.230
90-5424	.139	95-335	.5	95-771	.40	96-1416	.230
90-5425	.139	95-336	.5	95-772	.40	96-1500	.230
90-5426	.139	95-339	.6	95-775	.41	96-1502	.230
90-5428	.139	95-340	.6	95-776	.41	96-1504	.230
90-5431	.139	95-346	.11	95-777	.44	96-1506	.230
90-5432	.139	95-347	.136	95-778	.43	96-1508	.230
90-5433	.139	95-348	.136	95-781	.44	96-1510	.230
90-5434	.139	95-352	.11	95-809	.56	96-1512	.230
90-5435	.139	95-358	.9	95-810	.60	96-1514	.230
90-5436	.139	95-360	.8	95-826	.55	96-1516	.230
90-5438	.139	95-361	.8	95-832	.59	96-1550	.231
90-5499	.139	95-362	.136	95-842	.54	96-1552	.231
90-5500	.139	95-364	.14	95-847	.54	96-1621	.185
90-5710	.139	95-374	.36	95-853	.54	96-1627	.184
90-6095	.139	95-386	.36	95-869	.54	96-1640	.184
90-6195	.139	95-409	.26	95-934	.29	96-1641	.184
90-6280	.139	95-421	.26	95-938	.29	96-1642	.184
90-6281	.139	95-426	.23	95-952	.32	96-1649	.185
90-6610	.140	95-431	.23	96-0557	.136	96-1650	.185
90-6887	.141	95-436	.25	96-0567	.136	96-1651	.185
90-7520	.141	95-442	.25	96-0577	.136	96-1652	.185
90-7525	.141	95-447	.24	96-0670	.124,190	96-1653	.185
90-7530	.140	95-452	.24	96-0857	.135,190	96-1662	.185
90-7540	.140	95-458	.24	96-0867	.135	96-1664	.185
90-7610	.36	95-463	.24	96-0877	.135,190	96-1665	.185
90-7710	.36	95-470	.28	96-1001	.128,190	96-1666	.185
90-8301	.75	95-471	.28	96-1006	.128,190	96-1667	.184
90-8302	.75	95-473	.28	96-1011	.128,190	96-1668	.184
90-8303	.75	95-477	.28	96-1016	.128,190	96-1669	.185
90-8304	.75	95-481	.28	96-1021	.128,190	96-1670	.185
90-8305	.75	95-483	.28	96-1031	.128,190	96-1671	.184
91-1290	.36	95-485	.28	96-1032	.128	96-1672	.184
91-1298	.36	95-492	.28	96-1034	.128	96-1673	.184
93-1153	.132	95-494	.28	96-1035	.128,190	96-1674	.184
94-4025	.177	95-500	.27	96-1100	.160,190	96-1679	.185,200
94-4026	.176	95-501	.27	96-1105	.160,190	96-1680	.185
95-103	.7	95-504	.27	96-1110	.160,190	96-1700	.174
95-104	.7	95-512	.27	96-1115	.160,190	96-1703	.178
95-105	.16	95-513	.27	96-1120	.160,190	96-1704	.176
95-107	.7	95-514	.27	96-1125	.160,190	96-1705	.177
95-109	.7	95-515	.27	96-1130	.160,190	96-1710	.175
95-222	.13	95-516	.27	96-1140	.160	96-1712	.180
95-226	.13	95-517	.27	96-1142	.160	96-1713	.176
95-231	.13	95-518	.27	96-1144	.160	96-1714	.180
95-241	.13	95-521	.27	96-1146	.160	96-1715	.175
95-254	.16	95-525	.27	96-1148	.160	96-1722	.178
95-265	.2	95-571	.34	96-1150	.160	96-1723	.180
95-272	.2	95-577	.34	96-1152	.160	96-1724	.174
95-275	.2	95-586	.34	96-1160	.160,190	96-1725	.180
95-281	.2	95-592	.37	96-1190	.160,190	96-1726	.179
95-284	.2	95-606	.34	96-1192	.160,190	96-1731	.175
95-285	.31	95-611	.34	96-1194	.160,190	96-1735	.180

96-1740	180	96-2110	167	96-2537	23,194	96-2626	36,197
96-1744	175	96-2136	167	96-2538	23,194	96-2630	34,196
96-1747	177	96-2137	167	96-2539	23,194	96-2632	34,196
96-1780	185	96-2138	167	96-2540	8	96-2634	196
96-1782	185	96-2140	167	96-2541	8	96-2636	196
96-1784	185	96-2142	167	96-2542	8	96-2642	136
96-1786	185	96-2144	167	96-2543	8	96-2644	136
96-1788	185	96-2146	167	96-2544	28,194	96-2648	136
96-1790	185	96-2148	167	96-2545	28,194	96-2649	192
96-1792	185	96-2150	167	96-2546	28,194	96-2650	192
96-1793	185	96-2160	166	96-2547	28,194	96-2651	192
96-1794	185	96-2162	166	96-2550	24,194	96-2652	194
96-1795	185	96-2164	166	96-2551	24,194	96-2653	194
96-1796	185	96-2166	166	96-2552	24,194	96-2654	191
96-1797	185	96-2170	166	96-2553	24,194	96-2655	193
96-1799	185	96-2172	166	96-2554	26,194	96-2656	193
96-1801	179	96-2174	166	96-2555	26,194	96-2657	194
96-1805	174	96-2176	166	96-2556	26,194	96-2658	194
96-1806	174	96-2178	166	96-2557	26,194	96-2659	195
96-1811	185	96-2180	166	96-2558	43,193	96-2660	193
96-1812	185	96-2182	166	96-2559	43,193	96-2661	193
96-1813	185	96-2184	166	96-2560	25,194	96-2662	191
96-1814	185	96-2186	166	96-2561	25,194	96-2663	191
96-1815	185	96-2190	166	96-2562	25,194	96-2680	6,192
96-1816	185	96-2192	166	96-2563	25,194	96-2682	6,192
96-1818	185	96-2194	166	96-2566	27,197	96-2684	31
96-1819	185	96-2196	166	96-2567	27,197	96-2685	31
96-1820	185	96-2198	166	96-2568	38,193	96-2701	16
96-1821	185	96-2402	16,191	96-2569	38,193	96-2702	16
96-1830	185	96-2404	16,191	96-2570	40,193	96-2703	16
96-1832	185	96-2406	37,197	96-2571	40,193	96-2704	16
96-1834	185	96-2408	37,197	96-2572	41,193	96-2705	32
96-1836	185	96-2410	44,193	96-2573	41,193	96-2706	32
96-1838	176	96-2412	44,193	96-2575	29,196	96-2707	27,197
96-1845	231	96-2502	13,191	96-2576	29,196	96-2708	27,197
96-1846	231	96-2503	13,191	96-2578	39,193	96-2903	173
96-1847	231	96-2504	7,192	96-2579	39,193	96-2906	173
96-1848	231	96-2505	7,192	96-2580	59,195	96-2909	173
96-1849	231	96-2506	7,192	96-2581	59,195	96-2910	173
96-1850	231	96-2507	7,192	96-2582	55,195	96-2915	173
96-1851	231	96-2510	191	96-2583	55,195	96-2917	173
96-1852	231	96-2511	191	96-2584	60,195	96-2919	173
96-1853	231	96-2512	9,191	96-2585	60,195	96-2931	173
96-1860	231	96-2513	9,191	96-2586	56,195	96-2951	173
96-1862	231	96-2516	5,192	96-2587	56,195	96-2956	173
96-1864	231	96-2517	5,192	96-2590	195	96-3160	166
96-1866	231	96-2518	14,191	96-2591	195	96-3162	166
96-1867	190	96-2519	14,191	96-2594	54,195	96-3164	166
96-1868	231	96-2520	2,192	96-2595	54,195	96-3166	166
96-1870	231	96-2521	2,192	96-2596	11,191	96-3170	166
96-1872	231	96-2522	2,192	96-2598	11,191	96-3171	179
96-1874	231	96-2523	2,192	96-2602	135	96-3172	166
96-1876	231	96-2524	3	96-2603	135	96-3174	166
96-1900	231	96-2525	3	96-2604	135	96-3176	166
96-1901	231	96-2526	3	96-2605	135	96-3178	166
96-1904	178	96-2527	3	96-2606	135	96-3180	166
96-1905	231	96-2528	35,196	96-2607	135	96-3181	179
96-1906	231	96-2529	35,196	96-2613	136	96-3182	166
96-2100	167	96-2530	4,192	96-2615	136	96-3184	166
96-2102	167	96-2531	4,192	96-2617	136	96-3186	166
96-2104	167	96-2532	34,196	96-2620	36,197	96-3190	166
96-2106	167	96-2533	34,196	96-2622	36,197	96-3192	166
96-2108	167	96-2536	23,194	96-2624	36,197	96-3194	166

# NUMERICAL INDEX



96-3196	166	97-0606	105	98-2047	42,48	98-7822	83
96-3198	166	97-0623	105	98-2048	42,48	98-7832	83
96-4100	190	97-0634	105	98-2050	32	98-7834	83
96-4105	209,222	97-1045	111	98-2051	32	98-7862	81
96-4140	190	97-1046	111	98-2070	33	98-7866	81
96-4150	139	97-1056	111	98-2071	33	98-7868	81
96-4170	138	97-1057	111	98-2080	53	98-7872	81
96-7027	185,198	97-1146	110	98-2081	53	98-7874	81
96-7040	184	97-1150	107	98-243	127	98-7890	81
96-7051	185	97-1156	111	98-247	127	98-7892	81
96-7072	185	97-1235	107	98-251	127	98-7894	81
96-7174	185,199	97-1238	112	98-258	124	98-7922	80
96-7185	184	97-1240	112	98-267	124	98-7924	80
96-7187	184	97-1241	112	98-268	124	98-7928	80
96-7412	184	97-1242	112	98-3055	93	98-7930	80
96-7459	184	97-1243	112	98-3056	93	98-7934	80
96-7460	171	97-1245	107	98-3186	84	98-7936	80
96-7548	185	97-1251	109	98-3188	84	98-7950	80
96-7581	184	97-1255	109	98-3190	84	98-7952	80
96-7620	184	97-1259	109	98-3192	84	98-7954	80
96-7624	184	97-1262	109	98-382	138	98-7960	81
96-7635	184	97-1280	109	98-4008	157		
96-7712	184	97-1285	109	98-4012	157		
96-7725	184	97-1286	109	98-4020	157		
96-7755	184	97-1308	110	98-4108	157		
96-7887	184	97-1309	110	98-4112	157		
96-7906	156	97-1315	112	98-4120	157		
96-7907	156	97-1318	112	98-472	111		
96-9256	190	97-1340	119	98-475	109		
96-9257	190	97-1530	69	98-476	109		
96-9321	190	97-1531	69	98-477	109		
97-0035	105	97-1540	69	98-478	109		
97-0048	105	97-1541	69	98-483	110		
97-021	156	97-1555	69	98-485	111		
97-029	156	97-1560	69	98-489	112		
97-033	169	97-1565	69	98-490	107		
97-0335	112	97-1570	69	98-492	107		
97-038	169	97-1600	105	98-503	106		
97-0474	110	97-1605	105	98-505	106		
97-0503	106	97-1610	105	98-508	104		
97-0505	106	97-1650	117	98-7277	81		
97-0507	106	97-1652	117	98-7278	81		
97-0509	106	97-1654	117	98-7700	82		
97-0512	106	97-1660	110	98-7702	82		
97-0522	106	97-1661	110	98-7706	82		
97-0524	106	97-1662	110	98-7708	82		
97-0528	106	97-1663	110	98-7718	82		
97-0532	106	97-372	71	98-7740	82		
97-0536	106	97-373	71	98-7742	82		
97-0539	106	97-384	71	98-7744	82		
97-0542	106	97-388	73	98-7758	82		
97-0546	104	98-1075	84	98-7780	83		
97-0548	104	98-1076	84	98-7782	83		
97-0552	106	98-162	128	98-7786	83		
97-0554	106	98-164	128	98-7788	83		
97-0555	107	98-165	128	98-7792	83		
97-0562	104	98-166	128	98-7794	83		
97-0564	106	98-167	128	98-7810	85		
97-0581	104	98-170	128	98-7812	85		
97-0582	104	98-171	128	98-7815	85		
97-0583	104	98-172	128	98-7816	85		
97-0601	105	98-173	128	98-7817	85		
97-0604	105	98-174	128	98-7820	83		