

SURGERY CENTER & CENTRAL SUPPLY













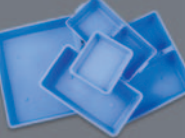

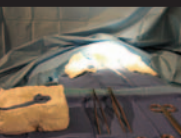

Featuring

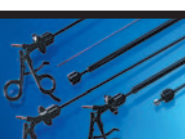
Sklar's NEW line of:

- **BAND BAGS**
- **DRAPES**
- **GAUZE & COTTON**
- **GOWNS**

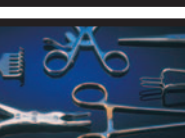

Table of Contents

<p>STERILE PROCEDURE KITS* 2-64</p>		<p>BRUSHES 166-170</p>	
<p>BASIC SETUP PACKS 65-66</p>		<p>PLASTIC WARE 171-174</p>	
<p>EQUIPMENT COVERS 68-82</p>		<p>STAINLESS STEELWARE 175-189</p>	
<p>DRAPES 83-97</p>		<p>INSTRUMENT IDENTIFICATION/ PROTECTION 190-191</p>	
<p>WOUND CARE PRODUCTS 98-111</p>		<p>GYNECOLOGY PRODUCTS 192-196</p>	
<p>GOWNS & PROTECTIVE APPAREL 112-119</p>		<p>LAPAROSCOPIC INSTRUMENTS 197-209</p>	
<p>OR TOWELS & ACCESSORIES 120-133</p>		<p>DISPOSABLE INSTRUMENTS 210-215</p>	
<p>STERILE DISPOSABLES 134-144</p>		<p>SKLAR SURGICAL INSTRUMENT SETS 216-229</p>	
<p>STETHOSCOPES & MISCELLANEOUS 145-151</p>		<p>SKLAR SURGICAL INSTRUMENTS 230-292</p>	
<p>CARE AND CLEANING & DISINFECTANTS 152-165</p>		<p>TERMS & CONDITIONS DISCLAIMERS 306</p>	

*The convenience kits illustrated in this catalog are representative of Sklar's assembly capabilities. The final design and approval of the kit is the responsibility of the customer and will be managed in accordance with the Sklar Design and Development process.



ALL-PURPOSE INSTRUMENT TRAYS

ALL-PURPOSE INSTRUMENT TRAY

CASE/ZO 96-4339



CONTENTS

- 1 Iris Scissor, Straight
- 1 Mosquito Hemostat, Straight, Delicate
- 1 Thumb Forcep, Wire
- 1 Safety Pin
- 2 Cotton Tip Applicators
- 1 PVP Prep Pad
- 2 Gauze, 3" x 3"
- 1 Alcohol Prep Pad

ALL-PURPOSE INSTRUMENT TRAY

CASE/ZO 96-4340



CONTENTS

- 1 Adson Forcep, Serrated, Stainless Steel
- 2 Gauze, 3" x 3"
- 1 Kelly Hemostat, Curved, Stainless Steel
- 1 Alcohol Prep Pad
- 1 PVP Prep Pad
- 1 Safety Pin
- 1 Scissor, S/B, Stainless Steel
- 2 Cotton Tip Applicators

ALL-PURPOSE INSTRUMENT TRAY

CASE/ZO 96-4341



CONTENTS

- 1 Thumb Forcep, Wire
- 2 Gauze, 3" x 3"
- 1 Mosquito Hemostat, Straight, Stainless Steel
- 1 Alcohol Prep Pad
- 1 PVP Prep Pad
- 1 Safety Pin
- 1 Iris Scissor, Straight, Stainless Steel
- 2 Cotton Tip Applicators

ALL-PURPOSE INSTRUMENT TRAY

CASE/ZO 96-4342



CONTENTS

- 1 Alcohol Prep Pad
- 2 Gauze, 3" x 3"
- 1 Kelly Hemostat, Straight, Stainless Steel
- 1 PVP Prep Pad
- 1 Scissor, S/B, Stainless Steel
- 1 Safety Pin
- 2 Cotton Tip Applicators
- 1 Thumb Forcep, Wire



ALL-PURPOSE INSTRUMENT TRAY

CASE/20 96-4343



CONTENTS

- 1 Alcohol Prep Pad
- 2 Gauze, 3" x 3"
- 1 Insert Forcep, Wire
- 1 Mosquito Hemostat, Straight, Wire
- 1 PVP Prep Pad
- 1 Scissor, S/S, Wire
- 1 Safety Pin
- 2 Cotton Tip Applicators

ALL-PURPOSE INSTRUMENT TRAY

CASE/20 96-4437



CONTENTS

- 1 Alcohol Prep Pad
- 2 Gauze, 3" x 3"
- 1 Kelly Hemostat, Curved, Stainless Steel
- 1 PVP Prep Pad
- 1 Scissor, S/B, Stainless Steel
- 1 Safety Pin
- 2 Cotton Tip Applicators
- 1 Thumb Forcep, Wire

CROSS REFERENCE:

ALL-PURPOSE INSTRUMENT TRAYS

SKLAR	MEDICAL ACTION	MEDLINE	BUSSE	CARDINAL
96-4339	-	-	-	NI15-0055
96-4340	-	-	-	NI15-9000
96-4341	-	-	-	15-9700
96-4342	61211	-	755	25008-020
96-4343	61209	DVNJ07600	753	24008-040
96-4437	61210	-	754	25008-010





GENERAL PURPOSE TRAYS

GENERAL PURPOSE TRAY

CASE/50 **96-4466** WITH FLOOR GRADE INSTRUMENTS, CSR WRAP



CONTENTS

- | | |
|--------------------------|---------------------|
| 1 Kelly Hemostat, Curved | 1 Safety Pin |
| 1 PVP Swabstick | 1 Alcohol Swabstick |
| 1 Dressing Forcep | 1 OR Scissor, S/B |
| 1 Shallow Procedure Tray | 2 Gauze, 4" x 4" |
| 2 Cotton Tip Applicators | |

GENERAL PURPOSE TRAY

CASE/50 **96-4467**



CONTENTS

- | | |
|--------------------------|------------------|
| 1 Kelly Forcep, Straight | 1 Gauze, 4" x 4" |
| 1 Dressing Forcep | 1 Scissor, S/S |
| 1 Gauze, 2" x 2" | 1 Drape |
| 1 Foam Tray | |

GENERAL PURPOSE TRAY

CASE/25 **96-1700** WITH ECONO FLOOR GRADE INSTRUMENTS



CONTENTS

- | | |
|--------------------------|--------------------------|
| 1 Kelly Forcep, Curved | 1 PVP Swabstick |
| 1 Adson Forcep, Serrated | 1 Alcohol Swabstick |
| 1 OR Scissor, S/B | 2 Cotton Tip Applicators |
| 1 Safety Pin | 2 Gauze, 4" x 4" |
| 1 Foam Tray | |

GENERAL PURPOSE TRAY

CASE/25 **96-1701** WITH PLASTIC/WIRE-FORM INSTRUMENTS



CONTENTS

- | | |
|-----------------------------|--------------------------|
| 1 Foam Tray | 1 PVP Swabstick |
| 1 Scissor, Wire | 1 Alcohol Swabstick |
| 1 Tissue Forcep, Plastic | 2 Cotton Tip Applicators |
| 1 Hemostat, Curved, Plastic | 2 Gauze, 4" x 4" |
| 1 Safety Pin | |



GENERAL PURPOSE TRAY

CASE/25 96-1757 WITHOUT INSTRUMENTS



CONTENTS

- | | |
|------------------|--------------------------|
| 1 Safety Pin | 1 Alcohol Swabstick |
| 1 Foam Tray | 2 Cotton Tip Applicators |
| 1 PVP Swab Stick | 2 Gauze, 4" x 4" |

GENERAL UTILITY TRAY

CASE/10 96-1727



CONTENTS

- | | |
|---------------------------------|-----------------------------|
| 1 Mini Scalpel | 1 Syringe, 5 cc, Luer Lock |
| 1 Fenestrated Drape, with Patch | 1 Syringe, 10 cc, Luer Lock |
| 3 Gauze, 4" x 4" | 1 Syringe, 20 cc, Luer Lock |
| 2 Absorbent Towels | 2 Specimen Tubes with Cap |
| 1 Bandaid | 1 PVP Swab Sticks, Triples |
| 1 Needle, 18G x 1-1/2" | 1 Lidocaine, 1%, 5ml |
| 1 Needle, 21G x 1-1/2" | 1 Tray |
| 1 Needle, 25G x 5/8" | |

The convenience kits illustrated in this catalog are representative of Sklar's assembly capabilities.

The final design and approval of the kit is the responsibility of the customer and will be managed in accordance with the Sklar Design and Development process.





SHAVE PREP TRAY

CASE/50 96-4344



CONTENTS

- 1 Drape,
- 2 Gauze, 4" x 4"
- 1 Razor
- 1 Soap Sponge
- 2 Cotton Tip Applicators

SHAVE PREP TRAY

CASE/50 96-4345



CONTENTS

- 1 Drape, 13" x 19"
- 1 Drape, 17" x 19"
- 2 Gauze, 4" x 4"
- 1 Prep Razor
- 1 Soap Sponge
- 2 Cotton Tip Applicators
- 1 Washcloth

SHAVE PREP TRAY

CASE/10 96-1806



CONTENTS

- 1 Prep Razor
- 1 Prep Tray
- 1 Soap Sponge
- 2 Cotton Tip Applicators
- 1 Drape 13" x 19"
- 1 Drape 17" x 19"
- 1 Absorbent Towel

BASIC SKIN PREP TRAY

CASE/20 96-1805



CONTENTS

- 2 Applicator Prep Sticks
- 1 PVP, 2 oz. Scrub Bottle
- 1 PVP, 2 oz. Prep Bottle
- 1 Shallow Procedure Tray
- 1 Ziplock Bag
- 12 Gauze, 4" x 4"
- 1 Absorbent Towel
- 3 Bowls





BASIC SET UP TRAY

CASE/6 96-4323

CONTENTS

- | | | |
|-----------------------------|--------------------------|---|
| 1 Bedside Bag | 1 Light Handle Cover | 1 Pair Gloves, Synthetic, Powder-Free, Walleted |
| 2 Blade, No. 10 | 1 Mayo Stand Cover | 2 Cotton Tip Applicators |
| 1 Blade, No. 15 | 1 Needle Counter, 20 Ct. | 2 Absorbent Towels |
| 1 Bowl | 1 Skin Marker with Ruler | 6 Small Wing Sponges |
| 4 Drapes, Utility with Tape | 1 Back Table Cover | 3 Applicator Prep Sticks |
| 10 Gauze, 4" x 4" | 9 OR Towels | 1 PVP-I Scrub Bottle |
| 2 Gowns, Non-Reinforced | 1 3-Compartment Tray | 1 PVP-I Paint Bottle |
| 5 Lap Sponges | 1 2-Compartment Tray | |



BASIC SET UP TRAY

CASE/6 96-4324

CONTENTS

- | | | |
|-----------------------------|-------------------------------------|---|
| 1 Bedside Bag | 1 Mayo Stand Cover | 1 3-Compartment Tray |
| 2 Blade, No. 10 | 1 Needle, 18G x 1-1/2" | 1 2-Compartment Tray |
| 1 Blade, No. 15 | 1 Needle Counter, 20 Ct. | 1 Pair Gloves, Synthetic, Powder-Free, Walleted |
| 1 Bowl | 1 Skin Marker with Ruler | 2 Cotton Tip Applicators |
| 1 Cautery Pencil | 1 Syringe, 10 mL, Luer Lock | 2 Absorbent Towels |
| 1 Medicine Cup with Lid | 1 Suction Tubing | 6 Small Wing Sponges |
| 4 Drapes, Utility with Tape | 1 Back Table Cover | 3 Applicator Prep Sticks |
| 10 Gauze, 4" x 4" | 1 Cautery Tip, Coated | 1 PVP-I Scrub Bottle |
| 2 Gowns, Non-Reinforced | 9 OR Towels | 1 PVP-I Paint Bottle |
| 5 Lap Sponges | 1 Yankauer Suction Tube, Non-Vented | |
| 1 Light Handle Cover | | |



MINI TRAY

CASE/B 96-4325

CONTENTS

- | | |
|-------------------------------|-------------------------------------|
| 1 Bedside Bag | 2 Light Handle Cover |
| 2 Blade, No. 10 | 1 Needle Counter, 20 Ct. |
| 1 Blade, No. 15 | 1 Skin Marker with Ruler |
| 1 Bulb Irrigation Syringe | 1 Suction Tubing |
| 1 Cautery Pencil | 1 Back Table Cover |
| 1 Tubing Connector | 1 Cautery Tip, Coated |
| 1 Specimen Container with Lid | 6 OR Towels |
| 1 Medicine Cup with Lid | 1 Yankauer Suction Tube, Non-Vented |
| 10 Gauze, 4" x 4" | |
| 5 Lap Sponges, | |



BASIN TRAY

CASE/4 96-4326

CONTENTS

- | | | |
|-------------------------------|--------------------------|-------------------------------------|
| 1 Bedside Bag | 10 Gauze, 4" x 4" | 1 Suction Tubing |
| 1 Emesis Basin | 2 Gowns, Non-Reinforced | 1 Back Table Cover |
| 2 Blade, No. 10 | 5 Lab Sponges | 1 Cautery Tip, Coated |
| 1 Blade, No. 15 | 2 Light Handle Covers | 7 OR Towels |
| 1 Bowl | 1 Mayo Stand Cover | 1 Yankauer Suction Tube, Non-Vented |
| 1 Bulb Irrigation Syringe | 1 Needle Counter, 20 Ct. | |
| 1 Cautery Pencil | 2 OR Basins | |
| 1 Connector Tubing | 1 Pitcher | |
| 1 Specimen Container with Lid | 1 Skin Marker with Ruler | |
| 1 Medicine Cup with Lid | | |





BASIC SETUP TRAYS

BASIN TRAY

CASE/4 **96-4327**



CONTENTS

- | | | |
|-------------------------------|--------------------------|-------------------------------------|
| 1 Bedside Bag | 1 Medicine Cup with Lid | 1 Pitcher |
| 1 Emesis Basin | 10 Gauze, 4" x 4" | 1 Skin Marker with Ruler |
| 2 Blade, No. 10 | 2 Gowns, Non-Reinforced | 1 Suction Tubing |
| 1 Blade, No. 15 | 5 Lap Sponges | 1 Back Table Cover |
| 1 Bowl | 2 Light Handle Cover | 1 Cautery Tip, Coated |
| 1 Bulb Irrigation Syringe | 1 Mayo Stand Cover | 7 OR Towels |
| 1 Cautery Pencil | 1 Needle Counter, 20 Ct. | 1 Yankauer Suction Tube, Non-Vented |
| 1 Tubing Connector | 2 OR Basins | |
| 1 Specimen Container with Lid | | |

MINI TRAY

CASE/40 **96-4328**



CONTENTS

- 1 Suture Bag
- 1 Needle Counter, 20 Ct.
- 2 Light Handle Covers
- 1 Skin Marker with Ruler
- 8 Labels
- 1 Cautery Polisher
- 1 Rubber Band, Latex-Free

SINGLE BASIN TRAY

CASE/5 **96-4329**

CASE/5 **96-4330**

CASE/5 **96-4331**



CONTENTS

- 1 CSR Wrap, 55" x 72"
- 1 Ring Basin

CONTENTS

- 1 CSR Wrap, 54" x 54"
- 1 Ring Basin

CONTENTS

- 2 CSR Wraps, 54" x 54"
- 1 Ring Basin

BASIC BASIN TRAY

CASE/4 **96-4332**



CONTENTS

- 1 Pitcher
- 1 Bulb Irrigation Syringe
- 1 Bowl
- 1 Specimen Container with Lid
- 1 Medicine Cup with Lid
- 1 Yankauer Suction Tube, Non-Vented
- 1 Emesis Basin
- 1 Suction Tubing
- 1 CSR Wrap
- 1 Ring Basin



SINGLE BASIN TRAY

CASE/5 96-4333



CONTENTS

- | | |
|-------------------------------|-------------------------------------|
| 1 Ring Basin | 1 Yankauer Suction Tube, Non-Vented |
| 1 Pitcher | 1 Cautery Polisher |
| 1 Bowl | 1 Needle Counter, 80 Ct. |
| 1 Emesis Basin | 1 Skin Marker with Ruler |
| 1 Specimen Container with Lid | 8 Labels |
| 1 Medicine Cup with Lid | 1 Suction Tubing |
| 1 Suture Bag | 10 Gauze, 4" x 4", X-Ray |
| 1 Blade, No. 10 | 6 OR Towels |
| 1 Blade, No. 15 | 1 Back Table Cover |
| 1 Bulb Irrigation Syringe | |

SINGLE START UP TRAY

CASE/4 96-4334



CONTENTS

- 1 Ring Basin
- 1 Medicine Cup
- 1 Emesis Basin
- 1 Bowl
- 2 CSR Wrap

BASIN START-UP TRAY

CASE/5 96-4335



CONTENTS

- 1 Ring Basin
- 1 Pitcher
- 1 Bowl
- 1 Emesis Basin
- 1 Specimen Container with Lid
- 1 Medicine Cup
- 2 Light Handle Covers
- 1 Needle Counter, 20 ct.
- 2 CSR Wraps

DOUBLE BASIN TRAY

CASE/4 96-4336



CONTENTS

- | | |
|-------------------------------------|--------------------------|
| 2 Ring Basin | 1 Cautery polisher |
| 1 Pitcher | 1 Needle Counter, 80 Ct. |
| 1 Bowl | 1 Skin Marker with Ruler |
| 1 Emesis Basin | 8 Labels |
| 1 Specimen Container with Lid | 1 Suction Tubing |
| 1 Medicine Cup with Lid | 10 Gauze, 4" x 4", X-Ray |
| 1 Suture Bag | 10 Lap Sponges |
| 2 Blade, No. 10 | 6 OR Towels |
| 1 Blade, No. 15 | 1 Back Table Cover |
| 1 Bulb Irrigation Syringe | |
| 1 Yankauer Suction Tube, Non-Vented | |





BASIC SETUP TRAYS

UNIVERSAL TRAY

CASE/4 96-4337



CONTENTS

- | | |
|-------------------------------------|--------------------------|
| 1 Pitcher | 1 Cautery Tip Cleaner |
| 1 Emesis Basin | 1 Needle Counter, 20 Ct. |
| 1 Bulb Irrigation Syringe | 1 Gauze, 4" x 4", X-Ray |
| 2 Bowls | 2 CSR Wraps |
| 2 Medicine Cups | 1 Suction Tubing |
| 1 Yankauer Suction Tube, Non-Vented | 2 Ring Basins |
| 10 Lap Sponges | |

DOUBLE START UP TRAY

CASE/5 96-4338



CONTENTS

- 2 Emesis Basins
- 2 Bowls
- 2 Medicine Cups
- 2 Ring Basins
- 2 CSR Wraps

CROSS REFERENCE:

BASIC SETUP TRAYS

SKLAR	MEDLINE	CARDINAL
96-4344	-	13-1000
96-4345	-	N113-0096
96-1805	-	-
96-1806	-	-
96-4323	DYNJS0103	-
96-4324	DYNJS0104	-
96-4325	DYNJS0104	-
96-4326	DYNJS0100	-
96-4327	DYNJS0101	-
96-4328	DYNJ06800	-
96-4329	DYNJB5007	-
96-4330	DYNJ06400	-
96-4331	DYNJ06500	-
96-4332	DYNJ06802	-
96-4333	DYNJ06903	-
96-4334	DYNJ06610A	-
96-4335	DYNJ06010	-
96-4336	DYNJ06804	-
96-4337	DYNJ06006	-
96-4338	DYNJ06600	-

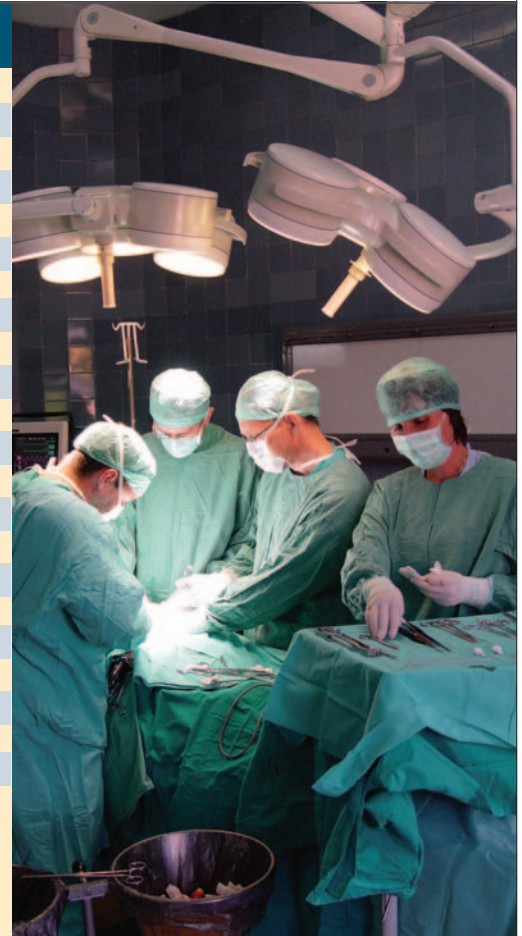

For price quotes contact your Sklar Account Managers for details.



CIRCUMCISION TRAY

CASE/20 96-4425



CONTENTS

- | | |
|---|---|
| 1 Circumcision Drape, Fenestrated | 1 Probe, Stainless Steel |
| 1 Adson Forcep, Serrated, Stainless Steel | 2 Mosquito Hemostats, Curved, Stainless Steel |
| 1 Adson Tissue Forcep | 2 Mosquito Hemostats, Straight, Stainless Steel |
| 4 Circumcision Straps | 2 Medicine Cups, Plastic |
| 1 Scalpel, No. 10 | 2 Gauze, 2" x 2" |
| 1 Webster Needle Holder, Stainless Steel | 5 Cotton Sponges |
| | 1 Scissor, S/B, Stainless Steel |

CIRCUMCISION TRAY

CASE/10 96-4426



CONTENTS

- | | |
|---|-----------------------------------|
| 1 Adson Forcep, Serrated, Stainless Steel | 4 Gauze, 4" x 4" |
| 1 Scissor, S/B, Stainless Steel | 1 Medicine Cup |
| 3 Mosquito Hemostats, Straight, Stainless Steel | 2 Safety Pins |
| 1 Probe, Stainless Steel | 1 Towel |
| 1 Scalpel, No. 10 | 1 Circumcision Drape, Fenestrated |
| 1 PVP Prep Packet | 4 Circumcision Straps |

CIRCUMCISION TRAY

CASE/20 96-4427



CONTENTS

- | |
|---|
| 1 Scalpel, No. 10 |
| 1 Strabismus Scissor, Curved, Stainless Steel |
| 1 Adson Forceps, Serrated, Stainless Steel |
| 3 Mosquito Hemostats, Straight, Stainless Steel |
| 1 Petroleum Gauze |
| 8 Gauze, 2" x 2" |
| 1 Circumcision Drape, Fenestrated |

CIRCUMCISION TRAY

CASE/10 96-4428



CONTENTS

- | | |
|--|--|
| 1 Circumcision Drape, Fenestrated | 1 Probe, Stainless Steel |
| 1 Forcep, Plastic | 1 Scalpel, No. 10 |
| 5 Gauze, 4" x 4" | 1 Strabismus Scissors, Straight, Stainless Steel |
| 2 Mosquito Hemostats, Curved, Stainless Steel | 1 PVP Swabsticks, Triples |
| 1 Mosquito Hemostat, Straight, Stainless Steel | 1 Towel, Cloth |



CIRCUMCISION TRAYS

CIRCUMCISION TRAY

CASE/20 96-4429

CONTENTS

- | | |
|--|-----------------------------------|
| 2 Drapes | 1 Scalpel, No. 10 |
| 1 Probe with Eye, Stainless Steel | 1 Petroleum Gauze |
| 1 Iris Forcep, Straight, Stainless Steel | 1 Safety Pin |
| 2 Kelly Hemostats, Straight, Stainless Steel | 6 Gauze, 4" x 4" |
| 1 Kelly Hemostat, Curved | 1 Circumcision Drape, Fenestrated |
| 1 Scissors, S/B, Stainless Steel | |



CIRCUMCISION TRAY

CASE/10 96-4430

CONTENTS

- | | |
|---|----------------------------------|
| 1 Circumcision Drape, Fenestrated | 1 Safety Pin |
| 1 Adson Tissue Forcep | 1 Scalpel, No. 10 |
| 3 Gauze, 3" x 3" | 1 Scissors, S/B, Stainless Steel |
| 3 Gauze, 2" x 2" | 1 Petroleum Gauze |
| 1 Mosquito Hemostat, Curved, Stainless Steel | 4 Circumcision Straps |
| 2 Mosquito Hemostats, Straight, Stainless Steel | 2 Towels, Cloth |
| 1 Probe, Stainless Steel | |



CIRCUMCISION TRAY

CASE/30 96-4431

CONTENTS

- | | |
|--|-----------------------------------|
| 1 Scissor, S/B, Stainless Steel | 1 Scalpel, No. 10 |
| 1 Mosquito Hemostat, Straight, Stainless Steel | 1 Safety Pin |
| 1 Mosquito Hemostat, Curved, Stainless Steel | 3 Gauze, 2" x 2" |
| 1 Adson Tissue Forcep | 3 Gauze, 3" x 3" |
| 1 Mogen Clamp with Probe | 1 Petroleum Gauze, 3" x 9" |
| | 1 Circumcision Drape, Fenestrated |
| | 1 Towel, Paper |



CIRCUMCISION TRAY

CASE/20 96-1746 WITH ECONO FLOOR GRADE INSTRUMENTS

CONTENTS

- | | |
|---|-------------------------|
| 1 Scalpel, No. 10 | 10 Gauze 3" x 3" |
| 1 Probe with Eye, Stainless Steel | 1 OR Towel, Fenestrated |
| 2 Mosquito Hemostats, Straight | 1 Petroleum Gauze |
| 1 Mosquito Hemostat, Curved | 1 OR Towel |
| 1 OR Scissors, S/B | 1 Tray |
| 1 Adson Forceps, Serrated, Stainless Steel | 2 Safety Pins |
| 1 Pair Gloves, Synthetic, Powder-Free, Walleted | 1 Medicine Cup |
| | 1 PVP, Prep Packet |



CIRCUMCISION TRAY

CASE/20 | 96-4470 | WITH ECONO FLOOR GRADE INSTRUMENTS, CSR WRAP



CONTENTS

- | | |
|---|----------------------------|
| 1 Probe with Eye, Stainless Steel | 1 OR Scissors, S/B |
| 1 Adson Forcep, Serrated, Stainless Steel | 1 Scalpel, No. 10 |
| 2 Mosquito Hemostats, Straight | 2 Safety Pins, |
| 1 Mosquito Hemostat, Curved | 10 Gauze, 3" x 3" |
| 1 OR Towel | 1 OR Towel, Fenestrated |
| 1 Petroleum Gauze | 1 Gloves, Latex-Free, Pair |
| 1 PVP, Prep Packet | 1 Tray |

CIRCUMCISION TRAY

CASE/10 | 96-4471 | WITH ECONO FLOOR GRADE INSTRUMENTS



CONTENTS

- | | |
|--------------------------------|---|
| 2 Circumcision Straps | 1 Probe |
| 1 PVP Swabsticks, Triple | 1 Iris Scissor, Straight, Stainless Steel |
| 2 Mosquito Hemostats, Straight | 1 Adson Forcep, Serrated, Stainless Steel |
| 1 Mosquito Hemostat, Curved | 5 Gauze, 2" x 2" |

CIRCUMCISION TRAY

CASE/30 | 96-4472



CONTENTS

- | | |
|-----------------------------------|-----------------------------------|
| 1 Gauze, 2" x 2" | 1 Circumcision Drape, Fenestrated |
| 1 Scissor | 2 Medicine Cups |
| 1 Webster Needle Holder | 4 Towels |
| 1 Probe with Eye, Stainless Steel | 2 Cotton Tip Applicators |
| 2 Safety Pins | 1 Adson Tissue Forcep |
| 4 Circumcision Straps | 2 Mosquito Hemostats, Straight |
| 1 Mosquito Hemostat, Curved | |

CROSS REFERENCE:

CIRCUMCISION TRAYS

SKLAR	CARDINAL
96-4425	NI10-0004
96-4426	10-00078
96-4427	10-0011
96-4428	10-0021
96-4429	10-0065
96-4430	10-2000
96-4431	NI12-0356
96-1746	-
96-4470	-
96-4471	-
96-4472	-





DIALYSIS TRAYS

DIALYSIS TRAY

CASE/50 96-4432

CONTENTS

- 4 Transparent Tape Strips
- 2 Transparent Tapes
- 2 Gauze, 4" x 4"
- 1 PVP Swabsticks, Triple
- 1 Neosprin Foil Packet
- 1 Drape
- 1 Gloves, Latex-Free, Pair



DIALYSIS ON / OFF TRAY

CASE/30 96-4433

CONTENTS

On Kit:

- 1 Fenestrated Drape
- 3 Gauze, 4" x 4"
- 1 Gloves, Latex-Free, Pair
- 2 Needles, 18G x 1-1/2"
- 2 Alcohol Swabsticks
- 2 PVP Swabsticks
- 4 Syringes, 10 cc, Luer Lock
- 1 Transparent Tape,

Off Kit:

- 1 Flexible Bandage
- 1 Drape
- 2 Gauze, 4" x 4"
- 1 Gloves, Latex-Free, Pair
- 4 Needles, 18G x 1-1/2"
- 2 Syringes, 3 cc, Luer Lock
- 2 Syringes, 10 cc, Luer Lock



DIALYSIS TRAY

CASE/30 96-4434

CONTENTS

- 1 Fenestrated Drape
- 10 Gauze, 4" x 4"
- 1 Guidewire
- 1 Lidocaine Ampule
- 1 Needle, 22G x 1-1/2"
- 1 Needle, 27G x 1/2"
- 1 Needle Introducer, 18G x 2-3/4"
- 1 Scapel, No. 11
- 1 PVP Solution
- 2 Applicator Swab Sticks
- 1 Syringe, 3 cc, Luer Lock
- 2 Syringes, 10 cc, Luer Slip
- 2 Vessel Dilators, 11Fr



HEMODIALYSIS DRESSING TRAY

CASE/30 96-4435

CONTENTS

- 1 Fenestrated Drape
- 1 Transparent Dressing
- 1 Gauze, 2" x 2"
- 1 Gauze, 4" x 4"
- 1 Gloves, Latex-Free, Pair
- 1 Dressing Change Label
- 2 Masks with Ear Loops
- 1 Skin Protectant Prep Pad
- 1 Refuse Bag
- 1 PVP Ointment
- 1 Alcohol Swabsticks, Triple
- 1 PVP Swabsticks, Triple



PERITONEAL DIALYSIS TRAY

CASE/30 96-4436



CONTENTS

- 1 Forcep, Plastic
- 10 Gauze, 4" x 4"
- 1 Gloves, Latex-Free, Pair
- 1 Hydrogen Peroxide
- 6 Cotton Tip Applicators
- 1 Towel, Paper

CROSS REFERENCE:

DIALYSIS TRAYS

SKLAR	CARDINAL
96-4432	12-0059B
96-4433	12-0169
96-4434	12-0092
96-4435	12-0113
96-4436	12-0071

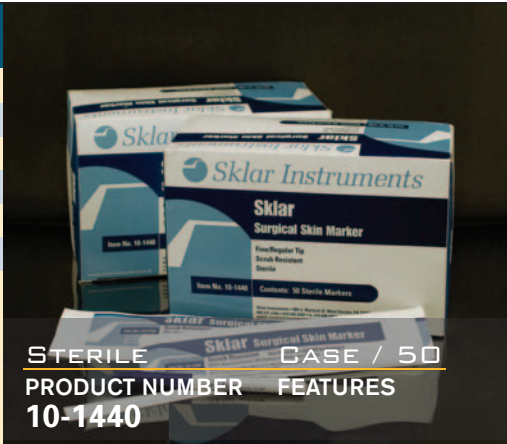

STERILE CASE / 50
 PRODUCT NUMBER 10-1440 FEATURES

DRESSING CHANGE TRAY

DRESSING CHANGE TRAYS / STERILE

CASE/20 96-4346



CONTENTS

- 1 Transparent Dressing
- 1 Scissors, S/B, Stainless Steel,
- 4 Gauze, 3" x 3"
- 2 IV Split Dressings
- 2 Transparent Tapes
- 1 Benzoin Swabstick
- 1 PVP Ointment
- 1 Alcohol Swabsticks, Triple
- 1 Cotton Tip Applicator
- 2 Gloves, Latex-Free, Pair
- 1 Drape
- 1 Mask
- 1 Wrap

CVP DRESSING TRAY

CASE/20 96-4347



CONTENTS

- 1 Drape
- 1 Dressing Change Label
- 2 Skin Protectant Prep Pads
- 1 PVP Cotton Tip Applicator, Triple
- 1 Alcohol Swabsticks, Triple
- 1 Transparent Dressing 4" x 4.75"
- 2 Transparent Tape Strips, 1" x 5"
- 2 Transparent Tape Strips, 1/2" x 4"



DRESSING CHANGE TRAYS

CVP DRESSING TRAY

CASE/20 96-4348



- CONTENTS**
- 1 Transparent Dressing
 - 1 Suture Strip
 - 1 Scissors, S/B, Wire
 - 4 Gauze, 3" x 3"
 - 1 Transparent Tape
 - 2 Gloves, Latex-Free, Pair
 - 1 Benzoin Swabstick
 - 1 PVP Swabsticks, Triple
 - 1 Alcohol Swabsticks, Triple

DRESSING CHANGE TRAY

CASE/50 96-4349



- CONTENTS**
- 1 Dressing Change Label
 - 1 Transparent Dressing, 4" x 4-3/4"
 - 1 Transparent Dressing, 2-3/8" x 2-3/4"
 - 2 Gauze, 2" x 2"
 - 1 Transparent Tape
 - 1 PVP Swabsticks, Triple
 - 1 Alcohol Swabsticks, Triple
 - 1 Drape
 - 1 Gloves, Latex-Free, Pair

CENTRAL LINE DRESSING CHANGE

CASE/20 96-4350



- CONTENTS**
- 1 Transparent Dressing
 - 1 Dressing Change Label
 - 2 Gauze, 3" x 3"
 - 2 IV Split Dressings
 - 1 Transparent Tape
 - 1 Skin Protectant Swabstick
 - 2 Gauze, 2" x 2"
 - 1 PVP Swabsticks, Triple
 - 1 Alcohol Swabsticks, Triple
 - 1 Alcohol Prep Pad
 - 2 Gloves, Latex-Free, Pair
 - 1 Bedside Bag
 - 2 Masks with Ear Loops

DRESSING CHANGE TRAY

CASE/30 96-4351



- CONTENTS**
- 1 Scissors, S/B, Wire
 - 2 Gauze, 4" x 4"
 - 1 Cotton Tip Applicator
 - 1 Transparent Tape
 - 1 PVP Ointment
 - 1 Transparent Dressing
 - 1 PVP Swabsticks, Triple
 - 1 Alcohol Swabsticks, Triple
 - 1 Gloves, Latex-Free, Pair
 - 1 Mask with Ear Loops



PEDIATRIC DRESSING CHANGE TRAY

CASE/30 96-4352



CONTENTS

- | | |
|---|------------------------------|
| 1 Transparent Dressing, 4" x 4 3/4" | 1 PVP Ointment |
| 1 Transparent Dressing, 2 3/4" x 2 3/8" | 1 Scissors, S/B, Wire |
| 2 Non-Woven Sponge | 1 Acetone Swabsticks, Triple |
| 2 Gauze, 2" x 2" | 1 Benzoin Swabstick |
| 1 Gloves, Vinyl, Pair | 1 PVP Swabsticks, Triple |
| 1 Dressing Change Label | 1 Transparent Tape |
| 1 Mask with Ear Loops | 1 Durapore Tape |

VASCULAR ACCESS DRESSING TRAY

CASE/50 96-4353



CONTENTS

- 1 Drape
- 1 Transparent Dressing, 4" x 4"
- 1 Gloves, Latex-Free, Pair
- 1 Dressing Change Label
- 1 Mask with Ear Loops
- 1 Alcohol Swabsticks, Triple
- 1 Benzoin Swabstick
- 1 PVP Swabsticks, Triple

DRESSING CHANGE TRAY

CASE/50 96-4354



CONTENTS

- 1 Transparent Dressing
- 1 Durapore Tape
- 1 PVP Swabsticks, Triple
- 1 J&J Biopatch

CVC TRANSPARENT TRAY

CASE/30 96-4355



CONTENTS

- 1 Dressing
- 2 Gloves, Vinyl, Pair
- 1 Dressing Change Label
- 2 Masks with Ear Loops
- 1 Alcohol Swabsticks, Triple
- 1 PVP Swabsticks, Triple
- 2 Skin Protectant Swabsticks
- 1 Silk-Like Tape



DRESSING CHANGE TRAY

CASE/30 96-4356

CONTENTS

- 1 Drape
- 1 Transparent Dressing
- 1 Gloves, Latex-Free, Pair
- 1 Dressing Change Label
- 1 Mask with Ear Loops
- 1 Skin Protectant Prep Pad
- 1 Non-Woven Sponge
- 1 Alcohol Swabsticks, Triple
- 1 PVP Swabsticks, Triple
- 1 Tape



NEONATE DRESSING CHANGE TRAY

CASE/30 96-4357

CONTENTS

- 1 Transparent Dressing
- 1 Gloves, Latex-Free, Pair
- 2 Mask with Ear Loops
- 1 Scissors, S/S Wire
- 1 Suture Strip
- 1 Cotton Tip Applicator
- 1 Alcohol Swabsticks, Triple
- 1 PVP Swabsticks, Triple



DRESSING CHANGE TRAY

CASE/30 96-4358

CONTENTS

- 1 Transparent Dressing
- 4 Gauze, 2" x 2"
- 1 Dressing Change Label
- 1 Alcohol Swabsticks, Triple
- 1 Cotton Tip Applicator
- 1 Skin Protectant Prep Pad
- 1 Alcohol Swabsticks, Triple
- 3 Alcohol Prep Pads
- 1 Pair Gloves, Vinyl



DRESSING CHANGE TRAY

CASE/30 96-4359

CONTENTS

- 1 Transparent Dressing
- 1 Dressing Change Label
- 1 PVP Prep Pad
- 2 Skin Protectant Swabsticks
- 1 Drape
- 1 Gloves, Powder-Free Cuffed, Medium, Pair
- 1 Mask with Ear Loops



CENTRAL LINE DRESSING TRAY

CASE/30 96-4360

CONTENTS

- | | |
|-------------------------|------------------------------|
| 1 Transparent Dressing | 1 Benzoin Swabstick |
| 1 Dressing Change Label | 1 PVP Swabsticks, Triple |
| 2 Gauze, 4" x 4" | 1 Alcohol Swabsticks, Triple |
| 2 Gauze, 2" x 2" | 1 Gloves, Latex-Free, Pair |
| 2 IV Split Dressings | 1 Mask with Ear Loops |
| 1 Cotton Tip Applicator | |
| 1 Transparent Tape | |



DRESSING CHANGE SUPPORT TRAY

CASE/30 96-4361

CONTENTS

- 2 Gauze, 4" x 4"
- 2 Gauze, 2" x 2"
- 1 Transparent Tape
- 1 PVP Swabsticks, Triple
- 1 Gloves, Latex-Free, Pair
- 1 Mask with Ear Loops



DRESSING CHANGE SUPPORT TRAY

CASE/30 96-4362

CONTENTS

- 2 Gauze, 4" x 4"
- 2 Gauze, 2" x 2"
- 1 Transparent Tape
- 1 PVP Ointment
- 1 Cotton Tip Applicator
- 1 PVP Swabsticks, Triple
- 1 Alcohol Swabsticks, Triple
- 1 Gloves, Latex-Free, Pair
- 1 Mask with Ear Loops



CENTRAL LINE DRESSING TRAY

CASE/30 96-4363

CONTENTS

- 1 Transparent Dressing
- 1 Dressing Change Label
- 1 PVP Swabsticks, Triple
- 1 Skin Protectant Swabstick
- 1 Transparent Tape
- 1 Drape
- 1 Gloves, Vinyl, Pair
- 2 Mask with Ear Loops





DRESSING CHANGE TRAYS

DRESSING CHANGE TRAY

CASE/30 96-4364

CONTENTS

- | | |
|-------------------------|------------------------------|
| 1 Transparent Dressing | 1 Triple Antibiotic Ointment |
| 1 Dressing Change Label | 1 Skin Protectant Prep Pad |
| 1 Transparent Tape | 1 PVP Swabsticks, Triple |
| 1 Gauze, 4" x 4" | 1 Alcohol Swabsticks, Triple |
| 1 Gauze, 2" x 2" | 3 Alcohol Prep Pads |
| 1 Non-Woven Sponge | 1 Gloves, Latex-Free, Pair |
| 1 IV Spilt Dressing | 1 Refuse Bag |
| 1 Cotton Tip Applicator | 1 Mask with Ear Loops |



DRESSING CHANGE SUPPORT TRAY

CASE/30 96-4365

CONTENTS

- | | |
|------------------------|------------------------------|
| 1 Transparent Dressing | 1 Skin Protection Swabstick |
| 1 Gauze, 4" x 4" | 1 PVP Swabsticks, Triple |
| 1 Gauze, 2" x 2" | 1 Alcohol Swabsticks, Triple |
| 1 Non-Woven Sponge | 1 Drape |
| 1 IV Spilt Dressing | 1 Gloves, Vinyl, Pair |
| 1 Transparent Tape | 1 Mask with Ear Loops |
| 1 PVP Ointment | |



DRESSING CHANGE TRAY / LATEX FREE

CASE/30 96-4366

CONTENTS

- | | |
|------------------------------|---------------------------------|
| 1 Transparent Dressing | 1 IV Spilt Dressing |
| 1 PVP Swabsticks, Triple | 1 Transparent Tape |
| 1 Alcohol Swabsticks, Triple | 1 PVP Ointment |
| 1 Gauze, 4" x 4" | 1 Gloves, Latex-Free, Pair-Free |
| 1 Gauze, 2" x 2" | 1 Mask with Ear Loops |
| 1 Non-Woven Sponge | |



DRESSING CHANGE TRAY

CASE/30 96-4367

CONTENTS

- | | |
|----------------------------|------------------------------|
| 1 Transparent Dressing | 1 Skin Protection Prep Pad |
| 1 Non-Woven Sponge | 1 Refuse Bag |
| 1 IV Split Dressing | 1 PVP Ointment |
| 1 Gauze, 4" x 4" | 1 Cotton Tip Applicator |
| 1 Gauze, 2" x 2" | 1 PVP Swabsticks, Triple |
| 1 Gloves, Latex-Free, Pair | 1 Alcohol Swabsticks, Triple |
| 1 Mask with Ear Loops | 1 Transparent Tape |
| 3 Alcohol Prep Pads | |





DRESSING CHANGE TRAY

CASE/30 96-4368

CONTENTS

- | | |
|----------------------------|------------------------------|
| 1 Non-Woven Sponge | 3 Alcohol Prep Pads |
| 1 IV Split Dressing | 1 Skin Protectant Prep Pad |
| 1 Transparent Dressing | 1 Refuse Bag |
| 1 Gauze, 4" x 4" | 1 Cotton Tip Applicator |
| 1 Gauze, 2" x 2" | 1 Triple Antibiotic Ointment |
| 1 Gloves, Latex-Free, Pair | 1 PVP Swabsticks, Triple |
| 1 Dressing Change Label | 1 Alcohol Swabsticks, Triple |
| 1 Mask with Ear Loops | 1 Transparent Tape |



DRESSING CHANGE TRAY

CASE/30 96-4369

CONTENTS

- | | |
|----------------------------|------------------------------|
| 1 Transparent Dressing | 3 Alcohol Prep Pads |
| 1 IV Split Dressing | 1 Skin Protectant Prep Pad |
| 1 Non-Woven Sponge | 1 Refuse Bag |
| 1 Gauze, 4" x 4" | 1 PVP Ointment |
| 1 Gauze, 2" x 2" | 1 Cotton Tip Applicator |
| 1 Gloves, Latex-Free, Pair | 1 PVP Swabsticks, Triple |
| 1 Dressing Change Label | 1 Alcohol Swabsticks, Triple |
| 1 Mask with Ear Loops | 1 Transparent Tape |



DRESSING CHANGE TRAY

CASE/30 96-4370

CONTENTS

- | | |
|----------------------------|------------------------------|
| 1 IV Split Dressing | 1 Skin Protectant Prep Pad |
| 1 Non-Woven Sponge | 1 Refuse Bag |
| 1 Gauze, 4" x 4" | 1 Scissors, S/B, Wire |
| 1 Gauze, 2" x 2" | 1 PVP Ointment |
| 1 Gloves, Latex-Free, Pair | 1 Cotton Tip Applicator |
| 1 Dressing Change Label | 1 PVP Swabsticks, Triple |
| 1 Mask with Ear Loops | 1 Alcohol Swabsticks, Triple |
| 3 Alcohol Prep Pads | 1 Durapore Tape |
| 1 Woven Elastic Dressing | |



DRESSING CHANGE TRAY

CASE/30 96-4371

CONTENTS

- | | |
|----------------------------|------------------------------|
| 1 Transparent Dressing | 3 Alcohol Prep Pads |
| 1 IV Split Dressing | 1 Skin Protectant Prep Pad |
| 1 Non-Woven Sponge | 1 Refuse Bag |
| 1 Gauze, 4" x 4" | 1 PVP Ointment |
| 1 Gauze, 2" x 2" | 1 Cotton Tip Applicator |
| 1 Gloves, Latex-Free, Pair | 1 PVP Swabsticks, Triple |
| 1 Dressing Change Label | 1 Acetone Swabsticks, Triple |
| 1 Mask with Ear Loops | 1 Transparent Tape |



DRESSING CHANGE TRAYS

DRESSING CHANGE TRAY

CASE/30 96-4372



CONTENTS

- 1 Transparent Dressing
- 1 IV Split Dressing
- 1 Non-Woven Sponge
- 1 Gauze, 4" x 4"
- 1 Gloves, Latex-Free, Pair
- 1 Mask with Ear Loops
- 1 PVP Ointment
- 1 PVP Swabsticks, Triple
- 1 Alcohol Swabsticks, Triple
- 1 Transparent Tape

DRESSING CHANGE TRAY

CASE/30 96-4373



CONTENTS

- 1 Drape
- 1 Transparent Dressing
- 1 IV Split Dressing
- 1 Non-Woven Sponge
- 1 Gauze, 4" x 4"
- 1 Gauze, 2" x 2"
- 1 Gloves, Latex-Free, Pair
- 1 Mask with Ear Loops
- 1 PVP Ointment
- 1 PVP Swabsticks, Triple
- 1 Alcohol Swabsticks, Triple
- 1 Skin Protectant Swab Stick
- 1 Transparent Tape

WOUND CARE TRAY

CASE/30 96-4374



CONTENTS

- 1 Drape
- 8 Gauzes, 4" x 4"
- 2 Gloves, Vinyl, Pair
- 1 Hydrogen Peroxide
- 1 Measuring Device
- 1 Refuse Bag
- 1 Saline
- 1 PVP Swabsticks, Triple
- 2 Skin Protectant Swabsticks
- 1 Transpore Tape

DRESSING CHANGE TRAY

CASE/30 96-4375



CONTENTS

- 1 Transparent Dressing
- 1 IV Split Dressing
- 1 Non-Woven Sponge
- 1 Gauze, 4" x 4"
- 1 Gauze, 2" x 2"
- 1 Gloves, Vinyl, Pair
- 1 Mask with Ear Loops
- 1 PVP Ointment
- 1 PVP Swabsticks, Triple
- 1 Alcohol Swabsticks, Triple
- 1 Transparent Tape



MINOR DRESSING TRAY

CASE/25 96-1702 WITH ECONO FLOOR GRADE INSTRUMENTS



CONTENTS

- | | |
|-----------------------|--------------------|
| 1 OR Scissors, S/B | 1 Tray |
| 1 Dressing Forcep | 1 PVP Prep Pad |
| 1 Adson Tissue Forcep | 1 Alcohol Prep Pad |
| 1 Paper Tape | 3 Gauze, 4" x 4" |
| 1 Refuse Bag | 1 Towel / Drape |

MINOR DRESSING TRAY

CASE/25 96-1704 WITH PLASTIC / WIRE-FORM INSTRUMENTS



CONTENTS

- | | |
|----------------------------|--------------------|
| 1 Wire Formed Scissor | 1 Tray |
| 1 Dressing Forcep, Plastic | 1 PVP Prep Pad |
| 1 Tissue Forcep, Plastic | 1 Alcohol Prep Pad |
| 1 Paper Tape | 3 Gauze, 4" x 4" |
| 1 Refuse Bag | 1 Towel / Drape |

DRESSING CHANGE TRAY

CASE/20 96-4439



CONTENTS

- | | |
|---------------------------|--------------------------|
| 1 Polylined Sterile Field | 1 PVP Swabsticks, Triple |
| 1 Polybag with Twist Tie | 1 Transpore Tape |
| 1 Safety Pin | 1 Transfer Forcep |
| 4 Gauze, 4" x 4" | 1 Suture Forcep |
| 1 Scissor, S/B | 1 Abdominal Pad |

DRESSING CHANGE TRAY

CASE/30 96-4440



CONTENTS

- | | |
|----------------------------|-------------------------------|
| 1 Dressing Change Label | 2 Non-Woven Sponges |
| 1 Tegaderm Dressing | 2 Gauze, 2" x 2" |
| 1 PVP Ointment | 1 PVP Swabsticks, Triple |
| 1 Mask with Ear Loops | 1 Alcohol Swabsticks, Triple |
| 1 Gloves, Latex-Free, Pair | 1 Benzoin Tincture Applicator |
| 1 Towel / Drape | |



DRESSING CHANGE TRAYS

IV CATHETER DRESSING TRAY

CASE/30 96-4441



CONTENTS

- 1 PVP Ointment
- 1 Gauze, 4" x 4"
- 1 Gloves, Latex-Free, Pair
- 1 Gauze, 2" x 2"
- 1 Dressing Change Label
- 1 Non-Woven Split Sponge
- 1 Transparent Tape
- 1 Non-Adhering Pad
- 1 Mask with Ear Loops
- 1 PVP Swabsticks, Triple
- 1 Polylined Drape
- 1 Alcohol Swabsticks, Triple
- 1 Transparent Dressing with Label

TPN / CVC DRESSING TRAY

CASE/30 96-4442



CONTENTS

- 1 Mask with Ear Loops
- 1 Non-Adhering Sponge
- 1 Gloves, Latex-Free, Pair
- 1 PVP Swabsticks, Triple
- 1 Polylined Drape
- 1 Alcohol Swabsticks, Triple
- 1 IV Split Dressing
- 1 PVP Ointment
- 1 Transparent Tape
- 1 Gauze, 4" x 4"
- 1 Dressing Change Label
- 2 Gauze, 2" x 2"
- 1 Transparent Dressing

CROSS REFERENCE:

DRESSING CHANGE TRAYS

SKLAR	CARDINAL
96-4346	03-0020
96-4347	BN03-0023A
96-4348	BN03-0042B
96-4349	03-0066A
96-4350	03-0073
96-4351	03-0075A
96-4352	03-0186
96-4353	BN03-0190A
96-4354	03-0195
96-4355	03-0210
96-4356	03-0215
96-4357	03-0220
96-4358	03-0225B
96-4359	03-0228
96-4360	03-0243
96-4361	N103-0491
96-4362	N103-0492
96-4363	03-0263
96-4364	N103-0496
96-4365	N103-0497
96-4366	N103-0498
96-4367	03-3100A
96-4368	03-3000A
96-4369	03-3200A
96-4370	03-3400A
96-4371	03-3700

COTTON TIP APPLICATORS

STERILE

PRODUCT NUMBER	FEATURES/QUANTITIES
96-8923 6"	Plastic Handle 2pc pk/50 pks/1000pc cs
96-8924 6"	Plastic Handle 6pc pk/50 pks/3000pc cs
96-8936 3"	Wooden Handle 2pc pk/50 pks/1000pc cs
96-8937 6"	Wooden Handle 6pc pk/50 pks/1000pc cs



CROSS REFERENCE:		DRESSING CHANGE TRAYS, CONT.	
SKLAR	MEDICAL ACTION	MEDLINE	CARDINAL
96-4372	-	-	03-3900
96-4373	61249	DYND74661	03-4500
96-4374	-	-	12-0136
96-4375	-	-	26012-639
96-1702	-	-	-
96-1704	-	-	-
96-4439	-	-	-
96-4440	-	-	-
96-4441	-	-	-
96-4442	-	-	-

SKLAR GAUZE SPONGES

SKLAR offers a highly absorbent sponge which is ideal for a number of applications.

LATEX-FREE

CALL: 800.221.2166



CYSTO-TUR TRAY GENERAL SURGERY TRAYS / STERILE



CASE/4	96-4300	CONTENTS	
		1 Emesis Basin	4 OR Towels
		1 Bowl	4 Utility Drapes with Tape
		1 Specimen Container with Lid	5 Gauze, 4" x 4", 12-Ply
		1 Medicine Cup	10 Gauze, 4" x 4", 16-Ply
		1 Suture Bag	3 Absorbent Towel
		1 Cath. 18 Fr.	1 Mayo Stand Cover
		1 Lube Jelly	2 Leggings
		1 Irrigation Set	2 Gown, XL
		1 Syringe, 10 mL, Luer Lock	1 Drape, Cysto without Leggings
		1 Suction Tubing	1 Back Table Cover
			1 3-Compartment Tray
			1 2-Compartment Tray
			1 Gloves, Synthetic, Powder-Free, Walleted, Pair
			2 Cotton Tip Applicator
			2 OR Towels
			6 Small Wing Sponge
			3 Applicator Prep Sticks
			1 PVP-I Scrub Bottle
			1 PVP-I Paint Bottle



CASE/4	96-4301	CONTENTS	
		1 Emesis Basin	1 Suction Tubing
		1 Bowl	1 Yankauer Fine Cap.
		1 Specimen Container with Lid	10 Gauze, 4" x 4" X-Ray
		1 Medicine Cup	4 Drapes, Utility
		1 Suture Bag	1 Absorbent Towel
		1 Needle 25G x 1-1/2"	2 OR Towels
		1 Syringe, 10 mL, Luer Lock	1 Mayo Stand Cover
		4 Cotton Tip Applicator	2 Gowns
		1 Sponge, Tonsil X-Ray	1 Drape
		1 Needle Counter, 20 Ct.	1 Back Table Cover
		1 Cath. 10 Fr.	



NASAL / ENT TRAY

CASE/4 96-4302



CONTENTS

- | | |
|---------------------|-------------------------------------|
| 1 Bedside Bag | 2 Light Handle Covers |
| 1 Blade, No. 15 | 1 Mayo Stand Cover |
| 1 Bowl, 16 oz. | 1 Needle, 27G x 1-1/4" |
| 1 Bowl, 32 oz. | 1 Needle Counter, 20 ct |
| 4 Medicine Cups | 1 Syringe, 10 mL Control, Luer Lock |
| 1 Drape | 1 Suction Tubing |
| 1 Drape, EENT Split | 1 Back Table Cover |
| 10 Gauze, 4" x 4" | 2 Absorbent Towels |
| 1 Gown, LG | 2 OR Towels |
| 1 Gown, XL | |

EYE TRAY

CASE/6 96-4303



CONTENTS

- | | |
|----------------------------|--------------------------|
| 1 Bowl | 1 Syringe Ear / Ulcer |
| 1 Prep Tray | 1 PVP Prep Pack |
| 1 Medicine Cup | 1 Eye Spears, 10 / Pack |
| 1 Suture Bag | 1 Eye Pad Oval |
| 5 Gauze, 4" x 4" | 1 Instrument Wipe |
| 4 OR Towels | 1 Drape |
| 1 Absorbent Towel | 1 CSR Wrap |
| 6 Cotton Tip Applicators | 1 Mayo Stand Cover |
| 1 Needle, 18G x 1-1/2" | 2 Gowns, Non-Reinforced |
| 1 Needle, 25G x 5/8" | 1 Back Table Cover |
| 1 Syringe, 1 mL, Luer Lock | 1 Needle Counter, 20 Ct. |
| 1 Syringe, 3 mL, Luer Lock | |

EYE TRAY

CASE/3 96-4304



CONTENTS

- | | | |
|----------------------------|-----------------------------|---------------------------|
| 1 Foam Tray | 1 Eye Pad Oval | 1 Syringe, 1mL, Luer Lock |
| 1 Blade, 6400 | 1 Needle, 25G x 5/8" | 1 Needle, 27G x 1-1/2" |
| 1 Prep Tray | 1 Syringe, 3 mL, Luer Lock | 1 Drape Head, with Tape |
| 1 Syringe Ear / Ulcer | 1 Syringe, 10 mL, Luer Lock | 1 Drape EENT Split |
| 1 Filter Millex GS | 2 Drape Utility with Tape | 1 Cotton Tip Applicator |
| 1 Needle, 18G x 1-1/2" | 2 OR Towels | 1 Drape Ophthalmic Incise |
| 10 Gauze, 4" x 4" | 1 Instrument Wipe | 1 Eye Shield Waffle |
| 1 Eraser Wetfield Str. 18G | 1 Eye Spears, 10 / Pack | 1 Mayo Stand Cover |
| 1 Suture Bag | 2 Gowns, Non-Reinforced | 1 Back Table Cover |

L & D TRAY

CASE/3 96-4305



CONTENTS

- | | | |
|--------------------------|-----------------------------------|------------------------|
| 1 Ring Basin | 2 Absorbent Towels | 2 Leggings |
| 1 Wash Basin | 4 OR Towels | 1 Drape, Abdominal |
| 1 Bowl, 32 oz. | 1 Syringe, 10 mL | 1 Gown |
| 1 Bowl, 16 oz. | 1 Syringe Ear / Ulcer | 1 Gown, Non-Reinforced |
| 30 Gauze, 4" x 4", X-Ray | 1 Needle, 22G x 1-1/2" | 1 CSR Wrap |
| 2 Packing Sponge, X-Ray | 1 Cord Clamp | 1 Back Table Cover |
| 1 OB Pads, 11" | 1 Drape | |
| 1 Baby Blanket | 1 Drape, Underbuttocks with Pouch | |



NEURO-CRANI TRAY

CASE/2 96-4308



CONTENTS

1 Bowl	1 Needle, 18G x 1-1/2"	5 Lap Sponges
1 Prep Tray	1 Syringe, 10 mL, Luer Lock	10 Gauze 4" x 4", X-Ray
1 Emesis Basin	1 Syringe, 20 mL, Luer Lock	12 OR Towels
1 Medicine Cup	1 Syringe, 10 mL, Control	1 Telfa Pad
1 Specimen Container with Lid	1 Syringe, Ear / Ulcer	1 Absorbent Towel
1 Poly Bag	1 Skin Marker with Ruler	4 Utility Drapes with Tape
1 Foam Tray	2 Light Handle Covers	1 Drape
1 Suture Bag	1 Needle Counter, 60 Ct.	1 Mayo Stand Cover
1 Blade, No.10	1 Sponge, Neuro .5" x .5", 10 Pack	1 Drape, Crani Incise with Pouch
1 Blade, No. 15	1 Sponge, Neuro .5" x 3", 10 Pack	1 Gown, Fabric-Reinforced
1 Blade, No. 11	1 Sponge, Neuro 1" x 3", 10 Pack	1 Gown
1 Needle, 22G x 1"	1 Bone Wax	1 Back Table Cover
1 Needle, 25G x 1-1/2"	1 Suction Tubing	

BASIC EXTREMITY TRAY

CASE/4 96-4309



CONTENTS

1 Bedside Bag	10 Gauze, 4" x 4", 12-Ply
2 Blades, No. 15	10 Gauze, 4" x 4", 16-Ply
1 Bandage, Conforming	2 Gowns, Non-Reinforced
1 Bandage	1 Mayo Stand Cover
1 Esmark Bandage	1 Needle Counter, 20 ct.
1 Bulb Irrigation Syringe	1 Stockinette
1 Drape	1 Suction Tubing
1 Drape, Extremity	1 Back Table Cover
1 Drape, U Plastic with Tape	7 OR Towels

MAJOR EXTREMITY TRAY

CASE/4 96-4310



CONTENTS

1 Bedside Bag	1 Medicine Cup	1 Needle, 25G x 1-1/2"
1 Poly Bag	1 Drape	1 Needle Counter, 20 Ct.
1 Emesis Basin	1 Drape, Extremity	1 Skin Marker with Ruler
1 Blade, No. 10	1 Drape, U Plastic with Tape	1 Stockinette
2 Blades, No. 15	10 Gauze, 4" x 4", 12-Ply	1 Syringe, 10 mL, Luer Lock
1 Elastic Bandage Roll	10 Gauze, 4" x 4", 16-Ply	1 Suction Tubing
1 Esmark Bandage	1 Gown, Fabric Reinforced	1 Back Table Cover
1 Bowl	1 Gown, Non-Reinforced	1 Cautery Tip, Coated
1 Bulb Irrigation Syringe	2 Light Handle Covers	7 OR Towels
1 Cautery Pencil with Holster	1 Mayo Stand Cover	

HAND TRAY

CASE/2 96-4311



CONTENTS

1 Bowl	10 Gauze, 4" x 4"	1 Drape, Hand
1 Tray, Rectangular	10 Gauze, 4" x 4", X-Ray	1 Drape
1 Poly-Bag	1 Needle Counter, 20 Ct.	1 Gown, Non-Reinforced
1 Blade, No. 11	4 OR Towels	1 Gown Fabric-Reinforced
1 Blade, No. 15	1 Undercast padding	1 Back Table Cover
1 Needle, 25G x 1-1/2"	1 Stockinette	1 Suture Bag
1 Needle, 18G x 1-1/2"	1 Esmark Bandage	
1 Syringe, Ear / Ulcer	1 Absorbent Towel	
1 Syringe 10 mL, Luer Lock	1 Mayo Stand Cover	
1 Skin Marker with Ruler		



GENERAL SURGERY TRAYS

TOTAL JOINT TRAY

CASE/2 96-4312



CONTENTS

- | | | |
|---------------------|-------------------------------------|------------------------------|
| 2 Ring Basins | 1 Bulb Syringe | 1 Bandage, Latex-Free |
| 1 Pitcher | 1 Skin Marker with Ruler | 1 Esmark Bandage |
| 1 Bowl | 1 Suction Tubing | 1 Stockinette |
| 1 Emesis Basin | 1 Yankauer Suction Tube, Non-Vented | 10 Lap Sponges |
| 1 Tray, Rectangular | 1 Needle Counter, 60 Ct. | 10 Gauze, 4" x 4", 12-Ply |
| 1 Foam Tray | 1 CSR Wrap | 10 Gauze, 4" x 4", X-Ray |
| 1 Suture Bag | 2 Light Handle Covers | 12 OR Towels |
| 1 Poly Bag | 1 Non-Adhering, Dressing | 1 Mayo Stand Cover |
| 1 Blade, No. 10 | 1 Dressing, Combine | 1 Drape, U-Plastic with Tape |
| 1 Blade, No. 15 | 1 Dressing, Petrolatum | 1 Back Table Cover |
| 1 Blade, No. 20 | 1 Bandage | |

KNEE ARTHROSCOPY TRAY

CASE/2 96-4313



CONTENTS

- | | | |
|---------------------------|-----------------------------|---------------------------------|
| 1 Prep Tray | 1 Syringe, 10 mL, Luer Lock | 1 Stockinette |
| 1 Bowl | 1 Syringe, 30 mL, Luer Lock | 1 Drape, Arthroscopy with Pouch |
| 1 Suture Bag | 1 Needle Counter 20 ct | 1 Drape |
| 1 Poly Bag | 1 Dressing | 1 Drape, U-Plastic with Tape |
| 10 Gauze, 4" x 4", 12-Ply | 1 Esmark Bandage | 1 Mayo Stand Cover |
| 10 Gauze, 4" x 4", X-Ray | 1 Bandage | 1 Gown |
| 4 OR Towels | 1 Bandage, Latex-Free | 1 Gown, Fabric-Reinforced |
| 1 Absorbent Towel | 1 Undercast Padding | 1 Back Table Cover |
| 1 Blade, No. 11 | 1 Suction Tubing | 1 Spinal Needle 18G x 3.5" |
| 1 Needle, 18G x 1-1/2" | | |

BASIC SHOULDER TRAY

CASE/2 96-4314



CONTENTS

- | | | |
|-----------------------------|-----------------------------|------------------------------|
| 1 Bowl | 1 Blade, No. 15 | 1 Stockinette |
| 1 Prep Tray | 1 Needle, 18G x 1-1/2" | 1 Mayo Stand Cover |
| 1 Medicine Cup | 1 Skin Marker with Ruler | 3 Absorbent Towel |
| 1 Suture Bag | 8 Labels | 1 Gown |
| 10 Gauze, 4" x 4", 12-Ply | 1 Syringe, 10 mL, Luer Lock | 1 Gown, Fabric-Reinforced |
| 10 Gauze, 4" x 4", X-Ray | 1 Syringe, 60 mL, Luer Lock | 1 Drape Split w / Adhesive |
| 6 OR Towels | 1 Syringe, 30 mL, Luer Lock | 1 Drape |
| 5 Lap Sponges | 1 Suction Tubing | 1 Drape, U Plastic with Tape |
| 1 Blade, No. 11 | 1 Dressing, Petrolatum | 1 Drape, Shoulder Split |
| 1 Spinal Needle, 18G x 3.5" | 1 Dressing, Combine | 1 Back Table Cover |
| 6 Small Wing Sponges | 1 Bandage, Latex-Free | 1 3-Compartment Tray |
| 3 Applicator Prep Sticks | 1 PVP-I Scub Bottle | 1 2-Compartment Tray |
| | 1 PVP-I Paint Bottle | 2 Cotton-Tip Applicators |

ARTHROSCOPY TRAY

CASE/2 96-4315



CONTENTS

- | | | |
|------------------------|-----------------------------|-----------------------------|
| 1 Ring Basin | 1 Needle Counter 10 Ct. | 1 Bandage Roll |
| 1 Pitcher | 1 Skin Marker with Ruler | 1 Bandage |
| 1 Emesis Basin | 1 Irrigation Set | 1 Esmark Bandage |
| 1 Bowl | 1 Suction Tubing | 1 Stockinette |
| 1 Medicine Cup | 10 Gauze, 4" x 4" | 1 Mayo Stand Cover |
| 1 Foam Tray | 6 OR Towels | 1 Drape Arthroscopy w/Pouch |
| 1 Suture Bag | 1 Needle Spinal 18G x 3.5" | 2 Gowns, Fabric-Reinforced |
| 1 Blade, No. 11 | 1 Syringe, 20 mL, Luer Lock | 1 Back Table Cover |
| 1 Needle, 18G x 1-1/2" | 1 Dressing, Combine | |



ARTHROSCOPY TRAY

CASE/2 96-4316



CONTENTS

- | | | |
|--------------------------|--|---------------------------------|
| 1 Bowl | 1 Needle, 22G x 1-1/2" | 1 Undercast Padding |
| 1 Prep Tray | 1 Needle, 18G x 3.5", Spinal | 1 Bandage |
| 1 Medicine Cup | 1 Needle, 25G x 1-1/2" | 1 Bandage, Latex-Free |
| 1 Emesis Basin | 1 Needle Counter 20 Ct. | 1 Esmark Bandage |
| 1 Suture Bag | 1 Skin Marker with Ruler | 1 Stockinette |
| 10 Gauze, 4"x4" 12-Ply | 8 Labels | 1 Mayo Stand Cover |
| 10 Gauze 4"x 4", X-Ray | 1 Syringe, 10 mL, Luer Lock | 2 Absorbent Towel |
| 6 OR Towels | 1 Syringe, 20 mL, Luer Lock | 1 Gown |
| 1 Poly Bag | 1 Syringe, 30 mL, Luer Lock | 1 Gown, Fabric-Reinforced |
| 1 Blade, No. 11 | 1 Syringe, 60 mL, Luer Lock | 1 Drape, Arthroscopy with Pouch |
| 1 Blade, No. 15 | 1 Suction Tubing | 1 Drape, U Plastic with Tape |
| 1 Needle, 18G x 1-1/2" | 1 Petroleum Dressing, 1"x 8" | 1 Back Table Cover |
| 2 Cotton Tip Applicators | 1 Gloves, Synthetic, Powder Free, Latex Free, Walleted, Pair | 1 3-Compartment Tray |
| 1 PVP-I Scub Bottle | 1 Dressing, Combine | 1 2-Compartment Tray |
| 1 PVP-I Paint Bottle | | 3 Applicator Prep Sticks |

MAJOR LAPAROTOMY TRAY

CASE/2 96-4317



CONTENTS

- | | | |
|-------------------------------|---------------------------|--|
| 1 Bedside Bag | 10 Gauze, 4" x 4" | 1 Syringe, 10 mL, Luer Lock |
| 1 Emesis Basin | 2 Gown, Fabric-Reinforced | 1 Suction Tubing |
| 2 Blade, No. 10 | 1 Gown, Non-Reinforced | 1 Back Table Cover |
| 1 Blade, No. 15 | 10 Lap Sponges | 1 Cautery Tip, Coated |
| 1 Bowl, Graduated | 2 Light Handle Covers | 14 OR Towels |
| 1 Bulb Irrigation Syringe | 1 Mayo Stand Cover | 1 Yankauer Suction Tube Non-Vented |
| 1 Cautery Pencil with Holster | 1 Needle 25G x 1-1/2" | 1 3-Compartment Tray |
| 1 Specimen Container with Lid | 1 Needle Counter, 20 Ct. | 1 2-Compartment Tray |
| 2 Medicine Cup | 1 OR Basin | 1 Gloves, Synthetic, Powder Free, Walleted, Pair |
| 1 Drape, Laparotomy T-Sheet | 2 Cotton Tip Applicators | 1 PVP-I Scub Bottle |
| 4 Drape, Utility with Tape | 2 Absorbent Towels | 1 PVP-I Paint Bottle |
| 6 Small Wing Sponges | 3 Applicator Prep Sticks | |

BASIC LAPAROTOMY TRAY

CASE/4 96-4318



CONTENTS

- | | |
|-----------------------------|------------------------------------|
| 1 Bedside Bag | 10 Lap Sponges |
| 2 Blade, No. 10 | 1 Mayo Stand Cover |
| 1 Blade, No. 15 | 1 Needle Counter, 20 Ct. |
| 1 Drape, Laparotomy T-Sheet | 1 Suction Tubing |
| 10 Gauze, 4"x 4" | 1 Back Table Cover |
| 1 Gown, Fabric-Reinforced | 8 OR Towels |
| 1 Gown, Non-Reinforced | 1 Yankauer Suction Tube Non-Vented |

D & C / GYN TRAY

CASE/4 96-4319



CONTENTS

- | | |
|-----------------------------------|--|
| 1 Catheter, 14 Fr. | 2 Leggings |
| 1 Specimen Container with Lid | 2 Lube Jelly, 5 Gm Foil Pack |
| 1 Drape, Lithotomy T-Sheet | 1 OB Pad |
| 1 Drape, Underbuttocks with Pouch | 1 Back Table Cover |
| 1 Non-Adhesive Dressing | 14 OR Towels |
| 10 Gauze, 4" x 4" | 1 3-Compartment Tray |
| 1 Gown, Non-Reinforced | 1 2-Compartment Tray |
| 3 Applicator Prep Sticks | 1 Gloves, Synthetic, Powder Free, Walleted, Pair |
| 2 Cotton Tip Applicators | 1 PVP-I Scub Bottle |
| 6 Small Wing Sponges | 1 PVP-I Paint Bottle |
| 2 Absorbent Towels | |





GENERAL SURGERY TRAYS

LAPAROSCOPE CHOLE TRAY

CASE/4 96-4320



CONTENTS

- | | | |
|-------------------------------|----------------------------------|---------------------------------|
| 1 Bowl | 1 Pneumo Needle, 120 mm | 1 Steri-Strip, .5" x 4", 1 Card |
| 1 Emesis Basin | 1 Skin Marker with Ruler | 10 Gauze, 4" x 4", X-Ray |
| 1 Tray Prep | 1 Syringe, 10 mL, Luer Lock | 6 OR Towels |
| 1 Specimen Container with Lid | 1 Needle Counter 30 Ct. | 4 Drape Utility |
| 1 Medicine Cup | 2 Light Handle Covers | 1 Absorbent Towel |
| 1 Suture Bag | 1 Fog Reduction Device | 1 Mayo Stand Cover |
| 1 Blade, No. 15 | 1 Suction Tubing | 2 Gowns, Non-Reinforced |
| 1 Blade, No. 11 | 1 Insufflation Tubing, Luer Lock | 1 Drape, Endoscopy |
| 1 Needle 22G x 1-1/2" | 1 Bandage, Adhesive | 1 Back Table Cover |

LAPAROSCOPE CHOLE TRAY

CASE/2 96-4321



CONTENTS

- | | | |
|-----------------|-----------------------------|-------------------------------|
| 1 Pitcher | 1 Medicine Cup | 8 OR Towels |
| 1 Ring Basin | 10 Gauze, 4" x 4", X-Ray | 4 Clamp Towel, Plastic |
| 1 Blade, No. 15 | 1 Suture Bag | 1 Needle Counter 30 Ct. |
| 1 Blade, No. 11 | 1 Syringe, 5 mL, Luer Lock | 1 Drape |
| 1 Blade, No. 10 | 1 Syringe, 10 mL, Luer Lock | 1 Drape, Endoscopy |
| 2 Gowns, LG | 5 Lap Sponges | 1 Cautery Pencil with Holster |
| 2 Gowns, XL | 1 Cautery Tip Cleaner | 1 Mayo Stand Cover |
| 1 Bowl | 1 Absorbent Towel | 1 Suction Tubing |
| 1 CSR Wrap | 2 Light Handle Covers | 1 Back Table Cover |

MINOR SURGERY TRAY

CASE/1 □ 96-1744 WITH ECONO FLOOR GRADE INSTRUMENTS



CONTENTS

- | | |
|--------------------------------|------------------------|
| 1 Scalpel, No. 15, Long | 1 Adson Tissue Forcep |
| 3 Mosquito Hemostats, Curved | 1 Dressing Forcep |
| 2 Mosquito Hemostats, Straight | 15 Gauze, 4" x 4" |
| 1 Webster Needle Holder | 2 OR Towels |
| 1 Iris Scissor, Curved | 1 Drape, Clear Utility |
| 1 Hemostat, Straight | 2 Prep Trays |
| 1 OR Scissors, S/B | |

CROSS REFERENCE: GENERAL SURGERY TRAYS

SKLAR	MEDLINE
96-4300	DYNJS0502
96-4301	DYNJS0701
96-4302	DYNJS0702
96-4303	DYNJS0120
96-4304	DYNJ08334
96-4305	DYNJ08240
96-4308	DYNJS1001
96-4309	DYNJS0801
96-4310	DYNJS0804
96-4311	DYNJS0805
96-4312	DYNJS0830

OR TOWELS

STERILE CASE / 50

PRODUCT NUMBER

96-1662



CROSS REFERENCE: GENERAL SURGERY TRAYS, CONT.

SKLAR	MEDLINE
96-4312	DYNJS0830
96-4313	DYNJS0811
96-4314	DYNJS0840
96-4315	DYNJ08333
96-4316	DYNJS0810
96-4317	DYNJS0301
96-4318	DYNJS0302
96-4319	DYNJS0901
96-4320	DYNJS0310
96-4321	DYNJ06364
96-1744	

SKLAR STERILE WATER

STERILE CASE / 48

PRODUCT NUMBER

10-1601



INCISION AND DRAINAGE TRAYS

INCISION AND DRAINAGE TRAY

CASE/20 96-4403



CONTENTS

- 1 Kelly Hemostat, Straight, Wire
- 1 Insert Forcep, Wire
- 1 Safety Scalpel, No. 11
- 1 Refuse Bag
- 1 PVP Prep Pad
- 4 Gauze, 4" x 4"
- 1 Alcohol Prep Pad
- 1 Drape
- 1 Drape, Fenestrated

INCISION AND DRAINAGE TRAYS

INCISION AND DRAINAGE TRAY

CASE/20 96-4404



CONTENTS

- 1 Kelly Hemostat, Straight, Wire
- 1 Insert Forcep, Wire
- 1 Scalpel, No. 11
- 1 Refuse Bag
- 1 PVP Prep Pad
- 4 Gauze Sponges, 4" x 4"
- 1 Alcohol Prep Pad
- 1 Drape
- 1 Drape, Fenestrated

INCISION AND DRAINAGE TRAY

CASE/20 96-4405



CONTENTS

- 1 Kelly Hemostat, Straight, Stainless Steel
- 1 Thumb Forcep, Wire
- 1 Scalpel, No. 11
- 1 Refuse Bag
- 4 Gauze Sponges, 4" x 4"
- 1 PVP Prep Pad
- 1 Alcohol Prep Pad
- 1 Drape
- 1 Drape, Fenestrated



INCISION AND DRAINAGE TRAY

CASE/20 96-4406

CONTENTS

- 1 Scissor, S/B, Stainless Steel
- 1 Kelly Hemostat, Straight, Stainless Steel
- 1 Thumb Forcep, Wire,
- 1 Scalpel, No. 11
- 1 Refuse Bag
- 4 Gauze, 4" x 4"
- 1 PVP Prep Pad
- 1 Alcohol Prep Pad
- 1 Towel / Drape
- 1 Drape, Fenestrated



INCISION AND DRAINAGE TRAY

CASE/25 96-1713 WITH ECONO FLOOR GRADE INSTRUMENTS

CONTENTS

- 1 OR Scissor, S/B
- 1 Dressing Forcep
- 1 Hemostat, Straight
- 1 Scalpel, No. 1, Long
- 1 Refuse Bag
- 1 PVP Swab Sticks, Triple
- 1 Alcohol Swabsticks, Triple
- 4 Gauze, 4" x 4"
- 1 Drape, Fenestrated
- 1 Towel / Drape
- 1 Tray



INCISION AND DRAINAGE TRAY

CASE/25 96-1753 WITH PLASTIC/WIRE-FORM INSTRUMENTS

CONTENTS

- 1 Scissor, Wire Form
- 1 Dressing Forcep, Plastic
- 1 Hemostat, Straight, Plastic
- 1 Scalpel, No. 11, Long
- 1 Refuse Bag
- 1 Tray
- 1 PVP Swabsticks, Triple
- 1 Alcohol Swabsticks, Triple
- 4 Gauze, 4" x 4"
- 1 Drape, Fenestrated
- 1 Towel / Drape



CASE/25 96-1755 WITHOUT INSTRUMENTS

CROSS REFERENCE:

INCISION AND DRAINAGE TRAYS

SKLAR	MEDICAL ACTION	MEDLINE	BUSSE	CARDINAL
96-4403	-	-	-	NI15-0056
96-4404	61200	-	758	24006-010
96-4405	-	DYNJ07900	-	25006-010
96-4406	61227	DYNJS1024	-	25006-040
96-1713	-	-	-	-
96-1753	-	-	-	-
96-1755	-	-	-	-

The convenience kits illustrated in this catalog are representative of Sklar's assembly capabilities. The final design and approval of the kit is the responsibility of the customer and will be managed in accordance with the Sklar Design and Development process.



CENTRAL LINE TRAY

CASE/30 96-4443

CONTENTS

- | | |
|----------------------------|------------------------------|
| 1 Mask with Ear Loops | 1 Alcohol Swabsticks, Triple |
| 1 Gloves, Latex-Free, Pair | 1 PVP Swabsticks, Triple |
| 1 Gauze, 2" x 2" | 1 PVP Ointment |
| 1 Gauze, 4" x 4" | 1 Transparent Dressing |
| 1 IV Split Dressing | 1 Non-Woven Sponge |
| 1 Roll Medical Tape | |



CUT DOWN TRAY

CASE/10 96-4444 WITH ECONO GRADE INSTRUMENTS, CSR WRAP

CONTENTS

- | | |
|----------------------------|---------------------------------|
| 1 Scalpel, No. 11 | 2 Mosquito Hemostats, Straight |
| 2 Instrument Trays | 15 Gauze, 4" x 4" |
| 2 OR Towels | 3 Mosquito Hemostats, Curved |
| 1 Scalpel, No. 15 | 1 Webster Needle Holder, Smooth |
| 1 OR Scissor, S/B | 1 Mayo-Hegar Needle Holder |
| 1 Adson Tissue Forcep | 1 Kelly Hemostat, Straight |
| 1 Drape, Utility with Tape | 1 Dressing Forcep |



IV START TRAY

CASE/50 96-1705

CONTENTS

- 1 PVP Prep Pad
- 1 Alcohol Prep Pad
- 1 Transparent Tape
- 1 Tourniquet, Latex-Free
- 2 Gauze, 2" x 2"
- 1 Transparent Dressing with Label
- 1 Gloves, Synthetic, Powder-Free, Walleted, Pair



IV START TRAY

CASE/100 96-4445

CONTENTS

- 2 Gauze, 2" x 2", Non-Woven
- 1 Transparent Tape
- 1 Tourniquet, Latex-Free
- 1 Alcohol Prep Pad
- 1 Transparent Dressing, Framed
- 1 PVP Prep Pad
- 1 Dressing Change Label





IV START TRAY

CASE/100 96-4446

SAME CONTENTS AS 96-4445 BUT FEATURING TRANSPARENT DRESSING WITHOUT FRAME



IV START TRAY

CASE/100 96-4447

CONTENTS

- | | |
|-----------------------------|---|
| 2 Gauze, 2" x 2", Non-Woven | 1 Transparent Dressing, Framed |
| 1 Transparent Tape | 1 ChloroPrep® Applicator 1.5 ml with Insert |
| 1 Tourniquet, Latex-Free | 1 Dressing Change Label |



IV START TRAY

CASE/100 96-4448

CONTENTS

- | | |
|-----------------------------|----------------------------|
| 2 Gauze, 2" x 2", Non-Woven | 1 Transparent Dressing |
| 1 Transparent Tape | 1 Antimicrobial PVP Ampule |
| 1 Tourniquet, Latex-Free | 2 Alcohol Prep Pad |
| 1 Dressing Change Label | |



IV START TRAY

CASE/100 96-4449

CONTENTS

- | | |
|--------------------------|--|
| 1 Dressing Change Label | 1 ChloroPrep® Ampule, 0.67ml with Insert |
| 1 Transparent Tape | 1 Transparent Dressing, Framed |
| 1 Tourniquet, Latex-Free | 2 Gauze, 2" x 2", Non-Woven |



IV START TRAY

CASE/100 96-4450

CONTENTS

- | | |
|--------------------------|--|
| 1 Dressing Change Label | 1 ChlorPrep® Applicator 1.5 ml with Insert |
| 1 Transparent Tape | 1 Transparent Dressing with Cloth Border |
| 1 Tourniquet, Latex-Free | 2 Gauze, 2" x 2", Non-Woven |



IV START TRAY

CASE/100 96-4451

CONTENTS

- | | |
|--------------------------|--|
| 1 Dressing Change Label | 1 ChlorPrep® Ampule (3 mL) wotj Omsert |
| 1 Transparent Tape | 1 Transparent Dressing, Framed |
| 1 Tourniquet, Latex-Free | 2 Gauze, 2" x 2", Non-Woven |



IV START TRAY

CASE/100 96-4452

CONTENTS

- | | |
|--------------------------|------------------------------|
| 1 Dressing Change Label | 1 Antimicrobial PVP Prep Pad |
| 1 Transparent Tape | 1 Bandage |
| 1 Tourniquet, Latex-Free | 2 Gauze, 2" x 2", Non-Woven |
| 1 Alcohol Prep Pad | |

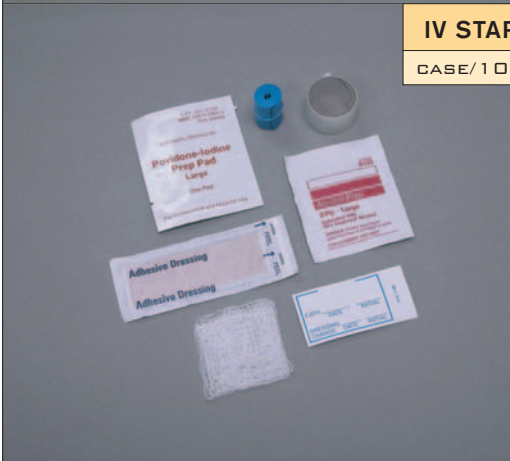

IV START TRAY

CASE/100 96-4453

CONTENTS

- | | |
|-------------------------|--------------------------------|
| 1 Dressing Change Label | 1 Transparent Dressing, Framed |
| 1 Transparent Tape | 1 Antimicrobial PVP Ampule |
| 1 Tourniquet | 2 Gauze, 2" x 2", Non-Woven |
| 1 Alcohol Pad | |





IV START TRAY

CASE/100 96-4454

CONTENTS

- | | |
|----------------------------------|-------------------------------|
| 1 Dressing Dressing Change Label | 1 Transparent Dressing, Frame |
| 1 Transparent Tape | 1 Antimicrobial PVP Ampule |
| 1 Tourniquet, Latex-Free | 2 Gauze, 2" x 2", Non-Woven |
| 1 Alcohol Pad | |



IV START TRAY

CASE/100 96-4455

CONTENTS

- | | |
|----------------------------------|-----------------------------|
| 1 Alcohol Prep Pad | 1 PVP Prep Pad |
| 1 Dressing Dressing Change Label | 1 Transparent Tape |
| 1 Tourniquet, Latex-Free | 2 Gauze, 2" x 2", Non-Woven |
| 1 Adhesive Bandage | |

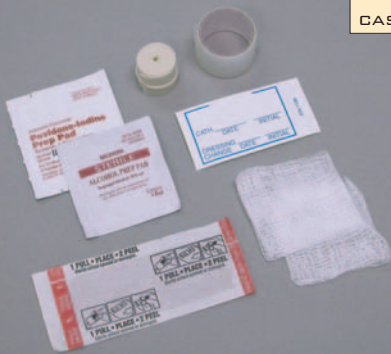

IV START TRAY

CASE/50 96-4456

CONTENTS

- | | |
|----------------------------|--------------------------------|
| 1 Gloves, Latex-Free, Pair | 1 Transparent Dressing, Framed |
| 1 Alcohol Prep Pad | 2 Gauze, 2" x 2", Non-Woven |
| 1 Tourniquet, Latex-Free | 1 Transparent Tape |
| 1 Dressing Change Label | 1 PVP Ampule |



CVC TRAY

CASE/30 96-4457

CONTENTS

- | | |
|----------------------------|--|
| 1 Gloves, Latex-Free, Pair | 1 Non-Woven Sponge, 2" x 2" |
| 1 Polylined Drape | 1 Gauze, 4" x 4" |
| 1 Dressing Change Label | 1 Gauze, 2" x 2" |
| 1 Transparent Tape | 1 ChloraPrep® Applicator, 3 ml (Mediflex™) |
| 1 Transparent Dressing | 1 Skin Prep Pad |
| 1 Mask with Ear Loops | |





ER LACERATION TRAY

CASE/20 96-4476 WITH ECONO FLOOR GRADE INSTRUMENTS

CONTENTS

- 1 Mosquito Hemostat, Curved
- 1 Adson Tissue Forceps
- 1 Webster Needle Holder
- 1 Iris Scissors, Straight, Stainless Steel
- 2 Medicine Cups
- 1 Needle, 27G x 1-1/2"
- 1 Needle, 25G x 5/8"
- 1 Needle, 18G x 1-1/2"
- 1 Syringe, 10 cc, Luer Lock
- 10 Gauze, 4" x 4"
- 5 Gauze, 2" x 2"
- 2 Absorbent Towels
- 1 Polylined Fenestrated Drape
- 1 Polylined Drape



ER LACERATION TRAY

CASE/20 96-4395

CONTENTS

- 1 Fenestrated Drape
- 5 Gauze, 2" x 2"
- 10 Gauze, 4" x 4"
- 1 Lidocaine, 5 mL
- 1 Needle, 30G x 1"
- 1 Needle, 27G x 1-1/4"
- 1 Needle 20G x 1-1/2"
- 1 Webster Needle Holder
- 1 Iris Scissors, Straight, Stainless Steel
- 1 Adson Tissue Forcep
- 1 Syringe, 10 cc, Control, Luer Lock
- 2 Towels, Cloth



ER LACERATION TRAY

CASE/20 96-4396

CONTENTS

- 1 Fenestrated Drape
- 5 Gauze, 2" x 2"
- 10 Gauze, 4" x 4"
- 1 Needle, 18G x 1-1/2"
- 1 Needle, 27G x 1-1/2"
- 1 Needle 25G x 5/8"
- 1 Webster Needle Holder
- 1 Iris Scissors, Straight, Stainless Steel
- 1 Mosquito Hemostat, Curved, Stainless Steel
- 1 Adson Tissue Forcep
- 1 Syringe, 10 cc, Control, Luer Lock
- 2 Towels, Paper



ER LACERATION TRAY

CASE/20 96-4397

CONTENTS

- 2 Medicine Cups
- 1 Fenestrated Drape
- 5 Gauze, 2" x 2"
- 10 Gauze, 4" x 4"
- 1 Needle, 18G x 1-1/2"
- 1 Needle, 27G x 1-1/2"
- 1 Needle 25G x 5/8"
- 1 Webster Needle Holder
- 1 Iris Scissors, Straight, Stainless Steel
- 1 Mosquito Hemostat, Curved, Stainless Steel
- 1 Adson Tissue Forceps, Stainless Steel
- 2 Cotton Tip Applicators
- 1 Syringe, 10 cc, Control, Luer Lock
- 2 Towels, Paper





LACERATION TRAY

CASE/20 96-4398

CONTENTS

- | | |
|------------------------|--|
| 2 Medicine Cups | 1 Webster Needle Holder |
| 1 Fenestrated Drape | 1 Iris Scissors, Straight, Stainless Steel |
| 5 Gauze, 2" x 2" | 1 Mosquito Hemostat, Curved |
| 10 Gauze, 4" x 4" | 1 Adson Tissue Forcep |
| 1 Needle, 18G x 1-1/2" | 2 Cotton Tip Applicators |
| 1 Needle, 27G x 1-1/2" | 1 Syringe, 10 cc, Control, Luer Lock |
| 1 Needle, 25G x 5/8" | 2 Towels, Paper |



LACERATION TRAY

CASE/20 96-4390

CONTENTS

- | | |
|------------------------|--|
| 2 Medicine Cups | 1 Needle 30G x 1" |
| 1 Fenestrated Drape | 1 Webster Needle Holder |
| 5 Gauze, 2" x 2" | 1 Iris Scissors, Straight, Stainless Steel |
| 10 Gauze, 4" x 4" | 1 Mosquito Hemostat, Curved |
| 1 Needle, 18G x 1-1/2" | 1 Adson Tissue Forcep |
| 1 Needle, 27G x 1-1/2" | 1 Syringe, 10 cc, Luer Lock |
| 1 Needle 25G x 5/8" | 2 Towels, Cloth |



LACERATION TRAY

CASE/20 96-4391

CONTENTS

- 1 Fenestrated Drape
- 1 Adson Tissue Forcep
- 5 Gauze, 2" x 2"
- 10 Gauze, 4" x 4"
- 1 Mosquito Hemostat, Curved
- 1 Webster Needle Holder
- 1 Iris Scissors, Straight, Stainless Steel
- 1 Towel, Cloth



LACERATION TRAY

CASE/20 96-4392

CONTENTS

- | | |
|-----------------------------|--|
| 1 Fenestrated Drape | 1 Adson Tissue Forcep |
| 1 Needle, 18G x 1-1/2" | 1 Mosquito Hemostat, Curved |
| 1 Needle, 27G x 1-1/2" | 1 Webster Needle Holder |
| 1 Needle, 20G x 1-1/2" | 1 Iris Scissors, Straight, Stainless Steel |
| 1 Syringe, 10 cc, Luer Lock | 10 Gauze, 4" x 4" |
| 1 Towel, Cloth | |



MAJOR LACERATION TRAY

CASE/1 2 **96-1710** WITH ECONO FLOOR GRADE INSTRUMENTS

CONTENTS

- | | |
|--|-------------------------------------|
| 1 Mosquito Hemostat, Curved | 1 Needle, 25G x 5/8" |
| 1 Adson Forcep, Serrated, Stainless Steel | 1 Needle, 18G x 1-1/2" |
| 1 Adson Tissue Forcep | 1 Syringe, 10 cc Control, Luer Lock |
| 1 Webster Needle Holder | 10 Gauze, 4" x 4" |
| 1 Iris Scissors, Straight, Stainless Steel | 5 Gauze, 2" x 2" |
| 2 Medicine Cups | 2 OR Towels |
| 1 Needle, 30G x 1" | 1 OR Towel, Fenestrated |
| 1 Needle, 27G x 1-1/2" | 1 Tray |
| | 1 Lidocaine 1%, 30 mL |



MINOR LACERATION TRAY – A

CASE/1 2 **96-1715** WITH ECONO FLOOR GRADE INSTRUMENTS

CONTENTS

- | | |
|--|-----------------------------|
| 1 Webster Needle Holder | 1 Needle, 18G x 1-1/2" |
| 1 Iris Scissors, Straight, Stainless Steel | 1 Syringe, 10 cc, Luer Lock |
| 1 Mosquito Hemostat, Curved | 10 Gauze, 4" x 4" |
| 1 Adson Forcep, Serrated, Stainless Steel | 5 Gauze, 2" x 2" |
| 2 Medicine Cups | 2 OR Towels |
| 1 Needle, 27G x 1-1/4" | 1 OR Towel, Fenestrated |
| 1 Needle, 25G x 5/8" | 1 Tray |



MINOR LACERATION TRAY – B

CASE/1 2 **96-1718** WITH ECONO FLOOR GRADE INSTRUMENTS

CONTENTS

- 1 OR Scissor
- 1 Baumgartner Needle Holder
- 1 Adson Tissue Forcep
- 10 Gauze, 4" x 4"
- 5 Gauze, 2" x 2"
- 1 Absorbent Towel
- 1 Fenestrated Drape
- 1 Instrument Tip
- 1 Tray



MINOR LACERATION TRAY – C

CASE/1 2 **96-1716** WITH PLASTIC/WIRE-FORM INSTRUMENTS

CONTENTS

- | | |
|-----------------------------|-----------------------------|
| 1 Scissor, Wire | 1 Needle, 25G x 5/8" |
| 1 Dressing Forcep, Plastic | 1 Needle, 18G x 1-1/2" |
| 1 Hemostat, Curved, Plastic | 1 Syringe, 10 cc, Luer Lock |
| 10 Gauze, 4" x 4" | 2 Medicine Cups |
| 5 Gauze, 2" x 2" | 1 Absorbent Towel |
| 1 Fenestrated Drape | 1 Tray |
| 1 Needle, 27G x 1-1/4" | |



CASE/1 2 **96-1717** WITHOUT INSTRUMENTS



LACERATION TRAYS

CROSS REFERENCE:

LACERATION TRAYS

SKLAR	CARDINAL
96-4395	05-5000
96-4396	05-5100
96-4397	05-5200
96-4398	05-5300
96-4390	05-5400
96-4391	05-5500
96-4392	BN05-6000
96-1710	-
96-1715	-
96-1718	-
96-1716	-
96-1717	-

SEE PAGE 155 FOR ORDERING INFORMATION. ▶



FACIAL LACERATION TRAY

CASE/20 96-4385



CONTENTS

- | | |
|----------------------------------|---|
| 1 Fenestrated Drape | 1 Iris Scissors, Straight, Stainless Steel |
| 1 Adson Forceps, Stainless Steel | 1 Metzenbaum Scissors, Straight Stainless Steel, 5-1/2" |
| 1 Adson Tissue Forcep | 10 Gauze, 4" x 4" |
| 1 Mosquito Hemostat, Curved | |
| 1 Webster Needle Holder | |
| 2 Medicine Cups | |

FACIAL LACERATION TRAY

CASE/20 96-4386



CONTENTS

- | | |
|--|-----------------------------|
| 1 Fenestrated Drape | 1 Needle, 27G x 1-1/2" |
| 1 Iris Forcep, Straight, Stainless Steel | 1 Needle, 25G x 5/8" |
| 1 Mosquito Hemostat, Curved | 1 Webster Needle Holder |
| 1 Iris Scissors, Straight, Stainless Steel | 1 Syringe, 10 cc, Luer Lock |
| 1 Needle, 18G x 1-1/2" | 10 Gauze, 4" x 4" |
| | 2 Towels, Cloth |



Hospital, Surgery Center and Physician Instrument Cleaning Products

CARE & CLEANING

DECONTAMINATES • DETERGENTS • LUBRICANTS

▶ SEE PAGES 152 THRU 165 FOR ORDERING INFORMATION.



FACIAL LACERATION TRAY

CASE/20 96-4387



CONTENTS

- | | |
|--|--|
| 1 Fenestrated Drape | 1 Needle, 25G x 5/8" |
| 1 Adson Forceps, Serrated, Stainless Steel | 1 Webster Needle Holder |
| 1 Iris Scissors, Straight, Stainless Steel | 1 Mosquito Hemostat, Curved, Stainless Steel |
| 1 Needle, 18G x 1-1/2" | 5 Gauze, 2" x 2" |
| 1 Needle, 27G x 1-1/2" | 10 Gauze, 4" x 4" |
| | 2 Medicine Cups |
| | 2 Towels, Paper |

FACIAL LACERATION TRAY

CASE/20 96-4388



CONTENTS

- | | |
|--------------------------|--|
| 2 Medicine Cups | 1 Mosquito Hemostat, Straight |
| 1 Fenestrated Drape | 1 Iris Scissors, Straight |
| 2 Towels, Cloth | 1 Metzenbazaum Scissors, Straight, Stainless Steel |
| 10 Gauze, 4" x 4" | 2 Webster Needle Holders |
| 1 Adson Forcep, Serrated | 1 Adson Forcep, Delicate |

FACIAL PLASTIC LACERATION TRAY

CASE/10 96-1707 WITH ECONO FLOOR GRADE INSTRUMENTS



CONTENTS

- | | |
|---|-------------------------------------|
| 1 Curved Mosquito Hemostat | 1 Needle, 25G x 5/8" |
| 1 Adson Forcep, Serrated, Stainless Steel | 1 Needle, 18G x 1-1/2" |
| 1 Adson Tissue Forcep | 1 Syringe, 10 cc Control, Luer Lock |
| 1 Webster Needle Holder | 1 Tray |
| 1 Iris Scissor, Straight | 10 Gauze, 4" x 4" |
| 2 Medicine Cups | 5 Gauze, 2" x 2" |
| 1 Needle, 30G x 1" | 1 OR Towel, Fenestrated |
| 1 Needle, 27G x 1-1/2" | 2 OR Towel |

CROSS REFERENCE:

LACERATION TRAYS

SKLAR	CARDINAL
96-4385	02-0003
96-4386	02-0008
96-4387	02-6200
96-4388	12-0357
96-1707	-

If you don't see your tray in our catalog—we'll make it for you.

CUSTOM PROCEDURE TRAYS IN 21 DAYS!





WOUND CLOSURE TRAY

CASE/20 96-4402



CONTENTS

- | | |
|---|-----------------------------|
| 1 Fenestrated Drape | 5 Gauze, 2" x 2" |
| 1 Baumgartner Needle Holder | 1 Syringe, 10 cc, Luer Lock |
| 1 Iris Scissor, Straight, Stainless Steel | 1 Needle, 18G x 1-1/2" |
| 1 Mosquito Hemostat, Curved | 1 Needle, 27G x 1-1/2" |
| 1 Adson Tissue Forcep | 1 Needle, 25G x 5/8" |
| 10 Gauze, 4" x 4" | 2 Medicine Cups |
| | 2 Towels, Paper |

WOUND CLOSURE TRAY

CASE/25 96-1730 WITH ECONO FLOOR GRADE INSTRUMENTS



CONTENTS

- 1 Webster Needle Holder
- 1 OR Scissor, S/B
- 1 Tissue Forcep
- 1 Kelly Forcep, Curved
- 1 Refuse Bag
- 1 PVP Swab Stick, Single
- 1 Alcohol Swab Stick, Single
- 4 Gauze, 4" x 4"
- 1 Absorbent Towel
- 1 Fenestrated Drape
- 1 Tray

WOUND CLOSURE TRAY

CASE/25 96-1731 WITH PLASTIC/WIRE-FORM INSTRUMENTS



CONTENTS

- 1 Scissor, Wire
- 1 Dressing Forcep, Plastic
- 1 Hemostat, Curved, Plastic
- 1 Absorbent Towel
- 1 Refuse Bag
- 1 PVP Swab Stick, Single
- 1 Alcohol Swab Stick, Single
- 4 Gauze, 4" x 4"
- 1 Fenestrated Drape
- 1 Tray

WOUND CLOSURE TRAY

CASE/25 96-1759 WITHOUT INSTRUMENTS



CONTENTS

- 1 Absorbent Towel
- 1 Refuse Bag
- 1 PVP Swab Stick, Single
- 1 Alcohol Swab Stick, Single
- 4 Gauze, 4" x 4"
- 1 Fenestrated Drape
- 1 Tray





WOUND CLOSURE TRAY

CASE/20 96-4389

CONTENTS

- | | |
|--|------------------------|
| 2 Medicine Cups | 1 Needle, 25G x 5/8" |
| 1 Mosquito Hemostat, Straight | 1 Needle, 18G x 1-1/2" |
| 1 Adson TISSUEForcep | 1 Needle, 27G x 1-1/2" |
| 1 Iris Scissors, Straight, Stainless Steel | 10 Gauze, 4" x 4" |
| 1 Webster Needle Holder | 5 Gauze, 2" x 2" |
| 1 Syringe, 10 cc, Luer Lock | 2 Towels, Cloth |
| | 1 Fenestrated Drape |



WOUND CLOSURE TRAY

CASE/20 96-4393

CONTENTS

- 1 Towel / Drape
- 1 Fenestrated Drape
- 1 Insert Forceps, Wire
- 4 Gauze, 4" x 4"
- 1 Kelly Hemostat, Curved, Wire
- 1 Needle Holder, Serrated, Wire
- 1 Alcohol Prep Pad
- 1 PVP Prep Pad
- 1 Refuse Bag
- 1 Scissors, S/B, Wire



WOUND CLOSURE TRAY

CASE/20 96-4394

CONTENTS

- 1 Towel / Drape
- 1 Fenestrated Drape
- 1 Adson Tissue Forcep
- 1 Baumgartner Needle Holder
- 1 Scissors, S / B, Stainless Steel
- 1 Refuse Bag
- 1 PVP Prep Pad
- 4 Gauze, 4" x 4"
- 1 Alcohol Prep Pad



WOUND CLOSURE TRAY

CASE/20 96-4399

CONTENTS

- 1 Towel / Drape
- 1 Fenestrated Drape
- 1 Kelly Hemostat, Curved, Stainless Steel
- 1 Adson Tissue Forcep
- 1 Baumgartner Needle Holder
- 1 Scissors, S/B, Stainless Steel
- 1 Refuse Bag
- 1 PVP Prep Pad
- 4 Gauze, 4" x 4"
- 1 Alcohol Prep Pad



WOUND CLOSURE TRAYS

WOUND CLOSURE TRAY

CASE/20 96-4400



CONTENTS

- 1 Towel / Drape
- 1 Fenestrated Drape
- 1 Iris Scissors, Straight, Stainless Steel
- 1 Mosquito Hemostat, Curved, Stainless Steel
- 1 Adson Tissue Forcep
- 1 Baumgartner Needle Holder
- 1 Refuse Bag
- 1 PVP Prep Pad
- 4 Gauze, 4" x 4"
- 1 Alcohol Prep Pad

WOUND CLOSURE TRAY

CASE/20 96-4401



CONTENTS

- 1 Fenestrated Drape
- 1 Webster Needle Holder
- 1 Iris Scissors, Straight, Stainless Steel
- 1 Mosquito Hemostat, Curved, Stainless Steel
- 1 Adson Tissue Forcep
- 10 Gauze, 4" x 4"
- 5 Gauze, 2" x 2"
- 1 Syringe, 10 cc, Luer Lock
- 1 Needle, 18G x 1-1/2"
- 1 Needle, 27G x 1-1/2"
- 1 Needle, 25G x 5/8"
- 2 Medicine Cups
- 2 Towels, Paper

WOUND CLOSURE TRAY

CASE/20 96-4478



CONTENTS

- 1 Webster Needle Holder
- 1 PVP Swab Stick, Single
- 1 OR Scissor
- 1 Alcohol Swab Stick, Single
- 1 Tissue Forcep
- 1 Refuse Bag
- 1 Mosquito Hemostat, Curved
- 1 Tray
- 4 Gauze, 4" x 4"
- 1 Absorbent Towel
- 1 Fenestrated Drape

DELUXE WOUND CLOSURE TRAY

CASE/20 96-4479



CONTENTS

- 1 Baumgartner Needle Holder
- 1 Kelly Hemostat, Curved
- 1 OR Scissor
- 1 Metal Tissue Forcep
- 1 Poly Bag with Twist Tie
- 1 Drape, Fenestrated
- 1 Towel / Drape
- 1 PVP Prep Pad
- 1 Alcohol Prep Pad
- 4 Gauze, 4" x 4"



DEBRIDEMENT TRAY, STAGE 1

CASE/20 96-1904



CONTENTS

- 1 Iris Scissors, Straight
- 1 Scalpel, No. 15
- 1 Dressing Forcep
- 1 Gloves, Latex-Free, Pair
- 1 Alcohol Prep Pad
- 1 PVP Prep Pad
- 2 Tip Protectors
- 1 Gauze, 4" x 4"

DEBRIDEMENT TRAY, STAGE 3

CASE/20 96-1804



CONTENTS

- 1 Syringe, 60 cc
- 1 Medicine Cup
- 1 Cotton Tip Applicator
- 1 Saline Solution
- 1 Gloves, Latex-Free, Pair
- 1 Abdominal Pad
- 2 Non-Woven Sponge
- 1 Drape Towel
- 6 Gauze, 4" x 4"
- 1 Poly Bag with Twist Tie
- 1 Tongue Depressor
- 1 Transpore Tape
- 1 Skin Protectant Swab Stick
- 2 Non Adhering Pads
- 1 Wound Measuring Device
- 1 Dressing Change Label

CROSS REFERENCE:

WOUND CLOSURE TRAYS

SKLAR	MEDICAL ACTION	MEDLINE	BUSSE	CARDINAL
96-4402	-	-	-	ACS-S-LAC 2
96-1730	-	-	-	-
96-1731	-	-	-	-
96-1759	-	-	-	-
96-4389	-	-	-	ACS-S-LAC 4
96-4393	-	-	-	05-9300
96-4394	61203	-	751	25004-010
96-4399	61204	-	756	25004-020
96-4400	61214	-	757	25004-040
96-4401	-	DYNJ03000	-	ACS-S-LAC 1
96-4478	-	-	-	-
96-4479	-	-	-	-
96-1904	-	-	-	-
96-1804	-	-	-	-



SKLAR brand banded bags are available in both sterile and non-sterile. A multipurpose covering with an elastic opening. Quick and easy to fit over a variety of O.R. equipment.

800.221.2166





NERVE BLOCK PAIN TRAY

CASE/1 □ 96-1748

CONTENTS

- | | |
|-----------------------------|---------------------------------|
| 2 Needle, 18G x 1-1/2" | 1 PVP Prep Packet |
| 1 Needle, 25G x 1-1/2" | 3 Applicator Prep Sticks |
| 1 Syringe, 3 cc, Luer Lock | 1 Tray |
| 2 Syringe, 5 cc, Luer Lock | 1 Small Tray |
| 1 Syringe, 20 cc, Luer Lock | 2 Lidocaine, 1%, 5 mL |
| 2 Absorbent Towels | 1 NaCl Solution, 0.9%, 10 mL |
| 4 Utility Drapes with Tape | 1 Fenestrated Drape, with Patch |
| 1 Bandaid | 10 Gauze, 4" x 4" |
| 1 Ampule Holder | |



ARTHROGRAM TRAY

CASE/1 □ 96-1745

CONTENTS

- | | |
|------------------------------|------------------------------------|
| 1 Needle, 18G X 1-1/2" | 1 Tray |
| 1 Needle, 20G X 1-1/2" | 1 20" Extension Set |
| 1 Needle, 21G X 1-1/2" | 1 3-way Stopcock |
| 1 Needle, 25G X 5/8" | 1 Fenestrated Drape with Ply Patch |
| 2 Syringes, 10 cc, Luer Lock | 5 Gauze, 3" X 3" |
| 1 Syringe, 20 cc, Luer Lock | 1 Bandaid |
| 1 Lidocaine, 1%, 5 mL | 1 Towel / Drape |
| 1 PVP Swab Sticks, Triples | |



CYST ASPIRATION TRAY

CASE/25 □ 96-1807

CONTENTS

- 1 Needle, 21G x 1-1/2"
- 1 Syringe, 10 cc, Luer Lock
- 1 Tray
- 1 PVP Swab Sticks, Triples
- 5 Gauze, 4" X 4"



CYST/FNA/CORE TRAY

CASE/1 □ 96-1803

CONTENTS

- | | |
|------------------------------------|--------------------------------|
| 1 Scalpel, No. 11 | 1 Syringe, 5 cc, Luer Lock |
| 1 Fenestrated Drape with Ply Patch | 1 Syringe, 10 cc, Luer Lock |
| 6 Gauze, 4" X 4" | 1 Lidocaine, 1%, 5 mL |
| 1 Solution Bowl | 1 PVP Swab Sticks, Triples |
| 1 Needle, 18G x 1-1/2" | 1 Alcohol Swab Sticks, Triples |
| 1 Needle, 21G x 1-1/2" | 1 Tray |
| 1 Needle, 22G x 1-1/2" | 1 Latex Ultrasound Probe Cover |
| 1 Needle, 25G x 5/8" | 1 Ziplock Bag |
| | 1 Ampule Holder |



HYSTEROSALPINGOGRAM (BASIC) TRAY

CASE/1 □ 96-1721



CONTENTS

- | | |
|---|--|
| 1 Plastic Uterine Sound | 1 Rayon Swab |
| 1 Fenestrated Drape | 1 PVP Ointment |
| 1 Drape, Half | 1 Sklar Lubricating Jelly |
| 6 Gauze, 4" x 4" | 1 PVP Prep Packet |
| 1 Needle, 18G x 1-1/2" | 1 Half Deep Tray |
| 1 Stopcock, 1 way, Luer Lock | 1 Large Foam Tray |
| 1 Syringe, 10 cc, Luer Lock | 1 Uterine Injector |
| 1 Syringe, 10 cc, Control | 1 Extension Set, 20" |
| 1 Gloves, Synthetic, Powder Free, Walleted Pair | 1 Graves Vaginal Speculum, Medium, Plastic |
| | 1 Ziplock Bag |

AMNIOCENTESIS TRAY

CASE/1 □ 96-1722



CONTENTS

- | | |
|-------------------------------|-------------------------------------|
| 1 Needle, 25G x 5/8" | 1 Fenestrated Drape, with Ply Patch |
| 1 Needle, 22G x 1-1/2" | 8 Gauze, 4" x 4" |
| 1 Needle, 22G x 3.5" (Spinal) | 1 Absorbent Towel |
| 1 Syringe, 5 cc, Luer Lock | 1 Bandaid |
| 1 Syringe, 10 cc, Luer Lock | 1 Lidocaine, 1%, 5 mL |
| 1 Syringe, 20 cc, Luer Lock | 1 Tray |
| 3 Specimen Tubes with Caps | 1 5 Micron Filter Straw |
| 1 PVP Swab Sticks, Triples | 1 Plastic Ruler |
| 1 Ultrasound Gel Pack | |

CT BIOPSY TRAY

CASE/1 □ 96-1723



CONTENTS

- | | |
|-----------------------------|---------------------------------|
| 1 Mini Scalpel | 2 Lidocaine, 1%, 5 mL |
| 2 Absorbent Towels | 1 Alcohol Prep Pad |
| 1 Bandaid | 1 PVP Swab Sticks, Triples |
| 4 Syringes, 10cc, Luer Lock | 1 Tray |
| 1 Safety Needle, 25G x 5/8" | 1 Paper Ruler |
| 1 Needle, 22G x 1-1/2" | 1 Fenestrated Drape, with Patch |
| 1 Ampule Holder | 10 Gauze, 4" x 4" |

ULTRASOUND TRAY

CASE/1 □ 96-1801



CONTENTS

- | | |
|------------------------------|---------------------------------|
| 1 Needle, 20G x 1-1/2" | 3 Applicator Prep Sticks |
| 1 Needle, 25G x 1-1/2" | 1 Tray |
| 3 Syringes, 10 cc, Luer Lock | 1 Paper Ruler |
| 12 Gauze, 3" x 3" | 1 Shallow Prep Tray |
| 3 Towel / Drapes | 1 Lidocaine, 1%, 5 mL |
| 1 Bandaid | 1 Fenestrated Drape, with Patch |



LABOR AND DELIVERY TRAY

CASE/5 96-3171



CONTENTS

- | | |
|-------------------------------------|--------------------------|
| 1 Needle, 21G x 1" | 1 Vaginal Delivery Drape |
| 1 Syringe, 10 cc Control, Luer Lock | 1 Drape Sheet |
| 1 Bulb Irrigation Syringe | 1 Back Table Cover |
| 1 Cord Clamp | 2 Maternity Pad |
| 1 Lap Sponges | 4 OR Towels |
| 1 Utility Bowl with Lid | 5 Gauze, 4" x 4", 12-Ply |
| 1 Specimen Tube with Cap | |

C-SECTION TRAY

CASE/5 96-3181



CONTENTS

- | | | |
|---|--------------------------|--------------------|
| 1 Bulb Irrigation Syringe | 1 Band Bag | 1 Abdominal Pad |
| 1 Gloves, Synthetic, Powder-Free Walleted, Pair | 1 Tray | 1 Mayo Stand Cover |
| 1 Plastic Tube with Cap | 1 Foam Tray | 10 Lap Sponges |
| 1 Suction Tubing | 1 CSR Wrap | 4 OR Towels |
| 3 Applicator Prep Sticks | 1 Gown, Large | 1 Prep Tray |
| 1 PVP Prep Bottle | 1 Back Table Cover | |
| 1 Foam Needle Counter | 1 Vaginal Delivery Drape | |
| | 1 Maternity Pad | |

LLETZ ELECTROSURGERY TRAY

CASE/10 96-1916



CONTENTS

- | | |
|----------------------|--------------------------------------|
| 1 Needle, 30G x 1" | 1 Lugol's Iodine Contrast Medium |
| 1 Pantyliner | 1 Monsel's Hemostatic Paste |
| 1 Absorbent Underpad | 1 Lidocaine 2%, 10 mL |
| 6 Rayon Swabs | 1 Lidocaine w/ Epinephrine 2%, 30 mL |
| 1 Alcohol Prep Pad | 1 Endocervical Needle, 27G x 3-1/4" |
| 1 Tray | 1 Ziplock Bag |
| 1 Ampule Holder | |

SPINAL TRAY

CASE/20 96-1802



CONTENTS

- | | |
|-----------------------------|---------------------------------|
| 1 Needle, 18G x 1-1/2" | 1 PVP Ointment |
| 1 Needle, 21G x 1-1/2" | 1 PVP Swab Sticks, Triples |
| 1 Spinal Needle, 22G x 3.5" | 1 Alcohol Swab Sticks, Triples |
| 1 Syringe, 3 cc, Luer Lock | 1 Shallow Prep Tray |
| 1 Syringe, 10 cc, L/S | 4 Gauze, 4" x 4" |
| 1 Specimen Tube with Cap | 1 Fenestrated Drape, with Patch |
| 1 Bandaid | |





C-SECTION TRAY

CASE/1 96-4306

CONTENTS

- | | | |
|---|-------------------------------|------------------------|
| 1 Drape C-Section with Pouch and Fenestration | 2 Blades, No. 10 | 6 OR Towels |
| 1 Bowl | 1 Blade, No. 20 | 2 Gowns, Reinforced |
| 1 Medicine Cup | 1 Baby Blanket | 1 Gown, Non-Reinforced |
| 2 CSR Wrap | 2 OB Pad | 2 Ring Basin |
| 1 Yankauer Suction Tube, Non-Vented | 1 Wash Basin | 1 Suction Tubing |
| 1 Suture Bag | 1 Back Table Cover | |
| 15 Lap Sponges | 1 Mayo Stand Cover | |
| 1 Ear / Ulcer Syringe | 1 Fenestrated Drape with Tape | |
| | 1 Cord Clamp | |



C-SECTION TRAY

CASE/2 96-4307

CONTENTS

- | | | |
|-------------------------------|------------------------------------|--|
| 2 Ring Basin | 1 Vacutainer, 7 mL, Lavender | 2 Absorbent Towels |
| 1 Placenta Basin | 1 Vacutainer, 10 mL, Red | 4 Drape, Utility with Tape |
| 1 Pitcher | 1 Syringe, Ear / Ulcer | 1 Dressing, Non-Adhering |
| 1 Emesis Basin | 1 Yankauer Suction Tube Non-Vented | 2 OB, Pad |
| 1 Bowl | 2 Light Handle Covers | 1 Head Warmer |
| 1 Specimen Container with Lid | 1 Cord Clamp | 1 Baby Blanket |
| 1 Medicine Cup | 1 Suction Tubing | 1 Mayo Stand cover |
| 1 Foam Tray | 1 Needle Counter, 20 ct. | 2 Gowns, Non-Reinforced |
| 1 Suture Bag | 1 Skin Marker with Ruler | 1 Gown, Fabric-Reinforced |
| 2 Blades, No. 10 | 10 Gauze 4" x 4", 12-Ply | 1 Drape, C-Section with Pouch and Fenestration |
| 1 Blade, No. 20 | 10 Gauze 4" x 4", X-Ray | 1 Back Table Cover |
| 1 Needle, 18" x 1-1/2" | 20 Lap Sponges | 1 CSR Wrap |
| 1 Syringe, 10 mL, Luer Lock | 5 OR Towels | |
| 1 Syringe, 20 mL, Luer Lock | | |

CROSS REFERENCE:

OB/GYN PROCEDURE TRAYS

SKLAR	MEDLINE
96-1748	-
96-1745	-
96-1807	-
96-1803	-
96-1721	-
96-1722	-
96-1723	-
96-1801	-
96-3171	-
96-3181	-
96-1916	-
96-1802	-
96-4306	DYNJ08030
96-4307	DYNJS0612

SKLAR CERVIX BRUSH



SKLAR'S Cervix Brush is made of polyethylene and has a total length of 20 centimeters. The top portion uses a soft flexible brush to obtain cell samples. The brush consists of 57 semi-circular plastic bristles of various lengths. The shape is such that the top edges of the brush follow the contours of the cervix. The longer middle bristles reach deep into the endocervical canal. The shorter bristles touch both the ectocervical area and transformation zone at the same time.

STERILE CASE / 100

PRODUCT NUMBER FEATURES

96-4140

NON-STERILE CASE / 100

PRODUCT NUMBER FEATURES

96-4140NS





SUTURE REMOVAL TRAYS

SUTURE REMOVAL TRAY

CASE/50	96-4407	96-4408	96-4409
		<p>CONTENTS</p> <ul style="list-style-type: none"> 1 Gauze, 3" x 3" 1 Insert Forcep, Wire 1 PVP Prep Pad 1 Alcohol Prep Pad 1 Iris Scissors, Straight, Stainless Steel 	<p>CONTENTS</p> <ul style="list-style-type: none"> 1 Gauze, 3" x 3" 1 Adson Forcep, Serrated, Stainless Steel 1 Iris Scissor, Straight, Stainless Steel

SUTURE REMOVAL TRAY

CASE/50	96-4410	96-4438	96-4411
		<p>CONTENTS</p> <ul style="list-style-type: none"> 1 Gauze, 3" x 3" 1 Forcep, Plastic 1 PVP Prep Pad 1 Alcohol Prep Pad 1 Littauer Scissors, Wire 	<p>CONTENTS</p> <ul style="list-style-type: none"> 1 Gauze, 3" x 3" 1 Forcep, Plastic 1 Littauer Scissors, Wire

SUTURE REMOVAL TRAY

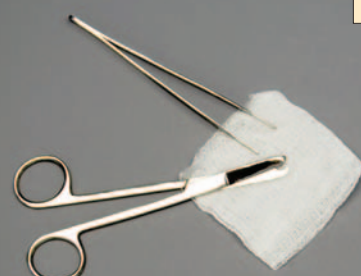
CASE/50	96-4412	96-4413	96-4414
		<p>CONTENTS</p> <ul style="list-style-type: none"> 1 Gauze, 3" x 3" 1 Staple Remover, Metal 1 PVP Prep Pad 1 Alcohol Prep Pad 	<p>CONTENTS</p> <ul style="list-style-type: none"> 1 Thumb Forcep, Stainless Steel 1 Gauze, 3" x 3" 1 Kelly Hemostat, Straight 1 Scissors, S/B, Stainless Steel

SUTURE REMOVAL TRAY

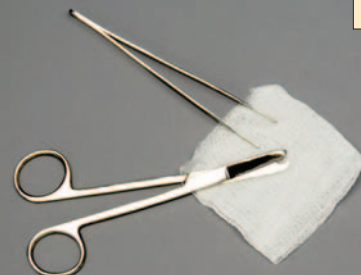
CASE/50	96-4415	96-4416	96-4417
		<p>CONTENTS</p> <ul style="list-style-type: none"> 1 Adson Forcep, Serrated, Stainless Steel 1 Gauze, 3" x 3" 1 Mosquito Hemostat, Curved 1 Iris Scissor, Curved, Stainless Steel 	<p>CONTENTS</p> <ul style="list-style-type: none"> 1 Adson Forcep, Serrated, Stainless Steel 1 Gauze, 3" x 3" 1 Littauer Scissor, Stainless Steel



SUTURE REMOVAL TRAY

CASE/50	96-4418		96-4419		96-4420	
---------	---------	--	---------	--	---------	--

CONTENTS

- 1 Gauze 3" x 3"
- 1 Forcep, Plastic
- 1 Littauer Scissor, Plastic

CONTENTS

- 1 Staple Remover, Metal
- 1 Gauze, 3" x 3"

CONTENTS

- 1 Littauer Scissor, Wire
- 1 Insert Forcep, Wire
- 1 Gauze, 3" x 3"



SUTURE REMOVAL TRAY

CASE/50	96-4421		96-4422		96-4423	
---------	---------	--	---------	--	---------	--

CONTENTS

- 1 Littauer Scissor, Stainless Steel
- 1 Thumb Forcep, Wire
- 1 Gauze, 3" x 3"
- 1 PVP Prep Pad
- 1 Alcohol Prep Pad

CONTENTS

- 1 Gauze, 3" x 3"
- 1 Littauer Scissor, Wire
- 1 Thumb Forcep, Wire

CONTENTS

- 1 Iris Scissor, Curved
- 1 Thumb Forcep, Wire
- 1 PVP Prep Pad
- 1 Gauze, 3" x 3"
- 1 Alcohol Prep Pad



SUTURE REMOVAL TRAY

CASE/50	96-4424					
---------	---------	--	--	--	--	--

CONTENTS

- 1 Thumb Forcep, Wire
- 1 Gauze, 2" x 2"
- 1 PVP Prep Pad
- 1 Alcohol Prep Pad
- 1 Iris Scissor, Straight



Floor Grade Quality Instruments

**ECONO
Instruments**





PREMIUM SUTURE REMOVAL TRAY

CASE/10 96-1729 WITH SKLARCLIP



CONTENTS

- 1 Sklarclip Suture Removal Scissors
- 1 Dressing Forceps
- 1 Tray
- 1 Tip Protector
- 1 PVP Prep Pad
- 1 Alcohol Prep Pad
- 2 Gauze, 4" x 4"

SUTURE TRAY

CASE/10 96-1725 WITH ECONO FLOOR GRADE INSTRUMENTS



CONTENTS

- 1 Adson Tissue Forcep
- 1 Iris Scissor, Straight, Stainless Steel
- 1 Baumgartner Needle Holder
- 1 Fenestrated Drape
- 1 Plain Drape
- 20 Gauze, 4" x 4"
- 1 Needle, 20G x 1-1/2"
- 1 Needle, 25G x 5/8"
- 1 Syringe, 5 cc, Luer Lock
- 1 Lidocaine, 1%, 5 mL
- 1 PVP Prep Packet
- 1 Tray
- 1 Ampule Holder

SUTURE REMOVAL TRAY – A

CASE/50 96-1734 WITH ECONO FLOOR GRADE INSTRUMENTS



CONTENTS

- 1 Iris Scissor, Straight, Stainless Steel
- 1 Dressing Forcep
- 1 PVP Prep Pad
- 1 Alcohol Prep Pad
- 2 Gauze, 4" x 4"
- 2 Tip Protectors

SUTURE REMOVAL TRAY – B

CASE/50 96-1736 WITH ECONO FLOOR GRADE INSTRUMENTS



CONTENTS

- 1 Littauer Suture Scissor
- 1 Dressing Forcep
- 1 PVP Prep Pad
- 1 Alcohol Prep Pad
- 1 Gauze, 4" x 4"
- 2 Tip Protectors



SUTURE REMOVAL TRAY – C

CASE/50 | 96-1738 | WITH ECONO FLOOR GRADE INSTRUMENTS



CONTENTS

- 1 Littauer Suture Scissor
- 1 Dressing Forcep
- 1 Gauze, 4" x 4"
- 2 Tip Protectors

SUTURE REMOVAL TRAY – D

CASE/50 | 96-1740 | WITH ECONO FLOOR GRADE INSTRUMENTS



CONTENTS

- 1 Iris Scissor, Straight, Stainless Steel
- 1 Dressing Forcep
- 1 Gauze, 4" x 4"
- 2 Tip Protectors

SUTURE REMOVAL TRAY – E

CASE/50 | 96-1735 | WITH PLASTIC / WIRE-FORM INSTRUMENTS



CONTENTS

- 1 Littauer Scissor, Plastic
- 1 Dressing Forcep, Plastic
- 1 PVP Prep Pad
- 1 Alcohol Prep Pad
- 1 Gauze, 4" x 4"
- 1 Tip Protector

SUTURE REMOVAL TRAY – F

CASE/50 | 96-1737 | WITH PLASTIC / WIRE-FORM INSTRUMENTS



CONTENTS

- 1 Wire Formed Scissor
- 1 Dressing Forcep, Plastic
- 1 PVP Prep Pad
- 1 Alcohol Prep Pad
- 1 Tip Protector
- 1 Gauze, 4" x 4"



SUTURE REMOVAL TRAY

CASE/50 | **96-4458** | WITH FLOOR GRADE INSTRUMENTS, CSR WRAP



CONTENTS

- 1 Iris Scissors, Straight, Stainless Steel
- 2 Tip Protectors
- 1 Alcohol Prep Pad
- 1 Dressing Forceps
- 1 PVP Prep Pad
- 1 Gauze, 4" x 4"

SUTURE REMOVAL TRAY

CASE/50 | **96-4459** | WITH FLOOR GRADE INSTRUMENTS, CSR WRAP



CONTENTS

- 1 Iris Scissors, Straight, Stainless Steel
- 2 Tip Protectors
- 1 Alcohol Prep Pad
- 1 Dressing Forceps
- 1 Gauze, 4" x 4"

SUTURE REMOVAL TRAY

CASE/50 | **96-4460**



CONTENTS

- 1 Littauer Scissors, Plastic
- 1 Suture Scissors, Plastic
- 1 Gauze, 3" x 3"

SUTURE REMOVAL TRAY

CASE/50 | **96-4461**



CONTENTS

- 1 Iris Scissor, Straight, Stainless Steel
- 1 Adson Forcep, Serrated
- 1 Gauze, 3" x 3"
- 1 Alcohol Pad
- 1 Iodophor PVP Pad



SUTURE REMOVAL TRAY

CASE/50 96-4462

CONTENTS

- 1 Metal Littauer Scissor, Stainless Steel
- 1 Adson Forcep, Serrated
- 1 Gauze, 4" x 4"



SUTURE TRAY

CASE/25 96-4465 WITH FLOOR GRADE INSTRUMENTS, CSR WRAP

CONTENTS

- 1 Adson Tissue Forcep
- 1 Iris Scissor, Straight, Stainless Steel
- 1 Baumgartner Needle Holder
- 1 Needle, 20G x 1-1/2"
- 1 Needle, 20G x 5/8"
- 1 Syringe, 5 cc, Luer Lock
- 20 Gauze, 4" x 4"
- 1 Fenestrated Drape
- 1 PVP Prep Packet
- 1 Plain Drape
- 1 Lidocaine, 1%, 5 mL
- 1 2-Compartment Tray



STAPLE REMOVAL TRAY

CASE/50 96-1732 WITH PLASTIC INSTRUMENT

CONTENTS

- 1 Staple Remover
- 1 Gauze, 4" x 4"



SKIN STAPLE REMOVER TRAY

CASE/4B 96-4463 CASE/4B 96-4464

CONTENTS

- 1 Staple Remover, Metal
- 1 Gauze, 3" x 3"

CONTENTS

- 1 Staple Remover, Plastic
- 1 Gauze, 3" x 3"



The convenience kits illustrated in this catalog are representative of Sklar's assembly capabilities. The final design and approval of the kit is the responsibility of the customer and will be managed in accordance with the Sklar Design and Development process.



SUTURE REMOVAL TRAYS

CROSS REFERENCE: SUTURE REMOVAL TRAYS

SKLAR	MEDICAL ACTION	MEDLINE	BUSSE	CARDINAL
96-4407	-	-	-	06-6000
96-4408	-	-	-	06-0012
96-4409	-	-	-	06-0084
96-4410	-	-	-	06-6100
96-4438	-	-	-	06-6200
96-4411	-	-	-	06-6300
96-4412	-	-	-	06-6500
96-4413	-	-	-	06-6700
96-4414	-	-	-	06-6900
96-4415	-	-	-	06-7000
96-4416	68537	-	-	06-7100
96-4417	-	-	-	06-7200
96-4418	-	-	-	06-9400
96-4419	-	-	-	12-0001
96-4420	61108	MSD707555	-	24000-005
96-4421	61104	-	-	25000-050
96-4422	61531	MDS708550	718	24000-006
96-4423	-	-	-	25000-006
96-4424	-	-	-	SR211
96-1725	-	-	-	-
96-1729	-	-	-	-
96-1725	-	-	-	-
96-1734	-	-	-	-
96-1736	-	-	-	-
96-1738	-	-	-	-
96-1740	-	-	-	-
96-1735	-	-	-	-
96-1737	-	-	-	-
96-4458	-	-	-	-
96-4459	-	-	-	-
96-4460	-	-	-	-
96-4461	-	-	-	-
96-4462	-	-	-	-
96-4465	-	-	-	-
96-1732	-	-	-	-
96-4463	-	-	-	-
96-4464	-	-	-	-



ASSORTED BRUSHES FOR A WIDE RANGE OF SURGICAL EQUIPMENT

INSTRUMENT BRUSHES





TRACHEOSTOMY CARE TRAY

CASE/ZD 96-4376

CONTENTS

- 1 Tracheostomy Brush
- 1 Twill Tape
- 1 Tracheostomy Sponge
- 4 Dressing, 4" x 4"
- 1 Gloves, Vinyl, Pair
- 6 Pipe Cleaners
- 4 Cotton Tip Applicators
- 1 Towel, Paper
- 1 Drape



TRACHEOSTOMY CARE TRAY

CASE/ZD 96-4377

CONTENTS

- 1 Tracheostomy Brush
- 1 Twill Tape
- 1 Tracheostomy Sponge
- 4 Dressing, 4" x 4"
- 1 Gloves, Vinyl, Pair
- 2 Pipe Cleaners
- 5 Cotton Tip Applicators
- 1 Towel, Paper
- 1 Drape



TRACHEOSTOMY CARE TRAY

CASE/ZD 96-4378

CONTENTS

- 1 Tracheostomy Brush
- 1 Twill Tape
- 1 Tracheostomy Sponge
- 4 Dressing, 4" x 4"
- 1 Gloves, Vinyl, Pair
- 6 Pipe Cleaners, 5-1/2"
- 4 Cotton Tip Applicators
- 1 Towel, Paper



TRACHEOSTOMY CARE TRAY

CASE/ZD 96-4379

CONTENTS

- 1 Tracheostomy Brush
- 1 Twill Tape
- 1 Tracheostomy Sponge
- 4 Dressing, 4" x 4"
- 1 Gloves, Latex-Free, Pair
- 2 Hydrogen Peroxide
- 3 Pipe Cleaners
- 3 Cotton Tip Applicators
- 1 Towel, Paper
- 1 Drape
- 1 2-Compartment Tray



TRACHEOSTOMY CARE TRAY

CASE/20 96-4380



CONTENTS

- 1 Tracheostomy Brush
- 1 Tracheostomy Sponge Dressing, 4" x 4"
- 4 Dressing, 4" x 4"
- 1 Forcep, Plastic
- 1 Gloves, Vinyl, Pair
- 6 Pipe Cleaners
- 2 Cotton Tip Applicators
- 1 Twill Tape
- 2 Drape

TRACHEOSTOMY CARE TRAY

CASE/20 96-4381



CONTENTS

- 1 Tracheostomy Brush, Medium
- 1 Twill Tape
- 4 Dressing, 4" x 4"
- 1 Gloves, Vinyl, Pair
- 1 Hydrogen Peroxide
- 2 Pipe Cleaners
- 1 Saline, 100 mL
- 4 Cotton Tip Applicators
- 1 Drape
- 1 Suction Catheter, 14 Fr.
- 1 Tracheostomy Sponge Dressing, 4" x 4"

TRACHEOSTOMY CARE TRAY

CASE/20 96-4382



CONTENTS

- 4 Drapes
- 4 Allis Clamps, 4-5, Stainless Steel
- 4 Towel Clamps, Plastic
- 1 Medicine Cup
- 1 Dilator
- 1 Adson Forcep, Serrated, Stainless Steel
- 1 Adson Forcep, Fine Point
- 1 Forcep, Stainless Steel
- 1 Thumb Forcep, Stainless Steel
- 1 Towel, Paper
- 25 Gauze, 4" x 4"
- 2 Kelly Hemostats, Curved
- 2 Kelly Hemostats, Straight
- 2 Mosquito Hemostats, Curved
- 1 Medicine Dropper
- 1 Webster Needle Holder
- 2 Needles, 25G x 5/8"
- 2 Needles, 20G x 1-1/2"
- 2 Needles, 18G x 1-1/2"
- 1 Trousseau Trachial Dilator
- 1 Weitlaner Retractor, Stainless Steel
- 1 Scalpel, No. 11
- 1 Scalpel, No. 10
- 1 Littauer Scissors, Stainless Steel
- 1 Mayo Scissors, Straight, Stainless Steel
- 1 Metzenbaum Scissors, Curved, Stainless Steel
- 1 Jackson Tracheal Tenaculum
- 1 Suction Tip, 8 Fr.
- 1 Suction Tip, 10 Fr.
- 2 Syringes, 10 cc, Luer Lock
- 1 Syringe, 6 cc, Luer Lock
- 1 4-Compartment Tray

TRACHEOSTOMY INSERTION TRAY

CASE/10 96-4383



CONTENTS

- 1 Metzenbaum Scissors, Straight, Stainless Steel
- 2 Kelly Hemostats, Straight
- 1 Webster Needle Holder, Stainless Steel
- 1 Skin Hook
- 1 Adson Tissue Forcep
- 1 Knife Handle, No. 3
- 6 Gauze, 4" x 4"
- 4 Tracheostomy Sponge Dressing, 4" x 4"
- 1 Medicine Cup with Lid
- 1 Fenestrated Drape, with Ply Patch
- 1 2-Compartment Tray
- 1 Army / Navy Retractors



TRACHEOSTOMY CARE TRAY

CASE/ZO 96-4384



CONTENTS

- 1 Tracheostomy Brush
- 1 Twill Tape
- 1 Tracheostomy Sponge Dressing, 4" x 4"
- 2 Hydrogen Peroxide
- 1 Gloves, Vinyl, Pair
- 4 Pipe Cleaners
- 2 Cotton Tip Applicators
- 2 Drapes
- 4 Dressing, 4" x 4"

TRACHEOSTOMY CARE TRAY

CASE/ZO 96-4496



CONTENTS

- 1 2-Compartment Tray
- 1 Removable Basin
- 1 Gloves, Latex-Free, Pair
- 1 Polylined Towel / Drape
- 1 Flexible Nylon Brush
- 1 Tracheostomy Sponge Dressing, 4" x 4"
- 2 Cotton Tip Applicators
- 4 Dressing, 4" x 4"
- 4 Pipe Cleaners
- 1 Twill Tape

TRACHEOSTOMY CARE TRAY

CASE/ZO 96-4497



CONTENTS

- 1 3-Compartment Tray
- 2 Towel / Drape
- 1 Flexible Nylon Brush
- 1 Tissue Forcep, Plastic
- 4 Pipe Cleaners
- 1 Tracheostomy Sponge Dressing, 4" x 4"
- 2 Cotton Tip Applicators
- 4 Dressing, 4" x 4"
- 1 Twill Tape

TRACHEOSTOMY CARE TRAY

CASE/ZO 96-4498



CONTENTS

- 1 3-Compartment Tray
- 1 Polylined Towel / Drape
- 1 Flexible Nylon Brush
- 1 Twill Tape
- 1 Gloves, Latex-Free Pair
- 1 Saline Solution, 100 mL
- 1 Tracheostomy Sponge Dressing, 4" x 4"
- 2 Cotton Tip Applicator
- 4 Dressing, 4" x 4"
- 4 Pipe Cleaners
- 1 Foam Neck Pad
- 2 Hydrogen Peroxide, 1oz., 3% Solution



TRACHEOSTOMY CARE TRAYS

TRACHEOSTOMY CARE TRAY

CASE/20 96-4499

CONTENTS

- | | |
|----------------------------|---|
| 1 3-Compartment Tray | 2 Towels / Drapes |
| 1 Gloves, Latex-Free, Pair | 4 Dressing, 4" x 4" |
| 1 Tissue Forcep, Plastic | 2 Cotton Tip Applicators |
| 1 Twill Tape | 1 Tracheostomy Sponge Dressing, 4" x 4" |
| 4 Pipe Cleaners | 1 Flexible Nylon Brush |



TRACHEOSTOMY CARE TRAY

CASE/20 96-1703

CONTENTS

- | | |
|-----------------------------|---|
| 1 Tissue Forcep, Plastic | 1 Tracheostomy Brush |
| 1 Gloves, Latex-Free, Pair | 3 Pipe Cleaners |
| 3 Cotton Tipped Applicators | 1 Tracheostomy Sponge Dressing, 4" x 4" |
| 3 Prep Trays | 1 Paper/Poly Drape |
| 1 Twill Tape | 3 Gauze, 4" x 4" |



CROSS REFERENCE:

TRACHEOSTOMY CARE TRAYS

SKLAR	CARDINAL
96-4376	NI11-0031
96-4377	NI11-0032
96-4378	NI11-0033
96-4379	11-0006
96-4380	11-1100
96-4381	11-0019
96-4382	11-0022
96-4383	NI11-0028
96-4384	NI11-1350A
96-4496	
96-4497	
96-4498	
96-4499	
96-4500	
96-1703	

SKLAR STERILE PRODUCTS

VALUE - Sklar provides high quality products at a competitively low cost to ensure your hospital unsurpassed value.

CONVENIENCE - Made to order samples of custom procedure trays and fast delivery of finished product guarantees your convenience.

SERVICE - Sklar and your Prime Vendor Distributor offer twice the service of any other source.



ECONOMY BEDSIDE SET

CASE/20 96-2300

CONTENTS

- 1 Carafe with Strapped Lid
- 1 Carafe Jacket
- 1 Plastic Liner
- 1 Draw String Bag



BEDSIDE SET

CASE/20 96-2301

CONTENTS

- 1 Carafe with Strapped Lid
- 1 Carafe Jacket
- 1 Plastic Liner
- 1 Tumbler Clear Plastic
- 1 Draw String Bag



ECONOMY ADMISSION PACK

CASE/20 96-2302

CONTENTS

- 1 Carafe with Strapped Lid
- 1 OR Basin
- 1 Hand and Body Lotion
- 1 Patient Belonging Bag with Handle
- 1 Draw String Bag



ADMISSION PACK

CASE/20 96-2303

CONTENTS

- 1 Carafe with Strapped Lid
- 1 Tumbler Clear Plastic
- 1 OR Basin
- 1 Emesis Basin
- 1 Soap Dish
- 1 Soap
- 1 Adult Toothbrush
- 1 Patient Belonging Bag with Handle
- 1 Draw String Bag





ADMISSION TRAYS

DELUXE ADMISSION TRAY

CASE/10 96-2304



CONTENTS

- | | |
|----------------------------|-------------------------------------|
| 1 Carafe with Strapped Lid | 1 Freshmint Toothpaste |
| 1 Carafe Jacket | 1 Adult Toothbrush |
| 1 Facial Tissues | 1 Hand and Body Lotion |
| 1 OR Basin | 1 Black Comb |
| 1 Emesis Basin | 1 Shampoo |
| 1 Cup | 1 Conditioner |
| 1 Soap | 1 Patient Belonging Bag with Handle |
| 1 Soap Dish | 1 Draw String Bag |

DELUXE AMENITIES TRAY

CASE/30 96-2305



CONTENTS

- 1 Soap
- 1 Hand and Body Lotion
- 1 Black Comb
- 1 Deodorant
- 1 Mouth Wash
- 1 Freshmint Toothpaste
- 1 Adult Toothbrush
- 1 Shampoo
- 1 Conditioner
- 1 Draw String Bag

ECONOMY AMENITIES TRAY

CASE/50 96-2306



CONTENTS

- 1 Freshmint Toothpaste
- 1 Adult Toothbrush
- 1 Black Comb
- 1 Draw String Bag

DENTURE AMENITIES TRAY

CASE/50 96-2307



CONTENTS

- 1 Adult Toothbrush
- 1 Denture Tablets
- 1 Denture Cup with Lid
- 1 Draw String Bag



SHAVING ADMENITIES TRAY

CASE/50 96-2308



CONTENTS

- 1 Surgery Prep Razor, Double Edge
- 1 Shaving Cream
- 1 Draw String Bag

ECONOMY MATERNITY TRAY

CASE/50 96-2309



CONTENTS

- 5 OB Pads
- 1 Ziplock Bag
- 1 Draw String Bag

MATERNITY TRAY

CASE/50 96-2310



CONTENTS

- 1 Stretch Briefs
- 3 Peri Cold Packs
- 1 Draw String Bag

DELUXE MATERNITY TRAY

CASE/20 96-2311



CONTENTS

- 9 OB Pads
- 2 Stretch Briefs
- 1 Peri Bottle
- 12 Sani-Bag
- 10 OB Pads
- 5 Underpads
- 3 Peri Cold Packs
- 1 Draw String Bag



ECONOMY BABY CARE TRAY

CASE/50 96-2312

CONTENTS

- 1 Baby Comb
- 1 Soap
- 1 Tape Measure
- 1 Baby Wipes
- 1 Bulb Irrigation Syringe
- 1 Draw String Bag



BABY CARE TRAY

CASE/50 96-2313

CONTENTS

- 1 Baby Comb
- 1 Soap
- 1 Tape Measure
- 1 Baby Wipes
- 1 Bulb Irrigation Syringe
- 1 Sklar Lubricating Jelly
- 1 Digital Thermometer
- 1 Draw String Bag



DELUXE BABY CARE TRAY

CASE/20 96-2314

CONTENTS

- 1 Baby Comb
- 1 Soap
- 1 Tape Measure
- 1 Baby Wipes
- 1 Bulb Irrigation Syringe
- 1 Sklar Lubricating Jelly
- 1 Digital Thermometer
- 1 Hand and Body Lotion
- 15 Diapers, Newborn
- 1 Draw String Bag



FATHERS DELIVERY TRAY

CASE/20 96-2315

CONTENTS

- 1 Bouffant Cap
- 1 Scrub Top
- 1 Scrub Bottom
- 2 Shoe Covers
- 1 Mask with Ear Loop
- 1 Draw String Bag



SKLAR BASIC SET-UP PACKS

ALL INFORMATION CONCERNING PRODUCT CONTENT AND COMPOSITION; THE FUNCTION, CARE, MAINTENANCE, AND INTENDED USE OF PRODUCTS; AND ANY WARNINGS RESPECTING THE PRODUCTS IN THIS CATALOG ARE DERIVED EXCLUSIVELY FROM EACH PRODUCT'S MANUFACTURER. AS SUCH, SKLAR MAKES NO REPRESENTATIONS OR WARRANTIES - EITHER EXPRESS OR IMPLIED - RESPECTING THE SAME. IF ADDITIONAL INFORMATION ABOUT ANY PRODUCT IS NEEDED, PLEASE CONTACT A SKLAR SALES REPRESENTATIVE, WHO WILL ASSIST YOU IN OBTAINING THE INFORMATION FROM THE PRODUCT'S MANUFACTURER.

96-0001

SKLAR BASIC PACK

STERILE

CASE / 10

CONTENTS

- 1 Back Table Cover, 44" x 75"
- 2 Utility Drapes with Tape, 17" x 26"
- 1 Suture Bag
- 1 Drape Sheet, Large, 60" x 76"

96-0002

SKLAR BASIC PACK

STERILE

CASE / 10

CONTENTS

- 1 Back Table Cover, 44" x 75"
- 1 Mayo Stand Cover, Reinforced, 23" x 54"
- 1 Suture Bag
- 1 Drape Sheet, Medium 72" x 44"

96-0003

SKLAR BASIC PACK

STERILE

CASE / 10

CONTENTS

- 1 Back Table Cover, 44" x 75"
- 1 Mayo Stand Cover, Reinforced, 23" x 54"
- 1 Suture Bag

96-0004

SKLAR BASIC PACK I

STERILE

CASE / 10

CONTENTS

- 1 Back Table Cover, 44" x 75"
- 1 Mayo Stand Cover, Reinforced, 23" x 54"
- 2 Absorbent Towel
- 2 Utility Drapes with Tape, 17" x 26"
- 1 Suture Bag
- 1 Drape Sheet, Small 60" x 44"
- 1 Drape Sheet, Medium 72" x 44"

96-0005

SKLAR BASIC PACK II

STERILE

CASE / 10

CONTENTS

- 1 Back Table Cover, 44" x 75"
- 1 Mayo Stand Cover, Reinforced, 23" x 54"
- 1 Absorbent Towel
- 2 Utility Drapes with Tape, 17" x 26"
- 1 Suture Bag

96-0006

SKLAR BASIC PACK III

STERILE

CASE / 10

CONTENTS

- 1 Back Table Cover, 44" x 75"
- 1 Mayo Stand Cover, Reinforced, 23" x 54"
- 2 Utility Drapes with Tape, 17" x 26"
- 1 Suture Bag
- 1 Drape Sheet, Medium 72" x 44"

SKLAR BASIC SET-UP PACKS

96-0011 SKLAR BASIC PACKS WITH REINFORCED GOWNS

STERILE CASE / 6

CONTENTS

- 1 Heavy Duty Back Table Cover, 60" x 90"
- 1 Large External Impervious Reinforced Gown
- 1 X-Large Internal Impervious Reinforced Gown
- 1 Mayo Stand Cover, Reinforced, 23" x 54"
- 2 Absorbent Towels
- 2 Utility Drapes with Tape, 17" x 26"
- 1 Suture Bag
- 2 Drapes, Large 60" x 76"

96-0007 SKLAR BASIC PACK WITH NON-REINFORCED GOWNS

STERILE

CASE / 10

CONTENTS

- 1 Back Table Cover, 44" x 75"
- 2 Large Non-Reinforced Gowns
- 1 Mayo Stand Cover, Reinforced, 23" x 54"
- 2 Absorbent Towel
- 2 Utility Drapes with Tape, 17" x 26"
- 1 Suture Bag
- 1 Drape Sheet, Small 60" x 44"
- 1 Drape Sheet, Medium 76" x 44"

96-0008 SKLAR BASIC PACK WITH NON-REINFORCED GOWNS

STERILE

CASE / 10

CONTENTS

- 1 Back Table Cover, 44" x 90"
- 2 Large Non-Reinforced Gowns
- 1 Mayo Stand Cover, Reinforced, 23" x 54"
- 2 Utility Drapes with Tape, 17" X 26"
- 1 Suture Bag
- 1 Drape Sheet, Small 60" x 44"

96-0009 SKLAR BASIC PACKS WITH REINFORCED GOWNS

STERILE

CASE / 6

CONTENTS

- 1 Back Table Cover, 44" x 75"
- 1 Large External Impervious Reinforced Gown
- 1 X-Large Internal Impervious Reinforced Gown
- 1 Mayo Stand Cover, Reinforced, 23" x 54"
- 2 Absorbent Towel
- 2 Utility Drapes with Tape, 17" x 26"
- 1 Suture Bag
- 1 Drape Sheet, Small 60" x 44"
- 1 Drape Sheet, Large 60" x 76"

96-0010 SKLAR BASIC PACKS WITH REINFORCED GOWNS

STERILE

CASE / 6

CONTENTS

- 1 Back Table Cover, 44" x 75"
- 1 Large External Impervious Reinforced Gown
- 1 X-Large Internal Impervious Reinforced Gown
- 1 Mayo Stand Cover, Reinforced, 23" x 54"
- 2 Absorbent Towel
- 2 Utility Drapes with Tape, 17" x 26"
- 1 Suture Bag



STERILE AND NON-STERILE COMPONENTS



REINFORCED BACK TABLE COVERS

NON-STERILE CASE / 50

PRODUCT NUMBER	FEATURES
96-5120	44" x 44"
96-5122	44" x 75"
96-5124	44" x 90"
96-5126	60" x 90"

NON-STERILE CASE / 100

PRODUCT NUMBER	FEATURES
96-5121	44" x 44"
96-5123	44" x 75"
96-5125	44" x 90"
96-5127	60" x 90"

STERILE CASE / 20

PRODUCT NUMBER	FEATURES
96-5128	44" x 44"
96-5129	44" x 75"
96-5130	44" x 90"
96-5131	60" x 90"

BULK, NON-STERILE

NON-STERILE

PRODUCT NUMBER	FEATURES/QUANTITIES
96-5525	44" x 44" 1000 pc
96-5526	44" x 75" 800 pc
96-5527	44" x 90" 700 pc
96-5528	60" x 90" 500 pc

HEAVY DUTY

NON-STERILE

PRODUCT NUMBER	FEATURES/QUANTITIES
96-1111	83" x 44" Cs / 25
96-1112	83" x 44" Cs / 50
96-1113	83" x 44" Cs / 100

STERILE

PRODUCT NUMBER	FEATURES/QUANTITIES
96-1081	60" x 90" Cs / 25
96-1082	70" x 110" Cs / 15

BULK, NON-STERILE

PRODUCT NUMBER	FEATURES/QUANTITIES
96-1083	60" x 90" Cs / 400
96-1084	70" x 110" Cs / 260



CROSS REFERENCE:

BACK TABLE COVERS

SKLAR	CARDINAL	MEDLINE	KIMBERLY CLARK
96-5120	-	-	79440
96-5122	A8376N	05528/61026	79445
96-5124	A8146N	05527/61025	79495
96-5126	A8184N	31405/SPT-2320	79067
96-5121	-	-	79440
96-5123	A8376N	05528/61026	79445
96-5125	A8146N	05897/61025	79495
96-5127	A8184N	31405/SPT-2320	79067
96-5128	-	-	-
96-5129	8376	DYNJP2309	-
96-5130	8377	DYNJP2311	89618, 89611
96-5131	8378	DYNJP2320	89631
96-5525	-	-	79440
96-5526	A8376N	05528/61026	79445
96-5527	A8146N	05528/61025	79495
96-5528	A8184N	31405/SPT-2320	79068
96-1111	-	-	-
96-1112	-	-	-
96-1113	-	-	-
96-1081	8386	DYNJP2314	89057, 89906
96-1082	8385	DYNJP2317	89908
96-1083	A8153N	31359/SPT-2314	79006
96-1084	A8152N	SPT-2317	79008



SET UP COVERS

NON-STERILE CASE / 100

PRODUCT NUMBER	FEATURES
96-5065	44" x 70"
96-5068	54" x 80"
96-5071	54" x 90"

NON-STERILE CASE / 50

PRODUCT NUMBER	FEATURES
96-5066	44" x 70"
96-5069	54" x 80"
96-5072	54" x 90"

STERILE CASE / 25

PRODUCT NUMBER	FEATURES
96-5067	44" x 70"
96-5070	54" x 80"
96-5073	54" x 90"



DISPOSABLE COVER FOR SURGICAL LIGHT HANDLE.



LIGHT HANDLE COVERS

NON-STERILE CASE / 700

PRODUCT NUMBER	FEATURES/QUANTITIES
96-8931	Singles, Soft

NON-STERILE CASE / 50

PRODUCT NUMBER	FEATURES/QUANTITIES
96-8932	Singles, Soft

STERILE CASE / 50

PRODUCT NUMBER	FEATURES/QUANTITIES
96-5578	2 pc pk, Soft

CROSS REFERENCE:

SET UP COVERS

SKLAR	3M	ADVANCE	CFI
96-5065	-	-	CFI-702 NS
96-5068	-	5480CNS	-
96-5071	-	5490CNS	-
96-5066	-	-	CFI-702 NS
96-5069	-	5480CNS	-
96-5072	-	5490CNS	-
96-5067	-	-	CFI-702
96-5070	-	5490C	-
96-5073	-	5490C	-

LIGHT HANDLE COVERS

SKLAR	3M	ADVANCE
96-8931	-	LK601NS
96-8932	-	LK601NS
96-5578	06-LK602	-

FLUOROSCOPE COVERS

NON-STERILE CASE / 100

PRODUCT NUMBER	FEATURES
96-5088	18" x 20"
96-5079	18" x 24"
96-5091	30" x 36"
96-1086	35" x 43"
96-5094	36" x 30"
96-5082	36" x 44"
96-5085	44" x 60"
96-5560	52" x 52"
96-5561	84" x 110"

NON-STERILE CASE / 50

PRODUCT NUMBER	FEATURES
96-5089	18" x 20"
96-5080	18" x 24"
96-5092	30" x 36"
96-1087	35" x 43"
96-5095	36" x 30"
96-5083	36" x 44"
96-5086	44" x 60"
96-5562	52" x 52"
96-5563	84" x 110"

STERILE CASE / 25

PRODUCT NUMBER	FEATURES
96-5090	18" x 20"
96-5081	18" x 24"
96-5093	30" x 36"
96-1088	35" x 43"
96-5096	36" x 30"
96-5084	36" x 44"
96-5087	44" x 60"
96-5564	52" x 52"
96-5534	84" x 110"

FLUOROSCOPE COVERS W/ ADHESIVE STRIPS

NON-STERILE CASE / 100

PRODUCT NUMBER	FEATURES
96-S1012NS	36" x 44" (91 x 111cm)

NON-STERILE BOX / 10

PRODUCT NUMBER	FEATURES
96-S1012	36" x 44" (60 x 91cm)

SEE PAGE 71 FOR CROSS REFERENCE.

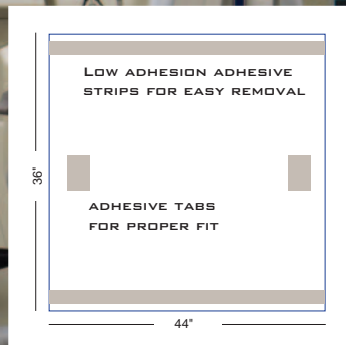
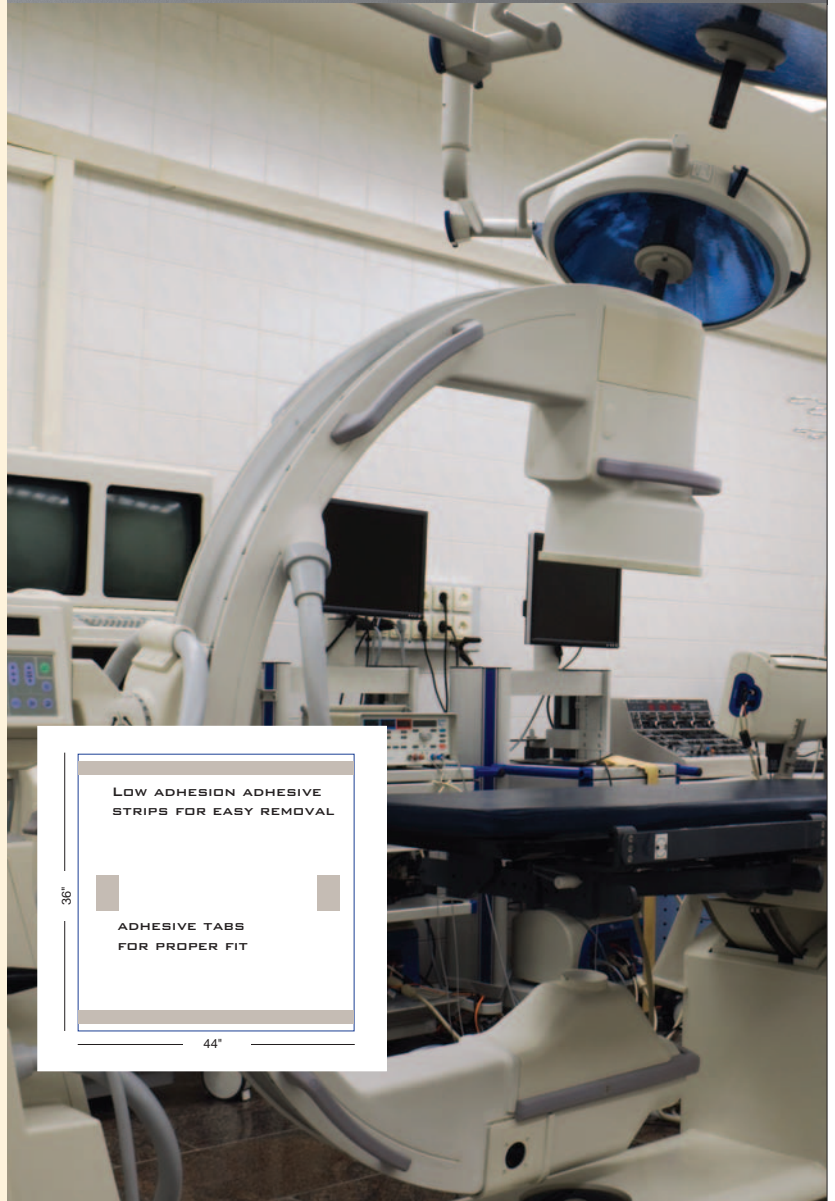
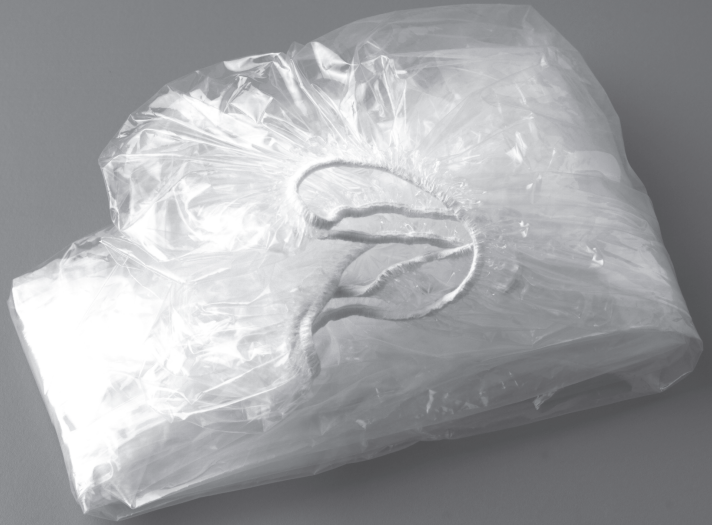

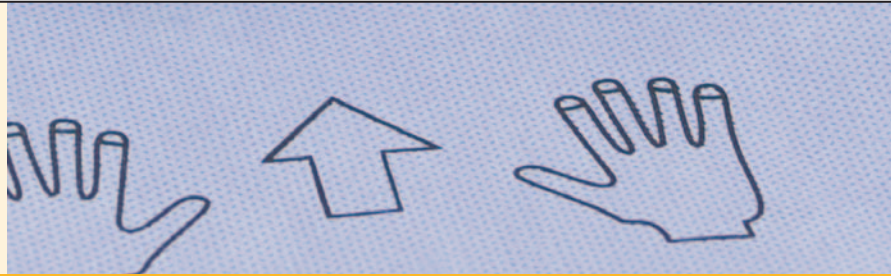

CROSS REFERENCE: FLUOROSCOPE COVERS

SKLAR	3M	ADVANCE	CARDINAL	CFI	MEDLINE	MICROTEK	KIMBERLY CLARK
96-5088	-	-	CFI-664 NS	-	2018RT	-	-
96-5079	-	-	-	-	-	-	-
96-5091	-	02-3036TL	-	CFI-667 NS	-	3036RT	-
96-1086	-	02-3636TL	-	CFI-657 NS	63636R	3636RT	-
96-5094	-	02-3630TL	29-63039	CFI-655 NS	-	3630RT	-
96-5082	-	02-3648TL	-	-	-	3648RT	-
96-5085	-	02-4060TL	-	-	-	4060RT	EZ-4060
96-5560	-	02-5050TL	-	-	60050S	5050RT	-
96-5561	-	-	-	-	-	-	-
96-5089	-	-	CFI-664 NS	-	2018RT	-	-
96-5080	-	-	-	-	-	-	-
96-5092	-	02-3036TL	-	CFI-667 NS	-	3036RT	-
96-1087	-	02-3636TL	-	CFI-657 NS	63636R	3636RT	-
96-5095	-	02-3630TL	29-63039	CFI-655 NS	-	3630RT	-
96-5083	-	02-3648TL	-	-	-	3648RT	-
96-5086	-	02-4060TL	-	-	-	4060RT	EZ-4060
96-5562	-	02-5050TL	-	-	60050S	5050RT	-
96-5563	-	-	-	-	-	-	-
96-5090	-	-	CFI-664	-	2018RT	-	-
96-5081	-	-	-	-	-	-	-
96-5093	-	01-3036	-	CFI-667	-	63036RT	-
96-1088	-	01-3636	-	CFI-657	-	63636RT	-
96-5096	-	01-3630	-	CFI-655	-	63630RT	-
96-5084	-	01-3648	-	-	-	63648RT	-
96-5087	-	01-4060	-	-	-	64060RT	-
96-5564	-	01-5050	-	-	-	65050RT	-
96-5534	-	-	-	-	-	-	-
96-S1012NS	1012NS	-	-	-	-	-	-
96-S1012	1012	-	-	-	-	-	-

CROSS REFERENCE: MAYO STAND COVERS

SKLAR	3M	ADVANCE	CARDINAL	CFI	MEDLINE	KIMBERLY CLARK
96-5566	-	MS2054NS	-	-	-	-
96-5135	9036NS	-	A8337N	CFI-708 NS	11348	79601
96-1089	-	-	-	-	-	-
96-5567	-	-	A8339N	-	SPT-2505	79602
96-1091	-	-	-	-	-	-
96-5570	-	MS2054NS	-	-	-	-
96-5136	9036NS	-	A8337N	CFI-708 NS	11348	79601
96-1108	-	-	-	-	-	-
96-5571	-	-	A8339N	-	PPT-2505	79602
96-1093	-	-	-	-	-	-
96-5574	-	05-MS2054	-	-	-	-
96-5137	9036	-	8337	CFI-708 NS	DYNJP2500	89601
96-1094	-	-	-	-	-	-
96-5575	-	-	8339	-	DYNJP2510	89602
96-1096	-	-	-	-	-	-
96-1131	-	-	-	-	-	-
96-1132	-	-	-	-	-	-
96-1133	-	-	-	-	-	-
96-1134	-	-	-	-	-	-
96-1135	-	-	-	-	-	-





MAYO STAND COVERS

NON-STERILE CASE / 100

PRODUCT NUMBER	FEATURES
96-5566	20" x 54"
96-5135	23" x 54"
96-1089	24" x 40.5" Clear
96-5567	30" x 57"
96-1091	36" x 72" Clear

NON-STERILE CASE / 50

PRODUCT NUMBER	FEATURES
96-5570	20" x 54"
96-5136	23" x 54"
96-1108	24" x 40.5" Clear
96-5571	30" x 57"
96-1093	36" x 72" Clear

STERILE CASE / 20

PRODUCT NUMBER	FEATURES
96-5574	20" x 54"
96-5137	23" x 54"
96-1094	24" x 40.5" Clear
96-5575	30" x 57"
96-1096	36" x 72" Clear

BULK, NON-STERILE

NON-STERILE

PRODUCT NUMBER	FEATURES/QUANTITIES
96-1131	20" x 54" 1000 Pcs
96-1132	23" x 54" 1000 Pcs
96-1133	24" x 40.5" Clear 1000 Pcs
96-1134	30" x 57" 800 Pcs
96-1135	36" x 72" Clear 800 Pcs

SEE PAGE 71 FOR CROSS REFERENCE.





DOME COVERS

NON-STERILE CASE / 100

PRODUCT NUMBER	FEATURES
96-5050	14" Deep
96-1101	18" Deep
96-5053	22" Deep
96-5056	27" Deep
96-1109	30" Deep

NON-STERILE CASE / 50

PRODUCT NUMBER	FEATURES
96-5051	14" Deep
96-1103	18" Deep
96-5054	22" Deep
96-5057	27" Deep
96-1104	30" Deep

STERILE CASE / 20

PRODUCT NUMBER	FEATURES
96-5052	14" Deep
96-1106	18" Deep
96-5055	22" Deep
96-5058	27" Deep
96-1107	30" Deep



CROSS REFERENCE:

DOME COVERS

SKLAR	3M	ADVANCE	CFI	MEDLINE	MICROTEK
96-5050	KP14LNS	CFI-763 NS	-	-	-
96-1101	1096	KP18LNS	CFI-911 NS	-	3815
96-5053	1097	KP22LNS	CFI-821 NS	-	3815
96-5056	-	03-KP27	CFI-786 NS	-	-
96-1109	-	KP30LNS	CFI-785 NS	-	3816
96-5051	-	KP14LNS	CFI-763 NS	-	-
96-1103	1096	KP18LNS	CFI-911 NS	-	3815
96-5054	1097	KP22LNS	CFI-821 NS	-	3815
96-5057	-	03-KP27	CFI-786 NS	-	-
96-1104	-	KP30LNS	CFI-785 NS	-	3816
96-5052	-	03-KP14	CFI-763	-	-
96-1106	1096	03-KP18	CFI-911	-	60020S
96-5055	1097	03-KP22	CFI-821	-	60020S
96-5058	-	03-KP27	CFI-786	DYNJE600265	60026S
96-1107	-	03-KP30	CFI-785	-	60026S



BAND BAGS WITH TAPE

NON-STERILE CASE / 100

PRODUCT NUMBER	FEATURES
96-5000	8" x 8"
96-1059	10" x 10"
96-5582	12" x 12"
96-5001	12" x 24"
96-5515	15" x 15"
96-5516	20" x 18"
96-5583	20" x 20"
96-1061	20" x 28"
96-5002	30" x 15"
96-1062	30" x 20"
96-5517	30" x 30"
96-5584	30" x 36"
96-5518	36" x 15"
96-5010	36" x 20"
96-5580	36" x 24"
96-1068	36" x 28"
96-5581	36" x 30"
96-5004	36" x 36"
96-5585	36" x 40"
96-5579	36" x 48"
96-5586	36" x 50"
96-1052	36" x 54"
96-5529	40" x 30"
96-5530	40" x 40"
96-5018	40" x 60"
96-5007	42" x 36"
96-5531	44" x 36"
96-1047	44" x 40"
96-5008	50" x 36"
96-5012	50" x 40"
96-5009	50" x 50"
96-5604	54" x 90"
96-5600	60" x 30"

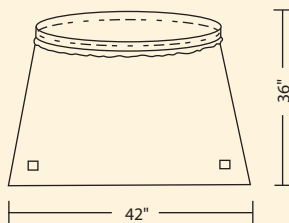

LATEX-FREE

BAND BAGS WITH TAPE

SKLAR brand banded bags are available in both sterile and non-sterile. A multipurpose covering with an elastic opening. Quick and easy to fit over a variety of O.R. equipment.

STERILE	CASE / 20	STERILE	CASE / 20
PRODUCT NUMBER	FEATURES	PRODUCT NUMBER	FEATURES
96-5013	8" x 8"	96-5017	36" x 36"
96-1069	10" x 10"	96-5594	36" x 40"
96-5591	12" x 12"	96-5589	36" x 48"
96-5014	12" x 24"	96-5595	36" x 50"
96-5522	15" x 15"	96-5587	36" x 54"
96-1072	20" x 18"	96-5532	40" x 30"
96-5592	20" x 20"	96-5533	40" x 40"
96-5016	20" x 28"	96-5019	40" x 60"
96-5015	30" x 15"	96-5020	42" x 36"
96-1073	30" x 20"	96-1054 4	4" x 36"
96-5524	30" x 30"	96-5024 4	4" x 40"
96-5593	30" x 36"	96-5021	50" x 36"
96-5588	36" x 15"	96-1053	50" x 40"
96-5023	36" x 20"	96-5022	50" x 50"
96-1057	36" x 24"	96-5025	54" x 90"
96-5603	36" x 28"	96-5601	60" x 30"
96-5590	36" x 30"		

SEE PAGE 75 FOR CROSS REFERENCE.



CROSS REFERENCE:

BAND BAGS WITH TAPE

SKLAR	3M	ADVANCE	CARDINAL	CFI	KIMBERLY CLARK	MEDLINE	MICROTEK
96-5000	-	-	-	-	-	-	-
96-1059	-	02-1010TL	-	-	-	-	1010RT
96-5582	-	02-1212TL	-	-	-	-	1212RT
96-5001	-	-	-	-	-	-	1224RT
96-5515	-	-	-	-	-	-	1515RT
96-5516	-	-	-	CFI-664 NS	-	-	2018RT
96-5583	-	02-2020TL	-	CFI-651 NS	-	DYNJE600205	2020RT
96-1061	-	02-2028TL	-	-	-	-	2028RT
96-5002	-	-	-	-	-	-	3015RT
96-1062	-	02-3020TL	-	-	-	-	3020RT
96-5517	-	02-3030TL	29-30309	CFI-661 NS	-	-	3030RT
96-5584	-	02-3036TL	-	CFI-667 NS	-	DYNJE63036R	3036RT
96-5518	-	-	-	CFI-833 NS	-	-	3625RT
96-5010	-	02-3620TL	29-36209	CFI-654 NS	EZ20CC	-	3620RT
96-5580	-	-	-	CFI-932 NS	-	-	3624RT
96-1068	-	02-3628TL	-	CFI-835 NS	-	DYNJE63628R	3628RT
96-5581	-	02-3630TL	29-63039	CFI-655 NS	-	-	3630RT
96-5004	-	02-3636TL	-	CFI-657 NS	-	63636R	3636RT
96-5585	-	02-3640TL	-	CFI-879 NS	-	-	3640RT
96-5579	-	02-3648TL	-	-	-	-	3648RT
96-5586	-	-	-	-	-	-	3650RT
96-1052	-	02-3654TL	-	-	-	-	3654RT
96-5529	-	02-4030TL	-	CFI-761 NS	-	-	4030RT
96-5530	-	02-4040TL	-	CFI-827 NS	EZ-4040	60040S	4040RT
96-5018	-	02-4060TL	-	-	EZ-4060	-	4060RT
96-5007	-	-	-	-	-	-	4236RT
96-5531	-	-	-	CFI-777T NS	-	-	4436RT
96-1047	-	-	-	-	-	-	4440RT
96-5008	-	-	-	-	-	-	5036RT
96-5012	-	02-4440TL	-	-	-	-	5040RT
96-5009	-	02-5050TL	-	-	-	60050S	5050RT
96-5604	-	-	-	-	-	-	5490RT
96-5600	-	-	-	-	-	-	6030RT
96-5013	-	-	-	-	-	-	6080BRT
96-1069	-	01-1010	-	-	-	-	61010RT
96-5591	-	01-1212	-	-	-	-	61212RT
96-5014	-	-	-	-	-	-	61220RT
96-5522	-	-	-	-	-	-	61515RT
96-1072	-	46753	-	CFI-664	-	-	62018RT
96-5592	-	01-2020	-	CFI-651	-	-	62020RT
96-5016	-	01-2028	-	-	-	-	62028RT
96-5015	-	-	-	-	-	-	63015RT
96-1073	-	01-3020	-	-	-	-	63018RT
96-5524	-	01-3030	29-30309	CFI-661	-	-	63030RT
96-5593	-	01-3036	-	CFI-667	-	DYNJE63036R	63036RT
96-5588	-	-	-	CFI-833	-	-	63615RT
96-5023	-	01-3620	29-36209	CFI-654	EZ20CC	-	63620RT
96-1057	-	-	-	CFI-932	-	-	63624RT
96-5603	-	01-3628	-	CFI-835	-	DYNJE63628R	63628RT
96-5590	4750	01-3630	29-63039	CFI-655	-	-	63630RT
96-5017	-	01-3636	-	CFI-657	-	-	63636RT
96-5594	-	01-3640	-	CFI-879	-	-	63640RT
96-5589	-	01-3648	-	-	-	-	63648RT
96-5595	-	-	-	-	-	-	63650RT
96-5587	-	01-3654	-	-	-	-	63650RT
96-5532	-	01-4030	-	CFI-761	-	-	64030RT
96-5533	-	01-4040	-	CFI-827	EZ-4040	60040S	64040RT
96-5019	-	01-4060	-	-	EZ-4060	-	64060RT
96-5020	-	-	-	-	-	-	64236RT
96-1054	-	-	-	CFI-777T	-	-	64436ST
96-5024	-	-	-	-	-	-	64440RT
96-5021	-	-	-	-	-	-	65036RT
96-1053	-	01-5040	-	-	-	-	65040RT
96-5022	-	01-5050	-	-	-	60050S	65050RT
96-5025	-	1311223	-	-	-	-	65490RT
96-5601	-	-	-	-	-	-	66030RT





MICROSCOPE DRAPES

- LATEX-FREE
- POLY DRAWSTRAPS
- LOCKING CLOSURES

LEICA DRAPES

STERILE CASE / 10

PRODUCT NUMBER	FEATURES
96-5140	44" x 120" (115 x 305cm)
96-1157	54" x 102" (137 x 259cm)
96-5679	54" x 105" (137 x 267cm) Observation Tubes: Monocular or Stereo
96-5142	54" x 120" (137 x 305cm)
96-5144	54" x 150" (137 x 318cm)

ZEISS OPMI® DRAPES

STERILE CASE / 10

PRODUCT NUMBER	FEATURES
96-1158	20" x 62" (51 x 157cm)
96-5680	20" x 64" (51 x 1163cm)
96-5146	20" x 65" (51 x 164cm) Observation Tubes: Without
96-5681	41" x 64" (104 x 163cm)
96-5682	41" x 120" (104 x 305cm)
96-5150	44" x 80" (115 x 305cm)
96-5152	44" x 120" (115 x 305cm) Observation Tubes: Monocular or Stereo

ZEISS MD DRAPES

STERILE CASE / 10

PRODUCT NUMBER	FEATURES
96-5154	46" x 80" (117 x 203cm)
96-5156	46" x 120" (117 x 305cm) Observation Tubes: Stereo
96-5158	54" x 105" (137 x 267cm)

SEE PAGE 77 FOR CROSS REFERENCE.

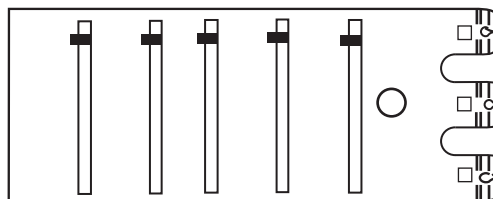

96-5140 LEICA - 44" x 120"

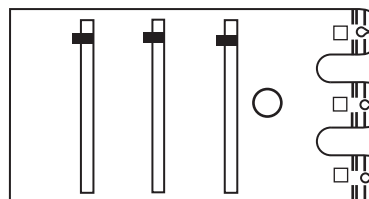

96-5679 LEICA - 54" x 105"

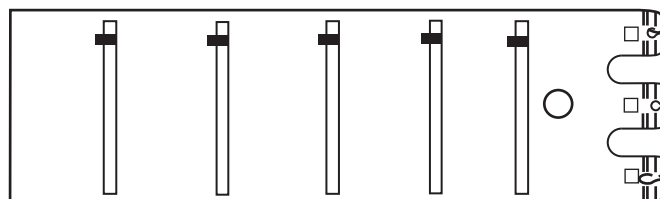

96-5144 LEICA - 54" x 150"

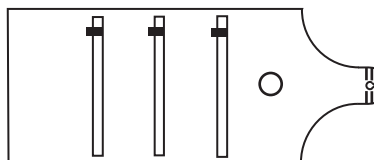

96-5680 OPMI - 20" x 64"

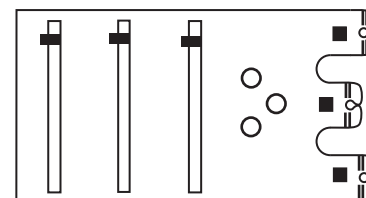

96-5681 ZEISS OPMI - 41" x 64"

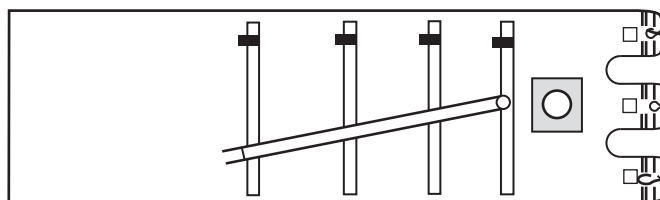

96-5682 ZEISS OPMI - 41" x 120"

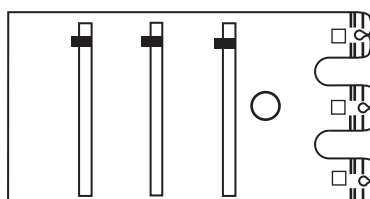

96-5154 ZEISS MD - 46" x 80"

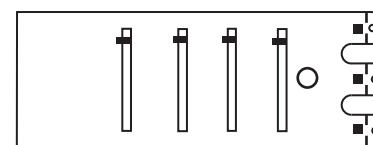

96-5156 ZEISS MD - 46" x 120"



CROSS REFERENCE:**MICROSCOPE DRAPES**

SKLAR	3M	ADVANCE	CARDINAL	MEDLINE	MICROTEK
96-5140	4792	-	-	-	-
96-1157	-	-	-	-	5952CL
96-5679	4794	-	29-59529	-	5952CL
96-5142	-	09-MK957	29-35919	-	3591
96-5144	-	4793	09-MK957	-	3591
96-1158	-	-	-	-	2918
96-5680	-	09-MK901	29-49219	DYNJE5010	2918
96-5146	-	09-MK901	-	-	-
96-5681	-	09-MK909	29-49459	-	4945
96-5682	-	-	29-29039	-	2903
96-5150	-	09-MK905	29-29629	-	2962
96-5152	-	09-MK906	29-29389	-	2938
96-5154	4785	09-MK936	29-48629	-	4862CL
96-5156	4787	09-MK937	29-48389	DYNJE5030	4838CL
96-5158	-	09-MK907	29-59529	-	4952

CROSS REFERENCE:**C-ARM DRAPES**

SKLAR	3M	ADVANCE	CARDINAL	MICROTEK	MEDLINE
96-1156	1013	-	-	-	-
96-5229	-	-	-	4973	-
96-5231	1101	-	-	2951	-
96-5233	4738	-	-	4951	-
96-5230	-	-	-	4951R	-
96-5232	-	-	-	890017	-
96-5234	-	-	-	890016	-
96-5235	-	-	-	C9-108M	-
96-5690	-	09-MK951	29-35919	C9-106M	-
96-1118	4739	-	-	8888M	-
96-5692	-	-	29-88389	8838M	-
96-1230	-	D&-CA104	29-49519	4951	DYNE44DD
96-1231	-	07-CA106	-	-	-

Sklar has 5 choices of quality surgical instruments...more than any other company!

**OR GRADE****Sklar OR Quality Instruments**

Our best operating room quality instruments incorporating the highest grades of surgical steel, finely detailed craftsmanship and exacting standards of manufacturing. These instruments are imported from Germany.

**PREMIUM GRADE****Sklar Premium™ Instruments**

Our finest OR grade instruments with the addition of a unique Sklar performance feature to meet the specific surgical needs of the clinician.

**MID GRADE****Surgi-OR™ Mid-Grade Quality Instruments**

These mid-grade instruments are forged from surgical grade stainless steel and crafted to offer significant value at reduced costs for the operating room as well as other important surgical settings.

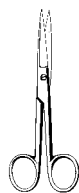
**OFFICE INSTRUMENTATION****Merit Office Instrumentation**

A cost-effective line of instruments ideally suited for routine, minor surgical use in the office setting.

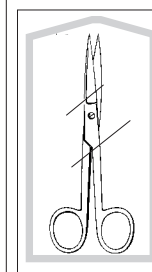
**FLOOR GRADE, STERILE****Econo Sterile™ Instruments**

The added convenience and cost-savings of these ready-to-use sterile instruments make Econo Sterile an exceptional value.



C-ARM DRAPES, FULL SIZE, UNIVERSAL

STERILE CASE / 20

PRODUCT NUMBER	FEATURES
96-1156	41" x 65" (103 x 165.1cm)
96-5229	41" x 90" (103 x 230cm)
96-5231	60" x 105" (152 x 267cm)
96-5233	41" x 74" (104 x 188cm)

STERILE CASE / 10

PRODUCT NUMBER	FEATURES
96-5230	41" x 74" (104 x 188cm)
96-5232	41" x 125" (104 x 318cm)
96-5234	41" x 65" (104 x 165cm)

C-ARM DRAPES, MINI

STERILE CASE / 20

PRODUCT NUMBER	FEATURES
96-5235	54" x 84" (137 x 213cm)
96-5690	41" x 84" (104 x 213cm)

STERILE CASE / 40

PRODUCT NUMBER	FEATURES
96-1118	54" x 78" (137 x 198cm)
96-5692	41" x 59" (104 x 149cm)

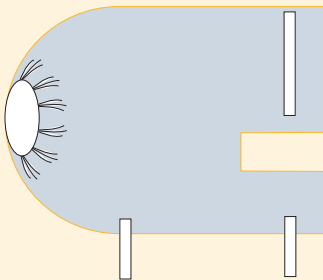

96-5692
LATEX-FREE ELASTIC OPENING

SEE PAGE 77 FOR CROSS REFERENCE.

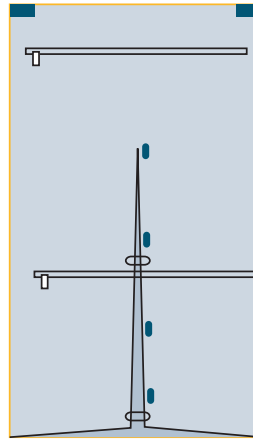

96-5229

- 41" x 90" (103 x 230cm)
- 54" SPLIT WITH TAPE TABS FOR CLOSURE

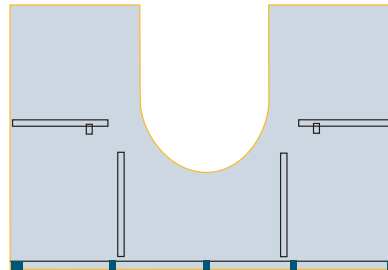

96-5231

- 60" x 105" (152 x 267cm)
- ONE PIECE FOR COMPLETE COVERAGE

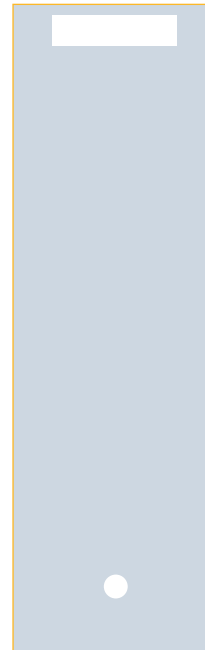

96-5233

- 41" x 74" (104 x 188cm)
- UNIVERSAL DRAPE

96-5230

- 41" x 74" (104 x 188cm)
- UNIVERSAL DRAPE
- CLIPS AND LATEX-FREE RUBBER BANDS

96-5232

- 41" x 125" (104 x 318cm)
- UNIVERSAL DRAPE
- CLIPS AND LATEX-FREE RUBBER BANDS

96-5234

- 41" x 65" (104 x 165cm)
- UNIVERSAL DRAPE
- CLIPS AND LATEX-FREE RUBBER BANDS

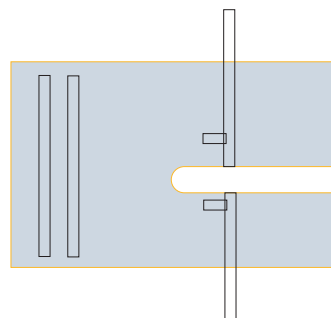

96-5235

- MINI C-ARM DRAPE FOR DEC 6800, 54" x 84" (137 x 213cm)

LASER DRAPES

STERILE CASE / 10

PRODUCT NUMBER	FEATURES
96-5161 54	" x 105" (137 x 267cm)
96-5162	54" x 105" (137 x 267cm)
96-5164	41" x 120" (104 x 305cm)
96-5163	41" x 120" (104 x 305cm)
96-5165	20" x 64" (51 x 136cm)
96-5160	20" x 30" (51 x 76cm)

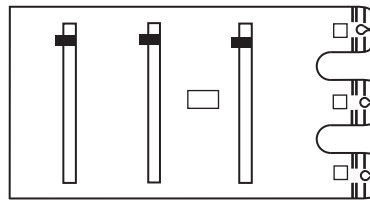

96-5161 Without Laser Arm Drape
With Standard Ocular Covers

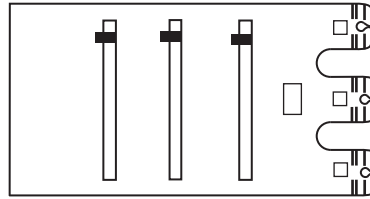

96-5162 Without Laser Arm Drape
Standard Ocular Covers

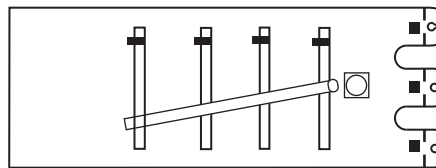

96-5164 Attached Laser Arm Drape
Standard Ocular Covers

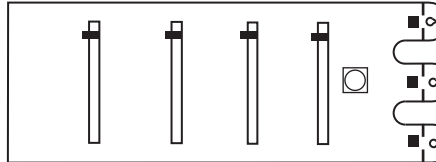

96-5163 Attached Without Laser Arm Drape
Standard Ocular Covers

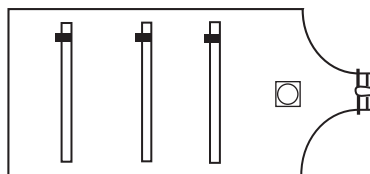

96-5165 Attached Laser Arm Drape
Standard Ocular Covers (2 Set)

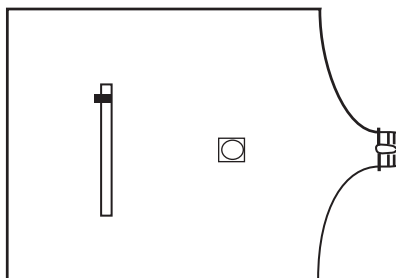

96-5160 Without Laser Arm Drape
Standard Ocular Covers (2 Set)

CROSS REFERENCE: LASER DRAPES

SKLAR	CARDINAL	MICROTEK
96-5161	-	2960
96-5162	-	3905
96-5164	29-29039	2903
96-5163	-	2907
96-5165	-	2918
96-5160	-	2910



C-ARM DRAPES, UNIVERSAL C-ARM/MOBILE X-RAY DRAPE

STERILE CASE / 20

PRODUCT NUMBER FEATURES

96-1230 44" x 74" (111 x 188cm)

96-1231 27" x 17" x 70"
(68.6 x 42.5 x 177.8cm)

SEE PAGE 77 FOR CROSS REFERENCE.

ULTRASOUND PROBE DRAPE

STERILE CASE / 20

PRODUCT NUMBER FEATURES

96-1232 5" x 96" (13 x 244cm)

- One piece design for rounded/cylindrical probe heads
- Elasticized material

FOOT CONTROL PANEL DRAPE

NON-STERILE CASE / 50

PRODUCT NUMBER FEATURES

96-1233 14" x 30" (36 x 76cm)

- Adhesive closure strip

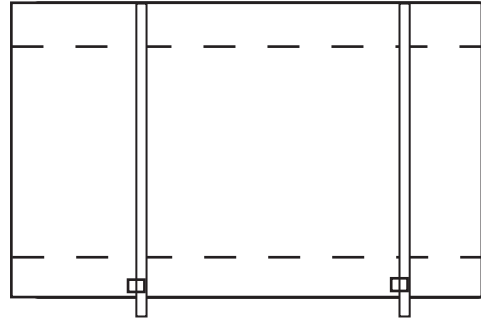

96-1231
C-ARM/MOBILE X-RAY DRAPE WITH POLY STRAPS
FOR GATHERING OF EXCESS DRAPE MATERIAL
AROUND C-ARM.

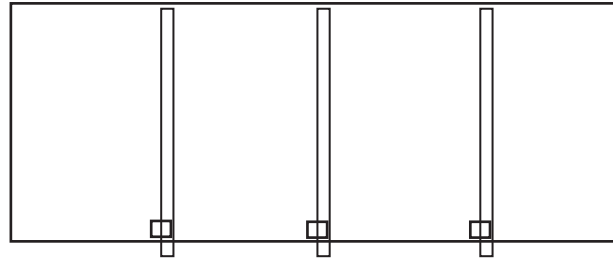

96-1230
LATEX-FREE
POLY DRAWSTRAPS

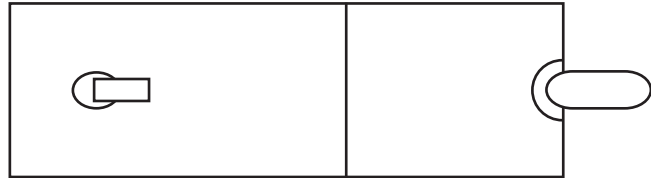

96-1232
ELASTIC MATERIAL
ONE-PIECE DESIGN

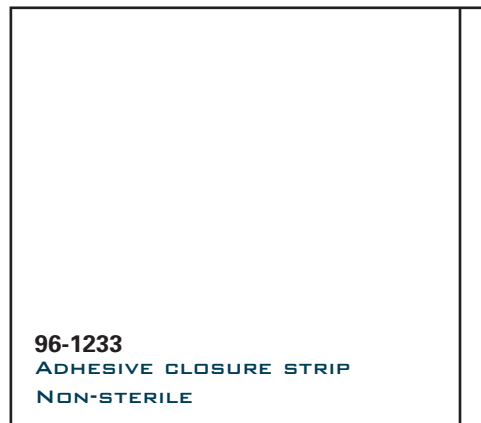

96-1233
ADHESIVE CLOSURE STRIP
NON-STERILE

CROSS REFERENCE:

ULTRASOUND PROBE DRAPE / FOOT CONTROL PANEL DRAPE

SKLAR	ADVANCE	CARDINAL	CFI	MEDLINE	MICROTEK
96-1232	IPC100	29-37879	-	-	3787
96-1233	FS1430NS	29-49269	CFI664	DYNJE5700	4926N





VIDEO CAMERA DRAPE

STERILE CASE / 25
 PRODUCT NUMBER FEATURES
96-5200 5" x 96" (13 x 244cm)



96-5200

- LATEX-FREE
- TELESCOPE FOLD W/CUFF
- ADHESIVE CLOSURE STRIP

UNIVERSAL VIDEO CAMERA DRAPE

STERILE CASE / 25
 PRODUCT NUMBER FEATURES
96-5202 7" x 96", Universal



96-5202

- LATEX-FREE
- TELESCOPE FOLD W/CUFF
- ADHESIVE CLOSURE STRIP
- ELASTIC TIP

CLOSED-SYSTEM CAMERA DRAPE

STERILE CASE / 25
 PRODUCT NUMBER FEATURES
96-5204 7" x 96", Closed, (18 x 244cm)
96-1119 9" x 96", Closed, (23 x 244cm)

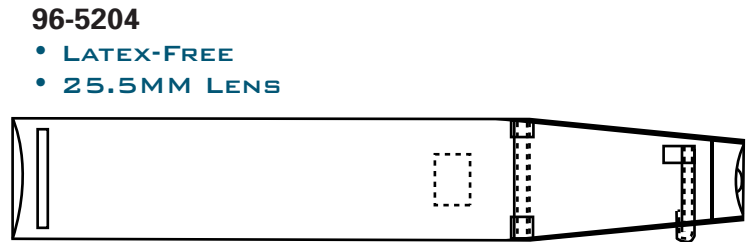

96-5204

- LATEX-FREE
- 25.5MM LENS

LASER ARM DRAPE

STERILE CASE / 25
 PRODUCT NUMBER FEATURES
96-5683 9" x 96" (23 x 244cm)

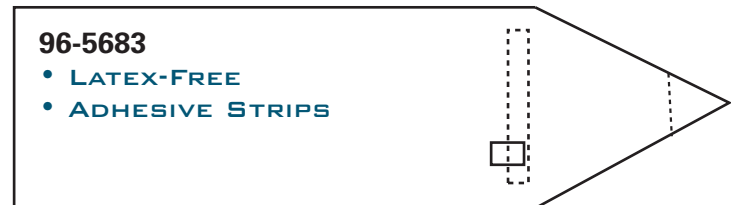

96-5683

- LATEX-FREE
- ADHESIVE STRIPS

CROSS REFERENCE:

CAMERA DRAPES

SKLAR	MEDLINE	CARDINAL	3M	MICROTEK	ADVANCE	CFI
96-5200	DYNJE4250	29-59009	4730	9900	04-CC220	5432
96-5202	DYNJE4200	29-29049	1100	9604	04-CC218	CFI-1504
96-5204	-	-	4731	3501	04-CC900	-
96-1119	-	-	-	-	04-CC900	-
96-5683	DYNJE4300	-	-	5902	-	-



X-RAY CASSETTE

DRAPES

STERILE CASE / 20

PRODUCT NUMBER	FEATURES
96-5249	24" x 40" (61 x 102cm) Fold and Lock
96-5251	20" x 41" (51 x 104cm) Fold and Lock
96-5253	24" x 25" (61 x 64cm) Adhesive Closure
96-5255	23" x 25" (58 x 62cm) Release Liner
96-5257	20" x 24" (51x61cm) Release Liner
96-1234	21" x 36" Cover (NOT SHOWN)
96-5693	16" X 20" (41 x 51cm)

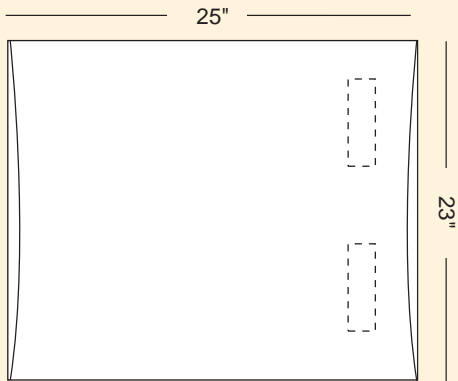

96-5255

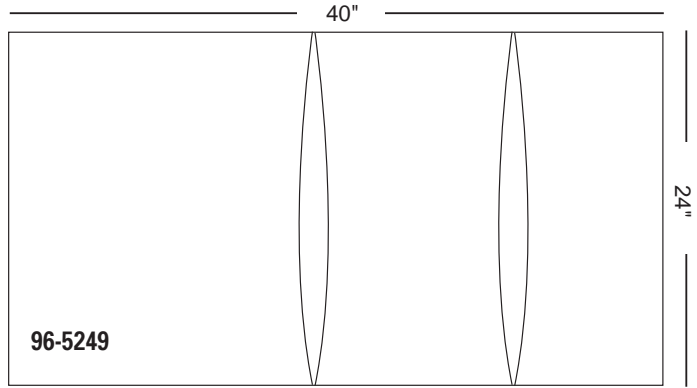

96-5249

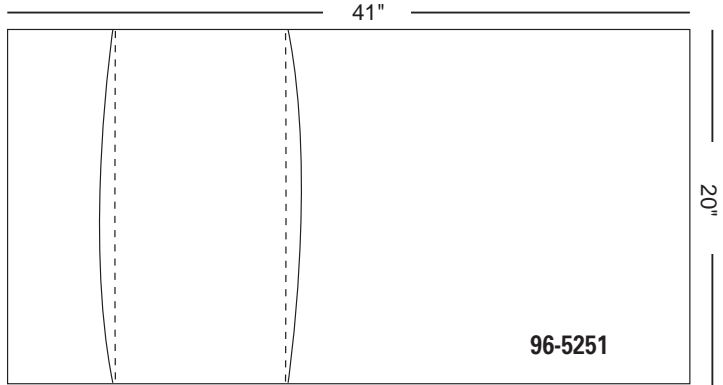

96-5251

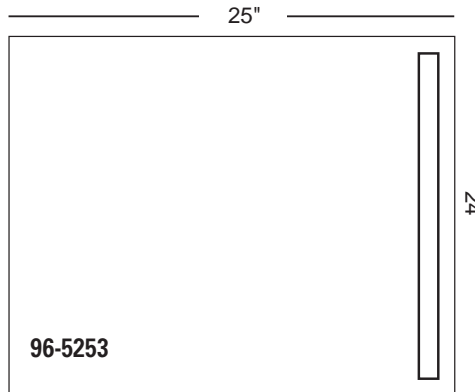

96-5253

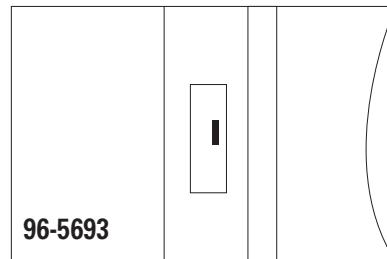

96-5693

CROSS REFERENCE: X-RAY CASSETTE DRAPES

SKLAR	MEDLINE	CARDINAL	3M	MICROTEK	ADVANCE	CFI
96-5249	DYNJE4000	29-49559	-	4955	05-CD02	-
96-5251	DYNJE4000	29-49559	-	4955	05-CD02	CFI-958
96-5253	-	-	1011	4954	05-CD01	-
96-5255	DYNJE4010	-	-	4935	05-CD03	-
96-5257	-	29-25329	4742	25320	05-CD01	5446
96-1234	-	-	-	-	-	-
96-5693	-	-	-	25220	-	-



HALF DRAPE SHEET, 60" x 44"

STERILE CASE / 40

PRODUCT NUMBER FEATURES
96-1212 60" x 44"

NON-STERILE CASE / 100

PRODUCT NUMBER FEATURES
96-5605 60" x 44"

MEDIUM DRAPE SHEET, 76" x 44"

STERILE CASE / 40

PRODUCT NUMBER FEATURES
96-1213 76" x 44"

NON-STERILE CASE / 100

PRODUCT NUMBER FEATURES
96-5606 76" x 44"

LARGE DRAPE SHEET, 76" x 60"

STERILE CASE / 40

PRODUCT NUMBER FEATURES
96-1214 76" x 60"

NON-STERILE CASE / 100

PRODUCT NUMBER FEATURES
96-5607 76" x 60"

XLARGE DRAPE SHEET, 100" x 76"

STERILE CASE / 20

PRODUCT NUMBER FEATURES
96-5608 100" x 76"

NON-STERILE CASE / 40

PRODUCT NUMBER FEATURES
96-5609 100" x 76"

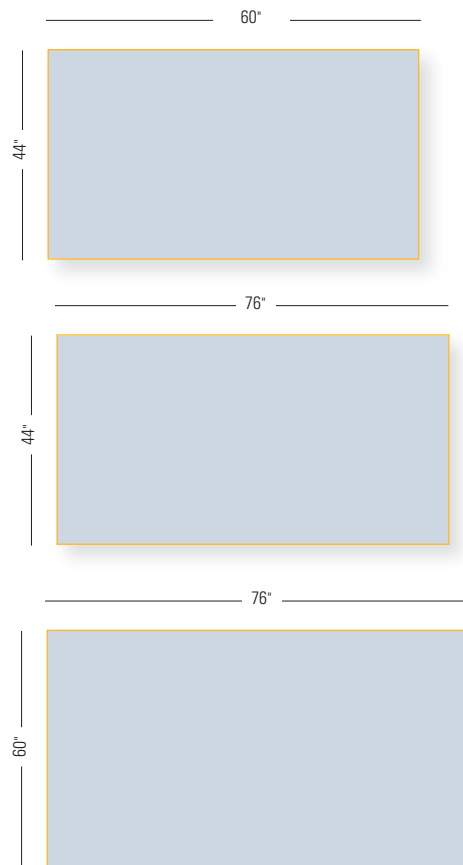

CROSS REFERENCE:

DRAPE SHEETS

SKLAR	CARDINAL	KIMBERLY CLARK	MEDLINE
96-1212	9358	89101	DYNJP2410
96-5605	9358	79102	14185
96-1213	9355	89111	DNYJP2412
96-5606	9355	79111	9440
96-1214	9349	89121, 89124, 89128	DYNJP2414
96-5607	9349	79124	14184
96-5608	9444	89131, 89138	DYNJP2419
96-5609	9444	79132	SPT-DRAPXLS



SMALL DRAPE WITH ADHESIVE APERTURE

NON-STERILE	CASE / 200
PRODUCT NUMBER	FEATURES
96-S1020NS	16" x 16" (40 x 40cm)

MEDIUM DRAPE WITH ADHESIVE APERTURE

NON-STERILE	CASE / 100
PRODUCT NUMBER	FEATURES
96-S1030NS	33" x 51" (83 x 129cm)

STERILE	BOX / 10
PRODUCT NUMBER	FEATURES
96-S1020	16" x 16" (40 x 40cm)
96-S1030	33" x 51" (83 x 129cm)

- OVAL APERTURE WITH ADHESIVE AREA
- ADHESIVE OPTIMIZED FOR SKIN
- NON-LINTING, TEAR RESISTANT, POLY RELEASE LINER
- SOFT, DRAPEABLE, LOW-GLARE MATTE FINISH FILM

OPHTHALMIC DRAPE WITH APERTURE AND POUCHES

NON-STERILE	CASE / 50
PRODUCT NUMBER	FEATURES
96-S1064NS	55" x 70" (139 x 177cm)
96-S1164NS	55" x 115" (139 x 292cm)

STERILE	BOX / 20
PRODUCT NUMBER	FEATURES
96-S1064	55" x 70" (139 x 177cm)
96-S1164	55" x 115" (139 x 292cm)

SEE PAGE 85 FOR CROSS REFERENCE.

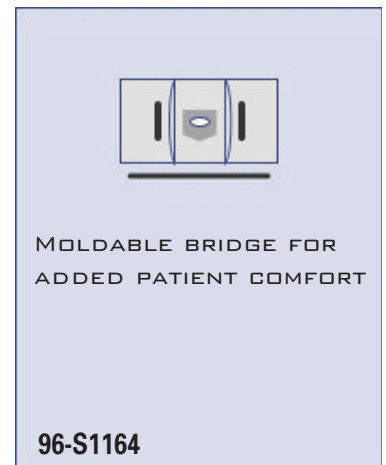
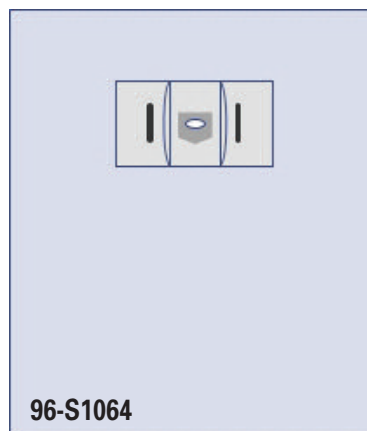
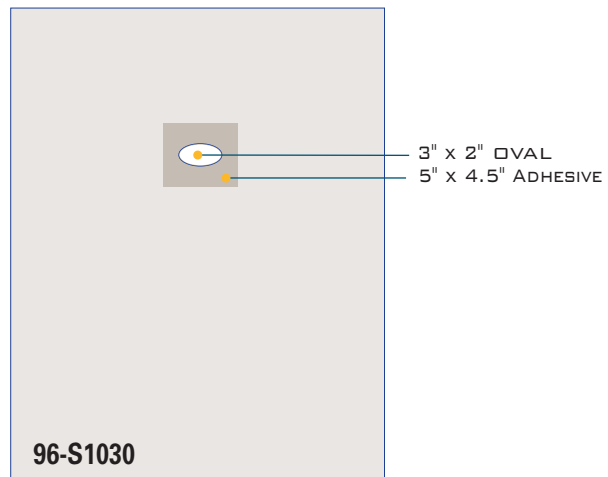
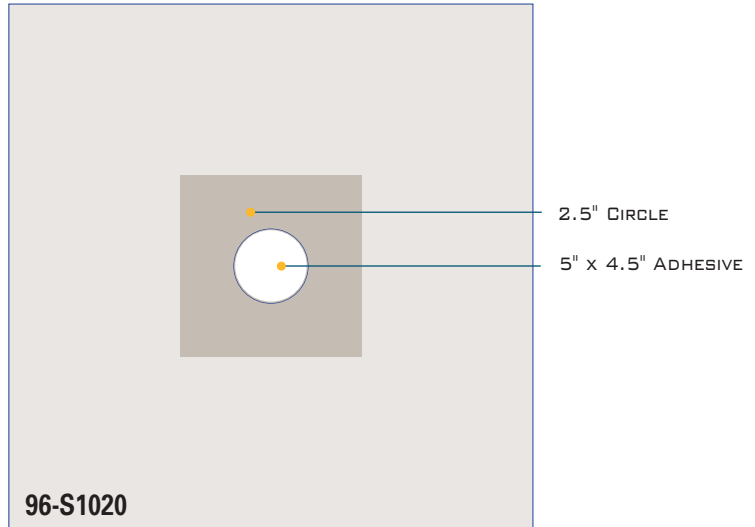

- OVAL APERTURE WITH ADHESIVE AREA
- ADHESIVE OPTIMIZED FOR SKIN
- SADDLE-BAG POUCHES WITH MOLDABLE STRIPS FOR FLUID CONTAINMENT
- LOW-LINTING, CONFORMABLE NON-WOVEN MATERIAL



CROSS REFERENCE: SMALL / MEDIUM DRAPES

SKLAR	3M	MICROTEK
96-S1020NS	1020NS	-
96-S1030NS	1030NS	-
96-S1020	1020	ISO1020
96-S1030	1030	ISO1030

OPHTHALMIC / EENT DRAPE

SKLAR	3M	MICROTEK
96-S1064NS	1064NS	-
96-S1164NS	1164NS	-
96-S1064	1064	ISO1064
96-S1164	1164	-
96-1024NS	1024NS	-
96-S1024	1024	-

INCISE DRAPE

SKLAR	3M	MICROTEK
96-S1035NS	1035NS	-
96-S1021NS	1021NS	-
96-S1035	1035	ISO1065
96-S1021	1021	ISO1021
96-S1060NS	1060NS	-
96-S1061NS	1061NS	-
96-S1060	1060	ISO1065
96-S1061	1061	ISO1021

REFRACTIVE

SKLAR	3M
96-S1022NS	1022NS
96-S1022	1022

PATIENT ISOLATION

SKLAR	3M	MICROTEK
96-S1014NS	1014NS	5960
96-S1017NS	1017NS	6960
96-S1014	1014	5960
96-S1017	1017	6960

POLY U-DRAPE

SKLAR	3M	MICROTEK
96-S1015NS	1015NS	-
96-S1019NS	1019NS	-
96-S1015	1015	ISO1015
96-S1019	1019	ISO1019

Color Key



Reinforce-
ment

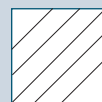

Clear Poly

Fabric



Adhesive

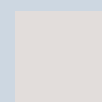

Low Glare
Matte Finish



OPHTHALMIC INCISE DRAPES

NON-STERILE CASE / 100

PRODUCT NUMBER FEATURES

96-S1060NS 48" x 51" (121 x 129cm)

96-S1061NS 48" x 51" (121 x 129cm)
with Pouch

STERILE BOX / 10

PRODUCT NUMBER FEATURES

96-S1060 48" x 51" (121 x 129cm)

96-S1061 48" x 51" (121 x 129cm)
with Pouch

REFRACTIVE DRAPE

NON-STERILE CASE / 200

PRODUCT NUMBER FEATURES

96-S1022NS 16" x 10.7" (40 x 27cm)

STERILE BOX / 10

PRODUCT NUMBER FEATURES

96-S1022 16" x 10.7" (40 x 27cm)

- SPLIT APERTURE FOR EASIER RETRACTION OF EYE LID AND LASHES
- ADHESIVE OPTIMIZED FOR SKIN
- NON-LINTING, TEAR RESISTANT, POLY RELEASE LINER
- THIN, SOFT, DRAPEABLE, LOW-GLARE MATTE FINISH FILM

SEE PAGE 85 FOR CROSS REFERENCE.

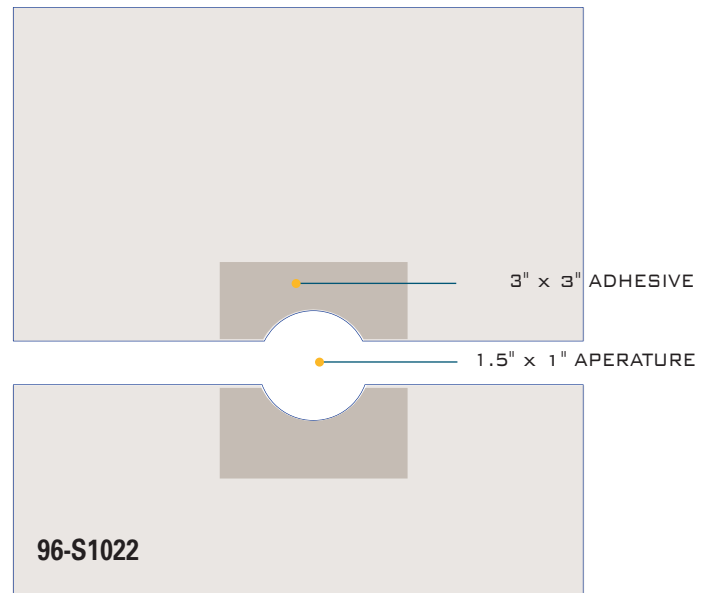
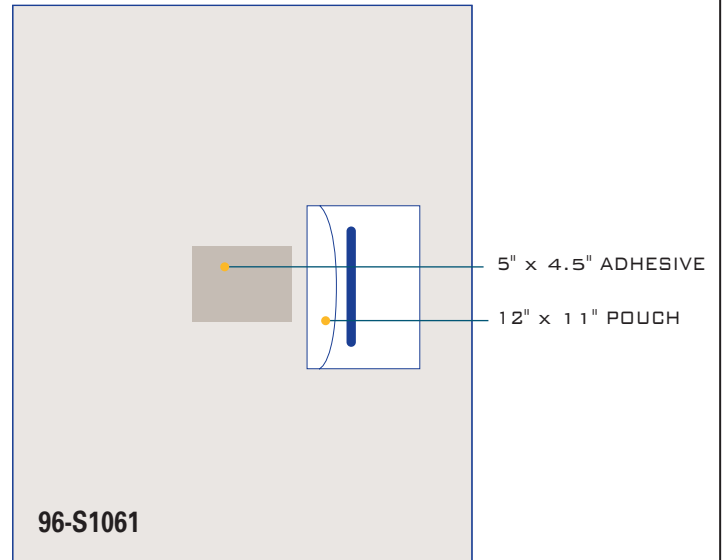
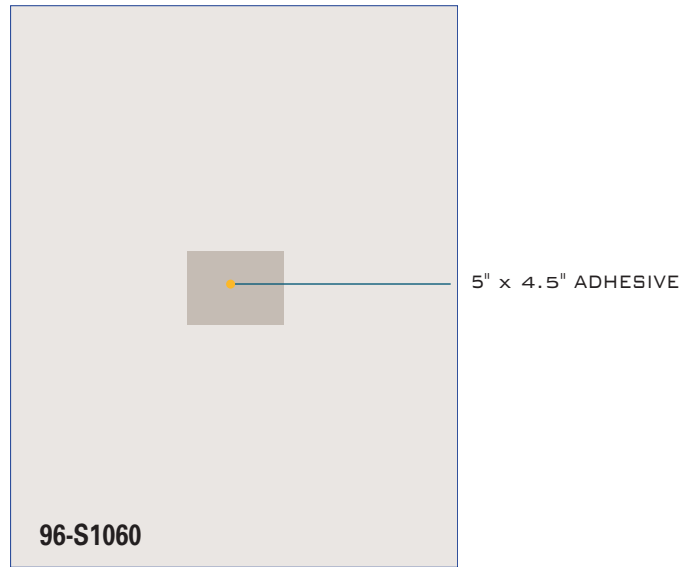

EENT DRAPE WITH ADHESIVE APERTURE AND POUCH

NON-STERILE CASE / 100

PRODUCT NUMBER FEATURES
96-S1024NS 19" x 15" (48 x 38cm)

STERILE BOX / 10

PRODUCT NUMBER FEATURES
96-S1024 19" x 15" (48 x 38cm)

INCISE DRAPES

NON-STERILE CASE / 200

PRODUCT NUMBER FEATURES
96-S1035NS 6.5" x 7.5" (16 x 19cm)
96-S1021NS 16" x 16" (40 x 40cm)

STERILE BOX / 10

PRODUCT NUMBER FEATURES
96-S1035 6.5" x 7.5" (16 x 19cm)
96-S1021 16" x 16" (40 x 40cm)

- INCISE ADHESIVE AREA
- ADHESIVE OPTIMIZED FOR SKIN
- NON-LINTING, TEAR RESISTANT, POLY RELEASE LINER
- THIN, SOFT, DRAPEABLE, LOW-GLARE MATTE FINISH FILM

All information concerning product content and composition; the function, care, maintenance, and intended use of products; and any warnings respecting the products in this catalog are derived exclusively from each product's manufacturer. As such, Sklar makes no representations or warranties - either express or implied - respecting the same. If additional information about any product is needed, please contact a Sklar sales representative, who will assist you in obtaining the information from the product's manufacturer.

SEE PAGE 85 FOR CROSS REFERENCE.

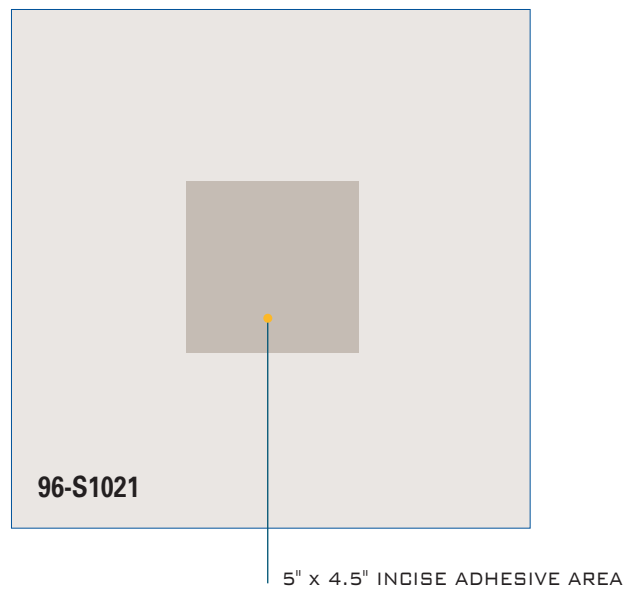
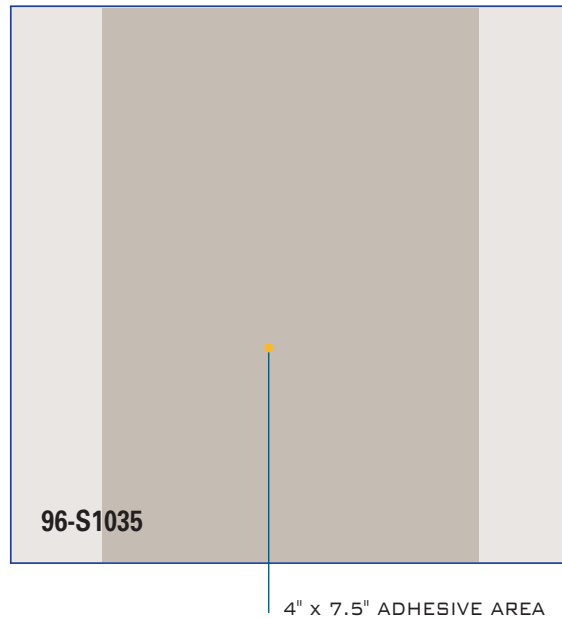
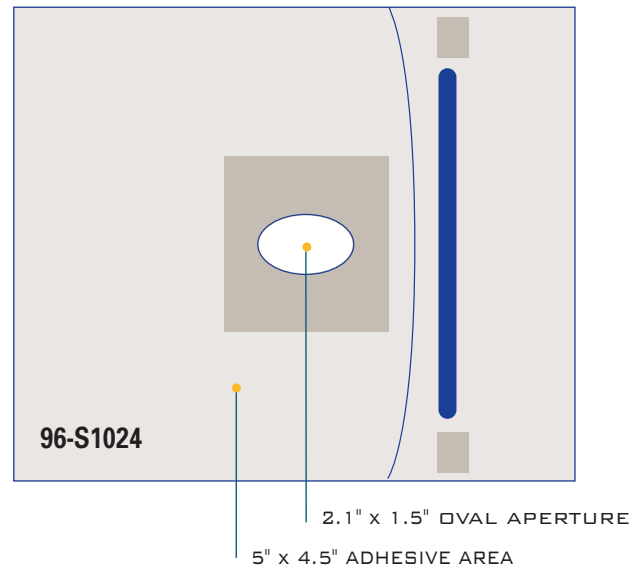



ORTHOPEDIC

PATIENT ISOLATION DRAPES

NON-STERILE CASE / 50

PRODUCT NUMBER FEATURES

96-S1014NS 125" x 84" (317 x 213cm)

96-S1017NS 125" x 84" (317 x 213cm)

STERILE BOX / 5

PRODUCT NUMBER FEATURES

96-S1014 125" x 84" (317 x 213cm)

96-S1017 125" x 84" (317 x 213cm)

- LESS AGGRESSIVE ADHESIVE STRIP FOR EASY REMOVAL
- AGGRESSIVE INCISE ADHESIVE WITH NO RESIDUE
- CLEAR, STRONG POLY FILM

POLY U-DRAPES

NON-STERILE CASE / 100

PRODUCT NUMBER FEATURES

96-S1015NS 48" x 52" (121 x 132cm)

96-S1019NS 48" x 71" (121 x 180cm)

STERILE BOX / 10

PRODUCT NUMBER FEATURES

96-S1015 48" x 52" (121 x 132cm)

96-S1019 48" x 71" (121 x 180cm)

- "U" FENESTRATION WITH WIDE ADHESIVE AREA
- AGGRESSIVE ADHESIVE FOR IMPROVED ADHESION
- AGGRESSIVE ADHESIVE WITH NO RESIDUE

SEE PAGE 85 FOR CROSS REFERENCE.

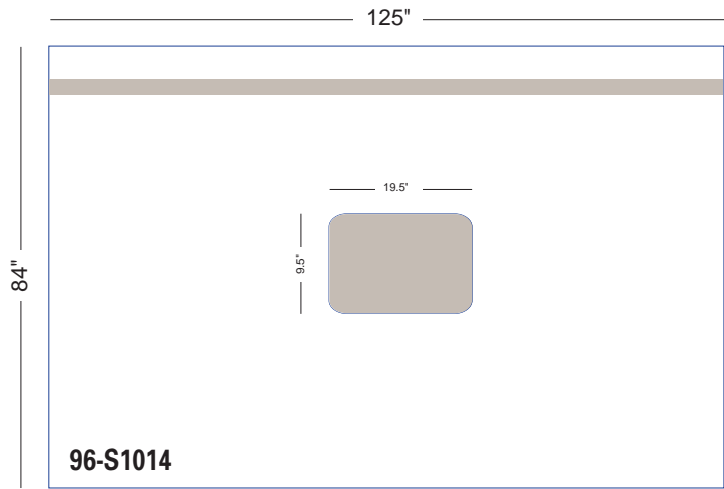

96-S1014

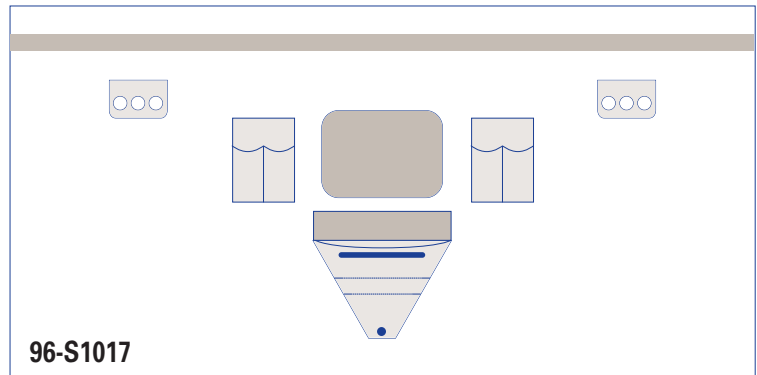

96-S1017

- TWO CORD HOLDERS AND INSTRUMENT POUCHES FOR BETTER ORGANIZATION
- LARGE POUCH WITH MICRO SCREEN, SUCTION PORT AND CAP FOR IMPROVED FLUID CONTROL

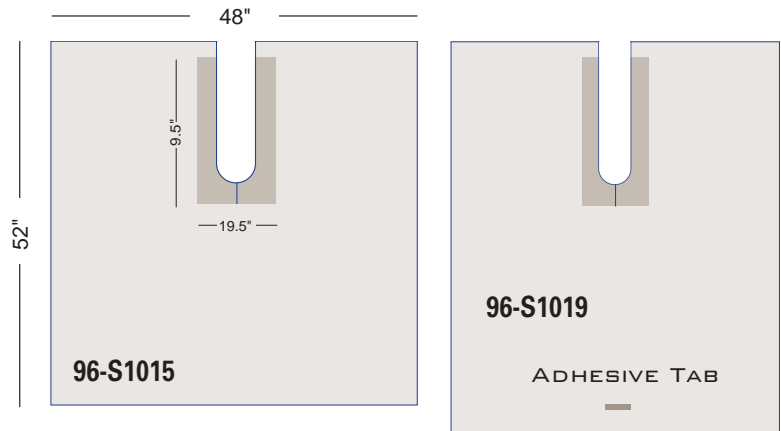

96-S1015

96-S1019

ADHESIVE TAB

- STRONG, DRAPEABLE, LOW-GLARE MATTE FINISH FILM
- SPLIT POLY LINER FOR EASE OF APPLICATION





INSTRUMENTS

EENT SPLIT DRAPE

NON-STERILE CASE / 25

PRODUCT NUMBER FEATURES
96-5409 77" x 120"

STERILE CASE / 10

PRODUCT NUMBER FEATURES
96-5410 77" x 120"

EXTREMITY

NON-STERILE CASE / 25

PRODUCT NUMBER FEATURES
96-5413 77" x 126"

96-5666 87" x 123"

STERILE CASE / 10

PRODUCT NUMBER FEATURES
96-5414 77" x 126"

96-5667 87" x 123"

Color Key



Reinforcement

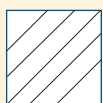

Clear Poly



Fabric

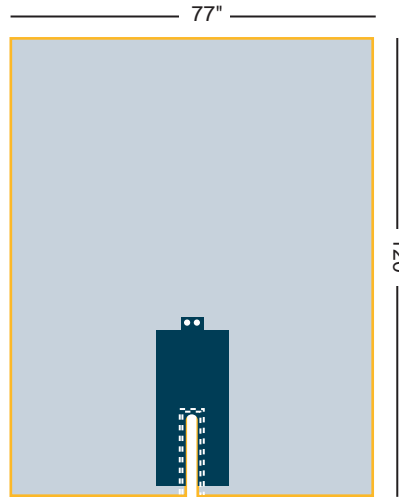

EENT SPLIT DRAPE
 SPLIT 3" x 23" WITH TAPE
 REINFORCED 20" x 38"
 TUBE HOLDER

96-5409

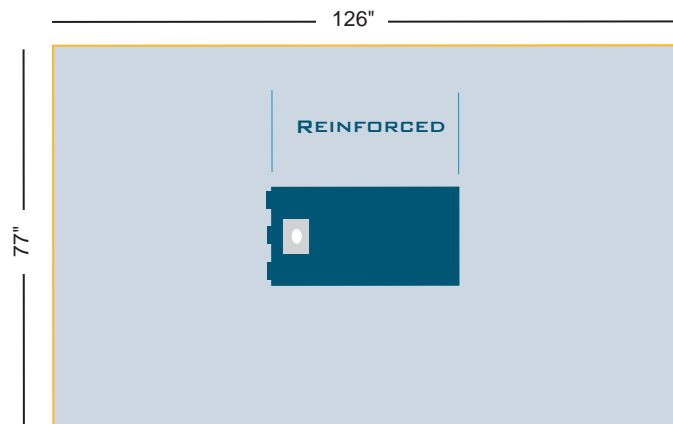

96-5413

EXTREMITY DRAPE
 FENESTRATION 3" x 2"
 OVAL, ELASTICIZED
 REINFORCED 20" x 38"
 TUBE HOLDERS

CROSS REFERENCE:

EENT SPLIT DRAPE

SKLAR	CARDINAL	KIMBERLY CLARK	MEDLINE
96-5409	29436	89301, 89321	SPT-2450S
96-5410	29436	89301, 89321	DYNJP249B

EXTREMITY DRAPES

SKLAR	CARDINAL	KIMBERLY CLARK	MEDLINE
96-5413	29414, 29415	89276, 89279	SPT-2550S
96-5666	29419	89271, 89272	SPT-8610S
96-5414	29414, 29415	89276, 89279	DYNJP8002
96-5667	29419	89271, 89272	DYNJP8005

Contact your SKLAR Account Manager at for more information.





TOWEL DRAPES

NON-STERILE CASE / 200

PRODUCT NUMBER	FEATURES
96-S1000NS	18" x 12" (45 x 30cm)
96-S1010NS	18" x 24" (45 x 60cm)

STERILE BOX / 10

PRODUCT NUMBER	FEATURES
96-S1000	18" x 12" (45 x 30cm)
96-S1010	18" x 24" (45 x 60cm)

- AGGRESSIVE ADHESIVE WITH NO RESIDUE
- NON-LINTING, TEAR RESISTANT, POLY RELEASE LINER
- STRONG, DRAPABLE, LOW-GLARE MATTE FINISH FILM

96-S1000

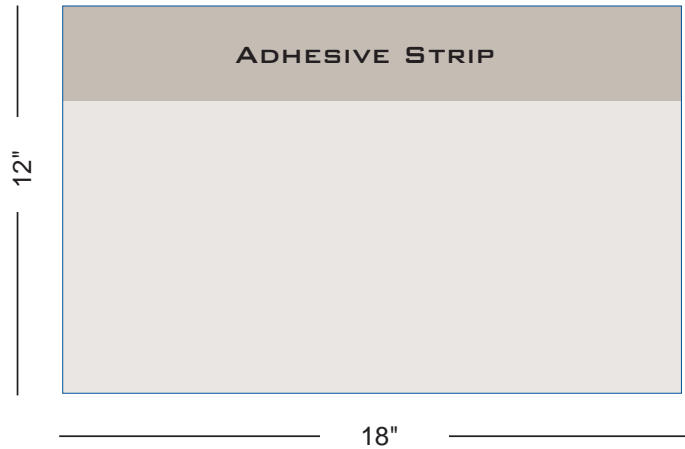

96-S1010

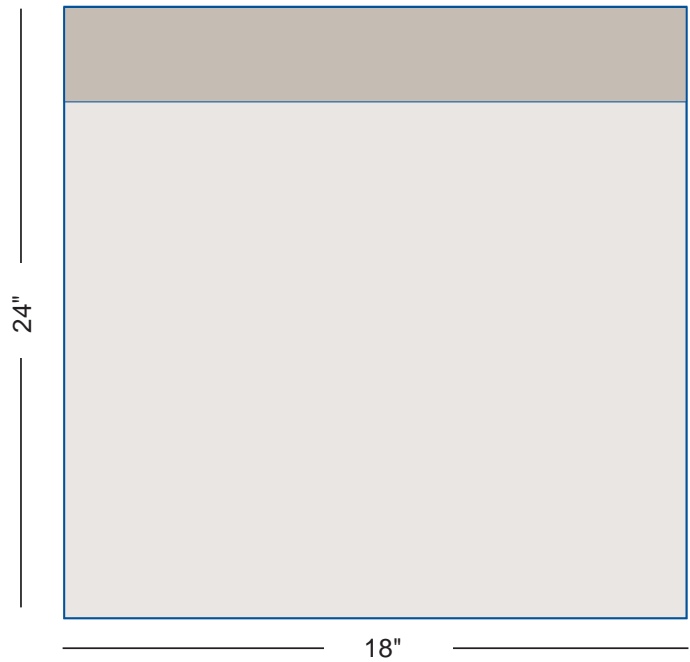

CROSS REFERENCE:

TOWEL DRAPES

SKLAR	MEDLINE	3M	MICROTEK
96-S1000NS	DYNJSD1000	1000NS	-
96-S1010NS	DYNJSD1010	1010NS	-
96-S1000	DYNJSD1000	1000	ISO1000
96-S1010	DYNJSD1010	1010	ISO1010



ANGIO DRAPE WITH DUAL CIRCULAR FENESTRATION

NON-STERILE CASE / 20

PRODUCT NUMBER	FEATURES
96-7071	75" x 110" (191 x 279cm)
96-5673	75" x 125" (191 x 318cm)
96-5674	86" x 135" (218 x 343cm)

STERILE CASE / 10

PRODUCT NUMBER	FEATURES
96-7755	75" x 110" (191 x 279cm)
96-5672	75" x 125" (191 x 318cm)
96-7778	86" x 135" (218 x 343cm)

FEMORAL ANGIOGRAPHY DRAPE

NON-STERILE CASE/20

PRODUCT NUMBER	FEATURES
96-5676	76" x 124" (193 x 315cm)

STERILE CASE/10

PRODUCT NUMBER	FEATURES
96-5675	76" x 124" (193 x 315cm)

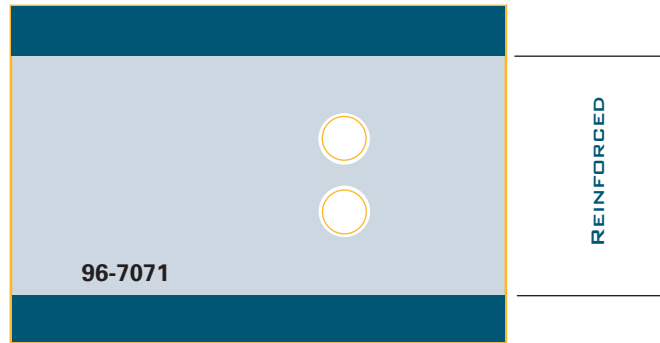

- ANGIOGRAPHY DRAPES WITH DUAL CIRCULAR FENESTRATIONS

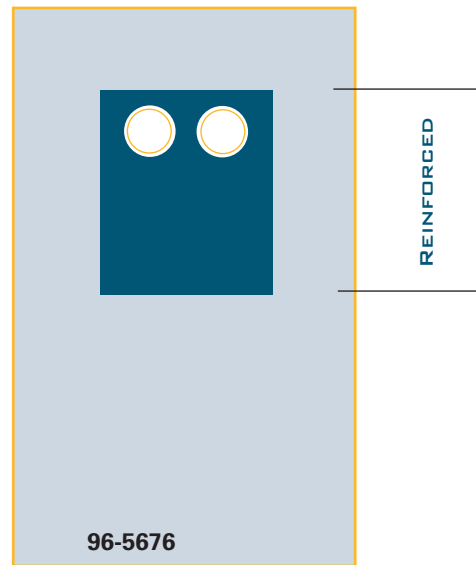

- 3.5" ADHESIVE CIRCULAR FENESTRATIONS
- REINFORCED MATERIALS

CROSS REFERENCE:

ANGIO DRAPE WITH DUAL CIRCULAR FENESTRATION

SKLAR	CARDINAL	KIMBERLY CLARK	MEDLINE	MICROTEK
96-7071	29457	89461	27082	-
96-5673	29457	89461	27083	-
96-5674	-	-	27084	-
96-7755	29457	89461	DYNJP4101	-
96-5672	29460	89704, 89705, 89706, 89464	DYNJP4102	-
96-7778	-	-	DYNJP4104	-

FEMORAL ANGIOGRAPHY DRAPE

SKLAR	CARDINAL	KIMBERLY CLARK	MEDLINE	MICROTEK
96-5676	-	79704	-	-
96-5675	-	89704	-	3928



UTILITY DRAPE WITH TAPE

NON-STERILE CASE / 200

PRODUCT NUMBER FEATURES

96-5404 15" x 26"

NON-STERILE CASE / 50

PRODUCT NUMBER FEATURES

96-5405 15" x 26"

STERILE CASE / 25

PRODUCT NUMBER FEATURES

96-5406 15" x 26"

CLEAR UTILITY DRAPE WITH FENESTRATION

NON-STERILE CASE / 200

PRODUCT NUMBER FEATURES

96-5421 24" x 36"

NON-STERILE CASE / 50

PRODUCT NUMBER FEATURES

96-5422 24" x 36"

STERILE CASE / 25

PRODUCT NUMBER FEATURES

96-5423 24" x 36"

Color Key



Reinforcement

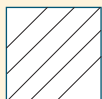

Clear Poly

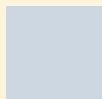

Fabric

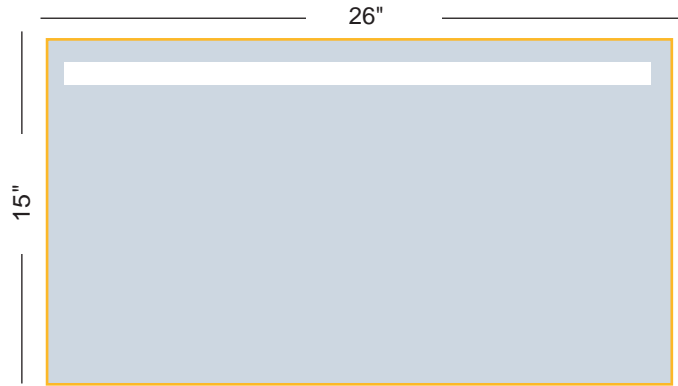

96-5404

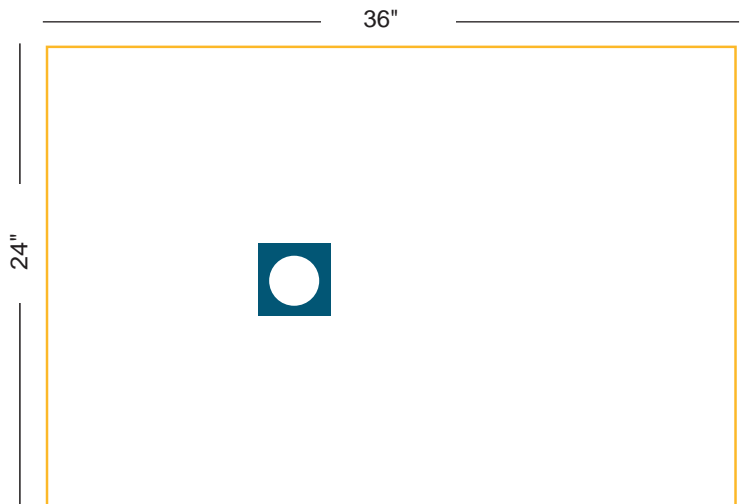

96-5421

CROSS REFERENCE:

UTILITY DRAPE WITH TAPE

SKLAR	CARDINAL	KIMBERLY CLARK	MEDLINE
96-5404	-	79737	12496
96-5405	-	-	12496
96-5406	7553	89731	DYNJP2405



UTILITY DRAPE (2 PER PACKAGE)

NON-STERILE CASE / 200

PRODUCT NUMBER	FEATURES
96-S1089NS	24" x 26" (60 x 66cm)

STERILE BOX / 40

PRODUCT NUMBER	FEATURES
96-S1089	24" x 26" (60 x 66cm)

- ABSORBENT LOW-LINTING, STRIKE THROUGH RESISTANT, SOFT AND DRAPEABLE NON-WOVEN MATERIAL
- ABSORBENT LAYER FOR ADDITIONAL FLUID CONTROL
- TWO DRAPES PER STERILE PACKAGE FOR CONVENIENCE AND ECONOMY

MINOR PROCEDURE DRAPE

NON-STERILE CASE / 100

PRODUCT NUMBER	FEATURES
96-S1092NS	24" x 26" (60 x 66cm)

STERILE BOX / 25

PRODUCT NUMBER	FEATURES
96-S1092	24" x 26" (60 x 66cm)

- CIRCULAR APERTURE WITH ADHESIVE AREA
- AGGRESSIVE ADHESIVE WITH NO RESIDUE
- NON-LINTING, TEAR RESISTANT, POLY RELEASE LINER
- ABSORBENT, LOW-LINTING, STRIKE THROUGH RESISTANT, SOFT AND DRAPEABLE NON-WOVEN MATERIAL

APERTURE 2.5" CIRCLE 4.5" x 5" ADHESIVE

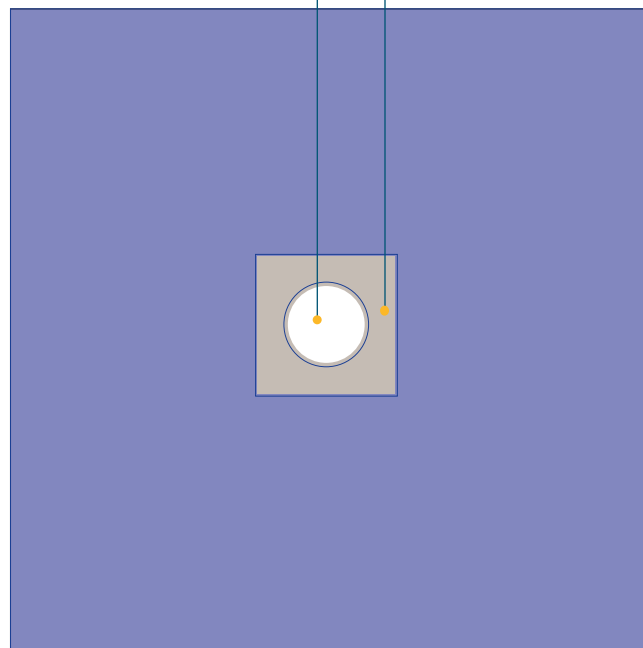

CROSS REFERENCE:

UTILITY DRAPE

SKLAR	3M
96-S1089NS	1089NS
96-S1089	1089

MINOR PROCEDURE DRAPE

SKLAR	3M	KIMBERLY CLARK
96-S1092NS	1092NS	79206
96-S1092	1092	89206



UROLOGICAL DRAPE

NON-STERILE CASE / 50

PRODUCT NUMBER FEATURES
96-S1071NS 24" x 36" (60 x 91cm)

STERILE BOX / 10

PRODUCT NUMBER FEATURES
96-S1071 24" x 36" (60 x 91cm)

APERTURE POUCH

NON-STERILE CASE / 100

PRODUCT NUMBER FEATURES
96-S1072NS 18" x 9" (45 x 22cm)

STERILE BOX / 10

PRODUCT NUMBER FEATURES
96-S1072 18" x 9" (45 x 22cm)

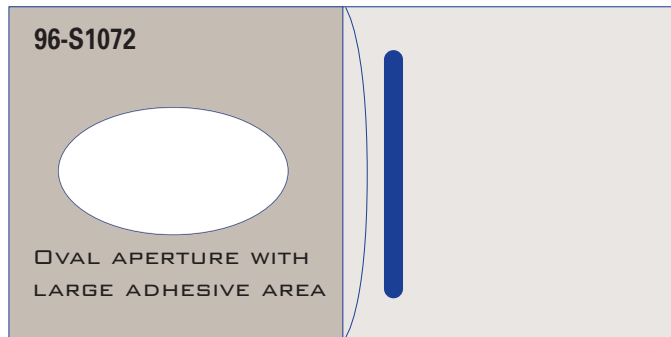
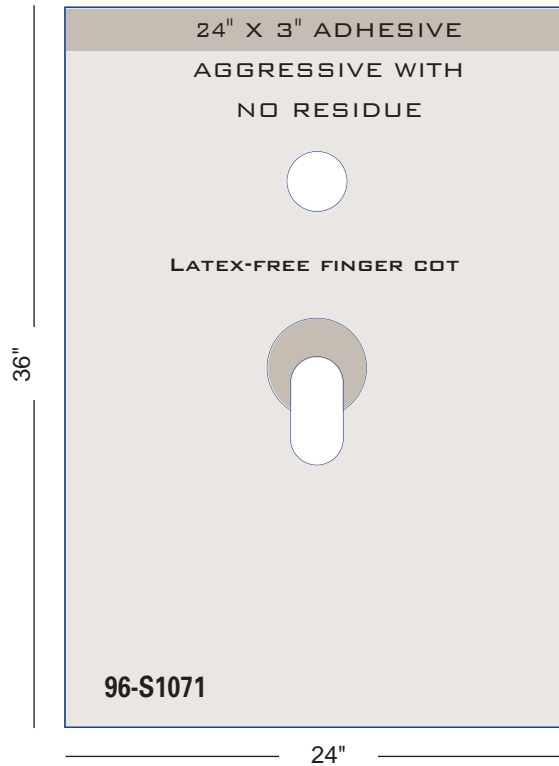

SEE PAGE 96 FOR CROSS REFERENCE.



**UNDER BUTTOCKS
DRAPES WITH POUCH**

NON-STERILE	CASE / 50
PRODUCT NUMBER	FEATURES
96-5415	35" x 48"
NON-STERILE	CASE / 80
PRODUCT NUMBER	FEATURES
96-5418	40" x 44"
STERILE	CASE / 10
PRODUCT NUMBER	FEATURES
96-5417	35" x 48"
STERILE	CASE / 30
PRODUCT NUMBER	FEATURES
96-5419	40" x 44"

**PEDIATRIC LAPAROTOMY
DRAPE**

STERILE	CASE / 20
PRODUCT NUMBER	FEATURES
96-5686	72" x 100" (182.9 x 254cm)

SEE PAGE 96 FOR CROSS REFERENCE.

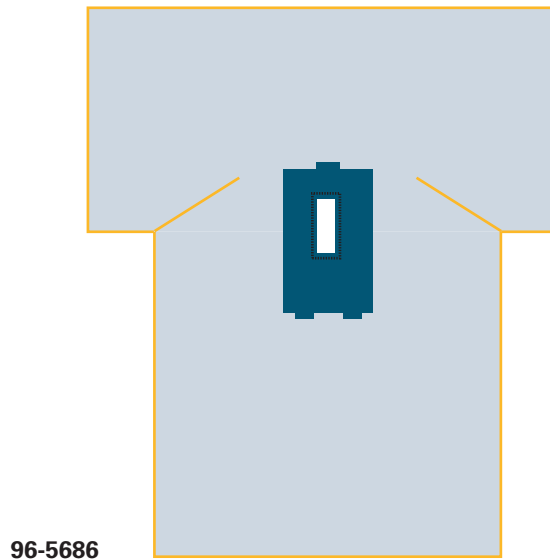
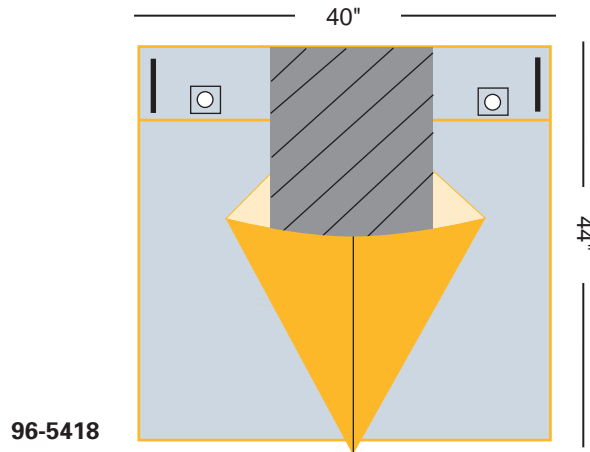
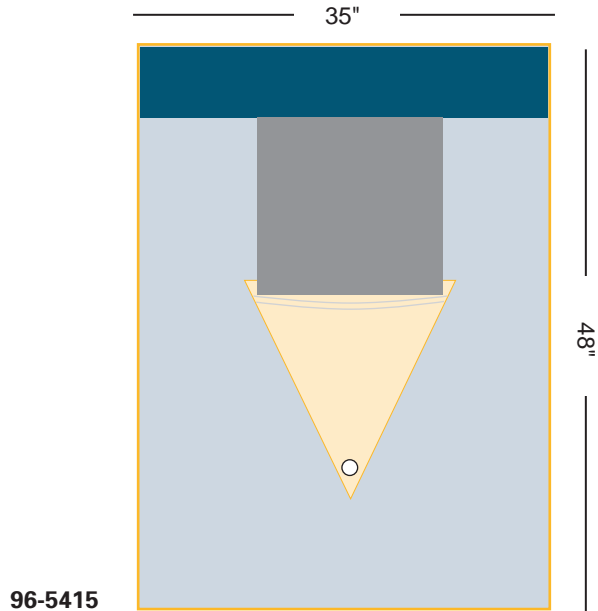

CROSS REFERENCE: UROLOGICAL DRAPES

SKLAR	3M	MEDLINE	MICROTEK
96-S1071NS	1071NS	D1071NS	-
96-S1071	1071	-	ISO1071

APERTURE POUCH

SKLAR	3M	MICROTEK
96-S1072NS	1072NS	-
96-S1072	1072	ISO1072

CROSS REFERENCE: UNDER BUTTOCK DRAPES WITH POUCH

SKLAR	3M	CARDINAL	KIMBERLY CLARK	MEDLINE	MICROTEK
96-5415	1084NS	8483	89413	SPT-2490	4561
96-5417	1084	8483	89413	DYNJP6001	4561
96-5418	-	8482, 8484	89414	08454	-
96-5419	-	8482, 8484	89414	DYNJP6002	-

PEDIATRIC LAPAROTOMY DRAPE

SKLAR	3M	CARDINAL	KIMBERLY CLARK	MEDLINE	MICROTEK
96-5686	-	29492	89241, 66886	DYNJP3007	-

CROSS REFERENCE: CHEST / BREAST DRAPE

SKLAR	3M	CARDINAL	KIMBERLY CLARK	MEDLINE	MICROTEK
96-1117	-	29420	89227	DYNJP2491	-

U-DRAPE

SKLAR	3M	CARDINAL	KIMBERLY CLARK	MEDLINE	MICROTEK
96-5689	-	3524	89041	DYNJP2494	-

SPLIT SHEET

SKLAR	3M	CARDINAL	KIMBERLY CLARK	MEDLINE	MICROTEK
96-5688	-	29420	89227	DYNJP2491	-



CHEST / BREAST DRAPE

STERILE CASE / 20

PRODUCT NUMBER FEATURES
96-1117 104" x 122" (264.2 x 309.9cm)

U-DRAPE

STERILE CASE / 20

PRODUCT NUMBER FEATURES
96-5689 76.5" x 114" (194.3 x 289.6cm)

SPLIT SHEET

STERILE CASE / 20

PRODUCT NUMBER FEATURES
96-5688 77" x 100" (194.3 x 289.6cm)

Color Key

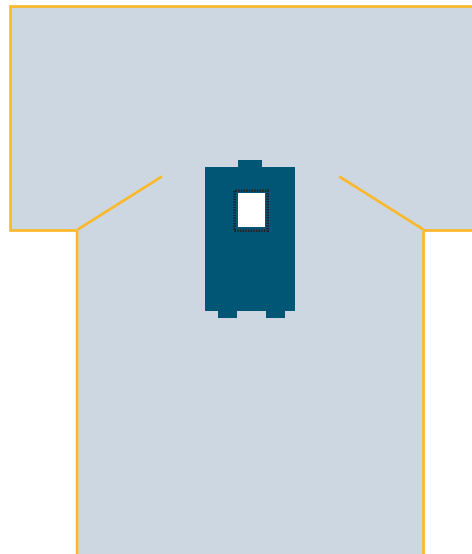
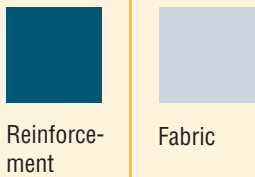

96-1117

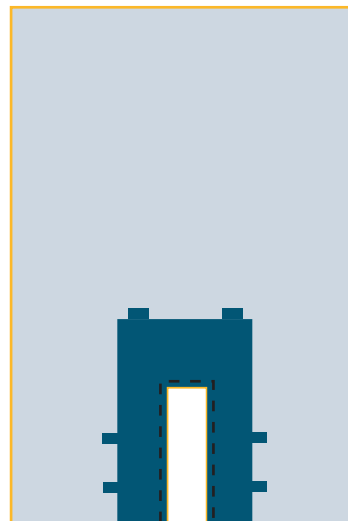

96-5689

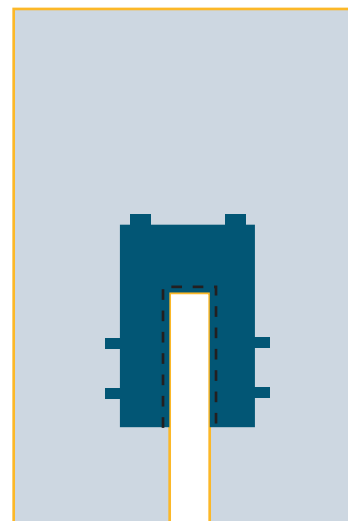

96-5688

SEE PAGE 96 FOR CROSS REFERENCE.



**GAUZE PADS
WOVEN**

STERILE 1'S

PRODUCT NUMBER	FEATURES/QUANTITIES
96-1314	2" x 2", 12-Ply 1/pk, 100pk/bx, 24bx/cs
96-1317	3" x 3", 12-Ply 1/pk, 100pk/bx, 24bx/cs
96-1319	4" x 4", 12-Ply 1/pk, 100pk/bx, 12bx/cs

GAUZE SPONGES WOVEN

NON-STERILE

PRODUCT NUMBER	FEATURES/QUANTITIES
96-5280	2" x 2", 8-Ply, 200pc pk/25pk cs/5000pc cs
96-5281	2" x 2", 12-Ply, 200pc pk/40pk cs/8000pc cs
96-5282	3" x 3", 8-Ply, 200pc pk/20pk cs/4000pc cs
96-5283	3" x 3", 12-Ply, 200pc pk/20pk cs/4000pc cs
96-5284	4" x 4", 8-Ply, 200pc pk/20pk cs/4000pc cs
96-5285	4" x 4", 12-Ply, 200pc pk/25pk cs/5000pc cs
96-5286	4" x 4", 16-Ply, 200pc pk/10pk cs/2000pc cs
96-5267	4" x 8", 12-Ply, 200pc pk/10pk cs/2000pc cs

STERILE

PRODUCT NUMBER	FEATURES/QUANTITIES
96-5287	2" x 2", 8-Ply, 2pc pk/50pk bx/30 bx cs/3000pc cs
96-5288	4" x 4", 8-Ply, 2pc pk/50pk bx/24 bx cs/2400pc cs
96-5289	3" x 3", 12-Ply, 2pc pk/50pk bx/24 bx cs/2400pc cs
96-5290	4" x 4", 12-Ply, 2pc pk/50pk bx/12 bx cs/1200pc cs
96-5268	4" x 8", 12-Ply, 2pc pk/50pk bx/12 bx cs/1200pc cs

SEE PAGE 99 FOR CROSS REFERENCE.



GAUZE SPONGES

NON-WOVEN SPONGES

NON-STERILE

PRODUCT NUMBER FEATURES/QUANTITIES

96-5628 2" x 2", 4-Ply, 200pc pk/5000 cs

96-5629 3" x 3", 4-Ply, 200pc pk/4000 cs

96-5630 4" x 4", 4-Ply, 200pc pk/2000 cs

STERILE

PRODUCT NUMBER FEATURES/QUANTITIES

96-1364 2" x 2", 4-Ply, 2pk /50pk bx/30bx cs

96-1365 3" x 3", 4-Ply, 2pk /40pk bx/30bx cs

96-1366 4" x 4", 4-Ply, 2pk /50pk bx/12bx cs



CROSS REFERENCE:

GAUZE SPONGES, WOVEN

SKLAR	MEDLINE	CARDINAL	DYNAREX	ALLEGIANCE	KENDALL	DUKAL
96-1314	-	-	3352	-	3381	1212
96-1317	-	-	3353	-	6132	1312
96-1319	-	-	3354	-	6309	1412
96-5280	NON25208	GZ2208	3222	GZ2208	2146	2085
96-5281	NON24212	GZ2212	3223	-	2252	2128
96-5282	-	-	3232	-	-	3084
96-5283	NON25312	GZ3312	3233	GZ3312	2346	3124
96-5284	NON25408	GZ4408	3242	GZ4408	2556	4084
96-5285	NON25412	GZ4412	3243	GZ4412	2634	4122
96-5286	NON25416	GZ4416	3244	GZ4416	2733	4162
96-5267	NON25812	-	-	GZ8412	2835	8412
96-5287	NON21420	GZ2208-2	3322	GZ2208-2	1806	6208
96-5288	NON21422	-	3342	-	1903	6408
96-5289	-	-	3333	-	-	6312
96-5290	NON21424	GZ4412-2	3343	GZ4412-2	3033	6412
96-5268	NON21842	-	3344	-	2259	6842

CROSS REFERENCE:

GAUZE SPONGES, NON-WOVEN

SKLAR	MEDLINE	DYNAREX	ALLEGIANCE	KENDALL	DUKAL
96-5628	NON25224	-	NW2204	9022	2102
96-5629	NON25334	-	NW3304	9023	2103
96-5630	NON25444	-	NW4404	9024	2104
96-1364	NON21224	3362	NW2204-2	8042	7224
96-1365	NON21334	3363	NW3304-2	8043	7334
96-1366	NON21444	3364	NW4404-2	8044	7444



KERLIX™ SUPER SPONGES

NON-STERILE

PRODUCT NUMBER FEATURES/QUANTITIES

96-5631 6" x 6.75", 12-Ply, 600pc pk

96-5632 7.75" x 8.75", 12-Ply, 400pc pk

96-5633 9.75" x 10.75", 16-Ply, 200pc pk

Kerlix is a trademark of Kendall

STERILE 2'S IN PAPER POUCH

STERILE CASE / 480

PRODUCT NUMBER FEATURES/QUANTITIES

96-5634 6" x 6.75", 12-Ply, 40pc pk/12bx cs

STERILE 5'S IN PAPER POUCH

STERILE CASE / 600

PRODUCT NUMBER FEATURES/QUANTITIES

96-5635 6" x 6.75", 12-Ply, 50pc pk/12bx cs

STERILE 10'S IN SOFT POUCH

STERILE CASE / 480

PRODUCT NUMBER FEATURES/QUANTITIES

96-5636 6" x 6.75", 12-Ply, 10pc pk/48bx cs

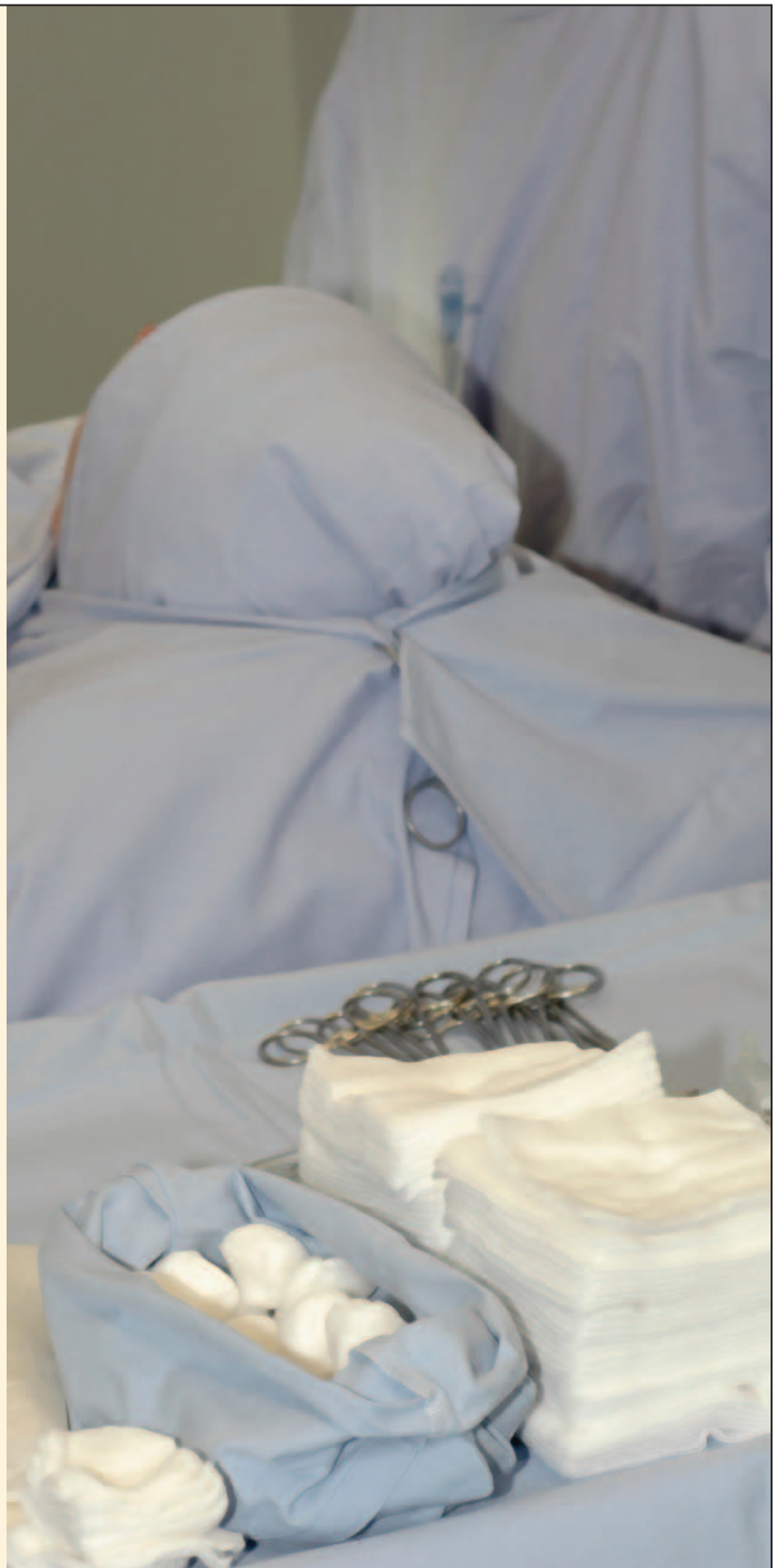

CROSS REFERENCE:

GAUZE

SKLAR	MEDLINE	CARDINAL	DYNAREX	ALLEGIANCE	KENDALL	DUKAL
96-5631	-	-	3163	-	1167	-
96-5632	-	-	-	-	1272	-
96-5633	-	-	-	-	6035	-
96-5634	NON25852	FLM-2	3163	FLM-2	2585	2021
96-5635	NON25853	FLM-5	-	FLM-5	3085	2025
96-5636	NON25854	FLM-10	-	FLM-10	7310	2030





WOUND CARE

POST-OP SPONGES

STERILE, 2'S

PRODUCT NUMBER	FEATURES/QUANTITIES
96-1369	4" x 3", 25 pk bx/24bx cs/600pk cs
96-1370	4" x 4", 25 pk bx/24bx cs/600pk cs

ABDOMINAL PADS

NON-STERILE

PRODUCT NUMBER	FEATURES/QUANTITIES
96-5265	5" x 9", 25 bg/16bg cs
96-5266	8" x 10", 25 bg/16bg cs

STERILE, 1'S

PRODUCT NUMBER	FEATURES/QUANTITIES
96-5649	5" x 9", 1pc pk/25pk bx/16bx cs/400pc cs
96-5650	8" x 7.5", 1pc pk/12pk bx/20bx cs/240pc cs
96-5651	8" x 10", 1pc pk/16pk bx/20bx cs/320pc cs

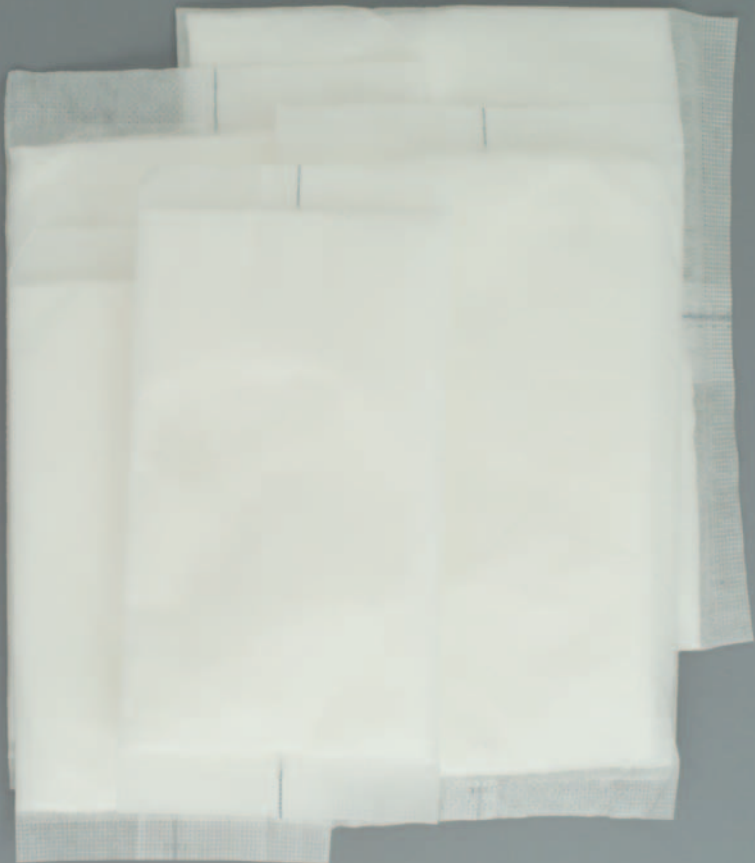

WOUND CARE

CROSS REFERENCE:

POST-OP SPONGES / ABDOMINAL PADS

SKLAR	MEDLINE	CARDINAL	DYNAREX	ALLEGIANCE	KENDALL	DUKAL
96-1367	-	CVD403A	-	-	-	5434
96-1368	-	CVD404A	-	-	-	5444
96-1369	NON21441	CVD403-2A	3346	CVD403-2	3157	-
96-1370	NON21442	CVD404-2A3347	-	CVD404-2	2913	-
96-5265	NON21451	820509	-	AB0509	8190/6196	-
96-5266	NON21456	820810	-	AB0810-1	8194/6198	-
96-5649	NON21450	820509-1	3501	AB0509-1	9190/7196	-
96-5650	NON21453	820875-1	3502	AB0875-1	9192/7197	-
96-5651	NON21454	820810-1	-	AB0810-1	9194/7198	-



EYE PADS

STERILE

PRODUCT NUMBER	FEATURES/QUANTITIES
96-5269	1-5/8" x 2-5/8" 1pk/50pk bx/12bx cs

X-RAY DETECTABLE GAUZE

NON-STERILE

PRODUCT NUMBER	FEATURES/QUANTITIES
96-5615	4" x 4", 12-Ply, 200pc pk/10pk cs/2000pc cs
96-5616	4" x 4", 16-Ply, 200pc pk/10pk cs/2000pc cs
96-5617	4" x 4", 32-Ply, 100pc pk/20pk cs/2000pc cs
96-5618	4" x 8", 12-Ply, 200pc pk/10pk cs/2000pc cs
96-5691	4" x 8", 16-Ply, 100pc pk/10pk cs/1000pc cs
96-5619	4" x 8", 24-Ply, 100pc pk/10pk cs/1000pc cs

STERILE BANDED BLISTER PACKS

PRODUCT NUMBER	FEATURES/QUANTITIES
96-5705	4" x 4", 12-Ply, 200pc pk/10pk cs/2000pc cs
96-5610	4" x 4", 16-Ply, 200pc pk/10pk cs/2000pc cs
96-5611	4" x 4", 32-Ply, 100pc pk/20pk cs/2000pc cs
96-5612	4" x 8", 12-Ply, 200pc pk/10pk cs/2000pc cs
96-5613	4" x 8", 16-Ply, 100pc pk/10pk cs/1000pc cs
96-5614	4" x 8", 24-Ply, 100pc pk/10pk cs/1000pc cs



CROSS REFERENCE:

EYE PADS / X-RAY DETECTABLE GAUZE

SKLAR	MEDLINE	CARDINAL	3M	DYNAREX	ALLEGIANCE	KENDALL	DUKAL
96-5269	NON21600	EP2581	1537	3360	EP2581	2841	-
96-5615	-	GT4412	-	-	-	-	4412-2X
96-5616	NON25430	GT4416	-	-	-	7148	4416-2X
96-5617	NON25433	-	-	-	-	4334	-
96-5618	NON25432	GT8412	-	-	-	7462	-
96-5691	-	-	-	-	-	7463	-
96-5619	NON25438	GT8424	-	-	-	7466	-
96-5705	-	-	-	-	-	-	-
96-5610	NON21430LF	GT4416-10	-	-	GT4416-10	7317	416-2X
96-5611	NON21433	-	-	-	-	7320	432-2X
96-5612	NON21432LF	GT8412-10	-	-	GT8412-10	7318	482-2X
96-5613	-	GT8416-10	-	-	-	7319	486-2X
96-5614	NON21438	-	-	-	-	7321	-



COTTON BALLS

NON-STERILE

PRODUCT NUMBER	FEATURES/QUANTITIES
96-5700	Medium, 2000 bg/2 bg cs
96-5699	Large, 1000 bg/2 bg cs

STERILE

PRODUCT NUMBER	FEATURES/QUANTITIES
96-1669	Medium, 2000 bg/2 bg cs
96-1670	Large, 1000 bg/2 bg cs

COTTON POUND ROLL

NON-STERILE

PRODUCT NUMBER	FEATURES/QUANTITIES
96-5703	Large, 500pc pk 4pk cs/2000pc cs
96-5704	Small, 1000pc pk 5pk cs/5000pc cs

STERILE

PRODUCT NUMBER	FEATURES/QUANTITIES
96-5701	Large, 5pc pk 100pk cs/500pc cs
96-5702	Small, 5pc pk 100pk cs/500pc cs
96-5687	25 Roll Case



CROSS REFERENCE:

COTTON

SKLAR	MEDLINE	CARDINAL	DYNAREX	KENDAL	DUKAL
96-5700	MDS21461	C15000-500	3170	2600	801
96-5699	MDS21462	C15000-510	3169	2602	802
96-1669	NON6101	-	-	-	-
96-1670	-	C15000-300	-	-	-
96-5703	-	-	-	-	-
96-5704	-	C15300-010	-	-	-
96-5701	-	-	-	-	-
96-5702	-	-	-	-	-
96-5687	NON6026	-	-	-	CR1-125



COHESIVE BANDAGES

LATEX-FREE

NON-STERILE

PRODUCT NUMBER	FEATURES/QUANTITIES
96-1340	1" Dark Blue, 30 roll cs
96-1341	1" White, 30 roll cs
96-1342	1" Tan, 30 roll cs
96-1343	1" Assorted, 30 roll cs
96-1344	2" Dark Blue, 36 roll cs
96-1345	2" White, 36 roll cs
96-1346	2" Tan, 36 roll cs
96-1347	2" Assorted, 36 roll cs
96-1348	3" Dark Blue, 24 roll cs
96-1349	3" White, 24 roll cs
96-1350	3" Tan, 24 roll cs
96-1351	3" Assorted, 24 roll cs



CROSS REFERENCE:

COHESIVE BANDAGES

SKLAR	MEDLINE	CARDINAL	3M	DYNAREX	KENDAL	DUKAL
96-5637	MDS088002	CBF25	2082	-	-	-
96-5638	MDS088003	CBF35	2083	-	-	-
96-5639	MDS088004	CBF45	2084	-	-	-
96-5640	MDS088006	CBF65	2086	-	-	-
96-1340	-	-	1581B	-	4581B	8015DB
96-1341	-	-	-	-	-	8015W
96-1342	-	CBL15	1581	3171	-	8015T
96-1343	-	CBCL15	-	3181	-	8015AS
96-1344	-	-	1582B	-	4582B	8025DB
96-1345	-	-	-	-	-	-
96-1346	-	CBL25	1582	3172	-	8025T
96-1347	-	CBCL25	-	3182	-	8025AS
96-1348	-	-	1583B	-	4583B	8035DB
96-1349	-	-	1583W	-	4583W	-
96-1350	-	CBL35	1583	3173	-	8035T
96-1351	-	CBCL35	1583A	3183	-	8035AS



STRETCH GAUZE

NON-STERILE

PRODUCT NUMBER	FEATURES/QUANTITIES
96-1301	2" x 4.1 Yds 12 rolls box/8 box cs/96
96-1302	3" x 4.1 Yds 12 rolls box/8 box cs/96
96-1303	4" x 4.1 Yds 12 rolls box/8 box cs/96
96-1306	6" x 4.1 Yds 6 rolls box/8 box cs/48

STERILE

PRODUCT NUMBER	FEATURES/QUANTITIES
96-1307	2" x 4.1 Yds 12 rolls box/8 box cs/96
96-1309	3" x 4.1 Yds 12 rolls box/8 box cs/96
96-1311	4" x 4.1 Yds 12 rolls box/8 box cs/96
96-1313	6" x 4.1 Yds 6 rolls box/8 box cs/48



ELASTIC BANDAGES LATEX-FREE, CREPE, COTTON

NON-STERILE CASE / 200

PRODUCT NUMBER	FEATURES/QUANTITIES
96-1352	2" x 400 cm, 75g/m2 20 rolls bx/10bx cs
96-1353	3" x 400 cm, 75g/m2 20 rolls bx/10bx cs
96-1354	4" x 400 cm, 75g/m2 20 rolls bx/10bx cs
96-1355	6" x 400 cm, 75g/m2 20 rolls bx/10bx cs
96-1356	2" x 400 cm, 90g/m2 20 rolls bx/10bx cs
96-1357	3" x 400 cm, 90g/m2 20 rolls bx/10bx cs
96-1358	4" x 400 cm, 90g/m2 20 rolls bx/10bx cs
96-1359	6" x 400 cm, 90g/m2 20 rolls bx/10bx cs



SEE PAGE 111 FOR CROSS REFERENCE.





NON-ADHERENT PADS

STERILE 1'S

PRODUCT NUMBER FEATURES/QUANTITIES

96-1371 2" x 3", 100/bx 12bx/cs 1200/cs

96-1372 3" x 4", 100bx/12bx cs/1200cs

96-1373 2" x 8", 50bx/12bx cs/600cs

PROTECTION FOR CUTS, SCRAPES AND BURNS.

- WILL NOT STICK TO WOUND
- HIGH ABSORBENCY
- ALLOWS AIR IN

NON-WOVEN DRAIN AND IV SPONGES

STERILE

PRODUCT NUMBER FEATURES/QUANTITIES

96-1380 2" x 3", 6-ply, 2 pch/35 pch/1400 cs

96-1382 4" x 4", 6-ply, 2 pch/25 pch/600 cs

VERSATILE NON-WOVEN SPONGE WITH PRE-CUT FENESTRATION TO FIT AROUND MOST DRAINS, TUBES, CATHETERS, OR IV'S.



CROSS REFERENCE:

STRETCH GAUZE / ELASTIC BANDAGES / NON-ADHERENT PADS / NON-WOVEN

SKLAR	MEDLINE	CARDINAL	3M	DYNAREX	ALLEGIANCE	KENDALL	DUKAL
96-1301	NON27496	PRO0402	-	3102	PRO402-1	8072	402
96-1302	NON27497	PRO0403	-	3103	PRO403-1	8073	403
96-1303	NON27498	PRO0404	-	3104	PRO404-1	8074	404
96-1306	NON27499	PRO0406	-	3106	PRO406-1	8076	405
96-1307	-	PRO0402-01	-	3112	-	-	-
96-1309	-	PRO0403-01	-	3113	-	-	-
96-1311	-	PRO0404-01	-	3114	-	-	-
96-1313	-	PRO0406-01	-	3116	-	-	-
96-1352	NON25700	-	-	3423	NA0302-1	1961	-
96-1353	-	-	-	-	-	-	-
96-1354	-	-	-	-	-	-	-
96-1355	-	-	-	-	-	-	-
96-1356	-	-	-	-	-	-	-
96-1357	-	-	-	-	-	-	-
96-1358	-	-	-	-	-	-	-
96-1359	-	-	-	-	-	-	-
96-1371	-	-	-	-	-	-	-
96-1372	-	-	-	-	-	-	-
96-1373	-	-	-	-	-	-	-
96-1380	-	-	-	-	-	7087	-
96-1382	-	-	-	-	-	7086	-



PAPER TAPE

NON-STERILE

PRODUCT NUMBER	FEATURES/QUANTITIES
96-1322	.5" x 10 Yds 24 box/12 box cs/288 rolls
96-1323	1" x 10 Yds 12 box/12 box cs/144 rolls
96-1324	2" x 10 Yds 6 box/12 box cs/72 rolls
96-1327	3" x 10 Yds 4 box/12 box cs/48 rolls

TRANSPARENT TAPE

NON-STERILE

PRODUCT NUMBER	FEATURES/QUANTITIES
96-1329	.5" x 10 Yds 24 box/12 box cs/288 rolls
96-1330	1" x 10 Yds 12 box/12 box cs/144 rolls
96-1331	2" x 10 Yds 6 box/12 box cs/72 rolls
96-1333	3" x 10 Yds 4 box/12 box cs/48 rolls

CLOTH TAPE

NON-STERILE

PRODUCT NUMBER	FEATURES/QUANTITIES
96-1335	.5" x 10 Yds 24 box/12 box cs/288 rolls
96-1337	1" x 10 Yds 12 box/12 box cs/144 rolls
96-1338	2" x 10 Yds 6 box/12 box cs/72 rolls
96-1339	3" x 10 Yds 4 box/12 box cs/48 rolls



CROSS REFERENCE:

PAPER TAPE / TRANSPARENT TAPE / CLOTH TAPE

SKLAR	MEDLINE	CARDINAL	3M	DYNAREX	ALLEGIANCE	KENDALL	DUKAL
96-1322	NON260012	-	1530-0	3551	-	1596	P50
96-1323	NON260001	32261	1530-2	3552	32261	1914	P110
96-1324	NON260002	32262	1530-2	3553	32262	2419	P210
96-1327	NON260003	-	1530-3	3554	-	3394	P310
96-1329	NON260212	-	15270-0	3571	-	8533	T50
96-1330	NON260201	-	15270-1	3572	32271	9534	T110
96-1331	NON260202	-	15270-2	3573	32272	9535	T210
96-1333	NON260203	-	15270-3	3574	-	9536	T310
96-1335	NON260112	3230A	1538-0	3561	-	7137	C50
96-1337	NON260101	3231A	1538-1	3562	32266	7138	C110
96-1338	NON260102	3233A	1538-1	3563	32267	7138	C210
96-1339	NON260103	3234	1538-3	3564	32268	7140	C310



TRIANGULAR BANDAGE

NON-STERILE

PRODUCT NUMBER FEATURES/QUANTITIES
96-5259 40" x 40" x 56" 1pk, 12pk bg/20bg cs

FINGER BANDAGE

FLEXIBLE

STERILE CASE / 3000

PRODUCT NUMBER FEATURES/QUANTITIES
96-5222 .75" x 3" 100 pcs bx/30 bx cs
96-5223 1" x 3" 100 pcs bx/30 bx cs

SHEER

STERILE CASE / 3000

PRODUCT NUMBER FEATURES/QUANTITIES
96-5250 .75" x 3" 100 pcs bx/30 bx cs
96-5252 1" x 3", 100 pcs bx/30 bx cs

PLASTIC

STERILE CASE / 3000

PRODUCT NUMBER FEATURES/QUANTITIES
96-5254 .75" x 3", 100 pc bx/30 bx cs
96-5256 1" x 3", 100 pcs bx/30 bx cs

POLY DRAPE / TOWELS

NON-STERILE CASE / 6 BOXES

PRODUCT NUMBER FEATURES/QUANTITIES
96-5258 13" x 18", 3-Ply, 250 pc bx
96-8945 17" x 19", 2-Ply, 250 pc bx



CROSS REFERENCE:

WOUND CARE

SKLAR	MEDLINE	DYNAREX	ALLEGIANCE	KENDALL	DUKAL
96-5259	NONTRI300	3680			CTB40
96-5222	NON25650	3611	BF3403	BF3403	-
96-5223	NON25660	3612	BFO103	6135	-
96-5250	NON25500	3601	BS3403	3065	-
96-5252	NON25600	3602	BSO103	3270	-
96-5254	-	-	-	-	7028
96-5256	-	-	-	-	7031
96-5258	-	-	-	-	-
96-8945	-	-	-	-	-



TOURNIQUETS, LATEX-FREE

NON-STERILE

PRODUCT NUMBER	FEATURES/QUANTITIES
96-8933	1" x 18" Flat/Boxed Box 250/Cs 1000
96-8934	1" x 18" Roll/Banded Box 100/Cs 1200
96-1159	1" x 18" Reel/Perforated Box 25/Cs 500

STOCKINETTES

NON-STERILE CASE / 24

PRODUCT NUMBER	FEATURES/QUANTITIES
96-5469	2" x 11 Yards, Roll
96-5470	3" X 11 Yards, Roll
96-5471	4" x 11 Yards, Roll
96-5472	5" x 11 Yards, Roll
96-1360	2" x 25 Yards, 6 Rolls Cs
96-1361	3" x 25 Yards, 6 Rolls Cs
96-1362	4" x 25 Yards, 6 Rolls Cs
96-1363	6" x 25 Yards, 6 Rolls Cs



CROSS REFERENCE:

TOURNIQUETS / STOCKINETTES

SKLAR	MEDLINE	KIMBERLY CLARK	CARDINAL	3M	DYNAREX	DUKAL
96-8933	-	-	-	-	-	-
96-8934	-	-	B4060	-	-	-
96-1159	-	-	-	-	-	-
96-5469	-	-	-	-	-	-
96-5470	-	-	-	-	-	-
96-5471	-	-	-	-	-	-
96-5472	-	-	-	-	-	-
96-1360	MDT221200	59963	-	MS02	3692	30112
96-1361	MDT221203	59964	-	MS03	3693	30113
96-1362	MST221204	59965	-	MS04	3694	30114
96-1363	-	92503	-	3696	-	30116





ESMARK BANDAGE KITS

Esmark bandages offer maximum and consistent pressure to extremities for exsanguination prior to surgery.

FEATURES/BENEFITS

- Smooth, comfortable material
- Provides consistent elongation for optimum compression
- Ease of use
- 6 sizes available in Latex and Latex-Free
- Conveniently packaged in sterile pouch.

Each Esmark Bandage Kit contains 1 Bandage and 1 CSR Wrap.

LATEX

STERILE	CASE / 20
PRODUCT NUMBER	FEATURES
96-1793	3" x 12'
96-1792	3" x 9'
96-1795	4" x 12'
96-1794	4" x 9'
96-1797	6" x 12'
96-1796	6" x 9'

LATEX-FREE

STERILE	CASE / 20
PRODUCT NUMBER	FEATURES
96-1649	3" x 9'
96-1680	3" x 12'
96-1650	4" x 9'
96-1651	4" x 12'
96-1652	6" x 9'
96-1653	6" x 12'



CROSS REFERENCE:

ESMARK BANDAGE KITS

SKLAR	MEDLINE	CARDINAL	MICROTEK	KENDALL
96-1793	DYNT05115A	23580-034	-	-
96-1792	DYNP05114A	23850-033	-	-
96-1795	DYNJ05117A	23580-044	-	-
96-1794	DYNJ05116A	23580-043	-	-
96-1797	-	23580-064	-	-
96-1796	DYNP05118A	23580-063	-	-
96-1649	DYNP05914	24593-033A	4309	4309
96-1680	-	24593-034A	4312	4312
96-1650	DYNJ05916	24593-043A	4409	4409
96-1651	-	24593-044A	4412	4412
96-1652	DYNJ05918	24593-063A	4609	4609
96-1653	-	24593-064A	4612	4612



COTTON

RAYON SWABS

STERILE

PRODUCT NUMBER	FEATURES/QUANTITIES
96-8925	8" 2pc pk/50pks/100pc cs
96-8926	8" 6pc pk/50pks/300pc cs
96-7051	8" 3pc pk/50pks/150pc cs

COTTON TIP APPLICATORS

STERILE

PRODUCT NUMBER	FEATURES/QUANTITIES
96-8923	6" Plastic Handle 2pc pk/50 pks/1000pc cs
96-8924	6" Plastic Handle 6pc pk/50 pks/3000pc cs
96-8936	3" Wooden Handle 2pc pk/50 pks/1000pc cs
96-8937	6" Wooden Handle 6pc pk/50 pks/1000pc cs

LATEX-FREE

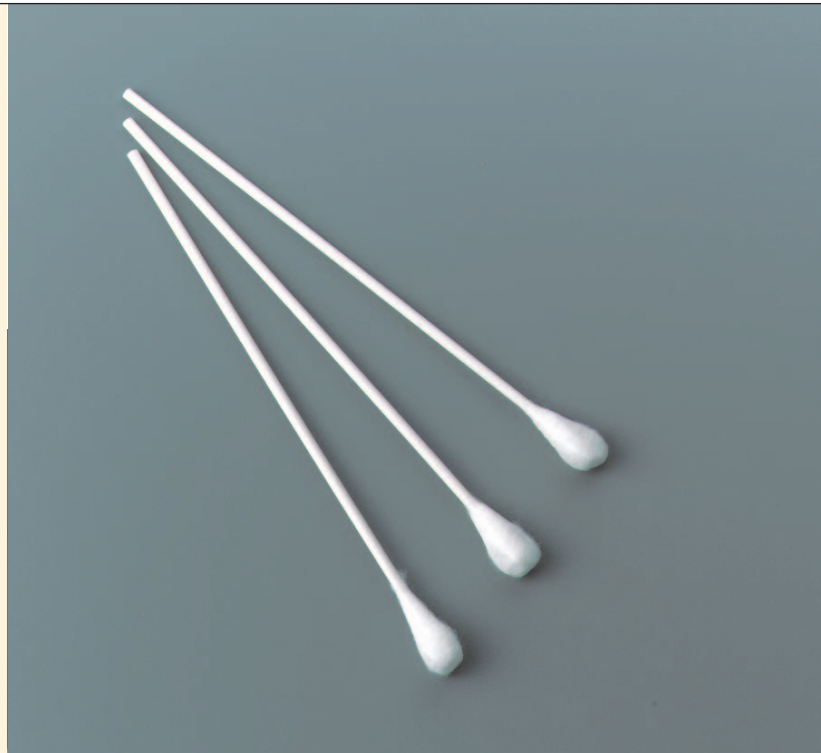

CROSS REFERENCE:

COTTON

SKLAR	CARDINAL	DYNAREX	ALLEGIANCE
96-8925	-	-	-
96-8926	-	-	-
96-7051	-	-	-
96-8923	C15050-006	4305	-
96-8924	-	-	-
96-8936	C15053-003	4303	TQ-1301LF
96-8937	-	-	-



ISOLATION MASK

STERILE CASE / 500
 PRODUCT NUMBER FEATURES
96-5552 Earloop, Yellow

PROCEDURE FACE MASK

STERILE CASE / 500
 PRODUCT NUMBER FEATURES
96-1136 Medium Fluid Resistant,
 Earloop, Blue
 50 Pcs PKG / 10 PKG CASE

PROCEDURE FACE MASK WITH VISOR, HIGH FLUID

STERILE CASE / 100
 PRODUCT NUMBER FEATURES
96-1137 Anti-Fog Foam Strip,
 Anti-Glare Strip, Indigo
 25 Pcs PKG / 4 PKG CASE

SURGICAL FACE MASKS

STERILE CASE / 300
 PRODUCT NUMBER FEATURES
96-1139 Classic, Tie-On, Blue
96-1138 Anti-Fog Film Strip,
 Tie-On, Green
96-1176 Sensitive Skin, Anti-Fog
 Film Strip, Tie-On, White
96-1177 Ultra-Soft, Horizontal Tie,
 White w/Blue Swoosh
96-1178 High Fluid Resistant,
 Anti-Fog, Tie-On, Indigo
96-1179 High Fluid Resistant, Visor,
 Anti-Fog Foam Strip,
 Anti-Glare Strip, Indigo
96-1180 Visor
 50 Pcs PKG / 6 PKG CASE



SKLAR OFFERS A FULL RANGE OF SURGICAL, PROCEDURE AND ISOLATION MASKS FOR EFFECTIVE PROTECTION. WE OFFER THE MOST POPULAR STYLES TO SUIT CLINICAL REQUIREMENTS AND PERSONAL PREFERENCES FOR USE IN THE OPERATING ROOM, GENERAL MEDICINE, OR ANY OTHER AREA REQUIRING FACIAL PROTECTION. OUR MASKS ARE SUITABLE FOR DROPLET PRECAUTIONS AGAINST INFLUENZA AND OTHER INFECTIOUS PATHOGENS.



MOLDED CONE SURGICAL MASKS

NON-STERILE

PRODUCT NUMBER FEATURES/QUANTITIES

96-1374

Sklar does not represent or warrant that the products it sells offer absolute protection from exposure to blood, contaminants, infectious diseases, or the risk of contracting infectious diseases. Consistent with OSHA requirements, employers assess each medical task to be performed and the type of blood or contaminant exposure that is expected. Employers then choose appropriate protective apparel for employees in order to prevent contamination of their skin or clothing.



CROSS REFERENCE:

PROTECTIVE APPAREL

SKLAR	MEDLINE	KIMBERLY CLARK	CARDINAL	3M	DYNAREX	DUKAL	PRECEPT
96-5552	-	47117	1070061	-	-	-	15100
96-1136	-	62115	1074534	1820	2201	1530	15111
96-1137	-	62116	1074635	1820FS	2202	-	65-3345
96-1139	NON27376	48201	1001013	1816	2205	1540	15201
96-1138	NON27378A	48215	1752005	1832	-	-	15211
96-1176	NON27385	-	1073035	1833	-	-	15216
96-1177	NON27400	48390	1071039	1816W	-	-	-
96-1178	NON27379A	-	1071235	1818	-	1550	15520
96-1179	-	48247	1071135	1818FSG	-	1560	15530
96-1180	-	41204	F1SHIELD50	-	-	-	-
96-1151	-	-	1043010	-	-	-	35-3015
96-1165	-	-	1043010	-	-	-	-
96-1181	NONSH600	-	-	-	-	-	-
96-1182	NONSH600	-	-	-	-	-	-
96-5551	CRI2000	69561	-	-	-	-	-
96-5554	CRI2003	69252	-	-	-	-	-
96-1149	-	69520	-	-	2121	311	5200
96-1189	-	-	-	-	-	-	-
96-1166	-	-	-	-	-	-	-
96-1186	-	-	-	-	-	-	-
96-5553	-	-	-	-	-	-	-
96-1167	-	-	-	-	-	-	-
96-1168	-	69221	-	-	2103	321B	22010
96-1169	-	69053	-	-	2113	324B	22111
96-1170	-	-	-	-	-	-	-
96-1171	-	-	-	-	-	-	-
96-1172	-	69221	-	-	-	-	-
96-1173	-	69053	-	-	-	-	-
96-1374	-	-	-	-	2203	-	65-3333
96-1141	-	69984	-	-	-	301SP	-
96-1143	-	69127	-	-	2141	301	-
96-1145	-	69981	-	-	-	303	-
96-1147	-	69025	-	-	-	-	-



BEARD COVERS

NON-STERILE CASE / 500

PRODUCT NUMBER FEATURES

96-1151 White, Polyspun Bond
Ear Loop, Latex Free,
Universal Size

100 PCS PKG / 5 PKG CASE

STERILE CASE / 25

PRODUCT NUMBER FEATURES

96-1165 White, Polyspun Bond
Ear Loop, Latex Free,
Universal Size

HOOD & BEARD COVERS

NON-STERILE CASE / 500

PRODUCT NUMBER FEATURES

96-1181 PSB, Blue

100 PCS PKG / 5 PKG CASE

STERILE CASE / 25

PRODUCT NUMBER FEATURES

96-1182 PSB, Blue

SHOE COVERS

NON-STERILE CASE / 300

PRODUCT NUMBER FEATURES

96-1153 Anti-Skid, Universal, Blue

96-1154 Anti-Skid, Large, Blue

100 PCS PKG / 3 PKG CASE

STERILE CASE / 25

PRODUCT NUMBER FEATURES

96-5551 Anti-Skid, Universal, Blue

96-5554 Anti-Skid, Large, Blue

SEE PAGE 113 FOR CROSS REFERENCE.



HOOD AND BEARD COVERS FEATURE A FLEXIBLE ELASTIC BAND AND LIGHTWEIGHT PSB OR SMS MATERIAL FOR OPTIMAL COVERAGE. UNIVERSAL SIZE, NON-STERILE, LATEX FREE.

LATEX-FREE



Anti-Skid



SURGEON'S CAPS

NON-STERILE CASE / 500

PRODUCT NUMBER FEATURES

96-1149 Blue, PSB, Latex Free,
Universal Size

96-1189 Blue, SMS, Fluid Resistant
Latex Free, Universal Size

100 PCS PKG / 5 PKG CASE

STERILE CASE / 25

PRODUCT NUMBER FEATURES

96-1166 Blue, PSB, Latex Free,
Universal Size

96-1186 Blue, SMS, Fluid Resistant
Latex Free, Universal Size

BOUFANTS

NON-STERILE CASE / 500

PRODUCT NUMBER FEATURES

96-5553 21", Butterfly, Blue

96-1167 24", Butterfly, Blue

96-1168 21", Blue

96-1169 24", Blue

100 PCS PKG / 5 PKG CASE

STERILE CASE / 25

PRODUCT NUMBER FEATURES

96-1170 21", Butterfly, Blue

96-1171 24", Butterfly, Blue

96-1172 21", Blue

96-1173 24", Blue

OUR SURGEON'S CAPS ARE AVAILABLE IN EITHER PSB MATERIAL OR A FLUID RESISTANT SMS MATERIAL. UNIVERSAL SIZE, NON-STERILE, LATEX FREE.

FEATURES & BENEFITS

- LATEX FREE
- NON-STERILE
- DISPENSER BOXES
- SINGLE USE

SKLAR'S BOUFFANT CAPS ARE CONSTRUCTED FROM THE FINEST TO ENSURE LIGHT WEIGHT, COOL AND COMFORTABLE FIT. AVAILABLE IN BOTH 21" AND 24", POLYSPUN BOND (PSB), NON-STERILE, LATEX FREE.

SEE PAGE 113 FOR CROSS REFERENCE.

GOWNS

NON-REINFORCED

NON-STERILE CASE / 25

PRODUCT NUMBER FEATURES

96-5329 Large

96-5331 Xtra Large

96-5333 XXtra Large

STERILE CASE / 25

PRODUCT NUMBER FEATURES

96-5330 Large

96-5332 Xtra Large

96-5334 XXtra Large Cs / 15

REINFORCED CHEST AND SLEEVE

NON-STERILE CASE / 25

PRODUCT NUMBER FEATURES

96-5335 Large

96-5337 Xtra Large

96-5339 XXtra Large

STERILE CASE / 25

PRODUCT NUMBER FEATURES

96-5336 Large

96-5338 Xtra Large

96-5340 XXtra Large Cs / 15

IMPERVIOUS CHEST AND SLEEVE

NON-STERILE CASE / 25

PRODUCT NUMBER FEATURES

96-5341 Large

96-5343 Xtra Large

96-5345 XXtra Large

STERILE CASE / 25

PRODUCT NUMBER FEATURES

96-5342 Large

96-5344 Xtra Large

96-5011 XXtra Large Cs / 15

LATEX-FREE

SEE PAGE 118 FOR CROSS REFERENCE.



BULK, NON-STERILE NON-REINFORCED

PRODUCT NUMBER FEATURES/QUANTITIES

96-5003 Large 400

96-5005 Xtra Large 400

96-5006 XXtra Large 300

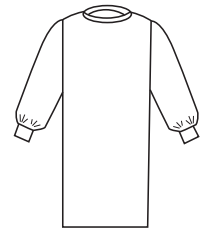

NON-REINFORCED

REINFORCED CHEST AND SLEEVE

PRODUCT NUMBER FEATURES/QUANTITIES

96-5519 Large 400

96-5520 Xtra Large 400

96-5521 XXtra Large 300



REINFORCED CHEST AND SLEEVE

IMPERVIOUS CHEST AND SLEEVE

PRODUCT NUMBER FEATURES/QUANTITIES

96-5596 Large 400

96-5597 Xtra Large 400

96-5599 XXtra Large 300



IMPERVIOUS CHEST AND SLEEVE



ISOLATION GOWNS

NON-STERILE CASE / 100

PRODUCT NUMBER	FEATURES
96-1141	Yellow, Lightweight, Full back, Universal Size AAMI Level 0, Elastic Cuffs, Tie Neck, Tie Waist
96-1143	Yellow, Lightweight, Full back, Universal Size AAMI Level 1, Elastic Cuffs, Tie Neck, Tie Waist
96-1145	Yellow, Medium Weight, Full back, Universal Size AAMI Level 2, Elastic Cuffs, Tie Neck, Tie Waist
96-1147	Yellow, Heavy Weight, Full back, Universal Size AAMI Level 3, Elastic Cuffs, Tie Neck, Tie Waist

10 PCS BAG / 5 BAGS CASE

All information concerning product content and composition; the function, care, maintenance, and intended use of products; and any warnings respecting the products in this catalog are derived exclusively from each product's manufacturer. As such, Sklar makes no representations or warranties - either express or implied - respecting the same. If additional information about any product is needed, please contact a Sklar sales representative, who will assist you in obtaining the information from the product's manufacturer.

SEE PAGE 118 FOR CROSS REFERENCE.



FEATURES & BENEFITS

- 100% LATEX FREE
- FULL LENGTH FOR MAXIMUM COVERAGE
- AVAILABLE IN BOTH ELASTIC AND KNIT CUFFS
- SEAMS ARE ULTRASONICALLY WELDED RATHER THAN SEWN TO ELIMINATE PINHOLES AND PREVENT POSSIBLE STRIKE THROUGH
- EXTRA LONG WAIST AND NECK TIE ENSURES PROPER FIT
- AVAILABLE IN BOTH UNIVERSAL AND XXL SIZES

CROSS REFERENCE: GOWNS

SKLAR	MEDLINE	KIMBERLY CLARK	CARDINAL	PRECEPT
96-5329	SPT-2401SMS	7011S	-	-
96-5331	SPT-24022MS	70121	-	-
96-5333	SPT-2403SMS	70131	-	-
96-5330	DYNJP2401	95111	9515	33100
96-5332	DYNJP2402	95121	9545	33105
96-5334	DYNJP2403	95131	9575	33110
96-5335	SPT-2501SMS	70211	-	-
96-5337	SPT-2502SMS	70221	-	16-2993
96-5339	SPT-2503SMS	70231	-	16-2994
96-5336	DYNJP2501	95211	9511	33300
96-5338	DYNJP2502	95221	9541	33305
96-5340	DYNJP2503	95231	9571	33110
96-5341	SPT-2601SMS	70311	-	8572
96-5343	SPT-2602SMS	70321	-	8576
96-5345	SPT-2903SMS	70331	-	8579
96-5342	DYNJP2601	95311	9010	33200
96-5344	DYNJP2602	95321	9040EL	33205
96-5011	DYNJP2603	95331	9070	-
96-5003	-	79115	-	-
96-5005	-	79116	-	-
96-5006	-	-	-	-
96-5519	-	79211	-	-
96-5520	-	79212	-	-
96-5521	-	-	-	-
96-5596	-	79311	-	8572B
96-5597	-	79312	-	8576B
96-5599	-	-	-	-





SKLAR VINYL GLOVES

- LATEX-FREE
- POWDER-FREE
- NON-STERILE
- AMBIDEXTROUS

VINYL GLOVES

NON-STERILE	BOX OF 100
PRODUCT NUMBER	FEATURES
96-1161	X-Small
96-1162	Small
96-1163	Medium
96-1164	Large
96-1175	X-Large



SHOULDER POUCH

NON-STERILE	CASE / 50
PRODUCT NUMBER	FEATURES
96-S1067NS	36" x 29" (91 x 73cm)
STERILE	BOX / 5
PRODUCT NUMBER	FEATURES
96-S1067	36" x 29" (91 x 73cm)

- OVAL APERTURE WITH SLIT AND ADHESIVE AREAS
- AGGRESSIVE ADHESIVE WITH NO RESIDUE
- HEAVY, LOW-GLARE MATTE FINISH FILM FOR ADDITIONAL STRENGTH
- TWO MOLDABLE STRIPS, AND ONE FOAM STRIP TO ENHANCE POUCH PERFORMANCE
- TWO SUCTION PORTS WITH CAPS FOR IMPROVED FLUID CONTROL

INSTRUMENT POUCH

NON-STERILE	CASE / 200
PRODUCT NUMBER	FEATURES
96-S1018NS	6.75" x 12" (17 x 30cm)
STERILE	BOX / 10
PRODUCT NUMBER	FEATURES
96-S1018	6.75" x 12" (17 x 30cm)

- TWO COMPARTMENTS FOR CAUTERIES OR CATHETERS
- NEW HIGH TACK, AGGRESSIVE ADHESIVE FOR BETTER ADHESION TO LINEN OR NON-WOVEN MATERIALS
- HEAVY, LOW-GLARE MATTE FINISH FILM

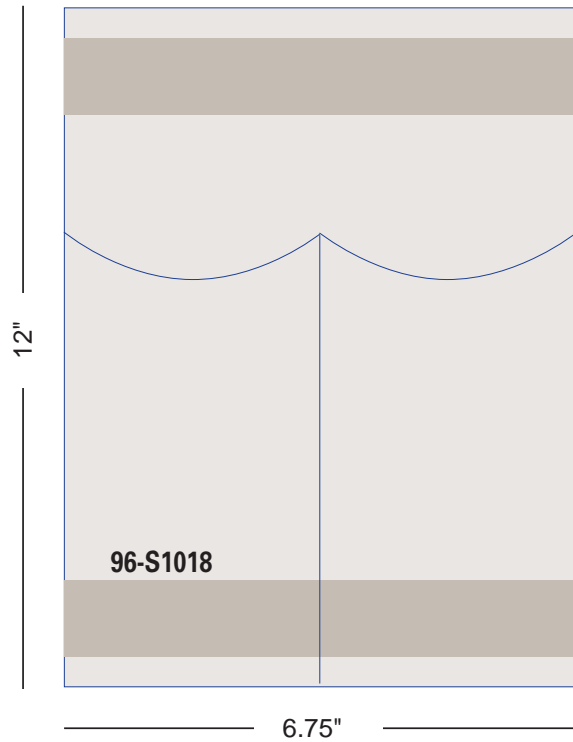
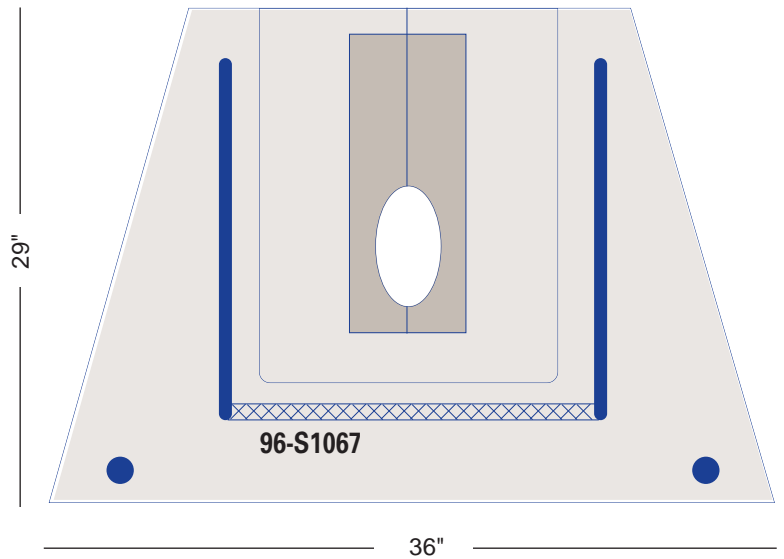

CROSS REFERENCE:		SHOULDER POUCH	
SKLAR	3M		
96-S1067NS	1067NS		
96-S1067	S1067		
		INSTRUMENT POUCH	
SKLAR	3M	CARDINAL	MICROTEK
96-S1018NS	1018NS	-	8918
96-S1018	1018	29-10189	ISO1018



ISOLATION BAG

NON-STERILE CASE / 100

PRODUCT NUMBER FEATURES
96-S1003NS 20" x 20" (50 x 50cm)

STERILE BOX / 10

PRODUCT NUMBER FEATURES
96-S1003 20" x 20" (50 x 50cm)

FLUID POUCH

NON-STERILE CASE / 200

PRODUCT NUMBER FEATURES
96-S1016NS 20" x 19" (50 x 48cm)

STERILE BOX / 10

PRODUCT NUMBER FEATURES
96-S1016 20" x 19" (50 x 48cm)

- WIDE ADHESIVE AREA FOR BETTER ADHESION
- AGGRESSIVE ADHESIVE WITH NO RESIDUE
- NON-LINTING, TEAR RESISTANT, POLY RELEASE LINER
- MOLDABLE STRIP TO ENHANCE POUCH PERFORMANCE
- MICRO SCREEN FOR IMPROVED FILTERING SYSTEM

ISOLATION BAG

- SOFT, STRONG, CLEAR FILM WITH SEAMLESS BOTTOM
- COTTON DRAW-STRINGS FOR EASE OF CLOSURE
- CUFFED OPENING TO IMPROVE STERILE DELIVERY



FLUID POUCH

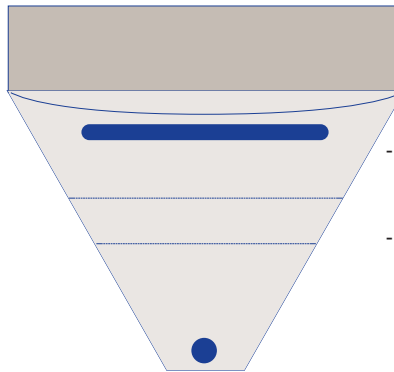

- SUCTION PORT WITH CAP FOR IMPROVED FLUID CONTROL
- HEAVY, LOW-GLARE MATTE FINISH FILM

CROSS REFERENCE:

ISOLATION BAG

SKLAR	3M	MICROTEK
96-S1016NS	1016NS	-
96-S1016	1016	ISO1016

FLUID POUCH

SKLAR	3M	CARDINAL	MICROTEK
96-S1003NS	1003NS	-	-
96-S1003	1003	29-10039	ISO1003



OR TOWELS

STERILE CASE / 50

PRODUCT NUMBER FEATURES/QUANTITIES
96-1662 Pack of 2

STERILE CASE / 20

PRODUCT NUMBER FEATURES/QUANTITIES
96-1621 Pack of 4

STERILE CASE / 12

PRODUCT NUMBER FEATURES/QUANTITIES
96-8939 Pack of 6

STERILE CASE / 10

PRODUCT NUMBER FEATURES/QUANTITIES
96-8938 Pack of 8

**OR TOWELS,
 FENESTRATED**

STERILE CASE / 25

PRODUCT NUMBER FEATURES/QUANTITIES
96-7548 Pack of 2

STERILE CASE / 20

PRODUCT NUMBER FEATURES/QUANTITIES
96-8940 Pack of 4

STERILE CASE / 12

PRODUCT NUMBER FEATURES/QUANTITIES
96-8941 Pack of 6

STERILE CASE / 10

PRODUCT NUMBER FEATURES/QUANTITIES
96-8942 Pack of 8

OR TOWELS, BULK

NON-STERILE

PRODUCT NUMBER FEATURES/QUANTITIES
96-5627 400 Towels



CROSS REFERENCE:		OR TOWELS	
SKLAR	CARDINAL	KENDALL	DUKAL
96-1662	28700-002	77702	CT-02B
96-1621	28700-004	77704	CT-04B
96-8939	28700-006	77706	-
96-8938	28700-008	77708	-
96-7548	-	-	-
96-8940	-	-	-
96-8941	-	-	-
96-8942	-	-	-
96-5627	28100-999	-	-



NEW!

100% COTTON WEAVE SKLAR OR TOWELS

ACCESSORIES

STERILE CASE / 50

PRODUCT NUMBER FEATURES/QUANTITIES

96-1940 Pack of 2

STERILE CASE / 20

PRODUCT NUMBER FEATURES/QUANTITIES

96-1942 Pack of 4

STERILE CASE / 12

PRODUCT NUMBER FEATURES/QUANTITIES

96-1944 Pack of 6

STERILE CASE / 10

PRODUCT NUMBER FEATURES/QUANTITIES

96-1946 Pack of 8

BULK, NON-STERILE

PRODUCT NUMBER FEATURES/QUANTITIES

96-1949 300 Towels

**CALL FOR
PRICE QUOTES.**

100% COTTON WEAVE OR TOWELS

FEATURES AND BENEFITS

- 100% PURE COTTON WITH NATURAL FEEL
- LESS ABRASIVE TO WOUNDS
- MORE ABSORBENT
- BIODEGRADABLE AND ENVIRONMENTAL FRIENDLY
- COMPACT FOR SHIPPING & STORAGE





SKLAR CSR WRAPS

A non-woven, non-absorbent sterilization wrap, which is soft yet, durable, and drapes like a cloth. Sklar's CSR wrap is designed as a protective wrap in order to sterilize products by steam, and ethylene oxide sterilization.

CSR wraps are ideally suited for operating room, central supply, kit packing and other areas where equipment is wrapped prior to sterilization.

NON-STERILE CASE / 1000

PRODUCT NUMBER FEATURES

96-1121 9" x 9"

96-1122 12" x 12"

NON-STERILE CASE / 400

PRODUCT NUMBER FEATURES

96-1123 24" x 24"

96-1124 36" x 36"

NON-STERILE CASE / 150

PRODUCT NUMBER FEATURES

96-1126 45" x 45"

NON-STERILE CASE / 100

PRODUCT NUMBER FEATURES

96-1127 48" x 48"

LATEX-FREE



CROSS REFERENCE:

CSR WRAPS

SKLAR	MEDLINE	KIMBERLY CLARK	CARDINAL	DYNAREX
96-1121	-	10709	AT32309	-
96-1122	-	10712	AT32312	4412
96-1123	GEM1124	10724	AT32324	4424
96-1124	-	10736	AT32336	4436
96-1126	-	10745	-	4445
96-1127	-	10748	-	4448



PIPE CLEANERS

STERILE CASE / 50

PRODUCT NUMBER FEATURES

- 96-8927** 2 pc pk
- 96-8928** Pks / 6

SAFETY PINS

STERILE CASE / 50

PRODUCT NUMBER FEATURES

- 96-8105** #1 2 pc pk/25pk cs
- 96-1667** #2 2 pc pk/25pk cs
- 96-1668** #3 2 pc pk/25pk cs

**TAPE MEASURES,
PAPER**

STERILE CASE / 25

PRODUCT NUMBER FEATURES

- 96-7635**

SHORT STOP

STERILE CASE / 10

PRODUCT NUMBER FEATURES

- 96-8497** Adhesive back
(NOT SHOWN)





IV START LABELS

STERILE CASE / 100
 PRODUCT NUMBER FEATURES
96-8935

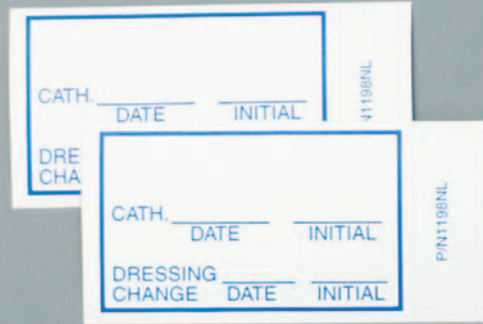

PEN AND LABEL SYSTEMS

STERILE CASE / 50
 PRODUCT NUMBER FEATURES
96-8961



PLASTIC RULERS

STERILE CASE / 100
 PRODUCT NUMBER FEATURES
96-1674 6"

RUBBER BANDS

STERILE CASE / 100
 PRODUCT NUMBER FEATURES

96-1671	#16	50 pc pk/2 pk cs
96-5906	#18	50 pc pk/2 pk cs
96-1672	#31	50 pc pk/2 pk cs
96-1673	#32	50 pc pk/2 pk cs

STERILE CASE / 50
 PRODUCT NUMBER FEATURES

96-5908	#64	2 pc pk/25 pk cs
----------------	-----	------------------

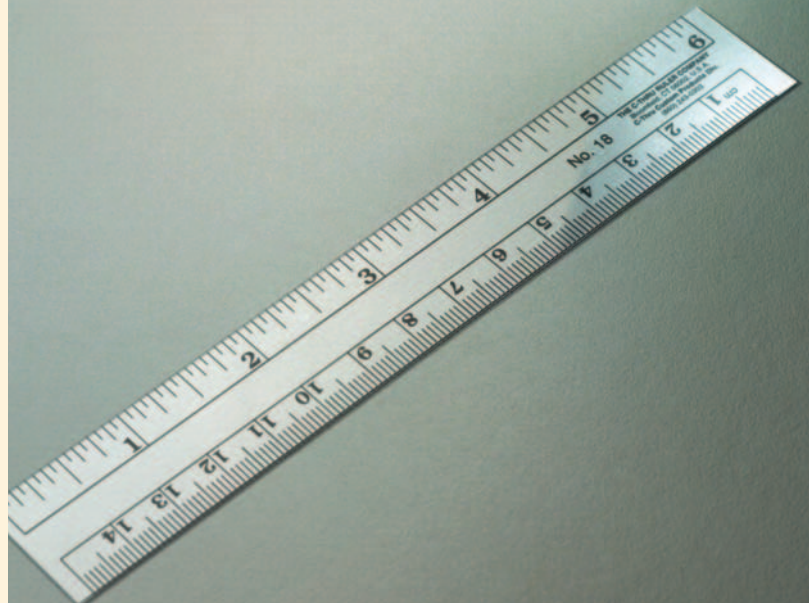

ZIPLOCK BAGS

STERILE		CASE / 50
PRODUCT NUMBER	FEATURES	
96-7005	10" x 12"	
96-7003	6" x 6"	
96-7766	6" x 8"	
96-7007	8" x 10"	

REFUSE BAGS

NON-STERILE		CASE / 50
PRODUCT NUMBER	FEATURES	
96-5110	16" x 18", Clear	
96-5111	16" x 18", Red	

NON-STERILE		CASE / 100
PRODUCT NUMBER	FEATURES	
96-5116	16" x 18", Clear	
96-5115	16" x 18", Red	

UROLOGICAL DRAINAGE BAGS

NON-STERILE	
PRODUCT NUMBER	FEATURES/QUANTITIES
96-1655	Liebel™ Tables, 10 / cs
96-1657	Siemens™ Tables, 20 / cs

STERILE	
PRODUCT NUMBER	FEATURES/QUANTITIES
96-1654	Liebel™ Tables, 10 / cs
96-1656	Siemens™ Tables, 20 / cs



LATEX-FREE



Our urology drain bags are designed specifically for the Siemens™ and Liebel™ Tables.



ULTRASOUND GEL PACKS

STERILE CASE/50
 PRODUCT NUMBER FEATURES
96-7668

SKIN PROTECTANT SWAB STICKS

STERILE CASE/50
 PRODUCT NUMBER FEATURES
96-7626

INFANT URINE COLLECTION, 200 ML

STERILE CASE/50
 PRODUCT NUMBER FEATURES
96-8991

BENZOIN TINCTURE APPLICATORS

STERILE CASE/50
 PRODUCT NUMBER FEATURES
96-7624

Clear Ultrasound Gel has no perfumes, no color, is hypoallergenic and water soluble. Performs best when used for diagnostic and therapeutic medical ultrasound procedures. It contains no formaldehyde and is not a spermicide. Single use packets



No-Sting Protective Swab.

- Effective protection between skin and tape
- Helps tape and film adhesion
- No-sting, non-irritating



STOPCOCK / WITH ROT

STERILE CASE / 50

PRODUCT NUMBER	FEATURES
96-7617	3-Way HP
96-7117	3-Way LP

BLADE REMOVAL

STERILE CASE / 100

PRODUCT NUMBER	FEATURES
96-7460	

APPLICATOR PREP STICK

STERILE CASE / 100

PRODUCT NUMBER	FEATURES/QUANTITIES
96-7040	6" 50 pc pk/2pk cs

ANGLED SPONGE STICK

STERILE CASE / 100

PRODUCT NUMBER	FEATURES/QUANTITIES
96-7187	50 pc pk/2pk cs

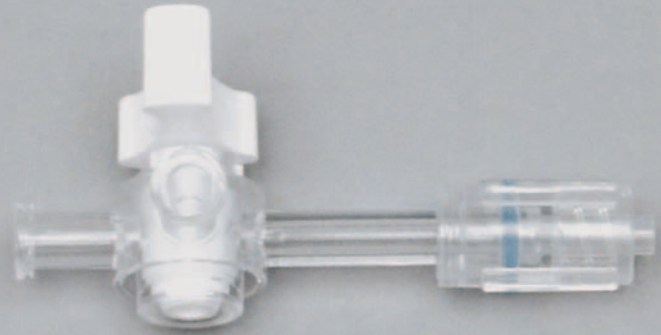



BULB IRRIGATION SYRINGES, 60 CC

STERILE	CASE / 50
<hr/>	
PRODUCT NUMBER	FEATURES
96-8989	

PISTON IRRIGATION SYRINGES, 60 CC

STERILE	CASE / 50
<hr/>	
PRODUCT NUMBER	FEATURES
96-8990	

EAR / ULCER SYRINGES

STERILE	CASE / 50
<hr/>	
PRODUCT NUMBER	FEATURES
96-9321	1 oz.
96-9256	2 oz.
96-9257	3 oz.

PREP RAZORS, PLASTIC

STERILE	CASE / 100
<hr/>	
PRODUCT NUMBER	FEATURES
96-2956	



WOUND DRAINAGE, RESERVOIR WITH VINYL TUBING AND TROCAR

STERILE	CASE / 10
PRODUCT NUMBER	FEATURES
96-5473	7 Fr Small
96-5474	10 Fr Medium
96-5475	15 Fr Large
96-5476	19 Fr Large

UMBILICAL CLAMP

STERILE	CASE / 50
PRODUCT NUMBER	FEATURES
96-8960	

PLASTIC NOSE CLIP

NON-STERILE	BOX OF 100
PRODUCT NUMBER	FEATURES
96-2950	Foam
STERILE	BOX OF 100
PRODUCT NUMBER	FEATURES
96-2951	Foam

TUBING CONNECTOR, 5 IN 1

STERILE	CASE / 100
PRODUCT NUMBER	FEATURES
96-8988	





**SKIN STAPLE
REMOVER**

STERILE CASE / 100

PRODUCT NUMBER FEATURES

96-8949

DENTAL MIRROR

STERILE CASE / 50

PRODUCT NUMBER FEATURES

96-7887

**TOWEL CLAMP,
PLASTIC**

STERILE CASE / 50

PRODUCT NUMBER FEATURES

96-5655

**20" EXTENSION SET
WITH CLAMP**

STERILE CASE / 25

PRODUCT NUMBER FEATURES

96-7725

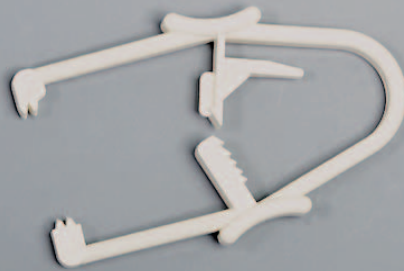

OXYGEN MASKS

NON-STERILE

CASE / 50

PRODUCT NUMBER	FEATURES
96-5324	Adult, curved, flared tip with 7 ft. tubing (over the ear)
96-5325	Adult, Curved, Non-Flared Tip with 7 ft Tubing (over the ear)



SUCTION CATHETERS

NON-STERILE

CASE / 50

PRODUCT NUMBER	FEATURES
96-5478 10 Fr	Coiled Graduated
96-5479 10 Fr	Straight Graduated
96-5480 12 Fr	Coiled
96-5481 12 Fr	Straight
96-5482 14 Fr	Coiled
96-5483 14 Fr	Straight
96-5484 16 Fr	Coiled
96-5485 16 Fr	Straight
96-5486 18 Fr	Coiled
96-5487 18 Fr	Straight
96-5488 6 Fr	Straight Graduated
96-5489 8 Fr	Coiled Graduated
96-5490 8 Fr	Straight Graduated
96-5491 6 Fr	Coiled Graduated





SKLAR ENDOMETRIAL CANNULA

STERILE CASE / 25

PRODUCT NUMBER	FEATURES
96-4100	O.D. Size: 3.0mm Length: 23.5cm

SKLAR STERILE WATER

For Irrigation and Suction Catheter Procedures
Not for Injection

STERILE CASE / 48

PRODUCT NUMBER	FEATURES
10-1601	100 mL Bottles



STERILE DISPOSABLE SKLAR CLEANWHEEL

Prevents cross-infection (MRSA, HEP B) during Diabetic foot testing and routine Orthopedic, Neurologic and Neurosurgical Examinations, in the ER or exam room, giving the Doctor a rapid assessment without the worry of cross-infection.



SKLAR STERILE DISPOSABLE CLEANWHEEL

Professional, single-use neurological pinwheel. Protects both the patient and the doctor from direct contact and needle stick cross-infection during routine sensory examinations. Recommended for initial neurological assessment.

STERILE

PRODUCT NUMBER	FEATURES
96-7905	36 Units
96-7907	144 Units

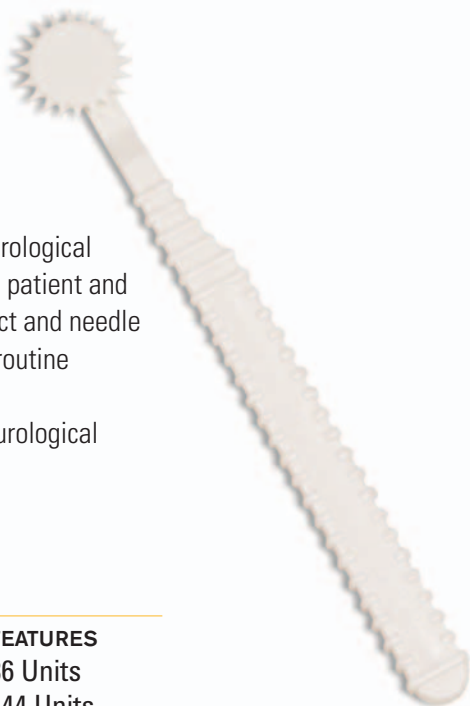

The Cleanwheel® A Brief History

For decades, doctors have been using neurological pinwheels to test a patient's ability to feel sensation over a particular area of skin. Loss of feeling over a "dermatome" (as these areas of skin are referred to) alerts doctors to the probability of nerve function loss, which in turn helps doctors to determine the further diagnostic studies and / or appropriate care needed for a myriad of possible causes.

Today, doctors continue to use non-sterile metal pinwheels, safety pins - and even paper clips for sensitively testing. These practices raise serious cross-infection potential for both topical and bloodborn pathogens - as well as reliability concerns with patient response to testing.



RETRACTABLE SAFETY SYRINGE



SKLAR RETRACTABLE SAFETY SYRINGE

- Single-Use Only
- Luer Lock Syringe with Needles
- Sterile, Disposable

STERILE	CASE / 1000
PRODUCT NUMBER	FEATURES
62-4746	3ML Syringe, 22G x 1-1/2" Needle
62-4748	3ML Syringe, 23G x 1" Needle
62-4750	3ML Syringe, 25G x 5/8" Needle
62-4752	3ML Syringe, 25G x 1" Needle
62-4760	5ML Syringe, 25G x 1-1/2" Needle

STERILE	Box / 100
PRODUCT NUMBER	FEATURES
62-4746M	3ML Syringe, 22G x 1-1/2" Needle
62-4748M	3ML Syringe, 23G x 1" Needle
62-4750M	3ML Syringe, 25G x 5/8" Needle
62-4752M	3ML Syringe, 25G x 1" Needle
62-4760M	5ML Syringe, 25G x 1-1/2" Needle

CROSS REFERENCE: SAFETY SYRINGE

SKLAR	BD	KENDALL
62-4746	309593	8881533254
62-4748	309594	8881533338
62-4750	309592	8881533510
62-4752	-	-
62-4760	-	-



SKLAR SYRINGES



CROSS REFERENCE:

SYRINGES

SKLAR	BD	KENDALL
62-1661	301025	8881103066
62-3726	301073	8881103025
62-3728	301077	8881103010
62-4714	301027	8881103028
62-4629	301028	8881116028
62-6714	301029	8881112083
62-6716	301030	8881112059
62-7706	301031	8881120193
62-7708	301032	8881120037
62-7807	301033	8881135019
62-7809	301034	8881135084
62-8464	301037	8881160157
62-8465	301035	8881160629
62-8466	301036	8881160405
62-1659	309602	8881501400
62-3718	309585	8881513934
62-4707	309603	8881516937
62-4628	301603	8881516911
62-6707	309604	8881512878
62-6633	301604	8881512852
62-7701	309661	8881520657
62-7801	309650	8881569224
62-8453	309653	8881560125
62-8455	309654	8881560224
62-8454	309620	8881560141
62-3702	309570	8881513512
62-3703	309581	8881513538
62-3706	309571	8881513330
62-3708	309572	8881513231
62-3710	309574	8881513256
62-3711	309575	8881513132
62-3713	309577	8881513157
62-3715	309578	8881513033
62-3716	309579	8881513058
62-4703	309632	8881516135
62-4704	309633	8881516150
62-4705	309634	-
62-4706	309635	8881516051
62-6703	309642	8881512738
62-6704	309643	8881512746
62-6705	309644	-
62-6706	309645	8881512662

BULK NON-STERILE SYRINGES

PRODUCT NUMBER	FEATURES	QUANTITIES
62-1661	1cc Luer-Slip, Syringe	Cs 3000
62-3726	3cc Luer-Lock, Syringe	Cs 5000
62-3728	3cc Luer-Slip, Syringe	Cs 1600
62-4714	5cc Luer-Lock, Syringe	Cs 3000
62-4629	5cc Luer-Slip, Syringe	Cs 3000
62-6714	10cc Luer-Lock, Syringe	Cs 1800
62-6716	10cc Luer-Slip, Syringe	Cs 1800
62-7706	20cc Luer-Lock, Syringe	Cs 900
62-7708	20cc Luer-Slip, Syringe	Cs 900
62-7807	30cc Luer-Lock, Syringe	Cs 225
62-7809	30cc Luer-Slip, Syringe	Cs 225
62-8464	60cc Catheter Tip, Syringe	Cs 400
62-8465	60cc Luer-Lock, Syringe	Cs 400
62-8466	60cc Luer-Slip, Syringe	Cs 400

STERILE SYRINGES

PRODUCT NUMBER	FEATURES	QUANTITIES
62-1659	1cc Luer-Slip, Syringe	Cs 1000
62-3718	3cc Luer-Lock, Syringe	Cs 1000
62-4707	5cc Luer-Lock, Syringe	Cs 1000
62-4628	5cc Luer-Slip, Syringe	Cs 1000
62-6707	10cc Luer-Lock, Syringe	Cs 1000
62-6633	10cc Luer-Slip, Syringe	Cs 1000
62-7701	20cc Luer-Lock, Syringe	Cs 500
62-7801	30cc Luer-Lock, Syringe	Cs 500
62-8453	60cc Luer-Lock, Syringe	Cs 100
62-8455	60cc Luer-Slip, Syringe	Cs 100
62-8454	60cc Catheter Tip, Syringe	Cs 100

STERILE SYRINGES WITH NEEDLES

PRODUCT NUMBER	FEATURES	QUANTITIES
62-3702	3cc Luer-Lock, 22 Gauge x 5/8" Needle	Cs 1000
62-3703	3cc Luer-Lock, 22 Gauge x 1" Needle	Cs 1000
62-3706	3cc Luer-Lock, 23 Gauge x 1" Needle	Cs 1000
62-3708	3cc Luer-Lock, 22 Gauge x 1" Needle	Cs 1000
62-3710	3cc Luer-Lock, 22 Gauge x 1-1/2" Needle	Cs 1000
62-3711	3cc Luer-Lock, 21 Gauge x 1" Needle	Cs 1000
62-3713	3cc Luer-Lock, 21 Gauge x 1-1/2" Needle	Cs 1000
62-3715	3cc Luer-Lock, 20 Gauge x 1" Needle	Cs 1000
62-3716	3cc Luer-Lock, 20 Gauge x 1-1/2" Needle	Cs 1000
62-4703	5cc Luer-Lock, 21 Gauge x 1" Needle	Cs 1000
62-4704	5cc Luer-Lock, 21 Gauge x 1-1/2" Needle	Cs 1000
62-4705	5cc Luer-Lock, 20 Gauge x 1" Needle	Cs 1000
62-4706	5cc Luer-Lock, 20 Gauge x 1-1/2" Needle	Cs 1000
62-6703	10cc Luer-Lock, 21 Gauge x 1" Needle	Cs 1000
62-6704	10cc Luer-Lock, 21 Gauge x 1-1/2" Needle	Cs 1000
62-6705	10cc Luer-Lock, 20 Gauge x 1" Needle	Cs 1000
62-6706	10cc Luer-Lock, 20 Gauge x 1-1/2" Needle	Cs 1000



SKLAR SURGICAL SKIN MARKER

SKLAR surgical skin markers are designed to allow the surgeon to conveniently demarcate selected sites, prior to or during surgical procedures.

- Scrub resistant ink
- Durable tip
- Non-smearing
- Sterile

STERILE CASE / 50

PRODUCT NUMBER FEATURES

10-1440





LATEX-FREE

SKLARSAFE™ SAFETY SCALPELS

- Protective, transparent sheath can be opened, closed, and locked with a single hand
- Precision stainless steel blade made in England
- Sturdy, “sure-grip” handle
- Audible “click” when sheath advanced to locked position
- OSHA Compliant
- Individually sealed in sturdy film and Tyvek® pack

STERILE BOX OF 10

PRODUCT NUMBER

FEATURES

06-3094

Number 10

06-3095

Number 11

06-3096

Number 15

BULK NON-STERILE

NON-STERILE

BOX OF 500

PRODUCT NUMBER

FEATURES

06-3130

Number 10

06-3132

Number 11

06-3134

Number 15

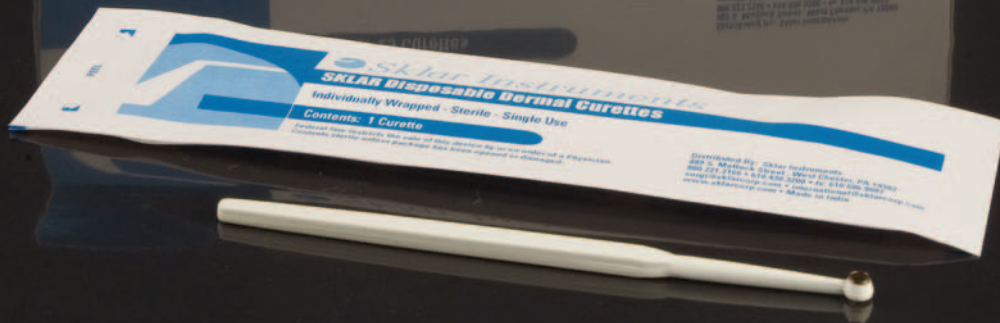
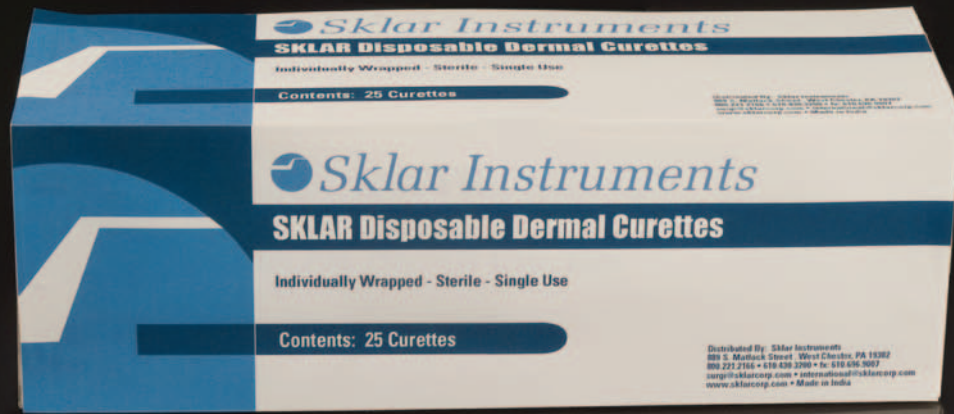

LATEX-FREE

DERMAL CURETTES

STERILE	BOX OF 25
PRODUCT NUMBER	FEATURES
96-1190	2 mm
96-1192	3 mm
96-1194	4 mm
96-1196	5 mm
96-1198	7 mm
96-1199	Multi-pack, 5 each

Individually packed in sterile pouches, disposable.



**SKLAR DISPOSABLE
DERMAL CURETTES
SURGICAL STEEL TIPS**

The surgical grade steel tip is mounted on a sturdy plastic handle and correctly positioned to efficiently affect curettage



YANKAUER SUCTION TIPS

The SKLAR Yankauer is a rigid, curved, one-piece design, made from a blend of clear, blue-tinted, shatterproof plastic. Edges are smooth and clean, with no flash or parting lines. Clear tips permit visual monitoring of suction fluids. A ribbed, universal connector fits securely on all types of tubing. SKLAR Yankauers are available with or without a suction control vent, in two tip styles.

SUCTION CONNECTING TUBE

Choose from several lengths. Durable 5 or 6 mm inner diameter tubing withstands heavy duty suctioning. Each end has two soft female connectors securely fit any male connector.

STERILE	CASE / 50
PRODUCT NUMBER	FEATURE
96-5620	3/16" X 6'
96-5621	3/16" X 10'
96-5622	3/16" X 12'
96-5623	1/4" X 6'
96-5624	1/4" X 10'
96-5625	1/4" X 12'

WWW.SKILARCORP.COM



YANKAUER SUCTION TIPS

NON-STERILE	BOX / 50
PRODUCT NUMBER	FEATURE
96-4171	Vented, Plastic Yankauer Suction Tube
96-4172	Non-Vented, Plastic Yankauer Suction Tube
STERILE	BOX / 10
PRODUCT NUMBER	FEATURE
96-4174	Vented, Econo Sterile Yankauer Suction Tube
96-4175	Non-Vented, Econo Sterile Yankauer Suction Tube





**EAR CURETTES
DISPOSABLE**

STERILE	BOX OF 50
PRODUCT NUMBER	FEATURES
96-1036	Assorted
96-1017	Adult Large
96-1012	Child Medium
96-1002	Cup
96-1007	Loop
96-1022	Pedi Small

www.SKLARCORP.com



**SKLAR
DISPOSABLE EAR CURETTES**



LATEX-FREE





LATEX-FREE

SKLAR TRU-PUNCH DISPOSABLE VULVAR BIOPSY PUNCH

The SKLAR Tru-Punch has a seamless steel tip carefully honed for a razor sharp incision and perfect sample. The ribbed and hollow handle permits tissue to be easily dislodged.

STERILE	BOX / 25	STERILE	BOX / 50
PRODUCT NUMBER	FEATURES	PRODUCT NUMBER	FEATURES
96-0192	1 mm	96-1092	1 mm
96-1097	1.5 mm	96-1098	1.5 mm
96-1140	2 mm	96-1100	2 mm
96-0102	2.5 mm	96-1102	2.5 mm
96-1142	3 mm	96-1105	3 mm
96-1144	3.5 mm	96-1110	3.5 mm
96-1146	4 mm	96-1115	4 mm
96-1148	5 mm	96-1120	5 mm
96-1150	6 mm	96-1125	6 mm
96-1152	8 mm	96-1130	8 mm
96-1160		96-0160	
Assorted - 5 of each: 2, 3, 3.5, 4, & 5mm		Assorted - 5 of each: 2, 3, 3.5, 4, & 5mm	



BLADES & SCALPELS

SCALPELS, DISPOSABLE

STERILE	BOX OF 10
PRODUCT NUMBER	FEATURES
06-3110	#10
06-3111	#11
06-3112	#12
06-3115	#15
06-3120	#20
06-3121	#21
06-3122	#22
06-3123	#23

STAINLESS STEEL SURGICAL BLADES

STERILE	BOX OF 100
PRODUCT NUMBER	FEATURES
06-3100	#10
06-3101	#11
06-3102	#12
06-3103	#15
06-3104	#20
06-3105	#21
06-3107	#23

CARBON STEEL SURGICAL BLADES

STERILE	BOX OF 100
PRODUCT NUMBER	FEATURES
06-3010	#10
06-3011	#11
06-3012	#12
06-3015	#15
06-3020	#20
06-3021	#21
06-3022	#22
06-3023	#23



SPRAGUE RAPPAPORT- TYPE STETHOSCOPES

- MOST POPULAR STYLE OF STETHOSCOPES
- OFFERS UNLIMITED FLEXIBILITY WHILE MAINTAINING OUTSTANDING ACOUSTICAL QUALITIES
- AVAILABLE IN A VARIETY OF POPULAR COLORS
- INCLUDES: FIVE INTERCHANGEABLE CHEST PIECES – THREE BELLS (ADULT, MEDIUM, AND INFANT) AND TWO DIAPHRAGMS (SMALL AND LARGE) FOR A CUSTOM EXAMINATION; PLUS THREE DIFFERENT SIZED EARTIPS
- HEAVY-WALLED 22" VINYL TUBING BLOCKS OUT EXTRANEIOUS SOUNDS

PRODUCT NUMBER	FEATURES
06-2304	Blue
06-1627	Black
06-1625	Gray
06-2315	Burgundy
06-2311	Magenta
06-2312	Teal
06-2313	Purple
06-2316	Blue Glitter
06-2317	Pink Glitter
06-2318	Teal Glitter
06-2319	Purple Glitter
06-2320	Blue Frosted
06-2321	Magenta Frosted
06-2322	Purple Frosted

CALL: 800.221.2166
WWW.SKILARCORP.COM



CARDIOLOGY STETHOSCOPES

- DUAL INNER-SPRING STAINLESS STEEL BINAURAL AND DEEP CONE-SHAPED STAINLESS STEEL BELL OFFER EXCELLENT ACOUSTICAL SENSITIVITY.
- DIAPHRAGM RETAINING RING ENSURES PROPER DIAPHRAGM FIT FOR OPTIMUM SOUND TRANSMISSION.
- LATEX-FREE

PRODUCT NUMBER	FEATURES
06-2303	25" Black
06-1600	25" Gray

STAINLESS STEEL STETHOSCOPES

- UNSURPASSED QUALITY AND VALUE
- FEATURES A DELUXE STAINLESS STEEL CHEST PIECE, 22" TUBING AND A STAINLESS STEEL DUAL INNER-SPRING BINAURAL
- COLOR-COORDINATED ONCHILL RING AND DIAPHRAGM RETAINING RING PROVIDE ADDED PATIENT COMFORT
- LATEX FREE

ADULT

PRODUCT NUMBER	FEATURES
06-2302	30" Blue
06-2300	30" Black
06-1601	30" Gray
06-2301	30" Burgundy

INFANT

PRODUCT NUMBER	FEATURES
06-1603	30" Gray
06-2424	30" Pink
06-2425	30" Light Blue



06-1600



06-1601

06-2425

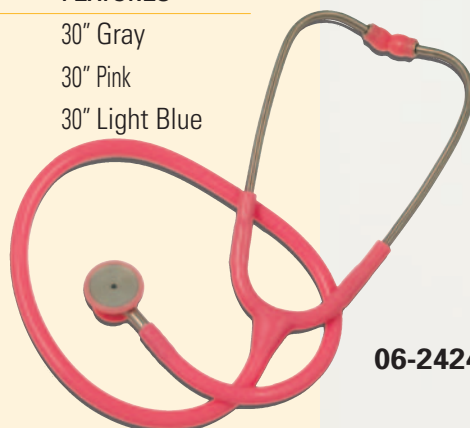

06-2424

STETHOSCOPES PEDIATRIC & NEWBORN

- SPECIFICALLY DESIGNED AND SIZED TO FIT THE NEEDS OF CHILDREN AND NEWBORNS
- FEATURES A UNIQUELY RAISED DIAPHRAGM FOR GREATER SOUND AMPLIFICATION
- LATEX-FREE

NEWBORN (BELL 1 3/16", DIAPHRAGM 1 3/16")

PRODUCT NUMBER	FEATURES
06-1642	31" Gray
06-2426	31" Pink
06-2427	31" Light Blue

PEDIATRIC (BELL 1-3/16", DIAPHRAGM 1-3/4")

PRODUCT NUMBER	FEATURES
06-1640	31" Gray
06-2415	31" Pink
06-2416	31" Light Blue



DUAL HEAD

- IDEAL FOR INTAKE AND GENERAL EXAMINATION
- LATEX-FREE

PRODUCT NUMBER	FEATURES
06-2331	30" Blue
06-1630	30" Black
06-1632	30" Gray
06-2332	30" Burgundy
06-2333	30" Magenta
06-2334	30" Teal
06-2335	30" Purple



06-2427



06-1630



06-1632



STETHOSCOPES

NURSES

- OFFERS AN ECONOMICAL SOLUTION FOR THOSE SITUATIONS THAT REQUIRES A QUALITY LISTENING DEVICE.
- WIDE VARIETY OF COLORS
- LATEX-FREE

PRODUCT NUMBER	FEATURES
06-1004	30" Blue
06-1635	30" Black
06-1638	30" Gray
06-2340	30" Burgundy
06-2341	30" Magenta
06-2342	30" Teal
06-2343	30" Purple



STETHOSCOPES

DISPOSABLE

- DESIGNED FOR SINGLE PATIENT USE TO PREVENT CROSS CONTAMINATION IN INFECTIOUS SITUATIONS
- FEATURES A PLASTIC OR CHROME BINAURAL AND ULTRA SENSITIVE PLASTIC CHEST PIECE
- REMARKABLE ACOUSTIC PERFORMANCE
- 30" Y-TUBING
- LATEX-FREE

PRODUCT NUMBER	FEATURES
06-1201	30" Blue
06-1202	30" Yellow

FETAL

- DESIGNED FOR SUPERIOR SOUND SENSITIVITY
- INCLUDES A CHROME-PLATED BRASS BINAURAL AND VINYL-COATED HEADREST
- 22" Y-TUBING
- LATEX-FREE

PRODUCT NUMBER	FEATURES
06-1662	29" Black

BOWLES

- CHROME-PLATED BRASS BINAURAL
- CHROME-PLATED RAISED METAL STEM CHEST PIECE
- 22" Y-TUBING
- LATEX-FREE

PRODUCT NUMBER	FEATURES
06-1648	30" Black

TEACHING

- SPECIALLY DESIGNED FOR MULTI-FUNCTION TEACHING APPLICATIONS
- INCLUDES A CHROME-PLATED BRASS BINAURAL AND VINYL-COATED HEADREST
- 36" TUBING FOR COMFORTABLE TWO-PERSON USE
- LATEX-FREE

PRODUCT NUMBER	FEATURES
06-1668	36" Black



06-1202



06-1662



06-1648



06-1668



DESK MERCURIAL SPHYGMOMANOMETER

MERCURIAL ACCURACY, PLUS LATEX-FREE SAFETY ALL IN ONE. SKLAR'S LATEX-FREE DESKTOP MERCURIAL SPHYGMOMANOMETER FEATURES MERCURIAL PRECISION, A MERCURY RESERVOIR LOCK TO PREVENT SPILLS DURING TRANSPORTATION AND BOASTS A LATEX-FREE INFLATION SYSTEM MADE FROM THE FINEST NEOPRENE AVAILABLE. THE EASY-TO-READ 300 MMHG SCALE, DELUXE GRAY CALIBRATED NYLON CUFF AND DELUXE AIR RELEASE VALVE ADD TO THIS DURABLE DESK-TOP UNIT.

PRODUCT NUMBER	FEATURES
06-2671	Adult Nylon Cuff

ANEROID SPHYGMOMANOMETERS KITS

INCLUDES: GAUGE, CUFF, BULB, VALVE AND CARRYING CASE

PRODUCT NUMBER	FEATURES
06-2655	Large Adult
06-2654	Adult
06-2656	Child
06-2657	Gauge Only





SKLAR DIGITAL THERMOMETERS

Skларs digital thermometers are water and shatter resistant. Come light-weight with digital read. Measures oral and rectal temperatures, signals with a tone when measurement is complete. Automatic shut-down feature to preserve battery life.

WWW.SKLARCORP.COM

NON-STERILE	CASE/24
PRODUCT NUMBER	FEATURES
96-5380	Automatic Alarm
96-5381	Flexible Tip
96-5382	Water Resistant Flex Tip
96-5383	High Accuracy
96-5384	Water Resistant
96-5385	Sheath, Clear

**NEW!
7-DAY
FORMULA**

Sklar

High Level Disinfecting/Sterilizing Solution

Sklar-Cide™

**NOW AVAILABLE IN
NEW 7-DAY FORMULA**

Item# 10-1621
7 Day Case / 4 Gallons



www.sklarcorp.com



INSTRUMENT CARE AND CLEANING

SKLAR-CIDE™

HIGH LEVEL DISINFECTING / STERILIZING SOLUTION

Sklar-Cide™ provides a safe and efficient means for the high-level disinfection or sterilization of medical, ophthalmic, dental and surgical devices including endoscopes and lensed instruments. It may be used as a standard soak solution or in automatic reprocessing units set at room temperature. Unlike other solutions, there is no need to increase the solution temperature to provide high-level disinfection in 25 minutes.

Sklar-Cide™ is a surfactant-free, activated glutaraldehyde liquid chemical sterilant and high-level disinfectant. Its active ingredient is glutaraldehyde in a nominal concentration of 3%. When the powered activator is added, the solution turns green in color to indicate its readiness for use. In addition to the active ingredient, this ready-to-use solution contains buffers, wetting agents, and a rust and corrosion inhibitor and it has a pleasant fragrance.

Sklar-Cide™ produces high-level disinfection at room temperature in as little time as 25 minutes, and complete sterilization in 10 hours at room temperature.

CASE / 4

PRODUCT NUMBER	FEATURES
10-1623	28HLD 1 Gallon Bottles
10-1622	14HLD 1 Gallon Bottles

GLUTARALDEHYDE STRIPS

CASE / 2

PRODUCT NUMBER	FEATURES
96-4105	2.1% MEC



**INSTRUMENT CARE
AND CLEANING**

**SKLAR
DISINFECTANT™**

**READY-TO-USE
SPRAY SURFACE
DISINFECTANT**

3 Minute Kill Time!

- Ready to use, non-toxic formula
- Specially formulated for the control of cross contamination
- Effective against C. Diff, TB, HBV, HCV, Hydrophilic and Lipophilic viruses including HIV-1 (AIDS Virus), bacteria and fungi on inanimate objects.
- Safe for all areas of the facility including the NICU, operating rooms, isolation rooms, patient care areas and laboratories
- Satisfies OSHA's Bloodborne Pathogen Standards
- Non-irritating formula
- EPA registered

CASE / 6

PRODUCT NUMBER	FEATURES
10-1643	24 oz. Spray Bottles

CASE / 4

PRODUCT NUMBER	FEATURES
10-1653	1 Gallon Bottles



NEW



READY-TO-USE

CASE / 6

PRODUCT NUMBER	FEATURES
10-1616	100 Wipes

CASE / 12

PRODUCT NUMBER	FEATURES
10-1617	100 Wipes

**SKLAR DISINFECTANT™
SURFACE WIPES**

- BACTERICIDAL
- VIRUCIDAL
- FUNGICIDAL
- DISINFECTANT / CLEANER





CASE / 12

PRODUCT NUMBER	FEATURES
10-2722	22 oz. Refillable Spray Bottles

CASE / 4

PRODUCT NUMBER	FEATURES
10-2724	1 Gallon Bottles

BOX OF 32

PRODUCT NUMBER	FEATURES
10-2774	1/2 oz. Pouches

SKLAR SPRAY-ZYME™ MULTI-ENZYME BASED INSTRUMENT PRESOAK & CLEANER

The newest product from Sklar for expert care of your surgical instruments. This multi-enzymatic spray creates a heavy foam which lasts for hours, keeping soiled instruments moist to avoid encrustation while also pre-cleaning prior to processing.

SKLAR-ZYME™ POUCHES

CONVENIENT VALUE

Each pouch of SKLAR-ZYME produces one gallon of enzymatic detergent. This convenient, easy to use product guarantees very little waste and is ideal for the office or smaller surgical setting.



SKLAR SOAK

- Non-Glutaraldehyde
- PH Neutral Formula Designed for Safe Use on all Surgical Instruments and Stainless Steel

Immersing soiled instruments in SKLAR SOAK for three minutes substantially reduces the risk of exposure to many infectious organisms including TB and such viruses as HIV-1 (AIDS) as well as C. Diff bacteria and fungi.

If full immersion is not possible then cover soiled instruments with SKLAR SPRAY ZYME enzymatic foam to prevent harmful encrustation while also precleaning.

- Non-Caustic Formula allows for use as a manual cleaner or in ultrasonic units.
- Effective Against: C. Diff, TB, HBV, HIV-(AIDS), virus (hydrophilic and Lipophilic), cc bacteria (including MRSA and VRE), and fungi.
- EPA Registered
- Meets all OSHA standards on blood borne pathogen destruction
- Ready to use

CASE / 4

PRODUCT NUMBER	FEATURES
10-1603	1 Gallon Bottles





SKLAR INSTRU-GUARD™ ONE STEP

A "ONE STEP"
INSTRUMENT CLEANER
AND LUBRICANT

Extends Instrument Life

SKLAR INSTRU-GUARD contains a penetrating lubricant that protects and helps extend the life of surgical instruments. The detergents and emulsifiers quickly break up and remove organic soils from box locks and other hard to reach places.

SKLAR INSTRU-GUARD contains four rust inhibitors to control corrosion and eliminate scaling and spotting. It does not contain phosphates and can reduce the time and cost involved in processing your instruments by cleaning and lubricating in one easy step.

CASE / 4

PRODUCT NUMBER	FEATURES
10-2800	1 Gallon Bottles

SINGLE

PRODUCT NUMBER	FEATURES
10-2801	1 Gallon Bottle



**SKLAR
INSTRU-GUARD
LUBE™**

**SURGICAL INSTRUMENT
LUBRICANT / RUST
INHIBITOR**

- Increase the Life of Instruments
- Protects all Surgical Instruments

SKLAR INSTRU-GUARD LUBE is an easy-to-use, water soluble, non-silicone lubricant and rust inhibitor. When used daily as a rinse after every cleaning it keeps moving parts operating smoothly and remains effective after autoclaving, but without leaving an oily residue.

Regular lubrication is essential no matter which cleaning method is employed (including ultrasonic). SKLAR INSTRU-GUARD LUBE is ideal for maintaining instrument quality and performance

CASE / 4

PRODUCT NUMBER	FEATURES
10-1635	1 Gallon Bottles Concentrated

CASE / 12

PRODUCT NUMBER	FEATURES
10-1636	8 oz Spray Bottles





SKLAR KLEEN™ LOW FOAM

SKLAR KLEEN™ LF (Low Foam) is an especially effective and economical liquid cleaner for surgical instruments and laboratory glassware. SKLAR KLEEN™ LF maintains a low foam to ensure efficient and trouble free action in washer/sterilizers and tunnel washers. The low, non-aggressive pH (7.5 ± 0.5) is non-corrosive to surgical instrumentation and will not etch glassware. SKLAR KLEEN™ LF is formulated to disperse quickly and is well suited for automatic injection systems. SKLAR KLEEN™ LF is concentrated in order to provide a very cost-effective solution.

CASE / 4

PRODUCT NUMBER	FEATURES
10-2701	1 Gallon Bottles



SKLAR KLEEN™ LIQUID DETERGENT REGULAR FORMULA FOR MANUAL AND ULTRASONIC CLEANING

SKLAR KLEEN™ LIQUID is non-corrosive, non aggressive, phosphate free and biodegradable. We have specifically developed SKLAR KLEEN™ LIQUID for manual and ultrasonic cleaning. It is moderately alkaline, affording optimum cleaning without etching glassware or attacking instrument metal.

CASE / 4

PRODUCT NUMBER	FEATURES
10-1613	1 Gallon Bottles

CASE / 6

PRODUCT NUMBER	FEATURES
10-1612	8 oz Container

PRODUCT NUMBER	FEATURES
10-1607	5 lb. Container

CASE / 4

PRODUCT NUMBER	FEATURES
10-1608	5 lb. Container, Powder

CASE / 6

PRODUCT NUMBER	FEATURES
10-1630	3-1/2 lb. New Pitcher Design Power





SKLAR ENZYMATIC™ DETERGENT

MULTI-ENZYME DETERGENT CONCENTRATE

100% Biodegradable

SKLAR ENZYMATIC DETERGENT is a low-foaming, fast acting detergent specifically designed for use when instruments and/or cloth materials become soiled with organic debris.

SKLAR ENZYMATIC DETERGENT may be used as a manual instrument cleaner as well as a pre-soak for blood-contaminated linens, clothing and instruments. It is also used in ultrasonic units and in washer/sterilizer/decontaminators. When used as directed, the enzymatic pH neutral formula is safe for use on rubber, plastic, stainless steel instruments, and surgical equipment as well as cloth.

CASE / 4

PRODUCT NUMBER	FEATURES
10-2777	1 Gallon Bottles



AS EASY AS 1 DECONTAMINATION 2 CLEANING 3 LUBRICATION!

STEP ONE - DECONTAMINATION



SKLAR SPRAY DISINFECTANT™

DISINFECTANT/DECONTAMINANT CLEANER WITH A 3 MINUTE KILL TIME!

SKLAR DISINFECTANT™ is a pre-cleaner and disinfectant for the safe decontamination of soiled surgical instruments, medical and surgical equipment, and inanimate surfaces including plastics, stainless steel, chrome, glass, Plexiglass® and baked on painted surfaces. The use of Sklar Disinfectant™ for 3 minutes kills infectious organisms including Hepatitis B Virus, Hepatitis C Virus, TB, HIV-1 (AIDS), Herpes Simplex Virus 1 and 2 and Polio.

STEP TWO - CLEANING

SKLAR KLEEN DETERGENTS AND ENZYMATICS

Sklar has an array of agents for effectively cleaning not only your surgical instruments, but for other metals, glassware, plastic, and rubber. SKLAR KLEEN detergent is available as a powder or liquid. Our ENZYMATIC products, specially formulated for processing instruments heavily laden with organic debris, are concentrated and available in a variety of sizes. Sklar also offers SPRAY-ZYME a new foam spray pre-cleaner.



CHOOSE THE CLEANING PRODUCT RIGHT FOR YOU!

STEP THREE - LUBRICATION

SKLAR LUBRICANT AND SPRAY LUBE

SKLAR LUBE should be a part of your instrument processing regimen to guarantee extending the life and performance of this very important investment. Sklar offers several different types of lubricant to suit your needs. All designed specifically for surgical instruments, they each contain rust inhibitors to protect against corrosion, rusting, and staining.



**YOUR INSTRUMENTS
WILL LOOK AND
WORK LIKE NEW!**



YOUR FINAL STEP IS
AUTOCLAVE **STERILIZATION**

SKLAR POLISH™

INSTRUMENT STAIN REMOVER

Non-Abrasive

SKLAR POLISH is an efficient stain remover for use on all of your metal surgical instruments, including stainless steel, chrome and brass. It will brighten instrument trays, basins and racks and may also be used on porcelain and tile surfaces.



CASE / 6

PRODUCT NUMBER	FEATURES
10-1629	8 oz. Jars

SKLAR FRESH™

ODOR ABSORBER

Liquid Spray

SKLAR FRESH™ is an environmentally friendly blend of pure biodegradable organic essential oils and trace elements. It is a non-allergic liquid spray that neutralizes odors at their source. Simply spray SKLAR FRESH™ directly in the air or on the source. (i.e. bathrooms, refuse, soiled items from vomitus, incontinence odors, etc.)

CASE / 12

PRODUCT NUMBER	FEATURES
10-2842	22 oz. Spray Bottles

SKLAR

SANITIZING GEL™

CASE / 12

PRODUCT NUMBER	FEATURES
10-2850	8 oz. Pump





TROUBLE SHOOTING

CORROSION

- Problem:** Debris and residue in box locks, serrations and ratchets.
- Solution:** Serrations, box locks and ratchets should be carefully cleaned and rinsed. A soft bristle brush is effective in these difficult areas.
- Problem:** Moisture remaining on the instruments within the sterile wrapped packs; excessive moisture in autoclave during sterilization and termination of cycle.
- Solution:** Preheat autoclave, drying time cannot be accelerated, open autoclave door slightly. Routinely inspect valves. Malfunctioning valves can precipitate corrosion.
- Problem:** Some local water supplies contain excessive quantities of alkali. This can manifest itself by depositing corrosive matter on the instruments.
- Solution:** It is generally accepted that cold distilled or demineralized water be used during sterilization. An alternative is to use the local water supply, while instituting a program of preventive maintenance. Carefully clean surfaces with SKLAR KLEEN™, using SKLAR POLISH™ to remove difficult stains and SKLAR LUBE™ for proper lubrication.

PITTING

- Problem:** Instruments are inevitably exposed to chemical compounds that initiate pitting. The most common are saline solutions and blood.
- Solution:** It is essential that instruments be rinsed with distilled or demineralized water and then cleaned routinely.
- Problem:** Some Non-Sklar detergents contain a chloride or have an acid base. If rinsing is not thorough, the residual detergent can precipitate pitting. Hydrochloric acid can be formed by the combination of chloride in the cleaner and steam, causing the instrument to pit.
- Solution:** Evaluate detergents without a chloride base. SKLAR KLEEN™ is recommended.
- Problem:** Instruments may be pitted when the detergent used has an excessively high PH. If instruments are not rinsed thoroughly, and then autoclaved, the heat increases the effect of the solution on the instruments.
- Solution:** Use only detergents specifically developed for instrument cleaning. Sklar Kleen™ products are pH balanced.

BROWNISH STAIN

- Problem:** This stain is more obvious on dull finish instruments. Most likely, it is a deposit of chromium oxide. The thin hard layer protects stainless steel from corrosion precipitated by the atmosphere. The brownish film (sometimes dull blue) occurs naturally when stainless is heated. Occasionally this stain can be traced to the sterilizer. Improper cleaning compounds could contain polyphosphates that cause the copper components in the sterilizer to be deposited by electrolytic action on the stainless steel instruments.
- Solution:** Water supply to autoclave should be cold and demineralized. Use the correct amount of SKLAR KLEEN™ as recommended for best results.

BLUISH GRAY STAINS

- Problem:** Cold sterilizing solutions.
- Solution:** In the preparation of the solution make certain the manufacturer's directions are followed accurately. To minimize discoloration use distilled water and add a rust inhibitor. Using the solution beyond recommended time limitations will cause the solution to become corrosive.



TROUBLE SHOOTING

No Steel is Truly “Stainless”

It's a fact that so-called stainless steel is subject to both water-spotting and staining. However what many people identify as a “rust” problem usually turns out to be something else.

Most often the problem is actually a stain caused by a surface deposit. These deposits appear in a variety of colors depending upon the type of deposit involved. Once the cause is found and eliminated, most of the time the problem quickly diminishes or disappears completely.

As you probably know, stainless steel is ideally suited for the surgical suite because it is rust resistant, it can be honed to an extremely sharp edge or fine point, and it can be hardened to maintain the delicate, yet precise, requirements of the surgeon. But it is this hardenable quality – the amount of carbon used during the manufacturing process – coupled with harsh chemicals and improper care that renders stainless steel susceptible to corrosion.

Sklar's products are specially formulated to provide cost effective instrument care

RUST DEPOSIT

Problem: Sterilizing instruments of different metals in the same cycle will cause rusting. An electrolytic action carries the carbon particles from the exposed metal and deposits them on the stainless steel instruments.

The rapid oxidation of molecules results in a surface film of rust.

Solution: The ideal technique would be to sterilize the two types of instruments separately. It is recommended that chrome plated instruments that indicate signs of peeling or flaking be replaced with stainless steel instruments.

Problem: The rust film on the surface of stainless steel instruments can be caused by chemicals in the detergent. Excess amounts of iron or other minerals from the local water supply may cause the rust deposits.

Solution: It is recommended that instruments be rinsed with distilled or demineralized water. Surface rust can be removed by light buffing or an application of SKLAR POLISH™.

LIGHT AND DARK COLORED SPOTS

Problem: Spotting caused by slow evaporation of water drops identified with the mineral content of the water.

Solution: Eliminate water droplets by adhering to autoclave manufacturer's operating instructions. Autoclave door should not be opened until steam has been completely vented.

SKLAR INSTRUMENT CARE KIT

A TRIO OF SKLAR'S CARE AND CLEANING PRODUCTS TO KEEP INSTRUMENTS IN TIPTOP SHAPE.

EACH KIT INCLUDES:

- 1 SKLAR SPRAY LUBE, 8 OZ.
- 1 SKLAR KLEEN, 8 OZ.
- 1 SKLAR POLISH, 8 OZ.
- 1 NYLON BRISTLE CLEANING BRUSH
- 1 STAINLESS STEEL BRISTLE CLEANING BRUSH

PRODUCT NUMBER: 10-1625





BRUSHES

TRACHEAL TUBE BRUSHES

NON-STERILE CASE / 50

PRODUCT NUMBER FEATURES/QUANTITIES

78-2821 Small, 6" x 1/2" Dia. Pk / 6

78-2822 Medium, 7" x 5/8" Dia. Pk / 6

78-2823 Large, 7-1/2" x 3/4" Dia. Pk / 6

78-2813 Multi-Pack Pk / 3

INSTRUMENT CLEANING

BRUSHES

NON-STERILE CASE / 50

PRODUCT NUMBER FEATURES/QUANTITIES

10-1650 St Stainless Steel Bristles Pk / 3

10-1651 Nylon Bristles Pk / 3

10-1652 Stainless Steel Bristles Pk / 12

10-1657 Nylon Bristles, Pk / 12

10-1658 Stainless Steel Bristles Pk / 24

10-1659 Nylon Bristles, Pk / 24

DISPOSABLE

10-1645 Nylon Bristles, Pk / 12

10-1648 Nylon Bristles, Pk / 24

DOUBLE-END INSTRUMENT
CLEANING BRUSHES

10-1444 Nylon Bristles, Pk / 3



BRUSHES

CANNULA INSTRUMENT CLEANING BRUSHES PACKS OF 3

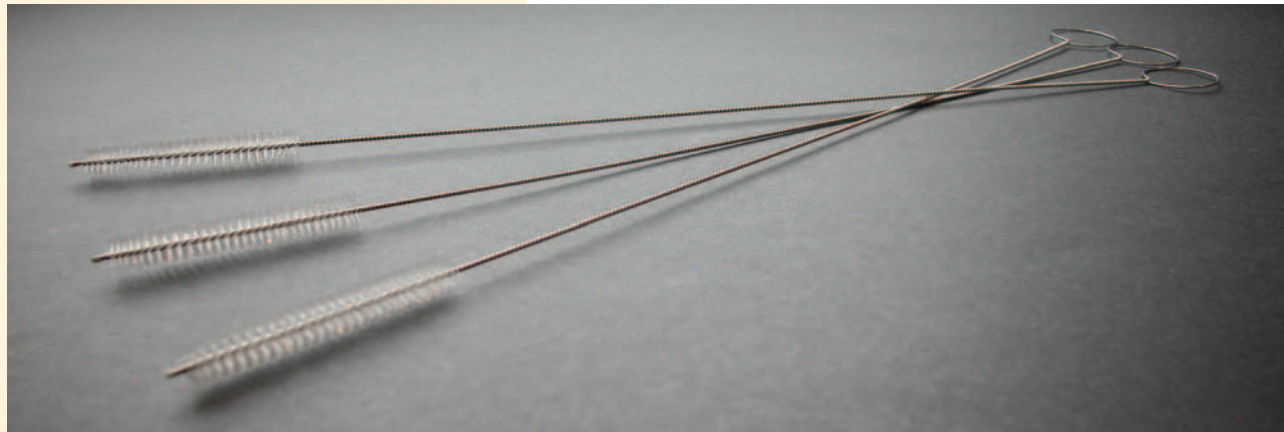

CLEANING BRUSHES



PACKS OF 3

Double Tapered

10-1384 6" Length

10-1388 8" Length

CANNULA INSTRUMENT CLEANING BRUSHES PACKS OF 3

PRODUCT NUMBER	FEATURES
10-1350	12" Length, 2mm Diameter
10-1660	12" Length, 3mm Diameter
10-1352	12" Length, 4mm Diameter
10-1354	12" Length, 5mm Diameter
10-1356	12" Length, 6mm Diameter
10-1664	15" Length, 9mm Diameter
10-1668	15" Length, 25mm Diameter
10-1362	18" Length, 5mm Diameter
10-1364	18" Length, 10mm Diameter
10-1366	18" Length, 15mm Diameter
78-2824	19" Length, 3mm Diameter
10-1370	24" Length, 2.5mm Diameter
10-1372	24" Length, 5mm Diameter
10-1374	24" Length, 7mm Diameter,
10-1376	24" Length, 10mm Diameter

** Medical Nylon Bristles And Stainless Steel Wire Brushes Are Reusable.*

BRUSHES

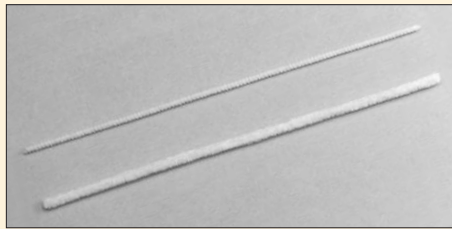
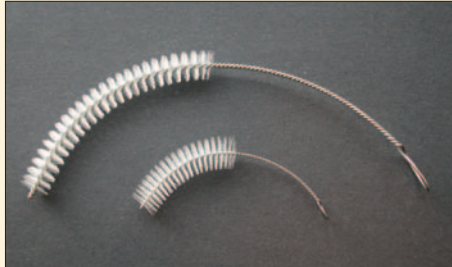

TRACHEOSTOMY TUBE CLEANING BRUSHES

PRODUCT NUMBER	FEATURES	QUANTITIES
78-2831	Large 8" for Trach Tube sizes 6-12 3-3/4" x 1/2" Bristle Dimension	Pack of 3

CANNULA INSTRUMENT (PIPE) CLEANERS

PRODUCT NUMBER	FEATURES	QUANTITIES
10-1470	12" Length 1/8" Diameter	Pack of 3
10-1472	12" Length 1/4" Diameter	Pack of 3

INSTRUMENT SPOT REMOVER PAD

Use for OR Grade Finish (Satin) Instruments

PRODUCT NUMBER	FEATURES	QUANTITIES
10-1415	6" x 9"	Pack of 10
10-1414	6" x 9"	1 Each

BRUSHES

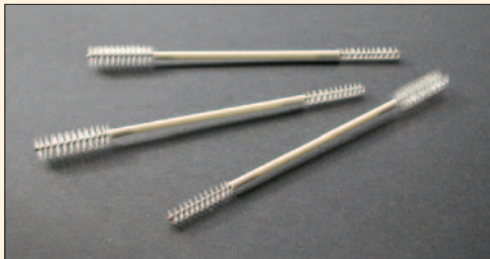
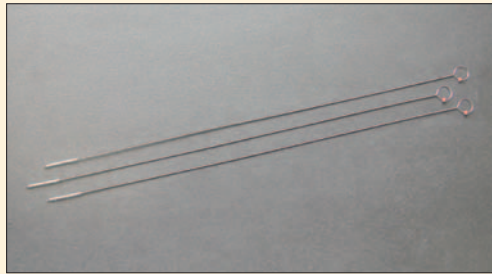

**SUCTION TUBE CLEANING
 BRUSHES (BARON & FRAZIER)**

PRODUCT NUMBER	FEATURES	QUANTITIES
10-1396	1.6mm, 6"	Pack of 3
10-1400	2mm, 8"	Pack of 3
10-1401	2.3mm, 8"	Pack of 3
10-1402	2.6mm, 8"	Pack of 3
10-1403	3mm, 8"	Pack of 3
10-1404	3.3mm, 8"	Pack of 3
10-1405	3.6mm, 8"	Pack of 3
10-1406	4mm, 8"	Pack of 3

DOUBLE END VALVE BRUSHES

PRODUCT NUMBER	FEATURES	QUANTITIES
10-1398	5-3/4" Length 9mm and 5mm Diameter Tips	Pack of 3

**BRUSH DRYING RACK &
 BRUSH HOLDER**

PRODUCT NUMBER	FEATURES	QUANTITIES
10-1399	Brush Rack	1 Each
10-1545	Brush Holder	1 Each

BRUSHES



MEDICAL SURFACE CLEANING BRUSH*

USE ON SINKS, AUTOCLAVES, ULTRASONIC CLEANERS, BOWLS, BASINS, ETC.

10-1418 Pack / 3

3" wide x 3-1/4" long brush head. 4-1/2" plastic handle, white medical grade nylon bristles are 2" long

*Sklar has modeled this product on the Food and Drug Administration HACCP program for prevention of cross contamination in food borne illness.



LARGE INSTRUMENT CLEANING BRUSH*

USE ON RETRACTORS, SPECULA, ETC.

1" wide x 5" long brush head. 5" plastic handle. White medical-grade nylon bristles are 1" long

10-1420 Pack / 3



AUTOCLAVE CLEANING BRUSH

USE ON AUTOCLAVE CHAMBERS AND DOORS, SINKS, CARTS, ETC.

3" wide x 3-1/4" long brush head. 16" plastic handle. White medical grade nylon bristles are 2" long

10-1422 Pack / 3



AUTOCLAVE CLEANING BRUSH KIT

- (1) telescopic handle extends from 24" to 48"
- (1) large cleaning brush 5-1/2" wide x 7-1/2" long with round corner bristles.
- (1) hand brush, 4-1/2" handle

10-1424 1 Each

DENTURE CUP

NON-STERILE	CASE / 25
PRODUCT NUMBER	FEATURES
96-8955	With Screw Lid
96-8956	With Out / Lid
08-1009	With Lid, 8 oz.

MEDICINE CUP

NON-STERILE	CASE / 50
PRODUCT NUMBER	FEATURES
96-7027	2 oz.
NON-STERILE	CASE/25
PRODUCT NUMBER	FEATURES
96-7154	4 oz.
96-8951	10 oz.

SPECIMEN CUP

NON-STERILE	CASE / 250
PRODUCT NUMBER	FEATURES
08-1003	8 oz.
NON-STERILE	CASE / 25
PRODUCT NUMBER	FEATURES
96-8952	With Screw Lid
96-8953	With Out Lid
96-7646	With Out Lid, 8 oz.

LATEX-FREE

www.SKLARCORP.com





PITCHERS

NON-STERILE CASE/50

PRODUCT NUMBER FEATURES
96-7268 Open Handle, 12 mL
08-1020 With Attached Cover



SPECIMEN TUBE

NON-STERILE CASE/150

PRODUCT NUMBER FEATURES
96-7459 50 Pks / 3



LATEX-FREE

CALL: 800.221.2166



BOWLS

Multi-purpose utility bowls are available in four convenient sizes. Made from durable, heavy-weight polypropylene.

NON-STERILE
CASE/25/10//20/5

PRODUCT NUMBER	FEATURES
96-7028	8 oz.
96-7020	16 oz.
96-7174	32 oz.
96-7451	48 oz.

Also, available in bulk non-sterile.



EMESIS BASIN

Calibrated for easy measuring.

NON-STERILE CASE/250

PRODUCT NUMBER	FEATURES
96-7543	700 cc
08-1017	700 cc Pink
08-1018	500 cc Pink



ROUND BASIN

NON-STERILE CASE/50

PRODUCT NUMBER	FEATURES
96-1679	7 Quart
08-1011	5 Quart Pink

RECTANGULAR BASIN

NON-STERILE CASE/50

PRODUCT NUMBER	FEATURES
08-1012	6 Quart Pink



LATEX-FREE



TRAYS

NON-STERILE	CASE / 25
PRODUCT NUMBER	FEATURES
96-7024	1/2" Deep
96-7033	1/2" Shallow
96-7177	2-Compartment
96-7178	3-Compartment
96-7175	Full Deep
96-7025	Small Shallow Prep

GUIDEWIRE BOWLS

Made from durable, heavy-weight polypropylene. Built-in lip and recessed bottom to hold guidewire in place and allow for easy removal.

NON-STERILE	CASE / 10
PRODUCT NUMBER	
96-1630	

BED PANS

NON-STERILE	CASE / 50
PRODUCT NUMBER	FEATURES
08-1013	Pontoon
08-1014	Stackable
08-1015	Stackable, Heavy Duty C/25
08-1016	With Handle / Female

SOAP DISH

NON-STERILE	CASE / 1000
PRODUCT NUMBER	FEATURES
08-1019	3-1/2" x 2-1/4"



LATEX-FREE



SKLARTITE™ Sterilization Container System

SKLARTITE™ SEALED CONTAINERS

Extra Small	8" W x 11" L	Medium	12" W x 17" L
10-1217	4" Height	10-1226	4" Height
10-1218	5" Height	10-1227	5" Height
10-1219	6" Height	10-1228	6" Height
Small	12" W x 12" L	10-1229	7" Height
10-1220	4" Height	Large	12" W x 23" L
10-1221	5" Height	10-1232	4" Height
10-1222	6" Height	10-1233	5" Height
10-1223	7" Height	10-1234	6" Height
		10-1235	7" Height

SKLARTITE™ BASKETS

Extra Small	8" W x 11" L	Medium	11" W x 16" L
10-1212	3" Height	10-1250	3" Height
Small	11" W x 11" L	10-1252	4" Height
10-1242	3" Height	10-1253	5" Height
10-1244	4" Height	Large	11" W x 22" L
		10-1260	4" Height
		10-1262	5" Height

FOAM INSERTS (DISPOSABLE)

Blue, Pack of 75

10-1205 3/8" x 20" x 10-1/2"

REPLACEMENT FILTERS (DISPOSABLE)

1000 Per Case

10-1278 7-3/4" x 7-1/2"

10-1283 9-1/2" x 9-1/2"

SILICONE MATS

1000 Per Case

10-1282 Extra Small 7-1/4" x 10-3/4"

10-1284 Sm all 11" x 11"

10-1286 Medium 11" x 16"

10-1288 Large 11" x 22"



STAINLESS STEELWARE

IODINE CUP

10-1670	6 oz.	3 7/16" x 2"	10-1670-12 - Pk/12 10-1670-48 - Pk/48
10-1671	14 oz.	4 3/8" x 2 5/8"	10-1671-12 - Pk/12 10-1671-48 - Pk/48

MEDICINE CUP

Graduated Measure

10-1675	2 oz.	10-1675-12 - Pk/12 10-1675-48 - Pk/48
----------------	-------	--

Graduated, Plastic Autoclavable

10-1585	2 oz.	10-1585-12 - Pk/12 10-1585-48 - Pk/48
----------------	-------	--

TUMBLER

10-1536	7 oz.	2 7/8" x 3 1/8"	10-1536-12 - Pk/12
----------------	-------	-----------------	---------------------------

PITCHER / BEAKER

10-1172	125 ml	2 1/8" x 2 5/8"
10-1173	250 ml	2 5/8" x 3 1/4"
10-1174	600 ml	3 3/8" x 4 5/8"
10-1176	2000 ml	4 7/8" x 7 1/8"
10-1177	3000 ml	5 1/2" x 8 1/4"
10-1178	4000 ml	6 1/8" x 8 7/8"

With Closed Handle

10-1180	3000 ml	6 1/16" x 7"	
10-1181	4000 ml	6 7/8" x 8 7/8"	
10-1539	2000 ml	5 1/16" x 6 5/8"	10-1539-12 - Pk/12



STAINLESS STEELWARE

GRADUATED MEASURE

Stainless Steel

10-1552	16 oz.	3 3/4" x 4 5/8"	10-1552-12 - Pk/12
10-1510	32 oz.	4 3/4" x 5 1/4"	10-1510-12 - Pk/12
10-1674	64 oz.	5 1/2" x 6 1/2"	10-1674-12 - Pk/12



MIXING / SOLUTION BOWLS

10-1488	7/8 qt.	6 5/8" x 2 1/2"	10-1488-12 - Pk/12
10-1491	1 5/8 qt.	8 1/8" x 3"	10-1491-12 - Pk/12
10-1492	3 qt.	9 3/4" x 4"	10-1492-12 - Pk/12
10-1493	5 qt.	11 7/8" x 4 1/2"	10-1493-12 - Pk/12
10-1494	6 3/4 qt.	12 3/4" x 5 1/4"	
10-1495	8 qt.	13 5/16" x 5 7/16"	



SPONGE BOWLS

10-1496	12 oz.	4 1/2" x 2"	10-1496-12 - Pk/12
10-1498	22 oz.	5" x 2 3/8"	10-1498-12 - Pk/12
10-1484	29 oz.	5 9/16" x 2 9/16"	10-1484-12 - Pk/12
10-1485	36 oz.	6 1/4" x 2 3/4"	10-1485-12 - Pk/12
10-1483	48 oz.	7 1/8" x 2 3/4"	10-1483-12 - Pk/12
10-1486	64 oz.	7 9/16" x 3"	10-1486-12 - Pk/12



SOLUTION BASINS

10-1489	4 1/2 qt.	12" x 4 1/2"	10-1489-12 - Pk/12
10-1490	6 qt.	12 3/4" x 4 1/2"	10-1490-12 - Pk/12
10-1505	7 qt.	13 5/8" x 4 5/8"	10-1505-12 - Pk/12
10-1507	9 1/2 qt.	14 1/2" x 5"	10-1507-12 - Pk/12



STAINLESS STEELWARE

EMESIS BASINS

10-1497	10 oz.	6 5/8" x 3 1/2" x 1 1/2"	10-1497-12 - Pk/12
10-1698	12 oz.	8 1/8" x 3 5/8" x 1 5/8"	10-1698-12 - Pk/12
10-1699	26 oz.	9 7/8" x 4 1/2" x 2 1/8"	10-1699-12 - Pk/12
10-1487	48 oz.	12 1/8" x 5 3/4" x 2 1/4"	



HOSPITAL KICK BUCKET

With Lid and Roll Stand

10-1551 | 13 qt. | 11 5/8" x 9 1/4"

HOSPITAL BUCKET

With Lid

10-1450 | 13 qt. | 11 5/8" x 9 1/4"

10-1451 | 16 qt. | 11 3/4" x 10 1/8"

Without Lid

10-1182 | 13 qt. | 11 5/8" x 9 1/4"

10-1183 | 16 qt. | 11 3/4" x 10 1/8"

10-1184 | 20 qt. | 13 3/4" x 11 3/16"



STORAGE CONTAINERS

With Lid

10-1186 | 3 gal. | 10 3/16" x 9"

10-1188 | 4 gal. | 13" x 9"

10-1189 | 5 gal. | 13" x 11"

10-1190 | 6 gal. | 13" x 13"



STAINLESS STEELWARE

LAB / UTILITY SCOOPS

10-1192	5" x 2 1/2"
10-1193	5" x 7 1/2"



FUNNELS

With Hanging Hook

10-1157	2 3/8 oz.	3" x 3 3/4"
10-1158	6 3/8 oz.	4 1/8" x 4 7/8"
10-1159	13 oz.	5 1/8" x 5 5/8"
10-1160	22 1/4 oz.	6 1/4" x 6 5/8"
10-1170	32 oz.	7" x 8 3/8"
10-1171	64 oz.	8 3/8" x 9 1/2"

MAYO TRAYS

Non-Perforated

10-1690	10" x 6 1/2" x 3/4"	10-1690-12 - Pk/12
10-1691	13 11/16" x 9 13/16" x 3/4"	10-1691-12 - Pk/12
10-1692	15 1/8" x 10 5/8" x 3/4"	10-1692-12 - Pk/12
10-1693	17" x 10 5/8" x 3/4"	10-1693-12 - Pk/12
10-1694	19 1/8" x 12 5/8" x 3/4"	10-1694-12 - Pk/12
10-1695	21 1/4" x 16 1/4" x 7/8"	10-1695-12 - Pk/12

Perforated

10-1684	10" x 6 1/2" x 3/4"	10-1684-12 - Pk/12
10-1685	13 3/4" x 9 3/4" x 3/4"	10-1685-12 - Pk/12
10-1686	15 1/8" x 10 5/8" x 3/4"	10-1686-12 - Pk/12
10-1687	17" x 11 5/8" x 3/4"	10-1687-12 - Pk/12
10-1688	19 1/8" x 12 5/8" x 3/4"	10-1688-12 - Pk/12



STAINLESS STEELWARE

INSTRUMENT TRAYS

WITH ROLLED BEAD EDGE

10-1532	25" x 15" x 7/8"	
10-1876	10" x 6 1/2" x 3/4"	10-1876-12 - Pk/12
10-1883	13 11/16" x 9 13/16" x 3/4"	10-1883-12 - Pk/12
10-1884	15 1/8" x 10 5/8" x 3/4"	10-1884-12 - Pk/12
10-1683	17" x 11 5/8" x 3/4"	10-1683-12 - Pk/12
10-1888	19 1/8" x 12 5/8" x 3/4"	10-1888-12 - Pk/12
10-1680	21 1/4" x 16 1/4" x 7/8"	10-1680-12 - Pk/12

PERFORATED

10-1758	12 3/4" x 10 3/8" x 2 1/2"	
10-1757	12 3/4" x 10 3/8" x 1 1/4"	
10-1759	20 3/4" x 12 3/4" x 2 1/2"	
10-1941	20 3/4" x 12 3/4" x 1 1/4"	
10-1942	20 3/4" x 12 3/4" x 6"	

SOLID

10-1850	12 3/4" x 10 1/2" x 2 1/2"	
10-1860	12 3/4" x 10 1/2" x 4"	
10-1877	12 1/4" x 7 3/4" x 2 1/4"	10-1877-12 - Pk/12
10-1744	12 3/4" x 6 7/8" x 2 1/2"	10-1744-12 - Pk/12

PERFORATED

10-1852	12 3/4" x 10 1/2" x 2 1/2"	
10-1862	12 3/4" x 10 1/2" x 4"	
10-1864	Cover For Above Trays	
10-1878	Cover For 10-1877	10-1878-12 - Pk/12
10-1724	Cover For 10-1744	10-1724-12 - Pk/12

10-1748	16 1/2" x 10" x 2 1/2"	10-1748-12 - Pk/12
10-1756	Cover For 10-1748	10-1756-12 - Pk/12
10-1753	13 7/8" x 12 7/8" x 2 1/2"	10-1753-12 - Pk/12
10-1754	Cover For 10-1753	10-1754-12 - Pk/12
10-1755	6 7/8" x 4 1/4" x 2"	10-1755-12 - Pk/12
10-1737	Cover For 10-1755	10-1737-12 - Pk/12

10-1742	10 3/8" x 6 3/8" x 2 1/2"	10-1742-12 - Pk/12
10-1542	Cover For 10-1742	10-1542-12 - Pk/12
10-1950	12 3/4" x 10 3/8" x 2 1/2"	10-1950-12 - Pk/12
10-1952	12 3/4" x 10 3/8" x 4"	10-1952-12 - Pk/12
10-1882	Cover For 10-1950 & 10-1952	10-1882-12 - Pk/12

10-1870	12 3/4" x 10 1/2" x 6"	10-1870-6 - Pk/6
10-1746	12 3/4" x 10 3/8" x 2 1/2"	10-1746-6 - Pk/6
10-1747	12 3/4" x 10 3/8" x 4"	10-1747-6 - Pk/6
Cover For 10-1746 & 10-1747		
10-1882		10-1882-6 - Pk/6



STAINLESS STEELWARE

HIGH-SIDED INSTRUMENT TRAYS

PERFORATED

10-1879	12 1/4" x 7 3/4" x 2 1/4"
10-1892	12" x 7 3/4" x 2"
10-1874	10" x 6 1/2" x 2"
10-1943	12 3/4" x 10 3/8" x 4"

CATHETER INSTRUMENT TRAYS

10-1738	8 7/8" x 5" x 2"	10-1738-12 - Pk/12
10-1760	8 7/8" x 5" x 3"	10-1760-12 - Pk/12

Flat Cover For 10-1738 (not pictured)

10-1722		10-1722-12 - Pk/12
----------------	--	---------------------------

Dome Cover For 10-1760 (pictured)

10-1761		10-1761-12 - Pk/12
----------------	--	---------------------------

10-1955	8 3/4" x 3 1/4" x 1 1/2"	10-1955-12 - Pk/12
10-1956	Cover For 10-1955	10-1956-12 - Pk/12
10-1886	17 1/4" x 4 1/2" x 2"	10-1886-12 - Pk/12
10-1887	Cover For 10-1886	10-1887-12 - Pk/12



STAINLESS STEELWARE

STERILIZATION TRAYS

10-1706 | 8 1/2" x 8" x 1 1/4"
With 2 1/2" x 2 1/2" Compartment

10-1716 | 10 1/2" x 20" x 2 1/2"
With 10 1/2" x 5" Compartment

10-1700 | 8 1/2" x 8" x 1 1/4"

10-1702 | 10 1/2" x 10" x 1 1/2"

10-1703 | 15" x 10 1/2" x 1 1/4"

10-1707 | 8 1/2" x 12" x 1 1/4"

10-1708 | 8" x 14" x 1 1/4"

DOUBLE DECK MICRO TRAYS

10-1717 | 10" x 15" x 2 1/4"

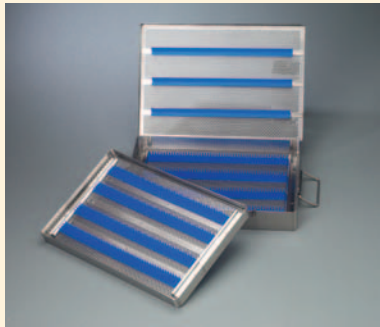

STERILIZATION TRAYS

Sterilization Box (not pictured)

10-1705 | 6 3/8" x 3 3/8" x 1 3/4"

Sterilization Trays (pictured)

10-1710 | 10" x 6 1/2" x 2 1/2"

10-1714 | 15" x 10 1/2" x 3 1/2"

10-1718 | 10" x 6 1/2" x 2"

10-1720 | 20" x 10 1/2" x 3 1/2"



STAINLESS STEELWARE

STERILIZATION TRAYS

10-1750	6 qt.	20 3/4" x 6 3/8" x 4"
10-1752	9 qt.	20 3/4" x 6 3/8" x 6"
10-1854	Cover For Above Trays	
10-1750-12 - Pk/12	6 qt.	20 3/4" x 6 3/8" x 4"
10-1752-12 - Pk/12	9 qt.	20 3/4" x 6 3/8" x 6"
10-1854-12 - Pk/12	Cover For Above Trays	

10-1948	20 3/4" x 12 3/4" x 6"
10-1953	20 3/4" x 12 3/8" x 2 1/2"
10-1954	20 3/4" x 12 3/4" x 4"
10-1535	Cover For Above Trays
10-1948-12 - Pk/12	20 3/4" x 12 3/4" x 6"
10-1953-12 - Pk/12	20 3/4" x 12 3/8" x 2 1/2"
10-1954-12 - Pk/12	20 3/4" x 12 3/4" x 4"
10-1535-12 - Pk/12	Cover For Above Trays

HIGH SIDED STERILIZATION TRAYS

PERFORATED

10-1740	8 7/8" x 5" x 2"
----------------	------------------



STAINLESS STEELWARE

STERILIZATION TRAYS / BATH SETS

Solid Tray

10-1948 | 20 3/4" x 12 3/4" x 6"

10-1948-12 - Pk/12

Perforated Tray

10-1949 | 20 3/4" x 12 3/4" x 4"

10-1949-12 - Pk/12

Cover

10-1535 |

10-1535-12 - Pk/12

FLASH STERILIZATION TRAY

10-1711 | 10" x 6 1/2" x 2"

MESH BOTTOM STERILIZATION TRAY

10-1957 | 20 3/4" x 12 3/4" x 4"



STAINLESS STEELWARE

CLEANING BASKET

PERFORATED

10-1560 | 12 3/4" x 10 3/8" x 6"

10-1729 | 4 1/4" x 7 1/4" x 2"

10-1731 | 6" x 9" x 3"

10-1732 | 8 1/2" x 12 1/2" x 3 1/2"

10-1733 | 9 1/2" x 16" x 4"

10-1734 | 12" x 21" x 5"

10-1736 | 14" x 20" x 5"

LIFTING HANDLES

10-1725 | One Pair For Trays Pictured at Left

RETRIEVING HANDLES

10-1712 | Single Handle For Flash Tray Pictured at Left

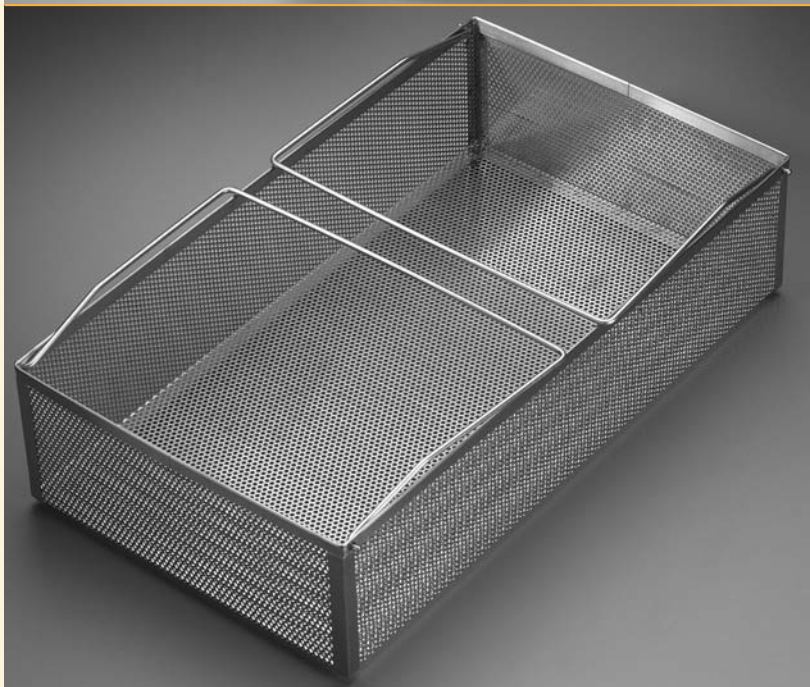

STAINLESS STEELWARE

OINTMENT JARS

With Cover

10-1525 | 9 oz. | 3 1/8" x 2 3/4" | **10-1525-12** - Pk/12

STORAGE CONTAINERS

10-1140	1 1/4 qt.	4 9/16" x 5 3/4"
10-1142	2 1/16 qt.	5 3/8" x 6 5/8"
10-1144	3 3/16 qt.	6 1/2" x 7"
10-1146	4 3/4 qt.	7 3/8" x 7 7/8"
10-1148	6 1/8 qt.	8" x 8 3/4"
10-1150	8 1/4 qt.	8 3/4" x 9 5/8"
10-1152	12 1/8 qt.	9 5/8" x 11"
10-1540	2 qt.	5 7/16" x 6 5/8" 10-1540-12 - Pk/12

DRESSING JARS

With Cover

10-1523	1/2 qt.	4 1/8" x 2 1/4"	10-1523-12 - Pk/12
10-1533	1 1/4 qt.	4 1/8" x 5 1/2"	10-1533-12 - Pk/12
10-1538	1 7/8 qt.	4 7/8" x 6 1/4"	10-1538-12 - Pk/12
10-1527	3 qt.	5 7/8" x 6 3/4"	10-1527-12 - Pk/12
10-1543	4 3/4 qt.	6 3/4" x 7 3/4"	10-1543-12 - Pk/12
10-1544	6 qt.	7 1/4" x 8 3/8"	10-1544-12 - Pk/12
10-1547	8 qt.	8" x 9 3/8"	10-1547-12 - Pk/12

FORCEP JARS

10-1550	1" x 4"	Base 2 7/16"	10-1550-12 - Pk/12
10-1541	2 1/4" x 4 1/2"	Base 3 5/8"	10-1541-12 - Pk/12
10-1545	2 1/4" x 7"	Base 3 11/16"	10-1545-12 - Pk/12



INSTRUMENT STRINGERS

POSILOK SINGLE LINK INSTRUMENT HOLDER

PRODUCT NUMBER	FEATURES
10-1332	8" X 2-1/2"
10-1337	14" X 2-1/2"
10-1338	16" X 2-1/2"

INSTRUMENT STRINGER

PRODUCT NUMBER	FEATURES
10-1340	6"

WORCESTER INSTRUMENT HOLDER

PRODUCT NUMBER	FEATURES
10-1839	13" X 13"

10-1332



10-1340

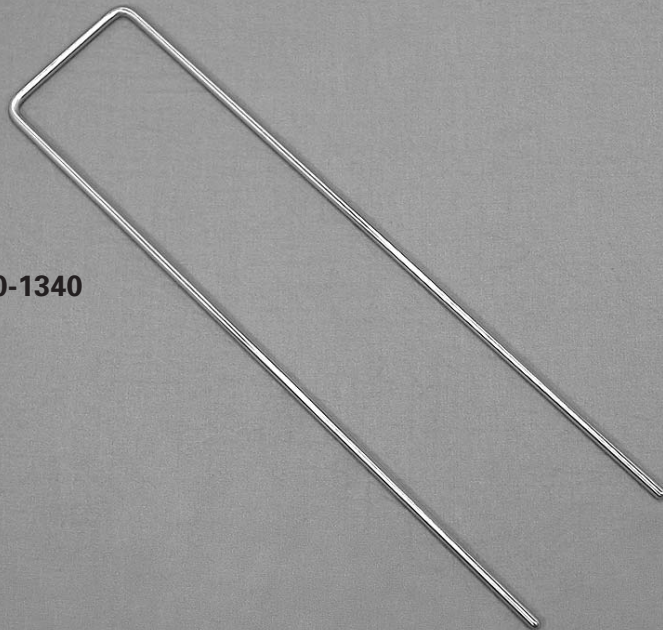

10-1839

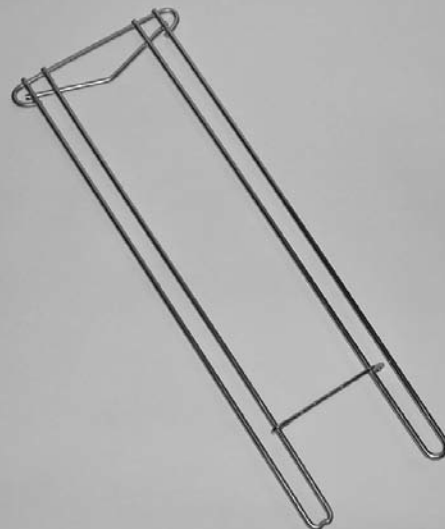



INSTRUMENT STRINGERS

INSTRUMENT STRINGER

PRODUCT NUMBER	FEATURES	
10-1836	66" X 5"	
10-1838	88" X 5"	
10-1342	8"	8" X 2-1/2"
10-1344	10"	12" X 2-1/2"
10-1346	12"	16" X 2-1/2"
10-1347	14"	18" X 2-1/2"
10-1348	16"	18" X 2-1/2"
10-1349	18"	18" X 2-1/2"

POSILOK INSTRUMENT RACK

PRODUCT NUMBER	FEATURES
10-1763	

INSTRUMENT HOLDER

PRODUCT NUMBER	FEATURES
10-1775	6"
10-1776	12"

10-1836

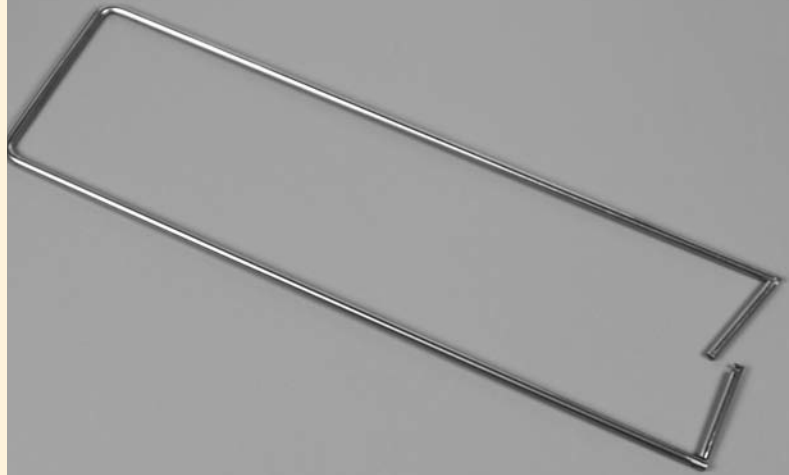

10-1763



10-1775



INSTRUMENT STRINGERS

E-Z LOCK INSTRUMENT STRINGER

PRODUCT NUMBER	FEATURES
10-1806	6" x 2-1/2"
10-1808	8" x 2-1/2"
10-1810	10" x 2-1/2"
10-1812	12" x 2-1/2"
10-1816	16" x 2-1/2"
10-1818	18" x 2-1/2"

WEINSTEIN INSTRUMENT STRINGER

PRODUCT NUMBER	FEATURES
10-1800	5-1/2"
10-1805	11-1/4"

BUNT INSTRUMENT STRINGER

PRODUCT NUMBER	FEATURES
10-1770	

SAUNDERS INSTRUMENT RACK

PRODUCT NUMBER	FEATURES
10-1780	

10-1806



10-1800

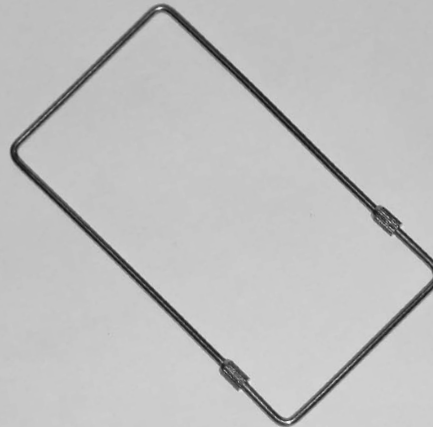

10-1770

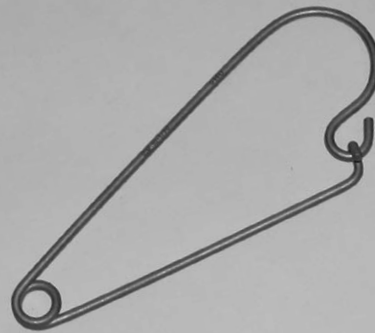

10-1780

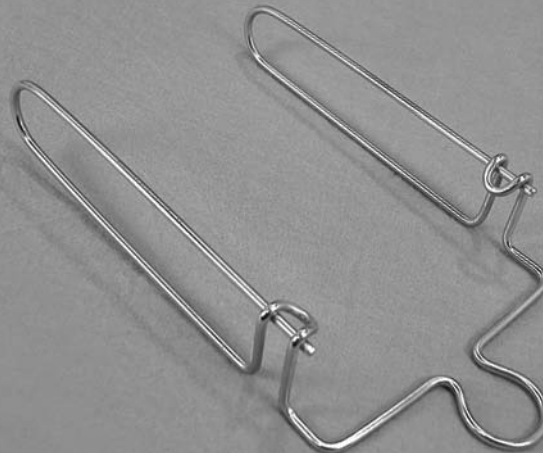

SKLARTIP™ INSTRUMENT PROTECTORS - VENTED
PACKS OF 100



96-1400
11.0mm -
1/32" x 3/4"
Maroon



96-1402
6.0mm -
3/16" x 1"
Yellow

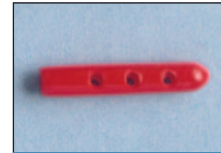

96-1404
4.0mm -
1/8" x 1"
Red



96-1406
3.0mm -
7/64" x 3/4"
Green



96-1408
2.0mm -
5/64" x 3/4"
Blue



96-1410
1.5mm -
1/16" x 3/4"
White



96-1412
25 x 3.0mm-
1/8" x 1" x 1"
Black



96-1414
18 x 3.0mm
5/64" x 5/8" x 1"
Brown



96-1416
10 x 3.0mm
1/16" x 3/8" x 1"
Orange

SKLARTIP™ INSTRUMENT PROTECTORS - NON-VENTED
PACKS OF 100



96-1500
11.0mm -
1/32" x 3/4"
Maroon



96-1502
6.0mm -
3/16" x 1"
Yellow



96-1504
4.0mm -
1/8" x 1"
Red



96-1506
3.0mm -
7/64" x 3/4"
Green

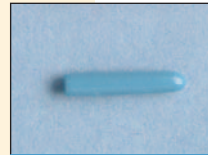

96-1508
2.0mm -
5/64" x 3/4"
Blue

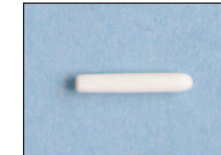

96-1510
1.5mm -
1/16" x 3/4"
White



96-1512
25 x 3.0mm
1/8" x 1" x 1"
Black



96-1514
18 x 3.0mm
5/64" x 5/8" x 1"
Brown

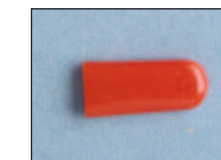

96-1516
10 x 3.0mm
1/16" x 3/8" x 1"
Orange

BOOTS

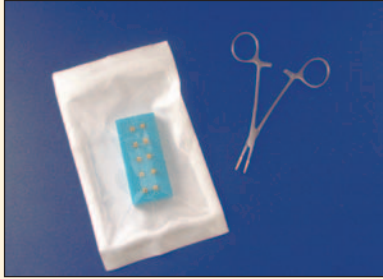

Packs of 3 & 5

- | | | | |
|----------------|------------------|----------|-----------|
| 96-1550 | Mini Package | (3 pair) | Pack of 3 |
| 96-1552 | Standard Package | (5 pair) | Pack of 5 |

Color-coded Sklar Suture Boots eliminate the use of cut tubing and catheters, while providing a firmer grip for tagging sutures. Conveniently sterile-packed, radiopaque and non-toxic, Sklar Boots will not damage even the most delicate suture materials.

ID SHEET TAPE



1 Each

- | | | | | | |
|----------------|--------------------------------|--------|----------------|--------------------------------|--------|
| 96-1845 | Dark Blue with White Stripes, | 1 each | 96-1850 | Brown with White Stripes, | 1 each |
| 96-1846 | Dark Green with White Stripes, | 1 each | 96-1851 | Lavender with White Stripes, | 1 each |
| 96-1847 | Red with White Stripes, | 1 each | 96-1852 | Light Blue with White Stripes, | 1 each |
| 96-1848 | Yellow with White Stripes, | 1 each | 96-1853 | Pink with White Stripes, | 1 each |
| 96-1849 | Orange with White Stripes, | 1 each | | | |

Color-coding is convenient with Sklar ID Sheet Tape. There are many combinations of tapes fixed to an easily removed backing. Each 8-1/2" x 11" sheet contains 374" of tape. Lasts through many autoclaving and gas sterilizing procedures.

ID ROLL TAPE

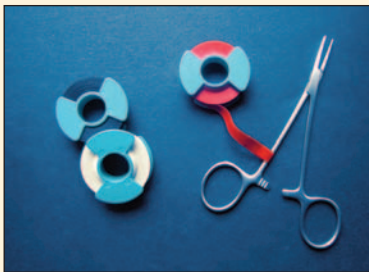

1 Each

- | | | | |
|----------------|----------------|----------------|-----------------------|
| 96-1860 | White, 1 each | 96-1870 | Purple, 1 each |
| 96-1862 | Green, 1 each | 96-1872 | Blue, 1 each |
| 96-1864 | Yellow, 1 each | 96-1874 | Red, 1 each |
| 96-1866 | Orange, 1 each | 96-1876 | Brown, 1 each |
| 96-1868 | Black, 1 each | 96-1878 | Bright Orange, 1 each |

Sklar ID Roll Tape is a convenient color coding tape to make instruments easily recognized. It's autoclavable and available in 10 colors. Each roll length is 300" and 1/4" wide. Lasts through many autoclaving and gas sterilizing procedures.

INSTRUMENT ID TAGS



Packs of 100 & Cases of 1000

- | | | | |
|----------------|---------------|------|-------------|
| 96-1900 | "Repair Tag" | Red | Pack / 100 |
| 96-1901 | "Repair Tag" | Red | Case / 1000 |
| 96-1905 | "Sharpen Tag" | Blue | Pack / 100 |
| 96-1906 | "Sharpen Tag" | Blue | Case / 1000 |

Plastic Identification tags for serviced instruments and equipment

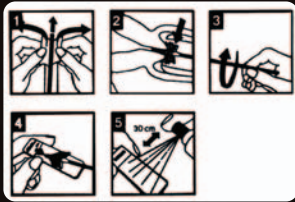
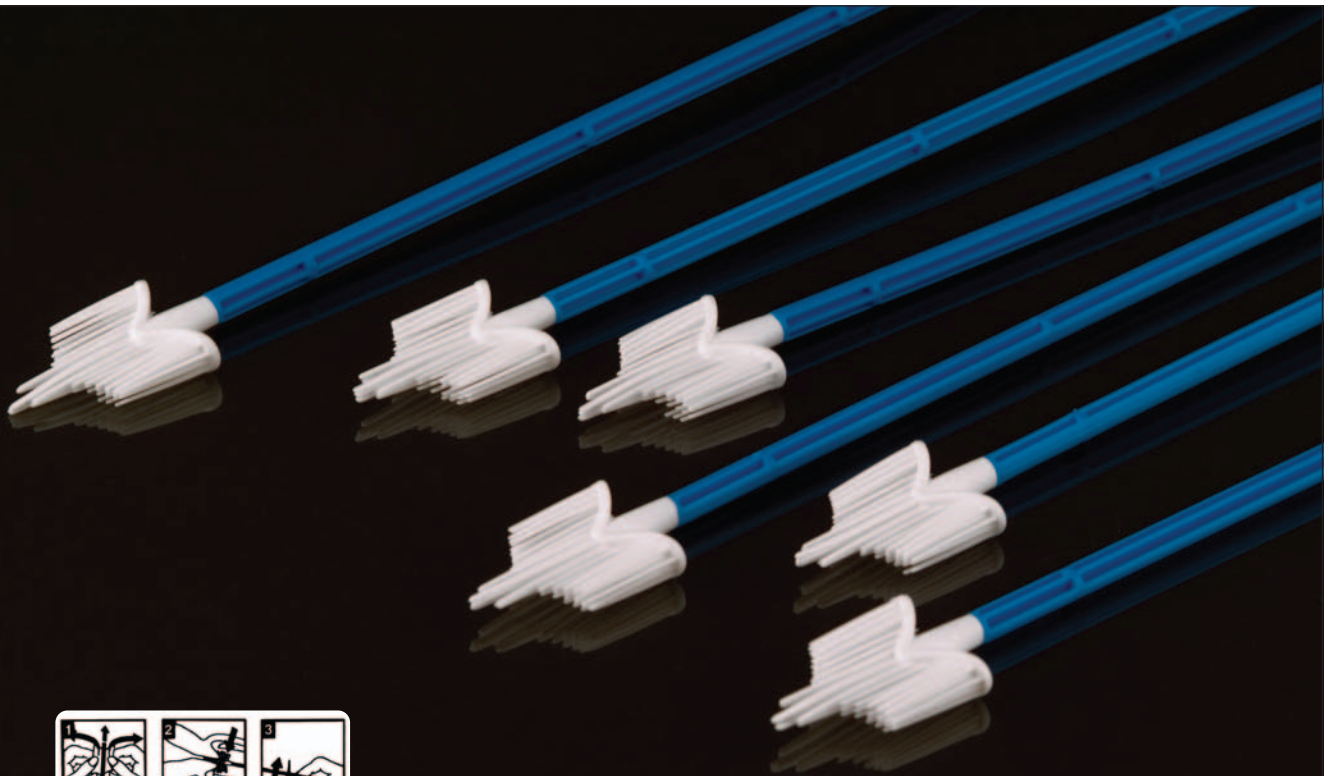

SKLAR CERVIX BRUSH CERVICAL CELL SAMPLER

SKLARS Cervix Brush is made of polyethylene and has a total length of 20 centimeters. The top portion uses a soft flexible brush to obtain cell samples. The brush consists of 57 semi-circular plastic bristles of various lengths. The shape is such that the top edges of the brush follow the contours of the cervix. The longer middle bristles reach deep into the endocervical canal. The shorter bristles touch both the ectocervical area and transformation zone at the same time.

SKLAR CERVIX BRUSH

STERILE CASE / 100

PRODUCT NUMBER FEATURES

96-4140

NON-STERILE CASE / 100

PRODUCT NUMBER FEATURES

96-8946

CALL: 800.221.2166



SKLAR SILICONE VAGINAL DILATORS

Sklar Silicone Vaginal Dilators are used to enlarge the vagina for the purposes of examination, a surgical procedure or for the relief of vaginismus. This is accomplished by supporting or distending the vaginal canal. They are contraindicated in acute genital tract or pelvic infections or with non-compliant patients.

Normal Anatomy

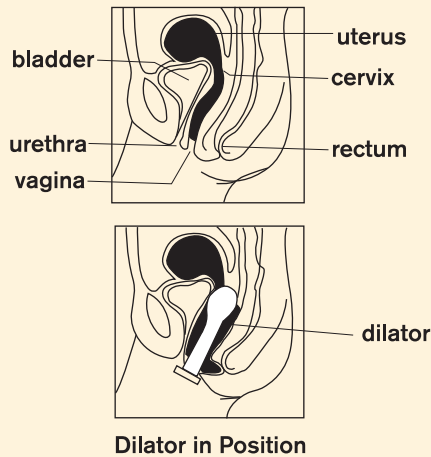

Dilator in Position

SKLAR OS DILATORS

STERILE	SET OF 3
PRODUCT NUMBER	FEATURES
96-4150	Teflon Reusable Set Includes Os Locator, Canal Finder and Fundus Dilator



VAGINAL DILATOR AVAILABLE SIZES

STERILE	SETS OF 4			
PRODUCT NUMBER	FEATURES			
90-5264	Large Family	Length	Small OD	Large OD
	XL	150.0mm	30.0mm	38mm
	L	138.0mm	25.5mm	32mm
	M	128.0mm	22.5mm	28.0mm
	S	120.0mm	19.5mm	24.0mm
90-5262	Medium Family	Length	Small OD	Large OD
	XL	95.0mm	26.0mm	33.0mm
	L	86.0mm	22.5mm	28.0mm
	M	78.0mm	19.5mm	23.0mm
	S	75.0mm	12.5mm	17.0mm
90-5260	Small Family	Length	Small OD	Large OD
	XL	75.0mm	13.5mm	18.0mm
	L	65.0mm	12.0mm	16.0mm
	M	60.0mm	10.5mm	14.0mm
	S	50.0mm	9.5mm	13.0mm



**LATEX-FREE
SINGLE-USE**

SKLARSPEC™ DISPOSABLE GRAVES VAGINAL SPECULA

SKLARSPEC plastic specula are clear, disposable, and comfortable. Plastic material allows 360 degree visibility and reduces thermal shock. Provides protection of the doctor, the nurse and the patient from cross contamination. Clean up is eliminated by single-use only. Plastic material avoids unpleasant temperature shock associated with metal. One hand operation with wide range adjustment.

GRAVES STYLE

STERILE	CASE / 100
PRODUCT NUMBER	FEATURES
96-1877	Large
96-1857	Small
NON-STERILE	CASE / 100
PRODUCT NUMBER	FEATURES
96-0857	Small
96-0867	Medium
96-0877	Large





SKLAR MONSEL'S FERRIC SUBSULFATE PASTE

A ONE-TIME USE pre-mixed paste packaged in convenient ready-to-use bottles.

Also includes 12 rayon tip applicators.

PRODUCT NUMBER

96-1200

www.SKLARCORP.com

SKLAR LUGOL'S STRONG IODINE SOLUTION USP

A ONE-TIME USE pre-mixed iodine solution packaged in convenient ready-to-use bottles.

Also includes 12 rayon tip applicators.

PRODUCT NUMBER

96-1210



GYN BIOPSY PUNCHES

Precision engineered and hand crafted, Sklar Biopsy Punches are recognized as the finest in the field. A complete selection of forcep tips combined with three specific handle configurations provide the flexibility, comfort and control required by the most selective physicians.

SKLAR OR GRADE

Sklar OR Grade biopsy punches insure the highest level of hand crafted workmanship. The precision, balance and feel of these fine instruments is apparent from the moment the physician lifts it from the tray.

PRODUCT NUMBER	FEATURES
90-6820	Eppendorfer Biopsy Forcep
90-6610	Kevorkian-Younger Biopsy Force
90-6600	Wittner Biopsy Forcep Straight
90-6602	Wittner Biopsy Forcep Angular

MICRO-CUT

MICRO-CUT PREMIUM GRADE

Micro-Cut Premium Grade biopsy punches combine the same fine craftsmanship of our OR Grade with a knife honed edge on the upper jaw for a cleaner and more precise cut.

PRODUCT NUMBER	FEATURES
90-8010	Micro-Cut Eppendorfer Biopsy Forcep
90-8905	Micro-Cut Kevorkian-Younger Biopsy Force
90-8900	Micro-Cut Wittner Biopsy Forcep Straight

EPPENDORFER

4mm x 8mm Bite



KEVORKIAN-YOUNGE

3mm x 9.7mm Bite



WITTNER STRAIGHT

4mm x 8mm Bite



WITTNER ANGULAR

4mm x 8mm Bite



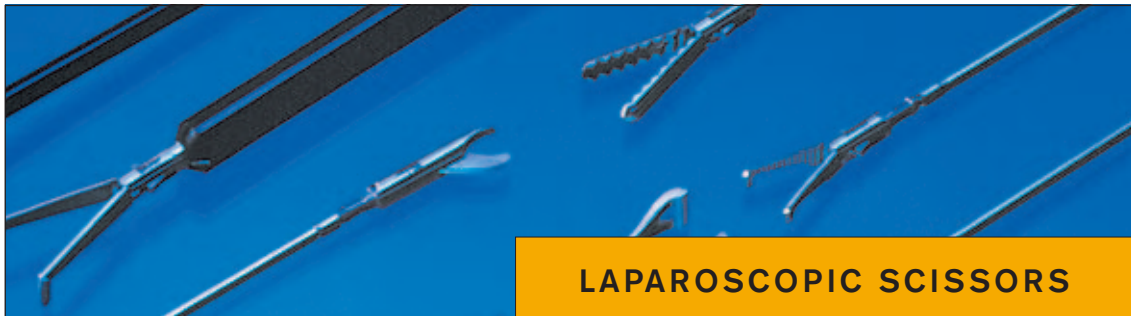

LAPAROSCOPIC SCISSORS

SKLARTECH
5000

METZENBAUM SCISSORS

STRAIGHT - 33CM 5MM

31-9005XC Complete Instrument 31-9005 Replacement Insert



METZENBAUM SCISSORS

CURVED - 33CM 5MM

31-9010XC Complete Instrument 31-9010 Replacement Insert



HOOK SCISSORS

33CM 5MM

31-9015XC Complete Instrument 31-9015 Replacement Insert



MICROSCISSOR

STRAIGHT - 33CM 5MM

31-9020XC Complete Instrument 31-9020 Replacement Insert



MICROSCISSOR

CURVED - 33CM 5MM

31-9025XC Complete Instrument 31-9025 Replacement Insert



"X" Handle

When purchased as a complete instrument, Sklartech Laparoscopic Scissors, Dissectors and Forceps include the insert with tip, insulated cannula and handle with locking collar. The illustrated handle is a non-ratchet pattern which may be fully rotated. Featuring an electro-surgical connector, the "X" handle is fully insulated.

COMPLETE INSTRUMENT:
INSERT WITH TIP
INSULATED CANNULA
HANDLE WITH COLLAR



SKLARTECH
5000

LAPAROSCOPIC FORCEPS



	<p>MIXTER FORCEPS DIAMOND SERRATIONS - 32CM 5MM</p> <p>31-9035XC Complete Instrument 31-9035 Replacement Insert</p>
	<p>CURVED DISSECTING FORCEPS CROSS SERRATIONS, CURVED - 32CM 5MM</p> <p>31-2568XC Complete Instrument 31-2568 Replacement Insert</p>
	<p>DOLPHIN FORCEPS WITH SPOON - 33CM 5MM</p> <p>31-9040XC Complete Instrument 31-9040 Replacement Insert</p>
	<p>CLAW FORCEPS 33CM 5MM</p> <p>31-9045XC Complete Instrument 31-9045 Replacement Insert</p>
	<p>SHARP TRAUMATIC GRASPING FORCEPS 33CM 5MM</p> <p>31-9075YC Complete Instrument 31-9075 Replacement Insert</p>
	<p>MARYLAND DISSECTOR CROSS SERRATIONS - 33CM 5MM</p> <p>31-9030XC Complete Instrument 31-9030 Replacement Insert</p>

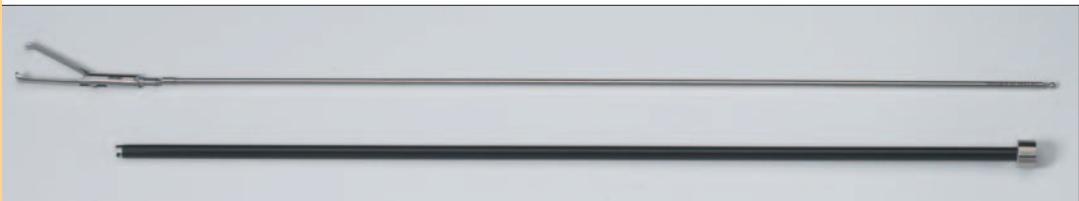

COMPLETE
INSTRUMENT:
INSERT WITH TIP
INSULATED
CANNULA
HANDLE WITH
COLLAR

The replacement insert and insulated cannula are easily separated for cleaning and reprocessing by gently unscrewing the insert from the cannula. To re-attach these parts simply align the tip and cannula and screw back together.





LAPAROSCOPIC FORCEPS

SKLARTECH
5000

MARYLAND DISSECTOR

DIAMOND SERRATIONS - 33CM 10MM

31-9120XC Complete Instrument 31-9120 Replacement Insert



MIXTER FORCEPS

90° ANGLE - 33CM 10MM

31-9125XC Complete Instrument 31-9125 Replacement Insert



CLAW FORCEPS

33CM 10MM

31-9130XC Complete Instrument 31-9130 Replacement Insert



SPOON FORCEPS

33CM 10MM

31-9135XC Complete Instrument 31-9135 Replacement Insert



BABCOCK FORCEPS

33CM 10MM

31-9140YC Complete Instrument 31-9140 Replacement Insert



"X" Handle

Complete Instrument









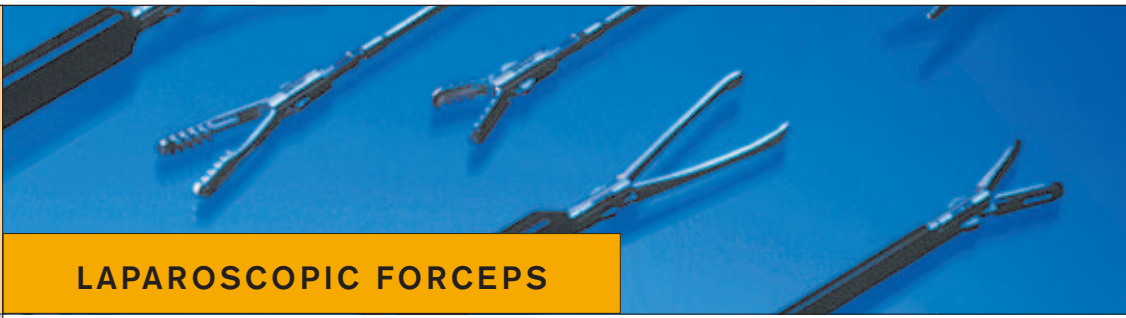

As with all Sklar complete laparoscopic instruments, the handles and replacement inserts are easily interchangeable to perform as intended and required by the surgeon. A Sklartech 5000 instrument includes the handle, insert with tip, the insulating cannula and a locking collar which secures the insert/cannula to the handle while allowing full rotation.



SKLARTECH
5000

LAPAROSCOPIC FORCEPS



	<p>STANDARD GRASPING FORCEPS 33CM 5MM</p> <p>31-9050YC Complete Instrument 31-9050 Replacement Insert</p>
	<p>GRASPING FORCEPS WITH SPOON - 33CM 5MM</p> <p>31-9080YC Complete Instrument 31-9080 Replacement Insert</p>
	<p>POINTED GRASPING FORCEPS WITH SPOON - 32CM 5MM</p> <p>31-9085YC Complete Instrument 31-9085 Replacement Insert</p>
	<p>FENESTRATED GRASPING FORCEPS 33CM 5MM</p> <p>31-9090YC Complete Instrument 31-9090 Replacement Insert</p>
	<p>FENESTRATED GRASPING FORCEPS LONG JAWS - 33CM 5MM</p> <p>31-9095YC Complete Instrument 31-9095 Replacement Insert</p>
	<p>MAXI (FUNDUS) GRASPING FORCEPS 33CM 5MM</p> <p>31-9100YC Complete Instrument 31-9100 Replacement Insert</p>
	<p>ENDO CLINCH GRASPING FORCEPS 33CM 5MM</p> <p>31-9055YC Complete Instrument 31-9055 Replacement Insert</p>
	<p>WAVE GRASPING FORCEPS 33CM 5MM</p> <p>31-9060YC Complete Instrument 31-9060 Replacement Insert</p>
	<p>DEBAKEY FORCEPS 40MM JAWS - 33CM 5MM</p> <p>31-9065YC Complete Instrument 31-9065 Replacement Insert</p>
	<p>ALLIGATOR GRASPING FORCEPS DOUBLE ACTION - 32CM 5MM</p> <p>31-9070YC Complete Instrument 31-9070 Replacement Insert</p>
	



LAPAROSCOPIC HANDLES/CANNULAS

SKLAR "XC" CARBON HANDLE

31-9001XC Lightweight, carbon fiber reinforced non-conductive safety handle with locking collar. Non-ratchet design and fully rotating as well as a proximally positioned high-frequency connector. "XC" handle used primarily with miniature instruments.



SKLAR "YC" CARBON HANDLE

31-9002YC Lightweight, carbon reinforced non-conductive safety handle with locking collar. Ratchet design and fully rotating as well as a proximally positioned high-frequency connector. "YC" handle used primarily with miniature instruments.



REPLACEMENT LOCKING COLLAR

31-9160



INSULATED CANNULA 33CM 5MM
31-9155



INSULATED CANNULA 33 CM 10MM
31-9150 with permanent locking collar attached

LAPAROSCOPIC TROCARS

HASSON TROCAR 11MM WITH OBTURATOR



31-1001 (A) Trap Door – complete with 11mm obturator
 31-1002 (B) Trumpet Valve – complete with 11mm obturator
 31-0004 Replacement Obturator

S-RETRACTOR



60-6130 Set of 2

STANDARD TRAP DOOR CANNULA & TROCAR



31-1003 (A) Trap Door Cannula with 5.5mm trocar
 31-1004 (B) Trap Door Cannula with 11mm trocar

STANDARD TRUMPET VALVE CANNULA & TROCAR



31-1007 Trumpet valve cannula with 5.5mm trocar 31-1009 Trumpet valve cannula with 12mm trocar
 31-1008 Trumpet valve cannula with 11mm trocar

REPLACEMENT TROCAR FOR STANDARD CANNULAS



31-1010 Pyramidal Trocar 5.5mm 31-1011 Pyramidal Trocar 11mm 31-1012 Pyramidal Trocar 12mm

THREADED CANNULA SLEEVE

INTERCHANGEABLE WITH STANDARD SMOOTH CANNULA



31-1020 (A) 5.5mm
 31-1022 (B) 11mm

SNAP ON FLIP REDUCER



31-1042 11mm to 5.5mm

TROCAR CANNULA SEALS

	3mm	5.5mm	11mm	12mm	Hasson 11mm
External Seal For use with Trap Door and Trumpet Valve Cannula	Red 31-4320	Red 31-0003	Blue 31-0001	Green 31-0010	Blue/Grey 31-0001/31-0002
Internal Seal For use with Trap Door Cannula	Grey 31-4321	Grey 31-4323	Yellow 31-4324		Yellow 31-4324



SKLARTECH

5000

LAPAROSCOPIC NEEDLE HOLDERS



TC NEEDLE HOLDER

TUNGSTEN CARBIDE - 5MM SOLID SHAFT

31-2553 non-insulated, solid shaft with inline handle, tungsten carbide jaw inserts

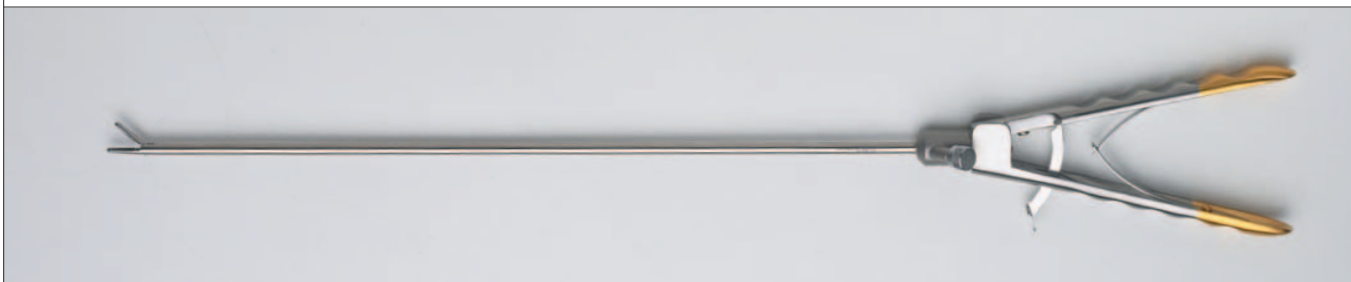

TC NEEDLE HOLDER

TUNGSTEN CARBIDE - 5MM FLUSHABLE SHAFT

non-insulated, flushable shaft with inline handle, tungsten carbide jaw inserts

- 31-2550 (A) straight
- 31-2551 (B) curved right
- 31-2552 (C) curved left

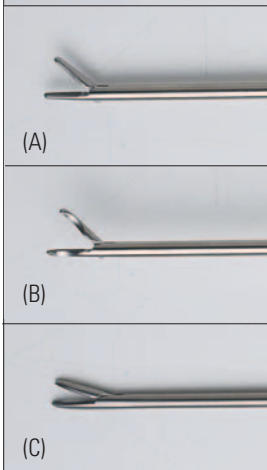



(A)

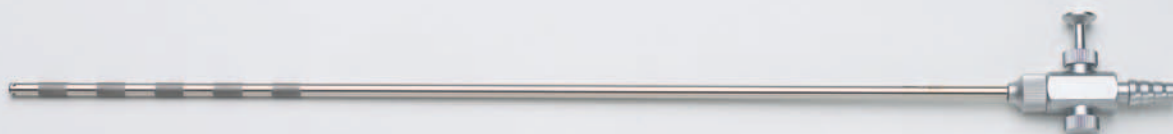

(B)



(C)

SUCTION IRRIGATION SYSTEM NON-INSULATED

- 31-2238 (A) Dual Trumpet Valve – fits 5mm or 10mm Sheath (includes 5mm Sheath)
- 31-2258 (B) Single Trumpet Valve – fits 5mm or 10mm Sheath (includes 5mm Sheath)
- 31-4003 (C) 5mm Sheath only
- 31-4004 10mm Sheath only (not shown)



(A)



(B)



(C)

HIGH VOLUME SUCTION IRRIGATION SYSTEM NON-INSULATED

- 31-2239 (A) Dual Trumpet Valve – includes 5mm and 10mm Sheath (shown with 10mm Sheath)
- 31-2347 (B) 5mm Replacement Sheath
- 31-2349 (C) 10mm Replacement Sheath



SKLARTECH

5000

LAPAROSCOPIC ELECTROSURGERY

INSULATED ELECTRODES, WITH SUCTION

- 31-2235 (A) Spatula Electrode 5mm
- 31-2237 (B) L-Hook Electrode 5mm
- 31-2241 (C) Knife Electrode 5mm
- 31-2243 (D) J-Hook Electrode 5mm
- 31-2244 (E) Blunt Electrode 5mm
- 31-2245 (F) Button Electrode 5mm
- 31-2247 (G) Cone Electrode 5mm

Each coagulating electrode (A through G) is able to connect to the suction control valve of choice listed below, choose from A, B, or C. Insulated electrode and valve ordered separately.

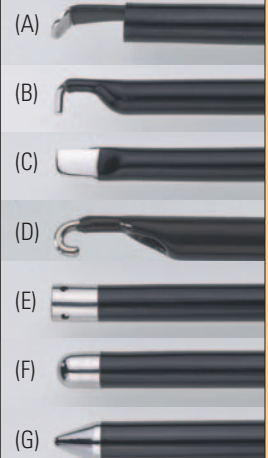

HIGH FREQUENCY SUCTION CONTROL VALVES

- 31-2227 (A) Insulated Suction Control with Single Trumpet Valve
- 31-2233 (B) Insulated Suction Control with Double Trumpet Valve
- 31-2229 (C) Insulated Suction Control with Double Trumpet Valve and Handle

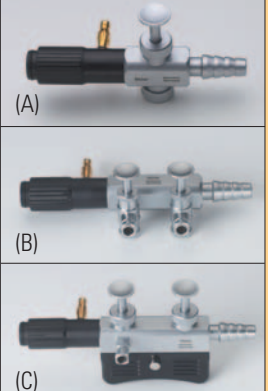

ELECTROSURGICAL CABLE

- 31-2242 Monopolar



INSULATED ELECTRODES, WITHOUT SUCTION

- 31-2435 (A) Spatula Electrode 5mm
- 31-2437 (B) L-Hook Electrode 5mm
- 31-2441 (C) Knife Electrode 5mm
- 31-2443 (D) J-Hook Electrode 5mm
- 31-2444 (E) Blunt Electrode 5mm
- 31-2445 (F) Button Electrode 5mm
- 31-2447 (G) Cone Electrode 5mm

Each electrode has a permanently fitted adapter for connecting to the electrosurgical cable. Cable is ordered separately.

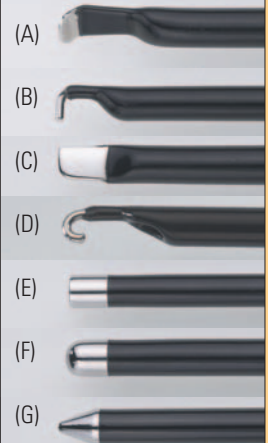

SKLARTECH

5000

LAPAROSCOPIC ACCESSORIES



VERRES NEEDLE WITH STOPCOCK

- 31-2327 100mm
- 31-2350 120mm
- 31-2352 150mm



NEEDLE FOR INJECTION & IRRIGATION

- 31-2355 Luer Lock – 32cm 5mm



GRADUATED PROBE

- 31-2365 32cm 5mm

SKLARTECH

5000
MINIATURE

MINIATURE LAPAROSCOPIC SCISSORS

MINIATURE METZENBAUM SCISSORS

STRAIGHT - 32CM 3MM

31-4306XC Complete Instrument 31-4306 Replacement Cannula/Insert (one piece)



MINIATURE METZENBAUM SCISSORS

CURVED - 32CM 3MM

31-4303XC Complete Instrument 31-4303 Replacement Cannula/Insert (one piece)



MINIATURE METZENBAUM SCISSORS

CURVED, SERRATED - 32CM 3MM

31-4307XC Complete Instrument 31-4307 Replacement Cannula/Insert (one piece)



MINIATURE HOOK SCISSORS

32CM 3MM

31-4304XC Complete Instrument 31-4304 Replacement Cannula/Insert (one piece)



MINIATURE PUNCH

32CM 3MM

31-4305XC Complete Instrument 31-4305 Replacement Cannula/Insert (one piece)



Complete Instrument:
Handle with collar and
cannula/insert

"YC" Handle



"XC" Handle

The complete Miniature Laparoscopic instrument is provided with the much lighter carbon handle in either ratchet (YC) or non-ratchet (XC) pattern. However, unlike the standard laparoscopic instrument, the insert/cannula, either as part of a complete instrument or as a replacement, is a permanent one-piece construction.



SKLARTECH
5000
 MINIATURE

MINIATURE LAPAROSCOPIC FORCEPS



MINIATURE MARYLAND DISSECTOR

CROSS SERRATIONS - 32CM 3MM

31-4310XC Complete Instrument 31-4310 Replacement Cannula/Insert (one piece)



MINIATURE ATRAUMATIC DISSECTOR

32CM 3MM

31-4311XC Complete Instrument 31-4311 Replacement Cannula/Insert (one piece)



MINIATURE SPOON FORCEPS

32CM 3MM

31-4315XC Complete Instrument 31-4315 Replacement Cannula/Insert (one piece)



MINIATURE SPOON FORCEPS

SERRATED - 32CM 3MM

31-4316XC Complete Instrument 31-4316 Replacement Cannula/Insert (one piece)



MINIATURE KELLY FORCEPS

32CM 3MM

31-4309XC Complete Instrument 31-4309 Replacement Cannula/Insert (one piece)



MINIATURE DUCK NOSE FORCEPS

32CM 3MM

31-4314YC Complete Instrument 31-4314 Replacement Cannula/Insert (one piece)



MINIATURE FENESTRATED GRASPING FORCEPS

32CM 3MM

31-4317YC Complete Instrument 31-4317 Replacement Cannula/Insert (one piece)



MINIATURE GRASPING FORCEPS

32CM 3MM

31-4308YC Complete Instrument 31-4308 Replacement Cannula/Insert (one piece)



MINIATURE GRASPING FORCEPS

HEAVY SERRATIONS - 32CM 3MM

31-4312YC Complete Instrument 31-4312 Replacement Cannula/Insert (one piece)



MINIATURE COBRA GRASPING FORCEPS

32CM 3MM

31-4313YC Complete Instrument 31-4313 Replacement Cannula/Insert (one piece)



Complete Instruments at right include "XC" Handle



Complete Instruments at right include "YC" Handle





MINIATURE LAPAROSCOPIC ACCESSORIES

SKLARTECH
5000
MINIATURE

SKLAR "XC" CARBON HANDLE

31-9001XC Lightweight, carbon fiber reinforced non-conductive safety handle with locking collar. Non-ratchet design and fully rotating as well as a proximally positioned high-frequency connector.



SKLAR "YC" HANDLE

31-9002YC Lightweight, carbon fiber reinforced non-conductive safety handle with locking collar. Ratchet design and fully rotating as well as a proximally positioned high-frequency connector.



MINIATURE ENDOSCOPE
AUTOCLAVABLE - 3MM

31-4301

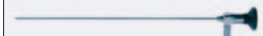

MINIATURE TROCAR SET
REUSABLE - 3MM

31-4302 Trocar Set
31-4318 Replacement Obturator 3mm

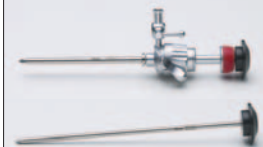

MINIATURE ELECTRODES, WITHOUT SUCTION
HIGH FREQUENCY, INSULATED - 3MM

Each electrode has a permanently fitted adapter for connecting to the electrosurgical cable (ordered separately).

31-4325 (A) Spatula Electrode
31-4326 (B) L-Hook Electrode
31-4327 (C) J-Hook Electrode



ELECTROSURGICAL CABLE

31-2242 Monopolar



PLASTIC INSTRUMENTS

TWEEZER FORCEP

NON-STERILE BOX OF 100

PRODUCT NUMBER FEATURES

96-5656

STERILE BOX OF 100

PRODUCT NUMBER FEATURES

96-5657

UTILITY FORCEP

NON-STERILE BOX OF 100

PRODUCT NUMBER FEATURES

96-2914 4", Narrow Jaw

STERILE BOX OF 100

PRODUCT NUMBER FEATURES

96-2915 4", Narrow Jaw

DRESSING FORCEP

NON-STERILE BOX OF 100

PRODUCT NUMBER FEATURES

96-2916 5"

STERILE BOX OF 100

PRODUCT NUMBER FEATURES

96-2917 5"

LITTAUER SUTURE

SCISSOR

NON-STERILE BOX OF 100

PRODUCT NUMBER FEATURES

96-2905 4-1/2"

STERILE BOX OF 100

PRODUCT NUMBER FEATURES

96-2906 4-1/2"

 **Sklar**
INSTRUMENTS



96-5656



96-2914



96-2916



96-2905

PLASTIC INSTRUMENTS

HOFF STYLE TOWEL CLAMP: 1

NON-STERILE BOX OF 100

PRODUCT NUMBER FEATURES
96-5658 Curved

STERILE BOX OF 100

PRODUCT NUMBER FEATURES
96-5659 Curved

HOFF STYLE TOWEL CLAMP: 2

NON-STERILE BOX OF 100

PRODUCT NUMBER FEATURES
96-5660 Curved

STERILE BOX OF 100

PRODUCT NUMBER FEATURES
96-5661 Curved

TOWEL CLAMP

NON-STERILE BOX OF 100

PRODUCT NUMBER FEATURES
96-2930 5", Non-Perforating

STERILE BOX OF 100

PRODUCT NUMBER FEATURES
96-2931 5", Non-Perforating

NASAL SPECULUM

DISPOSABLE

NON-STERILE CASE / 48

PRODUCT NUMBER FEATURES
96-0670 6-1/2"



96-5658



96-5660



96-2930



96-0670



PLASTIC INSTRUMENTS

TUBE CLAMP

NON-STERILE BOX OF 100

PRODUCT NUMBER FEATURES

96-2902

STERILE BOX OF 100

PRODUCT NUMBER FEATURES

96-2903

TUBE OCCLUDING CLAMP

NON-STERILE BOX OF 100

PRODUCT NUMBER FEATURES

96-2911

STERILE BOX OF 100

PRODUCT NUMBER FEATURES

96-2912 |

HEMOSTATIC FORCEP

NON-STERILE BOX OF 100

PRODUCT NUMBER FEATURES

96-2907 5-1/4", Straight

96-2908 5-1/4", Curved

STERILE BOX OF 100

PRODUCT NUMBER FEATURES

96-2909 5-1/4", Straight

96-2910 5-1/4", Curved

SPONGE FORCEP

NON-STERILE BOX OF 100

PRODUCT NUMBER FEATURES

96-2918 9-1/2"

STERILE BOX OF 100

PRODUCT NUMBER FEATURES

96-2919 9-1/2"



96-2902



96-2911



96-2907



96-2918





UTILITY SHEARS

Professional quality stainless steel utility scissors with a polished finish are designed for everyday use. 10 brightly colored polypropylene handles to choose from. Autoclavable up to 290.

 **Sklar**
INSTRUMENTS

NON-STERILE

CASE / 50

PRODUCT NUMBER

96-5390

96-5391

96-5392

96-5393

96-5394

96-5395

96-5396

96-5397

96-5398

96-5399

FEATURES

Yellow

Orange

Purple

Burgandy

Magenta

Navy Blue

Royal

Teal Blue

Lime Green

Hunter Green

STERILE

CASE / 25

PRODUCT NUMBER

96-1220

96-1221

96-1222

96-1223

96-1224

96-1225

96-1226

96-1227

96-1228

96-1229

FEATURES

Yellow

Orange

Purple

Burgandy

Magenta

Navy Blue

Royal

Teal Blue

Lime Green

Hunter Green





WIREFORMS

SCISSORS

STERILE	CASE / 50
PRODUCT NUMBER	FEATURES
96-8971	4.5", Littauer
96-8973	4.5", Sharp/Blunt
96-8972	5.25", Sharp/Blunt
96-8975	5.25", Sharp/Sharp

NEEDLE HOLDER, 5.25"

STERILE	CASE / 50
PRODUCT NUMBER	FEATURES
96-8968	Smooth
96-8974	Serrated

96-8971



96-8973

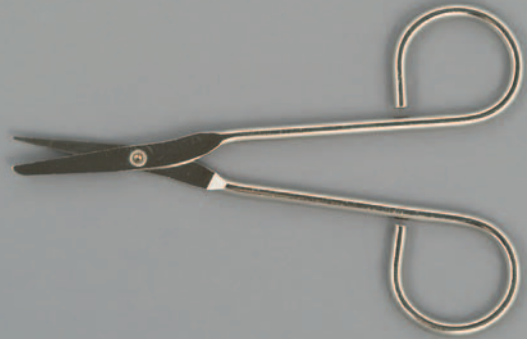

96-8972



96-8968

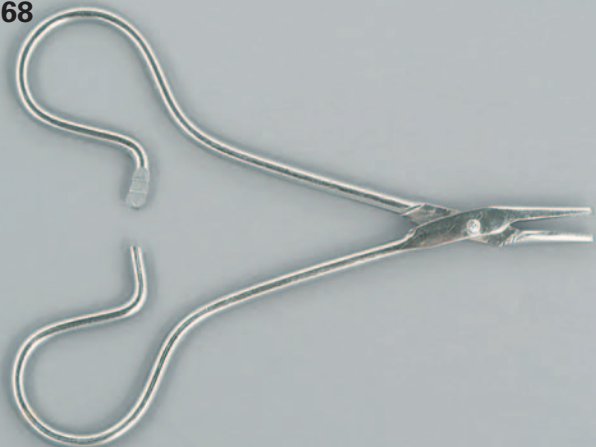

WIREFORMS

KELLY FORCEP, 5.5"

STERILE CASE / 50

PRODUCT NUMBER	FEATURES
96-8967	Straight
96-8966	Curved

HALSTEAD FORCEP, 5"

STERILE CASE / 50

PRODUCT NUMBER	FEATURES
96-8964	Straight
96-8965	Curved

TOWEL FORCEP, 5.25"

STERILE CASE / 50

PRODUCT NUMBER	FEATURES
96-8962	

SPONGE FORCEP

STERILE CASE / 50

PRODUCT NUMBER	FEATURES
96-8969	7"-Serrated
96-8970	9.5"-Serrated

THUMB FORCEP, 1 X 2, 4.5"

STERILE CASE / 50

PRODUCT NUMBER	FEATURES
96-8963	

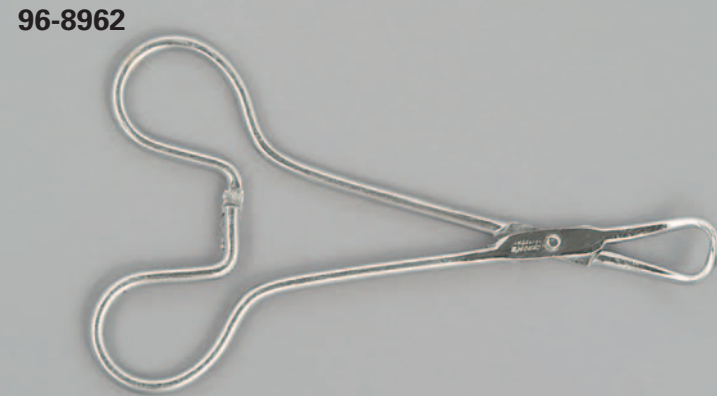
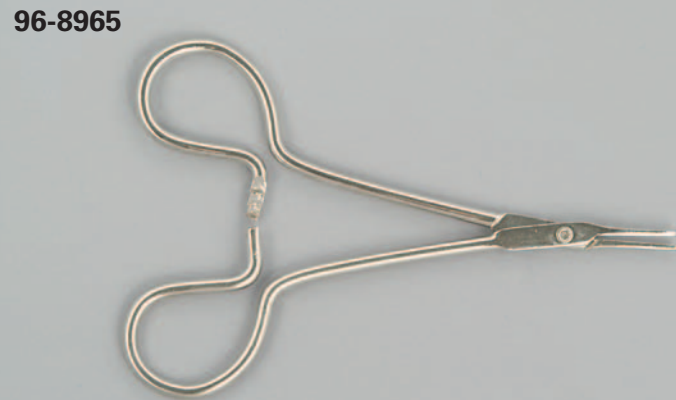

MAJOR BASIC SURGERY SET (98-1000)

PRODUCT NUMBER	DESCRIPTION	QUANTITY	PRODUCT NUMBER	DESCRIPTION	QUANTITY
06-2860	Metal Ruler 6" -----	1	23-1157	Sklarlite Stevens Cvd 4 1/4" -----	1
06-2903	Scalpel Handle #3 -----	2	30-1560	Probe Dbl End 6" -----	2
06-2904	Scalpel Handle #4 -----	2	30-1960	Probe W/Eye 6" -----	2
07-1805	Yankauer Suction Tube Stainless -----	2	36-1662	Babcock Intestinal Forceps 6 1/4" -----	2
10-1805	Weinstein Sterilizing Rack 11 1/4" -----	3	36-1677	Babcock Intestinal Forceps 8" -----	2
15-1555	Mayo Dissecting Scissors Str 5 1/2" -----	1	36-2160	Allis Tissue Forceps 4x5 6" -----	3
15-2567	Mayo Dissecting Scissors Cvd 6 3/4" -----	1	36-2275	Allis Tissue Forceps 5x6 7 1/2" -----	6
17-1235	Hartmann Mosquito Str Del Ser 3 1/2" -----	3	47-1447	Brown Adson Tissue Forceps 4 3/4" -----	2
17-1335	Hartmann Mosquito Cvd Del Ser 3 1/2" -----	3	47-2147	Adson Forceps Serr Jaw 4 3/4" -----	1
17-1450	Halsted Mosquito Forceps Str 5" -----	6	47-2955	Backhaus Towel Clamp 5 1/4" -----	12
17-1550	Halsted Mosquito Forceps Cvd 5" -----	6	55-9090	Metz-Nelson Scissors Cvd 9" -----	1
17-2262	Roch-Pean Forceps Cvd 6 1/4" -----	6	60-1085	US Army Retractor Set/2 8 1/2" -----	2
17-2280	Roch-Pean Forceps Cvd 8" -----	3	60-1681	Richardson Retractor w/Sklar-Grip Handle Med -----	1
17-2462	Roch-Pean Forceps Str 6 1/4" -----	6	60-1691	Richardson Retractor w/Sklar-Grip Handle Large -----	1
17-2480	Roch-Pean Forceps Str 8" -----	3	60-1695	Richardson-Eastman Retractor Set/2 -----	1
17-2662	Roch-Ochsner Forceps Cvd 6 1/4" -----	2	60-2713	Deaver Retractor Sklar Grip Handle #2 1" x 13" -----	2
17-2862	Roch-Ochsner Forceps Str 6 1/4" -----	2	60-3090	Deaver Retractor #0 1" x 9" -----	2
17-2880	Roch-Ochsner Forceps Str 8" -----	2	60-3212	Deaver Retractor #3 1 1/2" x 12" -----	2
17-3055	Crile Forceps Str 5 1/2" -----	12	60-3312	Deaver Retractor #4 2" x 12" -----	1
17-3155	Crile Forceps Cvd 5 1/2" -----	12	60-3598	Zalkind Ribbon Retractor 3/4" x 7" -----	2
19-1055	Dressing Forceps 5 1/2" -----	2	60-3610	Zalkind Retractor Malleable 1" x 13" -----	2
19-1080	Dressing Forceps 8" -----	2	60-3615	Zalkind Retractor Malleable 1 1/2" x 13" -----	2
19-1255	Tissue Forceps 1x2 5 1/2" -----	3	60-6162	Mathieu Retractor D/E Sharp 6 1/4" -----	2
19-1280	Tissue Forceps 1x2 8" -----	1	60-6164	Senn Retractor D/E Blunt 6 1/4" -----	2
19-2280	Russian Tissue Forceps 8" -----	2	60-6670	Balfour Abdominal Retractor 7" -----	1
21-8031	Mayo-Hegar NH Serr 6" T-C -----	2	74-3075	Schmidt Hemostat Half Cvd Jaws 7 1/2" -----	2
21-8032	Mayo-Hegar NH Serr 7" T-C -----	2	75-5670	Metzenbaum Scissors Cvd 7" -----	2
23-1106	Sklarlite Operating Scissors S/B St 5 1/2" -----	2	87-2195	Foerster Sponge Forceps Str Serr 9 1/2" -----	2
23-1130	Sklarlite Operating Scissors S/B Cvd 5 1/2" -----	2	87-2395	Foerster Sponge Forceps Cvd Serr 9 1/2" -----	2

MINOR BASIC SURGERY SET (98-1002)

PRODUCT NUMBER	DESCRIPTION	QUANTITY	PRODUCT NUMBER	DESCRIPTION	QUANTITY
06-2903	Scalpel Handle #3 -----	2	23-1167	Sklarlite Mayo Dissecting Scissors Cvd 6 3/4" -----	1
06-2904	Scalpel Handle #4 -----	2	30-1560	Probe D/E 6" -----	2
07-1805	Yankauer Suction Tube Stainless -----	2	36-2160	Allis Tissue Forceps 4x5 6" -----	3
15-2555	Mayo Dissecting Scissors Cvd 5 1/2" -----	1	47-1447	Brown Adson Tissue Forceps 4 3/4" -----	2
15-2567	Mayo Dissecting Scissors Cvd 6 3/4" -----	1	47-2955	Backhaus Towel Clamp 5 1/4" -----	12
17-1450	Halsted Mosquito Forceps Str 5" -----	6	50-2008	Frazier Suction Tube 8 Fr -----	1
17-1550	Halsted Mosquito Forceps Cvd 5" -----	6	60-1075	Goelet D/E Retractor 1 1/4" x 1 1/2" -----	2
17-3055	Crile Forceps Str 5 1/2" -----	12	60-1085	US Army Retractor Set/2 8 1/2" -----	2
17-3155	Crile Forceps Cvd 5 1/2" -----	12	60-3598	Zalkind Ribbon Retractor 3/4" x 7" -----	2
19-1055	Dressing Forceps 5 1/2" -----	2	60-6162	Senn Retractor D/E Sharp 6 1/4" -----	2
19-1080	Dressing Forceps 8" -----	1	60-6164	Senn Retractor D/E Blunt 6 1/4" -----	2
19-1255	Tissue Forceps 1x2 5 1/2" -----	3	75-5670	Metzenbaum Scissors Cvd 7" -----	2
21-8031	Mayo-Hegar NH Serr 6" T-C -----	2	87-2195	Foerster Sponge Forceps Str Serr 9 1/2" -----	2
23-1102	Sklarlite Operating Scissors SS St 5 1/2" -----	2	87-2395	Foerster Sponge Forceps Cvd Serr 9 1/2" -----	2
23-1166	Sklarlite Mayo Dissecting Scissors Cvd 5 1/2" -----	1			



INFANT LAPAROTOMY SET (98-1022)

PRODUCT NUMBER	DESCRIPTION	QUANTITY	PRODUCT NUMBER	DESCRIPTION	QUANTITY
22-9030	Baby Balfour Retr -----	1	17-1550	Halsted Mosquito Cvd 5" -----	6
60-3596	Ribbon Ret 1/2" x 7" -----	1	22-6155	Babcock 5 1/2" -----	3
60-3598	Deaver Retr 3/4" x 7" -----	1	22-6157	Allis 5 1/2" 4 x 5 -----	3
22-8360	Miller-Senn Retr Sharp -----	1	47-2047	Adson Tissue Forceps 1 x 2 4 3/4" -----	1
22-8460	Miller-Senn Retr Blunt -----	1	47-2147	Adson Dressing Forceps Serr 4 3/4" -----	1
60-1350	Parker Retr Set of 2 -----	1	22-4350	Semkin Tissue Forceps 5" -----	1
22-3555	Rochester-Pean 5 1/2" Str -----	3	22-4150	Semkin Dressing Forceps 5" -----	1
22-3655	Rochester-Pean 5 1/2" Cvd -----	3	14-1055	Operating Scissors S/B 5 1/2" -----	1
18-1752	Rochester-Ochsner 5 1/2" Str -----	3	22-1070	Metzenbaum 7" Delicate Cvd -----	1
18-1852	Rochester-Ochsner 5 1/2" Cvd -----	3	22-1057	Metzenbaum-Lahey 5 3/4" Cvd -----	1
17-3055	Crile Fcps Str 5 1/2" -----	4	06-2903	Scalpel Handle #3 -----	2
17-3155	Crile Fcps Cvd 5 1/2" -----	4	74-1470	Sponge Forceps 7" Str Serr -----	2
17-1450	Halsted Mosquito Str 5" -----	6	22-6585	Pediatric Yankauer Suction Tube -----	1

GYNECOLOGICAL SURGERY SET (98-1016)

PRODUCT NUMBER	DESCRIPTION	QUANTITY	PRODUCT NUMBER	DESCRIPTION	QUANTITY
06-2903	Scalpel Handle #3 -----	1	36-2295	Allis Tissue Forceps 5x6 10" -----	2
06-2904	Scalpel Handle #4 -----	1	47-2955	Backhaus Towel Clamp 5 1/4" -----	8
06-2915	Scalpel Handle #3L -----	1	51-4382	Potts-Smith Dressing Forceps 8 1/4" T-C -----	1
06-2920	Scalpel Handle #4L -----	1	55-9090	Metz-Nelson Scissors Cvd 9" -----	1
07-1805	Yankauer Suction Tube Stainless -----	1	55-9190	Metz-Nelson Scissors Str 9" -----	1
14-2065	Operating Scissors 6 1/2" Cvd SH/BI -----	1	80-1410	Bozeman Forceps Dbl Cvd 10" -----	2
17-1055	Pratt T-Shaped Clamp Str 5 1/2" -----	2	87-2195	Foerster Sponge Forceps Str Serr 9 1/2" -----	2
17-2280	Roch-Pean Forceps Cvd 8" -----	3	90-1590	Mayo Dissecting Scissors Str 9" -----	1
17-2480	Roch-Pean Forceps Str 8" -----	3	90-1690	Mayo Dissecting Scissors Cvd 9" -----	1
17-2680	Roch-Ochsner Forceps Cvd 8" -----	3	90-1977	Heaney Forceps Lght Single Tooth 7 3/4" -----	2
17-2880	Roch-Ochsner Forceps Str 8" -----	3	90-2177	Heaney Forceps Heavy Single Tooth 7 3/4" -----	2
17-3062	Crile Forceps Str 6 1/4" -----	6	90-2680	Phaneuf Uterine Artery Forceps Ang 8" -----	2
17-3162	Crile Forceps Cvd 6 1/4" -----	6	90-2782	De Alvarez Forceps 8 1/4" -----	2
19-1080	Dressing Forceps 8" -----	1	90-3030	Eastman Retractor Sm Bld 3" x 1 1/2" -----	1
19-1280	Tissue Forceps 1x2 8" -----	2	90-3035	Eastman Retractor Mdm Bld 3 1/2" x 1 1/2" -----	1
19-2280	Russian Tissue Forceps 8" -----	1	90-3040	Eastman Retractor Lrg Bld 4" x 1 1/2" -----	1
19-2310	Russian Tissue Forceps 10" -----	1	90-3526	Auward Speculum Med 2.5 Lbs Bld -----	1
20-2480	Mayo-Hegar NH 8" -----	1	90-3700	Graves Vaginal Speculum Sm 3/4" x 3" -----	1
20-4682	Heaney NH 8 1/4" -----	2	90-3701	Graves Vaginal Speculum Med 1 1/2" x 4" -----	1
21-8032	Mayo-Hegar NH Serr 7" T-C -----	2	90-3702	Graves Vaginal Speculum Lrg 1 3/8" x 4 1/2" -----	1
21-8033	Mayo-Hegar NH Serr 8" T-C -----	2	90-4926	Hank Dilator St Of 6 In Khaki Roll -----	1
23-1102	Sklarlite Operating Scissors SS St 5 1/2" -----	1	90-5413	Simpson Sound Cm Graduation -----	1
23-1106	Sklarlite Operating Scissors SB St 5 1/2" -----	1	90-7995	Schweizer Uter/Cerv Forceps 9 1/2" -----	1
34-2023	Poole Suction Tube Slip on Stn 23 Fr -----	2	91-1290	Schroeder Tenaculum Forceps 9 1/2" -----	2
36-2275	Allis Tissue Forceps 5x6 7 1/2" -----	2	97-1560	Allis Grasping Forceps 7 1/2" T-C -----	2

HYSTERECTOMY SET (98-1024) USED WITH MAJOR BASIC SET

PRODUCT NUMBER	DESCRIPTION	QUANTITY	PRODUCT NUMBER	DESCRIPTION	QUANTITY
87-2195	Foerster Sponge Forceps Straight 9½" -----	2	17-2680	Rochester-Ochsner Forceps Curved 8" -----	4
36-2295	Allis Tissue Forceps 5 x 6 Teeth 9½" -----	2	15-2567	Mayo Dissecting Scissors Cvd 6¾" -----	1
55-2894	Mixer Rt. Angle Forceps -----	2	55-9080	Metzenbaum Scissors Curved -----	1
74-3075	Schmidt Curved Hemostat -----	2	19-2280	Russian Tissue Forceps -----	1
20-4682	Heaney Needle Holders -----	2	52-5195	DeBakey Tissue Forceps -----	1
90-2380	Heaney Clamps -----	6	06-2915	Scalpel Handle #3L -----	1
90-2480	Heaney-Ballentine Clamps Str -----	2	60-3090	Deaver Retractor 1" x 9" -----	1
90-2580	Heaney-Ballentine Clamps Cvd -----	1	60-3112	Deaver Retractor 1" x 12" -----	1
17-2880	Rochester-Ochsner Forceps Straight 8" -----	8	60-3212	Deaver Retractor 1½" x 12" -----	1

D AND C SET (98-1014)

PRODUCT NUMBER	DESCRIPTION	QUANTITY	PRODUCT NUMBER	DESCRIPTION	QUANTITY
06-2903	Scalpel Handle #3 -----	1	90-3701	Graves Vaginal Speculum Med 1¼" x 4" -----	1
06-2907	Scalpel Handle #7 -----	1	90-3702	Graves Vaginal Speculum Lrg 1¾" x 4½" -----	1
06-2915	Scalpel Handle #3L -----	1	90-3710	Pederson Vaginal Speculum Sm ½" x 3" -----	1
17-3062	Crile Forceps Str 6¼" -----	6	90-3995	Kogan Endospec W/Gauge & Screws -----	1
17-3162	Crile Forceps Cvd 6¼" -----	6	90-4713	Goodell Dilator Lrg 13" -----	1
19-1080	Dressing Forceps 8" -----	1	90-4826	Hegar Dilators St Of 8 In Khaki Roll -----	1
19-1280	Tissue Forceps 1x2 8" -----	1	90-5312	Sims Sound Pln 12½" -----	1
21-1260	Crile-Murray NH Serr 6" T-C Sklar Grip -----	1	90-5422	Sims Curette Sharp 11" #2 -----	1
21-8032	Mayo-Hegar NH Serr 7" T-C -----	1	90-5423	Sims Curette Sharp 11" #3 -----	1
47-2955	Backhaus Towel Clamp 5¼" -----	6	90-5424	Sims Curette Sharp 11" #4 -----	1
80-1410	Bozeman Forceps Dbl Cvd 10" -----	1	90-5425	Sims Curette Sharp 11" #5 -----	1
87-2395	Foerster Sponge Forceps Cvd Serr 9½" -----	2	90-6612	Kevork-Young Endo Cur W/Basket 12" -----	1
90-3130	Jackson Retractor Sm Bld 3" x 1½" -----	1	91-1290	Schroeder Tenaculum Forceps 9½" -----	1
90-3135	Jackson Retractor Mdm Bld 3½" x 1½" -----	1	92-5095	Javerts Forceps Serr Jaws 9½" -----	1
90-3526	Auward Speculum Med 2.5 lbs Bld 7x3.8 Cm -----	1			

SMALL GYN BIOPSY SET (98-1026)

PRODUCT NUMBER	DESCRIPTION	QUANTITY	PRODUCT NUMBER	DESCRIPTION	QUANTITY
91-1290	Schroeder Tenaculum Forceps 9½" -----	1			
90-3990	Kogen Endocervical Speculum Narrow -----	1			
90-8335	Quick Release Iris Hook 9" -----	1			
90-6612	Kevorkian Curette With Basket -----	1			
90-7525	Sklar Oval Biopsy Forceps 3 x 5 mm -----	1			

GYNECOLOGICAL BIOPSY SET (98-1018)

PRODUCT NUMBER	DESCRIPTION	QUANTITY	PRODUCT NUMBER	DESCRIPTION	QUANTITY
80-1410	Bozeman Forceps Dbl Cvd 10" -----	1	90-5413	Simpson Sound Cm Graduation -----	1
87-2195	Foerster Sponge Forceps Str Serr 9½" -----	2	90-5423	Sims Curette Sharp 11" #3 -----	1
87-2395	Foerster Sponge Forceps Cvd Serr 9½" -----	2	90-6292	Novak Endometr Cur 9¼" 4mm -----	1
90-3526	Auward Speculum Med 2.5Lbs Bld -----	1	90-6612	Kevork-Young Endo Cur W/Bas 12" -----	1
90-3700	Graves Vaginal Speculum Sm ¾" x 3" -----	1	90-6887	Tischler Cerv Biopsy Forceps 8½" -----	1
90-3701	Graves Vaginal Speculum Med ¼" x 4" -----	1	90-7492	Gelhorn Biopsy Forceps 9½" -----	1
90-3702	Graves Vaginal Speculum Lrg 1¾" x 4½" -----	1	90-7710	Bozeman Dbl Cvd 1 Large Ring 10¼" -----	1
90-3995	Kogan Endospec W/Gauge & Screws -----	1	91-1290	Schroeder Tenaculum Forceps 9½" -----	1



OBSTETRICAL SET (98-1020)

PRODUCT NUMBER	DESCRIPTION	QUANTITY	PRODUCT NUMBER	DESCRIPTION	QUANTITY
14-1060	Operating Scissors Str 6" Sh/Bl	1	21-8032	Mayo-Hegar NH Serr 7" T-C	2
14-2060	Operating Scissors Cvd 6" Sh/Bl	1	21-8033	Mayo-Hegar NH Serr 8" T-C	1
15-1567	Mayo Dissecting Scissors Str 6 3/4"	1	36-2380	Allis-Thoms Forceps 6x7 8"	1
16-1610	S E Mayo Diss Scissors Cvd 6 3/4" T-C	1	47-2955	Backhaus Towel Clamp 5 1/4"	12
17-2272	Roch-Pean Forceps Cvd 7 1/4"	3	87-2395	Foerster Sponge Forceps Cvd Serr 9 1/2"	2
17-2472	Roch-Pean Forceps Str 7 1/4"	3	90-1755	Braun Epstmy Ang 5 1/2"	1
17-2880	Roch-Ochsner Forceps Str 8"	1	90-3035	Eastman Retractor Mdm Bld 3 1/2" x 1 1/2"	1
17-3062	Crile Forceps Str 6 1/4"	3	90-3040	Eastman Retractor Lrg Bld 4 x 1 1/2"	1
17-3162	Crile Forceps Cvd 6 1/4"	6	91-4310	Iowa Puncturing Forceps 10"	1
19-1060	Dressing Forceps 6"	2	92-1114	Simpson Ob Forceps Long 14 1/4"	1
19-1260	Tissue Forceps 1x2 6"	2	92-2215	McLane-Tuck-Luikart Ob Forceps 15 1/2"	1
19-2280	Russian Tissue Forceps 8"	2	92-2314	Simpson Luikart Ob Forceps 14"	1

CESAREAN SECTION SET (98-1028) USED WITH MAJOR BASIC SET

PRODUCT NUMBER	DESCRIPTION	QUANTITY	PRODUCT NUMBER	DESCRIPTION	QUANTITY
90-1590	Mayo Dissecting Scissors Straight 9" -----	1	90-3135	Jackson Vaginal Retractor -----	1
90-1690	Mayo Dissecting Scissors Curved 9" -----	1	90-2680	Phaneuf Forceps Angular 8" -----	2
20-2910	Masson Meedle Holder 10 1/2" -----	1	87-2195	Foerster Sponge Serr Str 9 1/2" -----	1
21-8060	Heany Needle Holder Curved 8 1/4" T-C -----	1	92-1012	DeLee Obstetrical Forceps 12" -----	1

RECTAL SURGERY SET (98-1012)

PRODUCT NUMBER	DESCRIPTION	QUANTITY	PRODUCT NUMBER	DESCRIPTION	QUANTITY
06-2903	Scalpel Handle #3	1	36-2275	Allis Tissue Forceps 5x6 7 1/2"	2
06-2904	Scalpel Handle #4	1	47-2955	Backhaus Towel Clamp 5 1/4"	6
13-1055	Operating Scissors Str Sh/Sh 5 1/2"	1	50-2010	Frazier Suction Tube 10 Fr	1
14-1055	Operating Scissors Str Sh/Bl 5 1/2"	1	50-2012	Frazier Suction Tube 12 Fr	1
15-1555	Mayo Dissecting Scissors Str 5 1/2"	1	75-5670	Metzenbaum Scissors Cvd 7"	1
15-2567	Mayo Dissecting Scissors Cvd 6 3/4"	1	80-1735	Yeoman Rectal Punch 13 3/8"	1
17-1055	Pratt T-Shaped Clamp Str 5 1/2"	2	80-2132	Pratt Rectal Speculum Lrg	1
17-2055	Kelly Forceps Str 5 1/2"	6	80-2688	Hirschman Anoscope Sm	1
17-2155	Kelly Forceps Cvd 5 1/2"	6	80-2689	Hirschman Anoscope Med	1
17-2272	Roch-Pean Forceps Cvd 7 1/4"	3	80-2690	Hirschman Anoscope Lrg	1
17-2472	Roch-Pean Forceps Str 7 1/4"	3	80-2715	Buie Suction Tube W/Valve 15 Fr	1
17-2880	Roch-Ochsner Forceps Str 8"	2	80-2870	Larry Rectal Probe 7 1/8"	1
17-2957	Pennington Clamp Str 6"	2	80-3185	Pratt Crypt Hook Short 8 1/2"	1
19-1060	Dressing Forceps 6"	1	80-3510	Barr Crypt Hook D/E 10 1/2"	1
19-1260	Tissue Forceps 1x2 6"	1	80-3927	Sawyer Retractor Sklar Grip Hdl Med	1
21-1260	Crile-Murray NH Serr 6" T-C SG	2	80-3935	Sawyer Retractor Sklar Grip Hdl Lrg	1
21-8032	Mayo-Hegar NH Serr 7" T-C	1	87-2395	Foerster Sponge Forceps Cvd Serr 9 1/2"	2
36-2160	Allis Tissue Forceps 4x5 6"	2			



RUDD CLINIC HEMORRHOIDAL LIGATION SET (80-1014)

PRODUCT NUMBER	DESCRIPTION	QUANTITY	PRODUCT NUMBER	DESCRIPTION	QUANTITY
80-2245	Rectal Speculum	1			
80-1872	Grasping Forceps	1			
80-1972	100 "O" Rings	1			
80-1910	Ligator	1			

PLASTIC SURGERY SET (98-1004)

PRODUCT NUMBER	DESCRIPTION	QUANTITY	PRODUCT NUMBER	DESCRIPTION	QUANTITY
17-1235	Hartmann Mosquito Str Del Ser 3½"	3	17-1235	Hartmann Mosquito Str Del Ser 3½"	3
17-1335	Hartmann Mosquito Cvd Del Ser 3½"	3	17-1335	Hartmann Mosquito Cvd Del Ser 3½"	3
17-1450	Halsted Mosquito Forceps Str 5"	6	17-1450	Halsted Mosquito Forceps Str 5"	6
17-1550	Halsted Mosquito Forceps Cvd 5"	6	17-1550	Halsted Mosquito Forceps Cvd 5"	6
20-2070	Mayo-Hegar NH 7"	1	20-2070	Mayo-Hegar NH 7"	1
21-1260	Crile-Murray NH Serr 6" T-C Sklar Grip	1	21-1260	Crile-Murray NH Serr 6" T-C Sklar Grip	1
21-8013	Ryder Micro NH Serr 6" T-C	1	21-8013	Ryder Micro NH Serr 6" T-C	1
22-2760	Reynolds Sciss Nar Tip Cvd 6"	1	22-2760	Reynolds Sciss Nar Tip Cvd 6"	1
22-2652	Ragnell Dissecting Scissors Cvd 5"	1	22-2652	Ragnell Dissecting Scissors Cvd 5"	1
22-4150	Semkin Dressing Forceps Nar 5"	2	22-4150	Semkin Dressing Forceps Nar 5"	2
22-4350	Semkin Tissue Forceps Narrow 1x2 5"	2	22-4350	Semkin Tissue Forceps Narrow 1x2 5"	2
22-8360	Miller-Senn Retractor Sh D/E 6"	1	22-8360	Miller-Senn Retractor Sh D/E 6"	1
22-8460	Miller-Senn Retractor BI D/E 6"	1	22-8460	Miller-Senn Retractor BI D/E 6"	1
22-9027	Alm Retractor 2¾"	1	22-9027	Alm Retractor 2¾"	1
23-1106	Sklarlite Operating Scissors S/B St 5½"	2	23-1106	Sklarlite Operating Scissors S/B St 5½"	2
23-1158	Sklarlite Strabismus Scissors Str 4½"	1	23-1158	Sklarlite Strabismus Scissors Str 4½"	1
23-1164	Sklarlite Mayo Dissecting Scissors Str 5½"	1	23-1164	Sklarlite Mayo Dissecting Scissors Str 5½"	1
23-1167	Sklarlite Mayo Dissecting Scissors Cvd 6¾"	1	23-1167	Sklarlite Mayo Dissecting Scissors Cvd 6¾"	1
23-1280	Sklarlite Sklarcut Scissors Blunt Cvd 5¾"	1	23-1280	Sklarlite Sklarcut Scissors Blunt Cvd 5¾"	1
23-2510	Sklarlite XD Crile Forceps Str 5½"	12	23-2510	Sklarlite XD Crile Forceps Str 5½"	12
23-2513	Sklarlite XD Crile Forceps Cvd 5½"	12	23-2513	Sklarlite XD Crile Forceps Cvd 5½"	12
47-1047	Wagner Scissors Str S/S 4¾"	2	47-1047	Wagner Scissors Str S/S 4¾"	2
47-1068	Wagner Scissors Cvd S/B 4¾"	1	47-1068	Wagner Scissors Cvd S/B 4¾"	1
47-1447	Brown Adson Tissue Forceps 4¾"	2	47-1447	Brown Adson Tissue Forceps 4¾"	2
47-2834	Jansen Retractor Sh 3x3 4"	1	47-2834	Jansen Retractor Sh 3x3 4"	1
50-1372	Adson Forceps Str 7¼"	3	50-1372	Adson Forceps Str 7¼"	3
50-1472	Adson Forceps Cvd 7¼"	3	50-1472	Adson Forceps Cvd 7¼"	3
50-2012	Frazier Suction Tube 12 Fr	2	50-2012	Frazier Suction Tube 12 Fr	2
50-3047	Adson Tissue Forceps 1x2 4¾"	1	50-3047	Adson Tissue Forceps 1x2 4¾"	1
50-3147	Adson Dressing Forceps Serr 4¾"	1	50-3147	Adson Dressing Forceps Serr 4¾"	1
55-2855	Gemini Clamp Del Ang 5½"	2	55-2855	Gemini Clamp Del Ang 5½"	2
57-1445	Crile Retractor D/E Small	2	57-1445	Crile Retractor D/E Small	2
60-3598	Zalkind Ribbon Retractor ¾" x 7"	2	60-3598	Zalkind Ribbon Retractor ¾" x 7"	2

BASIC PLASTIC SURGERY SET (98-1030)

PRODUCT NUMBER	DESCRIPTION	QUANTITY	PRODUCT NUMBER	DESCRIPTION	QUANTITY
50-2007	Frazer Suction Tube 7 Fr.	1	50-3047	Adson Tissue Forceps 1 x 2 4¾"	1
50-1953	Baron Suction Tube 3 Fr.	1	50-3147	Adson Dressing Forceps Serrated 4¾"	1
50-1955	Baron Suction Tube 5 Fr.	1	22-9027	Alm Retractor 2¾"	1
22-4150	Semkin Tissue Forceps 1 x 2 5"	1	22-2652	Ragnell Dissecting Scissors Curved 5"	1
22-4350	Semkin Tissue Forceps Serrated 5"	1	65-6357	Castroviejo Needle Holder Smooth	1
47-1145	Iris Scissors Straight 4½"	1	21-8000	Halsey Needle Holder Smooth T-C 5"	1
47-1245	Iris Scissors Curved 4½"	1			



BASIC PODIATRY (98-1010)

PRODUCT NUMBER	DESCRIPTION	QUANTITY	PRODUCT NUMBER	DESCRIPTION	QUANTITY
06-2903	Scalpel Handle #3 -----	1	23-2110	Sklarlite Crile Forceps Str 5½" -----	3
06-3052	Surgical Blades Non-Ster #11 100'S -----	1	23-2113	Sklarlite Crile Forceps Cvd 5½" -----	3
06-3056	Surgical Blades Non-Ster #15 100'S -----	1	23-2602	Sklarlite Adson Tissue 1x2 4 ¾" -----	2
11-1055	Lister Bandage Scissors 5½" -----	1	40-9825	Joseph Rasp Str Hndl 6 1/2" -----	1
11-1255	Knowles Bandage Scissors 5½" -----	1	47-2380	Freer D/E Dissector S/B 7" -----	1
13-1055	Operating Scissors Str Sh/Sh 5½" -----	1	47-2935	Backhaus Towel Clamp 3½" -----	6
15-1355	Stitch Scissors Standard 5½" -----	1	50-1355	Dandy Scalp Hemostatic Forcep 5½" -----	1
16-2800	Wire Cut Scissors Ang 4 ¾" T-C -----	1	50-2006	Frazier Suction Tube 6 Fr -----	2
17-1450	Halsted Mosquito Forceps Str 5" -----	3	50-3147	Adson Dressing Forceps Serr 4 ¾" -----	2
17-1550	Halsted Mosquito Forceps Cvd 5" -----	3	97-0104	Cuticle Scissors Rng Hdl Chr 4" -----	1
19-1055	Dressing Forceps 5½" -----	2	97-0335	Tissue Nipper 4" 9mm Cnxv Jaw -----	1
19-1255	Tissue Forceps 1x2 5½" -----	1	97-0532	Curette/Exc D/E #58 1-2 -----	1
19-3045	Standard Fine Splntr Forceps 4½" -----	1	97-0536	Curette/Exc D/E #58 1-3 -----	1
21-8002	Webster NH Smooth 5" T-C -----	1	97-0542	Spatula And Packer D/E #91 -----	1
21-8027	Olsen-Hegar NH Serr 5½" T-C -----	1	97-0545	Corn Chisel Cvd Edge Spoon -----	1
23-1102	Sklarlite Operating Scissors SS St 5½" -----	1	97-0554	Ingrown Nail Inst Fenestrated -----	1
23-1106	Sklarlite Operating Scissors SB St 5½" -----	1	97-1150	Ingrn Nail Splitr Dbl Spr Stnl -----	1
23-1189	Sklarlite Spencer Stitch Scissors 4½" -----	1	97-1318	Platypus Nail Forceps Wide 5¼" -----	1

SURGICAL INSTRUMENT SETS

BASIC HAND SURGERY SET (98-1008)

PRODUCT NUMBER	DESCRIPTION	QUANTITY	PRODUCT NUMBER	DESCRIPTION	QUANTITY
06-2860	Metal Ruler 6" -----	1	23-2105	Sklarlite Halsted Mosquito Str 5" -----	6
06-2903	Scalpel Handle #3 -----	1	23-2106	Sklarlite Halsted Mosquito Cvd 5" -----	6
06-2904	Scalpel Handle #4 -----	1	23-2600	Sklarlite Adson Dressing Ser 4 ¾" -----	1
16-2800	Sklar Edge Wire Cut Scissors Ang 4 ¾" T-C -----	1	23-2602	Sklarlite Adson Tissue 1x2 4 ¾" -----	2
17-2655	Roch-Ochsner Forceps Cvd 5 ½" -----	1	23-2603	Sklarlite Adson-Brown Sd-Grsp 4 ¾" -----	1
17-2855	Roch-Ochsner Forceps Str 5½" -----	1	23-2851	Sklarlite Allis Forceps 4x5 6" -----	1
18-2257	Allis Tenaculum Forceps Del 5¾" -----	2	23-2861	Sklarlite XD Allis Forceps 4x5 5" -----	1
21-8004	Derf NH Serr 4¾" T-C -----	1	22-2760	Reynolds Scissors Serr Cvd 6" -----	1
21-8006	Crile-Wood NH Serr Narrow 6" T-C -----	1	47-2380	Freer D/E Dissector S/B 7" -----	1
21-8013	Ryder Micro NH Serr 6" T-C -----	1	47-2500	Joseph Hook 1/Pr Sh 6¼" -----	2
22-1241	Stevens Tenot Scissors Cvd 4½" -----	1	47-2502	Joseph Hook 2/Pr Sh 6 ¼" 2 mm -----	2
22-1342	Stevens Tenot Scissors Cvd 4½" -----	1	47-2935	Backhaus Towel Clamp 3½" -----	2
22-2545	Metz Lahey Scissors Cvd 4½" -----	1	47-2955	Backhaus Towel Clamp 5¼" -----	6
22-4250	Semkin Dressing Forceps Del 5" -----	1	50-1290	Cushing Nerve/Vein Retractor 9" -----	1
22-4450	Semkin Tissue Forceps Del 1x2 5" -----	2	50-2007	Frazier Suction Tube 7 Fr -----	1
22-8360	Miller-Senn Retractor Sh D/E 6" -----	1	50-2008	Frazier Suction Tube 8 Fr -----	1
23-1153	Sklarlite XD Iris Scissors Str 4½" -----	1	57-1445	Crile Retractor D/E 4½" -----	1
23-1155	Sklarlite XD Iris Scissors Cvd 4½" -----	1	60-1085	US Army Retractor Set/2 8½" -----	1
23-1168	Sklarlite XD Mayo Dissecting Str 5½" -----	1	60-6162	Senn Retractor D/E Sharp 6¼" -----	1
23-1170	Sklarlite XD Mayo Dissecting Cvd 5½" -----	1	74-1470	Ballenger Sponge Forceps Serr Str 7" -----	2
23-1175	Sklarlite Metz-Lahey Scissors Cvd 6" -----	1	74-1670	Ballenger Sponge Forceps Serr Cvd 7" -----	2
23-2100	Sklarlite Hartmann Mosquito Str 3½" -----	3	87-2195	Foerster Sponge Forceps Serr Str 9½" -----	2
23-2101	Sklarlite Hartmann Mosquito Cvd 3½" -----	3			



BASIC ORTHOPEDIC SURGERY SET (98-1006)

PRODUCT NUMBER	DESCRIPTION	QUANTITY	PRODUCT NUMBER	DESCRIPTION	QUANTITY
98-1006	Complete Set		40-2480	Kern Bone Forceps w/o Ratchet Xsm 5 ³ / ₄ "	1
06-2860	Metal Ruler 6"	1	40-2485	Kern Forceps 8 ¹ / ₂ "	1
06-2903	Scalpel Handle #3	1	40-2670	Lewin Bone Forceps Serr 7"	1
06-2904	Scalpel Handle #4	1	40-2922	Lowman Clamp Small Jaw 1 ¹ / ₈ "	1
11-1060	Lister Bandage Scissors Large Rng 8"	1	40-2925	Lowman Clamp 4 ³ / ₄ " 1x1 ¹ / ₂ " Jaw	1
13-1055	Operating Scissors 5 ¹ / ₂ " Str Sh/Sh	1	40-3177	Liston Bone Forceps Ang 7 ³ / ₄ "	1
14-1055	Operating Scissors 5 ¹ / ₂ " Str Sh/Bl	2	40-3710	Stille-Liston Bone Forceps Str 10 ¹ / ₂ "	1
14-2055	Operating Scissors 5 ¹ / ₂ " Cvd Sh/Bl	1	40-4270	Beyer Rongeur Cvd On Flat 7"	1
15-1355	Stitch Scissors Standard 5 ¹ / ₂ "	1	40-4272	Ruskin Rongeur Str 7 ¹ / ₄ "	1
15-1567	Mayo Dissecting Scissors Str 6 ³ / ₄ "	1	40-5780	Hajek Bone Mallet 8"	1
15-2567	Mayo Dissecting Scissors Cvd 6 ³ / ₄ "	2	40-6667	Hibbs Osteotome 9 ¹ / ₂ " x 10 mm	1
16-2800	S E Wire Cut Scissors Ang 4 ³ / ₄ " T-C	1	40-6668	Hibbs Osteotome 9 ¹ / ₂ " x 13 mm	1
17-1772	Mixer Forceps Rt Ang 7 ¹ / ₄ "	4	40-6711	Hibbs Chisel 9 ¹ / ₂ " x 10 mm	1
17-2055	Kelly Forceps Str 5 ¹ / ₂ "	12	40-6715	Hibbs Chisel 9 ¹ / ₂ " x 13 mm	1
17-2155	Kelly Forceps Cvd 5 ¹ / ₂ "	12	40-7400	Key Elevator 7 ¹ / ₂ " x 1 ¹ / ₄ "	1
17-2272	Roch-Pean Forceps Cvd 7 ¹ / ₄ "	3	40-7402	Key Elevator 7 ¹ / ₂ " x 1 ¹ / ₂ "	1
17-2472	Roch-Pean Forceps Str 7 ¹ / ₄ "	3	40-9365	Sayre Elevator Blunt D/E 6 ¹ / ₂ "	1
19-1055	Dressing Forceps 5 ¹ / ₂ "	2	42-1765	Weitlaner-Beckman Retractor Sh 6"	1
19-1080	Dressing Forceps 8"	2	42-1965	Weitlaner Retractor Sh 3x4 6 ¹ / ₂ "	1
19-1255	Tissue Forceps 1x2 5 ¹ / ₂ "	2	47-2935	Backhaus Towel Clamp 3 ¹ / ₂ "	4
19-1280	Tissue Forceps 1x2 8"	2	47-2955	Backhaus Towel Clamp 5 ¹ / ₄ "	12
21-8032	Mayo-Hegar Nh Serr 7" T-C	1	50-2008	Frazier Suction Tube 8 Fr	1
21-8033	Mayo-Hegar Nh Serr 8" T-C	1	50-2010	Frazier Suction Tube 10 Fr	1
36-2160	Allis Tissue Forceps 4x5 6"	2	50-2012	Frazier Suction Tube 12 Fr	1
36-2275	Allis Tissue Forceps 5x6 7 ¹ / ₂ "	2	55-7175	Hibbs Retractor 2" x 5 ⁵ / ₈ " Bld 7 ¹ / ₂ "	2
40-1775	Needle Nose Pliers 5 ¹ / ₂ "	1	60-6162	Senn Retractor D/E Sharp 6 ¹ / ₄ "	2
40-2275	Bone/Cartilage Clamp Cvd 8"	1	60-6164	Senn Retractor D/E Blunt 6 ¹ / ₄ "	2



LAMINECTOMY SURGERY SET (98-1032)

PRODUCT NUMBER	DESCRIPTION	QUANTITY	PRODUCT NUMBER	DESCRIPTION	QUANTITY
98-1032	Complete Set		47-2955	Backhaus Towel Clamp 5 1/4"-----	12
06-2903	Scalpel Handle #3 -----	1	87-2195	Foerster Sponge Forceps Str Serr 9 1/2" -----	6
06-2904	Scalpel Handle #4 -----	1	42-3418	Love-Kerrison Rongeur 6" Upbite 5 mm -----	1
06-2907	Scalpel Handle #7 -----	1	42-3429	Love-Kerrison Rongeur 6" Downbite 5 mm -----	1
15-1567	Mayo Scissors Straight 6 3/4" -----	1	42-3150	Love-Gruenwald Rongeur 6" 2 x 10 mm -----	1
15-2567	Mayo Scissors Curved 6 3/4" -----	1	42-3156	Love-Gruenwald Rongeur Str 7" 3 x 10 mm -----	1
75-5570	Metzenbaum Scissors Curved 7" -----	1	42-3158	Love-Gruenwald Rongeur Upbite 7" 3 x 10 mm -----	1
14-1055	Operating Scissors S/B Straight 5 1/2" -----	1	42-3160	Love-Gruenwald Rongeur Downbite 7" 3 x 10 mm -----	1
14-2055	Operating Scissors S/B Curved 5 1/2" -----	1	40-7000	Spinal Curettes 8" 000-----	1
19-1055	Dressing Forceps 5 1/2" -----	1	40-7100	Spinal Curettes 8" 00 -----	1
19-1080	Dressing Forceps 8" Serrated -----	2	40-7110	Spinal Curettes 8" 0 -----	1
19-1255	Tissue Forceps 5 1/2" 1 x 2 -----	1	40-7111	Spinal Curettes 8" 1 -----	1
19-1280	Tissue Forceps 8" 1 x 2 -----	2	40-7112	Spinal Curettes 8" 2 -----	1
22-6770	Cushing Forceps Serrated 7" -----	1	40-7113	Spinal Curettes 8" 3 -----	1
22-6870	Cushing Forceps 1 x 2 7" -----	1	40-7114	Spinal Curettes 8" 4 -----	1
50-3371	Adson Bayonet Forceps 7 1/2" Serrated -----	1	40-7115	Spinal Curettes 8" 5 -----	1
17-1450	Halsted Straight 5" -----	12	40-7116	Spinal Curettes 8" 6 -----	1
17-1550	Halsted Curved 5" -----	12	40-3670	Luer Rongeur Curved-----	1
17-3062	Crile Straight 6 1/4" -----	12	40-4092	Leksell Rongeur Std Wide -----	1
17-3162	Crile Curved 6 1/4"-----	12	40-3910	Horsley Rongeur D/A Angular -----	1
36-2260	Allis Tissue Forceps 5 x 6 6" -----	4	40-3985	Stille Luer Rongeur Straight -----	1
57-1322	Beckman-Adson Retractor Sharp -----	2	40-4090	Stille Luer Rongeur Angular -----	1
42-1975	Weitlaner Retractor 8" Sharp -----	2	40-3710	Stille Liston Bone Cutter Straight-----	1

BASIC EYE SURGERY SET (98-1034)

PRODUCT NUMBER	DESCRIPTION	QUANTITY	PRODUCT NUMBER	DESCRIPTION	QUANTITY
98-1034	Complete Set		64-2342	Castroviejo Scissors Corneal Left 4 1/2"-----	1
06-2903	Scalpel Handle #3 -----	1	65-6357	T-C Castroviejo Needle Holder Straight W/Lock -----	1
06-2907	Scalpel Handle #7 -----	1	66-2740	Eye Dressing Forceps Serrated Straight 4"-----	1
64-1342	Stevens Tenotomy Scissors Curved Blunt 4 1/2"-----	1	66-2940	Eye Dressing Forceps Serrated Straight 4"-----	1
64-1242	Stevens Tenotomy Scissors Straight Blunt 4 1/2" -----	1	66-3340	Eye Dressing Forceps 1 x 2 Straight 4" -----	1
47-1235	Iris Scissors Straight 3 1/2"-----	1	66-3540	Eye Dressing Forceps 1 x 2 1/2" Curved 4" -----	1
47-1135	Iris Scissors Straight 4 1/2"-----	1	66-5340	Arruga Capsule Forceps -----	1
47-1245	Iris Scissors Curved 4 1/2" -----	1	65-1535	Castroviejo Eye Speculum -----	1
18-1050	Halsted Mosquito Forceps Straight 5" Delciate-----	2	65-1532	Lancaster Eye Speculum -----	1
18-1150	Halsted Mosquito Forceps Curved 5" Delciate -----	4	65-1842	Demarres Lid Retractor #2 -----	1
64-2242	Castroviejo Scissors Corneal Right 4 1/2"-----	1	47-2955	Backhaus Towel Clamps 3 1/2" -----	1

TONSIL SET (98-1036)

PRODUCT NUMBER	DESCRIPTION	QUANTITY	PRODUCT NUMBER	DESCRIPTION	QUANTITY
98-1036	Complete Set		75-2161	Wieder Tongue Depressor Large -----	1
75-5570	Metzenbaum Scissors Curved 7" -----	1	74-3075	Schmidt Tonsil Hemostats -----	2
15-2567	Mayo Scissors Curved 6 3/4"-----	1	75-6387	Hurd Dissector & Pillar Retractor-----	1
75-1015	Jennings Mouth Gag Small -----	1	17-2262	Rochester-Pean Forceps Curved 6 1/4"-----	2
75-1016	Jennings Mouth Gag Medium -----	1	06-2907	Scalpel Handle #7 -----	1
75-1017	Jennings Mouth Gag Large -----	1	47-2955	Backhaus Towel Clamps 5 1/2" -----	1
36-2275	Allis Tissue Forceps 7 1/2" -----	1	87-2195	Sponge Forceps Serrated Straight 9 1/2" -----	1
07-1805	Yankauer Suction Tube Stainless-----	1	20-1270	Crile Wood Needle Holder 7" -----	1
74-2575	Tonsil Forceps White 7 1/2" -----	2	75-9612	Hartman Tonsil Punch-----	1
75-2160	Wieder Tongue Depressor Small -----	1	75-2320	Love Urula Retractor-----	1



MYRINGOTOMY SET (98-1038)

PRODUCT NUMBER	DESCRIPTION	QUANTITY	PRODUCT NUMBER	DESCRIPTION	QUANTITY
47-1145	Iris Scissors Straight Sharp/Sharp -----	1	50-1957	Baron Suction Tube 7 Fr-----	1
68-1765	Applicator Twist End 6½" -----	1	67-1150	Wilde Ear Forceps Delicate 5" -----	1
68-1865	Applicator Triangle End 6½" -----	1	67-2515	Buck Ear Curette Straight Sharp #0 -----	1
67-2005	Ear Knife -----	1	67-2516	Buck Ear Curette Straight Sharp #1 -----	1
67-6010	Boucheron Ear Speculum Set of 4 -----	1	67-2490	Buck Ear Curette Straight Blunt #0-----	1
67-6025	Boucheron Ear Speculum Infant-----	1	67-2491	Buck Ear Curette Straight Blunt #1-----	1
50-1953	Baron Suction Tube 3 Fr-----	1	67-1036	Hartman Ear Forceps Delicate 3½"-----	1
50-1955	Baron Suction Tube 5 Fr-----	1			

MCGIVNEY HEMORRHOID LIGATOR SET (80-1945)

PRODUCT NUMBER	DESCRIPTION	QUANTITY	PRODUCT NUMBER	DESCRIPTION	QUANTITY
80-1872	Sklar Hemorrhoid Forceps 7¼" -----	1	80-2245	Ives Rectal Speculum -----	1
80-1950	McGivney Hemorrhoid Ligator, Complete With Loading Cone and 100 "O" Rings -----	1			

WILSON VASECTOMY SET (85-6222)

PRODUCT NUMBER	DESCRIPTION	QUANTITY	PRODUCT NUMBER	DESCRIPTION	QUANTITY
85-6223	Vas Fixation Fcp 5" Oval Tip -----	1			
85-6224	Vas Piercing Fcp 5" -----	1			

COLPOSCOPY SET (90-8557)

PRODUCT NUMBER	DESCRIPTION	QUANTITY	PRODUCT NUMBER	DESCRIPTION	QUANTITY
90-6612	Kogan Endo Speculum - Wide Wire Blades -----	1	90-7520	Tischler Oval Biopsy Forcep - 3mm x 7mm Bite-----	1
85-6224	Kevorkian-Young Endo Crtte - 12" With Basket -----	1	90-8334	Emmet (Iris) Hook - 4mm Dia, 9" Long, Quick Release -----	1

BASIC NAIL SET (98-1009)

PRODUCT NUMBER	DESCRIPTION	QUANTITY	PRODUCT NUMBER	DESCRIPTION	QUANTITY
97-1046	Nail Nipper Barrel Spring 5½" -----	1	97-1262	Littauer Cutting Forceps 6" -----	1
97-1242	Tissue Nippers 4½" -----	1	97-1662	Nail Splitter Tapered Jaw 5" -----	1
97-1255	Littauer Cutting Forceps 4 ½" -----	1			



BASIC TOTAL HIP SET (98-1011)

PRODUCT NUMBER	DESCRIPTION	QUANTITY	PRODUCT NUMBER	DESCRIPTION	QUANTITY
98-1011	Complete Set		40-6666	ibbs Osteotome 6 mm 9½" -----	1
06-2860	Metal Ruler 6" -----	1	40-6667	Hibbs Osteotome 10 mm 9½" -----	1
06-2904	Scalpel Handle #4 -----	2	40-6668	Hibbs Osteotome 13 mm 9½" -----	1
06-2907	Scalpel Handle #7 -----	1	40-6855	Bone Hook "T" Handle Large" -----	1
07-1805	Yankauer Suction Tube -----	1	40-7451	Mini Hohmann Bone Elevator 8 mm 6½" -----	1
15-1567	Mayo Dissecting Scissors Str 6¾" -----	1	40-7453	Hohmann Bone Elevator 43 mm 10¾" -----	1
15-2567	Mayo Dissecting Scissors Cvd 6¾" -----	1	40-7455	Hohmann Bone Elevator 20 mm 10¾" -----	1
17-1450	Halsted Mosquito Forceps Str 5" -----	6	40-9712	Putti Bone Rasp Flat End / Conic End 12" -----	1
17-2280	Rochester-Pean Forceps Cvd 8" -----	2	42-1965	Weitlaner Retractor 3 x 4 Prongs Sharp 6½" -----	2
17-2880	Rochester-Ochsner Forceps Str 8" -----	2	47-2935	Backhaus Towel Clamp 3½" -----	6
17-3162	Crile Forceps Cvd 6¼" -----	6	47-2955	Backhaus Towel Clamp 5¼" -----	2
19-1255	Tissue Forceps 1 x 2 Teeth 5½" -----	2	50-1472	Adson Forceps Cvd 7¼" -----	4
19-1655	Tissue Forceps 3 x 4 Teeth 5½" -----	2	55-7175	Hibbs Retractor 2" x 5/8" Blade 9" -----	2
19-2280	Russian Tissue Forceps 8" -----	2	55-9080	Metzenbaum Scissors Cvd 8" -----	1
20-1270	Crile-Wood Needle Holder (DeBakey) 7" -----	2	60-1699	Richardson-Eastman Retractor Dble End Sm -----	1
20-2480	Mayo-Hegar Needle Holder 8" -----	2	60-5604	olkman Retractor 4 Prong Sharp 8½" -----	2
36-2275	Allis Tissue Forceps 5 x 6 Teeth 7½" -----	2	60-5606	Volkman Retractor 6 Prong Sharp 8½" -----	2
40-3188	Beyer Rongeur Cvd 7" -----	1	60-6570	Gelpi Retractor 7" -----	1
40-3985	Stille-Luer Bone Rongeur Str 8½" -----	1	75-5670	Metzenbaum Scissors Cvd 7" -----	1
40-4085	Stille-Luer Bone Rongeur Cvd 8½" -----	1	87-2195	Foerster Sponge Forceps Str Serr 9½" -----	2
40-5765	Gerzog Bone Mallet 7½" -----	1	90-1690	Mayo Dissecting Scissors Cvd 9" -----	1

SURGICAL INSTRUMENT SETS

KNEE SET (98-1013)

PRODUCT NUMBER	DESCRIPTION	QUANTITY	PRODUCT NUMBER	DESCRIPTION	QUANTITY
98-1013	Complete Set		40-7400	Key Elevator ¼" x 7½" -----	1
06-2903	Scalpel Handle #3 -----	2	40-7402	Key Elevator ½" x 7½" -----	1
06-2904	Scalpel Handle #4 -----	1	40-8250	Blount Knee Retractor -----	2
06-2907	Scalpel Handle #7 -----	1	40-8272	Adson Elevator Round 6¾" -----	1
11-1055	Lister Bandage Scissors 5½" -----	1	40-9685	Bone File 8½" -----	1
15-1567	Mayo Dissecting Scissors Str 6¾" -----	2	41-1120	Martin Scissors Heavy Serr 7¾" -----	1
15-2567	Mayo Dissecting Scissors Cvd 6¾" -----	1	47-2380	Freer Elevator Double End 7¼" -----	1
17-2655	Rochester-Ochsner Forceps Cvd 5½" -----	2	47-2955	Backhaus Towel Clamp 5¼" -----	6
17-2662	Rochester-Ochsner Forceps Cvd 6¼" -----	4	47-3415	Downing Cartilage Knife 10" -----	1
17-3055	Crile Forcep Str 5½" -----	4	47-3420	Smillie Cartilage Knife Str 6¾" -----	1
17-3162	Crile Forcep Cvd 6¼" -----	4	47-3422	Smillie Cartilage Knife Left 6¾" -----	1
19-1255	Tissue Forceps 1 x 2 Teeth 5½" -----	2	47-3424	Smillie Cartilage Knife Right 6¾" -----	1
19-1655	Tissue Forceps 3 x 4 Teeth 5½" -----	2	50-2008	Frazier Suction Tube 8 French -----	1
20-1270	Crile-Wood Needle Holder (DeBakey) 7" -----	2	60-1085	US Army Retractor (Set of 2) 8½" -----	1
22-8255	Weitlaner Retractor 3 x 4 Prong Sharp 5½" -----	2	60-5602	Volkman Retractor 2 Prong Sharp 8½" -----	2
36-2060	Allis Tissue Forceps 3 x 4 Teeth 6" -----	4	60-5604	Volkman Retractor 4 Prong Sharp 8½" -----	2
40-2275	Bone/Cartilage Clamp Cvd 8" -----	1	60-6164	Senn Retractor Double End Blunt 6¼" -----	2
40-2290	Smillie Meniscus Hook 5¾" -----	1	75-5670	Metzenbaum Scissors Cvd 7" -----	1
40-2660	Dingman Bone/Cartilage clamp Small -----	1	98-2047	Micro Adson Forceps 1 x 2 Teeth 4¾" -----	2



BASIC DERMAL INSTRUMENT SET (98-1058)

PRODUCT NUMBER	DESCRIPTION	QUANTITY	PRODUCT NUMBER	DESCRIPTION	QUANTITY
98-1058	Complete Set		30-1945	Probe w/ Eye 4½" -----	1
06-4120	Shamberg Comedone Extractor -----	1	30-1955	Probe w/ Eye 5½" -----	1
06-4125	Unna Comedone Extractor 5¾" -----	1	36-2060	Allis Tissue Forceps 3 x 4 Teeth 6" -----	1
11-1045	Lister Bandage Scissors 4½" -----	1	36-2275	Allis Tissue Forceps 5 x 6 Teeth 7½" -----	1
11-1055	Lister Bandage Scissors 5½" -----	1	47-1145	Iris Scissors Str 4½" -----	1
15-1555	Mayo Dissecting Scissors Str 5½" -----	1	47-1245	Iris Scissors Cvd 4½" -----	1
15-2555	Mayo Dissecting Scissors Cvd 5½" -----	1	47-1246	Iris Scissors Del Str 4½" -----	1
17-1235	Hartmann Mosquito Forceps Str 3½" -----	1	47-1248	Iris Scissors Del Cvd 4½" -----	1
17-1335	Hartmann Mosquito Forceps Cvd 3½" -----	1	47-1360	Metzenbaum Scissors Cvd 5¾" -----	1
17-1450	Halsted Mosquito Forceps Str 5" -----	1	47-2047	Adson Tissue Forceps 1 x 2 Teeth Del 4¾" -----	1
17-1550	Halsted Mosquito Forceps Cvd 5" -----	1	47-2147	Adson Dressing Forceps Del Serr 4¾" -----	1
19-1055	Dressing Forceps Serrated 5½" -----	1	47-2935	Backhaus Towel Clamp 3½" -----	1
19-1255	Tissue Forceps 1 x 2 Teeth 5½" -----	1	47-2955	Backhaus Towel Clamp 5¼" -----	1
19-3035	Splinter Forceps 3½" -----	1	50-3047	Adson Tissue Forceps 1 x 2 Teeth 4¾" -----	1
19-3045	Splinter Forceps 4½" -----	1	50-3147	Adson Dressing Forceps Serr 4¾" -----	1
20-1350	Webster Needle Holder Del Smooth 5" -----	1	64-1242	Stevens Tenotomy Scissors Str 4½" -----	1
20-1352	Webster Needle Holder Del Serr 5" -----	1	64-1342	Stevens Tenotomy Scissors Cvd 4½" -----	1
20-1547	Derf Needle Holder Serr 4¾" -----	1	67-2502	Buck Curette Angled Sharp #2 -----	1
20-1750	Halsey Needle Holder Smooth 5" -----	1	67-2517	Buck Curette Str Sharp #2 -----	1
20-1751	Halsey Needle Holder Serr 5" -----	1	74-1370	Ballenger Sponge Forceps Str Smooth 7" -----	1
20-2747	Olsen-Hegar Needle Holder 4¾" -----	1	74-1670	Ballenger Sponge Forceps Cvd Serr 7" -----	1
20-2755	Olsen-Hegar Needle Holder 5½" -----	1	75-5460	Metzenbaum Scissors Str 5¾" -----	1

BASIC TISSUE DISSECTION SET (98-1064)

PRODUCT NUMBER	DESCRIPTION	QUANTITY	PRODUCT NUMBER	DESCRIPTION	QUANTITY
98-1064	Complete Set		24-2155	Healy Suture Forceps 5½" -----	1
06-2903	Scalpel Handle #3 -----	1	47-1145	Iris Scissors Str 4½" -----	1
06-3011	Surgical Blades #11 (Box of 100) -----	1	47-1235	Iris Scissors Cvd 3½" -----	1
06-3015	Surgical Blades #15 (Box of 100) -----	1	47-2047	Adson Tissue Forceps 1 x 2 Teeth 4¾" -----	1
17-1650	Halsted Mosquito Forceps 1 x 2 Teeth Str 5" -----	1	47-2147	Adson Dressing Forceps Serr 4¾" -----	1
18-1050	Halsted Mosquito Forceps Str 5" -----	3	47-2502	Joseph Skin Hook Sharp 2 Prong 2 mm -----	1
18-1150	Halsted Mosquito Forceps Cvd 5" -----	3	47-2505	Joseph Skin Hook Sharp 2 Prong 5 mm -----	1
20-1750	Halsey Needle Holder Smooth 5" -----	1	47-2570	Gilles Skin Hook 3 mm 7" -----	1
22-1163	Dressing Forceps Del Str 5½" -----	1	47-2572	Gilles Skin Hook 4 mm 7" -----	1
22-2545	Dissecting Scissors Del Cvd 4¾" -----	1	64-3280	Gradle Dissecting Scissors Sharp 3¾" -----	1
22-2652	Ragnell Dissecting Scissors Cvd 5" -----	1	65-1841	Desmarres Retractor Small 5½" -----	1
22-2947	Northbent Suture Scissors 44¾" -----	1	66-3540	Tissue Forceps Half Curved 1 x 2 Teeth 4" -----	1



BASIC NASAL SET (98-1091)

PRODUCT NUMBER	DESCRIPTION	QUANTITY	PRODUCT NUMBER	DESCRIPTION	QUANTITY
98-1091	Complete Set		47-1058	Wagner Sciss Cvd S/S Sm 4 1/2"	1
06-2907	Scalpel Handle #7	1	47-2500	Joseph Hook 1/Pr Sh 6 1/4"	1
06-2910	Scalpel Hand #3 W/Metric Scale	1	47-2502	Joseph Hook 2/Pr Sh 6 1/4" 2Mm	1
07-1805	Yankauer Suct Tube Stainless	1	47-2507	Joseph Hook 2/Pr Sh 6 1/4" 7Mm	1
16-1605	S E Mayo Dis Sciss Cvd 5 1/2" Tc	1	47-2935	Backhaus Towel Clamp 3 1/2"	4
16-1905	S E Metz Lahey Crv Del 5 3/4" Tc	1	50-2007	Frazier Suct Tube 7Fr	2
16-2105	S E Metz Sciss Cvd Del 7 Tc	1	50-3047	Adson Tissue Fcp 1X2 4 3/4"	2
17-1450	Halsted Mosq Fcp Str 5"	6	60-1085	Us Army Retr Set/2 D/E 8 1/4"	1
21-8001	Halsey Nh Serr Tc 5 1/4"	1	60-6162	Senn D/E Retractor Sharp 6"	2
22-6157	Allis Tiss Del Fcp 4X5 5 1/2"	2	66-1940	Graefe Fix Fcp W/O Cat 4 1/8"	1
41-1050	Joseph Scissors Str 5 3/4"	1	68-1765	Farrell Applicator Twist 6 1/2"	1
41-1054	Joseph Scissors Cvd 5 3/4"	1	70-1030	Killian Med W/Set Screw 3"	1
41-1198	Laser Cottle Septal Spec 2"	1	70-1071	Vienna Child Size	1
41-1410	Aufricht Retr Solid Bld 6 1/2"	1	70-4470	Wilde Ear/Nsl Fcp Serr Ang 7"	1

MAJOR NASAL SET (98-1092) USED WITH BASIC NASAL SET

PRODUCT NUMBER	DESCRIPTION	QUANTITY	PRODUCT NUMBER	DESCRIPTION	QUANTITY
98-1092	Complete Set		47-2500	Joseph Hook 1/Pr Sh 6 1/4"	1
06-2860	Steel Ruler 6"	1	47-2505	Joseph Hook 2/Pr Sh 6 1/4" 5Mm	2
16-1905	S E Metz Lahey Crv Del 5 3/4" Tc	1	47-2570	Gillies Skin Hook 7" 3Mm	1
16-2105	S E Metz Sciss Cvd Del 7 Tc	1	50-3147	Adson Dressing Fcp Serr 4 3/4"	1
21-8007	Crile Wood Nh Serr 7" Tc	1	64-1442	Strabismus Sciss Str 4 1/2"	1
40-5870	Sklar Mallet W/Repl Plst Discs	1	64-1542	Strabismus Sciss Crv 4 1/2"	1
40-9815	Maltz Rasp 7" Bkd Cut	1	65-1841	Desmarres Lid Retr 12Mm	1
40-9825	Joseph Rasp Fine Crss Serr 6 1/4"	1	65-6732	Castroviejo Caliper 3 1/4"	1
40-9841	Aufricht Glabellar Rasps 8" Bkd	1	66-1040	Cottle Columella Fcp 4 1/2"	1
41-1169	Cottle Dorsal Sciss Ang 6 1/2"	1	67-1050	Hartman Ear Fcp Light Serr Jaw	1
41-1198	Laser Cottle Septal Spec 2"	2	67-1465	Jansen Nasal Fcp Bayonet 6 1/2"	1
41-1235	Cottle Elev Cm-Grad D/E 9	1	67-4622	Sheehan Osteo Str 6 1/4" 4Mm	1
41-1240	Joseph Perio Elev 7" X6.5Mm	1	67-4626	Sheehan Osteo Str 6 1/4" 8Mm	1
41-1245	Joseph Perio Elev 6 1/4" X4.5Mm	1	67-4628	Sheehan Osteo Str 6 1/4" 10Mm	1
41-1255	Cottle Nasal Knife Sh 5 1/2" 4Mm	1	67-4630	Sheehan Osteo Str 6 1/4" 12Mm	1
41-1340	Cottle Nasal Osteo 6 1/2" Cvd	1	70-1030	Killian Med W/Set Screw 3"	1
41-1370	Cinelli Osteo Grd 2Sd Str 10Mm	1	70-4352	Foman Nas Low Lat Scis Cv 5 3/4"	1
41-1382	Cot Knife Grd/Retr 8" 5Mm Hook	1	70-5190	Ash Sept Straightening Fcp 9"	1
41-1383	Neiv Knife Gd/Retr 6 1/2" D-End	1	70-7504	Ballenger Swivel Knife 4Mm	1
41-1385	Cottle Ret 5 1/2" 4Prng 2Reces	1	70-7805	Joseph Bone Saw Str 7 1/2"	1
41-1396	Fomon Retr Ball End Dbl 6 1/4"	1	74-3075	Schmidt Half Crv Tons Fcp 7 1/2"	2
41-1398	Converse Alar Retr D/E 4 1/2"	1	97-1505	Maltz Rasp Se Fine Tc	1
47-1135	Iris Sciss Str S/S 3 1/2"	1	97-1506	Maltz Rasp Se Medium Tc	1
47-2380	Freer Elevator De Sh/Bl 7 1/4"	1			



BASIC EAR-SET (98-1093)

PRODUCT NUMBER	DESCRIPTION	QUANTITY	PRODUCT NUMBER	DESCRIPTION	QUANTITY
98-1093	Complete Set		50-2009	Frazier Suction Tube 9 Fr	1
06-2910	Scalpel Hand #3 W/Metric Scale.....	1	50-3047	Adson Tissue Fcp 1 X 2 4 ³ / ₄ "	1
16-1605	S E Mayo Dis Sciss Cvd 5 ¹ / ₂ " Tc	1	50-3147	Adson Dressing Fcp Serr 4 ³ / ₄ "	1
16-1905	S E Metz Lahey Crv Del 5 ³ / ₄ " Tc	1	60-1891	Langenbeck Retr Sm 9"	1
16-2105	S E Metz Sciss Cvd Del 7 Tc	1	60-1892	Langenbeck Retr Med 9"	1
17-1450	Halsted Mosq Fcp Str 5"	6	60-6162	Senn D/E Retractor Sharp 6"	2
17-2055	Kelly Fcp Str 5 ¹ / ₂ "	2	60-6320	Allport Retr Sharp 4"	1
21-8001	Halsey Nh Serr Tc 5 ¹ / ₄ "	1	64-1542	Strabismus Sciss Crv 4 ¹ / ₂ "	1
24-2342	Sut Wire Cut Scis Ser Ang 4 ³ / ₄ "	1	66-1940	Graefe Fix Fcp W/O Cat 4 ¹ / ₈ "	1
36-2160	Allis Tiss Fcp 4 X 5 6"	2	67-1465	Jansen Nasal Fcp Bayonet 6 ¹ / ₂ "	1
42-1824	Wullstein Endaur Ret 3 X 3 Sh 5"	1	67-2514	Buck Ear Curette Sh Str #00	1
47-2380	Freer Elevator De Sh/BI 7 ¹ / ₄ "	1	67-2516	Buck Ear Curette Sh Str #1	1
47-2500	Joseph Hook 1/Pr Sh 6 ¹ / ₄ "	2	67-6011	Boucheron Ear Spec 5Mm Chrome.....	1
47-2832	Jansen Retractor Blunt 3 X 3 4"	1	67-6012	Boucheron Ear Spec 6Mm Chrome	1
47-2935	Backhaus Towel Clamp 3 ¹ / ₂ "	4	67-6013	Boucheron Ear Spec 7Mm Chrome.....	1
50-2007	Frazier Suct Tube 7 Fr	1	67-6014	Boucheron Ear Spec 8Mm Chrome.....	1

CATARACT SURGERY SET (98-1094)

PRODUCT NUMBER	DESCRIPTION	QUANTITY	PRODUCT NUMBER	DESCRIPTION	QUANTITY
98-1094	Complete Set		65-1842	Desmarres Lid Retr 14Mm	1
06-2907	Scalpel Handle #7	1	65-2960	Troutman Blade Breaker	1
06-2910	Scalpel Hand #3 W/Metric Scale	1	65-3216	Graefe Strabismus Hook Med	1
21-8040	Castro Nh W/Lk Str Sm 5 ¹ / ₂ " Tc	1	65-3216	Graefe Strabismus Hook Med	1
21-8043	Castro Nh W/Lk Cvd Del 5 ¹ / ₂ " Tc	1	65-4062	Castro Cyclodial Spat .5Mm	1
22-1241	Stevens Tenot Del Crv S/S 4 ¹ / ₂ "	1	65-6732	Castroviejo Caliper 3 ¹ / ₄ "	1
23-2505	Sklarlite Xd Halst Mosq 5" St"	4	65-7635	Fox Aluminum Eye Shield	2
23-2506	Sklarlite Xd Halst Mosq Cvd 5	6	65-8216	Wilder Lens Scoop Smooth	1
47-1135	Iris Sciss Str S/S 3 ¹ / ₂ "	1	65-9085	Kirby Hook & Expressor De 14.5	1
47-1235	Iris Sciss Cvd S/S 3 ¹ / ₂ "	1	66-1036	Desmarres Chal Fcps 3 ¹ / ₂ " Med	1
47-2935	Backhaus Towel Clamp 3 ¹ / ₂ "	4	66-1940	Graefe Fix Fcp W/O Cat 4 ¹ / ₈ "	1
64-1735	Wilmer Sciss 4" Ang On Flat "	1	66-2440	Obrien Fix Del 4"	1
64-1950	Vannas Sciss Str Del 3"	1	66-2640	Castro Fix Fcp .3Mm 1 X 2 4"	1
64-2242	Castroviejo Corneal Right 4 ¹ / ₄ "	1	66-2740	Eye Dress Fcp Str Serr 4"	1
64-2342	Castroviejo Corneal Lft 4 ¹ / ₄ "	1	66-2940	Eye Dress Fcp 1/2" Crv Serr 4"	1
64-3050	Iris Micro-Min Sciss Str 4" X del"	1	66-3240	Eye Tiss Fcps 1 X 2 Str 4"	1
64-3142	Westcott Tenotomy Sciss 5" Rt	1	66-3340	Eye Tissue Fcp 1 X 2 Str 4"	1
64-3280	Gradle Sciss Sl Cvd Sh 3 ³ / ₄ "	1	66-5340	Arruga Capsule Fcps 4"	1
64-3294	Castroviejo Corneal Sciss 4" Rt	1	66-5342	Fcp Arruga Capsule 4" New Curve	1
64-3296	Castroviejo Corneal Sciss 4" Lt	1	66-6105	Castro Suture Fcp Str 4" X .5Mm	1
65-1528	Park-Maumenee Eye Speculum	1	66-7261	Fcp Colibri Corneal Util .4Mm	1
65-1532	Lancaster Eye Speculum 3 ¹ / ₄ "	1	97-1450	#3K Handle/Mini Podiatry Blades.....	1
65-1535	Castroviejo Spec 3 ¹ / ₂ "	1			



BREAST AUGMENTATION/REDUCTION SET (98-1095)

PRODUCT NUMBER	DESCRIPTION	QUANTITY	PRODUCT NUMBER	DESCRIPTION	QUANTITY
98-1095	Complete Set		47-2505	Joseph Hook 2/Pr Sh 6¼" 5Mm	1
06-2860	Steel Ruler 6"	1	47-2935	Backhaus Towel Clamp 3½"	4
06-2908	Round Scalpel Handle Straight	2	50-2008	Frazier Suct Tube 8 Fr	1
10-1497	Emesis Basin 10 oz	1	50-3047	Adson Tissue Fcp 1 X 2 4¾"	2
15-2567	Mayo Diss Sciss Cvd 6¾"	1	50-3147	Adson Dressing Fcp Serr 4¾"	1
17-1235	Hartmann Mosq Str Serr 3½"	4	52-5177	Debakey Atra Fcp 2Mm 7¾"	1
17-1450	Halsted Mosq Fcp Str 5"	2	60-1085	Us Army Retr Set/2 D/E 8¼"	2
17-2855	Kocher Fcps Str 1 X 2 5½"	2	60-3312	Deaver #4 2 X 12	2
19-1245	Tissue Fcp 1 X 2 4½"	2	60-3596	Zalkind Ribbon Retr ½" X 7.75"	3
20-1350	Webster Nh Smooth Jaw 5¼"	2	60-6162	Senn D/E Retractor Sharp 6"	1
20-1450	Baumgartner Nh Serr 5½"	2	64-1242	Stev Tenot Sciss Str 4½" Bb	1
20-2755	Olsen Hegar Nh 5½"	3	64-1342	Stev Tenot Sciss Crv 4½" Bb	1
20-4682	Heaney Nh 8¼"	1	65-4107	Bowman Lach Probe Sz 7/8" Chrome	1
22-2520	Goldman-Fox Sciss 5" Cvd Serr	1	74-3075	Schmidt Half Crv Tons Fcp 7½"	1
36-2160	Allis Tiss Fcp 4 X 5 6"	2	75-5570	Metzenbaum Scissors Str 7"	1
47-1145	Iris Sciss Str S/S 4½"	1	75-5670	Metzenbaum Scissors Cvd 7"	1
47-1245	Iris Sciss Cvd S/S 4½"	1	91-6100	Bipolar Adson Fcp 1Mm 4¾"	1
47-2502	Joseph Hook 2/Pr Sh 6¼" 2Mm	1			

BLEPHAROPLASTY SET (98-1096)

PRODUCT NUMBER	DESCRIPTION	QUANTITY	PRODUCT NUMBER	DESCRIPTION	QUANTITY
98-1096	Complete Set		22-2653	Ragnell Sciss Str 5""	1
06-2860	Steel Ruler 6"	1	47-2502	Joseph Hook 2/Pr Sh 6¼" 2Mm	2
06-2910	Scalpel Hand #3 W/Metric Scale	1	47-2935	Backhaus Towel Clamp 3½"	4
15-3585	SklarCut Iris Sciss Str S/S 4½"	1	50-3047	Adson Tissue Fcp 1 X 2 4¾"	1
15-3590	SklarCut Iris Sciss Crv S/S 4½"	1	65-1842	Desmarres Lid Retr 14Mm	1
17-1450	Halsted Mosq Fcp Str 5"	2	65-6732	Castroviejo Caliper 3¼"	1
17-1550	Halsted Mosq Fcp Cvd 5"	2	66-4132	Bishop-Harmon Eye Fcp 1 X 2 3.5"	1
21-8002	Webster Nh Smooth 5¼" Tc	2			

RHYTIDECTOMY / FACELIFT SET (98-1097)

PRODUCT NUMBER	DESCRIPTION	QUANTITY	PRODUCT NUMBER	DESCRIPTION	QUANTITY
98-1097	Complete Set		22-2835	Spencer Stitch Sciss 3½"	1
06-2860	Steel Ruler 6"	1	36-2160	Allis Tiss Fcp 4 X 5 6"	2
06-2907	Scalpel Handle #7	1	41-1105	Rhytidectomy Scis D/E Cvd 6½"	1
06-2910	Scalpel Hand #3 W/Metric Scale	1	47-1147	Blepharoplas Sci Crv Ser 4¾"	1
15-3549	Sklet Castanares Flcft Str 6¼"	1	47-1447	Adson Brown Tiss Sd Grasp 4¾"	1
15-3585	Sklet Iris Sciss Str S/S 4½"	1	47-2510	Joseph Hook 2/Pr Sh 6¼" 10Mm	2
15-3590	Sklet Iris Sciss Crv S/S 4½"	1	47-2935	Backhaus Towel Clamp 3½"	2
16-1510	S E Mayo Dis Sciss Str 6¾" Tc	1	47-2955	Backhaus Towel Clamp 5¼" 2	
16-1905	S E Metz Lahey Crv Del 5¾" Tc	1	50-2008	Frazier Suct Tube 8 Fr	1
17-1450	Halsted Mosq Fcp Str 5"	2	50-3047	Adson Tissue Fcp 1 X 2 4¾"	1
17-1550	Halsted Mosq Fcp Cvd 5"	2	52-3370	Potts-Smith Tiss Fcp 1 X 2 7"	1
21-8002	Webster Nh Smooth 5¼" Tc	1	52-5062	Debakey Atra Fcp 6¼" 1.5Mm	1
21-8006	Crile Wood Nh Serr Nar/Jw 6" Tc	1	52-5162	Debakey Atra Fcp Str 6¼" 2Mm	1
21-8080	Webster Nh Serr 5¼" Tc	2	60-1085	Us Army Retr Set/2 D/E 8¼"	2
22-1063	Tissue Fcp Del 1X2 5½"	1	60-1676	Richardson W/Sklrgrp Hndl Smll	1
22-1162	Dress Fcp Del Serr 5"	1	60-2812	Deaver Skl Gr Hdl #3 1½" X 12"	1
22-2653	Ragnell Sciss Str 5"	1	60-6162	Senn D/E Retractor Sharp 6"	2



OR-GRADE INSTRUMENTS

Our finest Surgical Instruments, crafted to the highest standards.

SKLARLITE™

A lighter version of the standard pattern, without sacrificing strength and durability

SKLARLITE XD™

The most sensitive and delicate instruments available

SKLARCUT™

Featuring ultra-fine serrations for improved grip throughout entire cut

SKLARHONE™

Constructed with one knife blade and one standard scissor edge, smooth or serrated

SKLAR EDGE™

Crafted of Tungsten Carbide - the standard for performance and quality - 5-year warranty

SURGI-OR™

Significant value at reduced cost for OPERATING ROOM & SURGERY CENTER and other important surgical settings

MERIT™

For routine surgical use and reliable performance in a variety of clinical settings

ECONO™

Economically manufactured floor-grade instruments - greatest utility at the lowest cost

ECONO-STERILE™

Convenient ready-to-use sterile economy instruments

OPERATING ROOM GRADE

OPERATING SCISSORS Straight



S/S	13-1045	4½"
	13-1050	5"
	13-1055	5½"
	13-1060	6"
	13-1065	6½"
S/B	14-1045	4½"
	14-1050	5"
	14-1055	5½"
	14-1060	6"
	14-1065	6½"
	14-1058	6½"
	Heavy	
B/B	15-1045	4½"
	15-1050	5"
	15-1055	5½"
	15-1060	6"
	15-1065	6½"

DELICATE		
S/S	22-1145	4½"
	22-1150	5"
	22-1155	5½"
S/B	22-1245	4½"
	22-1250	5"
	22-1255	5½"
B/B	22-1345	4½"
	22-1350	5"
	22-1355	5½"

SKLARLITE™		
S/S	23-1100	4½"
	23-1101	5"
	23-1102	5½"
S/B	23-1104	4½"
	23-1105	5"
	23-1106	5½"
SKLARLITE EXTRA DELICATE™		
S/S	23-1112	4½"
	23-1113	5"
	23-1114	5½"
S/B	23-1116	4½"
	23-1117	5"
	23-1118	5½"



SKLAR EDGE™		
T-C		
S/S	16-1055	5½"
S/B	16-1056	5½"
B/B	16-1057	5½"
SKLARCUT™		
S/S	15-3500	5½"
S/B	15-3505	5½"

SKLARLITE SKLARCUT™		
S/S	23-1260	5½"
S/B	23-1262	5½"
SKLARHONE™		
Smooth		
S/S	15-3342	5½"
S/B	15-3343	5½"
Serrated		
S/S	15-3442	5½"
S/B	15-3443	5½"

OPERATING ROOM & SURGERY CENTER

PREMIUM GRADE

PAKISTAN

OPERATING SCISSORS Straight



SURGERY CENTER

SURGI-OR™		
S/S	95-275	5½"
	95-284	6½"

S/B	95-265	4½"
	95-272	5½"
	95-281	6½"



PHYSICIAN

MERIT™		
S/S	97-266	4½"
	97-275	5½"
	97-284	6½"
B/B	97-269	4½"
	97-278	5½"
	97-288	6½"

S/B	97-263	4½"
	97-272	5½"
	97-281	6½"



FLOOR GRADE

ECONO™		
Box/12		
S/S	21-266	4½"
	21-275	5½"
	21-284	6½"
B/B	21-278	5½"
	21-288	6½"

S/B	21-263	4½"
	21-272	5½"
	21-281	6½"



STERILE

ECONO-STERILE™		
Sterile		
Box/50		
S/S	96-2520	5½"
	96-2522	5½"
S/B		

Box/25		
S/S	96-2521	5½"
	96-2523	5½"
S/B		

OPERATING ROOM GRADE

OPERATING SCISSORS Curved



Curved
S/S
13-2045 4½"
13-2050 5"
13-2055 5½"
13-2060 6"
13-2065 6½"

S/B
14-2045 4½"
14-2050 5"
14-2055 5½"
14-2060 6"
14-2065 6½"

B/B
15-2045 4½"
15-2050 5"
15-2055 5½"
15-2060 6"
15-2065 6½"

DELICATE
Curved
S/S
22-1445 4½"
22-1450 5"
22-1455 5½"

S/B
22-1545 4½"
22-1550 5"
22-1555 5½"

B/B
22-1645 4½"
22-1650 5"
22-1655 5½"

SKLARLITE™
Curved
S/S
23-1124 4½"
23-1126 5½"

S/B
23-1128 4½"
23-1130 5½"

**SKLARLITE
EXTRA
DELICATE™**
Curved
S/S
23-1136 4½"
23-1138 5½"

S/B
23-1140 4½"
23-1142 5½"



SKLAR EDGE™
T-C
Curved
S/S
16-1155 5½"

S/B
16-1156 5½"

SKLARCUT™
Curved
S/S
15-3510 5½"

S/B
15-3515 5½"

**SKLARLITE
SKLARCUT™**
Curved
S/S
23-1264 5½"

S/B
23-1266 5½"

SKLARHONET™
Curved, Smooth
S/S
15-3348 5½"

S/B
15-3349 5½"

Curved, Serrated
S/S
15-3448 5½"

S/B
15-3449 5½"

OPERATING ROOM & SURGERY CENTER

PREMIUM GRADE

PAKISTAN

OPERATING SCISSORS Curved



SURGERY CENTER

SURGI-OR™
S/S
95-295 5½"

S/B
95-292 5½"

B/B
95-299 5½"



PHYSICIAN

MERIT™
S/S
97-295 5½"

S/B
97-292 5½"

B/B
97-299 5½"



FLOOR GRADE

ECONO™
Box/12
S/S
21-294 4½"
21-295 5½"

B/B
21-299 5½"
21-300 6½"

S/B
21-291 4½"
21-292 5½"
21-293 6½"



STERILE

ECONO-STERILE™
Box/50
96-2524 5½" S/B
96-2525 5½" S/S

Box/25
96-2526 5½" S/B
96-2527 5½" S/S

Contact your Account Manager for Details.

OPERATING ROOM GRADE

MAYO DISSECTING SCISSORS



Straight
15-1555 5½"
15-1567 6¾"
90-1590 9"

Curved
15-2555 5½"
15-2567 6¾"
90-1690 9"

Heavy Pattern
 Curved
15-2569 6¾"

DELICATE
 Straight
22-1556 5½"
22-1567 6¾"

Curved
22-2555 5½"
22-2567 6¾"

SKLARLITE™
 Straight
23-1164 5½"
23-1165 6¾"

Curved
23-1166 5½"
23-1167 6¾"

**SKLARLITE
 EXTRA
 DELICATE™**
 Straight
23-1168 5½"
23-1169 6¾"

Curved
23-1170 5½"
23-1171 6¾"



SKLARCUT™
 Straight
15-3550 5½"
15-3555 6¾"

Curved
15-3560 5½"
15-3565 6¾"

**SKLARLITE
 SKLARCUT™**
 Straight
23-1274 6¾"

Curved
23-1278 6¾"

**SKLAR EDGE™
 T-C**
 Straight
16-1505 5½"
16-1510 6¾"
16-1515 9"

Curved
16-1605 5½"
16-1610 6¾"
16-1615 9"

SKLARHONET™
 Straight, Smooth
15-3325 5½"
15-3326 6¾"

Curved, Smooth
15-3330 5½"
15-3331 6¾"

OPERATING ROOM & SURGERY CENTER

PREMIUM GRADE

PAKISTAN

MAYO DISSECTING SCISSORS



SURGERY CENTER

SURGI-OR™
 Straight
95-308 5½"
95-321 6¾"

Curved
95-330 5½"
95-325 6¾"



PHYSICIAN

MERIT™
 Straight
97-308 5½"
97-321 6¾"

Curved
97-312 5½"
97-325 6¾"



FLOOR GRADE

ECONO™
 Box/12
 Straight
21-308 5½"
21-321 6¾"

Curved
21-312 5½"
21-325 6¾"



STERILE

ECONO-STERILE™
 Straight, Sterile
 Box/50
96-2530 5½"

Box/25
96-2531 5½"

Over 5 Thousand Instrument Patterns In-Stock.



OPERATING ROOM GRADE

METZENBAUM (LAHEY) SCISSORS



Straight
22-2550 4½"
75-5460 5¾"

Curved
22-2545 4½"
47-1360 5¾"

DELICATE
Straight
22-2450 4½"
22-2460 5¾"

Curved
22-2650 4½"
22-1057 5¾"

SKLARLITE™
Straight
23-1172 4½"
23-1173 5¾"

Curved
23-1174 4½"
23-1175 5¾"

**SKLARLITE
EXTRA
DELICATE™**
Straight
23-1176 4½"
23-1177 5¾"

Curved
23-1178 4½"
23-1179 5¾"



SKLAR EDGE™ T-C
Straight, Delicate
16-1805 5¾"

Straight, Standard
16-1810 5¾"

Curved, Delicate
16-1905 5¾"

Curved, Standard
16-1910 5¾"

SKLARCUT™
Curved
15-3570 5¾"

**SKLARLITE
SKLARCUT™**
Curved
23-1280 5¾"

SKLARHONET™
Curved
15-3306 5¾"

OPERATING ROOM & SURGERY CENTER

PREMIUM GRADE

PAKISTAN

METZENBAUM (LAHEY) SCISSORS



SURGERY CENTER

SURGI-OR™
Straight
95-335 5¾"

Curved
95-336 5¾"



PHYSICIAN

MERIT™
Straight
97-335 5¾"

Curved
97-336 5¾"



FLOOR GRADE

ECONO™
Box/12
Straight
21-335 5½"

Box/12
Curved
21-336 5½"



STERILE

ECONO-STERILE™
Box/50
Straight, Sterile
96-2516 5¾"

Box/25
Straight, Sterile
96-2517 5¾"

Contact your Account Manager for Details.



OPERATING ROOM GRADE

METZENBAUM DISSECTING SCISSORS



Straight
75-5570 7"
55-9180 8" Nelson
55-9190 9" Nelson
55-9310 10" Nelson
55-9311 11" Nelson

Curved
75-5670 7"
55-9080 8" Nelson
55-9090 9" Nelson
55-9210 10" Nelson
55-9411 11" Nelson
55-9612 12" Nelson
55-9614 14" Nelson

DELICATE
 Straight
22-1071 7"
55-9184 8" Nelson

Curved
22-1070 7"
55-9084 8"

SKLARLITE™
 Straight
23-1180 7"

Curved
23-1182 7"

**SKLARLITE
 EXTRA
 DELICATE™**
 Straight
23-1184 7"

Curved
23-1186 7"



SKLAR EDGE™ T-C
 Straight
16-2005 7" Delicate
16-2010 7" Standard
16-2210 9" Standard
 Nelson

Curved
16-2105 7" Delicate
16-2110 7" Standard
16-2310 9" Standard
 Nelson
16-2311 11" Standard
 Nelson

SKLARCUT™
 Curved
15-3575 7"

**SKLARLITE
 SKLARCUT™**
 Curved
23-1267 7"

SKLARHONET™
 Curved,
 Smooth
15-3310 7"
15-3311 8"
15-3315 9"

Curved,
 Serrated
15-3410 7"

OPERATING ROOM & SURGERY CENTER

PREMIUM GRADE

PAKISTAN

METZENBAUM DISSECTING SCISSORS



SURGERY CENTER

SURGI-OR™
 Straight
95-339 7"

Curved
95-340 7"



PHYSICIAN

MERIT™
 Straight
97-339 7"

Curved
97-340 7"



FLOOR GRADE

ECONO™
 Straight
 Box/12
21-339 7"

Curved
21-340 7"



STERILE

ECONO-STERILE™
 Curved, Sterile
 Box/50
96-2680 7"

Box/25
96-2682 7"



OPERATING ROOM GRADE

IRIS SCISSORS



Straight
S/S
47-1135 3½"
47-1145 4½"

Curved
S/S
47-1235 3½"
47-1245 4½"

Angular
S/S
64-2142 4½"

DELICATE
Straight
S/S
22-1135 3½"
47-1246 4½"

Curved
S/S
22-1235 3½"
47-1248 4½"

SKLARLITE™
Straight
S/S
23-1148 3½"
23-1149 4½"

Curved
S/S
23-1150 3½"
23-1151 4½"

**SKLARLITE
EXTRA
DELICATE™**
Straight
S/S
23-1152 3½"
23-1153 4½"

Curved
S/S
23-1154 3½"
23-1155 4½"



**SKLAR EDGE™
T-C**
Straight
16-2405 4½"

Curved
16-2505 4½"

SKLARCUT™
Straight
15-3585 4½"

Curved
15-3590 4½"

**SKLARLITE
SKLARCUT™**
Straight
23-1268 4½"

Curved
23-1270 4½"

SKLARHONET™
Straight, Smooth
15-3352 4½"

Curved, Smooth
15-3357 4½"

Straight, Serrated
15-3452 4½"

Curved, Serrated
15-3457 4½"

OPERATING ROOM & SURGERY CENTER

PREMIUM GRADE

PAKISTAN

IRIS SCISSORS



SURGERY CENTER

SURGI-OR™
Straight
95-103 3½"
95-104 4½"

Curved
95-107 3½"
95-109 4½"



PHYSICIAN

MERIT™
Straight
98-103 3½"
98-104 4½"

Curved
98-107 3½"
98-109 4½"



FLOOR GRADE

ECONO™
Box/12
Straight
21-102 2½"
21-103 3½"
21-104 4½"

Curved
21-107 3½"
21-109 4½"



STERILE

ECONO-STERILE™
Box/50
Sterile
96-2504 4½" Straight
96-2506 4½" Curved

Box/25
Sterile
96-2505 4½" Straight
96-2507 4½" Curved

Contact your Account Manager for Details.



OPERATING ROOM GRADE

STRABISMUS SCISSORS



Straight
64-1442 4½"

Curved
64-1542 4½"

DELICATE
Straight
22-1442 4½"

Curved
22-1542 4½"

SKLARLITE™
Straight
23-1158 4½"

Curved
23-1159 4½"

**SKLARLITE
EXTRA
DELICATE™**
Straight
23-1162 4½"

Curved
23-1163 4½"



SKLAR EDGE™
T-C
Straight
16-2605 4½"

Curved
16-2705 4½"

OPERATING ROOM & SURGERY CENTER

PREMIUM GRADE

PAKISTAN

STRABISMUS SCISSORS



SURGERY CENTER

SURGI-OR™
Straight
95-360 4½"

Curved
95-361 4½"



PHYSICIAN

MERIT™
Straight
97-360 4½"

Curved
97-361 4½"



STERILE

ECONO-STERILE™
Sterile
Box/50
96-2540 4½" Straight
96-2541 4½" Curved

Box/25
96-2542 4½" Straight
96-2543 4½" Curved

Over 5 Thousand Instrument Patterns In-Stock.



OPERATING ROOM GRADE

SPENCER STITCH SCISSORS



22-2835 3½"
22-2845 4½"

DELICATE
22-2834 3½"
22-2844 4½"

SKLARLITE™
23-1188 3½"
23-1189 4½"

**SKLARLITE
EXTRA
DELICATE™**
23-1193 3½"
23-1194 4½"



OPERATING ROOM & SURGERY CENTER

PAKISTAN

SPENCER STITCH SCISSORS



SURGERY CENTER

SURGI-OR™
95-346 3½"
95-352 4½"



PHYSICIAN

MERIT™
97-346 3½"
97-352 4½"



FLOOR GRADE

ECONO™
Box/12
21-346 3½"
21-352 4½"



STERILE

ECONO-STERILE™
Sterile
Box/50
96-2596 4½"

Box/25
96-2598 4½"

Contact your Account Manager for Details.



OPERATING ROOM GRADE

LITTAUER STITCH SCISSORS



15-1355 5½"

DELICATE
22-1354 5½"

SKLARLITE™
23-1190 5½"

SKLARLITE
EXTRA
DELICATE™
23-1195 5½"



OPERATING ROOM & SURGERY CENTER

PAKISTAN

LITTAUER STITCH SCISSORS



SURGERY CENTER

SURGI-OR™
95-358 5½"



PHYSICIAN

MERIT™
97-358 5½"



FLOOR GRADE

ECONO™
Box/12
21-358 5½"



STERILE

ECONO-STERILE™
Sterile
Box/50
96-2510 3½"
96-2512 5½"

Box/25
96-2511 3½"
96-2513 5½"

Over 5 Thousand Instrument Patterns In-Stock.



OPERATING ROOM GRADE

WIRE CUTTING SCISSORS



Angular Serrated
24-2342 4 $\frac{3}{4}$ "

Angular Serrated
Heavy Pattern
24-2349 4 $\frac{3}{4}$ "



SKLAR EDGE™ T-C
Angular Serrated
Tungsten Carbide

16-2800 4 $\frac{3}{4}$ "

OPERATING ROOM & SURGERY CENTER

PREMIUM GRADE

PAKISTAN

WIRE CUTTING SCISSORS



SURGERY CENTER

SURGI-OR™
Angular
Serrated
95-364 4 $\frac{3}{4}$ "



PHYSICIAN

MERIT™
Angular Serrated
97-364 4 $\frac{3}{4}$ "



FLOOR GRADE

ECONO™
Box/12
Straight
21-363 4 $\frac{1}{2}$ "

Box/12
Angular
21-364 4 $\frac{3}{4}$ "

STERILE

ECONO-STERILE™
Sterile, Angular
Box/50
96-2518 4 $\frac{3}{4}$ "

Box/25
96-2519 4 $\frac{3}{4}$ "



OPERATING ROOM GRADE

LISTER BANDAGE SCISSORS



11-1035 3½"
 11-1045 4½"
 11-1055 5½"
 11-1072 7¼"
 11-1080 8"

Large Ring
 11-1060 8"

DELICATE

22-1054 5½"
 22-1072 7¼"

SKLARLITE™

23-1199 5½"
 23-1200 7¼"

SKLARLITE EXTRA DELICATE™

23-1202 5½"
 23-1203 7¼"



OPERATING ROOM & SURGERY CENTER

PAKISTAN

LISTER BANDAGE SCISSORS



SURGERY CENTER

SURGI-OR™
 95-222 3½"
 95-226 4½"
 95-231 5½"
 95-241 7¼"



PHYSICIAN

MERIT™
 97-222 3½"
 97-226 4½"
 97-231 5½"
 97-237 5½" with Clip
 97-241 7¼"



FLOOR GRADE

ECONO™
 Box/12
 21-222 3½"
 21-226 4½"
 21-231 5½"
 21-237 5½" with Clip
 21-241 7¼"

STERILE

ECONO-STERILE™
 Sterile
 Box/50
 96-2502 5½"
 Box/25
 96-2503 5½"

Over 5 Thousand Instrument Patterns In-Stock.



OPERATING ROOM GRADE

KNOWLES BANDAGE SCISSORS



11-1255 5 1/2"

OPERATING ROOM & SURGERY CENTER

PAKISTAN

KNOWLES BANDAGE SCISSORS



SURGERY CENTER

SURGI-OR™
95-254 5 1/2"



PHYSICIAN

MERIT™
97-254 5 1/2"



FLOOR GRADE

ECONO™
Box/12
21-254 5 1/2"

STERILE

ECONO-STERILE™
Sterile
Box/50
96-2402 5 1/2"

Box/25
96-2404 5 1/2"

Contact your Account Manager for Details.



OPERATING ROOM GRADE

MULTI-CUT UTILITY SCISSORS



Serrated
 11-1278 6" Standard
 11-1280 7½" Standard
 11-1281 7½" Blue
 11-1282 7½" Green
 11-1283 7½" Red
 11-1284 7½" White



◀ SEE PAGE 213 FOR ORDERING INFORMATION.

OPERATING ROOM & SURGERY CENTER

PAKISTAN

MULTI-CUT UTILITY SCISSORS



SURGERY CENTER

SURGI-OR™
 Serrated
 95-105 7½" Standard



PHYSICIAN

MERIT™
 Serrated
 97-105 7½" Standard



FLOOR GRADE

ECONO™
 Box/12
 21-101 5½"

STERILE

ECONO-STERILE™
 Sterile
 Box/50
 96-2702 5½"
 96-2704 7"

Box/25
 96-2701 5½"
 96-2703 7"

Over 5 Thousand Instrument Patterns In-Stock.





OR-GRADE INSTRUMENTS

Our finest Surgical Instruments, crafted to the highest standards.

SKLARLITE™

A lighter version of the standard pattern, without sacrificing strength and durability

SKLARLITE XD™

The most sensitive and delicate instruments available

SKLARCUT™

Featuring ultra-fine serrations for improved grip throughout entire cut

SKLARHONE™

Constructed with one knife blade and one standard scissor edge, smooth or serrated

SKLAR EDGE™

Crafted of Tungsten Carbide - the standard for performance and quality - 5-year warranty

SURGI-OR™

Significant value at reduced cost for OPERATING ROOM & SURGERY CENTER and other important surgical settings

MERIT™

For routine surgical use and reliable performance in a variety of clinical settings

ECONO™

Economically manufactured floor-grade instruments - greatest utility at the lowest cost

ECONO-STERILE™

Convenient ready-to-use sterile economy instruments

OPERATING ROOM GRADE HALSTED MOSQUITO FORCEPS



- | | | |
|-----------------|---------------|--|
| Straight | | |
| 17-1450 | 5" | |
| 17-1650 | 1X2 5" | |
| 17-1459 | 5" | |
| | Heavy Pattern | |
| Curved | | |
| 17-1550 | 5" | |
| 17-1750 | 1X2 5" | |
| 17-1559 | 5" | |
| | Heavy Pattern | |
| DELICATE | | |
| Straight | | |
| 18-1050 | 5" | |
| Curved | | |
| 18-1150 | 5" | |

- | | | |
|----------------------------------|----|--|
| SKLARLITE™ | | |
| Straight | | |
| 23-2105 | 5" | |
| Curved | | |
| 23-2106 | 5" | |
| SKLARLITE EXTRA DELICATE™ | | |
| Straight | | |
| 23-2505 | 5" | |
| Curved | | |
| 23-2506 | 5" | |



OPERATING ROOM & SURGERY CENTER

PAKISTAN

HALSTED MOSQUITO FORCEPS



SURGERY CENTER

- | | |
|------------------|----|
| SURGI-OR™ | |
| Straight | |
| 95-426 | 5" |
| Curved | |
| 95-431 | 5" |



PHYSICIAN

- | | |
|---------------|----|
| MERIT™ | |
| Straight | |
| 97-426 | 5" |
| Curved | |
| 97-431 | 5" |



FLOOR GRADE

- | | |
|---------------|-------------|
| ECONO™ | |
| Box/12 | |
| 21-426 | 5" Straight |
| Box/12 | |
| 21-431 | 5" Curved |



STERILE

- | | |
|-----------------------|-------------|
| ECONO-STERILE™ | |
| Sterile | |
| Box/50 | |
| 96-2536 | 5" Straight |
| 96-2538 | 5" Curved |
| Box/25 | |
| 96-2537 | 5" Straight |
| 96-2539 | 5" Curved |



OPERATING ROOM GRADE

CRILE HEMOSTATIC FORCEPS



Straight
17-3055 5½"
17-3062 6¼"
17-3075 7½"
17-3068 6¼"
 Heavy Pattern

Curved
17-3155 5½"
17-3162 6¼"
17-3175 7½"
17-3168 6¼"
 Heavy Pattern

DELICATE
18-1952 5½" Straight
18-2052 5½" Curved

SKLARLITE™
23-2110 5½" Straight
23-2113 5½" Curved

**SKLARLITE
 EXTRA DELICATE™**
23-2510 5½" Straight
23-2513 5½" Curved



OPERATING ROOM & SURGERY CENTER

PAKISTAN

CRILE HEMOSTATIC FORCEPS



SURGERY CENTER

SURGI-OR™
 Straight
95-447 5½"
95-458 6¼"

Curved
95-452 5½"
95-463 6¼"



PHYSICIAN

MERIT™
 Straight
97-447 5½"
97-458 6¼"

Curved
97-452 5½"
97-463 6¼"



FLOOR GRADE

ECONO™
 Box/12
 Straight
21-447 5½"

Curved
21-452 5½"



STERILE

ECONO-STERILE™
 Sterile
 Box/50
96-2550 5½" Straight
96-2552 5½" Curved

Box/25
96-2551 5½" Straight
96-2553 5½" Curved

Over 5 Thousand Instrument Patterns In-Stock.



OPERATING ROOM GRADE

KELLY HEMOSTATIC FORCEPS



Straight
17-2055 5½"
74-3260 7"
 Heavy Pattern

Curved
17-2155 5½"
74-3270 7"
 Heavy Pattern

DELICATE
18-1552 5½" Straight

18-1652 5½" Curved

SKLARLITE™
23-2107 5½" Straight

23-2108 5½" Curved

**SKLARLITE
 EXTRA DELICATE™**
23-2507 5½" Straight

23-2508 5½" Curved



OPERATING ROOM & SURGERY CENTER

PAKISTAN

KELLY HEMOSTATIC FORCEPS



SURGERY CENTER

SURGI-OR™
 Straight
95-436 5½"

Curved
95-442 5½"



PHYSICIAN

MERIT™
 Straight
97-436 5½"

Curved
97-442 5½"



FLOOR GRADE

ECONO™
 Box/12
 Straight
21-436 5½"

Curved
21-442 5½"



STERILE

ECONO-STERILE™
 Sterile
 Box/50
96-2560 5½" Straight
96-2562 5½" Curved

Box/25
96-2561 5½" Straight
96-2563 5½" Curved

Contact your Account Manager for Details.



OPERATING ROOM GRADE

HARTMANN MOSQUITO HEMOSTATS



Straight,
Serrated
17-1235 3½"

Curved,
Serrated
17-1335 3½"

DELICATE
Straight
17-1230 3½"

Curved
17-1232 3½"

SKLARLITE™
Straight
23-2100 3½"

Curved
23-2101 3½"

**SKLARLITE
EXTRA DELICATE™**
Straight
23-2500 3½"

Curved
23-2501 3½"



OPERATING ROOM & SURGERY CENTER

PAKISTAN

HARTMANN MOSQUITO HEMOSTATS



SURGERY CENTER

SURGI-OR™
Straight
95-409 3½"

Curved
95-421 3½"



PHYSICIAN

MERIT™
Straight
97-409 3½"

Curved
97-421 3½"



FLOOR GRADE

ECONO™
Box/12
Straight
21-409 3½"

Curved
21-421 3½"



STERILE

ECONO-STERILE™
Sterile
Box/50
96-2554 3½" Straight
96-2555 3½" Curved

Box/25
96-2556 3½" Straight
96-2557 3½" Curved



OPERATING ROOM GRADE

ROCHESTEER-OCHSNER FORCEPS



Straight, 1 X 2 Teeth

17-2855 5½" Kocher
17-2862 6"
17-2872 7¼"
17-2880 8"
17-2890 10"
17-2878 7¼"
 Heavy Pattern

Curved, 1 X 2 Teeth

17-2655 5½" Kocher
17-2662 6"
17-2672 7¼"
17-2680 8"
17-2690 10"

DELICATE

Straight, 1 X 2 Teeth
22-3755 5½" Kocher
17-2962 6"

Curved, 1 X 2 Teeth

22-3855 5½" Kocher
17-2762 6"

SKLARLITE™

Straight, 1 X 2 Teeth
23-2560 6¼"

Curved, 1 X 2 Teeth

23-2568 6¼"

**SKLARLITE
 EXTRA DELICATE™**

Straight, 1 X 2 Teeth
23-2577 6¼"

Curved, 1 X 2 Teeth

23-2585 6¼"



OPERATING ROOM & SURGERY CENTER

PAKISTAN

ROCHESTEER-OCHSNER FORCEPS



SURGERY CENTER

SURGI-OR™

Straight
 1 X 2 Teeth

95-500 5½" Kocher
95-504 6"
95-521 7¼"
95-513 8"
95-515 9"
95-517 10"

Curved
 1 X 2 Teeth

95-501 5½" Kocher
95-512 6"
95-525 7¼"
95-514 8"
95-516 9"
95-518 10"



PHYSICIAN

MERIT™

Straight

97-504 6½"

Curved

97-512 6½"



STERILE

ECONO-STERILE™

Sterile

Box/50

96-2707 6¼" Straight
96-2708 6¼" Curved

Box/25

96-2566 6¼" Straight
96-2567 6¼" Curved



OPERATING ROOM GRADE

ROCHESTER-PEAN FORCEPS



Straight
17-2455 5½"
17-2462 6¼"
17-2467 6¾"
Heavy
17-2472 7¼"
17-2480 8"
36-2690 9"
36-2710 10¼"

Curved
17-2255 5½"
17-2262 6¼"
17-2267 6¾"
Heavy
17-2272 7¼"
17-2280 8"
36-2790 9"
36-2810 10¼"

DELICATE
Straight
22-3555 5½"
Curved
22-3655 5½"
17-2362 6¼"
22-2280 8"

SKLARLITE™
Straight
23-2532 6¼"
Curved
23-2538 6¼"
23-2542 7¼"

SKLARLITE
EXTRA DELICATE™
Straight
23-2552 6¼"
Curved
23-2561 6¼"
23-2563 7¼"



OPERATING ROOM & SURGERY CENTER

PAKISTAN

ROCHESTER-PEAN FORCEPS



SURGERY CENTER

SURGI-OR™
Straight
95-470 5½"
95-473 6¼"
95-481 7¼"
95-492 8"
95-483 9"
95-494 10¼"

Curved
95-471 5½"
95-477 6¼"
95-485 7¼"



PHYSICIAN

MERIT™
Straight
97-470 5½"
97-473 6¼"
97-481 7¼"
97-492 8"
97-483 9"
97-494 10¼"

Curved
97-471 5½"
97-477 6¼"
97-485 7¼"



FLOOR GRADE

ECONO™
Box/12
Straight
21-470 5½"
21-473 6¼"
21-481 7¼"
21-492 8½"

Curved
21-471 5½"
21-477 6¼"
21-485 7¼"
21-498 8½"



STERILE

ECONO-STERILE™
Sterile
Box/50
96-2544 6¼" Straight
96-2546 6¼" Curved

Box/25
96-2545 6¼" Straight
96-2547 6¼" Curved



OPERATING ROOM GRADE

ALLIS FORCEPS



3 X 4
36-2060 6"

4 X 5
36-2160 6"

5 X 6
36-2260 6"
36-2275 7½"
36-2295 9½"
36-2278 7½"
Heavy

Atraumatic Jaw
36-2298 6"
36-2280 8"
36-2385 10"

DELICATE
4 X 5
18-2140 4"
18-2155 5"
22-6157 5½"
18-2162 6"

5 X 6
18-2164 6"

SKLARLITE™
4 X 5
23-2851 6"

5 X 6
23-2852 6"

**SKLARLITE
EXTRA
DELICATE™**
4 X 5
23-2861 5"
23-2862 5½"
23-2864 6"

5 X 6
23-2865 6"



**TUNGSTEN
CARBIDE**
97-1555 6"
97-1560 7½"

OPERATING ROOM & SURGERY CENTER

PREMIUM GRADE

PAKISTAN

ALLIS FORCEPS



SURGERY CENTER

SURGI-OR™
5 X 6
95-934 6"
95-938 7½"



PHYSICIAN

MERIT™
4 X 5
97-930 6"

5 X 6
97-934 6"
97-938 7½"



FLOOR GRADE

ECONO™
Box/12
4 X 5
21-930 6"

5 X 6
21-934 6"

6 X 7
21-938 7½"



STERILE

ECONO-STERILE™
Sterile
Box/50
96-2576 6"

Box/25
96-2575 6"



OPERATING ROOM GRADE

BABCOCK FORCEPS



22-6155 5½"
36-1662 6¼"
36-1677 8"
36-1692 9½"

**OPERATING ROOM &
SURGERY CENTER**



**TUNGSTEN
CARBIDE**
97-1565 6¼"
97-1570 8"

PREMIUM GRADE

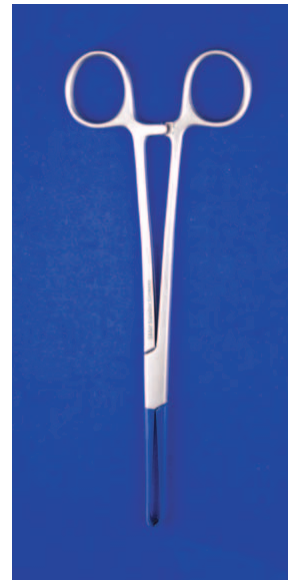

SKLAR BLUE™
91-5268 8"
91-5270 9½"

**SKLAR BLACK™
LASER**
90-2278 8"
90-2295 9½"

ELECTROSURGICAL

PAKISTAN

BABCOCK FORCEPS



SURGERY CENTER
SURGI-OR™
95-952 6¼"

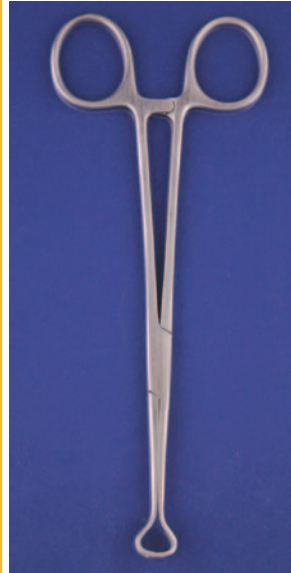

PHYSICIAN
MERIT™
97-952 6¼"

STERILE
ECONO-STERILE™
Sterile
Box/50
96-2705 6¼"
Box/25
96-2706 6¼"



OPERATING ROOM GRADE

DUNAWAY CIRCUMCISION FORCEPS



SURGI-OR™
With Bead Tip

95-456 4"

OPERATING ROOM &
SURGERY CENTER



SKLAR SOAK™ LIQUID

Surgical Instrument Soak

Item# 10-1603 Case of 4 Gallons

- Non-Caustic Formula allows for use as a manual cleaner or in ultrasonic units.
- Effective Against: C. Diff, TB, HBV, HIV-1 (AIDS), virus (hydrophilic and Lipophilic), cc bacteria (including MRSA and VRE), and fungi.
- EPA Registered
- Meets all OSHA standards on blood borne pathogen destruction
- Ready to use

PAKISTAN

DUNAWAY DISSECTING FORCEPS



SURGI-OR™
With Bead Tip

95-466 6" Straight
95-467 6" Curved

OPERATING ROOM &
SURGERY CENTER



SklarTite™

Sterilization Container System

Maximum Sterile Integrity
Economical, Low Cost-per-Cycle

The SklarTite™ line of sealed containers provides a simple yet effective system for the sterilization of operating room instruments. Designed for strength and light in weight, SklarTite™ containers are formed from an aircraft grade anodized aluminum alloy. Other sizes available by special order.

Phone: 610.430.3200

Toll Free: 800.221.2166

◀ SEE PAGE 175 FOR ORDERING INFORMATION.



OPERATING ROOM GRADE

MAGILL CATHETER FORCEPS



07-1777 6½" Infant
 07-1780 8" Child
 07-1797 10" Adult



SKLAR SPRAY SURFACE DISINFECTANT™

• Bactericidal • Virucidal •
 Fungicidal • Tuberculocidal
 Ready-To-Use
 Contains Biodegradable Detergent
 Non-Glutaraldehyde Formula

Kills Clostridium Difficile

3 Minute Kill Time!

Item# 10-1643 Case of 6, 24 oz.
 Spray Bottles

Item# 10-1653 Case of 4 Gallons

OPERATING ROOM & SURGERY CENTER

PAKISTAN

MAGILL CATHETER FORCEPS



SURGERY CENTER

SURGI-OR™
 95-285 8" Child
 95-289 10" Adult



PHYSICIAN

MERIT™
 98-285 8" Child
 98-289 10" Adult

FLOOR GRADE

ECONO™
 Box/12
 21-285 7¼" Child
 21-289 9¾" Adult

STERILE

ECONO-STERILE™
 Sterile
 Box/50
 96-2689 7¼" Child
 96-2684 10" Adult
 Box/25
 96-2685 10" Adult



OPERATING ROOM GRADE

LORNA (EDNA) TOWEL CLAMP



Non-Perforating
 47-2837 3½"
 47-2852 5¼"



SKLAR-CIDE™
 HIGH LEVEL DISINFECTING /
 STERILIZING SOLUTION
**NOW AVAILABLE IN A
 NEW 7-DAY FORMULA**

Item# 10-1621
 Case of 4 Gallons

OPERATING ROOM & SURGERY CENTER

PAKISTAN

LORNA (EDNA) TOWEL CLAMP



SURGERY CENTER

SURGI-OR™
 95-629 3½"
 95-635 5¼"



PHYSICIAN

MERIT™
 97-629 3½"
 97-635 5¼"



FLOOR GRADE

ECONO™
 Box/12
 21-604 3½"



STERILE

ECONO-STERILE™
 Sterile
 Box/50
 96-2528 3½"
 Box/25
 96-2529 3½"



OPERATING ROOM GRADE

FOERSTER SPONGE FORCEPS



Straight
87-2095 9½" Smooth
87-2195 9½" Serrated
87-2199 9½" Serrated
Heavy Pattern

Curved
87-2295 9½" Smooth
87-2395 9½" Serrated

OPERATING ROOM & SURGERY CENTER

PAKISTAN

FOERSTER SPONGE FORCEPS



SURGERY CENTER

SURGI-OR™

Straight
95-571 7" Serrated
95-577 9½" Serrated

Curved
95-586 9½" Serrated



PHYSICIAN

MERIT™

Straight
97-577 9½" Serrated

Curved
97-586 9½" Serrated



FLOOR GRADE

ECONO™

Box/12
Straight
21-577 9½" Serrated

Curved
21-586 9½" Serrated



STERILE

ECONO-STERILE™

Sterile
Box/50
Straight
96-2532 9½" Serrated

Box/25
Straight
96-2533 9½" Serrated



OPERATING ROOM GRADE

BACKHAUS TOWEL CLAMP



47-2935 3½"
47-2945 4½"
47-2955 5¼"
47-2960 6"

Heavy Pattern
47-2959 5¼"

OPERATING ROOM & SURGERY CENTER

PAKISTAN

BACKHAUS TOWEL CLAMP



SURGERY CENTER

SURGI-OR™
95-606 3½"
95-611 5¼"



PHYSICIAN

MERIT™
97-606 3½"
97-611 5¼"



FLOOR GRADE

ECONO™
Box/12
21-606 3½"
21-608 5¼"



STERILE

ECONO-STERILE™
Sterile
Box/50
96-2630 3½"
96-2634 5¼"

Box/25
96-2632 3½"
96-2636 5¼"



OPERATING ROOM GRADE

TUBE OCCLUDING FORCEPS



Straight
Smooth Jaw
17-3995 5½"
17-3996 6½"
17-3997 7"

OPERATING ROOM & SURGERY CENTER

PAKISTAN

TUBE OCCLUDING FORCEPS



SURGERY CENTER

SURGI-OR™
Straight
Smooth Jaw
95-592 7"



PHYSICIAN

MERIT™
PRESBYTERIAN
TUBE OCCLUDING FORCEPS
Straight
Smooth Jaw
97-592 6½"



FLOOR GRADE

ECONO™
Box/12
Straight
Smooth Jaw
21-598 7"

Straight
Serrated Jaw
21-599 7"



STERILE

ECONO-STERILE™
Sterile
Box/50
Straight, Smooth Jaw
96-2406 7"

Box/25
Straight, Smooth Jaw
96-2408 7"



OPERATING ROOM GRADE

DRESSING FORCEPS



Serrated
19-1045 4½"
19-1050 5"
19-1055 5½"
19-1060 6"
19-1070 7"
19-1080 8"
19-1110 10"
19-1112 12"

DELICATE
 Serrated
22-1161 4½"
22-1162 5"
22-1163 5½"
22-1164 6"

SKLARLITE™
 Serrated
23-2824 4½"
23-2826 5"
23-2828 5½"
23-2830 6"

**SKLARLITE
 EXTRA
 DELICATE™**
 Serrated
23-2834 4½"
23-2836 5"
23-2838 5½"



**TUNGSTEN
 CARBIDE**
 Serrated
51-3460 6"
51-3480 8"

OPERATING ROOM & SURGERY CENTER

PREMIUM GRADE

PAKISTAN

DRESSING FORCEPS



SURGERY CENTER

SURGI-OR™
 Serrated
95-705 4½"
95-710 5"
95-727 5½"
95-731 6"
95-736 8"



PHYSICIAN

MERIT™
 Serrated
97-705 4½"
97-710 5"
97-727 5½"
97-731 6"
97-736 8"



FLOOR GRADE

ECONO™
 Box/12
 Serrated
21-710 5"
21-727 5½"
21-731 6"
21-736 8"



STERILE

ECONO-STERILE™
 Sterile
 Box/50
 Serrated
96-2568 5"

 Box/25
 Serrated
96-2569 5"



OPERATING ROOM GRADE

TISSUE FORCEPS



1 X 2 Teeth
19-1245 4½"
19-250 5"
19-1255 5½"
19-1258 5½" Heavy
19-1260 6"
19-1270 7"
19-1280 8"
19-1310 10"
19-1312 12"

DELICATE
 1 X 2 Teeth
22-1063 5½"

SKLARLITE™
 1 X 2 Teeth
23-2811 5½"

**SKLARLITE
 EXTRA DELICATE™**
 1 X 2 Teeth
23-2819 5½"



OPERATING ROOM & SURGERY CENTER

PAKISTAN

TISSUE FORCEPS



SURGERY CENTER

SURGI-OR™
 1 X 2 Teeth
95-753 4½"
95-757 5"
95-762 5½"
95-766 6"



PHYSICIAN

MERIT™
 1 X 2 Teeth
97-753 4½"
97-757 5"
97-762 5½"
97-766 6"

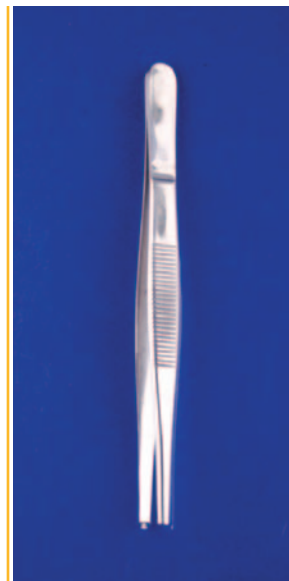

FLOOR GRADE

ECONO™
 Box/12
 1 X 2 Teeth
21-753 4½"
21-757 5"
21-762 5½"
21-766 6"



STERILE

ECONO-STERILE™
 Sterile
 Box/50
 1 X 2 Teeth
96-2578 5"

 Box/25
 1 X 2 Teeth
96-2579 5"



OPERATING ROOM GRADE

ADSON DRESSING FORCEPS



Serrated
50-3147 4 3/4"

DELICATE
Serrated
47-2147 4 3/4"

SKLARLITE™
Serrated
23-2600 4 3/4"

SKLARLITE
EXTRA DELICATE™
Serrated
23-2604 4 3/4"



OPERATING ROOM & SURGERY CENTER

PAKISTAN

ADSON DRESSING FORCEPS



SURGERY CENTER

SURGI-OR™
Serrated
95-771 4 3/4"

Delicate, Serrated
95-772 4 3/4"



PHYSICIAN

MERIT™
Serrated
97-771 4 3/4"

Delicate, Serrated
97-772 4 3/4"



FLOOR GRADE

ECONO™
Box/12
Serrated
21-771 4 3/4"

Delicate, Serrated
21-772 4 3/4"



STERILE

ECONO-STERILE™
Sterile
Box/50
Serrated
96-2570 4 3/4"

Box/25
Serrated
96-2571 4 3/4"



OPERATING ROOM GRADE

ADSON TISSUE FORCEPS



1 X 2 Teeth
50-3047 4 3/4"

1 X 2 Teeth
 Heavy Pattern
50-3045 4 3/4"

DELICATE
 1 X 2 Teeth
47-2047 4 3/4"

2 X 3 Teeth
47-2049 4 3/4"

SKLARLITE™
 1 X 2 Teeth
23-2602 4 3/4"

**SKLARLITE
 EXTRA
 DELICATE™**
 1 X 2 Teeth
23-2606 4 3/4"



TUNGSTEN CARBIDE
 Serrated, with
 Tungsten Carbide
 Insert
51-3447 4 3/4"

1 X 2 Teeth, with
 Platform Tungsten
 Carbide Insert
51-3049 4 3/4"

OPERATING ROOM & SURGERY CENTER

PREMIUM GRADE

PAKISTAN

ADSON TISSUE FORCEPS



SURGERY CENTER

SURGI-OR™
 1 X 2 Teeth
95-775 4 3/4"

1 X 2 Teeth, Delicate
95-776 4 3/4"



PHYSICIAN

MERIT™
 1 X 2 Teeth
97-775 4 3/4"

1 X 2 Teeth, Delicate
97-776 4 3/4"



FLOOR GRADE

ECONO™
 Box/12
 1 X 2 Teeth
21-775 4 3/4"

1 X 2 Teeth, Delicate
21-776 4 3/4"



STERILE

ECONO-STERILE™
 Sterile
 Box/50
 1 X 2 Teeth
96-2572 4 3/4"

Box/25
 1 X 2 Teeth
96-2573 4 3/4"



OPERATING ROOM GRADE



Side-Grasping
47-1447 4¾"

Angled
47-1450 4¾"

DELICATE
Side-Grasping
47-2447 4¾"

SKLARLITE™
Side-Grasping
23-2603 4¾"

SKLARLITE
EXTRA
DELICATE™
Side-Grasping
23-2608 4¾"

LITEGRIP™
Side-Grasping
47-1448 4¾"

OPERATING ROOM & SURGERY CENTER

ADSON-BROWN FORCEPS



TUNGSTEN CARBIDE
Side-Grasping, with
Tungsten Carbide Insert
51-1447 4¾"

LITEGRIP™
TUNGSTEN CARBIDE
Side-Grasping, with
Tungsten Carbide Insert
51-1448 4¾"

PREMIUM GRADE

PAKISTAN

ADSON-BROWN FORCEPS



SURGERY CENTER

SURGI-OR™
Side-Grasping
95-778 4¾"



PHYSICIAN

MERIT™
Side-Grasping
97-778 4¾"



FLOOR GRADE

ECONO™
Box/12
Side-Grasping
21-778 4¾"



STERILE

ECONO-STERILE™
Sterile
Box/50
Side-Grasping
96-2558 4¾"

Box/25
Side-Grasping
96-2559 4¾"



OPERATING ROOM GRADE

FINEPOINT SPLINTER FORCEPS



19-3035 3½"
 19-3040 4"
 19-3045 4½"

SKLAR INSTRUMENT CARE KIT

A TRIO OF SKLAR'S CARE AND CLEANING PRODUCTS TO KEEP INSTRUMENTS IN TIPTOP SHAPE.

Each Kit Contains:

- 1 Spray Lube, 8 oz.
- 1 Kleen, 8 oz.
- 1 Polish, 8 oz.
- 1 Polish, 8 oz.
- 1 Nylon Bristle Cleaning Brush
- 1 Stainless Steel Bristle Cleaning Brush

PRODUCT NUMBER

10-1625



OPERATING ROOM & SURGERY CENTER

PAKISTAN

FINEPOINT SPLINTER FORCEPS



SURGERY CENTER

SURGI-OR™
 95-777 3½"
 95-781 4½"



PHYSICIAN

MERIT™
 97-777 3½"
 97-781 4½"



FLOOR GRADE

ECONO™
 Box/12
 21-777 3½"
 21-781 4½"



STERILE

ECONO-STERILE™
 Sterile
 Box/50
 96-2410 4½"
 Box/25
 96-2412 4½"



OR-GRADE INSTRUMENTS

Our finest Surgical Instruments, crafted to the highest standards.

SKLARLITE™

A lighter version of the standard pattern, without sacrificing strength and durability

SKLARLITE XD™

The most sensitive and delicate instruments available

SKLARCUT™

Featuring ultra-fine serrations for improved grip throughout entire cut

SKLARHONE™

Constructed with one knife blade and one standard scissor edge, smooth or serrated

SKLAR EDGE™

Crafted of Tungsten Carbide - the standard for performance and quality - 5-year warranty

SURGI-OR™

Significant value at reduced cost for OPERATING ROOM & SURGERY CENTER and other important surgical settings

MERIT™

For routine surgical use and reliable performance in a variety of clinical settings

ECONO™

Economically manufactured floor-grade instruments - greatest utility at the lowest cost

ECONO-STERILE™

Convenient ready-to-use sterile economy instruments

OPERATING ROOM GRADE



WEBSTER NEEDLE HOLDER
Smooth
20-1350 5¼"

Serrated
20-1352 5¼"

Smooth,
Heavy Pattern
20-3090 5¼"

OPERATING ROOM & SURGERY CENTER

SKLARLITE™ WEBSTER NEEDLE HOLDER
Smooth
23-2125 5¼"

Serrated
23-2120 5¼"

SKLARLITE EXTRA DELICATE™ WEBSTER NEEDLE HOLDER
Smooth
23-2225 5¼"

Serrated
23-2220 5¼"

WEBSTER NEEDLE HOLDER

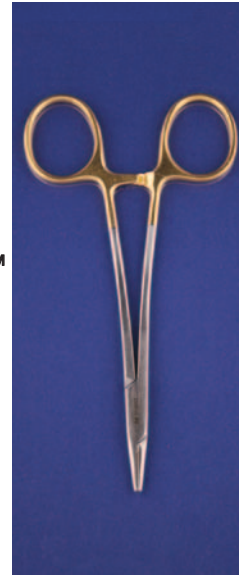

TUNGSTEN CARBIDE WEBSTER NEEDLE HOLDER
Smooth
Tungsten Carbide Insert
21-8002 5¼"

Serrated
Tungsten Carbide Insert
21-8080 5¼"

SKLARGRIP™ CARBIDE WEBSTER NEEDLE HOLDER
Smooth, Carbide Coating
21-1650 5¼"

Serrated, Carbide Coating
21-1652 5¼"

PREMIUM GRADE

PAKISTAN



SURGERY CENTER

SURGI-OR™ WEBSTER NEEDLE HOLDER
Smooth
95-809 5¼"



PHYSICIAN

MERIT™ WEBSTER NEEDLE HOLDER
Smooth
97-809 5"



FLOOR GRADE

ECONO™ WEBSTER NEEDLE HOLDER
Smooth
Box/12
21-809 5"



STERILE

ECONO-STERILE™ WEBSTER NEEDLE HOLDER
Smooth
Box/50
96-2586 5"

Smooth
Box/25
96-2587 5"

OPERATING ROOM GRADE

DERF NEEDLE HOLDERS

**DERF
NEEDLE HOLDER**
Serrated
20-1547 4¾"

**SKLARLITE™
DERF
NEEDLE HOLDER**
Serrated
23-2124 4¾"

**SKLARLITE
EXTRA
DELICATE™
DERF
NEEDLE HOLDER**
Serrated
23-2224 4¾"



**TUNGSTEN
CARBIDE
DERF
NEEDLE HOLDER**
Serrated, Tungsten
Carbide Insert
21-8004 4¾"

**SKLARGRIP™
CARBIDE
DERF
NEEDLE HOLDER**
Serrated, Carbide
Coating
21-1547 4¾"

OPERATING ROOM & SURGERY CENTER

PREMIUM GRADE

PAKISTAN

DERF NEEDLE HOLDER

SURGERY CENTER

**SURGI-OR™
DERF
NEEDLE HOLDER**
Serrated
95-826 4¾"

PHYSICIAN

**MERIT™
DERF
NEEDLE HOLDER**
Serrated
97-826 4¾"

FLOOR GRADE

**ECONO™
DERF
NEEDLE HOLDER**
Serrated
Box/12
21-826 4¾"

STERILE

**ECONO-STERILE™
DERF
NEEDLE HOLDER**
Sterile
Serrated
Box/50
96-2582 4¾"

Box/25
96-2583 4¾"



OPERATING ROOM GRADE

MAYO-HEGAR NEEDLE HOLDER



MAYO-HEGAR NEEDLE HOLDER

Serrated
20-2052 5½"
20-2060 6"
20-2070 7"
20-2480 8"
20-2490 9"

Serrated,
 Broad Jaw
20-2270 7"

Serrated,
 Masson
20-2910 10½"
20-2911 11½"

SKLARLITE™ MAYO-HEGAR NEEDLE HOLDER

Serrated
23-2128 7"

SKLARLITE EXTRA DELICATE™ MAYO-HEGAR NEEDLE HOLDER

Serrated
23-2228 7"



TUNGSTEN CARBIDE MAYO-HEGAR NEEDLE HOLDER

Serrated, Tungsten Carbide Insert
21-8031 6"
21-8032 7"
21-8033 8"
21-8034 10½"
21-8035 12"

SKLARGRIPT™ MAYO-HEGAR NEEDLE HOLDER

Serrated, Carbide Coating
21-2060 6"
21-2070 7"
21-2480 8"

Serrated, Carbide Coating
 Masson
21-2910 10½"

OPERATING ROOM & SURGERY CENTER

PREMIUM GRADE

PAKISTAN

MAYO-HEGAR NEEDLE HOLDER



SURGERY CENTER

SURGI-OR™ MAYO-HEGAR NEEDLE HOLDER

Serrated
95-842 5½"
95-847 6"
95-853 7"
95-869 8"



PHYSICIAN

MERIT™ MAYO-HEGAR NEEDLE HOLDER

Serrated
97-842 5½"
97-847 6"
97-853 7"
97-869 8"



FLOOR GRADE

ECONO™ MAYO-HEGAR NEEDLE HOLDER

Serrated
 Box/12
21-842 5"
21-847 6"
21-853 7"
21-869 8"



STERILE

ECONO-STERILE™ MAYO-HEGAR NEEDLE HOLDER

Sterile
 Serrated
 Box/50
96-2594 6"
 Box/25
96-2595 6"



OPERATING ROOM GRADE

HALSEY NEEDLE HOLDER



**HALSEY
NEEDLE HOLDER**
Smooth
20-1750 5¼"

Serrated
20-1751 5¼"

**SKLARLITE™
HALSEY
NEEDLE HOLDER**
Smooth
23-2135 5¼"

Serrated
23-2130 5¼"

**SKLARLITE
EXTRA
DELICATE™
HALSEY
NEEDLE HOLDER**
Smooth
23-2235 5¼"

Serrated
23-2230 5¼"



**TUNGSTEN
CARBIDE
HALSEY
NEEDLE HOLDER**
Smooth, Tungsten
Carbide Insert
21-8000 5¼"

Serrated, Tungsten
Carbide Insert
21-8001 5¼"

**SKLARGRIP™
HALSEY
NEEDLE HOLDER**
Light Model
Smooth, Carbide
Coating
21-1750 5¼"

Serrated, Carbide
Coating
21-1850 5¼"

OPERATING ROOM & SURGERY CENTER

PREMIUM GRADE

PAKISTAN

HALSEY NEEDLE HOLDER



SURGERY CENTER
**SURGI-OR™
HALSEY
NEEDLE HOLDER**
Smooth
95-810 5¼"



PHYSICIAN
**MERIT™
HALSEY
NEEDLE HOLDER**
Smooth
97-810 5"



FLOOR GRADE
**ECONO™
HALSEY
NEEDLE HOLDER**
Smooth
Box/50
21-810 5"



STERILE
**ECONO-STERILE™
HALSEY
NEEDLE HOLDER**
Sterile
Smooth
Box/50
96-2584 5"

Box/25
96-2585 5"



OPERATING ROOM GRADE

BAUMGARTNER NEEDLE HOLDER



**BAUMGARTNER
NEEDLE HOLDER**
Serrated
20-1450 5½"

**SKLARLITE™
BAUMGARTNER
NEEDLE HOLDER**
Serrated
23-2132 5½"

**SKLARLITE
EXTRA DELICATE™
BAUMGARTNER
NEEDLE HOLDER**
Serrated
23-2232 5½"



**TUNGSTEN CARBIDE
BAUMGARTNER
NEEDLE HOLDER**
Serrated, Tungsten
Carbide Insert
21-8005 5½"

**SKLARGRIP™
BAUMGARTNER
NEEDLE HOLDER**
Serrated,
Carbide Coating
21-1450 5½"

OPERATING ROOM & SURGERY CENTER

PREMIUM GRADE

PAKISTAN

BAUMGARTNER NEEDLE HOLDER



SURGERY CENTER

**SURGI-OR™
BAUMGARTNER
NEEDLE HOLDER**
Serrated
95-832 5½"



PHYSICIAN

**MERIT™
BAUMGARTNER
NEEDLE HOLDER**
Serrated
97-832 5¼"



FLOOR GRADE

**ECONO™
BAUMGARTNER
NEEDLE HOLDER**
Serrated
Box/12
21-832 5½"



STERILE

**ECONO-STERILE™
BAUMGARTNER
NEEDLE HOLDER**
Sterile
Serrated
Box/50
96-2580 5½"

Box/25
96-2581 5½"

SKLAR OB/GYN

MEDICAL/SURGICAL
PRODUCTS FOR CARE
OF THE FEMALE
PATIENT

OR-Grade Instruments

Our finest Surgical
Instruments, crafted to the
highest standards

SURGI-OR™

Significant value at reduced
cost for OPERATING ROOM
& SURGERY CENTER and
other important surgical
settings

MERIT™

For routine surgical use and
reliable performance in a
variety of clinical settings

SKLAR BLUE™

ELECTROSURGERY
INSTRUMENTATION
features our exclusive

SKLAR BLUE™

coating, providing and
effective patient-safe
surface that prevents
transmission of RF current
through the instrument

SKLAR BLACK™

GYNECOLOGY LASER
INSTRUMENTATION is
coated with a safe and
durable black polymer
developed exclusively
for Laser surgery to
dramatically diminish
reflected laser energy

OPERATING ROOM GRADE GRAVES VAGINAL SPECULUM

**GRAVES VAGINAL
SPECULUM**

- 90-3800** 2¾" x ⅝"
X-Small
- 90-3700** 3" x ⅜"
Small
- 90-3701** 4" x 1¼"
Med
- 90-3702** 4½" x 1⅜"
Large
- 90-3802** 4¾" x 1½"
X-Large
- 90-3803** 6" x 1½"
X-Long

**MID-GRADE
GRAVES VAGINAL
SPECULUM**

- 95-303** 3" x ⅜"
Small
- 95-312** 4" x 1¼"
Med
- 95-324** 4½" x 1⅜"
Large

OPERATING ROOM & SURGERY CENTER
PAKISTAN
PEDERSON VAGINAL SPECULUM

**PEDERSON VAGINAL
SPECULUM**

- Narrow Blades
- 90-3849** 2¾" x ½"
X-Small
- 90-3710** 3" x ½"
Small
- 90-3713** 4" x ⅝"
Med
- 90-3711** 4¾" x 1"
Large
- 90-3851** 4¾" x 1⅜"
X-Large
- 90-3712** 4" x ⅝"
Slender

**MID-GRADE
PEDERSON VAGINAL
SPECULUM**

- 95-347** 3" x ½"
Small
- 95-348** 4" x ⅝"
Med
- 95-362** 4¾" x 1"
Large

*Contact your Account Manager for Details.
Over 5 Thousand Instrument Patterns In-Stock.*

OPERATING ROOM GRADE

VAGINAL SPECULUM



**GRAVES
VAGINAL
SPECULUM
WIDE-VIEW
PATTERN**
With large proximal
opening for
instrumentation
90-3705 4" x 1½"
Medium



**FREEWAY GRAVES
VAGINAL
SPECULUM**
Open Side 90° Angle
90-3750 4" x 1½"

OPERATING ROOM & SURGERY CENTER

OPERATING ROOM GRADE

VAGINAL SPECULUM



**FREEWAY GRAVES
VAGINAL
SPECULUM**
Open Side 45° Angle
90-3752 4" x 1½"



**COLLIN
VAGINAL
SPECULUM**
90-3945 4¼" x 1½"

Over 5 Thousand Instrument Patterns In-Stock.



OPERATING ROOM GRADE

VAGINAL SPECULUM



CUSCO VAGINAL SPECULUM

90-3957 3" x 1½" Small
90-3959 3½" x 1¾" Med
90-3960 3¾" x 1¾" Large



LATERAL VAGINAL RETRACTOR Ratchet Handle

90-3980
Blades fit inside
Vaginal Speculum

OPERATING ROOM & SURGERY CENTER

OPERATING ROOM GRADE

WEIGHTED VAGINAL SPECULUM



AUVARD WEIGHTED VAGINAL SPECULUM 2¾" x 1½"

90-3525
Light 2lbs.

90-3526
Med 2½lbs.

90-3527
Heavy 3lbs.

X-Long Blades
4" x 1¾"

90-3530
Med 2½lbs.



STEINER-AUVARD WEIGHTED VAGINAL SPECULUM

90-3559
2½" lbs.
5½" x 1¼"

Contact your Account Manager for Details.



OPERATING ROOM GRADE

SKLAR BLUE™ ELECTROSURGICAL



**SKLAR BLUE™
GRAVES
VAGINAL
SPECULUM**

With permanent
smoke evacuation
tube

- 91-5020** 3" x ¾"
Small
- 91-5022** 4" x 1¼"
Med
- 91-5024** 4½" x 1¾"
Large
- 91-5028** 4¾" x 1½"
X-Lg



**SKLAR BLUE™
GRAVES
VAGINAL
SPECULUM**

Without tube or ring

- 91-5066** 2¾" x ⅝"
X-Small
- 91-5060** 3" x ¾"
Small
- 91-5062** 4" x 1¼"
Med
- 91-5064** 4½" x 1¾"
Large
- 91-5068** 4¾" x 1½"
X-Large

OPERATING ROOM & SURGERY CENTER

OPERATING ROOM GRADE

SKLAR BLUE™ ELECTROSURGICAL



**SKLAR BLUE™
GRAVES
VAGINAL
SPECULUM**

With slip rings for disposable
smoke evacuation tube

- 91-5015** 2¾" x ⅝" X-Small
- 91-5010** 3" x ¾" Small
- 91-5012** 4" x 1¼" Med
- 91-5014** 4½" x 1¾" Large
- 91-5018** 4¾" x 1½" X-Large

Over 5 Thousand Instrument Patterns In-Stock.



OPERATING ROOM GRADE

SKLAR BLUE™ ELECTROSURGICAL



SKLAR BLUE™ PEDERSON VAGINAL SPECULUM

With permanent
smoke evacuation
tube

- 91-5042** 3" x ½" Small
- 91-5044** 4" x ¾" Med
- 91-5046** 4¾" x 1" Lg
- 91-5047** 4¾" x 1½" X-Lg
- 91-5050** 4" x ⅝" Slender



SKLAR BLUE™ PEDERSON VAGINAL SPECULUM

Without tube or ring

- 91-5082** 3" x ½" Small
- 91-5084** 4" x ¾" Med
- 91-5086** 4¾" x 1" Large
- 91-5088** 2¾" x 1½" X-Small
- 91-5092** 4" x ⅝" Slender

OPERATING ROOM & SURGERY CENTER

OPERATING ROOM GRADE

SKLAR BLUE™ ELECTROSURGICAL



SKLAR BLUE™ PEDERSON VAGINAL SPECULUM

With rings for
disposable smoke
evacuation tube

- 91-5032** 3" x ½" Small
- 91-5034** 4" x ¾" Med
- 91-5036** 4¾" x 1" Large
- 91-5038** 2¾" x ½" X-Sm
- 91-5040** 4" x ⅝" Slender

Contact your Account Manager for Details.



OPERATING ROOM GRADE

SKLAR BLUE™ ELECTROSURGICAL



**SKLAR BLUE™
SIMS VAGINAL
RETRACTOR**
Single End
91-5200
Medium 3" x 1¼"
91-5202
Medium 3" x 1¼"
with loop to hold
and direct
disposable smoke
evacuation tubing



**SKLAR BLUE™
KOGAN
ENDOCERVICAL
SPECULUM**
With
Ratchet Handle

Narrow
Wire Blades
91-5235

Wide
Wire Blades
91-5234



**SKLAR BLUE™
SCHROEDER
TENACULUM
FORCEPS**
91-5450 9½"
91-5452 10"
91-5455 10¼"

OPERATING ROOM & SURGERY CENTER

OPERATING ROOM GRADE

SKLAR BLUE™ ELECTROSURGICAL



**SKLAR BLUE™
ALLIS TISSUE
FORCEPS**
5 x 6 Teeth
91-5278 7½"
91-5440 9½"



**SKLAR BLUE™
EMMETT HOOK
(IRIS)**
6mm
91-5241 9" #1
91-5245 12" #1



**SKLAR BLUE™
POTTS-SMITH
FORCEPS**
91-5411 7"
Serrated
91-5412 10"
Serrated
91-5413 8½"
1 X 2
91-5414 10"
1 X 2

Over 5 Thousand Instrument Patterns In-Stock.



OPERATING ROOM GRADE

SKLAR BLACK™ LASER



**SKLAR BLACK™
LASER GRAVES
VAGINAL SPECULUM**
With permanent smoke
evacuation tube

- 90-9015 3" x ¾"
Small
- 90-9016 4" x 1¼"
Med
- 90-9018 4½" x 1¾"
Large
- 90-9020 4¾" x 1½"
X-Lg



**SKLAR BLACK™
LASER GRAVES
VAGINAL SPECULUM**
Without tube or ring

- 90-3812 2¾" x ⅝"
X-Small
- 90-3804 3" x ¾"
Small
- 90-3806 4" x 1¼"
Med
- 90-3808 4½" x 1¾"
Large
- 90-3810 4¾" x 1½"
X-Lg

OPERATING ROOM & SURGERY CENTER

OPERATING ROOM GRADE

SKLAR BLACK™ LASER



**SKLAR BLACK™
LASER GRAVES
VAGINAL SPECULUM**
With slip rings for smoke
evacuation tubing

- 90-9005 2¾" x ⅝" X-Small
- 90-9000 3" x ¾" Small
- 90-9002 4" x 1¼" Med
- 90-9004 4½" x 1¾" Large
- 90-9006 4¾" x 1½" X-Large



OPERATING ROOM GRADE

SKLAR BLACK™ LASER



**SKLAR BLACK™
LASER PEDERSON
VAGINAL SPECULUM**
With permanent smoke
evacuation tube

90-9040	3" x ½"
	Small
90-9042	4" x ⅜"
	Med
90-9044	4¾" x 1"
	Large
90-9048	4¾" x 1½"
	X-Lg
90-9050	4" x ⅝"
	Slender



**SKLAR BLACK™
LASER PEDERSON
VAGINAL SPECULUM**
Without tube or ring

90-3841	2¾" x ½"
	X-Small
90-3833	3" x ½"
	Small
90-3839	4" x ⅜"
	Med
90-3835	4¾" x 1"
	Large
90-3837	4" x ⅝"
	Slender

OPERATING ROOM & SURGERY CENTER

OPERATING ROOM GRADE

SKLAR BLACK™ LASER

**SKLAR BLACK™
LASER PEDERSON
VAGINAL SPECULUM**
With slip rings for
disposable smoke
evacuation tube

90-9035	2¾" x ½"	X-Small
90-9030	3" x ½"	Small
90-9032	4" x ⅜"	Med
90-9034	4¾" x 1"	Large
90-9038	4" x ⅝"	Slender

OPERATING ROOM GRADE

SKLAR BLACK™ LASER



SKLAR BLACK™ LASER AUVARD WEIGHTED VAGINAL SPECULUM Blade 2¼" x 1½"

90-9100 Med 2½ lbs.
without loop

90-9102 Med 2½ lbs.
with loop to hold and
direct disposable evacu-
ation tubing

Long Blade 4" x 1½"

90-9106 Med 2½ lbs.
without loop

90-9108 Med 2½ lbs.
with loop to hold and
direct disposable evacu-
ation tubing



SKLAR BLACK™ LASER STEINER-AUVARD WEIGHTED VAGINAL SPECULUM X-Long Blade 5½" x 1½"

90-3560 2½ lbs.
without loop

90-3561 2½ lbs.
with loop to hold and
direct
disposable evacuation
tubing

OPERATING ROOM & SURGERY CENTER

OPERATING ROOM GRADE

SKLAR BLACK™ LASER



SKLAR BLACK™ LASER LATERAL VAGINAL RETRACTOR

90-8845
Ratchet Handle

Contact your Account Manager for Details.



OPERATING ROOM GRADE

SKLAR BLACK™ LASER



SKLAR BLACK™ LASER TENACULUM HOOKS

Emmett
90-2171 #1
90-2172 #2
90-2173 #3
90-2174 #4
90-2175 #5
90-2170
Set of 5



LASER DEPTH AND WIDTH RULERS

11" Overall Length
90-2242
Depth in mm



SKLAR BLACK™ LASER ALLIS FORCEPS

90-2276 7½"
Allis, 5 x 6
90-2279 9½"
Allis, 5 x 6

OPERATING ROOM & SURGERY CENTER

OPERATING ROOM GRADE

SKLAR BLACK™ LASER



SKLAR BLACK™ LASER DEBAKEY ATRAUMATIC FORCEPS 2.0 mm jaws

90-2310 7¼"
90-2312 9½"



SKLAR BLACK™ LASER SCHWEIZER FORCEPS

90-2350 9½"

Over 5 Thousand Instrument Patterns In-Stock.



OPERATING ROOM GRADE

EIGHTED VAGINAL SPECULUM



**GARRIGUE
WEIGHTED
VAGINAL
SPECULUM**
3" x 1½"

90-3535
Light 2lbs.

90-3536
Med 2½lbs.

90-3537
Heavy 3lbs.



**HENROTIN
WEIGHTED
VAGINAL
SPECULUM**

90-3555
3 lbs.
3¼" x 1¼"
Blade Angled
Down



**BERLIND-
AUVARD
WEIGHTED
VAGINAL
SPECULUM**

90-3558
2½" lbs.
4¼" x 1¼"

OPERATING ROOM & SURGERY CENTER

OPERATING ROOM GRADE

VAGINAL RETRACTOR



**SIMS
VAGINAL
RETRACTOR**

Double End
90-3150 #1
¾" x 2½"
1" x 3"

90-3151 #2
1" x 2½"
1¼" x 3"

90-3152 #3
1" x 3"
1¼" x 3¼"

90-3153 #4
1¼" x 3"
1½" x 3¼"

90-3154 #5
1¼" x 3¼"
1½" x 4"



**SIMS
VAGINAL
RETRACTOR**

Single End
90-3225
Small
2½" x 1"

90-3230
Med
3" x 1¼"

90-3235
Large
3½" x 1½"



**SKLAR BLUE™
SIMS
VAGINAL
RETRACTOR**
Single End

91-5200
Medium 3" x 1¼"

91-5202
Medium 3" x 1¼"
with loop to hold
and direct
disposable smoke
evacuation tubing

Contact your Account Manager for Details.

OPERATING ROOM GRADE

VAGINAL RETRACTOR



**SIMS-KELLY
VAGINAL
RETRACTOR**
Sklar-Grip
Handle

90-3422 Small
2¼" x 1"

90-3427 Med
2½" x 1¼"

90-3430 Large
3" x 1½"



**SIMS
VAGINAL
RETRACTOR**
Sklar-Grip
Handle

90-3327 Small
2¼" x 1"

90-3330 Med
3" x 1¼"

90-3335 Lg
3½" x 1½"



**O'SULLIVAN-
O'CONNOR
VAGINAL
RETRACTOR**

90-3045 With 3
Interchangeable
Blades:

Small Blade
1½" x ¾"

Medium Blade
3" x 1½"

Large Blade
3½" x 1¼"

OPERATING ROOM & SURGERY CENTER

OPERATING ROOM GRADE

VAGINAL RETRACTOR



**JACKSON
VAGINAL
RETRACTOR**
Single End

90-3130 Small
3" x 1½"

90-3135 Med
3½" x 1½"

90-3140 Lg
4" x 1½"

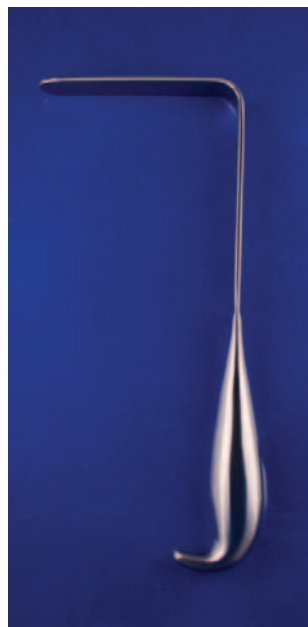

**BRANTLEY-
TURNER
VAGINAL
RETRACTOR**
4" x 1¼" Blade

90-3470 7"



**PRYOR-PEAN
VAGINAL
RETRACTOR**
4¼" x 1" Blade

90-3510 10¼"

Over 5 Thousand Instrument Patterns In-Stock.



OPERATING ROOM GRADE

OB/GYN INSTRUMENTS



**SEGOND
VAGINAL
SPATULA**
4¾" x 1¾"
90-3610 10½"



**TAUBER
VAGINAL
SPATULA**
3½" x 1¾"
90-3692 9¾"



**DELEE
RETRACTOR**
2¾" x 2"
Right
90-3450
Left
90-3451
Universal
90-3452

OPERATING ROOM & SURGERY CENTER



SKLAR MONSEL'S FERRIC SUBSULFATE PASTE

A ONE-TIME USE pre-mixed paste packaged in convenient ready-to-use bottles.

Also includes 12 rayon tip applicators.

PRODUCT NUMBER

96-1200

SKLAR LUGOL'S STRONG IODINE SOLUTION USP

A ONE-TIME USE pre-mixed paste packaged in convenient ready-to-use bottles.

Also includes 12 rayon tip applicators.

PRODUCT NUMBER

96-1210

Contact your Account Manager for Details.



OPERATING ROOM GRADE

KOGAN ENDOCERVICAL SPECULUM



KOGAN ENDOCERVICAL SPECULUM
With Gauge and Screws
Wide Wire Blades
90-3995



KOGAN ENDOCERVICAL SPECULUM
With Spring Handle
Wide Wire Blades
90-3994



KOGAN ENDOCERVICAL SPECULUM
With Ratchet Handle
Wide Wire Blades
90-3998



SKLAR BLUE™ KOGAN ENDOCERVICAL SPECULUM
With Ratchet Handle
Narrow Wire Blades
91-5235
Wide Wire Blades
91-5234

OPERATING ROOM & SURGERY CENTER

OPERATING ROOM GRADE

FORCEPS



BOZEMAN FORCEPS
One Large Ring
S-Curve
90-7710 10 1/4"



BOZEMAN FORCEPS
Straight
90-7610 10 1/2"
S-Curve
80-1410 10 1/4"
S-Curve Heavy Pattern
80-1419 10 1/4"



SKLAR BLUE™ SCHROEDER TENACULUM FORCEPS
91-5450 9 1/2"
91-5455 10 1/4"

Over 5 Thousand Instrument Patterns In-Stock.



OPERATING ROOM GRADE

OB/GYN INSTRUMENTS



**COHEN
UTERINE
MANIPULATOR**
91-1293



**SKLAR BLUE™
ALLIS TISSUE
FORCEPS**
5 x 6 Teeth
91-5278 7½"
91-5440 9½"



**SCHWEIZER
UTERINE FORCEPS**
Straight
90-7995 9½"

OPERATING ROOM & SURGERY CENTER

OPERATING ROOM GRADE

OB/GYN INSTRUMENTS



**CLEMETSON
UTERINE
FORCEPS**
Straight,
No Ratchet
90-7895 9½"



**LAUFE UTERINE
POLYP FORCEPS**
Curved
90-7977 7¼"



**CAMPION
UTERINE
FORCEPS**
Curved
90-7898 9¼"

Contact your Account Manager for Details.



OPERATING ROOM GRADE

OB/GYN INSTRUMENTS



**GELPI-LOWRIE
FORCEPS**

90-1885 8½"



**PHANEUF
FORCEPS**

Angled
90-2680 8¼"

Straight
90-2682 8¼"



**DE ALVAREZ
CLAMP**

Double Curve
90-2782 8¼"

OPERATING ROOM & SURGERY CENTER

OPERATING ROOM GRADE

OB/GYN INSTRUMENTS



**GUSBERG
HYSTERECTOMY
CLAMP**

Curved
90-2780 8"



**HEANEY-BALLENTINE
FORCEPS**

Longitudinal Serrations

90-2480 8" Straight
90-2580 8" Curved

Over 5 Thousand Instrument Patterns In-Stock.



OPERATING ROOM GRADE

OB/GYN



HEANEY FORCEPS
 Single Tooth
 Light Model
90-1977 7¾"
 Single Tooth
 Heavy Model
90-2177 8¼"
 Double Tooth
 Heavy Model
90-2280 8"
90-2387 8¼"



HYSTERECTOMY CLAMP
 Longitudinal
 Serrations
 Full Curve
90-2793 9½"
 Angular
90-2794 9½"



EMMET HOOK (IRIS) 4mm
90-8334 9" #2
90-8344 12" #2

OPERATING ROOM & SURGERY CENTER

OPERATING ROOM GRADE

OB/GYN



SKLAR BLUE™ EMMET HOOK (IRIS)
 6mm
91-5241 9" #1
91-5245 12" #1



SIMS UTERINE SOUND MALLEABLE
 Non-Graduated
 Silver Plated
90-5312 12½"
 Inch Markings
 Graduated
 Silver Plated
90-5314 12½"
 Cm Markings

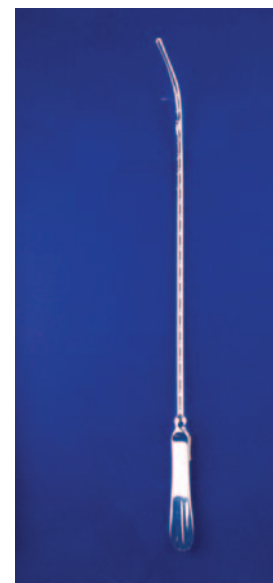

SIMPSON UTERINE SOUND MALLEABLE
 Graduated
 Silver Plated
90-5412 12½"
 Inch Markings
90-5413 12½"
 Cm Markings

Contact your Account Manager for Details.



OPERATING ROOM GRADE

UTERINE DILATORS



**SKLAR
MINI-DILATOR/
OS FINDER SET**
Small Size
Uterine Dilator

90-6280 Five Dilators from 1mm to 3mm in 0.5mm increments. All five interchange on a universal handle.



**HANK
UTERINE
DILATOR**

90-4925 Set of 6 without Khaki Roll

90-4926 Set of 6 with Khaki Roll

American Scale

90-4910 9-10

90-4912 11-12

90-4914 13-14

90-4916 15-16

90-4918 17-18

90-4920 19-20

90-4908 7-8
Narrow



**HEGAR
UTERINE
DILATOR**

Double End
90-4825 Set of 8 without Khaki Roll

90-4826 Set of 8 with Khaki Roll

90-4802 1-2mm

90-4804 3-4mm

90-4806 5-6mm

90-4808 7-8mm

90-4810 9-10mm

90-4812 11-12mm

90-4814 13-14mm

90-4816 15-16mm

90-4818 17-18mm

OPERATING ROOM & SURGERY CENTER

OPERATING ROOM GRADE

UTERINE DILATORS



**PRATT UTERINE
DILATOR**

90-5250 Set of 8

90-5215 13-15 French

90-5219 17-19 French

90-5223 21-23 French

90-5227 25-27 French

90-5231 29-31 French

90-5235 33-35 French

90-5239 37-39 French

90-5243 41-43 French



**KLEEGMAN
DILATOR**

90-4902 10½"
Narrow



**GOODELL
UTERINE
DILATOR**

90-4713 13"

Over 5 Thousand Instrument Patterns In-Stock.

OPERATING ROOM GRADE

OB/GYN

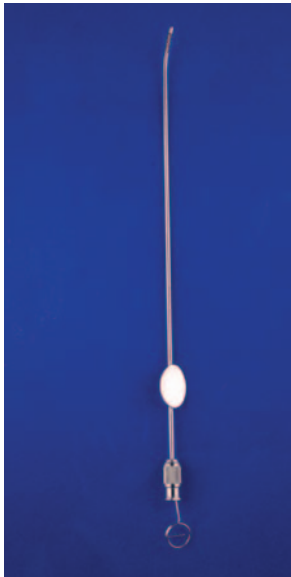

**NOVAK
ENDOMETRIAL
CURETTE**
90-6289 9½" 1mm
90-6290 9½" 2mm
90-6291 9½" 3mm
90-6292 9½" 4mm



**HOLDEN
UTERINE
CURETTE**
Semi-Sharp
90-5710 10¾"
X-Small



**IUD
EXTRACTOR**
90-8210 10½"

OPERATING ROOM & SURGERY CENTER

OPERATING ROOM GRADE

OB/GYN



**HEANEY
UTERINE
CURETTE**
Serrated
90-6095 9½"
Open Curette
90-6195 9½"
With Cup



**HOLMAN-MATHIEU
CANNULA**
For
Hysterosalping-
ography
90-6582
8¼" (21cm) with
Luer-Lok Hub
Chrome-Plated
Small Size
90-6590
9" (22.9cm)
Large Size



**SIMS UTERINE
CURETTE**
Sharp, 11"
90-5499 No. 00
90-5500 No. 0
90-5421 No. 1
90-5422 No. 2
90-5423 No. 3
90-5424 No. 4
90-5425 No. 5
90-5426 No. 6
90-5428 Set of 6

Contact your Account Manager for Details.



OPERATING ROOM GRADE

OB/GYN



**LOUNSBURY
PLACENTA
CURETTE**
90-5713 13"
3/4" Wide



**SKLAR MINI
ENDOCERVICAL
CURETTE**
90-6285 Small
rounded tip for
easier entry into
stenosed cervix



**KEVORKIAN-YOUNGE
ENDOCERVICAL
CURETTE**
Narrow Tip
90-6611 12" without
Basket
90-6612 12" with
Basket

OPERATING ROOM & SURGERY CENTER

OPERATING ROOM GRADE

OB/GYN



SIMS SCISSORS
Straight
90-1280 8" S/S
90-1180 8" S/B
90-1080 8" B/B
Curved
90-1580 8" S/S
90-1480 8" S/B
90-1380 8" B/B



**BRAUN
EPISIOTOMY
SCISSORS**
Angular,
Guarded Blade
90-1755 5 1/2"
90-1785 8 1/2"



**UMBILICAL
SCISSORS**
Curved
92-5540 4"

Over 5 Thousand Instrument Patterns In-Stock.



OPERATING ROOM GRADE

OBSTETRICAL FORCEPS



McLANE-TUCKER-LUIKART OBSTETRICAL FORCEPS

92-2015 15½"



SIMPSON-LUIKART OBSTETRICAL FORCEPS

92-2314 14"



DE LEE OBSTETRICAL FORCEPS

92-1012 12"
For Cesarean Section

OPERATING ROOM & SURGERY CENTER

OPERATING ROOM GRADE

OBSTETRICAL FORCEPS



SIMPSON OBSTETRICAL FORCEPS

92-1112 12"
Short

92-1114 14½"
Long

McLANE-TUCKER OBSTETRICAL FORCEPS

92-1415 15½"



LAUFE DIVERGENT OBSTETRICAL FORCEPS

92-2912 12½"

Contact your Account Manager for Details.



OPERATING ROOM GRADE

OBSTETRICAL FORCEPS



**LAUFE-PIPER
OBSTETRICAL
FORCEPS**
For Breech
Presentation

92-2812 12"



**KELLY
PLACENTA
FORCEPS**
Curved

92-5012 12"



**JAVERTS
PLACENTA
FORCEPS**
Serrated

92-5095 9½"

OPERATING ROOM & SURGERY CENTER

OPERATING ROOM GRADE

OB/GYN



**COREY OVUM
FORCEPS**

92-5295 9½"



**BIERER OVUM
FORCEPS**
Serrated Jaw

92-5298 11"



**DISPOSABLE
SMOKE
EVACUATION
TUBING**
Case of 50, in 10"
Precut
¾" ID 1¼" OD

93-2160

Over 5 Thousand Instrument Patterns In-Stock.

OPERATING ROOM GRADE

LAR BLUE™ ELECTROSURGICAL



**SKLAR BLUE™
SCHROEDER
TENACULUM
FORCEPS**

91-5450 9½"
91-5452 10"
91-5455 10¼"



**SKLAR BLUE™
POTTS-SMITH
FORCEPS**

91-5411 7" Serrated
91-5412 10" Serrated
91-5413 8½" 1 X 2
91-5414 10" 1 X 2

OPERATING ROOM & SURGERY CENTER

OPERATING ROOM GRADE

STANDARD COLPOSCOPY SET



90-8557 STANDARD COLPOSCOPY SET

Includes:

90-3995 Kogan Endocervical Speculum - Wide Wire Blades
90-8334 Emmett Hook - 4mm Diameter, 9" Long
90-6612 Kevorkian-Younger Endocervical Curette - 12" with Basket
90-7520 Tischler Oval Biopsy Forcep - 3mm x 7mm Bite



OB/GYN DISPOSABLE INSTRUMENTS

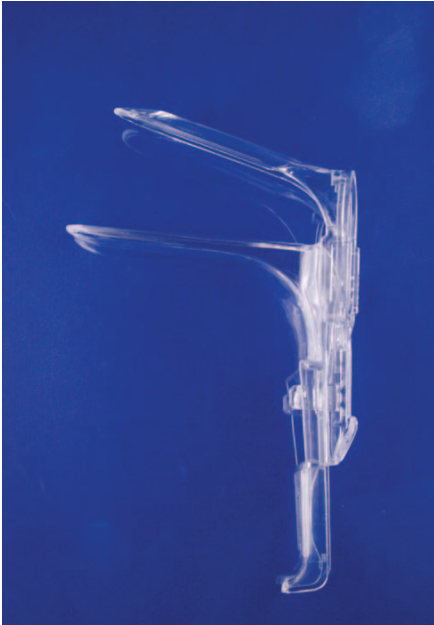

NON-STERILE, DISPOSABLE

PLASTIC VAGINAL SPECULUM, GRAVES STYLE
 Disposable, Non-Sterile
 Case of 100 (10 Packs of 10)

- 96-0857** Small
- 96-0867** Medium
- 96-0877** Large

Disposable, Sterile
 Case of 50

- 96-2602** Small
- 96-2604** Medium
- 96-2606** Large

STERILE, DISPOSABLE



ENDOMETRIAL SAMPLING SET
 Sterile, Box/10
96-4160 3mm

STERILE, DISPOSABLE



ENDOMETRIAL SAMPLING SET with 60CC SYRINGE
 Sterile, Box/10
96-4162 4mm
96-4164 5mm
96-4166 6mm

STERILE, DISPOSABLE



ENDOMETRIAL BIOPSY CANNULA
 Sterile, Box/25
96-4100 For Aspiration Biopsy

STERILE, DISPOSABLE

OB/GYN INSTRUMENTS



**NEEDLE
EXTENDERS,
REUSABLE**
Each
96-4190 3"
96-4192 4"
96-4194 5"
96-4196 6"

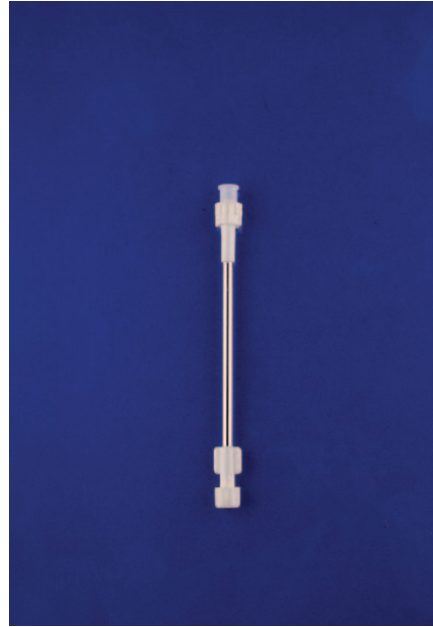

**NEEDLE
EXTENDERS,
DISPOSABLE**
PLASTIC LUER LOCK ADAPTER
Each
96-5190 3" Box/10, Sterile
96-5192 4" Box/10, Sterile
96-5194 5" Box/10, Sterile
96-5196 6" Box/10, Sterile



**OS DILATOR SET,
REUSABLE**
Teflon
96-4150
Set of 3 Dilators -
OS Locator
Canal Finder
Fundus Dilator

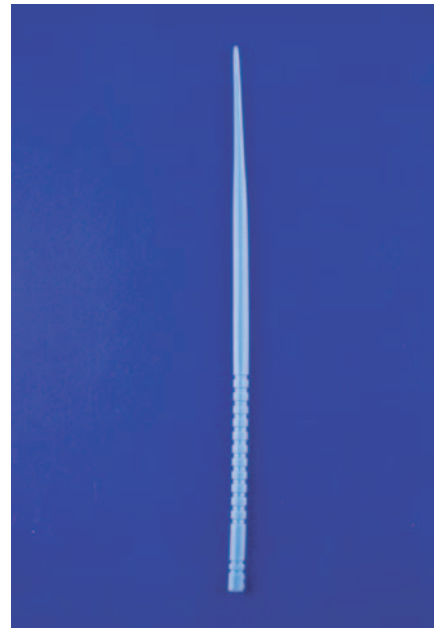

**OS DILATOR,
DISPOSABLE**
Box/50, Sterile
96-4155

STERILE, DISPOSABLE

Contact your Account Manager for Details.





STERILE, DISPOSABLE

SKLAR TRU-PUNCH DISPOSABLE VULVAR BIOPSY PUNCH
 Sterile, Box/50
96-1100 2mm
96-1105 3mm
96-1110 3.5mm
96-1115 4mm
96-1120 5mm
96-1125 6mm
96-1130 8mm

Sterile, Box/25
96-1140 2mm
96-1142 3mm
96-1144 3.5mm
96-1146 4mm
96-1148 5mm
96-1150 6mm
96-1152 8mm

Assorted
 Sterile, Box/25
96-1160 Assorted
 (5 each of - 2, 3, 3.5, 4, 5)



ENDOCERVICAL CURETTE
 Sterile, Box/25
96-4143



UTERINE MANIPULATOR/INJECTOR, DISPOSABLE
 Sterile, Box/12
96-4120 4.5mm O.D., 33cm Length



HIRSCHMAN ANOSCOPE, DISPOSABLE
 Pack/25
96-0910

STERILE, DISPOSABLE

NUMERICAL INDEX

06-1004	148	06-3015	144	10-1180	176	10-1374	167
06-1201	149	06-3020	144	10-1181	176	10-1376	167
06-1202	149	06-3021	144	10-1182	178	10-1380	167
06-1600	148	06-3022	144	10-1183	178	10-1382	155
06-1601	146	06-3023	144	10-1184	178	10-1384	167
06-1602	146	06-3094	139	10-1186	178	10-1386	167
06-1603	146	06-3095	139	10-1188	178	10-1388	167
06-1625	145	06-3096	139	10-1189	178	10-1392	155
06-1627	145	06-3100	144	10-1190	178	10-1394	169
06-1630	147	06-3101	144	10-1192	179	10-1396	169
06-1632	147	06-3102	144	10-1193	179	10-1398	169
06-1635	148	06-3103	144	10-1194	181	10-1399	169
06-1638	148	06-3104	144	10-1205	175	10-1400	169
06-1640	147	06-3105	144	10-1212	175	10-1401	169
06-1642	147	06-3107	144	10-1217	175	10-1402	169
06-1648	149	06-3110	144	10-1218	175	10-1403	169
06-1652	150	06-3112	144	10-1219	175	10-1404	169
06-1654	150	06-3115	144	10-1220	175	10-1405	169
06-1660	150	06-3120	144	10-1221	175	10-1406	169
06-1662	149	06-3121	144	10-1222	175	10-1407	169
06-1668	149	06-3122	144	10-1223	175	10-1408	169
06-2300	146	06-3123	144	10-1226	175	10-1409	169
06-2301	146	07-1777	252	10-1227	175	10-1414	168
06-2302	146	07-1780	252	10-1228	175	10-1415	168
06-2303	146	07-1797	252	10-1229	175	10-1418	170
06-2304	145	08-1003	171	10-1232	175	10-1419	170
06-2315	145	08-1004	172	10-1233	175	10-1420	170
06-2311	145	08-1009	171	10-1234	175	10-1421	170
06-2312	145	08-1011	173	10-1235	175	10-1422	170
06-2313	145	08-1012	173	10-1242	175	10-1424	170
06-2316	145	08-1013	174	10-1244	175	10-1440	138
06-2317	145	08-1014	174	10-1250	175	10-1442	166
06-2318	145	08-1015	174	10-1252	175	10-1444	166
06-2319	145	08-1016	174	10-1253	175	10-1450	178
06-2320	145	08-1017	173	10-1260	175	10-1451	178
06-2321	145	08-1018	173	10-1262	175	10-1460	158
06-2322	145	08-1019	174	10-1278	175	10-1470	168
06-2331	147	08-1020	172	10-1282	175	10-1472	168
06-2332	147	09-3096	139	10-1284	175	10-1483	177
06-2334	147	09-3111	144	10-1286	175	10-1483-12	177
06-2335	147	09-3122	144	10-1286	175	10-1484	177
06-2340	128	10-1140	144	10-1288	175	10-1484-12	177
06-2341	148	10-1142	144	10-1320	161	10-1485	177
06-2342	148	10-1144	144	10-1332	161	10-1485-12	177
06-2343	148	10-1146	144	10-1337	161	10-1486	177
06-2413	146	10-1148	144	10-1338	161	10-1486-12	177
06-2414	146	10-1150	144	10-1342	159	10-1487	178
06-2415	147	10-1152	144	10-1344	159	10-1488	177
06-2416	147	10-1157	179	10-1346	159	10-1488-12	177
06-2424	146	10-1158	179	10-1347	159	10-1489	177
06-2425	146	10-1159	179	10-1348	159	10-1489-12	177
06-2426	147	10-1160	179	10-1349	159	10-1490	177
06-2427	147	10-1170	179	10-1350	167	10-1490-12	177
06-2654	150	10-1171	179	10-1352	167	10-1491	177
06-2655	150	10-1172	176	10-1354	167	10-1491-12	177
06-2656	150	10-1173	176	10-1356	167	10-1492	177
06-2657	150	10-1174	176	10-1362	167	10-1492-12	177
06-2671	150	10-1175	176	10-1364	167	10-1493	177
06-3010	144	10-1176	176	10-1366	167	10-1493-12	177
06-3011	144	10-1177	176	10-1370	167	10-1494	177
06-3012	144	10-1178	176	10-1372	167	10-1495	177



NUMERICAL INDEX

10-1496	177	10-1629	163	10-1705	182	10-1800	160
10-1496-12	177	10-1630	160	10-1706	182	10-1805	160
10-1497	178	10-1635	159	10-1707	182	10-1806	160
10-1498	177	10-1636	159	10-1708	182	10-1808	160
10-1498-12	177	10-1643	154	10-1710	182	10-1810	160
10-1505	177	10-1645	166	10-1711	152	10-1812	160
10-1505-12	177	10-1648	166	10-1712	153	10-1816	160
10-1507	177	10-1650	166	10-1716	182	10-1818	160
10-1507-12	177	10-1651	166	10-1717	182	10-1836	159
10-1510	177	10-1652	166	10-1718	182	10-1838	159
10-1510-12	177	10-1653	154	10-1720	182	10-1839	161
10-1523	144	10-1657	166	10-1722	181	10-1850	180
10-1523-12	144	10-1658	166	10-1722-12	181	10-1852	180
10-1525	144	10-1659	166	10-1724	180	10-1854	183
10-1525-12	144	10-1660	167	10-1724-12	180	10-1854-12	183
10-1527	144	10-1664	167	10-1725	153	10-1860	180
10-1527-12	144	10-1668	167	10-1729	153	10-1862	180
10-1532	180	10-1670	176	10-1731	153	10-1864	180
10-1533	144	10-1670-12	176	10-1732	153	10-1870	180
10-1533-12	144	10-1670-48	176	10-1733	153	10-1870-6	180
10-1535	183	10-1671	176	10-1734	153	10-1874	181
10-1535-12	183	10-1671-12	176	10-1736	153	10-1876	180
10-1538	144	10-1671-48	176	10-1737	180	10-1876-12	180
10-1538-12	144	10-1674	177	10-1737-12	180	10-1877	180
10-1539	176	10-1674-12	177	10-1738	181	10-1877-12	180
10-1539-12	176	10-1675	176	10-1738-12	181	10-1878	180
10-1540	144	10-1675-12	176	10-1740	183	10-1878-12	180
10-1540-12	144	10-1675-48	176	10-1742	180	10-1879	181
10-1541	144	10-1680	180	10-1742-12	180	10-1882	180
10-1541-12	144	10-1680-12	180	10-1744	180	10-1882-12	180
10-1542	180	10-1683	180	10-1744-12	180	10-1882-6	180
10-1542-12	180	10-1683-12	180	10-1746	180	10-1883	180
10-1543	144	10-1684	179	10-1746-6	180	10-1883-12	180
10-1543-12	144	10-1684-12	179	10-1747	180	10-1884	180
10-1544	144	10-1685	179	10-1747-6	180	10-1884-12	180
10-1544-12	144	10-1685-12	179	10-1748	180	10-1886	181
10-1545	144	10-1686	179	10-1748-12	180	10-1886-12	181
10-1545	169	10-1686-12	179	10-1750	183	10-1887	181
10-1547	144	10-1687	179	10-1750-12	183	10-1887-12	181
10-1547-12	144	10-1687-12	179	10-1752	183	10-1888	180
10-1550	144	10-1688	179	10-1752-12	183	10-1888-12	180
10-1550-12	144	10-1688-12	179	10-1753	180	10-1892	181
10-1551	178	10-1690	179	10-1753-12	180	10-1941	180
10-1552	177	10-1690-12	179	10-1754	180	10-1942	180
10-1552-12	177	10-1691	179	10-1754-12	180	10-1943	181
10-1560	153	10-1691-12	179	10-1755	180	10-1948	183
10-1585	176	10-1692	179	10-1755-12	180	10-1948-12	183
10-1585-12	176	10-1692-12	179	10-1756	180	10-1949	152
10-1585-48	176	10-1693	179	10-1756-12	180	10-1950	180
10-1601	134	10-1693-12	179	10-1757	180	10-1950-12	180
10-1603	157	10-1694	179	10-1758	180	10-1952	180
10-1607	160	10-1694-12	179	10-1759	180	10-1952-12	180
10-1608	160	10-1695	179	10-1760	181	10-1953	183
10-1612	160	10-1695-12	179	10-1760-12	181	10-1953-12	183
10-1613	160	10-1698	178	10-1761	181	10-1954	183
10-1616	155	10-1698-12	178	10-1761-12	181	10-1954-12	183
10-1617	155	10-1699	178	10-1763	159	10-1955	181
10-1621	152	10-1699-12	178	10-1770	160	10-1955-12	181
10-1622	153	10-1700	182	10-1775	159	10-1956	181
10-1623	153	10-1702	182	10-1776	159	10-1956-12	181
10-1625	165	10-1703	182	10-1780	160	10-1957	152



NUMERICAL INDEX

10-2701	160	15-2569	232	17-1232	246	19-1080	257
10-2722	156	15-3248	231	17-1235	246	19-1110	257
10-2724	156	15-3306	233	17-1335	246	19-1112	257
10-2774	156	15-3310	234	17-1450	243	19-1245	258
10-2777	161	15-3311	234	17-1459	243	19-1255	258
10-2800	158	15-3315	234	17-1550	243	19-1258	258
10-2801	158	15-3325	232	17-1559	243	19-1260	258
10-2842	163	15-3326	232	17-1650	243	19-1270	258
10-2850	163	15-3330	232	17-1750	243	19-1280	258
10-3772	173	15-3331	232	17-2055	245	19-1310	258
11-1035	240	15-3343	230	17-2155	245	19-1312	258
11-1045	240	15-3349	231	17-2255	248	19-250	258
11-1055	240	15-3352	235	17-2262	248	19-3035	262
11-1060	240	15-3357	235	17-2267	248	19-3040	262
11-1072	240	15-3410	234	17-2272	248	19-3045	262
11-1078	240	15-3442	230	17-2280	248	20-1350	263
11-1080	240	15-3443	230	17-2362	248	20-1352	263
11-1255	241	15-3448	231	17-2455	248	20-1450	267
11-1278	242	15-3449	231	17-2462	248	20-1547	264
11-1280	242	15-3452	235	17-2467	248	20-1750	266
11-1281	242	15-3457	235	17-2472	248	20-1751	266
11-1282	242	15-3500	230	17-2480	248	20-2052	265
11-1283	242	15-3505	230	17-2655	247	20-2060	265
11-1284	242	15-3510	231	17-2662	247	20-2070	265
13-1045	230	15-3515	231	17-2672	247	20-2480	265
13-1050	230	15-3550	232	17-2680	247	20-2490	265
13-1055	230	15-3555	232	17-2690	247	20-2910	265
13-1060	230	15-3560	232	17-2762	247	20-2911	265
13-1065	230	15-3565	232	17-2855	247	20-3090	263
13-2045	231	15-3570	233	17-2862	247	21-101	242
13-2050	231	15-3575	234	17-2872	247	21-102	235
13-2055	231	15-3585	235	17-2878	247	21-103	235
13-2060	231	15-3590	235	17-2880	247	21-104	235
13-2065	231	16-1055	230	17-2890	247	21-107	235
14-1035	230	16-1056	230	17-2962	247	21-109	235
14-1045	230	16-1057	230	17-3055	244	21-1450	267
14-1050	230	16-1155	231	17-3062	244	21-1547	264
14-1055	230	16-1156	231	17-3068	244	21-1650	263
14-1058	230	16-1505	232	17-3075	244	21-1652	263
14-1060	230	16-1510	232	17-3155	244	21-1750	266
14-1065	230	16-1515	232	17-3162	244	21-1850	266
14-2045	231	16-1605	232	17-3168	244	21-2060	265
14-2050	231	16-1610	232	17-3175	244	21-2070	265
14-2055	231	16-1615	232	17-3995	256	21-222	240
14-2060	231	16-1805	233	17-3996	256	21-226	240
14-2065	231	16-1810	233	17-3997	256	21-231	240
15-1045	230	16-1905	233	18-1050	243	21-237	240
15-1050	230	16-1910	233	18-1150	243	21-241	240
15-1055	230	16-2005	234	18-1552	245	21-2450	265
15-1060	230	16-2010	234	18-1652	245	21-254	241
15-1065	230	16-2105	234	18-1952	244	21-263	230
15-1355	238	16-2110	234	18-2052	244	21-266	230
15-1555	232	16-2210	234	18-2140	249	21-272	230
15-1567	232	16-2310	234	18-2155	249	21-275	230
15-2045	231	16-2311	234	18-2162	249	21-281	230
15-2050	231	16-2405	235	18-2164	249	21-284	230
15-2055	231	16-2505	235	19-1045	257	21-285	252
15-2060	231	16-2605	236	19-1050	257	21-289	252
15-2065	231	16-2705	236	19-1055	257	21-291	231
15-2555	232	16-2800	239	19-1060	257	21-2910	265
15-2567	232	17-1230	246	19-1070	257	21-292	231



NUMERICAL INDEX

21-293	231	21-8031	265	22-2567	232	23-1178	233
21-294	231	21-8032	265	22-2650	233	23-1179	233
21-295	231	21-8033	265	22-2834	237	23-1180	234
21-299	231	21-8034	265	22-2835	237	23-1182	234
21-300	231	21-8035	265	22-2844	237	23-1184	234
21-308	232	21-8080	263	22-2845	237	23-1186	234
21-312	232	21-809	263	22-3555	248	23-1188	237
21-321	232	21-810	266	22-3655	248	23-1189	237
21-325	232	21-826	264	22-3755	247	23-1190	238
21-335	233	21-832	267	22-3855	247	23-1193	237
21-336	233	21-842	265	22-6155	250	23-1194	237
21-339	234	21-847	265	22-6157	249	23-1195	238
21-340	234	21-853	265	22-9084	234	23-1199	240
21-346	237	21-869	265	23-1100	230	23-1200	240
21-352	237	21-930	249	23-1101	230	23-1202	240
21-358	238	21-934	249	23-1102	230	23-1203	240
21-363	239	21-938	249	23-1104	230	23-1260	230
21-364	239	22-1054	240	23-1105	230	23-1262	230
21-409	246	22-1057	233	23-1106	230	23-1264	231
21-421	246	22-1063	258	23-1112	230	23-1266	231
21-426	243	22-1070	234	23-1113	230	23-1267	234
21-431	243	22-1071	234	23-1114	230	23-1268	235
21-436	245	22-1072	240	23-1116	230	23-1270	235
21-442	245	22-1135	235	23-1117	230	23-1274	232
21-447	244	22-1145	230	23-1118	230	23-1278	232
21-452	244	22-1150	230	23-1124	231	23-1280	233
21-470	248	22-1155	230	23-1125	231	23-2100	246
21-471	248	22-1161	257	23-1126	231	23-2101	246
21-473	248	22-1162	257	23-1128	231	23-2105	243
21-477	248	22-1163	257	23-1130	231	23-2107	245
21-481	248	22-1164	257	23-1135	231	23-2108	245
21-485	248	22-1235	235	23-1136	231	23-2110	244
21-492	248	22-1245	230	23-1138	231	23-2113	244
21-498	248	22-1250	230	23-1140	231	23-2120	263
21-577	254	22-1255	230	23-1142	231	23-2124	264
21-586	254	22-1345	230	23-1148	235	23-2125	263
21-598	256	22-1345	238	23-1149	235	23-2128	265
21-599	256	22-1350	230	23-1150	235	23-2130	266
21-604	253	22-1350	230	23-1151	235	23-2132	267
21-606	255	22-1355	230	23-1152	235	23-2135	266
21-608	255	22-1355	230	23-1153	235	23-2220	263
21-710	257	22-1442	236	23-1154	235	23-2224	264
21-727	257	22-1445	231	23-1155	235	23-2225	263
21-731	257	22-1450	231	23-1158	236	23-2228	265
21-736	257	22-1455	231	23-1159	236	23-2230	266
21-753	258	22-1542	236	23-1162	236	23-2232	267
21-757	258	22-1545	231	23-1163	236	23-2235	266
21-762	258	22-1550	231	23-1164	232	23-2500	246
21-766	258	22-1555	231	23-1165	232	23-2501	246
21-771	259	22-1556	232	23-1166	232	23-2505	243
21-772	259	22-1567	232	23-1167	232	23-2506	243
21-775	260	22-1645	230	23-1168	232	23-2507	245
21-776	260	22-1645	231	23-1169	232	23-2508	245
21-777	262	22-1650	231	23-1170	232	23-2510	244
21-778	261	22-1655	231	23-1171	232	23-2513	244
21-781	262	22-2280	248	23-1172	233	23-2532	248
21-8000	266	22-2450	233	23-1173	233	23-2538	248
21-8001	266	22-2460	233	23-1174	233	23-2542	248
21-8002	263	22-2545	233	23-1175	233	23-2552	248
21-8004	264	22-2550	233	23-1176	233	23-2560	247
21-8005	267	22-2555	232	23-1177	233	23-2561	248



NUMERICAL INDEX

23-2563	248	31-2247	205	31-4320	202	36-2060	249
23-2568	247	31-2258	204	31-4321	202	36-2160	249
23-2577	247	31-2327	206	31-4323	202	36-2260	249
23-2585	247	31-2347	204	31-4324	202	36-2275	249
23-2600	259	31-2349	204	31-4325	209	36-2278	249
23-2602	260	31-2350	206	31-4326	209	36-2280	249
23-2603	261	31-2352	206	31-4327	209	36-2295	249
23-2604	259	31-2355	206	31-9001XC	209	36-2298	249
23-2606	260	31-2365	206	31-9002YC	209	36-2385	249
23-2608	261	31-2435	205	31-9005	197	36-2690	248
23-2811	258	31-2437	205	31-9005XC	197	36-2790	248
23-2819	258	31-2441	205	31-9010	197	36-2810	248
23-2824	257	31-2443	205	31-9010XC	197	39-2710	248
23-2826	257	31-2444	205	31-9015	197	47-1135	235
23-2828	257	31-2445	205	31-9015XC	197	47-1145	235
23-2830	257	31-2447	205	31-9020	197	47-1235	235
23-2834	257	31-2450	199	31-9020XC	197	47-1245	235
23-2836	257	31-2451	199	31-9025	197	47-1246	235
23-2838	257	31-2550	203	31-9025XC	197	47-1248	235
23-2851	249	31-2551	203	31-9030	198	47-1360	233
23-2852	249	31-2552	203	31-9030XC	198	47-1447	261
23-2861	249	31-2553	203	31-9035	198	47-1448	261
23-2862	249	31-2568	198	31-9035XC	198	47-1450	261
23-2864	249	31-2568XC	198	31-9040	198	47-2047	260
23-2865	249	31-4001XC	219	31-9040XC	198	47-2049	260
24-2342	239	31-4002YC	219	31-9050	200	47-2147	259
24-2349	239	31-4003	204	31-9050YC	200	47-2447	261
31-0001	202	31-4004	204	31-9055	200	47-2837	253
31-0001	202	31-4301	209	31-9055YC	200	47-2852	253
31-0002	202	31-4302	209	31-9060	200	47-2935	255
31-0003	202	31-4303	207	31-9060YC	200	47-2945	255
31-0004	202	31-4303XC	207	31-9065	200	47-2955	255
31-0010	202	31-4304	207	31-9065YC	200	47-2959	255
31-1001	202	31-4304XC	207	31-9075	198	47-2960	255
31-1002	202	31-4305	207	31-9075	199	50-3045	260
31-1003	202	31-4305XC	207	31-9075YC	198	50-3047	260
31-1004	202	31-4306	207	31-9075YC	199	50-3147	259
31-1007	202	31-4306XC	207	31-9080	200	51-1447	261
31-1008	202	31-4307	207	31-9080YC	200	51-1448	261
31-1009	202	31-4307XC	207	31-9085	200	51-3049	260
31-1010	202	31-4308	208	31-9085YC	200	51-3447	260
31-1011	202	31-4308YC	208	31-9090	200	51-3460	257
31-1012	202	31-4309	208	31-9090YC	200	51-3480	257
31-1020	202	31-4309XC	208	31-9095	200	51-470	248
31-1022	202	31-4310	208	31-9095YC	200	55-9080	234
31-1030	202	31-4310XC	208	31-9100	200	55-9090	234
31-1032	202	31-4311	208	31-9100YC	200	55-9180	234
31-1042	202	31-4311XC	208	31-9120XC	199	55-9184	234
31-2227	205	31-4312	208	31-9125XC	199	55-9190	234
31-2229	205	31-4312YC	208	31-9130	199	55-9210	234
31-2233	205	31-4313	208	31-9130XC	199	55-9310	234
31-2235	205	31-4313YC	208	31-9135	199	55-9311	234
31-2237	205	31-4314	208	31-9135XC	199	55-9411	234
31-2238	204	31-4314YC	208	31-9140	199	55-9612	234
31-2239	204	31-4315	208	31-9140YC	199	55-9614	234
31-2241	205	31-4315XC	208	31-9150	201	60-6130	202
31-2242	205	31-4316	208	31-9155	201	62	195
31-2242	209	31-4316XC	208	31-9160	201	62	195
31-2243	205	31-4317	208	36-1662	250	62-1659	137
31-2244	205	31-4317YC	208	36-1677	250	62-1661	137
31-2245	205	31-4318	209	36-1692	250	62-3702	137



NUMERICAL INDEX

62-3702	195	62-7807	137	90-2278	250	90-3750	269
62-3703	137	62-7809	137	90-2279	277	90-3752	269
62-3703	195	62-8453	137	90-2280	284	90-3800	268
62-3706	137	62-8454	137	90-2295	250	90-3802	268
62-3706	195	62-8455	137	90-2310	277	90-3803	268
62-3708	137	62-8464	137	90-2312	277	90-3804	274
62-3708	195	62-8465	137	90-2350	277	90-3806	274
62-3710	137	62-8466	137	90-2387	284	90-3808	274
62-3710	195	62-8764	195	90-2480	283	90-3810	274
62-3711	137	64-1442	236	90-2519	285	90-3812	274
62-3713	137	64-1542	236	90-2580	283	90-3833	275
62-3713	195	64-2142	235	90-2680	283	90-3835	275
62-3715	137	65-6703	195	90-2682	283	90-3837	275
62-3715	195	74-3260	245	90-2780	283	90-3839	275
62-3716	137	74-3270	245	90-2782	283	90-3841	275
62-3716	195	75-5460	233	90-2793	284	90-3849	268
62-3717	195	75-5570	234	90-2794	284	90-3851	268
62-3718	137	75-5670	234	90-3045	279	90-3945	269
62-3718	195	78-2621	166	90-3130	279	90-3957	270
62-3726	137	78-2622	166	90-3135	279	90-3959	270
62-3728	137	78-2813	166	90-3140	279	90-3960	270
62-4628	137	78-2813	168	90-3150	278	90-3980	270
62-4629	137	78-2821	168	90-3151	278	90-3994	281
62-4703	137	78-2822	168	90-3152	278	90-3995	281
62-4703	195	78-2823	166	90-3153	278	90-3995	290
62-4704	137	78-2823	168	90-3154	278	90-3998	281
62-4705	137	78-2824	167	90-3225	278	90-4713	285
62-4705	195	78-2831	168	90-3230	278	90-4802	285
62-4706	137	78-2832	168	90-3235	278	90-4804	285
62-4706	195	80-1410	281	90-3312	290	90-4806	285
62-4707	137	80-1419	281	90-3327	279	90-4810	285
62-4707	195	80-1914	220	90-3330	279	90-4812	285
62-4714	137	80-1945	224	90-3422	279	90-4814	285
62-4746	136	85-6222	224	90-3427	279	90-4816	285
62-4746M	136	87-2095	254	90-3430	279	90-4818	285
62-4748	136	87-2195	254	90-3450	280	90-4825	285
62-4748M	136	87-2199	254	90-3451	280	90-4826	285
62-4750	136	87-2295	254	90-3452	280	90-4902	285
62-4750M	136	87-2395	254	90-3470	279	90-4912	285
62-4752	136	90+3335	279	90-3510	279	90-4914	285
62-4752M	136	90-1080	287	90-3525	270	90-4916	285
62-4760	136	90-1180	287	90-3526	270	90-4918	285
62-4760M	136	90-1280	287	90-3530	270	90-4919	285
62-6633	137	90-1380	287	90-3535	278	90-4920	285
62-6701	195	90-1480	287	90-3536	278	90-4925	285
62-6703	137	90-1580	287	90-3537	278	90-4926	285
62-6704	137	90-1590	232	90-3555	278	90-5215	285
62-6704	195	90-1690	232	90-3558	278	90-5223	285
62-6705	137	90-1755	287	90-3559	270	90-5227	285
62-6705	195	90-1785	287	90-3560	276	90-5231	285
62-6706	137	90-1885	283	90-3561	276	90-5235	285
62-6706	195	90-1977	284	90-3610	280	90-5239	285
62-6707	137	90-2170	277	90-3692	280	90-5243	285
62-6707	195	90-2171	277	90-3700	268	90-5250	285
62-6714	137	90-2172	277	90-3701	268	90-5260	193
62-6716	137	90-2173	277	90-3702	268	90-5262	193
62-7701	137	90-2174	277	90-3705	269	90-5264	193
62-7701	195	90-2175	277	90-3710	268	90-5312	284
62-7706	137	90-2177	284	90-3711	268	90-5314	284
62-7708	137	90-2242	277	90-3712	268	90-5413	284
62-7801	137	90-2276	277	90-3713	268	90-5421	286



NUMERICAL INDEX

90-5422	286	90-9048	275	91-5278	282	95-312	268
90-5423	286	90-9050	275	91-5411	273	95-321	232
90-5424	286	90-9100	276	91-5411	290	95-324	268
90-5425	286	90-9102	276	91-5412	273	95-325	232
90-5426	286	90-9106	276	91-5412	290	95-330	232
90-5499	286	90-9108	276	91-5413	273	95-335	233
90-5500	286	90-9412	284	91-5413	290	95-336	233
90-5710	286	91-1293	282	91-5414	273	95-339	234
90-5713	287	91-3120	199	91-5414	290	95-340	234
90-6095	286	91-5010	271	91-5428	286	95-346	237
90-6195	286	91-5012	271	91-5440	273	95-347	268
90-6280	285	91-5014	271	91-5440	282	95-348	268
90-6285	287	91-5018	271	91-5450	273	95-352	237
90-6289	286	91-5020	271	91-5450	281	95-3527	270
90-6290	286	91-5022	271	91-5450	290	95-358	238
90-6291	286	91-5024	271	91-5452	273	95-360	236
90-6292	286	91-5028	271	91-5452	290	95-361	236
90-6582	286	91-5032	272	91-5455	273	95-362	268
90-6590	286	91-5034	272	91-5455	281	95-364	239
90-6600	196	91-5036	272	91-5455	290	95-409	246
90-6602	196	91-5038	272	91-9015	271	95-421	246
90-6610	196	91-5040	272	92-1012	288	95-426	243
90-6611	287	91-5042	272	92-1112	288	95-431	243
90-6612	287	91-5044	272	92-1114	288	95-436	245
90-6820	196	91-5046	272	92-1415	288	95-442	245
90-7520	290	91-5047	272	92-2015	288	95-447	244
90-7670	281	91-5050	272	92-2160	289	95-448	244
90-7710	281	91-5060	271	92-2314	288	95-452	244
90-7895	282	91-5062	271	92-2812	289	95-456	251
90-7898	282	91-5064	271	92-2912	288	95-463	244
90-7977	282	91-5066	271	92-5012	289	95-466	251
90-7995	282	91-5068	271	92-5095	289	95-467	251
90-8010	196	91-5082	272	92-5295	289	95-470	248
90-8210	286	91-5084	272	92-5298	289	95-471	248
90-8334	284	91-5086	272	92-5540	287	95-477	248
90-8334	290	91-5088	272	95-103	235	95-481	248
90-8344	284	91-5092	272	95-104	235	95-483	248
90-8557	224	91-5120		95-105	242	95-485	248
90-8557	290	91-5122		95-107	235	95-492	248
90-8845	276	91-5130		95-109	235	95-494	248
90-8900	196	91-5132		95-222	240	95-500	247
90-8905	196	91-5140		95-226	240	95-501	247
90-9000	274	91-5142		95-231	240	95-504	247
90-9002	274	91-5162		95-241	240	95-512	247
90-9004	274	91-5200	273	95-2505	235	95-513	247
90-9005	274	91-5200	278	95-2517	233	95-514	247
90-9006	274	91-5202	273	95-254	241	95-515	247
90-9015	274	91-5202	278	95-265	230	95-516	247
90-9016	274	91-5234	273	95-272	230	95-517	247
90-9018	274	91-5234	281	95-275	230	95-518	247
90-9020	274	91-5235	273	95-281	230	95-521	247
90-9030	275	91-5235	281	95-284	230	95-525	247
90-9032	275	91-5241	273	95-285	252	95-571	254
90-9034	275	91-5241	284	95-289	252	95-577	254
90-9035	275	91-5245	273	95-292	231	95-586	254
90-9038	275	91-5245	284	95-295	231	95-592	256
90-9040	275	91-5268	250	95-299	231	95-606	255
90-9042	275	91-5270	250	95-303	268	95-611	255
90-9044	275	91-5278	273	95-308	232	95-629	253



NUMERICAL INDEX

95-635	253	96-1087	70	96-1145	117	96-1225	213
95-705	257	96-1088	70	96-1146	143	96-1226	213
95-710	257	96-1089	72	96-1146	293	96-1227	213
95-727	257	96-1091	72	96-1147	117	96-1228	213
95-731	257	96-1092	143	96-1148	143	96-1229	213
95-736	257	96-1093	72	96-1148	293	96-1230	80
95-753	258	96-1094	72	96-1149	115	96-1231	80
95-757	258	96-1096	72	96-1150	143	96-1232	80
95-762	258	96-1097	143	96-1150	293	96-1233	80
95-766	258	96-1098	143	96-1151	114	96-1234	82
95-771	259	96-1100	143	96-1152	143	96-1301	105
95-772	259	96-1100	293	96-1152	293	96-1302	105
95-775	260	96-1101	73	96-1153	114	96-1303	105
95-776	260	96-1103	73	96-1154	114	96-1306	105
95-777	262	96-1104	73	96-1156	78	96-1307	105
95-778	261	96-1105	143	96-1157	76	96-1309	105
95-781	262	96-1105	293	96-1158	76	96-1311	105
95-809	263	96-1106	73	96-1159	109	96-1313	105
95-810	266	96-1107	73	96-1160	143	96-1314	98
95-826	264	96-1108	72	96-1160	293	96-1317	98
95-832	267	96-1109	73	96-1161	119	96-1319	98
95-842	265	96-1110	143	96-1162	119	96-1322	107
95-847	265	96-1110	293	96-1163	119	96-1323	107
95-853	265	96-1111	68	96-1164	119	96-1324	107
95-869	265	96-1112	68	96-1165	114	96-1327	107
95-934	249	96-1113	68	96-1166	115	96-1329	107
95-938	249	96-1115	143	96-1167	115	96-1330	107
95-952	250	96-1115	293	96-1168	115	96-1331	107
96-0160	143	96-1117	97	96-1169	115	96-1333	107
96-0192	143	96-1118	78	96-1170	115	96-1335	107
96-0670	211	96-1119	81	96-1171	115	96-1337	107
96-0857	291	96-1120	143	96-1172	115	96-1338	107
96-0867	291	96-1120	293	96-1173	115	96-1339	107
96-0877	291	96-1121	124	96-1175	119	96-1340	104
96-0910	293	96-1122	124	96-1176	112	96-1341	104
96-1002	142	96-1123	124	96-1177	112	96-1342	104
96-1007	142	96-1124	124	96-1178	112	96-1343	104
96-1012	142	96-1125	143	96-1179	112	96-1344	104
96-1017	142	96-1125	293	96-1180	112	96-1345	104
96-1022	142	96-1126	124	96-1181	114	96-1346	104
96-1024NS	87	96-1127	124	96-1182	114	96-1347	104
96-1036	142	96-1130	143	96-1186	115	96-1348	104
96-1047	74	96-1130	293	96-1189	115	96-1349	104
96-1052	74	96-1131	72	96-1190	140	96-1350	104
96-1053	74	96-1132	72	96-1192	140	96-1351	104
96-1054	74	96-1133	72	96-1194	140	96-1352	114
96-1057	74	96-1134	72	96-1196	140	96-1353	105
96-1059	74	96-1135	72	96-1198	140	96-1354	105
96-1061	74	96-1136	112	96-1199	140	96-1355	105
96-1062	74	96-1137	112	96-1200	195	96-1356	105
96-1068	74	96-1138	112	96-1210	195	96-1357	105
96-1069	74	96-1139	112	96-1212	83	96-1358	105
96-1072	74	96-1140	143	96-1213	83	96-1359	105
96-1073	74	96-1140	293	96-1214	83	96-1360	109
96-1081	68	96-1141	117	96-1220	213	96-1361	109
96-1082	68	96-1142	143	96-1221	213	96-1362	109
96-1083	68	96-1142	293	96-1222	213	96-1363	109
96-1084	68	96-1143	117	96-1223	213	96-1364	99
96-1086	70	96-1144	293	96-1224	213	96-1365	99



NUMERICAL INDEX

96-1366	99	96-1797	110	96-2531	232	96-2684	252
96-1367	110	96-1845	163	96-2532	254	96-2685	252
96-1368	110	96-1846	163	96-2533	254	96-2689	252
96-1369	101	96-1847	163	96-2536	243	96-2701	160
96-1370	101	96-1848	163	96-2537	243	96-2701	242
96-1371	106	96-1849	163	96-2538	243	96-2702	242
96-1372	106	96-1850	163	96-2539	243	96-2703	242
96-1373	106	96-1851	163	96-2540	236	96-2704	242
96-1374	122	96-1852	163	96-2541	236	96-2705	250
96-1374	113	96-1853	163	96-2542	236	96-2706	250
96-1380	106	96-1860	163	96-2543	236	96-2707	247
96-1382	106	96-1862	163	96-2544	248	96-2708	247
96-1400	162	96-1864	163	96-2546	248	96-2902	131
96-1402	162	96-1868	163	96-2547	248	96-2902	212
96-1404	162	96-1870	163	96-2550	244	96-2903	212
96-1406	162	96-1872	163	96-2551	244	96-2905	211
96-1408	162	96-1874	163	96-2552	244	96-2906	211
96-1410	162	96-1876	163	96-2553	244	96-2907	210
96-1412	162	96-1878	163	96-2554	246	96-2908	210
96-1414	162	96-1900	163	96-2555	246	96-2909	210
96-1416	162	96-1901	163	96-2556	246	96-2910	210
96-1500	162	96-1905	163	96-2557	246	96-2914	210
96-1502	162	96-1906	163	96-2558	261	96-2915	210
96-1504	162	96-1916	182	96-2559	261	96-2916	211
96-1506	162	96-1940	123	96-2560	245	96-2917	211
96-1508	162	96-1942	123	96-2561	245	96-2918	211
96-1510	162	96-1944	123	96-2562	245	96-2919	211
96-1512	162	96-1946	123	96-2563	245	96-2930	210
96-1514	162	96-1949	123	96-2566	247	96-2931	210
96-1516	162	96-2402	241	96-2567	247	96-2950	210
96-1550	163	96-2404	241	96-2568	257	96-2951	210
96-1552	163	96-2406	256	96-2569	257	96-2956	130
96-1621	152	96-2408	256	96-2570	259	96-4100	134
96-1630	174	96-2410	262	96-2571	259	96-4100	291
96-1649	110	96-2412	262	96-2572	260	96-4105	153
96-1650	110	96-2454	248	96-2573	260	96-4120	293
96-1651	110	96-2502	240	96-2575	249	96-4140	188
96-1652	110	96-2503	240	96-2576	249	96-4143	293
96-1653	110	96-2504	235	96-2578	258	96-4150	193
96-1654	127	96-2506	235	96-2579	258	96-4150	292
96-1655	127	96-2507	235	96-2580	267	96-4155	292
96-1656	127	96-2510	238	96-2581	267	96-4160	291
96-1657	127	96-2511	238	96-2582	264	96-4162	291
96-1662	122	96-2512	238	96-2583	264	96-4164	291
96-1667	125	96-2513	238	96-2584	266	96-4166	291
96-1668	125	96-2516	233	96-2585	266	96-4171	141
96-1669	103	96-2518	239	96-2586	263	96-4172	141
96-1670	103	96-2519	239	96-2587	263	96-4174	141
96-1671	126	96-2520	230	96-2594	265	96-4175	141
96-1672	126	96-2521	230	96-2595	265	96-4190	292
96-1673	126	96-2522	230	96-2602	291	96-4192	292
96-1674	126	96-2523	230	96-2604	291	96-4194	292
96-1679	173	96-2524	231	96-2606	291	96-4196	292
96-1680	110	96-2525	231	96-2630	255	96-5000	74
96-1792	110	96-2526	231	96-2632	255	96-5001	74
96-1793	110	96-2527	231	96-2634	255	96-5002	74
96-1794	110	96-2528	253	96-2636	255	96-5003	116
96-1795	110	96-2529	253	96-2680	234	96-5004	74
96-1796	110	96-2530	232	96-2682	234	96-5005	116



NUMERICAL INDEX

96-5006	116	96-5116	127	96-5267	98	96-5419	95
96-5007	74	96-5120	68	96-5268	98	96-5421	92
96-5008	74	96-5121	68	96-5269	102	96-5422	92
96-5009	74	96-5122	68	96-5280	98	96-5423	92
96-5010	74	96-5123	68	96-5281	98	96-5469	109
96-5011	116	96-5124	68	96-5282	98	96-5470	109
96-5012	74	96-5125	68	96-5283	98	96-5471	109
96-5013	74	96-5126	68	96-5284	98	96-5472	109
96-5014	74	96-5127	68	96-5285	98	96-5473	131
96-5015	74	96-5128	68	96-5286	98	96-5474	131
96-5016	74	96-5129	68	96-5287	98	96-5475	131
96-5017	74	96-5130	68	96-5288	98	96-5476	131
96-5018	74	96-5131	68	96-5289	98	96-5478	133
96-5019	74	96-5135	72	96-5290	98	96-5479	133
96-5020	74	96-5136	72	96-5324	133	96-5480	133
96-5021	74	96-5137	72	96-5325	133	96-5481	133
96-5022	74	96-5140	76	96-5329	116	96-5482	133
96-5023	74	96-5142	76	96-5330	116	96-5483	133
96-5024	74	96-5144	76	96-5331	116	96-5484	133
96-5025	74	96-5146	76	96-5332	116	96-5485	133
96-5050	73	96-5150	76	96-5333	116	96-5486	133
96-5051	73	96-5152	76	96-5334	116	96-5487	133
96-5052	73	96-5154	76	96-5335	116	96-5488	133
96-5053	73	96-5156	76	96-5336	116	96-5489	133
96-5054	73	96-5158	76	96-5337	116	96-5490	133
96-5055	73	96-5160	79	96-5338	116	96-5491	133
96-5056	73	96-5161	79	96-5339	116	96-5496	292
96-5057	73	96-5162	79	96-5340	116	96-5515	74
96-5058	73	96-5163	79	96-5341	116	96-5516	74
96-5065	69	96-5164	79	96-5342	116	96-5517	74
96-5066	69	96-5165	79	96-5343	116	96-5518	74
96-5067	69	96-5190	292	96-5344	116	96-5519	116
96-5068	69	96-5192	292	96-5345	116	96-5520	116
96-5069	69	96-5194	292	96-5380	151	96-5521	116
96-5070	69	96-5200	81	96-5381	151	96-5522	74
96-5071	69	96-5202	81	96-5382	151	96-5524	74
96-5072	69	96-5204	81	96-5383	151	96-5525	68
96-5073	69	96-5222	108	96-5384	151	96-5526	68
96-5079	70	96-5223	108	96-5385	151	96-5527	68
96-5080	70	96-5229	78	96-5390	213	96-5528	68
96-5081	70	96-5230	78	96-5391	213	96-5529	74
96-5082	70	96-5231	78	96-5392	213	96-5530	74
96-5083	70	96-5232	78	96-5393	213	96-5531	74
96-5084	70	96-5233	78	96-5394	213	96-5532	74
96-5085	70	96-5234	78	96-5395	213	96-5533	74
96-5086	70	96-5235	78	96-5396	213	96-5534	70
96-5087	70	96-5249	82	96-5397	213	96-5551	114
96-5088	70	96-5250	108	96-5398	213	96-5552	112
96-5089	70	96-5251	82	96-5399	213	96-5553	115
96-5090	70	96-5252	108	96-5404	92	96-5554	114
96-5091	70	96-5253	82	96-5405	92	96-5560	70
96-5092	70	96-5254	108	96-5406	92	96-5561	70
96-5093	70	96-5255	82	96-5409	89	96-5562	70
96-5094	70	96-5256	108	96-5410	89	96-5563	70
96-5095	70	96-5257	82	96-5413	89	96-5564	70
96-5096	70	96-5258	108	96-5414	89	96-5566	72
96-5110	127	96-5259	108	96-5415	95	96-5567	72
96-5111	127	96-5265	101	96-5417	95	96-5570	72
96-5115	127	96-5266	101	96-5418	95	96-5571	72



NUMERICAL INDEX

96-5574	72	96-5638	113	96-7154	171	96-8960	131
96-5575	72	96-5639	113	96-7174	173	96-8961	126
96-5578	69	96-5640	113	96-7175	174	96-8962	215
96-5579	74	96-5641	113	96-7177	174	96-8963	215
96-5580	74	96-5642	113	96-7178	174	96-8964	215
96-5581	74	96-5643	113	96-7187	129	96-8965	215
96-5582	74	96-5644	113	96-7268	172	96-8966	215
96-5583	74	96-5649	101	96-7451	173	96-8967	215
96-5584	74	96-5650	101	96-7459	172	96-8968	214
96-5585	74	96-5651	101	96-7460	129	96-8969	215
96-5586	74	96-5655	132	96-7543	173	96-8970	215
96-5587	74	96-5656	212	96-7548	122	96-8971	214
96-5588	74	96-5657	212	96-7617	129	96-8972	214
96-5589	74	96-5658	212	96-7624	128	96-8973	214
96-5590	74	96-5659	212	96-7626	128	96-8974	214
96-5591	74	96-5660	212	96-7635	125	96-8975	214
96-5592	74	96-5661	212	96-7646	171	96-8988	131
96-5593	74	96-5666	89	96-7668	128	96-8989	130
96-5594	74	96-5667	89	96-7725	132	96-8990	130
96-5595	74	96-5672	91	96-7755	91	96-8991	128
96-5596	116	96-5673	91	96-7766	127	96-9256	130
96-5597	116	96-5674	91	96-7778	91	96-9257	130
96-5599	116	96-5675	91	96-7887	132	96-9321	130
96-5600	74	96-5676	91	96-7905	135	96-S1000	90
96-5601	74	96-5679	76	96-7906		96-S1000NS	90
96-5603	74	96-5680	76	96-7907		96-S1003	121
96-5604	74	96-5681	76	96-7907	135	96-S1003NS	121
96-5605	83	96-5682	76	96-8105	125	96-S1010	90
96-5606	83	96-5683	81	96-8497	125	96-S1010NS	90
96-5607	83	96-5686	95	96-8923	111	96-S1012	70
96-5608	83	96-5687	103	96-8924	111	96-S1012	86
96-5609	83	96-5688	97	96-8925	111	96-S1012NS	70
96-5610	102	96-5689	97	96-8926	111	96-S1012NS	86
96-5611	102	96-5690	78	96-8927	125	96-S1014	88
96-5612	102	96-5691	102	96-8927	125	96-S1014NS	88
96-5613	102	96-5692	78	96-8928	125	96-S1015	88
96-5614	102	96-5693	82	96-8928	125	96-S1015NS	88
96-5615	102	96-5699	103	96-8929	154	96-S1016	121
96-5616	102	96-5700	103	96-8930	154	96-S1016NS	121
96-5617	102	96-5701	103	96-8931	69	96-S1017	88
96-5618	102	96-5702	103	96-8932	69	96-S1017NS	88
96-5619	102	96-5703	103	96-8933	109	96-S1018	120
96-5620	141	96-5704	103	96-8934	109	96-S1018NS	120
96-5621	141	96-5705	102	96-8935	126	96-S1019	88
96-5622	141	96-5906	126	96-8936	111	96-S1019NS	88
96-5623	141	96-5908	126	96-8937	111	96-S1020	84
96-5624	141	96-7003	127	96-8938	122	96-S1020NS	84
96-5625	141	96-7005	127	96-8939	122	96-S1021	87
96-5627	122	96-7007	127	96-8940	122	96-S1021NS	87
96-5628	99	96-7020	173	96-8941	122	96-S1022	86
96-5629	99	96-7024	174	96-8942	122	96-S1022NS	86
96-5630	99	96-7025	174	96-8945	108	96-S1024	87
96-5631	100	96-7027	171	96-8946	188	96-S1030	84
96-5632	100	96-7028	173	96-8949	132	96-S1030NS	84
96-5633	100	96-7033	174	96-8951	171	96-S1035	87
96-5634	100	96-7040	129	96-8952	171	96-S1035NS	87
96-5635	100	96-7051	111	96-8953	171	96-S1060	86
96-5636	100	96-7071	91	96-8955	171	96-S1060NS	86
96-5637	113	96-7117	129	96-8956	171	96-S1061	86



NUMERICAL INDEX

96-S1061NS.....	86	97-471	248	98-1026	218
96-S1064	84	97-473	248	98-1028	219
96-S1064NS.....	84	97-477	248	98-103	235
96-S1067	120	97-481	248	98-1030	220
96-S1067NS.....	120	97-483	248	98-1032	223
96-S1071	94	97-485	248	98-1034	223
96-S1071NS.....	94	97-492	248	98-1036	223
96-S1072	94	97-494	248	98-1038	224
96-S1072NS.....	94	97-577	254	98-104	235
96-S1089	93	97-586	254	98-1040	224
96-S1089NS.....	93	97-592	256	98-1058	226
96-S1092	93	97-606	255	98-1064	226
96-S1092NS.....	93	97-611	255	98-107	235
96-S1164	84	97-629	253	98-109	235
96-S1164NS.....	84	97-635	253	98-1091	227
97-105	242	97-705	257	98-1092	227
97-1555	249	97-710	257	98-1093	228
97-1560	249	97-727	257	98-1094	228
97-1565	250	97-731	257	98-1095	229
97-1570	250	97-736	257	98-1096	229
97-222	240	97-753	258	98-1097	229
97-226	240	97-757	258	98-285	252
97-231	240	97-762	258	98-289	252
97-237	240	97-766	258	99-0857	194
97-241	240	97-771	259	99-0867	194
97-254	241	97-772	259	99-0877	194
97-263	230	97-775	260	99-1857	194
97-266	230	97-776	260	99-1877	194
97-275	230	97-777	262		
97-281	230	97-778	261		
97-284	230	97-781	262		
97-292	231	97-809	263		
97-295	231	97-810	266		
97-299	231	97-826	264		
97-308	232	97-832	267		
97-312	232	97-842	265		
97-321	232	97-847	265		
97-325	232	97-853	265		
97-335	233	97-869	265		
97-336	233	97-930	249		
97-339	234	97-934	249		
97-340	234	97-938	249		
97-346	237	97-952	250		
97-352	237	98-1000	216		
97-358	238	98-1002	216		
97-360	236	98-1004	220		
97-361	236	98-1006	222		
97-364	239	98-1008	221		
97-409	246	98-1009	224		
97-423	246	98-1010	221		
97-426	243	98-1011	225		
97-431	243	98-1012	219		
97-436	245	98-1013	225		
97-442	245	98-1014	218		
97-447	244	98-1016	217		
97-452	244	98-1018	218		
97-458	244	98-1020	219		
97-463	244	98-1022	217		
97-470	248	98-1024	218		





DISCLAIMERS:

All information concerning product content and composition; the function, care, maintenance, and intended use of products; and any warnings respecting the products in this catalog are derived exclusively from each product's manufacturer. As such, Sklar makes no representations or warranties - either express or implied - respecting the same. If additional information about any product is needed, please contact a Sklar sales representative, who will assist you in obtaining the information from the product's manufacturer.

The convenience kits (FDA recognized term) illustrated in this catalog are representative of Sklar's assembly capabilities. The final design and approval of the kit is the responsibility of the customer and will be managed in accordance with the Sklar Design and Development process.

COPYRIGHT © 2008
 SKLAR CORPORATION
 889 S. MATLACK STREET
 WEST CHESTER, PA 19382
 PHONE: 800.221.2166
 FAX: 610.696.9007
 E-MAIL: SURGI@SKLARCORP.COM

TERMS AND CONDITIONS

- PRICING IS F.O.B. WEST CHESTER, PA UNLESS OTHERWISE STATED AND MAY BE SUBJECT TO CHANGE.
- THERE IS A MINIMUM ORDER REQUIREMENT OF \$50 AT LIST PRICE. LIST PRICES ARE SUBJECT TO CHANGE.
- ALL SKLAR INSTRUMENTS ARE GUARANTEED TO BE FREE OF DEFECTS IN MATERIAL AND WORKMANSHIP. ANY INSTRUMENT WHICH PROVES DEFECTIVE IN WORKMANSHIP OR MATERIAL MAY BE REPAIRED OR REPLACED AT OUR DISCRETION WITHOUT CHARGE. THIS GUARANTEE IS VOID FOR INSTRUMENTS SERVICED BY ANY COMPANY OTHER THAN SKLAR INSTRUMENT REPAIR SERVICES.
- ALL SKLAR INSTRUMENTS ARE CAREFULLY INSPECTED BEFORE SHIPMENT. ANY CLAIMS MUST BE MADE WITHIN TEN (10) DAYS OF RECEIPT OF SHIPMENT.
- CUSTOMERS WITH ESTABLISHED ACCOUNTS THAT ARE IN GOOD STANDING WILL BE BILLED AT OUR STANDARD NET 30 DAY TERMS. CUSTOMERS MUST PROVIDE A PURCHASE ORDER NUMBER WHEN PLACING ORDERS.
- NEW ACCOUNTS MAY BE ESTABLISHED BY SUBMITTING CREDIT REFERENCES TO OUR CREDIT DEPARTMENT. WE REQUIRE ONE BANK REFERENCE AND THREE (3) TRADE REFERENCES INCLUDING CONTACTS, COMPLETE ADDRESSES AND TELEPHONE, FAX, AND E-MAIL INFORMATION. NEW DISTRIBUTORS ARE REQUIRED TO SUBMIT CREDIT REFERENCES ALONG WITH THEIR INITIAL STOCKING ORDER OF \$2,500 OR MORE.
- STANDARD STERILE KITS (THOSE IN OUR CATALOG) MAY BE RETURNED UP TO 30 DAYS PROVIDED THAT THE STERILITY OF THE INNER PACKS IS INTACT AND THE PRODUCT IS UNOPENED AND RESALEABLE.
- MOST CLEANING PRODUCTS ARE NOT RETURNABLE.
- CREDIT CARD OR PREPAYMENT IS REQUIRED FOR ALL CUSTOMERS WHO DO NOT HAVE A CURRENT ACCOUNT WITH SKLAR. WE ACCEPT VISA, MASTERCARD, AMERICAN EXPRESS AND DISCOVER.
- ESTABLISHED ACCOUNTS WITH SKLAR MUST BE PAID WITHIN TERMS. STATEMENTS ARE MAILED ON A MONTHLY BASIS. PAST DUE BALANCES WILL BE SUBJECT TO A FINANCE CHARGE. CREDITS MUST BE APPLIED AGAINST OPEN INVOICES ARE WILL NOT BE SUBJECT TO REFUND. UNUSED CREDITS MORE THAN SIX (6) MONTHS OLD WILL BE SUBJECT TO A 3% MONTHLY SERVICE CHARGE (MINIMUM \$1).





The Tradition Continues

NEW



DISINFECTANT™ Surface Wipes



Disinfectant™ Surface Wipes

BACTERICIDAL • VIRUCIDAL • FUNGICIDAL
3 Minute Kill Time!

- Ready to use pre-moistened towelettes, non-toxic formula
- Effective against C.diff, TB, HBV, HCV, Hydrophilic and Lipophilic viruses including HIV-1 (AIDS Virus), bacteria and fungi on surfaces
- Safe for all areas of the facility including the NICU, operating rooms, isolation rooms, patient care areas and laboratories
- Satisfies OSHA's Bloodborne Pathogen standards
- Non-irritating formula
- EPA registered

Item# 10-1616:

100 Towelettes per container, Case of 6

Item# 10-1617:

100 Towelettes per container, Case of 12

For price quotes, contact your Sklar Account Manager
or your Distributor Sales Representative

p 610.430.3200

f 610.696.9007

www.sklarcorp.com

surgi@sklarcorp.com

SklarSafe™ Disposable Safety Scalpels



Featuring the unique
"CLICK AND LOCK"
Safety Shield

06-3094 #10 Sterile, pack of 10

06-3095 #11 Sterile, pack of 10

06-3096 #15 Sterile, pack of 10



SKLAR Corporation
889 South Matlack Street
West Chester, PA 19382
610.430.3200
800.221.2166
Fax: 610.696.9007
International Fax: 610.430.3941
Surgi@sklarcorp.com
International@sklarcorp.com
www.sklarcorp.com



©COPYRIGHT 2009, SKLAR INSTRUMENTS, WEST CHESTER, PA. ALL RIGHTS RESERVED.
NO PORTION OF THIS CATALOG MAY BE REPRODUCED WITHOUT THE WRITTEN PERMISSION OF SKLAR.